

# ***can-am***<sup>®</sup>

## **CAN-AM WINCH**

# USER'S GUIDE

Includes Safety, Use and Maintenance Information

## **▲ WARNING**

Read this User's Guide thoroughly. It contains important safety information.  
Keep this User's Guide in the vehicle at all times.

---

219002430

**Original Instructions**

**⚠ WARNING**

**Disregarding any of the safety precautions and instructions contained in the User's Guide and on product safety labels could cause injury including the possibility of death.**

TM® Trademarks of BRP or its affiliates.

This is a non-exhaustive list of trademarks that are the property of Bombardier Recreational Products Inc. or its affiliates:

Can-Am®

All rights reserved. No parts of this manual may be reproduced in any form without the prior written permission of Bombardier Recreational Products Inc.

©Bombardier Recreational Products Inc. (BRP) 2024

Deutsch	Dieses Handbuch ist möglicherweise in Ihrer Landessprache verfügbar. Bitte wenden Sie sich an Ihren Händler oder besuchen Sie: <a href="http://www.operatorsguides.brp.com">www.operatorsguides.brp.com</a>
English	This guide may be available in your language. Check with your dealer or go to: <a href="http://www.operatorsguides.brp.com">www.operatorsguides.brp.com</a>
Español	Es posible que este manual esté disponible en su idioma. Consulte a su distribuidor o visite: <a href="http://www.operatorsguides.brp.com">www.operatorsguides.brp.com</a>
Français	Ce guide peut être disponible dans votre langue. Vérifier avec votre concessionnaire ou aller à: <a href="http://www.operatorsguides.brp.com">www.operatorsguides.brp.com</a>
Italiano	Questa guida potrebbe essere disponibile nella propria lingua. Contattare il concessionario o consultare: <a href="http://www.operatorsguides.brp.com">www.operatorsguides.brp.com</a>
中文	本手册可能有您的语种的翻译版本。请向经销商询问，或者登录 <a href="http://www.operatorsguides.brp.com">www.operatorsguides.brp.com</a> 查询。
日本語	このガイドは、言語によって翻訳版が用意されています。ディーラーに問い合わせるか、次のアドレスでご確認ください： <a href="http://www.operatorsguides.brp.com">www.operatorsguides.brp.com</a>
Nederlands	Deze handleiding kan beschikbaar zijn in uw taal. Vraag het aan uw dealer of ga naar: <a href="http://www.operatorsguides.brp.com">www.operatorsguides.brp.com</a>
Norsk	Denne boken kan finnes tilgjengelig på ditt eget språk. Kontakt din forhandler eller gå til: <a href="http://www.operatorsguides.brp.com">www.operatorsguides.brp.com</a>
Português	Este manual pode estar disponível em seu idioma. Fale com sua concessionária ou visite o site: <a href="http://www.operatorsguides.brp.com">www.operatorsguides.brp.com</a>
Русский	Воспользуйтесь руководством на вашем языке. Узнайте о его наличии у дилера или на странице по адресу <a href="http://www.operatorsguides.brp.com">www.operatorsguides.brp.com</a>
Suomi	Käyttöohjekirja voi olla saatavissa omalla kielelläsi. Tarkista jälleenmyyjältä tai käy osoitteessa: <a href="http://www.operatorsguides.brp.com">www.operatorsguides.brp.com</a>
Svenska	Denna bok kan finnas tillgänglig på ditt språk. Kontakta din återförsäljare eller gå till: <a href="http://www.operatorsguides.brp.com">www.operatorsguides.brp.com</a>

Covered Winch Models
Can-Am HD 2500 Can-Am HD 3500 Can-Am HD 4500

In Canada, products are distributed and serviced by Bombardier Recreational Products Inc. (BRP).

In the USA, products are distributed and serviced by BRPUS Inc.

In the European Economic Area (which is comprised of the member states of the European Union plus the United Kingdom, Norway, Iceland and Liechtenstein), the Commonwealth of the Independent States (including Ukraine and Turkmenistan) and Turkey, products are distributed and serviced by BRP European Distribution S.A. and other affiliates or subsidiaries of BRP.

For all other countries, products are distributed and serviced by Bombardier Recreational Products Inc. (BRP) or its affiliates.

# TABLE OF CONTENTS

## GENERAL INFORMATION

<b>GENERAL INFORMATION</b> .....	<b>6</b>
Know Before you Go .....	6
Safety Messages .....	6
About this User's Guide .....	6

## SAFETY INFORMATION

<b>GENERAL PRECAUTIONS</b> .....	<b>10</b>
Avoid Injuries .....	10
Accessories and Modifications .....	10
<b>SAFE OPERATION - RESPONSIBILITIES</b> .....	<b>11</b>
Owner - Be Responsible .....	11
Operator - Be Qualified and Responsible .....	11
<b>INSPECTION BEFORE EACH USE</b> .....	<b>12</b>
Inspection Check List .....	12
<b>PREPARE TO USE YOUR WINCH</b> .....	<b>13</b>
Protective Gear .....	13
Rigging .....	13
<b>AVOID ACCIDENTS</b> .....	<b>14</b>
Avoid Injuries .....	14
Avoid Winch Damage .....	14
Avoid Breakout of the Rope or the Cable .....	15
Avoid the Release of the Rope or the Cable .....	15
Avoid Hook Damage .....	16
<b>MOVING LOADS AND DOING WORK</b> .....	<b>17</b>
Proper Rigging .....	17
Winching .....	17
<b>IMPORTANT ON-PRODUCT LABELS</b> .....	<b>20</b>
Safety Label .....	20

## WINCH INFORMATION

<b>COMPONENTS</b> .....	<b>26</b>
Switch .....	27
Synthetic Rope or Wire Cable .....	27
Rope or Cable Guide .....	27
Motor .....	27
Brake .....	27
Free-spool .....	28
Hook .....	28
Hand Strap .....	28
Hook Stopper .....	28
Winch Remote Control Switch (if equipped) .....	28
Winch Solenoid .....	28

**MAINTENANCE**

**WINCH CARE** ..... **30**  
     Post-Operation Care ..... 30  
**STORAGE** ..... **31**

**COMPLIANCE INFORMATION**

**EU - DECLARATION OF CONFORMITY** ..... **34**  
**UK - DECLARATION OF CONFORMITY** ..... **35**  
**DISPOSAL REQUIREMENTS UNDER WEEE REGULATIONS** ..... **36**  
     For private households: Information on Disposal for Users of WEEE ..... 36  
     For professional users in the European Union ..... 36  
     For disposal in countries outside of the European Union ..... 36

**TECHNICAL SPECIFICATIONS**

**SPECIFICATIONS** ..... **38**  
     Can-AM HD 2500 ..... 38  
     Can-AM HD 3500 ..... 38  
     Can-AM HD 4500 ..... 38

**TROUBLESHOOTING**

**TROUBLESHOOTING GUIDELINES** ..... **40**  
     Troubleshooting ..... 40

**WARRANTY**

**BRP LIMITED WARRANTY USA AND CANADA: CAN-AM WINCH** ..... **44**  
**BRP INTERNATIONAL LIMITED WARRANTY: CAN-AM WINCH** ..... **45**  
**BRP LIMITED WARRANTY FOR THE EUROPEAN ECONOMIC AREA, THE COMMONWEALTH OF THE INDEPENDENT STATES AND TURKEY: CAN-AM WINCH** ..... **46**

**CUSTOMER INFORMATION**

**DATA PRIVACY INFORMATION** ..... **48**  
**CONTACT US** ..... **50**  
     Asia Pacific ..... 50  
     Europe, Middle East and Africa ..... 50  
     Latin America ..... 51  
     North America ..... 51  
**CHANGE OF ADDRESS AND OWNERSHIP** ..... **52**

# GENERAL INFORMATION

---

## GENERAL INFORMATION

Congratulations on your purchase of a new Can-Am® winch. It's backed by the BRP limited warranty and a network of authorized Can-Am Off-road dealers ready to provide the parts, accessories or service you may require.

Your dealer is committed to your satisfaction. If you need more information, please ask your dealer.

### Know Before you Go

To learn how to reduce the risk of accident for you or bystanders, read this User's Guide before you operate the winch.

Also, read all safety labels on your vehicle, winch or accessories.

Failure to follow the warnings contained in this User's Guide can result in **SERIOUS INJURY** or **DEATH**.

#### **WARNING**

To avoid severe injury or death or important components damages.

- Never use the winch cable/rope to retain a vehicle during trailering.
- Never ride with the winch cable/rope attached to a load or another vehicle.
- Only use the winch to help a stuck vehicle (snow, mud, etc.).
- Always refer to the winch manufacturer's instruction before pulling loads.

### Safety Messages

The types of safety messages, what they look like and how they are used in this guide are explained as follows:

The safety alert symbol  indicates a potential injury hazard.

#### **WARNING**

Indicates a potential hazard which, if not avoided, could result in serious injury or death.

#### **CAUTION**

Indicates a hazardous situation which, if not avoided, could result in minor or moderate injury.

#### **NOTICE**

Indicates an instruction which, if not followed, could result in severely damaged vehicle components or other property.

### About this User's Guide

This User's Guide has been prepared to acquaint the owner/operator of a new winch with the various controls, maintenance and safe operating instructions. It is indispensable for the proper use of the product.



Keep this User's Guide in the vehicle as you can refer to it for things such as maintenance, troubleshooting and instructing others.

Note that this guide is available in several languages. In the event of any discrepancy, the English version shall prevail.

If you want to view and/or print an extra copy of your User's Guide, simply visit the following website

**[www.operatorsguides.brp.com](http://www.operatorsguides.brp.com)**.

The information contained in this document is correct at the time of publication.

BRP, however, maintains a policy of continuous improvement of its products without imposing upon itself any obligation to install them on products previously manufactured.

Due to late changes, some differences between the manufactured product and the descriptions and/or specifications in this guide may occur.

BRP reserves the right at any time to discontinue or change specifications, designs, features, models or equipment without incurring any obligation upon itself.

This User's Guide should remain with the vehicle when it is sold.

This page is intentionally blank

# **SAFETY INFORMATION**

---

# GENERAL PRECAUTIONS

## Avoid Injuries

All moving components may create hazardous situations, which can be avoided when following proper usage of the winch.

Refer to all instructions in this guide to help you proceed in a safe manner, but always remain aware of dangers specific to your application.

Each situation has its own risks.

## Accessories and Modifications

Any modifications or addition of accessories may affect the proper operation of your winch.

Ask your authorized Can-Am Off-road dealer for suitable available accessories for your winch.

### **WARNING**

**Never attempt to modify the winch electrical system. Risk of fires, or risk of electrocution.**

---

# SAFE OPERATION - RESPONSIBILITIES

## **WARNING**

**Unsafe utilization of the winch without proper precautions may lead to an accident, serious injuries, such as amputations, cuts or burns.**

### **Owner - Be Responsible**

Read this User's Guide.

Always inspect and confirm the safe operating condition of your winch prior to winching.

Never allow anyone to operate the winch unless this person is responsible and has experience with winching. Consider supervising new operators.

Discuss the safety information with anyone who will be using the winch. Be sure that everyone understands the signs for proper winching.

### **Operator - Be Qualified and Responsible**

Read this User's Guide.

Become completely familiar with the operational controls.

Never use this winch with drugs or alcohol, or if tired or ill. These slow reaction time and impair judgment.

# INSPECTION BEFORE EACH USE

Always inspect and confirm the safe operating condition of your winch before usage.

## WARNING

Perform a thorough inspection before each use to detect any potential problem that could occur during operation. The inspection can help you monitor component wear and deterioration before they become a problem. Correct any problem that you discover to reduce the risk of an accident.

## Inspection Check List

### *What to Do Before Using the Winch*

ITEMS TO BE INSPECTED	INSPECTION TO PERFORM	✓
Cleanliness	Thoroughly clean all winch area, including pulling rope or cable out for cleaning. Avoid strong detergents.	
Synthetic rope	Verify if rope has any damage, replace if damaged.	
Wire cable	Look for kinks, tight loops, or broken wire strands	
Roller fairlead	Ensure area is clean, remove any obstructions, verify there is no damage or bends and that rollers run smoothly	
Hook	Verify hook is not crooked or damaged, and that hook latch closes properly	
Hand strap	Ensure hand strap is present. Always use hand strap to avoid injury.	
Switch condition	Ensure no cracks or exposed wires	
Motor operation	Ensure the motor works properly, also verify free spool works properly	
Battery condition	Ensure battery will have sufficient charge for operating the winch. When possible let engine idle while using the winch.	
	Ensure terminal screws are properly tightened.	
Solenoid condition	Ensure terminal nuts are properly tightened.	

---

# PREPARE TO USE YOUR WINCH

## Protective Gear

### *Eye Protection*

Use good quality safety goggles while operating the winch.

Do not use tinted glasses at night as they impair the ability to discern color.

### *Gloves*

Full-fingered leather work gloves protect hands from cuts and lacerations. Gloves that fit snugly will improve grip on the rope without binding to the rope while winching.

## Rigging

It is important to carry the appropriate rigging at all times on your vehicle.

### *Sling*

Use good quality sling rated for more than the maximum rating of the winch.

The sling eyelets must fit properly with the hook, with the hook latch closed.

### *Pulley Block*

Use good quality pulley block rated for more than the maximum rating of the winch.

Use pulley block to allow good angle of pull, or increase the pull capacity.

### *Tree Protection Strap*

Use good quality tree protection strap rated for more than the maximum rating of the winch.

### *Shackle*

Use good quality shackles rated for more than the maximum rating of the winch.

Ensure the shackles close and lock securely.

---

# AVOID ACCIDENTS

## Avoid Injuries

This winch can produce a considerable amount of pulling force.

Never use the winch in a condition that will result in dangerous situations

- Always inspect equipment before usage. Replace defective components.
- Always respect the maximum load capacity of the winch, including a safety factor.
- Always wear adequate protective gear.
- Never use the winch to lift objects or people.
- Always use the hand strap to manipulate the hook and rope/cable.
- Never put your hand on the rope/cable while winching.
- Ensure all components are in good working order.
- Never stay in the rope/cable trajectory area.
- Ensure good communication between workers and understand signs for winch operation.
- The operator must be able to see the entire work zone at all times.
- The rigging accessories are in good condition and appropriate for the work to be performed, including a safety factor.
- Always use rigging that is rated at least as much as the maximum load of the winch.
- The rigging must be properly done.
- No bystanders should be allowed in the work zone.

### **WARNING**

**Always stay clear of the rope or cable trajectory.  
A sweater or jacket suspended to the midpoint of the rope or cable will ensure the rope or cable will direct downwards in case of a rope breakout.**

### **WARNING**

**Never put fingers in the hook or hand between hook and roller fairlead. A convenient hand strap is installed onto the hook.**

### **WARNING**

**Never use the winch as a lifting device or a hoist.**

## Avoid Winch Damage

This winch can produce a considerable amount of pulling force.

Never use the winch in a condition that will result in winch damage.

- Always respect the maximum load capacity of the winch, including a safety factor
- Never install the winch on another location than the one described in the instruction sheet or as factory installed on your Can-Am vehicle.
- Never modify the original equipment
- Ensure all components are in good working order
- Do not use continuously as motor will overheat, or circuit breakers will trip.
- Listen and observe carefully when using winch, to prevent overloading the winch



- The operator must be able to see the entire work zone at all times
- The rigging must be properly done
- The use of a winch remote (if equipped) allows to stay out of the working zone and have a better view of the situation

## Avoid Breakout of the Rope or the Cable

This winch can produce a considerable amount of pulling force to the rope or cable.

Any rope or cable breakout may become hazardous to you or bystanders.

Never use the winch in a condition that will result in rope or cable breakout.

- Always inspect the rope or the cable for any damage. Replace if required.
- The rope or the cable must be strong enough for the work to be performed, including a safety factor.
- Never route the rope or the cable so it rubs against a surface.
- Never loop the rope or the cable and attach it to itself, always use a good condition sling suited for the load.
- The rope or the cable must be in good working condition.
- The use of a winch remote (if equipped) allows to stay out of the working zone and have a better view of the situation.
- The operator must be able to see the entire work zone at all times.
- The rigging accessories must be in good condition and appropriate for the work to be performed, including a safety factor.
- The rigging must be properly done.
- No bystanders should be allowed in the work zone.

### **WARNING**

**Always stay clear of the rope or cable trajectory.  
A sweater or jacket suspended to the midpoint of the rope or cable will ensure the rope or cable will direct downwards in case of a rope breakout.**

## Avoid the Release of the Rope or the Cable

When in tension, a release of the rope or the cable may become hazardous to you or bystanders.

Never use the winch in a condition that will result in rope or cable release.

- The clutch spool must be completely engaged to ensure the winch will not release when loaded.
- Always ensure there is still at least eight turns of rope or cable around the spool.
- The object to be winched must be safely immobilized once winching has been done.
- Never disengage the spool lock while the rope or cable is under tension.
- The tension in the rope or cable must be released once the winched object has been secured.
- The operator must be able to see the entire work zone at all times.

- No bystanders should be allowed in the work zone.

 **WARNING**

**Always stay clear of the rope or cable trajectory.  
A sweater or jacket suspended to the midpoint of the rope or cable will ensure the rope or cable will direct downwards in case of a rope breakout.**

## **Avoid Hook Damage**

Never use the winch in a condition that will result in hook damage.

- Always attach the sling to the hook so the load applied is in the center of the hook.
- The hook latch must be closed.
- The load must be applied correctly for the hook and the rope or the cable.
- The rigging accessories must be in good condition and appropriate for the work to be performed, including a safety factor.
- The rigging must be properly done.
- No bystanders should be allowed in the work zone.

# MOVING LOADS AND DOING WORK

## Proper Rigging

Your winch can help you perform a number of different tasks.

Rigging accessories are recommended to perform adequate and safe usage of your winch.

To prevent possible injury, follow the instructions and warnings from the rigging accessory manufacturer.

Always respect the load limits.

Always be aware that inappropriate rigging may result in serious injury or death.

Among all rigging equipment available, you should consider having at least the following equipment on your vehicle.

- Winch remote
- Sling
- Pulley block
- Tree protection strap
- Shackles

### **WARNING**

**Adequate rigging helps avoid rope breaking out or releasing from anchor point.**

## *Pulling Your Vehicle From a Fixed Point*

### **WARNING**

**The selection of an appropriate anchor point is critical to avoid an accident.**

## *Pulling an Object or Using Your Vehicle as a Recovery Vehicle*

### **WARNING**

**Safely securing your vehicle to avoid movement is critical to avoid an accident.**

## Winching

### **WARNING**

**Do not exceed the load limits of the winch.**

Load Limit of the Winch		
Can-Am HD 2500	1 134 kg (2,500 lb)	Always allow a safety factor
Can-Am HD 3500	1 587 kg (3,500 lb)	
Can-Am HD 4500	2 041kg (4,500 lb)	

The following signs are a general guideline for safely communicating with the person performing the winch controls. Most importantly avoid any confusion by reviewing the signs you will use with your teammate before usage.

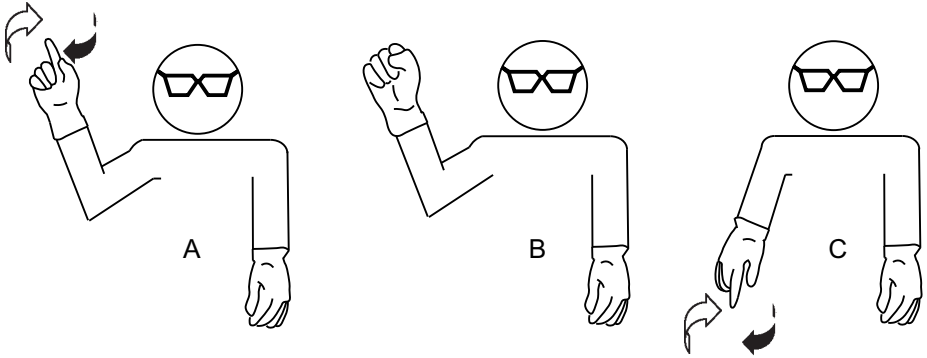

A. Winch-in. Index and arm up, making hand rotations

B. STOP. Arm up and closing fist

C. Winch-out. Index and arm down, making hand rotations

1. Observe the surrounding environment. Plan ahead for your safest strategy.
2. Ensure no bystanders are at risk.
3. Ensure good understanding of the plan and good communication between teammates for winching.
4. Become familiar and use standard signs for winching.
5. Take up any slack in the rope or cable and also the rigging before winching.
6. Once all slack is removed, verify your installation for safety, and suspend a sweater or a jacket in the middle of the rope or cable.
7. Proceed slowly and carefully.
8. Once winching is complete, secure the winched item, then remove the tension from the rope or cable and undo rigging.
9. After use, ensure to maintain a small tension on the rope or cable while winching in.
  - With the help of an assistant: have other person maintain a tension in the rope or cable while staying at least 1.84 m (6 ft) away from the vehicle.
  - Hold the rope or cable tight without letting it slide in your gloves
  - Proceed by alternating one arm after the other.
  - Once your rear hand gets close to the hook, have the operator stop, grab the hand strap and continue until rope or cable is safely stowed.
  - If proceeding alone, either pull a load to maintain tension in the rope or cable, or use the remote (if equipped) in one hand and the rope or cable in the other, while staying as far from the hawse or fairlead as possible.
  - Then activate-deactivate the winch one arm length at a time. Once you get close to the hook, stop the winch, grab the hand strap and continue until the rope is safely stowed.

10. When winching in, ensure the rope or cable loops are tight and sufficiently spread on the drum to avoid jams, rope or cable damage or sudden release of the rope or cable.

### ***Vehicle Settings When Winching***

It is recommended to maintain the pulling vehicle running at idle when winching to prevent battery drainage.

Pulling vehicle has to be properly blocked to avoid movement during winching.

If driver is operating winch from the vehicle (inside switch), ensure vehicle is stable, then apply brakes to secure the vehicle in place.

# IMPORTANT ON-PRODUCT LABELS

## Safety Label

Read and understand all the safety labels on your winch assembly.

These labels are affixed for the safety of the operator and bystanders.

The following labels should be considered permanent parts of the winch assembly. If missing or damaged, they can be replaced free of charge. See an authorized Can-Am Off-road dealer.

### NOTE:

In the event of any discrepancy between this guide and the winch assembly, the safety labels on the winch have precedence over the labels in this guide.

## Winch Label

HD 2500



OR



HD 3500

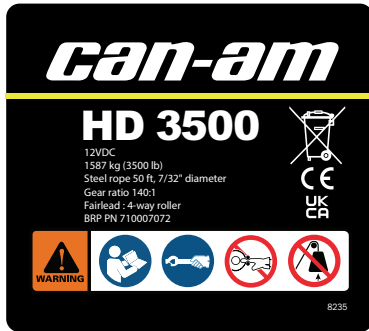

OR



HD 3500S

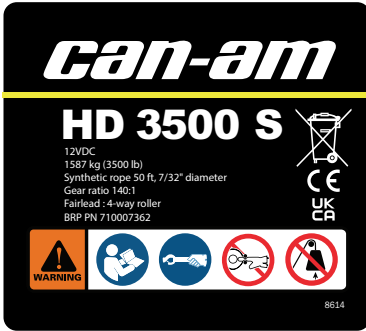

OR



HD 4500 - 4-way Roller Fairlead, Wire Cable

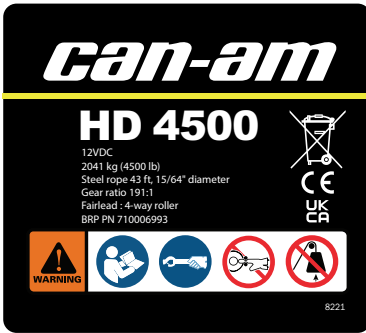

OR

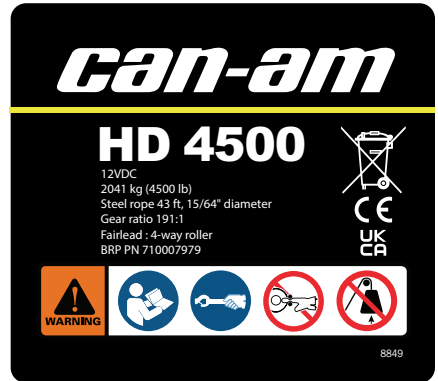

HD 4500 - 4-way Roller  
Fairlead, Synthetic Rope

**can-am**

**HD 4500**

12VDC  
2041 kg (4500 lb)  
Steel rope 43 ft, 15/64" diameter  
Gear ratio 191:1  
Fairlead :4-way roller  
BRP PN 710007030



8239

HD 4500S - Aluminum Hawse

**can-am**

**HD 4500 S**

12VDC  
2041 kg (4500 lb)  
Synthetic rope 50 ft, 1/4" diameter  
Gear ratio 191:1  
Fairlead : Aluminium hawse  
BRP PN 710006990



8222



## Hawse or Roller Fairlead Label

**⚠ WARNING**

Locate and read the User's guide. Improper use can result in **SEVERE INJURY** or **DEATH**. Follow all instructions and warnings.  
**Never** put your fingers into the hook.  
**Always** use the hand strap to manipulate the hook and rope.  
**Avoid** putting your hand between hook and hawse or roller fairlead. You can crush your fingers.  
**Never** use the winch to lift objects or people.

## Hand Strap Label

**⚠ WARNING**

**Do not** remove the hand strap from the hook.  
**Always** use the hand strap to manipulate the hook and rope.

This page is intentionally blank

# WINCH INFORMATION

# COMPONENTS

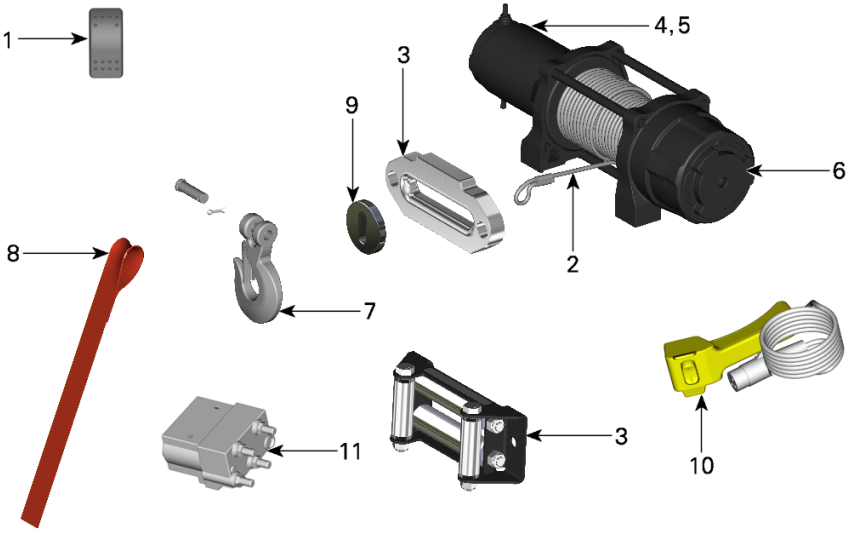

1. Switch
2. Synthetic rope or wire cable
3. Rope or Cable Guide
4. Motor
5. Brake
6. Free-spool
7. Hook
8. Hand Strap
9. Hook Stopper
10. Remote control switch
11. Winch Solenoid

## Switch

The winch can be activated by a winch control switch on your vehicle.

Depending the version of the kit, a remote control switch may be included with the winch accessory kit.

The remote control switch can also be purchased separately if needed.

## Synthetic Rope or Wire Cable

### ⚠ WARNING

**A damaged rope or cable may break suddenly and project objects at high speed or release the retaining force suddenly. Never use a damaged rope or a damaged cable.**

### Synthetic Rope

Synthetic rope can be used in wet or muddy applications.

If the rope has a large number of broken fibers, or shiny sections or compressed sections, replace it.

### NOTICE

**Never use a synthetic rope with a roller fairlead. It was designed to be used with hawse rope guide.**

### Wire Cable

A wire cable can be used as general purpose winching operations.

If the cable is kinked, has tight loops, or has broken wire strands, replace it.

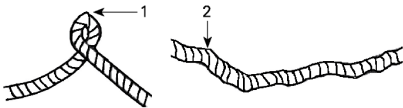

1. Tight loop
2. Kinks

### NOTICE

**Never use wire cable with hawse rope guide. It was designed to be used with roller fairlead.**

## Rope or Cable Guide

### Aluminum Hawse

A synthetic rope is matched with the aluminum hawse.

### Roller Fairlead

A wire cable is matched with the roller fairlead.

## Motor

### NOTICE

**Proper use and maintenance of the winch will be determinant in the life expectancy of your winch motor.**

### ⚠ CAUTION

**The gear ratio of the motor determines the number of motor revolutions for 1 spool revolution. Therefore the speed of the pull-in or pull-out will vary with how much rope is wound around the spool.**

## Brake

The winch motor is equipped with a brake to reduce the amount of pull-out when the winch switch is not activated anymore.

Depending on winch usage the brake will wear out until the winch is out of order.

Signs of brake fatigue is the decrease of brake pull-out capacity. This is a good indication of the end of life of the winch.

BRP does not supply these internal components. The winch assembly needs to be replaced.

## Free-spool

Your winch comes equipped with a free-spool mechanism.

Simply turn the free-spool knob located at the end of the winch clockwise to disengage the brake. This allows to pull the rope without using the winch motor.

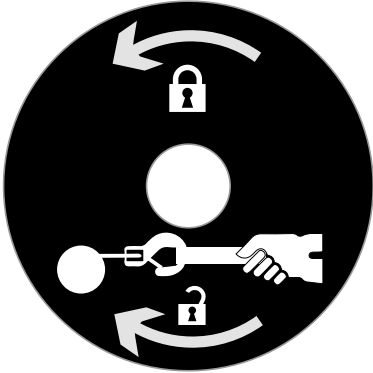

*FREE-SPOOL LABEL*

Always make sure to engage the brake before winching in.

## Hook

Your winch comes equipped with a hook.

### **⚠ WARNING**

**Never exceed hook capacity. Always ensure strap is properly attached to hook and hook latch is closed. Never remove hand strap from hook.**

## Hand Strap

Your winch comes equipped with a hand strap for safe operation.

Use the hand strap to avoid hand injuries.

### **⚠ WARNING**

**Always use the hand strap to pull the rope or the cable.**

## Hook Stopper

A hook stopper is installed to avoid damage to the winch, the hook, or the guide when pulling rope or cable in.

Avoid pulling the rope or the cable further than necessary.

The hook should just lean against the stopper.

## Winch Remote Control Switch (if equipped)

The use of a winch remote control helps staying out of the working zone and have a better view of the situation.

Depending the version of the kit, a remote control switch may be included with the winch accessory kit.

The remote control switch can also be purchased separately if needed.

## Winch Solenoid

The winch solenoid controls the current supplied from the battery to the winch motor.

# MAINTENANCE

---

# WINCH CARE

## Post-Operation Care

Thoroughly clean the winch and its components after each ride.

Pull-out the rope or the cable to clean and inspect for damage.

Pull-in the rope or the cable for storage.

Verify all other components for damage. Replace as required.



---

## **STORAGE**

If the vehicle is to be remain inactive for more than 21 days, disconnect the BLACK (-) cable of the battery.

Clean winch before storage.

Store in a dry and/or well ventilated environment to avoid corrosion.

This page is intentionally blank

# COMPLIANCE INFORMATION

# EU - DECLARATION OF CONFORMITY

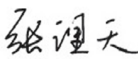
Manufacturer	Manufactured by: Zhejiang Nowvow Mechanical and Electrical Corp., Ltd NO.1689 Xianyuan Road, Jinhua, Zhejiang, China P.C: 321017
Product	Model: <u>Electric Planetary Winch</u>  Winch load :2500/3500/4500lbs  Serial No(s). 715006414,520002120, 710009072,710009939, 715007439,710007071, 710010022,710009410, 715006415,715007440, 710010021 710007072,710007362, 715006416,715006417, 715006441,715006442, 710006993,710006990, 710007030,710007979,
The person authorized to compile the technical file	BRP-Rotax GmbH Co. KG, Rotaxstrasse 1,Gunskirchen, A-4623, Austria +43 7246 6010
The object of the declaration described above is in conformity with the relevant Union harmonisation legislation	This declaration of conformity is issued under the sole responsibility of the manufacturer.  2006/42/EC 2014/30/EU 2011/65/EU 2012/19/EU EN ISO 12100:2010; EN 14492-1:2006+ A1:2009+ AC:2010 EN 55014-1:2017;EN 55014-2:2015
Signature & Title:   <b>Zhang Litian</b> <b><u>General Manager</u></b>	Date:  in Zhejiang  <b><u>07/03/2023</u></b>

# UK - DECLARATION OF CONFORMITY

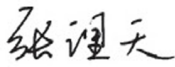
<p>Manufacturer</p>	<p>Manufactured by: Zhejiang Nowvow Mechanical and Electrical Corp., Ltd NO.1689 Xianyuan Road, Jinhua, Zhejiang, China P.C: 321017</p>
<p>Product</p>	<p>Model: <u>Electric Planetary Winch</u></p> <p>Winch load :<u>2500/3500/4500lbs</u></p> <p>Serial No(s). 715006414,520002120, 710009072,710009939, 715007439,710007071, 710010022,710009410, 715006415,715007440, 710010021 710007072,710007362, 715006416,715006417, 715006441,715006442, 710006993,710006990, 710007030,710007979,</p>
<p>The person authorized to compile the technical file</p>	<p>BRP UK Ltd., (BWM A accountants Limited) Suite 5.1, 12 Tithebarn Street, Liverpool, L2 2DT</p>
<p>The object of the declaration described above is in conformity with the relevant Union harmonisation legislation</p>	<p>This declaration of conformity is issued under the sole responsibility of the manufacturer.</p> <p>SI 2008/1597 SI 2016/1091 SI 2012/3032 SI 2013/3113 EN ISO 12100:2010;EN 14492-1:2006+A1:2009+AC:2010 EN 55014-1:2017;EN 55014-2:2015</p>
<p>Signature &amp; Title:</p> <p></p> <p>Zhang Litian <b><u>General Manager</u></b></p>	<p>Date:</p> <p>in Zhejiang</p> <p><u>07/03/2023</u></p>

---

# DISPOSAL REQUIREMENTS UNDER WEEE REGULATIONS

## For private households: Information on Disposal for Users of WEEE

This symbol on the product(s) and / or accompanying documents means that used electrical and electronic equipment (WEEE) should not be mixed with general household waste.

For proper treatment, recovery and recycling, please take this product(s) to designated collection points where it will be accepted free of charge.

Alternatively, in some countries, you may be able to return your products to your local retailer upon purchase of an equivalent new product.

Disposing of this product correctly will help save valuable resources and prevent any potential negative effects on human health and the environment, which could otherwise arise from inappropriate waste handling.

Please contact your local authority for further details of your nearest designated collection point. Penalties may be applicable for incorrect disposal of this waste, in accordance with your national legislation.

## For professional users in the European Union

If you wish to discard electrical and electronic equipment (EEE), please contact your dealer or supplier for further information.

## For disposal in countries outside of the European Union

This symbol is only valid in the European Union (EU). If you wish to discard this product please contact your local authorities or dealer and ask for the correct method of disposal.

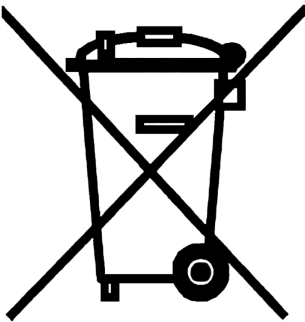

# **TECHNICAL SPECIFICATIONS**

---

# SPECIFICATIONS

## Can-AM HD 2500

Weight	8.5 kg (19 lb)
Power	0.8 kW (1.1 hp)
Motor drive ratio	140:1
Load capacity (pulling)	1134 kg (2,500 lb)

## Can-AM HD 3500

Weight	10 kg (22 lb)
Power	1.1 kW (1.5 hp)
Motor drive ratio	140:1
Load capacity (pulling)	1587 kg (3,500 lb)

## Can-AM HD 4500

Weight	Synthetic rope	8.5 kg (19 lb)
	Wire cable	10 kg (22 lb)
Power		1.2 kW (1.6 hp)
Motor drive ratio		191:1
Load capacity (pulling)		2041 kg (4,500 lb)



# TROUBLESHOOTING

---

# TROUBLESHOOTING GUIDELINES

## Troubleshooting

### 1. MOTOR DOES NOT TURN OR DOES NOT TURN BOTH WAYS

Poor connection

- *Verify if there are loose connections both at the solenoid location and at the winch itself.*
- *Check for broken wires.*
- *Check for corrosion.*

Defective winch remote button.

- *Contact an authorized Can-Am Off-road dealer to have switch replaced.*

Contact breakers have tripped

- *Allow several minutes to cool down before trying again.*

Freespool is engaged

- *Make sure to engage the brake so that the winch motor is coupled to the drum.*

### 2. MOTOR LACKS POWER

Weak battery

- *Check fault message in cluster.*
- *Check battery connections and terminals condition.*
- *Have the battery checked by an authorized Can-Am Off-road dealer.*

Motor is damaged

- *Have the winch replaced.*

### 3. MOTOR OVERHEATS

Winch was used for a long period.

- *Allow motor and circuit breakers to cool down.*

Motor is damaged

- *Have the winch replaced.*

### 4. WINCH WILL NOT RETAIN THE LOAD APPLIED

Load is above capacity

- *Reduce load as much as possible.*
- *Use a block to double the line with a pulley block.*

Internal brake damage

- *Have the winch replaced.*

This page is intentionally blank

# WARRANTY

---

# **BRP LIMITED WARRANTY USA AND CANADA: CAN-AM WINCH**

Bombardier Recreational Products Inc. ("BRP") warrants its Can-Am winch sold by authorized Can-Am Off-road dealers and/or distributors in the United States of America and in Canada from defects in material or workmanship for the period and under the conditions described below.

## **Factory Installed On Your New BRP Vehicle**

Normal vehicle warranty will apply to this accessory.

Please refer to your specific unit's BRP Operator's Guide for details.

Use other than which the product is designed for will void the product limited warranty.

## **Installed by Your Authorized Dealer / Distributor On Your New or Used BRP Vehicle**

For a period of **TWELVE (12) months** (unless otherwise stipulated or required by law) starting from the date of the retail sale, this limited warranty covers Parts, Accessories, and labour. BRP will repair or replace genuine BRP Parts and Accessories found defective in material and/or workmanship - further to normal use and service. Labour and collateral damages to the vehicle may be covered only if the failed part or accessory was installed by a BRP authorized Off-road dealer / distributor.

Use other than which the product is designed for will void the product limited warranty.

## **Not Installed By Your Authorized Dealer / Distributor**

For a period of **TWELVE (12) months** (unless otherwise stipulated or required by law) starting from the date of the retail sale, BRP will repair or replace BRP genuine Parts and Accessories if found defective in material and/or workmanship further to normal use and service. Labour and collateral damages to the vehicle are not covered if the failed part or accessory was not installed by a BRP authorized dealer / distributor.

Use other than which the product is designed for will void the product limited warranty.

---

# **BRP INTERNATIONAL LIMITED WARRANTY: CAN-AM WINCH**

Bombardier Recreational Products Inc. ("BRP") warrants its Can-Am winch sold by Can-Am Off-road dealers and/or distributors authorized to distribute Can-Am winch outside of the United States of America, Canada, member states of the European Economic Area (which is comprised of the states of the European Union plus the United Kingdom, Norway, Iceland and Liechtenstein), Turkey, member states of the Commonwealth of Independent States (including Ukraine and Turkmenistan) from defects in material or workmanship for the period and under the conditions described below.

## **Factory Installed On Your New BRP Vehicle**

Normal vehicle warranty will apply to this accessory.

Please refer to your specific unit's BRP Operator's Guide for details.

Use other than which the product is designed for will void the product limited warranty.

## **Installed by Your Authorized Dealer / Distributor On Your New or Used BRP Vehicle**

For a period of **TWELVE (12) months** (unless otherwise stipulated or required by law) starting from the date of the retail sale, this limited warranty covers Parts, Accessories, and labour. BRP will repair or replace genuine BRP Parts and Accessories found defective in material and/or workmanship - further to normal use and service. Labour and collateral damages to the vehicle may be covered only if the failed part or accessory was installed by a BRP authorized Off-road dealer / distributor.

Use other than which the product is designed for will void the product limited warranty.

## **Not Installed By Your Authorized Dealer / Distributor**

For a period of **TWELVE (12) months** (unless otherwise stipulated or required by law) starting from the date of the retail sale, BRP will repair or replace BRP genuine Parts and Accessories if found defective in material and/or workmanship further to normal use and service. Labour and collateral damages to the vehicle are not covered if the failed part or accessory was not installed by a BRP authorized dealer / distributor.

Use other than which the product is designed for will void the product limited warranty.

---

# **BRP LIMITED WARRANTY FOR THE EUROPEAN ECONOMIC AREA, THE COMMONWEALTH OF THE INDEPENDENT STATES AND TURKEY: CAN-AM WINCH**

Bombardier Recreational Products Inc. ("BRP") warrants its Can-Am winch sold by Can-Am Off-road dealers and/or distributors authorized to distribute Can-Am winch in member states of the European Economic Area (which is comprised of the states of the European Union plus the United Kingdom, Norway, Iceland and Liechtenstein), in member states of the Commonwealth of Independent States (including Ukraine and Turkmenistan) and Turkey from defects in material or workmanship for the period and under the conditions described below.

## **Factory Installed On Your New BRP Vehicle**

Normal vehicle warranty will apply to this accessory.

Please refer to your specific unit's BRP Operator's Guide for details.

Use other than which the product is designed for will void the product limited warranty.

## **Installed by Your Authorized Dealer / Distributor On Your New or Used BRP Vehicle**

For a period of **TWELVE (12) months** (unless otherwise stipulated or required by law) starting from the date of the retail sale, this limited warranty covers Parts, Accessories, and labour. BRP will repair or replace genuine BRP Parts and Accessories found defective in material and/or workmanship - further to normal use and service. Labour and collateral damages to the vehicle may be covered only if the failed part or accessory was installed by a BRP authorized Off-road dealer / distributor.

Use other than which the product is designed for will void the product limited warranty.

## **Not Installed By Your Authorized Dealer / Distributor**

For a period of **TWELVE (12) months** (unless otherwise stipulated or required by law) starting from the date of the retail sale, BRP will repair or replace BRP genuine Parts and Accessories if found defective in material and/or workmanship further to normal use and service. Labour and collateral damages to the vehicle are not covered if the failed part or accessory was not installed by a BRP authorized dealer / distributor.

Use other than which the product is designed for will void the product limited warranty.



# **CUSTOMER INFORMATION**

---

# DATA PRIVACY INFORMATION

Bombardier Recreational Products Inc., its affiliates and subsidiaries (“BRP”) is committed to protecting your privacy and support a general policy of openness about how we collect, use and disclose your personal information in the course of managing our relationship with you. **More details can be found by visiting BRP’s Privacy Policy at: <https://brp.com/en/privacy-policy.html> or by scanning the QR Code below.**

Please be assured that we have appropriate security measures in place to ensure that your personal information is protected against loss and unauthorized access.

Your personal information that may be collected by BRP, directly from you or from authorized dealers or authorized third parties, includes:

- **Contact, Demographic & Registration Information** (e.g., name, full address, phone number, email, gender, ownership history, language of communication)
- **Vehicle Information** (e.g., serial number, purchase and delivery date, unit usage, vehicle location and movements)
- **Third Party Information** (e.g., information received from BRP partners, joint marketing activities information, social media)
- **Technological Information** (e.g., IP address, type of device, operating system, browser type, webpages you view, cookies and similar technologies when you use BRP or dealers’ websites or mobile application)
- **Interaction with BRP Information** (e.g., information collected when you call BRP’s in-house sales representatives, buy items on a BRP website, sign up for BRP emails, participate in BRP-sponsored contests and sweepstakes or attend BRP-sponsored events)
- **Transactional Information** (e.g., information necessary to handle returns, payment information when you purchase our products or services through our websites or mobile applications and other issues related to your purchase of BRP products)

This information may be used and processed for the following purposes:

- Safety & Security
- Customer Support for Sales and After Sales (e.g., complete or follow up with you about your purchase or maintenance)
- Registration & Warranty
- Communication (e.g., sending you a BRP satisfaction survey)
- Online Behavioural Advertising, Profiling and Location-Based Services (e.g., offer customized experience)
- Compliance & Dispute Resolution
- Marketing & Advertising
- Assistance (e.g., help with any delivery issues, handle returns, and other issues related to your purchase of BRP products).

We also may use personal information to generate aggregated or statistical data that no longer identifies you personally.

**Your personal information may be disclosed to the following: BRP, BRP’s authorized dealerships, distributors, service providers, advertising and market research partners and other authorized third parties.**

We may receive information about you from diverse sources, including third parties, such as BRP’s authorized dealerships and partners, with whom we offer

services or engage in joint-marketing activities. We may also receive information about you from social media platforms when you interact with us on those platforms.

Depending on the circumstances, your personal information may be communicated outside the region where you reside. Your personal information is retained only for as long as necessary for the purpose for which we obtained it and according to our retention policies.

To exercise your data privacy rights (e.g. right of access, right of rectification), to withdraw your consent in order to be removed from the address list for marketing purposes or for the satisfaction survey or for general data privacy questions, please contact BRP's Data Protection Officer at or by mail at **privacyofficer@brp.com** or by mail at:

BRP Legal Service, 726 St-Joseph, Valcourt, Quebec, Canada, J0E 2L0.

**When BRP processes your personal information, they do so in compliance with its Privacy Policy available at: <https://www.brp.com/en/privacy-policy.html> or by using the following QR Code.**



---

# CONTACT US

*www.brp.com*

## **Asia Pacific**

### **BRP Asia**

107D and 107E, 17/F, Tower 1,  
Grand Century Place, Mongkok,  
Kowloon, Hong Kong

### **Australia**

Level 26  
477 Pitt Street  
Sydney, NSW 2020

### **China**

上海市徐汇区衡山路10号6号楼301  
Rm 301, Building 6,  
No.10 Heng Shan Rd,  
Shanghai, China

### **Japan**

21F Shinagawa East One Tower  
2-16-1 Konan, Minato-ku-ku,  
Tokyo 108-0075

### **New Zealand**

Suite 1.6, 2-8 Osborne Street,  
Newmarket, Auckland 2013

## **Europe, Middle East and Africa**

### **Belgium**

Oktrooi plein 1  
9000 Gent

### **Czech Republic**

Stefanikova 43a  
Prague 5  
150 00

### **Germany**

Alte Papierfabrik 16  
D-40699 Erkrath

### **Finland**

Isoaavantie 7  
PL 8040  
96101 Rovaniemi

### **France**

Arteparc Bâtiment B  
Route de la côte d'Azur,

13 590 Meyreuil

**Norway**

Ingvald Ystgaardsvei 15  
N-7484 Trondheim  
Salg, marketing, ettermarked

**Sweden**

Spinnvägen 15  
903 61 Umeå  
Sweden 90821

**Switzerland**

Avenue d'Ouchy 4-6  
1006 Lausanne

**Latin America**

**Brazil**

Rua Odila Maia Rocha Brito, 25  
Edifício Beaumont, andar 1 ao 5  
CEP 13092-110 Campinas -SP

**Mexico**

Av. Ferrocarril 202  
Parque Industrial Querétaro  
Santo Rosa Jauregui, Querétaro  
C.P. 76220

**North America**

**Canada**

3200A, rue King Ouest,  
Suite 300  
Sherbrooke (Québec) J1L 1C9

**United States of America**

10101 Science Drive  
Sturtevant, Wisconsin  
53177

---

## CHANGE OF ADDRESS AND OWNERSHIP

If your address has changed or if you are the new owner of the vehicle, be sure to notify BRP by either:

- Notifying an authorized Can-Am dealer.
- **North America Only:** calling at 1 888 272-9222.
- Mailing one of the change of address cards on the following pages at one of the BRP addresses indicated in the *Contact Us* section of this guide.

In case of change of ownership, please join a proof that the former owner agreed to the transfer.

Notifying BRP, even after the expiration of the limited warranty, is very important as it enables BRP to reach the vehicle owner if necessary, like when safety recalls are initiated. It is the owner's responsibility to notify BRP.

**STOLEN UNITS:** If your personal vehicle is stolen, you should notify BRP or an authorized Can-Am dealer. We will ask you to provide your name, address, phone number, the vehicle identification number and the date it was stolen.



This page is  
intentionally blank





This page is  
intentionally blank























Model No. \_\_\_\_\_

**VEHICLE**

IDENTIFICATION NUMBER (V.I.N.) \_\_\_\_\_

**ENGINE**

IDENTIFICATION NUMBER (E.I.N.) \_\_\_\_\_

**Owner:** \_\_\_\_\_

NAME

No.

STREET

APT

CITY

STATE/PROVINCE

ZIP/POSTAL CODE

**Purchase Date** \_\_\_\_\_

YEAR

MONTH

DAY

**Warranty Expiry Date** \_\_\_\_\_

YEAR

MONTH

DAY

To be completed by the dealer at the time of the sale.

DEALER IMPRINT AREA

This page is intentionally blank



## **⚠ WARNING**

**TO REDUCE THE RISK OF SERIOUS INJURY PR DEATH**, read this User's Guide and safety labels.

### **AVOID INJURIES**

- All moving components may create hazardous situations, which can be avoided when following proper usage of the winch. Refer to all instructions in this guide to help you proceed in a safe manner, but always remain of dangers specific to your application. Each situation has it own risks.

### **OPERATE RESPONSIBLY**

- Always inspect and confirm the safe operation condition of your which prior to winching.
- Never allow anyone to operate the winch unless this person is responsible and has experience with winching. Consider supervising new operators.
- Discuss the safety information with anyone who will be using the winch. Be sure that everyone understandings the signs for proper winching.

### **BE QUALIFIED AND RESPONSIBLE**

- Become completely familiar with the operational controls.
- Never use this winch with drugs or alcohol, or if tired or ill. These slow reaction time and impair judgment.

®TM and the BRP logo are trademarks of BOMBARDIER RECREATIONAL PRODUCTS INC. or its affiliates.

©2024 BOMBARDIER RECREATIONAL PRODUCTS INC. ALL RIGHTS RESERVED.

[www.brp.com](http://www.brp.com)

**ALUMACRAFT®**

**CAN-AM®**

**LYNX®**

**MANITOU®**

**QUINTREX®**

**ROTAX®**

**SEA-DOO®**

**SKI-DOO®**