

SEA·DOO®

FISH PRO SCOUT

OPERATOR'S GUIDE

Operator's Guide

NO NO NO NO

⚠ WARNING

Read this Operator's Guide thoroughly. It contains important safety information. Minimum recommended operators age: 16 years old. Keep this Operator's Guide in the watercraft.

219002225

Original Instructions

⚠ WARNING

Disregarding any of the safety precautions and instructions contained in the Operators's Guide, SAFETY VIDEO and on-product safety labels could cause injury including the possibility of death.

CALIFORNIA PROPOSITION 65 WARNING

⚠ WARNING

Operating, servicing and maintaining a recreational marine vessel can expose you to chemicals including engine exhaust, carbon monoxide, phthalates, and lead, which are known to the State of California to cause cancer and birth defects or other reproductive harm. To minimize exposure, avoid breathing exhaust, do not idle the engine except as necessary, service your vehicle in a well-ventilated area and wear gloves or wash your hands frequently when servicing your vehicle. For more information go to www.p65warnings.ca.gov/products/passenger-vehicle.

In Canada, products are distributed and serviced by Bombardier Recreational Products Inc. (BRP).

In the USA, products are distributed and serviced by BRPUS Inc.

In the European Economic Area (which is comprised of the member states of the European Union plus the United Kingdom, Norway, Iceland and Liechtenstein), the Commonwealth of the Independent States (including Ukraine and Turkmenistan) and Turkey, products are distributed and serviced by BRP European Distribution S.A. and other affiliates or subsidiaries of BRP.

For all other countries, products are distributed and serviced by Bombardier Recreational Products Inc. (BRP) or its affiliates.

TM® Trademarks of BRP or its affiliates.

This is a non-exhaustive list of trademarks that are the property of Bombardier Recreational Products Inc. or its affiliates:

4-TEC TM	iBR TM	ROTAX [®]	T.O.P.S. TM
D.E.S.S. TM	iControl TM	Fish PRO TM	VT TM
ECO TM	iTC TM	Sea-Doo [®]	XPST TM
ACE TM			

All rights reserved. No parts of this Manual may be reproduced in any form without the prior written permission of Bombardier Recreational Products Inc.

©Bombardier Recreational Products Inc. (BRP) 2021

BRP Inc.

KNOW BEFORE YOU GO

Basic Rules for Safe PWC Operation

Know Before You Go: Basic Rules For Safe PWC Operation

Improper operation can result in severe injury or death.

Operators Must Be Qualified

Make sure operator is 16 or older and has taken a boater course.
Your state (pr province) may have additional requirements.



Operators Must Avoid Collisions

- ☑ Scan constantly for people, objects and other watercraft.
- ☑ Stay far enough away from others so you can always safely coast to a stop.
- ☑ Do not release throttle when trying to steer away from objects-as with other powerboats, **you need throttle to steer.**



Protect All Riders

- ☑ Falls can result in severe injury or death.
- ☑ All riders must wear shorts with neoprene (wet suit material) to keep water from being forcefully injected into rectum or vagina during a fall backward. riders not wearing neoprene shorts have received severe rectal, vaginal, and internal injuries resulting in permanent damages.
- ☑ All riders must wear an approved PFD (Personal Flotation Device). Wear Neoprene.
- ☑ Be sure riders are properly seated and holding on. Riders can be thrown off PWC during unexpected acceleration or aggressive operation. Avoid aggressive operation, sharp turns, and unexpected acceleration.
- ☑ Do not apply throttle when anyone is boarding or at rear of PWC.
- ☑ Do not jump wakes or waves - jumping can cause injuries such as back or spinal injury (paralysis).

Do not ride if you are not dressed appropriately.

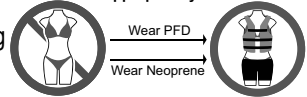

Do not permit reckless operation:

- ☑ Do not go near others to spray or splash them with water, go too close to other boats, or go too fast for traffic conditions.
- ☑ Never ride after consuming alcohol or drugs.

Available Languages

Deutsch	Dieses Handbuch ist möglicherweise in Ihrer Landessprache verfügbar. Bitte wenden Sie sich an Ihren Händler oder besuchen Sie: www.operatorsguides.brp.com
English	This guide may be available in your language. Check with your dealer or go to: www.operatorsguides.brp.com
Español	Es posible que este manual esté disponible en su idioma. Consulte a su distribuidor o visite: www.operatorsguides.brp.com
Français	Ce guide peut être disponible dans votre langue. Vérifier avec votre concessionnaire ou aller à: www.operatorsguides.brp.com
Italiano	Questa guida potrebbe essere disponibile nella propria lingua. Contattare il concessionario o consultare: www.operatorsguides.brp.com
中文	本手册可能有您的语种的翻译版本。请向经销商询问，或者登录 www.operatorsguides.brp.com 查询。
日本語	このガイドは、言語によって翻訳版が用意されています。ディーラーに問い合わせるか、次のアドレスでご確認ください： www.operatorsguides.brp.com
Nederlands	Deze handleiding kan beschikbaar zijn in uw taal. Vraag het aan uw dealer of ga naar: www.operatorsguides.brp.com
Norsk	Denne boken kan finnes tilgjengelig på ditt eget språk. Kontakt din forhandler eller gå til: www.operatorsguides.brp.com
Português	Este manual pode estar disponível em seu idioma. Fale com sua concessionária ou visite o site: www.operatorsguides.brp.com
Русский	Воспользуйтесь руководством на вашем языке. Узнайте о его наличии у дилера или на странице по адресу www.operatorsguides.brp.com
Suomi	Käyttöohjekirja voi olla saatavissa omalla kielelläsi. Tarkista jälleenmyyjältä tai käy osoitteessa: www.operatorsguides.brp.com
Svenska	Denna bok kan finnas tillgänglig på ditt språk. Kontakta din återförsäljare eller gå till: www.operatorsguides.brp.com

Covered Model

Fish Pro Scout 130

TABLE OF CONTENTS

GENERAL INFORMATION

FOREWORD	10
Know Before You Go	10
Safety Messages	10
About this Operator's Guide.....	10

SAFETY INFORMATION

BEFORE YOU GO	14
Operating Age and Ability	14
Drugs and Alcohol	14
Safe Boating Courses	14
Applicable Boating Laws	14
Protective Gear	14
Helmets: Weighing the Risks vs Benefits	15
Required Equipment	15
GET FAMILIAR WITH THE PWC	16
Jet Thrust.....	16
Steering	16
Tether Cord.....	16
Braking (if Equipped with iBR)	16
Learning Key (if Equipped)	17
Cargo and Storage	17
Accessories and Modifications.....	17
RIDE SAFELY	19
Riding with Passenger(s).....	19
Avoiding Collisions.....	19
Riding Behaviors	19
Speeding	20
Reboarding	20
Moving Parts	20
Know the Waters	21
Navigation Rules	21
Night-Time Operation.....	21
Carbon Monoxide Poisoning.....	21
Gasoline Fires and Other Hazards	22
Burns From Hot Parts	22
Watersports (Towing with the PWC).....	23
PRACTICES EXERCISES	26
Where to Practice Exercises.....	26
Practice Exercises	26
FUELING	27
Fueling Procedure	27
Fuel Requirements	27
Recommended Fuel	28
TRAILERING INFORMATION	29
IMPORTANT ON-PRODUCT LABELS	30
Watercraft Safety Labels	30
Molded Safety Pictogram	42
Hang Tag.....	43

Compliance Labels and Hang Tag	45
PRE-RIDE INSPECTION	50
What to Do Before Launching the Watercraft	50
What to Do After Launching the Watercraft	54
REGULAR MAINTENANCE	56

WATERCRAFT INFORMATION

CONTROLS	58
Handlebar	58
Throttle Lever	58
Right Controller	59
Engine Cut-Off Switch	59
Left Controller.....	60
Engine START/STOP Button.....	61
intelligent Brake and Reverse (iBR) Lever.....	62
INFO Button (If Equipped)	62
TRIP Button (If Equipped).....	62
EQUIPMENT	64
Glove Box	64
Front Storage Compartment	66
Fire Extinguisher Holder	66
Safety Kit Holder.....	67
Seat.....	67
Passenger Handholds.....	68
Boarding Ladder (If Equipped)	68
Boarding Platform.....	69
Front and Rear Eyelets	70
Mooring Cleats	70
Bilge Drain Plugs	71
Cooler.....	72
Fish Finder Sonar and Mount.....	75
Front Rod Holder for Trolling.....	76
Cup Holder.....	77
Storage Bin Tackle Box Storage	77
4.5" DIGITAL DISPLAY	78
Multifunction Gauge Description	78
Warning Lamps and Indicators	80
Settings	81
BREAK-IN PERIOD	83
Operation During Break-In Period	83
OPERATING INSTRUCTIONS	84
Boarding the Watercraft	84
How to Start the Engine.....	88
How to Stop the Engine.....	88
How to Steer the Watercraft.....	89
How to Engage Neutral	90
How to Engage Forward.....	90
How to Engage and Use Reverse	90
How to Engage and Use Braking.....	91
How to Use the Variable Trim System	93
General Operating Recommendations	96

OPERATING MODES	99
Default Riding Mode	99
Sport Mode	99
ECO Mode (Fuel Economy Mode).....	100
Speed Control Modes (If Equipped).....	100
Ski Mode (If Equipped).....	104
Learning Key Mode.....	104
SPECIAL PROCEDURES	105
Jet Pump Water Intake and Impeller Cleaning.....	105
Capsized Watercraft	107
Submerged Watercraft	108
Water-Flooded Engine	108
Towing the Watercraft in Water	108

MAINTENANCE

MAINTENANCE SCHEDULE	110
MAINTENANCE PROCEDURES	113
Engine Oil	113
Engine Coolant.....	116
Ignition Coils	117
Spark Plugs.....	117
Exhaust System	118
Ride Plate and Water Intake Grate	119
Sacrificial Anodes	119
Ski/Wakeboard Pylon (Wake)	120
Fuses	120
WATERCRAFT CARE	123
Post-Operation Care.....	123
Seat Cleaning.....	123
Body and Hull.....	123
STORAGE	125
Propulsion System.....	125
Fuel System.....	125
Engine and Exhaust.....	125
Electrical System	126
Engine Compartment.....	127
Body and Hull.....	127
PRESEASON PREPARATION	128

TECHNICAL INFORMATION

WATERCRAFT IDENTIFICATION	130
Hull Identification Number	130
Engine Identification Number.....	130
RF D.E.S.S. KEY	131
MULTIFUNCTION GAUGE REGULATORY INFORMATION	133
PREMIUM AUDIO SOUND SYSTEM	137
ENGINE EMISSIONS INFORMATION	138
Manufacturer's Responsibility	138
Dealer's Responsibility	138

Owner's Responsibility	138
EPA Emission Regulations	138
Evaporative Emission Control System	138
EAC DECLARATION OF CONFORMITY	139
EC-DECLARATION OF CONFORMITY	140

TECHNICAL SPECIFICATIONS

TECHNICAL SPECIFICATIONS	142
---------------------------------------	------------

TROUBLESHOOTING

TROUBLESHOOTING GUIDELINES	146
MONITORING SYSTEM	152
Fault Codes	152
Indicator Lights and Message Display Information	152
Beeper Code Information	155

WARRANTY

BRP LIMITED WARRANTY – USA AND CANADA: 2022 SEA-DOO PERSONAL WATERCRAFT	158
1. SCOPE	158
2. LIMITATIONS OF LIABILITY	158
3. EXCLUSIONS – ARE NOT WARRANTED	158
4. WARRANTY COVERAGE PERIOD	159
5. CONDITIONS REQUIRED FOR WARRANTY COVERAGE	159
6. WHAT TO DO TO OBTAIN WARRANTY COVERAGE	160
7. WHAT BRP WILL DO	160
8. TRANSFER	160
9. CONSUMER ASSISTANCE	161
US EPA EMISSION-RELATED WARRANTY	162
Emission-Related Warranty Period	162
Components Covered	162
Limited Applicability	163
CALIFORNIA EVAPORATIVE EMISSIONS CONTROL SYSTEM WARRANTY STATEMENT	165
Your Warranty Rights and Obligations	165
MANUFACTURER'S WARRANTY COVERAGE:	165
OWNER'S WARRANTY RESPONSIBILITIES:	165
CALIFORNIA AND NEW YORK EMISSION CONTROL WARRANTY STATEMENT FOR MODEL YEAR 2022 SEA-DOO PERSONAL WATERCRAFT	167
Your Warranty Rights and Obligations	167
Star Rating System	169
BRP INTERNATIONAL LIMITED WARRANTY: 2022 SEA-DOO PERSONAL WATERCRAFT	171
1. SCOPE OF THE LIMITED WARRANTY	171
2. LIMITATIONS OF LIABILITY	171
3. EXCLUSIONS – ARE NOT WARRANTED	172
4. WARRANTY COVERAGE PERIOD	172

5. CONDITIONS TO HAVE WARRANTY COVERAGE 173

6. WHAT TO DO TO OBTAIN WARRANTY COVERAGE 173

7. WHAT BRP WILL DO 174

8. TRANSFER 174

9. CONSUMER ASSISTANCE 174

**BRP LIMITED WARRANTY FOR THE EUROPEAN ECONOMIC AREA,
THE COMMONWEALTH OF THE INDEPENDENT STATES AND TURKEY:
2022 SEA-DOO PERSONAL WATERCRAFT 175**

1. SCOPE OF THE LIMITED WARRANTY 175

2. LIMITATIONS OF LIABILITY 175

3. EXCLUSIONS – ARE NOT WARRANTED 176

4. WARRANTY COVERAGE PERIOD 176

5. CONDITIONS TO HAVE WARRANTY COVERAGE 177

6. WHAT TO DO TO OBTAIN WARRANTY COVERAGE 177

7. WHAT BRP WILL DO 177

8. TRANSFER 178

9. CONSUMER ASSISTANCE 178

MAINTENANCE RECORDS 179

CUSTOMER INFORMATION

PRIVACY INFORMATION 184

CONTACT US 185

 Asia 185

 Europe 185

 North America 185

 Oceania 185

 South America 185

CHANGE OF ADDRESS/OWNERSHIP 186

This page is intentionally blank

GENERAL INFORMATION

FOREWORD

Congratulations on your purchase of a new Sea-Doo® personal watercraft (PWC). It is backed by the BRP warranty and a network of authorized Sea-Doo personal watercraft dealers ready to provide the parts, service or accessories you may require.

Your dealer is committed to your satisfaction. He has taken training to perform the initial setup and inspection of your watercraft as well as completed the final adjustment before you took possession. If you need more complete servicing information, please ask your dealer.

At delivery, you were also informed of the warranty coverage and signed the *Pre-Delivery Check List* to ensure your new watercraft was prepared to your entire satisfaction.

Know Before You Go

To learn how to reduce the risk for you or other persons being injured or killed, read the following sections before you operate the watercraft:

- *Safety Information*
- *Watercraft Information.*

Read and understand all safety labels on your watercraft and watch attentively the *Safety Video* located at:

<https://www.sea-doo.com/safety>

Or, use the following QR code.



Safety Messages

This Operator's Guide utilizes the following symbols and words to emphasize particular information:

The safety alert symbol  indicates a potential injury hazard.

WARNING

Indicates a potential hazard which, if not avoided, could result in serious injury or death.

CAUTION

Indicates a potentially hazardous situation which, if not avoided, could result in minor or moderate injury.

NOTICE

Indicates an instruction which, if not followed, could severely damage watercraft components or other property.

About this Operator's Guide

This Operator's Guide has been prepared to acquaint the owner/operator or passenger with this personal watercraft and its various controls, maintenance and safe riding instructions.

Keep this Operator's Guide in the watercraft as you can refer to it for the operation, instructing others, maintenance and troubleshooting. This Operator's Guide needs to remain with the watercraft when it's sold.

This guide is available in several languages. In the event of any discrepancy, the English version shall prevail.

If you want to view and/or print an extra copy of your Operator's Guide, simply visit the following website:

www.operatorsguides.brp.com

The informations contained in this document are correct at the time of publication. However, BRP maintains a policy of continuous improvement of its products without imposing upon itself an obligation to install them on

products previously manufactured. Due to late changes, some differences between the manufactured product and the descriptions and/or specifications in this guide may occur. BRP reserves the right at any time to discontinue or change specifications, designs, features, models or equipment without incurring any obligation upon itself.

This page is intentionally blank

SAFETY INFORMATION

BEFORE YOU GO

⚠ WARNING

Disregarding any of the safety precautions and instructions contained in this section could cause injury including the possibility of death.

Operating Age and Ability

Operators must be qualified. Make sure the operator is 16 or older and has taken a boater safety course. Your state (or province) may have additional requirements. Laws regarding the minimum age and licensing requirements vary from one jurisdiction to another. Be sure to contact the local boating authorities for information regarding the legal operation of a PWC in the intended jurisdiction of use.

Operation of this PWC with a disability that impairs vision, reaction time, judgment, or operation of the controls is not recommended.

Remember that sun, wind, fatigue or illness may impair your judgment and reaction time.

Each passenger must be able to simultaneously place both feet firmly flat against each footwell when properly seated.

Drugs and Alcohol

Never ride after consuming alcohol or drugs. Riding on a watercraft requires the operator and passenger(s) to be sober, attentive and alert. The use of drugs and alcohol, singly or in combination, decreases reaction time, impedes judgment, impairs vision, and inhibits your ability to safely ride on a watercraft.

Safe Boating Courses

Many countries recommend or require a boating safety course. Check with your local competent authorities.

Applicable Boating Laws

Check boating laws applicable to the waterways where you intend to use your watercraft. Learn the local navigation rules.

Protective Gear

All riders **MUST** wear:

1. An approved **Personal Flotation Device (PFD)** meeting your country regulations. The size of the PFD shall be appropriate for the wearer.
2. **Shorts with neoprene** (wetsuit material) to keep water from being forcefully injected into rectum or vagina during a fall backward. Riders not wearing neoprene shorts have received severe rectal, vaginal, and internal injuries resulting in permanent damage. Normal swimwear does not adequately protect against forceful entry of water into the lower male or female body opening(s).

Footwear, gloves, safety goggles or glasses can be worn. Wind, water spray, bugs and speed may cause a person's eyes to water and create blurred vision.

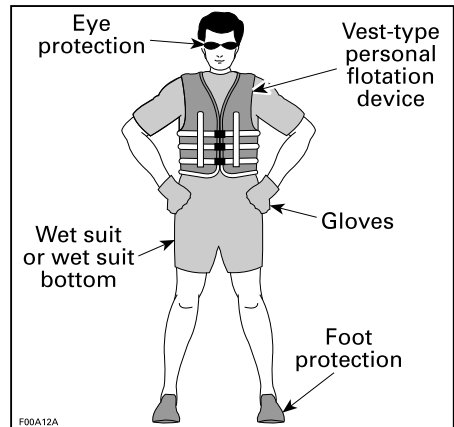

If you are planning a ride in cold weather or water, consider adding appropriate warm clothing such as a

complete wet suit or dry suit. Not only will it make your ride more comfortable, but it may delay or protect you from hypothermia if you fall into cold water. Be prepared for changing conditions.

Helmets: Weighing the Risks vs Benefits

Since each option minimizes some risks, but increases others, before each ride you must decide whether to wear or not wear a helmet based on your particular situation. If you decide to wear a helmet, look for helmets that meet DOT or Snell standards, and if possible, choose one designed for motorized watersports.

Helmets are designed to offer some degree of protection in case of impacts to the head. In most motorized sports, the benefits of wearing a helmet clearly outweigh the drawbacks. However, in the case of motorized watersports such as riding personal watercraft, this is not necessarily true as there are some particular risks associated with the water.

Benefits

A helmet helps to reduce the risk of injury in case of a head impact against a hard surface such as another craft in the case of a collision. Similarly, a helmet with a chin guard might help prevent injuries to the face, jaw or teeth.

Risks

On the other hand, in some situations when falling off the watercraft, helmets have a tendency to catch the water, like a "bucket", and put severe stresses on the neck or spine. This could result in choking, severe or permanent neck or spine injury or death. Helmets may also interfere with peripheral vision and hearing, or increase fatigue which could contribute to increase the risk of a collision.

Required Equipment

As the owner of the watercraft, you are responsible for ensuring that all required safety equipment is aboard. Check your local regulations about requirements.

This could include:

- Fire extinguisher. Maintenance, repair and refilling must be carried out in accordance with the manufacturer's instructions.
- A watertight flashlight or approved flares
- Sound-producing device (horn, whistle or bell etc.)
- Visual Distress Signal
- Phone in a watertight compartment designed for this application
- Current local map
- First aid kit
- Throw rope.

GET FAMILIAR WITH THE PWC

The performance of this watercraft may exceed the performance of other watercrafts you may have operated. Do not assume that all PWCs handle identically.

Make sure you read and understand the content of this Operator's Guide to become completely familiar with the controls and operation of the watercraft before embarking on your first trip, or taking on a passenger(s). If you have not had the opportunity to do so, practice driving solo in a suitable traffic-free area to become accustomed to the feel and response of each control. Be fully familiar with all controls before accelerating above idle speed.

Jet Thrust

Your PWC features a jet drive propulsion system. The water is drawn up from underneath the PWC from the intake grate and is accelerated by the venturi to produce thrust. This accelerated water is going out at the rear of the craft.

All riders must wear Shorts with neoprene (wetsuit material) to keep water from being forcefully injected into rectum or vagina during a fall backward. Riders not wearing neoprene shorts have received severe rectal, vaginal, and internal injuries resulting in permanent damage. Normal swimwear does not adequately protect against forceful entry of water into the lower male or female body opening(s).

The jet pump may pick up debris and throw it rearward causing a risk of injuring people, damaging the jet pump, or other property.

Do not start the engine or operate the watercraft if anyone is in the water nearby, or near the rear of the watercraft.

Steering

Your watercraft has a steerable nozzle at the rear of the boat controlled by the handlebars which direct the stream of water from left to right. To turn the watercraft, both steering and throttle are necessary.

Do not release throttle when trying to steer away from objects — as with other powerboats, you need throttle to steer.

If the engine is shut off, steering is lost.

Tether Cord

Keep the tether cord lip attached to the operator's PFD or wrist (wrist strap required) at all times and keep it free from snagging on the handlebars to help ensure the engine stops should the operator fall off.

If the operator falls off the watercraft and the tether cord is not attached as recommended, the watercraft engine will not stop and your PWC may continue to move forward. You may not be able to swim back to it.

After riding, always remove the tether cord from the engine cut-off switch to avoid unauthorized use by children or others and to prevent starting in a closed environment (e.g.: garage).

To prevent accidental starting, always detach the tether cord from the engine cut-off switch when swimmers are boarding, nearby, or during removal of any weeds or debris from the intake grate.

Braking (if Equipped with iBR)

Most watercrafts have no means of braking.

On some models, advancement in technologies now permits us to offer a braking system called the iBR (intelligent Brake and Reverse). Practice

braking maneuvers in a safe traffic-free area to become familiar with handling under braking and with stopping distances under various operating conditions.

Stopping distance will vary depending on initial speed, load, wind, number of riders and water conditions. The amount of braking power commanded by the operator using the iBR lever will also affect stopping distance.

When braking, riders must brace themselves against the deceleration force to prevent from moving forward on the watercraft and losing balance.

When operating an iBR equipped watercraft, be aware that other boats following or operating in close proximity may not be able to stop as quickly. When at speed and the brake is first applied, a plume of water will shoot up in the air behind the watercraft which may cause the operator of the following watercraft to momentarily lose sight of your PWC. Inform the operator of a watercraft who intends to follow you in a convoy formation of the braking capability of your PWC, the meaning of the plume of water and the need of keeping a greater distance between watercraft.

The brake feature of the iBR system cannot prevent your PWC from drifting due to current or wind. It has no braking effect on the rearward velocity. Also note that your engine must be running to be able to use the brake.

Learning Key (if Equipped)

The Sea-Doo LK™ learning key limits the speed of the watercraft. It could be an option for first time users and less experienced operators to learn how to operate the watercraft.

Please consult your BRP authorized Sea-Doo dealer to see if this accessory is available for your model.

Cargo and Storage

Do not store any objects in areas that are not designed specifically for storage.

Do not transport cargo on the rear platform unless it is properly secured with a BRP LinQ™ certified accessory. Compatible accessories which are not BRP certified may not be considered as fit for this purpose.

When carrying loads on the rear platform of the watercraft or onto cargo accessories, reduce your speed and adapt your driving behavior to reduce the risk of ejection from watercraft or contact with cargo possibly leading to injuries.

Do not exceed the payload or passenger capacities for your watercraft. Overloading can affect manoeuvrability, stability and performance. Also, heavy seas reduce capacity.

Never carry loads on the rear platform when practicing watersports. The cargo may interfere with the rope and unsecure it, becoming an obstacle to the person being towed.

Refer to *Technical Specifications* for the maximum loading capacity.

Accessories and Modifications

Any modifications or addition of accessories approved by BRP may affect the handling of your vehicle. It is important to take the time to get familiar with the vehicle once modifications are made to understand how to adapt your driving behavior accordingly.

Avoid installing equipment not specifically approved by BRP for the vehicle and avoid unauthorized modifications. These modifications and equipment have not been tested by BRP and may create hazards. For example, they could:

- Create a loss of control and increase risk of crash
- Cause overheating or short circuits increasing the risk of fire or burn injuries
- Affect the protection features provided by the vehicle.

Your vehicle may also become illegal to ride.

As an example, installing an additional GPS or cell phone support may prevent the driving capabilities of the vehicle and increase the risk of a loss of control.

Ask your authorized BRP dealer for suitable available accessories for your vehicle.

RIDE SAFELY

Riding with Passenger(s)

The operator is responsible to inform and protect the passenger(s) invited to ride.

Instruct all passenger(s) to use the handholds, seat strap, or to hold on to the waist of the person in front of them. Each passenger must be able to simultaneously place both feet firmly flat against each footwell when properly seated.

Be sure riders are properly seated and holding on. Riders can be thrown off PWC during unexpected acceleration or aggressive operation. Avoid aggressive operation, sharp turns, and unexpected acceleration.

Falls can result in severe injury or death.

All riders must wear shorts with neoprene (wet suit material) to keep water from being forcefully injected into rectum or vagina during a fall backward. Riders not wearing neoprene shorts have received severe rectal, vaginal, and internal injuries resulting in permanent damage.

When going over waves, riders(s) may raise their body slightly off the seat to absorb the shocks with their legs.

When braking or decelerating, riders must brace themselves against the deceleration force to prevent from moving forward on the watercraft and losing balance.

Riding with passenger(s) makes the PWC handle differently and requires greater skill.

Avoiding Collisions

Scan constantly for people, objects and other watercraft.

Stay far enough away from others so you can always safely coast to a stop. Do not release throttle when trying to steer away from objects – as with other powerboats, you need throttle to steer.

Be alert for conditions that may limit your visibility or block your vision of others.

Do not go near others to spray or splash them with water, go too close to other boats, or go too fast for traffic conditions. You may misjudge the ability of the watercraft or your own riding skills and strike a boat or person.

If your watercraft is equipped with a braking system, be aware that other boats following or operating in close proximity may not be able to stop as quickly.

Stopping distance will vary depending on initial speed, load, wind and water conditions. The amount of braking power commanded by the operator using the iBR lever will also affect stopping distance.

Although the preferable manoeuvre to avoid an obstacle is to steer away while applying throttle, the iBR can also be used by fully braking and turning in the direction to avoid the obstacle.

Riding Behaviors

Ride within your limits and level of riding ability.

Scan constantly for people, objects and other watercraft. Stay far enough away from others so you can always safely coast to a stop.

Avoid aggressive operation, sharp turns, and unexpected acceleration that can cause riders to be thrown off.

Avoid riding in very rough waters or practicing extreme manoeuvres like jumping wakes or waves - jumping can cause injuries such as back or spinal injuries (paralysis).

Speeding

Speeding While your watercraft has the capacity of operating at high speeds, it is strongly recommended that high-speed operation only be applied when ideal conditions exist and are permitted. Higher speed operation requires a higher degree of skill and increases the risk of severe injuries.

The forces generated on the body of riders while turning, negotiating waves or wakes, operating in choppy waters, or falling off the watercraft, especially at higher speeds, may cause injury including the possibility of broken bones or more serious bodily injuries.

Reboarding

Reboarding Operator and passenger(s) need to know how to swim and how to reboard the PWC from the water. Boarding in deep water can be strenuous.

Also, make sure you and all passengers know how to reboard when accessories are installed at the rear. Board the watercraft from the rear and carefully get around the accessories. If you have difficulties, you should know how to remove the accessories and move them towards the front to provide better access to the boarding platform.

If the accessories are too heavy, swim toward the side, use passenger handhold and/or seat strap to lift yourself aboard.

Ask inexperienced riders to practice how to board the watercraft close to shore (all methods explained here) before venturing into deep water, especially when cargo is installed aboard on the rear platform.

To prevent accidental starting, always detach the tether cord from the engine cut-off switch when passenger(s) swimmers are boarding.

Moving Parts

Never turn handlebar while someone is near the rear of watercraft. Keep away from steering moving parts (nozzle, iBR gate, linkages, etc.).

Keep away from the intake grate while the engine is running. Items such as long hair, loose clothing, or PFD straps can become entangled in moving parts.

Be aware of the iBR gate movement when starting the engine, shutting down the engine or using the iBR lever. Automatic movement of the gate may squeeze fingers or toes of people taking a hold on the back of your PWC.

Know the Waters

Know the waters in which the watercraft is to be operated.

Current, tides, rapids, hidden obstacles, wakes and waves, etc., can affect safe operation. It is not advisable to operate the watercraft in rough waters or inclement weather. Keep an eye on the weather. Check local weather broadcasts before departure. Be alert to changing conditions.

Keep accurate and up-to-date charts of the boating area on board. Before getting underway, check water conditions in the planned boating area.

Ensure there is enough fuel on board for the planned trip. Always verify fuel level before use and during the ride. Apply the principle of 1/3 of the fuel to reach your destination, 1/3 to return, and keep 1/3 in reserve. Allow for changes due to adverse weather or other delays.

In shallow water, proceed with caution and at very low speeds. Grounding or abrupt stops may result in injury and watercraft damage. Debris may also be picked up and thrown rearward by the jet pump onto people.

Navigation Rules

Always ride responsibly and safely. Use common sense and courtesy.

Operating a watercraft can be compared with driving on unmarked highways and roads. To prevent collisions or avoid other boaters, a system of operating rules must be followed. Generally keep to your right and safely avoid collisions by keeping a safe distance from other watercrafts, boats, people and objects.

Make sure you know and understand the navigation system applicable to the waterways where you intend to use the watercraft.

Navigational aids on shore or on waters, such as signs or buoys, can assist you in identifying safe waters. They can indicate:

- whether you should keep to the right (starboard) or to the left (port) of the buoy
- which channel you can continue
- whether you are entering a restricted or controlled area such as a no wake or low speed zone
- hazards
- speed limits, no power craft or boating, anchorage and other useful information.

Respect no wake zones, the environment, and the rights of other users of the waterways.

Night-Time Operation

PWCs are not designed for night-time operation.

Carbon Monoxide Poisoning

All engine exhaust contains carbon monoxide, a deadly gas. Breathing carbon monoxide can cause headaches, dizziness, drowsiness, nausea, confusion and eventually death.

Carbon monoxide is a colorless, odorless, tasteless gas that may be present even if you do not see or smell any engine exhaust. Deadly levels of carbon monoxide can collect rapidly, and you can quickly be overcome and unable to save yourself. Also, deadly levels of carbon monoxide can linger for hours or days in enclosed or poorly ventilated areas. If you experience any symptoms of carbon monoxide poisoning, leave the area immediately, get fresh air and seek medical treatment.

To prevent serious injury or death from carbon monoxide:

- Never run the watercraft in poorly ventilated or partially enclosed areas such as boat houses, garage, seawalls or other boats in close proximity. Even if you try to ventilate engine exhaust, carbon monoxide can rapidly reach dangerous levels.
- Never run the watercraft outdoors where engine exhaust can be drawn into a building through openings such as windows and doors.
- Never stand behind the watercraft while the engine is running. A person standing behind a running engine may inhale high concentrations of exhaust fumes.

After riding, always remove the tether cord from the engine cut-off switch to avoid unauthorized use by children or others and to prevent starting in a closed environment (ex: garage).

Gasoline Fires and Other Hazards

Gasoline is extremely flammable and highly explosive. Fuel vapors can spread and be ignited by a spark or flame many feet away from the engine. To reduce the risk of fire or explosion, follow these instructions:

- Use only an approved red gasoline container to store fuel.
- Strictly adhere to the instructions in *Fueling* section.
- Never start watercraft if gasoline or gasoline vapor odors is present in the engine compartment.
- Never start or operate the engine if the fuel cap is not properly secured.
- Do not carry gasoline containers in the front storage compartment.
- Use only a BRP approved LinQ fuel caddy, which shall be properly installed and secured.
- Never refill the fuel caddy on the PWC, refill on shore.
- On a 3-up vehicle, never tow a skier or a wakeboarder while having a fuel caddy installed.

Gasoline is poisonous and can cause injury or death.

- Never siphon gasoline with your mouth.
- If you swallow gasoline, get any in your eyes, or inhale gasoline vapors, see a doctor immediately.

If gasoline is spilled on you, wash thoroughly with soap and water and change your clothes.

Burns From Hot Parts

Certain components may become hot during operation. Avoid contact during and shortly after operation to avoid burns.

Watersports (Towing with the PWC)

3-UP Models Only

Attachment and Towing Devices

Certain PWC models come equipped with tow eyelets or a ski pylon.

Use ski pylon to attach a tow rope for a skier or wake boarder.

Use rear tow eyelet to attach a tow rope for a tube.

Do not use these attachment points or any other portion of the watercraft to tow a parasail, kites, gliders or any devices which can become airborne or for pulling any other craft. Personal injury or severe damage may occur.

Never carry loads on the rear platform when practicing watersports. The cargo may interfere with the rope and unsecure it, becoming an obstacle to the person being towed.

PWC Capacity When Towing

Always carry an observer to observe the person being towed and inform the operator about the participants' hand signals. The operator must focus his attention on operating the watercraft and the waters ahead.

You need to have seats for everyone: operator, observer, towed person. Therefore, if you are the only vessel, a 3-seater PWC is necessary and you can tow only one person.

Towing and Observing

If you have never towed someone behind your PWC before, it is a good idea to spend some hours as an observer, working with and learning from an experienced operator. It is also important to be aware of the skill and experience of the person being towed.

Pulling a tube, skier or wakeboarder makes the watercraft handle differently and requires greater skill.









Always respect the safety and comfort of the person being towed.

Proceed with only as much speed as required and follow the observers' instructions.

Do not make tight sharp turns or use the braking system unless absolutely necessary. Remember that although this PWC is manoeuvrable and has stopping capabilities, the person in tow may not be able to avoid an obstacle, or your PWC.

If you are the observer, make sure you and the person being towed know the hand signals.

Hand Signals

1. Speed up Thumbs up		5. Cut motor Slashing hand across throat	
2. Slow down Thumbs down		6. OK after all Hands clasped over the head	
3. Turn Circling motion above head followed by pointing in the direction of the turn		7. Stop Hand raised with fingers outstretched	
4. Back to shore Pat top of head		8. All OK An "O" made with the thumb and index finger	

Give immediate attention to a person who has fallen. He or she is vulnerable in the water alone and may not be seen by other boaters.

Participate in watersports only in safe areas. Stay away from other boats, channels, beaches, restricted areas, swimmers, and heavily travelled waterways and underwater obstructions.

Tow Rope

Never wrap the tow rope around your wrist, hand or any body part. The rope may suddenly lose its slack and cause you serious injuries such as amputation.

Both the operator and observer shall monitor the location of the tow rope when participating in watersports. A slack tow rope can become entangled with a person(s) or objects on the PWC or in the water, particularly when making a tight turn or circling, and cause serious personal injury.

Do not pull the tow rope in front of other boats and be careful not to run over the rope with the PWC because it could get trapped in the jet pump.

Do not tow a person in any watersport on a short tow rope such that the person inhales exhaust fumes in concentration. Inhalation of concentrated exhaust fumes, which contain carbon monoxide, can result in CO poisoning, personal injury and death.

Use a tow rope of sufficient length and size and make sure it is adequately secured to your watercraft.

Always store tow rope when not in use. While some watercrafts are equipped or can be fitted with a specially designed towing mechanism, avoid installing a tow pole on a PWC. It can become a hazard should someone fall on it.

PRACTICES EXERCISES

It is always a good idea to practice and get familiar with all controls, functions and handling characteristics of your watercraft before venturing on the water.

Where to Practice Exercises

Find a suitable area to practice the exercises. Ensure the area meet the following requirements:

- No traffic
- No obstacles
- No swimmers
- No current
- Ample space to maneuver
- Water depth is adequate.

Practice Exercises

Practice alone the following exercises.

Turning

Practice turning in circles in both directions at slow speed.

When comfortable with the exercise, increase difficulty by making some figure 8.

When this is mastered, repeat the above exercises but at increased speed.

Stopping Distances

Practice stopping the watercraft in a straight line at various speeds and braking force. Remember that watercraft speed, load, water conditions, current and wind also affect stopping distances.

Practice releasing the throttle while going at speed and feel the deceleration rate with different speed.

Repeat exercise, but this time while applying iBR lever (if equipped). Note that the iBR system takes control of the throttle.

Steering and Avoiding an Obstacle

Practice obstacle avoidance (choose a virtual point on the water) by steering watercraft and maintaining throttle.

Repeat exercise, but this time release throttle while turning.

Repeat exercise, but this time while applying iBR lever (if equipped). Note that the iBR system takes control of the throttle.

NOTE:

With this exercise, you will learn that you need throttle to steer the watercraft in a different direction.

Reverse

Practice reverse operation to learn how the watercraft operates in reverse and reacts with steering inputs.

NOTE:

Remember that steering direction is reversed when backing.

Docking

Practice docking using the throttle, the steering and the iBR (if equipped) to become familiar with the response if the PWC and to develop good control skills.

Slow Speed Mode, Ski Mode and Speed Limiter Mode (if equipped)

If your watercraft has any of these modes, it is also important to understand their operation and to become familiar with these features prior to using them on a ride with other people.

WARNING

The ski and the speed limiter modes are not an automatic pilot; they will not drive the watercraft for you.

FUELING

Fueling Procedure

Fuel is flammable and explosive under certain conditions. Do not smoke or allow open flames or sparks in the vicinity.

1. Stop engine.
2. Have the operator and passenger(s) get out of watercraft.
3. If on the water, moor the watercraft securely to the dock.
4. Unscrew slowly the fuel cap counterclockwise to stabilize pressure before removing it.

NOTE:

A short whistling sound is normal.

5. Insert the spout into the filler neck.

NOTE:

Be certain that you are putting fuel in the right location and not using a ventilation hole or ski pylon hole by mistake.

6. Pour fuel slowly so the air can escape from the tank and prevent fuel flow back. Be careful not to spill fuel.
7. Stop filling after the release of the gas pump nozzle handle and wait a moment before removing the spout. Do not retract the gas pump nozzle to put more fuel into the fuel tank. Do not overfill.
8. Reinstall the fuel cap and fully tighten it.
9. Always wipe off any fuel spillage from the watercraft.
10. After refueling, always open or remove the seat or the lateral panel (depending on models) and ensure there is no gasoline odor inside the engine compartment. Do not start watercraft if you smell gasoline odor.

Fuel Requirements

NOTICE

Always use fresh gasoline.

Gasoline will oxidize; the result is loss of octane, volatile compounds, and the production of gum and varnish deposits which can damage the fuel system.

Alcohol fuel blending varies by country and region. Your vehicle has been designed to operate using the recommended fuels, however, be aware of the following:

- Use of fuel containing alcohol above the percentage specified by government regulations is not recommended and can result in the following problems in the fuel system components:
 - Starting and operating difficulties.
 - Deterioration of rubber or plastic parts.
 - Corrosion of metal parts.
 - Damage to internal engine parts.

- Inspect frequently for the presence of fuel leaks or other fuel system abnormalities if you suspect the presence of alcohol in gasoline exceeds the current government regulations.
- Alcohol blended fuels attract and hold moisture which may lead to fuel phase separation and can result in engine performance problems or engine damage.

Recommended Fuel

The gasoline must have the following minimum octane requirements:

Engine	Recommended Fuel
300	Use Premium gasoline with an AKI (RON+MON)/2 octane rating of 92 or an RON octane rating of 95.
All other	Use common gasoline with an AKI (RON+MON)/2 octane rating of 87 or an RON octane rating of 91.

Use unleaded gasoline containing MAXIMUM 10% ethanol.



NOTICE

Never experiment with other fuels. Engine or fuel system damages may occur with the use of an inadequate fuel.

NOTICE

Do NOT use fuel from fuel pumps labeled E85.

Use of fuel labeled E15 is prohibited by U.S. EPA Regulations.

TRAILERING INFORMATION

NOTICE

The span of the trailer bunks including bunk width should be adjusted to provide support throughout the full length of the hull. The ends of both trailer bunks should not exceed the length of the watercraft.

Ensure the trailer wheels are positioned so that the center of gravity of the watercraft is slightly ahead of the wheels to properly support the weight of the watercraft.

Carry the watercraft in its normal operating position.

Check the applicable laws and regulations in your area concerning towing a trailer, especially for the following items:

- Brake system
- Tow vehicle weight
- Mirrors.

Respect tow vehicle maximum weight capacity and the tongue weight capacity as recommended by the manufacturer.

Tie the watercraft to both front and rear (bow/stern) eyelets so that it is firmly secured on the trailer. Use additional tie-downs if necessary.

Ensure fuel tank cap, front storage compartment cover, glove box cover, boarding platform and seat are properly latched.

Remove all cargo and equipment attached.

Observe trailering safety precautions.

Do not route ropes or tie-downs over the seat or attach them to the grab handle to avoid these parts permanently damaged. Wrap ropes or tie-downs with rags or similar protectors where they can come into contact with the watercraft body.

A Sea-Doo cover can protect the watercraft, particularly when driving on dirt roads, to prevent dirt entry through the air inlet openings.

When trailering 2 watercrafts, it may be necessary to remove the inner wakeboard rack, if equipped.

For more information, see the following video: SEA-DOO HOW TO SERIES - PROPER WATERCRAFT TRAILERING

<https://www.youtube.com/watch?v=mXtHWldt7yl>

Or, use the following QR code.



IMPORTANT ON-PRODUCT LABELS

Watercraft Safety Labels

These labels are affixed to the vehicle for the safety of the operator, passengers or bystanders.

The operator and when applicable, the passenger, shall read and understand this information before riding.

The labels illustrated on the following pages are on your watercraft. If missing or damaged, they can be replaced free of charge. See an authorized Sea-Doo dealer.

NOTE:

In the event of any discrepancy between this guide and the vehicle, the safety labels on the vehicle have precedence over the labels in this guide.

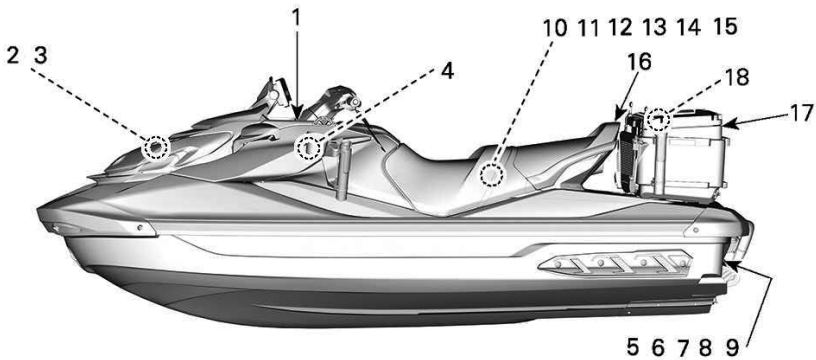

1. General Warning Label
2. Storage Compartment Label
3. Fuel Warning Label
4. Glove Box Use Label
5. Re-Boarding Label
6. Tip Over Label
7. iBR Protector Label - Moving Parts
8. iBR Gate Label - Moving parts
9. Do Not Use To Onboard
10. Checking Engine Oil Label
11. Engine Oil and Components Hot
12. Do Not Sit Pictogram
13. Battery Label
14. Coolant Hot - Do Not Open Label
15. Air Intake Silencer Label
16. Passenger Transportation
17. Cooler utilization label
18. Cooler installation label

General Warning Label

⚠ WARNING

16+ **Require Proper Operation of the Boat**
Improper operation can result in severe injury or death.
Operators Must Be Qualified

- ✓ Make sure operator is 16 or older and has taken a boater safety course. Your state (or province) may have additional requirements.

Operators Must Avoid Collisions

- ✓ Scan constantly for people, objects and other watercraft.
- ✗ Stay far enough away from others so you can always safely coast to a stop.

Do not release throttle when trying to steer away from objects—as with other powerboats, you need throttle to steer.

Watch safety video.
<https://www.ssa-doo.com/owners/safety/safety-video.html>

Read Operator's Guide
<https://www.ssa-doo.com/owners/operatorguide.html>

Protect All Riders

- ✓ Wear shorts with neoprene (wet suit material) and an approved PFD (personal flotation device) - see Rider Safety section of this label.
- ✗ Tell riders to read the Rider Safety section and make sure they are dressed appropriately.
- ✗ Do not apply throttle when anyone is boarding or al rear of PWC.
- ✓ Be sure riders are properly seated and holding on.
- ✓ Avoid aggressive operation, sharp turns, and unexpected acceleration that can cause riders to be thrown off.
- ✗ Do not jump waves or wakes - jumping can cause injuries such as back or spinal injuries (paralysis).

Do Not Permit Reckless Operation:

- ✗ Do not go near others to spray or splash them with water, go too close to other boats, or go too fast for traffic conditions.
- ✗ Never ride after consuming alcohol or drugs.

RIDER SAFETY

Falls Can Result in Severe Injury or Death

to keep water from being forcefully injected into rectum or vagina during a fall backward. Riders not wearing neoprene shorts have received severe rectal, vaginal, and internal injuries resulting in permanent damage.

- ✓ You must wear shorts with neoprene (wet suit material)
- ✓ You must wear an approved PFD (personal flotation device).
- ✓ Be sure you are properly seated and holding on. Riders can be thrown off PWC during unexpected acceleration or aggressive operation.
- ✗ Never ride after consuming alcohol or drugs.

Do not ride if you are not dressed appropriately.

Wear PFD

Wear Neoprene

See Operator's Guide

Storage Compartment Label

⚠ WARNING

Inside the storage compartment:

- Never carry loose, fragile or hard sharp-edged objects.
- Maximum load: 9 kg (20 lb).
- Always close the cover before riding.

This is not a watertight compartment.

5904

Fuel Warning Label



⚠ WARNING

- After refueling, always remove the seat(s) to ensure there is no gasoline vapor odor inside the engine compartment.
- Gasoline vapor may cause fire or explosion.
- Do not overfill gas tank. • Avoid spilling gasoline.
- Wipe up spilled gasoline immediately.
- Keep the watercraft away from open flames and sparks.
- Do not start watercraft if liquid gasoline or gasoline vapor odor is present.
- Always replace the seat(s) before starting.

5678



⚠ AVERTISSEMENT

- Après avoir fait le plein toujours enlever le(s) siège(s) afin de s'assurer qu'il n'y ait pas d'émanation d'essence dans le compartiment moteur.
- Les émanations d'essence peuvent provoquer des incendies ou des explosions.
- Éviter de trop remplir le réservoir d'essence. • Éviter de renverser de l'essence.
- Essuyer immédiatement l'essence renversée • Garder la motomarine à l'écart des flammes et des étincelles. • Ne pas démarrer la motomarine en présence d'essence liquide ou d'émanation d'essence. • Toujours remettre le(s) siège(s) en place avant de démarrer la motomarine.

Glove Box Use Label

NOTICE



Refer to the operator's guide for recommendations on how to use the glove box .



5677

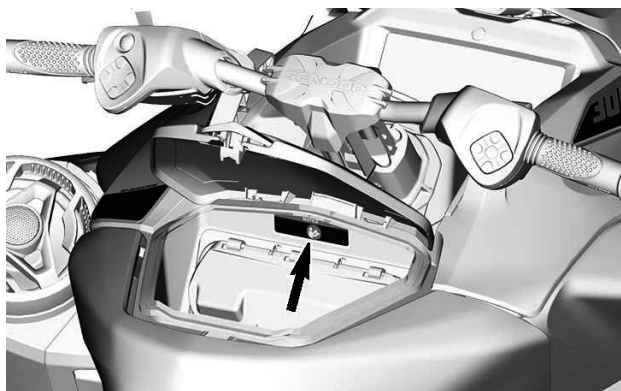

Re-Boarding Label

⚠ WARNING

AVOID SERIOUS INJURY OR DEATH:

- Engine must be turned off before re-boarding.
- Keep away from propulsion system and intake grate.

WHEN RE-BOARDING:

- Re-board one person at a time.
- Stay centered to keep balance.
- Never use the boarding step (if so equipped) for pulling, towing, jumping or boarding a PWC that is out of water or any purpose for which it was not designed.



219905498

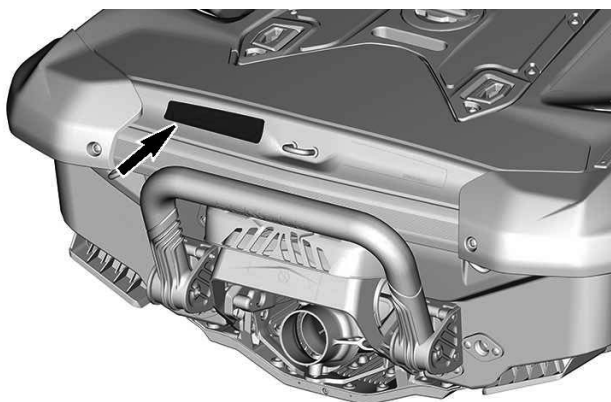

Tip Over Label

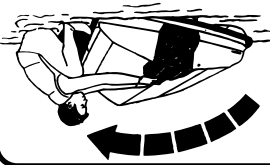
⚠ CAUTION	
When operating the engine while the watercraft is out of the water, the heat exchanger in the ride plate may become very hot. Avoid any contact with plate as burns may occur.	
219905494 	
	<ul style="list-style-type: none">• Roll boat on bumper rail.• Grab inlet grate and step.• Make sure engine is off.
NOTICE	

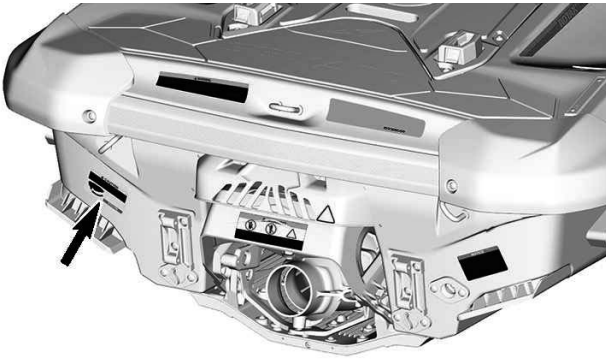

iBR Gate Protector Pictogram - Moving part



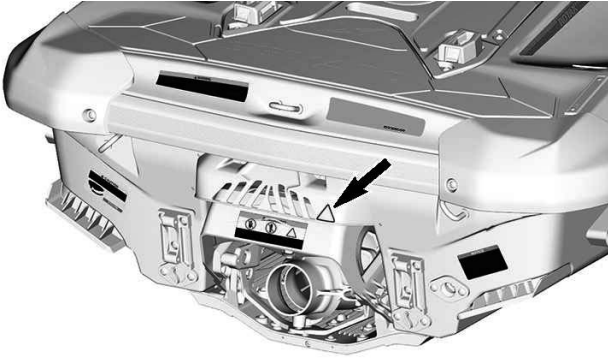

iBR Gate Label - Moving Part

⚠ WARNING

**Moving parts can crush and cut.
Keep hands and feet clear.**

219903078

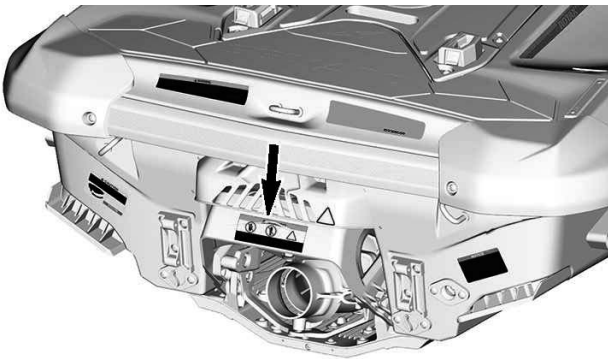

Do Not Use To Onboard



Checking Engine Oil Level

NOTICE

CHECKING ENGINE OIL LEVEL

- Make sure engine is at operating temperature. (Never let engine run out of water without the flush kit connected as it may damage the engine.)
- Vehicle must be level to perform verification.
- Let engine running at idle for at least 30 seconds.
- Stop engine and wait at least 30 seconds.
- Check oil level using the dipstick.

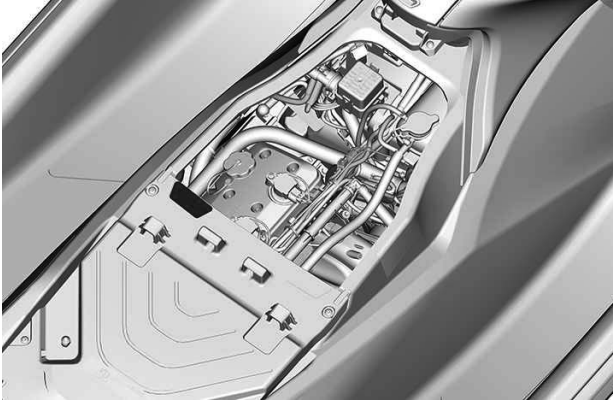

Engine Oil and Components Hot

CAUTION

ENGINE OIL AND CERTAIN COMPONENTS IN THE ENGINE COMPARTMENT MAY BE HOT. DIRECT CONTACT MAY RESULT IN SKIN BURN.



219905037

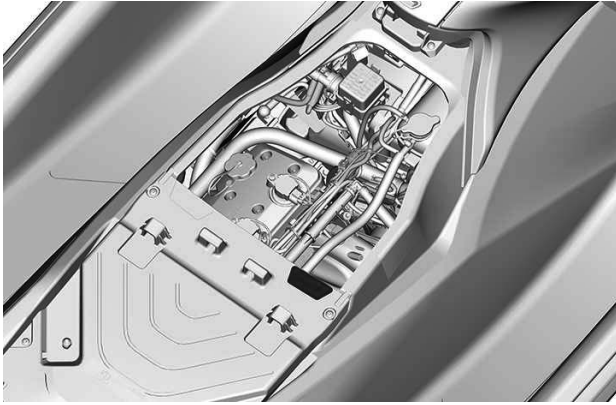

Do Not Sit Pictogram



⚠ WARNING

If a Ski-Pylon can be used on this PWC, always install the rear seat to prevent injury when in use.

Before riding the PWC make sure to properly install and lock the seat(s) into place.



5978



Battery Label

⚠ AVERTISSEMENT

- Enlever la batterie du bateau avant de la charger.
- Ne pas trop charger la batterie.
- Un chargement excessif pourrait faire exploser la batterie.

⚠ WARNING

- Remove battery from boat before charging.
- Do not overcharge battery.
- Improper charging of battery can cause explosion.

219905305

ROLL AROUND THE RED (+) BATTERY LEAD

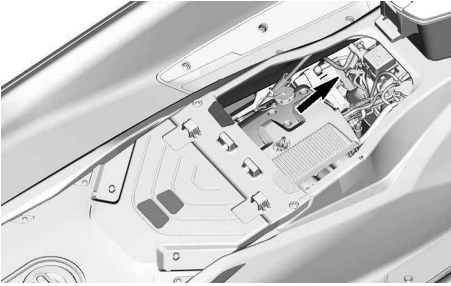

Coolant Hot - Do Not Open Label

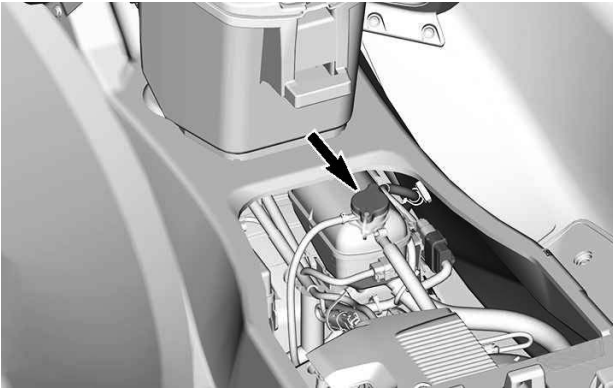

Air Intake Silencer Label

NOTICE

- To comply with noise regulations, this engine is designed to operate with an air intake silencer.
- Operation without air intake silencer or with one not properly installed may cause engine damage.

219903177A

LOCATED ON THE TOP OF THE AIR INTAKE SILENCER - UNDER THE ECM

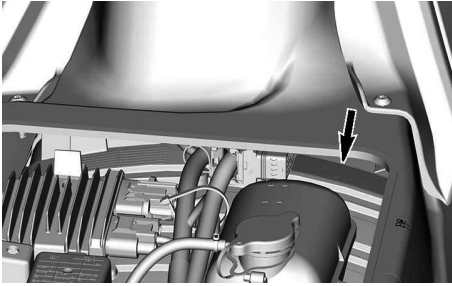

Passenger Transportation - Appropriate Wearing

⚠ WARNING

- Never carry passengers on rear platform, always use the rear seat to carry passengers.
- Wear shorts with neoprene and approved PFD.

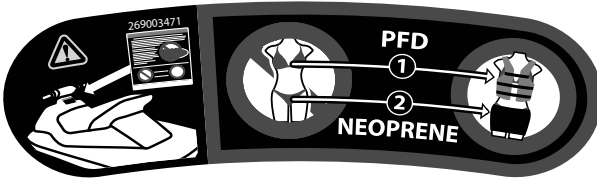

Cooler Utilization Label

⚠ WARNING

- NEVER allow a child or pet in cooler. Cooler lid is airtight which can lead to suffocation.
- NEVER transport flammable or dangerous material. Transporting flammable or dangerous material can lead to explosions.
- NEVER exceed max load of 50 kg (110 lb) inside the cooler.

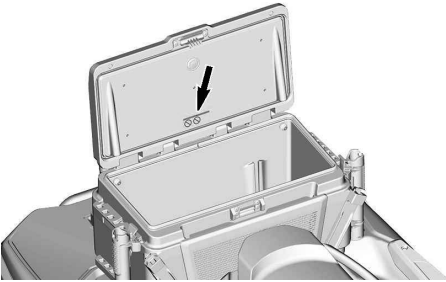
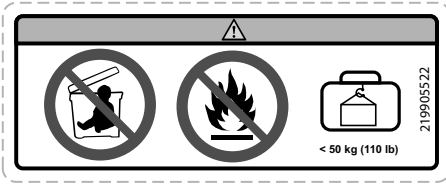

Cooler Installation Label

⚠ WARNING

- ALWAYS make sure that the cooler is securely attached to the platform before each ride and before towing the PWC on a trailer.
- BEFORE riding, make sure that you and every users of this PWC know how to board from the water with this cooler in place.

219905521

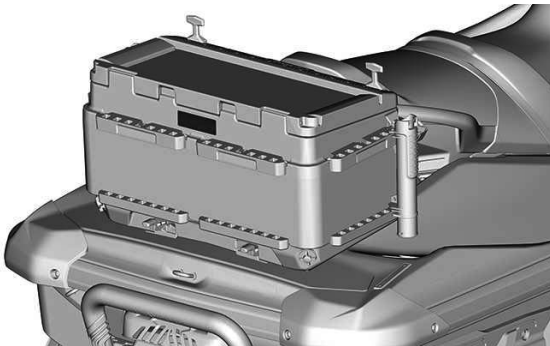

Molded Safety Pictogram

⚠ WARNING

Never put gasoline in this hole. Gasoline is extremely flammable and highly explosive. Fuel vapors can spread and be ignited by a spark or flame many feet away.



LABEL 1

Hang Tag

California Proposition 65 Warning

 **WARNING.** Operating, servicing and maintaining a recreational marine vessel can expose you to chemicals including engine exhaust, carbon monoxide, phthalates, and lead, which are known to the State of California to cause cancer and birth defects or other reproductive harm. To minimize exposure, avoid breathing exhaust, service your vessel in a well-ventilated area and wear gloves or wash your hands frequently when servicing this vessel.



For more information go to
www.P65warnings.ca.gov/products/marine

219905280

iBR Hang Tag



How to brake

- Squeeze brake lever.

How to reverse

- Maintain brake lever engaged.

How to go forward

- Tap throttle lever to engage forward movement from neutral position.
- Squeeze throttle lever to accelerate.

How to get to neutral

- Tap brake lever.

Refer to the operator's guide for more information.



211990201

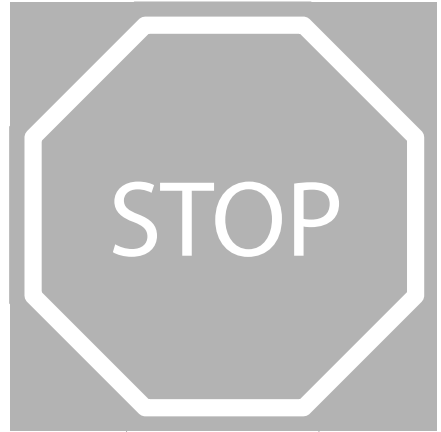

iBR[®]

INTELLIGENT BRAKE AND REVERSE

THIRD GENERATION

- Allows you to stop sooner for greater peace of mind.
- Recognized by the U.S. Coast Guard for improving boating safety since 2009.
- The Third Generation provides more precise and responsive control when braking and docking.

SEA DOO[®]

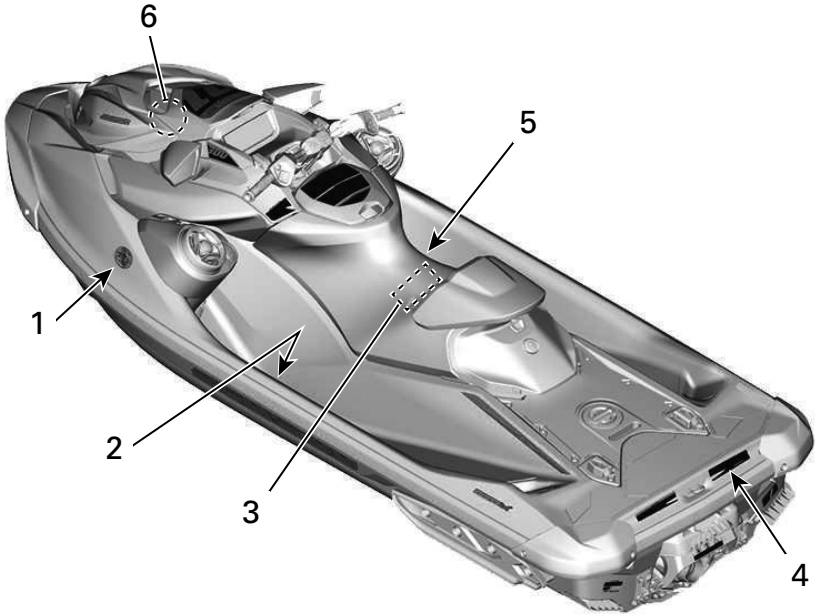

Compliance Labels and Hang Tag



LABEL 1

CANADIAN COMPLIANCE NOTICE AVIS DE CONFORMITÉ CANADIEN

**MAXIMUM RECOMMENDED SAFE LIMITS
LIMITES MAXIMALES DE SÉCURITÉ RECOMMANDÉES**

MAX.			kg lbs/lb
MAX.	 + 		kg lbs/lb

CATEGORY / CATÉGORIE: C

MAXIMUM WAVE / VAGUE MAXIMALE: **2.0 m**

MAXIMUM WIND SPEED / VITESSE DE VENT MAXIMALE: **33 knots/noeuds**

**BOMBARDIER RECREATIONAL PRODUCTS INC. (YDV)
VALCOURT, QUEBEC, CANADA
SKALDENSTRAAT 125, GENT, 9042, BE**

MODEL / MODÈLE :

THE MANUFACTURER DECLARES THAT THIS PRODUCT COMPLIES WITH THE CONSTRUCTION REQUIREMENTS OF THE SMALL VESSEL REGULATIONS, AS THEY READ ON THE DAY ON WHICH THE CONSTRUCTION OF THE VESSEL WAS STARTED OR ON THE DAY ON WHICH THE VESSEL WAS IMPORTED.

LE FABRICANT ATTESTE QUE CE PRODUIT EST CONFORME AUX EXIGENCES DE CONSTRUCTION DU REGLEMENT SUR LES PETITS BÂTIMENTS EN VIGUEUR À LA DATE DU DÉBUT DE SA CONSTRUCTION OU DE SON IMPORTATION.

**MAXIMUM CAPACITIES
ABOVE INFORMATION ALSO
APPLIES IN THE U.S.A.**



CAN ICES-2/ NMB-2

5864

LABEL 2- LOCATED INSIDE THE LH FOOTREST.

UK
CA
CE ROTAX STRASSE 1
A-4623. GUNSKIRCHEN. AT

LABEL 3 - ENGINE MANUFACTURER IDENTIFICATION

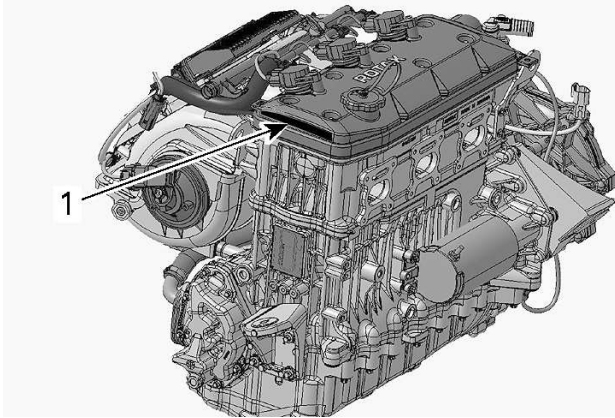

TYPICAL



1. Engine Manufacturer Identification

THIS BOAT IS MANUFACTURED BY BOMBARDIER RECREATIONAL PRODUCTS INC. PER 46 U.S.C. 4305 AND U.S. COAST GUARD GRANT OF EXEMPTION (CGB 88-001) THE COAST GUARD EXEMPTS THIS VESSEL FROM ONE OR MORE SAFETY REGULATIONS. CGB 88-001 STATES THAT CERTAIN REGULATIONS ARE INAPPLICABLE IN LIGHT OF THIS VESSEL'S CHARACTERISTICS AND THAT THE EXEMPTION WILL NOT HAVE AN ADVERSE EFFECT ON RECREATIONAL BOATING SAFETY. THIS BOAT COMPLIES WITH U.S. COAST GUARD SAFETY STANDARDS IN EFFECT ON THE DATE OF CERTIFICATION. ALL PERSONS SHOULD WEAR A LIFEJACKET (PERSONAL FLOTATION DEVICE) WHILE OPERATING OR RIDING ON THIS WATERCRAFT.

ASSEMBLED IN MEXICO



LABEL 4

EMISSION CONTROL SYSTEM INFORMATION			
BOMBARDIER RECREATIONAL PRODUCTS INC.			
THIS ENGINE CONFORMS TO		U.S. EPA & CALIFORNIA	
EMISSIONS REGULATIONS FOR MARINE SI ENGINES.			
RENSEIGNEMENT SUR LE DISPOSITIF ANTIPOLLUTION			
CE MOTEUR EST CONFORME AUX NORMES		DE L'EPA	
DES É.-U. POUR LES MOTEURS MARINS À ALLUMAGE COMMANDÉ.			
		ENGINE FAMILY / FAMILLE DE MOTEUR	
(EPA)		CERTIFICATION STANDARDS	
(FEL)		NORMES DE CERTIFICATION	
(CA)		EMISSION CONTROL SYSTEM	
(FEL)		SYSTÈME DE CONTRÔLE DES ÉMISSIONS	
MEETS CALIFORNIA EVAP EMISSIONS REGULATIONS FOR SPARK IGNITION MARINE WATERCRAFT. EVAP FAMILY EVAPORATIVE EMISSION CONTROL SYSTEM: SO SEE OPERATOR'S GUIDE FOR MAINTENANCE SCHEDULE AND FUEL, OIL AND SPARK PLUG SPECIFICATIONS. VOIR LE CALENDRIER D'ENTRETIEN ET LES SPÉCIFICATIONS D'ESSENCE, D'HUILE ET DE BOUGIE D'ALLUMAGE DANS LE GUIDE DE L'OPÉRATEUR.			
		219905703	

LABEL 5 - APPLICABLE FOR ALL MODELS IN CANADA AND UNITED STATES, APPLICABLE FOR MODELS EVERYWHERE EXCEPT CANADA AND UNITED STATES WHEN EQUIVALENT TO A MODEL CERTIFIED TO US. EPA STANDARDS



LABEL 6 - LOCATED NEAR GAS CAP

The Star Label means Cleaner Marine Engines

This engine has been certified as:



The Symbol for Cleaner Marine Engines:

Cleaner Air and Water

For a healthier lifestyle and environment.

Better Fuel Economy

Burns up to 30-40 percent less gas and oil than conventional carbureted two-stroke engines, saving money and resources.

Longer Emission Warranty

Protects consumer for worry free operation.

STAR LABEL HANG TAG



One Star-Low emission

The one-star label identifies personal watercraft, outboard, sterndrive and inboard engines that meet the Air Resources Board's Personal Watercraft and Outboard marine engine 2001 exhaust emission standards. Engines meeting these standards have 75% lower emissions than conventional carbureted two-stroke engines. These engines are equivalent to the U.S. EPA's 2006 standards for marine engines.



Two Stars-Very Low emission

The two-star label identifies personal watercraft, outboard, sterndrive and inboard engines that meet the Air Resources Board's Personal Watercraft and Outboard marine engine 2004 exhaust emission standards. Engines meeting these standards have 20% lower emissions than One Star - Low-Emission engines.



Three Stars-Ultra Low emission

The three-star label identifies engines that meet the Air Resources Board's Personal Watercraft and Outboard marine engine 2008 exhaust emission standards or the Sterndrive and Inboard marine engine 2003 exhaust emission standards. Engines meeting these standards have 65% lower emissions than One Star - Low Emission engines.



Four Stars-Super Ultra Low emission

The four-star label identifies engines that meet the Air Resources Board's Sterndrive and Inboard marine engine 2009 exhaust emission standards. Personal Watercraft and Outboard marine engines may also comply with these standards. Engines meeting these standards have 90% lower emissions than One Star - Low Emission engines.

BOMBARDIER RECREATIONAL PRODUCTS INC.
VALCOURT, QUÉBEC, CANADA
 Cleaner Watercraft - Get the facts 1-800-END-SMOG
 www.arb.ca.gov

2119902878

PRE-RIDE INSPECTION

We encourage you to have an Annual Safety Inspection of your vehicle. Please contact an authorized BRP dealer for further details. Though not required, it is recommended that an authorized BRP dealer performs the preseason preparation of your vehicle. Each visit to your authorized BRP dealer is a great opportunity for your dealer to verify if your vehicle is included in any safety campaign. We also urge you to visit your authorized BRP dealer in a timely manner if you become aware of any safety related campaigns.

WARNING

Perform a pre-ride inspection before each ride to detect potential problems during operation. The pre-ride inspection can help you monitor wear and deterioration before they become a problem. Correct any problems that you discover to reduce the risk of a breakdown or crash.

Before performing the pre-ride inspection, read and understand the *Controls* section.

What to Do Before Launching the Watercraft

WARNING

Engine should be off and the tether cord cap should always be removed from the engine cut-off switch prior to verifying any of the following points. Only start watercraft once all items have been checked and operate properly.

NOTE: Before starting the engine and taking off, it is recommended to shake vertically the rear of the watercraft to shake away any sand that may have accumulated near the propulsion and reverse systems.

Check the items listed in the following table before launching the watercraft.

ITEM	OPERATION
Hull	Inspect hull, ride plate and water inlet grate for damages
Jet pump water intake	Inspect/clean
Drain plugs	Tighten
Fuel tank	Refill
Engine compartment	Check for any visible fluid leaks and gasoline vapor odor
Engine oil level	Check/refill
Engine coolant level	Check/refill
Steering system	Check operation

iTC lever	Check operation. (Depress and release the lever to check for freedom of movement. If any friction is felt, the lever must be taken apart, cleaned, inspected for wear and lubricated)
iBR lever (if equipped)	Check operation. (Depress and release the lever to check for freedom of movement. If any friction is felt, the lever must be taken apart, cleaned, inspected for wear and lubricated)
Front storage compartment cover (if equipped), glove box and seat	Ensure they are closed and latched.
Wakeboard rack (if equipped)	<ul style="list-style-type: none"> – Ensure rack is properly installed and secured. – Make sure bungee cords are in good condition. – Ensure wakeboard is correctly installed in rack and secured.
Ski/wakeboard pylon (if equipped)	Inspect and check operation.
Engine START/STOP button	Check operation
Engine cut-off switch and the monitoring beeper	Check operation
Battery condition and connections	Check every month
Sacrificial anodes	Inspect every month (more often in saltwater use) and change if necessary

Hull

Inspect hull for cracks and other damages.

Jet Pump Water Intake

Remove weeds, shells, debris or anything else that could restrict the flow of water and damage the propulsion unit. Clean as necessary. If any obstruction cannot be removed, refer to an authorized *Sea-Doo* dealer for servicing.

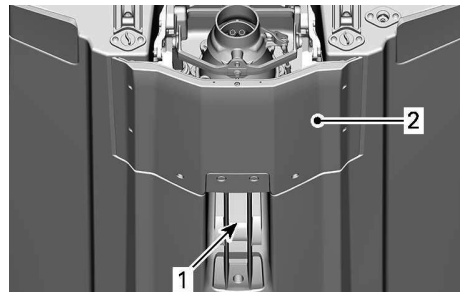

1. Water intake
2. Ride plate

Drain Plugs

Secure bilge drain plugs.

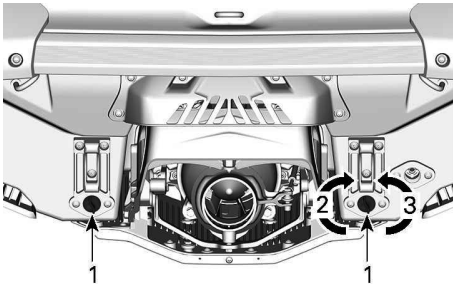

1. Bilge drain plug
2. Tighten
3. Untighten

⚠ WARNING

Ensure bilge drain plugs are properly secured prior to launching the watercraft in water.

Fuel Tank

Fill the fuel tank.

⚠ WARNING

Strictly adhere to instructions detailed in *Fueling Procedure*.

Engine Compartment

Inspect the engine compartment for fuel vapor odor.

⚠ WARNING

Should any leak or gasoline odor be present, do not apply electrical power or start the engine. You should seek service from an authorized *Sea-Doo* dealer, repair shop, or person of your own choosing for maintenance, repair, or replacement. Please refer to the *US EPA Emissions-related warranty* contained herein for information about warranty claims.

To access the engine compartment, remove the seats. Refer to *Removing the Seat*.

Engine Oil

Ensure oil level is within specification as described in *Maintenance Procedures* section.

Engine Coolant

Ensure coolant level is within specification as described in *Maintenance Procedures* section.

Check for coolant leaks on engine, in bilge and from ride plate.

⚠ CAUTION

When operating the engine with the watercraft out of the water, the engine and heat exchanger in the ride plate may become very hot. Avoid any contact with hot engine parts and the ride plate as burns may occur.

Steering System

Assisted by another person, check steering operation for free movement.

When the handlebar is horizontal, the jet pump nozzle should be in the straight ahead position. Ensure the jet pump nozzle pivots easily and in the same direction as the handlebar (e.g.: when handlebar is turned to the left, the nozzle opening must point towards the LH side of watercraft).

⚠ WARNING

Check handlebar and corresponding steering nozzle operation before starting. Never turn handlebar while someone is near the rear of the watercraft. Keep away from steering moving parts (nozzle, iBR gate, linkages etc.).

Throttle Lever

Check the Electronic Throttle Control lever (ETC) for free and smooth operation. It should return to its initial position immediately after it is released.

⚠ WARNING

Check throttle lever operation before starting the engine. If any friction is felt in the throttle lever, refer to an authorized *Sea-Doo* dealer.

iBR Lever

Check the iBR lever for free and smooth operation. It should return to its initial position immediately after it is released.

⚠ WARNING

Check iBR lever operation before starting the engine. If any friction is felt in the iBR lever, refer to an authorized *Sea-Doo* dealer.

Storage Compartments, Boarding Platform and Seat

Ensure the glove box, boarding platform, access panels, and seat are closed and latched.

⚠ WARNING

Ensure the seat, boarding platform, access panels, and all storage compartment covers are securely latched.

Wakeboard Rack (if equipped)

⚠ WARNING

Ensure wakeboard rack is properly secured to watercraft body, and that the wakeboard is properly positioned and secured to the rack prior to using watercraft. Ensure wakeboard retaining straps are in good condition.

Ski/Wakeboard Pylon (if equipped)

Make sure ski/wakeboard pylon is fully extended and locked before use. Completely retract and lock when not used.

⚠ WARNING

When using the ski pylon, never carry cargo or accessories on the boarding platform.

⚠ WARNING

Use caution with skier/wakeboarder in tow as tow rope may backlash to watercraft when released. Never perform a sharp turn when towing a skier, wakeboarder or any toy. Always store tow rope when not in use.

NOTICE

The ski/wakeboard pylon is designed for towing a skier or wakeboarder with a maximum weight of 114 kg (250 lb).

⚠ CAUTION

Never use the ski pylon to tow an inflatable tube. Always use the rear cleat for towing an inflatable tube.

Engine Cut-Off Switch and Engine START/STOP Button

Press the start button once without installing the tether cord on the engine cut-off switch.

Install the tether cord cap on the engine cut-off switch.

Press the START/STOP button to start the engine, then stop it by pressing the START/STOP button a second time.

Restart the engine, then stop it by removing the tether cord from the engine cut-off switch.

⚠ WARNING

Should the tether cord cap be loose or fail to remain on the engine cut-off switch, replace the tether cord immediately in order to avoid unsafe use. If removing the tether cord cap from the engine cut-off switch or pressing the START/STOP button does not stop the engine, do not use the watercraft. See your authorized Sea-Doo dealer.

What to Do After Launching the Watercraft

Check the items listed in the following table after launching the watercraft and before going for a ride.

⚠ WARNING

Engine should be off and the tether cord cap should always be removed from the engine cut-off switch prior to verifying any of the following points. Only start watercraft once all items have been checked and operate properly.

NOTE: Before starting the engine and taking off, it is recommended to shake vertically the rear of the watercraft to shake away any sand that may have accumulated near the propulsion and reverse systems.

Check the items listed in the following table before launching the watercraft.

ITEM	OPERATION
Information Center	Check operation.
Intelligent Brake and Reverse System (iBR)	Check operation.
Variable Trim System (VTS)	Check operation.

Information Center (Gauge)

1. Press START/STOP button and install tether cord on the engine cut-off switch.
2. As the information center cycles through its self-test function, ensure all indications come on.

⚠ WARNING

Always attach the tether cord clip to your PFD or to the wrist (wrist strap required).

iBR System

NOTICE

Ensure there is sufficient space ahead and behind watercraft to safely carry out the iBR system test to avoid a collision. Watercraft will move during test.

1. Remove the moorings lines securing the watercraft to the dock.
2. Start the engine and ensure the watercraft does not move.
3. On the left handlebar, depress the iBR lever completely in, the watercraft should move slowly backwards.
4. Release the iBR lever, there should not be any reverse thrust.

⚠ WARNING

Always ensure proper iBR system operation before taking the watercraft out for a ride.

Variable Trim System (VTS) (if equipped)

With the engine running in forward thrust, use the VTSTM system to move the jet pump nozzle up, and then down alternately to check VTS operation. Confirm the VTS position indicator movement in the information center.

Also test the VTS preset trim positions by double clicking the VTS UP/DOWN button (as applicable to model).

Refer to *Operating Instructions* for detailed instructions.

REGULAR MAINTENANCE

We encourage you to have an Annual Safety Inspection of your vehicle. Please contact an authorized BRP dealer for further details.

It is also recommended that an authorized Sea-Doo dealer performs the pre-season preparation of your vehicle.

Each visit to your authorized Sea-Doo dealer is a great opportunity for your dealer to verify if your vehicle is included in any safety campaign. We also urge you to visit your authorized Sea-Doo dealer in a timely manner if you become aware of any safety related campaigns.

WATERCRAFT INFORMATION

CONTROLS

Some vehicle safety labels are not shown on illustrations. For information on vehicle safety labels, refer to *Important On-Product Labels*.

Some indications, functions and features described in this section may not apply to every PWC model, or may be available as an option.

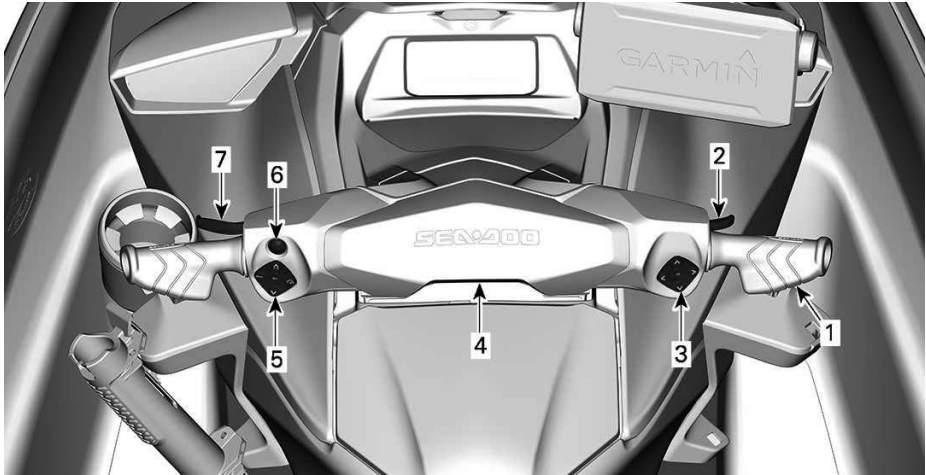

1. Handlebar
2. Throttle Lever
3. Right Controller
4. Engine cut-off Switch
5. Left Controller
6. Engine Start/Stop Button
7. iBR Lever

Handlebar

The handlebar controls the direction of the watercraft. During forward operation, turning the handlebar to the right steers the watercraft to the right and inversely.

⚠ WARNING

Check handlebar and corresponding steering nozzle operation before starting. Never turn handlebar while someone is near the rear of the watercraft. Keep away from propulsion system.

When operating in reverse, steering direction is reversed. Turning the handlebar to the right while backing up steers the watercraft to the left.

Throttle Lever

The throttle lever on the RH handlebar controls electronically the engine speed.

To increase or maintain watercraft speed, pull the throttle lever with your finger.

To decrease watercraft speed, release the throttle lever.

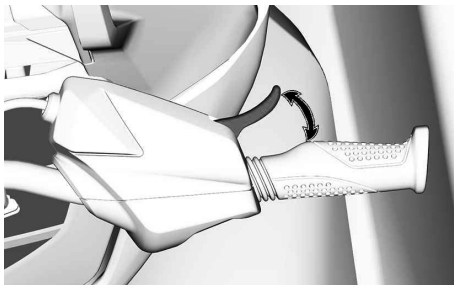

The throttle lever is spring loaded and should return to rest position (idle) when not pressed.

Right Controller

The right controller is located on the RH side of the handlebar.

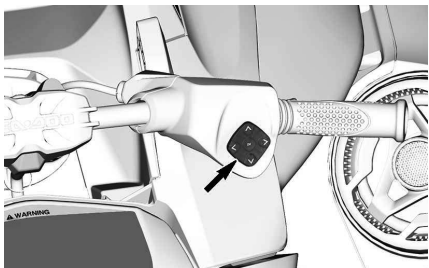

The right controller includes controls to navigate in the multifunction gauge.

- Arrow UP
- Arrow RH
- Arrow Down
- Arrow LH
- OK button.

Engine Cut-Off Switch

The engine cut-off switch is located in the middle of the handlebar.



To allow engine starting, the tether cord cap must be securely snapped to the engine cut-off switch.

⚠ WARNING

Always attach the tether cord clip to the operator's personal flotation device (PFD) or wrist (wrist strap required).



TYPICAL

1. Tether cord cap on the engine cut-off switch
2. Tether cord secured to operator's PFD

To stop engine, pull the tether cord cap from the engine cut-off switch.

⚠ WARNING

Should the engine be stopped, the brake function and all watercraft directional control is lost.

⚠ WARNING

Always disconnect tether cord when watercraft is not in operation in order to prevent accidental engine starting or to avoid unauthorized use by others, children, and to prevent theft.

Radio Frequency Digitally Encoded Security System (RF D.E.S.S.)

The tether cord cap contains an electronic circuit (D.E.S.S.™ key) that is programmed to give it a unique electronic serial number. This is the equivalent of a conventional key.

The D.E.S.S. system reads the key installed on the engine cut-off switch and only allows engine starting for keys it recognizes.

The D.E.S.S. system brings great flexibility. You can buy additional tether cords and have the D.E.S.S. keys programmed for your watercraft.

A total of ten D.E.S.S. keys can be programmed.

To have a key programmed to your watercraft, see your authorized BRP Sea-Doo dealer.

Left Controller

The left controller is located on the LH side of the handlebar.

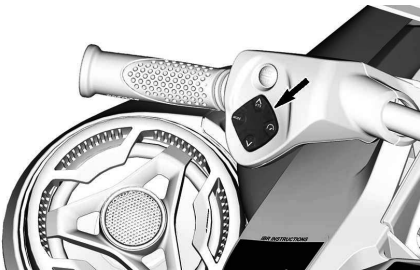

Variable Trim System (VTS) Button

It provides watercraft pitch trim adjustments by adjusting the vertical position of the jet nozzle.

The VTS can be electrically trimmed to desired attitude, or to one of three preset trim positions (full up, middle and full down).

Refer to *Operating Instructions* for details.

NOTE:

The VTS button is used for Neutral adjustment. This is to adjust the neutral position of the watercraft. Refer to *Operating Modes* for details

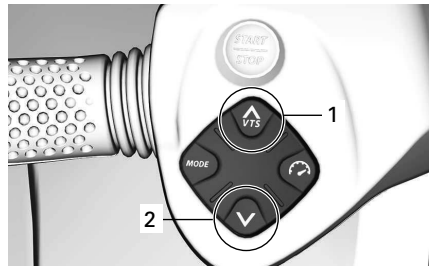

- 1. Bow up
- 2. Bow down

Speed Control Button (Trolling Mode)

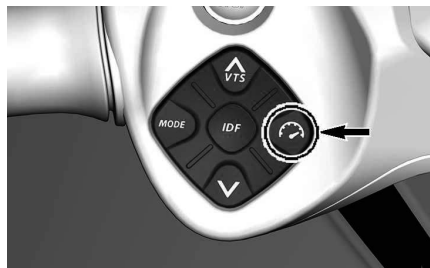

TYPICAL

Allow to set and control the speed related functions.

- Speed limiter
- Slow speed mode.

Mode Button



TYPICAL

It is used to choose between Normal, Sport or Eco mode.

Refer to *Operating Modes* for details.

intelligent Debris Free Pump (iDF) Button

Located in the center of the left controller.

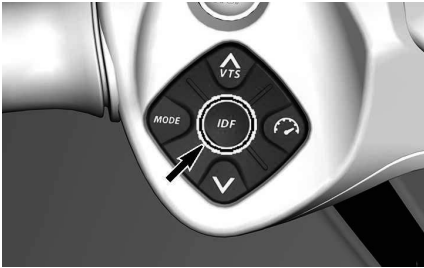

It allows to activate the iDF system. Refer to *How to Use the intelligent Debris Free Pump System* in *Operating Instructions* section.

Engine START/STOP Button

The engine START/STOP button is located on the LH handlebar.

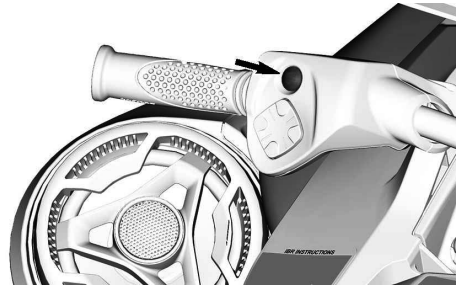

Engine Starting and Stopping

Refer to *Operating Instructions* for complete procedures on how to start and stop the engine.

Waking Up the Electrical System

Press the START/STOP button once without installing the tether cord on the engine cut-off switch.

This will power up the electrical system; the information center will cycle through a self-test function.

The electrical system will stay powered up for approximately 75 seconds after the START/STOP button was depressed.

When the tether cord is installed on the engine cut-off switch, the system will be powered for 60 minutes.

Every time the START/STOP button is pressed, the countdown restarts. When the battery voltage drops below 12.3V, the LOW BATTERY indicator lamp will light up and the electrical system will shut down after 75 seconds.

Post-Drive Battery Management

This feature allows keeping the electrical system awake to allow using accessories when the engine is turned off. It also prevents draining the battery too much when using accessories. When the battery voltage reaches 12.3V or less, the system will

automatically shut down to ensure being able to start the engine.

When the electrical system is activated by pressing start-stop briefly while the engine is shutdown the wake-up time will be managed as follows:

- Key off: System will shut down after 75 seconds.
- Key on: System will shut down after 60 minutes or if the voltage threshold is reached.

intelligent Brake and Reverse (iBR) Lever

The iBR lever on the LH handlebar can electronically command:

- Brake
- Reverse
- Neutral.

NOTE:

A minimum of 25% of iBR lever stroke is required to activate iBR functions.

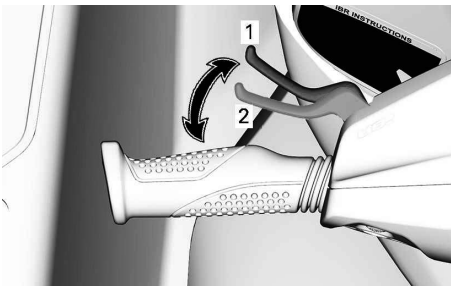

1. Lever rest position
2. 25% stroke required to activate iBR functions

At speed above 14 km/h (9 MPH), pulling the iBR lever will engage the brake.

NOTE:

If water current is 14 km/h (9 MPH) or above, the reverse can not be engaged as the speed threshold for the reverse is exceeded.

At speed below 14 km/h (9 MPH), pulling the iBR lever will engage reverse.

When the iBR lever is released after braking or reverse operation, the neutral is engaged.

⚠ WARNING

If throttle lever is still pulled in when releasing the iBR lever, forward movement will be initiated after a short delay. If forward acceleration is not desired, release the throttle lever.

NOTE:

The neutral position can be fine tuned by trimming the iBR system.

Refer to *Operating Instructions* for detailed instructions.

INFO Button (If Equipped)

The INFO button is located on the LH handlebar.

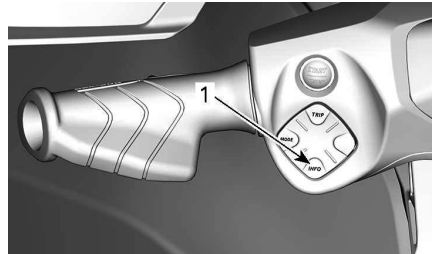

1. INFO button

It is used to navigate through the menu and to change some settings.

Refer to *Operating Modes* for details.

TRIP Button (If Equipped)

The TRIP button is located on the LH handlebar.

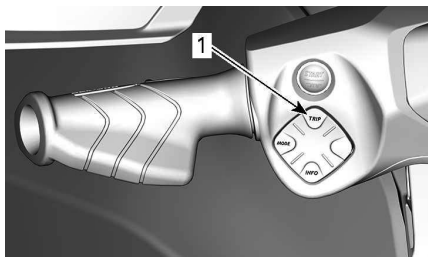

1. TRIP button

It is used to cycle through the trip-meter displays and the clock on the upper left display.

Refer to *Operating Modes* for details.

EQUIPMENT

Illustrations may not be accurate for every model and are only provided as a visual guide.

Some vehicle safety labels are not shown on illustrations. For information on vehicle safety labels, refer to *Watercraft Safety Labels*.

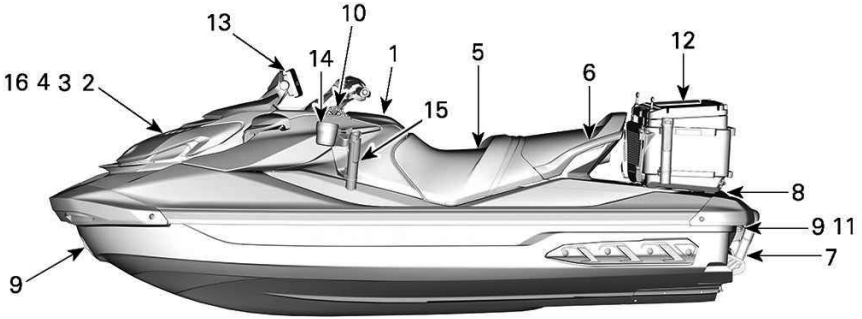

1. Glove Box
2. Storage Bin
3. Fire Extinguisher Holder
4. Safety Kit Holder
5. Seat
6. Passenger Handholds
7. Boarding Ladder
8. Boarding Platform
9. Front and Rear Eyelets
10. Mooring Cleats
11. Bilge Drain Plugs
12. Cooler
13. Sonar
14. Cup holder
15. Front Rod Holder for Trolling
16. Tackle box

Glove Box

A small, storage compartment for personal articles.

Pull on cover latch to open glove box.

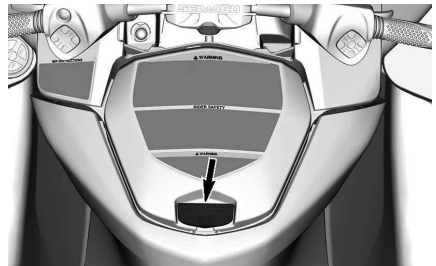

Watertight Compartment

Inside the glove box is located a small watertight storage compartment for

personal articles. Pull backwards on the two latches to open.



There is a protective foam located inside the watertight compartment to protect a phone from damages. Make sure the smartphone is held in place by the foam and not the edges of the receptacle and that you can close the lid. Always make sure the foam is completely dry before using.

Refer to *Maximum Phone Size* chart.

Maximum Phone Size	
Length	160 mm (6.3 in)
Width	85 mm (3.3 in)

NOTE:

Due to variation in smartphone sizes and cases styles, ensure there is no pressure on connector and/or phone when closing the lid.

Some models are equipped with a USB port used for charging. When using the USB port to charge a smartphone, always make sure to route the cable such that there is no pressure on either ends of the cable to prevent damage to cable or smartphone connectors.

NOTE:

For optimum performance, always use OEM USB cables. Low cost after-market cables may not have data lines and/or higher impedance which may result in poor charging performance or overheating.

Many models of smartphones have a brittle female connector so extra care should be taken when inserting in the watertight compartment. BRP recommends to use a short cable (no more than 25 cm (10 in)) so there is less extra cable length to stow.

The models not equipped with USB charging port are instead equipped with a rubber seal to ensure watertightness. There is a ventilation membrane that balance pressure inside and outside the compartment to ensure it can be opened without suctioning water droplets inside. The membrane itself is watertight. Watertightness of the compartment is finally ensured by pressing the compartment's door on the surrounding seal, using the two latches.

To ensure that articles inside the compartment are protected from the environment, the following recommendations should be followed:

Before and during use:

- Make sure the seal is intact, cleared and properly positioned.
- Make sure the ventilation membrane is intact and properly positioned.
- Make sure the seal around the USB charging port (or rubber seal) is intact and properly positioned.
- Completely dry the compartment and its contents before closing.
- Make sure nothing gets pinched between cover and box when closing compartment.
- Always close the compartment completely using the 2 latches.

After use:

- Remove smartphone from compartment.
- The USB charging port's integrated rubber cap should be installed to cover the connector.
- Always close the compartment completely using the 2 latches.

NOTE:

Use of desiccant in the watertight compartment is recommended to eliminate condensation. Replace desiccant frequently.

Front Storage Compartment

The front storage compartment that can be used to carry larger personal articles is located under the front cover.

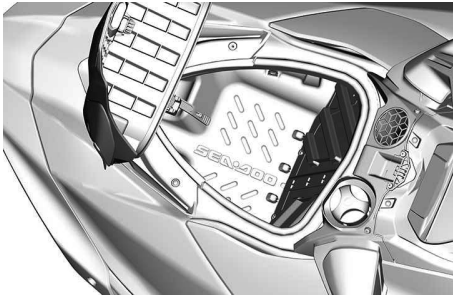
**How to Open Front Storage Compartment Cover**

Stop engine.

⚠ WARNING

When the front storage compartment cover is opened, the controls are not accessible to the driver.

Open the storage bin by pressing on the two release buttons and lifting the handlebar.

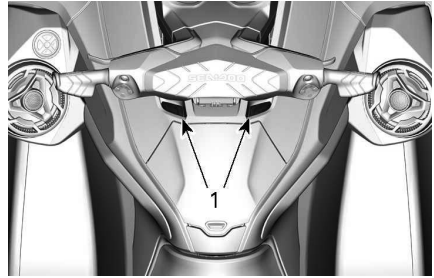

1. Release buttons

NOTICE

The maximum load allowable for the front storage compartment is 13 kg (30 lb) evenly distributed.

⚠ WARNING

Never leave any heavy or breakable objects loose in the front storage compartment. Do not overload. Never store or transport fuel or any other flammable products in this storage compartment. Never operate the watercraft with the storage compartment cover open or with improperly secured cargo.

Fire Extinguisher Holder**NOTE:**

Fire extinguisher is sold separately.

The fire extinguisher support is located under the front storage bin cover.

Use the rubber tie-downs to properly secure the fire extinguisher.

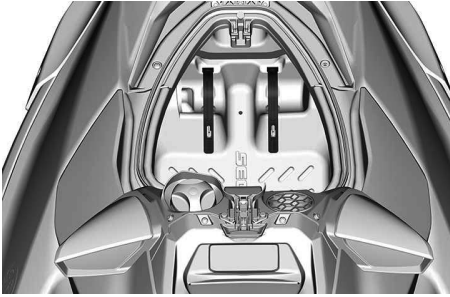

Safety Kit Holder

NOTE:

Safety kit is sold separately.

The safety kit support is located in the front storage bin.

Use the rubber tie-downs to properly secure the safety kit.

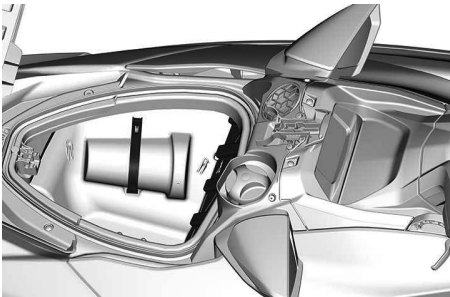

Seat

This model comes equipped with an ergonomic seat narrowing towards the front with knee grab design allowing you to position your legs towards the inside of the footwells, minimizing upper body fatigue and granting you more control when cornering.

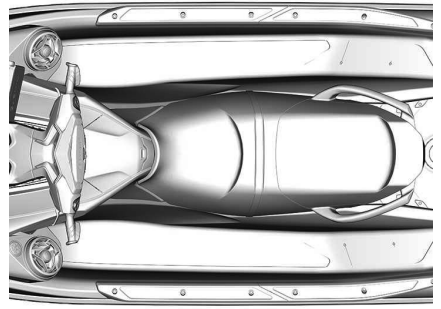

ERGONOMIC SEAT

Removing the Seat

1. Unlatch and remove the seat saddle, if installed.
2. Push on the two release buttons and lift the back end of the seat.

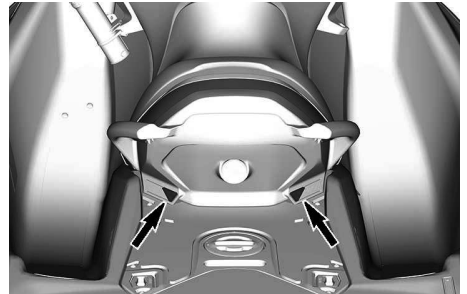

3. Then pull the latch handle up and remove the seat from the watercraft.

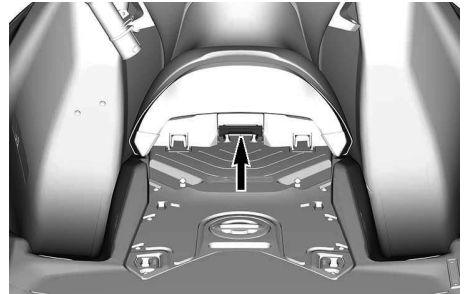

Installing the Seat

1. Insert the forward end of the seat in its retainer.

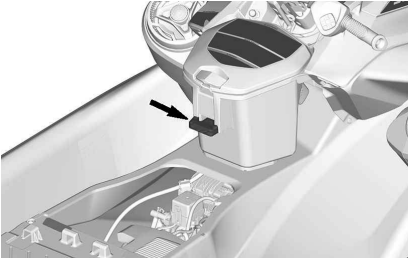

2. Insert the forward part of the seat back end into the retainers.

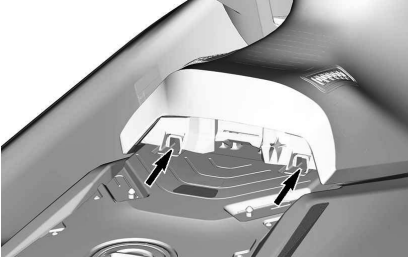

3. Align the seat back end latches with the latch pins and firmly press down on the seat back end to lock it in place.



4. Pull up on the seat back end to ensure it is properly latched.

⚠ CAUTION

Ensure the latches are properly locked onto the pins.

5. Secure the seat saddle.

Passenger Handholds

The seat strap provides a handhold for a passenger to hold on to when riding.

The sides of the molded grab handle at the rear of the seat also provide a handhold for a passenger. The rear portion of the molded grab handle provides a handhold for the skier/wakeboarder (if applicable) spotter or boarding the watercraft from the water.

NOTICE

Never use the molded grab handle to tow anything or to lift the watercraft.

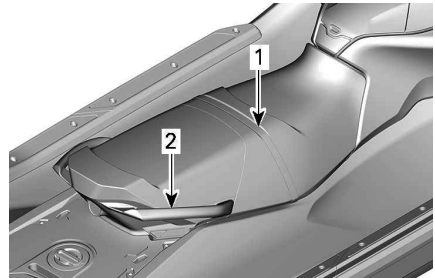

PASSENGER HANDHOLDS

1. Seat strap
2. Molded grab handle

Boarding Ladder (If Equipped)

A convenient ladder used for boarding the watercraft from the water.

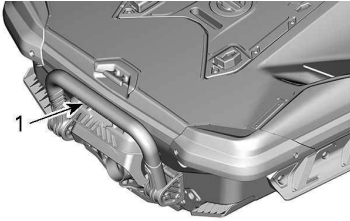
**TYPICAL**

1. Boarding ladder

⚠ WARNING

Do not apply throttle when anyone is boarding or at rear of PWC. You can shut down the engine

Pull down the ladder with your hand and hold until a foot or a knee is put on the ladder.

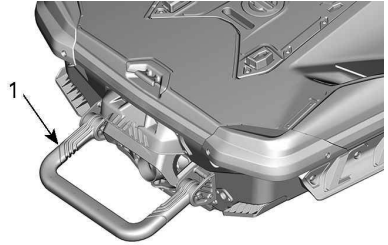
**TYPICAL**

1. Boarding ladder in lowered position

NOTICE

- Never use the ladder for boarding a watercraft that is out of water.
- Never use the ladder for pulling, towing, diving or jumping, or any other purpose other than as a boarding ladder.
- Stay on center of the ladder.
- Only one person at a time on the ladder.

⚠ WARNING

Be aware of the iBR gate movement when starting the engine, shutting down the engine or using the iBR lever. Automatic movement of the gate may squeeze fingers or toes of people taking a hold on the back or your PWC. Never use iBR gate as a supporting point to board the watercraft.

Boarding Platform

A boarding platform covers the rear deck area.

⚠ CAUTION

The two LinQ attachment points are used to carry accessories and should always be retracted when not in use.

Two indentations in the platform are used as foot rests for the rear facing

spotter when towing a skier, wakeboarder or tuber.

A ski pylon can be installed by removing the ski pylon hole cover in the middle of the platform. The ski pylon hole cover is **not** the fuel cap.

⚠ CAUTION

Always install ski pylon hole cover when ski pylon is not installed.

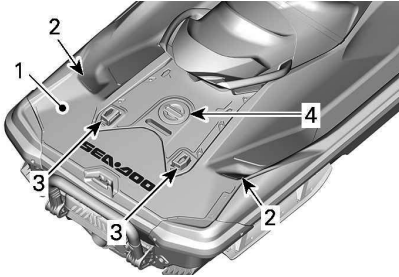

1. Boarding platform
2. Spotter foot rests
3. LinQ attachments
4. Ski pylon hole cover

Front and Rear Eyelets

Eyelets can be used for mooring, towing and as tie-down points when trailering your watercraft.



FRONT EYELET

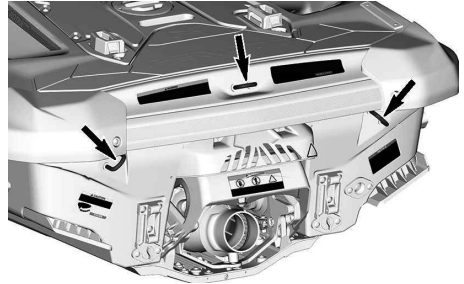

REAR EYELETS

⚠ WARNING

- The front and rear eyelets are rated at a breaking strength in the horizontal direction equivalent to the mass of the PWC in the fully loaded ready-for-use condition.
- Do not use these eyelets to lift the PWC, they are meant for pulling and towing. Doing so could result in serious injury.

NOTE:

- **Responsibility:** It is the owner's/ operator's responsibility to ensure that mooring lines, towing lines, anchor chain(s), anchor lines and anchor(s) are adequate for the vessel's intended use, i.e. the lines or chains do not exceed 80 % of the breaking strength of the respective strong point. Owners should also consider what action will be necessary when securing a tow line on board.
- **Non-metallic strong points:** Where non-metallic strong points are installed, their limited life time shall be taken into consideration. They shall be replaced once they show any signs of deterioration, visible surface cracks or permanent deformation.

Mooring Cleats

These cleats can be used for temporary docking such as when refueling.

The rear cleat can be used to tow an inflatable tube.

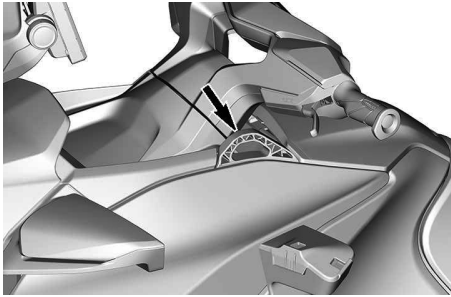

1. Mooring cleat

NOTICE

Never use mooring cleats to pull or lift the watercraft.

Bilge Drain Plugs

Unscrew drain plugs whenever watercraft is on the trailer. This will allow water accumulated in the bilge to be evacuated and helps to reduce condensation.

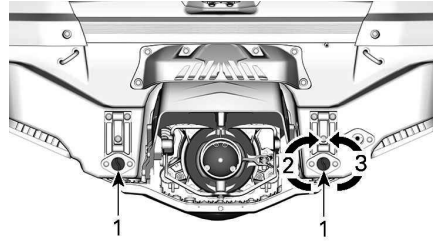

TYPICAL

1. Drain plugs
2. Tighten
3. Loosen

NOTICE

Ensure drain plugs are properly secured prior to launching the watercraft in water.

Cooler

This model comes equipped with a cooler and fishing rod holders.

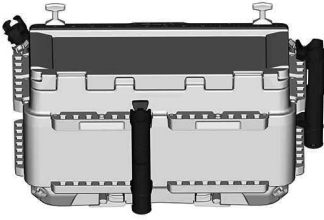

To install the cooler, refer to the following.

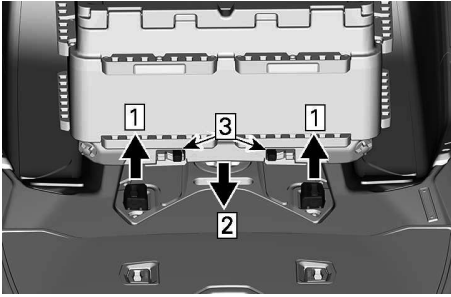

- Step 1. Lift LinQ
Step 2. Lower cooler
Step 3. Lock cooler in place

1. Lift LinQ attachments, making sure they are fully extended.
2. Lower cooler, making sure to be in the correct area.

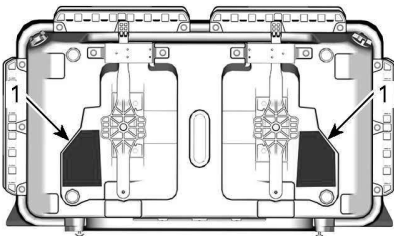

1. Correct area
3. Slide attachments toward the outside to lock.

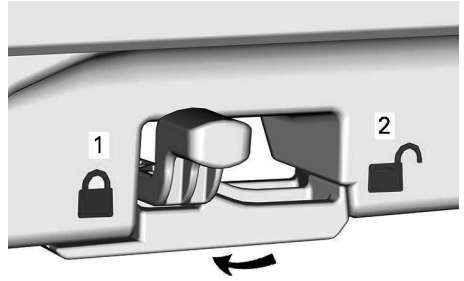

1. Locked
2. Unlocked
4. "Rock" cooler side to side and front to rear to ensure it is properly secured.

To remove the cooler, slide holding clamps toward the middle and simply lift the cooler.

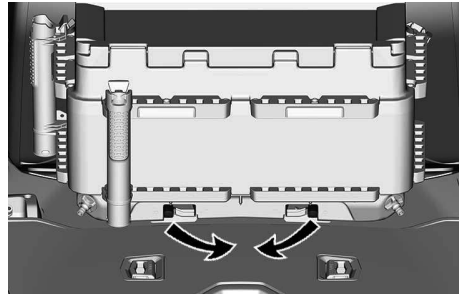

To lower the LinQ attachment when not in use, squeeze tabs.

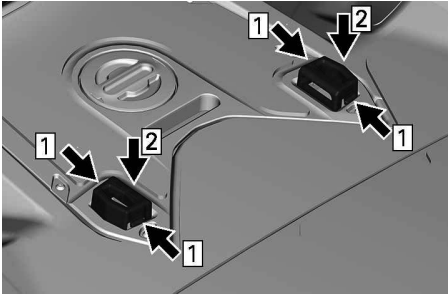

- Step 1. Squeeze LinQ attachments tabs.
Step 2. Lower LinQ attachments, making sure they are fully retracted.

⚠ CAUTION

To reduce the risk of injury, always lower the LinQ attachments when not in use.

The included rod holders can be installed at various locations on the cooler.



To remove the rod holders, press the tab and lift.

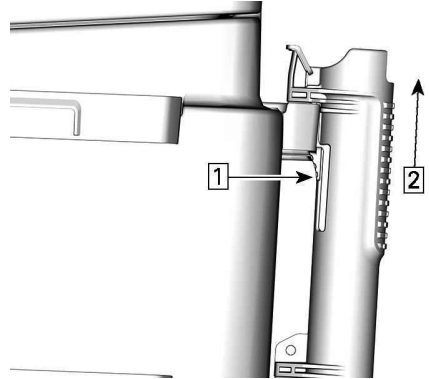

- Step 1. Press tab
Step 2. Lift rod holder

Two drain plugs are conveniently placed to empty the cooler.

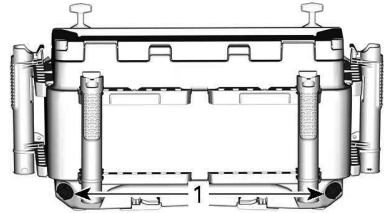

1. Drain plugs

The cargo net can be used to store various small objects.



⚠ WARNING

Adjust your speed when the cooler is installed. A loaded cooler will change the behavior of the PWC. Never leave anything on cooler lid while riding or trailering.

Fish Finder Sonar and Mount

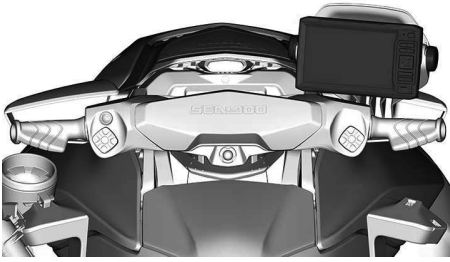

To remove the sonar, lift the tab and disconnect the electrical connectors.

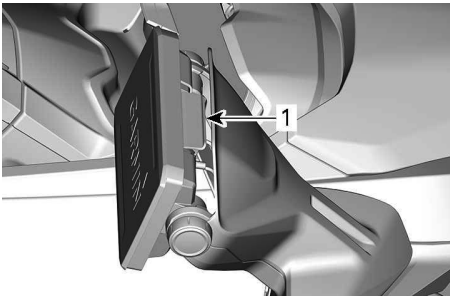

1. Lift tab to remove

NOTE:

It is important to install the protective caps when the sonar is not installed on the PWC and put a **light** coat of dielectric grease on the connector.

Refer to the included manufacturer guide for complete instructions.

To adjust the angle of the sonar, simply loosen the screws on the sides, place sonar at appropriate angle and retighten the screws.

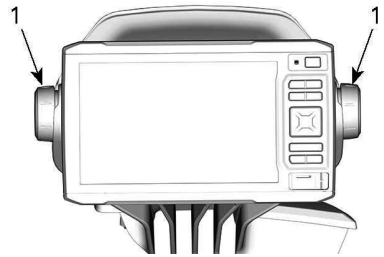

1. Angle screws

Front Rod Holder for Trolling

Two rod holders supports have been placed near the steering to install a rod holder.

This holder may be used to place and watch a fishing rod during trolling.

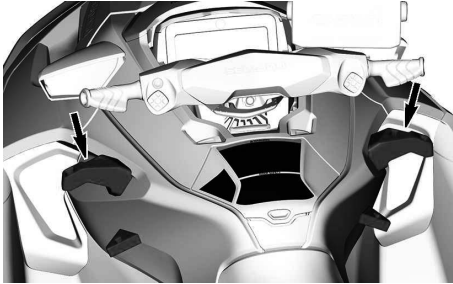

⚠ WARNING

Never ride with a fishing rod in the holder except during trolling. Always remove the fishing rod from the holder to ride from a spot to another. A treble hook could cause harm.

To remove the rod holder, press the tab and lift.

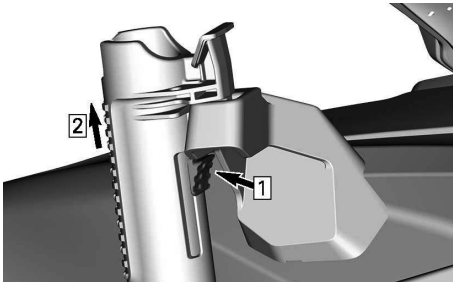

1. Press tab
2. Lift rod holder

Place the holder on left or right side.

Cup Holder

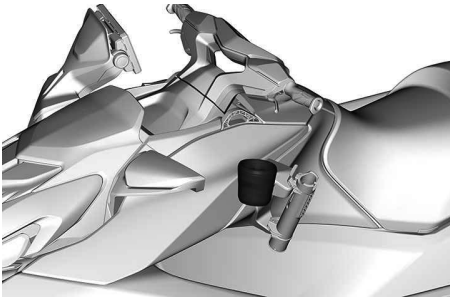

For your convenience, a cup holder can be added on the left or right fishing rod holder support.

The size of the container (bottle, cup, etc.) is important. A container with a large diameter will be retained more effectively than a small one.

It is therefore advisable to choose a container with the larger diameter as possible.

CAUTION

To avoid injury, remove any object from the cup holder when choppy water conditions occurs.

To remove the cup holder, press the tab and lift.

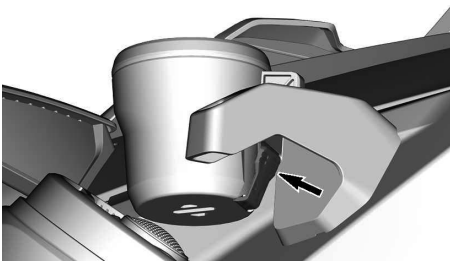

Place the cup holder on left or right fishing rod holder support.

Storage Bin Tackle Box Storage



4.5" DIGITAL DISPLAY

Multifunction Gauge Description

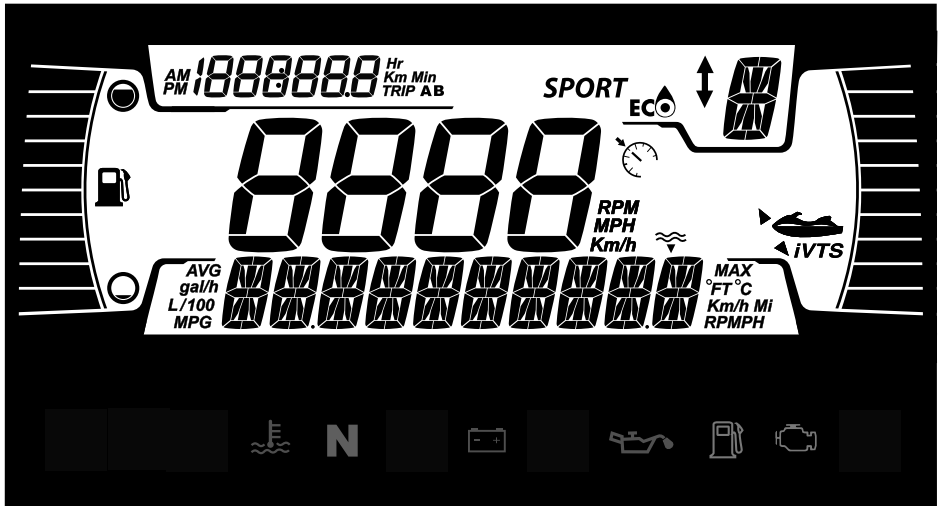

⚠ WARNING

Reading or tempering with the multifunction gauge can distract you from the operation of the vehicle, particularly from constantly scanning the environment. Always pay attention to water conditions, ensure your environment is clear and free from obstacles. Furthermore, when riding, only glance at the multifunction gauge briefly to stay focused on your environment.

The multifunction gauge includes digital gauges (temperature and tachometer), telltale lights, icons and a digital screen to see important information (speed, RPM, etc.).

Lower Display

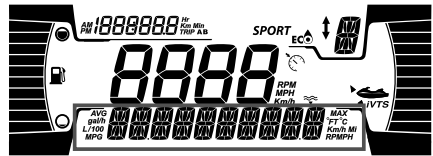

User can decide to display one the following:

- RPM
- Water temp : Displays the temperature of the water
- Depth (if equipped)
- Settings
- Messages
- Speed Stat (if equipped)

Left Lateral Display



The left lateral display includes:

- Fuel level indicator

Right Lateral Display



The right lateral display includes:

- VTS position

Central Display



The central display includes:

- Vehicle speed
- Speed control indicator (if equipped)

The speed control indicator in this display is only activated when a target speed is set.

iBR Position Display

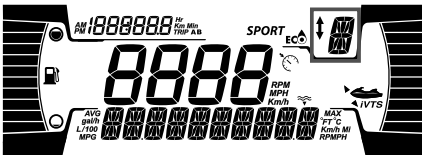

This display shows gears position of the iBR (if equipped):

- N (neutral)
- F (forward)
- R (reverse)

It can also display the selected speed level (1 to 9) when the slow speed mode is selected.

Left Upper Display

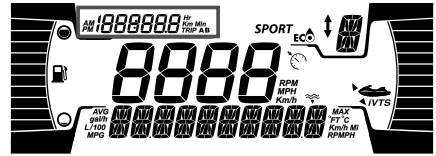

The left lateral display includes:

- Tripmeter
- Clock

User can decide to display one the following on the tripmeter:

- Vehicle hours : Displays the total vehicle hours
- Trip KM : Displays the distance since the last reset.
- Trip HR : Displays the time since the last reset.

NOTE:

Clock is shown only if the integrated GPS receives a signal from the satellites. This may take several seconds after waking up the system.

MODE Display

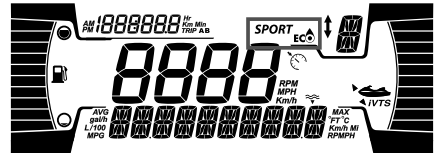

The MODE display indicate the selected alternative mode of operation:

- SPORT
- ECO

To cycle through the MODES;

- Press MODE button,
- Acknowledge the safety message by pressing and holding MODE button will get the SPORT mode,
- Pressing MODE button again will activate the SKI mode (if equipped),
- Pressing MODE button again will activate the ECO mode.

NOTE:

The SKI mode has no icon in the digital display. Refer to *operating modes* for more details.

Warning Lamps and Indicators

The following indicator lamps will alert you to a vehicle condition that may become serious. Some lamps will illuminate when starting the vehicle to make sure they work. If any lamps remain on after starting the vehicle, refer to the respective system warning lamp for further information.

NOTE:

Some warning indicators appear in the display of the multifunction gauge and function the same as an indicator lamp but do not display when starting the vehicle.

Telltale Lights - Lower Bar



Lights	Description
	ORANGE - Vehicle malfunction
	RED - The engine temperature is too high.
	GREEN - The neutral gear is selected
	RED - If illuminate while driving, it indicates a malfunction. Turn off all unnecessary electrical equipment and have the electrical and charging systems checked.
	RED - If illuminate while the engine running or

Lights	Description
	while driving, this indicates a malfunction. Stop the vehicle as soon as it is safe to do so and turn the engine off. Check the engine oil level. Have the lubrication system checked as soon as possible, even if the level being correct.
	ORANGE - Illuminate when the fuel level is low or when the fuel tank is near empty. Refuel as soon as possible.
	ORANGE Turned on: Malfunction of the vehicle emissions control system Blink: Engine limitation, the limp home mode is activated. Have the vehicle serviced immediately.

Icons and Indicators - Multifunction Display

Icons	Description
	Denotes SPORT mode is selected.
	Denotes ECO mode is selected.
	Steady ON: indicates that the VTS is activated (if equipped).
	Denotes Speed Limiter or Slow Speed mode (if equipped)

Settings

To...	Action
Navigate in the menu	Single press on INFO
Enter menu	Long press INFO
Edit value	Single press on INFO
Change information display	Press TRIP
Reset Trip (when displayed)	Long press TRIP
Fault codes/Maintenance	Long press INFO

Use the RIGHT arrow button or LEFT arrow button to navigate through setting menus. Use OK button to enter setting menu, to confirm selection or reset some values. Use UP arrow or DOWN arrow to change selected value.

Settings Menu

Using the RIGHT or LEFT arrow button, select **SETTINGS** and press OK button to enter setting menus.

Maintenance Reset

Select **RES MAINT** and hold OK button to reset maintenance.

NOTE:

The maintenance reset can only be done within the first 15 seconds of ECM wake-up when a maintenance is required.

Display Codes

Refer to *Displaying Fault Codes*.

Setting Tripmeter

Select **TRIP** and press UP or DOWN arrow button to cycle through **Vehicle Hours, Trip KM and Trip HR**.

Press and hold OK button to reset selected trip info.

Setting Learning Key

Connect a normal key to the vehicle. Select **L-KEY #** and press UP or DOWN arrow button to set the desired learning key level between 1 and 5.

Press and hold OK button to confirm.

NOTE:

The default learning key level is 1 (lowest performance).

Unit Selection

Select **UNITS** and press UP or DOWN arrow button to change units.

NOTE:

Changing units will apply to all the displayed units.

Setting Brightness

Select **BRIGHTNESS** and press UP or DOWN arrow button to adjust brightness level (from -4 to 4).

Setting Clock

Select **CLOCK**.

1. Press INFO button to select clock display.
2. Long press INFO button to enter clock editing.
3. Press INFO button to select 12:00 AM PM or 24:00 time base.
4. Long press INFO button to confirm and display hours.
5. Press INFO button to change hours.
6. Long press INFO button to confirm.

NOTE:

Menu available only if GPS is synchronized.

To exit **SETTINGS**, select **EXIT** and press OK button.

2 Keypads Models

1. Press OK button to select clock display.
2. Press UP or DOWN arrow button to select 12:00 AM PM or 24:00 time base.
3. Press OK button to confirm.
4. Press UP or DOWN arrow button to change hours.
5. Press OK button to confirm.

Resetting Speed Statistics (If Equipped)

Select **SPEED STAT** and press and hold OK button to reset the speed statistics.

NOTE:

The speed statistics are automatically reset after the gauge shut down.

Setting Language

The language of the display is factory setup by default in English. Refer to an authorized Sea-Doo dealer for language availability and to setup the gauge to your preference.

BREAK-IN PERIOD

Operation During Break-In Period

A break-in period of 10 operating hours is required before running the watercraft at sustained full throttle.

During this period, maximum throttle should not exceed 1/2 to 3/4 opening. However, brief full acceleration and speed variations contribute to a good break-in.

NOTICE

Continued wide open throttle accelerations or operation, prolonged cruising speeds are detrimental during the break-in period.

NOTE:

GTR 230: During the first 5 hours of operation, the engine management limits the engine maximum speed for engine protection. The engine performance will progressively increase during this period.

OPERATING INSTRUCTIONS

⚠ WARNING

Always perform the *Pre-Ride Inspection* before operating this watercraft. Be sure to read the *Safety Information* and the *Watercraft Information* sections and be thoroughly familiar with the iControl technology.

Should any control or instruction not be fully understood, refer to an authorized Sea-Doo dealer.

Boarding the Watercraft

As with any watercraft, boarding should be done carefully.

Make sure to practice each boarding method until fully able to safely board in any potential condition.

⚠ WARNING

Do not apply throttle when anyone is boarding or at rear of PWC. You can shut down the engine

Watercraft with iBR system

⚠ WARNING

Be aware of the iBR gate movement when starting the engine, shutting down the engine or using the iBR lever. Automatic movement of the gate may squeeze fingers or toes of people taking a hold on the back or your PWC. Never use iBR gate as a supporting point to board the watercraft.

Boarding from a Dock

1. Slowly place one foot on the watercraft footboard nearest the dock while holding the handlebar, and at the same time, transfer the body weight to the other side in order to balance the watercraft.
2. Then bring the other foot over the seat and place it on the other footboard.

3. Push the watercraft away from the dock.



Boarding from Water with the Cooler Installed

Board the watercraft using the boarding ladder and carefully get around the cooler. Refer to *BOARDING IN DEEP WATER*. If you have difficulties, proceed as follow.

Swim toward side, use passenger handhold and/or seat strap to lift yourself aboard.

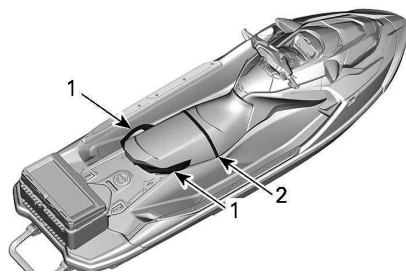

1. Passenger handhold
2. Seat strap

Boarding from Shallow Water

⚠ WARNING

Keep limbs away from propulsion system or intake grate. Never use propulsion systems a supporting point to board the watercraft.

1. Board the watercraft from either the side or the rear.

2. Ensure there is at least 90 cm (3 ft) of water underneath the lowest rear portion of the hull.

NOTE:

Take into account that the hull will be lower in the water when all passengers are aboard. Be certain to maintain the specified depth so sand, pebbles and rocks will not be drawn up in the jet pump.

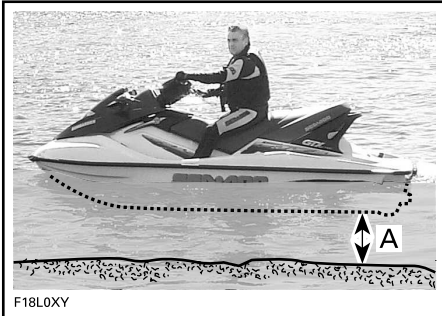

- A. Maintain at least 90 cm (3 ft) underneath the lowest rear portion of the hull when all passengers are aboard

NOTICE

Starting the engine or riding the watercraft in shallower water may damage the impeller or other jet pump components. Stay on center of the step. Only one person at a time on the ladder.

Boarding in Deep Water**⚠ WARNING**

Keep limbs away from propulsion system or intake grate. Never use propulsion systems a supporting point to board the watercraft.

⚠ WARNING

Ask inexperienced riders to practice how to board the watercraft close to shore (all methods explained here) before venturing into deep water, especially when cargo is installed aboard on the rear platform.

Operator Alone Without a Boarding Ladder

1. Using one hand, grab the rear handle.



1. Rear handle

NOTE:

If cargo is properly secured on the boarding platform, it can be used as a handle or removed and set aside in the footwell to get access to the handle. Always properly secure the cargo before riding.

2. With the other hand on the boarding platform, lift your body until you can lay one knee on the boarding platform.
3. Lay the other knee on the boarding platform.

**TYPICAL**

4. Take hold the seat or the seat strap to help maintain your balance and step forward onto the footboards on either side of the seat.



TYPICAL

5. Sit astride the seat.

It is possible to swim toward side, use passenger handhold and/or seat strap to lift yourself aboard.

NOTE:

The side boarding method is not recommended as a first try boarding method. It must only be used in last resort as it is not the easiest method to board a watercraft.

Operator Alone With a Boarding Ladder

1. Swim to the rear of the watercraft.
2. Using one hand, lower the boarding ladder.



TYPICAL

3. Using the other hand, take hold of the edge of the boarding platform, then pull yourself up so that you can knee onto the boarding ladder.



TYPICAL

NOTICE

- Stay on center of the ladder.
- Only one person at a time on the ladder.

4. Reach forward with one hand and take hold of the molded handles on the sides of the back seat or the rear handle, then stand on the boarding ladder.



1. Rear handle



TYPICAL

NOTE:

If cargo is properly secured on the boarding platform, it can be used as a handle or removed and set aside in the footwell to get access to the handle. Always properly secure the cargo before riding.

- With both hands on the handle behind the seat, step up onto the boarding platform.



TYPICAL



TYPICAL

- Take hold of the seat strap to help maintain your balance and step forward onto the footboards on either side of the seat.



TYPICAL

- Sit astride the seat.

Operator with a Passenger

- The operator climbs on the watercraft in the same way as explained previously.

In choppy water, while in the water, the passenger may hold the watercraft steady to help the operator climb aboard.



TYPICAL

NOTICE

Stay on center of the step. Only one person at a time on the step.

- The passenger then climbs onto the watercraft while the operator maintains balance by sitting as close as possible to the console.



TYPICAL - MODEL WITH BOARDING LADDER SHOWN



TYPICAL



TYPICAL

- The passenger must sit astride the seat and maintain a firm grip of a handhold or the waist of the person in front of them.



TYPICAL

How to Start the Engine

⚠ WARNING

Before starting the engine, the operator and passenger(s) should always:

- Be properly seated on the watercraft.
- Have a firm grip on a handhold or hold on to the waist of the person in front of them.
- Wear appropriate protective clothing including a PFD approved by local authorities and a wet suit bottom.

NOTICE

Ensure there is at least 90 cm (3 ft) of water under the lowest rear portion of the hull when all passengers are aboard prior to starting the engine. Otherwise damage to the propulsion system components may occur.

- Attach the tether cord clip to your PFD or to the wrist (wrist strap required).

⚠ WARNING

The tether cord shall always be attached to the operators personal flotation device or to the wrist (wrist strap required) when starting or operating the watercraft.

- Firmly grip handlebar with your left hand and place both feet on the footboards.
- Press the engine START/STOP button to wake up the electrical system.
- As the information center cycles through its self test function, install the tether cord on the engine cut-off switch.
- Depress the START/STOP button to start the engine.

NOTICE

In the event the engine does not start right away, do not hold START/STOP button more than 10 seconds to avoid starter overheating. A rest period should be observed between the cranking cycles to allow the starter to cool down. Refer to *Troubleshooting* section.

- Release engine START/STOP button after engine is started.

How to Stop the Engine

⚠ WARNING

To maintain watercraft directional control, the engine shall be running until the watercraft is stopped.

To shut off the engine:

- Press the engine START/STOP button, or
- Pull off the tether cord cap from the engine cut-off switch.

⚠ WARNING

Never leave the tether cord on the engine cut-off switch when disembarking watercraft to prevent theft, accidental engine starting, and to avoid unauthorized use by children or others.

If the engine is shut off using the START/STOP button and the tether cord is left on the engine cut-off switch, the electrical power will shut off after approximately 60 minutes to prevent battery discharge.

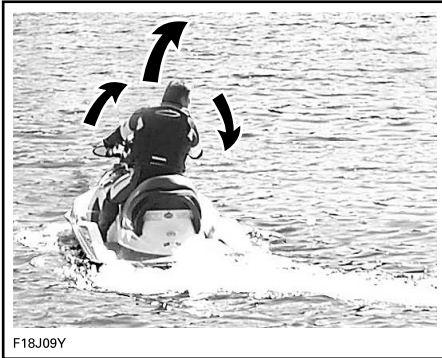
How to Steer the Watercraft

F18J09Y

Turning the handlebar pivots the jet pump nozzle which controls the watercraft direction. Turning the handlebar to the right will turn the watercraft to the right and inversely. You need to apply throttle to steer.

⚠ WARNING

Throttle must be applied and handlebar turned to change the direction of the watercraft. Steering efficiency will differ depending on the amount of throttle applied, the number of passengers, the load, the water conditions and the environmental factors such as the wind.

Unlike a car, a watercraft needs some throttle to turn. Practice in a safe area applying the throttle and turning away from an imaginary object. This is a good collision avoidance technique.

⚠ WARNING

Directional control is reduced when the throttle is released and lost when the engine is off.

The watercraft behaves differently with a passenger and requires greater skill. The passenger(s) shall grip the seat strap, the molded grab handle, or the waist of the person ahead of them. Reduce speed and avoid sharp turns. Avoid choppy water conditions when carrying a passenger.

Tight Turns and Other Special Maneuvers

Any tight turns or special maneuvers that will cause the air inlet openings to be kept under water for a prolonged time, water will seep into the bilge.

Combustion engines need air to operate; consequently this watercraft cannot be totally watertight.

NOTICE

If the air inlet openings are kept under water, such as turning constantly in tight circles, plunging the bow through waves, or capsizing the watercraft, water may seep into the bilge, which may cause severe damage to internal parts of the engine. Refer to the *Warranty* section contained in this guide.

How to Engage Neutral

⚠ WARNING

The drive shaft and impeller are always turning when the engine is running, even when the iBR gate is set to the neutral position. Keep away from the propulsion system of the watercraft.

When the watercraft is first started, the iBR system automatically sets the iBR gate to the neutral position by default.

If the gate is in forward thrust position, tap the iBR lever. The gate will move to neutral.

If braking or reverse is used, the iBR gate will move to the neutral position when the iBR lever is released, if throttle is not applied.

NOTE:

The throttle lever must be fully released for the iBR gate to move to the neutral position when the iBR lever is released.

If the engine is stopped in forward or reverse, the iBR gate will move to the neutral position on engine shutdown.

How to Trim the Neutral Position of the iBR

When in NEUTRAL, if the watercraft creeps forward or backward, the iBR system may be trimmed.

NOTE:

Movement of the watercraft when operating in neutral may be due to wind or water current.

To enter the Neutral Adjustment mode, hold down the VTS up or down button for 0.5 Sec.

The message **Neutral Adjust** will be displayed.

To adjust the neutral position:

- Watercraft is moving forwards - press the VTS DOWN button.
- Watercraft is reversing - press the VTS UP button.

Adjust to achieve no movement when the engine is at idle.

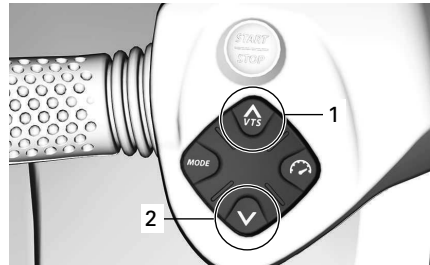

1. Bow up
2. Bow down

To exit the **Neutral Adjust**, press OK button or wait 25 sec.

How to Engage Forward

To engage forward thrust from neutral, tap on the throttle lever.

The gate will move to forward thrust position and the watercraft will accelerate forward.

To engage forward thrust from reverse, release the iBR lever while applying throttle moderately.

To re-engage forward thrust from braking, simultaneously pull in the throttle lever while releasing the iBR lever. The watercraft will accelerate forward after a short delay.

How to Engage and Use Reverse

Reverse can only be engaged between idle speed and the threshold forward speed of 14 km/h (9 MPH).

1. Pull in the iBR lever at least 25% of the lever travel.

2. Release the iBR lever to end reverse operation.
3. Apply enough throttle to stop rearward movement.

⚠ WARNING

The brake function has no effect when travelling in reverse.

When operating the iBR lever in reverse mode, the throttle lever can be used to control engine RPM, and thus the amount of reverse thrust produced.

By modulating both the iBR and throttle levers simultaneously, reverse thrust can be more precisely controlled. Too much RPM will create water turbulence and reduce reverse efficiency.

NOTE:

Engine power will be reduced to idle whenever the iBR lever position is changed.

Available engine power is limited in reverse mode, which limits reverse speed. However, speeds above 14 km/h (9 MPH) may be obtained in reverse depending on conditions.

⚠ WARNING

Only use reverse at slow speed and for the shortest time possible. Always ensure the path behind is clear of objects, obstacles and people.

When operating in reverse, turn the handlebar in the opposite direction that you want to move the rear of the watercraft.

For example, to steer the rear of the watercraft to port (left), turn the handlebar to starboard (right).

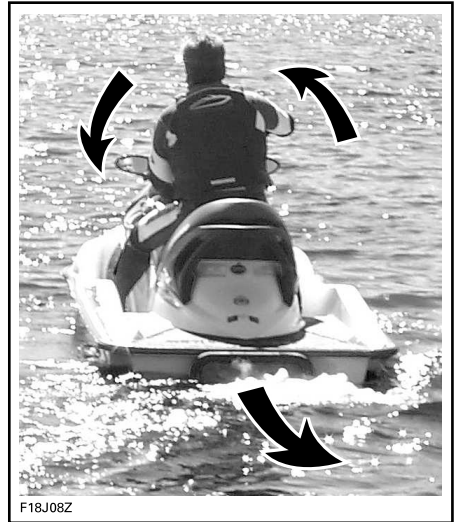

F18J08Z

TYPICAL - STEERING DIRECTION REVERSED WHEN BACKING

⚠ CAUTION

Steering direction in reverse thrust is opposite of forward thrust. To steer the stern to port (left) in reverse, turn the handlebar to starboard (right). To steer the stern to starboard (right), turn the handlebar to port (left). Reverse thrust operation should be practiced in open waters in order to become fully familiar with the controls and watercraft handling characteristics before operating in close quarters.

How to Engage and Use Braking

⚠ WARNING

The engine must be running to be able to use the brake. The brake is only applicable when operating in forward movement, it has no effect on rearward velocity. The brake cannot prevent your PWC from drifting due to current or wind.

The braking function can only be engaged during forward operation at or above the threshold speed of 14 km/h (9 MPH).

Braking is engaged and controlled when the iBR lever on the LH handlebar is pulled in at least 25% of its travel.

⚠ WARNING

Braking should be practiced in open waters and at gradually increasing speeds in order to become fully familiar with the controls and watercraft handling characteristics.

When iBR lever is applied, the throttle lever command is overridden and engine throttle control is now dependant on the iBR lever position. Braking can thus be modulated by using only the iBR lever.

Watercraft deceleration is proportional to the braking force. The more the iBR lever is pulled in, the greater the braking force applied.

NOTE:

Be careful to gradually actuate the iBR lever to adjust intensity of the braking force and simultaneously release the throttle lever.

⚠ CAUTION

When braking, riders must brace themselves against the deceleration force to prevent from moving forward on the watercraft and losing balance. The operator should always keep both hands on the handlebars, and all passengers should maintain a firm grip of a handhold or the waist of the person in front of them.

⚠ WARNING

Stopping distance will vary depending on initial speed, load, wind, number of riders, water conditions, and the amount of braking power commanded by the operator. Always adjust your riding style accordingly.

When the watercraft slows to less than 14 km/h (9 MPH), braking mode ends and reverse mode is engaged. Release the iBR lever once the watercraft is stopped. Otherwise, a rearward movement will be initiated.

⚠ CAUTION

As the watercraft slows to a stop, the wake created by the watercraft will catch up and tend to push the watercraft forward. Ensure there are no obstacles or bathers in the direction of travel.

If the throttle lever is still pulled in when releasing the iBR lever, the watercraft will accelerate forward after a short delay. Acceleration will be proportional to the throttle lever position.

⚠ WARNING

If forward acceleration is not desired when the brake lever is released, release the throttle lever.

When at speed and the brake is first applied, a plume of water will shoot up in the air behind the watercraft which may cause the operator of a following watercraft to momentarily loose sight of your PWC.

⚠ WARNING

It is important to inform other operators who intends to follow in a convoy formation of the braking and maneuvering capability of your vehicle, what the plume of water indicates, and that a greater distance should be maintained.

Braking in a Turn

Throttle must be applied for turning to ensure directional control. However braking can be initiated during a turn using the iBR lever as previously described. Get ready to maintain your balance while the wake is crossing your PWC.

⚠ CAUTION

As the watercraft slows to a stop while braking in a turn, the wake created by the watercraft will catch up and tend to push the watercraft sideways. Be prepared to maintain balance as the wake crossed the watercraft.

How to Use the Variable Trim System

The variable trim system (VTS) changes the vertical position of the jet pump nozzle to provide the operator with a fast, effective system to compensate for load, thrust, riding position and water conditions. Correctly adjusted, it can improve handling, reduce porpoising, and position the watercraft at its best riding attitude to attain maximum performance.

When first using the watercraft, the operator should become familiar with the use of the variable trim system (VTS) at varying speeds and water conditions. A mid-range trim is generally used when cruising. Experience alone will dictate the best trim for the conditions. During the watercraft break-in period, when lower speeds

are recommended, it is an excellent opportunity to become familiar with trim adjustment and its effects.

When the nozzle is positioned in an upward angle, the water thrust directs the bow of the watercraft upward. This position is used to optimize high speed.

When the nozzle is directed downward, the bow is forced downward and increases the watercraft turning capabilities. As with any watercraft, speed and operator body position and movement (body English), will determine the degree and sharpness of the watercraft turn. Porpoising can be reduced or eliminated if the nozzle is downward and speed is adjusted proportionately.

NOTE:

VTS position is indicated on a bar gauge in the right lateral display of the information center.

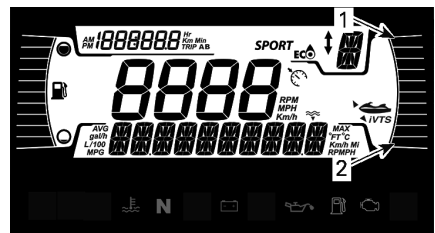

1. Bow up
2. Bow down

The VTS system allows for manually adjusting the trim position of the nozzle.

VTS Trimming Methods

AVAILABLE VTS TRIMMING METHODS	FISH PRO
VTS trim button	X
VTS "double click" trimming	X
Launch Control	-
Extended VTS	-
X = Indicates a standard feature - = See a Sea-Doo dealer for availability.	

Trimming the VTS Using the VTS Button

Nine trim positions are available.

With the watercraft operating in forward thrust, proceed as follows.

NOTE:

Pressing the VTS trim button without the engine in forward thrust will only change the indication. The nozzle will move to the selected VTS trim position when forward thrust is engaged.

1. Press the VTS UP button once to trim the bow of the watercraft up to the next up trim position.
2. Press the VTS DOWN button once to trim the bow of the watercraft down to the next down trim position.

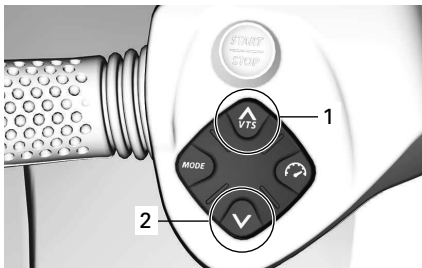

1. Bow up
2. Bow down

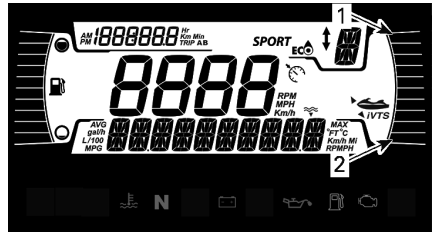

1. Bow up
2. Bow down

NOTE:

If the VTS UP or DOWN button is pressed and held, the pump nozzle will keep moving until the button is released at the desired trim attitude or the maximum trim position (up or down) is reached.

Using Preset Trim Positions

Three preset trim positions can be selected.

To select the highest trim position recorded, double-click on the VTS UP button (bow up).



To select the lowest trim position recorded, double-click on the VTS DOWN button (bow down).

Launch Control

The launch control is an automatic adjustment of the VTS to achieve optimum acceleration by getting on plane faster.

When the speed is below 20 km/h (12 MPH), the VTS lowers to it's lowest position and the VTS indicator flashes to indicate the system is ready for an acceleration.

When the speed exceeds 30 km/h (19 MPH), the VTS returns to the user selected position.

When the launch control function is activated, the iVTS icon is visible

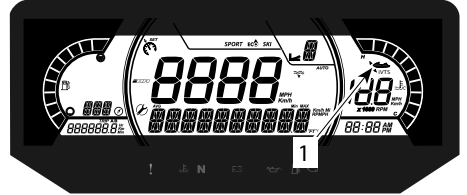

1. Launch control indicator

To activate the **Launch Control**, press simultaneously both VTS UP and VTS DOWN buttons.

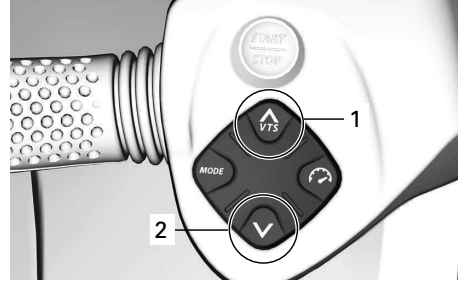

1. Up
2. Down

The message **ONE LAUNCH** will be displayed. The launch control will deactivate itself after one use.

Press simultaneously both VTS UP and VTS DOWN buttons again.



To select the mid trim position, it depends on the actual trim position. Double-click on the VTS UP button if it is positioned below mid trim or double-click on the VTS DOWN button if it is positioned above mid trim.



NOTE:
These preset trim positions are not adjustable.

The message **LAUNCH ON** will be displayed. The launch control will stay active until manually deactivated.

To deactivate the launch control, press simultaneously both VTS UP and VTS DOWN buttons again.

The message **LAUNCH OFF** will be displayed and the last selected driving mode will be activated.

NOTE: The launch control function is deactivated when the engine system is turn off

General Operating Recommendations

NOTICE

Combustion engines need air to operate; consequently this PWC cannot be totally watertight. Any maneuvers such as turning constantly in tight circles, plunging the bow through waves, or capsizing the watercraft, that cause the air inlet openings to be under water may cause severe engine problems due to water ingestion. Refer to *How to Steer the Watercraft* in the *Operating Instructions* section and the *Warranty* section contained in this Operator's Guide.

Rough Water or Poor Visibility Operation

Avoid operation in these conditions. If you must do so, proceed with caution using minimum speed.

Crossing Wakes or Waves

1. The operator must grip the handlebar firmly and keep both feet on the footboards.
2. The passenger must grip the handholds with both hands and keep both feet on the footboards.
3. Reduce speed.

4. Always be prepared to steer and maintain your balance as necessary.
5. When going over waves, raise your body slightly off the seat to absorb the shocks with your legs.
6. When crossing wakes, always keep a safe distance from watercraft ahead.

⚠ WARNING

When crossing wakes or waves, slow down. Operator and passenger(s) should brace themselves and adopt a semi-standing position to help absorb the bumps. Do not jump wakes or waves - jumping can cause injuries such as back or spinal injury (paralysis).

Stopping/Docking

When the throttle is released, the watercraft is slowed by water drag against the hull. The stopping distance will vary depending on the watercraft size, weight, speed, water surface condition, presence and direction of wind and current.

The iBR system can also be used for slowing down or for stopping more quickly, and for increasing maneuverability especially when docking.

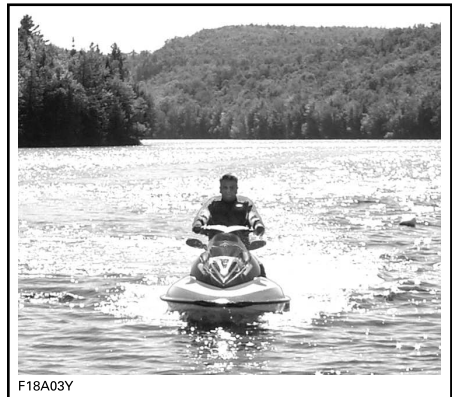

F18A03Y

The operator should practice in open waters at various speeds to become familiarized with the stopping distances under different conditions. Stopping using the iBR system in a straight line and in a turn should be practiced extensively to become familiar with the handling characteristics of the watercraft under partial or full braking conditions.

⚠ WARNING

Always practice braking in open waters ensuring there are no watercrafts or boats in your immediate vicinity, especially astern. Other users of the waterways may not be able to maneuver or stop in time to avoid you should you unexpectedly come to a full stop in front of them.

When at speed and the brake is first applied, a plume of water will shoot up in the air behind the watercraft and may cause the operator of a following watercraft to momentarily lose sight of your PWC.

⚠ WARNING

It is important to inform other operators who intends to follow in a convoy formation of the braking and maneuvering capability of your vehicle, what the plume of water indicates, and that a greater distance should be maintained.

The operator should also practice docking with an imaginary dock using the various controls available (iBR lever and throttle lever).

Release the throttle at a sufficient distance before the expected landing area.

Reduce speed to idle.

Maneuver using a combination of the iBR lever and throttle lever, shifting to

neutral, reverse, or forward as required.

Remember that when operating in reverse, steering direction is reversed. Turning the handlebars to the left will move the stern to the right when backing up, and vice-versa.

⚠ WARNING

Directional control is reduced when the throttle is released and/or when engine is off. Steering direction is reversed when operating the watercraft in reverse.

Beaching

NOTICE

It is not recommended to run the watercraft to the beach.

Drive slowly towards the beach and shut off the engine before the water is less than 90 cm (3 ft) deep under the lowest rear portion of the hull. Then pull the watercraft to the beach.

NOTICE

Riding the watercraft in shallow water may result in damage to the impeller, iBR components, or other jet pump components. Always shut off the engine before water is less than 90 cm (3 ft) deep and never use reverse or braking.

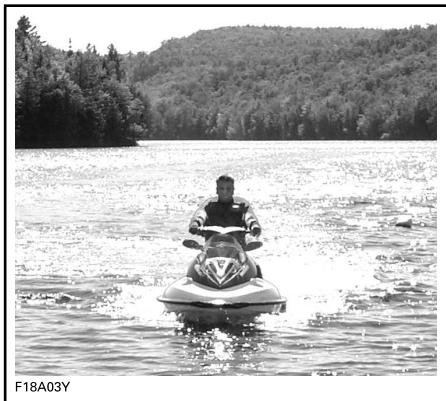

How to Use the intelligent Debris Free Pump System (iDF System)

The iDF system is designed to allow removing small debris or a cord caught in the jet pump by turning the propeller in reverse during a few seconds.

To activate the system, do the following:

1. Stop the engine.
2. Press and hold the iDF button.

The following messages can appear in the digital display during this step.

- **Engaging + R icon blinking** - The request is accepted and the sequence begins.
- **Stop engine then hold iDF** - Engine is still running and must be stopped before pressing the iDF button again.
- **High exhaust temperature** - Exhaust temperature is too high and needs to cool down before activating the sequence.
- **Disable** - The iDF system is not enabled on your PWC, see an authorized Sea-Doo dealer to enable it.

3. Start engine when the message **Press start to go** is displayed.

When the sequence is completed, the message **Ready to start** will be displayed.

4. Apply throttle when requested.

If the message **Impeller blocked** is displayed - this indicates that the blocking is too important and the system cannot turn the propeller in the opposite direction. Have the PWC servicing by an authorized Sea-Doo dealer.

5. After a few seconds, the engine will shut down automatically. **Engaging + R icon blinking** will appear.
6. Start engine when the message **Press start to go** is displayed.

When the sequence is completed, the message **Ready to start** will be displayed.

7. Start the engine and try the PWC when the message **Ready to start** will be displayed.
8. If the propulsion system has not returned to 100% of its original performance due to any remaining debris, stop engine and perform these steps again.

A moderate clog of weeds may require multiple cycles before they can be entirely cleared out.

- Between cycles, it is more efficient to try to drive the PWC to permit it to plane in order to help dislodge any remaining weeds before reattempting the iDF cycle.

If the problem persists after several tries, try the *On-Beach Water Cleaning* procedure, refer to *Jet pump Water Intake and Impeller Cleaning* in *Special Procedures* section.

OPERATING MODES

Operating mode available	FISH PRO
Touring mode	X
Sport mode	X
ECO mode	X
Speed limiter mode	X
Slow speed mode (Trolling mode)	X
Ski mode	-
Learning key mode	X

X = Indicates a standard feature
- = See a Sea-Doo dealer for availability.

To change the operating mode;

1. Press MODE button,
2. Acknowledge the safety message by pressing and holding MODE button will get the SPORT mode,
3. Pressing MODE button again will activate the ECO mode.



TYPICAL

Default Riding Mode

By default, the watercraft is set to DEFAULT riding mode of operation when started.

Sport Mode

SPORT MODE provides for instant throttle response and more rapid

accelerations than DEFAULT riding MODE.

Once activated, SPORT MODE will remain active until it is deactivated by the operator, or the engine is shut down whereby it defaults back to DEFAULT riding MODE.

Activating Sport Mode

To activate the Sport mode, press once on the MODE button while in DEFAULT riding mode. The sport icon will start to flash and a safety message will scroll. For safety reason, follow the instruction in the safety message to activate the sport mode. Once activated, the SPORT icon will turn ON.

Deactivating Sport Mode

A single press on MODE button will take you to the ECO mode.

ECO Mode (Fuel Economy Mode)

ECO mode provides a smoother throttle application and increased fuel economy.

Speed Control Modes (If Equipped)

To enter one of the speed control modes, press SPEED CTRL button. Depending of the speed of the

Speed Limiter Mode

Speed limiter mode is a function of iTC (intelligent Throttle Control) system that allows the operator to set the desired maximum watercraft speed.

This is useful when cruising for long distances, operating in limited speed zones, or towing a tuber, skier or wake boarder.

The operator must keep the throttle depressed to maintain forward speed.

Once the maximum speed is set, the operator can vary the watercraft speed from idle speed up to the set speed using the throttle lever. The set speed will not be exceeded even if the throttle lever is fully depressed.

As you proceed under a constant speed setting, keep your attention

watercraft, only one of the following modes will be activated.

Once the desired mode is activated, press the SPEED CTRL button then change the value with the UP or DOWN arrow button while the SET LEVEL or SET SPEED message is active.

To exit the selected speed control mode, press MODE button or long press SPEED CTRL button.

level up to maintain good situational awareness.

Slowing down is a matter of releasing the throttle lever further than the set point, or by pulling the iBR lever in.

If the iBR lever is pulled in for braking, Speed Limiter mode is overridden but **not deactivated**.

Once the iBR lever is released and the throttle is pulled in to engage forward thrust, the speed limiter function will reengage to limit the watercraft speed as it was set before.

Prerequisite for Speed Limiter Mode Activation

Speed limiter MODE can be activated when the watercraft is going at more than 15 km/h (9 MPH).

NOTE:

Speed limiter mode is not available if slow speed mode is engaged.

Activating Speed Limiter Mode

1. Maintain a constant speed.
2. Press the Speed Control button on the left keypad.

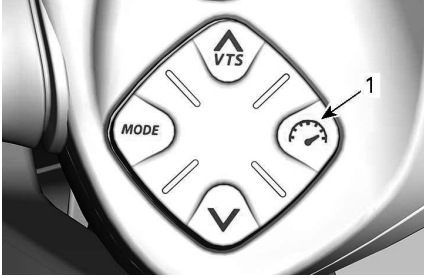

1. Speed Control button

You will hear a beep indicating that you are now in speed limiter mode, and the speed control MODE indicator will be lit.

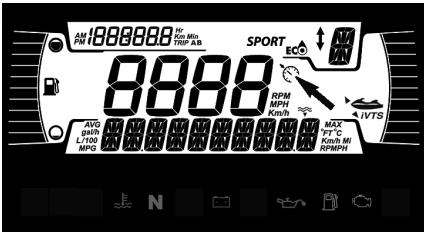

TYPICAL

NOTE:

Activating speed limiter mode of operation only limits the maximum speed available when depressing the throttle lever. The throttle lever must be held in to maintain forward speed. Watercraft speed can be varied from idle up to the set cruise speed using the throttle lever once the speed limiter function is activated. Watercraft speed may vary depending on water conditions during use.

Deactivating Speed Limiter Mode

To deactivate speed limiter mode:

1. Release the throttle lever.
2. Press and hold the SPEED CTRL button or press MODE button.

Deactivation of speed limiter mode is indicated by:

- The speed limiter indicator will go off.

NOTE:

If the throttle lever is not fully released when the button is pressed to deactivate the speed limiter mode, the speed control MODE indicator will remain on. The speed limiting function will stay active until the throttle is fully released, then the speed control MODE indicator will go out.

Slow Speed Mode

The Intelligent Throttle Control also allows for a Slow Speed Mode where the driver can adjust and set idle speed. This is useful when operating in slow speed zones where the driver must be especially attentive to possible obstacle avoidance.

If you accelerate above approximately 15 km/h (9 MPH), Slow Speed Mode will be deactivated and the engine will return to idle RPM when the throttle is released.

Should a situation arise where the operator must stop or accelerate quickly away from a hazardous situation, pulling in the iBR lever, or pulling in on the throttle lever will deactivate slow speed mode and normal control of the watercraft will be returned to the operator.

Prerequisite for Slow Speed Mode Activation

Slow Speed MODE can be activated when the watercraft is going at less than 15 km/h (9 MPH).

NOTE:

Slow speed mode is not available if speed limiter mode is engaged.

Activating Slow Speed Mode

To activate slow speed mode of operation:

1. Release the throttle lever to idle RPM.
2. Press the SPEED CONTROL button on the left keypad.

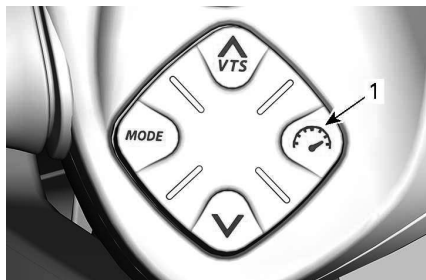

1. Speed Control button

The Speed Control indicator will come on in the multifunction display to indicate activation.

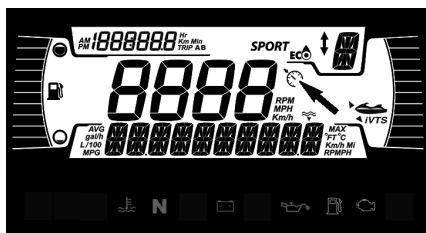

TYPICAL

A message will scroll in the multifunction display to specify that you are now in slow speed mode.

The default slow speed setting of 5 will show in the numerical display.

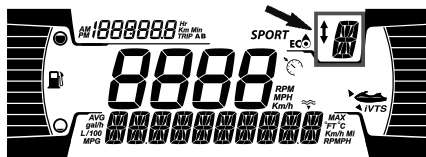

Changing Set Slow Speed

To **increase** or **decrease** the set slow speed, press the UP/DOWN button on the RH handlebar once, or repeatedly.

NOTE:

There are 9 slow speed settings available (1 through 9). Adjust slow speed mode to desired speed.

When pressing the up/down button, a message "SET LEVEL" will appear.

You can select from one of the 9 slow speed setting (1 to 9).

Level 5 is the default and it correspond to the normal idle of the vehicle. By using level 1-4 you can slow down the vehicle and go as slow as 1.5 km/h (1 MPH). The slow speed mode can be used as a trolling mode and is useful for fishing. Level 6-9 gives you the ability to go up to 12 km/h (7 MPH) without touching the throttle lever.

⚠ WARNING

The operator must always be seated in driving position at all times when pwc is at speed. - The tether cord must be attached to the operator's PFD or wrist (wrist strap required) at all times.

NOTE:

Speed will vary depending on load, wind and waves conditions

Deactivating Slow Speed Mode

The slow speed mode can be deactivated using any of the following methods:

- Pressing and holding the Speed Control button.
- Depressing the iBR lever.
- Accelerating past the set slow speed.

When deactivating SLOW SPEED MODE by accelerating using the throttle lever, the iBR gate stays in the forward position.

When using the iBR lever, the iBR gate will move towards the reverse position, then neutral when the lever is released.

SLOW SPEED MODE deactivation will be indicated in the following manner:

- The Speed Limiter indicator will go out

Ski Mode (If Equipped)

Ski mode allows for repeated and precisely controlled launches, and a set towing speed, specifically for towing a skier or wake boarder.

NOTE: A GPS signal is required in order for the ski function to appear in the cluster. To obtain a suitable GPS signal, we recommend that you take the vehicle outside.

RAMP Function

The RAMP function offers a pre-programmed setting for launching and accelerating the PWC.

RAMP 1 provides:

- Slowest launch (smoothest)
- Slowest acceleration rate

RAMP 5 provides:

- Quickest launch
- Quickest acceleration rate

TARGET SPEED Function

The TARGET SPEED function limits the maximum towing speed.

Once the RAMP has been selected, an average PWC target speed for that RAMP will be visible in the numerical display.

The operator may increase or decrease the target speed to any value within the selected RAMP speed range.

Using Ski Mode

Press MODE button to select the SKI mode.

Models with 2 Keypads only

1. Press OK button when SKI icon flashes.
2. Select ski ramp by using the UP or DOWN arrow button. Ramp 1 will give the slowest acceleration.

NOTE:

Acceleration ramp will not behave the same depending on the vehicle type, vehicle load and water conditions. For safety reasons, always start using ramp # 1 to familiarize your skier with acceleration and then change the ramp as needed.

3. Press OK or RIGHT arrow button to confirm acceleration ramp.
4. Select the maximum target speed by using the UP or DOWN arrow button.
5. Press OK or RIGHT arrow button to confirm.

NOTE:

At any moment you can use the LEFT and RIGHT arrow buttons to change the ramp and speed selection.

6. After your selection and when you are ready, press the OK button to activate the function.

NOTE:

MODE remains active and ready until another driving mode is chosen.

Deactivating Ski Mode

To end a ski run and completely deactivate ski mode, release the throttle to idle, then press the MODE button.

Learning Key Mode

The learning key provides a mode of operation whereby engine power and speed is limited.

There are 5 speed settings available.

By default, the speed setting is no 1.

Refer to *4.5" Digital Display* for adjustment.

SPECIAL PROCEDURES

Jet Pump Water Intake and Impeller Cleaning

WARNING

Keep away from intake grate while engine is running. Items such as long hair, loose clothing or personal flotation device straps can become entangled in moving parts.

Weeds, shells or debris can get caught on the intake grate, drive shaft and/or impeller. A clogged water intake may cause troubles such as:

- **Cavitation:** Engine speed is high but watercraft moves slowly due to reduced jet thrust, jet pump components may be damaged.
- **Overheating:** Since the jet pump operation controls the flow of water to cool the exhaust system, a clogged intake will cause the engine to overheat and damage engine internal components.

A weed clogged area can be cleaned as follows:

WARNING

If it is necessary to reach in to remove any foreign object caught in the propulsion system, the tether cord **MUST BE REMOVED** from the engine cut-off switch.

In-Water Cleaning

NOTICE

Ensure there is at least 90 cm (3 ft) of water under the lowest rear portion of the hull when all passengers are aboard prior to starting the engine. Otherwise damage to the propulsion system components may occur.

Models equipped with the iDF system

If the watercraft is equipped with the iDF system, use it now. Refer to *How to Use the intelligent Debris Free Pump System* in *Operating Instructions* section.

Models without iDF system

1. Rock the watercraft several times. Most of the time, this will remove the blockage.
2. Start engine and make sure watercraft operates properly.

If the aforementioned method does not work:

3. With engine running and before applying throttle, pull the iBR lever in to select reverse operation.
4. Vary throttle quickly several times.
5. Repeat procedure if necessary.

If system is still blocked, move the watercraft out of the water for cleaning. Refer to *On-Beach Water Cleaning*.

On-Beach Water Cleaning

WARNING

The tether cord **MUST BE REMOVED** from the engine cut-off switch to prevent accidental engine starting before cleaning the jet pump area.

1. Place a cardboard or a carpet beside the watercraft to prevent scratching when turning the watercraft for cleaning.
2. Rotate the watercraft to any side for cleaning.

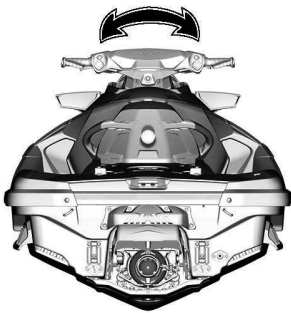
**TYPICAL**

3. If equipped, move the iBR to the forward position. Refer to *iBR Override Function* for detailed instructions.
4. Clean the water intake area.

If the system is still clogged, refer to an authorized Sea-Doo dealer for servicing.

NOTICE

Inspect water intake grate for damage. Refer to an authorized Sea-Doo dealer for repair as necessary.

iBR Override Function

When the iBR override function is activated, it allows the user to electrically move the iBR gate and nozzle through its full range of motion using the VTS control button.

NOTE:

The iBR override function is only available when the engine is not running.

⚠ WARNING

When moving the iBR gate using the iBR override function, ensure no one is near the rear of the watercraft. Movement of the gate may squeeze fingers.

NOTICE

An object or tool caught in the iBR system when using the iBR override function may cause damage to the iBR components. Remove all rigid foreign objects that may obstruct the iBR gate travel before moving it.

⚠ WARNING

If it is necessary to reach in to remove any foreign object caught in the propulsion system, strictly observe the following before proceeding:

- Remove tether cord from the engine cut-off switch.
- Wait at least 5 minutes.
- Do not press on START/STOP button. Should the START / STOP button be pressed, wait another 5 minutes.

Activating iBR Override Function

1. Power up the electrical system by pressing the START/STOP button.
2. Install the tether cord on the engine cut-off switch.

NOTE: The tether cord must be installed to ensure the information center will not shut off all indications after its self test function. Electrical power will stay on for approximately 1 hour.

3. Pull in and hold the iBR lever for the entire procedure.

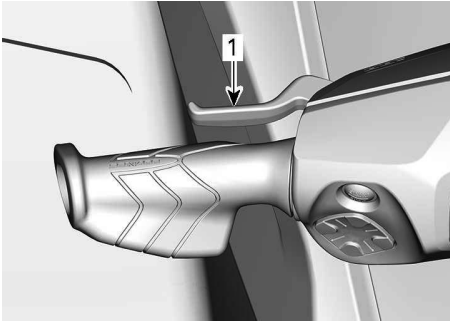

1. iBR lever pulled and held
4. When the **IBR OVERRIDE - PRESS MODE BUTTON** message appears in the multifunction gauge, press the MODE button.

When the function is activated, a ON message will be shown.

5. While still holding the iBR lever in, press the VTS UP/DOWN button to move the iBR gate to the desired position. Ensure the VTS indication in the multifunction gauge changes with the iBR gate movement. If the iBR gate moves upwards, the indication moves upwards.
6. Release the iBR lever.
7. Remove the tether cord from the engine cut-off switch.

⚠ WARNING

If it is necessary to reach in to remove any foreign object caught in the propulsion system, strictly observe the following before proceeding:

- Remove tether cord from the engine cut-off switch.
- Wait at least 5 minutes.
- Do not press on START/STOP button. Should the START / STOP button be pressed, wait another 5 minutes.

Capsized Watercraft

The watercraft is designed so that it should not turn over easily. Two

sponsors mounted on the side of the hull assist watercraft stability. If it turns over, it will remain capsized.

To turn the watercraft upright, ensure the engine is off and the D.E.S.S. key is **NOT** on its post, then grab the inlet grate, step on a side bumper rail and use your weight to rotate the watercraft towards you.

NOTE:

A label on the stern near the flushing connector provides instructions on how to turn the watercraft right side up. The label is upside down so that it can be read when the watercraft is overturned.



TYPICAL

The engine features a Tip-Over Protection System (T. O. P. S.™). When the watercraft tips over, the engine is automatically stopped.

When the watercraft is returned to its normal operating position, the engine can be started normally.

NOTICE

When the watercraft has been turned over 5 minutes, do not attempt to crank the engine to avoid water ingestion that would damage the engine. See an authorized Sea-Doo dealer as soon as possible.

NOTICE

If the engine does not crank, do not attempt to start it anymore. Otherwise, the engine could be damaged. See an authorized Sea-Doo dealer as soon as possible.

As soon as possible, check for presence of water in the bilge. Drain as necessary when back to the shore.

Submerged Watercraft

To limit damages to the engine, perform the following procedure as soon as possible.

1. Drain bilge.
2. If it was submerged in salt water, spray bilge and all components with fresh water using a garden hose to stop the salt corroding effect.

NOTICE

Never try to crank or start the engine. Water trapped in intake manifold would flow towards the engine and possibly cause severe engine damage.

3. Bring the watercraft to an authorized Sea-Doo dealer as soon as possible to have it serviced.

NOTICE

Failure to have the engine properly serviced may cause severe engine damage.

Water-Flooded Engine

NOTICE

Never try to crank or start the engine. Water trapped in intake manifold would flow towards the engine and possibly cause severe engine damage.

Bring the watercraft to an authorized Sea-Doo dealer as soon as possible to have it serviced.

NOTICE

Failure to have the engine properly serviced may cause severe engine damage.

Towing the Watercraft in Water

Special precautions should be taken when towing a Sea-Doo watercraft in water.

The maximum recommended towing speed is 8 km/h (5 MPH).

This will prevent the exhaust system from filling with water, which may lead to water being injected into and filling the engine. Without the engine running, there isn't any exhaust pressure to push the water out the exhaust outlet.

NOTICE

Failure to follow these instructions may result in damage to the engine. If you must tow a stranded watercraft in water, be sure not to exceed the maximum towing speed of 8 km/h (5 MPH).

NOTICE

Never tow a watercraft facing backwards as water intrusion may occur.

CAUTION

A tow line shall always be made fast in such a way that it can be released when under load.

MAINTENANCE

MAINTENANCE SCHEDULE

Maintenance is very important for keeping the watercraft in a safe operating condition. The watercraft should be serviced as per the maintenance schedule.

WARNING

Failure to properly maintain the vehicle according to the maintenance schedule and procedures can make it unsafe to operate.

EPA Regulation - Canadian and USA Vehicles

A repair shop or person of the owner's choosing may maintain, replace, or repair emission control devices and systems. These instructions do not require components or service by BRP or authorized Sea-Doo dealers.

Although an authorized Sea-Doo dealer has an in-depth technical knowledge and tools to service your vehicle, the emission-related warranty is not conditioned on the use of an authorized Sea-Doo dealer or any other establishment with which BRP has a commercial relationship.

Proper maintenance is the owner's responsibility. A warranty claim may be denied if, among other things, the owner or operator caused the problem through improper maintenance or use.

For emission-related warranty claims, BRP is limiting the diagnosis and repair of emission-related parts to the authorized Sea-Doo dealers. For more information, please refer to the *US EPA Emission-Related Warranty* contained in the *Warranty* section.

You must follow the instructions for fuel requirements in the fueling section of this manual. Even if gasoline containing greater than ten volume percent ethanol is readily available, the US EPA issued a prohibition against the use of gasoline containing greater than 10 vol% ethanol that applies to this vehicle. The use of gasoline containing greater than 10 vol% ethanol with this engine may harm the emission control system.

The maintenance schedule does not exempt the Pre-Ride Inspection and Post-Operation Care.

After Each Ride in Salt or Dirty Water

Rinse engine compartment with fresh water and drain salt water

Flush exhaust system

Every Month in Salt or Dirty Water

Spray anticorrosion lubricant to metallic components in engine compartment (every 10 hours in salt water use)

Inspect sacrificial anodes

**After First 6 Months or 50 Hours
(Whichever Comes First)**

Replace engine oil and filter (1630 ACE engines)

**Every Year at Preseason or 100 Hours of Operation
(Whichever Comes First)**

Inspect sacrificial anodes

Check for fault codes

Perform all items indicated in the Pre-Ride Inspection and Post Operation Care

Replace engine oil and filter

Inspect engine rubber mounts

Inspect the cooling system (coolant level, hoses and fasteners for leaks)

Visually inspect connection between throttle body and intake manifold

Inspect the air intake for damage on hoses and clamps

Inspect electrical connections and fastening (ignition system, starting system, fuel injectors, fuse box etc.)

Visually inspect area around carbon ring and drive shaft rubber bellows for the following signs of failure: black carbon dust and water sprays (more frequently when using PWC in dirty water)

Visually inspect impeller and bellow

Visually inspect impeller and wear ring for deep scratches, nicks and grooves

Remove impeller cover and inspect for signs of water intrusion

Visually inspect reverse gate bushing for excessive play

Inspect fuel cap, filler neck, fuel tank, straps, fuel lines and connections

Visually inspect coolant level in transducer support, top-off if necessary.

**Every 2 Years or 200 Hours of Operation
(Whichever Comes First)**

Replace spark plugs

Validate condition of jet pump bearing by manually spinning impeller checking for radial shaft play or noise

Verify and lubricate splines of the drive shaft and impeller

**Every 5 Years or 300 Hours of Operation
(Whichever Comes First)**

Replace the coolant

MAINTENANCE PROCEDURES

This section includes instructions for basic maintenance procedures.

⚠ WARNING
Turn off the engine and follow these maintenance procedures when performing maintenance. If you do not follow proper maintenance procedures you can be injured by hot parts, moving parts, electricity, chemicals or other hazards.

⚠ WARNING
Should removal of a locking device (e.g. lock tabs, self-locking fasteners, etc.) be required, always replace with a new one.

NOTICE
Never leave any object, rag, tool, etc., in the engine compartment or in the bilge.

Engine Oil

Recommended Engine Oil

Rotax® engines were developed and validated using the XPS™ oil. BRP recommends the use of its XPS engine oil or an equivalent at all time. Do not add any additives to the recommended engine oil. Damages caused by the use of an oil not suitable for the engine or by adding of an additives may not be covered by the BRP Limited Warranty.

XPS Recommended Engine Oil	
4T 5W40 Synthetic blend oil	
If the Recommended XPS Engine Oil is Not Available	
Engine Without Supercharger	Use a 5W40 4-stroke SAE synthetic engine oil meeting or exceeding the following lubricant industry specifications. Always check the API service label certification on the oil container, it must contain at least one of the indicated standards. API service classification SJ, SL, SM or SN
Engine With Supercharger	Use a 5W40 4-stroke SAE motorcycle engine oil compatible with wet clutches meeting or exceeding the following lubricant industry specifications. Always check the API service label certification on the oil container, it must contain at least one of the indicated standards. JASO-MA2 API service classification SJ, SL, SM or SN

Do not add any oil additives to the recommended engine oil. Damages

caused by the use of an oil not suitable for the engine or by adding of an

oil additives may not be covered by the BRP Limited Warranty.

If Watercraft is Out of the Water

NOTICE

Watercraft must be level.

CAUTION

When operating the engine while the watercraft is out of water, the heat exchanger in the ride plate may become very hot. Avoid any contact with the ride plate as burns may occur.

1. Raise trailer tow pole, then block in position when bumper rail is level.
2. Install a garden hose on the exhaust system flushing connector. Refer to *Exhaust System* in this section and follow the procedure.

NOTICE

Never run engine without supplying water to the exhaust system. Failure to cool exhaust system may severely damage it. Never run engine longer than 2 minutes. Drive line seal has no cooling when watercraft is out of water.

3. Remove the seat(s).
4. Start the engine.
5. Open the water tap.
6. Run the COLD engine at **idle for 30 seconds**.
7. Close water tap.
8. Bring engine RPM to 4000-4500 RPM for 15 seconds.
9. Stop the engine abruptly by pressing the start/stop button or removing the tether cord.
10. Wait at least 30 seconds for the oil to settle in the engine, then pull dipstick out and wipe clean.

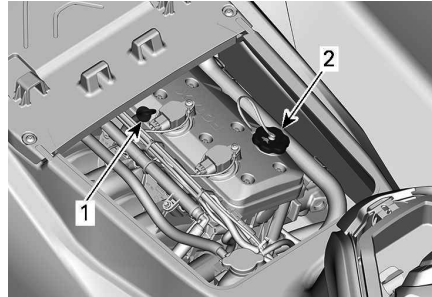

TYPICAL

1. Oil dipstick
2. Oil filler cap
11. Reinstall dipstick, push in completely.
12. Remove dipstick again and read oil level. It should be between the FULL and ADD marks.

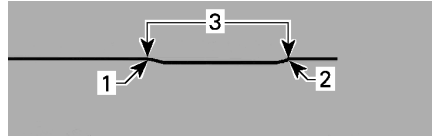

TYPICAL

1. Full
2. Add
3. Operating range
13. Add oil to ensure the level is between marks as required.
 1. Remove oil cap.
 2. Place a funnel in valve cover opening.
 3. Add a small amount of the recommended oil to reach the proper level.

NOTICE

Do not overfill.

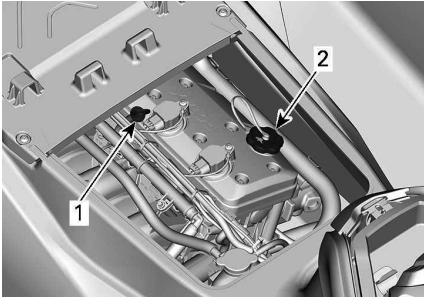
**TYPICAL**

1. Oil dipstick
2. Oil filler cap

NOTE:**Engine Oil Level****NOTICE**

Operating the engine with an improper level may severely damage engine.

 **CAUTION**

Many components in the engine compartment may be very hot. Direct contact may result in skin burn.

Engine Oil Change and Oil Filter Replacement

The oil change and filter replacement may be performed by an authorized Sea-Doo dealer, repair shop, or person of your own choosing.

Every time oil is added in the engine, the complete procedure explained in this section must be carried out again. Otherwise, you will obtain a false oil level reading.

14. Properly reinstall oil cap and dipstick.

NOTICE

Ensure that oil filler cap is tighten properly. Otherwise engine oil can spill out.

Engine Coolant

Recommended Engine Coolant

XPS Recommended Coolant
Extended life pre-mixed coolant
If the Recommended XPS Coolant is Not Available
Use a low silicate, extended life ethylene-glycol premixed coolant (50%-50%) specifically formulated for internal combustion aluminum engines.

NOTICE

Always use ethylene-glycol anti-freeze containing corrosion inhibitors specifically for internal combustion aluminum engines.

To prevent antifreeze deterioration, always use the same brand and grade. Never mix different brands or grades unless cooling system is completely flushed and refilled.

Engine Coolant Level

⚠ WARNING

Check coolant level with engine cold. Never add coolant when engine is hot.

⚠ CAUTION

Many components in the engine compartment may be very hot. Direct contact may result in skin burn.

1. Remove seats.
2. Locate the expansion tank cap.

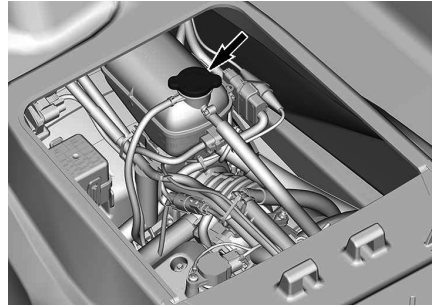

TYPICAL

With watercraft on a level surface, coolant level should be between MIN. and MAX. marks on coolant reservoir when engine is cold.

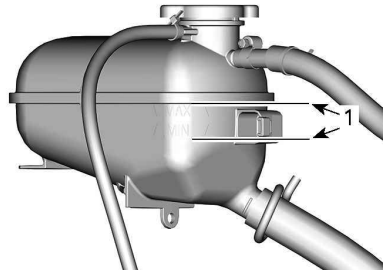

COOLANT EXPANSION TANK

1. Level between marks when engine is cold

NOTE:

The watercraft is level when it is in water. When on a trailer, raise trailer tow pole and block in this position when bumper rail is level.

Add coolant, see *Recommended Engine Coolant* for specification, to adjust coolant level between marks as required. Use a funnel to avoid spillage. Do not overfill.

3. Properly tighten the expansion tank cap. Reinstall seats.

NOTE:

A cooling system that frequently requires coolant is an indication of leaks or engine problems. See an authorized Sea-Doo dealer.

Engine Coolant Replacement

Coolant replacement should be performed by an authorized Sea-Doo dealer.

Ignition Coils

Ignition Coil Access

1. Remove tether cord from the engine cut-off switch.
2. Remove seat(s).
3. Remove engine service cover by removing the retaining screws.

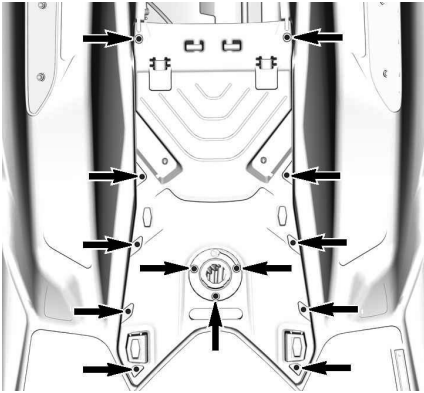

Ignition Coil Removal

1. Disconnect ignition coil connector.

NOTICE

Do not pry on ignition coil using any tool.

2. Remove ignition coil retaining screw.
3. Remove ignition coil from spark plug by rotating coil side to side as you pull up.

Ignition Coil Installation

1. Install ignition coil on spark plug.
2. Align the retaining screw hole of the ignition coil with the threaded hole on the valve cover.

3. Push the ignition coil all the way down until it rests on the valve cover.
4. Install and tighten retaining screw.

Tightening Torque	
Ignition coil retaining screw	9 ± 1 Nm (80 ± 9 lbf-in)

5. Reconnect ignition coil connector.
6. Install the engine service cover and tighten the screws to specification.

Tightening Torque	
Engine service cover screws	2.75 ± 0.25 Nm (24 ± 2 lbf-in)

7. Install the seats.

Spark Plugs

Spark Plug Removal

1. Remove ignition coils. Refer to *Ignition Coil Removal*.
2. Unscrew spark plug completely using a spark plug socket.

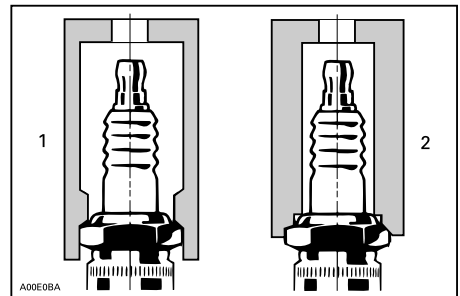

1. Approved socket
2. Improper socket
3. Clean the spark plug and cylinder head with compressed air.
4. Use the ignition coil to take spark plug out of its hole.

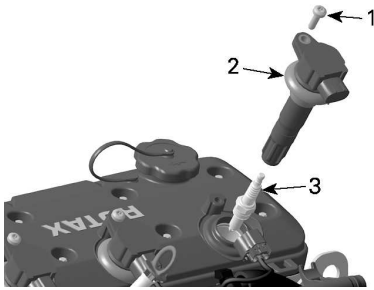

1. Retaining screw
2. Ignition coil
3. Spark plug

Spark Plug Installation

Prior to installation, ensure the contact surfaces of the cylinder head and spark plug are free of grime.

1. Using a wire feeler gauge, check electrode gap as specified in *Technical Specifications*.
2. Hand screw spark plug into cylinder head. Then, tighten the spark plug to specification with a spark plug socket.

Tightening Torque	
Spark plug	18 ± 2 Nm (159 ± 18 lbf-in)

3. Install ignition coils. Refer to *Ignition Coil Installation*.

Exhaust System

Exhaust System Flushing

Flushing the exhaust system with fresh water is essential to neutralize corroding effects of salt or other chemical products present in water. It will help to remove sand, salt, shells or other particles in water jackets and/or hoses.

Exhaust system flushing should be performed when the watercraft is not expected to be used further the same day or when the watercraft is stored for any extended time.

NOTICE

Failure to flush the system, when necessary, will severely damage exhaust system. Make sure engine operates during entire procedure.

⚠ WARNING

Perform these operations in a well ventilated area. Certain components in the engine compartment may be very hot. Direct contact may result in skin burn. Do not touch any electrical part or jet pump area when engine is running.

⚠ WARNING

When operating the engine while the watercraft is out of the water, the heat exchanger in the ride plate may become very hot. Avoid any contact with ride plate as burns may occur.

1. Connect a garden hose to connector located at the rear of watercraft. Do not open water tap yet.

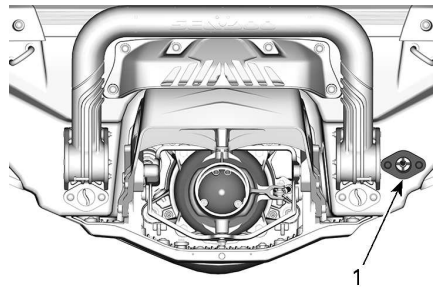

1. Water inlet connector

NOTE:

The following tool is recommended when a quick connect adapter is used to ease garden hose installation.

Recommended Tool	
Flushing connector adapter 295 500 473	

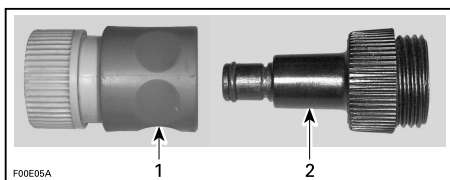

1. Quick connect adapter
 2. Flushing connector adapter
2. Start the engine then immediately open the water tap.

NOTICE

Always start the engine before opening the water tap. Open water tap immediately after engine is started to prevent overheating. Never run engine without supplying water to the exhaust system when watercraft is out of water.

3. Run the engine 90 seconds at idle.

NOTICE

Never run engine longer than 2 minutes. Drive line seal has no cooling when watercraft is out of water.

4. Ensure water flows out of jet pump while flushing.
5. Close the water tap, run the engine at 5000 RPM for 5 seconds and then stop the engine.

NOTICE

Always close the water tap before stopping the engine.

6. Disconnect the garden hose and the flushing connector adapter (if used).

Ride Plate and Water Intake Grate

Ride Plate and Water Intake Grate Inspection

Inspect ride plate and jet pump water intake grate for damage. See your Sea-Doo dealer to have any damaged part repaired or replaced.

⚠ WARNING

The tether cord must always be removed from the engine cut-off switch prior to inspecting the intake grate.

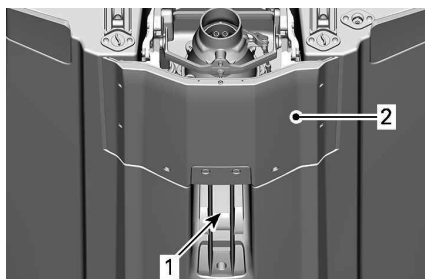

INSPECT THESE AREAS

1. Water intake
2. Ride plate

Sacrificial Anodes

Sacrificial Anode Inspection

Sacrificial anodes are present on:

- Pump
- Ride plate
- Intercooler (if equipped).

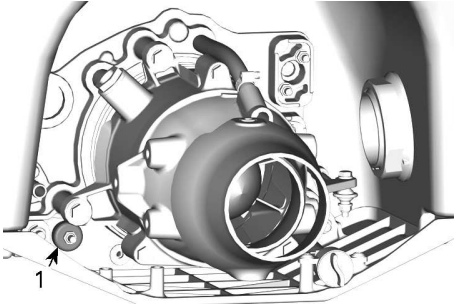

1. Sacrificial anode location

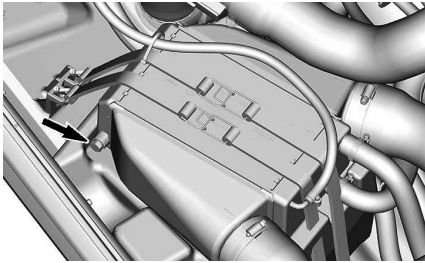

INTERCOOLER (IF EQUIPPED)

Ski/Wakeboard Pylon (Wake)

Ski/Wakeboard Pylon Inspection

Check ski/wakeboard pylon operation. Ensure it slides up and down easily.

Check locking mechanism operation.

Check fasteners tightness. If something is found defective, don't use ski/wakeboard pylon and see an authorized Sea-Doo dealer for repair.

Ski/Wakeboard Pylon Lubrication

Clean ski/wakeboard pylon and apply a light coat of super lube grease or equivalent.

Lubricate pylon throughout its length.

Wipe off all excess grease and reinstall pylon.

Extend and retract several times to distribute the lubricant.

Fuses

Fuse Inspection

If an electrical problem occurs, check the fuses. If a fuse is burnt, replace by one of the same rating.

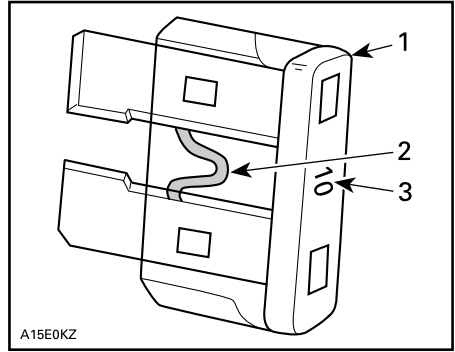

A15E0KZ

TYPICAL

1. Fuse
2. Check if melted
3. Ampere rating

NOTICE

Do not use a higher rated fuse as this can cause severe damage. If a fuse has burnt out, the source of the malfunction should be determined and corrected before re-starting. See an authorized Sea-Doo dealer for servicing.

Fuse Location

All fuses are located inside a single fuse box.

To access the fuse box:

Remove seat(s).

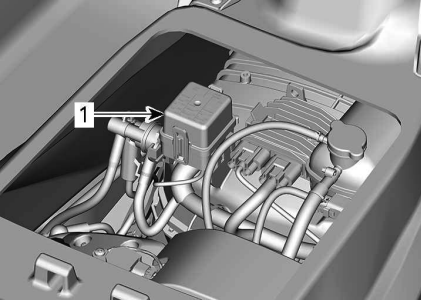
**TYPICAL****1. Fuse box**

To remove a fuse box cover, squeeze locking tabs together, hold and pull fuse box cover to open.

NOTE:

Fuse ratings and positions are illustrated on the fuse box cover.

Use the fuse remover/installer included in the fuse box to ease fuse removal.

Fuse Description

Fuse	Rating	Description
1	-	Not used
2	15 A	Fuel Inj., Ign. Coils and Fuel Pump
3	3 A	Bilge Pump (if equipped)
4	-	Not used
5	-	Not used
6	30 A	Charge
7	5 A	Cluster
8	-	Not used
9	30 A	iBR
10	5 A	Start/Stop
11	5 A	ECM
12	30 A	Battery
13	15 A	Diagnostic Tool 2
14	15 A	Diagnostic Tool 1, Accessory connector

WATERCRAFT CARE

Remove the watercraft from the water every day.

Post-Operation Care

Exhaust System Flushing

The exhaust system should be flushed daily when watercraft is used in salt or foul water.

Refer to *Maintenance Procedures*.

Additional Care for Foul Water or Salt Water Operation

When the watercraft is operated in foul water and particularly in salt water, additional care should be taken to protect the watercraft and its components.

Rinse watercraft bilge area with fresh water.

Never use a high pressure washer to clean the bilge. **USE LOW PRESSURE ONLY** (such as a garden hose).

High pressure can cause damages to electrical or mechanical systems.

 **CAUTION**

Allow engine to cool before performing any maintenance.

NOTICE

Failure to perform proper care such as: watercraft rinsing, exhaust system flushing and anti-corrosion treatment, when watercraft is used in salt water, will result in damage to the watercraft and its components. Never leave the watercraft stored in direct sunlight.

Seat Cleaning

Before applying a cleaning product on the seat, try removing marks with a white eraser.

Many marks, as shoes marks, can be removed easily with this method.

Body and Hull

Repair

If any repairs are needed to body components or to the hull, contact your authorized Sea-Doo dealer.

Cleaning

Wash the body and the hull with a soap and water solution (use only mild detergent). Rinse thoroughly with fresh water.

Remove marine organisms from the inside and outside of the hull.

NOTICE

Never clean using the following products:

- BRP Heavy Duty Cleaner
- Strong detergent
- Degreasing agent
- Ammonia
- Acetone or other ketones
- Alcohol
- Toluene or other aromatic solvents
- Chlorinated solvents
- Mineral spirits
- Paint thinners
- Petroleum based products.

Stains may be removed from the seat and fiberglass using the XPS All Purpose Cleaner and Degreaser or the equivalent.

To clean the carpets, use 3M™ Citrus Base Cleaner (24 oz spray can) or an equivalent.

 **WARNING**

Never apply plastic or vinyl protector on the carpets or seat as the surface will become slippery and the occupants may slip off the watercraft.

Respect the environment by ensuring fuel, oil or cleaning solutions do not drain into the waterways.

Protection

Apply a good quality marine wax to the body.

If the watercraft is to be stored outside, cover it with an opaque tarpaulin to prevent sun rays and grime from affecting the plastic components, watercraft finish, as well as preventing dust accumulation.

NOTICE

The watercraft should never be left in water for storage. Never leave the watercraft stored in direct sunlight. Never store watercraft in a plastic bag.

STORAGE

⚠ WARNING

Because fuel and oil are flammable, you should have an authorized Sea-Doo dealer, repair shop, or person of your own choosing to inspect the fuel system integrity as specified in the periodic inspection chart.

It is recommended that the watercraft be serviced by an authorized Sea-Doo dealer, repair shop, or person of your own choosing for storage, however the following operations can be performed by you with a minimum of tools.

NOTE:

Carry out the following tasks in the same order as detailed in this section.

NOTICE

Do not run the engine during the storage period.

Propulsion System

Jet Pump Cleaning

⚠ WARNING

Always remove tether cord from the engine cut-off switch to prevent unexpected engine starting before cleaning the jet pump area. Engine must not be running for this operation.

Rinse the jet pump by spraying water through its inlet and outlet openings.

Spray an anti-corrosive product on the propulsion system parts.

Service Product
Lubricant and anti-corrosive or equivalent

Jet Pump Inspection

See your authorized Sea-Doo dealer.

Fuel System

Fuel System Protection

A fuel stabilizer should be added in the fuel tank to prevent fuel deterioration and fuel system gumming. Follow stabilizer manufacturers' instructions for proper use.

Service Product
Fuel stabilizer

NOTICE

It is highly recommended to add fuel stabilizer at storage in order to maintain fuel system in good condition. Fuel stabilizer should be added prior to engine lubrication and fuel tank top up to ensure fuel system components protection against varnish deposits.

Fill up fuel tank completely as explained in *Fueling* section. Make sure there is no water inside fuel tank.

NOTICE

Should any water be trapped inside fuel tank, severe internal damage will occur to the fuel injection system.

Engine and Exhaust

Exhaust System Flushing

Perform procedure as described in *Maintenance Procedures* section.

Engine Oil and Filter Replacement

The oil change and filter replacement may be performed by an authorized Sea-Doo dealer, repair shop, or person of your own choosing.

Exhaust System Draining

In areas where temperature may freeze, water trapped in the exhaust system and intercooler must be removed.

Using the flushing connector, inject pressurized air at 379 kPa (55 lbf/in²) into system until there is no more water flowing from jet pump.

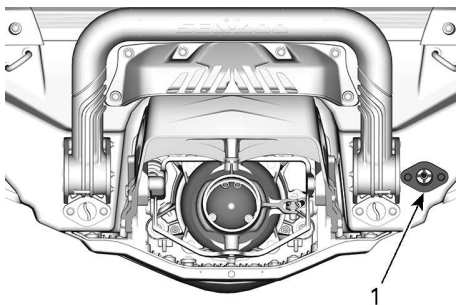

1. Flushing connector

The following hose can be fabricated to ease draining procedure.

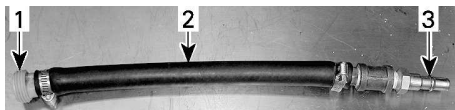

TYPICAL

1. Flushing connector adapter
2. Hose 12.7 mm (1/2 in)
3. Air hose male adapter

NOTICE

Failure to drain the exhaust system may cause severe damage to the exhaust manifold.

Remove special tools.

Engine Internal Lubrication

1. Remove the seat(s).
2. Remove spark plugs. Refer to *Maintenance Procedures* section.
3. By the spark plug holes, lubricate each cylinder.

Service Product

Lubricant and anti-corrosive or equivalent

4. Fully depress the throttle lever. Depressing the throttle lever will prevent fuel from being injected and to disable the ignition during engine cranking.
5. Press the START/STOP button to crank the engine a few turns. This will distribute the oil on the cylinder walls.
6. Apply anti-seize lubricant on spark plug threads, then reinstall them in the engine. Refer to *Maintenance Procedures* section.
7. Install the ignition coils. Refer to *Maintenance Procedures* section.

Engine Coolant Test

If antifreeze is not replaced, test its density.

The antifreeze replacement and a density test should be performed by an authorized Sea-Doo dealer. Refer to *Maintenance Schedule*.

NOTICE

Improper antifreeze density may result in freezing of the liquid in the cooling system if the watercraft is stored in an area where the freezing point is attained. This would seriously damage the engine.

Electrical System

Battery Removal and Charging

Contact your authorized Sea-Doo dealer.

⚠ WARNING

Never charge or boost the battery while installed in the watercraft.

Engine Compartment

Engine Compartment Cleaning

1. Clean the bilge with hot water and detergent or with bilge cleaner.
2. Rinse thoroughly.
3. Lift front end of watercraft to completely drain bilge through the bilge drain plugs.

Anticorrosion Treatment

Wipe off any residual water in the engine compartment.

Spray lubricant and anti-corrosive or equivalent over all metallic components in engine compartment.

NOTE:

The seat should be removed during storage. This will prevent engine compartment condensation and possible corrosion.

Body and Hull

Repair, clean and protect the watercraft as per procedures in *Watercraft Care* section.

PRESEASON PREPARATION

Maintenance preparation must be performed in conjunction with *Maintenance Schedule*.

Ensure to perform all tasks included in the **Every Year or 100 Hours** table.

Preseason maintenance preparation may be performed by an authorized Sea-Doo dealer, repair shop or person of your own choosing.

NOTE:

Though not required, it is recommended that an authorized Sea-Doo dealer perform preseason maintenance preparation at the same time that any safety-related factory campaigns are performed by the authorized Sea-Doo dealer.

WARNING

Only perform procedures as detailed in the *Maintenance Schedule*. It is recommended that the assistance of an authorized Sea-Doo dealer be periodically obtained on other components and systems not covered in this guide.

NOTICE

When component conditions seem less than satisfactory, replace using genuine BRP parts, or equivalents.

TECHNICAL INFORMATION

WATERCRAFT IDENTIFICATION

The main components of the watercraft (engine and hull) are identified by different serial numbers. It may sometimes become necessary to locate these numbers for warranty purposes or to trace the watercraft in the event of theft.

Hull Identification Number

The Hull Identification Number (HIN) is located on footboard at the rear of watercraft.

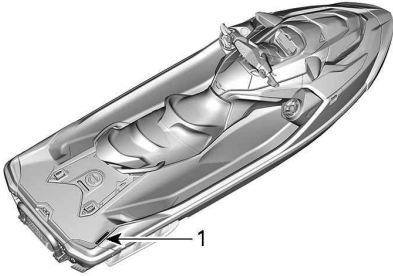

TYPICAL

1. Hull Identification Number (HIN)

It is composed of 12 digits:

YDV	12345	L	8	09
			Model year	
			Year of production	
			Month of production	
			Serial number (a letter may also be used as a digit)	
			Manufacturer	

Engine Identification Number

The Engine Identification Number (EIN) is located on the front end of the engine.

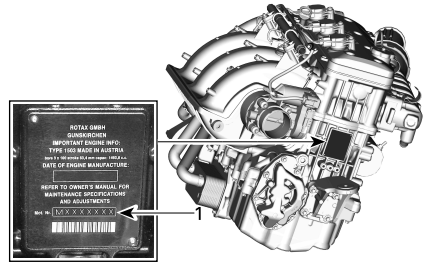

TYPICAL

1. Engine Identification Number (EIN)

RF D.E.S.S. KEY

This device complies with FCC Part 15 and Industry Canada license exempt RSS standard(s).

Operation is subject to the following two conditions: (1) this device may not cause interference, and (2) this device must accept any interference, including interference that may cause undesired operation of the device.

Changes or modifications not expressly approved by the party responsible for compliance could void the user's authority to operate the equipment.

IC Registration Number: 12006A-1001002222

FCC ID: 2ACER-1001002222

We, the party responsible for compliance, declare under our sole responsibility that the device is in conformity with the provisions of the following Council Directive: 2014/53/EU. To which this declaration relates is in conformity with the essential requirements and other relevant requirements. The product is in conformity with the following directives, harmonized standards and regulations:

Radio Equipment Directive (RED) 2014/53/EU and Harmonized Standards:

EN 300 330-2, EN 60950-1

This device complies with part 15 of the FCC Rules. Operation is subject to the following two conditions: (1) This device may not cause harmful interference, and (2) this device must accept any interference received, including interference that may cause undesired operation.

Changes or modifications not expressly approved by the party responsible for compliance could void the user's authority to operate the equipment.

This device contains licence-exempt transmitter(s)/receiver(s) that comply with Innovation, Science and Economic Development Canada's licence-exempt RSS (s). Operation is subject to the following two conditions:

(1) This device may not cause interference.

(2) This device must accept any interference, including interference that may cause undesired operation of the device.

L'émetteur/récepteur exempt de licence contenu dans le présent appareil est conforme aux CNR d'Innovation, Sciences et Développement économique Canada applicables aux appareils radio exempts de licence. L'exploitation est autorisée aux deux conditions suivantes:

(1) l'appareil ne doit pas produire de brouillage;

(2) l'appareil doit accepter tout brouillage radioélectrique subi, même si le brouillage est susceptible d'en compromettre le fonctionnement.

Radio Equipment Directive (RED)	2014/53/EU
Article 3.1a	Safety and health IEC 62368-1:2014
Article 3.1b	EMC CISPR 25:(2016); conducted emission CISPR 25:(2016); radiated emission ISO 11452-2 (2004); radiated electromagnetic field immunity
Article 3.2	Spectrum usage efficiency ETSI EN 300 330 V2.1.1 (2017-2)

MULTIFUNCTION GAUGE REGULATORY INFORMATION

Technical Information

Transmitter:

- BT operating frequency range: 2402 – 2480 MHz
- BT version: 4.2 (no BTLE)
- BT output power: < 8.5 dBm

Receiver:

- FM operating range: 76 - 108 MHz

Manufacturer and Address

Manufacturer:

- Robert Bosch LLC

Address:

- 38000 Hills Tech Drive,
Farmington Hills, MI 48331,
USA

To display the regulatory information on the vehicle digital display: From the home screen, access the main menu and keep the joystick pressed down for more than 10 seconds.

USA and Canada

This device complies with FCC Part 15 and Industry Canada license exempt RSS standard(s). Operation is subject to the following two conditions: (1) this device may not cause interference, and (2) this device must accept any interference, including interference that may cause undesired operation of the device.

Le présent appareil est conforme aux CNR d'Industrie Canada applicables aux appareils radio exempts de licence. L'exploitation est autorisée aux deux conditions suivantes:

- (1) l'appareil ne doit pas produire de brouillage, et
- (2) l'utilisateur de l'appareil doit accepter tout brouillage radioélectrique subi, même si le brouillage est susceptible d'en compromettre le fonctionnement.

Changes or modifications not expressly approved by the party responsible for compliance could void the user's authority to operate the equipment.

IC: 22868 - VDIBRHS01

FCC ID: 2AMJS - VDIBRHS01

RF exposure:

1. The equipment complies with FCC RF exposure limits set forth for an uncontrolled environment.
2. This equipment must be installed and operated with a separation distance of at least 20 cm from all persons.
3. The antenna(s) used for this transmitter must not be co-located or operating in conjunction with any other antenna or transmitter.

Mexico

IFETEL

Marca: Robert Bosch LLC

Modelo(s): VIPHI2BT

Número: RCPBOVI18-0967

NOM-121-SCT1-2009

La operación de este equipo está sujeta a las siguientes dos condiciones: (1) es posible que este equipo o dispositivo no cause interferencia perjudicial y (2) este equipo o dispositivo debe aceptar cualquier interferencia, incluyendo la que pueda causar su operación no deseada.

Brazil



03473-18-04473

Este equipamento opera em caráter secundário, isto é, não tem direito a proteção contra interferência prejudicial, mesmo de estações do mesmo tipo, e não pode causar interferência a sistemas operando em caráter primário.

Japan

This device is granted pursuant to the Japanese Radio Law (電波法) and the Japanese Telecommunications Business Law (電気通信事業法).

This device should not be modified (otherwise the granted designation number will become invalid).

Europe

Declaration of Conformity

Simplified EU Declaration of Conformity according Radio Equipment Directive 2014/53/EU



DE

Hiermit erklärt Robert Bosch LLC, dass der Funkanlagentyp VIPHI2BT der Richtlinie 2014/53/EU entspricht.
Der vollständige Text der EU-Konformitätserklärung ist unter der folgenden Internetadresse verfügbar: eu-doc.bosch.com

FR

Le soussigné, Robert Bosch LLC, déclare que l'équipement radioélectrique du type VIPHI2BT est conforme à la directive 2014/53/UE.

Le texte complet de la déclaration UE de conformité est disponible à l'adresse internet suivante: eu-doc.bosch.com

BG

С настоящото Robert Bosch LLC декларира, че този тип радиосъоръжение VIPHI2BT е в съответствие с Директива 2014/53/ЕС.

Цялостният текст на ЕС декларацията за съответствие може да се намери на следния интернет адрес: eu-doc.bosch.com

EL

Με την παρούσα ο/η Robert Bosch LLC, δηλώνει ότι ο ραδιοεξοπλισμός VIPHI2BT πληροί την οδηγία 2014/53/ΕΕ. Το πλήρες κείμενο της δήλωσης συμμόρφωσης ΕΕ διατίθεται στην ακόλουθη ιστοσελίδα στο διαδίκτυο: eu-doc.bosch.com

CS

Tímto Robert Bosch LLC prohlašuje, že typ rádiového zařízení VIPHI2BT je v souladu se směrnicí 2014/53/EU. Úplné znění EU prohlášení o shodě je k dispozici na této internetové adrese: eu-doc.bosch.com

DA

Hermed erklærer Robert Bosch LLC, at radioudstyrstypen VIPHI2BT er i overensstemmelse med direktiv 2014/53/EU.

EU-overensstemmelseserklæringens fulde tekst kan findes på følgende internetadresse: eu-doc.bosch.com

ET

Käesolevaga deklareerib Robert Bosch LLC, et käesolev raadioseadme tüüp VIPHI2BT vastab direktiivi 2014/53/EL nõuetele.

ELi vastavusdeklaratsiooni täielik tekst on kättesaadav järgmisel internetiaadressil: eu-doc.bosch.com

ES

Por la presente, Robert Bosch LLC declara que el tipo de equipo radioeléctrico VIPHI2BT es conforme con la Directiva 2014/53/UE.

El texto completo de la declaración UE de conformidad está disponible en la dirección Internet siguiente: eu-doc.bosch.com

FI

Robert Bosch LLC vakuuttaa, että radiolaitetyyppi VIPHI2BT on direktiivin 2014/53/EU mukainen.

EU-vaatimustenmukaisuusvakuutuksen täysimittainen teksti on saatavilla seuraavassa internetosoitteessa: eu-doc.bosch.com

EN

Hereby, Robert Bosch LLC declares that the radio equipment type VIPHI2BT is in compliance with Directive 2014/53/EU.

The full text of the EU declaration of conformity is available at the following internet address: eu-doc.bosch.com

HR

Robert Bosch LLC ovime izjavljuje da je radijska oprema tipa VIPHI2BT u skladu s Direktivom 2014/53/EU. Cjeloviti tekst EU izjave o sukladnosti dostupan je na sljedećoj internetskoj adresi: eu-doc.bosch.com

HU

Robert Bosch LLC igazolja, hogy a VIPHI2BT típusú rádióberendezés megfelel a 2014/53/EU irányelvnek.

Az EU-megfelelőségi nyilatkozat teljes szövege elérhető a következő internetes címen: eu-doc.bosch.com

IT

Il fabbricante, Robert Bosch LLC, dichiara che il tipo di apparecchiatura radio VIPHI2BT è conforme alla direttiva 2014/53/UE.

Il testo completo della dichiarazione di conformità UE è disponibile al seguente indirizzo Internet: eu-doc.bosch.com

LT

Aš, Robert Bosch LLC, patvirtinu, kad radijo įrenginių tipas VIPHI2BT atitinka Direktyvą 2014/53/ES.

Visas ES atitikties deklaracijos tekstas prieinamas šiuo interneto adresu: eu-doc.bosch.com

LV

Ar šo Robert Bosch LLC deklarē, ka radioiekārta VIPHI2BT atbilst Direktīvai 2014/53/ES.

Pilns ES atbilstības deklarācijas teksts ir pieejams šādā interneta vietnē: eu-doc.bosch.com

MT

B'dan, Robert Bosch LLC, niddikjara li dan it-tip ta' taghmir tar-radju VIPHI2BT huwa konformi mad-Direttiva 2014/53/UE.

It-test kollu tad-dikjarazzjoni ta' konformità tal-UE huwa disponibbli f'dan l-indirizz tal-Internet li ġej: eu-doc.

bosch.com

NL

Hierbij verklaar ik, Robert Bosch LLC, dat het type radioapparatuur VIPHI2BT conform is met Richtlijn 2014/53/EU.

De volledige tekst van de EU-conformiteitsverklaring kan worden geraadpleegd op het volgende internetadres: eu-doc.bosch.com

PL

Robert Bosch LLC niniejszym oświadcza, że typ urządzenia radiowego VIPHI2BT jest zgodny z dyrektywą 2014/53/UE.

Pełny tekst deklaracji zgodności UE jest dostępny pod następującym adresem internetowym: eu-doc.bosch.com

PT

O(a) abaixo assinado(a) Robert Bosch LLC declara que o presente tipo de equipamento de rádio VIPHI2BT está em conformidade com a Diretiva 2014/53/UE.

O texto integral da declaração de conformidade está disponível no seguinte endereço de Internet: eu-doc.

bosch.com

RO

Prin prezenta, Robert Bosch LLC declară că tipul de echipamente radio VIPHI2BT este în conformitate cu Directiva 2014/53/UE.

Textul integral al declarației UE de conformitate este disponibil la următoarea adresă internet: eu-doc.bosch.com

SV

Härmed försäkrar Robert Bosch LLC att denna typ av radioutrustning VIPHI2BT överensstämmer med direktiv 2014/53/EU.

Den fullständiga texten till EU-försäkran om överensstämmelse finns på följande webbadress: eu-doc.bosch.com

SL

Robert Bosch LLC potrjuje, da je tip radijske opreme VIPHI2BT skladen z Direktivo 2014/53/EU.

Celotno besedilo izjave EU o skladnosti je na voljo na naslednjem spletnem naslovu: eu-doc.bosch.com

SK

Robert Bosch LLC týmto vyhlasuje, že rádiové zariadenie typu VIPHI2BT je v súlade so smernicou 2014/53/EÚ.

Úplné EÚ vyhlásenie o zhode je k dispozícii na tejto internetovej adrese: eu-doc.bosch.com

IS

Robert Bosch LLC lýsir því hér með yfir að þráðlausi fjarskiptabúnaðurinn VIPHI2BT er í samræmi við tilskipun 2014/53/ESB.

Óstytta texta ESB-samræmisfyr lýsingarinnar er að finna á veffanginu: eu-doc.bosch.com

Liechtenstein

Hiermit erklärt Robert Bosch LLC, dass der Funkanlagentyp VIPHI2BT der Richtlinie 2014/53/EU entspricht.

Der vollständige Text der EU-Konformitätserklärung ist unter der folgenden Internetadresse verfügbar: eu-doc.bosch.com

NO

Hermed erklærer Robert Bosch LLC at radioutstyrstypen VIPHI2BT er i samsvar med direktiv 2014/53/EU.

Hele teksten i EU-samsvarserklæringen finnes på følgende internettadresse: eu-doc.bosch.com

RU

Компания Robert Bosch LLC настоящим заявляет, что радиотехническое оборудование категории VIPHI2BT отвечает требованиям Директивы 2014/53/EU.

Полный текст декларации соответствия ЕС доступен на сайте eu-doc.bosch.com.

PREMIUM AUDIO SOUND SYSTEM

This equipment has been tested and found to comply with the limits for a Class B digital device, pursuant to Part 15 of the FCC rules. These limits are designed to provide reasonable protection against harmful interference in a residential installation.

This equipment generates, uses, and can radiate radio frequency energy and, if not installed and used in accordance with the instructions, may cause harmful interference to radio communications. However, this is no guaranty that interference will occur in a particular installation.

If this equipment does cause harmful interference to radio or television reception, which can be determined by turning the equipment off or on, you are encouraged to try to correct the interference by one or more of the following measure:

- Reorient or relocate the receiving antenna.
- Increase the separation between the equipment and receiver.
- Connect the equipment to an outlet on a different circuit than the one to which the receiver is connected.
- Consult the dealer or an experienced radio/TV technician for help.

Changes or modifications not expressly approved by Mitek Corporation could void the user's authority to operate this equipment. This device complies with Part 15 of the FCC rules.

Operation is subject to the following two conditions:

- (1) This device may not cause harmful interference, and
- (2) This device must accept any interference received, including interference that may cause undesired operation.

IC Registration Number:
2AAOY278003465

FCC ID: 22793-278003464

L'émetteur/récepteur exempt de licence contenu dans le présent appareil est conforme aux CNR d'Innovation, Sciences et Développement économique Canada applicables aux appareils radio exempts de licence. L'exploitation est autorisée aux deux conditions suivantes :

(1) l'appareil ne doit pas produire de brouillage;

(2) l'appareil doit accepter tout brouillage radioélectrique subi, même si le brouillage est susceptible d'en compromettre le fonctionnement.

Radio Equipment Directive (RED) 2014/53/EU and Harmonized Standards:

- ETSI EN 300 328 V2.1.1 (2016-11)
- ETSI EN301 489-1 V2.1.1 (2017-02)
- ETSI EN301 489-17 V3.1.1 (2017-02)
- EN 62479:2010

ENGINE EMISSIONS INFORMATION

Manufacturer's Responsibility

Beginning with 1999 model year engines, PWC manufacturers of marine engines must determine the exhaust emission levels for each engine horsepower family and certify these engines with the United States of America Environmental Protection Agency (EPA). An emissions control information label, showing emission levels and engine specifications, must be placed on each watercraft at the time of manufacture.

Dealer's Responsibility

When performing service on all 1999 and more recent Sea-Doo watercraft that carry an emissions control information label, adjustments must be kept within published factory specifications.

Replacement or repair of any emission related component must be executed in a manner that maintains emission levels within the prescribed certification standards.

Dealers are not to modify the engine in any manner that would alter the horsepower or allow emission levels to exceed their predetermined factory specifications.

Exceptions include manufacturer's prescribed changes, such as altitude adjustments for example.

Owner's Responsibility

The owner/operator is required to have engine maintenance performed to maintain emission levels within prescribed certification standards.

The owner/operator is not to, and should not allow anyone to modify the engine in any manner that would alter the horsepower or allow emissions levels to exceed their predetermined factory specifications.

EPA Emission Regulations

All 1999 and more recent Sea-Doo watercraft manufactured by BRP are certified to the EPA as conforming to the requirements of the regulations for the control of air pollution from new watercraft engines. This certification is contingent on certain adjustments being set to factory standards. For this reason, the factory procedure for servicing the product must be strictly followed and, whenever practicable, returned to the original intent of the design.

The responsibilities listed above are general and in no way a complete listing of the rules and regulations pertaining to the EPA requirements on exhaust emissions for marine products. For more detailed information on this subject, you may contact:

U. S. Environmental Protection Agency
Certification Division
Gasoline Engine Compliance Center
2000 Traverwood Drive
Ann Arbor MI 48105
USA

EPA INTERNET WEB SITE:
www.epa.gov/otaq

Evaporative Emission Control System

Starting with MY 2018; personal watercraft sold in the State of California are certified to the California evaporative emissions regulations for spark ignition marine watercraft of the California Air Resources Board (13 CCR 2850 to 2869). These models are equipped with an evaporative emission control system consisting of Low Permeation Fuel Tank (LPFT), Low Permeation Fuel Line (LPFL) and a Pressure Relief Valve (PRV).

EAC DECLARATION OF CONFORMITY

Left blank for Eurasian Conformity
mark where applicable

EC-DECLARATION OF CONFORMITY



565 de la Montagne Street
Valcourt (Québec) J0E 2L0
Canada

Declaration of Conformity for Sea-Doo Personal Watercraft with the requirements of Directive 2013/53/EU

Manufacturer: Bombardier Recreational Products Inc. Address: 565 de la Montagne, Valcourt, J0E 2L0, Canada
Authorised Representative: BRP Europe N.V. Address: Skaldenstraat 125, Gent, 9042, Belgium

Notified Body for noise emission assessment: International Marine Certification Institute Address: Rue Abbe Cuypers 3, Brussels, B-1040, Belgium. ID Number: 0609
Notified Body for exhaust emission assessment: International Marine Certification Institute Address: Rue Abbe Cuypers 3, Brussels, B-1040, Belgium. ID Number: 0609

Assessment Module of construction: A , of noise emission: Aa/A1 , of exhaust emission: B+C

Other Community Directives applied: RED 2014/53/EU (EN 300 330-2, EN 60950-1) , EMC 2014/30/EU

Engine combustion cycle: 2 stroke <input type="checkbox"/> , 4 stroke <input checked="" type="checkbox"/>	Design and construction	ISO 13590:2003, ISO 10087:2019
Engine fuel type: Petrol: <input checked="" type="checkbox"/> , Diesel: <input type="checkbox"/>	Exhaust emission	ISO 18854:2015
Craft Design Category: C <input checked="" type="checkbox"/> , D <input type="checkbox"/>	Noise emission	ISO 14509-1:2008
Craft Trademark : Sea-Doo	Electromagnetic Compatibility	EN 55012:2007/A1:2009, EN 61000-6-1:2007

Sea-Doo PWC model	Propulsion engine	Exhaust emission certificate	Engine displ. (cm³)	Rated Power (kW)	Noise emission certificate	# of persons	Length of hull	Width of hull
FishPro SCOUT 130	Rotax 1630 ACE-130	EXBORP009	1630.5	100	SDBORP014	3	3,27	1,23
FishPro SPORT 170	Rotax 1630 ACE-170	EXBORP009	1630.5	125.03	SDBORP013	3	3,64	1,25
FishPro TROPHY 170	Rotax 1630 ACE-170	EXBORP009	1630.5	125.03	SDBORP013	3	3,64	1,25
GTI 130	Rotax 1630 ACE-130	EXBORP009	1630.5	100	SDBORP014	3	3,27	1,23
GTI 90	Rotax 900 ACE-90	EXBORP004	899.3	66.19	SDBORP014	3	3,27	1,23
GTI SE 130	Rotax 1630 ACE-130	EXBORP009	1630.5	100	SDBORP014	3	3,27	1,23
GTI SE 170	Rotax 1630 ACE-170	EXBORP009	1630.5	125.03	SDBORP014	3	3,27	1,23
GTR 230	Rotax 1630 ACE-230	EXBORP010	1630.5	169.16	SDBORP014	3	3,27	1,23
GTX 170	Rotax 1630 ACE-170	EXBORP009	1630.5	125.03	SDBORP013	3	3,35	1,25
GTX 230	Rotax 1630 ACE-230	EXBORP010	1630.5	169.16	SDBORP013	3	3,35	1,25
GTX Limited 300	Rotax 1630 ACE-300	EXBORP006	1630.5	217	SDBORP013	3	3,35	1,25
GTX PRO 130	Rotax 1630 ACE-130	EXBORP009	1630.5	100	SDBORP013	3	3,35	1,25
RXP-X RS 300	Rotax 1630 ACE-300	EXBORP006	1630.5	217	SDBORP015	2	3,27	1,22
RXT-X RS 300	Rotax 1630 ACE-300	EXBORP006	1630.5	217	SDBORP013	3	3,35	1,25
SPARK 2up	Rotax 900 ACE-90	EXBORP004	899.3	44.13	SDBORP010	2	2,77	1,17
SPARK 2up	Rotax 900 ACE-90	EXBORP004	899.3	66.19	SDBORP010	2	2,77	1,17
SPARK 2up TRIXX	Rotax 900 ACE-90	EXBORP004	899.3	66.19	SDBORP010	2	2,77	1,17
SPARK 3up	Rotax 900 ACE-90	EXBORP004	899.3	66.19	SDBORP010	3	3,02	1,18
SPARK 3up IBR	Rotax 900 ACE-90	EXBORP004	899.3	66.19	SDBORP010	3	3,02	1,18
SPARK 3up TRIXX	Rotax 900 ACE-90	EXBORP004	899.3	66.19	SDBORP010	3	3,02	1,18
WAKE 170	Rotax 1630 ACE-170	EXBORP009	1630.5	125.03	SDBORP014	3	3,27	1,23
WAKE PRO 230	Rotax 1630 ACE-230	EXBORP010	1630.5	169.16	SDBORP013	3	3,35	1,25

This declaration of conformity is issued under the sole responsibility of the personal watercraft manufacturer. I declare on behalf of the above personal watercraft manufacturer that the model year 2022 watercraft models and engines mentioned above which are marked comply with all applicable requirements in the way specified and are in conformity with the type for which above mentioned EU type-examination certificate(s) has(have) been issued.

Name & function : Martin Lachance

Signature and title: Director, Product Development, Sea-Doo

Martin Lachance (Mar 26, 2023 20:22 EDT)

Date (yr/month/day) : 2021/04/29, Valcourt, QC, Canada

Apr 29, 2021

SKI-DOO LYNX SEA-DOO Evinrude ROTAX CAN-AM

TECHNICAL SPECIFICATIONS

TECHNICAL SPECIFICATIONS

Rotax 1630 ACE - 130 engine

Engine	
Engine type	4-stroke, Single Over Head Camshaft (SOHC)
Declared Power ⁽¹⁾	100 kW @ 7300 RPM
Induction	Naturally-Aspirated
Number of cylinders	3
Number of valves	12 valves with hydraulic lifters (no adjustment)
Bore	100 mm (3.9 in)
Stroke	69.2 mm (2.7 in)
Displacement	1 630.5 cm ³ (99.5 in ³)
Compression ratio	11:1

⁽¹⁾ Declared power as per ISO 8665 at propeller-shaft.

Lubrication System			
Engine oil	Recommended oil	130 engine	4T 5W40 Synthetic blend oil
		Alternate oil if XPS products are not available	If not available, use a 5W40 motor oil that meets the requirements for API service classification SJ, SL, SM or SN. Refer to <i>Recommended Engine Oil</i>
	Capacity	2.01 L (2.12 qt(liq.,US)) oil change w/ filter ⁽²⁾	

Cooling System		
Type		Closed loop cooling system
Coolant	Recommended	Extended life pre-mixed coolant
	Alternative, or if not available	Use a low silicate, extended life ethylene-glycol premixed coolant (50%-50%) specifically formulated for internal combustion aluminum engines.
Cooling system capacity		3.0 L (3.2 qt(liq.,US))

Fuel System		
Fuel injection type		Multipoint fuel injection with iTC (intelligent Throttle Control). Single throttle body (60 mm) with an actuator
Fuel type	Regular unleaded gasoline - Refer to <i>Fuel Requirements</i>	87 AKI ((RON + MON)/2) inside North America 91 (RON) E10 outside North America
Fuel tank capacity (including reserve)		60 L (15.9 gal(liq.,US))

Electrical System		
Ignition system type		IDI (Inductive Discharge Ignition)
Battery		12 V, 18 A•h
Spark plug	Make and type	NGK, DCPR8E with solid post or equivalent
	Gap	0.80 to 0.90 mm(.031 to .035 in)
Capacity		135 ml (4.6 fl oz(US))

Propulsion		
Jet pump	Type	Axial flow single stage
Drive shaft	Coupling type	Crowned splines, direct drive

iBR and VTS	
VTS system	Electronically-controlled through the VTS control button with 3 preset positions

Weight and Loading Capacity	
Dry weight	355 kg (783 lb)
Number of passenger (driver incl.)	3
Load limit (passenger(s) and luggage)	272 kg (600 lb)
Storage capacity	203.8 L (43.8 gal(liq.,US))

Dimensions	
Overall length	331.8 cm (130.6 in)
Overall width	125 cm (49.2 in)
Overall height	117 cm (46.1 in)

Materials	
Impeller material	Stainless steel
Impeller housing/stator	Aluminum/aluminum

NOTE:

BRP reserves the right to make changes in design and specifications and/or to make additions to, or improvements in its products without imposing any obligation upon itself to install them on its products previously manufactured.

TROUBLESHOOTING

TROUBLESHOOTING GUIDELINES

ENGINE WILL NOT START

1. **Tether cord removed.**
 - Press START/STOP button.
 - Install tether cord cap over engine cut-off switch within 5 seconds after depressing the START/STOP button.
 - Press START/STOP button.
2. **ECM does not recognize the D.E.S.S. key.**
 - Refer to an authorized Sea-Doo dealer.
3. **Burnt fuse: main, electric starter or ECM.**
 - Check wiring then replace fuse(s).
4. **Discharged battery.**
 - Refer to an authorized Sea-Doo dealer.

WARNING

Do not charge or boost the battery while installed on the watercraft. Electrolyte is poisonous and dangerous. Avoid contact with eyes, skin and clothing.

5. **Battery connections, corroded or loose. Bad ground.**
 - Refer to an authorized Sea-Doo dealer.
6. **Water-flooded engine.**
 - Refer to *Water-Flooded Engine in Special Procedures*.
7. **Faulty sensor or ECM.**
 - Seek service from an authorized Sea-Doo dealer, repair shop, or person of your own choosing for maintenance, repair, or replacement. Please refer to the US EPA Emission-Related Warranty contained herein for information about warranty claims.
8. **Seized jet pump.**
 - Try to clean. Otherwise, refer to an authorized Sea-Doo dealer.

ENGINE CRANKS SLOWLY

1. **Loose battery cable connections.**
 - Check/clean/tighten.
2. **Discharged or weak battery.**
 - Refer to an authorized Sea-Doo dealer.
3. **Worn starter.**
 - Refer to an authorized Sea-Doo dealer.

ENGINE TURNS NORMALLY BUT WILL NOT START

1. **Fuel tank empty or water-contaminated.**
 - *Refill. Siphon and fill with fresh fuel.*
2. **Fouled/defective spark plugs.**
 - *Replace.*
3. **Blown fuse.**
 - *Check wiring then replace fuse(s).*
4. **Water-flooded engine.**
 - *Refer to Water-Flooded Engine in Special Procedures.*
5. **Engine management system fault detected (check engine pilot lamp is ON).**
 - *Seek service from an authorized Sea-Doo dealer, repair shop, or person of your own choosing for maintenance, repair, or replacement. Please refer to the US EPA Emission-Related Warranty contained herein for information about warranty claims.*
6. **Faulty fuel pump.**
 - *Seek service from an authorized Sea-Doo dealer, repair shop, or person of your own choosing for maintenance, repair, or replacement. Please refer to the US EPA Emission-Related Warranty contained herein for information about warranty claims.*

ENGINE MISFIRES, RUNS IRREGULARLY

1. **Fouled/defective/worn spark plugs.**
 - *Replace.*
2. **Fuel: Level too low, stale or water-contaminated.**
 - *Siphon and/or refill.*
3. **Faulty ignition coil(s).**
 - *Seek service from an authorized Sea-Doo dealer, repair shop, or person of your own choosing for maintenance, repair, or replacement. Please refer to the US EPA Emission-Related Warranty contained herein for information about warranty claims.*
4. **Clogged injectors.**
 - *Seek service from an authorized Sea-Doo dealer, repair shop, or person of your own choosing for maintenance, repair, or replacement. Please refer to the US EPA Emission-Related Warranty contained herein for information about warranty claims.*
5. **Engine management system fault detected (check engine pilot lamp is ON).**
 - *Refer to Monitoring System.*

ENGINE SMOKE

1. **Oil level too high.**
 - *Seek service from an authorized Sea-Doo dealer, repair shop, or person of your own choosing for maintenance, repair, or replacement. Please refer to the US EPA Emission-Related Warranty contained herein for information about warranty claims.*
2. **Water ingestion, coolant leak or damaged cylinder head gasket.**
 - *Seek service from an authorized Sea-Doo dealer, repair shop, or person of your own choosing for maintenance, repair, or replacement. Please refer to the US EPA Emission-Related Warranty contained herein for information about warranty claims.*
3. **Internal engine damage.**
 - *Seek service from an authorized Sea-Doo dealer, repair shop, or person of your own choosing for maintenance, repair, or replacement. Please refer to the US EPA Emission-Related Warranty contained herein for information about warranty claims.*

ENGINE OVERHEATS

1. **Clogged exhaust system.**
 - *Flush exhaust system.*
2. **Engine coolant level too low.**
 - *Refer to Maintenance Procedures.*
3. **Quick connect adapter left in flushing connector.**
 - *Remove adapter from flushing connector and retry watercraft. If problem persists, seek service from an authorized Sea-Doo dealer, repair shop, or person of your own choosing for maintenance, repair, or replacement. Please refer to the US EPA Emission-Related Warranty contained herein for information about warranty claims.*

ENGINE LACKS ACCELERATION OR POWER

1. **Learning key used.**
 - *Use a Normal key.*
2. **Not in Sport mode.**
 - *Select Sport mode.*
3. **Jet pump water intake clogged.**
 - *Clean. Refer to Jet Pump Water Intake and Impeller Cleaning in Special Procedures section.*
4. **Damaged impeller or worn-out wear ring.**
 - *Replace. Refer to an authorized Sea-Doo dealer.*
5. **Engine oil level too high.**
 - *Seek service from an authorized Sea-Doo dealer, repair shop, or person of your own choosing for maintenance, repair, or replacement. Please refer to the US EPA Emission-Related Warranty contained herein for information about warranty claims.*
6. **Weak spark.**
 - *Refer to ENGINE MISFIRES, RUNS IRREGULARLY.*
7. **Engine management system fault detected (check engine pilot lamp is ON).**
 - *Refer to Monitoring System.*
8. **Clogged injectors.**
 - *Seek service from an authorized Sea-Doo dealer, repair shop, or person of your own choosing for maintenance, repair, or replacement. Please refer to the US EPA Emission-Related Warranty contained herein for information about warranty claims.*
9. **Low fuel pressure.**
 - *Seek service from an authorized Sea-Doo dealer, repair shop, or person of your own choosing for maintenance, repair, or replacement. Please refer to the US EPA Emission-Related Warranty contained herein for information about warranty claims.*
10. **Water in fuel.**
 - *Siphon and replace.*
11. **Engine damaged by water ingestion.**
 - *Refer to an authorized Sea-Doo dealer.*

WATERCRAFT CAN NOT REACH TOP SPEED

1. **Jet pump water intake clogged.**
 - *Clean. Refer to Jet Pump Water Intake and Impeller Cleaning in Special Procedures section.*
2. **Damaged impeller or worn-out wear ring.**
 - *Replace. Refer to an authorized Sea-Doo dealer.*
3. **Engine management system fault detected (check engine pilot lamp is ON).**
 - *Refer to Monitoring System.*

WATERCRAFT STAYS IN NEUTRAL AFTER OPERATING THE iBR LEVER

1. **The iBR gate stays in neutral.**
 - *Release the throttle to idle RPM.*

iBR WILL NOT RETURN TO NEUTRAL POSITION (iBR INDICATOR LIGHT ON)

1. **iBR jammed with debris.**
 - *Clean and check for damage in the iBR gate and nozzle area.*
2. **iBR system malfunction.**
 - *Remove tether cord, wait four minutes, reinstall key and check iBR light to ensure fault is cleared.*
 - *Refer to an authorized Sea-Doo dealer if fault persists or reoccurs frequently.*

iBR WILL NOT RETURN TO NEUTRAL POSITION (iBR INDICATOR LIGHT OFF)

1. **Throttle lever not fully released during operation.**
 - *Release throttle lever fully to ensure iBR gate returns to neutral.*
2. **Throttle lever does not fully return to null when released.**
 - *Refer to an authorized Sea-Doo dealer.*

ABNORMAL NOISE FROM PROPULSION SYSTEM

1. **Weeds or debris jammed around impeller.**
 - *Clean. Refer to Jet Pump Water Intake and Impeller Cleaning in Special Procedures section.*
 - *Check for damage.*
2. **Damaged impeller shaft or drive shaft.**
 - *Refer to an authorized Sea-Doo dealer.*
3. **Water intrusion in jet pump causing bearing seizure.**
 - *Refer to an authorized Sea-Doo dealer.*

WATER FOUND IN BILGE

1. **Bailer system malfunction.**
 - *Have system inspected by an authorized Sea-Doo dealer.*
2. **Exhaust system leak.**
 - *Refer to an authorized Sea-Doo dealer.*
3. **Carbon ring at drive shaft worn.**
 - *Refer to an authorized Sea-Doo dealer.*

MONITORING SYSTEM

A system monitors the electronic components of the EMS (engine management system) iBR, and other components of the electrical system. When a fault occurs, it sends visual messages through the information center and/or audible signals through a beeper to inform you of a particular condition.

A fault code may also be recorded.

When a minor or transient fault occurs, the fault message and beeper will cease automatically if the condition that caused the fault does not exist anymore.

Releasing the throttle and letting the engine return to idle speed may allow normal operation to come back. If this does not work, try removing and reinstalling the tether cord on the engine cut-off switch.

The electronic system will react differently depending on the fault type. In severe failure, the engine may not be allowed to be started. In other cases, the engine will operate in limp home mode (reduced speed).

When a fault occurs, please refer to the *US EPA Emission-Related Warranty* contained herein for information about warranty claims.

Fault Codes

When a fault occurs, a numerical fault code may be recorded depending on the fault type and system.

These fault codes are used by authorized Sea-Doo dealers for

troubleshooting the watercraft systems when comparing them to a fault list.

Fault codes can be viewed in the information center multifunction display however, this function is only available if a fault is still active.

If there is an active fault code, it may be viewed by the operator on the multifunction display. The operator may then choose to call his authorized Sea-Doo dealer to pass on the fault code. The dealer will then advise the operator on the steps to take to solve the problem, or to stop using the watercraft and to bring it in to the dealer for repairs.

Displaying Fault Codes

Select **CODES**. If a fault code has occurred during your riding cycle, a **CODES** menu will be available in the settings menu. Press OK to see the list of faults.

NOTE:



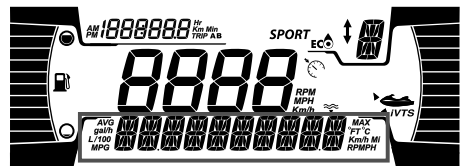

During normal riding conditions some fault codes may occur. Before contacting your local dealer, remove the key, make sure to wait 2 minutes until the electrical system shut down, then press start to wake up the electrical system. This will ensure occurred fault to disappear and only the active codes will remain ON in the CODES menu.



Indicator Lights and Message Display Information

The indicator lights (pilot lamps) and messages displayed in the information center will inform you of a particular condition or if an anomaly occurs.

For information on usual indicator lights, refer to appropriate digital display.

Indicator Light / Icon (ON)	Message Display	Description
	LOW or HIGH BATTERY VOLTAGE	Low/high battery voltage
	HIGH TEMPERATURE	Engine or exhaust system overheating
	CHECK ENGINE or LIMP HOME MODE	Check engine (minor fault req. maint.) or LIMP HOME MODE (major eng. fault)
	LOW OIL PRESSURE	Low oil pressure
	IBR MODULE ERROR	Light is steady with a buzzer and a check engine light: iBR system fault (refer to an authorized Sea-Doo dealer)
	-	Light is flashing: iBR system fault (refer to an authorized Sea-Doo dealer)
	-	Light is steady with no buzzer: iBR system still functional but needs to be inspected by an authorized Sea-Doo dealer

Message Display Information

HIGH EXHAUST TEMPERATURE	High exhaust temperature detected
HIGH ENGINE TEMPERATURE	High engine temperature detected
CHECK ENGINE	Engine system malfunction or maintenance required
LIMP HOME MODE	Major fault detected, engine power limited
FUEL SENSOR FAULT	Fuel level sensor fault
WATER TEMP SENSOR DEFECTIVE	Problem with water temperature sensor, not sending water temperature info.
IBR MODULE ERROR	iBR system malfunction
MAINTENANCE REQUIRED	Watercraft maintenance required

NOTICE

Running engine with low oil pressure may severely damage the engine.

Beeper Code Information

Beeper Codes	Description
1 long beep (while installing tether cord on watercraft engine cut-off switch)	Bad D.E.S.S. system connection. Reinstall tether cord cap correctly on the engine cut-off switch.
	Wrong D.E.S.S. key. Use a tether cord that has been programmed for the watercraft.
	Defective D.E.S.S. key. Use another tether cord with programmed D.E.S.S. key.
	Defective engine cut-off switch. Refer to an authorized Sea-Doo dealer.
	Improper operation of ECM or defective wiring harness. Seek service from an authorized Sea-Doo dealer, repair shop, or person of your own choosing for maintenance, repair, or replacement. Please refer to the <i>US EPA Emission-Related Warranty</i> contained herein for information about warranty claims.
A 2 seconds beep every 15 minutes interval	Engine management system fault. Seek service from an authorized Sea-Doo dealer, repair shop, or person of your own choosing for maintenance, repair, or replacement. Please refer to the <i>US EPA Emission-Related Warranty</i> contained herein for information about warranty claims.
	iBR system fault. Refer to an authorized Sea-Doo dealer.
A 2 seconds beep every 10 minutes interval	Low fuel level. Refill fuel tank. If problem persists, refer to an authorized Sea-Doo dealer.

Beeper Codes	Description
2 second beeps	<p>High engine temperature coolant. See <i>Engine Overheating</i>.</p>
	<p>Low oil pressure. Turn off engine as soon as possible. Check oil level and refill. Seek service from an authorized Sea-Doo dealer, repair shop, or person of your own choosing for maintenance, repair, or replacement. Please refer to the <i>US EPA Emission-Related Warranty</i> contained herein for information about warranty claims.</p>
Constant beep (Stops when vehicle is turned OFF)	<p>High exhaust temperature. Seek service from an authorized Sea-Doo dealer, repair shop, or person of your own choosing for maintenance, repair, or replacement. Please refer to the <i>US EPA Emission-Related Warranty</i> contained herein for information about warranty claims.</p>

NOTICE

If the monitoring beeper continuously sounds, stop engine as soon as possible.

WARRANTY

BRP LIMITED WARRANTY – USA AND CANADA: 2022 SEA-DOO PERSONAL WATERCRAFT

1. SCOPE

Bombardier Recreational Products Inc. (“BRP”) warrants its model-year 2022 Sea-Doo personal watercraft sold by authorized BRP Dealers (as defined below) in the United States of America (“USA”) and in Canada from defects in material or workmanship for the period and under the conditions described below. This limited warranty will become null and void if:

1. (1) The Sea-Doo personal watercraft was used for racing or any other competitive activity, at any point, even by a previous owner; or
2. The Sea-Doo personal watercraft has been altered or modified in such a way so as to adversely affect its operation, performance or durability, or has been altered or modified to change its intended use.

Non-factory installed parts and accessories are not covered under this limited warranty. Please refer to the applicable parts and accessories limited warranty text.

2. LIMITATIONS OF LIABILITY

THIS WARRANTY IS EXPRESSLY GIVEN AND ACCEPTED IN LIEU OF ANY AND ALL OTHER WARRANTIES, EXPRESSED OR IMPLIED, INCLUDING WITHOUT LIMITATION ANY WARRANTY OF MERCHANTABILITY OR FITNESS FOR A PARTICULAR PURPOSE. TO THE EXTENT THAT THEY CANNOT BE DISCLAIMED, THE IMPLIED WARRANTIES ARE LIMITED IN DURATION TO THE LIFE OF THE EXPRESS WARRANTY. INCIDENTAL AND CONSEQUENTIAL DAMAGES ARE EXCLUDED FROM COVERAGE UNDER THIS WARRANTY. SOME STATES/ PROVINCES DO NOT ALLOW FOR THE DISCLAIMERS, LIMITATIONS AND EXCLUSIONS IDENTIFIED ABOVE, AS A RESULT, THEY MAY NOT APPLY TO YOU. THIS WARRANTY GIVES YOU SPECIFIC RIGHTS, AND YOU MAY ALSO HAVE OTHER LEGAL RIGHTS WHICH MAY VARY FROM STATE TO STATE, OR PROVINCE TO PROVINCE.

Neither the distributor, any BRP dealer nor any other person has been authorized to make any affirmation, representation or warranty regarding the product, other than those contained in this limited warranty, and if made, shall not be enforceable against BRP. BRP reserves the right to modify this limited warranty at any time, being understood that such modification will not alter the warranty conditions applicable to the products sold while this warranty is in effect.

3. EXCLUSIONS – ARE NOT WARRANTED

The following are not warranted under any circumstances:

- Normal wear and tear;
- Routine maintenance items, tune ups, adjustments;
- Damage caused by failure to provide proper maintenance and/or storage, as described in the Operator’s Guide;
- Damage resulting from removal of parts, improper repairs, service, maintenance, modifications or use of parts not manufactured or approved by BRP or resulting from repairs done by a person that is not an authorized servicing BRP dealer;

- Damage caused by abuse, abnormal use, neglect, or operation of the product in a manner inconsistent with the recommended operation described in the Operator's Guide;
- Damage resulting from accident, submersion, fire, theft, vandalism or any act of God;
- Operation with fuels, oils or lubricants which are not suitable for use with the product (see the Operator's Guide);
- Damage from rust, corrosion or exposure to the elements;
- Damage from cooling system or jet pump blockage by foreign material;
- Water damages caused by water ingestion;
- Damages related to gel coat finish including but not limited to cosmetic gel coat finish, blisters or fiberglass delamination caused by blisters, crazing, spider or hairline cracks; and
- Incidental or consequential damages, or damages of any kind including without limitation towing, storage, telephone, rental, taxi, inconvenience, insurance coverage, loan payments, loss of time, loss of income.

4. WARRANTY COVERAGE PERIOD

This limited warranty will be in effect from (1) the date of delivery to the first retail consumer or (2) the date the product is first put into use, whichever occurs first and for the applicable period below:

1. TWELVE (12) CONSECUTIVE MONTHS for private use owners.
2. FOUR (4) CONSECUTIVE MONTHS for commercial use owners. A personal watercraft is used commercially when it is used in connection with generating income or any work or employment during any part of the warranty period. A personal watercraft is also used commercially when, at any point during the warranty period, it has commercial tags or is licensed for commercial use. This is a minimal warranty period which can be extended by any applicable warranty promotional program, as the case may be.
3. For emission-related components; please also refer to the *US EPA Emission-related warranty* contained herein.
4. For Sea-Doo personal watercrafts produced by BRP for sale in the State of California or New York that are originally sold to a resident or subsequently warranty registered to a resident in the State of California or New York, please also refer to the applicable California and New York Emissions Control Warranty Statement contained herein.
5. For Sea-Doo personal watercrafts produced by BRP for sale in the State of California that are originally sold to a resident or subsequently warranty registered to a resident in the State of California, please also refer to the CALIFORNIA EVAPORATIVE EMISSIONS CONTROL SYSTEM WARRANTY STATEMENT contained herein.

The repair or replacement of parts or the performance of service under any applicable warranty does not extend the life of such warranty beyond its original expiration date.

5. CONDITIONS REQUIRED FOR WARRANTY COVERAGE

This limited warranty coverage is available **only** if **each** of the following conditions has been fulfilled:

- The 2022 Sea-Doo personal watercraft must be purchased as new and unused by its first owner from a BRP dealer authorized to distribute Sea-Doo personal watercraft in the country in which the sale occurred;
- The BRP specified predelivery inspection process must be completed and documented and signed by the purchaser;
- The 2022 Sea-Doo personal watercraft must have undergone proper registration by an authorized BRP dealer;
- The 2022 Sea-Doo personal watercraft must be purchased in the country in which the purchaser resides; and
- Routine maintenance outlined in the Operator's Guide must be timely performed in order to maintain warranty coverage. BRP reserves the right to make warranty coverage contingent upon proof of proper maintenance.

BRP will not honour this limited warranty to any private use owner or commercial use owner if one of the preceding conditions has not been met. Such limitations are necessary in order to allow BRP to preserve both the safety of its products, and also that of its consumers and the general public.

6. WHAT TO DO TO OBTAIN WARRANTY COVERAGE

The customer must cease using the Sea-Doo personal watercraft upon the appearance of an anomaly. The customer must notify an authorized servicing BRP dealer within three (3) days of the appearance of a defect, and provide it with reasonable access to the product and reasonable opportunity to repair it. The customer must also present to the authorized BRP dealer, proof of purchase of the product and must sign the repair/work order prior to the start of the repair in order to validate the warranty repair. All parts replaced under this limited warranty become the property of BRP.

7. WHAT BRP WILL DO

BRP's obligations under this warranty are limited to, at its sole discretion, repairing parts found defective under normal use, maintenance and service, or replacing such parts with new genuine BRP parts without charge for parts and labor, at any authorized BRP dealer during the applicable warranty coverage period under the conditions described herein. No claim of breach of warranty shall be the cause for cancellation or rescission of the sale of the Sea-Doo personal watercraft to the owner.

In the event that service is required outside of the country of original sale, the owner will bear responsibility for any additional charges due to local practices and conditions, such as, but not limited to freight, insurance, taxes, license fees, import duties, and any and all other financial charges, including those levied by governments, states, territories and their respective agencies.

BRP reserves the right to improve or modify products from time to time without assuming any obligation to modify products previously manufactured.

8. TRANSFER

If the ownership of a product is transferred during the warranty coverage period, this limited warranty, subject to its terms and conditions, shall also be transferred and be valid for the remaining coverage period provided BRP or an authorized

Sea-Doo Distributor/Dealer receives a proof that the former owner agreed to the transfer of ownership, in addition to the coordinates of the new owner.

9. CONSUMER ASSISTANCE

In the event of a controversy or a dispute in connection with this BRP limited warranty, BRP suggests that you try to resolve the issue at the dealership level. We recommend discussing the issue with the authorized BRP dealer's service manager or owner.

If the matter still remains unresolved, contact BRP by filling out the customer contact form at www.brp.com or contact BRP by mail at one of the addresses listed under the *Contact Us* section of this guide.

US EPA EMISSION-RELATED WARRANTY

Bombardier Recreational Products Inc. ("BRP") warrants to the ultimate purchaser and each subsequent purchaser that this new engine, including all parts of its exhaust emission control system and its evaporative emission control system, meets two conditions:

1. It is designed, built, and equipped so it conforms at the time of sale to the ultimate purchaser with the requirements of 40 CFR 1045 and 40 CFR 1060.
2. It is free from defects in materials and workmanship that may keep it from meeting the requirements of 40 CFR 1045 and 40 CFR 1060.

Where a warrantable condition exists, BRP will repair or replace, as it elects, any part or component with a defect in materials or workmanship that would increase the engine's emissions of any regulated pollutant within the stated warranty period at no cost to the owner, including expenses related to diagnosing and repairing or replacing emission-related parts. All defective parts replaced under this warranty become the property of BRP.

For all emission-related warranty claims, BRP is limiting the diagnosis and repair of emission-related parts to the authorized Sea-Doo dealers, unless for emergency repairs as required by item 2 of the following list.

As a certifying manufacturer, BRP will not deny emission-related warranty claims based on any of the following:

1. Maintenance or other service BRP or BRP's authorized facilities performed.
2. Engine/equipment repair work that an operator performed to correct an unsafe, emergency condition attributable to BRP as long as the operator tries to restore the engine/equipment to its proper configuration as soon as possible.
3. Any action or inaction by the operator unrelated to the warranty claim.
4. Maintenance that was performed more frequently than BRP specify.
5. Anything that is BRP fault or responsibility.
6. The use of any fuel that is commonly available where the equipment operates unless BRP written maintenance instructions state that this fuel would harm the equipment's emission control system and operators can readily find the proper fuel. See maintenance information section and fuel requirements of fueling section.

Emission-Related Warranty Period

The emission-related warranty is valid for the following period whichever comes first:

	Hours	Months
Exhaust emission-related components	175	30
Evaporative emission-related components	N/A	24

Components Covered

The emission-related warranty covers all components whose failure would increase an engine's emissions of any regulated pollutant, including the following listed components:

1. For exhaust emissions, emission-related components include any engine parts related to the following systems:
 - Air-induction system
 - Fuel system
 - Ignition system
 - Exhaust gas recirculation systems
2. The following parts are also considered emission-related components for exhaust emissions:
 - Aftertreatment devices
 - Crankcase ventilation valves
 - Sensors
 - Electronic control units
3. The following parts are considered emission-related components for evaporative emissions:
 - Fuel tank
 - Fuel cap
 - Fuel line
 - Fuel line fittings
 - Clamps*
 - Pressure relief valves*
 - Control valves*
 - Control solenoids*
 - Electronic controls*
 - Vacuum control diaphragms*
 - Control cables*
 - Control linkages*
 - Purge valves
 - Vapor hoses
 - Liquid/vapor separator
 - Carbon canister
 - Canister mounting brackets
 - Carburetor purge port connector

NOTE:

Items with * as related to the evaporative emission control system.

4. Emission-related components also include any other part whose only purpose is to reduce emissions or whose failure will increase emissions without significantly degrading engine/equipment performance.

Limited Applicability

As a certifying manufacturer, BRP may deny emission-related warranty claims for failures that have been caused by the owner's or operator's improper maintenance or use, by accidents for which the manufacturer has no responsibility, or by acts of God. For example, an emission-related warranty claim need not be honored for failures that have been directly caused by the operator's abuse of the engine/equipment or the operator's use of the engine/equipment in a manner for which it was not designed and are not attributable to the manufacturer in any way.

If you have any questions regarding your warranty rights and responsibilities or for the name and location of the nearest authorized BRP Dealer you should contact BRP by filling out the customer contact form at www.brp.com or contact BRP by mail at one of the addresses listed under the *CONTACT US* section of this guide, or call at 1-888-272-9222

CALIFORNIA EVAPORATIVE EMISSIONS CONTROL SYSTEM WARRANTY STATEMENT

Your Warranty Rights and Obligations

The California Air Resources Board is pleased to explain the evaporative emissions control system's warranty on your 2022 spark-ignition marine watercraft (SIMW). In California, new spark-ignition marine watercraft must be designed, built, and equipped to meet the State's stringent anti-smog standards. Bombardier Recreational Products Inc. must warrant the evaporative emissions control system on your spark-ignition marine watercraft for the period listed below, provided there has been no abuse, neglect or improper maintenance of your spark-ignition marine watercraft.

Your evaporative emissions control system may include parts such as: canisters, carburetors, clamps, connectors, filters, fuel caps, fuel lines, fuel tanks, valves, vapor hoses, and other associated evaporative emissions control system components.

MANUFACTURER'S WARRANTY COVERAGE:

This evaporative emissions control system is warranted for two years. If any evaporative emission-related part on your spark-ignition marine watercraft (SIMW) is defective, the part will be repaired or replaced by Bombardier Recreational Products Inc.

PARTS COVERED:

1. Clamp(s)*
2. Fuel Cap
3. Fuel Line
4. Fuel Line Fitting(s)
5. Fuel Tank
6. Pressure Relief Valve(s)*
7. Vapor Hose(s)
8. All other parts not listed that may affect the evaporative emissions control system

NOTE:

Items with * as related to the evaporative emission control system.

OWNER'S WARRANTY RESPONSIBILITIES:

As the personal watercraft owner, you are responsible for performance of the required maintenance listed in your owner's manual. Bombardier Recreational Products Inc. recommends that you retain all receipts covering maintenance on your spark-ignition marine watercraft (SIMW), but Bombardier Recreational Products Inc. cannot deny warranty solely for the lack of receipts.

As the spark-ignition marine watercraft (SIMW) owner, you should however be aware that Bombardier Recreational Products Inc. may deny you warranty coverage if your spark-ignition marine watercraft (SIMW) or a part has failed due to abuse, neglect, improper maintenance or unapproved modifications.

You are responsible for presenting your spark-ignition marine watercraft (SIMW) to a Bombardier Recreational Products Inc. distribution center or service center

as soon as the problem exists. The warranty repairs should be completed in a reasonable amount of time, not to exceed 30 calendar days. If you have question regarding your warranty coverage, you should contact Bombardier Recreational Products at 1-888-272-9222.

CALIFORNIA AND NEW YORK EMISSION CONTROL WARRANTY STATEMENT FOR MODEL YEAR 2022 SEA-DOO PERSONAL WATERCRAFT

Your Warranty Rights and Obligations

The California Air Resources Board, the New York State Department of Environmental Conservation and Bombardier Recreational Products Inc. ("BRP") are pleased to explain the emission control system warranty on your Model Year 2022 Sea-Doo personal watercraft. In California and New York, new personal watercraft engines must be designed, built and equipped to meet the State's stringent anti-smog standards. BRP must warrant the emission control system on your personal watercraft engine for the period of time listed below provided there has been no abuse, neglect or improper maintenance of your personal watercraft engine.

Your emission control system may include parts such as the fuel injection system, the ignition system and catalytic converter. Also included may be hoses, belts, connectors and other emission related assemblies.

Where a warrantable condition exists, BRP will repair your personal watercraft engine at no cost to you including diagnosis, parts and labor provided that such work is performed by an authorized BRP dealer.

Manufacturer's Limited Warranty Coverage

This emission limited warranty covers Model Year 2022 Sea-Doo personal watercrafts certified and produced by BRP for sale in California or New York, that are originally sold in California or New York to a California or New York resident or subsequently warranty registered to a California or New York resident. The BRP limited warranty conditions for Sea-Doo personal watercrafts are still applicable to these models with the necessary modifications. Select emission control parts of your 2022 Sea-Doo personal watercrafts are warranted from the date of delivery to the first retail consumer for a period of 4 years, or for 250 hours of use, whichever occurs first. However, warranty coverage based on the hourly period is only permitted for personal watercraft equipped with the appropriate hour meters or their equivalent. If any emission-related part on your engine is defective under warranty, the part will be repaired or replaced by BRP.

Parts covered for a Model Year 2022 Sea-Doo personal watercraft:

Supercharger	Air intake adapter
Throttle position sensor	Spark plugs
Intake manifold air pressure sensor	Ignition coils
Intake manifold air temperature sensor	Air box
Engine temperature sensor	Intake and exhaust valve and seals
Knock sensor	Intake manifold
Engine control module ECM	Crankcase ventilation valve

Throttle body	Throttle body seal
Fuel rail	Intake manifold seal
Fuel injectors	Wire harness and connectors
Fuel pressure regulator	Fuel filter
Fuel pump	-

The emission warranty covers damage to other engine components that is caused by the failure of a warranted part. The BRP Operator's Guide provided contains written instructions for the proper maintenance and use of your personal watercraft. All emission warranty parts are warranted by BRP for the entire warranty period of the personal watercraft, unless the part is scheduled for replacement as required maintenance in the Operator's Guide.

Emission warranty parts that are scheduled for replacement, as required maintenance, are warranted by BRP for the period of time before the first scheduled replacement date for that part. Emission warranty parts that are scheduled for regular inspection, but not regular replacement, are warranted by BRP for the entire warranty period of the personal watercraft. Any emission warranty part repaired or replaced under the terms of this warranty statement is warranted by BRP for the remainder of the warranty period of the original part. All parts replaced under this limited warranty become the property of BRP.

Maintenance receipts and records should be transferred to each subsequent owner of the personal watercraft.

Owner's Warranty Responsibilities

As the owner of a 2022 Sea-Doo personal watercraft, you are responsible for the performance of the required maintenance listed in your Operator's Guide. BRP recommends that you retain all receipts covering maintenance of your personal watercraft engine, but BRP cannot deny warranty solely for the lack of receipts or your failure to ensure the performance of all scheduled maintenance.

As the owner of a Sea-Doo personal watercraft, you should however be aware that BRP may deny you warranty coverage if your engine(s) or a part has failed due to abuse, neglect, improper maintenance or unapproved modifications.

You are responsible for presenting your engine to an authorized BRP Sea-Doo Dealer as soon as a problem exists. The warranty repairs will be completed in a reasonable amount of time, not to exceed 30 days.

If you have any questions regarding your warranty rights and responsibilities or for the name and location of the nearest authorized BRP Sea-Doo dealer you should contact the Customer Assistance Center at 1-888-272-9222.

Star Rating System

For California and New York, your 2022 Sea-Doo spark-ignition marine watercraft (SIMW) has a special environmental label required by the California Air Resources Board. The label has 1, 2, 3 or 4 stars. A hangtag, provided with your spark-ignition marine watercraft (SIMW), describes the meaning of the star rating system.

The Star Label Means Cleaner Marine Engines

The Symbol for Cleaner Marine Engines:



F18L3CQ

Cleaner Air and Water

For a healthier lifestyle and environment.

Better Fuel Economy

Burns up to 30 - 40 percent less gas and oil than conventional carbureted two-stroke engines saving money and resources.

Longer Emission Warranty

Protects consumer for worry free operation.

SEA-DOO PERSONAL WATERCRAFT

One Star – Low Emission

The one-star label identifies personal watercraft, outboard, stern drive and in-board engines that meet the Air Resources Board's Personal Watercraft and Outboard marine engine 2001 exhaust emission standards. Engines meeting these standards have 75% lower emissions than conventional carbureted two-stroke engines. These engines are equivalent to the U.S. EPA's 2006 standards for marine engines.

Two Stars – Very Low Emission

The two-star label identifies personal watercraft, outboard, stern drive and in-board engines that meet the Air Resources Board's Personal Watercraft and Outboard marine engine 2004 exhaust emission standards. Engines meeting these standards have 20% lower emissions than One Star - Low-Emission engines.

Three Stars – Ultra Low Emission

The three-star label identifies engines that meet the Air Resources Board's Personal Watercraft and Outboard marine engine 2008 exhaust emission standards or the Stern drive and Inboard marine engine 2003 exhaust emission standards. Engines meeting these standards have 65% lower emissions than One Star – Low Emission engines.

Four Stars – Super Ultra Low Emission

The four-star label identifies engines that meet the Air Resources Board's Stern--drive and Inboard marine engine 2012 exhaust emission standards. Personal Watercraft and Outboard marine engines may also comply with these standards. Engines meeting these standards have 90% lower emissions than One Star – Low Emission engines.

For more information:	Cleaner Watercraft – Get the Facts 1 800 END-SMOG www.arb.ca.gov
-----------------------	--

BRP INTERNATIONAL LIMITED WARRANTY: 2022 SEA-DOO PERSONAL WATERCRAFT

1. SCOPE OF THE LIMITED WARRANTY

Bombardier Recreational Products Inc. ("BRP") warrants its 2022 Sea-Doo personal watercraft ("personal watercraft") sold by distributors or dealers authorized by BRP to distribute Sea-Doo personal watercrafts ("Sea-Doo Distributor/Dealer") outside of the fifty United States, Canada, member states of the European Economic Area (which is comprised of the member states of the European Union plus the United Kingdom, Norway, Iceland and Liechtenstein) ("EEA"), member states of the Commonwealth of the Independent States (including Ukraine and Turkmenistan) ("CIS") and Turkey, from defects in material or workmanship for the period and under the conditions described below.

Non-factory installed parts and accessories are not covered under this limited warranty. Please refer to the applicable parts and accessories limited warranty text.

This limited warranty will become null and void if:

1. The personal watercraft was used for racing or any other competitive activity, at any point, even by a previous owner; or
2. The personal watercraft has been altered or modified in such a way so as to adversely affect its operation, performance or durability or
3. The personal watercraft has been altered or modified to change its intended use.

2. LIMITATIONS OF LIABILITY

TO THE EXTENT PERMITTED BY LAW, THIS WARRANTY IS EXPRESSLY GIVEN AND ACCEPTED IN LIEU OF ANY AND ALL OTHER WARRANTIES, EXPRESSED OR IMPLIED, INCLUDING WITHOUT LIMITATION ANY WARRANTY OF MERCHANTABILITY OR FITNESS FOR A PARTICULAR PURPOSE. TO THE EXTENT THAT THEY CANNOT BE DISCLAIMED, THE IMPLIED WARRANTIES ARE LIMITED IN DURATION TO THE LIFE OF THE EXPRESS WARRANTY. INCIDENTAL AND CONSEQUENTIAL DAMAGES ARE EXCLUDED FROM COVERAGE UNDER THIS WARRANTY. SOME JURISDICTIONS DO NOT ALLOW FOR THE DISCLAIMERS, LIMITATIONS AND EXCLUSIONS IDENTIFIED ABOVE, AS A RESULT, THEY MAY NOT APPLY TO YOU. THIS WARRANTY GIVES YOU SPECIFIC RIGHTS AND YOU MAY ALSO HAVE OTHER LEGAL RIGHTS WHICH MAY VARY FROM COUNTRY TO COUNTRY. (FOR PRODUCTS PURCHASED IN AUSTRALIA SEE CLAUSE 4 BELOW).

Neither the Sea-Doo distributor/dealer nor any other person has been authorized to make any affirmation, representation or warranty regarding the product, other than those contained in this limited warranty, and if made, shall not be enforceable against BRP.

BRP reserves the right to modify this warranty at any time, being understood that such modification will not alter the warranty conditions applicable to the products sold while this warranty is in effect.

3. EXCLUSIONS – ARE NOT WARRANTED

The following are not warranted under this limited warranty under any circumstances:

- Replacement of parts due to normal wear and tear;
- Routine maintenance parts and services, including but not limited to tune ups, adjustments, oil, lubricant and coolant changes, spark plug replacement, water pumps and the like;
- Damage caused by negligence or failure to provide proper maintenance and/or storage, as described in the Operator's Guide;
- Damage resulting from removal of parts, improper repairs, service, maintenance, modification or use of parts or accessories not manufactured or approved by BRP which in its reasonable judgment are either incompatible with the product or adversely affect its operation, performance and durability, or resulting from repairs done by a person that is not an authorized servicing Sea-Doo Distributor/Dealer;
- Damage caused by abuse, misuse, abnormal use, neglect, racing, improper operation or operation of the product in a manner inconsistent with the recommended operation described in the Operator's Guide;
- Damage resulting from external damage, accident, submersion, fire, foreign object or water ingestion, theft, vandalism or any act of God;
- Operation with fuels, oils or lubricants which are not suitable for use with the product (see the Operator's Guide);
- Damage resulting from rust, corrosion or exposure to the elements;
- Damages from cooling system or jet pump blockage by foreign material;
- Damages to gel coat finish including but not limited to cosmetic gel coat finish defects, blisters, starring, crazing and fiberglass delamination caused by blisters, crazing, spider or hairline cracks; and
- Incidental or consequential damages, or damages of any kind including without limitation towing, storage, transportation expenses, telephone, rental, taxi, inconvenience, insurance coverage, loan payments, loss of time, loss of income or time missed for downtime experience due to service work.

4. WARRANTY COVERAGE PERIOD

This limited warranty will be in effect from (1) the date of delivery to the first retail consumer or (2) the date the product is first put into use, whichever occurs first and for a period of:

1. TWELVE (12) CONSECUTIVE MONTHS for private, recreational use. For AUSTRALIA and NEW ZEALAND only, TWENTY-FOUR (24) CONSECUTIVE MONTHS for private, recreational use.
2. FOUR (4) CONSECUTIVE MONTHS for commercial use,
This is a minimal warranty period which can be extended by any applicable warranty promotional program, as the case may be. A personal watercraft is used commercially when it is used in connection with generating income or any work or employment during any part of the warranty period. A personal watercraft is also used commercially when, at any point during the warranty period, it has commercial tags or is licensed for commercial use.

The repair or replacement of parts or the performance of service under this warranty does not extend the life of this warranty beyond its original expiration date.

Note that the duration and any other modalities of the warranty coverage are subject to the applicable national or local legislation in the customer's country.

FOR PRODUCTS SOLD IN AUSTRALIA ONLY

Nothing in these Warranty terms and conditions should be taken to exclude, restrict or modify the application of any condition, warranty, guarantee, right or remedy conferred or implied under the Competition and Consumer Act 2010 (Cth), including the Australian Consumer Law or any other law, where to do so would contravene that law, or cause any part of these terms and conditions to be void. The benefits given to you under this limited warranty are in addition to other rights and remedies that you have under Australian law.

Our goods come with guarantees that cannot be excluded under the Australian Consumer Law. You are entitled to a replacement or refund for a major failure and for compensation for any other reasonably foreseeable loss or damage. You are also entitled to have the goods repaired or replaced if the goods fail to be of acceptable quality and the failure does not amount to a major failure.

5. CONDITIONS TO HAVE WARRANTY COVERAGE

This warranty coverage is available **only** if **each** of the following conditions has been fulfilled:

- The 2022 Sea-Doo personal watercraft must be purchased as new and unused by its first owner from a Sea-Doo distributor/dealer authorized to distribute Sea-Doo personal watercrafts in the country in which the sale occurred;
- The BRP specified pre-delivery inspection process must be completed and documented;
- The 2022 Sea-Doo personal watercraft must have undergone proper registration by an authorized Sea-Doo distributor/dealer;
- The 2022 Sea-Doo personal watercraft must have been purchased in the country or union of countries in which the purchaser resides.
- Routine maintenance outlined in the Operator's Guide must be timely performed in order to maintain warranty coverage. BRP reserves the right to make warranty coverage contingent upon proof of proper maintenance.

BRP will not honor this limited warranty to any private use owner or commercial use owner if one of the preceding conditions has not been met. Such limitations are necessary in order to allow BRP to preserve both the safety of its products, and also that of its consumers and the general public.

6. WHAT TO DO TO OBTAIN WARRANTY COVERAGE

The customer must cease using the Sea-Doo personal watercraft upon the appearance of an anomaly. The customer must notify a servicing Sea-Doo distributor/dealer within two (2) days of the appearance of a defect, and provide it with reasonable access to the product and reasonable opportunity to repair it. The customer must also present to the authorized Sea-Doo distributor/dealer, proof of purchase of the product and must sign the repair/work order prior to starting the repair in order to validate the warranty repair. All parts replaced under this limited warranty become the property of BRP.

Note that the notification period is subject to the applicable national or local legislation in customer's country.

7. WHAT BRP WILL DO

To the extent permitted by law, BRP's obligations under this warranty are limited to, at its sole discretion, repairing parts found defective under normal use, maintenance and service, or replacing such parts with new genuine BRP parts without charge for parts and labor, at any authorized Sea-Doo distributor/dealer during the warranty coverage period under the conditions described herein. BRP's responsibility is limited to making the required repairs or replacements of parts. No claim of breach of warranty shall be cause for cancellation or rescission of the sale of the Sea-Doo personal watercraft to the owner. You may have other legal rights which may vary from country to country.

In the event that service is required outside of the country of original sale, the owner will bear responsibility for any additional charges due to local practices and conditions, such as, but not limited to, freight, insurance, taxes, license fees, import duties, and any and all other financial charges, including those levied by governments, states, territories and their respective agencies.

BRP reserves the right to improve or modify products from time to time without assuming any obligation to modify products previously manufactured.

8. TRANSFER

If the ownership of a product is transferred during the warranty coverage period, this limited warranty, subject to its terms and conditions, shall also be transferred and be valid for the remaining coverage period provided BRP or an authorized Sea-Doo distributor/dealer receives a proof that the former owner agreed to the transfer of ownership, in addition to the coordinates of the new owner.

9. CONSUMER ASSISTANCE

In the event of a controversy or a dispute in connection with this BRP limited warranty, BRP suggests that you try to resolve the issue at the dealership level. We recommend discussing the issue with the authorized BRP dealer's service manager or owner.

If the matter still remains unresolved, contact BRP by filling out the customer contact form at www.brp.com or contact BRP by mail at one of the addresses listed under the *Contact Us* section of this guide.

BRP LIMITED WARRANTY FOR THE EUROPEAN ECONOMIC AREA, THE COMMONWEALTH OF THE INDEPENDENT STATES AND TURKEY: 2022 SEA-DOO PERSONAL WATERCRAFT

1. SCOPE OF THE LIMITED WARRANTY

Bombardier Recreational Products Inc. ("BRP") warrants its 2022 Sea-Doo personal watercraft ("personal watercraft") sold by distributors or dealers authorized by BRP to distribute Sea-Doo personal watercrafts ("Sea-Doo distributor/dealer") in member states of the European Economic Area (which is comprised of the member states of the European Union plus the United Kingdom, Norway, Iceland and Liechtenstein) ("EEA"), in member states of the Commonwealth of the Independent States (including Ukraine and Turkmenistan) ("CIS") and Turkey from defects in material or workmanship for the period and under the conditions described below.

Non-factory installed parts and accessories are not covered under this limited warranty. Please refer to the applicable parts and accessories limited warranty text.

This limited warranty will become null and void if:

1. The personal watercraft was used for racing or any other competitive activity, at any point, even by a previous owner; or
2. The personal watercraft has been altered or modified in such a way so as to adversely affect its operation, performance or durability, or
3. The personal watercraft has been altered or modified to change its intended use.

2. LIMITATIONS OF LIABILITY

TO THE EXTENT PERMITTED BY LAW, THIS WARRANTY IS EXPRESSLY GIVEN AND ACCEPTED IN LIEU OF ANY AND ALL OTHER WARRANTIES, EXPRESSED OR IMPLIED, INCLUDING WITHOUT LIMITATION ANY WARRANTY OF MERCHANTABILITY OR FITNESS FOR A PARTICULAR PURPOSE. TO THE EXTENT THAT THEY CANNOT BE DISCLAIMED, THE IMPLIED WARRANTIES ARE LIMITED IN DURATION TO THE LIFE OF THE EXPRESS WARRANTY. INCIDENTAL AND CONSEQUENTIAL DAMAGES ARE EXCLUDED FROM COVERAGE UNDER THIS WARRANTY. SOME JURISDICTIONS DO NOT ALLOW FOR THE DISCLAIMERS, LIMITATIONS AND EXCLUSIONS IDENTIFIED ABOVE, AS A RESULT, THEY MAY NOT APPLY TO YOU. THIS WARRANTY GIVES YOU SPECIFIC RIGHTS, AND YOU MAY ALSO HAVE OTHER LEGAL RIGHTS WHICH MAY VARY FROM COUNTRY TO COUNTRY.

Neither the Sea-Doo distributor/dealer nor any other person has been authorized to make any affirmation, representation or warranty regarding the product, other than those contained in this limited warranty, and if made, shall not be enforceable against BRP.

BRP reserves the right to modify this warranty at any time, being understood that such modification will not alter the warranty conditions applicable to the products sold while this warranty is in effect.

3. EXCLUSIONS – ARE NOT WARRANTED

The following are not warranted under this limited warranty under any circumstances:

- Replacement of parts due to normal wear and tear;
- Routine maintenance parts and services, including but not limited to tune ups, adjustments, oil, lubricant and coolant changes, spark plug replacement, water pumps and the like;
- Damage caused by negligence or failure to provide proper maintenance and/or storage, as described in the Operator's Guide;
- Damage resulting from removal of parts, improper repairs, service, maintenance, modification or use of parts or accessories not manufactured or approved by BRP which in its reasonable judgement are either incompatible with the product or adversely affect its operation, performance and durability, or resulting from repairs done by a person that is not an authorized servicing Sea-Doo distributor/dealer;
- Damage caused by abuse, misuse, abnormal use, neglect, racing, improper operation or operation of the product in a manner inconsistent with the recommended operation described in the Operator's Guide;
- Damage resulting from external damage, accident, submersion, fire, foreign object or water ingestion, theft, vandalism or any act of God;
- Operation with fuel, oils or lubricants which are not suitable for use with the product (see the Operator's Guide);
- Damage resulting from rust, corrosion or exposure to the elements;
- Damages from cooling system or jet pump blockage by foreign material;
- Damages to gel coat finish including but not limited to cosmetic gel coat finish defects, blisters, starring, crazing and fiberglass delamination caused by blisters, crazing, spider or hairline cracks; and
- Incidental or consequential damages, or damages of any kind including without limitation towing, storage, transportation expenses, telephone, rental, taxi, inconvenience, insurance coverage, loan payments, loss of time, loss of income; or time missed for downtime experience due to service work.

4. WARRANTY COVERAGE PERIOD

This limited warranty will be in effect from (1) the date of delivery to the first retail consumer or (2) the date the product is first put into use, whichever occurs first and for a period of:

1. Twenty four (24) CONSECUTIVE MONTHS, for private, recreational use,
2. FOUR (4) CONSECUTIVE MONTHS for commercial use,
A personal watercraft is used commercially when it is used in connection with generating income or any work or employment during any part of the warranty period. A personal watercraft is also used commercially when, at any point during the warranty period, it has commercial tags or is licensed for commercial use.

The repair or replacement of parts or the performance of service under this warranty does not extend the life of this warranty beyond its original expiration date.

Note that the duration and any other modalities of the warranty coverage are subject to the applicable national or local legislation in the customer's country.

5. CONDITIONS TO HAVE WARRANTY COVERAGE

This warranty coverage is available **only** if **each** of the following conditions has been fulfilled:

- The 2022 Sea-Doo personal watercraft must be purchased as new and unused by its first owner from a Sea-Doo distributor/dealer authorized to distribute Sea-Doo personal watercrafts in the country in which the sale occurred;
- The BRP specified pre-delivery inspection process must be completed and documented;
- The 2022 Sea-Doo personal watercraft must have undergone proper registration by an authorized Sea-Doo distributor/dealer;
- The 2022 Sea-Doo personal watercraft must be purchased within the EEA by an EEA resident, in the CIS for residents of the countries comprised in such area and in Turkey for residents of Turkey; and
- Routine maintenance outlined in the Operator's Guide must be timely performed in order to maintain warranty coverage. BRP reserves the right to make warranty coverage contingent upon proof of proper maintenance.

BRP will not honor this limited warranty to any private use owner or commercial use owner if one of the preceding conditions has not been met. Such limitations are necessary in order to allow BRP to preserve both the safety of its products, and also that of its consumers and the general public.

6. WHAT TO DO TO OBTAIN WARRANTY COVERAGE

The customer must cease using the Sea-Doo personal watercraft upon the appearance of an anomaly. The customer must notify a servicing Sea-Doo distributor/dealer within two (2) months of the appearance of a defect, and provide it with reasonable access to the product and reasonable opportunity to repair it. The customer must also present to the authorized Sea-Doo distributor/dealer, proof of purchase of the product and must sign the repair/work order prior to starting the repair in order to validate the warranty repair. All parts replaced under this limited warranty become the property of BRP.

Note that the notification period is subject to the applicable national or local legislation in customer's country.

7. WHAT BRP WILL DO

To the extent permitted by law, BRP's obligations under this warranty are limited to, at its sole discretion, repairing parts found defective under normal use, maintenance and service, or replacing such parts with new genuine Sea-Doo parts without charge for parts and labor, at any authorized Sea-Doo distributor/dealer during the warranty coverage period under the conditions described herein. BRP's responsibility is limited to making the required repairs or replacements of parts. No claim of breach of warranty shall be cause for cancellation or rescission of the sale of the Sea-Doo personal watercraft to the owner. You may have other legal rights which may vary from country to country.

In the event that service is required outside of the country of original sale, or for EEA residents, if service is required outside of the EEA, for CIS residents, if service is required outside of the CIS, the owner will bear responsibility for any additional charges due to local practices and conditions, such as, but not limited to, freight, insurance, taxes, license fees, import duties, and any and all other

financial charges, including those levied by governments, states, territories and their respective agencies.

BRP reserves the right to improve or modify products from time to time without assuming any obligation to modify products previously manufactured.

8. TRANSFER

If the ownership of a product is transferred during the warranty coverage period, this warranty shall also be transferred and be valid for the remaining coverage period provided BRP or an authorized Sea-Doo distributor/dealer receives a proof that the former owner agreed to the transfer of ownership, in addition to the coordinates of the new owner.

9. CONSUMER ASSISTANCE

In the event of a controversy or a dispute in connection with this BRP limited warranty, BRP suggests that you try to resolve the issue at the dealership level. We recommend discussing the issue with the authorized BRP dealer's service manager or owner.

If the matter still remains unresolved, contact BRP by filling out the customer contact form at www.brp.com or contact BRP by mail at one of the addresses listed under the *Contact Us* section of this guide.

MAINTENANCE RECORDS

Send photocopy of maintenance record to BRP if needed.

Predelivery	
Serial number: _____ Mileage / km: _____ Hours: _____ Date: _____ Dealer no.: _____ Notes: _____ _____	Signature/Print:
Refer to vehicle Pre-Delivery Bulletin for detailed installation procedures	

First Inspection	
Mileage / km: _____ Hours: _____ Date: _____ Dealer no.: _____ Notes: _____ _____ _____	Signature/Print:
For maintenance schedule, refer to Maintenance Information section of this operator's guide	

Service	
Mileage / km: _____ Hours: _____ Date: _____ Dealer no.: _____ Notes: _____ _____ _____	Signature/Print:
For maintenance schedule, refer to Maintenance Information section of this operator's guide	

Service

Mileage / km: _____
 Hours: _____
 Date: _____
 Dealer no.: _____
 Notes: _____

Signature/Print:

For maintenance schedule, refer to Maintenance Information section of this operator's guide

Service

Mileage / km: _____
 Hours: _____
 Date: _____
 Dealer no.: _____
 Notes: _____

Signature/Print:

For maintenance schedule, refer to Maintenance Information section of this operator's guide

Service

Mileage / km: _____
 Hours: _____
 Date: _____
 Dealer no.: _____
 Notes: _____

Signature/Print:

For maintenance schedule, refer to Maintenance Information section of this operator's guide

Service

Mileage / km: _____
 Hours: _____
 Date: _____
 Dealer no.: _____
 Notes: _____

Signature/Print:

For maintenance schedule, refer to Maintenance Information section of this operator's guide

Service

Mileage / km: _____
 Hours: _____
 Date: _____
 Dealer no.: _____
 Notes: _____

Signature/Print:

For maintenance schedule, refer to Maintenance Information section of this operator's guide

This page is intentionally blank

CUSTOMER INFORMATION

PRIVACY INFORMATION

BRP wishes to inform you that your coordinates will be used for safety and warranty related purposes. Furthermore, BRP and its affiliates may use its customer list to distribute marketing and promotional information about BRP and related products.

To exercise your right to consult or correct your data, or to be removed from the addressee-list for direct marketing, please contact BRP.

By E-mail:
privacyofficer@brp.com

By mail:
BRP Legal Service
726 St-Joseph
Valcourt QC
Canada
J0E 2L0

CONTACT US

www.brp.com

Asia

Room 4609, Tower 2,
Grand Gateway 3 Hong Qiao
Road Shanghai,
China 200020

21F Shinagawa East One Tower
2-16-1 Konan, Minatoku-ku,
Tokyo 108-0075
Japan

Europe

Oktrooiplein 1/402
9000 Gent
Belgium

Itterpark 11
D-40724 Hilden
Germany

ARTEPARC Bâtiment B
Route de la côte d'Azur, Le Canet
13590 Meyreuil
France

Ingvald Ystgaardsvei 15
N-7484 Trondheim
Norway

Isoaavantie 7
PL 8040
96101 Rovaniemi

Spinnvägen 15
903 61 Umeå
Sweden

Avenue d'Ouchy 4-6
1006 Lausanne
Switzerland

North America

565 de la Montagne Street
Valcourt (Québec) J0E 2L0
Canada

Sa De Cv, Av. Ferrocarril 202
Parque Ind. Querétaro, Lote2-B
76220
Santa Rosa Jáuregui, Qro., Mexico

Sturtevant, Wisconsin, U.S.A.

10101 Science Drive
Sturtevant, Wisconsin
53177
U.S.A.

Oceania

6 Lord Street
Lakes Business Park
Botany, NSW 2019
Australia

3B Echelon Place, East Tamaki,
Auckland 2013,
New Zealand

South America

Rua James Clerck Maxwell, 230
TechnoPark Campinas SP 13069-380
Brazil

CHANGE OF ADDRESS/OWNERSHIP

If your address has changed or if you are the new owner of the boat, be sure to notify BRP by either:

- Notifying an authorized Sea-Doo dealer.
- **North America Only:** calling at 1 888 272-9222.
- Mailing one of the change of address cards on the following pages at one of the BRP addresses indicated in the *Contact Us* section of this guide.

In case of change of ownership, please join a proof that the former owner agreed to the transfer.

Notifying BRP, even after the expiration of the limited warranty, is very important as it enables BRP to reach the boat owner if necessary, like when safety recalls are initiated. It is the owner's responsibility to notify BRP.

STOLEN UNITS: In the event that your boat is stolen, you should notify your area's distributor warranty department of such. We will ask you to provide your name, address, phone number, Hull Identification Number and date it was stolen.

CHANGE OF ADDRESS <input type="checkbox"/>		CHANGE OF OWNERSHIP <input type="checkbox"/>		
VEHICLE IDENTIFICATION NUMBER				
<input type="text"/>	<input type="text"/>	<input type="text"/>	<input type="text"/>	<input type="text"/>
Model Number	Vehicle Identification Number (V.I.N.)			
OLD ADDRESS OR PREVIOUS OWNER:		NAME		
NO.		STREET		APT
CITY		STATE/PROVINCE		ZIP/POSTAL CODE
COUNTRY		TELEPHONE		
NEW ADDRESS OR NEW OWNER:		NAME		
NO.		STREET		APT
CITY		STATE/PROVINCE		ZIP/POSTAL CODE
COUNTRY		TELEPHONE		
E-MAIL ADDRESS				

CHANGE OF ADDRESS <input type="checkbox"/>		CHANGE OF OWNERSHIP <input type="checkbox"/>		
VEHICLE IDENTIFICATION NUMBER				
<input type="text"/>	<input type="text"/>	<input type="text"/>	<input type="text"/>	<input type="text"/>
Model Number	Vehicle Identification Number (V.I.N.)			
OLD ADDRESS OR PREVIOUS OWNER:		NAME		
NO.		STREET		APT
CITY		STATE/PROVINCE		ZIP/POSTAL CODE
COUNTRY		TELEPHONE		
NEW ADDRESS OR NEW OWNER:		NAME		
NO.		STREET		APT
CITY		STATE/PROVINCE		ZIP/POSTAL CODE
COUNTRY		TELEPHONE		
E-MAIL ADDRESS				

This page is
intentionally blank

CHANGE OF ADDRESS CHANGE OF OWNERSHIP 

VEHICLE IDENTIFICATION NUMBER

--	--	--	--	--	--	--	--	--	--	--	--	--	--	--	--	--	--	--	--

Model Number Vehicle Identification Number (V.I.N.)

OLD ADDRESS OR PREVIOUS OWNER:

NAME _____

NO. _____ STREET _____ APT _____

CITY _____ STATE/PROVINCE _____ ZIP/POSTAL CODE _____

COUNTRY _____ TELEPHONE _____

NEW ADDRESS OR NEW OWNER:

NAME _____

NO. _____ STREET _____ APT _____

CITY _____ STATE/PROVINCE _____ ZIP/POSTAL CODE _____

COUNTRY _____ TELEPHONE _____

E-MAIL ADDRESS _____

CHANGE OF ADDRESS CHANGE OF OWNERSHIP 

VEHICLE IDENTIFICATION NUMBER

--	--	--	--	--	--	--	--	--	--	--	--	--	--	--	--	--	--	--	--

Model Number Vehicle Identification Number (V.I.N.)

OLD ADDRESS OR PREVIOUS OWNER:

NAME _____

NO. _____ STREET _____ APT _____

CITY _____ STATE/PROVINCE _____ ZIP/POSTAL CODE _____

COUNTRY _____ TELEPHONE _____

NEW ADDRESS OR NEW OWNER:

NAME _____

NO. _____ STREET _____ APT _____

CITY _____ STATE/PROVINCE _____ ZIP/POSTAL CODE _____

COUNTRY _____ TELEPHONE _____

E-MAIL ADDRESS _____

This page is
intentionally blank

NOTE: _____

NOTE: _____

WATERCRAFT

Model No. _____

HULL

Identification Number (H.I.N.) _____

ENGINE

Identification Number (E.I.N.) _____

OWNER: _____
NAME

No. STREET APT

CITY STATE/PROVINCE ZIP/POSTAL CODE

Purchase Date | | |
YEAR MONTH DAY

Warranty Expiry Date | | |
YEAR MONTH DAY

To be completed by the authorized Sea-Doo dealer at the time of the sale.

DEALER IMPRINT AREA

⚠ WARNING

Before you operate this vehicle, read this Operator's Guide, all on-product safety labels and watch the safety video.



www.brp.com

SKI-DOO®

LYNX®

MANITOU®

SEA-DOO®

EVINRUDE®

ALUMACRAFT®

CAN-AM®

ROTAX®

219002225