

SEA-DOO®



2011

Sea-Doo Boats
**OPERATOR'S
GUIDE**
Includes,
**SAFETY, VEHICLE
and MAINTENANCE INFORMATION**

230 SERIES

⚠ WARNING

Read this guide thoroughly. It contains important safety information.
Minimum recommended operator's age: 16 years old.
Keep this Operator's Guide in the boat.

219 100 485

⚠ WARNING

Disregarding any of the safety precautions and instructions contained in this Operator's Guide, *SAFETY DVD* and on-product labels could cause injury including the possibility of death!

⚠ WARNING

This boat may exceed the performance of other boats you may have ridden in the past. Take time to familiarize yourself with your new boat.

CALIFORNIA PROPOSITION 65 WARNING

⚠ WARNING

This product contains or emits chemicals known to the state of California to cause cancer and birth defects or other reproductive harm.

In Canada, products are distributed by Bombardier Recreational Products Inc. (BRP).

In USA, products are distributed by BRP US Inc.

This is a non-exhaustive list of trademarks that are the property of Bombardier Recreational Products Inc. or its affiliates:

4-TEC™

Rotax®

WAKE™

Challenger*

Sea-Doo®

XPST™

D.E.S.S.™

* Trademark of Bombardier Inc. used under license.

Flitz is a registered trademark of Flitz International.

Gelcote is a trademark of Gelcote International.

Perfect Pass is a trademark of Perfect Pass Control System Inc.

Spray Nine is a trademark of Spray Nine Corporation.

TABLE OF CONTENTS

FOREWORD	6
Know Before you Go	6
Safety Messages	6
About this Operator's Guide	6

SAFETY INFORMATION

SPECIAL SAFETY MESSAGES	10
Reminders Regarding Operation	10
Before Getting Underway	11
Operators and Passengers Awareness	11
Carbon Monoxide and Boating	12
Water Sports	15
Hypothermia	19
Voluntary Inspections	19
Safe Boating Courses	19
SAFETY EQUIPMENT	20
Required Safety Equipment	20
Additional Recommended Equipment	23
PRACTICE EXERCISES	24
Where to Practice Exercises	24
Practice Exercises	24
Important Factors Not to Neglect	24
SAFE BOATING PRACTICES	26
Drugs and Alcohol	26
Safe Operation	26
NAVIGATION RULES	28
Operating Rules	28
FUELING	30
Recommended Fuel	30
Fueling Procedure	30
TRAILERING INFORMATION	32
LOCATION OF IMPORTANT ON-PRODUCT LABELS	33
Hang Tag	33
Safety Labels	34
Compliance Labels	38
Technical Information Labels	39
PRE-RIDE INSPECTION	40
Pre-Ride Check List When Boat is Trailered	41
Pre-Ride Check List When Boat is Docked	42
Fuel	43
Hull	43
Jet Pump Water Intakes	43
Bilge	43
Engine Compartment	43

PRE-RIDE INSPECTION (cont'd)

Main Battery Cut-Off Switch	43
Throttle/Shifter System	43
Steering System	44
Multifunction Gauge Cluster	44
Bilge Blower Switch	44
Towing Tower (Optional)	44
Bimini Top (Optional)	44
Mandatory Safety Boating Equipment	44
Storage Compartment Covers	44
Navigation Lights	44
Engine Start/Stop Buttons	44
Engine Cut-off Switch	44

BOAT INFORMATION

CONTROLS **46**

1) Steering Wheel	46
2) Throttle/Shifter Control	47
3) Engine Cut-off Switch	47
4) Ignition Switch	48
5) Bilge Blower Switch	49
6) Engine Start/Stop Buttons	49
7) Horn Switch	50
8) Bilge Pump Switch	50
9) Navigation Lights Switch	51
10) Deck Light Switch	51
11) MODE Button	52
12) SET Button	52
13) UP and DOWN Switch	52
14) Heating Fan Switch (230 WAKE)	53
15) Ballast System Switch (230 WAKE)	53

GAUGES **54**

1) Analog Speedometer	54
2) Analog Fuel Level Gauge	54
3) Analog Voltmeter	54
4) Information Center	55

EQUIPMENT **63**

1) Seats	66
2) Main Battery Cut-Off Switch	69
3) Storage Compartments	70
4) Grab Handles	73
5) Rear Grab Handles	73
6) Swim Platform	73
7) Ladder	73
8) Lights	74
9) AM/FM Radio	75

EQUIPMENT (cont'd)	
10) Radio Remote Control	76
11) Audio Input Jack/USB port	76
12) 12-Volt Power Outputs	76
13) Deck Drain	77
14) Bilge Drain Plug	77
15) Walk-Thru Door/Windshield	77
16) Cup Holders	77
17) Bow and Stern Eyelets	78
18) Mooring Cleats	78
19) Water Sport Towing Attachments	78
20) Heating System	82
21) Ballast System	83
22) Bimini Top	85
23) Cockpit Table	87
24) Wakeboard Storage Rack	88
25) Storage Nets	88
26) Windshield	88
BREAK-IN PERIOD	90
Operation During Break-In	90
OPERATING INSTRUCTIONS	91
Launching/Loading	91
Boarding the Boat	91
Starting the Engine	93
Leaving the Shore	94
Steering Operation	94
Throttle/Shifter Control Operation	94
Shutting Off the Engines	95
General Recommendations	96
OPERATING MODES	98
Ski Mode	98
Cruise Mode	99
Sync Mode	100
SPECIAL PROCEDURES	101
Jet Pump Water Intake and Impeller Cleaning	101
Towing the Boat in Water	101
Capsized Boat	102
Submerged Boat and Water-Flooded Engine	102

MAINTENANCE

BREAK-IN INSPECTION	104
MAINTENANCE SCHEDULE	106
MAINTENANCE PROCEDURES	109
Throttle Body	109
Engine Oil	109

MAINTENANCE PROCEDURES (cont'd)	
Engine Oil Change and Oil Filter Replacement	111
Engine Coolant	111
Ignition Coils	112
Exhaust System	113
Fuses and Circuit Breakers	114
Bilge Blower	116
Navigation Lights	116
Deck Drain	117
Latches and Hinges	117
Reverse Gates	118
Driver/Passenger Seat	118
Sacrificial Anodes	119
BOAT CARE	120
Post-Operation Care	120
Boat Cleaning and Protection	120
STORAGE	123
Jet Pump Cleaning	123
Fuel System Protection	123
Throttle Body Lubrication	123
Engine Oil and Filter Replacement	123
Intercooler Draining	123
Exhaust System Flushing	124
Exhaust System and Intercooler Protection	124
Engine Internal Lubrication	124
Engine Coolant Test	125
Battery Removal and Storage	126
Boat Cleaning/Repair	126
Boat Protection	126
PRESEASON PREPARATION	128
 TECHNICAL INFORMATION 	
BOAT IDENTIFICATION	130
Hull Identification Number	130
Engine Identification Number	130
ENGINE EMISSIONS INFORMATION	131
Manufacturer's Responsibility	131
Dealer's Responsibility	131
Owner Responsibility	131
EPA Emission Regulations	131
SPECIFICATIONS	132

TROUBLESHOOTING

TROUBLESHOOTING GUIDELINES 138

MONITORING SYSTEM 142

 Beeper Code Information 143

WARRANTY

BRP LIMITED WARRANTY FOR MODEL YEAR 2011 SEA-DOO® BOATS SOLD IN THE UNITED STATES AND CANADA..... 146

CALIFORNIA EMISSION CONTROL WARRANTY STATEMENT FOR MODEL-YEAR 2011 SEA-DOO® BOATS WITH 4-TEC® ENGINES OR 4-TEC® IC ENGINES..... 150

BRP INTERNATIONAL LIMITED WARRANTY FOR MODEL YEAR 2011 SEA-DOO® BOATS 154

BRP LIMITED WARRANTY FOR THE EUROPEAN AND THE RUSSIAN ECONOMIC AREA AND TURKEY: MODEL YEAR 2011 SEA-DOO® BOATS..... 158

PRIVACY INFORMATION 162

CHANGE OF ADDRESS/OWNERSHIP..... 163

FOREWORD

Congratulations on your purchase of a new Sea-Doo Boats. It is backed by the BRP limited warranty and a network of authorized Sea-Doo Boats dealers ready to provide the parts, service or accessories you may require.

At delivery, you were informed of the warranty coverage and signed the *PREDELIVERY CHECK LIST* to ensure your new boat was prepared to your entire satisfaction.

Your dealer is committed to your satisfaction. If you need more complete servicing information, please ask your dealer.

Know Before you Go

To learn how to reduce the risk of accident, read the following sections of this guide before you operate the boat:

- SAFETY INFORMATION
- BOAT INFORMATION.

Also, read all safety labels on your boat and watch your *SAFETY DVD*.

We highly recommend that you take a safe boating course. Please check your dealer or local authorities for availability in your area.

In certain areas, an operator competency card is mandatory to operate a pleasure craft.

Failure to follow the warnings contained in this Operator's Guide can result in SERIOUS INJURY or DEATH.

Safety Messages

The types of safety messages, what they look like and how they are used in this guide are explained as follows:

 DANGER
Indicates a hazardous situation which, if not avoided, will result in death or serious injury.

 WARNING
Indicates a potential hazard which, if not avoided, could result in serious injury or death.

 **CAUTION** Indicates a hazard situation which, if not avoided, could result in minor or moderate injury.

NOTICE Indicates an instruction which, if not followed, could severely damage boat components or other property.

About this Operator's Guide

This Operator's Guide has been prepared to acquaint the owner and the operator of a new boat with the various controls, maintenance and safe operating instructions. It is indispensable for the proper use of the product.

Keep this Operator's Guide in the boat as you can refer to it for things such as maintenance, troubleshooting and instructing others.

Note that this guide is available in several languages. In the event of any discrepancy, the English version shall prevail.

If you want to view and/or print an extra copy of your Operator's Guide, simply visit the following website at: www.operatorsguide.brp.com.

The informations contained in this document are correct at the time of publication. BRP, however, maintains a policy of continuous improvement of its products without imposing upon itself any obligation to install them on products previously manufactured. Due to late changes, some differences between the manufactured product and the descriptions and/or specifications in this guide may occur. BRP reserves the right at any time to discontinue or

change specifications, designs, features, models or equipment without incurring any obligation upon itself.

This Operator's Guide and the *SAFETY DVD* should remain with the boat when it's sold.

***This page is
intentionally blank***

SAFETY INFORMATION

SPECIAL SAFETY MESSAGES

Reminders Regarding Operation

- Engine exhaust contains carbon monoxide (CO), which can cause injury or death if inhaled in sufficient quantities. Educate all occupants about the risks and symptoms of CO accumulation and CO poisoning. For more information, refer to *CARBON MONOXIDE AND BOATING* section.
- Gasoline vapors can explode, resulting in injury or death. Always use blower for a minimum of 5 minutes before starting engine, then turn it OFF above idle speed. Use of the bilge blower should never replace "smelling" for gasoline vapor odors.
- If at any time, gasoline leaks/odors are found, do not start the engine. Have the boat serviced by an authorized Sea-Doo Boats dealer.
- Always keep in mind that as the throttle lever is returned to the idle position, less directional control is available. To turn the boat, both steering and throttle are necessary.
- This boat has no brake. Stopping distance will vary depending on initial speed, load, wind, and water conditions. Practice stopping and docking in a safe, traffic-free area to have an idea of how long it will take to stop the boat under varying conditions. Do not release the throttle when trying to steer away from objects. You need throttle to steer. Do not use the boat's reverse to stop.
- Do not start or operate the boat if any person is not properly seated in a seat intended for use when underway (not the sun deck or swim platform) or if a person is nearby in the water.
- The boat's jet thrust can cause injury. Always accelerate slowly, and decelerate in a controlled fashion.
- Observe the instructions on all safety labels. They are there to help assure that you have a safe and enjoyable outing.
- Riding with passenger(s) or pulling other boats, tubes, a skier or a wake boarder makes the boat handle differently and requires greater skill.
- Certain boats may come equipped with tow eyelets, a ski pole or a wakeboard tower which can be used to attach a tow rope for a skier, tube or wakeboarder. Do not use these attachment points or any other portion of the boat to tow a parasail or another craft. Personal injury or severe damage may occur.
- In shallow water, proceed with caution and at very low speeds. Grounding or abrupt stops may result in injury to you, your passengers or others. The jet pump may pick up debris and throw it rearward causing a risk of injuring people or damaging the jet pump or other property.
- Combustion engines need air to operate; consequently this boat can not be totally watertight. Any maneuvers such as figure eights that cause the upper deck to be under water may cause severe engine problems due to water ingestion. Refer to the *SPECIAL PROCEDURES* and *WARRANTY* sections contained in this Operator's Guide.
- Respect no wake zones, the rights of other water users and the environment. As the "skipper" and owner of a boat, you are responsible for damage to other boats caused by the wake of your boat. Do not let anyone throw refuse overboard.
- Between sunset and sunrise, use the boat's navigation lights and reduce speed. Do not operate the boat in reduced visibility.

- Do not add accessories or equipment that may adversely affect visibility or alter control of the boat.
- The skipper should personally take the helm during storms.

Before Getting Underway

- Always perform the pre-ride inspection as specified in this Operator's Guide.
- Do not exceed the payload or passenger capacities for this boat, which are listed on the capacity plate and in the specifications. Overloading can affect maneuverability, stability and performance. Also, heavy seas reduce capacity. A payload or person capacity plate is not an excuse for failure to use common sense or good judgment.
- Regularly inspect the boat, the hull, engine, safety equipment, and all other boating gear and keep them in safe operating condition.
- Be sure you have the minimum required safety equipment, PFDs and any additional gear needed for your cruise.
- Check that all lifesaving equipment, including fire extinguisher, is in safe operating condition and easily accessible. Show all passengers where this equipment is, and make sure they know how to use it.
- Keep an eye on the weather. Check local weather broadcasts before departure. Be alert to changing conditions.
- Keep accurate and up-to-date charts of the boating area on board. Before getting underway, check water conditions in the planned boating area.

- Before departure, file a Float Plan with a responsible person ashore.
- Keep enough fuel on board for the planned trip. Always verify fuel level before use and during the ride. Apply the principle of 1/3 of the fuel to reach your destination, 1/3 to return, and keep 1/3 in reserve. Allow for changes due to adverse weather or other delays.

Operators and Passengers Awareness

- Each boat operator has a responsibility to ensure the safety of his/her passenger(s) and of other water users. Please follow all safety instructions and operate your boat with care.
- Never operate a boat while under the influence of drugs or alcohol they slow reaction time and impair judgement. It is also a Federal offense. Allow only qualified drivers to operate your boat.
- Remember that sun, wind, fatigue or illness may impair your judgement and reaction time.
- At least one passenger should be able to operate the boat in case the operator is unexpectedly unable to do so.
- Operation of this boat by a person under 16 years of age or a person with a disability that impairs vision, reaction time, judgment, or operation of the controls is NOT recommended.
- Always use the tether cord when operating the boat and ensure that all passengers are familiar with its use.
- Ensure that any operator and all passengers know how to swim and how to re-board the boat from the water. If a passenger does not know how to swim, ensure that passenger wears a PFD at all times and take extra precautions when boating.

Carbon Monoxide and Boating

Burning a material containing carbon produces carbon monoxide (CO), an odorless and colorless gas. Because CO weighs the same as air, it can spread throughout an enclosed space unnoticed because you cannot see it or smell it. Any device used to burn carbon-based materials on a boat can be a source of CO. Common sources of CO include internal combustion engines.

CO reacts with the blood to reduce the ability of the blood to carry oxygen. The reduced oxygen supply to body tissues results in death of the tissue. Prolonged exposure can cause brain damage or death. In high concentrations, CO can be fatal within minutes. The effects of CO in lower concentrations are cumulative and can be just as lethal over long periods of time.

Symptoms of CO poisoning include: Itchy and watering eyes, flushed appearance, throbbing temples, inability to think coherently, ringing in the ears, tightness across the chest, headaches, drowsiness, nausea, dizziness, fatigue, vomiting, collapse, and convulsions. If any of these symptoms are evident, begin treatment immediately. Prompt action can make the difference between life and death.

- Evacuate the area and move the victim to fresh air.
- Administer oxygen if available and get medical help.
- Open all canvas enclosures to ventilate the area.
- Investigate the source of CO and take immediate corrective action.
- Be especially aware of other CO sources which may be near boat.

Carbon Monoxide Accumulation

Following are examples of possible situations where CO may accumulate within your boat while docked, anchored, or underway. Become fa-

miliar with these examples and their precautions to prevent personal injury or death.

WARNING

Exhaust fumes! Generator or hull exhaust from other vessels while either docked or anchored can emit poisonous CO gas and cause excessive accumulation within cabin and cockpit areas. Be alert for generator exhaust from your vessel or other vessels alongside. Exhaust outlets near a pier, dock, seawall or outlets blocked by any other means can cause excessive accumulation of poisonous CO gas within cockpit area.

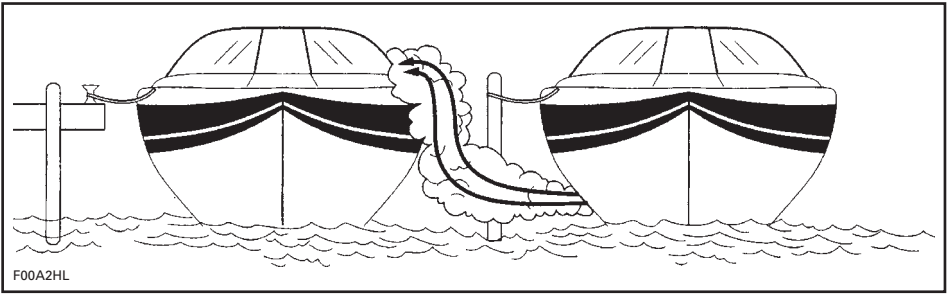

F00A2HL

VESSEL ALONGSIDE

WARNING

Engine exhaust fumes contain carbon monoxide (CO) which can accumulate in and around the boat (under bimini top, in cockpit, etc.). CO can be harmful or fatal if inhaled. Assure there is adequate ventilation whenever running engine(s).

Boat houses, seawalls, and other boats in close proximity or confined areas can contribute to increased CO levels. Operators must be aware that operation, mooring, and anchoring in an area with other boats puts them in jeopardy of CO accumulation from other sources. Likewise, a boat operator must be aware of how exhaust from his boat will affect others. Operation of the engines while moored may cause CO accumulation in your boat and those around you.

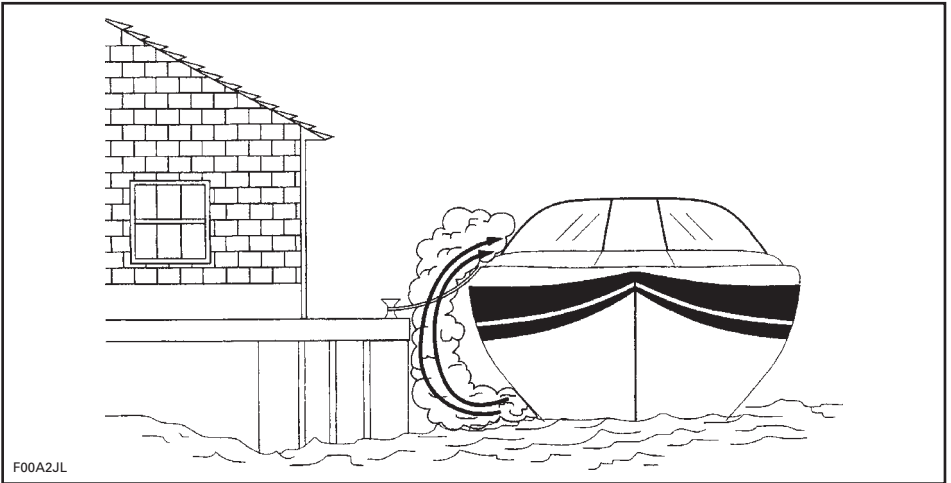

F00A2JL

CONFINED AREAS

Be sure to provide adequate ventilation. If the windshield has vents, open them before getting underway to increase positive air flow and decrease the chances of CO accumulation.

⚠ WARNING

Backdrafting! Under certain conditions, moving air currents can direct poisonous CO fumes into boat. These fumes can accumulate to dangerous levels without proper airflow. Provide adequate ventilation, redistribute the load or bring boat out of high bow angle.

While underway, CO concentrations can increase by backdrafting or “the station wagon effect”. Backdrafting is caused by factors such as relative wind direction, speed, or the bow being too high. To prevent this, open canvas whenever possible to provide positive airflow through the hull.

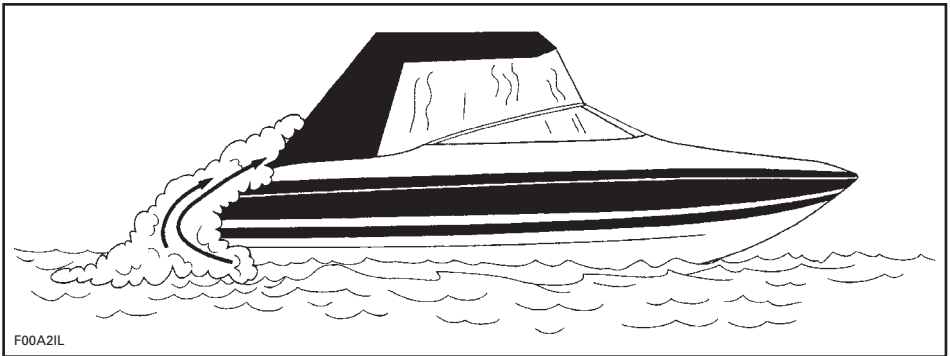

WHILE UNDERWAY (BACKDRAFTING)

Even with the best boat design and construction, CO may still accumulate in enclosed or confined areas under certain conditions. Continually observe passengers for symptoms of CO poisoning.

CO Detector

It is strongly recommended that you have CO detectors installed in boats with canvas enclosures. Monitors are available from your dealer. Monitors should be professionally installed and calibrated.

NOTE: A CO detector is not a gas fuel vapor detector. Gas fuel vapor detectors do not monitor the buildup of CO in an enclosed area.

Do NOT Operate your Boat without Performing the Following Checklist:

Each Boating Day

OPERATION	✓
Make sure you and your passengers know where exhaust outlets are located on the vessel	
Educate all passengers about the symptoms of CO poisoning and where CO may accumulate	
When docked or rafting with another boat, be aware of exhaust emissions from the other boat	
Confirm that water flows from the exhaust outlet when the engine(s) is (are) started	
Listen for any change in exhaust sound, which could indicate an exhaust component failure	
Test the operation of each CO alarm by pressing the test button (if so equipped)	

Water Sports

WARNING

Avoid Personal Injury! Your boat is not designed for and should not be used for pulling parasails, kites, gliders, or any device which can become airborne. Use boat only for appropriate water sports.

WARNING

Teak Surfing is extremely dangerous to participants due to their proximity to the rear of the boat where direct contact with the exhaust fumes from the boat engine is the highest. Carbon monoxide poisoning can occur and result in mental disorientation, dizziness, drowsiness, and loss of consciousness. The combination of carbon monoxide exposure and non-use of a life jacket (PFD) make this new water recreation activity an incredibly dangerous and potentially deadly sport.

Water skiing, wakeboarding, or riding a towed, inflatable apparatus are some of the more popular water sports. Taking part in any water sport requires increased safety awareness by the participant and the boat operator. If you have never pulled someone behind your boat before, it is a good idea to spend some hours as an observer, working with and learning from an experienced driver. It is also important to be aware of the skill and experience of the person being pulled. Always have a second person on board to observe the person in the water so the driver can concentrate on operating the boat.

Both the boat operator and observer should monitor the location of the towrope when participating in water sports. A slack tow rope can become entangled with person(s) or objects in the boat or in the water, particularly when making a tight turn or circling, and cause serious personal injury.

Everyone participating in a water sport should observe these guidelines:

- Allow only capable swimmers to take part in any water sport.

- Always wear an approved personal flotation device (PFD). Wearing a properly designed PFD helps a stunned or unconscious person stay afloat. A Type-IV water-ski vest is an approved and practical PFD.
- Have a second person aboard to observe the person being towed and inform the driver about the participant's hand signals. The driver must give full attention to operating the boat and the waters ahead.
- Be considerate to others you share the water with.
- Never allow a person to "teak surf" behind your boat. Do not tow a person in any water sport on a short tow rope such that the person inhales exhaust fumes in concentration. Inhalation of concentrated exhaust fumes, which contain carbon monoxide, can result in CO poisoning, personal injury and death.
- Give immediate attention to a person who has fallen. He or she is vulnerable in the water alone and may not be seen by other boaters.
- Approach a person in the water from the lee side (opposite the direction of the wind). Turn off the motor before coming close to the person.
- Turn off engine and anchor the boat before swimming.
- Participate in water sports only in safe areas. Stay away from other boats, channels, beaches, restricted areas, swimmers, and heavily traveled waterways and underwater obstructions.
- Swim only in areas designated as safe for swimming. These are usually marked with a swim area buoy. Do not swim alone or at night.



SWIM AREA BUOY

1. Do not water ski between sunset and sunrise. It is illegal in most states.
2. Do not drive the boat directly behind a water skier, tuber or wakeboarder. At 40 km/h (25 MPH), the boat will overtake a person who falls in the water 60 m (200 ft) in front of your boat in about 5 seconds.
3. Shut engine off and remove ignition key when anyone is in the water nearby.
4. Stay at least 45 m (150 ft) away from areas marked by a diver down float.

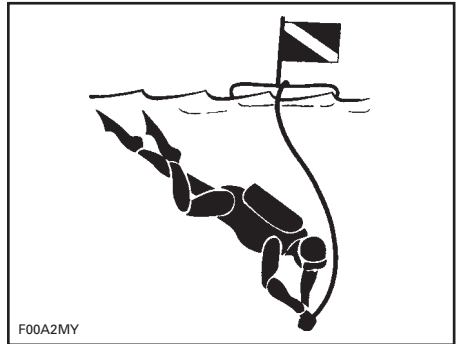

DIVER DOWN FLOAT

⚠ WARNING

Avoid personal injury! Do not allow anyone near the jet pump or intake grate, even when the engine is off. Items such as long hair, loose clothing or personal flotation device straps can become entangled in moving parts resulting in serious injury or drowning. In shallow water, shells, sand, pebbles or other objects could be drawn up by the jet pump and be thrown rearward.

For more information about water skiing, please contact your local water ski association.

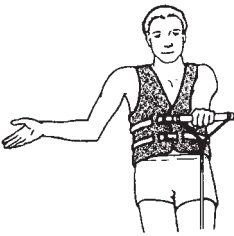

FASTER -
Palm of one hand pointing
upward.

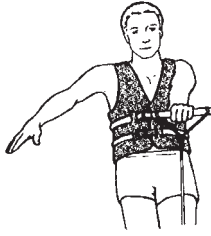

SLOWER -
Palm pointing down.



SPEED OK -
Arm upraised with thumb and
finger joined to form circle.

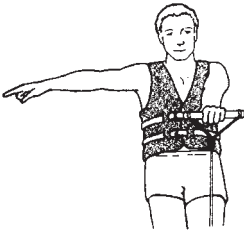

RIGHT TURN -
Arm outstretched pointing
to the right.

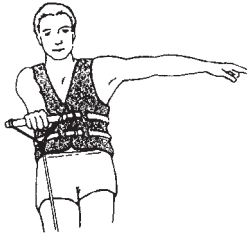

LEFT TURN -
Arm outstretched pointing
to the left.



RETURN TO DROP-OFF AREA -
Arm at 45 degree from body
pointing down to water and
swinging.



CUT MOTOR -
Finger drawn across
throat.

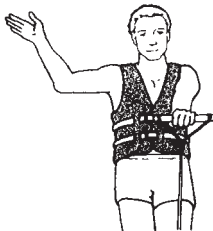

STOP -
Hand up, palm forward,
policeman style.



**SKIER OK.
AFTER THE FALL -**
Hands clenched
together overhead.

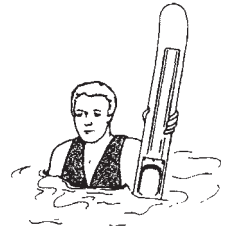

**PICK ME UP
OR FALLEN SKIER,
WATCH OUT -**
One ski extended
vertically out of water.

F00A2NL

SKIING SIGNALS

Hypothermia

Hypothermia, the loss of body heat to the water, is a significant cause of deaths in boating accidents. After an individual has succumbed to hypothermia, he or she will lose consciousness and then drown.

PFDs can increase survival time because of the insulation they provide.

Naturally, the warmer the water, the less insulation one will require. When operating in cold water (below 4.4°C (40°F)) consideration should be given to using a coat or jacket style PFD as they cover more of the body than the vest style PFDs.

Some points to remember about hypothermia protection:

1. While afloat in the water, do not attempt to swim unless it is to reach a nearby boat, fellow survivor, or a floating object on which you can lean or climb. Unnecessary swimming increases the rate of body heat loss. In cold water, drown-proof methods that require putting your head in the water are not recommended. Keep your head out of the water. This will greatly lessen heat loss and increase your survival time.
2. Keep a positive attitude about your survival and rescue. This will improve your chances of extending your survival time until rescue. Your will to live does make a difference!
3. If there is more than one person in the water, huddling is recommended while waiting to be rescued. This action tends to reduce the rate of heat loss and thus increase the survival time.
4. Always wear your PFD. It won't help you fight off the effects of hypothermia if you don't have it on when you go into the water.

Voluntary Inspections

Boating officials in many countries or their auxiliaries offer courtesy inspections to check out your boat. They will check for compliance with safety standards and required safety equipment. You may voluntarily consent to one of these inspections, and you are allowed time to make corrections without prosecution. Check with the competent authorities for details.

Safe Boating Courses

Many countries recommend or require a boating safety course. Check with your local competent authorities.

SAFETY EQUIPMENT

Required Safety Equipment

Operator and passenger(s) should have ready access to shatterproof glasses should riding conditions or personal preference warrant.

Wind, water spray and speed may cause a person's eyes to water and create blurred vision.

As the owner of the boat, you are responsible for assuring that all required safety equipment is aboard. You should also consider supplying additional equipment as needed for your safety and that of your passengers. Check local regulations about required safety equipment.

Safety equipment required by regulations is mandatory. Personal flotation devices must be fitted to the people wearing them. If local regulations require additional equipment, it must be approved by a competent authority. Minimum requirements include the following:

- Personal flotation devices (PFDs)
- Fire extinguisher (class B-1)
- Visual distress signals (VDS)
- Navigation lights
- Sound producing devices (horn, air horn or whistle).

A cellular telephone in a waterproof bag or container has also been found to be beneficial to boaters when in distress or just for contacting someone on shore.

Personal Flotation Devices (PFDs)

In many countries, regulations require that you have at least one approved personal flotation device (PFD) for each person in a recreational boat and require that all children under 13 years of age wear a PFD at all times when the boat is underway, except when below deck or in an enclosed cabin. You may not use your boat unless all PFDs are in serviceable condition, readily

accessible, legibly marked with the approval number, and of an appropriate size (within the weight range and chest size marked on the PFD) for each person on board.

A PFD provides buoyancy to help keep your head above the water and to help you remain in a satisfactory position while in the water. Body weight and age should be considered when selecting a PFD. The buoyancy provided by the PFD should support your weight in water. The size of the PFD should be appropriate for the wearer. Body weight and chest size are common methods used to size PFDs. It is your responsibility to ensure that you have the proper number and types of PFDs on board to comply with federal and local regulations and that your passengers know where they are and how to use them.

PFD Types

There are five types of approved PFDs.

PFD Type I, Wearable has the greatest required buoyancy. Its design allows for turning most unconscious persons in the water from face down position to a vertical or slightly backward, face-up position. It can greatly increase the chances of survival. Type I is most effective for all waters, especially offshore when rescue may be delayed. It is also the most effective in rough waters.

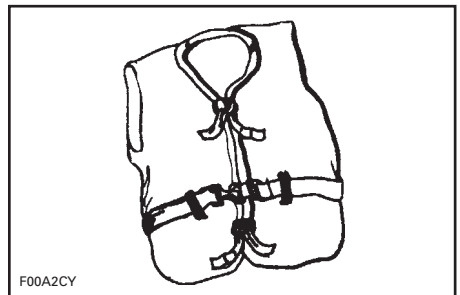

TYPE I — WEARABLE

PFD Type II, Wearable turns its wearer in the same way as Type I, but not as effectively. The Type II does not turn as many persons under the same conditions as a Type I. You may prefer to use this PFD where there is a probability of quick rescue such as in areas where other people are commonly involved in water activities.

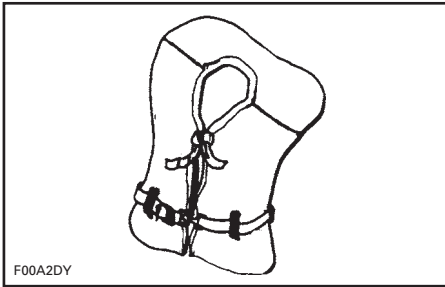

F00A2DY

TYPE II — WEARABLE

PFD Type III, Wearable allows wearers to place themselves in a vertical or slightly backward position. It does not turn the wearer. It maintains the wearer in a vertical or slightly backward position and has no tendency to turn the wearer face down. It has the same buoyancy as a Type II PFD and may be appropriate in areas where other people are commonly involved in water activities.

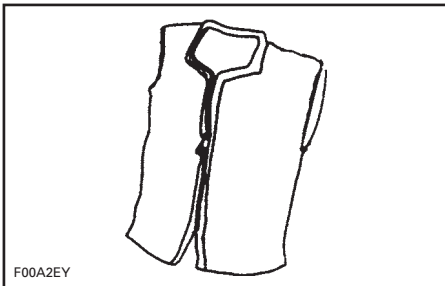

F00A2EY

TYPE III — WEARABLE

PFD Type IV, Throwable is required in addition to the PFDs previously discussed. The most common Type IV PFD is a buoyant cushion or ring buoy.

It is designed to be thrown to a person in the water, grasped and held by the user until he or she is rescued. A Type IV PFD should always be in serviceable condition and immediately available for use. Grasping this PFD may be difficult if the rescue is delayed or if the user is overcome by hypothermia (loss of body heat).

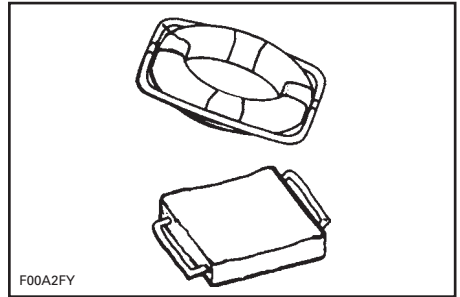

F00A2FY

TYPE IV — THROWABLE

PFD Type V, Wearable must be worn. When inflated, it provides buoyancy equivalent to Type I, II or III PFDs. When it is deflated, however, it may not support some people.

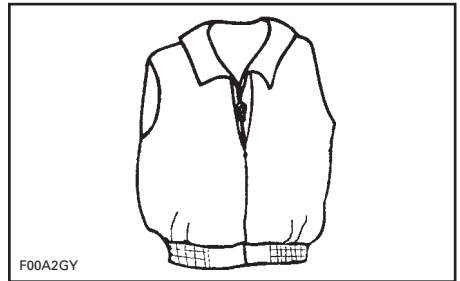

F00A2GY

TYPE V — WEARABLE

PFD Pointers

The purpose of a PFD is to help save your life. If you want it to support you when you are in the water, it needs to fit, float, and be in good condition.

- Try the PFD on and adjust it until it fits comfortably in and out of the water. Mark your PFD if you are the only wearer.

- To make sure the PFD works, wear it in the water. This will show you how it works and give you confidence when you use it.
- Teach children how to put a PFD on and allow them to try it in the water. That way, they know what the PFD is for and how it works. They will feel more comfortable with it if they suddenly find themselves in the water.
- If the PFD is wet, allow it to dry thoroughly before storing it. Do not dry it in front of a radiator or heater. Store it in a well-ventilated area.
- Keep PFDs away from sharp objects which can tear the fabric or puncture the flotation pads.
- For their own safety and the safety of others, all non-swimmers, poor swimmers, and small children should wear PFD's at all times whether the boat is stationary or moving.
- Check the PFD frequently to make sure that it is not torn, that flotation pads have no leaks, and that all seams and joints are securely sewn.
- If a PFD contains kapok, the kapok fibers may become waterlogged and lose their buoyancy after the vinyl inserts are punctured. If the kapok becomes hard or if it is soaked with water, replace it. It may not work when you need it.

Fire Extinguishers

As the owner of the boat, you are responsible for supplying an approved fire extinguisher. Check with the local competent authorities. Boats (less than 7.9 m (26 ft)) are required to carry one (1) B-1 type hand portable fire extinguisher unless the boat is equipped with a fixed fire extinguishing system in the engine compartment.

Hand-held portable fire extinguishers should be mounted in readily accessible locations away from the engine

compartment. All persons aboard should know the location and proper operation of the fire extinguisher(s).

NOTE: Don't test fire extinguishers by squirting small amounts of the extinguishing compound. The extinguisher might not work when you really need it!

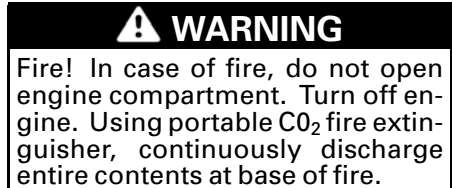

Visual Distress Signal Devices

Visual distress signal equipment may be of the pyrotechnic or non-pyrotechnic type. Regulations prohibit display of visual distress signals on the water under any circumstances except when assistance is required to prevent immediate or potential danger to persons on board a vessel. Check with the local authority to have proper equipment.

The equipment must be approved by the competent authorities, be in serviceable condition, and be stowed in a readily accessible location. Equipment having a date for serviceable life must be within the specified usage date shown.

Careful selection and proper stowage of visual distress equipment is very important if children are aboard.

DAY USE ONLY
Three orange smoke signals (one hand held and two floating) or one orange flag with black square and disk
NIGHT USE ONLY
One S-O-S electric distress light
DAY AND NIGHT USE
Three flares of the hand held, meteor or parachute type

Sound Signaling Devices

NOTE: No single signaling device is appropriate for all purposes. Consider keeping various types of equipment on board.

Boats less than 7.9 m (26 ft) in length are required to carry a hand, mouth, or power operated horn or whistle. It must produce a blast of two second duration and audible at a distance of at least 800 m (1/2 mi).

Following are standard whistle signals:

- One prolonged blast (warning signal)
- One short blast (pass on my port side)
- Two short blasts (pass on my starboard side)
- Three short blasts (engines in reverse)
- Five or more blasts (danger signal).

Navigation Lights

Navigation lights are intended to keep other vessels informed of your presence and course. If you are out on the water between sunset and sunrise, you are required to display appropriate navigation lights.

Additional Recommended Equipment

It is recommended that you acquire additional equipment for safe, enjoyable cruising. This list, which is not all inclusive, includes items you should consider acquiring.

Basic Gear

- Flashlight
- Mooring lines
- Compass
- Oar or paddle
- Distress signals
- First aid kit
- Dock fenders
- VHF radio
- EPIRB (Electronic Position Indicating Radio Beacon)
- Boat hook
- Extra warm clothing
- Local map
- Sunblock
- Tow line
- Second anchor and line
- Dewatering device (pump or bailer)
- Emergency supply of drinking water and food
- Cellular phone.

Tools

- Screwdrivers
- Pocket knife
- Pliers
- Electrician's tape
- Adjustable wrench
- Duct tape.

Spare Parts

- Extra bulbs
- Extra fuses.

PRACTICE EXERCISES

It is always a good idea to practice and get familiar with all controls, functions and handling characteristics of your boat before venturing on the water.

Always secure the tether cord to the engine cut-off switch and the clip to your PFD or a wrist strap.

Where to Practice Exercises

Find a suitable area to practice the exercises. Ensure the area meet the following requirements:

- No traffic
- No obstacles
- No swimmers
- No current
- Ample space to maneuver
- Water depth is adequate.

Practice Exercises

Practice **alone** the following exercises.

Turning

Practice turning in circles in both directions at slow speed. When comfortable with the exercise, increase difficulty by making some figure 8.

When this is mastered, repeat the above exercises but at increased speed.

Stopping Distances

Practice to stop the boat in a straight line at different speeds.

Remember, water drag is the main factor which reduce the boat speed and thus the stopping distance.

NOTE: Boat load, current and wind play also an important role and affect stopping distances.

Reverse

Practice reverse operation to learn how the boat operates in reverse and reacts with steering inputs.

NOTE: Always perform this exercise at slow speeds.

Avoiding an Obstacle

Practice to avoid an obstacle (choose a virtual point on the water) by steering boat and maintaining throttle.

Repeat exercise, but this time release throttle while turning.

NOTE: With this exercise, you will learn that you need throttle to steer the boat in a different direction.

Docking

Practice docking using the throttle and shift lever along with the steering to become familiar and develop good control skills.

Ski Mode and Cruise Mode

If your boat has the Ski Mode or Cruise mode, it is also important to understand their operations and get familiar with these features prior to use them on a ride with other people.

WARNING

The ski and the cruise modes are not an automatic pilot; they will not drive the boat.

Important Factors Not to Neglect

In addition, always remember that the following conditions have a direct impact on how your boat will behave and respond to different inputs:

- Load change
- Current
- Wind
- Water condition.

Make sure to be alert to these conditions, and adapt accordingly. If possible, practice further in these conditions.

For delicate maneuvers, the best advice is always to try to keep speed at a minimum.

SAFE BOATING PRACTICES

YOU are responsible for your own safety, the safety of your passengers, and the safety of fellow boaters. Ride smart from the start and we all win!

Drugs and Alcohol

Do not use drugs or drink alcohol while operating a boat. Like driving a car, driving a boat requires sober, attentive care. Operating a boat while intoxicated or under the influence of drugs is not only dangerous, but it is also a Federal offense carrying a significant penalty. These laws are vigorously enforced. The use of drugs and alcohol, singly or in combination, decreases reaction time, impedes judgment, impairs vision, and inhibits your ability to safely operate a boat.

WARNING

Alcohol consumption and boating do not mix! Operating under the influence endangers the lives of your passengers and other boaters. Federal laws prohibit operating a boat under the influence of alcohol or drugs.

Safe Operation

For safety reasons and proper care, always perform daily *PRE-RIDE INSPECTION* as specified in your Operator's Guide before operating your boat. Safe operation means that you do not misuse your boat nor do you allow your passengers to do so. Safe operation means using good judgment at all times. It includes, without limitation, the following actions:

- Load the boat within the limits listed on the capacity plate. Balance loads bow to stern and port to starboard.
- Maintain boat speed at or below the local legal limit. Avoid excessive speed or speeds not appropriate for operating conditions.

- Do not use the boat in weather or sea conditions beyond the skill or experience of the operator or the comfortable capability of the boat or passengers.
- Be sure at least one other passenger is familiar with the operation and safety aspects of the boat in case of an emergency.
- Make sure that passengers and gear do not obstruct the operator's view or ability to move.
- Do not exceed the maximum engine power rating stated on the certification plate attached to the boat.
- Observe all safety signs and warnings both inside the boat and in the immediate boating area.
- While your boat has the capacity of operating at high speeds, it is strongly recommended that high speed operation only be applied when ideal conditions exist and are permitted. Higher speed operation requires a higher degree of skill and increases the risk of severe injuries.
- In shallow water, proceed with caution and at very low speeds. Grounding or abrupt stops may result in injury. Debris may also be picked up and be thrown rearward by the jet pump onto people or property.
- Do not use the boat's reverse, to stop. You or your passenger(s) could be violently ejected forward or even off the boat onto the hazard.

Maneuverability of the Boat and Towing

- Always keep in mind that as the throttle lever is returned to idle position, less directional control is available, and when the engine is off, directional control is lost. You need throttle to steer.

- Do not overload the boat or take on more passengers than designated for the particular boat. Overloading can affect maneuverability, stability and performance.
 - Avoid adding on accessories or equipment which may alter your control of the boat.
 - Riding with a passenger(s) or pulling a tube, skier or wakeboarder makes the boat handle differently and requires greater skill.
 - Always respect the safety and comfort of your passenger(s) and person being towed on skis, wakeboard or other towables.
 - Always carry an observer when pulling a tube, skier or wakeboarder, proceed with only as much speed as required and follow the observer's instructions. Unless absolutely necessary, do not make tight, sharp turns. Keep a safe distance from the docks, other swimmers, craft or objects.
 - Use a tow rope of sufficient length and size and make sure it is adequately secured to your boat. Some boats are equipped or can be fitted with a specially designed towing mechanism. It can become a hazard should someone fall on it.
- age wear a PFD when the boat is underway unless they are in an enclosed cabin or below deck.
- Do not start or operate the boat if anyone is seated on the sun deck or swim platform, or is nearby in the water. Water and/or debris exiting jet thrust nozzle can cause severe injury.
 - The operator and passenger(s) should be properly seated before starting or moving the boat. All passenger(s) should be instructed to use the handholds or seat straps provided.
 - When accelerating a boat with a passenger(s), whether from a complete stop or while underway, always do so progressively. Fast acceleration may cause your passenger(s) to lose their balance or grip and strike something in the boat or fall out of the boat. Make sure that your passenger(s) know of, or anticipate, any rapid acceleration.

Passenger Safety

Before getting underway, show all passengers where emergency and safety equipment is stowed, and explain how to use it. Everyone aboard should wear rubber-soled shoes which resist slipping on wet surfaces. While underway, passengers should remain seated inside the deck rails. Don't allow passengers to drag their feet or hands in the water. Always use handholds and other safety hardware to prevent falls. All non-swimmers, poor swimmers, and children should wear a PFD at all times. Federal regulations require that children under 13 years of

First Aid

As a boat operator, you should be familiar with basic first aid procedures that may be needed while you are far from help. Fish hook accidents or minor cuts and abrasions may be the most serious mishaps on board a boat, but you should also learn the proper procedures and be ready to deal with the truly serious problems like excessive bleeding, hypothermia, and burns. First aid literature and courses are available through most Red Cross chapters.

Operation by Minors

Minors should always be supervised by an adult whenever operating a boat. Many countries have laws regarding the minimum age and licensing requirements of minors. Be sure to contact the state boating authorities for information. BRP recommends a minimum operator age of 16 years old.

NAVIGATION RULES

Operating Rules

Operating a boat can be compared with driving unmarked highways and roads. To prevent collisions or avoid other boaters, a system of operating rules must be followed. It's not only common sense... it's the law!

Check local and federal boating laws applicable to the waterways where you intend to use your boat. Learn the local rules of the road. Know and understand the applicable navigation system (such as buoys and signs).

Know the waters in which the boat is to be operated. Current, tides, rapids, hidden obstacles, wakes and waves etc. can affect safe operation. It is not advisable to operate the boat in rough or inclement weather.

Generally keep to your right and safely avoid other craft by keeping a safe distance from other craft, people and objects.

The following illustration identifies different parts of the boat that are used as directional reference points, the bow being the front of the boat. The port side of boat (left side) is visually identifiable by a RED light off the bow, and the starboard side (right side) by a GREEN light.

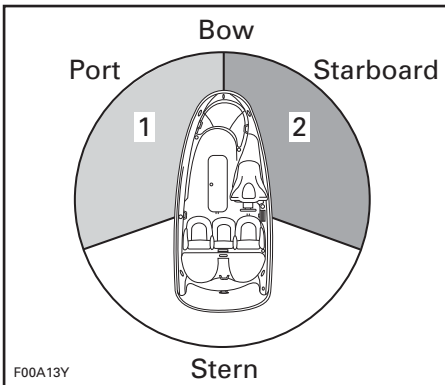

- TYPICAL**
1. RED light
2. GREEN light (yield zone)

Crossing

Give right of way to craft ahead and to your right. Never cross in front of another craft.

RED light (give way to the other craft).

GREEN light (you have the right of way).

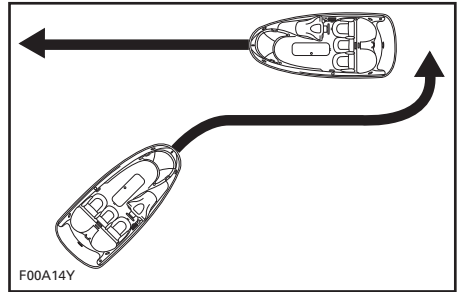

TYPICAL

Meeting Head-On

Keep right.

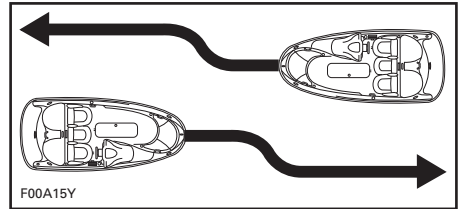

TYPICAL

Passing

Give right of way to other craft and keep clear.

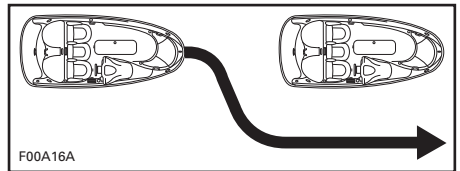

TYPICAL

Navigation System

Navigational aids, such as signs or buoys, can help you identify safe waters. Buoys will indicate whether you should keep to the right (starboard) or to the left (port) of the buoy or to which channel you can continue. They may also indicate whether you are entering a restricted or controlled area such as a no wake or speed zone. They may also indicate hazards or pertinent boating information. Markers may be located on shore or on the water. They can also indicate speed limits, no power craft or boating, anchorage and other useful information. (The shape of each type of marker will provide assistance.)

Make sure you know and understand the navigation system applicable to the waterways where you intend to use the boat.

Collision Avoidance

- Do not decrease throttle when trying to steer away from objects. You need throttle to steer.
- Always keep a constant lookout for other water users, other craft or objects, especially when turning. Be alert for conditions that may limit your visibility or block your vision of others.
- Respect the rights of other recreationists and/or bystanders and always keep a safe distance from all other craft, people and objects.
- Do not wake or wave jump, ride the surf line or attempt to spray or splash others with your boat. You may misjudge the ability of the boat or your own driving skills and strike a boat or person.

- This boat has the capability of turning more sharply than other boats. However, unless in an emergency, do not negotiate sharp, high speed turns. Such maneuvers make it hard for others to avoid you or understand where you are going. Also, you and/or your passenger(s) could be thrown from the boat.
- This boat has no brake. Stopping distance will vary depending on initial speed, load, wind, and water conditions. Practice stopping and docking in a safe, traffic free area to have an idea of how long it will take to stop the boat under varying conditions.
- Maintaining or increasing speed may be necessary to avoid a collision.

FUELING

Recommended Fuel

Use unleaded gasoline or oxygenated fuel containing a maximum total of 10% of ethanol or methanol. The gasoline used must have the following recommended octane rating.

NOTICE Never experiment with other fuels or fuel ratios. The use of inadequate fuel can result in boat performance deterioration and damage to critical parts in the fuel system and engine components.

Inside North America

MINIMUM OCTANE RATING		
87 (RON + MON)/2		
91 (RON + MON)/2	▼	▼
ENGINES	91	87
310 HP Naturally-aspirated	--	X
430 HP Supercharged Intercooled	X ⁽¹⁾	X
510 HP Supercharged Intercooled	X ⁽¹⁾	X

(1) For optimum engine performance.

Outside North America

MINIMUM OCTANE RATING		
92 RON		
95 RON	▼	▼
ENGINES	95	92
310 HP Naturally-Aspirated	--	X
430 HP Supercharged Intercooled	X ⁽¹⁾	X
510 HP Supercharged Intercooled	X ⁽¹⁾	X

(1) For optimum engine performance.

Fueling Procedure

⚠ WARNING

Fuel is flammable and explosive under certain conditions. Do not smoke or allow open flames or sparks in the vicinity.

Be very careful when fueling and adhere to the fueling procedures described below in this Operator's Guide and those given to you by the marina.

Know the capacity of the fuel tank. Avoid fueling at night except under well-lit conditions. Gas spills are not noticeable in the dark. Do not carry spare fuel or flammable liquids in any of the storage or engine compartments.

⚠ WARNING

Follow these safe boating fueling instructions explicitly.

On a Trailer

1. The boat should be level.
2. Ensure engine cover is closed to prevent fumes from entering the engine compartment.
3. Unscrew the cap counterclockwise and remove it slowly.



TYPICAL - FUEL TANK CAP

4. Insert the gas pump spout into the filler neck and fill up fuel tank.

⚠ WARNING

To prevent fuel back-flow, fill up tank slowly so the air can escape from the fuel tank.

5. Stop filling immediately after the release of the gas pump nozzle handle and wait a moment before removing the spout. Do not retract the gas pump nozzle to put more fuel in fuel tank.

⚠ WARNING

Do not overfill or top off the fuel tank and leave the boat in the sun. As temperature increases, fuel expands and may overflow.

6. Install and fully tighten the fuel tank cap.

⚠ WARNING

Always wipe off any fuel spillage from the boat.

In Water

1. Turn off engines.
2. Tie boat securely to the fueling pier.
3. Do not allow anyone to remain in or on the boat.
4. Ensure engine cover is closed to prevent fumes from entering the engine compartment.
5. Have a fire extinguisher close at hand.
6. Unscrew the cap counterclockwise and remove it slowly.



lmo2011-002-009

TYPICAL - FUEL TANK CAP

7. Insert the gas pump spout into the filler neck and fill up fuel tank.

⚠ WARNING

To prevent fuel back-flow, fill up tank slowly so the air can escape from the fuel tank.

8. Stop filling immediately after the release of the gas pump nozzle handle and wait a moment before removing the spout. Do not retract the gas pump nozzle to put more fuel in fuel tank.

⚠ WARNING

Do not overfill or top off the fuel tank and leave boat in the sun. As temperature increases, fuel expands and might overflow.

9. Install and fully tighten the fuel tank cap.

⚠ WARNING

Always wipe off any spillage from the boat.

TRAILERING INFORMATION

Refer to the trailer instructions for proper capacity, operation, maintenance, accessories and warranty.

Check the regulations in your area concerning towing a trailer, especially the following rules:

- Brake system
- Tow vehicle weight
- Mirrors.

NOTE: An optional brake system is available for your trailer, contact Karavan Trailers at: www.karavantrailers.com.

Take the following precautions when trailering the boat:

Tie the boat to both bow and stern (front/rear) eyelets so that it is firmly retained on the trailer.

Remove stern light (if installed).

Remove and store any loose objects from deck and seats.

WARNING

Failure to store loose objects may result in loss of objects and possible road hazards.

Ensure to close and latch:

- Storage compartments
- Seats
- Walk thru door
- Windshield door.

WARNING

Failure to close and latch equipments may lead to damage and possible road hazards.

Empty the ballast bags (if so equipped).

WARNING

Never tow a boat with water remaining in the ballast bags.

The weight of ballasts increases the load on the trailer, the axle, and the tires, which could lead to premature wear or failure. This also contributes to reduce the stability of your vehicle on the road by raising the center of gravity of the trailer.

Always completely empty the ballast bags before trailering.

Close bimini top (if so equipped).

A Sea-Doo mooring cover can protect the boat, particularly before driving on dirt roads, to prevent dirt entering through the air intake openings.

NOTICE Cockpit cover and bow cover should be used for storage only. To avoid damages to cover and their snaps, never travelling with these covers installed.

Observe trailering safety precautions.

LOCATION OF IMPORTANT ON-PRODUCT LABELS

The following labels are on your boat. If missing or damaged, they can be replaced free of charge. See an authorized Sea-Doo Boats dealer.

Please read the following labels carefully before operating your boat.

NOTE: The illustration of the boat indicates the approximate locations of the various labels. A dotted line indicates that the label is not on the outer surface, and that the seat or a cover of some type must be opened to see the label.

Hang Tag

The Star Label means Cleaner Marine Engines
This engine has been certified as:











The Symbol for Cleaner Marine Engines:
Cleaner Air and Water
For a healthier lifestyle and environment.
Better Fuel Economy
Burns up to 30-40 percent less gas and oil than conventional carbureted two-stroke engines, saving money and resources.
Longer Emission Warranty
Protects consumer for worry free operation.

○



One Star-Low emission
The one-star label identifies personal watercraft, outboard, sterndrive and inboard engines that meet the Air Resources Board's Personal Watercraft and Outboard marine engine 2001 exhaust emission standards. Engines meeting these standards have 75% lower emissions than conventional carbureted two-stroke engines. These engines are equivalent to the U.S. EPA's 2006 standards for marine engines.



Two Stars-Very Low emission
The two-star label identifies personal watercraft, outboard, sterndrive and inboard engines that meet the Air Resources Board's Personal Watercraft and Outboard marine engine 2004 exhaust emission standards. Engines meeting these standards have 20% lower emissions than One Star – Low-Emission engines.



Three Stars-Ultra Low emission
The three-star label identifies engines that meet the Air Resources Board's Personal Watercraft and Outboard marine engine 2008 exhaust emission standards or the Sterndrive and Inboard marine engine 2003 exhaust emission standards. Engines meeting these standards have 65% lower emissions than One Star – Low Emission engines.



Four Stars-Super Ultra Low emission
The four-star label identifies engines that meet the Air Resources Board's Sterndrive and Inboard marine engine 2009 exhaust emission standards. Personal Watercraft and Outboard marine engines may also comply with these standards. Engines meeting these standards have 90% lower emissions than One Star – Low Emission engines.

BOMBARDIER RECREATIONAL PRODUCTS INC.
VALCOURT, QUÉBEC, CANADA
Cleaner Watercraft - Get the facts 1-800-END-SMOG
www.ato.ca.gov

219902678

219902678

Safety Labels

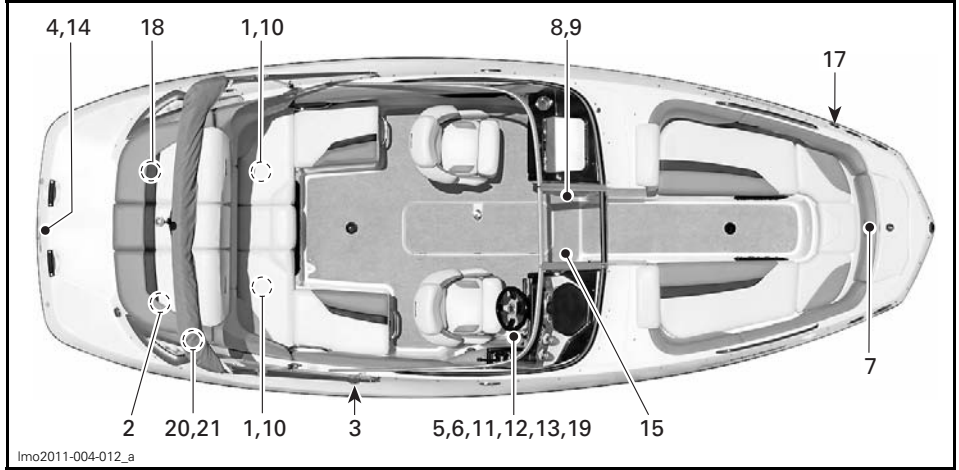

230 CHALLENGER

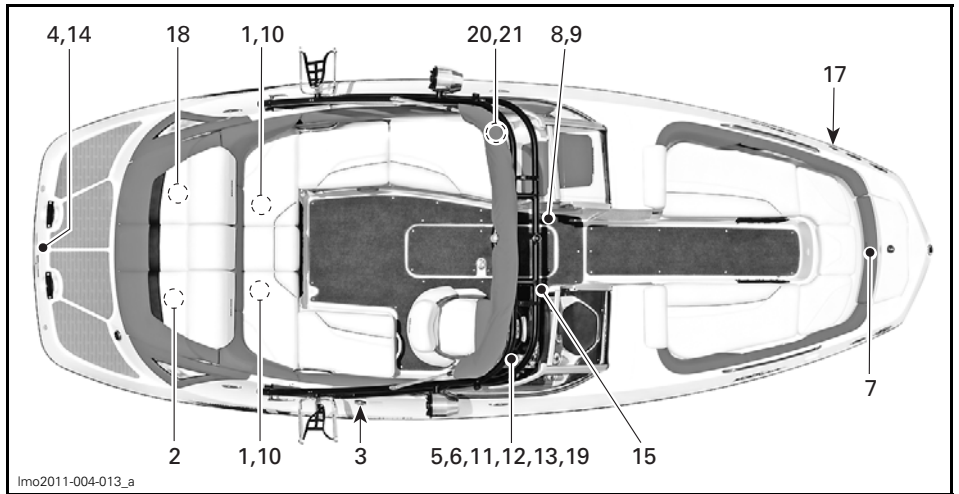

230 WAKE

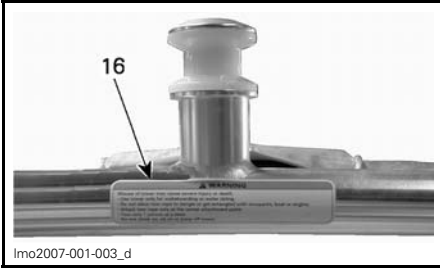

lmo2007-001-003_d

WAKE TOWER — OPTIONAL

⚠ WARNING / AVERTISSEMENT

CHECKING ENGINE OIL LEVEL

Vehicle must be level to perform verification. Bring engine to normal operating temperature then let idle for 30 seconds. Stop engine, wait for at least 30 sec. and check oil level using the dipstick. CAUTION: Never let engine run out of water without the flush kit connected as it may damage the engine. Oil may be hot.

VÉRIFICATION DU NIVEAU D'HUILE DU MOTEUR

Avec la motomarine à niveau et à température normale d'utilisation, laissez le moteur tourner au ralenti 30 secondes. Arrêtez le moteur, attendez au moins 30 sec. et vérifiez le niveau d'huile. ATTENTION: Ne pas laisser tourner le moteur hors de l'eau sans faire circuler de l'eau par le raccord de rinçage. L'huile peut être chaude.

219902674

219902674

LABEL 1: TYPICAL

⚠ WARNING

- Remove battery from boat before charging.
- Do not overcharge battery.
- Improper charging of battery can cause explosion.

204901330

204901330

LABEL 2

⚠ WARNING

Avoid serious personal injury or death.

- Turn off engine(s) before using swim platform.
- Keep people, clothing and hair away from jet nozzle(s) or intake grate(s) to avoid entanglement, drowning and carbon monoxide poisoning.

204901334

204901334

LABEL 4

⚠ WARNING

Avoid serious injury or death from fire or explosion from leaking fuel or vapors.

- Before fueling, turn off engine.
- Keep the boat level with no one aboard.
- Keep craft away from open flames and sparks.
- Use regular unleaded gasoline 87 pump octane.
- Do not overfill.
- Wipe up spilled gasoline.
- Inspect fuel system for leaks and verify components integrity at each pre-ride inspection.

204 902 065

204902065

LABEL 3

⚠ WARNING

Lock driver seat in forward position so that seat faces steering wheel during operation and does not swivel.

204901347

204901347

LABEL 5

⚠ CAUTION

- Do not use bimini top as a support.
- Operate boat only at low speeds if bimini top is in use.
- Top can break or dislodge causing a risk of personal injury or interference with boat operation.

204901331

204901331

LABEL 6: BIMINI TOP-OPTIONAL

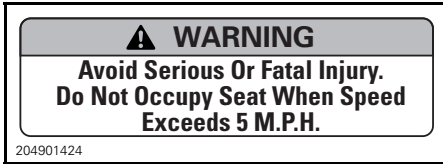

LABEL 7

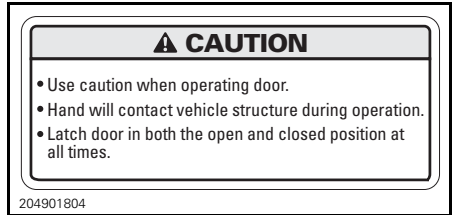

LABEL 9



LABEL 8



LABEL 10

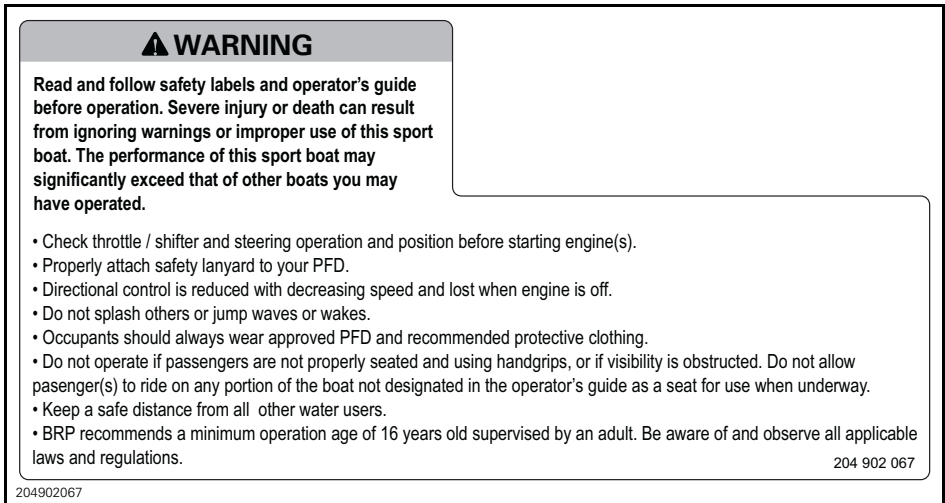

LABEL 11

⚠ WARNING

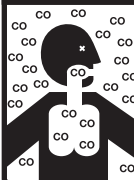

Carbon monoxide (CO) can cause brain damage or death.

Engine and generator exhaust contains odorless and colorless carbon monoxide gas.

Signs of carbon monoxide poisoning include nausea, headache, dizziness, drowsiness, and lack of consciousness.

Get fresh air if anyone shows signs of carbon monoxide poisoning.

See Owner's Manual for information regarding carbon monoxide poisoning.

204901625

204901625

LABEL 12

⚠ WARNING

Securely lock windshield door in the opened or closed position before getting underway and at all times while boat is in motion.

204901339

LABEL 13

⚠ DANGER

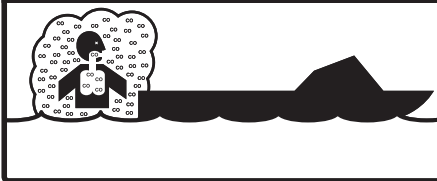

Carbon monoxide (CO) can cause brain damage or death.

Engine and generator exhaust contains odorless and colorless carbon monoxide gas.

Carbon monoxide will be around the back of the boat when engines or generators are running.

Move to fresh air if you feel nausea, headache, dizziness, or drowsiness.

204901626

204901626

LABEL 14

⚠ WARNING

Gasoline vapor may cause fire or explosion, resulting in serious injury or death. Inspect fuel system for leaks and verify components integrity at each pre-ride inspection.

Before starting engine

ALWAYS:

- Operate the bilge blower for 5 minutes.
- Open engine cover and check for gasoline vapor odor inside the engine compartment.
- Close the engine cover before starting the engine.

NEVER:

- Start the engine if gasoline vapor odor is present in the engine compartment.

204 902 066

204902066

LABEL 15

⚠ WARNING

Misuse of tower may cause severe injury or death.

- Use tower only for wakeboarding or water skiing.
- Do not allow tow rope to dangle or get entangled with occupants, boat or engine.
- Attach tow rope only at the center attachment point.
- Tow only 1 person at a time.
- Do not climb on, sit on or jump off tower.
- Never add accessories to the tower unless approved by BRP.

204 902 068

204902068

LABEL 16

⚠ DANGER

EXHAUST FUMES FROM ENGINES CONTAIN DEADLY CARBON MONOXIDE GAS (CO). BOATS WITH CANVAS OR POOR VENTILATION ARE MOST LIKELY TO COLLECT FUMES. CO SICKNESS SYMPTOMS INCLUDE HEADACHE, NAUSEA AND DIZZINESS. DO NOT MISTAKE FOR SEASICKNESS. VENTILATE BOAT. SEE BOAT OWNER'S MANUAL FOR MORE DETAIL. TH-23

lmo2011-001-014_a

LABEL 20 - IF EQUIPPED WITH "BIMINI TOP

⚠ WARNING

TOP SHOULD NOT BE USED WHEN VESSEL SPEED EXCEEDS 35 MPH

lmo2011-001-015_a

LABEL 21 - IF EQUIPPED WITH "BIMINI TOP

230 Challenger SE and 230 Wake

Compliance Labels



219902679

LABEL 17 - EMISSION CONTROL

BOMBARDIER RECREATIONAL PRODUCTS INC.
EMISSION CONTROL INFORMATION
THIS ENGINE IS CERTIFIED TO OPERATE ON UNLEADED GASOLINE AND CONFORMS TO 2010 U.S. EPA & CALIFORNIA EMISSIONS/EVAP REGULATIONS FOR MARINE SI ENGINES.

BOMBARDIER PRODUITS RÉCRÉATIFS INC.
RENSEIGNEMENTS SUR LE DISPOSITIF ANTIPOLLUTION

CE MOTEUR EST CERTIFIÉ POUR FONCTIONNER À L'ESSENCE SANS PLOMB ET IL RÉPOND AUX NORMES 2010 DE L'EPA DES É.-U. & RÉGLEMENTATIONS CALIFORNIENNES POUR LES MOTEURS MARINS À ALLUMAGE COMMANDÉ.

SEE OPERATORS GUIDE FOR MAINTENANCE SPECIFICATIONS.

ENGINE FAMILY	8BCXMI.50GS
FEL	16.17 g/kW-hr HC+NOx
ENGINE DISPLACEMENT	1493.0 cc
EXHAUST EMISSION CONTROL SYSTEM	MFI, SC CAC
SPARK PLUG TYPE	NGK-DCPR8E
SPARK PLUG GAP	0.930 in. / 0.7-0.8 mm
POWER	190 kW
FUEL LINE	9TDRLINE365-A15

FAMILLE DE MOTEUR
LIMITE DES ÉMISSIONS DE LA FAMILLE
CYLINDREE
SYSTÈME DE CONTRÔLE DES ÉMISSIONS
TYPE DE BOUGIE
ÉCARTEMENT DES ÉLECTRODES
PUISSANCE
BOYAU ESSENCE

DATE / NA

204901999

204901999

LABEL 18 - EPA COMPLIANCE

Technical Information Labels

230 Challenger

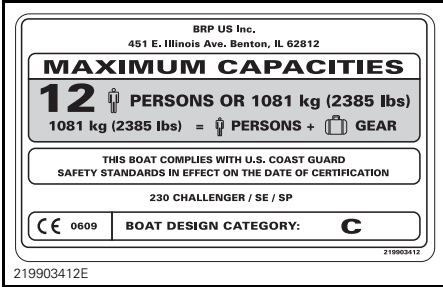

LABEL 19 – CAPACITY

230 WAKE

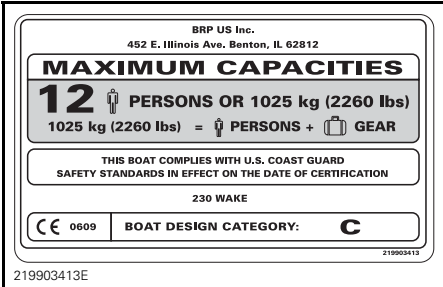

LABEL 19 – CAPACITY

PRE-RIDE INSPECTION

WARNING

The pre-ride inspection is very important before operating the boat. Bring all safety equipment required by local laws. Perform a pre-ride inspection before each ride to detect potential problems during operation. The pre-ride inspection can help you monitor wear and deterioration before they become a problem. Correct any problems that you discover to reduce the risk of a breakdown or crash. See an authorized Sea-Doo Boat dealer if necessary.

For more detailed information on these items, refer to the applicable sections.

WARNING

Engines should be off and the tether cord must always be removed from engine cut-off switch before verifying any of the following. Only start boat once all items have been checked and operate properly.

Pre-Ride Check List When Boat is Trailered

SUMMARY			
	ITEM	OPERATION	✓
BOAT ON TRAILER	Fuel tank	Refill.	
	Hull	Inspect for damage.	
	Jet pump water intake	Inspect/clean.	
	Bilge	Ensure drain plug is properly secured.	
	Engine compartment	Verify for leaks or gasoline vapor odor. Verify fuel system components integrity.	
	Bilge	Check for abnormal water presence in bilge.	
	Main battery cut-off switch	Ensure it is in the ON position.	
	Throttle lever	Check operation.	
	Shift lever	Check operation.	
	Steering	Check operation.	
	Bilge blower	Turn ON bilge blower for 5 minutes to ventilate bilge.	
	Multifunction gauge cluster	Gauge should turn ON and self-test when installing the tether cord on engine cut-off switch.	
	Towing tower (optional)	Check tightness of mounting points fasteners.	
	Bimini top (optional)	Check tightness of mounting points fasteners. Check for canvas damages.	
	Mandatory safety boating equipment	Ensure all required safety equipment is on board.	
	Storage compartment covers	Ensure they are closed and latched.	
	Navigation lights	Check operation.	
	Engines start/stop switch	Check operation for starting and stopping engine.	
Engine cut-off switch	Check if engine can be stopped by pulling off the tether cord from the engine cut-off switch.		
BOAT ON WATER (engine started)	Throttle lever	Check operation.	
	Shift lever	Check operation.	
	Steering	Check operation.	

Pre-Ride Check List When Boat is Docked

SUMMARY			
DOCKED BOAT	ITEM	OPERATION	✓
	Fuel tank	Refill.	
	Bilge	Check for abnormal water presence in bilge.	
	Engine compartment	Verify for leaks or gasoline vapor odor. Verify fuel system components integrity.	
	Main battery cut-off switch	Ensure it is in the ON position.	
	Throttle lever	Check operation.	
	Shift lever	Check operation.	
	Steering	Check operation.	
	Bilge blower	Turn ON bilge blower for 5 minutes to ventilate bilge.	
	Multifunction gauges cluster	Gauge should turn ON and self-test when installing the tether cord on engine cut-off switch.	
	Towing tower (optional)	Check tightness of mounting points fasteners.	
	Bimini top (optional)	Check tightness of mounting points fasteners. Check for canvas damages.	
	Mandatory safety boating equipment	Ensure all required safety equipment is on board.	
	Storage compartment covers	Ensure they are closed and latched.	
	Navigation lights	Check operation.	
Engine start/stop buttons	Check operation for starting and stopping engines.		
Engine cut-off switch	Check if engine can be stopped by pulling off the tether cord from the engine cut-off switch.		

Fuel

Make sure you have enough gasoline. Fill the fuel tank, as needed.

⚠ WARNING

Strictly adhere to instructions in the *FUELING PROCEDURE*.

Hull

Walk around your boat inspecting the hull for cracks or other damages.

Jet Pump Water Intakes

Remove weeds, shells, debris or anything else that could restrict the flow of water and damage the cooling systems or propulsion units. Clean as necessary. If any obstruction cannot be removed, refer to an authorized Sea-Doo Boats dealer for servicing.

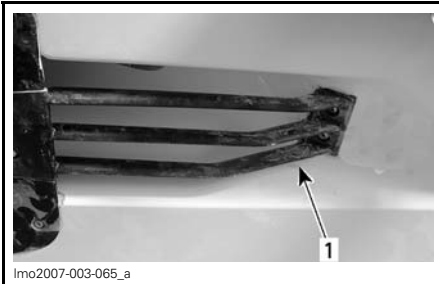

lmo2007-003-065_a

TYPICAL

1. Inspect this area

Inspect leading edges of the impellers, for nicks or bends, which greatly reduce performance of the boat.

Bilge

⚠ WARNING

Check for abnormal water presence in bilge. Make sure drain plug is properly secured before launching the boat in water.

Engine Compartment

Ensure that the engine compartment is free of gasoline vapor odors and visually, inspect fuel lines for deterioration and the condition of the fuel tank straps and their fasteners.

⚠ WARNING

If any leaks or gasoline vapor odors are present, **DO NOT** start engine or use electrical accessories. Consult an authorized Sea-Doo Boats dealer.

Main Battery Cut-Off Switch

Turn switch in the ON position to allow starting engine and use accessories.

Throttle/Shifter System

Throttle Lever

Check throttle lever for free and smooth operation.

⚠ WARNING

Check operation of throttle lever before starting the engines.

Shift Lever

Check that reverse gates moves freely. With shift lever in forward position, the gates must be in upward position and locked. With the shift lever in neutral position, gates must be in middle position. With shift lever in reverse position, gates must be in downward position.

⚠ WARNING

Verify the reverse gates lock.

To verify the reverse gates lock, move shift lever to the FORWARD position.

Pull backwards on the starboard reverse gate.

The reverse gates lock are working if the reverse gates stays in the up position.

NOTICE If the reverse gates does not stay in the up position when the shift lever is at FORWARD, do not operate the boat further, see an authorized Sea-Doo Boats dealer.

Steering System

Check steering for free and smooth operation. Have another person help check the jet pump nozzles pivot accordingly.

WARNING

Check operation of steering and corresponding steering nozzles before starting engines.

Multifunction Gauge Cluster

Check that the multifunction gauges cluster is powered and self testing when installing the tether cord to engine cut-off switch.

Bilge Blower Switch

Turn ON the bilge blower and make sure it is operational. Leave it on for 5 minutes to ventilate the bilge from potential gasoline vapor hazard.

Towing Tower (Optional)

Check towing tower, if so equipped. Check for tightness of mounting points fasteners and the integrity of the tower structure.

Bimini Top (Optional)

Check bimini top, if so equipped. Check for tightness of mounting points fasteners and the integrity of the structure. Check for canvas damages.

Mandatory Safety Boating Equipment

Make sure to have on board all safety equipment required by the local regulations (fire extinguisher, PFDs, visual distress signal devices, etc.) and they are in good condition. Check with a local competent authority for the required equipment.

Periodically check the straps buckles and fasteners of your personal flotation device to make sure that there are no rips or tears and that the buckles are functioning properly.

Storage Compartment Covers

Ensure they are closed and latched.

Navigation Lights

Ensure all navigation lights are operational and replace any defective light before using the boat.

Engine Start/Stop Buttons

Ensure engine start/stop buttons operate properly. Start and stop each engine using each switch individually.

WARNING

If engines do not shut-off when pushing engine start/stop buttons, do not operate the boat further, see an authorized Sea-Doo Boats dealer.

Engine Cut-off Switch

Verify when pulling off the tether cord from the engine cut-off switch that engine can be stopped.

WARNING

Do not use boat if engine can not be stopped by pulling off the tether cord.

BOAT INFORMATION

CONTROLS

Cockpit View

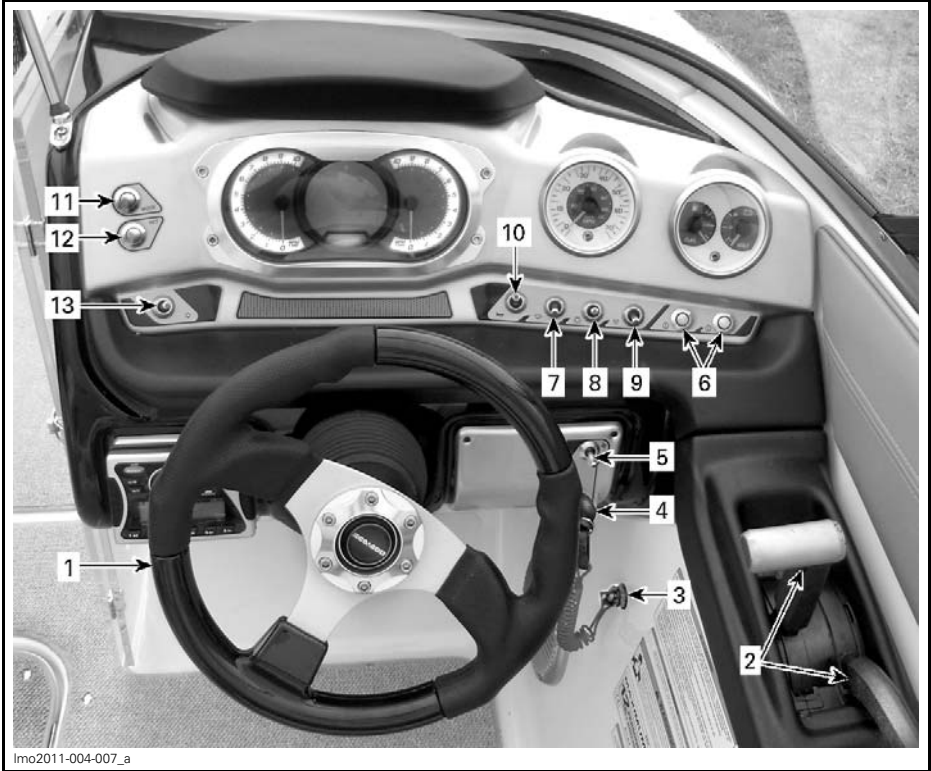

TYPICAL

1) Steering Wheel

The steering wheel controls the direction of the boat. Turning the steering wheel clockwise steers the boat to the right and inversely.

Tilt Steering

For your convenience, steering wheel can be adjusted in many positions. Push and hold button at the base of the steering column to adjust steering wheel vertically. Release button when adjusted to the desired position.

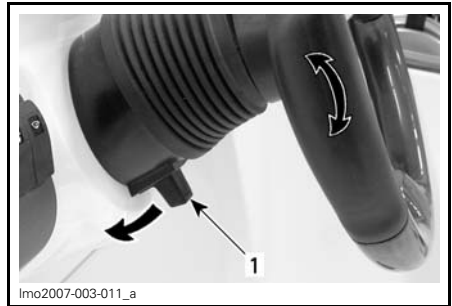

PUSH AND HOLD BUTTON TO ADJUST STEERING WHEEL
1. Button

2) Throttle/Shifter Control

Shifter Lever

A 3-position lever:

- Forward
- Neutral
- Reverse.

In order to shift:

- Throttle lever must be fully pulled back (idle speed position).
- Neutral lock detent button must be pressed (when in neutral).

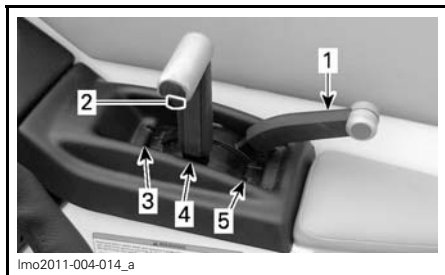

TYPICAL

1. Throttle lever must be fully pulled back to shift (idle speed)
2. Push neutral lock detent button
3. Forward
4. Neutral
5. Reverse

NOTICE Do not force lever, insure throttle lever is in idle position and neutral lock is disengaged before shifting.

⚠ WARNING

Shift lever should only be used when the engine is idling and boat is completely stopped.

⚠ WARNING

Only use reverse at slow speed and for the shortest time possible. Always ensure the path behind is clear of objects and persons including children playing in shallow water.

NOTICE Never rev the engine at high RPM in reverse.

Throttle Lever

When pushed forward, the boat accelerates. When fully pulled back, engines return to idle speed and the boat is gradually stopped by water drag.

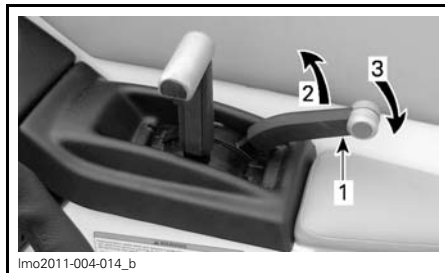

TYPICAL

1. Throttle lever (in idle position)
2. Increase speed
3. Decrease speed

3) Engine Cut-off Switch

The emergency engine stop switch is located on starboard side, between throttle lever and driver's console.

⚠ WARNING

Keep engine cut-off switch free from obstructions that could interfere with its operation. The proper use of the tether cord can prevent a runaway boat situation. Remove the tether cord when stopped to help prevent accidental starting.

The tether cord should be securely snapped onto the engine cut-off switch to allow engine starting.

Pulling the key from the engine cut-off switch stops engines.

⚠ WARNING

Should the tether cord become loose or fail to remain on engine cut-off switch, replace it immediately.

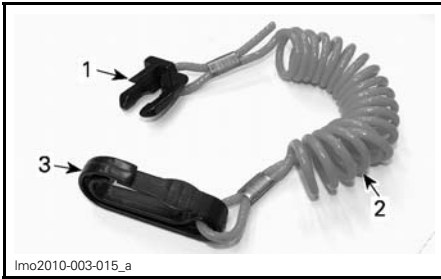

1. Safety lanyard clip (switch side)
2. Safety lanyard
3. Driver's clip

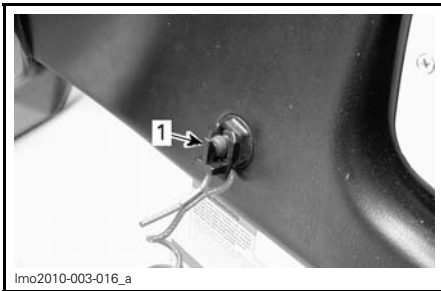

1. Safety lanyard clip secured to emergency engine stop switch

Always attach the tether cord to the operator using its Personal Flotation Device or a wrist strap and snap the key to the engine cut-off switch to be able to start each engine.

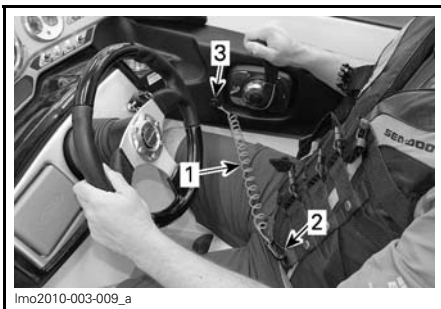

- TYPICAL**
1. Tether cord
 2. Secure tether cord clip to PFD
 3. Snap key to engine cut-off switch

⚠ WARNING
 Directional control is reduced when throttle is decreased and lost when engine is off. Always remove tether cord when boat is not in operation.

⚠ WARNING
 Do not lubricate the engine cut-off switch.

⚠ WARNING
 While the engines can be stopped using the Start/Stop buttons, good driving habits recommend that the tether cord also be disconnected when stopped.

4) Ignition Switch

The ignition switch is located to the right of steering wheel. It is a 3-position switch.

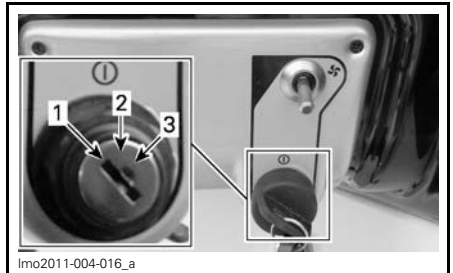

- IGNITION SWITCH POSITIONS**
1. OFF
 2. ACCESSORIES (lights and radio)
 3. ON

Two keys are provided with your boat. Insert key in switch and turn to the desired position. To remove key, turn key to OFF position then pull it out.

NOTICE If the key does not turn easily, do not force it. Pull it out and reinsert key.

NOTE: When turning the key to OFF position, the boat electrical system will take a few seconds to shut down.

⚠ WARNING

If you turn the ignition switch to OFF, it shuts off the engines and directional control is lost.

The ACCESSORIES position allows the operation of the radio. Remember that having the accessories ON without the engines running discharges the battery.

Deck lights do not require the key.

The ON position activates the complete electrical system. The ON position allows engines starting.

Always turn ignition key to the OFF position after engine has been stopped.

NOTE: While engine can be stopped by turning ignition key to OFF position, we recommend the engine be stopped by pressing the engine stop button.

5) Bilge Blower Switch

This switch is located on driver's console at the right of steering wheel. Above engine cut-off switch.

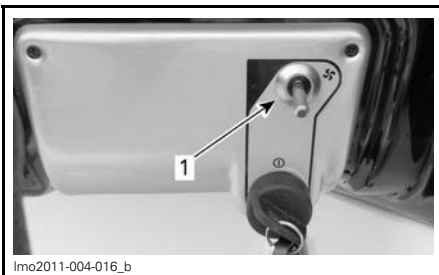

1. Bilge blower switch

A 2-position OFF/ON switch.

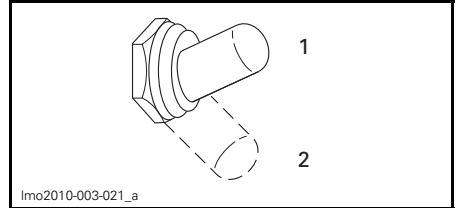

1. ON position
2. OFF position

When turned on, the blower ventilates the engine compartment.

⚠ WARNING

Gasoline vapors can explode, resulting in injury or death. Always use blower for a minimum of 5 minutes before starting engine and turn it OFF above idle speed. Use of the bilge blower should never replace "smelling" for gasoline vapor odors.

⚠ WARNING

If any leaks or gasoline vapor odors are present, do not start the engine. Consult an authorized Sea-Doo Boats dealer.

NOTICE Using the bilge blower for a prolonged time when the engines are not running will discharge the battery.

Blower should be turned off during boat operation.

6) Engine Start/Stop Buttons

The start/stop buttons are located to the RH side of the toggle switches below the analog fuel gauge.

This is a dual function push buttons. Used to start as well as to stop engines.

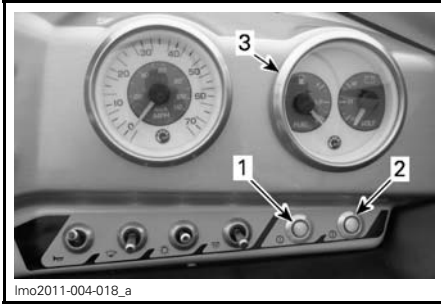

lmo2011-004-018_a

TYPICAL

1. For port engine
2. For starboard engine
3. Analog fuel gauge

Engine Starting and Stopping

Refer to *OPERATING INSTRUCTIONS* for complete procedure to start and stop the engine.

7) Horn Switch

This is a 2-position toggle type switch.

This switch is located on driver's console at the right of steering wheel. Below analog speedometer.

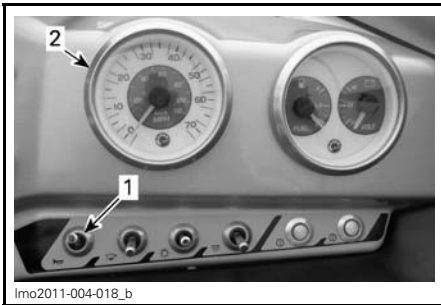

lmo2011-004-018_b

1. Horn switch
2. Analog speedometer

Raise the switch stem to activate the horn.

Release the switch stem to stop horn.

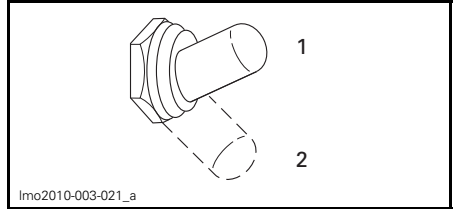

lmo2010-003-021_a

1. ON position
2. OFF position

8) Bilge Pump Switch

This is a 2-position OFF/ON switch.

This switch is located on driver's console at the right of steering wheel, below analog speedometer.

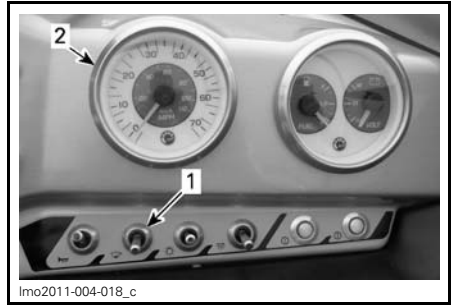

lmo2011-004-018_c

1. Bilge pump switch
2. Analog speedometer

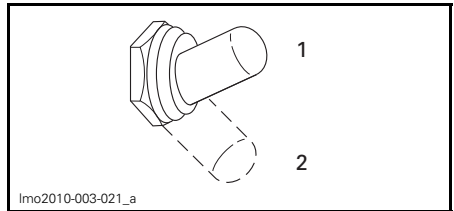

lmo2010-003-021_a

1. ON position
2. OFF position

Turn to ON position when a manual operation of the bilge pump is required (after cleaning, storage, etc.).

Turn switch to OFF when finished.

NOTICE Do not operate for a prolonged time if the bilge is dry: battery drainage will occur and pump will be damaged.

The bilge pump may be operated without the tether cord on its post.

NOTICE Always turn pump OFF when bilge is dry or before operating the engines above idle. Bilge pump will then switch to automatic mode.

Bilge Pump Automatic Mode

The bilge pump will automatically evacuate water from the bilge. A water sensor detects the water, activating the pump. After the water is pumped out, the pump shuts-off automatically.

NOTE: The automatic mode can not be deactivated, even if the main battery cut-off switch is turned OFF.

NOTICE Prolonged operation of the bilge pump when the boat is moored will lead to battery discharge and the bilge pump will quit working.

9) Navigation Lights Switch

This switch is located on driver's console at the right of steering wheel, below analog speedometer.

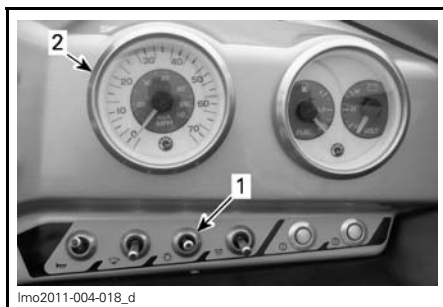

1. Navigation lights switch
2. Analog speedometer

This is a 3-position NAV/OFF/ANC switch.

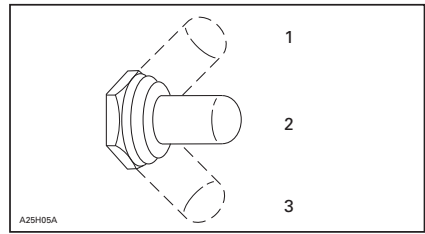

1. NAV
2. OFF
3. ANC

ANC: Turns on the anchorage light when the boat is anchored. Only the stern light is lit.

OFF: Turns off all lights.

NAV: Turns on both bow and stern lights and illuminates the gauges.

10) Deck Light Switch

This is a 2-position OFF/ON switch.

This switch is located on driver's console at the right of steering wheel, below analog speedometer.

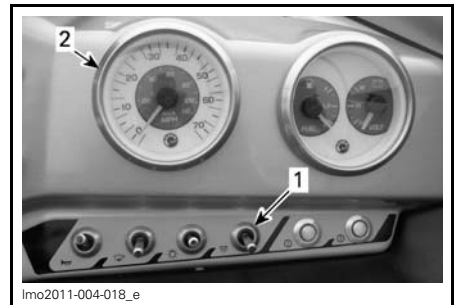

1. Deck light switch
2. Analog fuel gauge

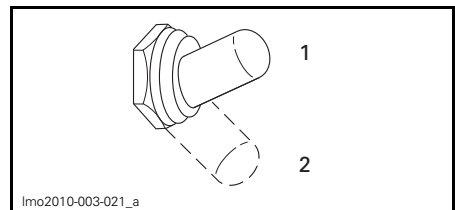

1. ON position
2. OFF position

Raise switch stem to ON position to turn on the deck lights.

Lower switch stem to OFF position to turn off the deck lights.

NOTICE Using the deck lights for a prolonged time when the engine is not running will discharge the battery.

11) MODE Button

This button is located on driver's console at the left of the information center.

Press this button to scroll various functions through the digital screen in the information center.

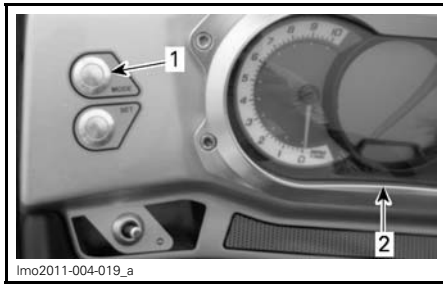

1. MODE button
2. Information center

For further details on the information center and the display modes, refer to *INFORMATION CENTER*.

12) SET Button

This button is located on driver's console at the left of the information center.

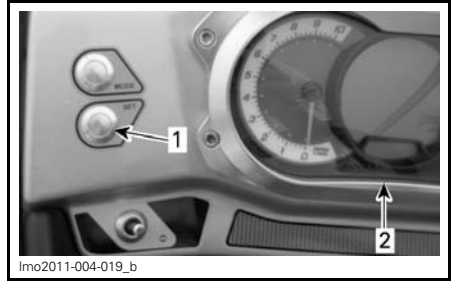

1. SET button
2. Information center

Press SET to select the desired function or to save any modified settings.

For further details on the information center and the display modes, refer to *INFORMATION CENTER*.

13) UP and DOWN Switch

This switch is located on driver's console at the left of the information center below the MODE and SET buttons.

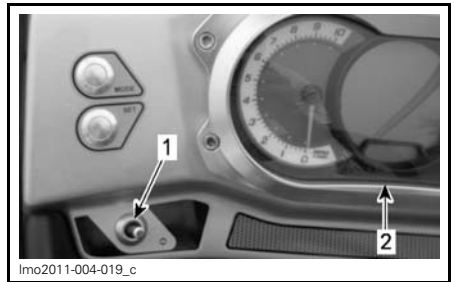

1. UP and DOWN switch
2. Information center

Move the switch stem up or down to navigate through the selected function using MODE or SET buttons or to modify settings.

NOTE: The UP and DOWN switch is also used for adjusting boat speed when operating in CRUISE mode.

For further details on the information center and the display modes, refer to *INFORMATION CENTER*.

14) Heating Fan Switch (230 WAKE)

This boat is equipped with a heating system to warm-up cockpit area or recreational activities users when needed.

This is a 3-position switch, up is high fan speed, middle is off and down is low fan speed.

It is located on the RH side of driver's console.

NOTICE Using the heating system fan for a prolonged time when the engines are not running will discharge the battery.

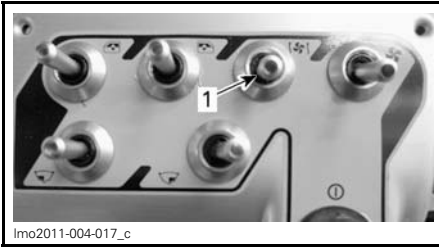

TYPICAL

1. Heating system switch

15) Ballast System Switch (230 WAKE)

230 Wake Only

The ballast bags allows you to fill and empty up to 454 kg (1,000 lb) of water in minutes at the touch of a button.

⚠ WARNING

The added weight of the ballast affects the handling characteristics of the boat. Do not perform high speed maneuvers when ballast bags contains water. Furthermore, it is then not recommended to operate the boat at speeds of more than 50 km/h (30 MPH).

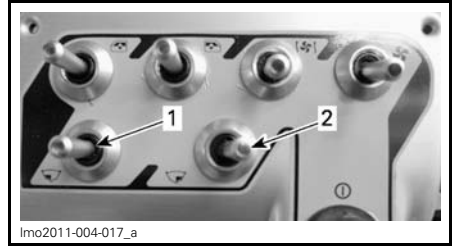

TYPICAL - BALLAST BAG SWITCHES

1. Port side ballast switch
2. Starboard side ballast switch

This is a 3-position switch.

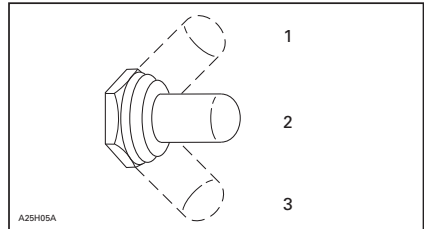

1. FILL
2. OFF
3. EMPTY

Raise switch stem to fill up the ballast bag.

Lower switch stem to empty the ballast bag.

NOTE: The ignition switch must be in the ACC or ON position to allow ballast system operation.

GAUGES

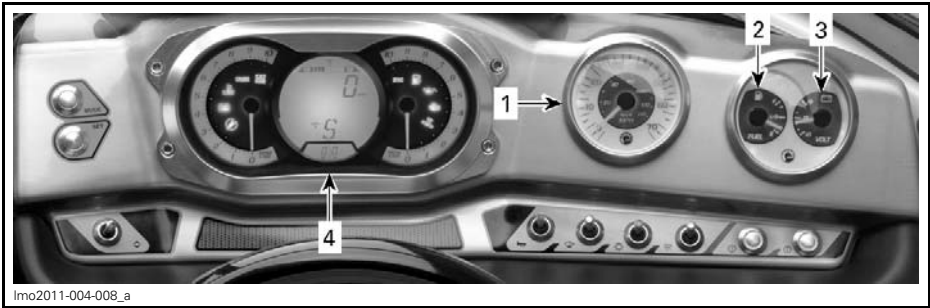

lmo2011-004-008_a

1) Analog Speedometer

The speedometer, located in the right top corner of the drivers' cockpit, provides an analog indication of the speed of the boat in miles per hour (MPH) and kilometers per hour (km/h).

The speed indication is based on a GPS (Global Positioning System) incorporated within the information center.

An indicator light seen in the right tachometer lights up when the GPS is receiving a good signal.



lmo2011-004-020_a

1. Analog fuel level gauge

The gauge is illuminated whenever the navigation lights are used.

The fuel level can also be verified without having engines running. Turn ignition key ON; the gauge will be activated for approximately 30 seconds.

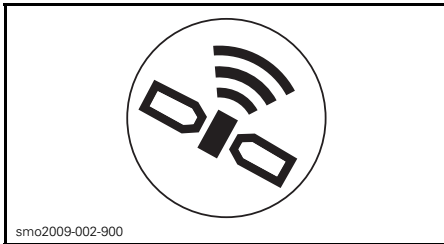

sno2009-002-900

GPS INDICATOR LIGHT

If for some reason the GPS signal is lost, a default mode is used whereby, the speed is calculated using information received from other systems to provide an estimated boat speed.

2) Analog Fuel Level Gauge

Located to the right of the speedometer, this gauge continuously indicates the amount of fuel in fuel tank when engines are running.

3) Analog Voltmeter

The voltmeter is located to the right of the speedometer.

The voltmeter displays the battery voltage. Normally, it should indicate around 14 V (volts).



1. Analog voltmeter

NOTE: It is normal to see a voltage drop during engine cranking.

4) Information Center

The information center is a cluster of gauge, indicator lights and a digital screen to display operational information to the operator.

The text message can be displayed in 3 different languages and the units of measurement can be displayed in metric or imperial units. See an authorized Sea-Doo boats to have the information center set to the unit of measurement and available language of your choice.

It allows the operator to view at a glance several indications such as , engines RPM, fuel level and engine temperature. The gauge can also be used to navigate through and select several functions, modes of operation and change certain settings and system parameters.

Indicator lamps advise the operator of selected functions or malfunctions.

The gauge incorporates a GPS (global positioning system) that it uses for the compass and speedometer indications, and provides signals to other systems as required for their operation.

NOTE: An information center self test can be initiated by turning the ignition key in ON position. All LCD segments and indicator lights will turn on for approximately 3 seconds.

Should a fault be detected during the self-test function, an error message will be displayed, an indicator light may come on, and an audible signal (beep code) may be heard to signal that a fault has been detected.

A fault code can be generated and memorized to assist your authorized Sea-Doo Boats dealer in troubleshooting the faulty system. Refer to *FAULT CODE DISPLAY* in this section for instructions on how to display fault codes.

⚠ WARNING

Reading the message on the information center digital screen can distract from the operation of the boat, particularly from constantly scanning the environment. This could lead to a collision. Before reading, ensure your environment is clear and free from obstacles, and bring the boat to a low speed. Before proceeding with any adjustments, make sure the surroundings are clear and safe to do so.

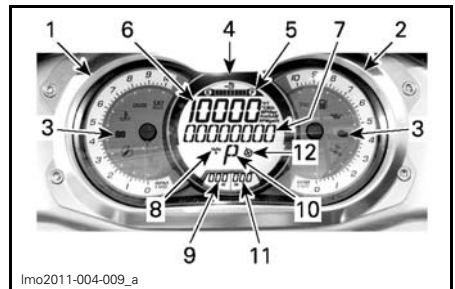

INFORMATION CENTER FUNCTIONS

1. Tachometer (Port Engine)
2. Tachometer (Starboard Engine)
3. Indicator lights
4. Digital screen
5. Fuel level
6. Numerical display
7. Multifunction display
8. Depth sounder indicator
9. Hour meter display (Port Engine)
10. Engine (P = Port, S = Starboard)
11. Hour meter display (Starboard Engine)
12. Compass

Analog Tachometers



The tachometers provide an analog indication of the revolutions per minute (RPM) of the engines. Multiply the indicated number by 1000 to obtain the actual engines RPM.



Indicator Lights

Indicator lights (pilot lamps), located in the tachometers, inform you of a selected function, a normal condition or a system anomaly.

An indicator light may be accompanied by a scrolling message in the multi-function display.

See table below for usual pilot lamp information. Refer to *MONITORING SYSTEM* for details on malfunction pilot lamps.

PILOT LAMPS	MESSAGE DISPLAY	DESCRIPTION
LH TACHOMETER		
	-	When turn ON: SKI MODE is engaged When blinking: SKI MODE is selected but not engaged
	-	CRUISE mode engaged
	MAINTENANCE REMINDER	Maintenance required

PILOT LAMPS	MESSAGE DISPLAY	DESCRIPTION
RH TACHOMETER		
	-	Indicate both engines turn at the same RPM*
	LOW-FUEL	Low fuel level, approx. 25% tank capacity 41.6 L (11 U.S. gal.)
	-	Good GPS uplink
* If this light stays OFF, check if the SYNCHRONIZATION MODE is activated. Otherwise, see an authorized Sea-Doo Boats dealer.		

Fuel Level

A bar gauge located on the top of the digital screen continuously indicates the amount of fuel in the fuel tank while riding.

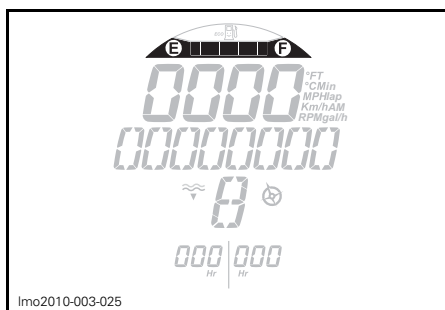

FUEL LEVEL INDICATOR

When the fuel tank is full, 8 segments (bars) of the indicator are turned on.

When there is only 2 segments of fuel indicated (approximately 25% fuel tank capacity or 41.6 L (11 U.S. gal.), the low fuel indicator light will come on to advise you of the low fuel condition.

An audible warning (one long beep) will be heard periodically as long as the low fuel condition exists.

Fuel Economy Mode

The iTC (intelligent Throttle Control) system allows to maintain a steady speed and constant RPM to reduce fuel consumption.

To engage the fuel economy mode:

1. Press MODE button repeatedly until ECO MODE is displayed.

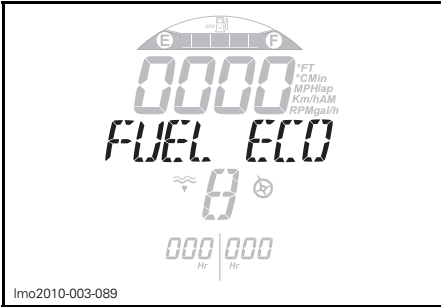

ECO MODE

2. Press the SET button once, the following message will be displayed "ECO MODE - PRESS SET to activate or MODE to exit".
3. Press and hold the SET button until ECO MODE reappears.

To confirm the ECO mode, the symbol ECO is displayed on the LH of the smiling fuel tank.

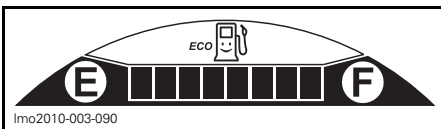

To cancel the fuel economy mode:

1. Move throttle/shifter handle in NEUTRAL position.

2. Press the MODE button.

Numerical Display

The numerical display is used to provide a variety of indications as per selection made from the DISPLAY function in the multifunction display:

- Water depth
- Engines RPM
- Boat speed
- Fuel consumption (instant and average)
- Remaining fuel range (distance and time)
- Engines temperature
- Altitude
- Top and average speed
- Top and average engines RPM
- Clock.

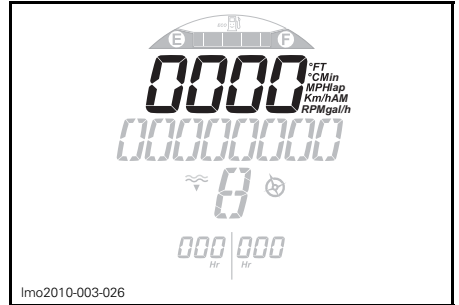

NUMERICAL DISPLAY

When the information center is first powered up, the numerical display defaults to the last function chosen by the operator from the multifunction display.

The numerical display is also used to display various system mode settings such as:

- SKI MODE setting
- CRUISE setting
- LAP TIME setting.

Changing Clock

1. Press MODE button repeatedly until SETTINGS is displayed.

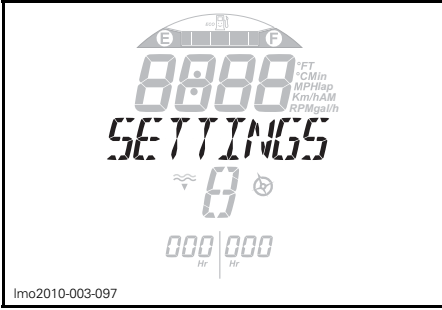

lmo2010-003-097

SETTINGS

2. Press the SET button to validate your choice. The hour and the message CLOCK will be displayed.



lmo2010-003-098

CLOCK

3. Press the SET button again, the message CHANGE CLOCK will be displayed.

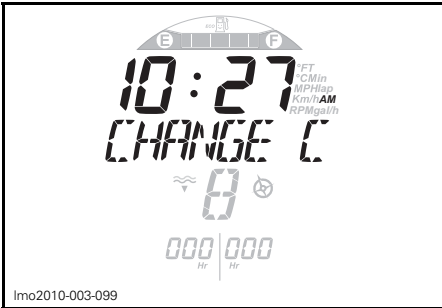

lmo2010-003-099

CHANGE CLOCK

4. Use UP and DOWN switch to adjust the clock.

5. Press MODE or SET button to save the clock and return to the main display.

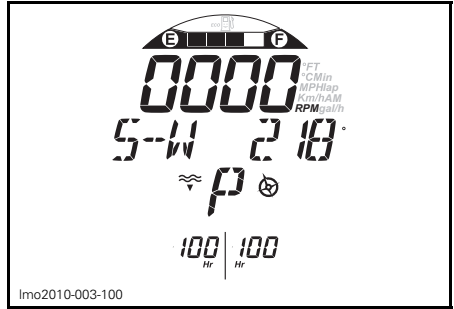

lmo2010-003-100

MAIN DISPLAY

Changing Numerical Display Indication

To change the indication in the numerical display, press the MODE button repeatedly until DISPLAY is visible in the multifunction display.

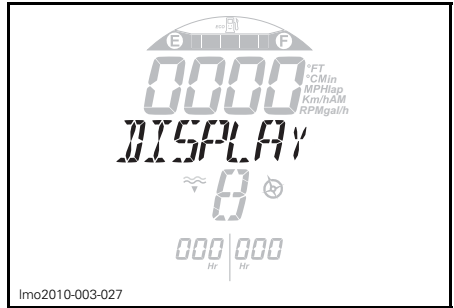

lmo2010-003-027

DISPLAY MENU

Move switch stem up or down until the preferred indication selection is visible in the multifunction display.

Press the SET button to select and save the preferred indication, or wait for the display function to time out. The last indication visible will be automatically save. The numerical display will then switch to the new indication with a small abbreviation of the indication type to its right:

- FT or M
- RPM

- MPH or Km/h
- °F or °C
- Lap
- Gal/h or L/h
- Min
- AM or PM.

For example, to display the ALTITUDE information:

- Press the MODE button repeatedly until DISPLAY is displayed.
- Then press SET button once.
- Lift up the UP and DOWN switch until ALTITUDE is displayed.
- And finally, press SET button to confirm and save your selection.

Lap Time Mode

The lap timer can be used to record up to 50 individual lap times.

To activate and use the lap timer, carry out the following:

1. Press MODE button repeatedly until LAP TIME is displayed.

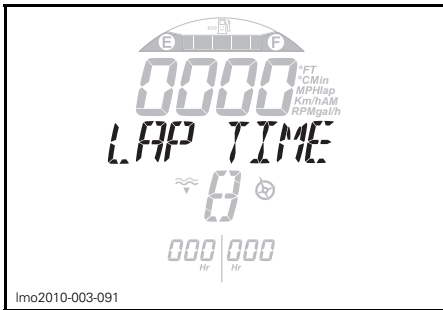

LAP TIME

2. Press the SET button once to confirm your selection. The first lap timer will be displayed.

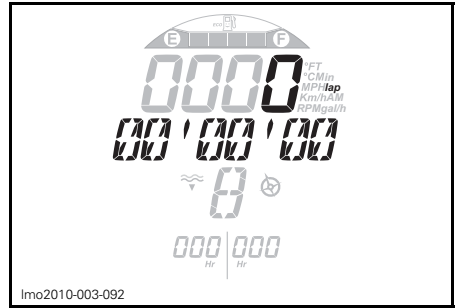

FIRST LAP TIMER

3. When ready, press the SET button to start the lap timer.



LAP TIMER STARTED

NOTE: The timer starts immediately when pressing the SET button.

4. To record each lap time, press the SET button at the start of each lap.

NOTE: The lap time will be recorded, the lap counter (in numerical display) will count the number of laps recorded, and the timer will continue to run.

5. To save the last lap time and stop the timer, press the MODE button.

To verify the recorded lap times, use the UP and DOWN switch to toggle through all lap times.

To reset an individual lap time:

1. Using the UP and DOWN switch, go to the lap time to be reset.

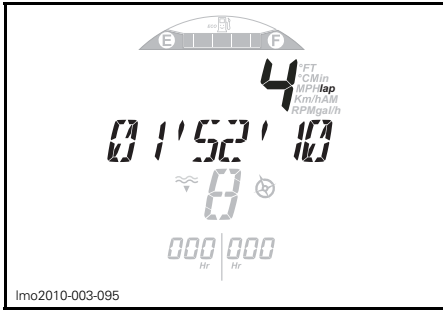

2. Press and hold the SET button until the lap time is reset.

To reset all lap times:

1. Using the UP and DOWN switch, go to ALL.

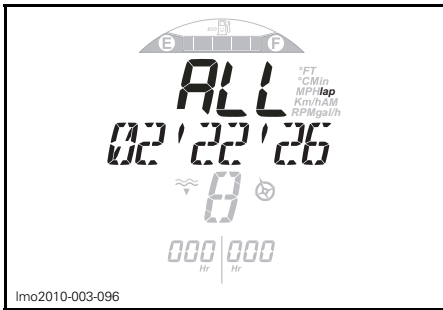

2. Press and hold the SET button until the time is reset to 0 (zero).

Multifunction Display

When the boat is being operated, the multifunction display provides an indication of compass heading or scrolling messages from the monitoring system.

It also displays a menu for the selection of various functions which, permit changing the numerical display indication, system modes of operation, settings, and displaying system fault codes.

WARNING

Selecting various numerical displays, system modes of operation or changing settings should only be carried out with the boat stopped. Selecting these various functions while operating the boat at speed is not recommended as it deters your attention from situational awareness.

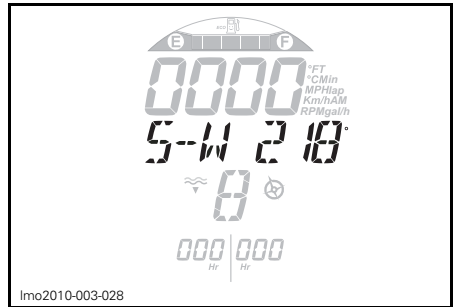

MULTIFUNCTION DISPLAY - COMPASS HEADING INDICATED

Selecting Functions

When operating at speed, the multifunction display normally provides an indication of the compass direction and azimuth the boat is traveling.

To select the various functions available through the multifunction display, press the MODE button repeatedly until the desired function is visible:

- SKI MODE
- CRUISE MODE
- DOCKING
- LAP TIME
- DISPLAY
- ECO
- FAULT CODES
- SETTINGS.

Then press the SET button to enter that function.

Each available function is explained in its applicable section.

NOTE: The fault code functions is available only when there is an active fault. The settings function is only available when the engine is shut off.

Depth Sounder Indicator

The numerical display can be selected to provide an indication of the water depth.

The system is capable of indicating water depth under the hull in single increments up to 50 m (164 ft).

NOTE: Under certain conditions, the digital screen may stop displaying. The digital screen's ability to display the depth depends on the conditions of use.

To activate depth indication, refer to *NUMERICAL DISPLAY* in this subsection.

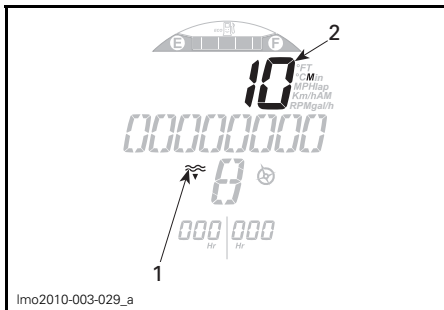

lmo2010-003-029_a

1. Depth finder indicator
2. Water depth indication

⚠ WARNING

Never use the depth sounder as a warning device to ride in shallow water.

Hour Meter Display (HR)

Continuously displays the time in hours of the boat engines usage.

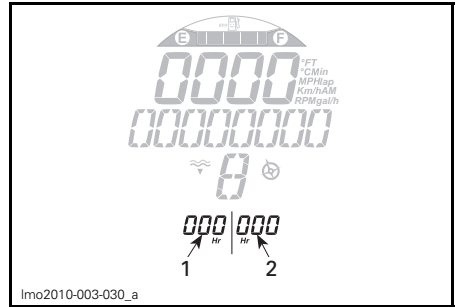

lmo2010-003-030_a

HOUR METER

1. Port side
2. Starboard side

Compass

A GPS incorporated in the information center provides the indication in the multifunction display.

The cardinal points, intermediate cardinal points, as well as the azimuth of the boat is travelling are displayed in the multifunction display by default when the boat is moving.

For a compass indication to be displayed, the GPS must have a good link with the navigation satellites. This is confirmed when the COMPASS active indicator is visible in the digital screen.

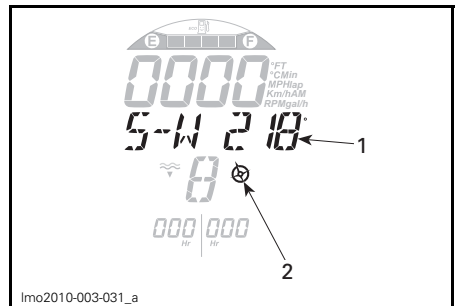

lmo2010-003-031_a

1. Compass indication
2. Compass active indicator

NOTE: The compass indication is only available above 5 km/h (3 MPH).

⚠ WARNING

Use the compass as a guide only. Not to be used for precision navigation purposes.

Engine Identification

Identify which engine is associated with the information from the numerical display.

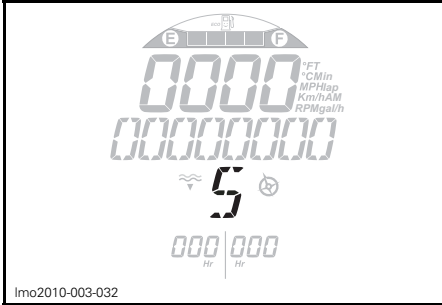

STARBOARD ENGINE SHOWN

P = PORT

S = STARBOARD

EQUIPMENT

NOTE: Some controls, instruments or equipment do not apply or are optional on some models. In these cases their reference numbers are deliberately missing in the illustrations.

Overall View

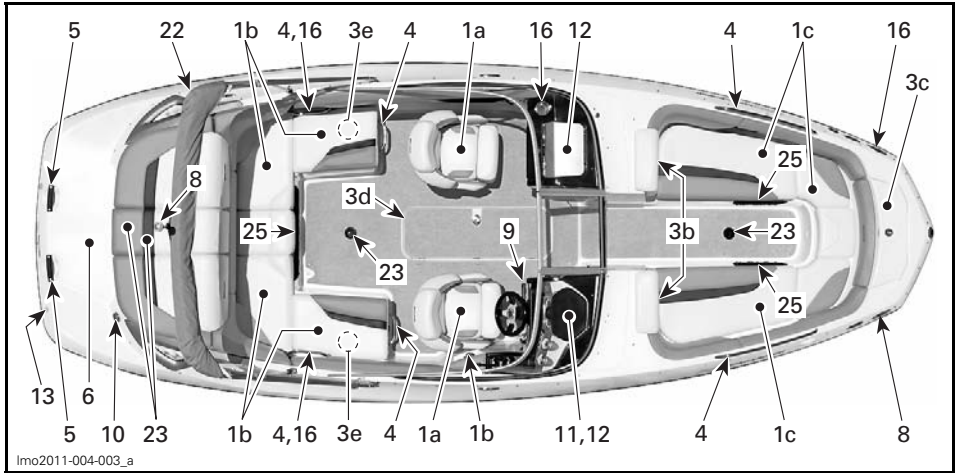

230 CHALLENGER

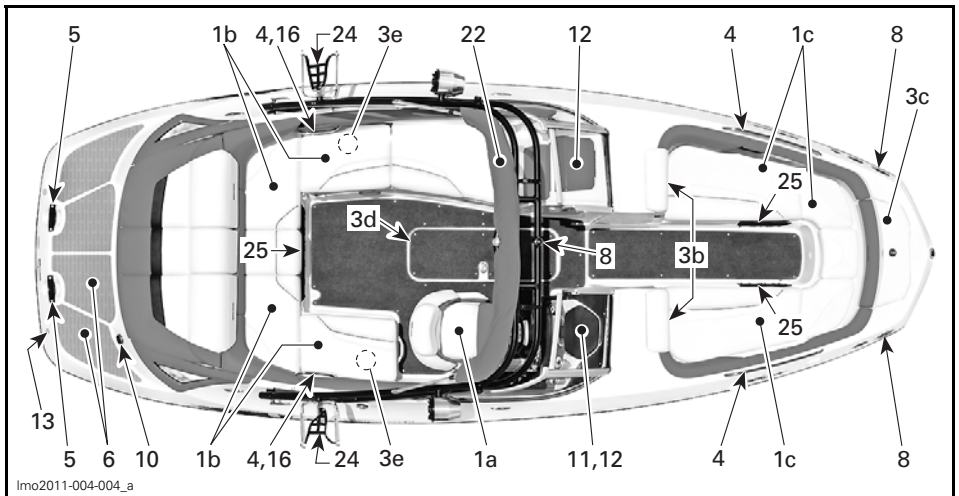

230 WAKE

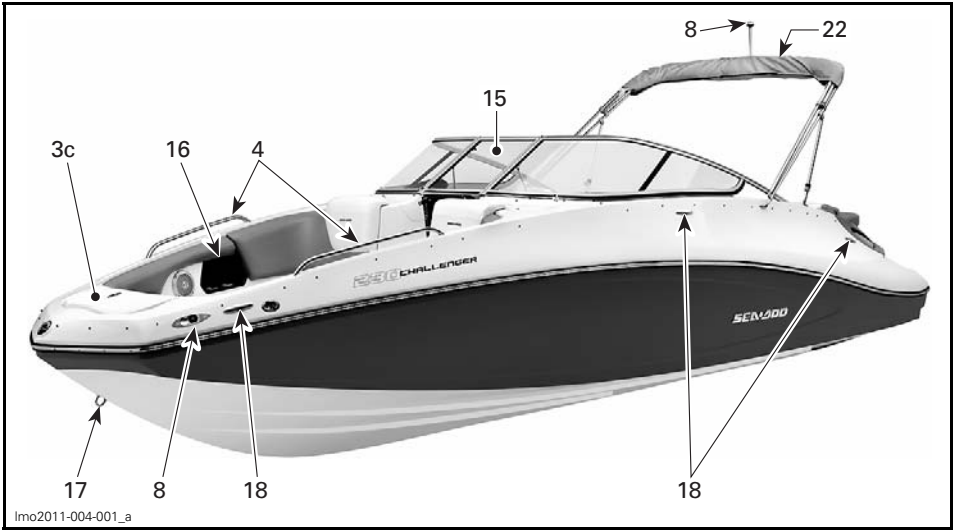

230 CHALLENGER

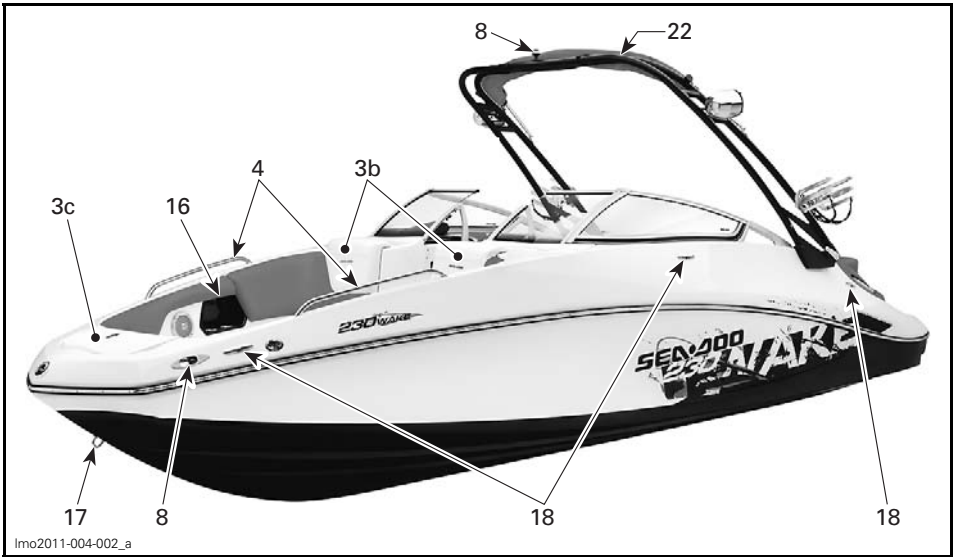

230 WAKE

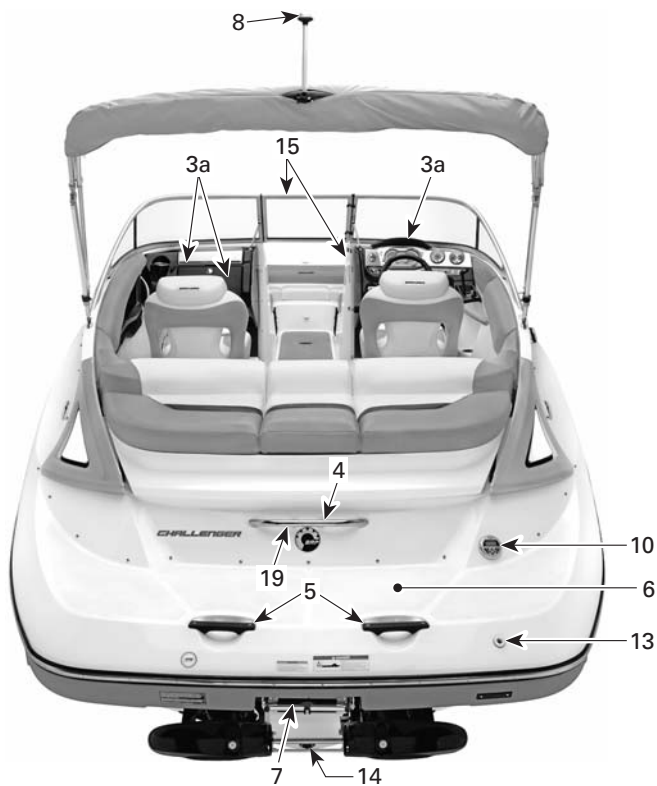

lmo2011-004-005_a

230 CHALLENGER

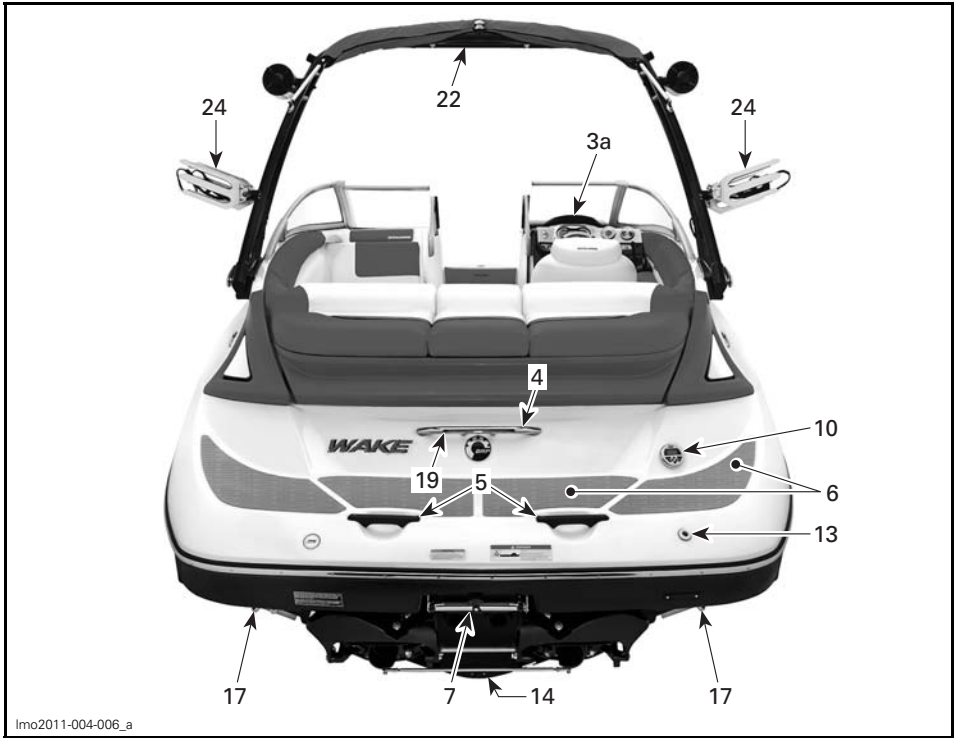

230 WAKE

1) Seats

1a) Driver/Passenger Seat

Swivel Adjustment

⚠ WARNING

Always ensure drivers seat swivel is locked so that seat faces steering wheel before riding.

230 Challenger and 230 Challenger SE

Both driver and passenger seats can swivel.

Pull and hold the lever located on the RH side of the seat, swivel seat to the desired position, then release lever.

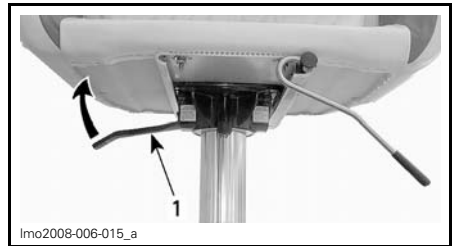

1. Lever

230 Wake

Driver seat can swivel.

Pull the lever located on the RH side of the seat

Swivel seat to the desired position, then push the lever down to lock the seat in position.

The mechanism resistance can be increased by turning the knob clockwise or decreased by turning the knob counterclockwise.

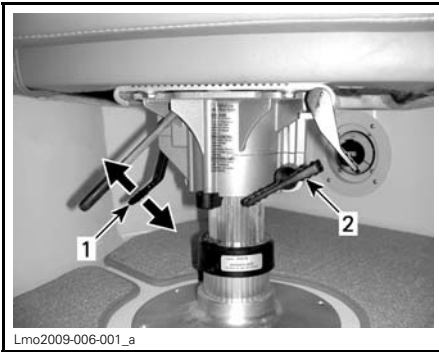

1. Lever (swivel operation)
2. Knob (resistance adjustment)

Forward and Backward Adjustment

Both driver and passenger seats can be adjusted forward or backward.

Pull and hold the lever located on the RH side of the seat, set the seat to the desired position, then release the lever.

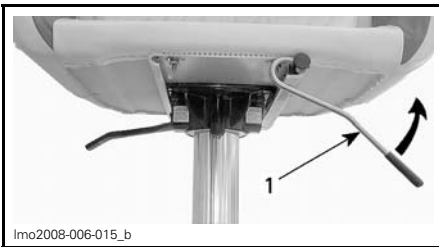

- 230 CHALLENGER SE PASSENGER SIDE**
1. Lever



- 230 WAKE AND 230 CHALLENGER SE HELM SEAT**
1. Lever

Height Adjustment

230 Wake and 230 Challenger SE

Driver seat can be adjusted in height.

To move the seat up, pull the foremost lever and release weight from the seat cushion. When the desired height is reached, release the lever.

To move the seat down, pull the foremost lever and apply weight on the seat cushion. When the desired height is reached, release the lever.



1. Lever

Seat Bolster Position Adjustment

Adjustable seat bolster that allows different seating positions for low speeds. It also allows the driver, if adjusted in an upright position, to stand up between the helm and the seat for low speed operation.



- TYPICAL — LIFT SEAT BOLSTER**

1b) Passenger Seats

Each passenger should be seated while underway.

There is storage beneath each side passenger seat cushion.

⚠ WARNING

Allow no one to sit on edge of the boat or to stand up while in operation. Seat and grab handles should be used in rough waters.

Typical Seat Cushion Opening

To open the storage compartment, pull on front portion of cushion.



lmo2009-006-008

TYPICAL — SEAT CUSHION OPEN

Side Passenger Seats and Storage

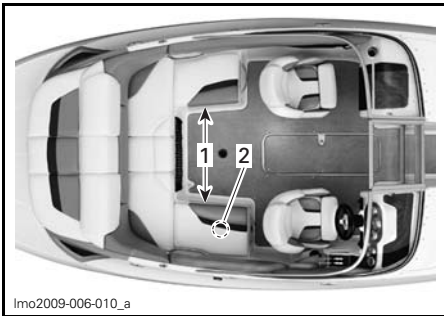

lmo2009-006-010_a

230 CHALLENGER AND
230 CHALLENGER SE SET-UP

1. Side seats and storage
2. Removable cooler

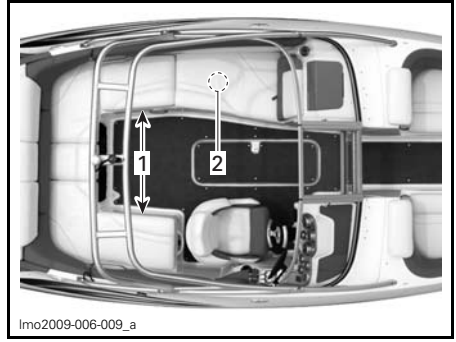

lmo2009-006-009_a

230 CHALLENGER AND 230 WAKE SET-UP

1. Side seats and storage
2. Removable cooler

The ballast bags are located beneath the aft side seat cushions.

NOTICE Avoid storing any items in ballast compartments that might damage ballast bags.

NOTICE Ensure to remove all items in ballast compartments before filling ballast bags.

Rear Seats and Storage

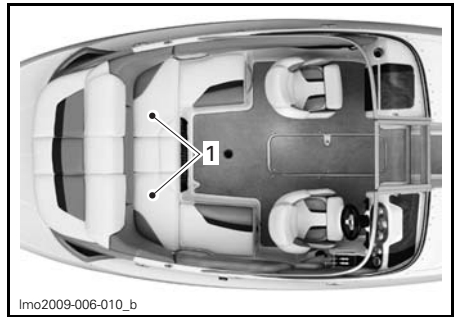

lmo2009-006-010_b

230 CHALLENGER AND
230 CHALLENGER SE SET-UP

1. Rear seats and storage

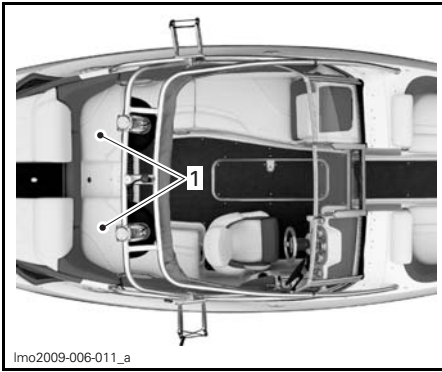

lmo2009-006-011_a

230 CHALLENGER AND 230 WAKE SET-UP

1. Rear seats and storage

Unlatch the retaining cord to access storage compartment below seat cushion.

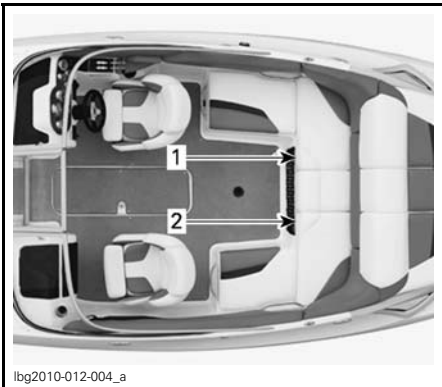

lbg2010-012-004_a

1. Underneath starboard cushion
2. Underneath port side cushion



lbg2010-012-002_a

RETAINING CORD

Before getting underway or towing the boat on a trailer, fasten the retaining cord on each rear side cushion.

⚠ WARNING

Ensure that the rear side cushions are properly secured to avoid loss of cushions while underway or when towing the boat on a trailer.

1c) Bow Seats

⚠ WARNING

No passenger should be seated on the most forward seat in the bow area above 8 km/h (5 MPH).

Use grab handles as necessary.

Bow Seat Storage Compartment

Lift the front portion of the seat cushion to open the storage compartment.



lmo2009-006-007

TYPICAL — STARBOARD SIDE SHOWN

2) Main Battery Cut-Off Switch

This switch allows a complete power cut-out of the electrical system.

When in OFF position, ALL electrical equipment and electronics will be OFF except bilge pump and radio/CD

memory power. The bilge pump will operate automatically with the battery switch on the OFF position.

Switch must be in the ON position to allow the use of electrical components and to start the engines.

NOTICE Stop engines before switching to the OFF position.



1. Main battery cut-off switch

It is recommended to set this switch to the OFF position whenever performing maintenance in the engine compartment, on the electrical system, for transportation or during short term storage.

NOTICE When the main battery cut-off switch is turned OFF while boat is moored, the automatic bilge pump will start if water comes up in the bilge.

3) Storage Compartments

NOTICE Never operate the boat with the glove box or storage compartment cover open.

3a) Glove Boxes

Convenient storage location for carrying small personal articles.

NOTE: Always relatch glove box before operating boat.

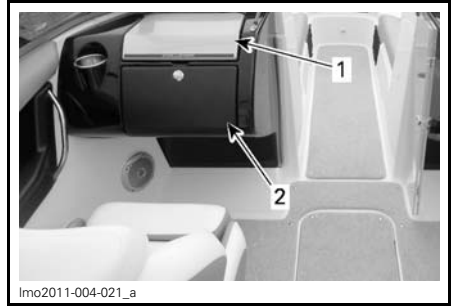

TYPICAL - 230 CHALLENGER

1. Lower glove box
2. Upper glove box



Operator's glove box is also provided. It is located just over the information center cluster.



3b) Console Storage compartment



Imo2007-003-019_a

TYPICAL - 230 WAKE EDITION

1. Glove box
2. Storage compartment

NOTE: To have access to storage compartment, lift seat backrest upward.



Imo2007-003-020

STORAGE COMPARTMENT — 230 WAKE EDITION

3c) Bow Storage Compartment

NOTICE Never leave breakable objects in the bow storage compartment. Never operate the boat with the bow storage compartment cover open.

A large, convenient storage compartment for anchor, PFD's, towels, etc.

To open, lift the latch ring and open cover gently until stopped by retaining shock.

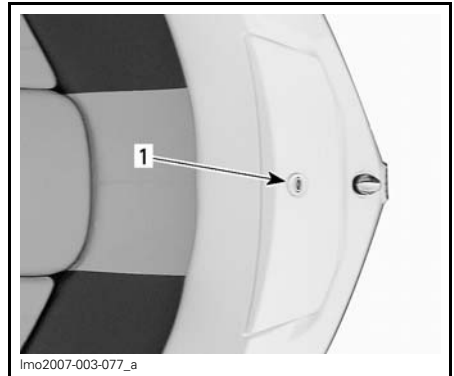

Imo2007-003-077_a

1. Latch

To close, lift the latch ring and slowly lower the cover.

NOTE: Always relatch compartment lid.

3d) Deck Storage Compartment

The deck storage compartment is a convenient lockable location for water-skis, paddles, anchor and rope, etc.

Use the provided key to unlock the compartment if needed.

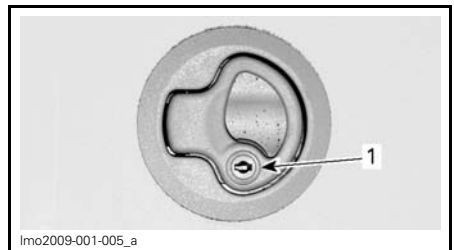

Imo2009-001-005_a

TYPICAL

1. Lock

NOTICE Never leave any heavy or loose breakable objects in the deck storage compartment. Never operate the boat with the deck storage compartment cover open.

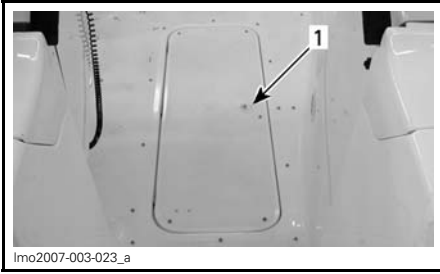

TYPICAL

1. Pull latch and lift cover

Lift the latch ring and open cover gently until stopped by retaining shock.

When completely opened, the cover remains in that position on calm water.

To close, lift the latch ring and slowly lower the cover.

Always close deck storage compartment cover before getting underway. Lock if desired.

3e) Rear Storage Compartment/Engine Cover/Release Handle

Convenient rear storage location for carrying large personal articles. Ideal location for spare Personal Flotation Device (PFD), towels, lunch etc.

The latch handle is located inside the glove box/storage compartment.



230 CHALLENGER/SE

1. Latch handle

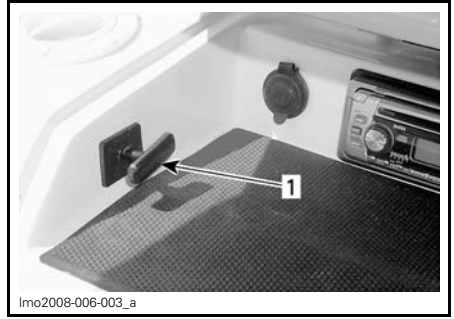

230 CHALLENGER SP/230 WAKE

1. Latch handle

To release latch, pull and turn latch handle. Turning the latch handle locks it in position. Lift storage compartment cover, the gas assist cylinder will complete the opening and hold the cover open.

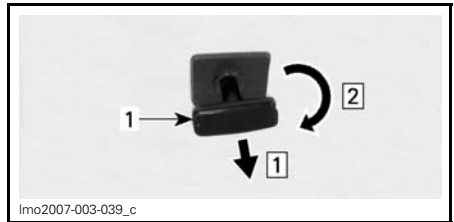

TYPICAL

1. Latch handle

Step 1: Pull

Step 2: Turn

Unlock the latch handle before closing cover.

NOTICE Never leave any heavy or breakable objects in the storage compartment. Never operate the boat with the rear storage compartment cover opened or unlocked.

⚠ WARNING
Always ensure rear storage compartment lid is closed and securely locked before trailering.

Storage Tray

NOTICE In order to avoid damage, **MAXIMUM LOAD** on storage tray must not exceed 22.5 kg (50 lb).

The storage tray is removable, allowing access to the engine compartment. Grab the handles and lift in a upward movement.

⚠ WARNING

When storage tray is lifted or removed, never touch any electrical part when starting engines or while in operation. Never leave any object, rag, tool, etc., in the engine compartment or in the bilge.

Ensure latch cable is returned to the locking position, then firmly close storage compartment cover to re-latch.

4) Grab Handles

Grab handles provide a handhold for the passengers.

Although grab handles are provided, never perform maneuvers that place a passenger or the driver at risk for being ejected or thrown out of their seat.

NOTICE Never use the grab handles to pull anything or to lift the boat.

Refer to components location illustrations at the beginning of this section for grab handle locations.

5) Rear Grab Handles

Provide a handhold for boarding when needed.

NOTICE Never use the grab handle to tow anything or to lift the boat.

6) Swim Platform

Provides an anti-skid surface for easy boarding either from front or rear of boat depending on the models.

⚠ WARNING

Engines must be off when using swim platform. Keep away from jets or intake grates.

7) Ladder

⚠ WARNING

Engines should be OFF when using ladder. Keep limbs away from jets or intake grates. Only one person at a time on the ladder. Never use the ladder for pulling, towing, diving or jumping, boarding a boat that is out of the water or any other purpose other than a ladder.

Located under the swim platform, the ladder conveniently helps in reboarding the boat.

Pull latch to release the ladder.



1. Latch

Slide ladder toward rear, then push down.



LADDER LOWERED

To store ladder, lift horizontally, slide toward front and secure latch.

NOTICE In order to avoid damage to the ladder, it should not be used when the boat is out of the water.

8) Lights

Bow Lights

Mandatory red and green lights. See *NAVIGATION LIGHT SWITCH* in this section.

Stern Light

230 Challenger

The stern light socket is provided for the mandatory white stern light.

NOTE: With this navigational lighting configuration, this boat can only be used on inland water after sunset.

Release stern light storage lock as shown.

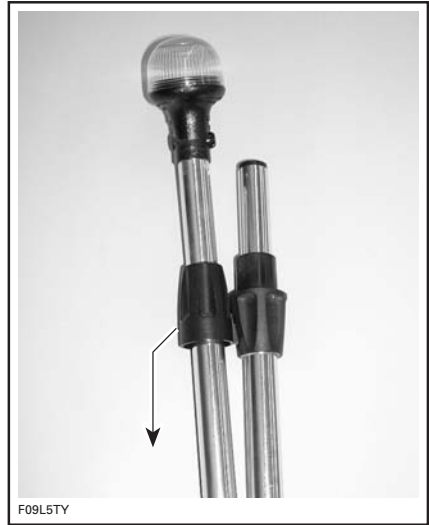

SLIDE THIS DIRECTION

Thread onto folding joint as shown below.

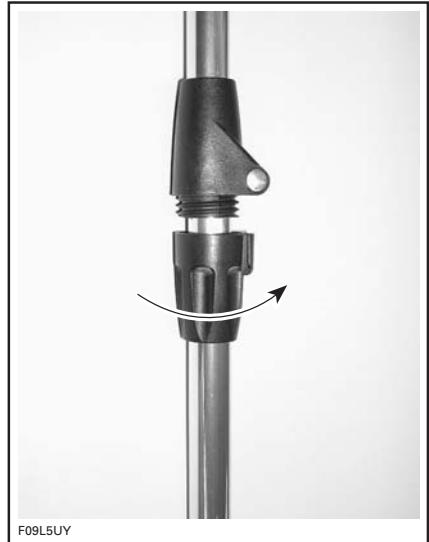

Lift connector cap.

Insert post in connector hole. Ensure to align hole keyway with post screw head.

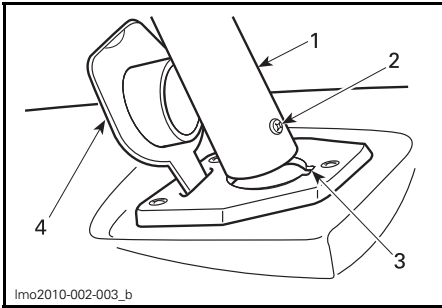

lmo2010-002-003_b

1. Stern light post
2. Post screw head
3. Hole keyway
4. Connector cap

Firmly push downward to engage terminals.

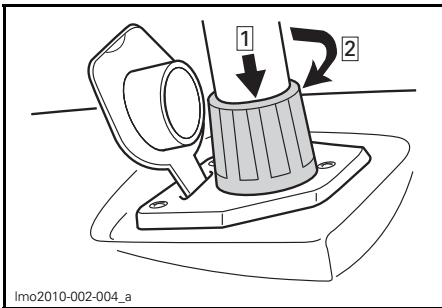

lmo2010-002-004_a

- Step 1: Push downward
Step 2: Turn clockwise to lock

Check light operation. See NAVIGATION LIGHT SWITCH as mentioned earlier in this section.

Push lock ring downward. Turn until locked. It may be necessary to slightly turn it to allow its insertion in the hole.

NOTICE Ensure DIELECTRIC GREASE (P/N 293 550 004) is present in connector area of light to prevent corrosion.

230 Challenger and 230 WAKE

Mandatory WHITE stern light (WHITE). The stern light is installed on the top of the bimini top.

Set the stern light pole upright by loosening the plastic knob.

When positioned correctly, tighten plastic knob to retain the pole in this position.

Connect both stern light connectors.

To turn the stern light on, see NAVIGATION LIGHTS SWITCH in this section.

NOTICE Using the stern light for a prolonged time when the engine is not running will discharge the battery.

Deck Lights

Convenient lights to use between sunset and sunrise. These lights can assist passenger when boarding as well as creating a nice ambience.



lmo2007-003-012

DECK LIGHT

9) AM/FM Radio

Refer to manufacturer's guide for complete explanation of features and controls.

NOTICE Using the AM/FM radio for a prolonged time without engines running may discharge the battery.



AM/FM RADIO

10) Radio Remote Control

A remote control for the radio is included as standard equipment and is located on the starboard side of the swing platform.

For radio remote control operation, please refer to the *MANUFACTURER'S INSTRUCTION SHEET*.

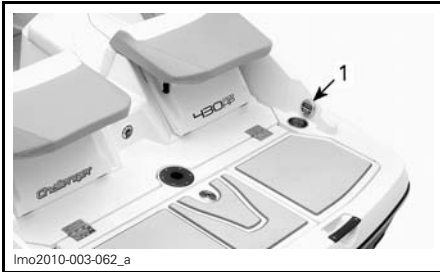

1. Radio remote control

11) Audio Input Jack/USB port

This boat is equipped with an audio input jack and a USB port. They are located in the driver's glove box.

Using these adapters, an audio player such as a CD player or a MP3 player can be connected to be played through the audio system.

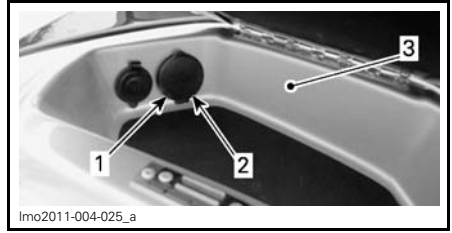

INSIDE GLOVE BOX

1. Audio input jack
2. USB port
3. Glove box

NOTE: Close protective cap when the audio input adapter is not in use.

12) 12-Volt Power Outputs

Two 12-volt power outputs are provided to power temporary accessories such as a cellular phone or other 12-volt portable devices.

One power output is located in the driver's glove box. The other power outlet is located inside the driver side passenger's glove box.

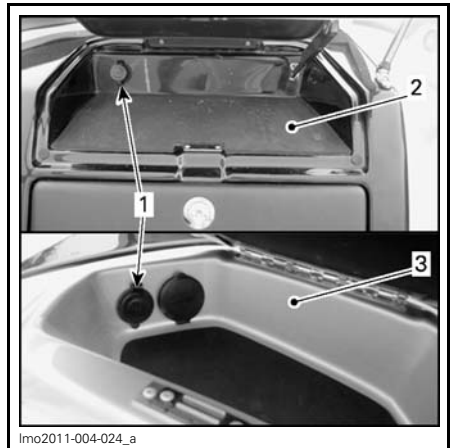

12-VOLT POWER OUTPUT LOCATION

1. 12-volt power output
2. Driver side passenger 's glove box
3. Driver's (upper) glove box

NOTICE Close protective cap when jack is not in use to protect against weather.

NOTICE Using 12-volt portable devices for a prolonged time without engine running may discharge the battery.

13) Deck Drain

Deck drain provides drainage of water from rain, deck washing, water splashing, etc.

Keep clean to avoid clogging.

14) Bilge Drain Plug

Once boat is on trailer, unscrew the drain plug, block the wheels and raise the bow slightly with the trailer jack (if so equipped) to allow water to drain.

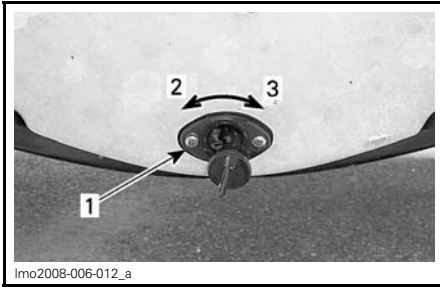

lmo2008-006-012_a

1. Drain plug
2. Loosen
3. Tighten

15) Walk-Thru Door/ Windshield

CAUTION

- Use caution when operating door.
- Hand will contact boat structure during operation.
- Latch door in the open and closed position at all times.
- Walkthru door should be stowed while trailering.

For your convenience, a walk-thru door can be unfolded from the side of driver's console to divert the air flow coming from the bow area.

Unlock door latch then unfold walk-thru door using the recess handle to open.

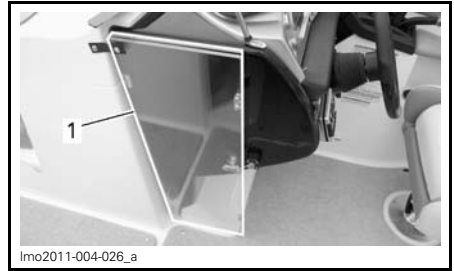

lmo2011-004-026_a

TYPICAL
1. Foldable door

NOTICE Once opened, the door must be latched to the port console using the door latch.

For more protection, when the door is set in close position, pull on the folded windshield and lock it in place using the latches on the windshield supports.

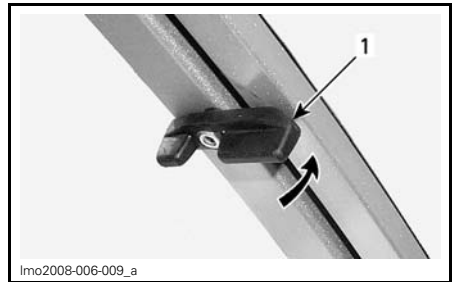

lmo2008-006-009_a

TYPICAL — TWO PER SIDE
1. Windshield lock

16) Cup Holders

Convenient locations for non-alcoholic beverages.

WARNING

Do not drink alcoholic beverages while aboard. Do not keep bottles, cans etc. in cup holders while riding at speed and/or on rough water.



1. Cup holder

17) Bow and Stern Eyelets

Bow Eyelet

Eyelets can be used for mooring, towing and as a tie-down point during transportation.



1. Bow eyelet

Stern Eyelets

Eyelets can be used for mooring, towing and as a tie-down point during transportation.



1. Stern eyelet

18) Mooring Cleats

When mooring to a dock, it is recommended to secure with both front and rear cleats. The use of dock lines with sealed air fenders is recommended to protect your boat.

NOTICE Never use mooring cleats to pull anything or to lift the boat.

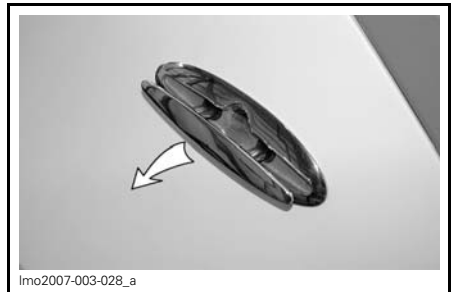

CHALLENGER SE AND WAKE EDITION MODELS

19) Water Sport Towing Attachments

Please read and often refer to *WATER SPORTS* information in the *SAFETY INFORMATION* section at the front of this guide.

⚠ WARNING

“Teak Surfing” is extremely dangerous to participants due to their proximity to the rear of the boat where direct contact with the exhaust fumes from the boat engine is the highest. Carbon monoxide poisoning can occur and result in mental disorientation, dizziness, drowsiness, and loss of consciousness. The combination of carbon monoxide exposure and non-use of a life jacket (PDF) make this new water recreation activity an incredibly dangerous and potentially deadly sport.

⚠ WARNING

When pulling a tube, skier or wakeboarder, always have an observer, proceed with only as much speed as required, and follow the observer's instructions.

⚠ WARNING

Pulling a tube, skier or wakeboarder makes the boat handle differently and requires greater skill. Unless absolutely necessary, do not make tight, sharp turns. Keep a safe distance from the docks, swimmers, other craft or objects. Be advised that serious injury can result if the tow rope becomes slack during a tight turn or when circling. The rope could become wrapped around the neck or limbs of a person.

Tow Hook

Provides rope attachment for towing activities.



NOTICE Never use the tow hook to tow any other craft.

Towing Tower (if equipped)

Provides rope attachment for towing activities.

⚠ WARNING

Pulling a tube, skier or wakeboarder makes the boat handle differently and requires greater skill. Unless absolutely necessary, do not make tight, sharp turns. Keep a safe distance from docks, swimmers, other craft or objects. Be advised that serious injury can result if the tow rope becomes slack during a tight turn or when circling. The rope could become wrapped around the neck or limbs of a person.

NOTICE The tower must be in the upright position and secured when boat is operated or when towed. Check clearance height around docks, shore, overhanging objects, bridges and power lines. The tower must not be used as a tie-down or tie-off point.

Lowering Tower

Lowering tower may be useful for storing the boat or for bridge clearance, on the water, at low speeds.

⚠ CAUTION To avoid injury, never lower the tower alone. Ask someone to hold the tower for manipulation.

EQUIPMENT

To lower the tower, proceed as follows:

1. Have someone to support the tower front section.
2. On LH side of tower, turn the handle 3/4 turn **COUNTERCLOCKWISE** to the unlock position.

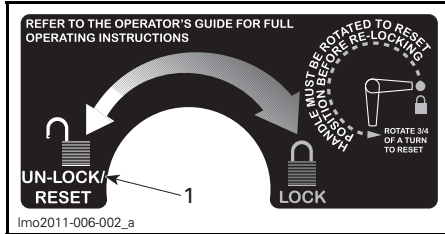

1. UNLOCK/ RESET position (port side)

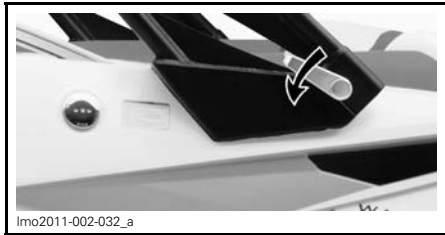

TURN HANDLE 3/4 TURN COUNTERCLOCKWISE (PORT SIDE)

3. On RH side of tower, turn the handle 3/4 turn **CLOCKWISE** to the unlock position.

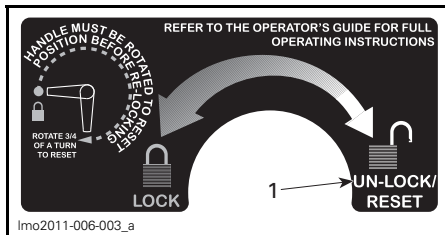

1. UNLOCK/ RESET position (starboard side)



TURN HANDLE 3/4 TURN CLOCKWISE (STARBOARD SIDE)

4. Carefully lower and hold tower.

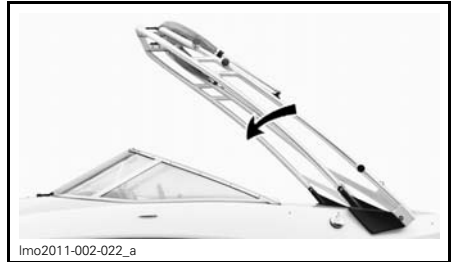

TYPICAL - LOWERING TOWER

NOTE: Use the holder brackets and knobs (provided with the boat) to secure tower in position.

5. Insert and secure hook end of the holder bracket into the tower mount of the boat.

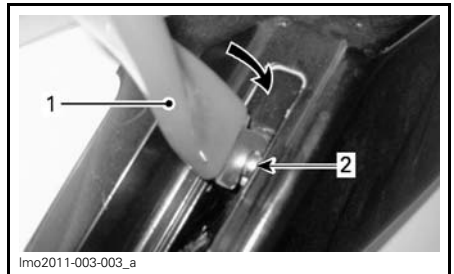

BRACKET HOOK IN TOWER MOUNT

1. Bracket hook
2. Tower mount pin

6. Secure the other end of bracket to tower leg end with the knob.

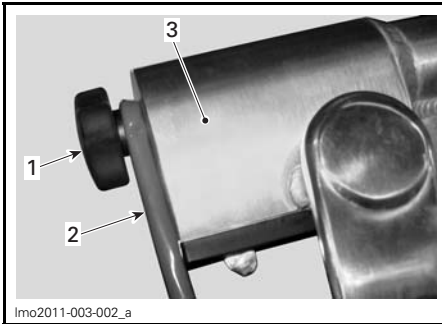

1. Knob
2. Holder bracket (upper end)
3. Tower leg end

NOTE: For holder bracket with 2 holes, use the upper hole.

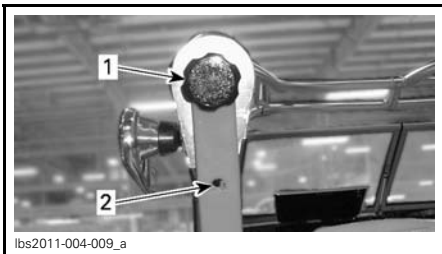

1. Upper hole (for knob location)
2. Lower hole

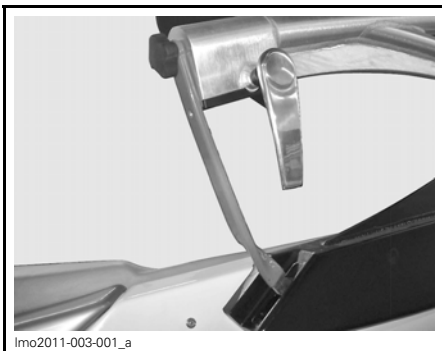

HOLDER BRACKET INSTALLED

7. Proceed with the holder bracket installation on the other side.

NOTICE When tower is folded down, always use the holder bracket and do not operate the boat more than 16 km/h (10 MPH). Never tow boat when tower is folded down.

Raising the Tower

The tower must be in the upright position when trailering boat or when riding.

Have someone to support the tower front section.

1. Remove tower support brackets from tower.
2. On both side of tower, confirms the handle is in the unlock position. If not, handle must be rotated to RESET position before re-locking the tower.

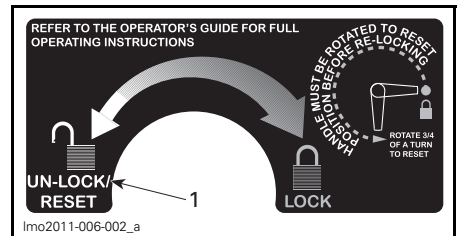

1. UNLOCK/RESET position (port side)

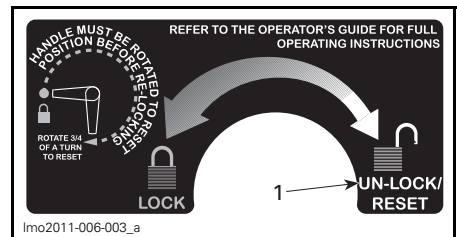

1. UNLOCK/RESET position (starboard side)

3. Raise the tower to its highest position.



lmo2011-002-022_b

TYPICAL - RAISING TOWER

- On both sides of tower, turn handle 3/4 of a turn to the LOCK position.

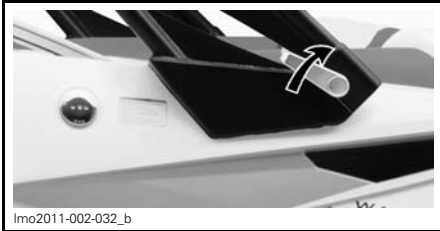

lmo2011-002-032_b

PORT SIDE - TURN HANDLE 3/4 TURN CLOCKWISE TO LOCK



lmo2011-002-029_d

STARBOARD SIDE - TURN HANDLE 3/4 TURN COUNTERCLOCKWISE TO LOCK

⚠ CAUTION Make sure to latch properly both sides of the tower before operating or towing the boat.

20) Heating System

230 Wake Only

This boat is equipped with a closed-loop heating system that can be used when the engines are running to heat-up cockpit area or recreational activities users when needed.

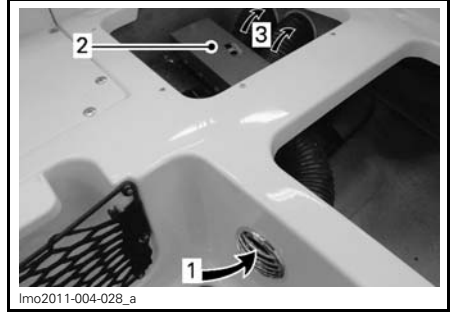

lmo2011-004-028_a

- Air inlet
- Air heater
- Air outlet

NOTICE Using the heating system fan for a prolonged time when the engines are not running will discharge the battery.

On the passenger's side, it is possible to stretch the heating duct for multi-purpose usage.

Gently pull on the heating duct grill to stretch.

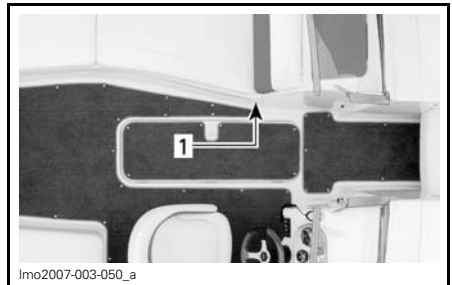

lmo2007-003-050_a

PASSENGER'S SIDE

- Multi-purpose heating duct



lmo2011-004-029_a

PASSENGER'S SIDE

1. Adjustable heating duct
2. Heating duct stretched

21) Ballast System**230 WAKE Only****To Fill**

NOTE: Boat must be in water to fill ballast bags.

NOTICE Ensure to remove all items in ballast compartments before filling ballast bags.

1. Open thru-hull valve(s) (port and/or starboard) located in the engine compartment.

NOTE: Handle will be in the vertical position when valve is open.

NOTICE Failure to open valve will cause damage to the pump components.

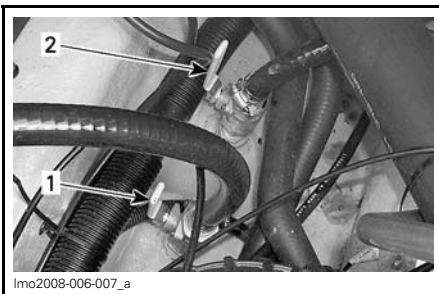

lmo2008-006-007_a

THRU-HULL VALVES — OPEN POSITION

1. Starboard bag
2. Port bag

Open the side storage compartments and monitor ballast bags while filling.

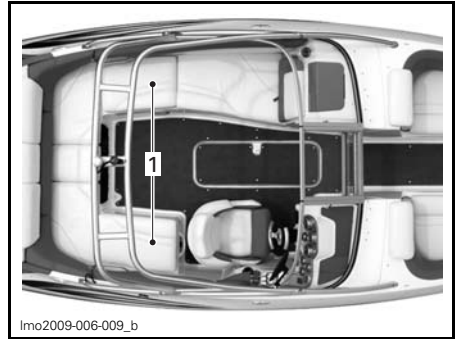

lmo2009-006-009_b

1. Side storage compartments
2. Select PORT or STARBOARD ballast switch on RH side of driver's console or underneath driver's armrest (depending on the model).
3. Select FILL position on ballast switch. Bag takes approximately 5 to 7 minutes to fill.

The bag is full when water evacuates from the ballast vent fitting located overboard on the PORT or STARBOARD side of the boat.

NOTICE It is always a good practice to monitor ballast bag filling and stop pump before it comes out from ballast vent fitting. Stop pump when you visually see that the ballast bag is full.

NOTICE While filling, in the event of ballast system leakage, the bilge pump will start to evacuate water from bilge automatically. To avoid having both pumps working against each other for a long period of time, we recommend watching for this matter. If a leak occurs, stop the ballast pump immediately and close the thru-hull valve. Detect and repair leak before using the system again.

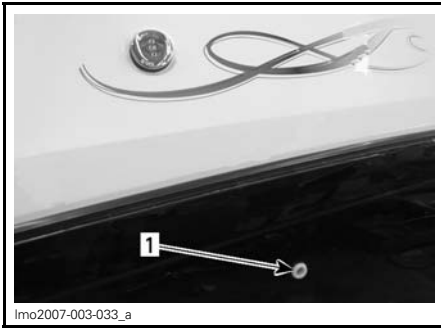
**TYPICAL**

1. Ballast vent fitting

4. Select the middle position on ballast switch when the ballast bag is full or filled to the desired level.

Repeat the same procedure for the other ballast bag.

NOTE: It is not necessary to close the engine compartment thru-hull valve once the system is full.

To Empty

1. Ensure thru-hull valves located in the engine compartment are in the open position.

NOTE: Handles will be in the vertical position when valves are opened.

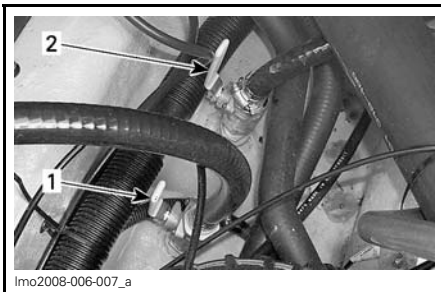
**THRU-HULL VALVES — OPEN POSITION**

1. Starboard bag
2. Port bag
2. Select PORT or STARBOARD ballast switch on RH side of driver's console or underneath driver's armrest (depending on the model).

3. Select EMPTY position on ballast switch. There is a noticeable tone different and some air bubbles will be present once the bag is empty.

4. Close thru-hull valve.

Repeat the same procedure for the other ballast bag.

NOTICE Closing of this valve is highly recommended when system is not in use. In the case of component failure, it prevents water from being taken on and possibly causing serious damage to the boat.

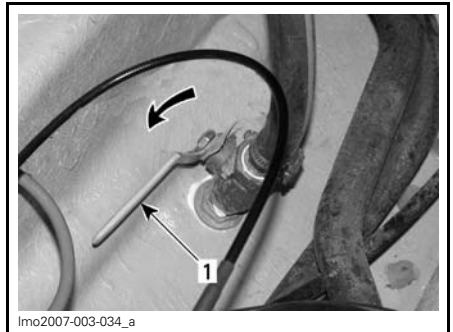
**TYPICAL — THRU-HULL VALVE**

1. Closed position

! WARNING

Never tow a boat with water remaining in the ballast bags. The weight of ballast increases the load on the trailer, the axle, and the tires, which could lead to premature wear or failure. This also contributes to reduce the stability of your boat on the road by raising the center of gravity of the trailer. Always completely empty the ballast bags before trailering.

To Flush

Both ballast bags should be flushed every time the boat is used on another stretch of water.

Use the following procedure to flush the ballast system.

1. Safely secure the boat on the trailer.
2. Ensure thru-hull valves located in the engine compartment are closed.

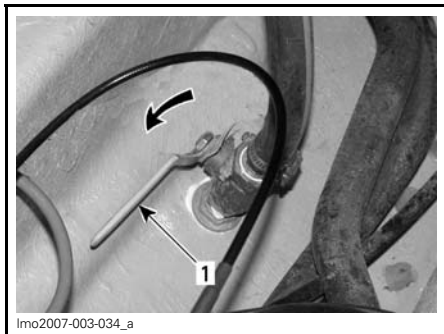

TYPICAL — THRU-HULL VALVE

1. Closed position

3. Using a garden hose with a spray nozzle, fill ballast bags. Hold the nozzle firmly against the ballast vent fitting and add water until the bag is full.

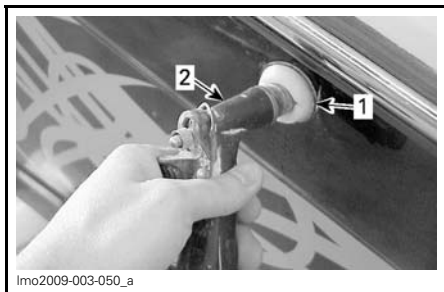

1. Ballast vent fitting
2. Spray nozzle

NOTE: Each ballast bag has a vent fitting located on its respective side of the hull.

4. When the ballast bags are full, open thru-hull valves.
5. Select EMPTY position on ballast switch.

6. Select OFF position on ballast switch when no more water flows out from underneath of hull.
7. Close thru-hull valve.

Repeat the procedure if necessary.

22) Bimini Top

If so Equipped

The bimini top is convenient for protection against inclement weather or sunshine.

! DANGER

- Exhaust fumes from engines contain deadly carbon monoxide gas (CO).
- Boat with bimini top are most likely to collect fumes.
- CO sickness symptoms include headache, nausea and dizziness. Do not mistake for seasickness.

! WARNING

- Avoid body contact with bimini top.
- Hold down straps are under tension.
- Do not use bimini top as a support.
- Do not use bimini top at speeds exceeding 56 km/h (35 MPH), otherwise top can break or dislodge causing a risk of personal injury or interference with boat operation.

Opening Bimini Top

Unzip cover and remove. Store cover in a storage area.

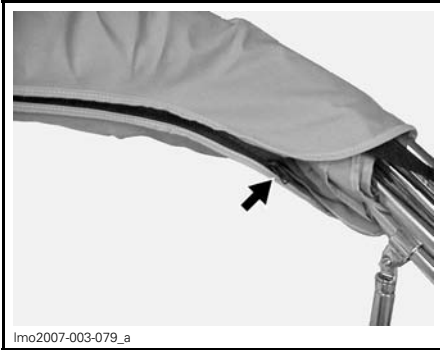

UNZIP COVER

Detach straps from bimini top frame.

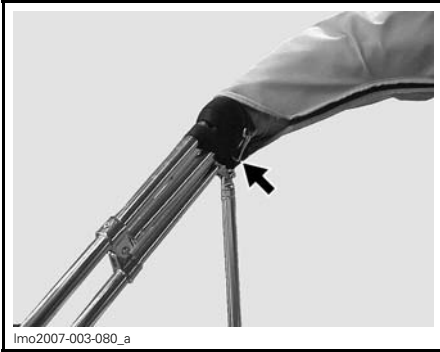

DETACH STRAPS

Lift bimini top to vertical position.
Unfold support poles from bimini top frame and secure them using pole brackets on body of boat.

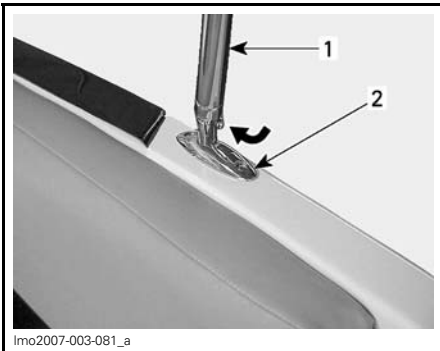

PUSH AND LOCK IN PLACE

1. Support pole
2. Pole bracket

Pull canvas towards the front of the boat and fasten straps to eyelets on body of boat.

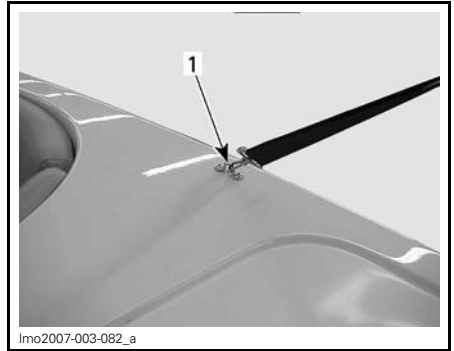

1. Hook strap to body eyelet

Adjust strap tension as needed.

Closing Bimini Top

NOTE: If canvas of bimini top has been splashed by salt water, rinse canvas with cold fresh water. At any time when canvas is wet, let dry before installing cover and storage.

Unhook front straps and fold front portion of bimini top towards the rear of the boat.

If you want to completely lay down the bimini top on the boat, detach support poles from their brackets and fold poles towards bimini top frame.

NOTE: Additional shorter support poles are provided with the boat if a lower closed position of the bimini top is desired, simply use the appropriate poles.

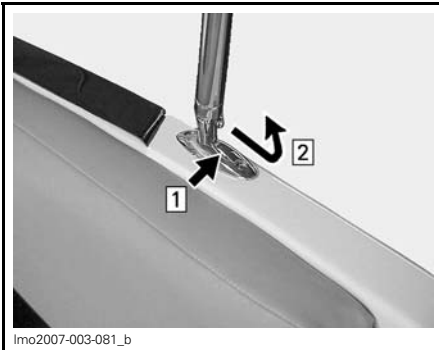

Step 1: Push on locking device
Step 2: Slide support pole out

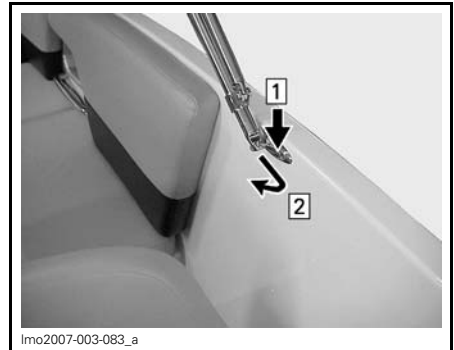

Step 1: Push on locking device
Step 2: Slide bimini top frame out

Gently lay down bimini top on boat.

Position the protective cover so that the zipper will be on the inner side of the bimini top and the starting end of the zipper will be on port side of boat.



Place bimini top straps inside cover and slowly zip while packing canvas inside cover.

NOTICE To avoid damages to the boat and/or bimini top, it is recommended to leave the bimini top supported with their supporting poles.

Removing Bimini Top from Boat

If it becomes necessary to remove bimini top from boat, proceed as follows: Detach bimini top frame at pivot point from their brackets.

With assistance, carefully lift bimini top and remove.

Installation is procedure in reverse, however, pay attention to bimini top orientation for proper positioning.

23) Cockpit Table

230 Challenger SE

Conveniently stored inside the rear storage compartment cover.

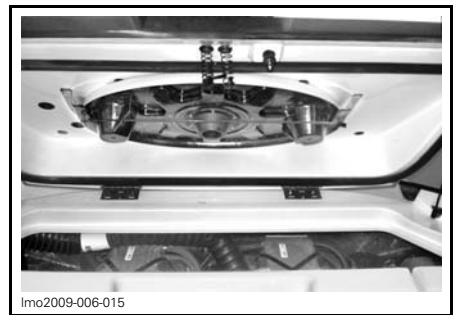

COCKPIT TABLE IN STORAGE POSITION

Release table post and place in floor receptacle. Twist gently to ensure proper fit.

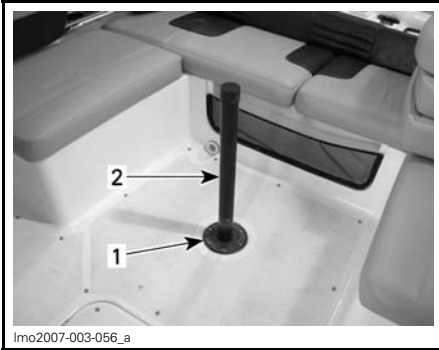

TYPICAL

- 1. Floor receptacle
- 2. Table post

Loosen bungee straps to remove table top, and install onto table post.



TYPICAL - COCKPIT TABLE INSTALLED

Close storage compartment cover.

Cockpit Table Storage

Storage of cockpit table is the reverse of installation.



24) Wakeboard Storage Rack

Convenient board racks on the tower allow you to have quick and easy access to your board.

Secure wakeboard to rack by using the elastic band.

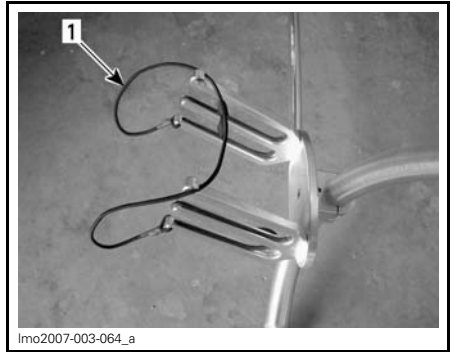

TYPICAL

- 1. Elastic band

25) Storage Nets

Located at the rear and at the front of the boat, these storage areas provide quick, easy access for additional articles.



TYPICAL

26) Windshield

For your convenience, a windshield is provided to divert the air flow.

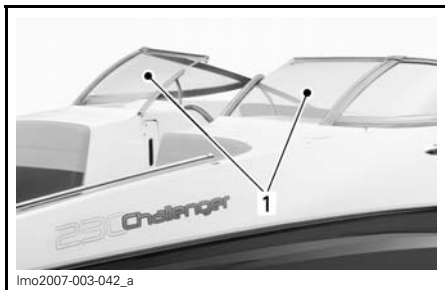

1. Windshield

BREAK-IN PERIOD

Operation During Break-In

NOTICE Carefully follow the instructions in this section. Failure to do so may reduce the life and/or performance of the engines.

A break-in period of 10 hours is required for each engine before continuous operation at full throttle.

To achieve a good break-in, a maximum of 3/4 throttle should be observed, however, brief acceleration and speed variations contribute to a good break-in.

NOTICE Continued wide open throttle runs and prolonged cruising without speed variations should be avoided. This can cause engine damage during the break-in period.

OPERATING INSTRUCTIONS

⚠ WARNING

Always perform *PRE-RIDE INSPECTION* before operating the boat. Become thoroughly familiar with all controls and the function of each. Should any control or instruction be not fully understood, refer to an authorized Sea-Doo Boats dealer.

Launching/Loading

NOTICE Before launching the boat, ensure the main battery cut-off switch is turned ON and the bilge plugs are fully screwed into place.

When finished loading the boat on trailer, turn the main battery cut-off switch to OFF.

Remove bilge plugs to drain bilge when boat is on trailer.

Boarding the Boat

As with any boat, boarding should be done carefully and engines must not be running.

⚠ WARNING

Engines must be OFF when boarding the boat or when using the swim platform.

NOTICE Never use propulsion system as a supporting point to board the boat.

Boarding from a Dock

When boarding from a dock, use the swim platform to climb aboard.



TYPICAL

NOTICE Although the boat requires only 30 cm (1 ft) of water to float, the engines should be started with at least 90 cm (3 ft) of water below the hull. If the depth of the water is less than 90 cm (3 ft) and the engine is running, the impeller is turning and debris can be drawn from the bottom and damage the propulsion system.

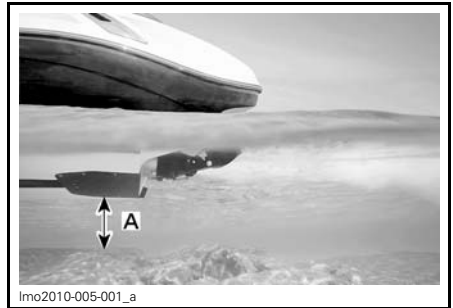

TYPICAL

A. 90 cm (3 ft)

Boarding from Shallow Water

In shallow water, board the boat from either the front or the rear using ladders.

Ensure there is at least 90 cm (3 ft) of water underneath the lowest rear portion of the hull.

Take into account that the hull will be lower in the water when all passengers are aboard. Be certain to maintain the specified depth so sand, pebbles and rocks will not be drawn up in the jet pump.

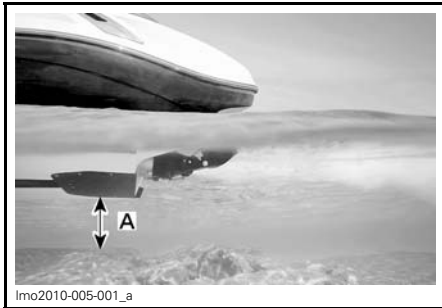

TYPICAL
A. 90 cm (3 ft)

NOTICE Starting the engine or riding the boat in shallower water may damage the impeller or other jet pump components.

Boarding from Deep Water

WARNING

Inexperienced riders should practice how to get aboard close to shore first before venturing into deep water.

WARNING

Engines should not be running while boarding. Never use propulsion components as a supporting point to board the boat.

- Swim to the rear of the boat.
- Release the retractable ladder, pulling ladder out and down into boarding position.
- Climb the ladder and pull yourself upward using the swim platform grab handles.

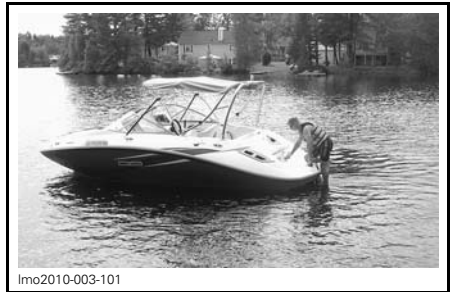

TYPICAL

When you can reach the engine cover grab handle, grip it and continue to pull yourself upward to place your knee on the swim platform.



TYPICAL

Continue to climb on engine cover to reach the deck.



TYPICAL

NOTE: The last boarded person must secure the ladder using the retaining latch prior to reach its seat.

NOTICE Do not leave ladder hanging when operating the boat. Before operating the boat, always fasten the ladder in place using the latch.

⚠ WARNING

Do not start engines until all passengers are properly seated.

Starting the Engine

NOTE: Before starting engines for the first time during the day, perform the complete pre-ride inspection as described in *PRE-RIDE INSPECTION*.

Open the engine compartment cover and ensure engine compartment is free of gasoline vapor odors.

⚠ WARNING

If any leaks or gasoline vapor odors are present, DO NOT start the engine and communicate with your authorized Sea-Doo Boats dealer.

1. Close the engine compartment cover.
2. Turn on bilge blower for 5 minutes then turn bilge blower switch off.

⚠ WARNING

Always activate bilge blower 5 minutes minimum before starting the engines to ventilate the bilge.

3. Attach the tether cord to you using your PFD or to a wrist strap.

⚠ WARNING

The tether cord must be attached to the operator all the time when engine is running.

4. Install the tether cord on the engine cut-off switch.

NOTE: The tether cord clip must be securely attached to the operator's PFD, clothing, arm, or leg. Be sure to attach the tether cord clip to a place where it is free of obstructions and to something that will move with the operator if he or she leaves the helm station.

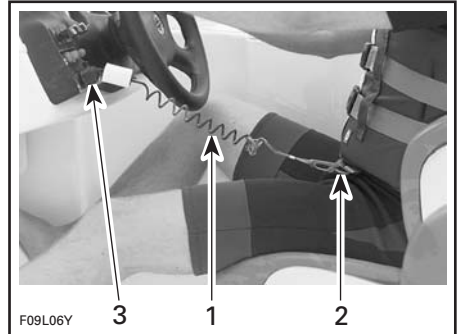
**TYPICAL**

1. Tether cord
 2. Secure tether cord clip to PFD
 3. Snap key to engine cut-off switch
5. Ensure all passengers are properly seated in accordance with the seating label. Refer to *SAFETY LABELS* section.

⚠ WARNING

Before starting the engines, the operator and passengers should always be properly seated. Do not allow swimmers and passengers to stay close to the propulsion system.

NOTICE Ensure there is at least 90 cm (3 ft) of water under the lowest rear portion of the hull when all passengers are aboard prior to starting the engine. Otherwise damage to the propulsion system may occur. Do not accelerate abruptly.

6. Ensure shifter is in neutral position and throttle lever in idle position.

7. Press and hold a start/stop button to crank the engine. Release immediately after engine is started. Start one engine at a time.

NOTICE To avoid starter motor overheating, the cranking period should not exceed 5 - 10 seconds and a rest period of 30 seconds should be observed between cranking cycles to let the starter cool down and its mechanism disengage.

8. Start the other engine by proceeding the same way as for the first engine.
9. Check tachometers to monitor engines.

Leaving the Shore

With throttle lever at idle position, move shift lever to the desired direction.

Slowly accelerate to reach deeper water. Do not apply full throttle until engine is warm.

⚠ WARNING

In shallow water, shells, sand, pebbles or other objects could be drawn up by the jet pump and thrown rearward.

Steering Operation

Turning the steering pivots the jet pump nozzles which control the boat direction. Turning the steering clockwise will turn the boat to the right and inversely.

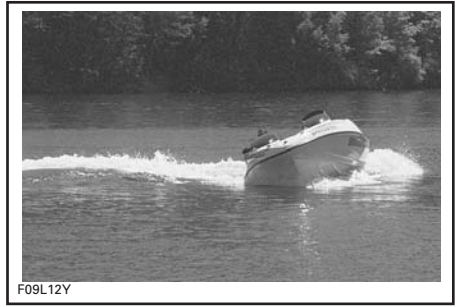

TYPICAL — RIGHT-HAND TURN

Above idle speed, the throttle must be applied to turn the boat.

⚠ WARNING

Throttle must be applied and steering turned to change the direction of the boat at speed. Steering efficiency will differ depending on the number of passengers, load and water conditions.

A jet propelled boat needs some throttle applied in order to turn. Practice in a safe area applying the throttle and turning away from an imaginary object. This is a good collision avoidance practice.

Throttle/Shifter Control Operation

When selecting the neutral or reverse position with the shifter lever, the reverse gates move up or down to the desired position.

Forward

To obtain forward:

1. Press the neutral lock detent and push shifter lever in the forward position.

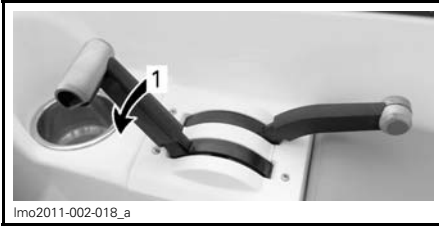
**TYPICAL**

1. Shifter lever in forward position

2. Push the throttle lever forward in order for the boat to advance.

NOTICE Do not force lever, insure throttle levers are in idle position before shifting.

Neutral

To obtain neutral, pull shifter lever to the upright position until it locks in neutral position. Reverse gates will be in the middle position, directing half of the thrust toward the front of the boat to minimize movement.

⚠ WARNING

When the shifter lever is in neutral position, the impellers are turning.

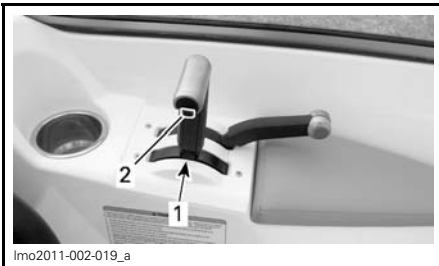
**TYPICAL**

1. Shifter lever in neutral position
2. Neutral lock detent enabled

Reverse

To obtain reverse, press the neutral lock detent and pull shifter lever completely to the rear. The reverse gates will be in downward position, directing all the thrust toward the front of the boat.

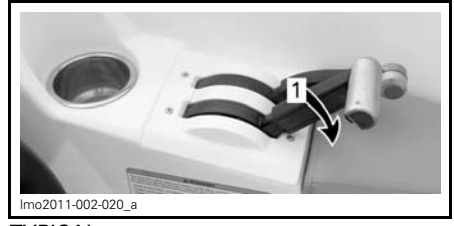
**TYPICAL**

1. Shifter lever in reverse position

NOTE: To obtain maximum efficiency and control from the reverse, increase engine speed slightly above idle. Too much RPM will create water turbulence and reduce reverse efficiency.

The boat behaves differently when using reverse. At first outing, carefully practice this maneuver away from anything with which you might collide.

⚠ WARNING

Become fully familiar with the reverse operation during your first ride and before carrying passengers.

Shutting Off the Engines

To shut off the engines, completely pull back throttle lever then remove the tether cord or press the engine Start/Stop buttons.

Always remove the tether cord from the engine cut-off switch.

⚠ WARNING

If engines are shut off, directional control is not available. Never leave the tether cord connected on the engine cut-off switch when boat is not in operation to avoid unauthorized use by children, theft or others.

General Recommendations

Rough Water or Poor Visibility Operation

Avoid operation in these conditions. If you must do so, proceed with caution and prudence using minimum speed. Turn on navigation lights if necessary.

Night Operation

Between sunset and sunrise, use the navigation lights and reduce speed.

WARNING

Navigation lights should always be used between sunset and sunrise. Ensure the stern light is installed. See *STERN LIGHT SOCKET* in this section for location and installation.

Crossing Waves

Reduce speed when crossing waves. Always be prepared to steer and balance as necessary.

When crossing wakes, always keep a safe distance from boat ahead.

WARNING

When crossing wakes, slow down. Operator and passenger(s) can brace themselves by posting. Do not jump waves or wakes.

Stopping/Docking

The boat is slowed by water drag. The stopping distance will vary depending on the boat's size, speed, water surface condition, presence and direction of wind and current.

The operator should become familiarized with the stopping distance under different conditions.

Reduce throttle speed to idle. Shift to neutral, reverse or forward as required when approaching a dock then shut off the engines just before coming alongside.

WARNING

Directional control is reduced when throttle is decreased and lost when engines are off.

When close to the dock, shut off the engines.

WARNING

While engines can be stopped by pressing the start/stop buttons, we strongly recommend the engines be stopped by removing the tether cord. This will install good habits.

Docking

The operator should also practice docking with an imaginary dock using the throttle/shifter lever. A docking mode is also available to help you during the procedure, see *DOCKING MODE* for more information.

Decrease the throttle at a sufficient distance before the expected landing area.

Reduce speed to idle.

Maneuver using the throttle/shifter lever, shifting to neutral, reverse, or forward as required.

Remember that when operating in reverse, steering direction is reversed. Turning the steering to the left will move the stern to the right when backing up, and vice-versa.

WARNING

Directional control is reduced when the throttle is decreased and lost when engines are off. Steering direction is reversed when operating the boat in reverse.

Docking Mode

This mode should be used each time you need to dock. In this mode a maximum of 3500 RPM is available when the throttle/shifter lever is moved between neutral and full throttle position. By limiting the thrust, the chance of overreacting is improved.

To select this mode:

1. Reduce throttle speed to idle.
2. Press the MODE button repeatedly until DOCKING is displayed in the information center.

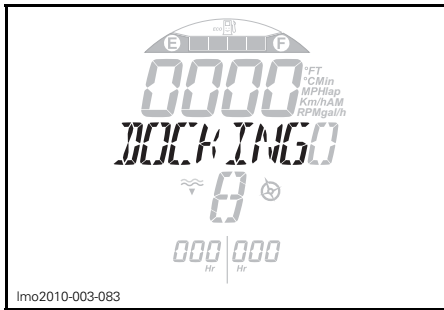

DOCKING

3. Press the SET button once, the following message will be displayed "PRESS AND HOLD SET BUTTON".
4. Press and hold the SET button until DOCKING reappears.
5. The docking mode is now activated and the information center returns to main display.

To cancel this mode:

1. Press the MODE button repeatedly until DOCKING is displayed in the information center.
2. Press the SET button once, the following message will be displayed "PRESS AND HOLD SET BUTTON".
3. Press the MODE button once. The DOCKING mode will turn OFF right after the throttle/shifter lever will be in NEUTRAL position.

NOTE: This mode is cancelled automatically when engines are turned off.

Beaching

NOTICE It is not recommended to run the boat onto the beach.

Slowly approach the beach and shut off the engines using the tether cord when water depth is 90 cm (3 ft) under the hull, then pull the boat to the beach. Ensure that all accessories are OFF.

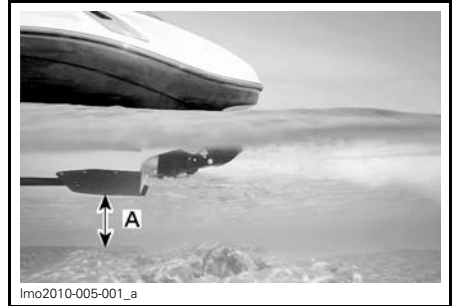

A. 90 cm (3 ft) of water under the hull

⚠ WARNING

In shallow water, shells, sand, pebbles or other objects could be drawn up by the jet pumps and be thrown rearward.

OPERATING MODES

Ski Mode

Ski Mode allows the driver to adjust launch intensity for different rider skill levels and tow sports while maintaining a constant speed. And, along with Intelligent Throttle Control (iTC), Ski Mode also makes driving easier.

The Ski Mode offers five acceleration curves with the slowest at RAMP 1 increasing to setting RAMP 5.

For each RAMP, a predetermined speed range is available.

RAMP	APPROX. SPEED
1	10 km/h to 35 km/h (6 MPH to 22 MPH)
2	15 km/h to 45 km/h (9 MPH to 28 MPH)
3	20 km/h to 55 km/h (12 MPH to 34 MPH)
4	30 km/h to 65 km/h (19 MPH to 40 MPH)
5	40 km/h to 67 km/h (25 MPH to 42 MPH)

Ski Mode Limitations

The Ski Mode is not an automatic pilot, it will not drive the boat.

Always leave your hand on the throttle and keep an eye on the water ahead. Pull back throttle to neutral to stop the boat (the Ski Mode immediately disengage setting boat control on manual).

Setting the Ski Mode

To activate the SKI MODE:

1. Press MODE button until SKI MODE is displayed.

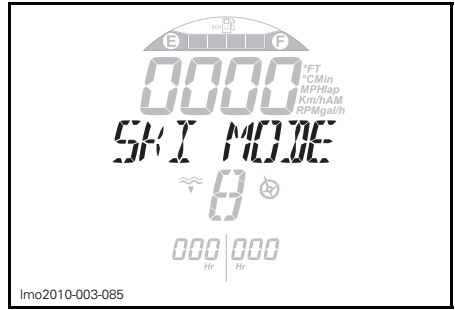

Imo2010-003-085

SKI MODE

2. Press the SET button once to enter SKI MODE. The following indications will be displayed.

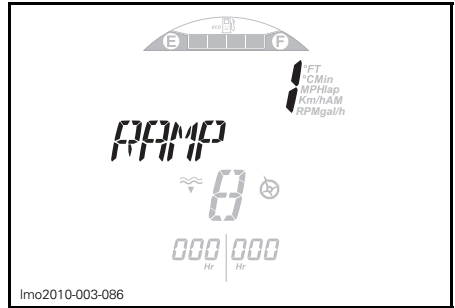

Imo2010-003-086

RAMP

3. Using the UP and DOWN switch, select the appropriate RAMP.
4. Press SET button to accept the selection.
5. Now determine the target speed using UP and DOWN switch.



Imo2010-003-087

TARGET SPEED

- Press SET button to confirm the speed. The indication SKI MODE will be displayed with the determined speed.



SKI MODE

- Press the SET button again to activate the launch sequence. At this time, the SKI MODE light blinks.

NOTE: In the launch sequence mode, 95% of throttle/shifter lever travel is available to position the boat and stretch the cord without engaging the SKI MODE.

- When everybody is ready (operator, watcher and skier or wakeboarder), push the throttle/shifter lever in full throttle position. The SKI MODE will be activated and the light turns ON.

Deactivating Temporarily the Ski Mode

To deactivate the SKI MODE temporarily, move the throttle/shifter lever in NEUTRAL position and press the MODE button to return to step 7 of SETTING THE SKI MODE. All of the throttle/shifter lever travel can be used without restriction.

The SKI MODE light will blink again and a beep will be heard every 3 seconds.

To reactivate the SKI MODE, place the throttle/shifter lever in NEUTRAL position and press the SET button to return to step 8 of SETTING THE SKI MODE.

Cancelling the Ski Mode

To cancel the SKI MODE, move the throttle/shifter lever in NEUTRAL position and press the MODE button twice.

Cruise Mode

⚠ WARNING

It is not recommended to use the CRUISE mode when pulling a tube, skier or wakeboarder. Maintain your speed manually or use the SKI MODE.

CRUISE mode is a function of iTC (Intelligent Throttle Control) system that allows to maintain a steady speed while riding the boat. It will increase or reduce engine speed as necessary.

This is useful when cruising for long distances or operating in limited speed zones.

NOTE: The boat speed may vary slightly depending on the weather or water conditions such as the wind or waves.

The CRUISE mode is designed to be used for prolonged drives on open waters.

⚠ WARNING

Improper use of the CRUISE mode can lead the boat to a loss of control.

Cruise Mode Limitations

The CRUISE mode is not an automatic pilot, it will not drive the boat.

The CRUISE mode does not anticipate for obstacles, other users, objects, etc, and will not steer or stop the boat.

Setting the Cruise Mode

NOTE: To use the CRUISE mode, the boat speed must be above approximately 10 km/h (6 MPH).

To activate the CRUISE mode:

1. Using the throttle/shifter lever, bring the boat at the speed you want to maintain.
2. Press MODE button repeatedly until CRUISE mode is displayed.

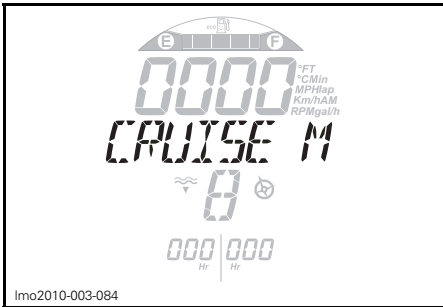

CRUISE MODE

3. Press the SET button once, the following message will be displayed "HOLD SET TO ACTIVATE OR MODE TO EXIT".
4. Hold the SET button until CRUISE mode reappears. At this time, the CRUISE light blinks and you hear one short beep.
5. Slightly move throttle/shifter lever forward until CRUISE light turns ON and activate the CRUISE mode.

Deactivating Temporarily the Cruise Mode

To deactivate the CRUISE mode temporarily, move the throttle/shifter lever backward.

To reactivate the CRUISE mode, push throttle/shifter lever in forward until the light turns ON again.

Cancelling the Cruise Mode

To cancel the CRUISE mode, move the throttle/shifter lever in NEUTRAL position and press the MODE button twice. Two short beeps will be heard.

Sync Mode

The SYNC mode is controlled by the iTC (intelligent Throttle Control). When the SYNC pilot lamp is ON, the iTC has synchronized both engines (same rpm's).

The iTC may SYNC the engines when the following parameters are achieved:

- Engines are above 3500 rpm's.
- Engines are not under acceleration or deceleration.

Some factors may prevent the SYNC mode to be active. Here is a brief list:

- Wind
- Water conditions
- Boat inputs from the drive
- Towing.

NOTE: If the iTC do not SYNC the engines, it should not be seen as a malfunction.

SPECIAL PROCEDURES

Jet Pump Water Intake and Impeller Cleaning

Water is drawn up by the impeller through these openings. The grate minimizes entry of foreign objects into the propulsion system.

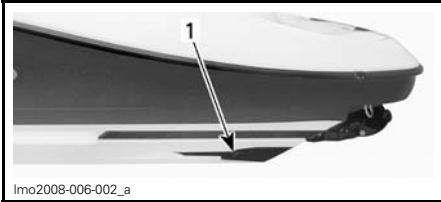

lmo2008-006-002_a

TYPICAL — BOTH SIDES

1. Intake grate

⚠ WARNING

Keep away from intake grates while engines are running. Items such as long hair, loose clothing or personal flotation device straps can become entangled in moving parts resulting in severe injury or drowning.

Weeds, shells or debris can get caught on the intake grates, drive shafts and/or impellers. A clogged water intake may cause troubles such as:

1. **Cavitation:** Engine speed is high but boat moves slowly due to reduced jet thrust; jet pump components may be damaged.
2. **Overheating:** Since the jet pump operation controls the flow of water to cool the exhaust system, a clogged intake will cause the engine to overheat and damage internal engine components.

The clogged area can be cleaned as follows:

In-water cleaning: Pull the tether cord from engine cut-off switch to stop engine(s). Let the boat stop by itself. Wait a while to allow weeds or other debris to escape from grate(s). It may be necessary to repeat the procedure.

In severe conditions if the above method does not work, the following can be performed:

1. With engine(s) running, put shifter lever in reverse position and vary throttle setting quickly several times.
2. Try accelerating again.

Most of the time, debris will escape from the propulsion system.

Out of water cleaning: If the system is still clogged, shut off the engine(s) by removing the tether cord.

⚠ WARNING

Always remove the tether cord from the engine cut-off switch to prevent accidental engines starting before cleaning the jet pumps area.

From underneath boat, manually clean water intakes area. If the system is still clogged, refer to an authorized Sea-Doo Boats dealer for servicing.

NOTICE Avoid operation in weeded areas. If unavoidable, vary speed. Weeds tend to entangle more at steady and slow speeds. Inspect water intake grates for damage. Refer to an authorized Sea-Doo Boats dealer for repair as necessary.

Towing the Boat in Water

Special precautions should be taken when towing a Sea-Doo boats in water.

Maximum recommended towing speed is 24 km/h (15 MPH).

When towing your boat in water, pinch the exhaust manifold water outlet hose on each engine with a LARGE HOSE PINCHER (P/N 529 032 500).

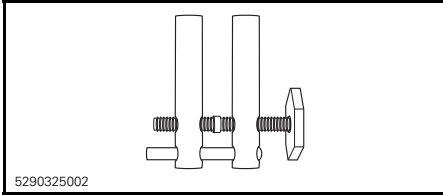

This will prevent the exhaust systems from filling which may lead to water being injected into the engines. Without the engines running there isn't any exhaust pressure to carry the water out the exhaust outlet.

NOTICE Failure to do this may result in damage to the engines. If your Sea-Doo boats must be towed in water and you do not have hose pinchers, be sure to stay well below the maximum towing speed of 24 km/h (15 MPH).

Install the hose pinchers on the exhaust manifold water outlet hoses as shown for each engine.

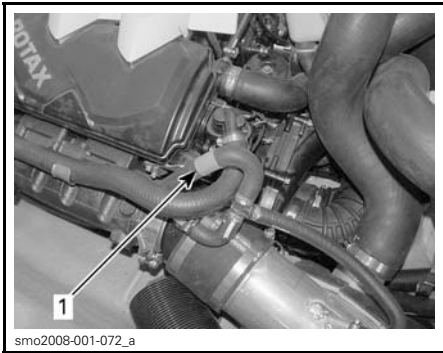

TYPICAL

1. Install hose pincher here

NOTICE When finished towing the boat, hose pinchers must be removed before operation. Failure to do so will result in engines damage.

Capsized Boat

This boat is designed so that it should not turn over easily due to its long and wide dimensions. If the boat ever capsizes, remember that it will continue to

float. It is usually best to remain with it so you will be more easily located by others.

⚠ WARNING

When boat is capsized, do not attempt to restart the engines. Operator and passengers should always wear approved personal flotation devices.

Submerged Boat and Water-Flooded Engine

To limit damages to the engines, perform the following procedure as soon as possible.

Drain bilge.

If it was submerged in salt water, spray bilge and all components with fresh water using a garden hose to stop the salt corroding effect.

NOTICE Never try to crank or start the engines. Water trapped in intake manifolds would flow towards the engines and may cause severe damage to the engines.

Bring the boat to be serviced by an authorized Sea-Doo Boats dealer as soon as possible.

NOTICE The longer the delay before you have the engine serviced, the greater the damage will be to the engines. Failure to have the engines properly serviced will cause severe engine damage.

MAINTENANCE

BREAK-IN INSPECTION

We suggest that after the first 10 hours of operation, the boat be checked by an authorized Sea-Doo Boats dealer. The break-in inspection is very important and must not be neglected.

NOTE: The break-in inspection is at the expense of the boat owner.

We recommend that this inspection be signed by an authorized Sea-Doo Boats dealer.

Date of inspection

Authorized dealer signature

Dealer name

BREAK-IN INSPECTION CHART	REPLACE				
	ADJUST				
	LUBRICATE				
	CLEAN				
	INSPECT				
ENGINE					
Engine oil and filter					X
Rubber mounts	X				
Corrosion protection			X		
EXHAUST SYSTEM					
Exhaust system fasteners, hoses and components condition. Also inspect for leaks	X				
COOLING SYSTEM					
Hose and fasteners	X				
Coolant	X				
FUEL SYSTEM					
Throttle bodies	X				
Fuel lines, connections, pressure relief valve and fuel system leak test	X				
Fuel tank straps	X				

BREAK-IN INSPECTION CHART	REPLACE				
	ADJUST				
	LUBRICATE				
	CLEAN				
	INSPECT				
AIR INTAKE SYSTEM					
Air filter	X				
ENGINE MANAGEMENT SYSTEM					
EMS sensors	X				
EMS fault codes	X				
ELECTRICAL SYSTEM					
Spark plugs	X				
Electrical connections (ignition system, starting system, fuel injectors etc.)	X				
Digitally Encoded Security System (D.E.S.S.)	X				
Main battery cut-off switch	X				
Battery support	X				
STEERING SYSTEM					
Steering cable and connections	X				
Steering nozzle bushings	X				
PROPULSION SYSTEM					
Carbon ring and rubber boot (drive shaft)	X				
Shifter system, cable and connections	X				
Impeller boot	X				
Impeller and wear ring	X				
HULL/BODY					
Windscreen and fasteners	X				
Drain plug (inside bilge). Check for obstructions	X				
Ski/wakeboard tow hook or tower and fasteners	X				

MAINTENANCE SCHEDULE

Maintenance is very important for keeping your boat in safe operating condition. Proper maintenance is the owner's responsibility. The boat should be serviced as per the maintenance schedule.

The maintenance schedule does not exempt the pre-ride inspection.

WARNING

Failure to properly maintain the boat according to the maintenance schedule can make it unsafe to operate.

The schedule should be adjusted according to operating conditions and use. Intensive use of boat will require greater frequency of inspection and maintenance.

We encourage you to have an Annual Safety Inspection of your boat.

A: ADJUST C: CLEAN I: INSPECT L: LUBRICATE R: REPLACE D: DEALER O: OPERATOR	EVERY 25 HOURS						TO BE PERFORMED BY	LEGEND
	EVERY 50 HOURS							
PART/TASK	EVERY 100 HOURS OR PRESEASON						LEGEND	LEGEND
	EVERY 200 HOURS OR 2 YEARS							
ENGINE								
Engine oil and filter				R (1)			D	(1) At storage period or after 100 hours of use whichever comes first. (2) Inspect slipping moment. (3) Every 10 hours in salt water use.
Rubber mounts			I				D	
Supercharger clutch (if so equipped)						I (2)	D	
Corrosion protection						L (3)	O	
EXHAUST SYSTEM								
Exhaust system fasteners, hoses and components condition	I			I (4)			D	(1) At storage period or after 100 hours of use whichever comes first. (4) Also inspect for leaks. (5) Daily flushing in salt water or foul water use.
Exhaust system flushing				(1) (5)			O	
COOLING SYSTEM								
Hose and fasteners				I			D	—
Coolant						R	D	
FUEL SYSTEM								
Throttle bodies				I, L (3)			O/D	(3) Every 10 hours in salt water use.
Fuel lines, connections, pressure relief valve and fuel system leak test				I			D	
Fuel tank straps				I			D	

A: ADJUST C: CLEAN I: INSPECT L: LUBRICATE R: REPLACE D: DEALER O: OPERATOR	EVERY 25 HOURS						TO BE PERFORMED BY LEGEND
	EVERY 50 HOURS						
	EVERY 100 HOURS OR PRESEASON						
	EVERY 200 HOURS OR 2 YEARS						
	PART/TASK						
ENGINE MANAGEMENT SYSTEM							
EMS sensors			I			D	—
EMS fault codes			I			D	
AIR INTAKE SYSTEM							
Air filter			I ⁽⁶⁾			D	(6) Replace if required.
ELECTRICAL SYSTEM							
Spark plugs			I	R		D	(3) Every 10 hours in salt water use. (7) Lubricate posts.
Electrical connections and fastening (ignition system, starting system, fuel injectors etc.)			I			D	
ECM and VCM connectors (visual inspection without disconnecting)			I ⁽³⁾			O	
Digitally Encoded Security System (D.E.S.S.)			I			D	
Main battery cut-off switch			I			D	
Battery support			I			D	
Battery			I, L ⁽⁷⁾			D	
Stern light connectors			L			O	
STEERING SYSTEM							
Steering cable and connections			I			D	—
Steering nozzle bushings			I			D	

MAINTENANCE SCHEDULE

A: ADJUST C: CLEAN I: INSPECT L: LUBRICATE R: REPLACE D: DEALER O: OPERATOR	EVERY 25 HOURS					TO BE PERFORMED BY LEGEND	
	EVERY 50 HOURS						
	EVERY 100 HOURS OR PRESEASON						
	EVERY 200 HOURS OR 2 YEARS						
	PART/TASK						
PROPULSION SYSTEM							
Drive shaft			L ⁽³⁾ (8)			D	(3) Every 10 hours in salt water use. (8) Lubricate for corrosion protection. (9) Inspect each month (every two weeks in salt water) and change when necessary.
Carbon ring and rubber boot (drive shaft)		I				D	
Shift system, cable and connections			I			D	
Reverse gate		L ⁽³⁾				O	
Drive shaft/impeller splines			I, L			D	
Impeller boot			I			D	
Impeller shaft seal, sleeve and O-ring			I ⁽³⁾			D	
Impeller and wear ring		I				D	
Sacrificial anode			(9)			O	
HULL/BODY							
Storage compartments covers latch(es), hinge(s), locks and cylinders			I, L ⁽³⁾			O	(3) Every 10 hours in salt water use. (10) Check for obstructions.
Windscreen and fasteners	I		I			O	
Deck drains/scupper valve			I			O	
Drain plug (inside bilge)			I ⁽¹⁰⁾			O	
Ski/wakeboard tow hook or tower and fasteners		I, L ⁽³⁾				O	

MAINTENANCE PROCEDURES

This section includes instructions for basic maintenance procedures. If you have the necessary mechanical skills and the required tools, you can perform these procedures. If not, see your authorized Sea-Doo Boats dealer.

Other important items in the maintenance schedule that are more difficult and require special tools are best performed by your authorized Sea-Doo Boats dealer.

⚠ WARNING

Turn off the engines and follow these maintenance procedures when performing maintenance. If you do not follow proper maintenance procedures you can be injured by hot parts, moving parts, electricity, chemicals or other hazards.

⚠ WARNING

Should removal of a locking device be required (e.g. lock tabs, self-locking fasteners, etc.), always replace it with a new one.

⚠ CAUTION Some components in the engine compartment may be very hot.

Throttle Body

Throttle Body Lubrication

Lubricate throttle body on each engine with XPS LUBE (P/N 293 600 016) or an equivalent.

Use the lubrication fitting located on top of engine.

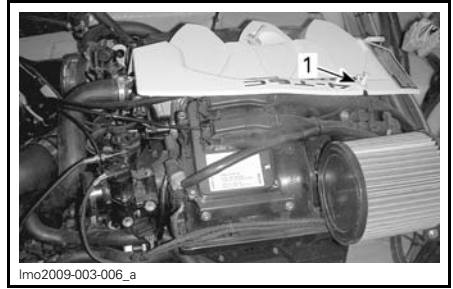

REMOVE CAP

1. Lubrication fitting

With the engine **not** running, make sure to spray lubricant at least 3 to 5 seconds for proper lubrication.

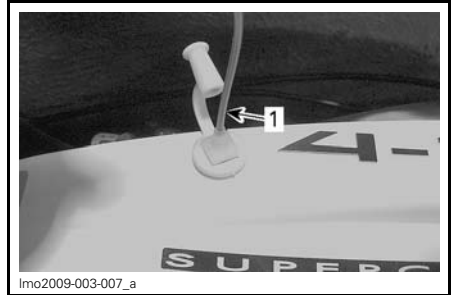

1. Can needle into lubrication fitting

Engine Oil

Recommended Engine Oil

310 HP Models

Use XPS SYNTHETIC BLEND OIL (SUMMER GRADE) (P/N 293 600 121).

NOTE: This engine has been developed and validated using the XPS™ Synthetic blend oil. BRP strongly recommends the use of its XPS Synthetic blend oil at all times.

If XPS™ engine oil is not available, use a 10W40 **mineral** engine oil compatible with wet clutches.

NOTICE NEVER use synthetic oil. This would impair the proper operation of the supercharger clutch. Do not add any additives to the recommended oil. Mineral oils (API service SM or SL) may also contain additives (friction modifiers) that may cause inappropriate slippage of the supercharger clutch and eventually lead to premature wear. Damages caused by oil which is not suitable for the engine will not be covered by the BRP limited warranty.

430 HP and 510 HP Models

Use XPS SYNTHETIC BLEND OIL (SUMMER GRADE) (P/N 293 600 121).

If XPS™ engine oil is not available, use a 10W40 mineral engine oil compatible with wet clutches.

NOTICE NEVER use synthetic oil. This would impair the proper operation of the supercharger clutch. Do not add any additives to the recommended oil. Mineral oils (API service SM or SL) may also contain additives (friction modifiers) that may cause inappropriate slippage of the supercharger clutch and eventually lead to premature wear. Damages caused by oil which is not suitable for the engine will not be covered by the BRP limited warranty.

Engine Oil Level

NOTICE Check level frequently and refill if necessary. Operating the engines with improper oil levels may severely damage engines.

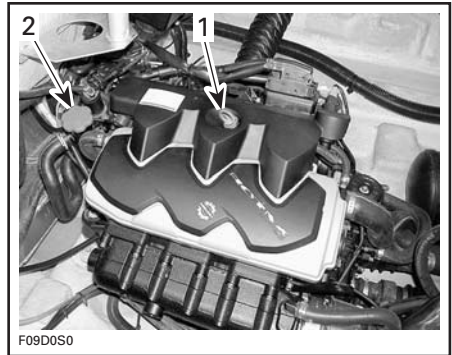

TYPICAL
 1. Dipstick
 2. Oil cap

Boat must be leveled.

Oil level can be checked either with boat in water or out of water.

If Boat is Out of the Water

If the boat is out of the water and on a trailer, block the wheels and raise the bow slightly with the trailer jack (if so equipped) until the bumper rail is level.

Install a garden hose to the flushing connector. Refer to *EXHAUST SYSTEM FLUSHING* in *MAINTENANCE PROCEDURES* and follow the procedure.

NOTICE Never run engine(s) without supplying water to the exhaust systems when boat is out of water. Failure to supply water to the exhaust systems may severely damage exhaust systems.

NOTICE Never run engine(s) longer than 2 minutes. Drive line seals has no cooling when boat is out of water.

Procedure Continuation (Boat Out or In Water)

It is of the utmost importance to follow this procedure in order to obtain an accurate reading of the engine oil level.

⚠ CAUTION Engine oil may be hot. Certain components in the engine compartment may be very hot. Direct contact may result in skin burn.

1. Ensure engine is at normal operating temperature.
2. Let engine idle for 30 seconds before stopping.
3. Stop engine.
4. **Wait at least 30 seconds.**
5. Pull dipstick out and wipe clean.

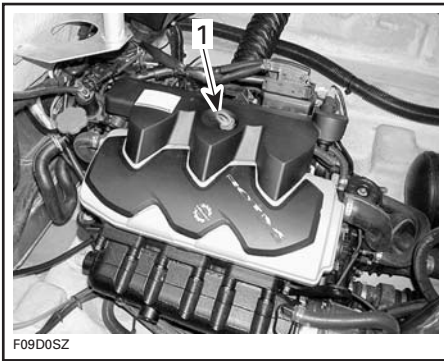

TYPICAL

1. Dipstick

6. Reinstall dipstick, push in completely.
7. Remove dipstick and read oil level. It should be between marks.

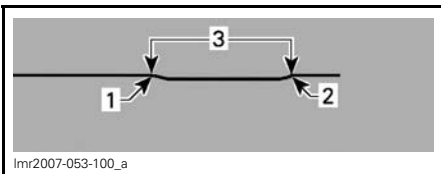

1. Full
2. Add
3. Operating range

8. If needed, add oil up to have the level between marks as required.

To add oil, unscrew oil cap. Place a funnel into the opening and add the recommended oil to the proper level.

Do not overfill.

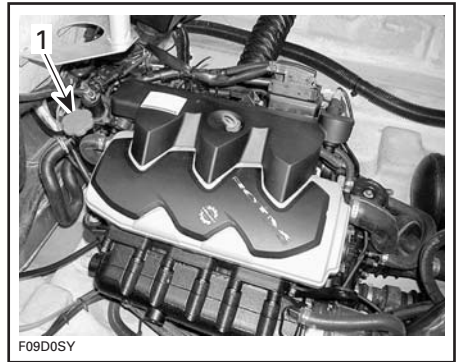

TYPICAL

1. Oil cap

NOTE: Every time oil is added in engine, the complete procedure explained above must be done. Otherwise, you will have a false oil level reading.

9. Properly reinstall oil cap and dipstick.
10. Repeat procedure for the other engine.
11. Wipe off any oil spillage.

Engine Oil Change and Oil Filter Replacement

The oil change and filter replacement should be performed by an authorized Sea-Doo Boats dealer.

Engine Coolant

Recommended Engine Coolant

Always use ethylene-glycol antifreeze containing corrosion inhibitors specifically for internal combustion aluminum engines.

NOTE: When available, it is recommended to use biodegradable antifreeze compatible with internal combustion aluminum engines. This will contribute to protecting the environment.

Cooling system must be filled with BRP PREMIXED COOLANT (P/N 219 700 362) or with a water and antifreeze solution (50% distilled water, 50% antifreeze).

To prevent antifreeze deterioration, always use the same brand. Never mix different brands unless cooling system is completely flushed and refilled. Refer to an authorized Sea-Doo Boats dealer.

Engine Coolant Level

With boat on a level surface, coolant should be between MIN. and MAX. level marks for each coolant reservoir when each engine is cold.

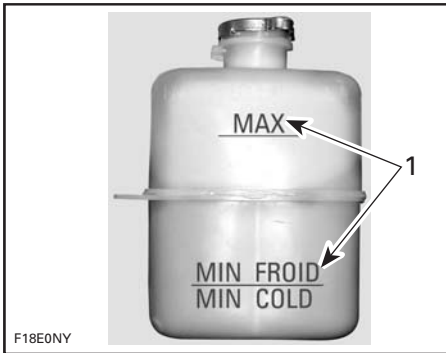

1. Level between marks when engine is cold

⚠ WARNING

Check coolant level with cold engines. Never add coolant in cooling system when engines are hot.

NOTE: The boat is considered level when it is in water. When boat is on a trailer, block the wheels and raise the bow slightly with the trailer jack (if so equipped) until the bumper rail is level.

Add coolant to have the level between marks as required. Use a funnel to avoid spillage. **Do not overfill.**

Properly reinstall and tighten filler cap.

NOTE: A cooling system that frequently requires coolant indicates leaks or engine problems. See an authorized Sea-Doo Boats dealer.

Engine Coolant Replacement

The coolant replacement should be performed by an authorized Sea-Doo Boats dealer.

Ignition Coils

Ignition Coil Installation

1. Pull rubber seal down.

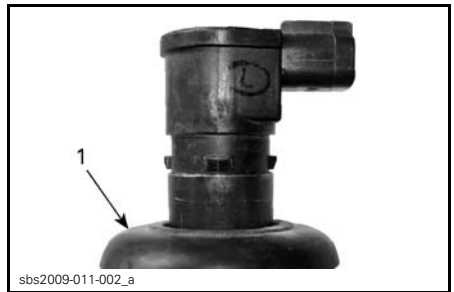

1. Rubber seal pulled down

2. Apply DOW CORNING 111 (P/N 413 707 000) to rubber seal seat as shown.

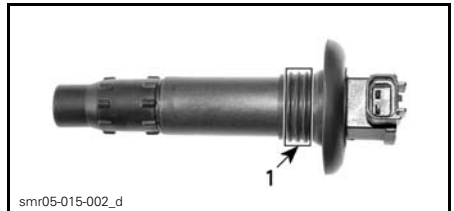

1. Apply product here

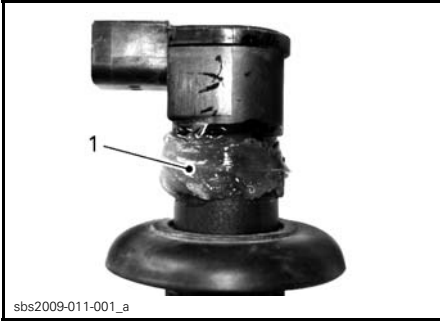

sbs2009-011-001_a

1. Apply product here

3. Pull rubber seal back on its seat making sure the tabs on the ignition coil and the slots in the seal properly match together.
4. Leave a ring of grease on top of the seal as shown to act as a water barrier. Wipe off the excess.

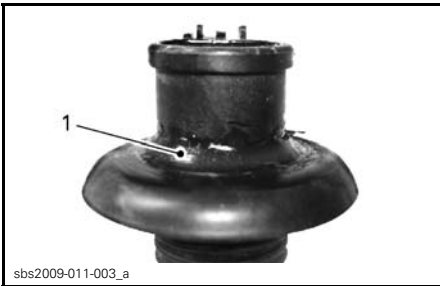

sbs2009-011-003_a

1. Correctly shaped excess of product

5. Push the ignition coil down to securely install it on the spark plug tip.
- NOTE:** Ensure the seal seats properly with the top surface of the engine.
- NOTE:** Ensure the seal seats properly with the engine top surface.
6. Reconnect ignition coil connectors.

Exhaust System

Exhaust System Flushing

Flushing the exhaust system and intercooler of each engines with fresh water is essential to neutralize corroding effects of salt or other chemical

products present in water. It will help to remove sand, salt, shells or other particles in water jackets and/or hoses.

⚠ WARNING

Perform this operation in a well ventilated area.

Proceed as follows:

1. Clean jet pump by spraying water in its inlet and outlet and then apply a coating of XPS LUBE (P/N 293 600 016) or equivalent.

⚠ WARNING

When operating the engine while the boat is out of the water, the heat exchanger in the ride plate may become very hot. Avoid any contact with ride plate as burns may occur.

2. Connect a garden hose to the connector located at the rear of boat on jet pump support. Do not open water tap at this time.



lmo2007-003-030_a

TYPICAL

1. Flushing connector

NOTE: Use an optional FLUSHING CONNECTOR ADAPTER (P/N 295 500 473) with a quick connect adapter to ease garden hose installation. No hose pincher is required to flush engine.

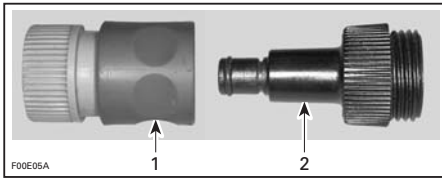

1. Quick connect adapter
2. Flushing connector adapter

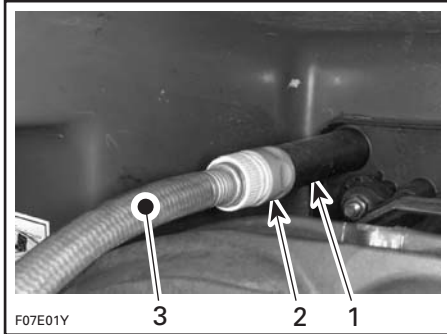

TYPICAL

1. Flushing connector
 2. Quick connect adapter and flushing connector adapter (optional, not mandatory)
 3. Garden hose
3. To flush, start engine then immediately open the water tap.

CAUTION Certain components in the engine compartment may be very hot. Direct contact may result in skin burn. Do not touch any electrical parts or jet pump area when engine is running.

NOTICE Never flush a hot engine. Always start the engine before opening the water tap. Open water tap immediately after engine is started to prevent overheating.

4. Run the engine about 20 seconds at a fast idle between 4000 - 5000 RPM.

NOTICE Never run engine without supplying water to the exhaust system when boat is out of water.

5. Ensure water flows out of jet pump while flushing. Otherwise, refer to an authorized Sea-Doo Boats dealer for servicing.

NOTICE Never run engine longer than 2 minutes. Drive line seal has no cooling when boat is out of water.

6. Close the water tap, then stop the engine.

NOTICE Always close the water tap before stopping the engine.

NOTICE Remove quick connect adapter after flushing operation (if used).

Fuses and Circuit Breakers

The electrical system is protected with fuses and circuit breakers.

To remove fuse from holder, pull fuse out. Check if filament is melted.

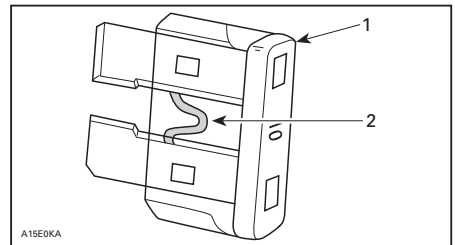

1. Fuse
2. Check if melted

If a fuse is defective, replace by one of the same rating.

NOTE: If the entire electrical system is down, make sure the main battery cut-off switch is properly turned on, refer to *CONTROLS, INSTRUMENTS AND EQUIPMENT*. If the main battery cut-off switch is ON, check the main breaker. See *MAIN BREAKER* below.

NOTICE Do not use a higher rated fuse as this can cause severe damage. If a fuse has blown, the source of malfunction should be determined and corrected before restarting. See an authorized Sea-Doo Boats dealer for servicing.

Main Circuit Breaker

The main circuit breaker is located in the engine compartment.

The main circuit breaker protects the entire electrical system except the automatic bilge pump.

The breaker can be manually opened (switched OFF) by depressing the test button.

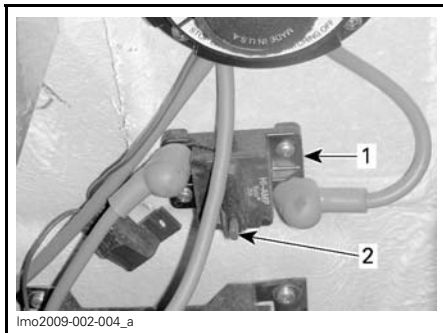

TYPICAL
 1. Main breaker
 2. Test button

If the breaker opens, it cuts the power supply. In that position the reset lever goes out of the breaker housing.

To reset an open breaker, push the reset lever back in.

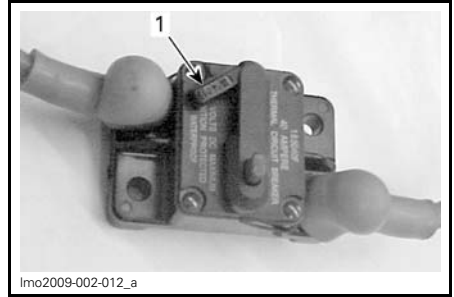

1. Reset lever in open (OFF) position

Vehicle Control Module (VCM) Fuses

Each engine has its own VCM.

Both VCM are located on the aft transom.

Refer to the fuse cover decal or the *SPECIFICATIONS* section for fuse identification.

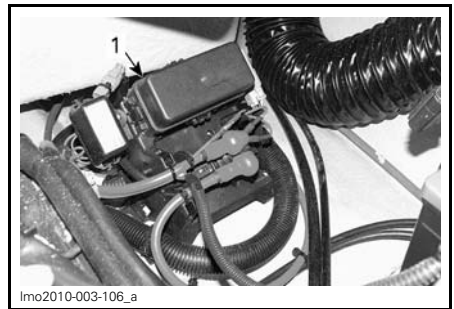

1. Fuse box

To remove a fuse cover, unlock the tabs and pull cover off.

Use the cover built-in fuse puller to pull fuses out.

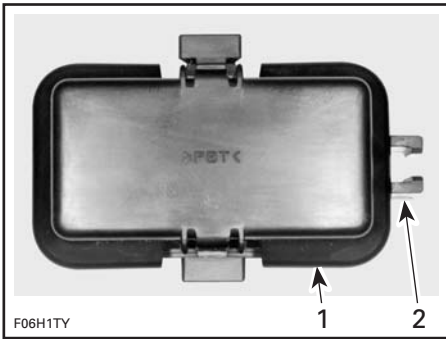

TYPICAL

1. Cover
2. Fuse puller

Circuit Breaker Panel

The circuit breaker panel is located underneath the driver console.

Refer to the inscriptions on the panel for circuit breaker identification.



1. Circuit breaker panel location



CIRCUIT BREAKER PANEL

Fuse Holders Location

Blower Motor

In engine compartment, near blower motor.

Charging System

In engine compartment, near each starter solenoid.

EFB

In engine compartment, near each starter solenoid.

Bilge Pump

Behind the main battery cut-off switch, inside the storage compartment.

Bilge Blower

Bilge Blower Operation Check

Verify bilge blower for proper operation.

Make sure that the blower ducts are not obstructed.



TYPICAL

1. Blower duct

! WARNING

If bilge blower does not operate properly, refer to an authorized Sea-Doo Boats dealer before starting the boat.

Navigation Lights

Bow and Stern Light Bulb Replacement

Unscrew lens counterclockwise and pull it out.



TYPICAL

1. Unscrew then pull

Pull bulb to remove it.



1. Pull and remove bulb

Deck Drain

The purpose of this drain is to evacuate water from the deck.

Remove any obstructions from deck drain outlet.

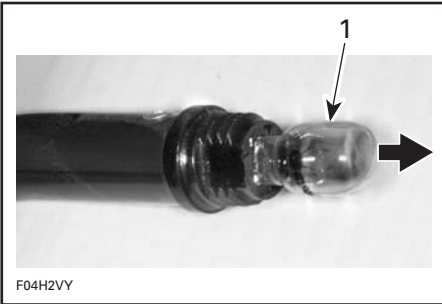

TYPICAL

1. Pull bulb out

Apply DIELECTRIC GREASE (P/N 293 550 004) on new bulb contact surface.

Assembly is the reverse of removal procedure.



TYPICAL

1. Scupper valve

Keep it clean to avoid clogging.

Deck Light Bulb Replacement



1. Gently pry here with a screwdriver

Latches and Hinges

The application of XPS LUBE (P/N 293 600 016) lubricant will help to prevent corrosion and keep proper operation of moving mechanisms.

Latches and Hinges Lubrication

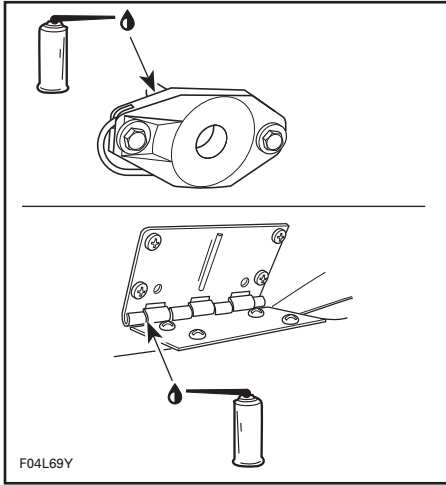

TYPICAL

Reverse Gates

Reverse Gate Lubrication

Lubricate pivot points and mechanism on both sides of each reverse gate with XPS LUBE (P/N 293 600 016) lubricant or equivalent.

Driver/Passenger Seat

Driver/Passenger Seat Lubrication

Keep a light film of grease on slide plate surfaces where the casting slides on.



TYPICAL

1. Light film of grease

Keep a light film of grease between the casting hub and the cup.

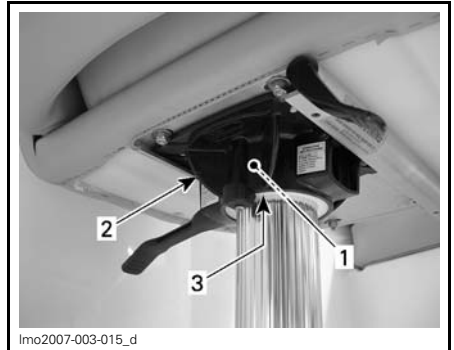

TYPICAL

1. Light film of grease

2. Casting hub

3. Cup

Periodically check and tighten the mounting nuts between the seat slide and the seat bottom.



TYPICAL

1. Mounting nuts

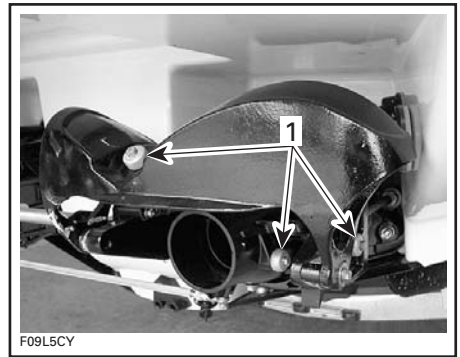

TYPICAL

1. Sacrificial anodes

Sacrificial Anodes

Sacrificial Anodes Inspection

Corrosion of metal parts, especially those exposed to saltwater, is common for boats. Corrosion can be caused by stray electric currents from shore power installations, improperly grounded AC lines and circuits, and poorly insulated DC powered equipment from boats moored nearby. Corrosion is accelerated when electric current is present.

Sacrificial anodes are attached to certain parts of this boat to reduce corrosion. The anode corrodes, rather than the part to which the anode is attached.

Change each anode when 50% by weight has corroded away.

Anodes are attached at the following locations:

- Ride shoe(s)/cooling plate(s)
- Pump housing(s)
- Reverse gate support(s)
- Steering nozzle(s)
- Reverse gate(s).

NOTICE Inspect anodes each time boat is to be launched. Do **NOT** paint anodes or apply protective coatings.

BOAT CARE

Post-Operation Care

Remove the boat from the water every day to prevent growth of marine organisms.

WARNING

Allow engine to cool before performing any maintenance.

Exhaust System Flushing

The exhaust system should be flushed daily when boat is used in salt or foul water.

Refer to *MAINTENANCE PROCEDURES*.

NOTE: On supercharged models, the intercooler is flushed at the same time.

Anticorrosion Treatment

To prevent corrosion, spray a corrosion inhibitor (salt water resistant) such as XPS LUBE (P/N 293 600 016) or equivalent over metallic components in engine compartment.

NOTE: Engine fogging should be done with XPS LUBE (P/N 293 600 016) whenever the boat is to be stored for few days or a long period.

Apply DIELECTRIC GREASE (P/N 293 550 004) (salt water resistant) on battery posts and cable connectors.

NOTICE Never leave rags or tools in the engine compartment or in the bilge.

Additional Care for Foul Water or Salt Water Use

When the boat is operated in foul water and particularly in salt water, additional care must be taken to protect the boat and its components.

Rinse trailer and boat's hull/bilge area with fresh water.

Never use a high pressure washer to clean the bilge. **USE LOW PRESSURE ONLY (such as a garden hose)**. High pressure can cause damages to electrical or mechanical systems.

NOTICE Failure to perform proper care such as: boat rinsing, exhaust system flushing and anticorrosion treatment, when used in salt water, will result in damage to the boat and its components. Never leave the boat stored in direct sunlight.

In coastal areas, special care should also be taken on stainless steel or chrome parts like grab handles, mooring cleats, fuel cap and navigation lights. Rinse with fresh water. Clean with a good car chrome polish. Protect with a good car or fiberglass wax.

Boat Cleaning and Protection

Engine Compartment Cleaning

The engine compartment should be cleaned with warm water and BRP HEAVY DUTY CLEANER (P/N 293 110 001), as required.

Unscrew the drain plug, block the wheels and raise the bow slightly with the trailer jack (if so equipped) to allow water to drain. Rinse thoroughly. Leave all compartments open to air dry.

Body Cleaning

First rinse with fresh water to remove dried salt water.

Wash the body with water and soap (only use mild detergent). Remove any marine organisms. Apply a marine wax containing no abrasive.

NOTICE Never clean fiberglass and plastic parts with strong detergent, degreasing agent, paint thinner, acetone, etc.

Apply a wax without abrasive such as silicone wax.

Carpet Cleaning

To clean the carpets, use 3M™ Citrus Base Cleaner or an equivalent. See the manufacturer's instructions.

Windshield Cleaning

Wash with BRP HEAVY DUTY CLEANER (P/N 293 110 001).

Clean only with flannel clothes.

NOTICE It is necessary to use flannel cloths on windshield to avoid damaging surface.

To remove scratches on windshield: Start with "Slip Streamer® Scratch Remover". Finish with "Slip Streamer® Cleaner and Polish".

NOTE: The later product may be used alone if only light scratches are noticeable.

NOTICE Never clean windshield with strong detergent, degreasing agent, paint thinner, acetone, products containing chlorine, etc.

Stains may be removed from seats and fiberglass with Spray Nine or the equivalent.

Stainless Steel and Chrome

To clean or polish stainless steel or chrome parts, always use a product specially develop for marine environment such as the Flitz Stainless Steel & Chrome Cleaner.

Vinyl Cleaning

Use XPS MULTI-PURPOSE CLEANER (P/N 219 701 709).

For dirt build up, let cleaner soak for approximately 10 minutes, then gently scrub with a soft bristle brush.

Refer to next table for other products that can also be used for cleaning vinyl.

Do not use any silicone-based protectants. They will extract the plasticizers, leaving the vinyl hard and brittle, and eventually cracking will occur.

RECOMMENDED PRODUCTS
1. XPS MULTI-PURPOSE CLEANER (P/N 219 701 709)
2. Dish soap (Dawn or Ivory) and water
3. Spary Nine
4. Fantastik
5. 3M Citrus Cleaner
6. 303 Protectant

NOTE: Always follow manufacturer's recommendations and instructions.

Vinyl Cleaning Recommendations for Special Stains

TYPE OF STAIN	STEP 1	STEP 2	STEP 3
Ballpoint ink *	E	B	A
Chewing gum	D	A	—
Coffee, tea, chocolate	B	—	—
Pencil	D	B	—
Grease	D	B	—
Household soil	A	B	—
Ketchup	A	B	—
Latex paint	A	B	—
Lipstick	A	B	—
Mildew or wet leaves *	C	B	A
Motor oil	B	—	—
Oil-based paint	D	B	—
Permanent marker *	E	B	C
Spray paint	B	B	—
Suntan lotion	A	B	—
Tar/asphalt	D	B	—
Yellow mustard	A	B	C
Recommended action: – A. Medium-soft brush, warm soapy water, rinse/dry. – B. XPS MULTI-PURPOSE CLEANER (P/N 219 701 709), rinse/dry. – C. One (1) tablespoon of ammonia, one-fourth (1/4) cup of hydrogen peroxide, three-fourth (3/4) cup of water, rinse/dry. – D. Wipe or scrape off excess (chill gum with ice before hand). – E. Denatured alcohol, rinse/dry.			

* Suntan lotion, tree pollen, wet leaves and some other products can contain dyes that stain permanently.

All cleaning methods must be followed by a thorough rinse with warm water.

Certain household cleaners, powdered abrasives, steel wool and industrial cleaners can cause damage and dis-

coloration and are not recommended. Dry cleaning fluids and lacquer solvents should not be used as they will remove printed pattern and gloss. Waxes should be used with caution as many contain dyes or solvents that can permanently damage the protective coating.

Please contact G&T industries "Marine Specialties Group" hot line at 1 800 318-2887 for any cleaning and care questions.

Corrosion Protection

Protect engine compartment metallic parts from corrosion using XPS LUBE (P/N 293 600 016) or an equivalent.

STORAGE

It is recommended that the boat be taken to an authorized Sea-Doo Boats dealer for proper storage but the following operations can be performed by you with a minimum of tools.

NOTE: Leave drain plug out during storage period.

NOTICE Do not run the engines during the storage period.

Jet Pump Cleaning

Clean jet pump by spraying water in its inlet and outlet and then apply a coating of XPS LUBE (P/N 293 600 016) or equivalent.

⚠ WARNING

Always remove tether cord cap from engine cut-off switch to prevent unexpected engine starting before cleaning the jet pump area. Engine must not be running for this operation.

Fuel System Protection

BRP FUEL STABILIZER (P/N 413 408 600) (or equivalent), can be added in fuel tank to prevent fuel deterioration and fuel system gumming. Follow stabilizer manufacturer's instructions for proper use.

NOTICE It is highly recommended to add fuel stabilizer at storage in order to maintain fuel system in good condition.

Throttle Body Lubrication

Lubricate throttle body of each engine. Refer to *MAINTENANCE PROCEDURES* for details.

Engine Oil and Filter Replacement

The oil change and filter should be performed by an authorized Sea-Doo Boats dealer.

Intercooler Draining

510 HP Models

It is important to expel any trapped water that may have accumulated from condensation in the intercooler of each engine.

Proceed as follows:

1. Open the engine cover.
2. Ensure there is an alignment line drawn on the intercooler outlet hose. This will ensure the hose is not twisted or kinked on reinstallation.
3. Loosen the clamp retaining the intercooler outlet hose.
4. Remove the intercooler outlet hose from the intercooler.

NOTE: This hose feeds the inlet of the supercharger.

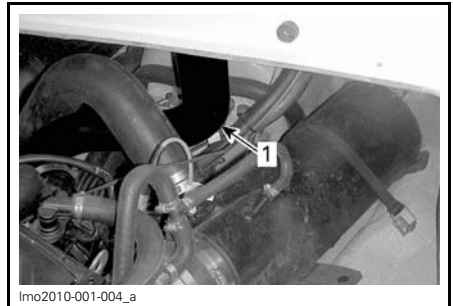

1. Intercooler outlet hose

5. Start and rev the engine up to 4000 RPM several times.

NOTE: Prevent air intake system from aspirating foreign objects which may cause severe engine or damage.

6. Stop engine.
7. Reinstall the intercooler air outlet hose, ensure it is properly aligned as prior to removal to ensure proper engine operation.

Exhaust System Flushing

Perform procedure as described in *MAINTENANCE* section.

Exhaust System and Intercooler Protection

The exhaust system is self draining, but the intercooler (430 HP) and exhaust manifold (310 HP, 430 HP and 510 HP engines) on each engine need to be properly drained to avoid damage.

NOTE: To drain the intercooler on 510 HP models, refer to *INTERCOOLER DRAINING* after this procedure.

Using the flushing connectors on jet pump supports, inject pressurized air (around 689 kPa (100 PSI)) into system until there is no more water flowing from the jet pumps.

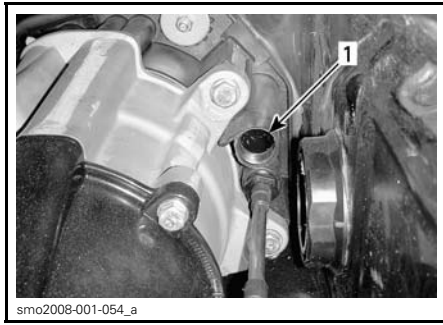

1. Flushing connector — location may differ

To ease the procedure, a custom hose can be assembled. See the following illustration.

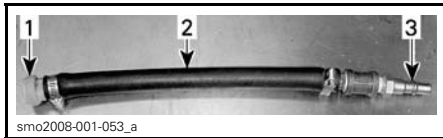

TYPICAL

1. Flushing connector adapter (P/N 295 500 473)
2. Hose 13 mm (1/2 in)
3. Air hose male adapter

NOTICE Failure to drain the exhaust system may cause severe damage to intercooler and exhaust manifold.

Engine Internal Lubrication

NOTE: Both engines must be internally lubricated for the storage period.

1. Open the engine compartment lid.
2. Remove storage tray.
3. Remove dipstick.
4. Remove engine cover.
5. Reinstall dipstick.
6. Disconnect ignition coil connectors.

⚠ WARNING

When disconnecting coil from spark plug, always disconnect coil from main harness first. Never check for engine ignition spark from an open coil and/or spark plug in the engine compartment as spark may cause fuel vapor to ignite.

IMPORTANT: Never cut the locking ties of ignition coil connectors. This would allow mixing the wires between cylinders.

7. Remove ignition coils.

NOTICE Ensure there is no dirt in coil holes before removing the spark plugs. Otherwise, dirt would fall into cylinder and will damage the internal components.

8. Remove spark plugs.

NOTE: After loosening the spark plugs, a coil may be used to remove the spark plugs. Simply bring the coil down to spark plug and “hook” it to then extract spark plug.

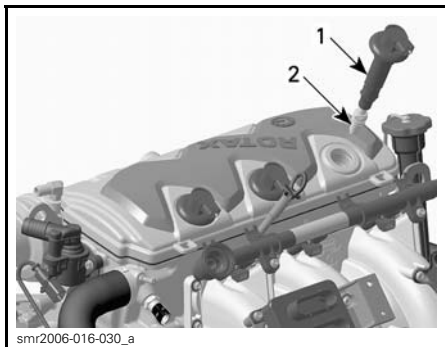

1. Ignition coil
2. Spark plug

9. Spray XPS LUBE (P/N 293 600 016) or equivalent, into spark plug holes.

NOTE: To allow engine lubrication for storage, the DROWNED MODE can be activated to prevent fuel injection and ignition while cranking in order to lubricate the cylinder walls.

Proceed as follows to activate drowned mode.

10. Ensure **both engines are OFF**.

⚠ WARNING

Both engines must be stopped when using drowned mode to lubricate the engines.

11. Install the tether cord on the engine cut-off switch.
12. Ensure the throttle/shifter lever is in the NEUTRAL position.
13. Activate the drowned mode as follows.
14. Move the throttle accelerator sensor (TAS) to the wide open throttle position (WOT).
15. Turn ignition key to ON position.

NOTE: The ECM will allow engine cranking while inhibiting fuel injection and ignition. Do not crank engine for more than 10 seconds.

16. Crank each engine a few turns to distribute the oil on cylinder walls.

NOTE: Ask a person to assist you for this operation.

17. Release TAS.
18. Turn ignition key OFF.
19. Apply LOCTITE 767 (ANTISEIZE LUBRICANT) (P/N 293 800 070) on spark plug threads then reinstall them.
20. Reinstall ignition coils. Reconnect ignition coil connectors.

NOTE: Prior to inserting the ignition coils onto the spark plugs, apply some DOW CORNING 111 (P/N 413 707 000) grease around the seal area that touches the spark plug hole. After installation, ensure the seal seats properly with the top surface of the engine.

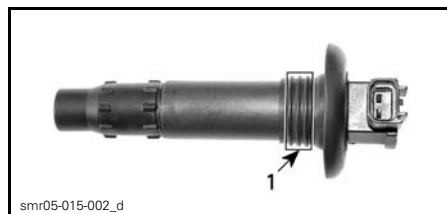

1. Apply product here

21. To reinstall engine cover, remove dipstick, push engine cover downward until it snaps.

22. Reinstall dipstick.

NOTE: It is recommended to fog the engine valves with XPS LUBE (P/N 293 600 016). Contact your authorized Sea-Doo Boats dealer.

Engine Coolant Test

If antifreeze is not replaced, test its density.

The antifreeze replacement and a density test should be performed by an authorized Sea-Doo Boats dealer.

NOTE: Antifreeze of each engine should be replaced every 200 hours or every 2 years to prevent antifreeze deterioration.

NOTICE Improper antifreeze density may allow freezing of the liquid in the cooling system if the boat is stored in an area where the freezing point is attained. This would seriously damage the engine.

Battery Removal and Storage

For battery removal, cleaning and storage, contact your authorized Sea-Doo Boats dealer.

Boat Cleaning/Repair

Wash the body and the trailer with soap and water solution (only use mild detergent). Rinse thoroughly with fresh water. Remove any marine organisms from the hull.

NOTICE Never clean apparent fiberglass and plastic parts with strong detergent, degreasing agent, paint thinner, acetone, etc.

Stains may be removed from seats and fiberglass with Knight's Spray-Nine or the equivalent.

If repairs are needed to the body or to the hull contact your authorized Sea-Doo Boats dealer. For paint touch up to mechanical parts use BRP spray paint. For minor gelcoat repairs, a Gelcote repair kit is available from Gelcote International at: www.gelcote.com.

Replace damaged labels/decals.

Once boat is on trailer, unscrew the drain plug, block the wheels and raise the bow slightly with the trailer jack (if so equipped) to allow water to drain. Clean the bilge with warm water and detergent or with bilge cleaner. Rinse thoroughly. Leave all compartments open to air dry.

Boat Protection

Apply a marine wax containing no abrasive.

The engine storage cover should be left partially opened during storage (detach the gas shocks from the cover to prevent full opening).

Remove storage tray. Place it on deck.

Using a flat screwdriver, lift tab as shown below.



TYPICAL — LIFT TAB

Detach cylinder end. Detach other side.

Block and leave engine cover lid open slightly.

This will avoid engine compartment condensation and possible corrosion.

Reattach cylinder ends to engine cover lid before operating boat.

If the boat is to be stored outside, cover it with a vented opaque tarpaulin to prevent UV (ultraviolet) rays and grime from affecting the plastic components, boat finish, as well as preventing dust accumulation.

NOTICE Never leave the boat stored in direct sunlight. UV radiation will dull finishes. The boat must never be left in water for storage.

For the storage period, block the wheels and raise the bow slightly with the trailer jack (if so equipped)

so drainage can take place. Ensure the drain plug is unscrewed and unobstructed.

PRESEASON PREPARATION

Maintenance preparation must be performed in conjunction with *PERIODIC MAINTENANCE CHART*.

Ensure to perform all tasks included in the **100 HOURS OR 1 YEAR** column.

Since technical skills and special tools are required, some operations should be performed by an authorized Sea-Doo Boats dealer.

NOTE: It is highly recommended that an authorized Sea-Doo Boats dealer perform factory campaigns in addition to the preseason preparation all at the same time.

WARNING

Only perform procedures as detailed in the *PERIODIC MAINTENANCE CHART*. It is recommended that the assistance of an authorized Sea-Doo Boats dealer be periodically obtained on other components and systems not covered in this guide.

NOTICE When component conditions seem less than satisfactory, replace using only genuine BRP parts, or approved equivalents.

TECHNICAL INFORMATION

BOAT IDENTIFICATION

The main components of the boat (hull and engines) are identified by different serial numbers. It may sometimes become necessary to locate these numbers for warranty purposes or to trace the boat in the event of theft.

Hull Identification Number

The Hull Identification Number (H.I.N.) is located on the right side of the transom.



TYPICAL

1. Hull Identification Number (H.I.N.)

Engine Identification Number

The Engine Identification Number (E.I.N.) is located on the upper crankcase on MAGNETO side of each engine.



1. Engine Identification Number (E.I.N.)

ENGINE EMISSIONS INFORMATION

Maintenance, replacement, or repair of the emission control devices and systems may be performed by any marine SI (spark ignition) engine repair establishment or individual.

Manufacturer's Responsibility

Beginning with 1999 model year engines, manufacturers of marine engines must determine the exhaust emission levels for each engine horsepower family and certify these engines with the United States of America Environmental Protection Agency (EPA). An emissions control information label, showing emission levels and engine specifications, must be placed on each boat at the time of manufacture.

Dealer's Responsibility

When performing service on all 1999 and more recent Sea-Doo Boats carrying an emissions control information label, adjustments must be kept within published factory specifications.

Replacement or repair of any emission related component must be executed in a manner that maintains emission levels within the prescribed certification standards.

Dealers are not to modify the engine in any manner that would alter the horsepower or allow emission levels to exceed their predetermined factory specifications.

Exceptions include manufacturer's prescribed changes, such as altitude adjustments for example.

Owner Responsibility

The owner/operator is required to have engine maintenance performed to maintain emission levels within prescribed certification standards.

The owner/operator is not to, and should not allow anyone to modify any engine in a manner that would alter the horsepower or allow emission levels to exceed predetermined factory specifications.

EPA Emission Regulations

All 1999 and more recent Sea-Doo boats manufactured by BRP are certified to the EPA as conforming to the requirements of the regulations for the control of air pollution from new boat engines. This certification is contingent on certain adjustments being set to factory standards. For this reason, the factory procedure for servicing the product must be strictly followed and, whenever practicable, returned to the original intent of the design.

The responsibilities listed above are general and in no way a complete listing of the rules and regulations pertaining to the EPA requirements on exhaust emissions for marine products. For more detailed information on this subject, you may contact the following locations:

MAIL:

U.S. Environmental Protection Agency
Office of Transportation and Air Quality
1200 Pennsylvania Ave. NW
Mail Code 6403J
Washington D.C. 20460

INTERNET WEB SITE:

<http://www.epa.gov/otaq/>

SPECIFICATIONS

MODELS		230 CHALLENGER
ENGINE		
Number of engines		2
Engine type		Rotax 1503 4-TEC, 4-stroke Single Over Head Camshaft (SOHC)
Exhaust system		Water cooled/water injected (opened loop). Direct flow from jet pump
Lubrication	Type	Dry sump (2 oil pumps). Replaceable oil filter. Water-cooled oil cooler
	Oil type	Refer to <i>MAINTENANCE PROCEDURES</i> section for more information
Number of cylinders		6 (3 per engine)
Displacement		1 493.8 cm ³ (91 in ³)
Induction type		Naturally-aspirated OR Supercharged intercooled
Maximum HP RPM ± 50 RPM		310 HP: 7300 430 HP and 510 HP: 8000
COOLING		
Type		Liquid cooled. Closedloop system (see also <i>EXHAUST SYSTEM</i>)
Coolant		Ethylene-glycol and distilled water (50%/50%). Use premix coolant from BRP or a coolant specially formulated for aluminum engines
ELECTRICAL		
Magneto generator output		360 W @ 6000 RPM
Ignition system type		DI (Digital Inductive)
Spark plug	Make and type	NGK, DCPR8E
	Gap	0.7 mm - 0.8 mm (.028 in - .031 in)
Starting system		Electric starter
Engine RPM limiter setting		310 HP: 7650 RPM 430 and 510 HP: 8000 RPM
Battery		Not supplied ⁽¹⁾ . 12 V group 24, marine starting battery with top-mounted, round taper type battery post

MODELS		230 CHALLENGER
ELECTRICAL (cont'd)		
Circuit breakers (panel)	CB1: Bilge pump	3 A
	CB2: Bilge blower	10 A
	CB3: Courtesy lights	3 A
	CB4: Navigation/anchor lights	3 A
	CB5: 12 Volt receptacles	10 A
	CB6: Horn	7 A
	CB7: Stereo	10 A
	CB8: Heater	10 A
	CB9: Port windshield	15 A
	CB10: Starboard windshield	15 A
Fuses (VCM)	F1: Fuel pump	10 A
	F2: Cylinder 3, ignition coil and injection	10 A
	F3: EMS	5 A
	F4: Cylinder 1, ignition coil and injection	10 A
	F5: Cylinder 2, ignition coil and injection	10 A
	F6: Gauges	2 A
Fuses (fuse holders)	Charging system	2 x 30 A
	EFB	2 x 15 A
	Blower motor	2 x 5 A
	Automatic bilge pump	3 A
	Ballast pump (Wake)	2 x 20 A

SPECIFICATIONS

MODELS		230 CHALLENGER
FUEL SYSTEM		
Fuel injection type		Multipoint Fuel Injection. Single throttle body (52 mm)
Fuel	OCTANE RATING (OPTIMUM PERFORMANCE)	
	Type	Premium unleaded gasoline
	Octane rating	Inside North America: 91 (RON + MON)/2 Outside North America: 95 RON
	MINIMUM OCTANE RATING	
	Type	Regular unleaded gasoline
	Octane rating	Inside North America: 87 (RON + MON)/2 Outside North America: 92 RON
PROPULSION		
Jet pump type		Axial flow single stage
Jet pump grease		Jet pump bearing grease (P/N 293 550 032) sold by BRP
Transmission		Direct drive
Pivoting angle of direction (nozzle)		20°
Minimum required water level for jet pump(s)		90 cm (3 ft) underneath the lowest rear portion of hull
DIMENSIONS		
Overall length		7.16 m (23.5 ft)
Beam		2.67 m (8.8 ft)
Draft		30.5 cm (1 ft)
Dead rise		21°
DIMENSIONS (ON TRAILER)		
Length (with swing-away tongue folded)		7.37 m (24.2 ft)
Width		2.67 m (8.8 ft)
Height	No tower	2.25 m (7.4 ft)
	Tower up	3.30 m (10.8 ft)

MODELS		230 CHALLENGER
WEIGHT AND LOADING CAPACITY		
Weight	230 Challenger	1 568 kg (3,457 lb)
	230 Challenger SE	1 588 kg (3,500 lb)
	230 Challenger SP	1 656 kg (3,650 lb)
	230 Wake	1 712 kg (3,774 lb)
Seating capacity		12
Load limit (passengers + luggage) (based on calm water operation)	230 Challenger/SE/SP	12 passengers OR 1 081 kg (2,383 lb)
	230 Wake	12 passengers OR 1 025 kg (2,260 lb)
Gross weight (on trailer)	230 Challenger/SE	2 374 kg (5,234 lb)
	230 Challenger SP	2 442 kg (5,384 lb)
	230 Wake	2 498 kg (5,507 lb)
CAPACITIES		
Engine oil (per engine)		3 L (3.2 qt (U.S. liq.)) oil change w/filter
Engine cooling system		5.5 L (5.8 qt (U.S. liq.)) total
Fuel tank (including reserve)		200 L (53 U.S. gal.)

⁽¹⁾ Recommended: Exide R-24-130, 12 V, 25 A•h (130 minutes reserve) or R-24-160 (160 minutes) or equivalent.

***This page is
intentionally blank***

TROUBLESHOOTING

TROUBLESHOOTING GUIDELINES

The following information is provided to help in diagnosing the probable source of simple troubles. You may be able to solve many of these problems rather quickly, but others may require the skills of a mechanical technician. In such a case, consult an authorized Sea-Doo Boats dealer for servicing.

BATTERY IS REGULARLY DISCHARGED

1. Check battery condition.
 - *Have the battery charged or replaced by an authorized Sea-Doo Boats dealer.*
2. Check charging system fuse.
 - *Replace fuse if necessary and have charging system checked by an authorized Sea-Doo Boats dealer.*

WARNING

See your authorized Sea-Doo Boats dealer to have the battery charged or replaced. Do not charge or boost the battery while installed in the engine compartment. Electrolyte is poisonous and capable of causing severe burns.

NO BEEPS ARE HEARD WHEN INSTALLING THE TETHER CORD ON ENGINE CUT-OFF SWITCH

1. Main battery cut-off switch is turned OFF.
 - *Verify and turn ON.*
2. Battery discharged.
 - *Have the battery charged or replaced by authorized Sea-Doo Boats dealer.*

ENGINE DOES NOT TURN OVER AND THE MONITORING BEEPER SOUNDS

1. Refer to *MONITORING SYSTEM* below.

ENGINE WILL NOT START

1. Tether cord removed.
 - *Install tether cord over engine cut-off switch.*
2. Engine management system does not recognize the tether cord (2 beeps are not heard when installing the tether cord).
 - *Refer to an authorized Sea-Doo Boats dealer.*
3. Burnt fuse.
 - *Check fuse(s). See an authorized Sea-Doo Boats dealer if problem is repetitive.*
4. Discharged battery.
 - *Have the battery charged or replaced by an authorized Sea-Doo Boats dealer.*
5. Battery connections, corroded or loose.
 - *Contact an authorized Sea-Doo Boats dealer.*
6. Water flooded engine.
 - *Contact an authorized Sea-Doo Boats dealer.*

ENGINE WILL NOT START (cont'd)

7. Obstructed jet pump.

- *Try to clean. Otherwise, refer to an authorized Sea-Doo Boats dealer.*

8. Faulty engine management system.

- *Refer to an authorized Sea-Doo Boats dealer.*

ENGINE TURNS SLOWLY

1. Loose battery cable connections.

- *Check/clean/tighten.*

2. Discharged or weak battery.

- *Have the battery charged or replaced by an authorized Sea-Doo Boats dealer.*

3. Bad ground(s).

- *Refer to an authorized Sea-Doo Boats dealer.*

4. Worn starter or related parts.

- *Refer to an authorized Sea-Doo Boats dealer.*

ENGINE TURNS NORMALLY BUT WILL NOT START

1. Fuel tank empty or water contaminated.

- *Refill or siphon and fill with fresh fuel.*

2. Fouled/defective spark plugs.

- *Replace.*

3. Burnt fuse.

- *Check fuse(s). See an authorized Sea-Doo Boats dealer if problem is repetitive.*

4. Water-flooded engine.

- *Refer to WATER-FLOODED ENGINE in SPECIAL PROCEDURES.*

5. Engine management system fault detected (check if engine pilot lamp is ON).

- *Refer to an authorized Sea-Doo Boats dealer.*

6. Faulty fuel pump.

- *Refer to an authorized Sea-Doo Boats dealer.*

ENGINE MISFIRES, RUNS IRREGULARLY

1. Fouled/defective/worn spark plugs.

- *Replace.*

2. Faulty ignition coil(s).

- *Contact an authorized Sea-Doo Boats dealer.*

3. Fuel: Level too low, stale or water contaminated.

- *Siphon and/or refill.*

4. Clogged injectors.

- *Refer to an authorized Sea-Doo Boats dealer.*

ENGINE MISFIRES, RUNS IRREGULARLY (cont'd)

5. Engine management system fault detected (check if engine pilot lamp is ON).
 - Refer to an authorized Sea-Doo Boats dealer.

ENGINE SMOKE

1. Oil level too high.
 - Refer to an authorized Sea-Doo Boats dealer.
2. Water ingestion, coolant leak or damaged cylinder head gasket.
 - Refer to an authorized Sea-Doo Boats dealer.
3. Internal engine damage.
 - Refer to an authorized Sea-Doo Boats dealer.

ENGINE OVERHEATING OR IMPROPER OIL PRESSURE (MONITORING BEEPER CONTINUOUSLY SOUNDS)

NOTICE If beeper continuously sounds, stop engine as soon as possible.

1. Check oil and coolant levels.
 - Refer to MAINTENANCE PROCEDURES. Refill if necessary.
2. Clogged jet pump water intake.
 - Perform the JET PUMP WATER INTAKE AND IMPELLER CLEANING PROCEDURE in SPECIAL PROCEDURES.
3. Clogged exhaust system.
 - Flush exhaust system.

NOTICE If these actions do not correct the problem, discontinue use and contact an authorized Sea-Doo Boats dealer.

ENGINE LACKS ACCELERATION OR POWER

1. Jet pump water intake clogged.
 - Clean. Refer to JET PUMP WATER INTAKE AND IMPELLER CLEANING in SPECIAL PROCEDURES section.
2. Damaged impeller or worn-out wear ring.
 - Replace. Refer to an authorized Sea-Doo Boats dealer.
3. Faulty supercharger or intercooler (255 engine).
 - Refer to an authorized Sea-Doo Boats dealer.
4. Supercharger clutch slipping.
 - Refer to an authorized Sea-Doo Boats dealer.
5. Weak spark.
 - Refer to ENGINE MISFIRES, RUNS IRREGULARLY in this section.
6. Engine management system fault detected (check if engine pilot lamp is ON).
 - Refer to an authorized Sea-Doo Boats dealer.

ENGINE LACKS ACCELERATION OR POWER (cont'd)

- 7. Clogged injectors.**
 - *Refer to an authorized Sea-Doo Boats dealer.*
- 8. Low fuel pressure.**
 - *Refer to an authorized Sea-Doo Boats dealer.*
- 9. Water in fuel.**
 - *Siphon and replace.*

BOAT CANNOT REACH TOP SPEED

- 1. Jet pump water intake clogged.**
 - *Perform the JET PUMP WATER INTAKE AND IMPELLER CLEANING PROCEDURE in SPECIAL PROCEDURES.*
- 2. Damaged impeller or worn-out wear ring.**
 - *Contact an authorized Sea-Doo Boats dealer.*
- 3. Faulty supercharger or intercooler (255 engine).**
 - *Refer to an authorized Sea-Doo Boats dealer.*
- 4. Engine management system fault detected (check if engine pilot lamp is ON).**
 - *Refer to an authorized Sea-Doo Boats dealer.*

ABNORMAL NOISE FROM PROPULSION SYSTEM

- 1. Weeds or debris jammed around impeller.**
 - *Perform the JET PUMP WATER INTAKE AND IMPELLER CLEANING PROCEDURE in SPECIAL PROCEDURES.*
- 2. Damaged impeller shaft or drive shaft.**
 - *Contact an authorized Sea-Doo Boats dealer.*

WATER FOUND IN BILGE

- 1. Drain plug(s) not tighten.**
 - *Tighten drain plugs.*
- 2. Defective scupper valve.**
 - *Refer to an authorized Sea-Doo Boats dealer.*
- 3. Exhaust system leak.**
 - *Refer to an authorized Sea-Doo Boats dealer.*
- 4. Carbon ring at drive shaft worn.**
 - *Refer to an authorized Sea-Doo Boats dealer.*

MONITORING SYSTEM

A system monitors the electronic components of the EMS (engine management system) and other components of the electrical system. When a fault occurs, it sends visual messages through the information center and/or audible signals through a beeper to inform you of a particular condition.

A fault code may also be recorded.

When a minor or transient fault occurs, the fault message and beeper will cease automatically if the condition that caused the fault does not exist anymore.

Releasing the throttle and letting the engine return to idle speed may allow normal operation to come back. If this does not work, try removing and reinstalling the tether cord on the engine cut-off switch.

The electronic system will react differently depending on the fault type. In severe failure, the engine may not be allowed to be started. In other cases, the engine will operate in limp home mode (reduced speed).

When a fault occurs, see an authorized Sea-Doo Boats dealer as soon as possible for inspection.

Beeper Code Information

BEEPER CODE ⁽¹⁾	DESCRIPTION
2 short beeps while installing tether cord on engine cut-off switch	Normal condition of D.E.S.S. Right tether cord installed correctly.
1 long beep while installing tether cord on engine cut-off switch or when pressing start/stop button	Shifter lever not in Neutral position. Move shifter to Neutral.
	Unable to read key (wrong installation or dirty key). Remove tether cord, make sure it's clean and reinstall.
	Invalid tether cord or D.E.S.S. fault. Make sure to use the proper cord for the boat. If it does not work, Contact an authorized Sea-Doo Boats dealer.
4 short beeps while pressing start/stop button with tether cord installed	Shifter is not in Neutral. Move shifter to Neutral.
1 short beep while moving shifter to neutral	Confirms that shifter is now in Neutral.
4 short beeps at different interval	tether cord has been left on its post without the engine running. Remove tether cord to prevent battery discharge.
Continuous beep	High engine coolant temperature. Refer to <i>ENGINE OVERHEATING</i> in <i>TROUBLESHOOTING GUIDELINES</i> .
	High exhaust temperature. Refer to <i>ENGINE OVERHEATING</i> in <i>TROUBLESHOOTING GUIDELINES</i> .
	Low or high engine oil pressure. Check oil level as soon as possible. If level good, discontinue use an contact an authorized Sea-Doo Boats dealer.

⁽¹⁾ Some beeper codes go with messages on the information display, refer to *CONTROLS, INSTRUMENTS AND EQUIPMENT* for details.

NOTICE If the monitoring beeper continuously sounds, stop engine as soon as possible.

***This page is
intentionally blank***

WARRANTY

BRP LIMITED WARRANTY FOR MODEL YEAR 2011 SEA-DOO® BOATS SOLD IN THE UNITED STATES AND CANADA

1) SCOPE

BRP US Inc.* ("BRP") warrants its new and unused Model Year 2011 Sea-Doo® boats ("boat") sold by authorized BRP dealers (as hereinafter defined) in the fifty United States and Canada ("dealer") from defects in material and workmanship for the period and under the conditions described below. This limited warranty will become null and void if: (1) the boat was used for racing or any other competitive activity, at any point, even by a previous owner; or (2) the boat has been altered or modified in such a way so as to adversely affect its operation, performance or durability, or has been altered or modified to change its intended use.

All genuine BRP parts and accessories, installed by an authorized BRP dealer at the time of delivery of the 2011 Sea-Doo® boat, carry the same warranty as that of the boat.

2) LIMITATIONS OF LIABILITY

THIS WARRANTY IS EXPRESSLY GIVEN AND ACCEPTED IN LIEU OF ANY AND ALL OTHER WARRANTIES, EXPRESSED OR IMPLIED, INCLUDING WITHOUT LIMITATION ANY WARRANTY OF MERCHANTABILITY OR FITNESS FOR A PARTICULAR PURPOSE. TO THE EXTENT THAT THEY CANNOT BE DISCLAIMED, THE IMPLIED WARRANTIES ARE LIMITED IN DURATION TO THE LIFE OF THE EXPRESS WARRANTY. INCIDENTAL AND CONSEQUENTIAL DAMAGES ARE EXCLUDED FROM COVERAGE UNDER THIS WARRANTY. SOME STATES/PROVINCES DO NOT ALLOW FOR THE DISCLAIMERS, LIMITATIONS AND EXCLUSIONS IDENTIFIED ABOVE, AS A RESULT, THEY MAY NOT APPLY TO YOU. THIS WARRANTY GIVES YOU SPECIFIC RIGHTS, AND YOU MAY ALSO HAVE OTHER LEGAL RIGHTS WHICH MAY VARY FROM STATE TO STATE, OR PROVINCE TO PROVINCE.

Neither the distributor, any BRP dealer nor any other person has been authorized to make any affirmation, representation or warranty regarding the product, other than those contained in this limited warranty, and if made, shall not be enforceable against BRP. BRP reserves the right to modify this warranty at any time, being understood that such modification will not alter the warranty conditions applicable to the products sold while this warranty is in effect.

3) EXCLUSIONS – ARE NOT WARRANTED

The following are not warranted under any circumstances:

- Normal wear and tear;
- Routine maintenance items, tune-ups, adjustments;
- Damage caused by failure to provide proper maintenance and/or storage, as described in the Operator's Guide;
- Damage resulting from removal of parts, improper repairs, service, maintenance, modifications or use of parts not manufactured or approved by BRP or resulting from repairs done by a person that is not an authorized servicing BRP dealer;
- Damage caused by abuse, misuse, abnormal use, neglect, racing, improper operation or operation of the boat in a manner inconsistent with the recommended operation described in the Operator's Guide;

- Damage resulting from external damage, submersion, water or foreign object ingestion, accident, fire, theft, vandalism or any act of God;
- Operation with fuels, oils or lubricants which are not suitable for the boat (see Operator’s Guide);
- Damage from rust, corrosion or exposure to the elements;
- Damage from cooling system or jet pump blockage by foreign material;
- Damage to gel coat finish including but not limited to cosmetic gel coat finish defects, blisters, starrng, crazing; and fiberglass delaminating caused by blisters, crazing, spyder or hairline cracks or exposure to the elements; and
- Incidental or consequential damages, or damages of any kind including without limitation towing, storage, telephone, rental, taxi, inconvenience, insurance coverage, loan payments, loss of time, loss of income.

4) WARRANTY COVERAGE DURATION

This limited warranty will be in effect from the date of delivery to the first retail consumer or the date the boat is first put into use, whichever occurs first and for a period of:

1. TWELVE (12) CONSECUTIVE MONTHS for private, recreational use, except that the deck and hull fiberglass structure are covered for SIXTY (60) CONSECUTIVE MONTHS.
2. FOUR (4) CONSECUTIVE MONTHS for commercial use, except that the deck and hull fiberglass structure is covered for TWELVE (12) CONSECUTIVE MONTHS. A boat is used commercially when it is used in connection with generating income or any work or employment during any part of the warranty period. A boat is also used commercially when, at any point during the warranty period, it has commercial tags or is licensed for commercial use.
3. Emission-related components that are installed on EPA certified boats registered in the USA are covered for thirty (30) consecutive months or 175 hours of engine use whichever occurs first. If the 175 hours of engine use are reached during the regular warranty coverage period, the emission-related components are still covered by BRP’s standard warranty until the end of regular coverage period.
4. The list of the current warranted emission-related components is known by your authorized BRP dealer.
5. For boats produced by BRP for sale in the state of California, that are originally sold to a resident or subsequently warranty registered to a resident in the state of California, please also refer to the applicable California Emissions Control Warranty Statement.

The repair or replacement of parts or the performance of service under this warranty does not extend the life of this warranty beyond its original expiration date.

5) CONDITIONS TO HAVE WARRANTY COVERAGE

This warranty coverage is available **only** if **each** of the following conditions has been fulfilled:

- The 2011 Sea-Doo® boat must be purchased as new and unused by its first owner from a BRP dealer authorized to distribute Sea-Doo® boats products in the country in which the sale occurred (“BRP dealer”);

- The BRP specified pre-delivery inspection process must be completed and documented and signed by the purchaser;
- The product must have undergone proper registration by an authorized BRP dealer;
- The 2011 Sea-Doo® boat must be purchased in the country in which the purchaser resides and
- Routine maintenance outlined in the Operator's Guide must be timely performed in order to maintain warranty coverage. BRP reserves the right to make warranty coverage contingent upon proof of proper maintenance.

BRP will not honor this limited warranty to any private use owner or commercial use owner if one of the preceding conditions has not been met. Such limitations are necessary in order to allow BRP to preserve both the safety of its products, and also that of its consumers and the general public.

6) WHAT TO DO TO OBTAIN WARRANTY COVERAGE

The customer must cease using the boat upon the appearance of an anomaly. The customer must notify a servicing BRP dealer within two (2) days of the appearance of a defect, and provide it with reasonable access to the product and reasonable opportunity to repair it. The customer must also present to the authorized BRP dealer, proof of purchase of the product and must sign the repair/work order prior to starting the repair in order to validate the warranty repair. All parts replaced under this limited warranty become the property of BRP.

7) WHAT BRP WILL DO

BRP's obligations under this warranty are limited to, at its sole discretion, repairing parts found defective under normal use, maintenance and service, or replacing such parts with new genuine BRP parts without charge for parts and labor, at any authorized BRP dealer during the warranty coverage period under the conditions described herein. BRP's responsibility is limited to making the required repairs or replacements of parts. No claim of breach of warranty shall be cause for cancellation or rescission of the sale of the boat to the owner.

in the event that service is required outside of the country of original sale, the owner will bear responsibility for any additional charges due to local practices and conditions, such as, but not limited to, freight, insurance, taxes, license fees, import duties, and any and all other financial charges, including those levied by governments, states, territories and their respective agencies.

BRP reserves the right to improve or modify products from time to time without assuming any obligation to modify products previously manufactured.

8) SUPPLIER WARRANTIES

Jensen+ audio components installed as original equipment on boats are warranted separately by ASA Electronics[†]. If such an audio component is installed on your Sea-Doo® boat, please contact your authorized BRP dealer for warranty coverage information and assistance.

If you cannot resolve the issue through your authorized BRP dealer, you can find all the contact information for ASA Electronics on their company website:

www.asaelectronics.com.

9) TRANSFER

If the ownership of a product is transferred during the warranty coverage period, this warranty shall also be transferred and be valid for the remaining coverage period provided that BRP is notified of such transfer of ownership in the following way:

1. The former owner contacts BRP (at the phone number provided below) or an authorized BRP dealer and gives the coordinates of the new owner; or
2. BRP or an authorized BRP dealer receives a proof that the former owner agreed to the transfer of ownership, in addition to the coordinates of the new owner.

10) CONSUMER ASSISTANCE

In the event of a controversy or a dispute in connection with this limited warranty, BRP suggests that you try to resolve the issue at the dealership level. We recommend discussing the issue with the authorized BRP dealer's service manager or owner.

If the issue has not yet been resolved, please submit your complaint in writing or call the appropriate number below:

In Canada

BOMBARDIER RECREATIONAL PRODUCTS INC.
SEA-DOO
Customer Assistance Center
75 J.A. Bombardier street
Sherbrooke QC J1L 1W3
Tel.: 819 566-3366

In USA

BRP US INC.
SEA-DOO
Customer Assistance Center
7575 Bombardier COURT
Wausau WI 54401
Tel.: 715 848-4957

*In Canada, products are distributed and serviced by Bombardier Recreational Products Inc
© 2010 Bombardier Recreational Products Inc. All rights reserved.

® Registered trademark of Bombardier Recreational Products Inc. or its subsidiaries.

+ is the trademark of its owner.

‡ is the trademark of its owner.

CALIFORNIA EMISSION CONTROL WARRANTY STATEMENT FOR MODEL-YEAR 2011 SEA-DOO® BOATS WITH 4-TEC® ENGINES OR 4-TEC® IC ENGINES

For California, your 2011 Sea-Doo® boat ("boat") has a special environmental label required by the California Air Resources Board. The label has 1, 2, 3 or 4 stars. A hangtag, provided with your boat, describes the meaning of the star rating system.

The Star Label Means Cleaner Marine Engines

The Symbol for Cleaner Marine Engines:



F18L3CQ

Cleaner Air and Water

For a healthier lifestyle and environment.

Better Fuel Economy

Burns up to 30 - 40 percent less gas and oil than conventional carbureted two-stroke engines, saving money and resources.

Longer Emission Warranty

Protects consumer for worry free operation.

One Star – Low Emission

The one-star label identifies personal watercraft, outboard, stern drive and inboard engines that meet the Air Resources Board's Personal Watercraft and Outboard marine engine 2001 exhaust emission standards. Engines meeting these standards have 75% lower emissions than conventional carbureted two-stroke engines. These engines are equivalent to the U.S. EPA's 2006 standards for marine engines.

Two Stars - Very Low Emission

The two-star label identifies personal watercraft, outboard, stern drive and inboard engines that meet the Air Resources Board's Personal Watercraft and Outboard marine engine 2004 exhaust emission standards. Engines meeting these standards have 20% lower emissions than One Star - Low-Emission engines.

Three Stars - Ultra Low Emission

The three-star label identifies engines that meet the Air Resources Board's Personal Watercraft and Outboard marine engine 2008 exhaust emission standards or the Stern drive and Inboard marine engine 2003 exhaust emission standards. Engines meeting these standards have 65% lower emissions than One Star – Low Emission engines.

Four Stars - Super Ultra Low Emission

The four-star label identifies engines that meet the Air Resources Board's Stern-drive and Inboard marine engine 2011 exhaust emission standards. Personal Watercraft and Outboard marine engines may also comply with these standards. Engines meeting these standards have 90% lower emissions than One Star – Low Emission engines.

For more information: Cleaner Watercraft – Get the Facts
1 800 END-SMOG
www.arb.ca.gov

Your Emission Control Warranty Rights and Obligations

The California Air Resources Board and BRP US Inc. ("BRP") are pleased to explain the emission control system warranty on your Model Year 2011 Sea-Doo® boat. In California, new boat engines must be designed, built and equipped to meet the State's stringent anti-smog standards. BRP must warrant the emission control system on your boat engine for the period of time listed below provided there has been no abuse, neglect or improper maintenance of your boat engine.

Your emission control system may include parts such as the fuel injection system, the ignition system and catalytic converter. Also included may be hoses, belts, connectors and other emission related assemblies.

Where a warrantable condition exists, BRP will repair your boat engine at no cost to you including diagnosis, parts and labor provided that such work is performed by an authorized BRP dealer.

Manufacturer's Limited Warranty Coverage

This emission limited warranty covers Model Year 2011 Sea-Doo® boats certified and produced by BRP for sale in California, that are originally sold in California to a California resident or subsequently warranty registered to a California resident. The BRP limited warranty conditions for Sea-Doo® boats are still applicable to these models with the necessary modifications. Select emission control parts of your 2011 Sea-Doo® boat are warranted from the date of delivery to the first retail consumer for a period of 4 years, or for 250 hours of use, whichever occurs first. However, warranty coverage based on the hourly period is only permitted for boat equipped with the appropriate hour meters or their equivalent. If any emission-related part on your engine is defective under warranty, the part will be repaired or replaced by BRP.

Parts Covered for Model Year 2011 Sea-Doo® boat Equipped with 4-TEC® Engines:

Idle Bypass Valve	Fuel Filter
Throttle Position Sensor	Intake Manifold
Intake Manifold Air Pressure Sensor	Air Box
Intake Manifold Air Temperature Sensor	Air Intake Adapter
Engine Temperature Sensor	Spark Plugs
Knock Sensor	Ignition Coils
Emission Control Module ECM	Intake and Exhaust Valve and Seals
Throttle Body	Crankcase Ventilation Valve
Fuel Rail	Throttle Body Seal
Fuel Injectors	Wire Harness and Connectors
Fuel Pressure Regulator	Intake Manifold Seal
Fuel Pump	

The emission warranty covers damage to other engine components that is caused by the failure of a warranted part. The BRP Operator’s Guide provided contains written instructions for the proper maintenance and use of your boat. All emission warranty parts are warranted by BRP for the entire warranty period of the boat, unless the part is scheduled for replacement as required maintenance in the Operator’s Guide.

Emission warranty parts that are scheduled for replacement, as required maintenance, are warranted by BRP for the period of time before the first scheduled replacement date for that part. Emission warranty parts that are scheduled for regular inspection, but not regular replacement, are warranted by BRP for the entire warranty period of the boat. Any emission warranty part repaired or replaced under the terms of this warranty statement is warranted by BRP for the remainder of the warranty period of the original part. All parts replaced under this limited warranty become the property of BRP. Maintenance receipts and records should be transferred to each subsequent owner of the boat.

Owner's Warranty Responsibilities

As the owner of a 2011 Sea-Doo® boat, you are responsible for the performance of the required maintenance listed in your Operator's Guide. BRP recommends that you retain all receipts covering maintenance your boat engine, but BRP cannot deny warranty solely for the lack of receipts or your failure to ensure the performance of all scheduled maintenance. As the owner of a Sea-Doo® boat, you should however be aware that BRP may deny you warranty coverage if your engine(s) or a part has failed due to abuse, neglect, improper maintenance or unapproved modifications. You are responsible for presenting your engine to an authorized BRP Dealer as soon as a problem exists. The warranty repairs will be completed in a reasonable amount of time, not to exceed 30 days. If you have any questions regarding your warranty rights and responsibilities or for the name and location of the nearest authorized BRP Dealer you should contact the Customer Assistance Center at 1-715-848-4957.

BRP INTERNATIONAL LIMITED WARRANTY FOR MODEL YEAR 2011 SEA-DOO® BOATS

1) SCOPE

BRP US Inc. ("BRP")* warrants its new and unused Model Year 2011 Sea-Doo® boats ("Boat") sold by authorized BRP Distributors/Dealers ("Distributor/Dealer") outside of the United States, Canada and states members of the European Economic Area (which is comprised of the states member of the European Union plus Norway, Iceland and Liechtenstein) Turkey, and states members of the Commonwealth of the Independent States ("CIS") (which is comprised of the Russian Federation and ex-members states of the USSR), will be free from defects in material and workmanship for the period and under the conditions below. This limited warranty will become null and void if: (1) the boat was used for racing or any other competitive activity, at any point, even by a previous owner; or (2) the boat has been altered or modified in such a way so as to adversely affect its operation, performance or durability, or has been altered or modified to change its intended use.

All genuine BRP parts and accessories, installed by an authorized BRP Distributor/Dealer (as hereinafter defined) at the time of delivery of the 2011 Sea-Doo® Boat, carry the same warranty as that of the Boat.

2) LIMITATIONS OF LIABILITY

THIS WARRANTY IS EXPRESSLY GIVEN AND ACCEPTED IN LIEU OF ANY AND ALL OTHER WARRANTIES, EXPRESSED OR IMPLIED, INCLUDING WITHOUT LIMITATION ANY WARRANTY OF MERCHANTABILITY OR FITNESS FOR A PARTICULAR PURPOSE. TO THE EXTENT THAT THEY CANNOT BE DISCLAIMED, THE IMPLIED WARRANTIES ARE LIMITED IN DURATION TO THE LIFE OF THE EXPRESS WARRANTIES. INCIDENTAL AND CONSEQUENTIAL DAMAGES ARE EXCLUDED FROM COVERAGE UNDER THIS WARRANTY. SOME STATES/PROVINCES DO NOT ALLOW FOR THE DISCLAIMERS, LIMITATIONS AND EXCLUSIONS IDENTIFIED ABOVE, AS A RESULT, THEY MAY NOT APPLY TO YOU. THIS WARRANTY GIVES YOU SPECIFIC RIGHTS, AND YOU MAY ALSO HAVE OTHER LEGAL RIGHTS WHICH MAY VARY FROM COUNTRY TO COUNTRY.

Neither the authorized BRP Distributor/Dealer, nor any other person has been authorized to make any affirmation, representation or warranty regarding the product, other than those contained in this limited warranty, and if made, shall not be enforceable against BRP. BRP reserves the right to modify this warranty at any time, being understood that such modification will not alter the warranty conditions applicable to the products sold while this warranty is in effect.

3) EXCLUSIONS – ARE NOT WARRANTED

The following are not warranted under any circumstances:

- Replacement of parts due to normal wear and tear;
- Routine maintenance parts and services, including but not limited to adjustments, oil, lubricant and coolant changes, spark plug replacement, water pumps and the like;
- Damage caused by improper or lack of maintenance or storage, or failure to follow the procedures and recommendations in the Operator's Guide;

- Damage resulting from removal of parts, improper repairs, service, maintenance, or modification, or use of parts or accessories not manufactured or approved by BRP, which in its reasonable judgment, are either incompatible with Boats or adversely affect its operation, performance, or durability, or resulting from repairs done by a person that is not an authorized BRP Distributor/Dealer;
- Damage caused by abuse, misuse, abnormal use, neglect, racing, improper operation or operation of the Boat in a manner inconsistent with the recommended operation described in the Operator's Guide;
- Damages resulting from external damage, submersion, water or foreign object ingestion, accident, fire, theft, vandalism or any act of God;
- Operation with fuel, oils or lubricants that are not suitable for the Boat (see Operator's Guide);
- Damage from rust, corrosion or exposure to the elements;
- Damage from cooling system or jet pump blockage by foreign material;
- Incidental or consequential damages, or damages of any kind including without limitation towing, storage, telephone, rental, taxi, inconvenience, insurance coverage, loan payments, loss of time, loss of income; and,
- Damage to gel coat finish including but not limited to cosmetic gel coat finish defects, blisters, starring, crazing; and fiberglass delaminating caused by blisters, crazing, spider or hairline cracks or exposure to the elements.

4) WARRANTY COVERAGE DURATION

This limited warranty will be in effect from the date of delivery to the first retail consumer or the date the boat is first put to use, whichever occurs first, for a period of:

- TWELVE (12) CONSECUTIVE MONTHS for private, recreational use, except for the deck and hull fiberglass structure that are covered for SIXTY (60) CONSECUTIVE MONTHS;
- FOUR (4) CONSECUTIVE MONTHS for commercial use, except for the deck and hull fiberglass structure that are covered for TWELVE (12) CONSECUTIVE MONTHS. A boat is used commercially when it is used in connection with generating income or any work or employment during any part of the warranty period. A Boat is also used commercially when, at any point during the warranty period, it has commercial tags or is licensed for commercial use.

The repair or replacement of parts or the performance of service to a Boat under this warranty does not extend the life of this limited warranty beyond its original expiration date.

5) CONDITIONS TO HAVE WARRANTY COVERAGE

This warranty coverage is available **only** if **each** of the following conditions has been fulfilled:

- The 2011 Sea-Doo® boats must be purchased as new and unused by its first owner from a BRP Distributor/Dealer authorized to distribute SEA-DOO® BOAT products in the country in which the sale occurred;
- The BRP specified pre-delivery inspection process must be completed and documented;
- The product must have undergone proper registration by an authorized BRP Distributor/Dealer;

- The 2011 Sea-Doo® boats must be purchased in the country in which the purchaser resides; and,
- Routine maintenance outlined in the Operator's Guide must be timely performed in order to maintain warranty coverage. BRP reserves the right to make warranty coverage contingent upon proof of proper maintenance.

BRP will not honor this limited warranty to any private use owner or commercial use owner if one of the preceding conditions has not been met. Such limitations are necessary in order to allow BRP to preserve both the safety of its products, and that of its consumers and the general public.

6) WHAT TO DO TO OBTAIN WARRANTY COVERAGE

The customer must notify a servicing BRP Distributor/Dealer within two (2) days of the appearance of a defect, and provide it with reasonable access to the product and reasonable opportunity to repair it. The customer must also present to the authorized BRP Distributor/Dealer, proof of purchase of the product and must sign the repair/work order prior to starting the repair in order to validate the warranty repair. All parts replaced under this limited warranty become the property of BRP.

7) WHAT BRP WILL DO

BRP's obligations under this warranty are limited to, at its sole discretion, repairing parts found defective under normal use, maintenance and service, or replacing such parts with new genuine BRP parts without charge for parts and labor, at any authorized BRP Distributor/Dealer during the warranty coverage period under the conditions described herein. BRP's responsibility is limited to making the required repairs or replacements of parts. No claim of breach of warranty shall be cause for cancellation or rescission of the sale of the boat to the owner.

In the event that service is required outside of the country of original sale, the owner will bear responsibility for any additional charges due to local practices and conditions, such as, but not limited to, freight, insurance, taxes, license fees, import duties, and any and all other financial charges, including those levied by governments, states, territories and their respective agencies.

BRP reserves the right to improve or modify products from time to time without assuming any obligation to modify products previously manufactured.

8) TRANSFER

If the ownership of a Product is transferred during the warranty coverage period, this warranty shall also be transferred and be valid for the remaining coverage period provided that BRP is notified of such transfer of ownership in the following way:

1. The former owner contacts BRP (at the phone number provided below) or an authorized Distributor/Dealer and gives the coordinates of the new owner; or
2. BRP or an authorized Distributor/Dealer receives a proof that the former owner agreed to the transfer of ownership, in addition to the coordinates of the new owner.

9) CONSUMER ASSISTANCE

In the event of a controversy or a dispute in connection with this limited warranty, BRP suggests that you try to resolve the issue at the dealership level.

If further assistance is required, the Distributor's service department should be contacted in order to resolve the matter. You will find your distributor's coordinates on www.brp.com.

If the matter still remains unresolved then contact BRP by writing to us at the address listed below.

For countries within Europe, Middle East and Africa, please contact our European office

BRP EUROPE N.V.

Customer Assistance Center
Skaldenstraat 125
9042 Gent
Belgique
Tel.: +32-9-218-26-00

For all other countries, please contact your local distributor or our North America office

BOMBARDIER RECREATIONAL PRODUCTS INC.

Customer Assistance Center
75 J.A. Bombardier Street
Sherbrooke QC J1L 1W3
Tel.: 1 819 566-3366

© 2010 Bombardier Recreational Products Inc. All rights reserved.

® Registered trademark of Bombardier Recreational Products Inc.

* For the territory covered by this limited warranty, products are distributed and serviced by Bombardier Recreational Products Inc. or its affiliates.

© 2010 Bombardier Recreational Products Inc. All rights reserved.

® Registered trademark of Bombardier Recreational Products Inc. or its affiliates.

BRP LIMITED WARRANTY FOR THE EUROPEAN AND THE RUSSIAN ECONOMIC AREA AND TURKEY: MODEL YEAR 2011 SEA-DOO® BOATS

1) SCOPE OF THE LIMITED WARRANTY

BRP US Inc. ("BRP")* warrants its new and unused model-year 2011 Sea-Doo® boats sold by authorized BRP distributors/dealers ("Distributors/Dealers") in member states of the European Economic Area ("EEA") (which is comprised of the state members of the European Union plus Norway, Iceland and Liechtenstein), in member states of the Commonwealth of the Independent States ("CIS") (which is comprised of the Russian Federation and ex-members states of the USSR), and Turkey from defects in material or workmanship for the period and under the conditions described below. This limited warranty will become null and void if: (1) the boat was used for racing or any other competitive activity, at any point, even by a previous owner; or (2) the boat has been altered or modified in such a way so as to adversely affect its operation, performance or durability, or has been altered or modified to change its intended use.

All genuine SEA-DOO® BOAT parts and accessories, installed by an authorized BRP Distributors/Dealers at the time of delivery of the 2011 Sea-Doo® boats, carry the same warranty as that of the boats.

2) LIMITATIONS OF LIABILITY

THIS WARRANTY IS EXPRESSLY GIVEN AND ACCEPTED IN LIEU OF ANY AND ALL OTHER WARRANTIES, EXPRESSED OR IMPLIED, INCLUDING WITHOUT LIMITATION ANY WARRANTY OF MERCHANTABILITY OR FITNESS FOR A PARTICULAR PURPOSE. TO THE EXTENT THAT THEY CANNOT BE DISCLAIMED, THE IMPLIED WARRANTIES ARE LIMITED IN DURATION TO THE LIFE OF THE EXPRESS WARRANTY. INCIDENTAL AND CONSEQUENTIAL DAMAGES ARE EXCLUDED FROM COVERAGE UNDER THIS WARRANTY. SOME JURISDICTIONS DO NOT ALLOW FOR THE DISCLAIMERS, LIMITATIONS AND EXCLUSIONS IDENTIFIED ABOVE, AS A RESULT, THEY MAY NOT APPLY TO YOU. THIS WARRANTY GIVES YOU SPECIFIC RIGHTS, AND YOU MAY ALSO HAVE OTHER LEGAL RIGHTS WHICH MAY VARY FROM COUNTRY TO COUNTRY.

Neither the BRP Distributor/Dealer nor any other person has been authorized to make any affirmation, representation or warranty regarding the product, other than those contained in this limited warranty, and if made, shall not be enforceable against BRP.

BRP reserves the right to modify this warranty at any time, being understood that such modification will not alter the warranty conditions applicable to the products sold while this warranty is in effect.

3) EXCLUSIONS – ARE NOT WARRANTED

The following are not warranted under any circumstances:

- Replacement of parts due to normal wear and tear;
- Routine maintenance parts and services, including but not limited to adjustments, oil, lubricant and coolant changes, spark plug replacement, water pumps and the like;
- Damage caused by improper or lack of maintenance or storage, or failure to follow the procedures and recommendations in the Operator's Guide;

- Damage resulting from removal of parts, improper repairs, service, maintenance, or modification, or use of parts or accessories not manufactured or approved by BRP, which in its reasonable judgment, are either incompatible with Boats or adversely affect its operation, performance, or durability, or resulting from repairs done by a person that is not an authorized BRP Distributor/Dealer;
- Damage caused by abuse, misuse, abnormal use, neglect, racing, improper operation or operation of the Boat in a manner inconsistent with the recommended operation described in the Operator's Guide;
- Damages resulting from external damage, submersion, water or foreign object ingestion, accident, fire, theft, vandalism or any act of God;
- Operation with fuel, oils or lubricants that are not suitable for the Boat (see Operator's Guide);
- Damage from rust, corrosion or exposure to the elements;
- Damage from cooling system or jet pump blockage by foreign material;
- Incidental or consequential damages, or damages of any kind including without limitation towing, storage, telephone, rental, taxi, inconvenience, insurance coverage, loan payments, loss of time, loss of income; and,
- Damage to gel coat finish including but not limited to cosmetic gel coat finish defects, blisters, starrng, crazing; and fiberglass delaminating caused by blisters, crazing, spider or hairline cracks or exposure to the elements.

4) WARRANTY COVERAGE PERIOD

This limited warranty will be in effect from the date of delivery to the first retail consumer or the date the product is first put into use, whichever occurs first and for a period of:

TWENTY-FOUR (24) CONSECUTIVE MONTHS for private use owners except for the deck and hull fiberglass structure that are covered for SIXTY (60) CONSECUTIVE MONTHS;

FOUR (4) CONSECUTIVE MONTHS for commercial use owners except for the deck and hull fiberglass structure that are covered for TWELVE (12) CONSECUTIVE MONTHS.

A boat is used commercially when it is used in connection with generating income or any work or employment during any part of the warranty period. A boat is also used commercially when, at any point during the warranty period, it has commercial tags or is licensed for commercial use.

The repair or replacement of parts or the performance of service under this warranty does not extend the life of this warranty beyond its original expiration date.

Note that the duration and any other modalities of the warranty coverage are subject to the applicable national or local legislation in your country.

5) CONDITIONS TO HAVE WARRANTY COVERAGE

This warranty coverage is available **only** if **each** of the following conditions has been fulfilled:

- The 2011 Sea-Doo® boats must be purchased as new and unused by its first owner from a BRP Distributor/Dealer authorized to distribute SEA-DOO® BOAT products in the country in which the sale occurred;

- The BRP specified pre-delivery inspection process must be completed and documented;
- The product must have undergone proper registration by an authorized BRP Distributor/Dealer;
- The 2011 Sea-Doo® boats must be purchased within the EEA by an EEA resident, in the CIS for residents of the countries comprised in such area and in Turkey for residents of Turkey; and
- Routine maintenance outlined in the Operator's Guide must be timely performed in order to maintain warranty coverage. BRP reserves the right to make warranty coverage contingent upon proof of proper maintenance.

BRP will not honor this limited warranty to any private use owner or commercial use owner if one of the preceding conditions has not been met. Such limitations are necessary in order to allow BRP to preserve both the safety of its products, and also that of its consumers and the general public.

6) WHAT TO DO TO OBTAIN WARRANTY COVERAGE

The customer must notify a servicing BRP Distributor/Dealer within two (2) months of the appearance of a defect, and provide it with reasonable access to the product and reasonable opportunity to repair it. The customer must also present to the authorized BRP Distributor/Dealer, proof of purchase of the product and must sign the repair/work order prior to starting the repair in order to validate the warranty repair. All parts replaced under this limited warranty become the property of BRP.

Note that the notification period is subject to the applicable national or local legislation in your country.

7) WHAT BRP WILL DO

BRP's obligations under this warranty are limited to, at its sole discretion, repairing parts found defective under normal use, maintenance and service, or replacing such parts with new genuine boat parts without charge for parts and labor, at any authorized BRP Distributor/Dealer during the warranty coverage period under the conditions described herein. BRP's responsibility is limited to making the required repairs or replacements of parts. No claim of breach of warranty shall be cause for cancellation or rescission of the sale of the boat to the owner.

In the event that service is required outside of the country of original sale, the owner will bear responsibility for any additional charges due to local practices and conditions, such as, but not limited to, freight, insurance, taxes, license fees, import duties, and any and all other financial charges, including those levied by governments, states, territories and their respective agencies.

BRP reserves the right to improve or modify products from time to time without assuming any obligation to modify products previously manufactured.

8) TRANSFER

If the ownership of a Product is transferred during the warranty coverage period, this warranty shall also be transferred and be valid for the remaining coverage period provided that BRP is notified of such transfer of ownership in the following way:

The former owner contacts BRP (at the phone number provided below) or an

authorized Distributor/Dealer and gives the coordinates of the new owner; or BRP or an authorized Distributor/Dealer receives proof that the former owner agreed to the transfer of ownership, in addition to the coordinates of the new owner.

9) CONSUMER ASSISTANCE

In the event of a controversy or a dispute in connection with this limited warranty, BRP suggests that you try to resolve the issue at the dealership level. We recommend discussing the issue with the authorized Distributor/Dealer's service manager or owner.

- If further assistance is required, the distributor's service department should be contacted in order to resolve the matter. You will find your distributor's coordinates on www.brp.com.
- If the matter still remains unresolved then contact BRP at the address listed below.

For countries within Europe, to the exception of the Scandinavian countries, and for countries within the CIS and Turkey, please contact our European office at:

BRP EUROPE N.V.

Customer Assistance Center
Skaldenstraat 125
9042 Gent
Belgium
Tel.: +32-9-218-26-00

For Scandinavian countries, please contact our office in Finland at:

BRP FINLAND OY

Service Department
Isoaavantie 7
FIN-96320 Rovaniemi
Finland
Tel.: +358163208111

For all other countries, please contact your local distributor or our North America office:

BOMBARDIER RECREATIONAL PRODUCTS INC.

Customer Assistance Center
75 J.A. Bombardier Street
Sherbrooke QC J1L 1W3
Tel.: 1 819 566-3366

* For the territory covered by this limited warranty, products are distributed and serviced by Bombardier Recreational Products Inc. or its affiliates.

© 2010 Bombardier Recreational Products Inc. All rights reserved.

® Registered trademark of Bombardier Recreational Products Inc.

PRIVACY INFORMATION

BRP wishes to inform you that your coordinates will be used for safety and warranty related purposes. Furthermore, BRP and its affiliates may use its customer list to distribute marketing and promotional information about BRP and related products.

To exercise your right to consult or correct your data, or to be removed from the addressee-list for direct marketing, please contact BRP.

By E-mail: **privacyofficer@brp.com**

By mail: BRP
Senior Legal Counsel-Privacy Officer
726 St-Joseph
Valcourt, QC
Canada
JOE 2L0

CHANGE OF ADDRESS/OWNERSHIP

If your address has changed or if you are the new owner of the boat, be sure to notify BRP by either:

- Mailing one of the following card below;
- **North America only:** calling at 715 848-4957 (USA) or 819 566-3366 (Canada);
- Contacting an authorized BRP distributor/dealer.

In case of change of ownership, please join a proof that the former owner agreed to the transfer.

Notifying BRP, even after the expiration of the limited warranty, is very important as it enables BRP to reach the boat owner if necessary, like when safety recalls are initiated. It is the owner's responsibility to notify BRP.

STOLEN UNITS: In the event that your boat is stolen, you should notify your area's distributor warranty department of such. We will ask you to provide your name, address, phone number, Hull Identification Number and date it was stolen.

In North America

BOMBARDIER RECREATIONAL PRODUCTS INC.

Warranty Department
75 J.-A. Bombardier Street
Sherbrooke, QC J1L 1W3
Canada

Scandinavian countries

BRP FINLAND OY

Service Department
Isoaavantie 7
FIN-96320 Rovaniemi
Tel.: + 358 16 3208 111

Other areas in the world except Scandinavian countries

BRP EUROPEAN DISTRIBUTION

Warranty Department
Chemin de Messidor 5-7
1006 Lausanne
Switzerland

***This page is
intentionally blank***

CHANGE OF ADDRESS

CHANGE OF OWNERSHIP



VEHICLE IDENTIFICATION NUMBER

Model Number

Vehicle Identification Number (V.I.N.)

OLD ADDRESS
OR PREVIOUS OWNER:

NAME

NO.

STREET

APT

CITY

STATE/PROVINCE

ZIP/POSTAL CODE

COUNTRY

TELEPHONE

NEW ADDRESS
OR NEW OWNER:

NAME

NO.

STREET

APT

CITY

STATE/PROVINCE

ZIP/POSTAL CODE

COUNTRY

TELEPHONE

E-MAIL ADDRESS

V00A2F

CHANGE OF ADDRESS

CHANGE OF OWNERSHIP



VEHICLE IDENTIFICATION NUMBER

Model Number

Vehicle Identification Number (V.I.N.)

OLD ADDRESS
OR PREVIOUS OWNER:

NAME

NO.

STREET

APT

CITY

STATE/PROVINCE

ZIP/POSTAL CODE

COUNTRY

TELEPHONE

NEW ADDRESS
OR NEW OWNER:

NAME

NO.

STREET

APT

CITY

STATE/PROVINCE

ZIP/POSTAL CODE

COUNTRY

TELEPHONE

E-MAIL ADDRESS

V00A2F

BOAT MODEL No. _____

HULL IDENTIFICATION NUMBER (H.I.N.) _____

ROTAX ENGINE IDENTIFICATION NUMBER (E.I.N.) _____

Owner: _____
NAME

No. STREET APT

CITY STATE/PROVINCE ZIP/POSTAL CODE

Purchase Date _____
YEAR MONTH DAY

Warranty Expiry Date _____
YEAR MONTH DAY

To be completed by the dealer at the time of the sale.

DEALER IMPRINT AREA

F00A35LA

Please verify with your selling dealer to ensure your SEA-DOO boat has been registered with BRP.

219 100 485

CA

OPERATOR'S GUIDE, 230 SERIES / ENGLISH
GUIDE DU CONDUCTEUR, SÉRIE 230 / ANGLAIS

FAIT AU / MADE IN CANADA

U/M:P.C.