

# SEA-DOO®



# 2011

Sea-Doo Boats  
**OPERATOR'S  
GUIDE**  
Includes,  
SAFETY, VEHICLE  
and MAINTENANCE INFORMATION

## 210 SERIES

**⚠ WARNING**

Read this guide thoroughly. It contains important safety information.  
Minimum recommended operator's age: 16 years old.  
Keep this Operator's Guide in the boat.

219 100 484

## **! WARNING**

Disregarding any of the safety precautions and instructions contained in this Operator's Guide, *SAFETY DVD* and on-product labels could cause injury including the possibility of death!

## **! WARNING**

This boat may exceed the performance of other boats you may have ridden in the past. Take time to familiarize yourself with your new boat.

### CALIFORNIA PROPOSITION 65 WARNING

## **! WARNING**

This product contains or emits chemicals known to the state of California to cause cancer and birth defects or other reproductive harm.

In Canada, products are distributed by Bombardier Recreational Products Inc. (BRP).

In USA, products are distributed by BRP US Inc.



This is a non-exhaustive list of trademarks that are the property of Bombardier Recreational Products Inc. or its affiliates:

4-TEC™

Rotax®

WAKE™

Challenger\*

Sea-Doo®

XPS™

\* Trademark of Bombardier Inc. used under license.

Flitz is a registered trademark of Flitz International.

Gelcote is a trademark of Gelcote International.

Spray Nine is a trademark of Spray Nine Corporation.

---

# FOREWORD

Congratulations on your purchase of a new Sea-Doo® Boats. It is backed by the BRP limited warranty and a network of authorized Sea-Doo Boats dealers ready to provide the parts, service or accessories you may require.

At delivery, you were informed of the warranty coverage and signed the *PREDELIVERY CHECK LIST* to ensure your new boat was prepared to your entire satisfaction.

Your dealer is committed to your satisfaction. If you need more complete servicing information, please ask your dealer.

## Know Before You Go

To learn how to reduce the risk of accident, read the following sections of this guide before you operate the boat:

- SAFETY INFORMATION
- BOAT INFORMATION.

Also, read all safety labels on your boat and watch attentively your *SAFETY DVD*.

We highly recommend that you take a safe boating course. Please check with your dealer or local authorities for availability in your area.

In certain areas, an operator competency card is mandatory to operate a pleasure craft.

Failure to follow the warnings contained in this Operator's Guide can result in SERIOUS INJURY or DEATH.

## Safety Messages

The types of safety messages, what they look like and how they are used in this guide are explained as follows:

 <b>DANGER</b>
Indicates a hazardous situation which, if not avoided, will result in death or serious injury.

 <b>WARNING</b>
Indicates a potential hazard which, if not avoided, could result in serious injury or death.

 **CAUTION** Indicates a hazard situation which, if not avoided, could result in minor or moderate injury.

**NOTICE** Indicates an instruction which, if not followed, could severely damage boat components or other property.

## About this Operator's Guide

This Operator's Guide has been prepared to acquaint the owner and the operator of a new boat with the various controls, maintenance and safe operating instructions. It is indispensable for the proper use of the product.

Keep this Operator's Guide in the boat as you can refer to it for things such as maintenance, troubleshooting and instructing others.

Note that this guide is available in several languages. In the event of any discrepancy, the English version shall prevail.

If you want to view and/or print an extra copy of your Operator's Guide, simply visit the following website [www.operatorsguide.brp.com](http://www.operatorsguide.brp.com).

The informations contained in this document are correct at the time of publication. BRP, however, maintains a policy of continuous improvement of its products without imposing upon itself any obligation to install them on products previously manufactured. Due to late changes, some differences between the manufactured product and the descriptions and/or specifications in this guide may occur. BRP reserves the right at any time to discontinue or

change specifications, designs, features, models or equipment without incurring any obligation upon itself.

This Operator's Guide and the *SAFETY DVD* should remain with the boat when it's sold.

---

# TABLE OF CONTENTS

<b>FOREWORD</b> .....	<b>1</b>
Know Before You Go .....	1
Safety Messages .....	1
About this Operator's Guide .....	1

## ***SAFETY INFORMATION***

<b>SPECIAL SAFETY MESSAGES</b> .....	<b>10</b>
Reminders Regarding Operation .....	10
Before Getting Underway .....	11
Operators and Passengers Awareness .....	11
Carbon Monoxide and Boating .....	12
Water Sports .....	15
Hypothermia .....	18
Voluntary Inspections .....	18
Safe Boating Courses .....	18
<b>SAFETY EQUIPMENT</b> .....	<b>19</b>
Required Safety Equipment .....	19
Additional Recommended Equipment .....	22
<b>PRACTICE EXERCISES</b> .....	<b>23</b>
Where to Practice Exercises .....	23
Practice Exercises .....	23
Important Factors Not to Neglect .....	23
<b>SAFE BOATING PRACTICES</b> .....	<b>25</b>
Drugs and Alcohol .....	25
Safe Operation .....	25
<b>NAVIGATION RULES</b> .....	<b>27</b>
Operating Rules .....	27
<b>FUELING</b> .....	<b>29</b>
Recommended Fuel .....	29
Fueling Procedure .....	29
<b>TRAILERING INFORMATION</b> .....	<b>31</b>
<b>LOCATION OF IMPORTANT ON-PRODUCT LABELS</b> .....	<b>32</b>
Hang Tag .....	32
Safety Labels .....	33
Compliance Labels .....	37
Technical Information Labels .....	38
<b>PRE-RIDE INSPECTION</b> .....	<b>39</b>
Pre-Ride Check List When Boat is Trailered .....	40
Pre-Ride Check List When Boat is Docked .....	41
Fuel .....	42
Hull .....	42
Jet Pump Water Intakes .....	42
Bilge .....	42
Engine Compartment .....	42

**PRE-RIDE INSPECTION (cont'd)**

Main Battery Cut-Off Switch .....	42
Throttle/Shifter System.....	43
Steering System .....	43
Multifunction Gauge Cluster .....	43
Bilge Blower Switch .....	43
Towing Tower (Optional).....	43
Bimini Top (Optional).....	43
Mandatory Safety Boating Equipment .....	43
Storage Compartment Covers .....	44
Navigation Lights.....	44
Engine Start/Stop Buttons.....	44
Engine Cut-off Switch .....	44

**BOAT INFORMATION**

**CONTROLS..... 46**

1) Steering Wheel .....	46
2) Throttle/Shifter Lever .....	47
3) Emergency Engine Stop Switch .....	47
4) Ignition Switch.....	48
5) Bilge Blower Switch.....	49
6) Start/Stop Buttons .....	49
7) Horn Switch.....	49
8) Bilge Pump Switch .....	50
9) Navigation Lights Switch .....	50
10) Deck Light Switch .....	51
11) Heating Fan Switch (210 WAKE).....	51
12) Ballast System Switch (210 WAKE) .....	52
13) MODE Button .....	52
14) SET Button .....	52
15) UP and DOWN Switch.....	53

**GAUGES..... 54**

1) Analog Speedometer .....	54
2) Analog Fuel Level Gauge .....	54
3) Analog Voltmeter .....	54
4) Information Center .....	55

**EQUIPMENT..... 63**

1) Seats .....	64
2) Main Battery Cut-Off Switch .....	66
3) Storage Compartments.....	66
4) Grab Handles .....	70
5) Rear Grab Handles .....	70
6) Swim Platform.....	70
7) Ladder .....	70
8) Lights.....	71
9) Radio .....	73

<b>EQUIPMENT (cont'd)</b>	
10) Radio Remote Control .....	73
11) Audio Input Jack/USB port .....	73
12) 12-Volt Power Outlets .....	74
13) Deck Drains .....	74
14) Bilge Drain Plug .....	74
15) Walk-Thru Door/Windshield .....	74
16) Cup Holders .....	75
17) Bow and Stern Eyelets .....	75
18) Mooring Cleats .....	76
19) Water Sport Towing Attachments .....	76
20) Heating System .....	81
21) Ballast System .....	81
22) Bimini Top .....	83
23) Cockpit Table .....	85
<b>BREAK-IN PERIOD .....</b>	<b>87</b>
Operating During Break-In .....	87
<b>OPERATING INSTRUCTIONS .....</b>	<b>88</b>
How to Launch or to Load Boat .....	88
How to Board the Boat .....	88
How to Start Engines .....	89
How to Leave the Shore .....	91
How to Shut Off the Engines .....	91
How to Steer Boat .....	91
How to Engage Neutral .....	92
How to Engage Forward .....	92
How to Engage Reverse .....	92
General Recommendations .....	93
<b>OPERATING MODES .....</b>	<b>96</b>
SKI MODE .....	96
CRUISE MODE .....	97
SYNC MODE .....	98
<b>SPECIAL PROCEDURES .....</b>	<b>99</b>
Jet Pump Water Intake and Impeller Cleaning .....	99
Towing the Boat in Water .....	99
Submerged Boat and Water-Flooded Engine .....	100

## **MAINTENANCE**

<b>BREAK-IN INSPECTION .....</b>	<b>102</b>
<b>MAINTENANCE SCHEDULE .....</b>	<b>104</b>
<b>MAINTENANCE PROCEDURES .....</b>	<b>107</b>
Engine Oil .....	107
Engine Coolant .....	109
Ignition Coils .....	109
Exhaust System .....	110

<b>MAINTENANCE PROCEDURES (cont'd)</b>	
Fuses and Circuit Breakers .....	112
Bilge Blower .....	113
Navigation Lights .....	114
Deck Drains .....	115
Latches and Hinges .....	115
Reverse Gates .....	116
Sacrificial Anodes .....	116
<b>BOAT CARE .....</b>	<b>117</b>
Post-Operation Care .....	117
Boat Cleaning and Protection .....	117
<b>STORAGE .....</b>	<b>120</b>
Jet Pump Cleaning .....	120
Fuel System Protection .....	120
Engine Oil and Filter Replacement .....	120
Exhaust System Flushing .....	120
Exhaust System and Intercooler Protection .....	120
Engine Internal Lubrication .....	121
Engine Coolant Test .....	122
Battery Removal and Storage .....	122
Boat Cleaning/Repair .....	122
Boat Protection .....	123
<b>PRESEASON PREPARATION .....</b>	<b>124</b>
<b>TECHNICAL INFORMATION</b>	
<b>BOAT IDENTIFICATION .....</b>	<b>126</b>
Hull Identification Number .....	126
Engine Identification Number .....	126
<b>ENGINE EMISSIONS INFORMATION .....</b>	<b>127</b>
Manufacturer's Responsibility .....	127
Dealer's Responsibility .....	127
Owner Responsibility .....	127
EPA Emission Regulations .....	127
<b>SPECIFICATIONS .....</b>	<b>128</b>
<b>TROUBLESHOOTING</b>	
<b>TROUBLESHOOTING GUIDELINES .....</b>	<b>134</b>
<b>MONITORING SYSTEM .....</b>	<b>138</b>
Pilot Lamps and Message Display Information .....	138
Beeper Code Information .....	139



**WARRANTY**

**BRP LIMITED WARRANTY FOR MODEL YEAR 2011 SEA-DOO® BOATS SOLD IN THE UNITED STATES AND CANADA..... 142**

**CALIFORNIA EMISSION CONTROL WARRANTY STATEMENT FOR MODEL-YEAR 2011 SEA-DOO® BOATS WITH 4-TEC® ENGINES OR 4-TEC® IC ENGINES..... 146**

**BRP INTERNATIONAL LIMITED WARRANTY FOR MODEL YEAR 2011 SEA-DOO® BOATS ..... 150**

**BRP LIMITED WARRANTY FOR THE EUROPEAN AND THE RUSSIAN ECONOMIC AREA AND TURKEY: MODEL YEAR 2011 SEA-DOO® BOATS..... 154**

**CUSTOMER INFORMATION**

**PRIVACY INFORMATION ..... 160**

**CHANGE OF ADDRESS/OWNERSHIP..... 161**



# ***SAFETY INFORMATION***

---

## SPECIAL SAFETY MESSAGES

### Reminders Regarding Operation

- Engine exhaust contains carbon monoxide (CO), which can cause injury or death if inhaled in sufficient quantities. Educate all occupants about the risks and symptoms of CO accumulation and CO poisoning. For more information, refer to *CARBON MONOXIDE AND BOATING* section.
- Gasoline vapors can explode, resulting in injury or death. Always use blower for a minimum of 5 minutes before starting engine, then turn it OFF above idle speed. Use of the bilge blower should never replace "smelling" for gasoline vapor odors.
- If at any time, gasoline leaks/odors are found, do not start the engine. Have the boat serviced by an authorized Sea-Doo Boats dealer.
- Always keep in mind that as the throttle lever is returned to the idle position, less directional control is available. To turn the boat, both steering and throttle are necessary.
- This boat has no brake. Stopping distance will vary depending on initial speed, load, wind, and water conditions. Practice stopping and docking in a safe, traffic-free area to have an idea of how long it will take to stop the boat under varying conditions. Do not release the throttle when trying to steer away from objects. You need throttle to steer. Do not use the boat's reverse to stop.
- Do not start or operate the boat if any person is not properly seated in a seat intended for use when underway (not the sun deck or swim platform) or if a person is nearby in the water.
- The boat's jet thrust can cause injury. Always accelerate slowly, and decelerate in a controlled fashion.
- Observe the instructions on all safety labels. They are there to help assure that you have a safe and enjoyable outing.
- Riding with passenger(s) or pulling other boats, tubes, a skier or a wakeboarder makes the boat handle differently and requires greater skill.
- Certain boats may come equipped with tow eyelets, a ski pole or a wakeboard tower which can be used to attach a tow rope for a skier, tube or wakeboarder. Do not use these attachment points or any other portion of the boat to tow a parasail or another craft. Personal injury or severe damage may occur.
- In shallow water, proceed with caution and at very low speeds. Grounding or abrupt stops may result in injury to you, your passengers or others. The jet pump may pick up debris and throw it rearward causing a risk of injuring people or damaging the jet pump or other property.
- Combustion engines need air to operate; consequently this boat can not be totally watertight. Any maneuvers such as figure eights that cause the upper deck to be under water may cause severe engine problems due to water ingestion. Refer to the *SPECIAL PROCEDURES* and *WARRANTY* sections contained in this Operator's Guide.
- Respect no wake zones, the rights of other water users and the environment. As the "skipper" and owner of a boat, you are responsible for damage to other boats caused by the wake of your boat. Do not let anyone throw refuse overboard.
- Between sunset and sunrise, use the boat's navigation lights and reduce speed. Do not operate the boat in reduced visibility.

- Do not add accessories or equipment that may adversely affect visibility or alter control of the boat.
- The skipper should personally take the helm during storms.

## **Before Getting Underway**

- Always perform the pre-ride inspection as specified in this Operator's Guide.
- Do not exceed the payload or passenger capacities for this boat, which are listed on the capacity plate and in the specifications. Overloading can affect maneuverability, stability and performance. Also, heavy seas reduce capacity. A payload or person capacity plate is not an excuse for failure to use common sense or good judgment.
- Regularly inspect the boat, the hull, engine, safety equipment, and all other boating gear and keep them in safe operating condition.
- Be sure you have the minimum required safety equipment, PFDs and any additional gear needed for your cruise.
- Check that all lifesaving equipment, including fire extinguisher, is in safe operating condition and easily accessible. Show all passengers where this equipment is, and make sure they know how to use it.
- Keep an eye on the weather. Check local weather broadcasts before departure. Be alert to changing conditions.
- Keep accurate and up-to-date charts of the boating area on board. Before getting underway, check water conditions in the planned boating area.

- Before departure, file a Float Plan with a responsible person ashore.
- Keep enough fuel on board for the planned trip. Always verify fuel level before use and during the ride. Apply the principle of 1/3 of the fuel to reach your destination, 1/3 to return, and keep 1/3 in reserve. Allow for changes due to adverse weather or other delays.

## **Operators and Passengers Awareness**

- Each boat operator has a responsibility to ensure the safety of his/her passenger(s) and of other water users. Please follow all safety instructions and operate your boat with care.
- Never operate a boat while under the influence of drugs or alcohol they slow reaction time and impair judgement. It is also a Federal offense. Allow only qualified drivers to operate your boat.
- Remember that sun, wind, fatigue or illness may impair your judgement and reaction time.
- At least one passenger should be able to operate the boat in case the operator is unexpectedly unable to do so.
- Operation of this boat by a person under 16 years of age or a person with a disability that impairs vision, reaction time, judgment, or operation of the controls is NOT recommended.
- Always use the tether cord when operating the boat and ensure that all passengers are familiar with its use.
- Ensure that any operator and all passengers know how to swim and how to re-board the boat from the water. If a passenger does not know how to swim, ensure that passenger wears a PFD at all times and take extra precautions when boating.

## Carbon Monoxide and Boating

Burning a material containing carbon produces carbon monoxide (CO), an odorless and colorless gas. Because CO weighs the same as air, it can spread throughout an enclosed space unnoticed because you cannot see it or smell it. Any device used to burn carbon-based materials on a boat can be a source of CO. Common sources of CO include internal combustion engines.

CO reacts with the blood to reduce the ability of the blood to carry oxygen. The reduced oxygen supply to body tissues results in death of the tissue. Prolonged exposure can cause brain damage or death. In high concentrations, CO can be fatal within minutes. The effects of CO in lower concentrations are cumulative and can be just as lethal over long periods of time.

Symptoms of CO poisoning include: Itchy and watering eyes, flushed appearance, throbbing temples, inability to think coherently, ringing in the ears, tightness across the chest, headaches, drowsiness, nausea, dizziness, fatigue, vomiting, collapse, and convulsions. If any of these symptoms are evident, begin treatment immediately. Prompt action can make the difference between life and death.

- Evacuate the area and move the victim to fresh air.

- Administer oxygen if available and get medical help.
- Open all canvas enclosures to ventilate the area.
- Investigate the source of CO and take immediate corrective action.
- Be especially aware of other CO sources which may be near boat.

### Carbon Monoxide Accumulation

Following are examples of possible situations where CO may accumulate within your boat while docked, anchored, or underway. Become familiar with these examples and their precautions to prevent personal injury or death.

#### **⚠ WARNING**

**Exhaust fumes!** Generator or hull exhaust from other vessels while either docked or anchored can emit poisonous CO gas and cause excessive accumulation within cabin and cockpit areas. Be alert for generator exhaust from your vessel or other vessels alongside. Exhaust outlets near a pier, dock, seawall or outlets blocked by any other means can cause excessive accumulation of poisonous CO gas within cockpit area.

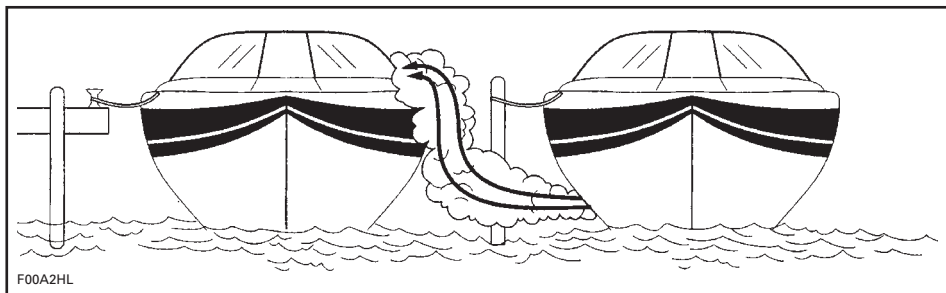

F00A2HL

VESSEL ALONGSIDE

**⚠ WARNING**

**Engine exhaust fumes contain carbon monoxide (CO) which can accumulate in and around the boat (under bimini top, in cockpit, etc.). CO can be harmful or fatal if inhaled. Assure there is adequate ventilation whenever running engine(s).**

Boat houses, seawalls, and other boats in close proximity or confined areas can contribute to increased CO levels. Operators must be aware that operation, mooring, and anchoring in an area with other boats puts them in jeopardy of CO accumulation from other sources. Likewise, a boat operator must be aware of how exhaust from his boat will affect others. Operation of the engines while moored may cause CO accumulation in your boat and those around you.

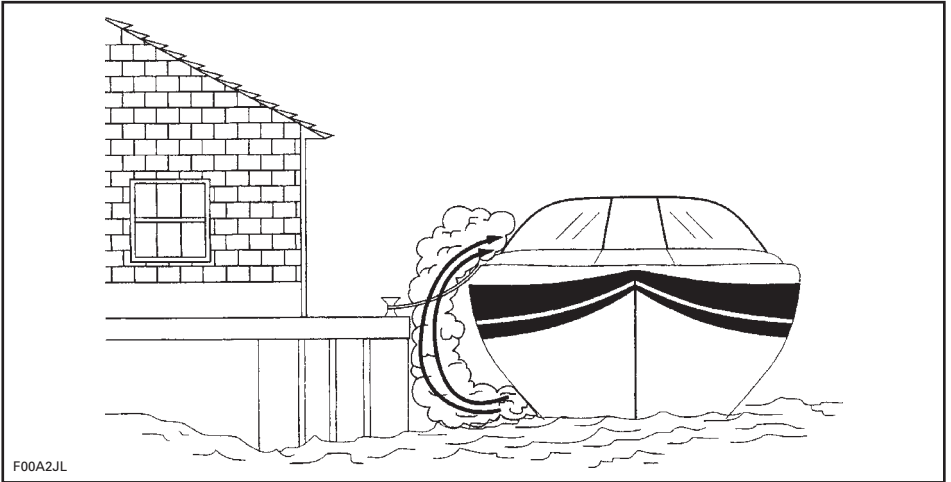

F00A2JL

**CONFINED AREAS**

Be sure to provide adequate ventilation. If the windshield has vents, open them before getting underway to increase positive air flow and decrease the chances of CO accumulation.

**⚠ WARNING**

**Backdrafting!** Under certain conditions, moving air currents can direct poisonous CO fumes into boat. These fumes can accumulate to dangerous levels without proper airflow. Provide adequate ventilation, redistribute the load or bring boat out of high bow angle.

While underway, CO concentrations can increase by backdrafting or "the station wagon effect". Backdrafting is caused by factors such as relative wind direction, speed, or the bow being too high. To prevent this, open canvas whenever possible to provide positive airflow through the hull.

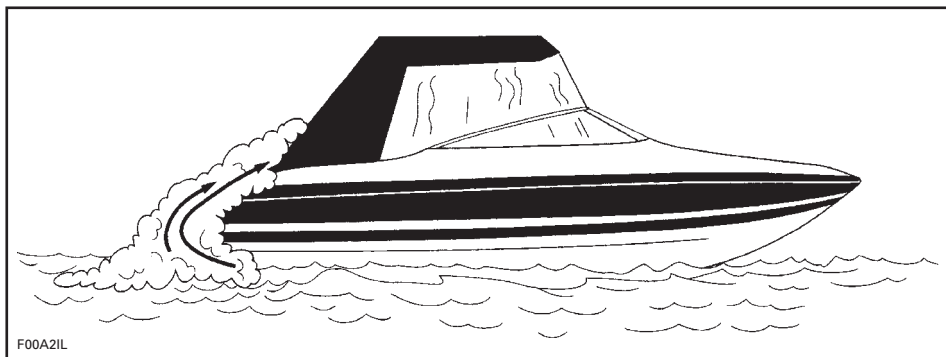

F00A21L

**WHILE UNDERWAY (BACKDRAFTING)**

Even with the best boat design and construction, CO may still accumulate in enclosed or confined areas under certain conditions. Continually observe passengers for symptoms of CO poisoning.

**CO Detector**

It is strongly recommended that you have CO detectors installed in boats with canvas enclosures. Monitors are available from your dealer. Monitors should be professionally installed and calibrated.

**NOTE:** A CO detector is not a gas fuel vapor detector. Gas fuel vapor detectors do not monitor the buildup of CO in an enclosed area.

**Do NOT Operate your Boat without Performing the Following Checklist:****Each Boating Day**

OPERATION	✓
Make sure you and your passengers know where exhaust outlets are located on the vessel	
Educate all passengers about the symptoms of CO poisoning and where CO may accumulate	
When docked or rafting with another boat, be aware of exhaust emissions from the other boat	
Confirm that water flows from the exhaust outlet when the engine(s) is (are) started	
Listen for any change in exhaust sound, which could indicate an exhaust component failure	
Test the operation of each CO alarm by pressing the test button (if so equipped)	



## Water Sports

### WARNING

**Avoid Personal Injury!** Your boat is not designed for and should not be used for pulling parasails, kites, gliders, or any device which can become airborne. Use boat only for appropriate water sports.

### WARNING

**Teak Surfing** is extremely dangerous to participants due to their proximity to the rear of the boat where direct contact with the exhaust fumes from the boat engine is the highest. Carbon monoxide poisoning can occur and result in mental disorientation, dizziness, drowsiness, and loss of consciousness. The combination of carbon monoxide exposure and non-use of a life jacket (PFD) make this new water recreation activity an incredibly dangerous and potentially deadly sport.

Water skiing, wakeboarding, or riding a towed, inflatable apparatus are some of the more popular water sports. Taking part in any water sport requires increased safety awareness by the participant and the boat operator. If you have never pulled someone behind your boat before, it is a good idea to spend some hours as an observer, working with and learning from an experienced driver. It is also important to be aware of the skill and experience of the person being pulled. Always have a second person on board to observe the person in the water so the driver can concentrate on operating the boat.

Both the boat operator and observer should monitor the location of the towrope when participating in water-sports. A slack tow rope can become entangled with person(s) or objects

in the boat or in the water, particularly when making a tight turn or circling, and cause serious personal injury.

Everyone participating in a water sport should observe these guidelines:

- Allow only capable swimmers to take part in any water sport.
- Always wear an approved personal flotation device (PFD). Wearing a properly designed PFD helps a stunned or unconscious person stay afloat. A Type-IV water-ski vest is an approved and practical PFD.
- Have a second person aboard to observe the person being towed and inform the driver about the participant's hand signals. The driver must give full attention to operating the boat and the waters ahead.
- Be considerate to others you share the water with.
- Never allow a person to “teak surf” behind your boat. Do not tow a person in any water sport on a short tow rope such that the person inhales exhaust fumes in concentration. Inhalation of concentrated exhaust fumes, which contain carbon monoxide, can result in CO poisoning, personal injury and death.
- Give immediate attention to a person who has fallen. He or she is vulnerable in the water alone and may not be seen by other boaters.
- Approach a person in the water from the lee side (opposite the direction of the wind). Turn off the motor before coming close to the person.
- Turn off engine and anchor the boat before swimming.
- Participate in water sports only in safe areas. Stay away from other boats, channels, beaches, restricted areas, swimmers, and heavily traveled waterways and underwater obstructions.
- Swim only in areas designated as safe for swimming. These are usually marked with a swim area buoy. Do not swim alone or at night.



SWIM AREA BUOY

1. Do not water ski between sunset and sunrise. It is illegal in most states.
2. Do not drive the boat directly behind a water skier, tuber or wakeboarder. At 40 km (25 mi), the boat will overtake a person who falls in the water 60 m (200 ft) in front of your boat in about 5 seconds.
3. Shut engine off and remove ignition key when anyone is in the water nearby.
4. Stay at least 45 m (150 ft) away from areas marked by a diver down float.

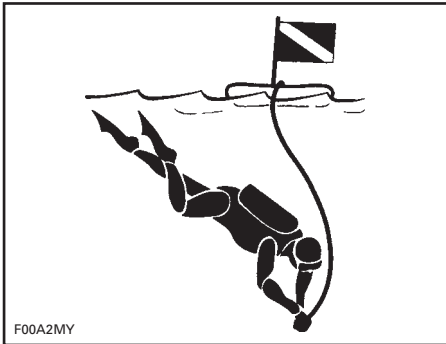

DIVER DOWN FLOAT

**⚠ WARNING**

**Avoid personal injury!** Do not allow anyone near the jet pump or intake grate, even when the engine is off. Items such as long hair, loose clothing or personal flotation device straps can become entangled in moving parts resulting in serious injury or drowning. In shallow water, shells, sand, pebbles or other objects could be drawn up by the jet pump and be thrown rearward.

For more information about water skiing, please contact your local water ski association.

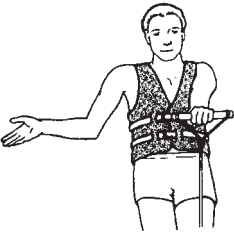

**FASTER -**  
Palm of one hand pointing  
upward.

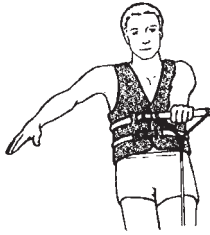

**SLOWER -**  
Palm pointing down.



**SPEED OK -**  
Arm upraised with thumb and  
finger joined to form circle.

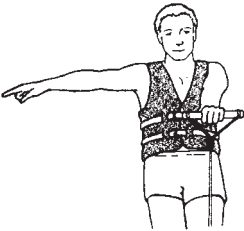

**RIGHT TURN -**  
Arm outstretched pointing  
to the right.

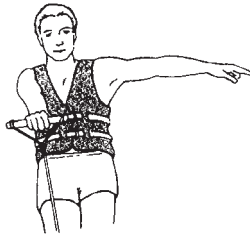

**LEFT TURN -**  
Arm outstretched pointing  
to the left.



**RETURN TO DROP-OFF AREA -**  
Arm at 45 degree from body  
pointing down to water and  
swinging.



**CUT MOTOR -**  
Finger drawn across  
throat.

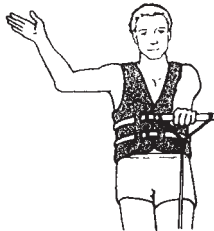

**STOP -**  
Hand up, palm forward,  
policeman style.



**SKIER OK.  
AFTER THE FALL -**  
Hands clenched  
together overhead.

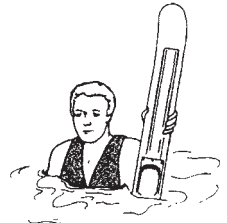

**PICK ME UP  
OR FALLEN SKIER,  
WATCH OUT -**  
One ski extended  
vertically out of water.

F00A2NL

## SKIING SIGNALS

## Hypothermia

Hypothermia, the loss of body heat to the water, is a significant cause of deaths in boating accidents. After an individual has succumbed to hypothermia, he or she will lose consciousness and then drown.

PFDs can increase survival time because of the insulation they provide.

Naturally, the warmer the water, the less insulation one will require. When operating in cold water (below 4.4°C (40°F)) consideration should be given to using a coat or jacket style PFD as they cover more of the body than the vest style PFDs.

Some points to remember about hypothermia protection:

1. While afloat in the water, do not attempt to swim unless it is to reach a nearby boat, fellow survivor, or a floating object on which you can lean or climb. Unnecessary swimming increases the rate of body heat loss. In cold water, drown-proof methods that require putting your head in the water are not recommended. Keep your head out of the water. This will greatly lessen heat loss and increase your survival time.
2. Keep a positive attitude about your survival and rescue. This will improve your chances of extending your survival time until rescue. Your will to live does make a difference!
3. If there is more than one person in the water, huddling is recommended while waiting to be rescued. This action tends to reduce the rate of heat loss and thus increase the survival time.
4. Always wear your PFD. It won't help you fight off the effects of hypothermia if you don't have it on when you go into the water.

## Voluntary Inspections

Boating officials in many countries or their auxiliaries offer courtesy inspections to check out your boat. They will check for compliance with safety standards and required safety equipment. You may voluntarily consent to one of these inspections, and you are allowed time to make corrections without prosecution. Check with the competent authorities for details.

## Safe Boating Courses

Many countries recommend or require a boating safety course. Check with your local competent authorities.

# SAFETY EQUIPMENT

## Required Safety Equipment

Operator and passenger(s) should have ready access to shatterproof glasses should riding conditions or personal preference warrant.

Wind, water spray and speed may cause a person's eyes to water and create blurred vision.

As the owner of the boat, you are responsible for assuring that all required safety equipment is aboard. You should also consider supplying additional equipment as needed for your safety and that of your passengers. Check local regulations about required safety equipment.

Safety equipment required by regulations is mandatory. Personal flotation devices must be fitted to the people wearing them. If local regulations require additional equipment, it must be approved by a competent authority. Minimum requirements include the following:

- Personal flotation devices (PFDs)
- Fire extinguisher (class B-1)
- Visual distress signals (VDS)
- Navigation lights
- Sound producing devices (horn, air horn or whistle).

A cellular telephone in a waterproof bag or container has also been found to be beneficial to boaters when in distress or just for contacting someone on shore.

### Personal Flotation Devices (PFDs)

In many countries, regulations require that you have at least one approved personal flotation device (PFD) for each person in a recreational boat and require that all children under 13 years of age wear a PFD at all times when the boat is underway, except when below deck or in an enclosed cabin. You may not use your boat unless all PFDs are in serviceable condition, readily

accessible, legibly marked with the approval number, and of an appropriate size (within the weight range and chest size marked on the PFD) for each person on board.

A PFD provides buoyancy to help keep your head above the water and to help you remain in a satisfactory position while in the water. Body weight and age should be considered when selecting a PFD. The buoyancy provided by the PFD should support your weight in water. The size of the PFD should be appropriate for the wearer. Body weight and chest size are common methods used to size PFDs. It is your responsibility to ensure that you have the proper number and types of PFDs on board to comply with federal and local regulations and that your passengers know where they are and how to use them.

### PFD Types

There are five types of approved PFDs.

**PFD Type I, Wearable** has the greatest required buoyancy. Its design allows for turning most unconscious persons in the water from face down position to a vertical or slightly backward, face-up position. It can greatly increase the chances of survival. Type I is most effective for all waters, especially offshore when rescue may be delayed. It is also the most effective in rough waters.

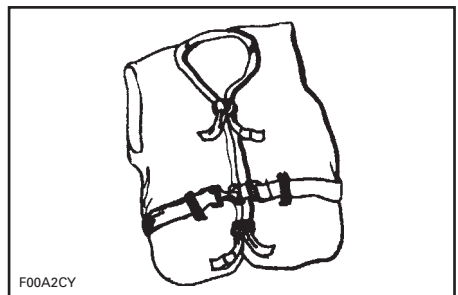

TYPE I — WEARABLE

**PFD Type II, Wearable** turns its wearer in the same way as Type I, but not as effectively. The Type II does not turn as many persons under the same conditions as a Type I. You may prefer to use this PFD where there is a probability of quick rescue such as in areas where other people are commonly involved in water activities.

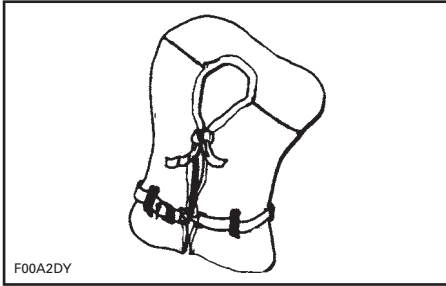

**TYPE II — WEARABLE**

**PFD Type III, Wearable** allows wearers to place themselves in a vertical or slightly backward position. It does not turn the wearer. It maintains the wearer in a vertical or slightly backward position and has no tendency to turn the wearer face down. It has the same buoyancy as a Type II PFD and may be appropriate in areas where other people are commonly involved in water activities.

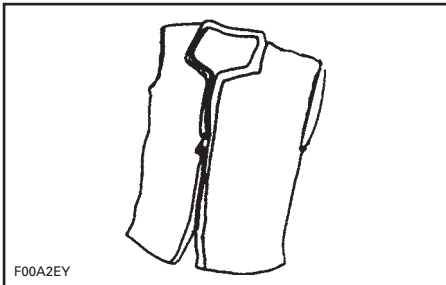

**TYPE III — WEARABLE**

**PFD Type IV, Throwable** is required in addition to the PFDs previously discussed. The most common Type IV PFD is a buoyant cushion or ring buoy.

It is designed to be thrown to a person in the water, grasped and held by the user until he or she is rescued. A Type IV PFD should always be in serviceable condition and immediately available for use. Grasping this PFD may be difficult if the rescue is delayed or if the user is overcome by hypothermia (loss of body heat).

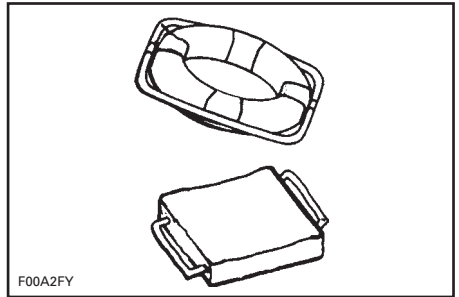

**TYPE IV — THROWABLE**

**PFD Type V, Wearable** must be worn. When inflated, it provides buoyancy equivalent to Type I, II or III PFDs. When it is deflated, however, it may not support some people.

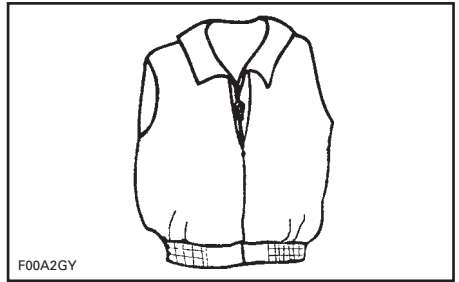

**TYPE V — WEARABLE**

### **PFD Pointers**

The purpose of a PFD is to help save your life. If you want it to support you when you are in the water, it needs to fit, float, and be in good condition.

- Try the PFD on and adjust it until it fits comfortably in and out of the water. Mark your PFD if you are the only wearer.

- To make sure the PFD works, wear it in the water. This will show you how it works and give you confidence when you use it.
- Teach children how to put a PFD on and allow them to try it in the water. That way, they know what the PFD is for and how it works. They will feel more comfortable with it if they suddenly find themselves in the water.
- If the PFD is wet, allow it to dry thoroughly before storing it. Do not dry it in front of a radiator or heater. Store it in a well-ventilated area.
- Keep PFDs away from sharp objects which can tear the fabric or puncture the flotation pads.
- For their own safety and the safety of others, all non-swimmers, poor swimmers, and small children should wear PFD's at all times whether the boat is stationary or moving.
- Check the PFD frequently to make sure that it is not torn, that flotation pads have no leaks, and that all seams and joints are securely sewn.
- If a PFD contains kapok, the kapok fibers may become waterlogged and lose their buoyancy after the vinyl inserts are punctured. If the kapok becomes hard or if it is soaked with water, replace it. It may not work when you need it.

## Fire Extinguishers

As the owner of the boat, you are responsible for supplying an approved fire extinguisher. Check with the local competent authorities. Boats (less than 7.9 m (26 ft)) are required to carry one (1) B-1 type hand portable fire extinguisher unless the boat is equipped with a fixed fire extinguishing system in the engine compartment.

Hand-held portable fire extinguishers should be mounted in readily accessible locations away from the engine

compartment. All persons aboard should know the location and proper operation of the fire extinguisher(s).

**NOTE:** Don't test fire extinguishers by squirting small amounts of the extinguishing compound. The extinguisher might not work when you really need it!

### WARNING

**Fire! In case of fire, do not open engine compartment. Turn off engine. Using portable CO<sub>2</sub> fire extinguisher, continuously discharge entire contents at base of fire.**

## Visual Distress Signal Devices

Visual distress signal equipment may be of the pyrotechnic or non-pyrotechnic type. Regulations prohibit display of visual distress signals on the water under any circumstances except when assistance is required to prevent immediate or potential danger to persons on board a vessel. Check with the local authority to have proper equipment.

The equipment must be approved by the competent authorities, be in serviceable condition, and be stowed in a readily accessible location. Equipment having a date for serviceable life must be within the specified usage date shown.

Careful selection and proper stowage of visual distress equipment is very important if children are aboard.

<b>DAY USE ONLY</b>
Three orange smoke signals (one hand held and two floating) or one orange flag with black square and disk
<b>NIGHT USE ONLY</b>
One S-O-S electric distress light
<b>DAY AND NIGHT USE</b>
Three flares of the hand held, meteor or parachute type

### Sound Signaling Devices

**NOTE:** No single signaling device is appropriate for all purposes. Consider keeping various types of equipment on board.

Boats less than 7.9 m (26 ft) in length are required to carry a hand, mouth, or power operated horn or whistle. It must produce a blast of two second duration and audible at a distance of at least 800 m (1/2 mi).

Following are standard whistle signals:

- One prolonged blast (warning signal)
- One short blast (pass on my port side)
- Two short blasts (pass on my starboard side)
- Three short blasts (engines in reverse)
- Five or more blasts (danger signal).

### Navigation Lights

Navigation lights are intended to keep other vessels informed of your presence and course. If you are out on the water between sunset and sunrise, you are required to display appropriate navigation lights.

## Additional Recommended Equipment

It is recommended that you acquire additional equipment for safe, enjoyable cruising. This list, which is not all inclusive, includes items you should consider acquiring.

### Basic Gear

- Flashlight
- Mooring lines
- Compass
- Oar or paddle
- Distress signals
- First aid kit
- Dock fenders
- VHF radio
- EPIRB (Electronic Position Indicating Radio Beacon)
- Boat hook
- Extra warm clothing
- Local map
- Sunblock
- Tow line
- Second anchor and line
- Dewatering device (pump or bailer)
- Emergency supply of drinking water and food
- Cellular phone.

### Tools

- Screwdrivers
- Pocket knife
- Pliers
- Electrician's tape
- Adjustable wrench
- Duct tape.



---

# PRACTICE EXERCISES

It is always a good idea to practice and get familiar with all controls, functions and handling characteristics of your boat before venturing on the water.

Always secure the tether cord to the engine cut-off switch and the clip to your PFD or a wrist strap.

## Where to Practice Exercises

Find a suitable area to practice the exercises. Ensure the area meet the following requirements:

- No traffic
- No obstacles
- No swimmers
- No current
- Ample space to maneuver
- Water depth is adequate.

## Practice Exercises

Practice **alone** the following exercises.

### Turning

Practice turning in circles in both directions at slow speed. When comfortable with the exercise, increase difficulty by making some figure 8.

When this is mastered, repeat the above exercises but at increased speed.

### Stopping Distances

Practice to stop the boat in a straight line at different speeds.

Remember, water drag is the main factor which reduce the boat speed and thus the stopping distance.

**NOTE:** Boat load, current and wind play also an important role and affect stopping distances.

### Reverse

Practice reverse operation to learn how the boat operates in reverse and reacts with steering inputs.

**NOTE:** Always perform this exercise at slow speeds.

### Avoiding an Obstacle

Practice to avoid an obstacle (choose a virtual point on the water) by steering boat and maintaining throttle.

Repeat exercise, but this time release throttle while turning.

**NOTE:** With this exercise, you will learn that you need throttle to steer the boat in a different direction.

### Docking

Practice docking using the throttle and shift lever along with the steering to become familiar and develop good control skills.

### Ski Mode and Cruise Mode

If your boat has the Ski Mode or Cruise mode, it is also important to understand their operations and get familiar with these features prior to use them on a ride with other people.

 <b>WARNING</b>
The ski and the cruise mode are not an automatic pilot; they will not drive the boat.

### Important Factors Not to Neglect

In addition, always remember that the following conditions have a direct impact on how your boat will behave and respond to different inputs:

- Load change
- Current
- Wind
- Water condition.

Make sure to be alert to these conditions, and adapt accordingly. If possible, practice further in these conditions.

For delicate maneuvers, the best advice is always to try to keep speed at a minimum.

---

# SAFE BOATING PRACTICES

YOU are responsible for your own safety, the safety of your passengers, and the safety of fellow boaters. Ride smart from the start and we all win!

## Drugs and Alcohol

Do not use drugs or drink alcohol while operating a boat. Like driving a car, driving a boat requires sober, attentive care. Operating a boat while intoxicated or under the influence of drugs is not only dangerous, but it is also a Federal offense carrying a significant penalty. These laws are vigorously enforced. The use of drugs and alcohol, singly or in combination, decreases reaction time, impedes judgment, impairs vision, and inhibits your ability to safely operate a boat.

### WARNING

Alcohol consumption and boating do not mix! Operating under the influence endangers the lives of your passengers and other boaters. Federal laws prohibit operating a boat under the influence of alcohol or drugs.

## Safe Operation

For safety reasons and proper care, always perform daily *PRE-RIDE INSPECTION* as specified in your Operator's Guide before operating your boat. Safe operation means that you do not misuse your boat nor do you allow your passengers to do so. Safe operation means using good judgment at all times. It includes, without limitation, the following actions:

- Load the boat within the limits listed on the capacity plate. Balance loads bow to stern and port to starboard.
- Maintain boat speed at or below the local legal limit. Avoid excessive speed or speeds not appropriate for operating conditions.

- Do not use the boat in weather or sea conditions beyond the skill or experience of the operator or the comfortable capability of the boat or passengers.
- Be sure at least one other passenger is familiar with the operation and safety aspects of the boat in case of an emergency.
- Make sure that passengers and gear do not obstruct the operator's view or ability to move.
- Do not exceed the maximum engine power rating stated on the certification plate attached to the boat.
- Observe all safety signs and warnings both inside the boat and in the immediate boating area.
- While your boat has the capacity of operating at high speeds, it is strongly recommended that high speed operation only be applied when ideal conditions exist and are permitted. Higher speed operation requires a higher degree of skill and increases the risk of severe injuries.
- In shallow water, proceed with caution and at very low speeds. Grounding or abrupt stops may result in injury. Debris may also be picked up and be thrown rearward by the jet pump onto people or property.
- Do not use the boat's reverse, to stop. You or your passenger(s) could be violently ejected forward or even off the boat onto the hazard.

## Maneuverability of the Boat and Towing

- Always keep in mind that as the throttle lever is returned to idle position, less directional control is available, and when the engine is OFF, directional control is lost. You need throttle to steer.

- Do not overload the boat or take on more passengers than designated for the particular boat. Overloading can affect maneuverability, stability and performance.
- Avoid adding on accessories or equipment which may alter your control of the boat.
- Riding with a passenger(s) or pulling a tube, skier or wakeboarder makes the boat handle differently and requires greater skill.
- Always respect the safety and comfort of your passenger(s) and person being towed on skis, wakeboard or other towables.
- Always carry an observer when pulling a tube, skier or wakeboarder, proceed with only as much speed as required and follow the observer's instructions. Unless absolutely necessary, do not make tight, sharp turns. Keep a safe distance from the docks, other swimmers, craft or objects.
- Use a tow rope of sufficient length and size and make sure it is adequately secured to your boat. Some boats are equipped or can be fitted with a specially designed towing mechanism. It can become a hazard should someone fall on it.

### **Passenger Safety**

Before getting underway, show all passengers where emergency and safety equipment is stowed, and explain how to use it. Everyone aboard should wear rubber-soled shoes which resist slipping on wet surfaces. While underway, passengers should remain seated inside the deck rails. Don't allow passengers to drag their feet or hands in the water. Always use handholds and other safety hardware to prevent falls. All non-swimmers, poor swimmers, and children should wear a PFD at all times. Federal regulations require that children under 13 years of

age wear a PFD when the boat is underway unless they are in an enclosed cabin or below deck.

- Do not start or operate the boat if anyone is seated on the sun deck or swim platform, or is nearby in the water. Water and/or debris exiting jet thrust nozzle can cause severe injury.
- The operator and passenger(s) should be properly seated before starting or moving the boat. All passenger(s) should be instructed to use the handholds or seat straps provided.
- When accelerating a boat with a passenger(s), whether from a complete stop or while underway, always do so progressively. Fast acceleration may cause your passenger(s) to lose their balance or grip and strike something in the boat or fall out of the boat. Make sure that your passenger(s) know of, or anticipate, any rapid acceleration.

### **First Aid**

As a boat operator, you should be familiar with basic first aid procedures that may be needed while you are far from help. Fish hook accidents or minor cuts and abrasions may be the most serious mishaps on board a boat, but you should also learn the proper procedures and be ready to deal with the truly serious problems like excessive bleeding, hypothermia, and burns. First aid literature and courses are available through most Red Cross chapters.

### **Operation by Minors**

Minors should always be supervised by an adult whenever operating a boat. Many countries have laws regarding the minimum age and licensing requirements of minors. Be sure to contact the state boating authorities for information. BRP recommends a minimum operator age of 16 years old.

# NAVIGATION RULES

## Operating Rules

Operating a boat can be compared with driving unmarked highways and roads. To prevent collisions or avoid other boaters, a system of operating rules must be followed. It's not only common sense... it's the law!

Check local and federal boating laws applicable to the waterways where you intend to use your boat. Learn the local rules of the road. Know and understand the applicable navigation system (such as buoys and signs).

Know the waters in which the boat is to be operated. Current, tides, rapids, hidden obstacles, wakes and waves etc. can affect safe operation. It is not advisable to operate the boat in rough or inclement weather.

Generally keep to your right and safely avoid other craft by keeping a safe distance from other craft, people and objects.

The following illustration identifies different parts of the boat that are used as directional reference points, the bow being the front of the boat. The port side of boat (left side) is visually identifiable by a RED light off the bow, and the starboard side (right side) by a GREEN light.

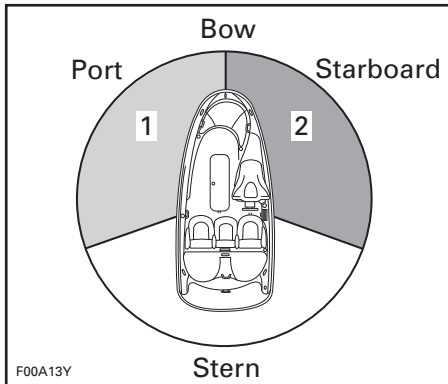

**TYPICAL**  
1. RED light  
2. GREEN light (yield zone)

## Crossing

Give right of way to craft ahead and to your right. Never cross in front of another craft.

RED light (give way to the other craft).

GREEN light (you have the right of way).

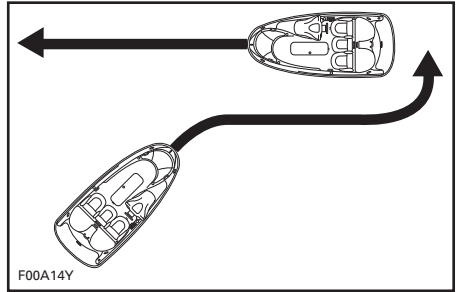

**TYPICAL**

## Meeting Head-On

Keep right.

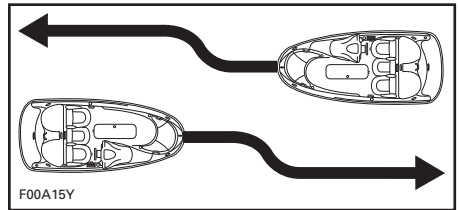

**TYPICAL**

## Passing

Give right of way to other craft and keep clear.

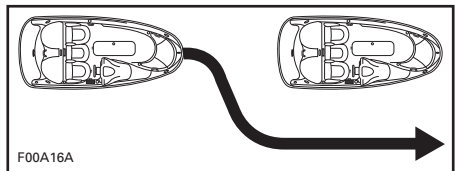

**TYPICAL**

## Navigation System

Navigational aids, such as signs or buoys, can help you identify safe waters. Buoys will indicate whether you should keep to the right (starboard) or to the left (port) of the buoy or to which channel you can continue. They may also indicate whether you are entering a restricted or controlled area such as a no wake or speed zone. They may also indicate hazards or pertinent boating information. Markers may be located on shore or on the water. They can also indicate speed limits, no power craft or boating, anchorage and other useful information. (The shape of each type of marker will provide assistance.)

Make sure you know and understand the navigation system applicable to the waterways where you intend to use the boat.

## Collision Avoidance

- Do not decrease throttle when trying to steer away from objects. You need throttle to steer.
- Always keep a constant lookout for other water users, other craft or objects, especially when turning. Be alert for conditions that may limit your visibility or block your vision of others.
- Respect the rights of other recreationists and/or bystanders and always keep a safe distance from all other craft, people and objects.
- Do not wake or wave jump, ride the surf line or attempt to spray or splash others with your boat. You may misjudge the ability of the boat or your own driving skills and strike a boat or person.

- This boat has the capability of turning more sharply than other boats. However, unless in an emergency, do not negotiate sharp, high speed turns. Such maneuvers make it hard for others to avoid you or understand where you are going. Also, you and/or your passenger(s) could be thrown from the boat.
- This boat has no brake. Stopping distance will vary depending on initial speed, load, wind, and water conditions. Practice stopping and docking in a safe, traffic free area to have an idea of how long it will take to stop the boat under varying conditions.
- Maintaining or increasing speed may be necessary to avoid a collision.

# FUELING

## Recommended Fuel

Use unleaded gasoline or oxygenated fuel containing a maximum of 10% of ethanol or methanol. The gasoline used must have the following recommended octane rating.

**NOTICE** Never experiment with other fuels. The use of inadequate fuel can result in boat performance deterioration and damage to critical parts in the fuel system and engine components.

### Inside North America

MINIMUM OCTANE RATING		
87 (RON + MON)/2		
91 (RON + MON)/2	▼	▼
ENGINES	91	87
310 HP Naturally-aspirated	--	X
430 HP Supercharged Intercooled	X <sup>(1)</sup>	X

(1) For optimum engine performance.

### Outside North America

MINIMUM OCTANE RATING		
92 RON		
95 RON	▼	▼
ENGINES	95	92
310 HP Naturally-Aspirated	--	X
430 HP Supercharged Intercooled	X <sup>(1)</sup>	X

(1) For optimum engine performance.

## Fueling Procedure

### **⚠ WARNING**

Fuel is flammable and explosive under certain conditions. Do not smoke or allow open flames or sparks in the vicinity.

Be very careful when fueling and adhere to the fueling procedures described below in this Operator's Guide and those given to you by the marina.

Know the capacity of the fuel tank. Avoid fueling at night except under well-lit conditions. Gas spills are not noticeable in the dark. Do not carry spare fuel or flammable liquids in any of the storage or engine compartments.

### **⚠ WARNING**

Follow these safe boating fueling instructions explicitly.

### On a Trailer

1. The boat should be level.
2. Ensure engine cover is closed to prevent fumes from entering the engine compartment.
3. Unscrew the cap counterclockwise and remove it slowly.



FUEL TANK CAP

4. Insert the gas pump spout into the filler neck and fill up fuel tank.

### **⚠ WARNING**

To prevent fuel back-flow, fill up tank slowly so the air can escape from the fuel tank.

5. Stop filling immediately after the release of the gas pump nozzle handle and wait a moment before removing the nozzle.

ing the spout. Do not retract the gas pump nozzle to put more fuel in fuel tank.

**⚠ WARNING**

Do not overfill or top off the fuel tank and leave the boat in the sun. As temperature increases, fuel expands and may overflow.

6. Install and fully tighten the fuel tank cap.

**⚠ WARNING**

Always wipe off any fuel spillage from the boat.

**In Water**

1. Turn off engines.
2. Tie boat securely to the fueling pier.
3. Do not allow anyone to remain in the boat.
4. Ensure engine cover is closed to prevent fumes from entering the engine compartment.
5. Have a fire extinguisher close at hand.
6. Unscrew the cap counterclockwise and remove it slowly.



FUEL TANK CAP

7. Insert the gas pump spout into the filler neck and fill up fuel tank.

**⚠ WARNING**

To prevent fuel back-flow, fill up tank slowly so the air can escape from the fuel tank.

8. Stop filling immediately after the release of the gas pump nozzle handle and wait a moment before removing the spout. Do not retract the gas pump nozzle to put more fuel in fuel tank.

**⚠ WARNING**

Do not overfill or top off the fuel tank and leave boat in the sun. As temperature increases, fuel expands and might overflow.

9. Install and fully tighten the fuel tank cap.

**⚠ WARNING**

Always wipe off any spillage from the boat.



---

# TRAILERING INFORMATION

Refer to the trailer instructions for proper capacity, operation, maintenance, accessories and warranty.

Check the regulations in your area concerning towing a trailer, especially the following rules:

- Brake system
- Tow vehicle weight
- Mirrors.

**NOTE:** An optional brake system is available for your trailer, contact Karavan Trailers:

[www.karavantrailers.com](http://www.karavantrailers.com).

## **WARNING**

Never tow a boat with water remaining in the ballast bag. The weight of ballasts increases the load on the trailer, the axle, and the tires, which could lead to premature wear or failure. This also contributes to reduce the stability of your vehicle on the road by raising the center of gravity of the trailer.

Take the following precautions when trailering the boat:

1. Tie the boat to both bow and stern (front/rear) eyelets so that it is firmly retained on the trailer.
2. Remove stern light (if installed).
3. Ensure all storage compartment covers are properly latched.
4. Ensure walk-thru door and windshield are securely locked in the opened or closed position.
5. Empty the ballast bag (if so equipped).
6. Close bimini top (if so equipped).
7. A Sea-Doo cover can protect the boat, particularly before driving on dirt roads, to prevent dirt entering through the air intake openings.

**NOTICE** Cockpit cover and bow cover should be used for storage only. To avoid damages to cover and their snaps, never travelling with these covers installed.

8. Observe trailering safety precautions.

**NOTICE** Always close and securely fasten rear storage compartment lid before trailering.

# LOCATION OF IMPORTANT ON-PRODUCT LABELS

The following labels are on your boat. If missing or damaged, they can be replaced free of charge. See an authorized Sea-Doo Boats dealer.

Please read the following labels carefully before operating your boat.

**NOTE:** The illustration of the boat indicates the approximate locations of the various labels. A dotted line indicates that the label is not on the outer surface, and that the seat or a cover of some type must be opened to see the label.

## Hang Tag

### The Star Label means Cleaner Marine Engines

This engine has been certified as:



**The Symbol for Cleaner Marine Engines:**

Cleaner Air and Water

For a healthier lifestyle and environment.

Better Fuel Economy

Burns up to 30-40 percent less gas and oil than conventional carbureted two-stroke engines, saving money and resources.

Longer Emission Warranty

Protects consumer for worry free operation.

219902678



**One Star-Low emission**

The one-star label identifies personal watercraft, outboard, sterndrive and inboard engines that meet the Air Resources Board's Personal Watercraft and Outboard marine engine 2001 exhaust emission standards. Engines meeting these standards have 75% lower emissions than conventional carbureted two-stroke engines. These engines are equivalent to the U.S. EPA's 2006 standards for marine engines.



**Two Stars-Very Low emission**

The two-star label identifies personal watercraft, outboard, sterndrive and inboard engines that meet the Air Resources Board's Personal Watercraft and Outboard marine engine 2004 exhaust emission standards. Engines meeting these standards have 20% lower emissions than One Star - Low-Emission engines.



**Three Stars-Ultra Low emission**

The three-star label identifies engines that meet the Air Resources Board's Personal Watercraft and Outboard marine engine 2008 exhaust emission standards or the Sterndrive and Inboard marine engine 2003 exhaust emission standards. Engines meeting these standards have 65% lower emissions than One Star - Low Emission engines.



**Four Stars-Super Ultra Low emission**

The four-star label identifies engines that meet the Air Resources Board's Sterndrive and Inboard marine engine 2009 exhaust emission standards. Personal Watercraft and Outboard marine engines may also comply with these standards. Engines meeting these standards have 90% lower emissions than One Star - Low Emission engines.

**BOMBARDIER RECREATIONAL PRODUCTS INC.**  
**VALCOURT, QUÉBEC, CANADA**  
Cleaner Watercraft - Get the facts 1-800-END-SMOG  
[www.arb.ca.gov](http://www.arb.ca.gov)

219902678

## Safety Labels

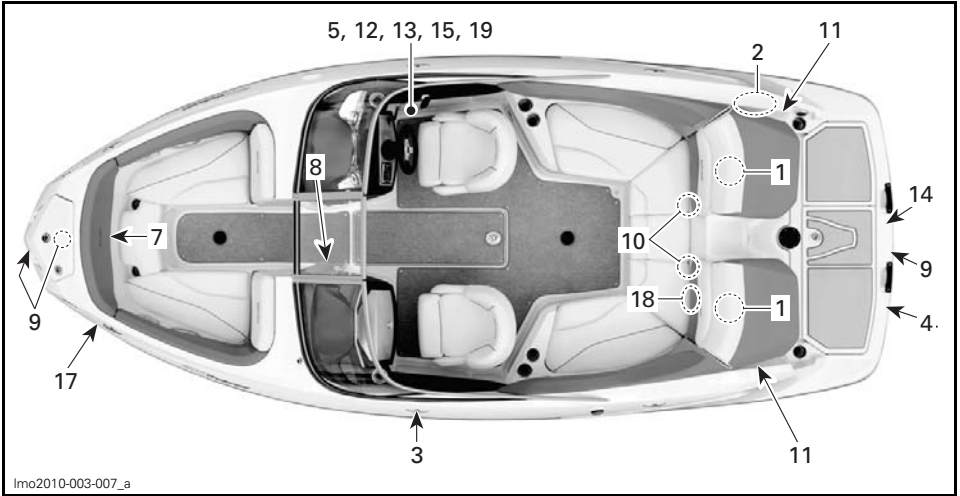

210 CHALLENGER\*

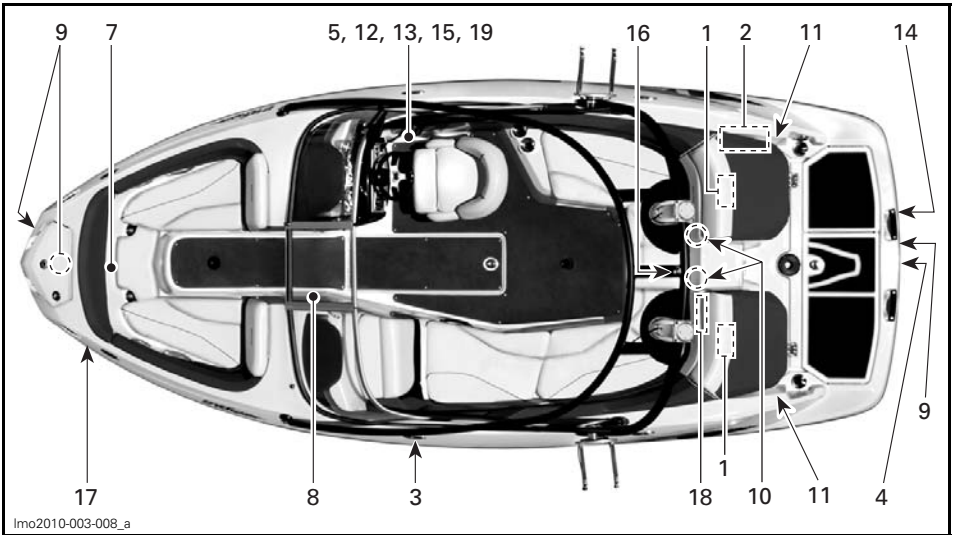

210 WAKE™

**⚠ WARNING / AVERTISSEMENT**

**CHECKING ENGINE OIL LEVEL**

Vehicle must be level to perform verification. Bring engine to normal operating temperature then let idle for 30 seconds. Stop engine, wait for at least 30 sec. and check oil level using the dipstick. CAUTION: Never let engine run out of water without the flush kit connected as it may damage the engine. Oil may be hot.

**VÉRIFICATION DU NIVEAU D'HUILE DU MOTEUR**

Avec la motomarine à niveau et à température normale d'utilisation, laissez le moteur tourner au ralenti 30 secondes. Arrêtez le moteur, attendez au moins 30 sec. et vérifiez le niveau d'huile. ATTENTION: Ne pas laisser tourner le moteur hors de l'eau sans faire circuler de l'eau par le raccord de rinçage. L'huile peut être chaude.

218902674

219902674

LABEL 1 - TYPICAL

**⚠ WARNING**

- Remove battery from boat before charging.
- Do not overcharge battery.
- Improper charging of battery can cause explosion.

204901330

204901330

LABEL 2

**⚠ CAUTION**

- Do not use bimini top as a support.
- Operate boat only at low speeds if bimini top is in use.
- Top can break or dislodge causing a risk of personal injury or interference with boat operation.

204901331

LABEL 6 - BIMINI TOP (NOT SHOWN)

**⚠ WARNING**

**Avoid serious injury or death from fire or explosion from leaking fuel or vapors.**

- Before fueling, turn off engine.
- Keep the boat level with no one aboard.
- Keep craft away from open flames and sparks.
- Use regular unleaded gasoline 87 pump octane.
- Do not overfill.
- Wipe up spilled gasoline.
- Inspect fuel system for leaks and verify components integrity at each pre-ride inspection.

204 902 065

204902065

LABEL 3

**⚠ WARNING**

**Avoid Serious Or Fatal Injury.  
Do Not Occupy Seat When Speed Exceeds 5 M.P.H.**

204901424

LABEL 7

**⚠ WARNING**

**Avoid serious personal injury or death.**

- Turn off engine(s) before using swim platform.
- Keep people, clothing and hair away from jet nozzle(s) or intake grate(s) to avoid entanglement, drowning and carbon monoxide poisoning.

204901334

204901334

LABEL 4



204900359

LABEL 8

**⚠ WARNING**

**Lock driver seat in forward position so that seats facing steering wheel during operation and does not swivel.**

204901347

LABEL 5

**⚠ WARNING**

- Engine must be OFF when using ladder or when swimmers are nearby.
- It is easier and safer to extend ladder while aboard boat, so extend prior to swimmer entering water.

204901335

204901335

LABEL 9



mmo2008-003-007

LABEL 10



219903239

LABEL 11

**⚠ WARNING**

Read and follow safety labels and operator's guide before operation. Severe injury or death can result from ignoring warnings or improper use of this sport boat. The performance of this sport boat may significantly exceed that of other boats you may have operated.

- Check throttle / shifter and steering operation and position before starting engine(s).
- Properly attach safety lanyard to your PFD.
- Directional control is reduced with decreasing speed and lost when engine is off.
- Do not splash others or jump waves or wakes.
- Occupants should always wear approved PFD and recommended protective clothing.
- Do not operate if passengers are not properly seated and using handgrips, or if visibility is obstructed. Do not allow passenger(s) to ride on any portion of the boat not designated in the operator's guide as a seat for use when underway.
- Keep a safe distance from all other water users.
- BRP recommends a minimum operation age of 16 years old supervised by an adult. Be aware of and observe all applicable laws and regulations.

204 902 067

204902067

LABEL 12

**⚠ WARNING**

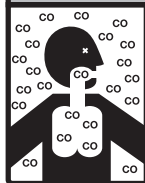

**Carbon monoxide (CO) can cause brain damage or death.**  
 Engine and generator exhaust contains odorless and colorless carbon monoxide gas. Signs of carbon monoxide poisoning include nausea, headache, dizziness, drowsiness, and lack of consciousness.  
 Get fresh air if anyone shows signs of carbon monoxide poisoning.  
 See Owner's Manual for information regarding carbon monoxide poisoning.

204901625

204901625

LABEL 13

**⚠ DANGER**

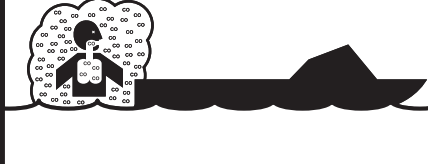

**Carbon monoxide (CO) can cause brain damage or death.**

Engine and generator exhaust contains odorless and colorless carbon monoxide gas.

Carbon monoxide will be around the back of the boat when engines or generators are running.

Move to fresh air if you feel nausea, headache, dizziness, or drowsiness.

204901626

204901626

LABEL 14

**⚠ WARNING**

Gasoline vapor may cause fire or explosion, resulting in serious injury or death. Inspect fuel system for leaks and verify components integrity at each pre-ride inspection.

Before starting engine

**ALWAYS:**

- Operate the bilge blower for 5 minutes.
- Open engine cover and check for gasoline vapor odor inside the engine compartment.
- Close the engine cover before starting the engine.

**NEVER:**

- Start the engine if gasoline vapor odor is present in the engine compartment.

204 902 066

204902066

LABEL 15

**⚠ WARNING**

**Misuse of tower may cause severe injury or death.**

- Use tower only for wakeboarding or water skiing.
- Do not allow tow rope to dangle or get entangled with occupants, boat or engine.
- Attach tow rope only at the center attachment point.
- Tow only 1 person at a time.
- Do not climb on, sit on or jump off tower.
- Never add accessories to the tower unless approved by BRP.

204 902 068

204902068

LABEL 16

**⚠ DANGER**

EXHAUST FUMES FROM ENGINES CONTAIN DEADLY CARBON MONOXIDE GAS (CO). BOATS WITH CANVAS OR POOR VENTILATION ARE MOST LIKELY TO COLLECT FUMES. CO SICKNESS SYMPTOMS INCLUDE HEADACHE, NAUSEA AND DISSINESS. DO NOT MISTAKE FOR SEASICKNESS. VENTILATE BOAT. SEE BOAT OWNER'S MANUAL FOR MORE DETAIL. TH-23

lmo2011-001-014\_a

IF EQUIPPED WITH "BIMINI TOP"

**⚠ WARNING**

TOP SHOULD NOT BE USED WHEN VESSEL SPEED EXCEEDS 35 MPH

lmo2011-001-015\_a

IF EQUIPPED WITH "BIMINI TOP"

## Compliance Labels



219902679

LABEL 17 - EMISSION CONTROL

<b>BOMBARDIER RECREATIONAL PRODUCTS INC.</b> <b>EMISSION CONTROL INFORMATION</b> THIS ENGINE IS CERTIFIED TO OPERATE ON UNLEADED GASOLINE AND CONFORMS TO 2010 U.S. EPA & CALIFORNIA EMISSIONS/EVAP REGULATIONS FOR MARINE SI ENGINES.		ENGINE FAMILY FEL ENGINE DISPLACEMENT EXHAUST EMISSION CONTROL SYSTEM SPARK PLUG TYPE SPARK PLUG GAP POWER FUEL LINE	<table border="1"> <tr><td>8BCXM1.506GN</td></tr> <tr><td>16.44 g/kW-hr HC+NOx</td></tr> <tr><td>1493.8 cc</td></tr> <tr><td>MFI, SC CAC</td></tr> <tr><td>NGK-DCPR8E</td></tr> <tr><td>0.030 in. / 0.7-0.8 mm</td></tr> <tr><td>116 kW</td></tr> <tr><td>9TORPLINE365-A15</td></tr> </table>	8BCXM1.506GN	16.44 g/kW-hr HC+NOx	1493.8 cc	MFI, SC CAC	NGK-DCPR8E	0.030 in. / 0.7-0.8 mm	116 kW	9TORPLINE365-A15	FAMILLE DE MOTEUR LIMITE DES ÉMISSIONS DE LA FAMILLE CYLINDRÉE SYSTÈME DE CONTRÔLE DES ÉMISSIONS TYPE DE BOUGIE ÉCARTEMENT DES ÉLECTRODES PUISSANCE BOYAU ESSENCE	DATE / NA <div style="border: 1px solid black; width: 100px; height: 40px; margin-top: 5px;"></div>
8BCXM1.506GN													
16.44 g/kW-hr HC+NOx													
1493.8 cc													
MFI, SC CAC													
NGK-DCPR8E													
0.030 in. / 0.7-0.8 mm													
116 kW													
9TORPLINE365-A15													
<b>BOMBARDIER PRODUITS RÉCRÉATIFS INC.</b> <b>RENSEIGNEMENTS SUR LE DISPOSITIF ANTIPOLLUTION</b> CE MOTEUR EST CERTIFIÉ POUR FONCTIONNER À L'ESSENCE SANS PLOMB ET IL RÉPOND AUX NORMES 2010 DE L'EPA DES É.-U. & RÉGLEMENTATIONS CALIFORNIENNES POUR LES MOTEURS MARINS À ALLUMAGE COMMANDÉ.		VOIR MANUEL DE L'OPÉRATEUR LES SPÉCIFICATIONS DE MAINTENANCE.											
SEE OPERATORS GUIDE FOR MAINTENANCE SPECIFICATIONS.		204901998											

LABEL 18 - EPA COMPLIANCE (310 HP)

<b>BOMBARDIER RECREATIONAL PRODUCTS INC.</b> <b>EMISSION CONTROL INFORMATION</b> THIS ENGINE IS CERTIFIED TO OPERATE ON UNLEADED GASOLINE AND CONFORMS TO 2010 U.S. EPA & CALIFORNIA EMISSIONS/EVAP REGULATIONS FOR MARINE SI ENGINES.		ENGINE FAMILY FEL ENGINE DISPLACEMENT EXHAUST EMISSION CONTROL SYSTEM SPARK PLUG TYPE SPARK PLUG GAP POWER FUEL LINE	<table border="1"> <tr><td>8BCXM1.506GS</td></tr> <tr><td>16.17 g/kW-hr HC+NOx</td></tr> <tr><td>1493.8 cc</td></tr> <tr><td>MFI, SC CAC</td></tr> <tr><td>NGK-DCPR8E</td></tr> <tr><td>0.030 in. / 0.7-0.8 mm</td></tr> <tr><td>160 kW</td></tr> <tr><td>9TORPLINE405-A15</td></tr> </table>	8BCXM1.506GS	16.17 g/kW-hr HC+NOx	1493.8 cc	MFI, SC CAC	NGK-DCPR8E	0.030 in. / 0.7-0.8 mm	160 kW	9TORPLINE405-A15	FAMILLE DE MOTEUR LIMITE DES ÉMISSIONS DE LA FAMILLE CYLINDRÉE SYSTÈME DE CONTRÔLE DES ÉMISSIONS TYPE DE BOUGIE ÉCARTEMENT DES ÉLECTRODES PUISSANCE BOYAU ESSENCE	DATE / SCIC <div style="border: 1px solid black; width: 100px; height: 40px; margin-top: 5px;"></div>
8BCXM1.506GS													
16.17 g/kW-hr HC+NOx													
1493.8 cc													
MFI, SC CAC													
NGK-DCPR8E													
0.030 in. / 0.7-0.8 mm													
160 kW													
9TORPLINE405-A15													
<b>BOMBARDIER PRODUITS RÉCRÉATIFS INC.</b> <b>RENSEIGNEMENTS SE R LE DISPOSITIF ANTIPOLLUTION</b> CE MOTEUR EST CERTIFIÉ POUR FONCTIONNER À L'ESSENCE SANS PLOMB ET IL RÉPOND AUX NORMES 2010 DE L'EPA DES É.-U. & RÉGLEMENTATIONS CALIFORNIENNES POUR LES MOTEURS MARINS À ALLUMAGE COMMANDÉ.		VOIR MANUEL DE L'OPÉRATEUR LES SPÉCIFICATIONS DE MAINTENANCE.											
SEE OPERATORS GUIDE FOR MAINTENANCE SPECIFICATIONS.		204902041											

LABEL 18 - EPA COMPLIANCE (430 HP)

## Technical Information Labels

### 210 Challenger/SP

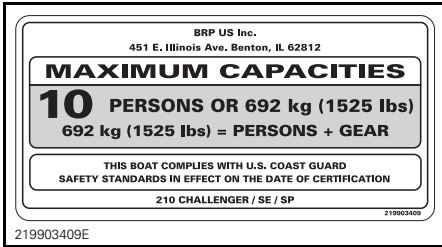

LABEL 19 – CAPACITY

### 210 Challenger/SP - CE

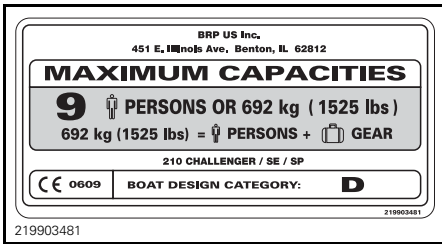

LABEL 19 – CAPACITY

### 210 WAKE

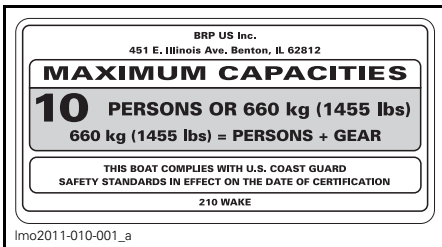

LABEL 19 – CAPACITY

### 210 WAKE - CE

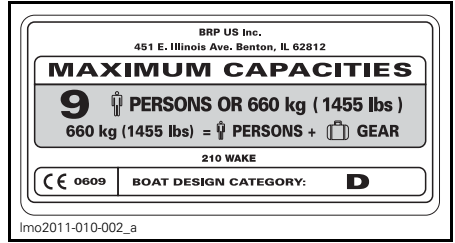

LABEL 19 – CAPACITY



---

## PRE-RIDE INSPECTION

### **WARNING**

The pre-ride inspection is very important before operating the boat. Bring all safety equipment required by local laws. Perform a pre-ride inspection before each ride to detect potential problems during operation. The pre-ride inspection can help you monitor wear and deterioration before they become a problem. Correct any problems that you discover to reduce the risk of a breakdown or crash. See an authorized Sea-Doo Boat dealer if necessary.

For more detailed information on these items, refer to the applicable sections.

### **WARNING**

Engines should be off and the tether cord must always be removed from engine cut-off switch before verifying any of the following. Only start boat once all items have been checked and operate properly.

## Pre-Ride Check List When Boat is Trailered

SUMMARY			
	ITEM	OPERATION	✓
BOAT ON TRAILER	Fuel tank	Refill.	
	Hull	Inspect for damage.	
	Jet pump water intake	Inspect/clean.	
	Bilge	Ensure drain plug is properly secured.	
	Engine compartment	Verify for leaks or gasoline vapor odor. Verify fuel system components integrity.	
	Bilge	Check for abnormal water presence in bilge.	
	Main battery cut-off switch	Ensure it is in the ON position.	
	Throttle lever	Check operation.	
	Shift lever	Check operation.	
	Steering	Check operation.	
	Bilge blower	Turn ON bilge blower for 5 minutes to ventilate bilge.	
	Multifunction gauge cluster	Gauge should turn ON and self-test when installing the tether cord on engine cut-off switch.	
	Towing tower (optional)	Check tightness of mounting points fasteners.	
	Bimini top (optional)	Check tightness of mounting points fasteners. Check for canvas damages.	
	Mandatory safety boating equipment	Ensure all required safety equipment is on board.	
	Storage compartment covers	Ensure they are closed and latched.	
	Navigation lights	Check operation.	
	Engines start/stop button	Check operation for starting and stopping engine.	
	Engine cut-off switch	Check if engine can be stopped by pulling off the tether cord from the engine cut-off switch.	
BOAT ON WATER (engine started)	Throttle lever	Check operation.	
	Shift lever	Check operation.	
	Steering	Check operation.	

## Pre-Ride Check List When Boat is Docked

SUMMARY			
DOCKED BOAT	ITEM	OPERATION	✓
	Fuel tank	Refill.	
	Bilge	Check for abnormal water presence in bilge.	
	Engine compartment	Verify for leaks or gasoline vapor odor. Verify fuel system components integrity.	
	Main battery cut-off switch	Ensure it is in the ON position.	
	Throttle lever	Check operation.	
	Shift lever	Check operation.	
	Steering	Check operation.	
	Bilge blower	Turn ON bilge blower for 5 minutes to ventilate bilge.	
	Multifunction gauges cluster	Gauge should turn ON and self-test when installing the tether cord on engine cut-off switch.	
	Towing tower (optional)	Check tightness of mounting points fasteners.	
	Bimini top (optional)	Check tightness of mounting points fasteners. Check for canvas damages.	
	Mandatory safety boating equipment	Ensure all required safety equipment is on board.	
	Storage compartment covers	Ensure they are closed and latched.	
	Navigation lights	Check operation.	
	Engine start/stop button	Check operation for starting and stopping engine.	
Engine cut-off switch	Check if engine can be stopped by pulling off the tether cord from the engine cut-off switch.		

## Fuel

Make sure you have enough gasoline. Fill the fuel tank, as needed.

### **⚠ WARNING**

Strictly adhere to instructions in the *FUELING PROCEDURE*.

## Hull

Walk around your boat inspecting the hull for cracks or other damages.

## Jet Pump Water Intakes

Remove weeds, shells, debris or anything else that could restrict the flow of water and damage the cooling systems or propulsion units. Clean as necessary. If any obstruction cannot be removed, refer to an authorized Sea-Doo Boats dealer for servicing.

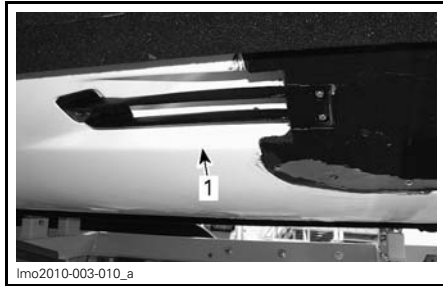

1. Inspect this area

Inspect leading edges of the impellers, for nicks or bends, which greatly reduce performance of the boat.

## Bilge

### **⚠ WARNING**

Check for abnormal water presence in bilge. Make sure drain plug is properly secured before launching the boat in water.

## Engine Compartment

Ensure that the engine compartment is free of gasoline vapor odors and visually, inspect fuel lines for deterioration and the condition of the fuel tank straps and their fasteners.

**NOTE:** The engine cover latch handle is located under the stern central cushion.



1. Location of the engine cover latch handle

### **⚠ WARNING**

If any leaks or gasoline vapor odors are present, **DO NOT** start engines or use electrical accessories. Consult an authorized Sea-Doo Boats dealer.

## Main Battery Cut-Off Switch

Turn switch in the ON position to allow starting engine and use accessories.



**MUST BE GREEN WHEN ON**

1. ON position

## Throttle/Shifter System

### WARNING

Check lever operation before starting the engines. Remove tether cord from the emergency engine stop switch to prevent an accidental starting.

Check lever for free and smooth operation.

Check that reverse gates moves freely.

- With throttle/shifter lever in forward position, the gates must be in upward position and locked.
- With the throttle/shifter lever in neutral position, gates must be in middle position.
- With throttle/shifter lever in reverse position, gates must be in downward position.

Check the efficiency of the reverse gates lock.

### WARNING

Check reverse gates lock before starting the engines.

To verify the reverse gates lock, move throttle/shifter lever to the FORWARD position.

Pull backwards on the starboard reverse gate.

The reverse gates lock are working if the reverse gates stays in the up position.

**NOTICE** If the reverse gates does not stay in the up position when the throttle/shifter lever is at FORWARD, do not operate the boat further, see an authorized Sea-Doo Boats dealer.

## Steering System

Check steering for free and smooth operation. Have another person help check the jet pump nozzle pivots accordingly.

### WARNING

Check operation of steering and corresponding steering nozzles before starting engines.

## Multifunction Gauge Cluster

Check that the multifunction gauges cluster is powered and self testing when installing the tether cord to engine cut-off switch.

## Bilge Blower Switch

Turn ON the bilge blower and make sure it is operational. Leave it on for 5 minutes to ventilate the bilge from potential gasoline vapor hazard.

## Towing Tower (Optional)

Check towing tower, if so equipped. Check for tightness of mounting points fasteners and the integrity of the tower structure.

## Bimini Top (Optional)

Check bimini top, if so equipped. Check for tightness of mounting points fasteners and the integrity of the structure. Check for canvas damages.

## Mandatory Safety Boating Equipment

Make sure to have on board all safety equipment required by the local regulations (fire extinguisher, PFDs, visual distress signal devices, etc.) and they are in good condition. Check with a local competent authority for the required equipment.

Periodically check the straps buckles and fasteners of your personal flotation device to make sure that there are no rips or tears and that the buckles are functioning properly.

## **Storage Compartment Covers**

Ensure they are closed and latched.

## **Navigation Lights**

Ensure all navigation lights are operational and replace any defective light before using the boat.

## **Engine Start/Stop Buttons**

Ensure start/stop buttons operate properly. Start and stop each engine using each button individually.

### **WARNING**

If engines do not shut-off when pushing engine start/stop buttons, do not operate the boat further, see an authorized Sea-Doo Boats dealer.

## **Engine Cut-off Switch**

Verify when pulling off the tether cord from the engine cut-off switch that engine can be stopped.

### **WARNING**

Do not use boat if engine can not be stopped by pulling off the tether cord.

# ***BOAT INFORMATION***

# CONTROLS

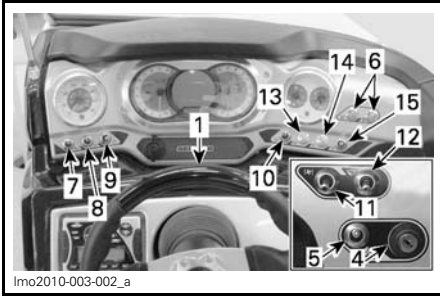

UPPER SECTION OF THE DRIVERS' CONSOLE

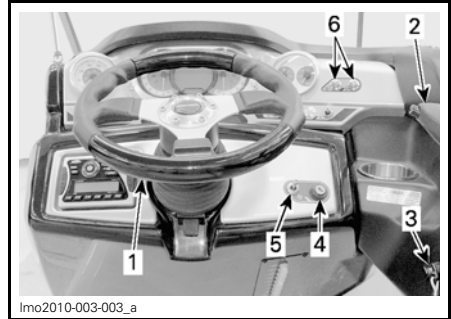

LOWER SECTION OF THE DRIVERS' CONSOLE

1. Steering wheel
2. Throttle/shifter lever
3. Emergency engine stop switch
4. Ignition switch
5. Blower switch
6. Engine start/stop buttons
7. Horn switch
8. Bilge pump switch
9. Navigation light switch
10. Deck lights switch
11. Heater switch
12. Ballast switch
13. MODE button
14. SET button
15. UP and DOWN switch

## 1) Steering Wheel

The steering wheel controls the direction of the boat. Turning the steering wheel clockwise steers the boat to the right and inversely.

### Tilt Steering

For your convenience, steering wheel can be adjusted in many positions. Push and hold button below the steering column to adjust steering wheel vertically. Release button when adjusted to the desired position.



PUSH AND HOLD BUTTON TO ADJUST STEERING WHEEL

1. Button



## 2) Throttle/Shifter Lever

A 3-position lever:

- Forward
- Neutral
- Reverse.



1. Throttle/shifter lever

To move the lever, push the controller release button.

**NOTICE** Always push controller release button before shifting to avoid damaging the lever and its components.

Refer to *OPERATING INSTRUCTIONS* section for detailed operation of forward, neutral and reverse.

## 3) Emergency Engine Stop Switch

The emergency engine stop switch is located on starboard side, between throttle lever and driver's console.



1. Emergency engine stop switch

### **⚠ WARNING**

Keep the emergency engine stop switch free from obstructions that could interfere with its operation. The proper use of the tether cord can prevent a runaway boat situation. Remove the tether cord clip from the switch when stopped to help prevent accidental starting.

The tether cord clip should be securely clipped onto the emergency engine stop switch to allow engines starting. Pulling the tether cord clip off the emergency engine stop switch shuts the engine OFF.

### **⚠ WARNING**

Should the tether cord clip become loose or fail to remain on the emergency engine stop switch, replace it immediately.

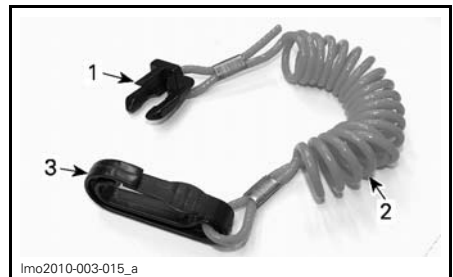

1. Tether cord clip (switch side)
2. Tether cord
3. Driver's clip

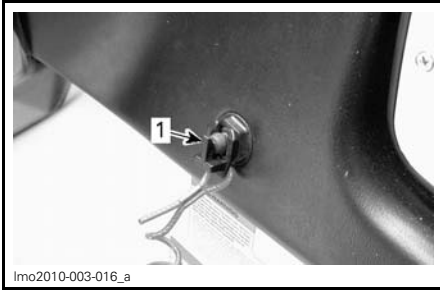

lmo2010-003-016\_a

1. Tether cord clip secured to emergency engine stop switch

**⚠ WARNING**

Always attach the tether cord to the operator using its Personal Flotation Device (PFD) or a wrist strap before starting the engine.

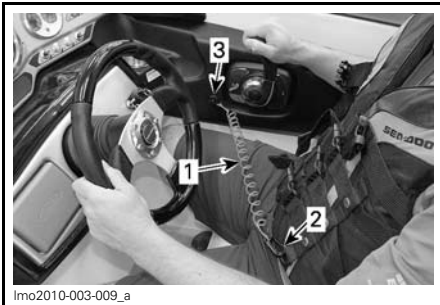

lmo2010-003-009\_a

1. Tether cord
2. Tether cord secured to PFD
3. Tether cord secured to switch

If emergency engine shut off is required, pull tether cord clip off the switch.

**⚠ WARNING**

Directional control is reduced when throttle is decreased and lost when engine is OFF. Always remove tether cord clip when boat is not in operation.

**4) Ignition Switch**

The ignition switch is located to the left of steering wheel. It is a 3-position switch.

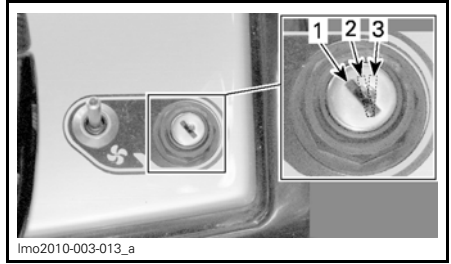

lmo2010-003-013\_a

**IGNITION SWITCH POSITIONS**

1. OFF
2. ACCESSORIES (lights and radio)
3. ON

Two keys are provided with your boat.

Insert key in switch and turn to the desired position. To remove key, turn key to OFF position then pull it out.

**NOTICE** If the key does not turn easily, do not force it. Pull it out and reinsert key.

**NOTE:** When turning the key to OFF position, the boat electrical system will take a few seconds to shut down.

**⚠ WARNING**

If you turn the ignition switch to OFF, it shuts off the engines and directional control is lost.

The ACCESSORIES position allows the operation of the deck lights and the radio. Remember that having the accessories on without the engines running discharges the battery.

The ON position activates the complete electrical system. The ON position allows engines starting.

Always turn ignition key to the OFF position after engine has been stopped.

**NOTE:** While engine can be stopped by turning ignition key to OFF position, we recommend the engine be stopped by pressing the engine stop button.

## 5) Bilge Blower Switch

This switch is located on driver's console at the right of steering wheel beside the ignition switch.

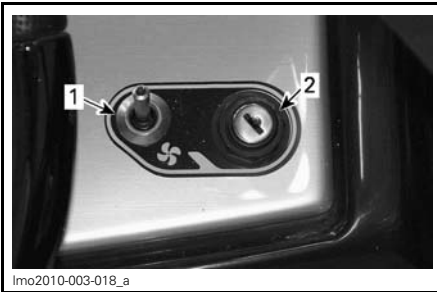

lmo2010-003-018\_a

### BILGE BLOWER SWITCH

1. Bilge blower switch
2. Ignition switch

This is a 2-position OFF/ON switch.

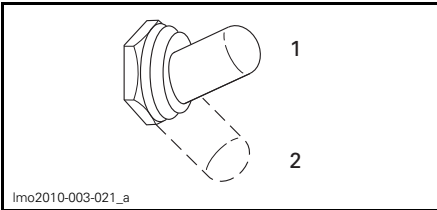

lmo2010-003-021\_a

1. ON position
2. OFF position

When turned on, the blower ventilates the engine compartment.

### **⚠ WARNING**

Gasoline vapors can explode. Always use blower for a minimum of 5 minutes before starting engine. Turn blower to OFF prior to start engines.

### **⚠ WARNING**

Use of the bilge blower does not subtracts from inspecting the engine compartment for fuel vapors. If any leaks or gasoline vapor odors are present, do not start the engines. Consult an authorized Sea-Doo Boats dealer.

**NOTICE** Using the bilge blower for a prolonged time when the engines are not running will discharge the battery.

Blower must be turned off during boat operation.

## 6) Start/Stop Buttons

The start/stop buttons are located beside the right analogical indicator.

Dual function push buttons. Used to start as well as to stop engines.

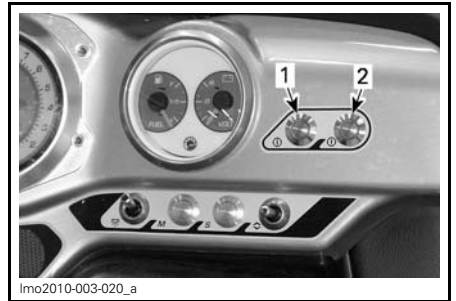

lmo2010-003-020\_a

1. For port engine
2. For starboard engine

## Engine Starting and Stopping

Refer to *OPERATING INSTRUCTIONS* for complete procedure to start and stop the engine.

## 7) Horn Switch

This switch is located on driver's console at the left of steering wheel. Below analog speedometer.

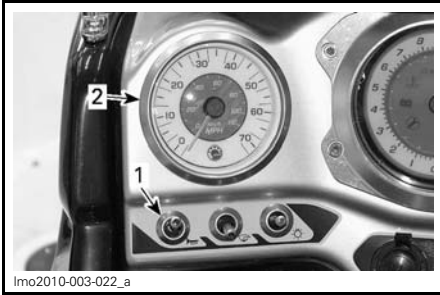

1. Horn switch
2. Analog speedometer

The horn switch is a 2-position toggle type switch.

Raise the switch stem to activate the horn.

Release the switch stem to stop horn.

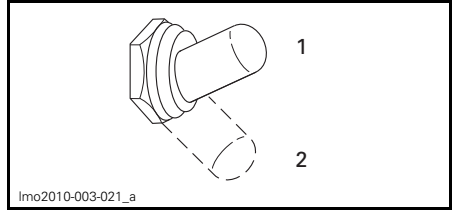

1. ON position
2. OFF position

Raise the switch stem to ON position when a manual operation of the bilge pump is required.

Lower switch stem to OFF when finished.

**NOTICE** To avoid damaging bilge pump, always turn pump OFF after water is evacuated.

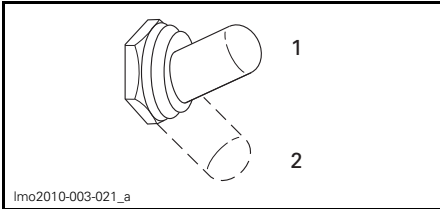

1. ON position
2. OFF position

## 8) Bilge Pump Switch

This switch is located on driver's console at the left of steering wheel, below analog speedometer.

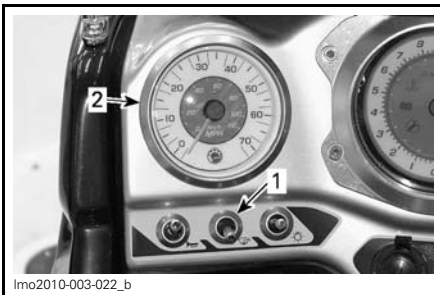

1. Bilge pump switch
2. Analog speedometer

This is a 2-position OFF/ON switch.

## Bilge Pump Automatic Mode

The bilge pump will evacuate automatically the water from the bilge.

A water sensor detects the water, activating the pump. After the water is pumped out, the pump shuts-off automatically.

**NOTE:** The automatic mode can not be deactivated, even if the main battery cut-off switch is turned OFF.

**NOTICE** Prolonged operation of the bilge pump when the boat is moored will lead to battery discharge and the bilge pump will quit working.

## 9) Navigation Lights Switch

This switch is located on driver's console at the right of steering wheel. Below analog speedometer.

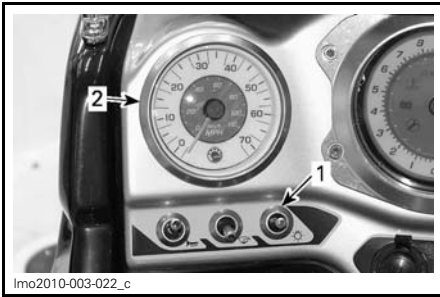

lmo2010-003-022\_c

1. Navigation lights switch
2. Analog speedometer

A 3-position NAV/OFF/ANC switch.

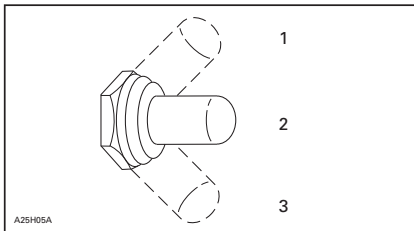

A25H05A

1. NAV
2. OFF
3. ANC

**ANC:** Turns on the anchorage light (stern light) when the boat is anchored.

**OFF:** Turns off all lights.

**NAV:** Turns on both bow and stern lights and illuminates the gauges.

## 10) Deck Light Switch

This switch is located on driver's console at the right of steering wheel, below the analog fuel gauge.

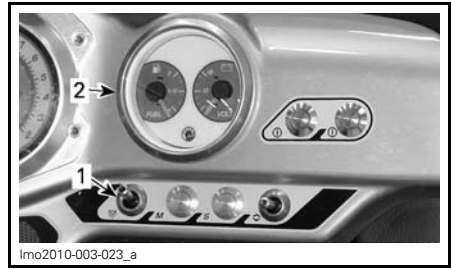

lmo2010-003-023\_a

1. Deck light switch
2. Analog fuel gauge

This is a 2-position OFF/ON switch.

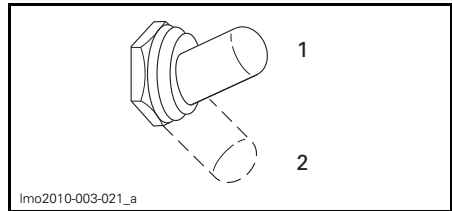

lmo2010-003-021\_a

1. ON position
2. OFF position

Raise switch stem to ON position to turn on the deck lights.

Lower switch stem to OFF position to turn off the deck lights.

**NOTE:** The ignition switch must be in the ACC or ON position to allow lights operation.

**NOTICE** Using the deck lights for a prolonged time when the engine is not running will discharge the battery.

## 11) Heating Fan Switch (210 WAKE)

This boat is equipped with a heating system to warm-up cockpit area or recreational activities users when needed.

Use the 2-position switch on the RH side of driver's console.

**NOTICE** Using the heating system fan for a prolonged time when the engines are not running will discharge the battery.



lmo2010-003-024\_a

1. Heating system switch

## 12) Ballast System Switch (210 WAKE)

The ballast bag allows you to fill up to 272 kg (600 lb) of water in minutes at the touch of a button.

### ⚠ WARNING

The added weight of the ballast affects the handling characteristics of the boat. Do not perform high speed maneuvers when ballast bag contains water. Furthermore, it is then not recommended to operate the boat at speeds of more than 50 km/h (30 MPH).

This switch is located on driver's console at the right of steering wheel, above the ignition switch.



lmo2010-003-024\_b

1. Ballast switch

This is a 3-position switch.

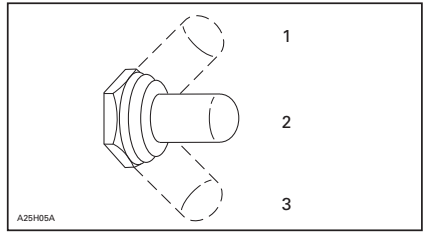

1. FILL
2. OFF
3. EMPTY

Raise switch stem to fill up the ballast bag.

Lower switch stem to empty the ballast bag.

**NOTE:** The ignition switch must be in the ACC or ON position to allow ballast system operation.

## 13) MODE Button

This button is located on driver's console at the right of steering wheel, below the analog fuel gauge.

Press this button to scroll various functions through the digital screen in the information center.

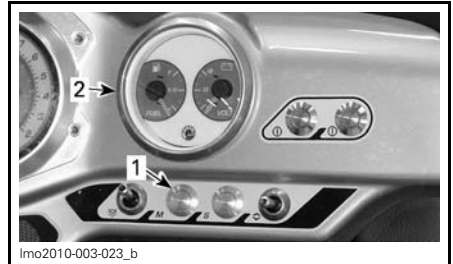

lmo2010-003-023\_b

1. MODE button
2. Analog fuel gauge

For further details on the information center and the display modes, refer to *INFORMATION CENTER*.

## 14) SET Button

This button is located on driver's console at the right of steering wheel, below the analog fuel gauge.

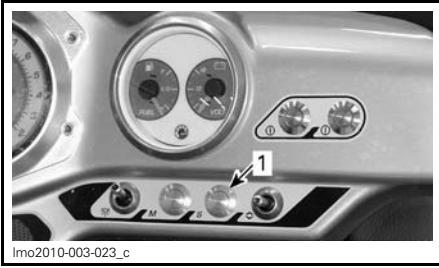

1. SET button

Press SET to select the desired function or to save any modified settings.

For further details on the information center and the display modes, refer to *INFORMATION CENTER*.

## 15) UP and DOWN Switch

This switch is located on driver's console at the right of steering wheel, below the analog fuel gauge.

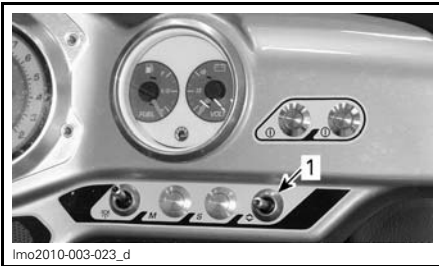

1. UP and DOWN switch

Move the switch stem up or down to navigate through the selected function using MODE or SET buttons or to modify settings.

**NOTE:** The UP and DOWN switch is also used for adjusting boat speed when operating in CRUISE mode.

For further details on the information center and the display modes, refer to *INFORMATION CENTER*.

# GAUGES

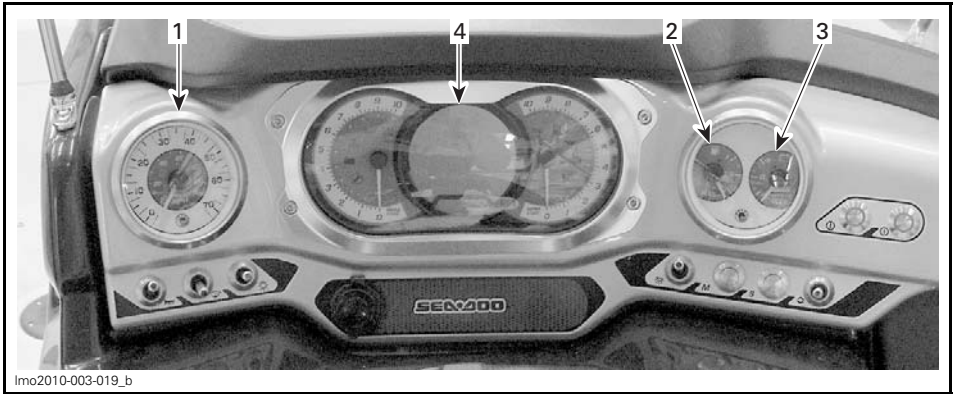

## 1) Analog Speedometer

The speedometer, located in the left top corner of the drivers' cockpit, provides an analog indication of the speed of the boat in miles per hour (MPH) and kilometers per hour (km/h).

The speed indication is based on a GPS (Global Positioning System) incorporated within the information center.

An indicator light seen in the right tachometer lights up when the GPS is receiving a good signal.



**GPS INDICATOR LIGHT**

If for some reason the GPS signal is lost, a default mode is used whereby, the speed is calculated using information received from other systems to provide an estimated boat speed.

## 2) Analog Fuel Level Gauge

Located to the right of the information center, this gauge continuously indicates the amount of fuel in fuel tank when engines are running.

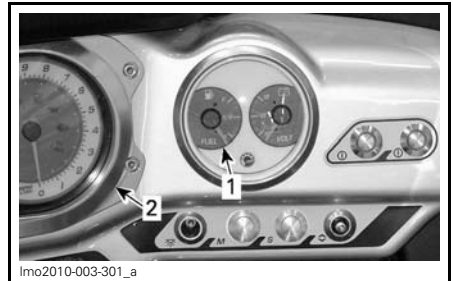

1. Analog fuel level gauge
2. Information center

The gauge is illuminated whenever the navigation lights are used.

The fuel level can also be verified without having engines running. Turn ignition key ON; the gauge will be activated for approximately 30 seconds.

## 3) Analog Voltmeter

The voltmeter is located to the right of the information center.

The voltmeter displays the battery voltage. Normally, it should indicate around 14 V (volts).



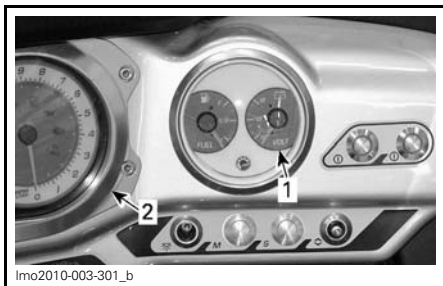

lmo2010-003-301\_b

1. Analog voltmeter
2. Information center

**NOTE:** It is normal to see a voltage drop during engine cranking.

## 4) Information Center

The information center is a cluster of gauge, indicator lights and a digital screen to the operator.

The text message can be displayed in 3 different languages and the units of measurement can be displayed in metric or imperial units. See an authorized Sea-Doo Boats to have the information center set to the unit of measurement and available language of your choice.

It allows the operator to view at a glance several indications such as , engines RPM, fuel level and engine temperature. The gauge can also be used to navigate through and select several functions, modes of operation and change certain settings and system parameters.

Indicator lamps advise the operator of selected functions or malfunctions.

The gauge incorporates a GPS (global positioning system) that it uses for the compass and speedometer indications, and provides signals to other systems as required for their operation.

**NOTE:** An information center self test can be initiated by turning the ignition key in ON position. All LCD segments and indicator lights will turn on for approximately 3 seconds.

Should a fault be detected during the self-test function, an error message will be displayed, an indicator light may come on, and an audible signal (beep code) may be heard to signal that a fault has been detected.

A fault code can be generated and memorized to assist your authorized Sea-Doo Boats dealer in troubleshooting the faulty system. Refer to **FAULT CODE DISPLAY** in this section for instructions on how to display fault codes.

### **⚠ WARNING**

**Do not adjust the display while riding. You could lose control.**

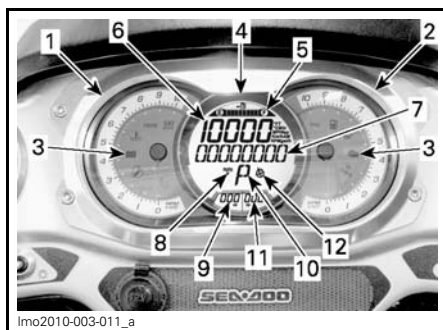

lmo2010-003-011\_a

### **INFORMATION CENTER FUNCTIONS**

1. Tachometer (Port Engine)
2. Tachometer (Starboard Engine)
3. Indicator lights
4. Digital screen
5. Fuel level
6. Numerical display
7. Multifunction display
8. Depth sounder indicator
9. Hour meter display (Port Engine)
10. Engine (P = Port, S = Starboard)
11. Hour meter display (Starboard Engine)
12. Compass

### **Tachometer**







The tachometers provide an analog indication of the revolutions per minute (RPM) of the engines. Multiply the indicated number by 1000 to obtain the actual engines RPM.

## Indicator Lights

Indicator lights (pilot lamps), located in the tachometers, inform you of a selected function, a normal condition or a system anomaly.

An indicator light may be accompanied by a scrolling message in the multi-function display.

See table below for usual pilot lamp information. Refer to *MONITORING SYSTEM* for details on malfunction pilot lamps.

PILOT LAMPS	MESSAGE DISPLAY	DESCRIPTION
<b>LH TACHOMETER</b>		
	-	When turn ON: SKI MODE is engaged. When blinking: SKI MODE is selected but not engaged
	-	CRUISE mode engaged
	MAINTENANCE REMINDER	Maintenance required
<b>RH TACHOMETER</b>		
	-	Indicate both engines turn at the same RPM
	LOW-FUEL	Low fuel level, approx. 25% tank capacity 41.6 L (11 U.S. gal.)
	-	Good GPS uplink

## Fuel Level

A bar gauge located on the top of the digital screen continuously indicates the amount of fuel in the fuel tank while riding.

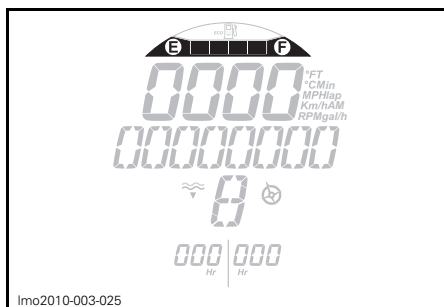

### FUEL LEVEL INDICATOR

When the fuel tank is full, 8 segments (bars) of the indicator are turned on.

When there is only 2 segments of fuel indicated (approximately 25% fuel tank capacity or 41.6 L (11 U.S. gal.)), the low fuel indicator light will come on to advise you of the low fuel condition.

An audible warning (one long beep) will be heard periodically as long as the low fuel condition exists.

### Fuel Economy Mode

The iTC (intelligent Throttle Control) system allows to maintain a steady speed and constant RPM to reduce fuel consumption.

To engage the fuel economy mode:

1. Press MODE button repeatedly until FUEL ECONOMY MODE is displayed.

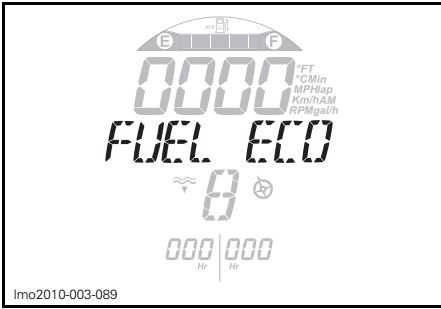
**FUEL ECONOMY MODE**

2. Press the SET button once, the following message will be displayed "FUEL ECONOMY MODE - PRESS SET to activate or MODE to exit".
3. Press and hold the SET button until FUEL ECONOMY MODE reappears.

To confirm the Fuel Economy mode, the symbol ECO is displayed on the LH of the smiling fuel tank.

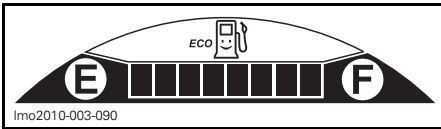

To cancel the fuel economy mode:

1. Move throttle/shifter handle in NEUTRAL position.
2. Press the MODE button.

### Numerical Display

The numerical display is used to provide a variety of indications as per selection made from the DISPLAY function in the multifunction display:

- Water depth
- Engines RPM
- Boat speed
- Fuel consumption (instant and average)
- Remaining fuel range (distance and time)
- Engines temperature
- Altitude
- Top and average speed

- Top and average engines RPM
- Clock.

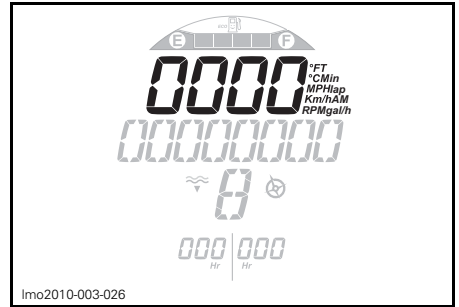
**NUMERICAL DISPLAY**

When the information center is first powered up, the numerical display defaults to the last function chosen by the operator from the multifunction display.

The numerical display is also used to display various system mode settings such as:

- SKI MODE setting
- CRUISE setting
- LAP TIME setting.

### Changing Clock

1. Press MODE button repeatedly until SETTINGS is displayed.

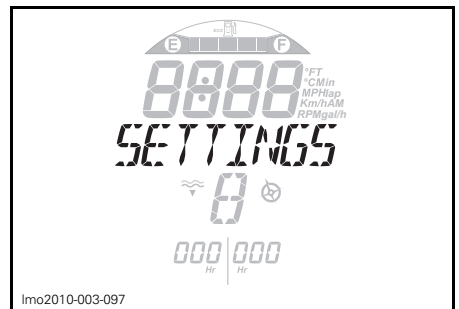
**SETTINGS**

2. Press the SET button to validate your choice. The hour and the message CLOCK will be displayed.



CLOCK

- Press the SET button again, the message CHANGE CLOCK will be displayed.

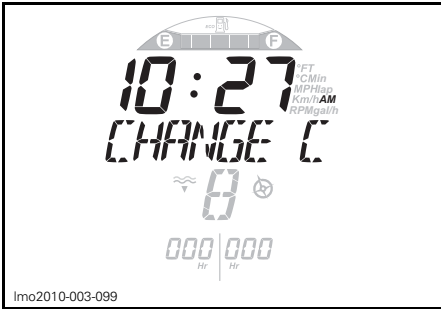

CHANGE CLOCK

- Use UP and DOWN switch to adjust the clock.
- Press MODE or SET button to save the clock and return to the main display.



MAIN DISPLAY

## Changing Numerical Display Indication

To change the indication in the numerical display, press the MODE button repeatedly until DISPLAY is visible in the multifunction display.

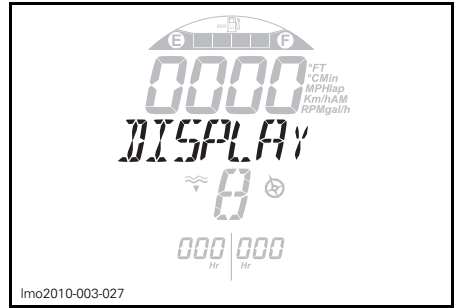

DISPLAY MENU

Move switch stem up or down until the preferred indication selection is visible in the multifunction display.

Press the SET button to select and save the preferred indication, or wait for the display function to time out. The last indication visible will be automatically save. The numerical display will then switch to the new indication with a small abbreviation of the indication type to its right:

- FT or M
- RPM
- MPH or Km/h
- °F or °C
- Lap
- Gal/h or L/h
- Min
- AM or PM.

For example, to display the ALTITUDE information:

- Press the MODE button repeatedly until DISPLAY is displayed
- Then press SET button once
- Lift up the UP and DOWN switch until ALTITUDE is displayed
- And finally, press SET button to confirm and save your selection.

## Lap Time Mode

The lap timer can be used to record up to 50 individual lap times.

The Lap Time mode is a chronograph to compile intermediate times after your rides. You can see any individual lap times or the total of lap times.

To activate and use the lap timer, carry out the following:

1. Press MODE button repeatedly until LAP TIME is displayed.



lmo2010-003-091

LAP TIME

2. Press the SET button once to confirm your selection. The first lap timer will be displayed.

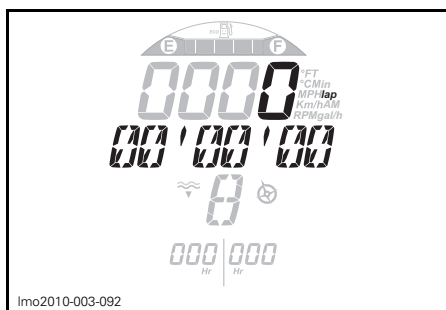

lmo2010-003-092

FIRST LAP TIMER

3. When ready, press the SET button to start the lap timer.



lmo2010-003-093

LAP TIMER STARTED

**NOTE:** The timer starts immediately when pressing the SET button.

4. To record each lap time, press the SET button at the start of each lap.

**NOTE:** The lap time will be recorded, the lap counter (in numerical display) will count the number of laps recorded, and the timer will continue to run.

5. To save the last lap time and stop the timer, press the MODE button.

To verify the recorded lap times, use the UP and DOWN switch to toggle through all lap times.

To reset an individual lap time:

1. Using the UP and DOWN switch, go to the lap time to be reset.

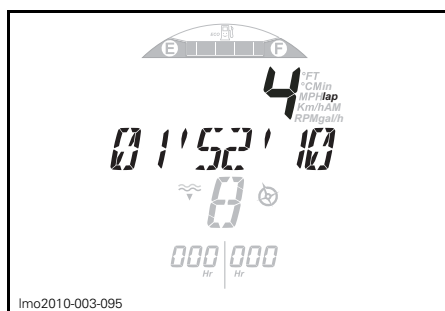

lmo2010-003-095

2. Press and hold the SET button until the lap time is reset.

To reset all lap times:

1. Using the UP and DOWN switch, go to ALL.



- Press and hold the SET button until the time is reset to 0 (zero).

### Multifunction Display

When the boat is being operated, the multifunction display provides an indication of compass heading or scrolling messages from the monitoring system.

It also displays a menu for the selection of various functions which, permit changing the numerical display indication, system modes of operation, settings, and displaying system fault codes.

### **⚠ WARNING**

Selecting various numerical displays, system modes of operation or changing settings should only be carried out with the boat stopped. Selecting these various functions while operating the boat at speed is not recommended as it deters your attention from situational awareness.

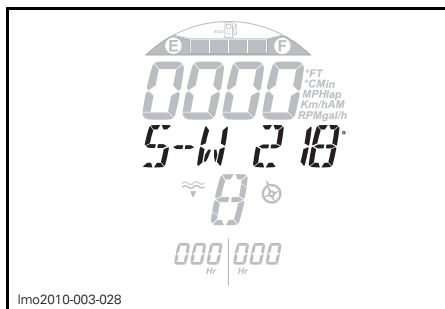

### MULTIFUNCTION DISPLAY - COMPASS HEADING INDICATED

### Selecting Functions

When operating at speed, the multifunction display normally provides an indication of the compass direction and azimuth the boat is traveling.

To select the various functions available through the multifunction display, press the MODE button repeatedly until the desired function is visible:

- SKI MODE
- CRUISE MODE
- DOCKING
- LAP TIME
- DISPLAY
- FUEL ECONOMY
- FAULT CODES
- SETTINGS
- SYNCHRONIZATION.

Then press the SET button to enter that function.

**NOTE:** The fault code function is available only when there is an active fault. The settings function is only available when the engine is shut off. The synchronization function is shown only. It can not be modified.

### Depth Sounder Indicator

The numerical display can be selected to provide an indication of the water depth.

The system is capable of indicating water depth under the hull in single increments up to 50 m (164 ft).

**NOTE:** Under certain conditions, the digital screen may stop displaying. The digital screen's ability to display the depth depends on the conditions of use.

To activate depth indication, refer to *NUMERICAL DISPLAY* in this subsection.

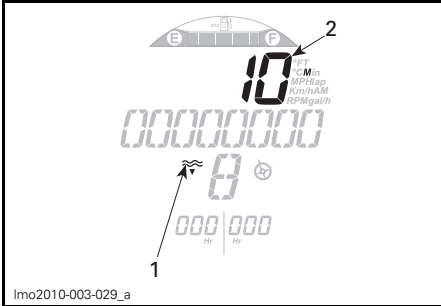

1. Depth finder indicator
2. Water depth indication

## ⚠ WARNING

Never use the depth sounder as a warning device to ride in shallow water.

## Hour Meter Display (HR)

Continuously displays the time in hours of the boat engines usage.

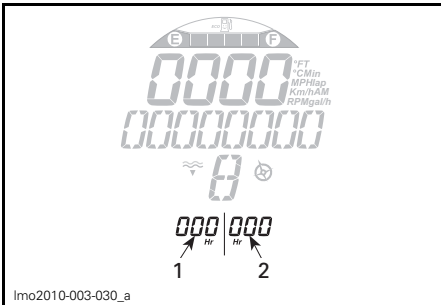

### HOURLY METER

1. Port side
2. Starboard side

## Compass

A GPS incorporated in the information center provides the indication in the multifunction display.

The cardinal points, intermediate cardinal points, as well as the azimuth the boat is travelling are displayed in the multifunction display by default when the boat is moving.

For a compass indication to be displayed, the GPS must have a good link with the navigation satellites. This is confirmed when the COMPASS active indicator is visible in the digital screen.

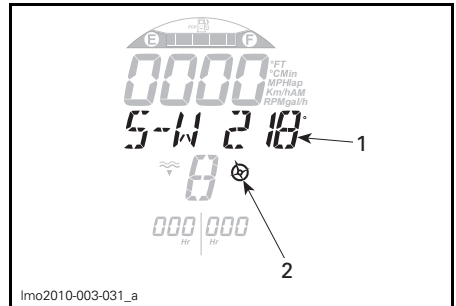

1. Compass indication
2. Compass active indicator

**NOTE:** The compass indication is only available above 5 km/h (3 MPH).

## ⚠ WARNING

Use the compass as a guide only. Not to be used for precision navigation purposes.

## Engine Identification

Identify which engine is associated with the information from the numerical display.

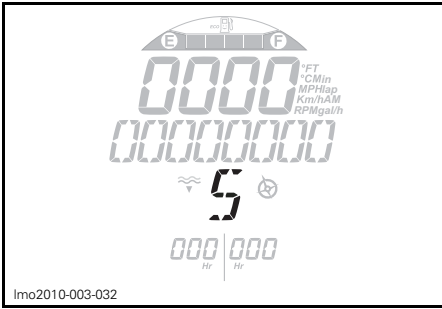

**STARBOARD ENGINE SHOWN**

*P = PORT*

*S = STARBOARD*



# EQUIPMENT

**NOTE:** Some equipment do not apply or are optional on some models. In these cases, their reference numbers are deliberately missing in the illustrations.

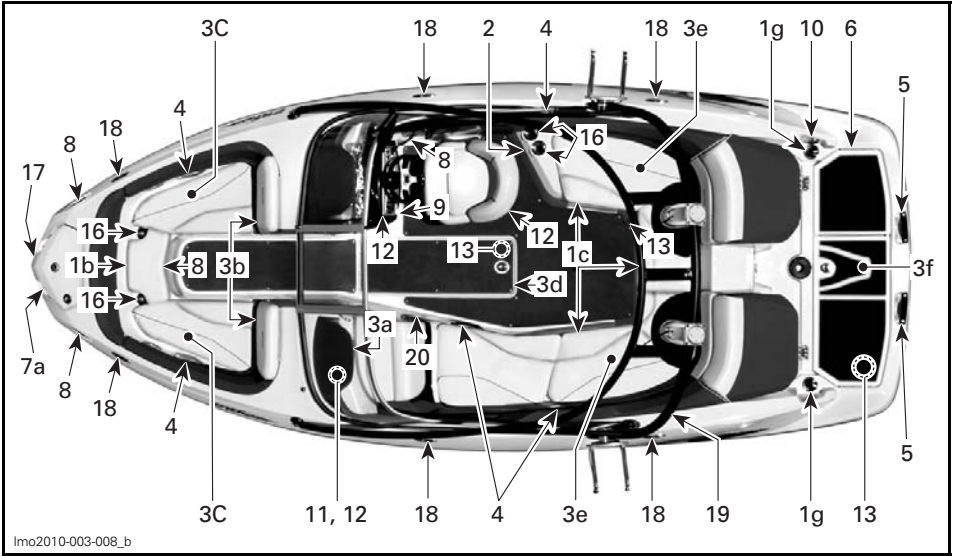

lmo2010-003-008\_b

TOP VIEW

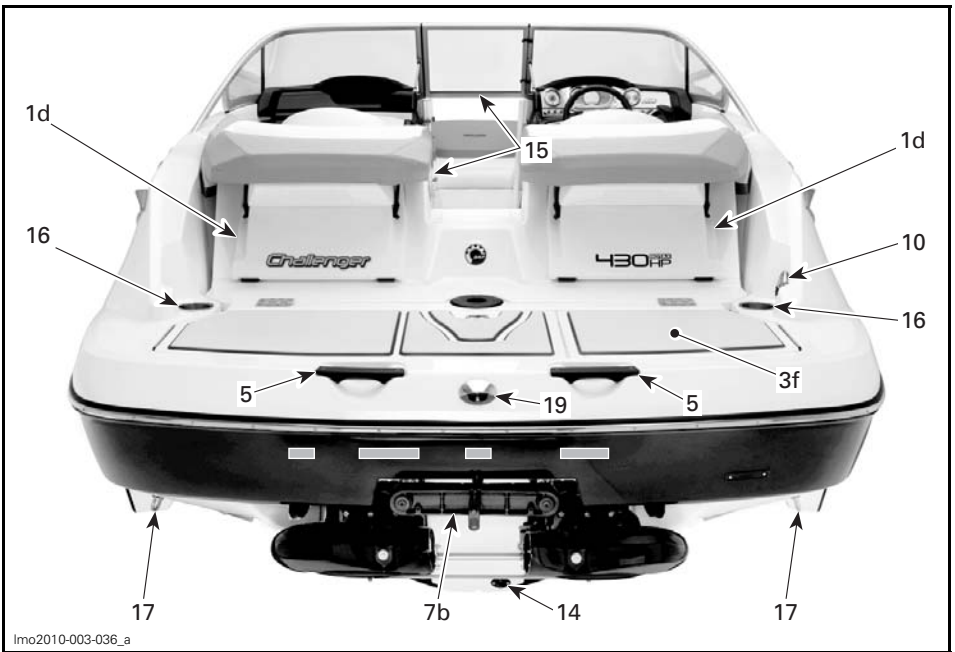

lmo2010-003-036\_a

REAR VIEW

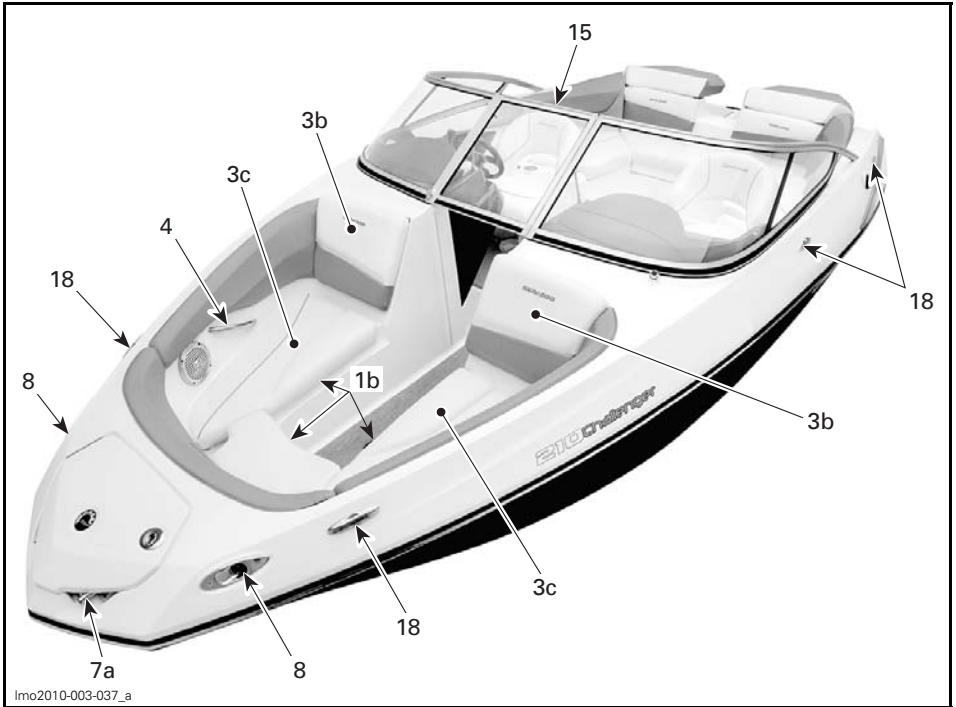

FRONT VIEW

## 1) Seats

### 1a) Bucket Seat

#### Swivel Adjustment

### **⚠ WARNING**

Always ensure driver's seat is locked so that seat faces steering wheel before riding.

Pull and hold the lever located on the RH side of the seat, swivel seat to the desired position, then release lever.

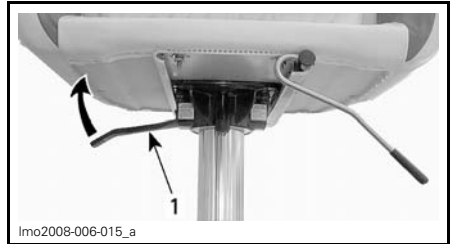

1. Lever

#### Forward and Backward Adjustment

Pull and hold the lever located on the RH side of the seat, set the seat to the desired position, then release the lever.

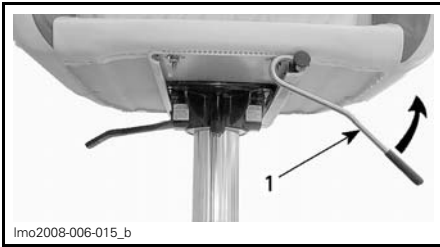

1. Lever

### Seat Bolster Position Adjustment

Adjustable seat bolster that allows different seating positions for low speeds. It also allows the driver, if adjusted in an upright position, to stand up between the helm and the seat for low speed operation.



1. Seat bolster in upper position

### 1b) Bow Seats

#### ⚠ WARNING

No passenger should be seated on the most forward seat in the bow area above 8 km/h (5 MPH).

Use grab handles as necessary.

The front cushion should be removed to avoid damaging it when somebody uses the front ladder to climb aboard. The magnetic retaining system allows for quick and easy removal or installation of the front seat.

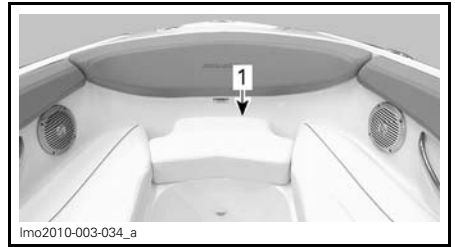

1. Front cushion

### 1c) Stern Seats

Each passenger should be seated while underway.

#### ⚠ WARNING

Allow no one to sit on edge of the boat or to stand up while in operation. Seat and grab handles should be used in rough waters.

The rear central cushion should be removed to avoid damaging it when using the rear walk-thru. The magnetic retaining system allows for quick and easy removal or installation of the central cushion.

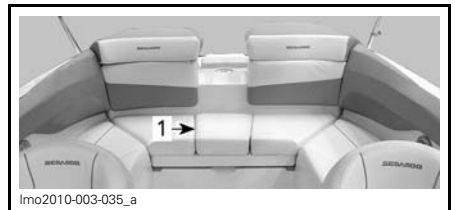

1. Central cushion

### 1d) Transat Seat

Lounge chairs to provide space to relax and viewing swimmers.

#### ⚠ WARNING

Engines must be off when somebody use the transat seats.

### To Open the Transat Seat

Unlock retaining latches, 2 by transat seat.



1. Retaining latches

Move the bottom of transat seat on the swim platform while lifting the top cushion of stern seat.

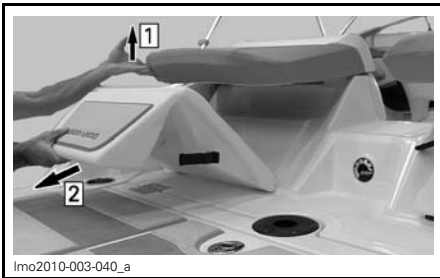

Step 1: Lift the top cushion  
Step 2: Move the bottom of transat seat

### To Close the Transat Seat

Lift the transat seat backrest and fold the seat under it.

Attach retaining latches.

## 2) Main Battery Cut-Off Switch

This switch is located on the starboard side nearby the rear bench seat, behind the driver's seat.



1. Main battery cut-off switch  
2. Driver's seat

This switch allows a complete power cut-out of the electrical system.

When in OFF position, ALL the electrical system will be OFF except for the bilge pump and radio memory power. The bilge pump **will** operate automatically with the battery switch on the OFF position.

Switch must be in the ON position to allow the use of electrical components and to start the engines.

**NOTICE** Stop engines before switching to the OFF position.

It is recommended to set this switch to the OFF position whenever performing maintenance in the engine compartment, on the electrical system, for transportation or during short term storage.

**NOTICE** Prolonged operation of the bilge pump when the boat is moored will lead to battery discharge and the bilge pump will quit operation.

## 3) Storage Compartments

### 3a) Glove Box

Convenient storage location for carrying small personal articles. It is located in the passenger's console.



1. Glove box cover

**NOTE:** Always relatch glove box before operating boat.

To open the glove box cover, press the button.



PRESS GLOVE BOX BUTTON

Turn the button counterclockwise.



TURN COUNTERCLOCKWISE

Lift the cover to accede to the glove box content.



GLOVE BOX OPENED

A parcel tray is available just over the glove box. It can be used to put money, key or cell phone.



1. Parcel tray  
2. Glove box cover

### 3b) Console Storage Compartment

**NOTICE** Never leave breakable objects in the console storage compartment. Never operate the boat with the console storage compartment cover opened.

Two large convenient storage compartments are available behind the bow seat backrests for anchor, PFD's, towels, etc.

To access the console storage compartment, pull the bottom of the bow seat backrest and lift it.



1. Bow seat backrest

To close the console storage compartment, slowly lower the bow seat backrest and insert the retaining pin into rubber grommet.

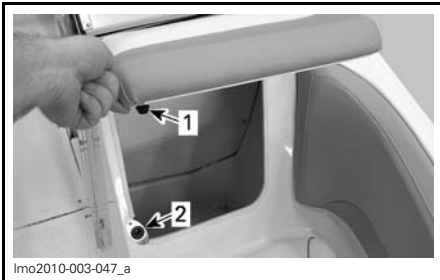

1. Retaining pin  
2. Rubber grommet

### 3c) Bow Storage Compartment

**NOTICE** Never leave breakable objects in the bow storage compartment. Never operate the boat with the bow storage compartment cover opened.

A large convenient storage compartment is available under each bow seat cushions for anchor, PFD's, towels, etc.

To access the bow storage compartment, simply lift the bow seat cushion.

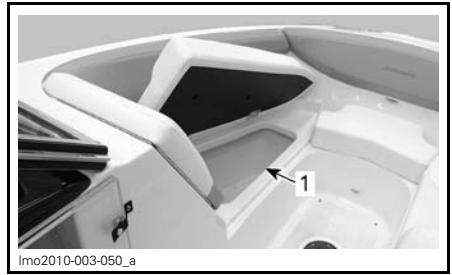

#### PORT SIDE SHOWN

1. Bow storage compartment

To close the bow storage compartment, slowly lower the cushion.

### 3d) Deck Storage Compartment

The deck storage compartment is a convenient lockable location for water-skis, paddles and ropes, etc.

Use the provided key to unlock the compartment if needed.

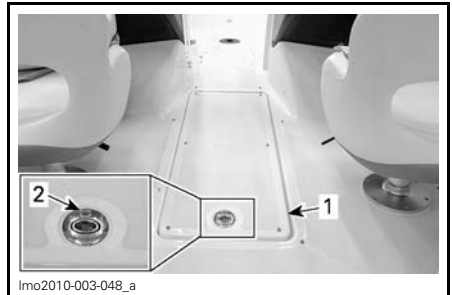

1. Deck storage compartment cover  
2. Lock

**NOTICE** Never leave any heavy or loose breakable objects in the deck storage compartment. Never operate the boat with the deck storage compartment cover opened.

To access the deck storage compartment, lift the latch ring and open cover gently until stopped by the retaining shock.



1. Deck storage compartment

When completely opened, the cover remains in that position on calm water. To close the deck storage compartment, lift the latch ring and slowly lower the cover.

Always close deck storage compartment cover before getting underway. Lock if desired.

### 3e) Stern Storage Compartment

Convenient storage locations for carrying large personal articles. Ideal location for spare Personal Flotation Device (PFD), towels, lunch, etc.

These storage compartment are located under each side stern seat cushion.

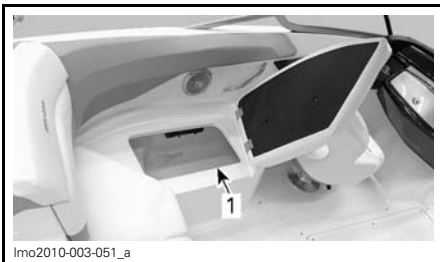

PORT SIDE SHOWN

1. Stern storage compartment

**NOTE:** For your convenience, a removable cooler has been installed in the starboard compartment.



STARBOARD SIDE SHOWN

1. Removable cooler

**NOTICE** Never leave any heavy or breakable objects in the storage compartment. Never operate the boat with the stern storage compartment cover opened.

### 3f) Swim Platform Storage Compartment

Located under the swim platform. This storage compartment is ideal for wet PFDs, wet towels, wakeboard, water-skis, paddles and rope, etc.

**NOTE:** Water can entered easily in this compartment, do not use it to store dry items.

To access the swim platform storage compartment, lift the latch ring and open the long cover. Open the short cover to have a complete access to the storage compartment.

**NOTICE** Do not try opening the covers of this storage compartment if a transat seat is opened or if the cockpit table is installed.



1. Lift the latch ring

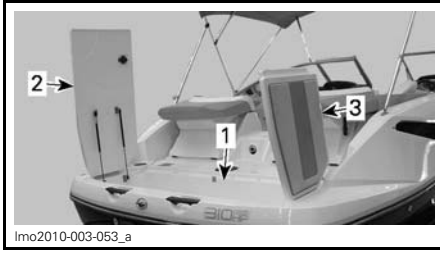

1. Swim platform storage compartment
2. Long cover
3. Short cover

To close swing platform the storage compartment, always lower the short cover first. Close the long cover and latch it.

#### 4) Grab Handles

Grab handles provide a handhold for the passengers.

Although grab handles are provided, never perform maneuvers that place a passenger or the driver at risk for being ejected or thrown out of their seat.

**NOTICE** Never use the grab handles to pull anything or to lift the boat.

Refer to components location illustrations at the beginning of this section for grab handle locations.

#### 5) Rear Grab Handles

Provide a handhold for boarding when needed.

**NOTICE** Never use the grab handle to tow anything or to lift the boat.



1. Rear grab handles

#### 6) Swim Platform

Provides an anti-skid surface for easy boarding.

#### **⚠ WARNING**

Do not start or operate the boat if a person is seated on the swim platform. Engines must be off when using swim platform. Keep away from propulsion system of the boat.

#### 7) Ladder

#### **⚠ WARNING**

Engines should be OFF when using any of the ladder. Never use ladder when boat is moving. Keep limbs away from propulsion system. Only one person at a time on the ladder. Never use the ladder for pulling, towing, diving or jumping.

**NOTICE** In order to avoid damage to the ladders, they should not be used when the boat is out of the water.

#### Front Ladder

Located in front of boat, the ladder conveniently helps in reboarding the boat.

Unlatch and lift the ladder cover.



1. Front ladder cover
2. Latch



Completely pull out and extend ladder, then push down.

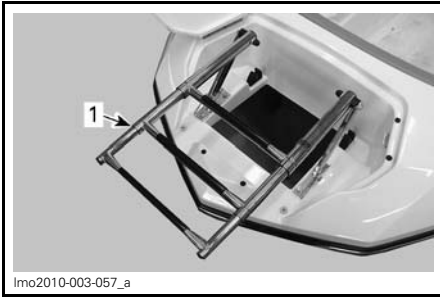

1. Ladder in extension

To store ladder, lift and retract ladder then fold it in its location.

Close and latch the cover.

### Rear Ladder

Located under the swim platform, the ladder conveniently helps in reboarding the boat.

Pull latch to release the ladder.



1. Latch

Slide ladder toward rear, then push down.



LADDER LOWERED

To store ladder, lift horizontally, slide toward front and secure latch.

## 8) Lights

### Bow Lights

Mandatory RED and GREEN lights.

### Stern Light

Mandatory WHITE stern light (WHITE).

### 210 Challenger

The stern light socket is provided for the mandatory white stern light.

**NOTE:** With this navigational lighting configuration, this boat can only be used on inland water after sunset.

1. Release stern light storage lock as shown.



**SLIDE THIS DIRECTION**

2. Thread onto folding joint as shown below.

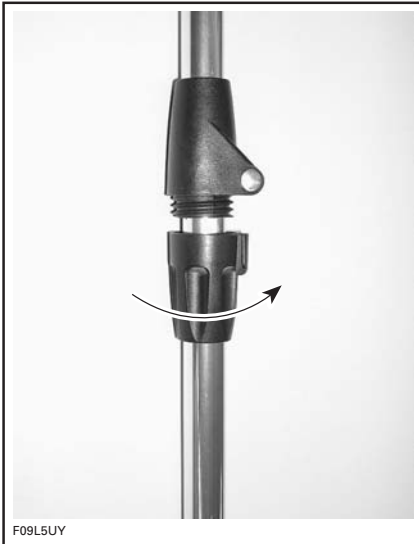

3. Lift connector cap.
4. Insert post in connector hole. Ensure to align hole keyway with post screw head.

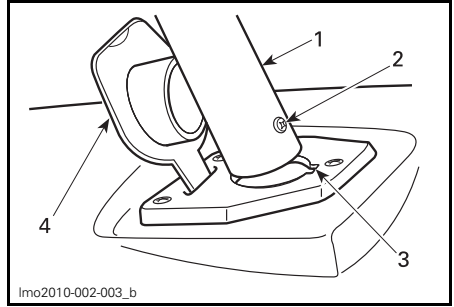

1. Stern light post
2. Post screw head
3. Hole keyway
4. Connector cap

5. Firmly push downward to engage terminals
6. Push lock ring downward. Turn until locked. It may be necessary to slightly turn it to allow its insertion in the hole.

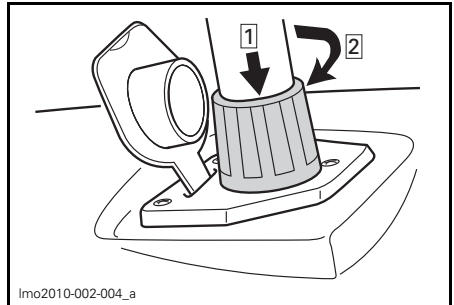

- Step 1: Push downward
- Step 2: Turn clockwise to lock

7. Check light operation.

**NOTICE** Ensure DIELECTRIC GREASE (P/N 293 550 004) is present in connector area of light to prevent corrosion.

Removal and storage of light is the reverse of installation.

### **210 Challenger SE/210 SP/ 210 WAKE**

The stern light is installed on the top of the bimini top.

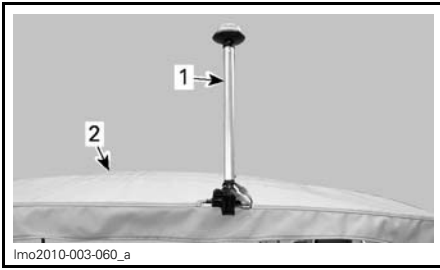

1. Stern light
2. Bimini top

Set the stern light pole upright by loosening the plastic knob.

When positioned correctly, tighten plastic knob to retain the pole in this position.

Connect both stern light connectors.

To turn the stern light on, see *NAVIGATION LIGHTS SWITCH* in *CONTROLS* section.

**NOTICE** Using the stern light for a prolonged time when the engine is not running will discharge the battery.

## Deck Lights

Convenient lights to use between sunset and sunrise. These lights can assist passenger when boarding as well as creating a nice ambience.



DECK LIGHT

## 9) Radio

The features and controls of the radio are detailed in the manufacturer's guide provided with the boat.

Refer to manufacturer's guide for complete explanation of features and controls.

**NOTICE** Using the radio for a prolonged time without engines running may discharge the battery.



## 10) Radio Remote Control

A remote control for the radio is included as standard equipment and is located on the starboard side of the swing platform.

For radio remote control operation, please refer to the *MANUFACTURER'S INSTRUCTION SHEET*.



1. Radio remote control

## 11) Audio Input Jack/USB port

This boat is equipped with an audio input jack and a USB port. They are located in the glove box.

Using these adapters, an audio player such as a CD player or a MP3 player can be connected to be played through the audio system.

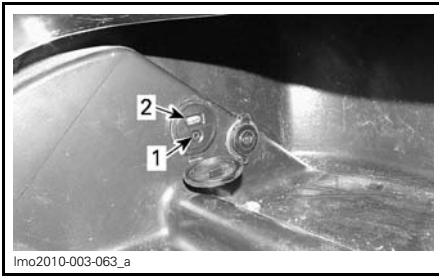

Imo2010-003-063\_a

#### INSIDE GLOVE BOX

1. Audio input jack
2. USB port

**NOTE:** Close protective cap when the audio input adapter is not in use.

## 12) 12-Volt Power Outlets

Two 12-volt power outlets are provided to power temporary accessories such as a cellular phone or other 12-volt portable devices.

**NOTICE** Using 12-volt portable devices for a prolonged time without engine running may discharge the battery.

One power outlet is located on driver's console below information center.



Imo2010-003-064\_a

#### DRIVER'S CONSOLE

1. 12-volt power outlet

The other power outlet is located inside the glove box.

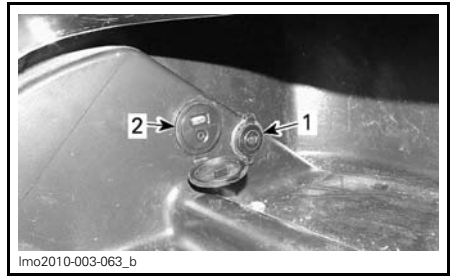

Imo2010-003-063\_b

#### INSIDE GLOVE BOX

1. 12-volt power outlet
2. Audio input adapter

**NOTE:** Close protective cap when the audio input adapter is not in use.

## 13) Deck Drains

Deck drain provides drainage of water from rain, deck washing, water splashing, etc.

Keep clean to avoid clogging.

## 14) Bilge Drain Plug

A drain plug is provided to allow water drainage from bilge when boat is out of the water.

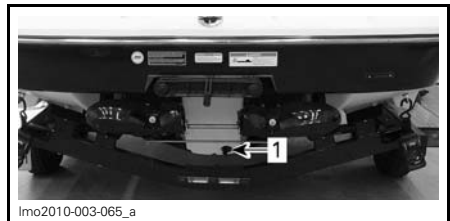

Imo2010-003-065\_a

1. Drain plug

## 15) Walk-Thru Door/ Windshield

### Walk-Thru Door

**CAUTION** Latch door in the open and closed position at all times.

For your convenience, a transparent walk-thru door can be closed between both consoles to divert the air flow coming from the bow area.

To place the door in close position, release the upper tie.

Unlock the door latch.

Open the door and insert its side into the rail on the passenger's console.

Secure the door by locking the door latch.

**NOTICE** Once opened, the door must be latched using the door latch.

To free the walk-thru way; unlock the door latch and push in the center of the door.

Fold the door against driver's console and secure it using the upper tie.

### Walk-Thru Windshield

A walk-thru windshield can be closed between consoles to minimize the air flow coming from the bow area.

In the open position, the walk-thru windshield is retained against the passenger's console.

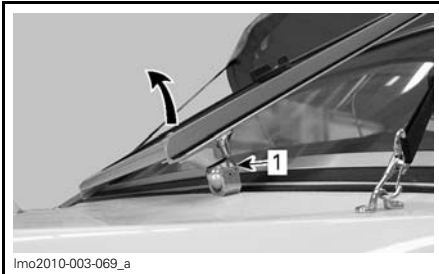

#### WALK-THRU WINDSHIELD IN OPENED POSITION

1. Windshield retainer (magnet)

To close the walk-thru windshield, simply pull the external side of windshield toward the center of the boat and lock it in position using the windshield lock.

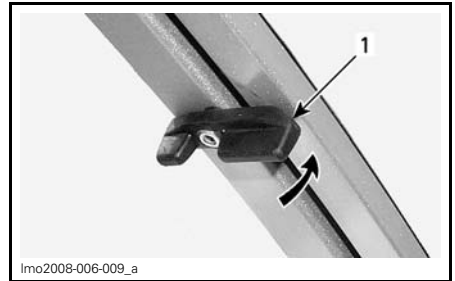

#### TYPICAL — BOTH SIDES

1. Windshield lock

## 16) Cup Holders

Convenient locations for non-alcoholic beverages.

### ⚠ WARNING

Do not drink alcoholic beverages while aboard. Do not keep bottles, cans, etc. in cup holders while riding at speed.

## 17) Bow and Stern Eyelets

### Bow Eyelet

Eyelets can be used for mooring, towing and as a tie-down point during transportation.

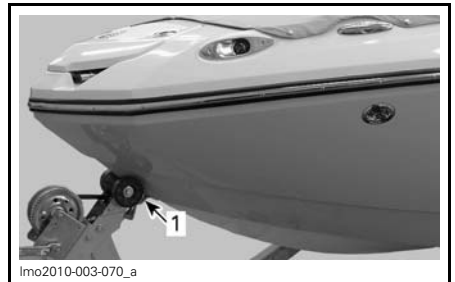

1. Bow eyelet

### Stern Eyelets

Eyelets can be used for mooring, towing and as a tie-down point during transportation.

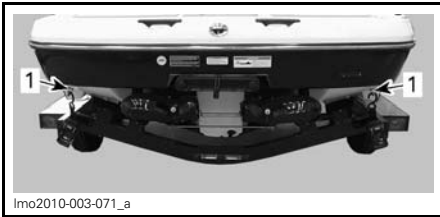

lmo2010-003-071\_a

1. Stern eyelets

## 18) Mooring Cleats

When mooring to a dock, it is recommended to secure with both front and rear cleats. The use of dock lines with sealed air fenders is recommended to protect your boat.

**NOTICE** Never use mooring cleats to pull anything or to lift the boat.

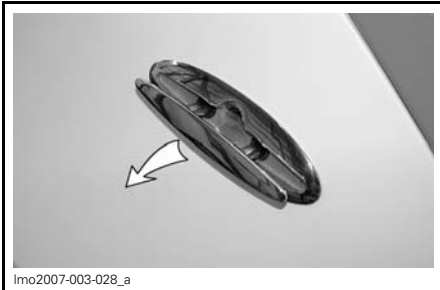

lmo2007-003-028\_a

## 19) Water Sport Towing Attachments

Please read and refer to *WATER SPORTS* information in the *SAFETY INFORMATION* section at the front of this guide.

### **⚠ WARNING**

“Teak Surfing” is extremely dangerous to participants due to their proximity to the rear of the boat where direct contact with the exhaust fumes from the boat engine is the highest. Carbon monoxide poisoning can occur and result in mental disorientation, dizziness, drowsiness, and loss of consciousness. The combination of carbon monoxide exposure and non-use of a life jacket (PDF) make this new water recreation activity an incredibly dangerous and potentially deadly sport.

### **⚠ WARNING**

When pulling a tube, skier or wakeboarder, always have an observer, proceed with only as much speed as required, and follow the observer's instructions.

### **⚠ WARNING**

Pulling a tube, skier or wakeboarder makes the boat handle differently and requires greater skill. Unless absolutely necessary, do not make tight, sharp turns. Keep a safe distance from the docks, swimmers, other craft or objects. Be advised that serious injury can result if the tow rope becomes slack during a tight turn or when circling. The rope could become wrapped around the neck or limbs of a person.

### **Ski Pole**

Remove the cap from the ski pole receptacle.

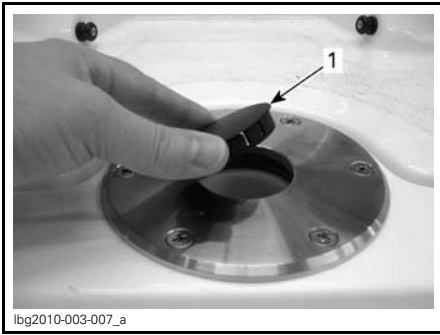

1. Receptacle cap removed for ski pole installation

Insert the ski pole with the grooved end up.

Push the ski pole down into the receptacle until the shoulder portion sits flush on the receptacle and ensure it is properly locked in the receptacle.

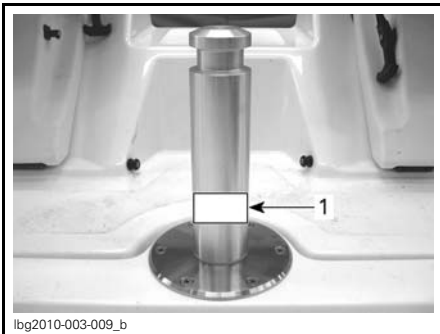

#### SKI POLE INSTALLED

1. Ski pole warning label

#### SKI POLE WARNING LABEL

##### WARNING

- Completely remove ski pole when not used.
- Make sure ski pole is locked into base before use.
- Maximum gross weight 225 kg (500 lb).

**NOTE:** The ski pole is equipped with spring loaded locking pins that engage a groove within the ski pole receptacle. When the pin locks engage, you should feel and hear them "click" in the groove.

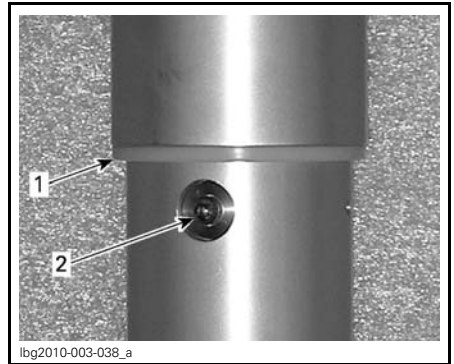

1. Ski pole shoulder  
2. Spring loaded locking pins (2)

The ski pole may now be used for towing a tube, water skier, wakeboarder or for mounting the table.

#### **⚠ WARNING**

- Always ensure the ski pole is properly locked in the receptacle before use.
- Always have an observer watch the tube, water skier or wakeboarder.
- Never use the ski pole for any other application than the one it has been designed for:  
example; Never use to tow any other watercraft
- Never exceed the load limit rating of the ski pole, maximum gross weight of 225 kg (500 lb). Overloading can affect maneuverability, stability and performance, or cause damage.
- Remove and properly store the ski pole when it is not being used to prevent possible injury.

Remove the ski pole and install the receptacle cap in the receptacle when the ski pole is not used.

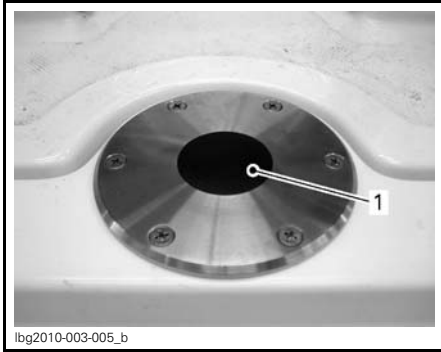

1. Ski pole removed and cap installed when not in use

### Tow Hook

#### 210 Challenger SE

Provides rope attachment for towing activities.



1. Tow hook

**NOTICE** Never use the tow hook to tow any other craft.

### Towing Tower

#### 210 WAKE

Provides rope attachment for towing activities.

The towing tower is for skiing or wakeboarding.

<b>PULLING WEIGHT LIMIT</b>
114 kg (250 lb)

**NOTICE** The tower must be in the upright position and secured when boat is operated or when towed. Check clearance height around docks, shore, overhanging objects, bridges and power lines. The tower must not be used as a tie-down or tie-off point.

### Wakeboard Storage Rack

Convenient board racks on the tower allow you to have quick and easy access to your wakeboard.

Secure wakeboard to rack by using the elastic band.

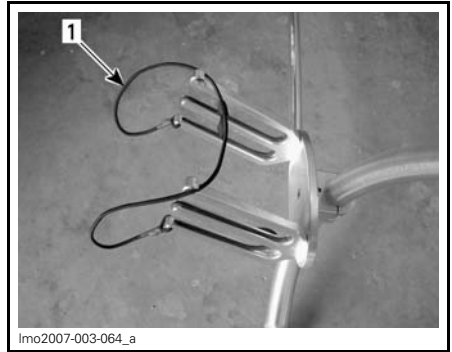

TYPICAL  
1. Elastic band

### Lowering Tower

Lowering tower may be useful for storing the boat or for bridge clearance, on the water, at low speeds.

**CAUTION** To avoid injury, never lower the tower alone. Ask someone to hold the tower for manipulation.

To lower the tower, proceed as follows:

1. Have someone to support the tower front section.
2. On LH side of tower, turn the handle 3/4 turn **COUNTERCLOCKWISE** to the unlock position.



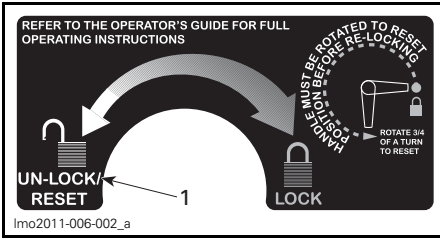

1. UNLOCK/RESET position (port side)

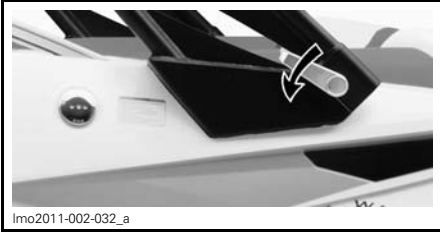

TURN HANDLE 3/4 TURN COUNTERCLOCKWISE (PORT SIDE)

3. On RH side of tower, turn the handle 3/4 turn **CLOCKWISE** to the unlock position.

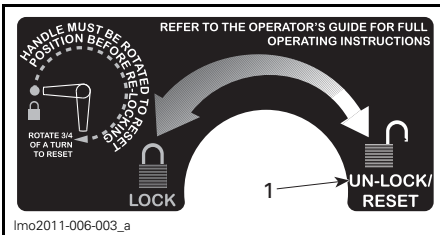

1. UNLOCK/RESET position (starboard side)

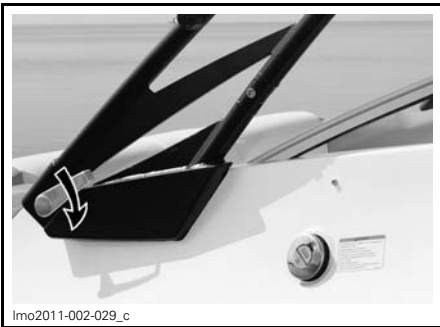

TURN HANDLE 3/4 TURN CLOCKWISE (STARBOARD SIDE)

4. Carefully lower and hold tower.



TYPICAL - LOWERING TOWER

**NOTE:** Use the holder brackets and knobs (provided with the boat) to secure tower in position.

5. Insert and secure hook end of the holder bracket into the tower mount of the boat.

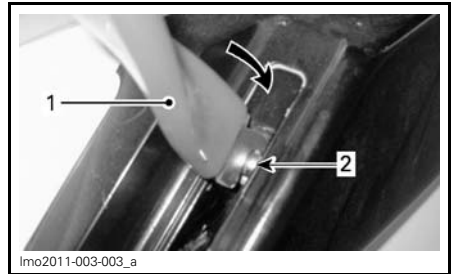

BRACKET HOOK IN TOWER MOUNT

1. Bracket hook  
2. Tower mount pin
6. Secure the other end of bracket to tower leg end with the knob.

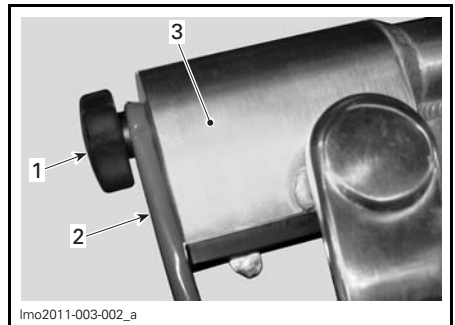

1. Knob  
2. Holder bracket (upper end)  
3. Tower leg end

**NOTE:** For holder bracket with 2 holes, use the upper hole.

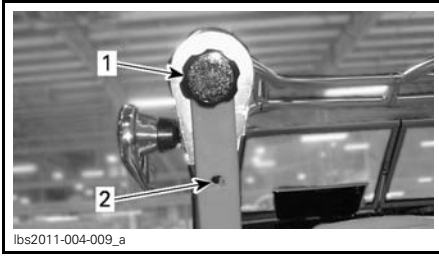

1. Upper hole (for knob location)
2. Lower hole

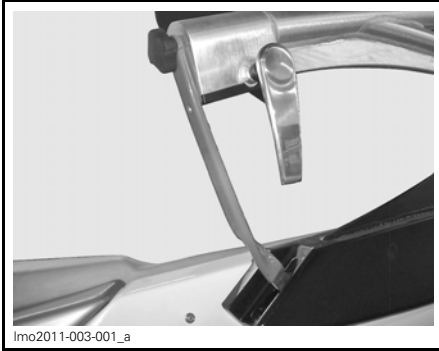

**HOLDER BRACKET INSTALLED**

7. Proceed with the holder bracket installation on the other side.

**NOTICE** When tower is folded down, always use the holder bracket and do not operate the boat more than 16 km/h (10 MPH). Never tow boat when tower is folded down.

**Raising the Tower**

The tower must be in the upright position when trailering boat or when riding.

Have someone to support the tower front section.

1. Remove tower support brackets from tower.
2. On both side of tower, confirms the handle is in the unlock position. If not, handle must be rotated to RESET position before re-locking the tower.

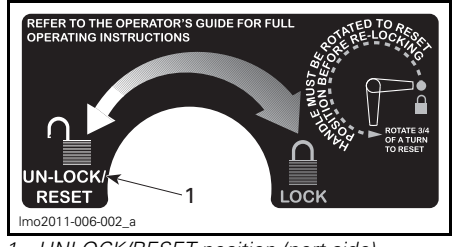

1. UNLOCK/RESET position (port side)

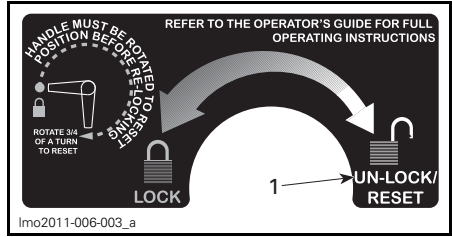

1. UNLOCK/RESET position (starboard side)

3. Raise the tower to its highest position.



**TYPICAL - RAISING TOWER**

4. On both sides of tower, turn handle 3/4 of a turn to the LOCK position.

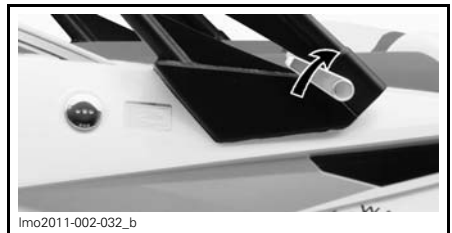

**PORT SIDE - TURN HANDLE 3/4 TURN CLOCKWISE TO LOCK**



lmo2011-002-029\_d

**STARBOARD SIDE - TURN HANDLE 3/4 TURN COUNTERCLOCKWISE TO LOCK**

**⚠ CAUTION** Make sure to latch properly both sides of the tower before operating or towing the boat.

## 20) Heating System

### 210 WAKE Only

This boat is equipped with a heating system that can be used when the engines are running to heat-up cockpit area or recreational activities users when needed.

Use the 2-position switch on the RH side of driver's console.

**NOTICE** Using the heating system fan for a prolonged time when the engines are not running will discharge the battery.



lmo2010-003-024\_a

1. Heating system switch

On the passenger's side, it is possible to stretch the heating duct for multi-purpose usage.

Gently pull on the heating duct grill to stretch.

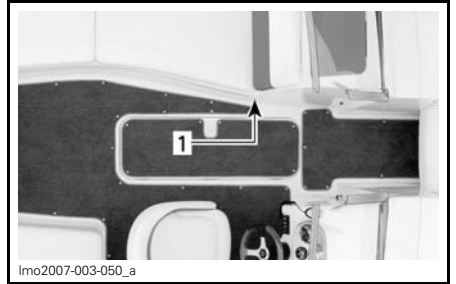

lmo2007-003-050\_a

**UNDER PASSENGER'S LOUNGER**  
1. Multi-purpose heating duct



lmo2007-003-051\_a

**HEATING DUCT STRETCHED**

## 21) Ballast System

### 210 WAKE Only

#### To Fill

**NOTE:** Boat must be in water to fill ballast bag.

1. Open thru-hull valve located in the engine compartment.

**NOTE:** Handle will be in the vertical position when valve is open.

**NOTICE** Failure to open valve will cause damage to the pump components.

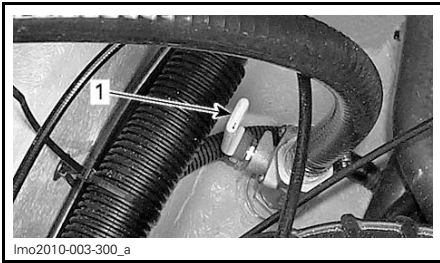

1. Thru-hull valve in open position

- Place the ballast switch in FILL position.



1. Ballast switch

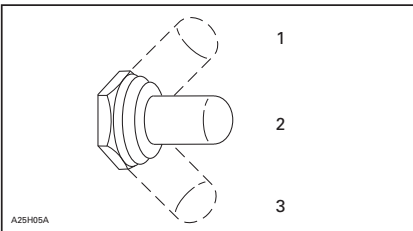

- FILL position
- OFF
- EMPTY position

The ballast is full when water evacuates from the ballast vent fitting located overboard on the PORT or STARBOARD side of the boat.

**NOTICE** It is always a good practice to monitor ballast bag filling and stop pump before it comes out from ballast vent fitting. Stop pump when you visually see that the ballast bag is full.

**NOTICE** While filling, in the event of ballast system leakage, the bilge pump will start to evacuate water from bilge automatically. To avoid having both pumps working against each other for a long period of time, we recommend to monitor the filling process. If a leak occurs, stop the ballast pump immediately and close the thru-hull valve. Have the ballast system inspected by a Sea-Doo boats dealer.

- When ballast is full or when the desired level is reached, move the ballast switch in OFF position.

**NOTE:** It is not necessary to close the engine compartment thru-hull valve once the system is full.

### To Empty

- Ensure thru-hull valve located in the engine compartment is in the open position.

**NOTE:** Handle will be in the vertical position when valve is opened.

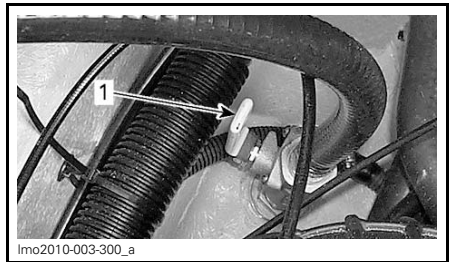

1. Thru-hull valve in open position

- Place the ballast switch in EMPTY position.

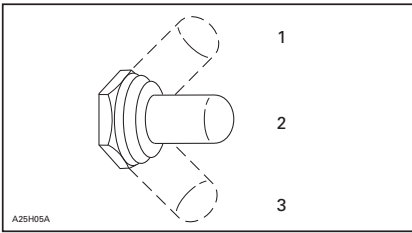

1. FILL position
2. OFF
3. EMPTY position

3. When ballast is empty, place switch in OFF position and close thru-hull valve.

**NOTE:** A noticeable different tone and some air bubbles appear when ballast is empty.

**NOTICE** Closing of this valve is highly recommended when system is not in use. In the case of component failure, it blocks water from entering in the system and prevents any water intrusion.

### **⚠ WARNING**

Never tow a boat with water remaining in the ballast bag. The weight of ballast increases the load on the trailer, the axle, and the tires, which could lead to premature wear or failure. This also contributes to reduce the stability of your boat on the road by raising the center of gravity of the trailer.

### To Flush

Ballast bag should be flushed every time the boat is used on another stretch of water.

Use the following procedure to flush the ballast system.

1. Safely secure the boat on the trailer.
2. Ensure thru-hull valve located in the engine compartment are closed.

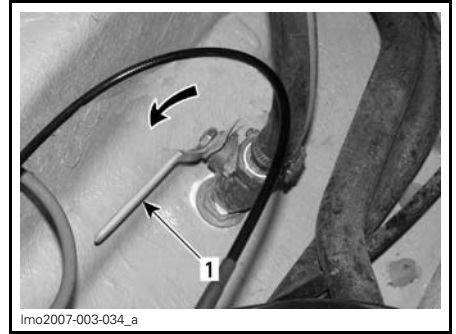

**TYPICAL — THRU-HULL VALVE**

1. Closed position

3. Using a garden hose with a spray nozzle, fill ballast bag using the ballast vent fitting. Hold the nozzle firmly against the ballast vent fitting and add water until the bag is full.

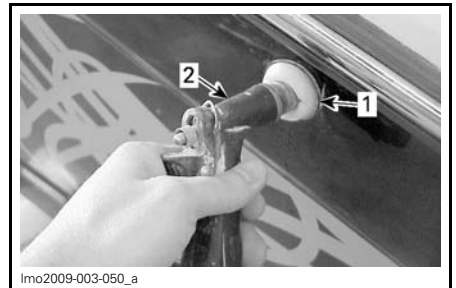

**TYPICAL**

1. Ballast vent fitting
2. Spray nozzle

4. When the ballast bag is full, open thru-hull valve.
  5. Select EMPTY position on ballast switch.
  6. Select OFF position on ballast switch when no more water flows out from underneath the hull.
  7. Close thru-hull valve.
- Repeat the procedure if necessary.

## 22) Bimini Top

The bimini top is convenient for protection against inclement weather or sunshine.

**! DANGER**

- Exhaust fumes from engines contain deadly carbon monoxide gas (CO).
- Boat with bimini top are most likely to collect fumes.
- CO sickness symptoms include headache, nausea and dizziness. Do not mistake for seasickness.

**! WARNING**

- Avoid body contact with bimini top.
- Hold down straps are under tension.
- Do not use bimini top as a support.
- Bimini top should not be used when boat speed exceeds 56 km/h (35 MPH).

**Opening Bimini Top**

Unzip cover and remove. Store cover in a storage area.

**UNZIP COVER**

Detach straps from bimini top frame.

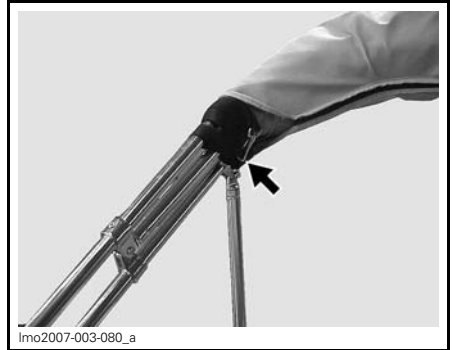
**DETACH STRAPS**

Pull canvas towards the front of the boat and fasten straps to eyelets on body of boat.

Adjust strap tension as needed.

**Closing Bimini Top**

**NOTE:** If canvas of bimini top has been splashed by salt water, rinse canvas with fresh water. At any time when canvas is wet, let dry before installing cover and storage.

Unhook front straps and fold front portion of bimini top towards the rear of the boat.

Position the protective cover so that the zipper will be on the inner side of the bimini top.



Place bimini top straps inside cover and slowly zip while packing canvas inside cover.

## Removing Bimini Top from Boat

If it becomes necessary to remove bimini top from boat, proceed as follows:

Unplug the stern light connector.

Detach bimini top frame from bracket pivot points.

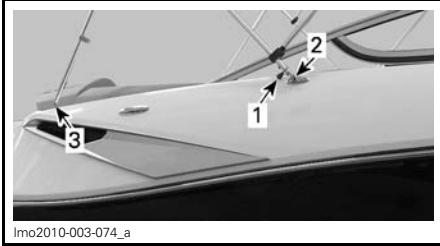

### STARBOARD SIDE SHOWN

1. Stern light connector
2. Front bimini top attachment
3. Rear bimini top attachment

With assistance, carefully lift bimini top and remove it.

The installation is the reverse of the removal procedure, however, pay attention to bimini top orientation for proper positioning.

## 23) Cockpit Table

The cockpit table is stored in a protective bag and place inside the stern storage compartment.

Two table posts are provided in the deck storage compartment. The long post is used for the deck and the short post for the swim platform.

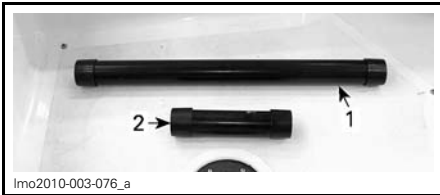

1. Long table post (bow installation)
2. Short table post (ski pole installation)

## **⚠** WARNING

Table must be stored before operating the boat.

## Table Installation in Bow

Release table post and place it in the floor receptacle. Twist gently to ensure proper fit.

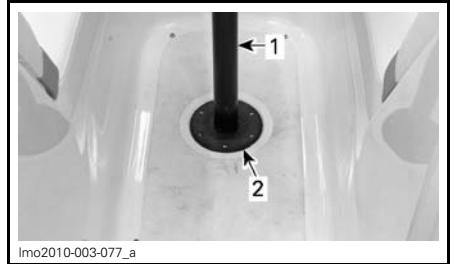

### TYPICAL

1. Floor receptacle
2. Table post

Install table onto post.



### TYPICAL - COCKPIT TABLE INSTALLED

## **⚠** WARNING

Cockpit table must be properly stored before operating boat.

## Table Installation in Ski Pole Receptacle

NOTE: The table post will not fit in the ski pole receptacle. Use the ski pole to mount the table.

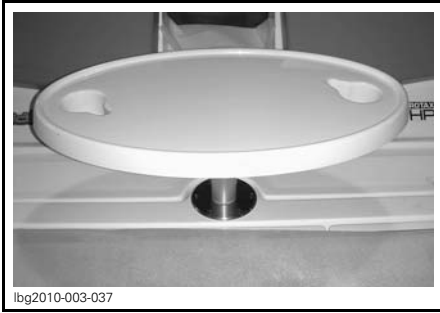

**TABLE MOUNTED ON SKI POLE**

Use the *SKI POLE* procedure prior to table installation.



---

# BREAK-IN PERIOD

## Operating During Break-In

**NOTICE** Carefully follow the instructions in this section. Failure to do so may reduce the life and/or performance of the engines.

A break-in period of 10 hours is required before continuous operation at full throttle.

To achieve a good break-in, a maximum of 3/4 throttle should be observed, however, brief acceleration and speed variations contribute to a good break-in.

**NOTICE** Continued wide open throttle runs and prolonged cruising without speed variations should be avoided. This can cause engine damage during the break-in period.

# OPERATING INSTRUCTIONS

## **⚠ WARNING**

Always perform the *PRE-RIDE INSPECTION* before operating this boat. Be sure to read the *SAFETY INFORMATION* and the *BOAT INFORMATION* sections.

Should any control or instruction not be fully understood, refer to an authorized Sea-Doo boats dealer.

## **How to Launch or to Load Boat**

**NOTICE** Before launching the boat, ensure the main battery cut-off switch is turned ON and the bilge plug is fully tightened into place.

When finished loading the boat on trailer, turn the main battery cut-off switch to OFF.

Remove bilge plug to drain bilge when boat is on trailer.

## **How to Board the Boat**

As with any boat, boarding should be done carefully and engines must not be running.

## **⚠ WARNING**

Engines must be OFF when boarding the boat or when using the swim platform.

**NOTICE** Never use propulsion system as a supporting point to board the boat.

## **Boarding from a Dock**

When boarding from a dock, use the swim platform to climb aboard.



lmo2010-003-100

TYPICAL

**NOTICE** Although the boat requires only 30 cm (1 ft) of water to float, the engines should be started with at least 90 cm (3 ft) of water below the hull. If the depth of the water is less than 90 cm (3 ft) and the engine is running, the impeller is turning and debris can be drawn from the bottom and damage the propulsion system.

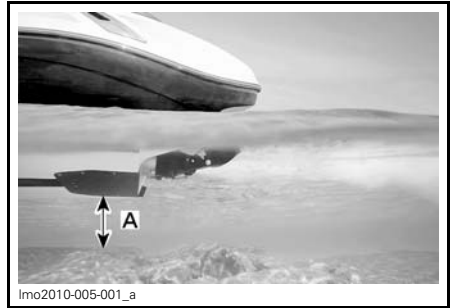

lmo2010-005-001\_a

TYPICAL

A. 90 cm (3 ft)

## **Boarding from Shallow Water**

In shallow water, board the boat from either the front or the rear using ladders.

Ensure there is at least 90 cm (3 ft) of water underneath the lowest rear portion of the hull.

Take into account that the hull will be lower in the water when all passengers are aboard. Be certain to maintain the specified depth so sand, pebbles and rocks will not be drawn up in the jet pump.

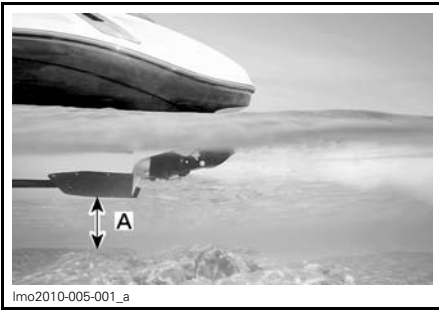

lmo2010-005-001\_a

TYPICAL

A. 90 cm (3 ft)

**NOTICE** Starting the engine or riding the boat in shallower water may damage the impeller or other jet pump components.

### Boarding from Deep Water

#### **⚠ WARNING**

Inexperienced riders should practice how to board the boat close to shore (all methods explained here) before venturing into deep water.

Swim to the rear of the boat.

Release the retractable ladder, pulling ladder out and down into boarding position.

Climb the ladder and pull yourself upward using the swim platform grab handles.



lmo2010-003-101

TYPICAL

When you can reach the engine cover grab handle, grip it and continue to pull yourself upward to place your knee on the swim platform.



lmo2010-003-102

TYPICAL

Continue to climb on engine cover to reach the deck.



lmo2010-003-103

TYPICAL

**NOTE:** The last boarded person must secure the ladder using the retaining latch prior to reach its seat.

**NOTICE** Before operating the boat, always fasten the ladder in place using the latch.

### How to Start Engines

**NOTE:** Before starting engines for the first time during the day, perform the complete *PRE-RIDE INSPECTION* as described in *PRE-RIDE INSPECTION*.

Open the engine compartment cover and ensure engine compartment is free of gasoline vapor odors.

**⚠ WARNING**

If any leaks or gasoline vapor odors are present, **DO NOT** start the engine and communicate with your authorized Sea-Doo boats dealer.

1. Make sure engine compartment cover is closed.
2. Turn ignition switch to ON.
3. Turn on bilge blower for 5 minutes then turn bilge blower switch off.

**⚠ WARNING**

Always activate bilge blower 5 minutes minimum before starting the engines to ventilate the bilge.

4. Attach the tether cord to you using your PFD or a wrist strap.

**⚠ WARNING**

The tether cord must be attached to the operator all the time when engines are running. Keep the emergency engine stop switch free from obstructions that could interfere with its operation. The proper use of the tether cord can prevent a runaway boat situation. Remove the tether cord clip when stopped to help prevent accidental starting. The tether cord clip must be reinstalled on the emergency engine stop switch before the engine can be restarted.

5. Install the tether cord clip on the emergency engine stop switch.

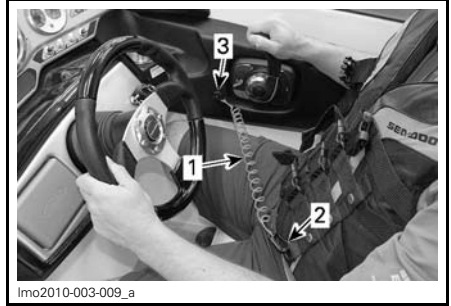

lmo2010-003-009\_a

**TYPICAL**

1. Tether cord
  2. Tether cord secured to PFD
  3. Other end of tether cord secured to the emergency engine stop switch
6. Ensure all passengers are properly seated in accordance with the seating label. Refer to *SAFETY LABELS* section.

**⚠ WARNING**

Before starting the engine, the operator and passengers should always be properly seated. Do not allow swimmers and passengers to stay close to the propulsion system.

**NOTICE** Ensure there is at least 90 cm (3 ft) of water under the lowest rear portion of the hull when all passengers are aboard prior to starting the engine. Otherwise damage to the propulsion system may occur. Do not accelerate abruptly.

7. Ensure shifter lever is in neutral position and throttle lever in idle position.
8. Press and hold a start/stop button to crank the engine.
9. Release start/stop button immediately after engine is started. Start one engine at a time.

If the engine fails to start after 10 seconds, wait a few seconds then retry.

**NOTICE** To avoid starter motor overheating, the cranking period should not exceed 5 - 10 seconds and a rest period of 30 seconds should be observed between cranking cycles to let the starter cool down and its mechanism disengage.

10. Start the other engine by proceeding the same way as for the first engine.
11. Check tachometers to monitor engines.

## How to Leave the Shore

Move throttle/shifter lever to forward position.

Slowly accelerate to reach deeper water. Do not apply full throttle until engine is warm.

### **⚠ WARNING**

In shallow water, shells, sand, pebbles or other objects could be drawn up by the jet pump and thrown rearward.

**NOTICE** Avoid boat operation in weeded areas. If unavoidable, vary boat speed.

## How to Shut Off the Engines

### **⚠ WARNING**

To maintain boat directional control, the engines should be running until the boat is stopped.

To shut off the engines:

1. Press the engine start/stop buttons.
2. Release the start/stop buttons as soon as the engines are shut down.
3. Remove the tether cord clip from the emergency engine stop switch if you disembarking the boat.

**NOTE:** Removing the tether cord clip from the emergency engine stop switch without depressing the start/stop buttons will also shut off the engines. This is designed as a safety feature should the operator be ejected from the boat. The engines should be also turned OFF by turning the ignition key in off position.

### **⚠ WARNING**

Never leave the tether cord clip on the emergency engine stop switch when disembarking boat to prevent theft, accidental engine starting, and to avoid unauthorized use by children or others.

## How to Steer Boat



TYPICAL — RIGHT-HAND TURN

Turning the steering pivots the jet pump nozzle which controls the boat direction. Turning the steering to the right will turn the boat to the right and inversely. The throttle should be applied to turn the boat.

### **⚠ WARNING**

Throttle must be applied and steering turned to change the direction of the boat. Steering efficiency will differ depending on the number of passengers, load, water conditions and environmental factors such as the wind.

A jet propelled boat needs some throttle to turn. Practice in a safe area applying the throttle and turning away from an imaginary object. This is a good collision avoidance technique.

**⚠ WARNING**

Directional control is reduced when the throttle is released and lost when the engines are off.

## How to Engage Neutral

**⚠ WARNING**

The drive shafts and impellers are always turning when the engines are running, even in neutral position. Keep away from the propulsion system of the boat.

To obtain neutral, place throttle/shift lever to the upright position. Reverse gates will be in the middle position, directing half of the thrust toward the front of the boat to minimize movement.



1. Throttle/shifter lever in neutral position

## How to Engage Forward

The throttle/shift lever should be in the forward position in order for the boat to advance.

To engage forward thrust from neutral, press the release button on the throttle/shifter lever head and push the

lever forward. The gate will move to forward thrust position and the boat will accelerate forward.

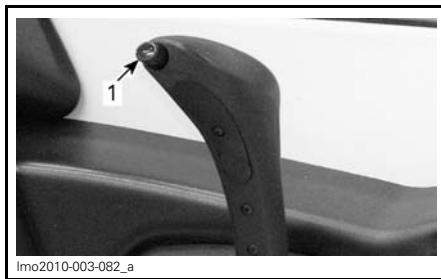

1. Release button



1. Throttle/shift lever in forward full throttle position

## How to Engage Reverse

**⚠ WARNING**

Only use reverse at slow speed and for the shortest time possible. Always ensure the path behind is clear of objects, obstacles and people. Become fully familiar with the reverse operation during your first ride and before carrying passengers.

To obtain reverse, press the release button on the throttle/shifter lever head and pull throttle/shift lever completely to the rear. The reverse gates will be in downward position, directing all the thrust toward the front of the boat.

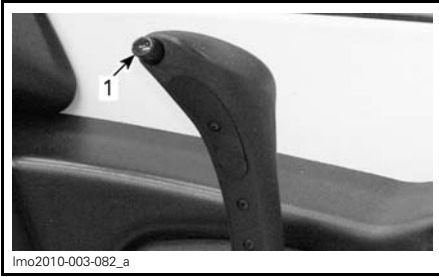

1. Release button



1. Throttle/shifter lever in reverse position

When operating in reverse, turn the steering in the opposite direction that you want to move the rear of the boat.

**NOTICE** Never rev the engine at high RPM in reverse.

For example, to steer the rear of the boat to port (left), turn the steering to clockwise.

**CAUTION** Steering direction in reverse thrust is opposite of forward thrust. To steer the stern to port (left) in reverse, turn the steering clockwise. To steer the stern to starboard (right), turn the steering counterclockwise. Reverse thrust operation should be practiced in open waters in order to become fully familiar with the controls and boat handling characteristics before operating in close quarters.

## General Recommendations

### Rough Water or Poor Visibility Operation

Avoid operation in these conditions. If you must do so, proceed with caution using minimum speed. Turn on navigation lights if necessary.

### Night Operation

Between sunset and sunrise, use the navigation lights and reduce speed.

### **WARNING**

Navigation lights should always be used between sunset and sunrise. Ensure the stern light is installed. See *STERN* in *EQUIPMENT* section for location and installation.

### Crossing Waves

Reduce speed.

Always be prepared to steer and balance as necessary.

When crossing wakes, always keep a safe distance from other craft ahead.

### **WARNING**

When crossing wakes, slow down. Operator and passenger(s) should brace themselves by posting. Do not jump waves or wakes.

### Stopping

The boat is slowed by water drag against the hull. The stopping distance will vary depending on the boat's size, weight, speed, water surface condition, presence and direction of wind and current.

The operator should practice in open waters at various speeds to become familiarized with the stopping distances under different conditions.

**⚠ WARNING**

Always practice stopping in open waters ensuring there are no watercrafts or boats in your immediate vicinity, especially astern.

**⚠ WARNING**

Directional control is reduced when the throttle is decreased and lost when engines are off.

**Docking**

The operator should also practice docking with an imaginary dock using the throttle/shifter lever. A docking mode is also available to help you during the procedure, see *DOCKING MODE* for more informations.

Decrease the throttle at a sufficient distance before the expected landing area.

Reduce speed to idle.

Maneuver using the throttle/shifter lever, shifting to neutral, reverse, or forward as required.

Remember that when operating in reverse, steering direction is reversed. Turning the steering to the left will move the stern to the right when backing up, and vice-versa.

**⚠ WARNING**

Directional control is reduced when the throttle is decreased and lost when engines are off. Steering direction is reversed when operating the boat in reverse.

**Docking Mode**

This mode should be used each time you need to dock. In this mode a maximum of 3500 RPM is available when the throttle/shifter lever is moved between neutral and full throttle position. By limiting the thrust, the docking manoeuvre is facilitated.

To select this mode:

1. Reduce throttle speed to idle.
2. Press the MODE button repeatedly until DOCKING is displayed in the information center.



Imo2010-003-083

**DOCKING**

3. Press the SET button once, the following message will be displayed "PRESS AND HOLD SET BUTTON".
4. Press and hold the SET button until DOCKING reappears.
5. The docking mode is now activated and the information center returns to main display.

To cancel this mode:

1. Press the MODE button repeatedly until DOCKING is displayed in the information center.
2. Press the SET button once, the following message will be displayed "PRESS AND HOLD SET BUTTON".
3. Press the MODE button once. The DOCKING mode will turn OFF right after the throttle/shifter lever will be in NEUTRAL position.

**NOTE:** This mode is cancelled automatically when engines are turned off.

**Beaching**

**NOTICE** It is not recommended to run the boat to the beach.

Drive slowly towards the beach and shut off the engines using start/stop buttons, or pulling the tether cord clip,



before the water depth is less than 90 cm (3 ft) under the lowest rear portion of the hull, then pull the boat to the beach. Turn ignition key OFF to ensure that all accessories are OFF.

**NOTICE** Riding the boat in shallow water may damage the impeller or other jet pump components. Always shut off the engines before water depth is less than 90 cm (3 ft) and never use reverse.

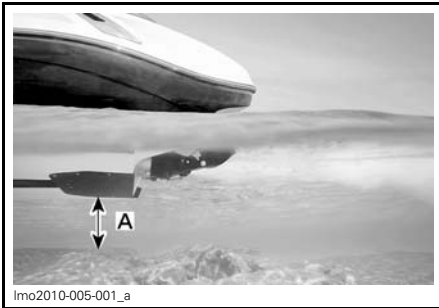

A. 90 cm (3 ft) of water under the hull

**⚠ WARNING**

In shallow water, shells, sand, pebbles or other objects could be drawn up by the jet pumps and be thrown rearward.

# OPERATING MODES

## SKI MODE

Ski Mode allows the driver to adjust launch intensity for different rider skill levels and tow sports while maintaining a constant speed. And, along with Intelligent Throttle Control (ITC), Ski Mode also makes driving easier.

The Ski Mode offers five acceleration curves with the slowest at RAMP 1 increasing to setting RAMP 5.

For each RAMP, a predetermined speed range is available.

RAMP	APPROX. SPEED
1	10 km/h to 35 km/h (6 MPH to 22 MPH)
2	15 km/h to 45 km/h (9 MPH to 28 MPH)
3	20 km/h to 55 km/h (12 MPH to 34 MPH)
4	30 km/h to 65 km/h (19 MPH to 40 MPH)
5	40 km/h to 67 km/h (25 MPH to 42 MPH)

### Ski Mode Limitations

The Ski Mode is not an automatic pilot, it will not drive the boat.

Always leave your hand on the throttle and keep an eye on the water ahead. Pull back throttle to neutral to stop boat (the Ski Mode immediately disengage setting boat control on manual).

### Setting the Ski Mode

To activate the SKI MODE:

1. Press MODE button until SKI MODE is displayed.

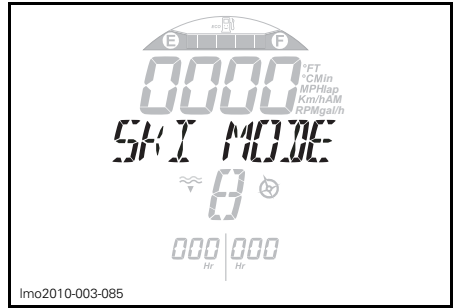

SKI MODE

2. Press the SET button once to enter SKI MODE. The following indications will be displayed.

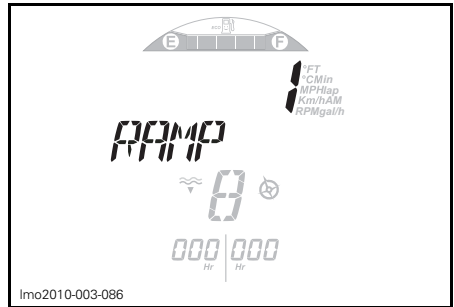

RAMP

3. Using the UP and DOWN switch, select the appropriate RAMP.
4. Press SET button to accept the selection.
5. Now determine the target speed using UP and DOWN switch.



TARGET SPEED

- Press SET button to confirm the speed. The indication SKI MODE will be displayed with the determined speed.



### SKI MODE

- Press the SET button again to activate the launch sequence. At this time, the SKI MODE light blinks.

**NOTE:** In the launch sequence mode, 95% of throttle/shifter lever travel is available to position the boat and stretch the cord without engaging the SKI MODE.

- When everybody is ready (operator, watcher and skier or wakeboarder), push the throttle/shifter lever in full throttle position. The SKI MODE will be activated and the light turns ON.

### Deactivating Temporarily the Ski Mode

To deactivate the SKI MODE temporarily, move the throttle/shifter lever in NEUTRAL position and press the MODE button to return to step 7 of SETTING THE SKI MODE. All of the throttle/shifter lever travel can be used without restriction.

The SKI MODE light will blink again and a beep will be heard every 3 seconds.

To reactivate the SKI MODE, place the throttle/shifter lever in NEUTRAL position and press the SET button to return to step 8 of SETTING THE SKI MODE.

### Cancelling the Ski Mode

To cancel the SKI MODE, move the throttle/shifter lever in NEUTRAL position and press the MODE button twice.

## CRUISE MODE

### ⚠ WARNING

It is not recommended to use the CRUISE mode when pulling a tube, skier or wakeboarder. Maintain your speed manually or use the SKI MODE.

CRUISE mode is a function of iTC (intelligent Throttle Control) system that allows to maintain a steady speed while riding the boat. It will increase or reduce engine speed as necessary.

This is useful when cruising for long distances or operating in limited speed zones.

**NOTE:** The boat speed may vary slightly depending on the weather or water conditions such as the wind or waves.

The CRUISE mode is designed to be used for prolonged drives on open waters.

### ⚠ WARNING

Improper use of the CRUISE mode can lead the boat to a loss of control.

### Cruise Mode Limitations

The CRUISE mode is not an automatic pilot, it will not drive the boat.

The CRUISE mode does not anticipate for obstacles, other users, objects, etc, and will not steer or stop the boat.

### Setting the Cruise Mode

**NOTE:** To use the CRUISE mode, the boat speed must be above approximately 10 km/h (6 MPH).

To activate the CRUISE mode:

1. Using the throttle/shifter lever, bring the boat at the speed you want to maintain
2. Press MODE button repeatedly until CRUISE mode is displayed.

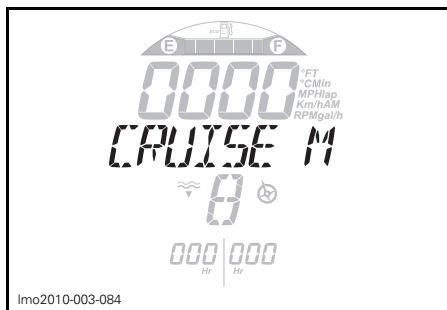

CRUISE MODE

3. Press the SET button once, the following message will be displayed "HOLD SET TO ACTIVATE OR MODE TO EXIT".
4. Hold the SET button until CRUISE mode reappears. At this time, the CRUISE light blinks and you hear one short beep.
5. Slightly move throttle/shifter lever forward until CRUISE light turns ON and activate the CRUISE mode.

### Deactivating Temporarily the Cruise Mode

To deactivate the CRUISE mode temporarily, move the throttle/shifter lever backward.

To reactivate the CRUISE mode, push throttle/shifter lever in forward until the light turns ON again.

### Cancelling the Cruise Mode

To cancel the CRUISE mode, move the throttle/shifter lever in NEUTRAL position and press the MODE button twice. Two short beeps will be heard.

## SYNC MODE

The SYNC mode is controlled by the iTC (intelligent Throttle Control). When the SYNC pilot lamp is ON, the iTC has synchronized both engines (same rpm's).

The iTC may SYNC the engines when the following parameters are achieved:

- Engines are above 3500 rpm's
- Engines are not under acceleration or deceleration.

Some factors may prevent the SYNC mode to be active, such as:

- Wind
- Water conditions
- Boat inputs from the driver
- Towing.

**NOTE:** If the iTC do not SYNC the engines, it should not be seen as a malfunction.

# SPECIAL PROCEDURES

## Jet Pump Water Intake and Impeller Cleaning

Water is drawn up by the impeller through these openings. The grate minimizes entry of foreign objects into the propulsion system.



TYPICAL — BOTH SIDES  
1. Intake grate

### **⚠ WARNING**

Keep away from intake grates while engines are running. Items such as long hair, loose clothing or personal flotation device straps can become entangled in moving parts resulting in severe injury or drowning.

Weeds, shells or debris can get caught on the intake grates, drive shafts and/or impellers. A clogged water intake may cause troubles such as:

1. **Cavitation:** Engine speed is high but boat moves slowly due to reduced jet thrust; jet pump components may be damaged.
2. **Overheating:** Since the jet pump operation controls the flow of water to cool the exhaust system, a clogged intake will cause the engine to overheat and damage internal engine components.

The clogged area can be cleaned as follows:

**In-water cleaning:** Pull the tether cord clip from the emergency engine stop switch to stop engines. Let the boat stop by itself. Wait a while to al-

low weeds or other debris to escape from grates. It may be necessary to repeat the procedure.

In severe conditions if the above method does not work, the following can be performed:

1. With engines running, put throttle/shifter lever in reverse position and vary throttle setting quickly several times.
2. Try accelerating again.

Most of the time, debris will escape from the propulsion system.

**Out of water cleaning:** If the system is still clogged, remove the tether cord clip from the emergency engine stop switch to prevent accidental engines starting.

### **⚠ WARNING**

Always remove the tether cord clip from the emergency engine stop switch to prevent accidental engines starting before cleaning the jet pumps area.

From underneath boat, manually clean water intakes area. If the system is still clogged, refer to an authorized Sea-Doo boats dealer for servicing.

**NOTICE** Avoid operation in weeded areas. If unavoidable, vary speed. Weeds tend to entangle more at steady and slow speeds. Inspect water intake grates for damage. Refer to an authorized Sea-Doo boats dealer for repair as necessary.

## Towing the Boat in Water

Special precautions should be taken when towing a Sea-Doo boats in water.

When towing your boat in water, pinch the exhaust manifold water outlet hose on each engine with a LARGE HOSE PINCHER (P/N 529 032 500).

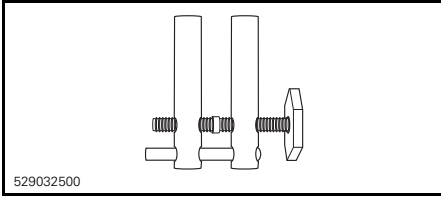

This will prevent the exhaust systems from filling which may lead to water being injected into the engines. Without the engines running there isn't any exhaust pressure to carry the water out the exhaust outlet.

**NOTICE** Failure to do this may result in damage to the engines. If your Sea-Doo boats must be towed in water and you do not have hose pinchers, be sure to stay well below the maximum towing speed of 24 km/h (15 MPH).

Install the hose pinchers on the exhaust manifold water outlet hoses as shown for each engine.

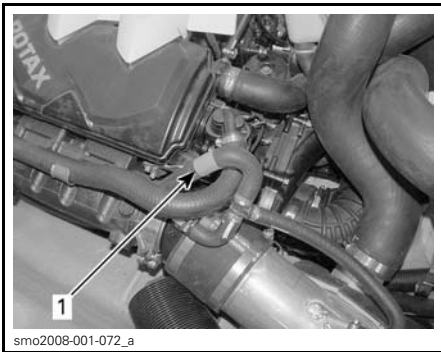

TYPICAL

1. Install hose pincher here

**NOTICE** When finished towing the boat, hose pinchers must be removed before operation. Failure to do so will result in engines damage.

## Submerged Boat and Water-Flooded Engine

To limit damages to the engines, perform the following procedure as soon as possible.

Drain bilge.

If it was submerged in salt water, spray bilge and all components with fresh water using a garden hose to stop the salt corroding effect.

**NOTICE** Never try to crank or start the engines. Water trapped in intake manifolds would flow towards the engines and may cause severe damage to the engines.

Bring the boat to be serviced by an authorized Sea-Doo boats dealer as soon as possible.

**NOTICE** The longer the delay before you have the engine serviced, the greater the damage will be to the engines. Failure to have the engines properly serviced will cause severe engine damage.

# ***MAINTENANCE***

# BREAK-IN INSPECTION

We suggest that after the first 10 hours of operation, the boat be checked by an authorized Sea-Doo boats dealer. The break-in inspection is very important and must not be neglected.

**NOTE:** The break-in inspection is at the expense of the boat owner.

We recommend that this inspection be signed by an authorized Sea-Doo boats dealer.

---

Date of inspection \_\_\_\_\_ Authorized dealer signature \_\_\_\_\_

---

Dealer name \_\_\_\_\_

<b>BREAK-IN INSPECTION CHART</b>	<b>REPLACE</b>				
	<b>ADJUST</b>				
	<b>LUBRICATE</b>				
	<b>CLEAN</b>				
	<b>INSPECT</b>				
<b>ENGINE</b>					
Engine oil and filter					X
Rubber mounts	X				
Corrosion protection			X		
<b>EXHAUST SYSTEM</b>					
Exhaust system fasteners, hoses and components condition. Also inspect for leaks.	X				
<b>COOLING SYSTEM</b>					
Hose and fasteners	X				
Coolant	X				
<b>FUEL SYSTEM</b>					
Throttle body	X				
Fuel lines, connections, pressure relief valve and fuel system leak test	X				
Fuel tank straps	X				
<b>AIR INTAKE SYSTEM</b>					
Air filter	X				



BREAK-IN INSPECTION CHART	REPLACE				
	ADJUST				
	LUBRICATE				
	CLEAN				
	INSPECT				
<b>ENGINE MANAGEMENT SYSTEM</b>					
EMS sensors	X				
EMS fault codes	X				
<b>ELECTRICAL SYSTEM</b>					
Spark plugs	X				
Electrical connections (ignition system, starting system, fuel injectors etc.)	X				
Emergency engine stop switch	X				
Main battery cut-off switch	X				
Battery support	X				
<b>STEERING SYSTEM</b>					
Steering cable and connections	X				
Steering nozzle bushings	X				
<b>PROPULSION SYSTEM</b>					
Carbon ring and rubber boot (drive shaft)	X				
Shifter system, cable and connections	X				
Impeller boot	X				
Impeller and wear ring	X				
<b>HULL/BODY</b>					
Windscreen and fasteners	X				
Drain plug (inside bilge). Check for obstructions.	X				
Ski/wakeboard post and fasteners	X				

# MAINTENANCE SCHEDULE

Maintenance is very important for keeping your boat in safe operating condition. Proper maintenance is the owner's responsibility. The boat should be serviced as per the maintenance schedule.

The maintenance schedule does not exempt the pre-ride inspection.

## WARNING

Failure to properly maintain the boat according to the maintenance schedule can make it unsafe to operate.

The schedule should be adjusted according to operating conditions and use. Intensive use of boat will require greater frequency of inspection and maintenance.

We encourage you to have an Annual Safety Inspection of your boat.

A: ADJUST C: CLEAN I: INSPECT L: LUBRICATE R: REPLACE D: DEALER O: OPERATOR	EVERY 25 HOURS						TO BE PERFORMED BY	LEGEND
	EVERY 50 HOURS							
PART/TASK	EVERY 100 HOURS OR Preseason						LEGEND	
	EVERY 200 HOURS OR 2 YEARS							
<b>ENGINE</b>								
Engine oil and filter			R <sup>(1)</sup>			D	(1) At storage period or after 100 hours of use whichever comes first. (2) Inspect slipping moment. (3) Every 10 hours in salt water use.	
Rubber mounts		I				D		
Supercharger clutch (if so equipped)				I <sup>(2)</sup>		D		
Corrosion protection				L <sup>(3)</sup>		O		
<b>EXHAUST SYSTEM</b>								
Exhaust system fasteners, hoses and components condition	I		I <sup>(4)</sup>			D	(1) At storage period or after 100 hours of use whichever comes first. (4) Also inspect for leaks (5) Daily flushing in salt water or foul water use.	
Exhaust system flushing			(1) (5)			O		
<b>COOLING SYSTEM</b>								
Hose and fasteners			I			D	-	
Coolant				R		D		

A: ADJUST C: CLEAN I: INSPECT L: LUBRICATE R: REPLACE D: DEALER O: OPERATOR	EVERY 25 HOURS					
	EVERY 50 HOURS					
	EVERY 100 HOURS OR Preseason					
	EVERY 200 HOURS OR 2 YEARS					
	TO BE PERFORMED BY					
PART/TASK						LEGEND
<b>FUEL SYSTEM</b>						
Throttle body			I			D
Fuel lines, connections, pressure relief valve and fuel system leak test			I			D
Fuel tank straps			I			D
<b>ENGINE MANAGEMENT SYSTEM</b>						
EMS sensors			I			D
EMS fault codes			I			D
<b>AIR INTAKE SYSTEM</b>						
Air filter			I (6)			D (6) Replace if required
<b>ELECTRICAL SYSTEM</b>						
Spark plugs			I	R		D
Ignition coils			I, L			D
Electrical connections and fastening (ignition system, starting system, fuel injectors etc.)			I			D
ECM and VCM connectors (visual inspection without disconnecting)			I (3)			O (3) Every 10 hours in salt water use.
Emergency engine stop switch			I			D (7) Lubricate posts.
Main battery cut-off switch			I			D
Battery support			I			D
Battery			I, L (7)			D
Stern light connectors			L			O

A: ADJUST C: CLEAN I: INSPECT L: LUBRICATE R: REPLACE D: DEALER O: OPERATOR	EVERY 25 HOURS					
	EVERY 50 HOURS					
	EVERY 100 HOURS OR Preseason					
	EVERY 200 HOURS OR 2 YEARS					
	TO BE PERFORMED BY					
PART/TASK						LEGEND
<b>STEERING SYSTEM</b>						
Steering cable and connections			I			D
Steering nozzle bushings			I			D
<b>PROPULSION SYSTEM</b>						
Drive shaft			L <sup>(3)</sup> (8)			D
Carbon ring and rubber boot (drive shaft)		I				D
Shift system, cable and connections			I			D
Reverse gate		L <sup>(3)</sup>				O
Drive shaft/impeller splines			I, L			D
Impeller boot			I			D
Impeller shaft seal, sleeve and O-ring			I <sup>(3)</sup>			D
Impeller and wear ring		I				D
Sacrificial anode			(9)			O
<b>HULL/BODY</b>						
Storage compartments covers latch(es), hinge(s), locks and cylinders			I, L <sup>(3)</sup>			O
Deck drains/scupper valve			I			O
Drain plug			I <sup>(10)</sup>			O
Ski/wakeboard tow hook or tower and fasteners		I, L <sup>(3)</sup>				O

(3) Every 10 hours in salt water use.  
 (8) Lubricate for corrosion protection.  
 (9) Inspect each month (every two weeks in salt water) and change when necessary.

(3) Every 10 hours in salt water use.  
 (10) Check for obstructions

# MAINTENANCE PROCEDURES

This section includes instructions for basic maintenance procedures. If you have the necessary mechanical skills and the required tools, you can perform these procedures. If not, see your authorized Sea-Doo boats dealer.

Other important items in the maintenance schedule that are more difficult and require special tools are best performed by your authorized Sea-Doo boats dealer.

**⚠ WARNING**

Turn off the engines and follow these maintenance procedures when performing maintenance. If you do not follow proper maintenance procedures you can be injured by hot parts, moving parts, electricity, chemicals or other hazards.

**⚠ WARNING**

Should removal of a locking device be required (e.g. lock tabs, self-locking fasteners, etc.), always replace it with a new one.

**⚠ CAUTION** Some components in the engine compartment may be very hot.

## Engine Oil

### Recommended Engine Oil

#### 310 HP Models

Use XPS SYNTHETIC BLEND OIL (SUMMER GRADE) (P/N 293 600 121).

**NOTE:** This engine has been developed and validated using the XPS™ Synthetic blend oil. BRP strongly recommends the use of its XPS Synthetic blend oil at all times.

If the XPS engine oil is not available, use a 5W40 engine oil meeting the requirements for API service classification SM, SL or SJ. Always check the

API service label certification on the oil container, it must contain at least one of the above standards.

#### 430 HP Models

Use XPS SYNTHETIC BLEND OIL (SUMMER GRADE) (P/N 293 600 121).

**NOTE:** This engine has been developed and validated using the XPS™ Synthetic blend oil. BRP strongly recommends the use of its XPS Synthetic blend oil at all times.

If XPS engine oil is not available, use a 10W40 mineral engine oil compatible with wet clutches.

**NOTICE** NEVER use synthetic oil. This would impair the proper operation of the supercharger clutch. Do not add any additives to the recommended oil. Mineral oils (API service SM or SL) may also contain additives (friction modifiers) that may cause inappropriate slippage of the supercharger clutch and eventually lead to premature wear. Damages caused by oil which is not suitable for the engine will not be covered by the BRP limited warranty.

### Engine Oil Level

**NOTICE** Check level frequently and refill if necessary. Operating the engines with improper oil levels may severely damage engines.

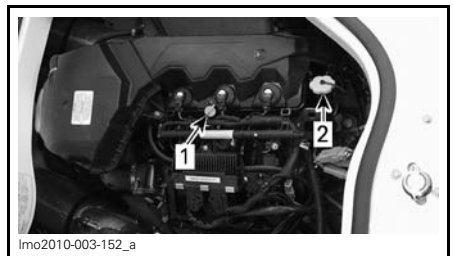

1. Dipstick
2. Oil cap

Boat must be leveled.

Oil level can be checked either with boat in water or out of water.

### If Boat is Out of the Water

If the boat is out of the water and on a trailer, block the wheels and raise the bow slightly with the trailer jack (if so equipped) until the bumper rail is level.

Install a garden hose to the flushing connector. Refer to *EXHAUST SYSTEM FLUSHING* in *MAINTENANCE PROCEDURES* and follow the procedure.

**NOTICE** Never run engine without supplying water to the exhaust system when boat is out of water, otherwise damage to the exhaust system may occur.

**NOTICE** Never run engine(s) longer than 2 minutes. Drive line seals has no cooling when boat is out of water.

### Procedure Continuation (Boat Out or In Water)

It is of the utmost importance to follow this procedure in order to obtain an accurate reading of the engine oil level.

**CAUTION** Engine oil may be hot. Certain components in the engine compartment may be very hot. Direct contact may result in skin burn.

1. Ensure engine is at normal operating temperature.
2. Let engine idle for 30 seconds before stopping.
3. Stop engine.
4. Wait at least 30 seconds.
5. Pull dipstick out and wipe clean.

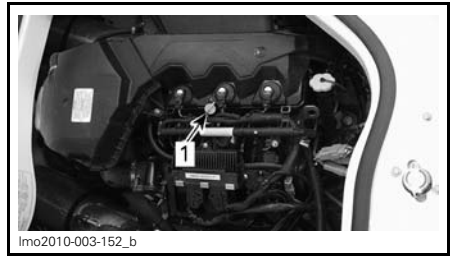

1. Dipstick

6. Reinstall dipstick, push in completely.
7. Remove dipstick and read oil level. It should be between marks.

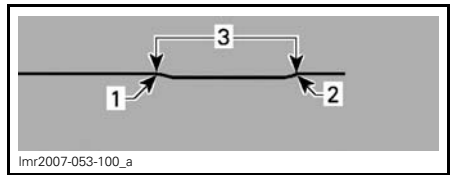

1. Full
2. Add
3. Operating range

8. If needed, add oil up to have the level between marks as required.

To add oil, unscrew oil cap. Place a funnel into the opening and add the recommended oil to the proper level.

Do not overfill.

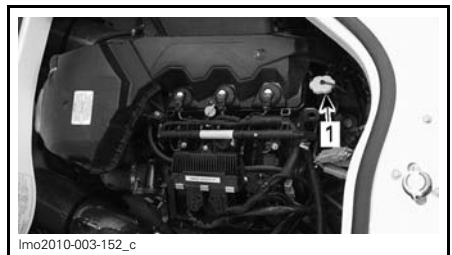

1. Oil cap

**NOTE:** Every time oil is added in engine, the complete procedure explained above must be done. Otherwise, you will have a false oil level reading.

9. Properly reinstall oil cap and dipstick.

10. Repeat procedure for the other engine.
11. Wipe off any oil spillage.

## Engine Oil Change and Oil Filter Replacement

The oil change and filter replacement should be performed by an authorized Sea-Doo boats dealer.

## Engine Coolant

### Recommended Engine Coolant

Always use ethylene-glycol antifreeze containing corrosion inhibitors specifically for internal combustion aluminum engines.

**NOTE:** When available, it is recommended to use biodegradable antifreeze compatible with internal combustion aluminum engines. This will contribute to protecting the environment.

Cooling system must be filled with BRP PREMIXED COOLANT (P/N 219 700 362) or with a water and antifreeze solution (50% distilled water, 50% antifreeze).

To prevent antifreeze deterioration, always use the same brand. Never mix different brands unless cooling system is completely flushed and refilled. Refer to an authorized Sea-Doo boats dealer.

### Engine Coolant Level

With boat on a level surface, coolant should be between MIN. and MAX. level marks for each coolant reservoir when each engine is cold.

**NOTE:** The coolant reservoirs are visible when the engine cover is opened.

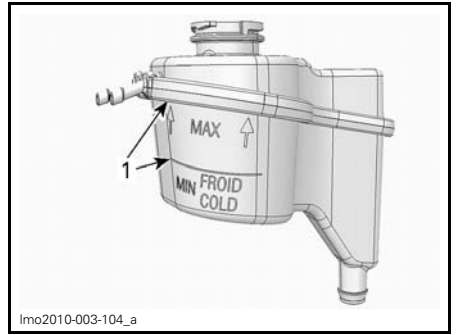

lmo2010-003-104\_a

1. Level between marks when engine is cold

## ⚠ WARNING

**Check coolant level with cold engines. Never add coolant in cooling system when engines are hot.**

**NOTE:** The boat is considered level when it is in water. When boat is on a trailer, block the wheels and raise the bow slightly with the trailer jack (if so equipped) until the bumper rail is level.

Add coolant to have the level between marks as required. Use a funnel to avoid spillage. **Do not overfill.**

Properly reinstall and tighten filler cap.

**NOTE:** A cooling system that frequently requires coolant indicates leaks or engine problems. See an authorized Sea-Doo boats dealer.

### Engine Coolant Replacement

The coolant replacement should be performed by an authorized Sea-Doo boats dealer.

## Ignition Coils

### Ignition Coil Installation

1. Pull rubber seal down.

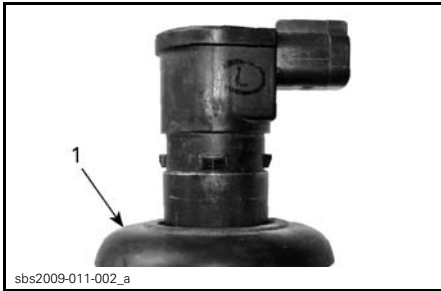

1. Rubber seal pulled down

2. Apply DOW CORNING 111 (P/N 413 707 000) to rubber seal seat as shown.

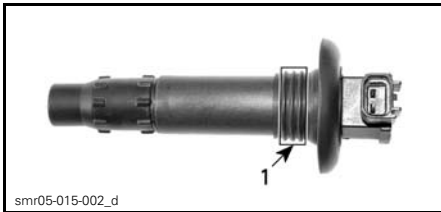

1. Apply product here

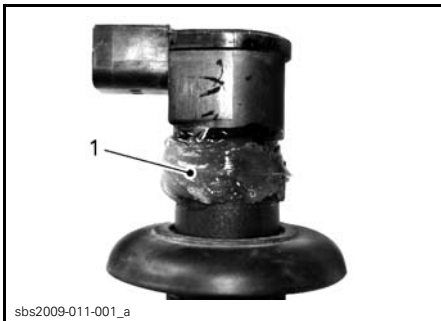

1. Apply product here

3. Pull rubber seal back on its seat making sure the tabs on the ignition coil and the slots in the seal properly match together.
4. Leave a ring of grease on top of the seal as shown to act as a water barrier. Wipe off the excess.

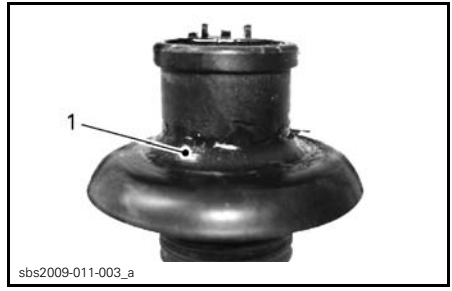

1. Correctly shaped excess of product

5. Push the ignition coil down to securely install it on the spark plug tip.
- NOTE:** Ensure the seal seats properly with the top surface of the engine.
- NOTE:** Ensure the seal seats properly with the engine top surface.
6. Reconnect ignition coil connectors.

## Exhaust System

### Exhaust System Flushing

Flushing the exhaust system and intercooler of each engine with fresh water is essential to neutralize corroding effects of salt or other chemical products present in water. It will help to remove sand, salt, shells or other particles in water jackets and/or hoses.

### **⚠ WARNING**

Perform this operation in a well ventilated area.

Proceed as follows:

1. Clean jet pump by spraying water in its inlet and outlet and then apply a coating of XPS LUBE (P/N 293 600 016) or equivalent.

**⚠ CAUTION** When operating the engine while the boat is out of the water, the heat exchanger in the ride plate may become very hot. Avoid any contact with ride plate as burns may occur.



2. Connect a garden hose to the connector located at the rear of boat on jet pump support. Do not open water tap at this time.



lmo2007-003-030\_a

**TYPICAL**

1. Flushing connector

**NOTE:** Use an optional FLUSHING CONNECTOR ADAPTER (P/N 295 500 473) with a quick connect adapter to ease garden hose installation. No hose pincher is required to flush engine.

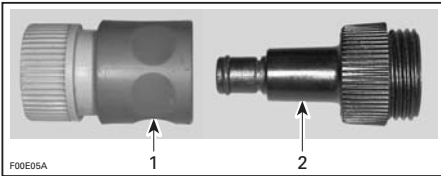

F00E05A

1. Quick connect adapter
2. Flushing connector adapter

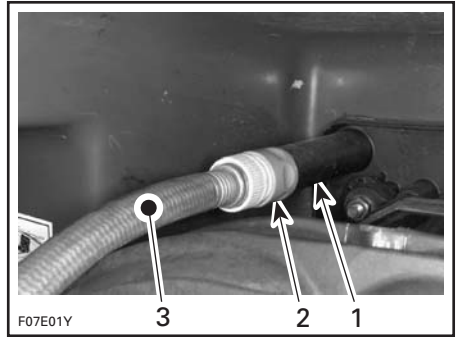

F07E01Y

**TYPICAL**

1. Flushing connector
2. Quick connect adapter and flushing connector adapter (optional, not mandatory)
3. Garden hose

3. To flush, start engine then immediately open the water tap.

**CAUTION** Certain components in the engine compartment may be very hot. Direct contact may result in skin burn. Do not touch any electrical parts or jet pump area when engine is running.

**NOTICE** Never flush a hot engine. Always start the engine before opening the water tap. Open water tap immediately after engine is started to prevent overheating.

4. Run the engine about 20 seconds at a fast idle between 4000 - 5000 RPM.

**NOTICE** Never run engine without supplying water to the exhaust system when boat is out of water.

5. Ensure water flows out of jet pump while flushing. Otherwise, refer to an authorized Sea-Doo boats dealer for servicing.

**NOTICE** Never run engine longer than 2 minutes. Drive line seal has no cooling when boat is out of water.

6. Close the water tap, then stop the engine.

**NOTICE** Always close the water tap before stopping the engine.

**NOTICE** Remove quick connect adapter after flushing operation (if used).

## Fuses and Circuit Breakers

The electrical system is protected with fuses and circuit breakers.

To remove fuse from holder, pull fuse out. Check if filament is melted.

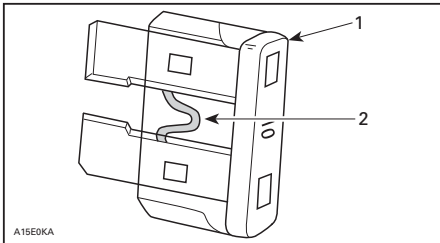

1. Fuse
2. Check if melted

If a fuse is defective, replace by one of the same rating.

**NOTE:** If the entire electrical system is down, make sure the main battery cut-off switch is properly turned on, refer to *EQUIPMENT*.

**NOTICE** Do not use a higher rated fuse as this can cause severe damage. If a fuse has blown, the source of malfunction should be determined and corrected before restarting. See an authorized Sea-Doo boats dealer for servicing.

## Vehicle Control Module (VCM) Fuses

Each engine has its own fuses box.

Both fuse boxes are located on the aft transom.

Refer to the fuse cover decal or the *SPECIFICATIONS* section for fuse identification.

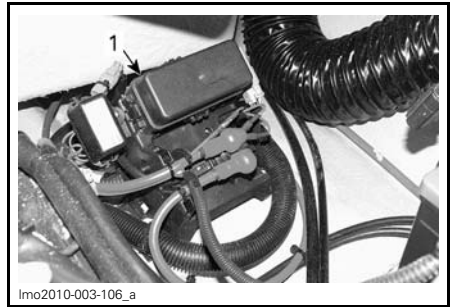

1. Fuse box

To remove a fuse cover, unlock the tabs and pull cover off.

Use the cover built-in fuse puller to pull fuses out.

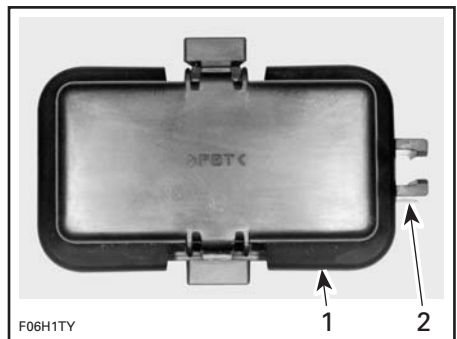

- TYPICAL**
1. Cover
  2. Fuse puller

## Circuit Breaker Panel

The circuit breaker panel is located underneath the driver console.

Refer to the inscriptions on the panel for circuit breaker identification.



lmo2010-003-107\_a

1. Circuit breaker panel location



lmo2009-006-005

CIRCUIT BREAKER PANEL

## Fuse Holders

### Blower Motor

The blower motor and its fuse holders are located nearby the battery.

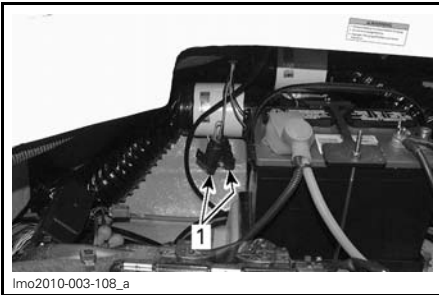

lmo2010-003-108\_a

1. Blower fuse holders

### Charging System

The fuse holder for the charging system of each engine is located beside each VCM fuse box.



lmo2010-003-109\_a

1. Charging system fuse holder

### Bilge Pump

The automatic bilge pump fuse is located in the engine compartment nearby bilge pump.

**NOTE:** In case of problem with bilge pump, check the circuit breaker panel too.

### Radio

The radio fuse holder is located in the operator's console.

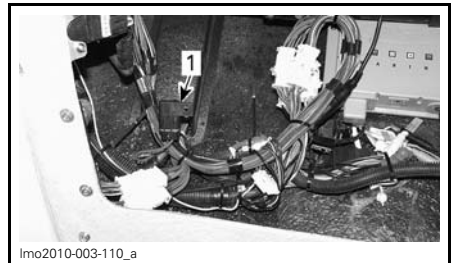

lmo2010-003-110\_a

1. Radio fuse holder

### Bilge Blower

#### Bilge Blower Operation Check

Verify bilge blower for proper operation.

Make sure that the blower duct is not obstructed.

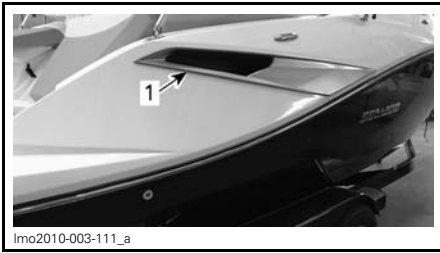

lmo2010-003-111\_a

**STARBOARD SIDE**

1. Blower duct

**⚠ WARNING**

If bilge blower does not operate properly, refer to an authorized Sea-Doo boats dealer before starting the boat.

**Navigation Lights**

**Bow Light Bulb Replacement**

Remove screws securing the bow light.

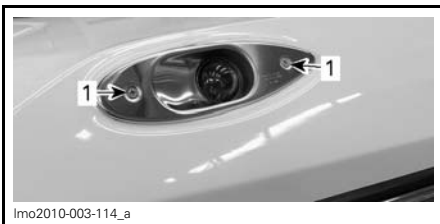

lmo2010-003-114\_a

1. Retaining screws

Turn bow light and remove the socket screws.

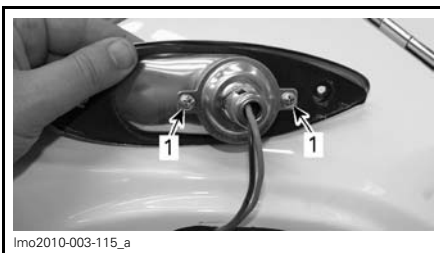

lmo2010-003-115\_a

1. Socket screws

Push bulb in and hold while turning counterclockwise to release.

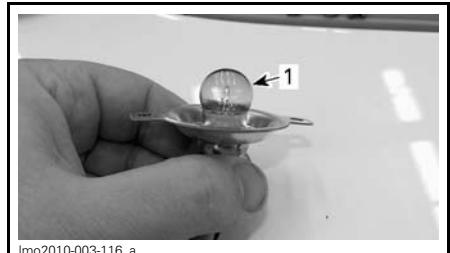

lmo2010-003-116\_a

1. Bulb

Apply DIELECTRIC GREASE (P/N 293 550 004) on new bulb contact surface.

Install the new bulb by pushing it in while turning clockwise.

Finger tight all screws.

**Stern Light Bulb Replacement**

Unscrew lens counterclockwise and pull it out.

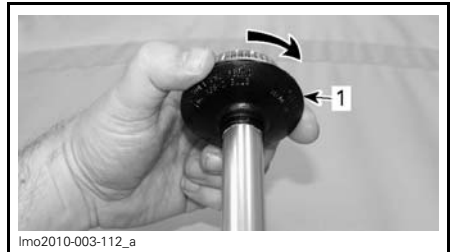

lmo2010-003-112\_a

**TYPICAL**

1. Unscrew then pull

Pull bulb to remove it.

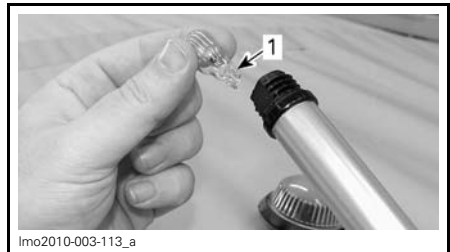

lmo2010-003-113\_a

**TYPICAL**

1. Pull bulb out

Apply DIELECTRIC GREASE (P/N 293 550 004) on new bulb contact surface.

Assembly is the reverse of removal procedure.

### Deck Light Bulb Replacement

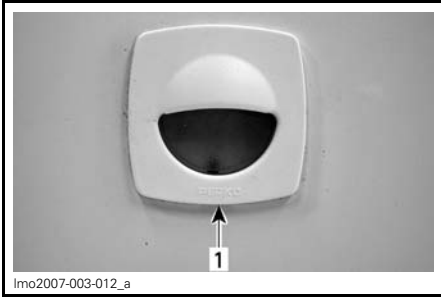

1. Gently pry here with a screwdriver



1. Pull and remove bulb

### Deck Drains

The purpose of this drain is to evacuate water from the deck.

Remove any obstructions from deck drain outlets.

Water drains out though the scupper valve located near the jet pump nozzle.



TYPICAL

1. Scupper valve

Keep it clean to avoid clogging.

### Latches and Hinges

The application of XPS LUBE (P/N 293 600 016) lubricant will help to prevent corrosion and keep proper operation of moving mechanisms.

### Latches and Hinges Lubrication

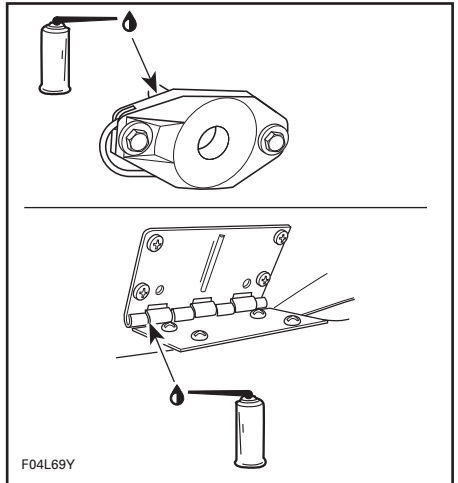

TYPICAL

## Reverse Gates

### Reverse Gate Lubrication

Lubricate pivot points and mechanism on both sides of each reverse gate with XPS LUBE (P/N 293 600 016) lubricant or equivalent.

## Sacrificial Anodes

### Sacrificial Anodes Inspection

Corrosion of metal parts, especially those exposed to saltwater, is common for boats. Corrosion can be caused by stray electric currents from shore power installations, improperly grounded AC lines and circuits, and poorly insulated DC powered equipment from boats moored nearby. Corrosion is accelerated when electric current is present.

Sacrificial anodes are attached to certain parts of this boat to reduce corrosion. The anode corrodes, rather than the part to which the anode is attached.

Change each anode when 50% by weight has corroded away.

Anodes are attached at the following locations:

- Ride plate
- Heat exchanger
- Pump housing
- Reverse gate support
- Steering nozzle
- Reverse gate.

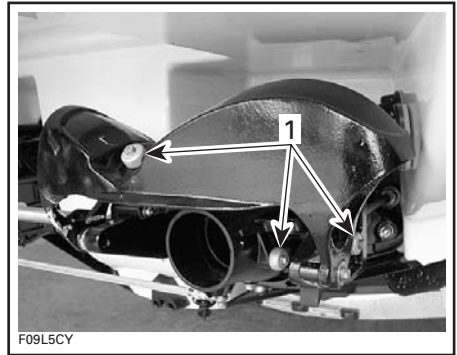

### TYPICAL

1. Sacrificial anodes

**NOTICE** Inspect anodes each time boat is to be launched. Do **NOT** paint anodes or apply protective coatings.

---

# BOAT CARE

## Post-Operation Care

Remove the boat from the water every day to prevent growth of marine organisms.

### **WARNING**

Allow engine to cool before performing any maintenance.

## Exhaust System Flushing

The exhaust system should be flushed daily when boat is used in salt or foul water.

Refer to *MAINTENANCE PROCEDURES*.

## Anticorrosion Treatment

To prevent corrosion, spray a corrosion inhibitor (salt water resistant) such as XPS LUBE (P/N 293 600 016) or equivalent over metallic components in engine compartment.

Apply DIELECTRIC GREASE (P/N 293 550 004) (salt water resistant) on battery posts and cable connectors.

**NOTICE** Never leave rags or tools in the engine compartment or in the bilge.

## Additional Care for Foul Water or Salt Water Use

When the boat is operated in foul water and particularly in salt water, additional care must be taken to protect the boat and its components.

Rinse trailer and boat's hull/bilge area with fresh water.

Never use a high pressure washer to clean the bilge. **USE LOW PRESSURE ONLY** (such as a garden hose). High pressure can cause damages to electrical or mechanical systems.

**NOTICE** Failure to perform proper care such as: boat rinsing, exhaust system flushing and anticorrosion treatment, when used in salt water, will result in damage to the boat and its components. Never leave the boat stored in direct sunlight.

In coastal areas, special care should also be taken on stainless steel or chrome parts like grab handles, mooring cleats, fuel cap and navigation lights. Rinse with fresh water. Clean with a good car chrome polish. Protect with a good car or fiberglass wax.

## Boat Cleaning and Protection

### Engine Compartment Cleaning

The engine compartment should be cleaned with warm water and BRP HEAVY DUTY CLEANER (P/N 293 110 001).

Unscrew the drain plug, block the wheels and raise the bow slightly with the trailer jack (if so equipped) to allow water to drain. Rinse thoroughly. Leave all compartments open to air dry.

### General Washing Tips

- Remove dust from surface.
- Use a sponge versus a cloth to wash and rinse the surface.
- Change the wash and rinse solutions frequently.
- To avoid streaking when cleaning soiled areas, start with the adjacent clean area and clean into the soiled area.

### Body Cleaning

First rinse with fresh water to remove dried salt water.

Wash the body with water and soap (only use mild detergent). Remove any marine organisms.

**NOTICE** Never clean fiberglass and plastic parts with strong detergent, degreasing agent, paint thinner, acetone, etc.

Apply a marine wax to protect the finish.

**Carpet Cleaning**

To clean the carpets, use 3M™ Citrus Base Cleaner or an equivalent. See the manufacturer's instructions.

**Windshield Cleaning**

Wash with BRP HEAVY DUTY CLEANER (P/N 293 110 001).

Clean only with flannel clothes.

**NOTICE** It is necessary to use flannel cloths on windshield to avoid damaging surface.

To remove scratches on windshield: Start with "Slip Streamer® Scratch Remover". Finish with "Slip Streamer® Cleaner and Polish".

**NOTE:** The later product may be used alone if only light scratches are noticeable.

**NOTICE** Never clean windshield with strong detergent, degreasing agent, paint thinner, acetone, products containing chlorine, etc.

**Vinyl Cleaning**

Use XPS MULTI-PURPOSE CLEANER (P/N 219 701 709).

For dirt build up, let cleaner soak for approximately 10 minutes, then gently scrub with a soft bristle brush.

Refer to next table for other products that can also be used for cleaning vinyl.

Do not use any silicone-based protectants. They will extract the plasticizers, leaving the vinyl hard and brittle, and eventually cracking will occur.

CLEANING PRODUCTS	
1.	XPS MULTI-PURPOSE CLEANER (P/N 219 701 709)
2.	Dish Soap (Dawn or Ivory) and water
3.	Spray Nine
4.	Fantastik
5.	3M Citrus Cleaner
6.	303 Protectant

**NOTE:** Always follow manufacturer's recommendations and instructions.



## Vinyl Cleaning Recommendations for Special Stains

TYPE OF STAIN	STEP 1	STEP 2	STEP 3
Ballpoint ink *	E	B	A
Chewing gum	D	A	—
Coffee, tea, chocolate	B	—	—
Pencil	D	B	—
Grease	D	B	—
Household soil	A	B	—
Ketchup	A	B	—
Latex paint	A	B	—
Lipstick	A	B	—
Mildew or wet leaves *	C	B	A
Motor oil	B	—	—
Oil-based paint	D	B	—
Permanent marker *	E	B	C
Spray paint	B	B	—
Suntan lotion	A	B	—
Tar/asphalt	D	B	—
Yellow mustard	A	B	C
Recommended action: – A. Medium-soft brush, warm soapy water, rinse/dry. – B. XPS MULTI-PURPOSE CLEANER (P/N 219 701 709), rinse/dry. – C. One (1) tablespoon of ammonia, one-fourth (1/4) cup of hydrogen peroxide, three-fourth (3/4) cup of water, rinse/dry. – D. Wipe or scrape off excess (chill gum with ice before hand). – E. Denatured alcohol, rinse/dry.			

\* Suntan lotion, tree pollen, wet leaves and some other products can contain dyes that stain permanently.

All cleaning methods must be followed by a thorough rinse with warm water.

Certain household cleaners, powdered abrasives, steel wool and industrial cleaners can cause damage and discoloration and are not recommended. Dry cleaning fluids and lacquer solvents should not be used as they will remove printed pattern and gloss. Waxes should be used with caution as many contain dyes or solvents that can permanently damage the protective coating.

Please contact G&T industries "Marine Specialties Group" hot line at 1 800 318-2887 for any cleaning and care questions.

### Stainless Steel and Chrome

To clean or polish stainless steel or chrome parts, always use a product specially developed for marine environment such as the Flitz Stainless Steel & Chrome Cleaner.

### Corrosion Protection

Protect engine compartment metallic parts from corrosion using XPS LUBE (P/N 293 600 016) or an equivalent.

## STORAGE

It is recommended that the boat be taken to an authorized Sea-Doo boats dealer for proper storage but the following operations can be performed by you with a minimum of tools.

**NOTE:** Leave drain plug out during storage period.

**NOTICE** Do not run the engines during the storage period.

### Jet Pump Cleaning

Clean jet pump by spraying water in its inlet and outlet and then apply a coating of XPS LUBE (P/N 293 600 016) or equivalent.

#### **⚠ WARNING**

Always remove tether cord from emergency engine stop switch to prevent unexpected engine starting before cleaning the jet pump area. Engine must not be running for this operation.

### Fuel System Protection

BRP FUEL STABILIZER (P/N 413 408 600) (or equivalent), can be added in fuel tank to prevent fuel deterioration and fuel system gumming. Follow stabilizer manufacturer's instructions for proper use.

**NOTICE** It is highly recommended to add fuel stabilizer at storage in order to maintain fuel system in good condition.

### Engine Oil and Filter Replacement

The oil change and filter should be performed by an authorized Sea-Doo boats dealer.

### Exhaust System Flushing

Perform procedure as described in *MAINTENANCE* section.

### Exhaust System and Intercooler Protection

The exhaust system is self draining, but the intercooler (430 HP) and exhaust manifold (310 HP and 430 HP engines) on each engine need to be properly drained to avoid damage.

Using the flushing connectors on jet pump supports, inject pressurized air (around 689 kPa (100 PSI)) into system until there is no more water flowing from the jet pumps.

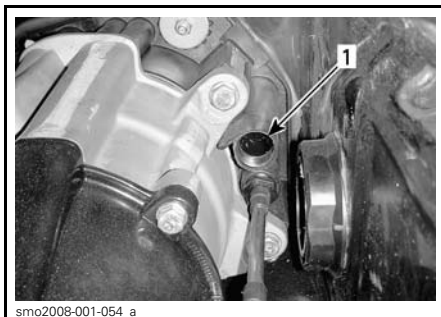

1. Flushing connector — location may differ

To ease the procedure, a custom hose can be assembled. See the following illustration.

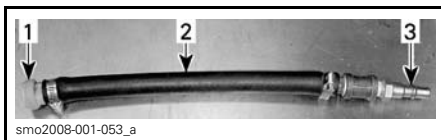

#### **TYPICAL**

1. Flushing connector adapter (P/N 295 500 473)
2. Hose 13 mm (1/2 in)
3. Air hose male adapter

**NOTICE** Failure to drain the exhaust system may cause severe damage to intercooler and exhaust manifold.

## Engine Internal Lubrication

**NOTE:** Both engines must be internally lubricated for the storage period.

1. Open the engine compartment lid.
2. Disconnect ignition coil connectors.

### **⚠ WARNING**

When disconnecting coil from spark plug, always disconnect coil from main harness first. Never check for engine ignition spark from an open coil and/or spark plug in the engine compartment as spark may cause fuel vapor to ignite.

**IMPORTANT:** Never cut the locking ties of ignition coil connectors. This would allow mixing the wires between cylinders.

3. Remove ignition coils.

**NOTICE** Ensure there is no dirt in coil holes before removing the spark plugs. Otherwise, dirt would fall into cylinder and will damage the internal components.

4. Remove spark plugs.

**NOTE:** After loosening the spark plugs, a coil may be used to remove the spark plugs. Simply bring the coil down to spark plug and “hook” it to then extract spark plug.

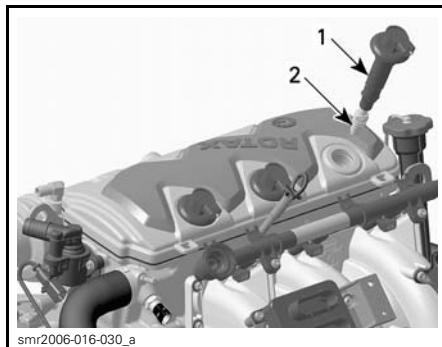

1. Ignition coil
2. Spark plug

5. Spray XPS LUBE (P/N 293 600 016) or equivalent, into spark plug holes.

**NOTE:** To allow engine lubrication for storage, the DROWNED MODE can be activated to prevent fuel injection and ignition while cranking in order to lubricate the the cylinder walls.

Proceed as follows to activate drowned mode.

6. Ensure **both engines are OFF.**

### **⚠ WARNING**

Both engines must be stopped when using drowned mode to lubricate the engines.

7. Install the tether cord on the engine cut-off switch.
8. Ensure the throttle/shifter lever is in the NEUTRAL position.
9. Activate the drowned mode as follows.
10. Move the throttle accelerator sensor (TAS) to the wide open throttle position (WOT).

**NOTE:** For TAS access and identification, refer to *INTELLIGENT THROTTLE CONTROL (ITC)* (210 Series) subsection.

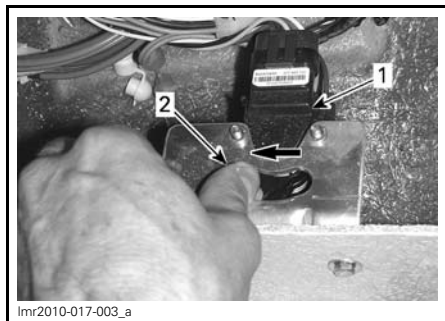

1. Throttle accelerator sensors (TAS)
2. Wide open throttle position (WOT)

11. Turn ignition key to ON position.

**NOTE:** The ECM will allow engine cranking while inhibiting fuel injection and ignition. Do not crank engine for more than 10 seconds.

12. Crank each engine a few turns to distribute the oil on cylinder walls.

**NOTE:** Ask a person to assist you for this operation.

13. Release TAS.

14. Turn ignition key OFF.

15. Apply LOCTITE 767 (ANTISEIZE LUBRICANT) (P/N 293 800 070) on spark plug threads then reinstall them.

16. Reinstall ignition coils. Reconnect ignition coil connectors.

**NOTE:** Prior to inserting the ignition coils onto the spark plugs, apply some DOW CORNING 111 (P/N 413 707 000) grease around the seal area that touches the spark plug hole. After installation, ensure the seal seats properly with the top surface of the engine.

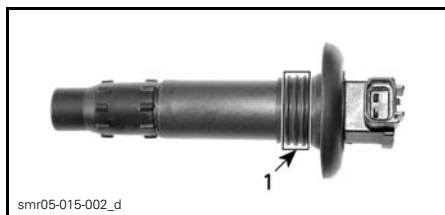

1. Apply product here

17. To reinstall engine cover, remove dipstick, push engine cover downward until it snaps.

18. Reinstall dipstick.

**NOTE:** It is recommended to fog the engine valves with XPS LUBE (P/N 293 600 016). Contact your authorized Sea-Doo boats dealer.

## Engine Coolant Test

If antifreeze is not replaced, test its density.

The antifreeze replacement and a density test should be performed by an authorized Sea-Doo boats dealer.

**NOTE:** Antifreeze of each engine should be replaced every 200 hours or every 2 years to prevent antifreeze deterioration.

**NOTICE** Improper antifreeze density may allow freezing of the liquid in the cooling system if the boat is stored in an area where the freezing point is attained. This would seriously damage the engine.

## Battery Removal and Storage

For battery removal, cleaning and storage, contact your authorized Sea-Doo boats dealer.

## Boat Cleaning/Repair

Clean boat and trailer. Refer to *BOAT CARE*.

Replace damaged labels/decals.

If repairs are needed to the body or to the hull contact your authorized Sea-Doo boats dealer. For paint touch up to mechanical parts use BRP spray paint. For minor gelcoat repairs, a Gelcote repair kit is available from Gelcote International at [www.gelcote.com](http://www.gelcote.com).

## Boat Protection

The engine storage cover should be left partially opened during storage (detach the four (4) gas shocks from the cover to prevent full opening).

Using a flat screwdriver, lift the tab locking the shock gas end.

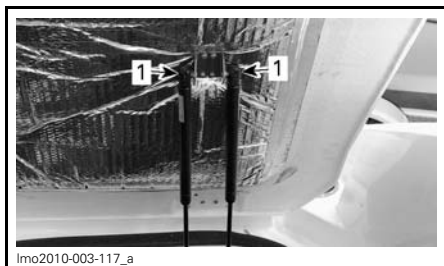

1. Retaining tabs

Detach all shock gas end.

Block and leave engine cover lid open slightly.

This will avoid engine compartment condensation and possible corrosion.

If the boat is to be stored outside, cover it with a vented opaque tarpaulin to prevent UV (ultraviolet) rays and grime from affecting the plastic components, boat finish, as well as preventing dust accumulation.

**NOTICE** Never leave the boat stored in direct sunlight. UV radiation will dull finishes. The boat must never be left in water for storage.

For the storage period, block the wheels and raise the bow slightly with the trailer jack (if so equipped) so drainage can take place. Ensure the drain plug is unscrewed and unobstructed.

---

## PRESEASON PREPARATION

Maintenance preparation must be performed in conjunction with *MAINTENANCE SCHEDULE*.

Ensure to perform all tasks included in the **100 HOURS OR 1 YEAR** column.

Since technical skills and special tools are required, some operations should be performed by an authorized Sea-Doo boats dealer.

**NOTE:** It is highly recommended that an authorized Sea-Doo boats dealer perform factory campaigns in addition to the preseason preparation all at the same time.

### **WARNING**

Only perform procedures as detailed in the *MAINTENANCE SCHEDULE*. It is recommended that the assistance of an authorized Sea-Doo boats dealer be periodically obtained on other components and systems not covered in this guide.

**NOTICE** When component conditions seem less than satisfactory, replace using only genuine BRP parts, or approved equivalents.

# ***TECHNICAL INFORMATION***

# BOAT IDENTIFICATION

The main components of the boat (hull and engines) are identified by different serial numbers. It may sometimes become necessary to locate these numbers for warranty purposes or to trace the boat in the event of theft.

## Hull Identification Number

The Hull Identification Number (H.I.N.) is located on the right side of the transom.



**TYPICAL**

1. Hull Identification Number (H.I.N.)

## Engine Identification Number

The Engine Identification Number (E.I.N.) is located on the upper crankcase on MAGNETO side of each engine.

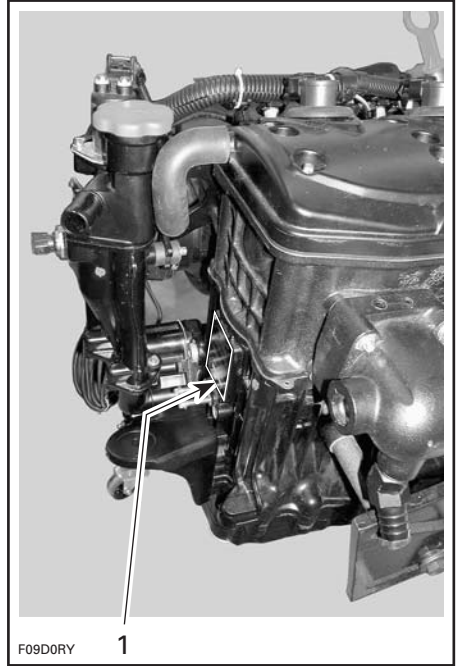

1. Engine Identification Number (E.I.N.)



---

# ENGINE EMISSIONS INFORMATION

Maintenance, replacement, or repair of the emission control devices and systems may be performed by any marine SI (spark ignition) engine repair establishment or individual.

## Manufacturer's Responsibility

Beginning with 1999 model year engines, manufacturers of marine engines must determine the exhaust emission levels for each engine horsepower family and certify these engines with the United States of America Environmental Protection Agency (EPA). An emissions control information label, showing emission levels and engine specifications, must be placed on each boat at the time of manufacture.

## Dealer's Responsibility

When performing service on all 1999 and more recent Sea-Doo boats carrying an emissions control information label, adjustments must be kept within published factory specifications.

Replacement or repair of any emission related component must be executed in a manner that maintains emission levels within the prescribed certification standards.

Dealers are not to modify the engine in any manner that would alter the horsepower or allow emission levels to exceed their predetermined factory specifications.

Exceptions include manufacturer's prescribed changes, such as altitude adjustments for example.

## Owner Responsibility

The owner/operator is required to have engine maintenance performed to maintain emission levels within prescribed certification standards.

The owner/operator is not to, and should not allow anyone to modify any engine in a manner that would alter the horsepower or allow emission levels to exceed predetermined factory specifications.

## EPA Emission Regulations

All 1999 and more recent Sea-Doo boats manufactured by BRP are certified to the EPA as conforming to the requirements of the regulations for the control of air pollution from new boat engines. This certification is contingent on certain adjustments being set to factory standards. For this reason, the factory procedure for servicing the product must be strictly followed and, whenever practicable, returned to the original intent of the design.

The responsibilities listed above are general and in no way a complete listing of the rules and regulations pertaining to the EPA requirements on exhaust emissions for marine products. For more detailed information on this subject, you may contact the following locations:

### MAIL:

U.S. Environmental Protection Agency  
Office of Transportation and Air Quality  
1200 Pennsylvania Ave. NW  
Mail Code 6403J  
Washington D.C. 20460

### INTERNET WEB SITE:

<http://www.epa.gov/otaq/>

# SPECIFICATIONS

MODEL		210 CHALLENGER SE	210 WAKE
<b>ENGINE</b>			
Engine type		Rotax® 1503 4-TEC™, 4-stroke, Single Over Head Camshaft (SOHC)	
Number of engines		2	
Exhaust system		Water cooled/water injected (opened loop). Direct flow from jet pump	
Lubrication	Type	Dry sump (2 oil pumps). Replaceable oil filter. Water-cooled oil cooler	
	Oil type	XPS summer grade oil Refer to <i>MAINTENANCE PROCEDURES</i> section for more information	
Number of cylinders		6	
Displacement		1 493.8 cm <sup>3</sup> (91 in <sup>3</sup> )	
Induction type		<b>310 HP:</b> Naturally-aspirated <b>430 HP:</b> Supercharger intercooled	
Maximum HP RPM		<b>310 HP:</b> 7300 ± 50 RPM <b>430 HP:</b> 8000 ± 50 RPM	
<b>COOLING</b>			
Type		Liquid cooled. Closed-loop system (see also <i>EXHAUST SYSTEM</i> )	
Coolant		Ethylene-glycol and distilled water (50%/50%). Use premix coolant from BRP or a coolant specially formulated for aluminum engines	
<b>ELECTRICAL</b>			
Magneto generator output		360 W @ 6000 RPM	
Ignition system type		DI (Digital Inductive)	
Spark plugs	Make and type	NGK DCPR8E	
	Gap	0.7 mm - 0.8 mm (.028 in - .031 in)	
Starting system		Electric starter	
Engine RPM limiter setting		<b>310 HP:</b> 7650 RPM <b>430 HP:</b> 8000 RPM	
Battery		Not supplied <sup>(1)</sup> . 12 V group 24, marine starting battery with top-mounted, round taper type battery post	

MODEL	210 CHALLENGER SE	210 WAKE
<b>ELECTRICAL (CONT'D)</b>		
Fuse box 1	F1: Gauge	3 A
	F2: Key switch	3 A
	F3: Depth sounder	3 A
	F4: Unused	-
	F5: Ignition	3 A
	F6: Fuel pump	10 A
	F7: Cylinder 1	10 A
	F8: Cylinder 2	10A
	F9: Cylinder 3	10 A
	F10: Unused	-
	F11: Diagnostic tool	15 A
	F12: Port/Starboard detection	-
	F13: Starter relay	10 A
	F14: CAPS	3 A
Fuse box 2	F15: Charge	30 A
	F16: Battery	30 A
Circuit breakers (panel)	CB1: Bilge pump	3 A
	CB2: Bilge blower	10 A
	CB3: Courtesy lights	3 A
	CB4: navigation/ anchor lights	3 A
	CB5: 12 Volt receptacles	10 A
	CB6: Horn	7 A
	CB7: Stereo	10 A
	CB8: Heater	10 A
	CB9: Port windshield	15 A
	CB10: Starboard windshield	15 A
Automatic bilge pump	3 A	

**SPECIFICATIONS**

<b>MODEL</b>		<b>210 CHALLENGER SE</b>	<b>210 WAKE</b>
<b>FUEL SYSTEM</b>			
Fuel injection type		Multipoint Fuel Injection. Single throttle body (52 mm)	
Fuel	<b>MINIMUM OCTANE RATING</b>		
	Type	<b>Regular</b> unleaded gasoline	
	Octane rating	Inside North America: 87 (RON + MON)/2 Outside North America: 92 RON	
	<b>OCTANE RATING (OPTIMUM PERFORMANCE)</b>		
	Type	<b>Premium</b> unleaded gasoline	
	Octane rating	Inside North America: 91 (RON + MON)/2 Outside North America: 95 RON	
<b>PROPULSION</b>			
Jet pump type		Axial flow single stage	
Jet pump grease type		Jet pump bearing grease (P/N 293 550 032) sold by BRP	
Transmission		Direct drive	
Pivoting angle of direction (nozzle)		20°	
Minimum required water level for jet pump		90 cm (3 ft) underneath the lowest rear portion of hull	
<b>DIMENSIONS</b>			
Overall length		6.25 m (20.5 ft)	
Beam		2.59 m (8.5 ft)	
Draft		30.5 cm (1 ft)	
Deadrise		21°	

MODEL		210 CHALLENGER SE	210 WAKE
<b>DIMENSIONS (ON TRAILER)</b>			
Length		6.35 m (20.8 ft)	
Width		2.59 m (8.5 ft)	
Height	No tower	2.20 m (7.2 ft)	–
	Tower down	2.20 m (7.2 ft)	
	Tower up	3.10 m (10.2 ft)	
<b>WEIGHT AND LOADING CAPACITY</b>			
Weight		1 406 kg (3,100 lb)	1 474 kg (3,250 lb)
Seating capacity		10 (except CE model)	
		9 (CE model)	
Load limit (passengers + luggage) (based on calm water operation)		692 kg (1,525 lb)	660 kg (1,455 lb)
Gross weight (on trailer)	No tower	1 846 kg (4,070 lb)	–
	With tower	1 914 kg (4,220 lb)	
Pulling weight limit	On tower	114 kg (250 lb)	
	On Ski Pole	225 kg (500 lb)	
<b>CAPACITIES</b>			
Engine oil		3 L (3.2 qt (U.S. liq.)) oil change with filter	
Engine cooling system		5.5 L (5.8 qt (U.S. liq.)) total	
Fuel tank (including reserve)		166.5 L (44 U.S. gal.)	

<sup>(1)</sup> Recommended: Exide R-24-130, 12 V, 25 A•h (130 minutes reserve) or R-24-160 (160 minutes) or equivalent.

***This page is  
intentionally blank***

# ***TROUBLESHOOTING***

---

# TROUBLESHOOTING GUIDELINES

The following information is provided to help in diagnosing the probable source of simple troubles. You may be able to solve many of these problems rather quickly, but others may require the skills of a mechanical technician. In such a case, consult an authorized Sea-Doo boats dealer for servicing.

---

## BATTERY IS REGULARLY DISCHARGED

1. **Check battery condition.**
  - *Have the battery charged or replaced by an authorized Sea-Doo boats dealer.*
2. **Check charging system fuse.**
  - *Replace fuse if necessary and have charging system checked by an authorized Sea-Doo boats dealer.*

### **WARNING**

See your authorized Sea-Doo boats dealer to have the battery charged or replaced. Do not charge or boost the battery while installed in the engine compartment. Electrolyte is poisonous and capable of causing severe burns.

---

## ENGINE DOES NOT TURN OVER AND THE MONITORING BEEPER SOUNDS

1. Refer to *MONITORING SYSTEM* below.

---

## ENGINE WILL NOT START

1. **Tether cord is removed.**
  - *Install tether cord over the emergency engine stop switch.*
2. **Ignition switch in OFF or ACC position.**
  - *Turn ignition switch in ON position.*
3. **Main battery cut-off switch is in OFF position.**
  - *Turn switch in ON position.*
4. **Throttle/shifter lever is not in neutral position.**
  - *Place the lever in neutral position.*
5. **Burnt fuse.**
  - *Check fuse(s). See an authorized Sea-Doo boats dealer if problem is repetitive.*
6. **Discharged battery.**
  - *Have the battery charged or replaced by an authorized Sea-Doo boats dealer.*
7. **Battery connections, corroded or loose.**
  - *Contact an authorized Sea-Doo boats dealer.*
8. **Water flooded engine.**
  - *Contact an authorized Sea-Doo boats dealer.*
9. **Obstructed jet pump.**
  - *Try to clean. Otherwise, refer to an authorized Sea-Doo boats dealer.*
10. **Faulty engine management system.**
  - *Refer to an authorized Sea-Doo boats dealer.*



---

**ENGINE TURNS SLOWLY**

---

- 1. Loose battery cable connections.**
  - *Check/clean/tighten.*
- 2. Discharged or weak battery.**
  - *Have the battery charged or replaced by an authorized Sea-Doo boats dealer.*
- 3. Bad ground(s).**
  - *Refer to an authorized Sea-Doo boats dealer.*
- 4. Worn starter or related parts.**
  - *Refer to an authorized Sea-Doo boats dealer.*

---

**ENGINE TURNS NORMALLY BUT WILL NOT START**

---

- 1. Fuel tank empty or water contaminated.**
  - *Refill or siphon and fill with fresh fuel.*
- 2. Fouled/defective spark plugs.**
  - *Replace.*
- 3. Burnt fuse.**
  - *Check fuse(s). See an authorized Sea-Doo boats dealer if problem is repetitive.*
- 4. Water-flooded engine.**
  - *Refer to WATER-FLOODED ENGINE in SPECIAL PROCEDURES.*
- 5. Engine management system fault detected (check if engine pilot lamp is ON).**
  - *Refer to an authorized Sea-Doo boats dealer.*
- 6. Faulty fuel pump.**
  - *Refer to an authorized Sea-Doo boats dealer.*

---

**ENGINE MISFIRES, RUNS IRREGULARLY**

---

- 1. Fouled/defective/worn spark plugs.**
  - *Replace.*
- 2. Faulty ignition coil(s).**
  - *Contact an authorized Sea-Doo boats dealer.*
- 3. Fuel: Level too low, stale or water contaminated.**
  - *Siphon and/or refill.*
- 4. Clogged injectors.**
  - *Refer to an authorized Sea-Doo boats dealer.*
- 5. Engine management system fault detected (check if engine pilot lamp is ON).**
  - *Refer to an authorized Sea-Doo boats dealer.*

---

**ENGINE SMOKE**

---

- 1. Oil level too high.**
  - *Refer to an authorized Sea-Doo boats dealer.*

---

ENGINE SMOKE (cont'd)

---

2. Water ingestion, coolant leak or damaged cylinder head gasket.
  - Refer to an authorized Sea-Doo boats dealer.
3. Internal engine damage.
  - Refer to an authorized Sea-Doo boats dealer.

---

ENGINE OVERHEATING OR IMPROPER OIL PRESSURE (MONITORING BEEPER CONTINUOUSLY SOUNDS)

---

**NOTICE** If beeper continuously sounds, stop engine as soon as possible.

1. Check oil and coolant levels.
  - Refer to MAINTENANCE PROCEDURES. Refill if necessary.
2. Clogged jet pump water intake.
  - Perform the JET PUMP WATER INTAKE AND IMPELLER CLEANING PROCEDURE in SPECIAL PROCEDURES.
3. Clogged exhaust system.
  - Flush exhaust system.

**NOTICE** If these actions do not correct the problem, discontinue use and contact an authorized Sea-Doo boats dealer.

---

ENGINE LACKS ACCELERATION OR POWER

---

1. Jet pump water intake clogged.
  - Clean. Refer to JET PUMP WATER INTAKE AND IMPELLER CLEANING in SPECIAL PROCEDURES section.
2. Damaged impeller or worn-out wear ring.
  - Replace. Refer to an authorized Sea-Doo boats dealer.
3. Supercharger clutch slipping.
  - Refer to an authorized Sea-Doo boats dealer.
4. Weak spark.
  - Refer to ENGINE MISFIRES, RUNS IRREGULARLY in this section.
5. Engine management system fault detected (check if engine pilot lamp is ON).
  - Refer to an authorized Sea-Doo boats dealer.
6. Clogged injectors.
  - Refer to an authorized Sea-Doo boats dealer.
7. Low fuel pressure.
  - Refer to an authorized Sea-Doo boats dealer.
8. Water in fuel.
  - Siphon and replace.

---

**BOAT CANNOT REACH TOP SPEED**

---

- 1. Jet pump water intake clogged.**
  - *Perform the JET PUMP WATER INTAKE AND IMPELLER CLEANING PROCEDURE in SPECIAL PROCEDURES.*
- 2. Damaged impeller or worn-out wear ring.**
  - *Contact an authorized Sea-Doo boats dealer.*
- 3. Engine management system fault detected (check if engine pilot lamp is ON).**
  - *Refer to an authorized Sea-Doo boats dealer.*

---

**ABNORMAL NOISE FROM PROPULSION SYSTEM**

---

- 1. Weeds or debris jammed around impeller.**
  - *Perform the JET PUMP WATER INTAKE AND IMPELLER CLEANING PROCEDURE in SPECIAL PROCEDURES.*
- 2. Damaged impeller shaft or drive shaft.**
  - *Contact an authorized Sea-Doo boats dealer.*

---

**WATER FOUND IN BILGE**

---

- 1. Drain plug(s) not tighten.**
  - *Tighten drain plugs.*
- 2. Defective scupper valve.**
  - *Refer to an authorized Sea-Doo boats dealer.*
- 3. Exhaust system leak.**
  - *Refer to an authorized Sea-Doo boats dealer.*
- 4. Carbon ring at drive shaft worn.**
  - *Refer to an authorized Sea-Doo boats dealer.*

# MONITORING SYSTEM

A system monitors the electronic components of the EMS (engine management system) and other components of the electrical system. When a fault occurs, it sends visual messages through the information center and/or audible signals through a beeper to inform you of a particular condition.

A fault code may also be recorded.

When a minor or transient fault occurs, the fault message and beeper will cease automatically if the condition that caused the fault does not exist anymore.

Releasing the throttle and letting the engine return to idle speed may allow normal operation to come back.

The electronic system will react differently depending on the fault type. In severe failure, the engine may not be allowed to be started. In other cases, the engine will operate in limp home mode (reduced speed).





When a fault occurs, see an authorized Sea-Doo boats dealer as soon as possible for inspection.

## Pilot Lamps and Message Display Information

Indicator lights (pilot lamps), located in the tachometers, inform you of a system anomaly.

An indicator light may be accompanied by a scrolling message in the multifunction display.

See table below for malfunction pilot lamp information.

PILOT LAMPS	BEEP	MESSAGE DISPLAY	DESCRIPTION
LH TACHOMETER			
	Continuous beep	HIGH TEMPERATURE	Engine or exhaust system overheating
	-	LOW or HIGH BATTERY VOLTAGE	Low/high battery voltage
RH TACHOMETER			
	Continuous beep	LOW OIL PRESSURE	Low oil pressure
	1 beep every 15 minutes	CHECK ENGINE or LIMP HOME MODE	Engine management system fault detected

**NOTICE** Running engine with low oil pressure may severely damage the engine.

## Beeper Code Information

BEEPER CODE <sup>(1)</sup>	DESCRIPTION
2 second beep	Indicates low fuel threshold.
Continuous beep	High engine coolant temperature. Refer to <i>ENGINE OVERHEATING</i> in <i>TROUBLESHOOTING GUIDELINES</i> .
	High exhaust temperature. Refer to <i>ENGINE OVERHEATING</i> in <i>TROUBLESHOOTING GUIDELINES</i> .
	Low or high engine oil pressure. Check oil level as soon as possible. If level good, discontinue use and contact an authorized Sea-Doo boats dealer.

<sup>(1)</sup> Some beeper codes go with messages on the information display, refer to *GAUGES* for details.

**NOTICE** If the monitoring beeper continuously sounds, stop engine as soon as possible.

***This page is  
intentionally blank***

# ***WARRANTY***

---

# **BRP LIMITED WARRANTY FOR MODEL YEAR 2011 SEA-DOO® BOATS SOLD IN THE UNITED STATES AND CANADA**

## **1) SCOPE**

BRP US Inc.\* ("BRP") warrants its new and unused Model Year 2011 Sea-Doo® boats ("boat") sold by authorized BRP dealers (as hereinafter defined) in the fifty United States and Canada ("dealer") from defects in material and workmanship for the period and under the conditions described below. This limited warranty will become null and void if: (1) the boat was used for racing or any other competitive activity, at any point, even by a previous owner; or (2) the boat has been altered or modified in such a way so as to adversely affect its operation, performance or durability, or has been altered or modified to change its intended use.

All genuine BRP parts and accessories, installed by an authorized BRP dealer at the time of delivery of the 2011 Sea-Doo® boat, carry the same warranty as that of the boat.

## **2) LIMITATIONS OF LIABILITY**

THIS WARRANTY IS EXPRESSLY GIVEN AND ACCEPTED IN LIEU OF ANY AND ALL OTHER WARRANTIES, EXPRESSED OR IMPLIED, INCLUDING WITHOUT LIMITATION ANY WARRANTY OF MERCHANTABILITY OR FITNESS FOR A PARTICULAR PURPOSE. TO THE EXTENT THAT THEY CANNOT BE DISCLAIMED, THE IMPLIED WARRANTIES ARE LIMITED IN DURATION TO THE LIFE OF THE EXPRESS WARRANTY. INCIDENTAL AND CONSEQUENTIAL DAMAGES ARE EXCLUDED FROM COVERAGE UNDER THIS WARRANTY. SOME STATES/PROVINCES DO NOT ALLOW FOR THE DISCLAIMERS, LIMITATIONS AND EXCLUSIONS IDENTIFIED ABOVE, AS A RESULT, THEY MAY NOT APPLY TO YOU. THIS WARRANTY GIVES YOU SPECIFIC RIGHTS, AND YOU MAY ALSO HAVE OTHER LEGAL RIGHTS WHICH MAY VARY FROM STATE TO STATE, OR PROVINCE TO PROVINCE.

Neither the distributor, any BRP dealer nor any other person has been authorized to make any affirmation, representation or warranty regarding the product, other than those contained in this limited warranty, and if made, shall not be enforceable against BRP. BRP reserves the right to modify this warranty at any time, being understood that such modification will not alter the warranty conditions applicable to the products sold while this warranty is in effect.

## **3) EXCLUSIONS – ARE NOT WARRANTED**

The following are not warranted under any circumstances:

- Normal wear and tear;
- Routine maintenance items, tune-ups, adjustments;
- Damage caused by failure to provide proper maintenance and/or storage, as described in the Operator's Guide;
- Damage resulting from removal of parts, improper repairs, service, maintenance, modifications or use of parts not manufactured or approved by BRP or resulting from repairs done by a person that is not an authorized servicing BRP dealer;
- Damage caused by abuse, misuse, abnormal use, neglect, racing, improper operation or operation of the boat in a manner inconsistent with the recommended operation described in the Operator's Guide;



- Damage resulting from external damage, submersion, water or foreign object ingestion, accident, fire, theft, vandalism or any act of God;
- Operation with fuels, oils or lubricants which are not suitable for the boat (see Operator’s Guide);
- Damage from rust, corrosion or exposure to the elements;
- Damage from cooling system or jet pump blockage by foreign material;
- Damage to gel coat finish including but not limited to cosmetic gel coat finish defects, blisters, starring, crazing; and fiberglass delaminating caused by blisters, crazing, spyder or hairline cracks or exposure to the elements; and
- Incidental or consequential damages, or damages of any kind including without limitation towing, storage, telephone, rental, taxi, inconvenience, insurance coverage, loan payments, loss of time, loss of income.

#### **4) WARRANTY COVERAGE DURATION**

This limited warranty will be in effect from the date of delivery to the first retail consumer or the date the boat is first put into use, whichever occurs first and for a period of:

1. TWELVE (12) CONSECUTIVE MONTHS for private, recreational use, except that the deck and hull fiberglass structure are covered for SIXTY (60) CONSECUTIVE MONTHS.
2. POUR (4) CONSECUTIVE MONTHS for commercial use, except that the deck and hull fiberglass structure is covered for TWELVE (12) CONSECUTIVE MONTHS. A boat is used commercially when it is used in connection with generating income or any work or employment during any part of the warranty period. A boat is also used commercially when, at any point during the warranty period, it has commercial tags or is licensed for commercial use.
3. Emission-related components that are installed on EPA certified boats registered in the USA are covered for thirty (30) consecutive months or 175 hours of engine use whichever occurs first. If the 175 hours of engine use are reached during the regular warranty coverage period, the emission-related components are still covered by BRP’s standard warranty until the end of regular coverage period.
4. The list of the current warranted emission-related components is known by your authorized BRP dealer.
5. For boats produced by BRP for sale in the state of California, that are originally sold to a resident or subsequently warranty registered to a resident in the state of California, please also refer to the applicable California Emissions Control Warranty Statement.

The repair or replacement of parts or the performance of service under this warranty does not extend the life of this warranty beyond its original expiration date.

#### **5) CONDITIONS TO HAVE WARRANTY COVERAGE**

This warranty coverage is available **only** if **each** of the following conditions has been fulfilled:

- The 2011 Sea-Doo® boat must be purchased as new and unused by its first owner from a BRP dealer authorized to distribute Sea-Doo® boats products in the country in which the sale occurred (“BRP dealer”);

- The BRP specified pre-delivery inspection process must be completed and documented and signed by the purchaser;
- The product must have undergone proper registration by an authorized BRP dealer;
- The 2011 Sea-Doo® boat must be purchased in the country in which the purchaser resides and
- Routine maintenance outlined in the Operator's Guide must be timely performed in order to maintain warranty coverage. BRP reserves the right to make warranty coverage contingent upon proof of proper maintenance.

BRP will not honor this limited warranty to any private use owner or commercial use owner if one of the preceding conditions has not been met. Such limitations are necessary in order to allow BRP to preserve both the safety of its products, and also that of its consumers and the general public.

## **6) WHAT TO DO TO OBTAIN WARRANTY COVERAGE**

The customer must cease using the boat upon the appearance of an anomaly. The customer must notify a servicing BRP dealer within two (2) days of the appearance of a defect, and provide it with reasonable access to the product and reasonable opportunity to repair it. The customer must also present to the authorized BRP dealer, proof of purchase of the product and must sign the repair/work order prior to starting the repair in order to validate the warranty repair. All parts replaced under this limited warranty become the property of BRP.

## **7) WHAT BRP WILL DO**

BRP's obligations under this warranty are limited to, at its sole discretion, repairing parts found defective under normal use, maintenance and service, or replacing such parts with new genuine BRP parts without charge for parts and labor, at any authorized BRP dealer during the warranty coverage period under the conditions described herein. BRP's responsibility is limited to making the required repairs or replacements of parts. No claim of breach of warranty shall be cause for cancellation or rescission of the sale of the boat to the owner.

In the event that service is required outside of the country of original sale, the owner will bear responsibility for any additional charges due to local practices and conditions, such as, but not limited to, freight, insurance, taxes, license fees, import duties, and any and all other financial charges, including those levied by governments, states, territories and their respective agencies.

BRP reserves the right to improve or modify products from time to time without assuming any obligation to modify products previously manufactured.

## **8) SUPPLIER WARRANTIES**

Jensen+ audio components installed as original equipment on boats are warranted separately by ASA Electronics<sup>†</sup>. If such an audio component is installed on your Sea-Doo® boat, please contact your authorized BRP dealer for warranty coverage information and assistance.

If you cannot resolve the issue through your authorized BRP dealer, you can find all the contact information for ASA Electronics on their company website:

[www.asaelectronics.com](http://www.asaelectronics.com).

## 9) TRANSFER

If the ownership of a product is transferred during the warranty coverage period, this warranty shall also be transferred and be valid for the remaining coverage period provided that BRP is notified of such transfer of ownership in the following way:

1. The former owner contacts BRP (at the phone number provided below) or an authorized BRP dealer and gives the coordinates of the new owner; or
2. BRP or an authorized BRP dealer receives a proof that the former owner agreed to the transfer of ownership, in addition to the coordinates of the new owner.

## 10) CONSUMER ASSISTANCE

In the event of a controversy or a dispute in connection with this limited warranty, BRP suggests that you try to resolve the issue at the dealership level. We recommend discussing the issue with the authorized BRP dealer's service manager or owner.

If the issue has not yet been resolved, please submit your complaint in writing or call the appropriate number below:

### **In Canada**

**BOMBARDIER RECREATIONAL PRODUCTS INC.**  
SEA-DOO  
Customer Assistance Center  
75 J.A. Bombardier street  
Sherbrooke QC J1L 1W3  
Tel.: 819 566-3366

### **In USA**

**BRP US INC.**  
SEA-DOO  
Customer Assistance Center  
7575 Bombardier COURT  
Wausau WI 54401  
Tel.: 715 848-4957

\*In Canada, products are distributed and serviced by Bombardier Recreational Products Inc  
© 2010 Bombardier Recreational Products Inc. All rights reserved.

® Registered trademark of Bombardier Recreational Products Inc. or its subsidiaries.

+ is the trademark of its owner.

‡ is the trademark of its owner.

---

# CALIFORNIA EMISSION CONTROL WARRANTY STATEMENT FOR MODEL-YEAR 2011 SEA-DOO® BOATS WITH 4-TEC® ENGINES OR 4-TEC® IC ENGINES

For California, your 2011 Sea-Doo® boat ("boat") has a special environmental label required by the California Air Resources Board. The label has 1, 2, 3 or 4 stars. A hangtag, provided with your boat, describes the meaning of the star rating system.

## The Star Label Means Cleaner Marine Engines

The Symbol for Cleaner Marine Engines:



F18L3CQ



### Cleaner Air and Water

For a healthier lifestyle and environment.

### Better Fuel Economy

Burns up to 30 - 40 percent less gas and oil than conventional carbureted two-stroke engines, saving money and resources.

### Longer Emission Warranty

Protects consumer for worry free operation.

### One Star – Low Emission

The one-star label identifies personal watercraft, outboard, stern drive and inboard engines that meet the Air Resources Board's Personal Watercraft and Outboard marine engine 2001 exhaust emission standards. Engines meeting these standards have 75% lower emissions than conventional carbureted two-stroke engines. These engines are equivalent to the U.S. EPA's 2006 standards for marine engines.

### Two Stars - Very Low Emission

The two-star label identifies personal watercraft, outboard, stern drive and inboard engines that meet the Air Resources Board's Personal Watercraft and Outboard marine engine 2004 exhaust emission standards. Engines meeting these standards have 20% lower emissions than One Star - Low-Emission engines.

### Three Stars - Ultra Low Emission

The three-star label identifies engines that meet the Air Resources Board's Personal Watercraft and Outboard marine engine 2008 exhaust emission standards or the Stern drive and Inboard marine engine 2003 exhaust emission standards. Engines meeting these standards have 65% lower emissions than One Star – Low Emission engines.

## **Four Stars - Super Ultra Low Emission**

The four-star label identifies engines that meet the Air Resources Board's Stern-drive and Inboard marine engine 2011 exhaust emission standards. Personal Watercraft and Outboard marine engines may also comply with these standards. Engines meeting these standards have 90% lower emissions than One Star – Low Emission engines.

For more information: Cleaner Watercraft – Get the Facts  
1 800 END-SMOG  
[www.arb.ca.gov](http://www.arb.ca.gov)

## **Your Emission Control Warranty Rights and Obligations**

The California Air Resources Board and BRP US Inc. ("BRP") are pleased to explain the emission control system warranty on your Model Year 2011 Sea-Doo® boat. In California, new boat engines must be designed, built and equipped to meet the State's stringent anti-smog standards. BRP must warrant the emission control system on your boat engine for the period of time listed below provided there has been no abuse, neglect or improper maintenance of your boat engine.

Your emission control system may include parts such as the fuel injection system, the ignition system and catalytic converter. Also included may be hoses, belts, connectors and other emission related assemblies.

Where a warrantable condition exists, BRP will repair your boat engine at no cost to you including diagnosis, parts and labor provided that such work is performed by an authorized BRP dealer.

## **Manufacturer's Limited Warranty Coverage**

This emission limited warranty covers Model Year 2011 Sea-Doo® boats certified and produced by BRP for sale in California, that are originally sold in California to a California resident or subsequently warranty registered to a California resident. The BRP limited warranty conditions for Sea-Doo® boats are still applicable to these models with the necessary modifications. Select emission control parts of your 2011 Sea-Doo® boat are warranted from the date of delivery to the first retail consumer for a period of 4 years, or for 250 hours of use, whichever occurs first. However, warranty coverage based on the hourly period is only permitted for boat equipped with the appropriate hour meters or their equivalent. If any emission-related part on your engine is defective under warranty, the part will be repaired or replaced by BRP.

**Parts covered for Model Year 2011 Sea-Doo® boat equipped with 4-TEC® engines:**

Idle Bypass Valve	Fuel Filter
Throttle Position Sensor	Intake Manifold
Intake Manifold Air Pressure Sensor	Air Box
Intake Manifold Air Temperature Sensor	Air Intake Adapter
Engine Temperature Sensor	Spark Plugs
Knock Sensor	Ignition Coils
Emission Control Module ECM	Intake and Exhaust Valve and Seals
Throttle Body	Crankcase Ventilation Valve
Fuel Rail	Throttle Body Seal
Fuel Injectors	Wire Harness and Connectors
Fuel Pressure Regulator	Intake Manifold Seal
Fuel Pump	

The emission warranty covers damage to other engine components that is caused by the failure of a warranted part. The BRP Operator's Guide provided contains written instructions for the proper maintenance and use of your boat. All emission warranty parts are warranted by BRP for the entire warranty period of the boat, unless the part is scheduled for replacement as required maintenance in the Operator's Guide.

Emission warranty parts that are scheduled for replacement, as required maintenance, are warranted by BRP for the period of time before the first scheduled replacement date for that part. Emission warranty parts that are scheduled for regular inspection, but not regular replacement, are warranted by BRP for the entire warranty period of the boat. Any emission warranty part repaired or replaced under the terms of this warranty statement is warranted by BRP for the remainder of the warranty period of the original part. All parts replaced under this limited warranty become the property of BRP. Maintenance receipts and records should be transferred to each subsequent owner of the boat.

## **Owner's Warranty Responsibilities**

As the owner of a 2011 Sea-Doo® boat, you are responsible for the performance of the required maintenance listed in your Operator's Guide. BRP recommends that you retain all receipts covering maintenance your boat engine, but BRP cannot deny warranty solely for the lack of receipts or your failure to ensure the performance of all scheduled maintenance. As the owner of a Sea-Doo® boat, you should however be aware that BRP may deny you warranty coverage if your engine(s) or a part has failed due to abuse, neglect, improper maintenance or unapproved modifications. You are responsible for presenting your engine to an authorized BRP Dealer as soon as a problem exists. The warranty repairs will be completed in a reasonable amount of time, not to exceed 30 days. If you have any questions regarding your warranty rights and responsibilities or for the name and location of the nearest authorized BRP Dealer you should contact the Customer Assistance Center at 1-715-848-4957.

---

# **BRP INTERNATIONAL LIMITED WARRANTY FOR MODEL YEAR 2011 SEA-DOO® BOATS**

## **1) SCOPE**

BRP US Inc. ("BRP")\* warrants its new and unused Model Year 2011 Sea-Doo® boats ("Boat") sold by authorized BRP Distributors/Dealers ("Distributor/Dealer") outside of the United States, Canada and states members of the European Economic Area (which is comprised of the states member of the European Union plus Norway, Iceland and Liechtenstein) Turkey, and states members of the Commonwealth of the Independent States ("CIS") (which is comprised of the Russian Federation and ex-members states of the USSR), will be free from defects in material and workmanship for the period and under the conditions below. This limited warranty will become null and void if: (1) the boat was used for racing or any other competitive activity, at any point, even by a previous owner; or (2) the boat has been altered or modified in such a way so as to adversely affect its operation, performance or durability, or has been altered or modified to change its intended use.

All genuine BRP parts and accessories, installed by an authorized BRP Distributor/Dealer (as hereinafter defined) at the time of delivery of the 2011 Sea-Doo® Boat, carry the same warranty as that of the Boat.

## **2) LIMITATIONS OF LIABILITY**

THIS WARRANTY IS EXPRESSLY GIVEN AND ACCEPTED IN LIEU OF ANY AND ALL OTHER WARRANTIES, EXPRESSED OR IMPLIED, INCLUDING WITHOUT LIMITATION ANY WARRANTY OF MERCHANTABILITY OR FITNESS FOR A PARTICULAR PURPOSE. TO THE EXTENT THAT THEY CANNOT BE DISCLAIMED, THE IMPLIED WARRANTIES ARE LIMITED IN DURATION TO THE LIFE OF THE EXPRESS WARRANTIES. INCIDENTAL AND CONSEQUENTIAL DAMAGES ARE EXCLUDED FROM COVERAGE UNDER THIS WARRANTY. SOME STATES/PROVINCES DO NOT ALLOW FOR THE DISCLAIMERS, LIMITATIONS AND EXCLUSIONS IDENTIFIED ABOVE, AS A RESULT, THEY MAY NOT APPLY TO YOU. THIS WARRANTY GIVES YOU SPECIFIC RIGHTS, AND YOU MAY ALSO HAVE OTHER LEGAL RIGHTS WHICH MAY VARY FROM COUNTRY TO COUNTRY.

Neither the authorized BRP Distributor/Dealer, nor any other person has been authorized to make any affirmation, representation or warranty regarding the product, other than those contained in this limited warranty, and if made, shall not be enforceable against BRP. BRP reserves the right to modify this warranty at any time, being understood that such modification will not alter the warranty conditions applicable to the products sold while this warranty is in effect.

## **3) EXCLUSIONS – ARE NOT WARRANTED**

The following are not warranted under any circumstances:

- Replacement of parts due to normal wear and tear;
- Routine maintenance parts and services, including but not limited to adjustments, oil, lubricant and coolant changes, spark plug replacement, water pumps and the like;
- Damage caused by improper or lack of maintenance or storage, or failure to follow the procedures and recommendations in the Operator's Guide;



- Damage resulting from removal of parts, improper repairs, service, maintenance, or modification, or use of parts or accessories not manufactured or approved by BRP, which in its reasonable judgment, are either incompatible with Boats or adversely affect its operation, performance, or durability, or resulting from repairs done by a person that is not an authorized BRP Distributor/Dealer;
- Damage caused by abuse, misuse, abnormal use, neglect, racing, improper operation or operation of the Boat in a manner inconsistent with the recommended operation described in the Operator's Guide;
- Damages resulting from external damage, submersion, water or foreign object ingestion, accident, fire, theft, vandalism or any act of God;
- Operation with fuel, oils or lubricants that are not suitable for the Boat (see Operator's Guide);
- Damage from rust, corrosion or exposure to the elements;
- Damage from cooling system or jet pump blockage by foreign material;
- Incidental or consequential damages, or damages of any kind including without limitation towing, storage, telephone, rental, taxi, inconvenience, insurance coverage, loan payments, loss of time, loss of income; and,
- Damage to gel coat finish including but not limited to cosmetic gel coat finish defects, blisters, starrng, crazing; and fiberglass delaminating caused by blisters, crazing, spider or hairline cracks or exposure to the elements.

#### **4) WARRANTY COVERAGE DURATION**

This limited warranty will be in effect from the date of delivery to the first retail consumer or the date the boat is first put to use, whichever occurs first, for a period of:

- TWELVE (12) CONSECUTIVE MONTHS for private, recreational use, except for the deck and hull fiberglass structure that are covered for SIXTY (60) CONSECUTIVE MONTHS;
- FOUR (4) CONSECUTIVE MONTHS for commercial use, except for the deck and hull fiberglass structure that are covered for TWELVE (12) CONSECUTIVE MONTHS. A boat is used commercially when it is used in connection with generating income or any work or employment during any part of the warranty period. A Boat is also used commercially when, at any point during the warranty period, it has commercial tags or is licensed for commercial use.

The repair or replacement of parts or the performance of service to a Boat under this warranty does not extend the life of this limited warranty beyond its original expiration date.

#### **5) CONDITIONS TO HAVE WARRANTY COVERAGE**

This warranty coverage is available **only** if **each** of the following conditions has been fulfilled:

- The 2011 Sea-Doo® boats must be purchased as new and unused by its first owner from a BRP Distributor/Dealer authorized to distribute SEA-DOO® BOAT products in the country in which the sale occurred;
- The BRP specified pre-delivery inspection process must be completed and documented;
- The product must have undergone proper registration by an authorized BRP Distributor/Dealer;

- The 2011 Sea-Doo® boats must be purchased in the country in which the purchaser resides; and,
- Routine maintenance outlined in the Operator's Guide must be timely performed in order to maintain warranty coverage. BRP reserves the right to make warranty coverage contingent upon proof of proper maintenance.

BRP will not honor this limited warranty to any private use owner or commercial use owner if one of the preceding conditions has not been met. Such limitations are necessary in order to allow BRP to preserve both the safety of its products, and that of its consumers and the general public.

## **6) WHAT TO DO TO OBTAIN WARRANTY COVERAGE**

The customer must notify a servicing BRP Distributor/Dealer within two (2) days of the appearance of a defect, and provide it with reasonable access to the product and reasonable opportunity to repair it. The customer must also present to the authorized BRP Distributor/Dealer, proof of purchase of the product and must sign the repair/work order prior to starting the repair in order to validate the warranty repair. All parts replaced under this limited warranty become the property of BRP.

## **7) WHAT BRP WILL DO**

BRP's obligations under this warranty are limited to, at its sole discretion, repairing parts found defective under normal use, maintenance and service, or replacing such parts with new genuine BRP parts without charge for parts and labor, at any authorized BRP Distributor/Dealer during the warranty coverage period under the conditions described herein. BRP's responsibility is limited to making the required repairs or replacements of parts. No claim of breach of warranty shall be cause for cancellation or rescission of the sale of the boat to the owner.

In the event that service is required outside of the country of original sale, the owner will bear responsibility for any additional charges due to local practices and conditions, such as, but not limited to, freight, insurance, taxes, license fees, import duties, and any and all other financial charges, including those levied by governments, states, territories and their respective agencies.

BRP reserves the right to improve or modify products from time to time without assuming any obligation to modify products previously manufactured.

## **8) TRANSFER**

If the ownership of a Product is transferred during the warranty coverage period, this warranty shall also be transferred and be valid for the remaining coverage period provided that BRP is notified of such transfer of ownership in the following way:

1. The former owner contacts BRP (at the phone number provided below) or an authorized Distributor/Dealer and gives the coordinates of the new owner; or
2. BRP or an authorized Distributor/Dealer receives a proof that the former owner agreed to the transfer of ownership, in addition to the coordinates of the new owner.

## **9) CONSUMER ASSISTANCE**

In the event of a controversy or a dispute in connection with this limited warranty, BRP suggests that you try to resolve the issue at the dealership level.

If further assistance is required, the Distributor's service department should be contacted in order to resolve the matter. You will find your distributor's coordinates on [www.brp.com](http://www.brp.com).

If the matter still remains unresolved then contact BRP by writing to us at the address listed below.

**For countries within Europe, Middle East and Africa, please contact our European office**

**BRP EUROPE N.V.**

Customer Assistance Center  
Skaldenstraat 125  
9042 Gent  
Belgique  
Tel.: +32-9-218-26-00

**For all other countries, please contact your local distributor or our North America office**

**BOMBARDIER RECREATIONAL PRODUCTS INC.**

Customer Assistance Center  
75 J.A. Bombardier Street  
Sherbrooke QC J1L 1W3  
Tel.: 1 819 566-3366

© 2010 Bombardier Recreational Products Inc. All rights reserved.

® Registered trademark of Bombardier Recreational Products Inc.

\* For the territory covered by this limited warranty, products are distributed and serviced by Bombardier Recreational Products Inc. or its affiliates.

© 2010 Bombardier Recreational Products Inc. All rights reserved.

® Registered trademark of Bombardier Recreational Products Inc. or its affiliates.

---

# **BRP LIMITED WARRANTY FOR THE EUROPEAN AND THE RUSSIAN ECONOMIC AREA AND TURKEY: MODEL YEAR 2011 SEA-DOO® BOATS**

## **1) SCOPE OF THE LIMITED WARRANTY**

BRP US Inc. ("BRP")\* warrants its new and unused model-year 2011 Sea-Doo® boats sold by authorized BRP distributors/dealers ("Distributors/Dealers") in member states of the European Economic Area ("EEA") (which is comprised of the state members of the European Union plus Norway, Iceland and Liechtenstein), in member states of the Commonwealth of the Independent States ("CIS") (which is comprised of the Russian Federation and ex-members states of the USSR), and Turkey from defects in material or workmanship for the period and under the conditions described below. This limited warranty will become null and void if: (1) the boat was used for racing or any other competitive activity, at any point, even by a previous owner; or (2) the boat has been altered or modified in such a way so as to adversely affect its operation, performance or durability, or has been altered or modified to change its intended use.

All genuine SEA-DOO® BOAT parts and accessories, installed by an authorized BRP Distributors/Dealers at the time of delivery of the 2011 Sea-Doo® boats, carry the same warranty as that of the boats.

## **2) LIMITATIONS OF LIABILITY**

THIS WARRANTY IS EXPRESSLY GIVEN AND ACCEPTED IN LIEU OF ANY AND ALL OTHER WARRANTIES, EXPRESSED OR IMPLIED, INCLUDING WITHOUT LIMITATION ANY WARRANTY OF MERCHANTABILITY OR FITNESS FOR A PARTICULAR PURPOSE. TO THE EXTENT THAT THEY CANNOT BE DISCLAIMED, THE IMPLIED WARRANTIES ARE LIMITED IN DURATION TO THE LIFE OF THE EXPRESS WARRANTY. INCIDENTAL AND CONSEQUENTIAL DAMAGES ARE EXCLUDED FROM COVERAGE UNDER THIS WARRANTY. SOME JURISDICTIONS DO NOT ALLOW FOR THE DISCLAIMERS, LIMITATIONS AND EXCLUSIONS IDENTIFIED ABOVE, AS A RESULT, THEY MAY NOT APPLY TO YOU. THIS WARRANTY GIVES YOU SPECIFIC RIGHTS, AND YOU MAY ALSO HAVE OTHER LEGAL RIGHTS WHICH MAY VARY FROM COUNTRY TO COUNTRY.

Neither the BRP Distributor/Dealer nor any other person has been authorized to make any affirmation, representation or warranty regarding the product, other than those contained in this limited warranty, and if made, shall not be enforceable against BRP.

BRP reserves the right to modify this warranty at any time, being understood that such modification will not alter the warranty conditions applicable to the products sold while this warranty is in effect.

## **3) EXCLUSIONS – ARE NOT WARRANTED**

The following are not warranted under any circumstances:

- Replacement of parts due to normal wear and tear;
- Routine maintenance parts and services, including but not limited to adjustments, oil, lubricant and coolant changes, spark plug replacement, water pumps and the like;
- Damage caused by improper or lack of maintenance or storage, or failure to follow the procedures and recommendations in the Operator's Guide;

- Damage resulting from removal of parts, improper repairs, service, maintenance, or modification, or use of parts or accessories not manufactured or approved by BRP, which in its reasonable judgment, are either incompatible with Boats or adversely affect its operation, performance, or durability, or resulting from repairs done by a person that is not an authorized BRP Distributor/Dealer;
- Damage caused by abuse, misuse, abnormal use, neglect, racing, improper operation or operation of the Boat in a manner inconsistent with the recommended operation described in the Operator's Guide;
- Damages resulting from external damage, submersion, water or foreign object ingestion, accident, fire, theft, vandalism or any act of God;
- Operation with fuel, oils or lubricants that are not suitable for the Boat (see Operator's Guide);
- Damage from rust, corrosion or exposure to the elements;
- Damage from cooling system or jet pump blockage by foreign material;
- Incidental or consequential damages, or damages of any kind including without limitation towing, storage, telephone, rental, taxi, inconvenience, insurance coverage, loan payments, loss of time, loss of income; and,
- Damage to gel coat finish including but not limited to cosmetic gel coat finish defects, blisters, starrng, crazing; and fiberglass delaminating caused by blisters, crazing, spider or hairline cracks or exposure to the elements.

#### **4) WARRANTY COVERAGE PERIOD**

This limited warranty will be in effect from the date of delivery to the first retail consumer or the date the product is first put into use, whichever occurs first and for a period of:

TWENTY-FOUR (24) CONSECUTIVE MONTHS for private use owners except for the deck and hull fiberglass structure that are covered for SIXTY (60) CONSECUTIVE MONTHS;

FOUR (4) CONSECUTIVE MONTHS for commercial use owners except for the deck and hull fiberglass structure that are covered for TWELVE (12) CONSECUTIVE MONTHS.

A boat is used commercially when it is used in connection with generating income or any work or employment during any part of the warranty period. A boat is also used commercially when, at any point during the warranty period, it has commercial tags or is licensed for commercial use.

The repair or replacement of parts or the performance of service under this warranty does not extend the life of this warranty beyond its original expiration date.

Note that the duration and any other modalities of the warranty coverage are subject to the applicable national or local legislation in your country.

#### **5) CONDITIONS TO HAVE WARRANTY COVERAGE**

This warranty coverage is available **only** if **each** of the following conditions has been fulfilled:

- The 2011 Sea-Doo® boats must be purchased as new and unused by its first owner from a BRP Distributor/Dealer authorized to distribute SEA-DOO® BOAT products in the country in which the sale occurred;

- The BRP specified pre-delivery inspection process must be completed and documented;
- The product must have undergone proper registration by an authorized BRP Distributor/Dealer;
- The 2011 Sea-Doo® boats must be purchased within the EEA by an EEA resident, in the CIS for residents of the countries comprised in such area and in Turkey for residents of Turkey; and
- Routine maintenance outlined in the Operator's Guide must be timely performed in order to maintain warranty coverage. BRP reserves the right to make warranty coverage contingent upon proof of proper maintenance.

BRP will not honor this limited warranty to any private use owner or commercial use owner if one of the preceding conditions has not been met. Such limitations are necessary in order to allow BRP to preserve both the safety of its products, and also that of its consumers and the general public.

## **6) WHAT TO DO TO OBTAIN WARRANTY COVERAGE**

The customer must notify a servicing BRP Distributor/Dealer within two (2) months of the appearance of a defect, and provide it with reasonable access to the product and reasonable opportunity to repair it. The customer must also present to the authorized BRP Distributor/Dealer, proof of purchase of the product and must sign the repair/work order prior to starting the repair in order to validate the warranty repair. All parts replaced under this limited warranty become the property of BRP.

Note that the notification period is subject to the applicable national or local legislation in your country.

## **7) WHAT BRP WILL DO**

BRP's obligations under this warranty are limited to, at its sole discretion, repairing parts found defective under normal use, maintenance and service, or replacing such parts with new genuine boat parts without charge for parts and labor, at any authorized BRP Distributor/Dealer during the warranty coverage period under the conditions described herein. BRP's responsibility is limited to making the required repairs or replacements of parts. No claim of breach of warranty shall be cause for cancellation or rescission of the sale of the boat to the owner.

In the event that service is required outside of the country of original sale, the owner will bear responsibility for any additional charges due to local practices and conditions, such as, but not limited to, freight, insurance, taxes, license fees, import duties, and any and all other financial charges, including those levied by governments, states, territories and their respective agencies.

BRP reserves the right to improve or modify products from time to time without assuming any obligation to modify products previously manufactured.

## 8) TRANSFER

If the ownership of a Product is transferred during the warranty coverage period, this warranty shall also be transferred and be valid for the remaining coverage period provided that BRP is notified of such transfer of ownership in the following way:

The former owner contacts BRP (at the phone number provided below) or an authorized Distributor/Dealer and gives the coordinates of the new owner; or BRP or an authorized Distributor/Dealer receives proof that the former owner agreed to the transfer of ownership, in addition to the coordinates of the new owner.

## 9) CONSUMER ASSISTANCE

In the event of a controversy or a dispute in connection with this limited warranty, BRP suggests that you try to resolve the issue at the dealership level. We recommend discussing the issue with the authorized Distributor/Dealer's service manager or owner.

- If further assistance is required, the distributor's service department should be contacted in order to resolve the matter. You will find your distributor's coordinates on [www.brp.com](http://www.brp.com).
- If the matter still remains unresolved then contact BRP at the address listed below.

**For countries within Europe, to the exception of the Scandinavian countries, and for countries within the CIS and Turkey, please contact our European office at:**

**BRP EUROPE N.V.**

Customer Assistance Center  
Skaldenstraat 125  
9042 Gent  
Belgium  
Tel.: +32-9-218-26-00

**For Scandinavian countries, please contact our office in Finland at:**

**BRP FINLAND OY**

Service Department  
Isoaavantie 7  
FIN-96320 Rovaniemi  
Finland  
Tel.: +358163208111

**For all other countries, please contact your local distributor or our North America office:**

**BOMBARDIER RECREATIONAL PRODUCTS INC.**

Customer Assistance Center  
75 J.A. Bombardier Street  
Sherbrooke QC J1L 1W3  
Tel.: 1 819 566-3366

\* For the territory covered by this limited warranty, products are distributed and serviced by Bombardier Recreational Products Inc. or its affiliates.

© 2010 Bombardier Recreational Products Inc. All rights reserved.

® Registered trademark of Bombardier Recreational Products Inc.



# ***CUSTOMER INFORMATION***

---

## PRIVACY INFORMATION

BRP wishes to inform you that your coordinates will be used for safety and warranty related purposes. Furthermore, BRP and its affiliates may use its customer list to distribute marketing and promotional information about BRP and related products.

To exercise your right to consult or correct your data, or to be removed from the addressee-list for direct marketing, please contact BRP.

**By E-mail:**        [privacyofficer@brp.com](mailto:privacyofficer@brp.com)

**By mail:**        BRP  
Senior Legal Counsel-Privacy Officer  
726 St-Joseph  
Valcourt QC  
Canada  
J0E 2L0

---

## CHANGE OF ADDRESS/OWNERSHIP

If your address has changed or if you are the new owner of the boat, be sure to notify BRP by either:

- Mailing one of the following card below;
- **North America only:** calling at 715 848-4957 (USA) or 819 566-3366 (Canada);
- Contacting an authorized BRP dealer.

In case of change of ownership, please join a proof that the former owner agreed to the transfer.

Notifying BRP, even after the expiration of the limited warranty, is very important as it enables BRP to reach the boat owner if necessary, like when safety recalls are initiated. It is the owner's responsibility to notify BRP.

**STOLEN UNITS:** In the event that your boat is stolen, you should notify your area's distributor warranty department of such. We will ask you to provide your name, address, phone number, Hull Identification Number and date it was stolen.

### **In North America**

#### **BOMBARDIER RECREATIONAL PRODUCTS INC.**

Warranty Department  
75 J.-A. Bombardier Street  
Sherbrooke QC J1L 1W3  
Canada

### **Other areas in the world except Scandinavian countries**

#### **BRP EUROPEAN DISTRIBUTION**

Warranty Department  
Chemin de Messidor 5-7  
1006 Lausanne  
Switzerland

### **Scandinavian countries**

#### **BRP FINLAND OY**

Service Department  
Isoaavantie 7  
FIN-96320 Rovaniemi  
Tel.: +358 16 3208 111

***This page is  
intentionally blank***

CHANGE OF ADDRESS CHANGE OF OWNERSHIP 

VEHICLE IDENTIFICATION NUMBER

Model Number

Vehicle Identification Number (V.I.N.)

OLD ADDRESS  
OR PREVIOUS OWNER:

NAME

NO.

STREET

APT

CITY

STATE/PROVINCE

ZIP/POSTAL CODE

COUNTRY

TELEPHONE

NEW ADDRESS  
OR NEW OWNER:

NAME

NO.

STREET

APT

CITY

STATE/PROVINCE

ZIP/POSTAL CODE

COUNTRY

TELEPHONE

E-MAIL ADDRESS

V00A2F

CHANGE OF ADDRESS CHANGE OF OWNERSHIP 

VEHICLE IDENTIFICATION NUMBER

Model Number

Vehicle Identification Number (V.I.N.)

OLD ADDRESS  
OR PREVIOUS OWNER:

NAME

NO.

STREET

APT

CITY

STATE/PROVINCE

ZIP/POSTAL CODE

COUNTRY

TELEPHONE

NEW ADDRESS  
OR NEW OWNER:

NAME

NO.

STREET

APT

CITY

STATE/PROVINCE

ZIP/POSTAL CODE

COUNTRY

TELEPHONE

E-MAIL ADDRESS

V00A2F



**BOAT MODEL No.** \_\_\_\_\_

**HULL IDENTIFICATION NUMBER (H.I.N.)** \_\_\_\_\_

**ROTAX ENGINE IDENTIFICATION NUMBER (E.I.N.)** \_\_\_\_\_

**Owner:** \_\_\_\_\_  
NAME

\_\_\_\_\_  
No. STREET APT

\_\_\_\_\_  
CITY STATE/PROVINCE ZIP/POSTAL CODE

**Purchase Date** \_\_\_\_\_  
YEAR MONTH DAY

**Warranty Expiry Date** \_\_\_\_\_  
YEAR MONTH DAY

To be completed by the dealer at the time of the sale.

DEALER IMPRINT AREA

F00A35LA

Please verify with your selling dealer to ensure your SEA-DOO boat has been registered with BRP.

219 100 484

CA

OPERATOR'S GUIDE, 210 SERIES / ENGLISH  
GUIDE DU CONDUCTEUR, SÉRIE 210 / ANGLAIS

FAIT AU / MADE IN CANADA

U/M:P.C.