

**SEA-DOO®**



**2011**

Sea-Doo Boats  
**OPERATOR'S  
GUIDE**  
Includes  
SAFETY, VEHICLE  
and MAINTENANCE  
INFORMATION

**200 SPEEDSTER™**

**⚠ WARNING**

Read this guide thoroughly. It contains important safety information.  
Minimum recommended operator's age: 16 years old.  
Keep this Operator's Guide in the boat.

2 6 4 0 0 0 0 6 6

**⚠ WARNING**

Disregarding any of the safety precautions and instructions contained in this Operator's Guide, *SAFETY DVD* and on-product labels could cause injury including the possibility of death!

**⚠ WARNING**

This boat may exceed the performance of other boats you may have ridden in the past. Take time to familiarize yourself with your new boat.

**CALIFORNIA PROPOSITION 65 WARNING**

**⚠ WARNING**

This product contains or emits chemicals known to the state of California to cause cancer and birth defects or other reproductive harm.

In Canada, products are distributed by Bombardier Recreational Products Inc. (BRP).

In USA, products are distributed by BRP US Inc.

This is a non-exhaustive list of trademarks that are the property of Bombardier Recreational Products Inc. or its affiliates:

4-TEC™

Sea-Doo®

Rotax®

D.E.S.S.™

Speedster™

XPS™

Flitz is a registered trademark of Flitz International.

Gelcote is a trademark of Gelcote International.

Spray Nine is a trademark of Spray Nine Corporation.

---

# FOREWORD

Congratulations on your purchase of a new Sea-Doo® Boat. It is backed by the BRP limited warranty and a network of authorized Sea-Doo Boats dealers ready to provide the parts, service or accessories you may require.

At delivery, you were informed of the warranty coverage and signed the *PREDELIVERY CHECK LIST* to ensure your new boat was prepared to your entire satisfaction.

Your dealer is committed to your satisfaction. If you need more complete servicing information, please ask your dealer.

## Know Before you Go

To learn how to reduce the risk of accident, read the following sections of this guide before you operate the boat:

- SAFETY INFORMATION
- BOAT INFORMATION.

Also, read all safety labels on your boat and watch your *SAFETY DVD*.

We highly recommend that you take a safe boating course. Please check your dealer or local authorities for availability in your area.

In certain areas, an operator competency card is mandatory to operate a pleasure craft.

Failure to follow the warnings contained in this Operator's Guide can result in **SERIOUS INJURY** or **DEATH**.

## Safety Messages

The types of safety messages, what they look like and how they are used in this guide are explained as follows:

 <b>DANGER</b>
Indicates a hazardous situation which, if not avoided, will result in death or serious injury.

 <b>WARNING</b>
Indicates a potential hazard which, if not avoided, could result in serious injury or death.

 **CAUTION** Indicates a hazard situation which, if not avoided, could result in minor or moderate injury.

**NOTICE** Indicates an instruction which, if not followed, could severely damage boat components or other property.

## About this Operator's Guide

This Operator's Guide has been prepared to acquaint the owner and the operator of a new boat with the various controls, maintenance and safe operating instructions. It is indispensable for the proper use of the product.

Keep this Operator's Guide in the boat as you can refer to it for things such as maintenance, troubleshooting and instructing others.

Note that this guide is available in several languages. In the event of any discrepancy, the English version shall prevail.

If you want to view and/or print an extra copy of your Operator's Guide, simply visit the following website **www.op-operatorsguide.brp.com**.

The informations contained in this document are correct at the time of publication. BRP, however, maintains a policy of continuous improvement of its products without imposing upon itself any obligation to install them on products previously manufactured. Due to late changes, some differences between the manufactured product and the descriptions and/or specifications in this guide may occur. BRP reserves the right at any time to discontinue or

change specifications, designs, features, models or equipment without incurring any obligation upon itself.

This Operator's Guide and the *SAFETY DVD* should remain with the boat when it's sold.

---

# TABLE OF CONTENTS

<b>FOREWORD</b> .....	<b>1</b>
Know Before you Go .....	1
Safety Messages.....	1
About this Operator's Guide .....	1

## ***SAFETY INFORMATION***

<b>SPECIAL SAFETY MESSAGES</b> .....	<b>10</b>
Reminders Regarding Operation .....	10
Carbon Monoxide and Boating .....	12
Water Sports .....	15
Hypothermia.....	19
Voluntary Inspections .....	19
Safe Boating Courses .....	19
<b>SAFETY EQUIPMENT</b> .....	<b>20</b>
Required Safety Equipment.....	20
Additional Recommended Equipment .....	23
<b>PRACTICE EXERCISES</b> .....	<b>24</b>
Where to Practice Exercises .....	24
Practice Exercises .....	24
Important Factors Not to Neglect.....	24
<b>SAFE BOATING PRACTICES</b> .....	<b>26</b>
Drugs and Alcohol.....	26
Safe Operation .....	26
<b>NAVIGATION RULES</b> .....	<b>28</b>
Operating Rules .....	28
<b>FUELING</b> .....	<b>30</b>
Recommended Fuel .....	30
Fueling Procedure.....	30
<b>TRAILERING INFORMATION</b> .....	<b>32</b>
<b>LOCATION OF IMPORTANT ON-PRODUCT LABELS</b> .....	<b>33</b>
Hang Tag .....	33
Safety Labels .....	34
Compliance Labels.....	37
Technical Information Labels.....	38
<b>PRE-RIDE INSPECTION</b> .....	<b>39</b>
Pre-Ride Check List When Boat is Trailered.....	40
Pre-Ride Check List When Boat is Docked.....	41
Fuel.....	42
Hull .....	42
Jet Pump Water Intakes .....	42
Bilge .....	42
Engine Compartment .....	42
Main Battery Cut-Off Switch .....	42
Throttle/Shifter System.....	42

**PRE-RIDE INSPECTION (cont'd)**

Steering System .....	43
Bilge Blower .....	43
Towing Tower (optional) .....	43
Bimini Top (Optional) .....	43
Mandatory Safety Boating Equipment .....	43
Storage Compartment Covers .....	43
Navigation Lights .....	43
Engine START/STOP Switches .....	43
Engine Cut-off Switch .....	43

**BOAT INFORMATION**

**CONTROLS ..... 46**

1) Steering Wheel .....	46
2) Throttle/Shift Control .....	46
3) Engine cut-off switch .....	47
4) Deck Lights Switch .....	48
5) Navigation Lights Switch .....	48
6) Bilge Pump Switch .....	49
7) Horn Switch .....	50
8) Bilge Blower Switch .....	50
9) Start/Stop Switches .....	51

**GAUGES ..... 52**

1) Fuel Gauge .....	52
2) Tachometers .....	52
3) Speedometer .....	52
4) Monitoring Gauges .....	53
5) Depth Finder .....	53

**EQUIPMENT ..... 55**

1) Bilge Drain Plug .....	56
2) Grab Handles .....	56
3) Rear Grab Handles .....	56
4) Ladder .....	57
5) Swim Platform .....	57
6) Driver's Seat .....	57
7) Passenger/Spotter Seat .....	58
8) Bow Seats .....	58
9) Rear Seats .....	59
10) Sun Deck .....	59
11) Cup Holders .....	60
12) Port/Starboard Console Storage Compartments .....	60
13) Glove Box .....	60
14) AM/FM Radio/CD Player .....	61
15) 12-Volt Power Outlet .....	61
16) Bow Storage Compartment .....	61
17) Deck Storage Compartment .....	62

<b>EQUIPMENT (cont'd)</b>	
18) Rear Storage Compartment (engine cover).....	62
19) Bow Lights .....	64
20) Stern Light Socket .....	64
21) Mooring Cleats .....	66
22) Bow and Stern Eyelets .....	66
23) Water Sport Towing Attachments.....	66
24) Main Battery Cut-Off Switch.....	67
25) Radio/CD Player Remote Control.....	68
26) Built-In Ice Chest.....	68
<b>BREAK-IN PERIOD.....</b>	<b>69</b>
Operating During Break-In.....	69
<b>OPERATING INSTRUCTIONS.....</b>	<b>70</b>
Launching/Loading.....	70
Boarding the Boat .....	70
Starting the Engines .....	72
Leaving the Shore .....	73
Steering Operation.....	73
Throttle/Shift Control Operation .....	73
Shutting Off the Engines .....	75
General Recommendations.....	75
<b>SPECIAL PROCEDURES .....</b>	<b>77</b>
Jet Pump Water Intake and Impeller Cleaning.....	77
Towing the Boat in Water.....	77
Capsized Boat .....	78
Submerged Boat and Water-Flooded Engine .....	78

## **MAINTENANCE**

<b>BREAK-IN INSPECTION .....</b>	<b>80</b>
<b>MAINTENANCE SCHEDULE .....</b>	<b>82</b>
<b>MAINTENANCE PROCEDURES .....</b>	<b>85</b>
Throttle Body .....	85
Throttle Cables .....	85
Engine Oil.....	85
Engine Coolant .....	87
Ignition Coils.....	88
Exhaust System.....	89
Fuses.....	90
Bilge Blower.....	92
Navigation Lights.....	93
Deck Drain and Scupper Valve .....	94
Latches and Hinges .....	94
Reverse Gates.....	94
Ski Post .....	94
Sacrificial Anodes .....	95

<b>BOAT CARE</b> .....	<b>96</b>
Post-Operation Care .....	96
Boat Cleaning and Protection .....	96
<b>STORAGE</b> .....	<b>99</b>
Jet Pump Cleaning .....	99
Fuel System Protection.....	99
Throttle Body Lubrication.....	99
Engine Oil and Filter Replacement.....	99
Intercooler Draining.....	99
Exhaust System Flushing .....	100
Exhaust System Protection .....	100
Engine Internal Lubrication.....	100
Engine Coolant Test.....	101
Battery Removal and Storage .....	102
Boat Cleaning/Repair .....	102
Boat Protection.....	102
<b>PRESEASON PREPARATION</b> .....	<b>103</b>

***TECHNICAL INFORMATION***

<b>BOAT IDENTIFICATION</b> .....	<b>106</b>
Hull Identification Number .....	106
Engine Identification Number .....	106
<b>ENGINE EMISSIONS INFORMATION</b> .....	<b>107</b>
Manufacturer's Responsibility .....	107
Dealer's Responsibility .....	107
Owner Responsibility .....	107
EPA Emission Regulations .....	107
<b>SPECIFICATIONS</b> .....	<b>108</b>

***TROUBLESHOOTING***

<b>TROUBLESHOOTING GUIDELINES</b> .....	<b>112</b>
<b>MONITORING SYSTEM</b> .....	<b>116</b>
Beeper Code Information .....	117

***WARRANTY***

<b>BRP LIMITED WARRANTY FOR MODEL YEAR 2011 SEA-DOO® BOATS SOLD IN THE UNITED STATES AND CANADA</b> .....	<b>120</b>
---	------------



**CALIFORNIA EMISSION CONTROL WARRANTY STATEMENT FOR MODEL-YEAR 2011 SEA-DOO® BOATS WITH 4-TEC® ENGINES OR 4-TEC® IC ENGINES..... 124**

**BRP INTERNATIONAL LIMITED WARRANTY FOR MODEL YEAR 2011 SEA-DOO® BOATS ..... 128**

**BRP LIMITED WARRANTY FOR THE EUROPEAN AND THE RUSSIAN ECONOMIC AREA AND TURKEY: MODEL YEAR 2011 SEA-DOO® BOATS..... 132**

***CUSTOMER INFORMATION***

**PRIVACY INFORMATION ..... 138**

**CHANGE OF ADDRESS/OWNERSHIP..... 139**



# ***SAFETY INFORMATION***

---

# SPECIAL SAFETY MESSAGES

## Reminders Regarding Operation

- Engine exhaust contains carbon monoxide (CO), which can cause injury or death if inhaled in sufficient quantities. Educate all occupants about the risks and symptoms of CO accumulation and CO poisoning. For more information, refer to *CARBON MONOXIDE AND BOATING* section.
- Gasoline vapors can explode, resulting in injury or death. Always use blower for a minimum of 5 minutes before starting engine, then turn it OFF above idle speed. Use of the bilge blower should never replace "smelling" for gasoline vapor odors.
- If at any time, gasoline leaks/odors are found, do not start the engine. Have the boat serviced by an authorized Sea-Doo Boats dealer.
- Always keep in mind that as the throttle lever is returned to the idle position, less directional control is available. To turn the boat, both steering and throttle are necessary.
- This boat has no brake. Stopping distance will vary depending on initial speed, load, wind, and water conditions. Practice stopping and docking in a safe, traffic-free area to have an idea of how long it will take to stop the boat under varying conditions. Do not release the throttle when trying to steer away from objects. You need throttle to steer. Do not use the boat's reverse to stop.
- Do not start or operate the boat if any person is not properly seated in a seat intended for use when underway (not the sun deck or swim platform) or if a person is nearby in the water.
- The boat's jet thrust can cause injury. Always accelerate slowly, and decelerate in a controlled fashion.
- Observe the instructions on all safety labels. They are there to help assure that you have a safe and enjoyable outing.
- Riding with passenger(s) or pulling other boats, tubes, a skier or a wake boarder makes the boat handle differently and requires greater skill.
- Certain boats may come equipped with tow eyelets, a ski pole or a wakeboard tower which can be used to attach a tow rope for a skier, tube or wakeboarder. Do not use these attachment points or any other portion of the boat to tow a parasail or another craft. Personal injury or severe damage may occur.
- In shallow water, proceed with caution and at very low speeds. Grounding or abrupt stops may result in injury to you, your passengers or others. The jet pump may pick up debris and throw it rearward causing a risk of injuring people or damaging the jet pump or other property.
- Combustion engines need air to operate; consequently this boat can not be totally watertight. Any maneuvers such as figure eights that cause the upper deck to be under water may cause severe engine problems due to water ingestion. Refer to the *SPECIAL PROCEDURES* and *WARRANTY* sections contained in this Operator's Guide.
- Respect no wake zones, the rights of other water users and the environment. As the "skipper" and owner of a boat, you are responsible for damage to other boats caused by the wake of your boat. Do not let anyone throw refuse overboard.
- Between sunset and sunrise, use the boat's navigation lights and reduce speed. Do not operate the boat in reduced visibility.

- Do not add accessories or equipment that may adversely affect visibility or alter control of the boat.
- The skipper should personally take the helm during storms.

### **Before Getting Underway**

- Always perform the pre-ride inspection as specified in this Operator's Guide.
- Do not exceed the payload or passenger capacities for this boat, which are listed on the capacity plate and in the specifications. Overloading can affect maneuverability, stability and performance. Also, heavy seas reduce capacity. A payload or person capacity plate is not an excuse for failure to use common sense or good judgment.
- Regularly inspect the boat, the hull, engine, safety equipment, and all other boating gear and keep them in safe operating condition.
- Be sure you have the minimum required safety equipment, PFDs and any additional gear needed for your cruise.
- Check that all lifesaving equipment, including fire extinguisher, is in safe operating condition and easily accessible. Show all passengers where this equipment is, and make sure they know how to use it.
- Keep an eye on the weather. Check local weather broadcasts before departure. Be alert to changing conditions.
- Keep accurate and up-to-date charts of the boating area on board. Before getting underway, check water conditions in the planned boating area.

- Before departure, file a Float Plan with a responsible person ashore.
- Keep enough fuel on board for the planned trip. Always verify fuel level before use and during the ride. Apply the principle of 1/3 of the fuel to reach your destination, 1/3 to return, and keep 1/3 in reserve. Allow for changes due to adverse weather or other delays.

### **Operators and Passengers Awareness**

- Each boat operator has a responsibility to ensure the safety of his/her passenger(s) and of other water users. Please follow all safety instructions and operate your boat with care.
- Never operate a boat while under the influence of drugs or alcohol. It is a Federal offense. Allow only qualified drivers to operate your boat.
- Remember that sun, wind, fatigue or illness may impair your judgment and reaction time.
- At least one passenger should be able to operate the boat in case the operator is unexpectedly unable to do so.
- Operation of this boat by a person under 16 years of age or a person with a disability that impairs vision, reaction time, judgment, or operation of the controls is NOT recommended.
- Always use the tether cord when operating the boat and ensure that all passengers are familiar with its use.
- Ensure that any operator and all passengers know how to swim and how to re-board the boat from the water. If a passenger does not know how to swim, ensure that passenger wears a PFD at all times and take extra precautions when boating.

## Carbon Monoxide and Boating

Burning a material containing carbon produces carbon monoxide (CO), an odorless and colorless gas. Because CO weighs the same as air, it can spread throughout an enclosed space unnoticed because you cannot see it or smell it. Any device used to burn carbon-based materials on a boat can be a source of CO. Common sources of CO include internal combustion engines.

CO reacts with the blood to reduce the ability of the blood to carry oxygen. The reduced oxygen supply to body tissues results in death of the tissue. Prolonged exposure can cause brain damage or death. In high concentrations, CO can be fatal within minutes. The effects of CO in lower concentrations are cumulative and can be just as lethal over long periods of time.

Symptoms of CO poisoning include: Itchy and watering eyes, flushed appearance, throbbing temples, inability to think coherently, ringing in the ears, tightness across the chest, headaches, drowsiness, nausea, dizziness, fatigue, vomiting, collapse, and convulsions. If any of these symptoms are evident, begin treatment immediately. Prompt action can make the difference between life and death.

- Evacuate the area and move the victim to fresh air.

- Administer oxygen if available and get medical help.
- Open all canvas enclosures to ventilate the area.
- Investigate the source of CO and take immediate corrective action.
- Be especially aware of other CO sources which may be near boat.

### Carbon Monoxide Accumulation

Following are examples of possible situations where CO may accumulate within your boat while docked, anchored, or underway. Become familiar with these examples and their precautions to prevent personal injury or death.

#### **⚠ WARNING**

**Exhaust fumes!** Generator or hull exhaust from other vessels while either docked or anchored can emit poisonous CO gas and cause excessive accumulation within cabin and cockpit areas. Be alert for generator exhaust from your vessel or other vessels alongside. Exhaust outlets near a pier, dock, seawall or outlets blocked by any other means can cause excessive accumulation of poisonous CO gas within cockpit area.

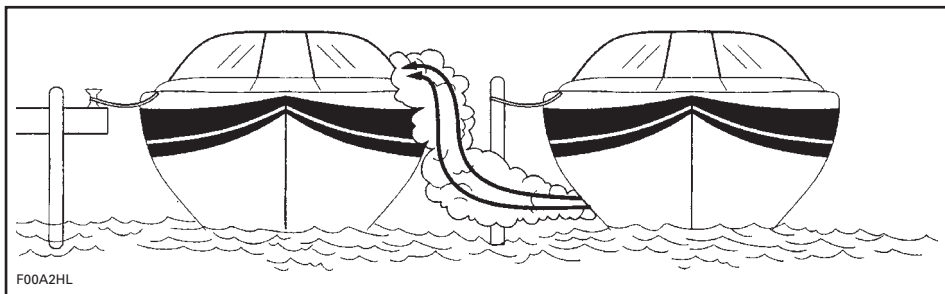

F00A2HL

VESSEL ALONGSIDE

**⚠ WARNING**

**Engine exhaust fumes contain carbon monoxide (CO) which can accumulate in and around the boat (under bimini top, in cockpit, etc.). CO can be harmful or fatal if inhaled. Assure there is adequate ventilation whenever running engine(s).**

Boat houses, seawalls, and other boats in close proximity or confined areas can contribute to increased CO levels. Operators must be aware that operation, mooring, and anchoring in an area with other boats puts them in jeopardy of CO accumulation from other sources. Likewise, a boat operator must be aware of how exhaust from his boat will affect others. Operation of the engines while moored may cause CO accumulation in your boat and those around you.

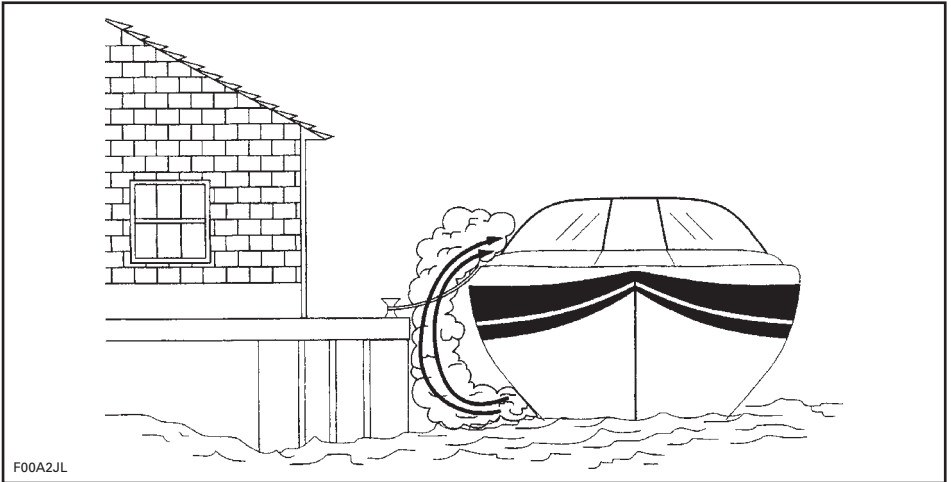

F00A2JL

**CONFINED AREAS**

Be sure to provide adequate ventilation. If the windshield has vents, open them before getting underway to increase positive air flow and decrease the chances of CO accumulation.

**⚠ WARNING**

**Backdrafting!** Under certain conditions, moving air currents can direct poisonous CO fumes into boat. These fumes can accumulate to dangerous levels without proper airflow. Provide adequate ventilation, redistribute the load or bring boat out of high bow angle.

While underway, CO concentrations can increase by backdrafting or "the station wagon effect". Backdrafting is caused by factors such as relative wind direction, speed, or the bow being too high. To prevent this, open canvas whenever possible to provide positive airflow through the hull.

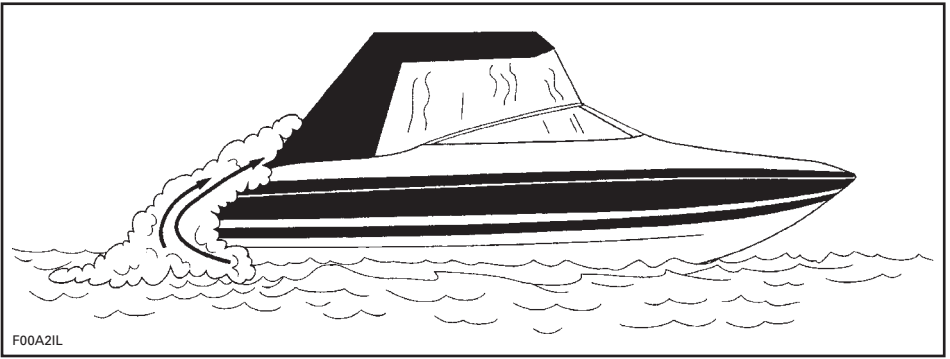

*WHILE UNDERWAY (BACKDRAFTING)*

Even with the best boat design and construction, CO may still accumulate in enclosed or confined areas under certain conditions. Continually observe passengers for symptoms of CO poisoning.



## CO Detector

It is strongly recommended that you have CO detectors installed in boats with canvas enclosures. Monitors are available from your dealer. Monitors should be professionally installed and calibrated.

**NOTE:** A CO detector is not a gas fuel vapor detector. Gas fuel vapor detectors do not monitor the buildup of CO in an enclosed area.

## Do NOT Operate your Boat without Performing the Following Checklist

### Each Boating Day

OPERATION	✓
Make sure you and your passengers know where exhaust outlets are located on the vessel.	
Educate all passengers about the symptoms of CO poisoning and where CO may accumulate.	
When docked or rafting with another boat, be aware of exhaust emissions from the other boat.	
Confirm that water flows from the exhaust outlet when the engine(s) is (are) started.	
Listen for any change in exhaust sound, which could indicate an exhaust component failure.	
Test the operation of each CO alarm by pressing the test button (if so equipped).	

## Water Sports

### WARNING

**Avoid personal injury!** Your boat is not designed for and should not be used for pulling parasails, kites, gliders, or any device which can become airborne. Use boat only for appropriate water sports.

### WARNING

**Teak surfing** is extremely dangerous to participants due to their proximity to the rear of the boat where direct contact with the exhaust fumes from the boat engine is the highest. Carbon monoxide poisoning can occur and result in mental disorientation, dizziness, drowsiness, and loss of consciousness. The combination of carbon monoxide exposure and non-use of a life jacket (PFD) make this new water recreation activity an incredibly dangerous and potentially deadly sport.

Water skiing, wakeboarding, or riding a towed, inflatable apparatus are some of the more popular water sports. Taking part in any water sport requires increased safety awareness by the participant and the boat operator. If you have never pulled someone behind your boat before, it is a good idea to spend some hours as an observer, working with and learning from an experienced driver. It is also important to be aware of the skill and experience of the person being pulled. Always have a second person on board to observe the person in the water so the driver can concentrate on operating the boat.

Both the boat operator and observer should monitor the location of the tow rope when participating in water sports. A slack tow rope can become entangled with person(s) or objects in the boat or in the water, particularly when making a tight turn or circling, and cause serious personal injury.

Everyone participating in a water sport should observe these guidelines:

- Allow only capable swimmers to take part in any water sport.

- Always wear an approved personal flotation device (PFD). Wearing a properly designed PFD helps a stunned or unconscious person stay afloat. A Type-IV water-ski vest is an approved and practical PFD.
- Have a second person aboard to observe the person being towed and inform the driver about the participant's hand signals. The driver must give full attention to operating the boat and the waters ahead.
- Be considerate to others you share the water with.
- Never allow a person to "teak surf" behind your boat. Do not tow a person in any water sport on a short tow rope such that the person inhales exhaust fumes in concentration. Inhalation of concentrated exhaust fumes, which contain carbon monoxide, can result in CO poisoning, personal injury and death.
- Give immediate attention to a person who has fallen. He or she is vulnerable in the water alone and may not be seen by other boaters.
- Approach a person in the water from the lee side (opposite the direction of the wind). Turn off the motor before coming close to the person.
- Turn off engine and anchor the boat before swimming.
- Participate in water sports only in safe areas. Stay away from other boats, channels, beaches, restricted areas, swimmers, and heavily traveled waterways and underwater obstructions.
- Swim only in areas designated as safe for swimming. These are usually marked with a swim area buoy. Do not swim alone or at night.



SWIM AREA BUOY

1. Do not water ski between sunset and sunrise. It is illegal in most states.
2. Do not drive the boat directly behind a water skier, tuber or wakeboarder. At 40 km (25 mi) per hour, the boat will overtake a person who falls in the water 60 m (200 ft) in front of your boat in about 5 seconds.
3. Shut engine off and remove ignition key when anyone is in the water nearby.
4. Stay at least 45 m (150 ft) away from areas marked by a diver down float.

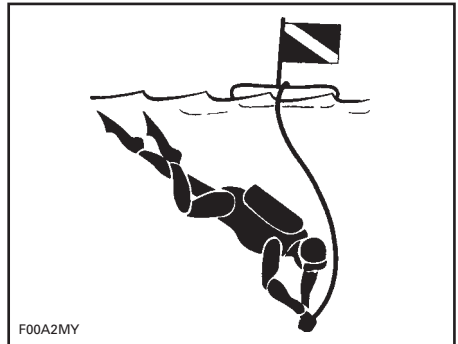

DIVER DOWN FLOAT

 **WARNING**

**Avoid personal injury!** Do not allow anyone near the jet pump or intake grate, even when the engine is off. Items such as long hair, loose clothing or personal flotation device straps can become entangled in moving parts resulting in serious injury or drowning. In shallow water, shells, sand, pebbles or other objects could be drawn up by the jet pump and be thrown rearward.

For more information about water skiing, please contact your local water ski association.

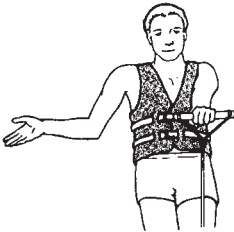

**FASTER -**  
Palm of one hand pointing  
upward.



**SLOWER -**  
Palm pointing down.



**SPEED OK -**  
Arm upraised with thumb and  
finger joined to form circle.

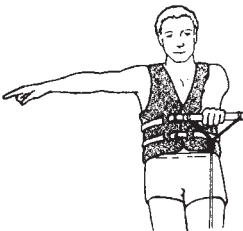

**RIGHT TURN -**  
Arm outstretched pointing  
to the right.

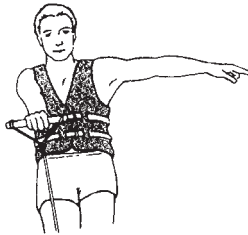

**LEFT TURN -**  
Arm outstretched pointing  
to the left.



**RETURN TO DROP-OFF AREA -**  
Arm at 45 degree from body  
pointing down to water and  
swinging.



**CUT MOTOR -**  
Finger drawn across  
throat.

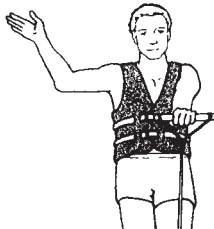

**STOP -**  
Hand up, palm forward,  
policeman style.



**SKIER OK.  
AFTER THE FALL -**  
Hands clenched  
together overhead.

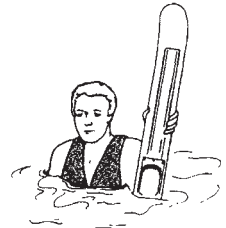

**PICK ME UP  
OR FALLEN SKIER,  
WATCH OUT -**  
One ski extended  
vertically out of water.

F00A2NL

**SKIING SIGNALS**

## Hypothermia

Hypothermia, the loss of body heat to the water, is a significant cause of deaths in boating accidents. After an individual has succumbed to hypothermia, he or she will lose consciousness and then drown.

PFDs can increase survival time because of the insulation they provide.

Naturally, the warmer the water, the less insulation one will require. When operating in cold water (below 4.4°C (40°F)) consideration should be given to using a coat or jacket style PFD as they cover more of the body than the vest style PFDs.

Some points to remember about hypothermia protection:

1. While afloat in the water, do not attempt to swim unless it is to reach a nearby boat, fellow survivor, or a floating object on which you can lean or climb. Unnecessary swimming increases the rate of body heat loss. In cold water, drown-proof methods that require putting your head in the water are not recommended. Keep your head out of the water. This will greatly lessen heat loss and increase your survival time.
2. Keep a positive attitude about your survival and rescue. This will improve your chances of extending your survival time until rescue. Your will to live does make a difference!
3. If there is more than one person in the water, huddling is recommended while waiting to be rescued. This action tends to reduce the rate of heat loss and thus increase the survival time.
4. Always wear your PFD. It won't help you fight off the effects of hypothermia if you don't have it on when you go into the water.

## Voluntary Inspections

Boating officials in many countries or their auxiliaries offer courtesy inspections to check out your boat. They will check for compliance with safety standards and required safety equipment. You may voluntarily consent to one of these inspections, and you are allowed time to make corrections without prosecution. Check with the competent authorities for details.

## Safe Boating Courses

Many countries recommend or require a boating safety course. Check with your local competent authorities.

# SAFETY EQUIPMENT

## Required Safety Equipment

Operator and passenger(s) should have ready access to shatterproof glasses should riding conditions or personal preference warrant.

Wind, water spray and speed may cause a person's eyes to water and create blurred vision.

As the owner of the boat, you are responsible for assuring that all required safety equipment is aboard. You should also consider supplying additional equipment as needed for your safety and that of your passengers. Check state and local regulations about required safety equipment.

Safety equipment required by regulations is mandatory. Personal flotation devices must be fitted to the people wearing them. If local regulations require additional equipment, it must be approved by a competent authority. Minimum requirements include the following:

- Personal flotation devices (PFDs)
- Fire extinguisher (class B-1)
- Visual distress signals (VDS)
- Navigation lights
- Sound producing devices (horn, air horn or whistle).

A cellular telephone in a waterproof bag or container has also been found to be beneficial to boaters when in distress or just for contacting someone on shore.

## Personal Flotation Devices (PFDs)

In many countries, regulations require that you have at least one approved personal flotation device (PFD) for each person in a recreational boat and require that all children under 13 years of age wear a PFD at all times when the boat is underway, except when below deck or in an enclosed cabin. You may not use your boat unless all PFDs are in serviceable condition, readily

accessible, legibly marked with the approval number, and of an appropriate size (within the weight range and chest size marked on the PFD) for each person on board.

A PFD provides buoyancy to help keep your head above the water and to help you remain in a satisfactory position while in the water. Body weight and age should be considered when selecting a PFD. The buoyancy provided by the PFD should support your weight in water. The size of the PFD should be appropriate for the wearer. Body weight and chest size are common methods used to size PFDs. It is your responsibility to ensure that you have the proper number and types of PFDs on board to comply with federal and local regulations and that your passengers know where they are and how to use them.

## PFD Types

There are five types of PFDs.

**PFD Type I, Wearable** has the greatest required buoyancy. Its design allows for turning most unconscious persons in the water from face down position to a vertical or slightly backward, face-up position. It can greatly increase the chances of survival. Type I is most effective for all waters, especially offshore when rescue may be delayed. It is also the most effective in rough waters.

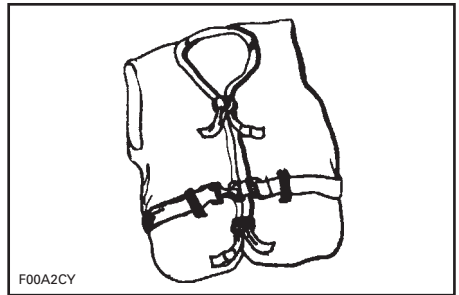

TYPE I — WEARABLE

**PFD Type II**, Wearable turns its wearer in the same way as Type I, but not as effectively. The Type II does not turn as many persons under the same conditions as a Type I. You may prefer to use this PFD where there is a probability of quick rescue such as in areas where other people are commonly involved in water activities.

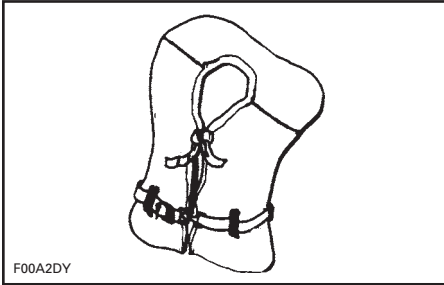

**TYPE II — WEARABLE**

**PFD Type III**, Wearable allows wearers to place themselves in a vertical or slightly backward position. It does not turn the wearer. It maintains the wearer in a vertical or slightly backward position and has no tendency to turn the wearer face down. It has the same buoyancy as a Type II PFD and may be appropriate in areas where other people are commonly involved in water activities.

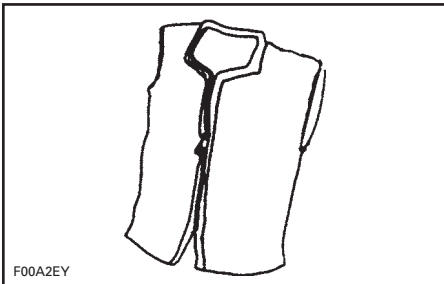

**TYPE III — WEARABLE**

**PFD Type IV**, Throwable is required in addition to the PFDs previously discussed. The most common Type IV PFD is a buoyant cushion or ring buoy. It is designed to be thrown to a per-

son in the water, grasped and held by the user until he or she is rescued. A Type IV PFD should always be in serviceable condition and immediately available for use. Grasping this PFD may be difficult if the rescue is delayed or if the user is overcome by hypothermia (loss of body heat).

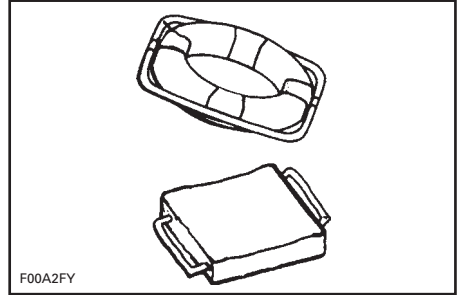

**TYPE IV — THROWABLE**

**PFD Type V**, Wearable must be worn. When inflated, it provides buoyancy equivalent to Type I, II or III PFDs. When it is deflated, however, it may not support some people.

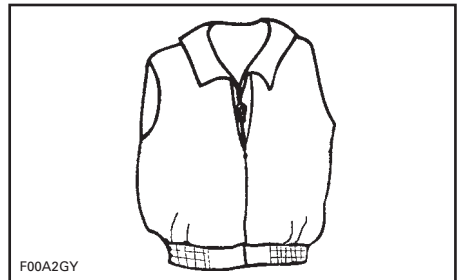

**TYPE V — WEARABLE**

### **PFD Pointers**

The purpose of a PFD is to help save your life. If you want it to support you when you are in the water, it needs to fit, float, and be in good condition.

- Try the PFD on and adjust it until it fits comfortably in and out of the water. Mark your PFD if you are the only wearer.

- To make sure the PFD works, wear it in the water. This will show you how it works and give you confidence when you use it.
- Teach children how to put a PFD on and allow them to try it in the water. That way, they know what the PFD is for and how it works. They will feel more comfortable with it if they suddenly find themselves in the water.
- If the PFD is wet, allow it to dry thoroughly before storing it. Do not dry it in front of a radiator or heater. Store it in a well-ventilated area.
- Keep PFDs away from sharp objects which can tear the fabric or puncture the flotation pads.
- For their own safety and the safety of others, all non-swimmers, poor swimmers, and small children should wear PFD's at all times whether the boat is stationary or moving.
- Check the PFD frequently to make sure that it is not torn, that flotation pads have no leaks, and that all seams and joints are securely sewn.
- If a PFD contains kapok, the kapok fibers may become waterlogged and lose their buoyancy after the vinyl inserts are punctured. If the kapok becomes hard or if it is soaked with water, replace it. It may not work when you need it.

### Fire Extinguishers

As the owner of the boat, you are responsible for supplying an approved fire extinguisher. Check with local competent authorities.

Boats (less than 7.9 m (26 ft)) are required to carry one (1) B-1 type hand portable fire extinguisher unless the boat is equipped with a fixed fire extinguishing system in the engine compartment.

Hand-held portable fire extinguishers should be mounted in readily accessible locations away from the engine

compartment. All persons aboard should know the location and proper operation of the fire extinguisher(s).

**NOTE:** Don't test fire extinguishers by squirting small amounts of the extinguishing compound. The extinguisher might not work when you really need it!

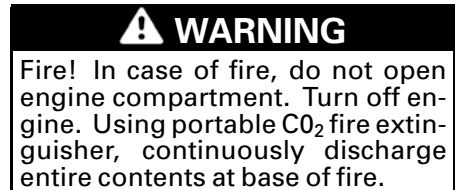

### Visual Distress Signal Devices

Visual distress signal equipment may be of the pyrotechnic or non-pyrotechnic type. Regulations prohibit display of visual distress signals on the water under any circumstances except when assistance is required to prevent immediate or potential danger to persons on board a vessel. Check with the local authority to have proper equipment.

The equipment must be approved by the competent authorities, be in serviceable condition, and be stowed in a readily accessible location. Equipment having a date for serviceable life must be within the specified usage date shown.

Careful selection and proper stowage of visual distress equipment is very important if children are aboard.



<b>DAY USE ONLY</b>
Three orange smoke signals (one hand held and two floating) or one orange flag with black square and disk.
<b>NIGHT USE ONLY</b>
One S-O-S electric distress light.
<b>DAY AND NIGHT USE</b>
Three flares of the hand held, meteor or parachute type.

### Sound Signaling Devices

**NOTE:** No single signaling device is appropriate for all purposes. Consider keeping various types of equipment on board.

Boats less than 7.9 m (26 ft) in length are required to carry a hand, mouth, or power operated horn or whistle. It must produce a blast of two second duration and audible at a distance of at least 800 m (1/2 mi).

Following are standard whistle signals:

- One prolonged blast (warning signal)
- One short blast (pass on my port side)
- Two short blasts (pass on my starboard side)
- Three short blasts (engines in reverse)
- Five or more blasts (danger signal).

### Navigation Lights

Navigation lights are intended to keep other vessels informed of your presence and course. If you are out on the water between sunset and sunrise, you are required to display appropriate navigation lights.

## Additional Recommended Equipment

It is recommended that you acquire additional equipment for safe, enjoyable cruising. This list, which is not all inclusive, includes items you should consider acquiring.

### Basic Gear

- Flashlight
- Mooring lines
- Compass
- Oar or paddle
- Distress signals
- First aid kit
- Dock fenders
- VHF radio
- EPIRB (Electronic Position Indicating Radio Beacon)
- Boat hook
- Extra warm clothing
- Local map
- Sunblock
- Tow line
- Second anchor and line
- Dewatering device (pump or bailer)
- Emergency supply of drinking water and food
- Cellular phone.

### Tools

- Screwdrivers
- Pocket knife
- Pliers
- Electrician's tape
- Adjustable wrench
- Duct tape.

### Spare Parts

- Extra bulbs
- Extra fuses.

---

# PRACTICE EXERCISES

It is always a good idea to practice and get familiar with all controls, functions and handling characteristics of your boat before venturing on the water.

Always secure the tether cord to the engine cut-off switch and the clip to your PFD or a wrist strap.

## Where to Practice Exercises

Find a suitable area to practice the exercises. Ensure the area meet the following requirements:

- No traffic
- No obstacles
- No swimmers
- No current
- Ample space to maneuver
- Water depth is adequate.

## Practice Exercises

Practice **alone** the following exercises.

### Turning

Practice turning in circles in both directions at slow speed. When comfortable with the exercise, increase difficulty by making some figure 8.

When this is mastered, repeat the above exercises but at increased speed.

### Stopping Distances

Practice to stop the boat in a straight line at different speeds.

Remember, water drag is the main factor which reduce the boat speed and thus the stopping distance.

**NOTE:** Boat load, current and wind play also an important role and affect stopping distances.

### Reverse

Practice reverse operation to learn how the boat operates in reverse and reacts with steering inputs.

**NOTE:** Always perform this exercise at slow speeds.

### Avoiding an Obstacle

Practice to avoid an obstacle (choose a virtual point on the water) by steering boat and maintaining throttle.

Repeat exercise, but this time release throttle while turning.

**NOTE:** With this exercise, you will learn that you need throttle to steer the boat in a different direction.

### Docking

Practice docking using the throttle and shift lever along with the steering to become familiar and develop good control skills.

### Ski Mode and Cruise Control Mode

If your boat has the Ski Mode or Cruise Control mode, it is also important to understand their operations and get familiar with these features prior to use them on a ride with other people.

## WARNING

The ski and the cruise control modes are not an automatic pilot; they will not drive the boat.

## Important Factors Not to Neglect

In addition, always remember that the following conditions have a direct impact on how your boat will behave and respond to different inputs:

- Load change
- Current
- Wind
- Water condition.

Make sure to be alert to these conditions, and adapt accordingly. If possible, practice further in these conditions.

For delicate maneuvers, the best advice is always to try to keep speed at a minimum.

---

# SAFE BOATING PRACTICES

YOU are responsible for your own safety, the safety of your passengers, and the safety of fellow boaters. Ride smart from the start and we all win!

## Drugs and Alcohol

Do not use drugs or drink alcohol while operating a boat. Like driving a car, driving a boat requires sober, attentive care. Operating a boat while intoxicated or under the influence of drugs is not only dangerous, but it is also a Federal offense carrying a significant penalty. These laws are vigorously enforced. The use of drugs and alcohol, singly or in combination, decreases reaction time, impedes judgment, impairs vision, and inhibits your ability to safely operate a boat.

### WARNING

Alcohol consumption and boating do not mix! Operating under the influence endangers the lives of your passengers and other boaters. Federal laws prohibit operating a boat under the influence of alcohol or drugs.

## Safe Operation

For safety reasons and proper care, always perform *PRE-RIDE INSPECTION* as specified in your Operator's Guide before operating your boat. Safe operation means that you do not misuse your boat nor do you allow your passengers to do so. Safe operation means using good judgment at all times. It includes, without limitation, the following actions:

- Load the boat within the limits listed on the capacity plate. Balance loads bow to stern and port to starboard.
- Maintain boat speed at or below the local legal limit. Avoid excessive speed or speeds not appropriate for operating conditions.

- Do not use the boat in weather or sea conditions beyond the skill or experience of the operator or the comfortable capability of the boat or passengers.
- Be sure at least one other passenger is familiar with the operation and safety aspects of the boat in case of an emergency.
- Make sure that passengers and gear do not obstruct the operator's view or ability to move.
- Do not exceed the maximum engine power rating stated on the certification plate attached to the boat.
- Observe all safety signs and warnings both inside the boat and in the immediate boating area.
- While your boat has the capacity of operating at high speeds, it is strongly recommended that high speed operation only be applied when ideal conditions exist and are permitted. Higher speed operation requires a higher degree of skill and increases the risk of severe injuries.
- In shallow water, proceed with caution and at very low speeds. Grounding or abrupt stops may result in injury. Debris may also be picked up and be thrown rearward by the jet pump onto people or property.
- Do not use the boat's reverse, to stop. You or your passenger(s) could be violently ejected forward or even off the boat onto the hazard.

## Maneuverability of the Boat and Towing

- Always keep in mind that as the throttle lever is returned to idle position, less directional control is available, and when the engine is off, directional control is lost. You need throttle to steer.

- Do not overload the boat or take on more passengers than designated for the particular boat. Overloading can affect maneuverability, stability and performance.
  - Avoid adding on accessories or equipment which may alter your control of the boat.
  - Riding with a passenger(s) or pulling a tube, skier or wakeboarder makes the boat handle differently and requires greater skill.
  - Always respect the safety and comfort of your passenger(s) and person being towed on skis, wakeboard or other towables.
  - Always carry an observer when pulling a tube, skier or wakeboarder, proceed with only as much speed as required and follow the observer's instructions. Unless absolutely necessary, do not make tight, sharp turns. Keep a safe distance from the docks, other swimmers, craft or objects.
  - Use a tow rope of sufficient length and size and make sure it is adequately secured to your boat. Some boats are equipped or can be fitted with a specially designed towing mechanism. It can become a hazard should someone fall on it.
- age wear a PFD when the boat is underway unless they are in an enclosed cabin or below deck.
- Do not start or operate the boat if anyone is seated on the sun deck or swim platform, or is nearby in the water. Water and/or debris exiting jet thrust nozzle can cause severe injury.
  - The operator and passenger(s) should be properly seated before starting or moving the boat. All passenger(s) should be instructed to use the handholds or seat straps provided.
  - When accelerating a boat with a passenger(s), whether from a complete stop or while underway, always do so progressively. Fast acceleration may cause your passenger(s) to lose their balance or grip and strike something in the boat or fall out of the boat. Make sure that your passenger(s) know of, or anticipate, any rapid acceleration.

### Passenger Safety

Before getting underway, show all passengers where emergency and safety equipment is stowed, and explain how to use it. Everyone aboard should wear rubber-soled shoes which resist slipping on wet surfaces. While underway, passengers should remain seated inside the deck rails. Don't allow passengers to drag their feet or hands in the water. Always use handholds and other safety hardware to prevent falls. All non-swimmers, poor swimmers, and children should wear a PFD at all times. Federal regulations require that children under 13 years of

### First Aid

As a boat operator, you should be familiar with basic first aid procedures that may be needed while you are far from help. Fish hook accidents or minor cuts and abrasions may be the most serious mishaps on board a boat, but you should also learn the proper procedures and be ready to deal with the truly serious problems like excessive bleeding, hypothermia, and burns. First aid literature and courses are available through most Red Cross chapters.

### Operation by Minors

Minors should always be supervised by an adult whenever operating a boat. Many countries have laws regarding the minimum age and licensing requirements of minors. Be sure to contact the competent authorities for information. BRP recommends a minimum operator age of 16 years old.

# NAVIGATION RULES

## Operating Rules

Operating a boat can be compared with driving unmarked highways and roads. To prevent collisions or avoid other boaters, a system of operating rules must be followed. It's not only common sense... it's the law!

Check local and federal boating laws applicable to the waterways where you intend to use your boat. Learn the local rules of the road. Know and understand the applicable navigation system (such as buoys and signs).

Know the waters in which the boat is to be operated. Current, tides, rapids, hidden obstacles, wakes and waves etc. can affect safe operation. It is not advisable to operate the boat in rough or inclement weather.

Generally keep to your right and safely avoid other craft by keeping a safe distance from other craft, people and objects.

The following illustration identifies different parts of the boat that are used as directional reference points, the bow being the front of the boat. The port side of boat (left side) is visually identifiable by a RED light off the bow, and the starboard side (right side) by a GREEN light.

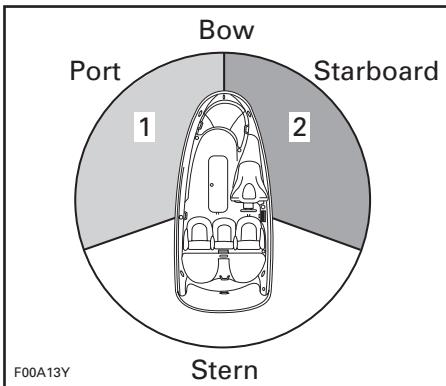

TYPICAL

1. RED light
2. GREEN light (yield zone)

## Crossing

Give right of way to craft ahead and to your right. Never cross in front of another craft.

RED light (give way to the other craft).

GREEN light (you have the right of way).

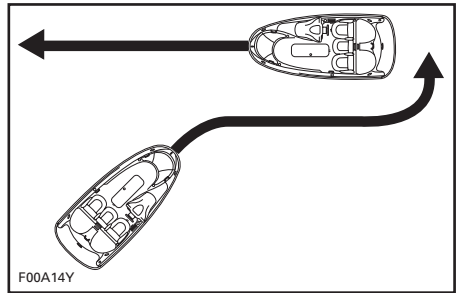

TYPICAL

## Meeting Head-On

Keep right.

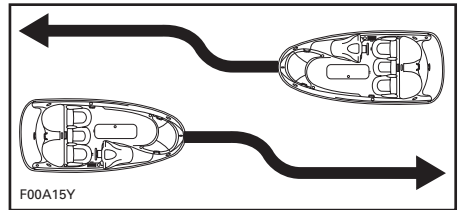

TYPICAL

## Passing

Give right of way to other craft and keep clear.

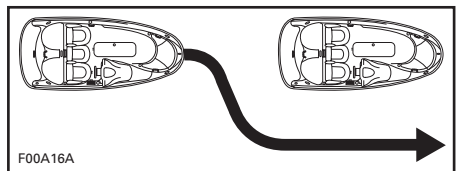

TYPICAL

## Navigation System

Navigational aids, such as signs or buoys, can help you identify safe waters. Buoys will indicate whether you should keep to the right (starboard) or to the left (port) of the buoy or to which channel you can continue. They may also indicate whether you are entering a restricted or controlled area such as a no wake or speed zone. They may also indicate hazards or pertinent boating information. Markers may be located on shore or on the water. They can also indicate speed limits, no power craft or boating, anchorage and other useful information. (The shape of each type of marker will provide assistance.)

Make sure you know and understand the navigation system applicable to the waterways where you intend to use the boat.

## Collision Avoidance

- Do not decrease throttle when trying to steer away from objects. You need throttle to steer.
- Always keep a constant lookout for other water users, other craft or objects, especially when turning. Be alert for conditions that may limit your visibility or block your vision of others.
- Respect the rights of other recreationists and/or bystanders and always keep a safe distance from all other craft, people and objects.
- Do not wake or wave jump, ride the surf line or attempt to spray or splash others with your boat. You may misjudge the ability of the boat or your own driving skills and strike a boat or person.

- This boat has the capability of turning more sharply than other boats. However, unless in an emergency, do not negotiate sharp, high speed turns. Such maneuvers make it hard for others to avoid you or understand where you are going. Also, you and/or your passenger(s) could be thrown from the boat.
- This boat has no brake. Stopping distance will vary depending on initial speed, load, wind, and water conditions. Practice stopping and docking in a safe, traffic free area to have an idea of how long it will take to stop the boat under varying conditions.
- Maintaining or increasing speed may be necessary to avoid a collision.

# FUELING

## Recommended Fuel

Use unleaded gasoline or oxygenated fuel containing a maximum total of 10% of ethanol or methanol. The gasoline used must have the following recommended octane rating.

**NOTICE** Never experiment with other fuels or fuel ratios. The use of inadequate fuel can result in boat performance deterioration and damage to critical parts in the fuel system and engine components.

### Inside North America

MINIMUM OCTANE RATING		
87 (RON + MON)/2		
91 (RON + MON)/2		
<b>ENGINES</b>	91	87
510 HP Supercharged Intercooled	X (1)	X

(1) For optimum engines performance.

### Outside North America

MINIMUM OCTANE RATING		
92 RON		
95 RON		
<b>ENGINES</b>	95	92
510 HP Supercharged Intercooled	X (1)	X

(1) For optimum engines performance.

## Fueling Procedure

### ⚠ WARNING

Fuel is flammable and explosive under certain conditions. Do not smoke or allow open flames or sparks in the vicinity. Always have an extinguisher close at hand during fueling procedure.

Be very careful when fueling and adhere to the fueling procedures described below in this Operator's Guide and those given to you by the marina.

Know the capacity of the fuel tank. Avoid fueling at night except under well-lit conditions. Gas spills are not noticeable in the dark. Do not carry spare fuel or flammable liquids in any of the storage or engine compartments.

### ⚠ WARNING

Follow these safe boating fueling instructions explicitly.

### On a Trailer

1. The boat should be level.
2. Ensure engine cover is closed to prevent fumes from entering the engine compartment.
3. Unscrew the cap counterclockwise and remove it slowly.



1. Fuel tank cap

4. Insert the gas pump spout into the filler neck and fill up fuel tank.

### ⚠ WARNING

To prevent fuel back-flow, fill up tank slowly so the air can escape from the fuel tank.

5. Stop filling immediately after the release of the gas pump nozzle handle and wait a moment before remov-



ing the spout. Do not retract the gas pump nozzle to put more fuel in fuel tank.

**⚠ WARNING**

Do not overfill or top off the fuel tank and leave the boat in the sun. As temperature increases, fuel expands and may overflow.

6. Install and fully tighten the fuel tank cap.

**⚠ WARNING**

Always wipe off any fuel spillage from the boat.

**In Water**

1. Turn off engines.
2. Tie boat securely to the fueling pier.
3. Do not allow anyone to remain in or on the boat.
4. Ensure engine cover is closed to prevent fumes from entering the engine compartment.
5. Unscrew the cap counterclockwise and remove it slowly.



1. Fuel tank cap

6. Insert the gas pump spout into the filler neck and fill up fuel tank.

**⚠ WARNING**

To prevent fuel back-flow, fill up tank slowly so the air can escape from the fuel tank.

7. Stop filling immediately after the release of the gas pump nozzle handle and wait a moment before removing the spout. Do not retract the gas pump nozzle to put more fuel in fuel tank.

**⚠ WARNING**

Do not overfill or top off the fuel tank and leave boat in the sun. As temperature increases, fuel expands and might overflow.

8. Install and fully tighten the fuel tank cap.

**⚠ WARNING**

Always wipe off any spillage from the boat.

---

## TRAILERING INFORMATION

Refer to the trailer instructions for proper capacity, operation, maintenance, accessories and warranty.

Check the regulations in your area concerning towing a trailer, especially the following rules:

- Brake system
- Tow vehicle weight
- Mirrors.

**NOTE:** An optional brake system is available for your trailer, contact Karavan Trailers at:

**www.karavantrailers.com.**

Take the following precautions when trailering the boat:

1. Tie the boat to both bow and stern (front/rear) eyelets so that it is firmly retained on the trailer.
2. Remove stern light (if installed).
3. Ensure that ski post is pushed down (if so equipped).
4. Ensure all storage compartment covers are properly latched.
5. Empty the ballast tank (if so equipped).
6. Close bimini top (if so equipped).
7. A Sea-Doo cover can protect the boat, particularly before driving on dirt roads, to prevent dirt entering through the air intake openings.

Observe trailering safety precautions.

**NOTICE** Always close and securely fasten rear storage compartment lid **before** trailering.

# LOCATION OF IMPORTANT ON-PRODUCT LABELS

The following labels are on your boat. If missing or damaged, they can be replaced free of charge. See an authorized Sea-Doo Boats dealer.

Please read the following labels carefully before operating your boat.

**NOTE:** The illustration of the boat indicates the approximate locations of the various labels. A dotted line indicates that the label is not on the outer surface, and that the seat or a cover of some type must be opened to see the label.

## Hang Tag

**The Star Label means Cleaner Marine Engines**  
This engine has been certified as:











**The Symbol for Cleaner Marine Engines:**  
Cleaner Air and Water  
For a healthier lifestyle and environment.

**Better Fuel Economy**  
Burns up to 30-40 percent less gas and oil than conventional carbureted two-stroke engines, saving money and resources.

**Longer Emission Warranty**  
Protects consumer for worry-free operation.



**One Star-Low emission**  
The one-star label identifies personal watercraft, outboard, sterndrive and inboard engines that meet the Air Resources Board's Personal Watercraft and Outboard marine engine 2001 exhaust emission standards. Engines meeting these standards have 75% lower emissions than conventional carbureted two-stroke engines. These engines are equivalent to the U.S. EPA's 2006 standards for marine engines.



**Two Stars-Very Low emission**  
The two-star label identifies personal watercraft, outboard, sterndrive and inboard engines that meet the Air Resources Board's Personal Watercraft and Outboard marine engine 2004 exhaust emission standards. Engines meeting these standards have 20% lower emissions than One Star – Low Emission engines.



**Three Stars-Ultra Low emission**  
The three-star label identifies engines that meet the Air Resources Board's Personal Watercraft and Outboard marine engine 2008 exhaust emission standards or the Sterndrive and Inboard marine engine 2003 exhaust emission standards. Engines meeting these standards have 65% lower emissions than One Star – Low Emission engines.



**Four Stars-Super Ultra Low emission**  
The four-star label identifies engines that meet the Air Resources Board's Sterndrive and Inboard marine engine 2009 exhaust emission standards. Personal Watercraft and Outboard marine engines may also comply with these standards. Engines meeting these standards have 90% lower emissions than One Star – Low Emission engines.

**BOMBARDIER RECREATIONAL PRODUCTS INC.**  
**VALCOURT, QUÉBEC, CANADA**  
Cleaner Watercraft - Get the facts 1-800-END-SMOG  
[www.arb.ca.gov](http://www.arb.ca.gov)

219902678

219902678

## Safety Labels

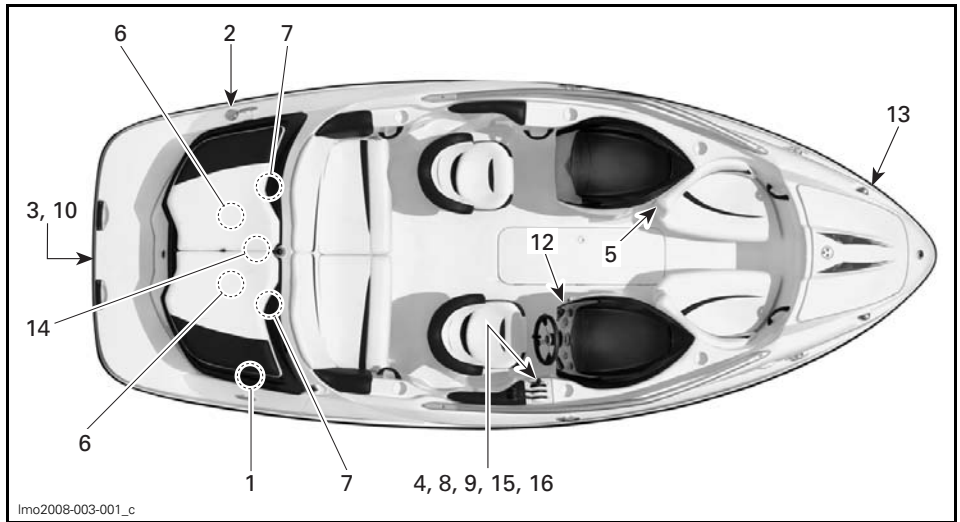

lmo2008-003-001\_c

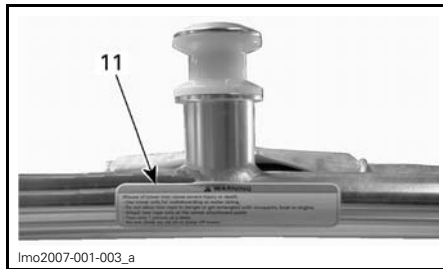

lmo2007-001-003\_a

TOWER (IF SO EQUIPPED)

**⚠ WARNING**

- Remove battery from boat before charging.
- Do not overcharge battery.
- Improper charging of battery can cause explosion.

204901330

LABEL 1

**⚠ WARNING**

Avoid serious injury or death from fire or explosion from leaking fuel or vapors.

- Before fueling, turn off engine.
- Keep the boat level with no one aboard.
- Keep craft away from open flames and sparks.
- Use regular unleaded gasoline 87 pump octane.
- Do not overfill.
- Wipe up spilled gasoline.
- Inspect fuel system for leaks and verify components integrity at each pre-ride inspection.

204 902 065

LABEL 2

**⚠ WARNING**

Avoid serious personal injury or death.

- Turn off engine(s) before using swim platform.
- Keep people, clothing and hair away from jet nozzle(s) or intake grate(s) to avoid entanglement, drowning and carbon monoxide poisoning.

204901334

LABEL 3

**⚠ WARNING**

Lock driver seat in forward position so that seat faces steering wheel during operation and does not swivel.

204901347

LABEL 4

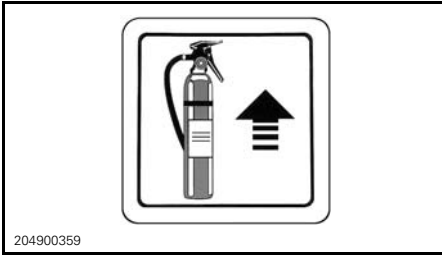

204900359

LABEL 5

**⚠ WARNING / AVERTISSEMENT**

**CHECKING ENGINE OIL LEVEL**

Vehicle must be level to perform verification. Bring engine to normal operating temperature then let idle for 30 seconds. Stop engine, wait for at least 30 sec. and check oil level using the dipstick. CAUTION: Never let engine run out of water without the flush kit connected as it may damage the engine. Oil may be hot.

---

**VÉRIFICATION DU NIVEAU D'HUILE DU MOTEUR**

Avec la motomarine à niveau et à température normale d'utilisation, laisser le moteur tourner au ralenti 30 secondes. Arrêter le moteur, attendre au moins 30 sec. et vérifier le niveau d'huile. ATTENTION: Ne pas laisser tourner le moteur hors de l'eau sans faire circuler de l'eau par le raccord de rinçage. L'huile peut être chaude.

2119902674A

2119902674

LABEL 6

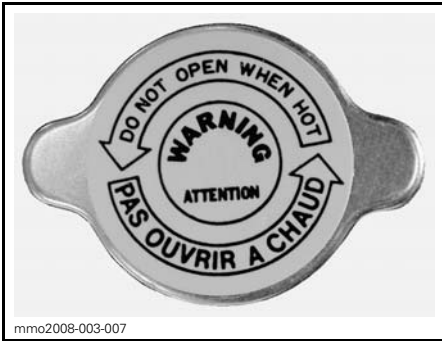

mme2008-003-007

LABEL 7

**⚠ WARNING**

Read and follow safety labels and operator's guide before operation. Severe injury or death can result from ignoring warnings or improper use of this sport boat. The performance of this sport boat may significantly exceed that of other boats you may have operated.

- Check throttle / shifter and steering operation and position before starting engine(s).
- Properly attach safety lanyard to your PFD.
- Directional control is reduced with decreasing speed and lost when engine is off.
- Do not splash others or jump waves or wakes.
- Occupants should always wear approved PFD and recommended protective clothing.
- Do not operate if passengers are not properly seated and using handgrips, or if visibility is obstructed. Do not allow passenger(s) to ride on any portion of the boat not designated in the operator's guide as a seat for use when underway.
- Keep a safe distance from all other water users.
- BRP recommends a minimum operation age of 16 years old supervised by an adult. Be aware of and observe all applicable laws and regulations.

204 902 067

204902067

LABEL 8

**⚠ WARNING**



**Carbon monoxide (CO) can cause brain damage or death.**

Engine and generator exhaust contains odorless and colorless carbon monoxide gas.

Signs of carbon monoxide poisoning include nausea, headache, dizziness, drowsiness, and lack of consciousness.

Get fresh air if anyone shows signs of carbon monoxide poisoning.

See Owner's Manual for information regarding carbon monoxide poisoning.

204901625

204901625

LABEL 9

**⚠ DANGER**



**Carbon monoxide (CO) can cause brain damage or death.**

Engine and generator exhaust contains odorless and colorless carbon monoxide gas.

Carbon monoxide will be around the back of the boat when engines or generators are running.

Move to fresh air if you feel nausea, headache, dizziness, or drowsiness.

204901626

204901626

LABEL 10

**⚠ WARNING**

**Misuse of tower may cause severe injury or death.**

- Use tower only for wakeboarding or water skiing.
- Do not allow tow rope to dangle or get entangled with occupants, boat or engine.
- Attach tow rope only at the center attachment point.
- Tow only 1 person at a time.
- Do not climb on, sit on or jump off tower.
- Never add accessories to the tower unless approved by BRP.

204 902 068

204902068

LABEL 11

**⚠ WARNING**

Gasoline vapor may cause fire or explosion, resulting in serious injury or death. Inspect fuel system for leaks and verify components integrity at each pre-ride inspection.

Before starting engine

**ALWAYS:**

- Operate the bilge blower for 5 minutes.
- Open engine cover and check for gasoline vapor odor inside the engine compartment.
- Close the engine cover before starting the engine.

**NEVER:**

- Start the engine if gasoline vapor odor is present in the engine compartment.

204 902 066

204902066

LABEL 12

**⚠ DANGER**

EXHAUST FUMES FROM ENGINES CONTAIN DEADLY CARBON MONOXIDE GAS (CO). BOATS WITH CANVAS OR POOR VENTILATION ARE MOST LIKELY TO COLLECT FUMES. CO SICKNESS SYMPTOMS INCLUDE HEADACHE, NAUSEA AND DISSINESS. DO NOT MISTAKE FOR SEASICKNESS. VENTILATE BOAT. SEE BOAT OWNER'S MANUAL FOR MORE DETAIL. TH-23

lmo2011-001-014\_a

IF EQUIPPED WITH "BIMINI TOP

**Compliance Labels**



219902679



LABEL 13 – EMISSION CONTROL

**⚠ WARNING**

**TOP SHOULD NOT BE USED WHEN VESSEL SPEED EXCEEDS 35 MPH**

lmo2011-001-015\_a

IF EQUIPPED WITH "BIMINI TOP

<b>EMISSION CONTROL INFORMATION</b> THIS ENGINE IS CERTIFIED TO OPERATE ON UNLEADED GASOLINE AND CONFORMS TO 2011 U.S. EPA & CALIFORNIA EMISSIONS/EVAP REGULATIONS FOR MARINE SI ENGINES.  <b>RENSEIGNEMENTS SER LE DISPOSITIF ANTIPOLLUTION</b> CE MOTEUR EST CERTIFIÉ POUR FONCTIONNER À L'ESSENCE SANS PLOMB ET IL RÉPOND AUX NORMES 2011 DE L'EPA DES E.-U. & RÉGLEMENTATIONS CALIFORNIENNES POUR LES MOTEURS MARINS À ALLUMAGE COMMANDE.	<b>ENGINE FAMILY</b> BBCKM1.5066S	<b>FAMILLE DE MOTEUR</b> LIMITE DES ÉMISSIONS DE LA FAMILLE	
	<b>FEL</b> 16.10 g/kW-hr HC+NOx 240 g/kW-hr CO	<b>EXHAUST EMISSION CONTROL SYSTEM</b> MFL SC CAC	
<b>SEE OPERATORS GUIDE FOR MAINTENANCE SPECIFICATIONS. VOIR MANUEL DE L'OPÉRATEUR LES SPECIFICATIONS DE MAINTENANCE.</b>  <b>BOMBARDIER RECREATIONAL PRODUCTS INC.</b>	<b>ENGINE DISPLACEMENT</b> 1493.8 cc	<b>TYPE DE BOUJIE</b> ÉCARTEMENT DES ÉLECTRODES	DATE / MO 
	<b>SPARK PLUG TYPE</b> NGK-DCPR8E	<b>POWER</b> 174 kW	
	<b>SPARK PLUG GAP</b> 0.030 in. / 0.7-0.8 mm.		
	<b>FUEL LINE</b> ATDRPLNE365-R15		

219903484

LABEL 14 – EPA COMPLIANCE

## Technical Information Labels

**UNDERWAY SEATING POSITIONS**

**MAXIMUM PERSONS**

**7**

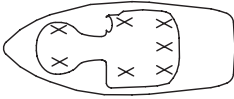

204902064

LABEL 15 – SEATING POSITION

BRP US Inc.  
 451 E. Illinois Ave, Benton, IL 62812

U.S. COAST GUARD

**MAXIMUM CAPACITIES**

**7** PERSONS OR 619 kg (1365 lbs)

619 kg (1365 lbs) = PERSONS + GEAR

THIS BOAT COMPLIES WITH U.S. COAST GUARD SAFETY STANDARDS IN EFFECT ON THE DATE OF CERTIFICATION

200 SPEEDSTER

CE 0609 BOAT DESIGN CATEGORY: C

219903408

LABEL 16 – CAPACITY



---

## PRE-RIDE INSPECTION

### **WARNING**

The pre-ride inspection is very important before operating the boat. Perform a pre-ride inspection before each ride to detect potential problems during operation. The pre-ride inspection can help you monitor wear and deterioration before they become a problem. Correct any problems that you discover to reduce the risk of a breakdown or crash. See an authorized Sea-Doo Boat dealer if necessary. Bring all safety equipment required by local laws.

For more detailed information on these items, refer to the applicable sections.

### **WARNING**

Engines should be off and the tether cord must always be removed from engine cut-off switch before verifying any of the following. Only start boat once all items have been checked and operate properly.

**Pre-Ride Check List When Boat is Trailered**

<b>SUMMARY</b>			
	<b>ITEM</b>	<b>OPERATION</b>	<b>✓</b>
<b>BOAT ON TRAILER</b>	Fuel tank	Refill.	
	Hull	Inspect for damage.	
	Jet pump water intake	Inspect/clean.	
	Bilge	Ensure drain plug is properly secured.	
	Engine compartment	Verify for leaks or gasoline vapor odor. Verify fuel system components integrity.	
	Bilge	Check for abnormal water presence in bilge.	
	Main battery cut-off switch	Ensure it is in the ON position.	
	Throttle levers	Check operation.	
	Shift lever	Check operation.	
	Steering	Check operation.	
	Bilge blower	Turn ON bilge blower for 5 minutes to ventilate bilge.	
	Towing tower (optional)	Check tightness of mounting points fasteners.	
	Bimini top (optional)	Check tightness of mounting points fasteners. Check for canvas damages.	
	Mandatory safety boating equipment	Ensure all required safety equipment is on board.	
	Storage compartment covers	Ensure they are closed and latched.	
	Navigation lights	Check operation.	
	Engines start/stop switches	Check operation for starting and stopping engines.	
Engine cut-off switch	Check if engines can be stopped by pulling off the tether cord from the engine cut-off switch.		
<b>BOAT ON WATER (Engine started)</b>	Throttle lever	Check operation.	
	Shift lever	Check operation.	
	Steering	Check operation.	

## Pre-Ride Check List When Boat is Docked

SUMMARY			
DOCKED BOAT	ITEM	OPERATION	✓
	Fuel tank	Refill.	
	Bilge	Check for abnormal water presence in bilge.	
	Engine compartment	Verify for leaks or gasoline vapor odor. Verify fuel system components integrity.	
	Main battery cut-off switch	Ensure it is in the ON position.	
	Throttle levers	Check operation.	
	Shift lever	Check operation.	
	Steering	Check operation.	
	Bilge blower	Turn ON bilge blower for 5 minutes to ventilate bilge.	
	Towing tower (optional)	Check tightness of mounting points fasteners.	
	Bimini top (optional)	Check tightness of mounting points fasteners. Check for canvas damages.	
	Mandatory safety boating equipment	Ensure all required safety equipment is on board.	
	Storage compartment covers	Ensure they are closed and latched.	
	Navigation lights	Check operation.	
	Engines start/stop switches	Check operation for starting and stopping engine.	
Engine cut-off switch	Check if engine can be stopped by pulling off the tether cord from the engine cut-off switch.		

## Fuel

Fill the fuel tank.

### **⚠ WARNING**

Strictly adhere to instructions in the *FUELING PROCEDURE*.

## Hull

Walk around your boat inspecting the hull for cracks or other damages.

## Jet Pump Water Intakes

Remove weeds, shells, debris or anything else that could restrict the flow of water and damage the cooling systems or propulsion units. Clean as necessary. If any obstruction cannot be removed, refer to an authorized Sea-Doo Boats dealer for servicing.

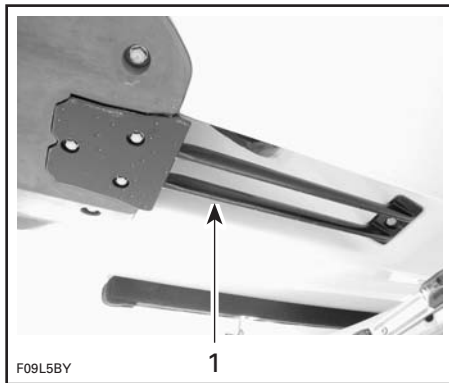

*TYPICAL*  
1. Inspect this area

Inspect leading edges of the impellers, for nicks or bends, which greatly reduce performance of the boat.

## Bilge

### **⚠ WARNING**

Check for abnormal water presence in bilge. Make sure drain plug is properly secured before launching the boat in water.

## Engine Compartment

Ensure that the engine compartment is free of gasoline vapor odors and visually, inspect fuel lines for deterioration and the condition of the fuel tank straps and their fasteners.

### **⚠ WARNING**

If any leaks or gasoline vapor odors are present, **DO NOT** start engine or use electrical accessories. Consult an authorized Sea-Doo Boats dealer.

## Main Battery Cut-Off Switch

Turn switch in the ON position to allow starting engine and use accessories.

## Throttle/Shifter System

### Throttle Levers

Check throttle levers for free and smooth operation.

### **⚠ WARNING**

Check operation of throttle levers before starting the engines.

### Shift Lever

Check that reverse gates moves freely. With shift lever in forward position, the gates must be in upward position and locked. With the shift lever in neutral position, gates must be in middle position. With shift lever in reverse position, gates must be in downward position.

### **⚠ WARNING**

Verify the reverse gates lock.

To verify the reverse gates lock, move shift lever to the FORWARD position.

Pull backwards on the starboard reverse gate.

The reverse gates lock is working if the reverse gates stays in the up position.

**NOTICE** If the reverse gates does not stay in the up position when the shift lever is at FORWARD, do not operate the boat further, see an authorized Sea-Doo Boats dealer.

## Steering System

Check steering for free and smooth operation. Have another person help check the jet pump nozzle pivots accordingly.

### **⚠ WARNING**

Check operation of steering and corresponding steering nozzles before starting engines.

## Bilge Blower

Turn ON the bilge blower and make sure it is operational. Leave it on for 5 minutes to ventilate the bilge from potential gasoline vapor hazard.

## Towing Tower (optional)

Check that all retaining bolts are in place and tight.



1. Front attachment bolts
2. Rear mounting bolt (knobs)

## Bimini Top (Optional)

Check bimini top, if so equipped. Check for tightness of mounting points fasteners and the integrity of the structure. Check for canvas damages.

## Mandatory Safety Boating Equipment

Make sure to have on board all safety equipment required by the local regulations (fire extinguisher, PFDs, visual distress signal devices, etc.) and they are in good condition. Check with a local competent authority for the required equipment.

Periodically check the straps buckles and fasteners of your personal flotation device to make sure that there are no rips or tears and that the buckles are functioning properly.

## Storage Compartment Covers

Ensure they are closed and latched.

## Navigation Lights

Ensure all navigation lights are operational and replace any defective light before using the boat.

## Engine START/STOP Switches

Ensure switches operate properly. Start and stop each engine using each switch individually.

### **⚠ WARNING**

If engines do not shut-off when pushing engine START/STOP switches, do not operate the boat further, see an authorized Sea-Doo Boats dealer.

## Engine Cut-off Switch

Verify when pulling off the tether cord from the engine cut-off switch that engines can be stopped.

### **⚠ WARNING**

Do not use boat if engines can not be stopped by pulling off the tether cord.

***This page is  
intentionally blank***

# ***BOAT INFORMATION***

# CONTROLS

**NOTE:** Some controls, instruments or equipment do not apply or are optional on some models. In these cases their reference numbers are deliberately missing in the illustrations.

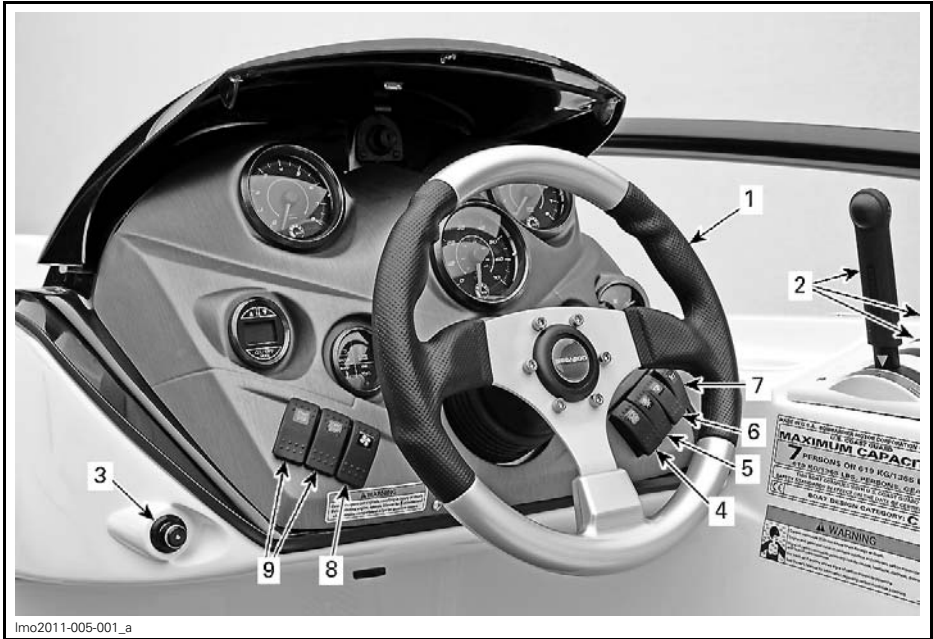

lmo2011-005-001\_a  
COCKPIT VIEW

## 1) Steering Wheel

The steering wheel controls the direction of the boat. Turning the steering wheel clockwise steers the boat to the right and inversely.

## 2) Throttle/Shift Control

### Shift Lever

A 3-position lever:

- Forward
- Neutral
- Reverse.

In order to shift:

- Throttle levers must be fully pulled back (idle speed)
- Neutral lock detent button must be pressed (when in neutral).

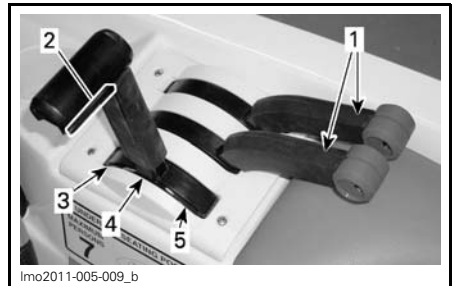

lmo2011-005-009\_b

### TYPICAL

1. Throttle levers must be fully pulled back to shift (idle speed)
2. Push neutral lock detent button
3. Forward
4. Neutral
5. Reverse

**NOTICE** Do not force lever, insure throttle levers are in idle position before shifting and the neutral lock button is pressed (i.e. disengaged).



**⚠ WARNING**

Shift lever should only be used when the engine is idling and boat is completely stopped.

**⚠ WARNING**

Only use reverse at slow speed and for the shortest time possible. Always ensure the path behind is clear of objects and persons including children playing in shallow water.

**NOTICE** Never rev the engine at high RPM in reverse.

**Throttle Lever(s)**

When pushed forward, the boat accelerates. When fully pulled back, engines return to idle speed and the boat is gradually stopped by water drag.

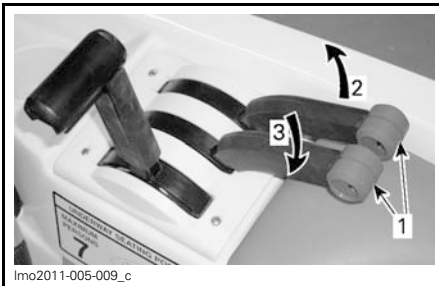

lmo2011-005-009\_c

**TYPICAL**

1. Port and starboard engine levers in idle speed position
2. To increase speed
3. To decrease speed

The port throttle lever controls the RPM of the port engine and the starboard lever controls the RPM of the starboard engine. Although each engine RPM can be controlled individually, we recommend moving both levers at the same time.

**3) Engine cut-off switch****⚠ WARNING**

Keep engine cut-off switch free from obstructions that could interfere with its operation. The proper use of the tether cord can prevent a runaway boat situation. Remove the tether cord when stopped to help prevent accidental starting.

The tether cord should be securely snapped onto the engine cut-off switch to allow engine starting.

Two short beeps should sound indicating the system is ready to allow engines starting. Otherwise, refer to the *MONITORING SYSTEM* section.

Pulling the key from the engine cut-off switch stops engines.

**⚠ WARNING**

Should the tether cord become loose or fail to remain on engine cut-off switch, replace it immediately.

Always attach the tether cord to the operator using its Personal Flotation Device or a wrist strap and snap the key to the engine cut-off switch to be able to start each engine.

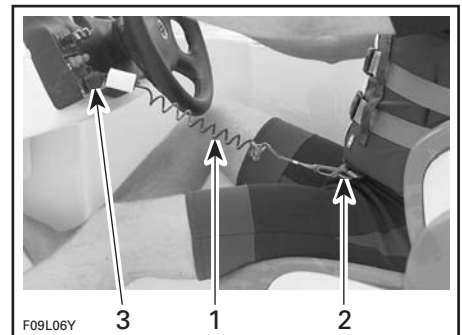

F09L06Y

**TYPICAL**

1. Tether cord
2. Secure tether cord clip to PFD
3. Snap key to engine cut-off switch

**⚠ WARNING**

Directional control is reduced when throttle is decreased and lost when engine is off. Always remove tether cord when boat is not in operation.

**⚠ WARNING**

Do not lubricate the engine cut-off switch.

**⚠ WARNING**

While the engines can be stopped using the START/STOP buttons, good driving habits recommend that the tether cord also be disconnected when stopped.

**Additional Information on the Digitally Encoded Security System (D.E.S.S.)**

The tether cord cap contains an electronic circuit (D.E.S.S.) key that gives it a unique electronic serial number.

To have additional D.E.S.S. keys programmed for your boat, refer to an authorized Sea-Doo Boats dealer.

If the engines are stopped with the START/STOP buttons while the tether cord cap remains on the engine cut-off switch, they can be restarted anytime by only pressing the START/STOP buttons during a period of approximately 10 minutes while the system remains under power. After this delay, it is necessary to remove and reinstall the tether cord cap on the engine cut-off switch to restart engines.

**4) Deck Lights Switch**

This is a 2-position OFF/ON switch.

This switch is located on driver's console at the right of steering wheel.



1. Deck light switch

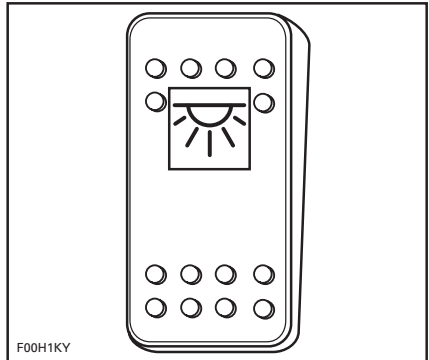

**DECK LIGHTS SWITCH**

Press switch to ON position to turn on the deck lights.

Press switch to OFF position to turn off the deck lights.

**NOTICE** Using the deck lights for a prolonged time when the engine is not running will discharge the battery.

**5) Navigation Lights Switch**

This is a 3-position NAV/OFF/ANC switch.

This switch is located on driver's console at the right of steering wheel.



1. Navigation lights switch



1. Bilge pump switch

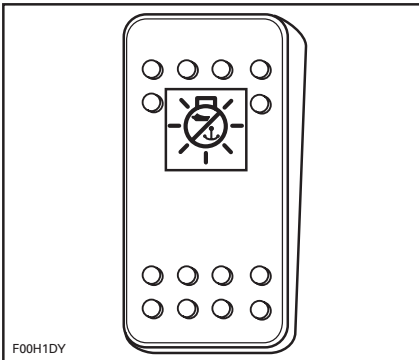

NAVIGATION LIGHTS SWITCH

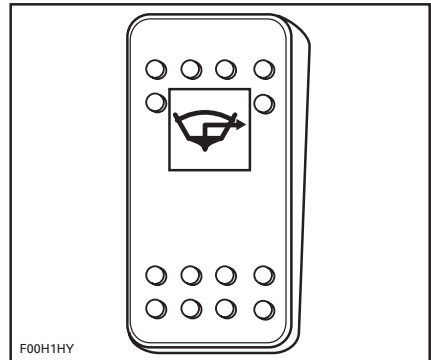

BILGE PUMP SWITCH

**ANC:** Turns on the anchorage light when the boat is anchored. Only the stern light is lit.

**OFF:** Turns off all lights.

**NAV:** Turns on both bow and stern lights and illuminates the gauges.

## 6) Bilge Pump Switch

This is a 2-position OFF/ON switch.

This switch is located on driver's console at the right of steering wheel.

Turn to ON position when a manual operation of the bilge pump is required (after cleaning, storage, etc.).

Turn switch to OFF when finished.

**NOTICE** Do not operate for a prolonged time if the bilge is dry: battery drainage will occur and pump will be damaged.

The bilge pump may be operated without the tether cord installed on the engine cut-off switch.

**NOTICE** Always turn pump OFF after water is evacuated or before operating the engines above idle. Bilge pump will then switch to automatic mode.

## Bilge Pump Automatic Mode

The bilge pump will automatically evacuate water from the bilge. A water sensor detects the water, activating the pump. After the water is pumped out, the pump shuts-off automatically.

**NOTE:** The automatic mode can not be deactivated, even if the main battery cut-off switch is turned OFF.

**NOTICE** Prolonged operation of the bilge pump when the boat is moored will lead to battery discharge and the bilge pump will quit working.

## 7) Horn Switch

This is a 2-position push type switch.

This switch is located on driver's console at the right of steering wheel.



1. Horn switch

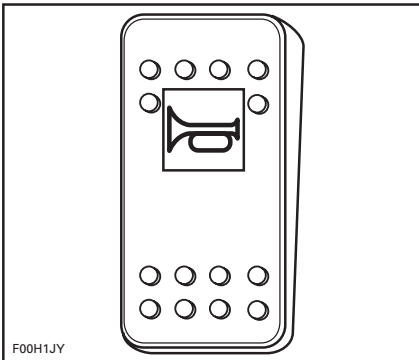

HORN SWITCH

Press and hold the switch to activate the horn.

Release the switch to stop horn.

## 8) Bilge Blower Switch

This is a 2-position OFF/ON switch.

This switch is located on driver's console at the left of steering wheel.

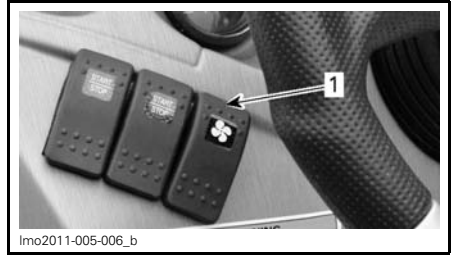

1. Bilge blower switch

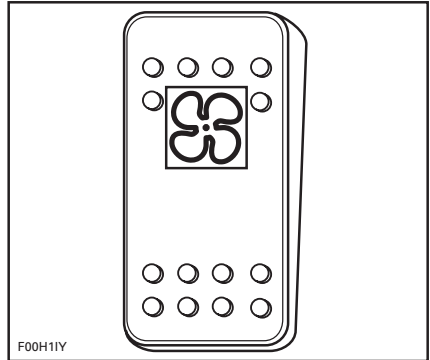

BILGE BLOWER SWITCH

When turned on, the blower ventilates the engine compartment.

**⚠ WARNING**

Gasoline vapors can explode, resulting in injury or death. Always use blower for a minimum of 5 minutes before starting engine and turn it OFF above idle speed. Use of the bilge blower should never replace "smelling" for gasoline vapor odors.

**⚠ WARNING**

If any leaks or gasoline vapor odors are present, do not start the engine. Consult an authorized Sea-Doo Boats dealer.

**NOTE:** Using the bilge blower for a prolonged time when the engines are not running will discharge the battery.

Blower should be turned off during boat operation.

## 9) Start/Stop Switches

Dual function START/STOP switches. Used to start as well as to stop engines.

These switches are located on driver's console at the left of steering wheel.

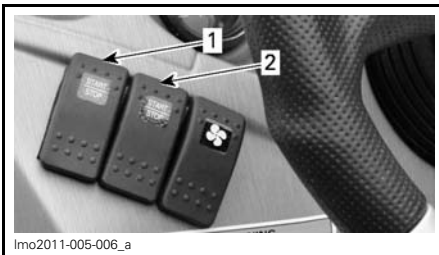
**TYPICAL**

1. For port engine
2. For starboard engine

## Engines Starting and Stopping

Refer to *OPERATING INSTRUCTIONS* for complete procedure to start and stop the engine.

# GAUGES

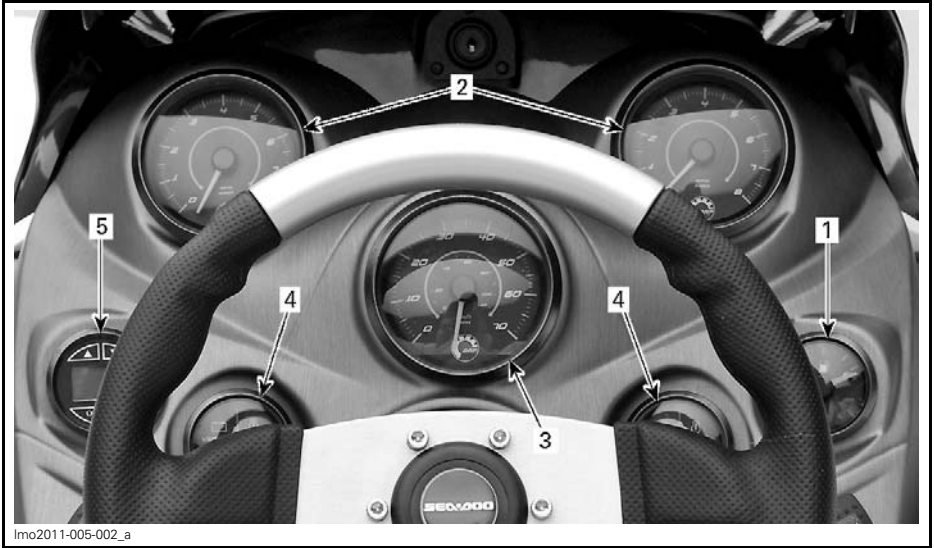

## 1) Fuel Gauge

Located in dashboard, this gauge continuously indicates the amount of fuel left in fuel tank when engines are running.



*TYPICAL - FUEL GAUGE*

The gauge is illuminated whenever the navigation lights are used.

The fuel level can also be verified without having engines running. With the tether cord removed from the engine cut-off switch, push either START/STOP switch; the gauge will be activated for approximately 30 seconds.

## 2) Tachometers

The tachometers indicate the revolutions per minute (RPM) of the engines. Multiply reading by 1000 to obtain actual RPM.



*TYPICAL - TACHOMETER*

The gauges are illuminated whenever the navigation lights are used.

## 3) Speedometer

The speedometer indicates the speed of the boat in miles per hour (MPH) and kilometers per hour (km/h).



lmo2009-003-012

TYPICAL - SPEEDOMETER

The gauge is illuminated whenever the navigation lights are used.

## 4) Monitoring Gauges

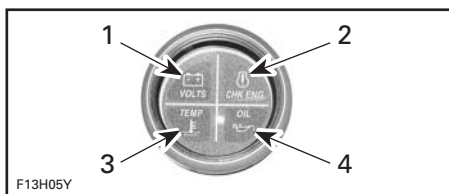

### TYPICAL

1. Battery
2. Engine
3. Temperature
4. Oil

### Low Battery Warning Light

Before the battery becomes too discharged to start the engines, the volts indicator light will come on.

When the indicator light is on, you should discontinue all use of electrical accessories immediately and start the engine(s) in order to recharge the battery.

### Check Engine Light

When the ECM detects a fault code, the check engine light will come on and a beep may sound.

Turn engine(s) off. Wait one (1) minute. Restart engine(s). If light(s) remains lit, take boat to nearest authorized Sea-Doo Boats dealer for servicing.

### Engine Temperature Light

**NOTICE** If the temperature indicator light comes on, stop engine(s) as soon as possible.

Turn off engine as soon as possible. Check engine oil level(s) and refill.

**NOTICE** Running engine(s) with low oil pressure may severely damage the engine(s).

Check engine coolant levels. Refer to *ENGINE COOLANT* in *MAINTENANCE PROCEDURES*. If engine(s) still overheats, continue the following procedure.

Perform *JET PUMP WATER INTAKE AND IMPELLER CLEANING* procedure described in *SPECIAL PROCEDURES*.

When back to shore, flush exhaust cooling system. Refer to *PRE-RIDE INSPECTION*.

Restart the engine(s). If this does not correct the situation, do not run the engine(s) further. Refer to an authorized Sea-Doo Boats dealer for servicing.

### Oil Pressure Light

The oil light turns on when the engine oil pressure is low or high in the engine(s). Check engine oil as soon as possible. If lamp remains ON contact an authorized Sea-Doo Boats dealer.

**NOTICE** Never run engines out of engine oil. Serious engine damage will occur.

## 5) Depth Finder

A depth finder is included as standard equipment and is located on the dashboard.

It displays the water depth under the hull within 0 m to 50 m (0 ft to 170 ft).



lmo2011-002-002

**NOTE:** Under certain water conditions, the gauge may stop displaying. The gauge ability to display the depth depends on the usage conditions.

**⚠ WARNING**

Never use the depth finder as a warning device to ride in shallow water.

Please refer to included *MANUFACTURER'S INSTRUCTION SHEET* for depth finder operation.



# EQUIPMENT

NOTE: Some equipments do not apply or could be optional. In these cases their reference numbers are deliberately missing in the illustrations.

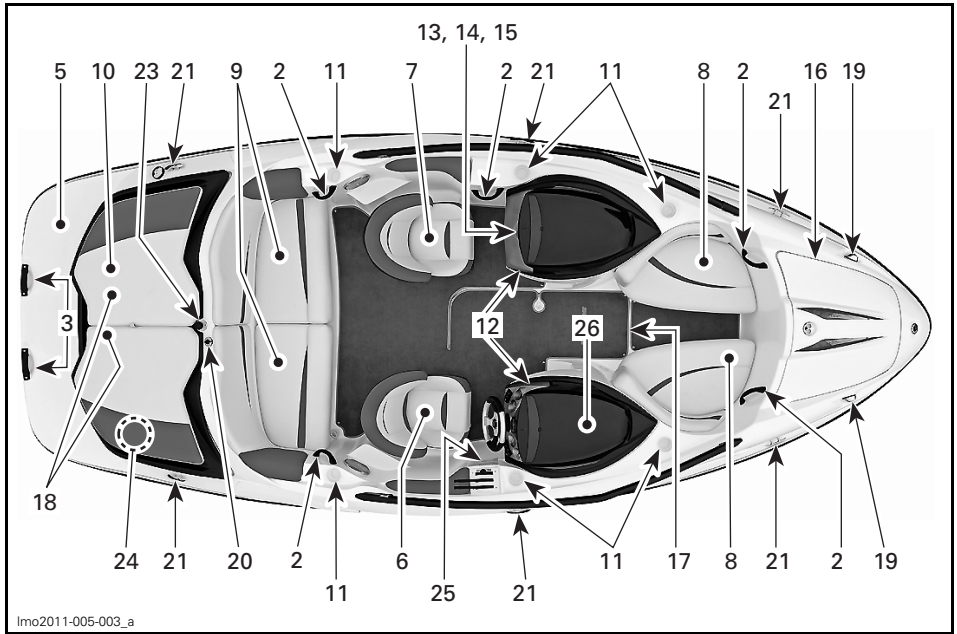

TYPICAL

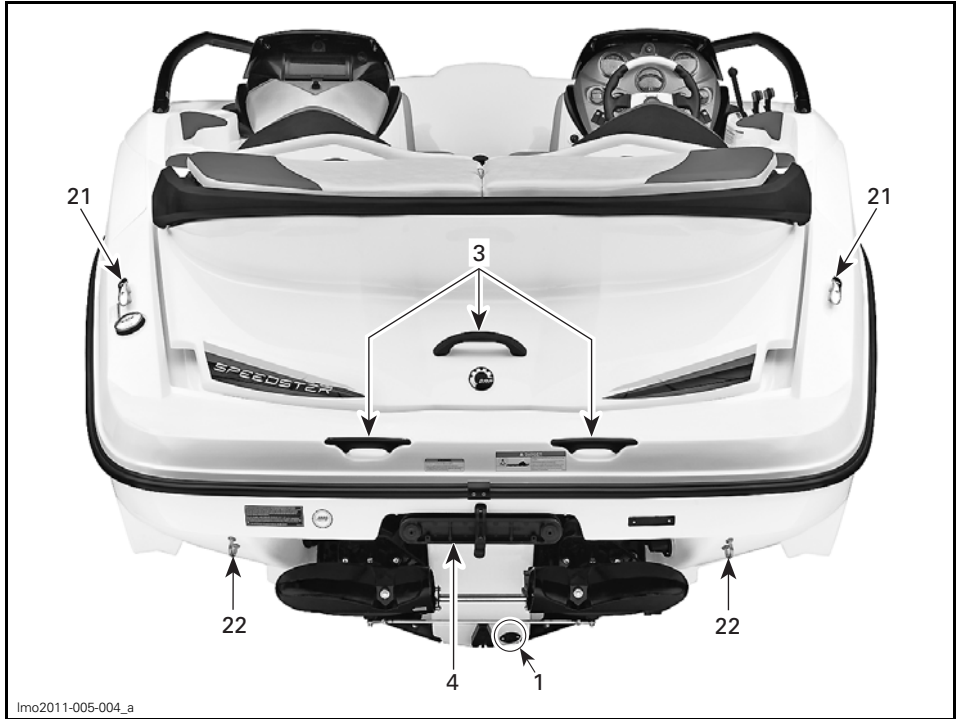

lmo2011-005-004\_a

TYPICAL — REAR VIEW

## 1) Bilge Drain Plug

Once boat is on trailer, unscrew the drain plug, block the wheels and raise the bow slightly with the trailer jack (if so equipped) to allow water to drain.

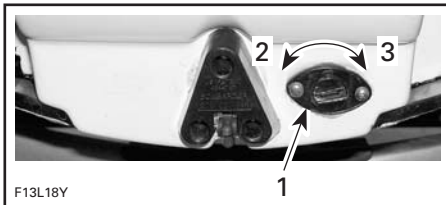

F13L18Y

TYPICAL

1. Drain plug
2. Loosen
3. Tighten

## 2) Grab Handles

Grab handles provide a handhold for the passengers.

Although grab handles are provided, never perform maneuvers that place a passenger or the driver at risk for being ejected or thrown out of their seat.

**NOTICE** Never use the grab handles to pull anything or to lift the boat.

Refer to components location illustrations at the beginning of this section for grab handle locations.

## 3) Rear Grab Handles

Provide a handhold for boarding when needed.

**NOTICE** Never use the grab handle to tow anything or to lift the boat.

## 4) Ladder

### **⚠ WARNING**

Engines should be OFF when using ladder. Keep limbs away from jets or intake grates. Only one person at a time on the ladder. Never use the ladder for pulling, towing, diving or jumping, boarding a boat that is out of the water or any other purpose other than a ladder.

Located under the swim platform, the ladder conveniently helps in reboarding the boat.

Pull latch to release the ladder.

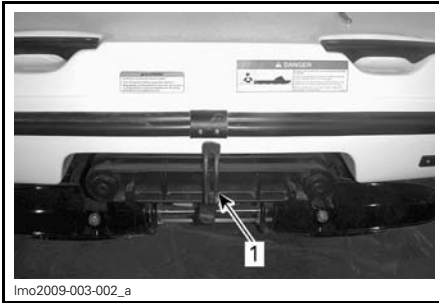

lmo2009-003-002\_a

TYPICAL  
1. Latch

Slide ladder toward rear, then push down.



lmo2009-003-003

TYPICAL — LADDER LOWERED

To store ladder, lift horizontally, slide toward front and secure latch.

**NOTICE** In order to avoid damage to the ladder, they should not be used when the boat is out of the water.

## 5) Swim Platform

Provides an anti-skid surface for easy boarding from the rear of boat.

### **⚠ WARNING**

Engines must be off when using swim platform. Keep away from jets or intake grates.

## 6) Driver's Seat

Each occupant should be seated while underway.

### **⚠ WARNING**

Allow no one to sit on edge of the boat or to stand up while in operation. Seat and grab handles should be used in rough waters.

### Swivel Adjustment

The seat can swivel.

Pull and hold lever to swivel seat.

Release lever after adjustment is completed.



lmo2008-003-004\_a

TYPICAL — PULL AND HOLD LEVER  
1. Lever



TYPICAL — SWIVEL SEAT

## **⚠ WARNING**

Always ensure driver's seat swivel is locked so that seat faces steering wheel before riding.

### Forward and Backward Adjustment

Driver's seat is adjustable forward and backward.

Push and hold lever down to unlock seat.

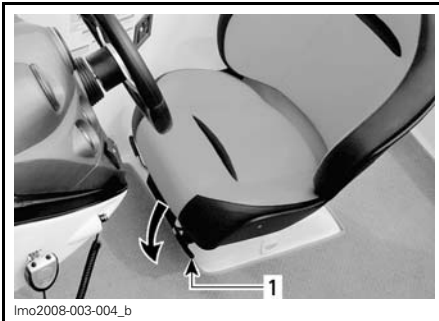

TYPICAL — PUSH AND HOLD LEVER  
1. Lever

Move seat at the desired position.

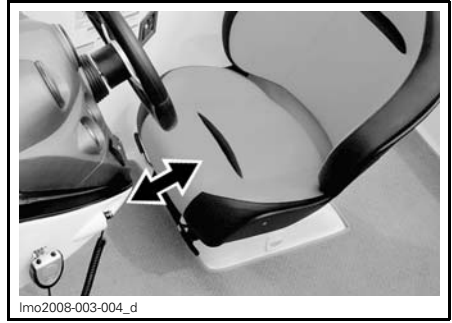

TYPICAL — ADJUST SEAT

Release lever after adjustment is completed.

## 7) Passenger/Spotter Seat

Located on starboard side, beside driver's seat, this seat is provided to be used by the observer when towing a skier, a tube or a wakeboarder. Rotate seat to rear facing position for use.

## **⚠ WARNING**

Always have an observer while towing a skier, a tube or a wakeboarder, proceed with only as much speed as required, and follow observer's instructions.

To adjust this seat, use the driver's seat procedure.

## 8) Bow Seats

## **⚠ WARNING**

No one should use the boarding step as a seat except when the boat is stopped.

## **⚠ WARNING**

Avoid serious or fatal injury. No passenger should be seated on the most forward seat in the bow area if it faces backwards when speed exceeds 8 km/h (5 MPH).

## Bow Seat Storage Compartment

Separate storage compartments are located under port and starboard cushions.

The fire extinguisher (sold separately) should not be loose in the storage compartment. It's storage position is indicated by the fire extinguisher label located at one of the storage compartments.

Release snaps, lift cushion up and away from position.

To reinstall seat, position L-bracket first, push seat down and fasten snaps.



TYPICAL

1. L-bracket

## 9) Rear Seats

Each passenger should be seated while underway.

### **⚠ WARNING**

Allow no one to sit on edge of the boat or to stand up while in operation. Seat and grab handles should be used in rough waters.

## Storage Compartment

### **⚠ WARNING**

Never leave any heavy or breakable objects in storage compartments. Never operate the boat with storage compartment covers opened.

Separate storage compartments are located under port and starboard cushions.

Release snaps, lift cushion up and away from position.

To reinstall seat, position L-bracket first, push seat down and fasten snaps.



TYPICAL

1. L-bracket

## 10) Sun Deck

A convenient space to rest or sunbathe while anchored.

### **⚠ WARNING**

Do not start or operate the boat if a person is seated on the sun deck.



lmo2008-003-005\_a  
TYPICAL  
1. Sun deck

## 11) Cup Holders

Convenient locations for non-alcoholic beverages.

### **⚠ WARNING**

Do not drink alcoholic beverages while aboard. Do not keep bottles, cans etc. in cup holders while riding at speed and/or on rough water.

## 12) Port/Starboard Console Storage Compartments

Convenient watertight, lockable storage compartments, the starboard side is equipped with a removable basket for an onboard cooler.

### **⚠ WARNING**

Never leave any heavy or loose breakable objects in the storage basket. Never operate the boat with the storage compartment cover open.

Push the latch button inward to unlock storage compartment cover. Lift cover until stopped by the retaining device. The cover will hold in this position on calm water.



lmo2008-003-017\_a  
1. Push button

The Operator's Guide should be kept in a waterproof bag and remain with the boat at all times.

**NOTICE** Do not remove the basket to use as additional storage area. Components can become entangled and cause serious operational hazards.

Push cover down to release mechanism then move down slowly. When bottomed on latch, firmly push cover to lock.

**NOTICE** Never leave any heavy or loose breakable objects in the storage basket. Never operate the boat with the storage compartment cover open.

## 13) Glove Box

Convenient lockable storage location for carrying small personal articles.

**NOTE:** Always relatch glove box before operating boat.

**NOTICE** Never operate the boat with the glove box cover open.



1. Glove box latch

## 14) AM/FM Radio/CD Player

Refer to manufacturer's guide for complete explanation of features and controls.

**NOTICE** Using the radio or the CD player for a prolonged time without engines running may discharge the battery.

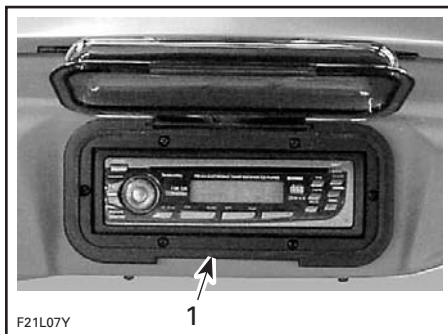

TYPICAL  
1. Radio/CD player

## 15) 12-Volt Power Outlet

A 12-volt power outlet is provided to power temporary accessories such as a cellular phone or other 12-volt portable devices.



1. 12-volt power outlet

**NOTICE** Close protective cap when the 12-volt power outlet is not in use to protect against weather.

**NOTICE** Using 12-volt portable devices for a prolonged time without engine running may discharge the battery.

## 16) Bow Storage Compartment



TYPICAL — BOW STORAGE COMPARTMENT

**NOTICE** Never leave breakable objects in the bow storage compartment. Never operate the boat with the bow storage compartment cover open.

A large, convenient storage compartment for PFD's, towels, etc.

To open, lift T-handle and turn in either direction and lift. To close, lower cover and turn handle so it will lay flush in its recess.

**NOTE:** Always relatch compartment lid.

## 17) Deck Storage Compartment

The deck storage compartment is a convenient lockable location for water skis, paddles, anchor and rope, etc.

Use the provided key to unlock the compartment if needed.

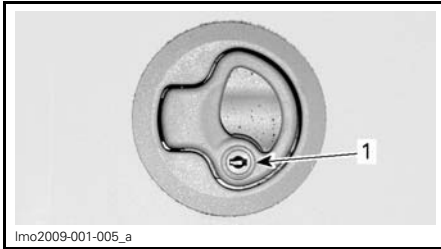

lmo2009-001-005\_a

1. Lock

**NOTICE** Never leave any heavy or loose breakable objects in the deck storage compartment. Never operate the boat with the deck storage compartment cover open.

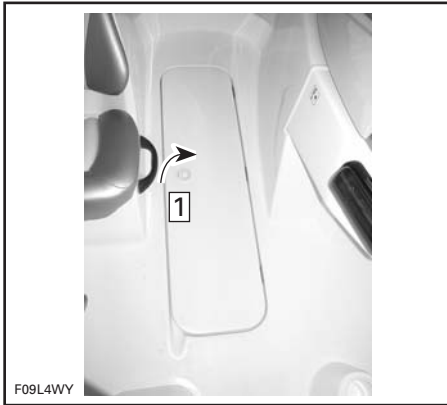

F09L4WY

**TYPICAL**

Step 1: Pull latch and lift cover

Lift the latch ring and open cover gently until gas assist cylinder is fully extended.

When completely opened, the cover remains in that position on calm water.

To close, gently lower the cover.

Lock if desired.

## 18) Rear Storage Compartment (engine cover)

Convenient rear storage location for carrying large personal articles. Ideal location for spare Personal Flotation Device (PFD), towels, lunch etc.

The rear storage compartment release handle is located in the passenger console storage compartment. Pull the release handle upward and open engine cover gently until stopped.

The gas assist cylinder will complete the opening and hold cover open.

**NOTICE** Never leave any heavy or breakable objects in the storage compartment. Never operate the boat with the rear storage compartment cover open.

### **⚠ WARNING**

When engine cover is lifted, never touch any electrical part when starting engine or while in operation. Never leave any object, rag or tool in the engine compartment or in the bilge.

**NOTICE** Always ensure rear storage compartment lid is closed and securely fastened before trailering.

Additional access to the rear storage compartment is available by pulling the loop located between the sun deck cushions.



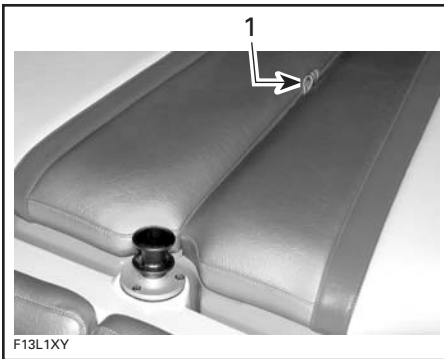

1. Pull this loop

This will open the starboard-side lid. The port side may then be opened.



TYPICAL — REAR STORAGE COMPARTMENT

A manual lock is provided to secure the rear storage compartment. Ensure sundeck cushions are properly closed and open rear storage compartment lid by lifting release handle in passenger console storage compartment.

Slide bolt into latch to secure.

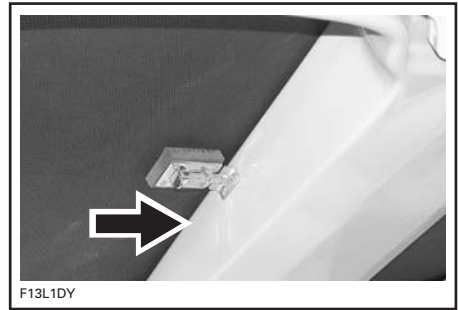

SLIDE THIS DIRECTION TO SECURE

### Storage Tray

**NOTICE** In order to avoid damage, **MAXIMUM LOAD** on storage tray must not exceed 22.5 kg (50 lb).

The storage tray is removable, allowing access to the engine compartment. Grab the handle and lift in a rearward movement until opposite holders release.

### **⚠️ WARNING**

When storage tray is lifted or removed, never touch any electrical part when starting engines or while in operation. Never leave any object, rag, tool, etc., in the engine compartment or in the bilge.

When reinstalling storage tray, properly locate it just below holders, gently lower tray then push it downward to lock.

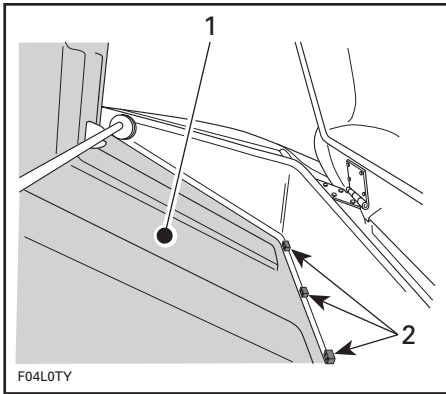

**TYPICAL**

1. Rear storage compartment tray
2. Tray under holders

Firmly close storage compartment cover to relatch.

## 19) Bow Lights

Mandatory red and green lights. See *NAVIGATION LIGHTS SWITCH* as mentioned earlier in this section.

## 20) Stern Light Socket

The stern light socket is provided for the mandatory white stern light.

The stern light is snapped on the storage tray.

**NOTE:** It is recommended to keep it in its storage compartment at all times except when needed.

**NOTICE** Using the stern light for a prolonged time when the engine is not running will discharge the battery.

### Stern Light Installation

1. To remove from storage cover, pull it out. Snap in place to store again.



**TYPICAL — STERN LIGHT IN STORAGE CLIPS**

2. Release stern light storage lock as shown.

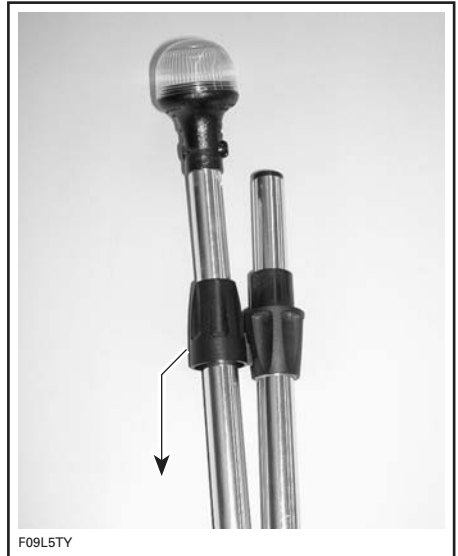

**SLIDE THIS DIRECTION**

3. Thread onto folding joint as shown below.

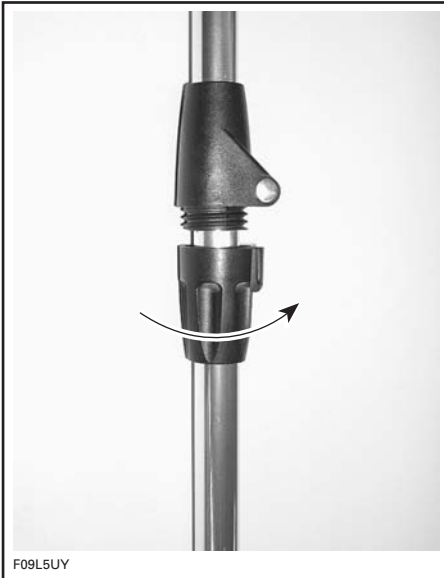

4. Lift connector cap.

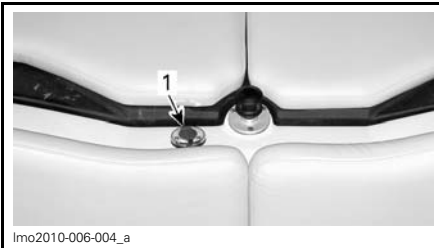

1. Connector cap

5. Insert post in connector hole. Ensure to align hole keyway with post screw head.

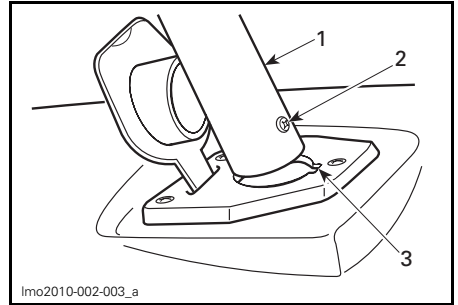

1. Stern light post  
2. Post screw head  
3. Hole keyway

6. Firmly push downward to engage terminals.  
7. Push lock ring downward. Turn until locked. It may be necessary to slightly turn it to allow its insertion in the hole.

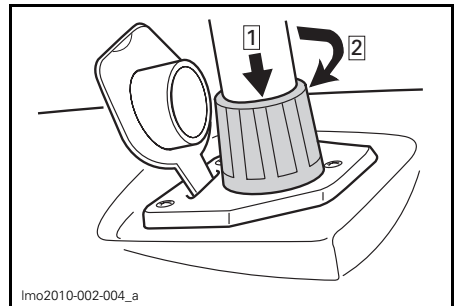

- Step 1: Push lock ring  
Step 2: Turn lock ring to lock it

8. Check light operation. See *NAVIGATION LIGHT SWITCH* as mentioned earlier in this section.

**NOTICE** Ensure DIELECTRIC GREASE (P/N 293 550 004) is present in connector area of light to prevent corrosion.

Removal and storage of light is the reverse of installation.

## 21) Mooring Cleats

When mooring to a dock, it is recommended to secure with both front and rear cleats. The use of dock lines with sealed air fenders is recommended to protect your boat.

**NOTICE** Never use mooring cleats to pull anything or to lift the boat.

## 22) Bow and Stern Eyelets

### Bow Eyelet

Eyelets can be used for mooring, towing and as a tie-down point during transportation.



1. Bow eyelet

### Stern Eyelets

Eyelets can be used for mooring, towing and as a tie-down point during transportation.



TYPICAL  
1. Stern eyelet

## 23) Water Sport Towing Attachments

Please read and often refer to *WATER SPORTS* information in the *SAFETY INFORMATION* section at the front of this guide.

### ⚠ WARNING

“Teak Surfing” is extremely dangerous to participants due to their proximity to the rear of the boat where direct contact with the exhaust fumes from the boat engine is the highest. Carbon monoxide poisoning can occur and result in mental disorientation, dizziness, drowsiness, and loss of consciousness. The combination of carbon monoxide exposure and non-use of a life jacket (PDF) make this new water recreation activity an incredibly dangerous and potentially deadly sport.

### ⚠ WARNING

When pulling a tube, skier or wakeboarder, always have an observer, proceed with only as much speed as required, and follow the observer's instructions.

### ⚠ WARNING

Pulling a tube, skier or wakeboarder makes the boat handle differently and requires greater skill. Unless absolutely necessary, do not make tight, sharp turns. Keep a safe distance from the docks, swimmers, other craft or objects. Be advised that serious injury can result if the tow rope becomes slack during a tight turn or when circling. The rope could become wrapped around the neck or limbs of a person.

## Ski Post

This boat comes equipped with a ski post. Use this post to pull a tube, water skier or wakeboarder.

Pull up the post to allow hooking a ski rope or other towables.

### **⚠ WARNING**

Always have observer watch skier. Ensure ski post is fully extended and locked before use. Completely retract when not used.

**NOTICE** Never use the ski post to tow any other craft.



1. Lift ski post to use

Push down when finished.

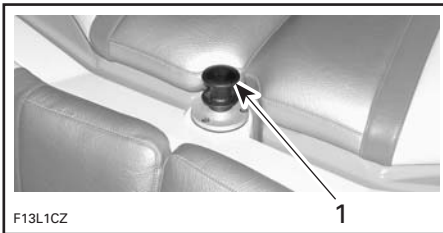

1. Ski post position when not in use

## Towing Tower

### **⚠ WARNING**

Pulling a tube, skier or wakeboarder makes the boat handle differently and requires greater skill. Unless absolutely necessary, do not make tight, sharp turns. Keep a safe distance from docks, swimmers, other craft or objects. Be advised that serious injury can result if the tow rope becomes slack during a tight turn or when circling. The rope could become wrapped around the neck or limbs of a person.

The towing tower is for skiing/wakeboarding.

**NOTICE** Towing tower **MUST** be fastened in the upright position to avoid damage to the boat and towing vehicle while in transport or water operation.

## 24) Main Battery Cut-Off Switch

This switch allows a complete power cut-out of the electrical system.

This switch is located on the vertical wall of the starboard side of the rear bench seat, behind the passenger's legs.

When in OFF position, ALL electrical equipment and electronics will be OFF **except** bilge pump. The bilge pump will operate automatically with the battery switch on the OFF position.

Switch must be in the ON position to allow the use of other accessories and to start the engines.

**NOTICE** Stop engines before switching to the OFF position.

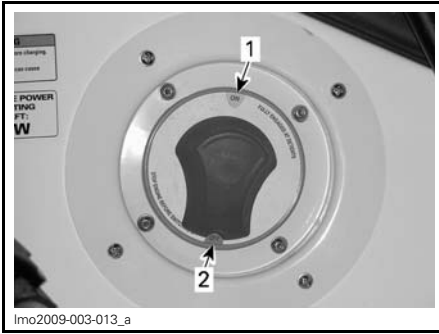

### MAIN BATTERY CUT-OFF SWITCH

1. ON position
2. OFF position

It is recommended to set this switch to the OFF position whenever performing maintenance in the engine compartment, on the electrical system, for transportation or during short term storage.

**NOTICE** When the main battery cut-off switch is turned OFF while boat is moored, the automatic bilge pump will start if water comes up in the bilge.

## 25) Radio/CD Player Remote Control

A remote control for the radio/CD player is included as standard equipment and is located on the dashboard.



TYPICAL — RADIO REMOTE CONTROL

Please refer to included *MANUFACTURER'S INSTRUCTION SHEET* for remote control operation.

## 26) Built-In Ice Chest

Convenient location that could be used as a cooler to keep non-alcoholic beverages cold.



BUILT-IN ICE CHEST

---

# BREAK-IN PERIOD

## Operating During Break-In

**NOTICE** Carefully follow the instructions of this section. Failure to do so may reduce the engine's life and/or performance.

A break-in period of 10 hours is required before continuous operation at full throttle.

To achieve a good break-in, throttle lever should not be advanced more than 3/4 opening, however, brief acceleration and speed variations contribute to a good break-in.

**NOTICE** Continued wide open throttle runs and prolonged cruising without speed variations should be avoided. This can cause engine damage during the break-in period.

# OPERATING INSTRUCTIONS

## **⚠ WARNING**

Always perform *PRE-RIDE INSPECTION* before operating the boat. Become thoroughly familiar with all controls and the function of each. Should any control or instruction be not fully understood, refer to an authorized Sea-Doo Boats dealer.

## Launching/Loading

**NOTICE** Before launching the boat, ensure the main battery cut-off switch is turned ON and the bilge plug is fully screwed into place.

When finished loading the boat on trailer, turn the main battery cut-off switch to OFF.

Remove bilge plug to drain bilge when boat is on trailer.

## Boarding the Boat

As with any boat, boarding should be done carefully and engine must not be running.

## **⚠ WARNING**

Engines must be OFF when boarding the boat or when using the swim platform.

**NOTICE** Never use propulsion system as a supporting point to board the boat.

## Boarding from a Dock

When boarding from a dock, use the swim platform to climb aboard.



TYPICAL

**NOTICE** Although the boat requires only 30 cm (1 ft) of water to float, the engines should be started with at least 90 cm (3 ft) of water below the hull. If the depth of the water is less than 90 cm (3 ft) and the engine is running, the impeller is turning and debris can be drawn from the bottom and damage the propulsion system.

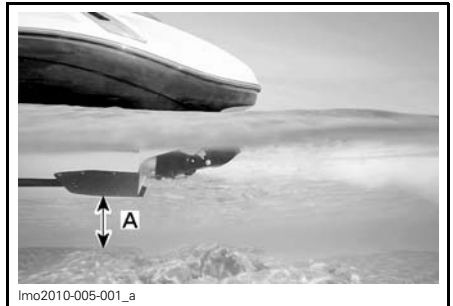

TYPICAL

A. 90 cm (3 ft)

## Boarding from Shallow Water

In shallow water, board the boat from either the front or the rear using ladders.

Ensure there is at least 90 cm (3 ft) of water underneath the lowest rear portion of the hull.

Take into account that the hull will be lower in the water when all passengers are aboard. Be certain to maintain the specified depth so sand, pebbles and rocks will not be drawn up in the jet pump.



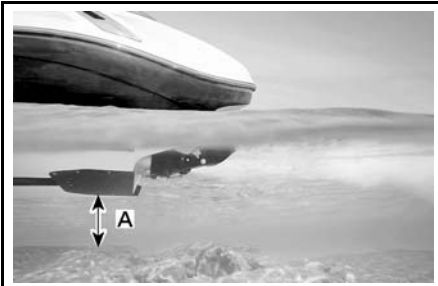

lmo2010-005-001\_a

TYPICAL

A. 90 cm (3 ft)

**NOTICE** Starting the engine or riding the boat in shallower water may damage the impeller or other jet pump components.

### Boarding from Deep Water

#### **⚠ WARNING**

Inexperienced riders should practice how to get aboard close to shore first before venturing into deep water.

#### **⚠ WARNING**

Engines should not be running while boarding. Never use propulsion components as a supporting point to board the boat.

Swim to the rear of the boat.

Release the retractable ladder, pulling ladder out and down into boarding position.

Climb the ladder and pull yourself upward using the swim platform grab handles.



lmo2010-003-101

TYPICAL

When you can reach the engine cover grab handle, grip it and continue to pull yourself upward to place your knee on the swim platform.



lmo2010-003-102

TYPICAL

Continue to climb on engine cover to reach the deck.



lmo2010-003-103

TYPICAL

**NOTE:** The last boarded person must secure the ladder using the retaining latch prior to reach its seat.

**NOTICE** Do not leave ladder hanging when operating the boat. Before operating the boat, always fasten the ladder in place using the latch.

**⚠ WARNING**

Do not start engines until all passengers are properly seated.

**Starting the Engines**

**NOTE:** Before starting engines for the first time during the day, perform the complete pre-ride inspection as described in *PRE-RIDE INSPECTION*.

Open the engine compartment cover and ensure engine compartment is free of gasoline vapor odors.

**⚠ WARNING**

If any leaks or gasoline vapor odors are present, **DO NOT** start the engine and communicate with your authorized Sea-Doo Boats dealer.

1. Close the engine compartment cover.
2. Turn on bilge blower for 5 minutes then turn bilge blower switch off.

**⚠ WARNING**

Always activate bilge blower 5 minutes minimum before starting the engines to ventilate the bilge.

3. Attach the tether cord to your PFD or to a wrist strap.

**⚠ WARNING**

The tether cord must be attached to the operator all the time when engine is running.

4. Install the tether cord on the engine cut-off switch.

**NOTE:** The tether cord clip must be securely attached to the operator's PFD, clothing, arm, or leg. Be sure to attach the tether cord clip to a place where it is free of obstructions and to something that will move with the operator if he or she leaves the helm station.

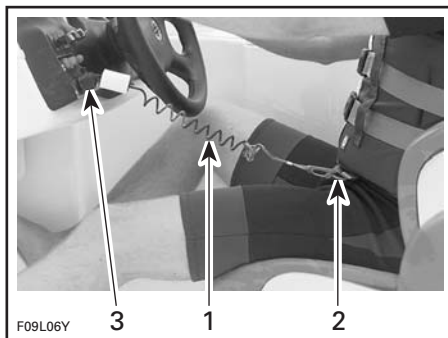
**TYPICAL**

1. Tether cord
2. Secure tether cord clip to PFD
3. Snap tether cord cap to engine cut-off switch

**NOTE:** If you hear beeper signals other than 2 short beeps, it indicates a particular condition that must be corrected. Refer to chart in the *MONITORING SYSTEM* section for the meaning of the coded signal.

5. Ensure all passengers are properly seated in accordance with the seating label. Refer to *SAFETY LABELS* section.

**⚠ WARNING**

Before starting the engines, the operator and passengers should always be properly seated. Do not allow swimmers and passengers to stay close to the propulsion system.

**NOTICE** Ensure there is at least 90 cm (3 ft) of water under the lowest rear portion of the hull when all passengers are aboard prior to starting the engine. Otherwise damage to the propulsion system may occur. Do not accelerate abruptly.

6. Ensure shift lever is in neutral position and throttle levers are in idle position.
7. Press and hold a START/STOP switch. Release immediately after engine is started. Start one engine at a time.

**NOTICE** To avoid starter motor overheating, the cranking period should not exceed 5 - 10 seconds and a rest period of 30 seconds should be observed between cranking cycles to let the starter cool down and its mechanism disengage. Pay attention not to discharge battery.

8. Check tachometers to monitor engines.

## Leaving the Shore

With throttle lever(s) at idle position, move shift lever to the desired position.

Slowly accelerate to reach deeper water. Do not apply full throttle until engines are warm.

### **⚠ WARNING**

In shallow water, shells, sand, pebbles or other objects could be drawn up by the jet pumps and thrown rearward.

## Steering Operation

Turning the steering pivots the jet pump nozzles which control the boat direction. Turning the steering clockwise will turn the boat to the right and inversely.

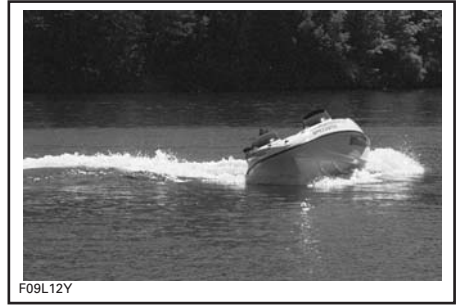

TYPICAL — RIGHT-HAND TURN

Above idle speed, the throttles must be applied to turn the boat.

### **⚠ WARNING**

Throttle must be applied and steering turned to change the direction of the boat at speed. Steering efficiency will differ depending on the number of passengers, load and water conditions.

A jet propelled boat needs some throttle applied in order to turn. Practice in a safe area applying the throttle and turning away from an imaginary object. This is a good collision avoidance practice.

## Throttle/Shift Control Operation

When selecting the neutral or reverse position with the shift lever, the reverse gates move up or down to the desired position.

### Forward

To obtain forward:

1. Press the neutral lock detent button and push shift lever in the forward position.

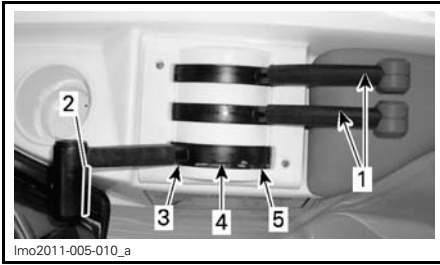

**TYPICAL**

1. Throttle levers must be fully pulled back (idle speed) to shift
2. Neutral lock detent button pressed
3. Forward
4. Neutral
5. Reverse

2. Push the throttle levers forward to increase speed.

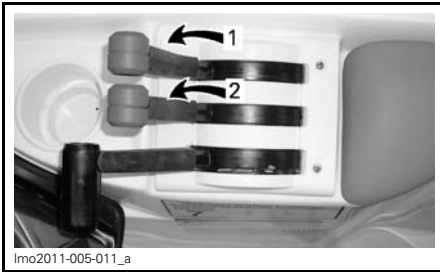

1. Starboard throttle lever in full forward position
2. Port throttle lever in full forward position

**Neutral**

To obtain neutral, pull shift lever to the upright position until it locks in neutral position. Reverse gates will be in the middle position, directing half of the thrust toward the front of the boat to minimize movement.

**⚠ WARNING**  
 When the shift lever is in neutral position, the impellers are turning.

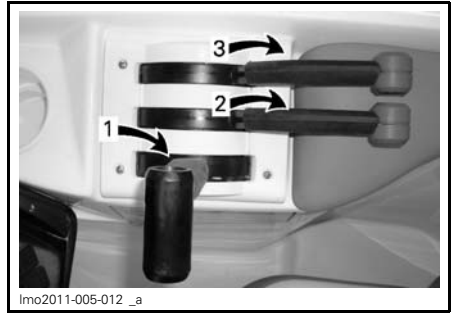

**TYPICAL**

1. Shift lever in neutral position
2. Port throttle lever in idle position
3. Starboard throttle lever in idle position

**Reverse**

To obtain reverse, press the neutral lock detent button and pull shift lever completely to the rear. Reverse gates will be in downward position, directing all the thrust toward the front of the boat.



**TYPICAL**

1. Shift lever in reverse position
2. Throttle levers in idle position

**NOTE:** To obtain maximum efficiency and control from the reverse, increase engine speed to slightly above idle. Too much RPM will create water turbulence and reduce reverse efficiency.

The boat behaves differently when using reverse. At first outing, carefully practice this maneuver away from anything with which you might collide.

**⚠ WARNING**

Become fully familiar with the reverse operation during your first ride and before carrying passengers.

**Shutting Off the Engines**

To shut off the engines, completely pull back throttle lever(s) then remove the tether cord or press the engine START/STOP buttons.

Always remove the tether cord from the engine cut-off switch.

**⚠ WARNING**

If engines are shut off, directional control is not available. Never leave the tether cord connected on the engine cut-off switch when boat is not in operation to avoid unauthorized use by children, theft or others.

**General Recommendations****Rough Water or Poor Visibility Operation**

Avoid operation in these conditions. If you must do so, proceed with caution and prudence using minimum speed. Turn on navigation lights if necessary.

**Night Operation**

Between sunset and sunrise, use the navigation lights and reduce speed.

**⚠ WARNING**

Navigation lights should always be used between sunset and sunrise. Ensure the stern light is installed. See *STERN LIGHT SOCKET* in this section for location and installation.

**Crossing Waves**

Reduce speed when crossing waves. Always be prepared to steer and balance as necessary.

When crossing wakes, always keep a safe distance from boat ahead.

**⚠ WARNING**

When crossing wakes, slow down. Operator and passenger(s) can brace themselves by posting. Do not jump waves or wakes.

**Stopping/Docking**

The boat is slowed by water drag. The stopping distance will vary depending on the boat's size, speed, water surface condition, presence and direction of wind and current.

The operator should become familiarized with the stopping distance under different conditions.

Reduce throttle speed to idle. Shift to neutral, reverse or forward as required when approaching a dock then shut off the engines just before coming alongside.

**⚠ WARNING**

Directional control is reduced when throttle is decreased and lost when engines are off.

When close to the dock, shut off the engines.

**⚠ WARNING**

While engines can be stopped by pressing the START/STOP buttons, we strongly recommend the engines be stopped by removing the tether cord. This will install good habits.

**Beaching**

**NOTICE** It is not recommended to run the boat onto the beach.

Slowly approach the beach and shut off the engines using the tether cord when water depth is 90 cm (3 ft) under the hull, then pull the boat to the beach. Ensure that all accessories are OFF.

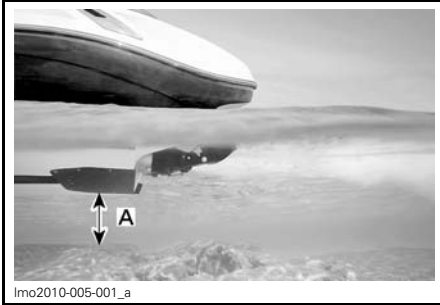

A. 90 cm (3 ft) of water under the hull

**⚠ WARNING**

In shallow water, shells, sand, pebbles or other objects could be drawn up by the jet pumps and be thrown rearward.

# SPECIAL PROCEDURES

## Jet Pump Water Intake and Impeller Cleaning

Water is drawn up by the impellers through these openings. The grates minimize entry of foreign objects into the propulsion systems.

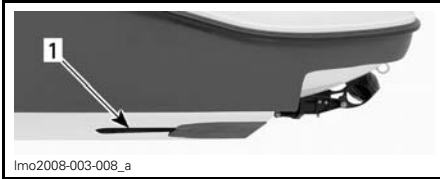

**TYPICAL**  
1. Inlet grate

### **⚠ WARNING**

Keep away from intake grates while engines are running. Items such as long hair, loose clothing or personal flotation device straps can become entangled in moving parts resulting in severe injury or drowning.

Weeds, shells or debris can get caught on the intake grates, drive shafts and/or impellers. A clogged water intake may cause troubles such as:

1. **Cavitation:** Engine speed is high but boat moves slowly due to reduced jet thrust; jet pump components may be damaged.
2. **Overheating:** Since the jet pump operation controls the flow of water to cool the exhaust system, a clogged intake will cause the engine to overheat and damage internal engine components.

The clogged area can be cleaned as follows:

**In-water cleaning:** Pull the tether cord from engine cut-off switch to stop engine(s). Let the boat stop by itself. Wait a while to allow weeds or other debris to escape from grate(s). It may be necessary to repeat the procedure.

In severe conditions if the above method does not work, the following can be performed:

1. With engine(s) running, put shift lever in reverse position and vary throttle setting quickly several times.
2. Try accelerating again.

Most of the time, debris will escape from the propulsion system.

**Out of water cleaning:** If the system is still clogged, shut off the engine(s) by removing the tether cord.

### **⚠ WARNING**

Always remove the tether cord from the engine cut-off switch to prevent accidental engines starting before cleaning the jet pumps area.

From underneath boat, manually clean water intakes area. If the system is still clogged, refer to an authorized Sea-Doo Boats dealer for servicing.

**NOTICE** Avoid operation in weeded areas. If unavoidable, vary speed. Weeds tend to entangle more at steady and slow speeds. Inspect water intake grates for damage. Refer to an authorized Sea-Doo Boats dealer for repair as necessary.

## Towing the Boat in Water

Special precautions should be taken when towing a Sea-Doo Boats in water.

Maximum recommended towing speed is 24 km/h (15 MPH).

When towing your boat in water, pinch the exhaust manifold water outlet hose on each engine with a LARGE HOSE PINCHER (P/N 529 032 500).

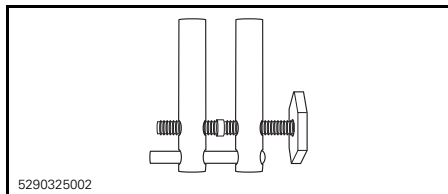

This will prevent the exhaust systems from filling which may lead to water being injected into the engines. Without the engines running there isn't any exhaust pressure to carry the water out the exhaust outlet.

**NOTICE** Failure to do this may result in damage to the engines. If your Sea-Doo Boats must be towed in water and you do not have hose pinchers, be sure to stay well below the maximum towing speed of 24 km/h (15 MPH).

Install the hose pinchers on the exhaust manifold water outlet hoses as shown for each engine.



TYPICAL

1. Install hose pincher here

**NOTICE** When finished towing the boat, hose pinchers must be removed before operation. Failure to do so will result in engines damages.

## Capsized Boat

This boat is designed so that it should not turn over easily due to its long and wide dimensions. If the boat ever cap-

sized, remember that it will continue to float. It is usually best to remain with it so you will be more easily located by others.

### **⚠ WARNING**

When boat is capsized, do not attempt to restart the engines. Operator and passengers should always wear approved personal flotation devices.

## Submerged Boat and Water-Flooded Engine

To limit damages to the engines, perform the following procedure as soon as possible.

1. Drain bilge.
2. If it was submerged in salt water, spray bilge and all components with fresh water using a garden hose to stop the salt corroding effect.

**NOTICE** Never try to crank or start the engines. Water trapped in intake manifolds would flow towards the engines and may cause severe damage to the engines.

3. Bring the boat to be serviced by an authorized Sea-Doo Boats dealer as soon as possible.

**NOTICE** The longer the delay before you have the engine serviced, the greater the damage will be to the engines. Failure to have the engines properly serviced will cause severe engine damage.



# ***MAINTENANCE***

# BREAK-IN INSPECTION

We suggest that after the first 10 hours of operation, the boat be checked by an authorized Sea-Doo Boats dealer. The break-in inspection is very important and must not be neglected.

**NOTE:** The break-in inspection is at the expense of the boat owner.

We recommend that this inspection be signed by an authorized Sea-Doo Boats dealer.

\_\_\_\_\_  
Date of inspection

\_\_\_\_\_  
Authorized dealer signature

\_\_\_\_\_  
Dealer name

<b>BREAK-IN INSPECTION CHART</b>	REPLACE				
	ADJUST				
	LUBRICATE				
	CLEAN				
	INSPECT				
<b>ENGINE</b>					
Engine oil and filter					X
Rubber mounts	X				
Corrosion protection			X		
<b>EXHAUST SYSTEM</b>					
Exhaust system fasteners, hoses and components condition. Also inspect for leaks.	X				
<b>COOLING SYSTEM</b>					
Hose and fasteners	X				
Coolant	X				
<b>FUEL SYSTEM</b>					
Throttle cable	X				
Throttle body	X				
Fuel lines, connections, pressure relief valve and fuel system leak test	X				
Fuel tank straps	X				

BREAK-IN INSPECTION CHART	REPLACE				
	ADJUST				
	LUBRICATE				
	CLEAN				
	INSPECT				
<b>AIR INTAKE SYSTEM</b>					
Air filter	X				
<b>ENGINE MANAGEMENT SYSTEM</b>					
EMS sensors	X				
EMS fault codes	X				
<b>ELECTRICAL SYSTEM</b>					
Spark plugs	X				
Electrical connections (ignition system, starting system, fuel injectors etc.)	X				
Main battery cut-off switch	X				
Battery support	X				
<b>STEERING SYSTEM</b>					
Steering cable and connections	X				
Steering nozzle bushings	X				
<b>PROPULSION SYSTEM</b>					
Carbon ring and rubber boot (drive shaft)	X				
Shifter system, cable and connections	X				
Impeller boot	X				
Impeller and wear ring	X				
<b>HULL/ BODY</b>					
Drain plug (inside bilge). Check for obstructions.	X				
Ski/ wakeboard post and fasteners	X				

# MAINTENANCE SCHEDULE

Maintenance is very important for keeping your boat in safe operating condition. Proper maintenance is the owner's responsibility. The boat should be serviced as per the maintenance schedule.

The maintenance schedule does not exempt the pre-ride inspection.

## WARNING

Failure to properly maintain the boat according to the maintenance schedule can make it unsafe to operate.

The schedule should be adjusted according to operating conditions and use. Intensive use of boat will require greater frequency of inspection and maintenance.

We encourage you to have an Annual Safety Inspection of your boat.

PART/TASK	EVERY 25 HOURS					LEGEND
	EVERY 50 HOURS					
	EVERY 100 HOURS OR Preseason					
	EVERY 200 HOURS OR 2 YEARS					
	TO BE PERFORMED BY					
<b>ENGINE</b>						
Engine oil and filter			R (1)		D	(1) At storage period or after 100 hours of use whichever comes first. (2) Inspect slipping moment. (3) Every 10 hours in salt water use.
Rubber mounts		I			D	
Supercharger clutch				I (2)	D	
Corrosion protection			L (3)		O	
<b>EXHAUST SYSTEM</b>						
Exhaust system fasteners, hoses and components condition			I (4)		D	(1) At storage period or after 100 hours of use whichever comes first. (4) Inspect also for leaks. (5) Daily flushing in salt water or foul water use.
Exhaust system flushing			(1) (5)		O	
<b>COOLING SYSTEM</b>						
Hose and fasteners			I		D	---
Coolant				R	D	

A: ADJUST C: CLEAN I: INSPECT L: LUBRICATE R: REPLACE D: DEALER O: OPERATOR	EVERY 25 HOURS						
	EVERY 50 HOURS						
	EVERY 100 HOURS OR Preseason						
	EVERY 200 HOURS OR 2 YEARS						
	TO BE PERFORMED BY						
PART/TASK						LEGEND	
<b>FUEL SYSTEM</b>							
Throttle cable			I (3)			D	(3) Every 10 hours in salt water use.
Throttle body			I, L (3)			O/D	
Fuel lines, connections, pressure relief valve and fuel system leak test			I			D	
Fuel tank straps			I			D	
<b>AIR INTAKE SYSTEM</b>							
Air filter			I (6)			D	(6) Replace if required.
<b>ENGINE MANAGEMENT SYSTEM (EMS)</b>							
EMS sensors			I			D	---
EMS fault codes			I			D	
<b>ELECTRICAL SYSTEM</b>							
Spark plugs			I	R		D	(3) Every 10 hours in salt water use.
Electrical connections (ignition system, starting system, fuel injectors etc.)			I			D	
ECM and VCM connectors (visual inspection without disconnecting)			I (3)			O	
Digitally Encoded Security System (D.E.S.S.)			I			D	
Main battery cut-off switch			I			D	
Battery support			I			D	
Battery			I			D	
Battery posts			L			D	
Stern light connectors			L			O	

**MAINTENANCE SCHEDULE**

A: ADJUST C: CLEAN I: INSPECT L: LUBRICATE R: REPLACE D: DEALER O: OPERATOR	EVERY 25 HOURS					
	EVERY 50 HOURS					
	EVERY 100 HOURS OR Preseason					
	EVERY 200 HOURS OR 2 YEARS					
	TO BE PERFORMED BY					
PART/TASK						LEGEND
<b>STEERING SYSTEM</b>						
Steering cable and connections			I			D
Steering nozzle bushings			I			D
<b>PROPULSION SYSTEM</b>						
Drive shaft			L <sup>(3)</sup> (7)			D
Carbon ring and rubber boot (drive shaft)		I				D
Shifter system, cable and connections			I			D
Reverse gate		L <sup>(3)</sup>				O
Drive shaft/impeller splines			I, L			D
Impeller boot			I			D
Impeller shaft seal, sleeve and O-ring			I <sup>(3)</sup>			D
Impeller and wear ring		I				D
Sacrificial anode				(8)		O
<b>HULL/BODY</b>						
Storage compartment cover locks, latches and hinges			I, L <sup>(3)</sup>			O
Deck drains/scupper valve			I			O
Drain plug (inside bilge)			I <sup>(9)</sup>			O
Ski/wakeboard post and fasteners		I, L <sup>(3)</sup>				O

(3) Every 10 hours in salt water use.  
 (7) Lubricate for corrosion protection.  
 (8) Inspect each month (every two weeks in salt water) and change when necessary.

(3) Every 10 hours in salt water use.  
 (9) Check for obstructions.

# MAINTENANCE PROCEDURES

This section includes instructions for basic maintenance procedures. If you have the necessary mechanical skills and the required tools, you can perform these procedures. If not, see your authorized Sea-Doo Boats dealer.

Other important items in the maintenance schedule that are more difficult and require special tools are best performed by your authorized Sea-Doo Boats dealer.

## **⚠ WARNING**

Turn off the engines and follow these maintenance procedures when performing maintenance. If you do not follow proper maintenance procedures you can be injured by hot parts, moving parts, electricity, chemicals or other hazards.

## **⚠ WARNING**

Should removal of a locking device be required (e.g. lock tabs, self-locking fasteners, etc.), always replace it with a new one.

**⚠ CAUTION** Some components in the engine compartment may be very hot.

## **Throttle Body**

### **Throttle Body Lubrication**

Lubricate throttle body of each engine with XPS LUBE (P/N 293 600 016) or an equivalent.

Use the lubrication fitting located on the top of engine.

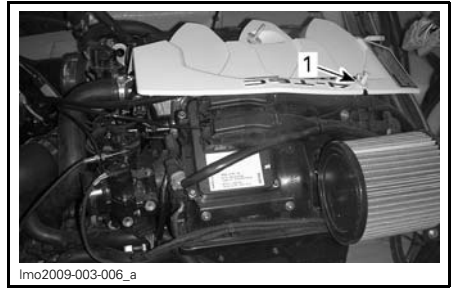

### **REMOVE CAP**

1. Lubrication fitting

With the engine **not** running, make sure to spray lubricant at least 3 to 5 seconds for proper lubrication.

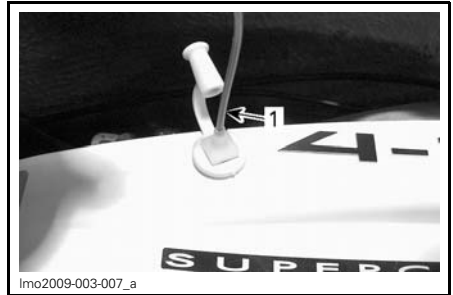

1. Can needle into lubrication fitting

## **Throttle Cables**

### **Throttle Cable Inspection**

Move the throttle levers forward and rearward once. They must operate smoothly. Refer to an authorized Sea-Doo Boats dealer if adjustment is necessary.

## **⚠ WARNING**

Do not alter or tamper with throttle cables adjustment or routing.

## **Engine Oil**

### **Recommended Engine Oil**

Use XPS SYNTHETIC BLEND OIL (SUMMER GRADE) (P/N 293 600 121).

This engine has been developed and validated using the XPS™ Synthetic blend oil. BRP strongly recommends the use of its XPS Synthetic blend oil at all times.

If XPS™ engine oil is not available, use a 10W40 mineral engine oil compatible with wet clutches.

**NOTICE** NEVER use synthetic oil. This would impair the proper operation of the supercharger clutch. Do not add any additives to the recommended oil. Mineral oils (API service SM or SL) may also contain additives (friction modifiers) that may cause inappropriate slippage of the supercharger clutch and eventually lead to premature wear. Damages caused by oil which is not suitable for the engine will not be covered by the BRP limited warranty.

### Engine Oil Level

**NOTICE** Check level frequently and refill if necessary. Operating the engines with improper oil levels may severely damage engines.

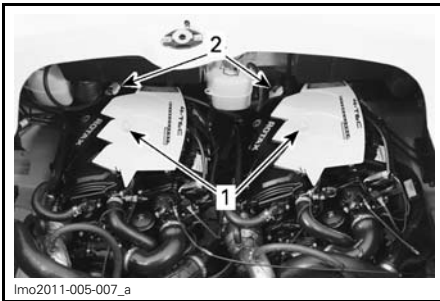

TYPICAL  
1. Dipstick  
2. Oil cap

Boat must be leveled.

Oil level can be checked either with boat in water or out of water.

### If Boat is Out of the Water

If the boat is out of the water and on a trailer, block the wheels and raise the bow slightly with the trailer jack (if so equipped) until the bumper rail is level.

Install a garden hose to the flushing connector. Refer to *EXHAUST SYSTEM FLUSHING* in *MAINTENANCE PROCEDURES* and follow the procedure.

**NOTICE** Never run engine(s) without supplying water to the exhaust systems when boat is out of water. Failure to supply water to the exhaust systems may severely damage exhaust systems.

**NOTICE** Never run engine(s) longer than 2 minutes. Drive line seals has no cooling when boat is out of water.

### Procedure Continuation (Boat Out or In Water)

It is of the utmost importance to follow this procedure in order to obtain an accurate reading of the engine oil level.

**CAUTION** Engine oil may be hot. Certain components in the engine compartment may be very hot. Direct contact may result in skin burn.

1. Ensure engine is at normal operating temperature.
2. Let engine idle for 30 seconds before stopping.
3. Stop engine.
4. Wait at least 30 seconds.
5. Pull dipstick out and wipe clean.



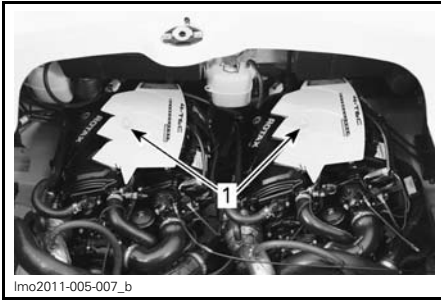

**TYPICAL**

1. Dipstick

6. Reinstall dipstick, push in completely.
7. Remove dipstick and read oil level. It should be between marks.

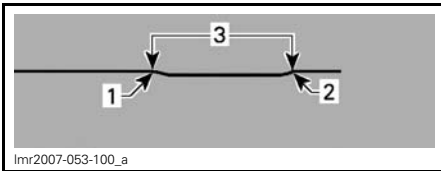

1. Full
2. Add
3. Operating range

8. If needed, add oil up to have the level between marks as required.
  - 8.1 Unscrew oil cap.
  - 8.2 Place a funnel into the opening and add the recommended oil to the proper level.

**NOTE:** Do not overfill.

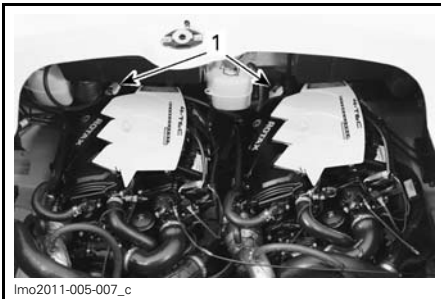

**TYPICAL**

1. Oil cap

**NOTE:** Every time oil is added in engine, the complete procedure explained above must be done. Otherwise, you will have a false oil level reading.

9. Properly reinstall oil cap and dipstick.
10. Repeat procedure for the other engine.
11. Wipe off any oil spillage.

**Engine Oil Change and Oil Filter Replacement**

The oil change and filter replacement should be performed by an authorized Sea-Doo Boats dealer.

**Engine Coolant**

**Recommended Engine Coolant**

Always use ethylene-glycol antifreeze containing corrosion inhibitors specifically for internal combustion aluminum engines.

**NOTE:** When available, it is recommended to use biodegradable antifreeze compatible with internal combustion aluminum engines. This will contribute to protecting the environment.

Cooling system must be filled with BRP PREMIXED COOLANT (P/N 219 700 362) or with a water and antifreeze solution (50% distilled water, 50% antifreeze).

To prevent antifreeze deterioration, always use the same brand. Never mix different brands unless cooling system is completely flushed and refilled. Refer to an authorized Sea-Doo Boats dealer.

**Engine Coolant Level**

With boat on a level surface, coolant should be between MIN. and MAX. level marks for each coolant reservoir when each engine is cold.

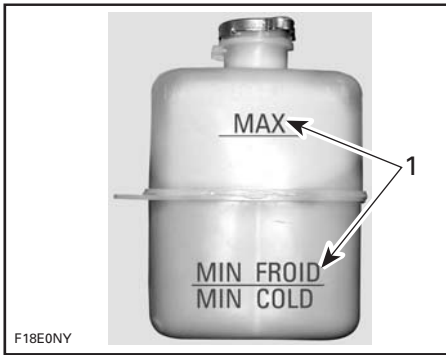

F18E0NY

1. Level between marks when engine is cold

## **⚠ WARNING**

Check coolant level with cold engines. Never add coolant in cooling system when engines are hot.

**NOTE:** The boat is considered level when it is in water. When boat is on a trailer, block the wheels and raise the bow slightly with the trailer jack (if so equipped) until the bumper rail is level.

Add coolant to have the level between marks as required. Use a funnel to avoid spillage. **Do not overfill.**

Properly reinstall and tighten filler cap.

**NOTE:** A cooling system that frequently requires coolant indicates leaks or engine problems. See an authorized Sea-Doo Boats dealer.

## **Engine Coolant Replacement**

The coolant replacement should be performed by an authorized Sea-Doo Boats dealer.

## **Ignition Coils**

### **Ignition Coil Installation**

1. Pull rubber seal down.

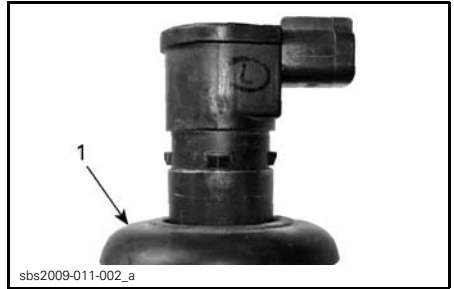

sbs2009-011-002\_a

1. Rubber seal pulled down

2. Apply DOW CORNING 111 (P/N 413 707 000) to rubber seal seat as shown.

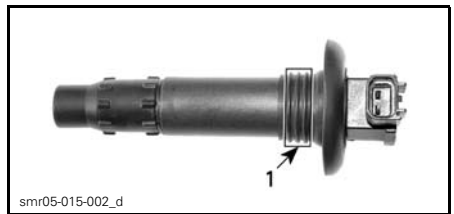

smr05-015-002\_d

1. Apply product here

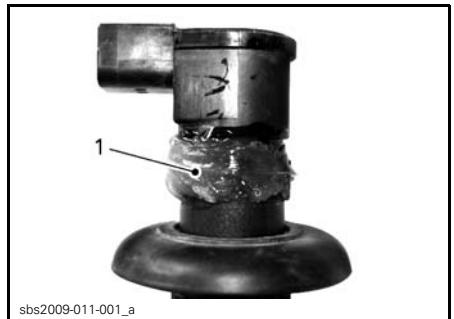

sbs2009-011-001\_a

1. Apply product here

3. Pull rubber seal back on its seat making sure the tabs on the ignition coil and the slots in the seal properly match together.

4. Leave a ring of grease on top of the seal as shown to act as a water barrier. Wipe off the excess.

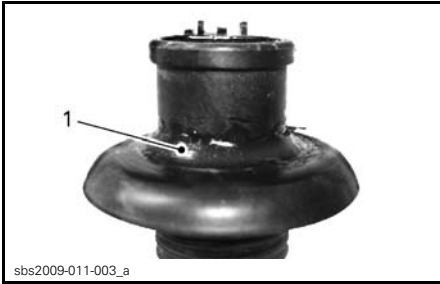

1. Correctly shaped excess of product

5. Push the ignition coil down to securely install it on the spark plug tip.

**NOTE:** Ensure the seal seats properly with the top surface of the engine.

**NOTE:** Ensure the seal seats properly with the engine top surface.

6. Reconnect ignition coil connectors.

## Exhaust System

### Exhaust System Flushing

Flushing the exhaust system and intercooler of each engines with fresh water is essential to neutralize corroding effects of salt or other chemical products present in water. It will help to remove sand, salt, shells or other particles in water jackets and/or hoses.

### **⚠ WARNING**

Perform this operation in a well ventilated area.

Proceed as follows:

1. Clean jet pump by spraying water in its inlet and outlet and then apply a coating of XPS LUBE (P/N 293 600 016) or equivalent.

### **⚠ WARNING**

When operating the engine while the boat is out of the water, the heat exchanger in the ride plate may become very hot. Avoid any contact with ride plate as burns may occur.

2. Connect a garden hose to the connector located at the rear of boat on jet pump support. Do not open water tap at this time.

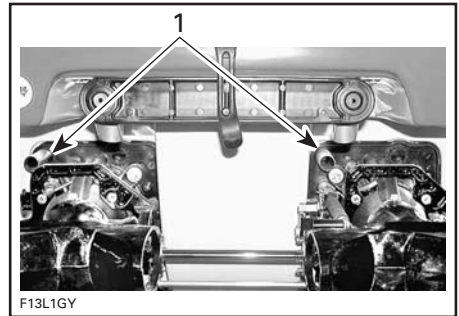

### TYPICAL

1. Flushing connectors

**NOTE:** An optional FLUSHING CONNECTOR ADAPTER (P/N 295 500 473) with a quick connect adapter to ease garden hose installation. No hose pincher is required to flush engine.

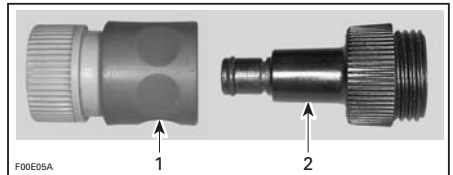

1. Quick connect adapter  
2. Flushing connector adapter

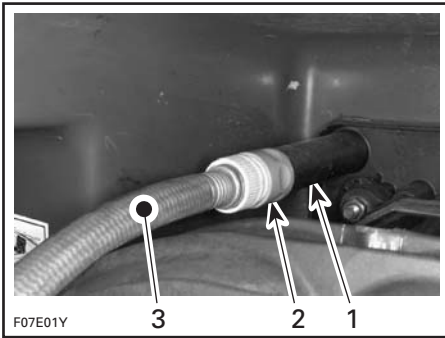

**TYPICAL**

1. Flushing connector
2. Quick connect adapter and flushing connector adapter (optional, not mandatory)
3. Garden hose

3. To flush, start engine then immediately open the water tap.

**CAUTION** Certain components in the engine compartment may be very hot. Direct contact may result in skin burn. Do not touch any electrical parts or jet pump area when engine is running.

**NOTICE** Never flush a hot engine. Always start the engine before opening the water tap. Open water tap immediately after engine is started to prevent overheating.

4. Run the engine about 20 seconds at a fast idle between 4000 - 5000 RPM.

**NOTICE** Never run engine without supplying water to the exhaust system when boat is out of water.

5. Ensure water flows out of jet pump while flushing. Otherwise, refer to an authorized Sea-Doo Boats dealer for servicing.

**NOTICE** Never run engine longer than 2 minutes. Drive line seal has no cooling when boat is out of water.

6. Close the water tap, then stop the engine.

**NOTICE** Always close the water tap before stopping the engine.

**NOTICE** Remove quick connect adapter after flushing operation (if used).

## Fuses

### Fuse Inspection and Replacement

The electrical system is protected with fuses.

To remove fuse from box or holder, pull fuse out. Check if filament is melted.

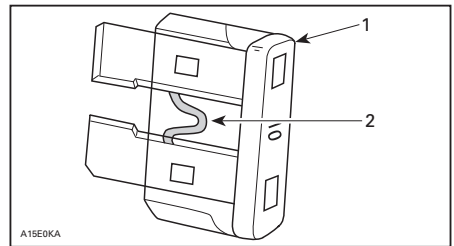

1. Fuse
2. Check if melted

If a fuse is defective, replace by one of the same rating.

**NOTE:** If the entire electrical system is down, make sure the main battery cut-off switch is properly turned on, refer to *MAIN BATTERY CUT-OFF SWITCH* in this section. If the battery switch is ON, check the main breaker. See *MAIN BREAKER* below.

**NOTICE** Do not use a higher rated fuse as this can cause a fire or severe damage. If a fuse has blown, the source of the malfunction should be determined and corrected before restarting. See an authorized Sea-Doo Boats dealer for servicing.

### Main Fuses

If nothing at all is working, check that main battery cut-off switch is in ON position.

Also, check main fuses connected to the main battery cut-off switch inside gunwale.

**NOTE:** There are spare fuses inside Engines Fuse Block (EFB) and Vehicle Control Module (VCM) fuse cover.

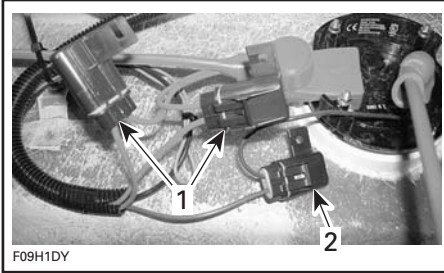

**TYPICAL — BEHIND BATTERY CUT-OFF SWITCH**

1. 2 x 20 A: VCM
2. 3 A: automatic bilge pump
3. 1 A: radio memory (not shown)

**Engines Accessory Fuses**

**NOTE:** Typical for both engines.

Fuses for engine-related components, Engine Control Module (ECM) or gauges are integrated in the Engine Fuse Block (EFB), which is located in the engine compartment.

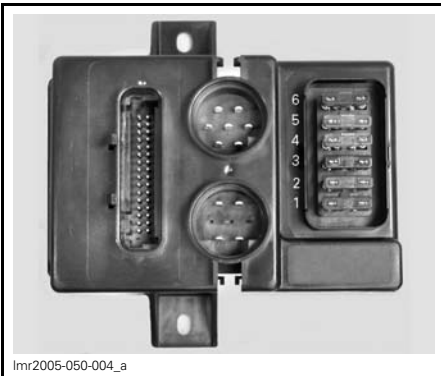

**EFB**

1. 10 A: Fuel pump
2. 10 A: Cylinder 3, ignition coil and injection
3. 5 A: ECM
4. 10 A: Cylinder 1, ignition coil and injection
5. 10 A: Cylinder 2, ignition coil and injection
6. 2 A: Gauges

To remove fuse cover, squeeze cover locking tabs and pull cover out to access fuses.

Use the cover tabs to remove the fuse.

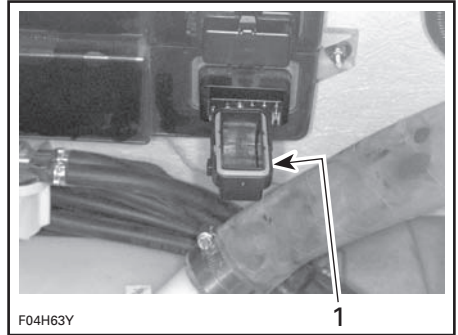

**TYPICAL**

1. Slide cover tabs each side of fuse then pull fuse out

When finished, ensure seal is properly placed in cover.

Carefully position cover on fuse block then firmly push until you hear a snapping sound for each locking tab.

The main fuses for the engine electrical system are located near each engine solenoid.

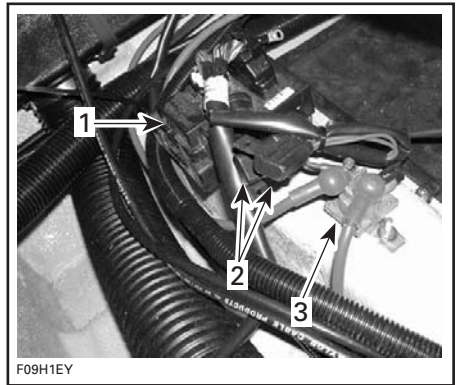

**TYPICAL**

1. EFB
2. Engine electrical system main fuses  
30 A: Charging system  
15 A: EFB
3. Solenoid

## Boat Accessory Fuses

Fuses for the boat electrical system are integrated in the Vehicle Control Module (VCM), which is located in the driver console ahead of the dash.

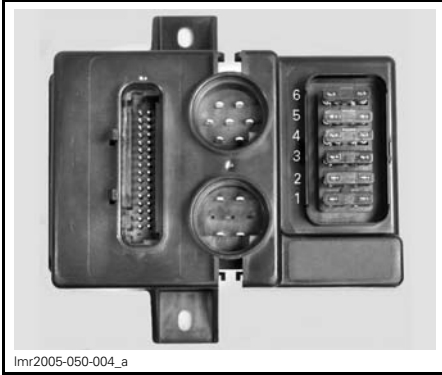

lmr2005-050-004\_a

### VCM

1. 10 A: Accessories
2. 10 A: Radio
3. 7.5 A: Blower
4. 3 A: Bilge pump
5. 3 A: NAV lights
6. 5 A: Courtesy lights

To remove fuse cover, squeeze cover locking tabs and pull cover out to access fuses.

Use the cover tabs to remove the fuse.

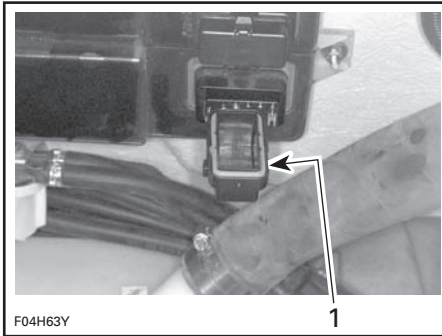

F04H63Y

### TYPICAL

1. Slide cover tabs each side of fuse then pull fuse out

When finished, ensure seal is properly placed in cover.

Carefully position cover on fuse block then firmly push until you hear a snapping sound for each locking tab.

## Automatic Bilge Pump Fuse

The automatic bilge pump fuse is located on the positive battery cable near the post.

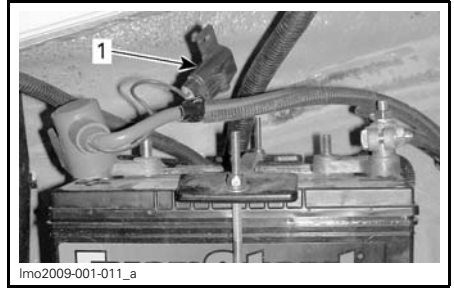

lmo2009-001-011\_a

1. Battery in line fuse

## Bilge Blower

### Bilge Blower Operation Check

Verify each bilge blower for proper operation.

Make sure that the ventilation ducts are not obstructed.

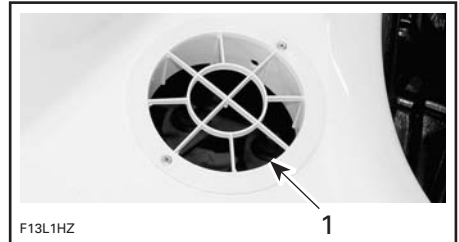

F13L1HZ

### TYPICAL

1. Blower duct

## ⚠ WARNING

If bilge blower does not operate properly, refer to an authorized Sea-Doo Boats dealer before starting the boat.

## Navigation Lights

### Bow Light Bulb Replacement

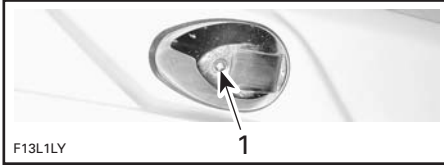

**TYPICAL**

1. Remove this screw

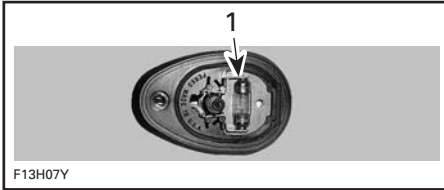

**TYPICAL**

1. Lift up to remove bulb

Assembly is essentially the reverse of removal procedures. However, pay particular attention to the following:

Apply DIELECTRIC GREASE (P/N 293 550 004) on new bulb contact surface.

### Stern Light Bulb Replacement

Unscrew lens counterclockwise and pull it out.

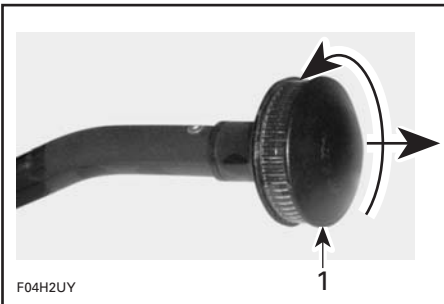

**TYPICAL**

1. Unscrew then pull

Pull bulb to remove it.

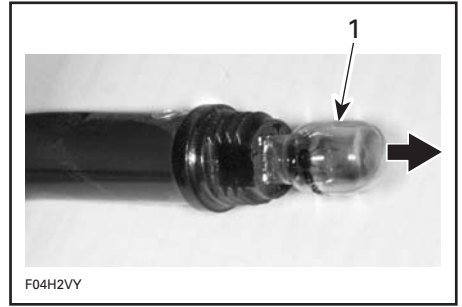

**TYPICAL**

1. Pull bulb out

Apply DIELECTRIC GREASE (P/N 293 550 004) on new bulb contact surface.

Assembly is the reverse of removal procedure.

### Stern Light Connector Lubrication

Apply DIELECTRIC GREASE (P/N 293 550 004) on stern light connectors as needed.

### Deck Light

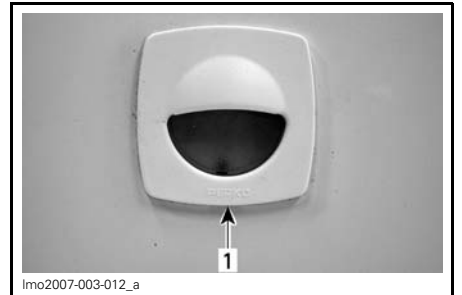

1. Gently pry here with a screwdriver



1. Pull and remove bulb

## Deck Drain and Scupper Valve

### Deck Drain Cleaning

The purpose of this drain is to evacuate water from the deck.

Remove any obstructions from deck drain outlet.

Water drains out though the scupper valve located near the jet pump nozzle.

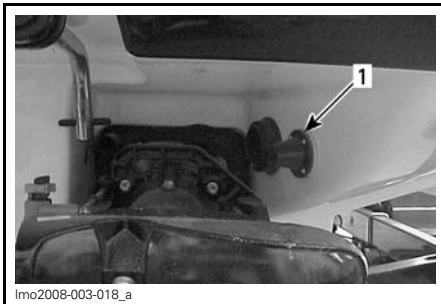

TYPICAL  
1. Scupper valve

Keep it clean to avoid clogging.

## Latches and Hinges

The application of XPS LUBE (P/N 293 600 016) will help to prevent corrosion and keep proper operation of moving mechanisms.

## Latch and Hinges Lubrication

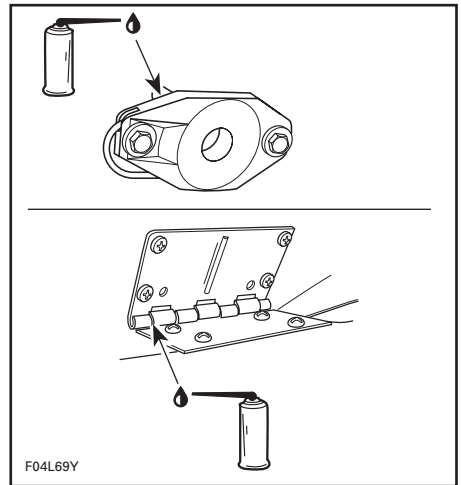

TYPICAL

## Reverse Gates

### Reverse Gate Lubrication

Lubricate pivot points and mechanism on both sides of each reverse gate with XPS LUBE (P/N 293 600 016) or equivalent.

## Ski Post

### Ski Post Lubrication

Lubricate ski post through all its length with XPS LUBE (P/N 293 600 016) or equivalent. Pull out then push in several times to distribute the lubricant.



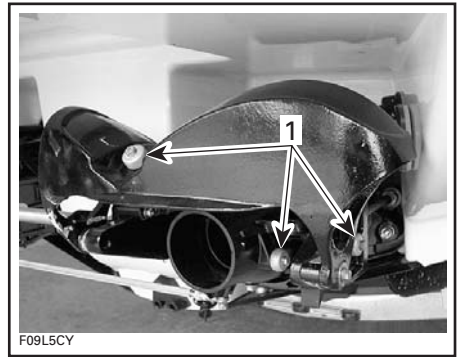
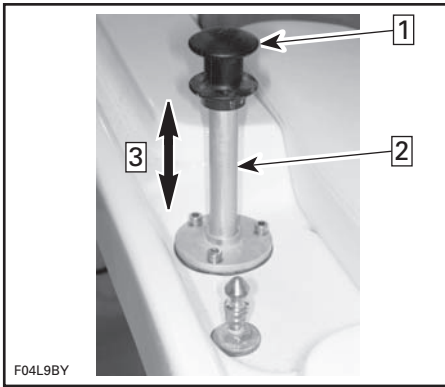

**TYPICAL**

1. Sacrificial anodes

**NOTICE** Inspect anodes each time boat is to be launched. Do **NOT** paint anodes or apply protective coatings.

**TYPICAL**

Step 1: Lift ski post to lubricate

Step 2: Lubricate here

Step 3: Move post up and down several times to distribute lubricant

## Sacrificial Anodes

### Sacrificial Anodes Inspection

Corrosion of metal parts, especially those exposed to saltwater, is common for boats. Corrosion can be caused by stray electric currents from shore power installations, improperly grounded AC lines and circuits, and poorly insulated DC powered equipment from boats moored nearby. Corrosion is accelerated when electric current is present.

Sacrificial anodes are attached to certain parts of this boat to reduce corrosion. The anode corrodes, rather than the part to which the anode is attached.

Change each anode when 50% by weight has corroded away.

Anodes are attached at the following locations:

- Ride shoe(s)/cooling plate(s)
- Pump housing(s)
- Reverse gate support(s)
- Steering nozzle(s)
- Reverse gate(s).

---

# BOAT CARE

## Post-Operation Care

Remove the boat from the water every day to prevent growth of marine organisms.

### **WARNING**

Allow engine to cool before performing any maintenance.

## Exhaust System Flushing

The exhaust system should be flushed daily when boat is used in salt or foul water.

Refer to *MAINTENANCE PROCEDURES*.

**NOTE:** On supercharged models, the intercooler is flushed at the same time.

## Anticorrosion Treatment

To prevent corrosion, spray a corrosion inhibitor (salt water resistant) such as XPS LUBE (P/N 293 600 016) or equivalent over metallic components in engine compartment.

**NOTE:** Engine fogging should be done with XPS LUBE (P/N 293 600 016) whenever the boat is to be stored for few days or a long period.

Apply DIELECTRIC GREASE (P/N 293 550 004) (salt water resistant) on battery posts and cable connectors.

**NOTICE** Never leave rags or tools in the engine compartment or in the bilge.

## Additional Care for Foul Water or Salt Water Use

When the boat is operated in foul water and particularly in salt water, additional care must be taken to protect the boat and its components.

Rinse trailer and boat's hull/bilge area with fresh water.

Never use a high pressure washer to clean the bilge. **USE LOW PRESSURE ONLY (such as a garden hose)**. High pressure can cause damages to electrical or mechanical systems.

**NOTICE** Failure to perform proper care such as: boat rinsing, exhaust system flushing and anticorrosion treatment, when used in salt water, will result in damage to the boat and its components. Never leave the boat stored in direct sunlight.

In coastal areas, special care should also be taken on stainless steel or chrome parts like grab handles, mooring cleats, fuel cap and navigation lights. Rinse with fresh water. Clean with a good car chrome polish. Protect with a good car or fiberglass wax.

## Boat Cleaning and Protection

### Engine Compartment Cleaning

The engine compartment should be cleaned with warm water and BRP HEAVY DUTY CLEANER (P/N 293 110 001), as required.

Unscrew the drain plug, block the wheels and raise the bow slightly with the trailer jack (if so equipped) to allow water to drain. Rinse thoroughly. Leave all compartments open to air dry.

### Body Cleaning

First rinse with fresh water to remove dried salt water.

Wash the body with water and soap (only use mild detergent). Remove any marine organisms.

**NOTICE** Never clean fiberglass and plastic parts with strong detergent, degreasing agent, paint thinner, acetone, etc.

Apply a marine wax to protect the finish.

## Carpet Cleaning

To clean the carpets, use 3M™ Citrus Base Cleaner or an equivalent. See the manufacturer's instructions.

## Windshield Cleaning

Wash with BRP HEAVY DUTY CLEANER (P/N 293 110 001).

Clean only with flannel clothes.

**NOTICE** It is necessary to use flannel cloths on windshield to avoid damaging surface.

To remove scratches on windshield: Start with "Slip Streamer® Scratch Remover". Finish with "Slip Streamer® Cleaner and Polish".

**NOTE:** The later product may be used alone if only light scratches are noticeable.

**NOTICE** Never clean windshield with strong detergent, degreasing agent, paint thinner, acetone, products containing chlorine, etc.

Stains may be removed from seats and fiberglass with Spray Nine or the equivalent.

## Stainless Steel and Chrome

To clean or polish stainless steel or chrome parts, always use a product specially develop for marine environment such as the Flitz Stainless Steel & Chrome Cleaner.

## Vinyl Cleaning

Use XPS MULTI-PURPOSE CLEANER (P/N 219 701 709).

For dirt build up, let cleaner soak for approximately 10 minutes, then gently scrub with a soft bristle brush.

Refer to next table for other products that can also be used for cleaning vinyl.

Do not use any silicone-based protectants. They will extract the plasticizers, leaving the vinyl hard and brittle, and eventually cracking will occur.

CLEANING PRODUCTS
1. XPS MULTI-PURPOSE CLEANER (P/N 219 701 709)
2. Dish Soap (Dawn or Ivory) and water
3. Fantastik
4. Spray Nine
5. 3M Citrus Cleaner
6. 303 Protectant

**NOTE:** Always follow manufacturer's recommendations and instructions.

## Vinyl Cleaning Recommendations for Special Stains

TYPE OF STAIN	STEP 1	STEP 2	STEP 3
Ballpoint ink *	E	B	A
Chewing gum	D	A	—
Coffee, tea, chocolate	B	—	—
Pencil	D	B	—
Grease	D	B	—
Household soil	A	B	—
Ketchup	A	B	—
Latex paint	A	B	—
Lipstick	A	B	—
Mildew or wet leaves *	C	B	A
Motor oil	B	—	—
Oil-based paint	D	B	—
Permanent marker *	E	B	C
Spray paint	B	B	—
Suntan lotion	A	B	—
Tar/asphalt	D	B	—
Yellow mustard	A	B	C

### Recommended action:

- A. Medium-soft brush, warm soapy water, rinse/dry.
- B. XPS MULTI-PURPOSE CLEANER (P/N 219 701 709), rinse/dry.
- C. One (1) tablespoon of ammonia, one-fourth (1/4) cup of hydrogen peroxide, three-fourth (3/4) cup of water, rinse/dry.
- D. Wipe or scrape off excess (chill gum with ice before hand).
- E. Denatured alcohol, rinse/dry.

\* Suntan lotion, tree pollen, wet leaves and some other products can contain dyes that stain permanently.

All cleaning methods must be followed by a thorough rinse with warm water.

Certain household cleaners, powdered abrasives, steel wool and industrial cleaners can cause damage and dis-

coloration and are not recommended. Dry cleaning fluids and lacquer solvents should not be used as they will remove printed pattern and gloss. Waxes should be used with caution as many contain dyes or solvents that can permanently damage the protective coating.

Please contact G&T industries "Marine Specialties Group" hot line at 1 800 318-2887 for any cleaning and care questions.

## Corrosion Protection

Protect engine compartment metallic parts from corrosion using XPS LUBE (P/N 293 600 016) or an equivalent.

# STORAGE

It is recommended that the boat be taken to an authorized Sea-Doo Boats dealer for proper storage, however you can perform the following operations with a minimum of tools.

**NOTE:** Leave drain plug out during storage period.

**NOTICE** Do not run the engine during the storage period.

**⚠ WARNING**

Because fuel and oil are flammable, have an authorized Sea-Doo Boats dealer inspect the fuel and oil systems integrity as specified in the *MAINTENANCE SCHEDULE*.

## Jet Pump Cleaning

Clean jet pump by spraying water in its inlet and outlet and then apply a coating of XPS LUBE (P/N 293 600 016) or equivalent.

**⚠ WARNING**

Always remove tether cord cap from engine cut-off switch to prevent unexpected engine starting before cleaning the jet pump area. Engine must not be running for this operation.

## Fuel System Protection

The BRP FUEL STABILIZER (P/N 413 408 600) (or equivalent) can be added in fuel tank to prevent fuel deterioration and fuel system gumming. Follow stabilizer manufacturer's instructions for proper use.

**NOTICE** It is highly recommended to add fuel stabilizer at storage in order to maintain fuel system in good condition.

## Throttle Body Lubrication

Lubricate throttle body of each engine. Refer to *MAINTENANCE PROCEDURES* for details.

## Engine Oil and Filter Replacement

The oil change and filter should be performed by an authorized Sea-Doo Boats dealer.

## Intercooler Draining

It is important to expel any trapped water that may have accumulated from condensation in the intercooler of each engine.

Proceed as follows:

1. Open the engine cover.
2. Ensure there is an alignment line drawn on the intercooler outlet hose. This will ensure the hose is not twisted or kinked on reinstallation.
3. Loosen the clamp retaining the intercooler outlet hose.
4. Remove the intercooler outlet hose from the intercooler.

**NOTE:** This hose feeds the inlet of the supercharger.

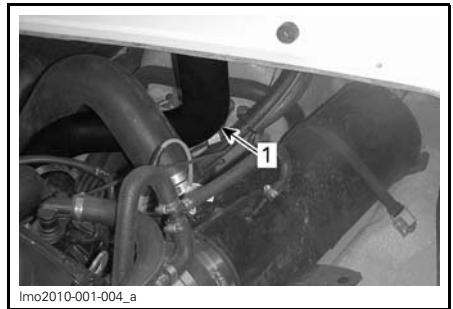

1. Intercooler outlet hose

5. Start and rev the engine up to 4000 RPM several times.

**NOTE:** Prevent air intake system from aspirating foreign objects which may cause severe engine or damage.

6. Stop engine.
7. Reinstall the intercooler air outlet hose, ensure it is properly aligned as prior to removal to ensure proper engine operation.

## Exhaust System Flushing

Perform procedure as described in *MAINTENANCE PROCEDURES* section.

## Exhaust System Protection

The exhaust system is self draining, but the intercooler and exhaust manifold on each engine need to be properly drained to avoid damage.

Using the flushing connector on jet pump support, inject pressurized air (around 689 kPa (100 PSI)) into system until there is no more water flowing from the jet pump.

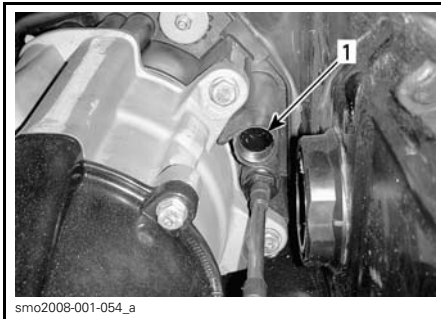

1. Flushing connector — location may differ

To ease the procedure, a custom hose can be assembled. See the following illustration.

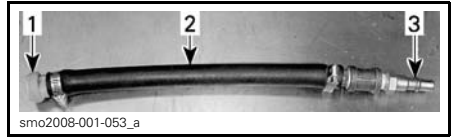

### TYPICAL

1. Flushing adapter (P/N 295 500 473)
2. Hose 13 mm (1/2 in)
3. Air hose male adapter

**NOTICE** Failure to drain the exhaust system may cause severe damage to intercooler and exhaust manifold.

## Engine Internal Lubrication

**NOTE:** Both engines must be internally lubricated for the storage period.

1. Open the engine compartment lid.
2. Remove storage tray.
3. Remove dipstick.
4. Remove engine cover.
5. Reinstall dipstick.
6. Disconnect ignition coil connectors.

## ⚠ WARNING

When disconnecting coil from spark plug, always disconnect coil from main harness first. Never check for engine ignition spark from an open coil and/or spark plug in the engine compartment as spark may cause fuel vapor to ignite.

**IMPORTANT:** Never cut the locking ties of ignition coil connectors. This would allow mixing the wires between cylinders.

7. Remove ignition coils.

**NOTICE** Ensure there is no dirt in coil holes before removing the spark plugs. Otherwise, dirt would fall into cylinder and will damage the internal components.

8. Remove spark plugs.

**NOTE:** After loosening the spark plugs, a coil may be used to remove the spark plugs. Simply bring the coil down to spark plug and "hook" it to then extract spark plug.

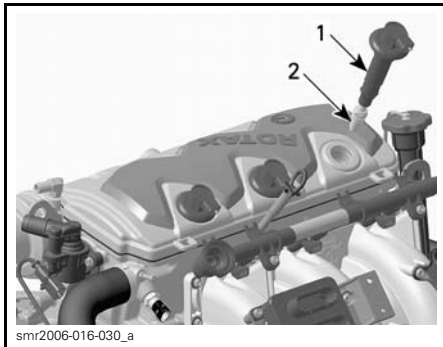

- smr2006-016-030\_a
1. Ignition coil
  2. Spark plug

9. Spray XPS LUBE (P/N 293 600 016) or equivalent, into spark plug holes.

10. To prevent fuel to be injected and also cut the ignition at the engine cranking, proceed as follows.

11. From the engine compartment, have a second person hold throttle bell crank in fully opened position.

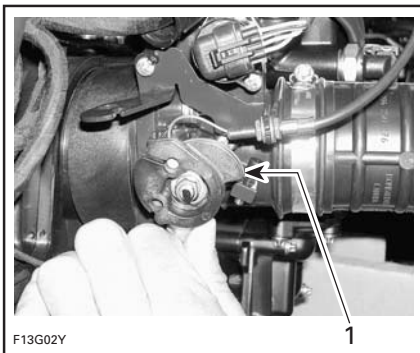

**TYPICAL**

- F13G02Y
1. Fully-opened position

12. Crank each engine a few turns to distribute the oil on cylinder wall.

13. Apply LOCTITE 767 (ANTISEIZE LUBRICANT) (P/N 293 800 070) on spark plug threads then reinstall them.

14. Reinstall ignition coils. Reconnect ignition coil connectors.

**NOTE:** Prior to inserting the ignition coils onto the spark plugs, apply some DOW CORNING 111 (P/N 413 707 000) grease around the seal area that touches the spark plug hole. After installation, ensure the seal seats properly with the top surface of the engine.

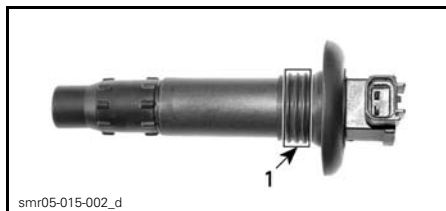

- smr05-015-002\_d
1. Apply product here

15. To reinstall engine cover, remove dipstick, push engine cover downward until it snaps.

16. Reinstall dipstick.

**NOTE:** It is recommended to fog the engine valves with XPS LUBE (P/N 293 600 016). Contact your authorized Sea-Doo Boats dealer.

## Engine Coolant Test

If antifreeze is not replaced, test its density.

The antifreeze replacement and a density test should be performed by an authorized Sea-Doo Boats dealer.

**NOTE:** Antifreeze of each engine should be replaced every 200 hours or every 2 years to prevent antifreeze deterioration.

**NOTICE** Improper antifreeze density may allow freezing of the liquid in the cooling system if the boat is stored in an area where the freezing point is attained. This would seriously damage the engine.

## Battery Removal and Storage

For battery removal, cleaning and storage, contact your authorized Sea-Doo Boats dealer.

## Boat Cleaning/Repair

Wash the body and the trailer with soap and water solution (only use mild detergent). Rinse thoroughly with fresh water. Remove any marine organisms from the hull.

**NOTICE** Never clean apparent fiberglass and plastic parts with strong detergent, degreasing agent, paint thinner, acetone, etc.

Stains may be removed from seats and fiberglass with Knight's Spray-Nine or the equivalent.

If repairs are needed to the body or to the hull contact your authorized Sea-Doo Boats dealer. For paint touch up to mechanical parts use BRP spray paint. For minor gelcoat repairs, a Gelcote repair kit is available from Gelcote International at [www.gelcote.com](http://www.gelcote.com).

Replace damaged labels or decals.

Once boat is on trailer, unscrew the drain plug, block the wheels and raise the bow slightly with the trailer jack (if so equipped) to allow water to drain. Clean the bilge with warm water and detergent or with bilge cleaner. Rinse thoroughly. Leave all compartments open to air dry.

## Boat Protection

Apply a marine wax containing no abrasive.

Remove storage tray. Place it on deck.

Using a flat screwdriver, lift tab as shown below.



TYPICAL — LIFT TAB

Detach cylinder end. Detach other side.

Block and leave engine cover lid open slightly.

This will avoid engine compartment condensation and possible corrosion.

Reattach cylinder ends to engine cover lid before operating boat.

If the boat is to be stored outside, cover it with a vented opaque tarpaulin to prevent UV (ultraviolet) rays and grime from affecting the plastic components, boat finish, as well as preventing dust accumulation.

**NOTICE** Never leave the boat stored in direct sunlight. UV radiation will dull finishes. The boat must never be left in water for storage.

For the storage period, block the wheels and raise the bow slightly with the trailer jack (if so equipped) so drainage can take place. Ensure the drain plug is unscrewed and unobstructed.



---

# PRESEASON PREPARATION

Maintenance preparation must be performed in conjunction with *MAINTENANCE SCHEDULE*.

Ensure to perform all tasks included in the **100 HOURS OR 1 YEAR** column.

Since technical skills and special tools are required, some operations should be performed by an authorized Sea-Doo Boats dealer.

**NOTE:** It is highly recommended that an authorized Sea-Doo Boats dealer perform factory campaigns in addition to the preseason preparation all at the same time.

## **WARNING**

Only perform procedures as detailed in the *MAINTENANCE SCHEDULE*. It is recommended that the assistance of an authorized Sea-Doo Boats dealer be periodically obtained on other components and systems not covered in this guide.

**NOTICE** When component conditions seem less than satisfactory, replace using only genuine BRP parts, or approved equivalents.

***This page is  
intentionally blank***

# ***TECHNICAL INFORMATION***

# BOAT IDENTIFICATION

The main components of the boat (hull and engines) are identified by different serial numbers. It may sometimes become necessary to locate these numbers for warranty purposes or to trace the boat in the event of theft.

## Hull Identification Number

The Hull Identification Number (H.I.N.) is located on the right side of the transom.



*TYPICAL*

1. Hull Identification Number (H.I.N.)

## Engine Identification Number

The Engine Identification Number (E.I.N.) is located on the upper crankcase on MAGNETO side of each engine.



1. Engine Identification Number (E.I.N.)

---

# ENGINE EMISSIONS INFORMATION

Maintenance, replacement, or repair of the emission control devices and systems may be performed by any marine SI (spark ignition) engine repair establishment or individual.

## **Manufacturer's Responsibility**

Beginning with 1999 model year engines, manufacturers of marine engines must determine the exhaust emission levels for each engine horsepower family and certify these engines with the United States of America Environmental Protection Agency (EPA). An emissions control information label, showing emission levels and engine specifications, must be placed on each boat at the time of manufacture.

## **Dealer's Responsibility**

When performing service on all 1999 and more recent Sea-Doo Boats carrying an emissions control information label, adjustments must be kept within published factory specifications.

Replacement or repair of any emission related component must be executed in a manner that maintains emission levels within the prescribed certification standards.

Dealers are not to modify the engine in any manner that would alter the horsepower or allow emission levels to exceed their predetermined factory specifications.

Exceptions include manufacturer's prescribed changes, such as altitude adjustments for example.

## **Owner Responsibility**

The owner/operator is required to have engine maintenance performed to maintain emission levels within prescribed certification standards.

The owner/operator is not to, and should not allow anyone to modify any engine in a manner that would alter the

horsepower or allow emission levels to exceed predetermined factory specifications.

## **EPA Emission Regulations**

All new 1999 and more recent Sea-Doo Boats manufactured by BRP are certified to the EPA as conforming to the requirements of the regulations for the control of air pollution from new boat engines. This certification is contingent on certain adjustments being set to factory standards. For this reason, the factory procedure for servicing the product must be strictly followed and, whenever practicable, returned to the original intent of the design.

The responsibilities listed above are general and in no way a complete listing of the rules and regulations pertaining to the EPA requirements on exhaust emissions for marine products. For more detailed information on this subject, you may contact the following locations:

### **MAIL:**

U.S. Environmental Protection Agency  
Office of Transportation and Air Quality  
1200 Pennsylvania Ave. NW  
Mail Code 6403J  
Washington D.C. 20460

### **INTERNET WEB SITE:**

<http://www.epa.gov/otaa/>

# SPECIFICATIONS

MODEL		200 SPEEDSTER
<b>ENGINE</b>		
Number of engines		2
Engine type		Rotax® 1503 4-TEC™, 4-stroke, Single Over Head Camshaft (SOHC)
Exhaust system		Water cooled/water injected (opened loop). Direct flow from jet pump
Lubrication	Type	Dry sump (2 oil pumps). Replaceable oil filter. Water-cooled oil cooler
	Oil type	XPS summer grade oil Refer to <i>MAINTENANCE PROCEDURES</i> section for more information
Number of cylinders		3
Displacement		1 493.8 cm <sup>3</sup> (91 in <sup>3</sup> )
Induction type		Supercharged intercooled
Maximum HP RPM		8000 RPM ± 50 RPM
<b>COOLING</b>		
Type		Liquid cooled. Closed loop system (see also <i>EXHAUST SYSTEM</i> )
Coolant		Ethylene-glycol and distilled water (50%/50%). Use premix coolant from BRP or a coolant specially formulated for aluminum engines
<b>ELECTRICAL</b>		
Magneto generator output		360 W @ 6000 RPM
Ignition system type		DI (Digital Inductive)
Spark plugs	Make and type	NGK, DCPR8E
	Gap	0.7 mm - 0.8 mm (.028 in - .031 in)
Starting system		Electric starter
Engine RPM limiter setting		8000 RPM
Battery		Not supplied <sup>(1)</sup> . 12 V group 24, marine starting battery with top-mounted, round taper type battery post

MODEL		200 SPEEDSTER
<b>ELECTRICAL (cont'd)</b>		
Fuses (engines)	F1: Fuel pump	10 A
	F2: Cylinder 3, ignition coil and injection	10 A
	F3: ECM	5 A
	F4: Cylinder 1, ignition coil and injection	10 A
	F5: Cylinder 2, ignition coil and injection	10 A
	F6: Gauges	2 A
Fuses (VCM)	F1: Accessories	10 A
	F2: Radio	10 A
	F3: Blower	10 A
	F4: Bilge pump	3 A
	F5: NAV lights	3 A
	F6: Courtesy lights	5 A
Fuses (boat)	VCM	2 x 20 A
	Charging system	2 x 30 A
	Automatic bilge pump	3 A
	Radio memory	1 A
	EFB	2 x 15 A
	Blower motor	2 x 5 A
<b>FUEL SYSTEM</b>		
Fuel injection type		Multipoint Fuel Injection. Single throttle body (52 mm)
Fuel	<b>MINIMUM OCTANE RATING</b>	
	Type	<b>Regular</b> unleaded gasoline
	Minimum octane rating	Inside North America: 87 (RON + MON)/2 Outside North America: 92 RON
	<b>FOR OPTIMUM ENGINES PERFORMANCE</b>	
	Type	<b>Premium</b> unleaded gasoline
	Octane rating	Inside North America: 91 (RON + MON)/2 Outside North America: 95 RON

**SPECIFICATIONS**

<b>MODEL</b>		<b>200 SPEEDSTER</b>
<b>PROPULSION</b>		
Jet pump type		Axial flow single stage
Jet pump grease		Jet pump bearing grease (P/N 293 550 032) sold by BRP
Transmission		Direct drive
Pivoting angle of direction (nozzle)		20°
Minimum required water level for jet pump(s)		90 cm (3 ft) underneath the lowest rear portion of hull
<b>DIMENSIONS</b>		
Overall length		6.02 m (19.8 ft)
Beam		2.44 m (8 ft)
Draft		30.5 cm (1 ft)
Dead rise		21°
<b>DIMENSIONS (ON TRAILER)</b>		
Length (with swing-away tongue folded)		6.42 m (21.1 ft)
Width		2.59 m (8.5 ft)
Height	No tower	1.98 m (6.5 ft)
	Tower down	2.16 m (7.1 ft)
	Tower up	3.02 m (9.9 ft)
<b>WEIGHT AND LOADING CAPACITY</b>		
Weight		1 256 kg (2,769 lb)
Seating capacity		7
Load limit (passengers + luggage) (based on calm water operation)		7 passengers OR 619 kg (1,365 lb)
Gross weight (on trailer)		1 858 kg (4,096 lb)
<b>CAPACITIES</b>		
Engine oil (per engine)		3 L (3.2 qt (U.S. liq.)) oil change with filter
Engine cooling system		5.5 L (5.8 qt (U.S. liq.)) total
Fuel tank (including reserve)		166 L (44 U.S. gal.)

(1) Recommended: Exide R-24-130, 12 V, 25 A•h (130 minutes reserve) or R-24-160 (160 minutes) or equivalent.



# ***TROUBLESHOOTING***

---

# TROUBLESHOOTING GUIDELINES

---

The following information is provided to help in diagnosing the probable source of simple troubles. You may be able to solve many of these problems rather quickly, but others may require the skills of a mechanical technician. In such a case, consult an authorized Sea-Doo Boats dealer for servicing.

## BATTERY IS REGULARLY DISCHARGED

---

1. Check battery condition.
  - *Have the battery charged or replaced by an authorized Sea-Doo Boats dealer.*
2. Check charging system fuse.
  - *Replace fuse if necessary and have charging system checked by an authorized Sea-Doo Boats dealer.*

## WARNING

See your authorized Sea-Doo Boats dealer to have the battery charged or replaced. Do not charge or boost the battery while installed in the engine compartment. Electrolyte is poisonous and capable of causing severe burns.

## NO BEEPS ARE HEARD WHEN INSTALLING THE TETHER CORD ON ENGINE CUT-OFF SWITCH

---

1. Main battery cut-off switch is turned OFF.
  - *Verify and turn ON.*
2. Battery discharged.
  - *Have the battery charged or replaced by authorized Sea-Doo Boats dealer.*

## ENGINE DOES NOT TURN OVER AND THE MONITORING BEEPER SOUNDS

---

1. Refer to *MONITORING SYSTEM* below.

## ENGINE WILL NOT START

---

1. Tether cord removed.
  - *Install tether cord over engine cut-off switch.*
2. Engine management system does not recognize the D.E.S.S. key (2 beeps are not heard when installing the tether cord).
  - *Refer to an authorized Sea-Doo Boats dealer.*
3. Burnt fuse.
  - *Check fuse(s). See an authorized Sea-Doo Boats dealer if problem is repetitive.*
4. Discharged battery.
  - *Have the battery charged or replaced by an authorized Sea-Doo Boats dealer.*
5. Battery connections, corroded or loose.
  - *Contact an authorized Sea-Doo Boats dealer.*
6. Water flooded engine.
  - *Contact an authorized Sea-Doo Boats dealer.*

---

**ENGINE WILL NOT START (cont'd)**

---

- 7. Obstructed jet pump.**
  - *Try to clean. Otherwise, refer to an authorized Sea-Doo Boats dealer.*
- 8. Faulty engine management system.**
  - *Refer to an authorized Sea-Doo Boats dealer.*

---

**ENGINE TURNS SLOWLY**

---

- 1. Loose battery cable connections.**
  - *Check/clean/tighten.*
- 2. Discharged or weak battery.**
  - *Have the battery charged or replaced by an authorized Sea-Doo Boats dealer.*
- 3. Bad ground(s).**
  - *Refer to an authorized Sea-Doo Boats dealer.*
- 4. Worn starter or related parts.**
  - *Refer to an authorized Sea-Doo Boats dealer.*

---

**ENGINE TURNS NORMALLY BUT WILL NOT START**

---

- 1. Fuel tank empty or water contaminated.**
  - *Refill or siphon and fill with fresh fuel.*
- 2. Fouled/defective spark plugs.**
  - *Replace.*
- 3. Burnt fuse.**
  - *Check fuse(s). See an authorized Sea-Doo Boats dealer if problem is repetitive.*
- 4. Water-flooded engine.**
  - *Refer to WATER-FLOODED ENGINE in SPECIAL PROCEDURES.*
- 5. Engine management system fault detected (check if engine pilot lamp is ON).**
  - *Refer to an authorized Sea-Doo Boats dealer.*
- 6. Faulty fuel pump.**
  - *Refer to an authorized Sea-Doo Boats dealer.*

---

**ENGINE MISFIRES, RUNS IRREGULARLY**

---

- 1. Fouled/defective/worn spark plugs.**
  - *Replace.*
- 2. Faulty ignition coil(s).**
  - *Contact an authorized Sea-Doo Boats dealer.*
- 3. Fuel: Level too low, stale or water contaminated.**
  - *Siphon and/or refill.*
- 4. Clogged injectors.**
  - *Refer to an authorized Sea-Doo Boats dealer.*

**ENGINE MISFIRES, RUNS IRREGULARLY (cont'd)**

---

5. Engine management system fault detected (check if engine pilot lamp is ON).
  - Refer to an authorized Sea-Doo Boats dealer.

**ENGINE SMOKE**

---

1. Oil level too high.
  - Refer to an authorized Sea-Doo Boats dealer.
2. Water ingestion, coolant leak or damaged cylinder head gasket.
  - Refer to an authorized Sea-Doo Boats dealer.
3. Internal engine damage.
  - Refer to an authorized Sea-Doo Boats dealer.

**ENGINE OVERHEATING OR IMPROPER OIL PRESSURE (MONITORING BEEPER CONTINUOUSLY SOUNDS)**

---

**NOTICE** If beeper continuously sounds, stop engine as soon as possible.

1. Check oil and coolant levels.
  - Refer to MAINTENANCE PROCEDURES. Refill if necessary.
2. Clogged jet pump water intake.
  - Perform the JET PUMP WATER INTAKE AND IMPELLER CLEANING PROCEDURE in SPECIAL PROCEDURES.
3. Clogged exhaust system.
  - Flush exhaust system.

**NOTICE** If these actions do not correct the problem, discontinue use and contact an authorized Sea-Doo Boats dealer.

**ENGINE LACKS ACCELERATION OR POWER**

---

1. Jet pump water intake clogged.
  - Clean. Refer to JET PUMP WATER INTAKE AND IMPELLER CLEANING in SPECIAL PROCEDURES section.
2. Damaged impeller or worn-out wear ring.
  - Replace. Refer to an authorized Sea-Doo Boats dealer.
3. Faulty supercharger or intercooler (255 engine).
  - Refer to an authorized Sea-Doo Boats dealer.
4. Supercharger clutch slipping.
  - Refer to an authorized Sea-Doo Boats dealer.
5. Weak spark.
  - Refer to ENGINE MISFIRES, RUNS IRREGULARLY in this section.
6. Engine management system fault detected (check if engine pilot lamp is ON).
  - Refer to an authorized Sea-Doo Boats dealer.

---

**ENGINE LACKS ACCELERATION OR POWER (cont'd)**

---

- 7. Clogged injectors.**
  - *Refer to an authorized Sea-Doo Boats dealer.*
- 8. Low fuel pressure.**
  - *Refer to an authorized Sea-Doo Boats dealer.*
- 9. Water in fuel.**
  - *Siphon and replace.*

---

**BOAT CANNOT REACH TOP SPEED**

---

- 1. Jet pump water intake clogged.**
  - *Perform the JET PUMP WATER INTAKE AND IMPELLER CLEANING PROCEDURE in SPECIAL PROCEDURES.*
- 2. Damaged impeller or worn-out wear ring.**
  - *Contact an authorized Sea-Doo Boats dealer.*
- 3. Faulty supercharger or intercooler (255 engine).**
  - *Refer to an authorized Sea-Doo Boats dealer.*
- 4. Engine management system fault detected (check if engine pilot lamp is ON).**
  - *Refer to an authorized Sea-Doo Boats dealer.*

---

**ABNORMAL NOISE FROM PROPULSION SYSTEM**

---

- 1. Weeds or debris jammed around impeller.**
  - *Perform the JET PUMP WATER INTAKE AND IMPELLER CLEANING PROCEDURE in SPECIAL PROCEDURES.*
- 2. Damaged impeller shaft or drive shaft.**
  - *Contact an authorized Sea-Doo Boats dealer.*

---

**WATER FOUND IN BILGE**

---

- 1. Drain plug(s) not tighten.**
  - *Tighten drain plugs.*
- 2. Defective scupper valve.**
  - *Refer to an authorized Sea-Doo Boats dealer.*
- 3. Exhaust system leak.**
  - *Refer to an authorized Sea-Doo Boats dealer.*
- 4. Carbon ring at drive shaft worn.**
  - *Refer to an authorized Sea-Doo Boats dealer.*

---

## MONITORING SYSTEM

A system monitors the electronic components of the EMS (engine management system) and other components of the electrical system. When a fault occurs, it sends visual messages through the information center and/or audible signals through a beeper to inform you of a particular condition.

A fault code may also be recorded.

When a minor or transient fault occurs, the fault message and beeper will cease automatically if the condition that caused the fault does not exist anymore.

Releasing the throttle and letting the engine return to idle speed may allow normal operation to come back. If this does not work, try removing and reinstalling the tether cord on its post.

The electronic system will react differently depending on the fault type. In severe failure, the engine may not be allowed to be started. In other cases, the engine will operate in limp home mode (reduced speed).

When a fault occurs, see an authorized Sea-Doo Boats dealer as soon as possible for inspection.

## Beeper Code Information

BEEPER CODE <sup>(1)</sup>	DESCRIPTION
2 short beeps while installing tether cord on engine cut-off switch	Normal condition of D.E.S.S. Right key installed correctly.
1 long beep while installing tether cord on engine cut-off switch or when pressing START/STOP switch	Shift lever not in Neutral position. Move shift lever to Neutral.
	Unable to read key (wrong installation or dirty key). Remove tether cord, make sure it's clean and reinstall.
	Invalid key or D.E.S.S. fault. Make sure to use the proper key for the boat. If it does not work, Contact an authorized Sea-Doo Boats dealer.
4 short beeps while pressing START/STOP switch with tether cord installed	Shift lever is not in Neutral. Move shift lever to Neutral.
1 short beep while moving shift lever to neutral	Confirms that shift lever is now in Neutral.
4 short beeps at different interval	Tether cord has been left on the engine cut-off switch without the engine running. Remove tether cord to prevent battery discharge.
Continuous beep	High engine coolant temperature. Refer to <i>ENGINE OVERHEATING</i> in <i>TROUBLESHOOTING GUIDELINES</i> .
	High exhaust temperature. Refer to <i>ENGINE OVERHEATING</i> in <i>TROUBLESHOOTING GUIDELINES</i> .
	Low or high engine oil pressure. Check oil level as soon as possible. If level good, discontinue use an contact an authorized Sea-Doo Boats dealer.

<sup>(1)</sup> Some beeper codes go with messages on the information display, refer to *CONTROLS, INSTRUMENTS AND EQUIPMENT* for details.

**NOTICE** If the monitoring beeper continuously sounds, stop engine as soon as possible.

***This page is  
intentionally blank***



# ***WARRANTY***

---

# **BRP LIMITED WARRANTY FOR MODEL YEAR 2011 SEA-DOO® BOATS SOLD IN THE UNITED STATES AND CANADA**

## **1) SCOPE**

BRP US Inc.\* ("BRP") warrants its new and unused Model Year 2011 Sea-Doo® boats ("boat") sold by authorized BRP dealers (as hereinafter defined) in the fifty United States and Canada ("dealer") from defects in material and workmanship for the period and under the conditions described below. This limited warranty will become null and void if: (1) the boat was used for racing or any other competitive activity, at any point, even by a previous owner; or (2) the boat has been altered or modified in such a way so as to adversely affect its operation, performance or durability, or has been altered or modified to change its intended use.

All genuine BRP parts and accessories, installed by an authorized BRP dealer at the time of delivery of the 2011 Sea-Doo® boat, carry the same warranty as that of the boat.

## **2) LIMITATIONS OF LIABILITY**

THIS WARRANTY IS EXPRESSLY GIVEN AND ACCEPTED IN LIEU OF ANY AND ALL OTHER WARRANTIES, EXPRESSED OR IMPLIED, INCLUDING WITHOUT LIMITATION ANY WARRANTY OF MERCHANTABILITY OR FITNESS FOR A PARTICULAR PURPOSE. TO THE EXTENT THAT THEY CANNOT BE DISCLAIMED, THE IMPLIED WARRANTIES ARE LIMITED IN DURATION TO THE LIFE OF THE EXPRESS WARRANTY. INCIDENTAL AND CONSEQUENTIAL DAMAGES ARE EXCLUDED FROM COVERAGE UNDER THIS WARRANTY. SOME STATES/PROVINCES DO NOT ALLOW FOR THE DISCLAIMERS, LIMITATIONS AND EXCLUSIONS IDENTIFIED ABOVE, AS A RESULT, THEY MAY NOT APPLY TO YOU. THIS WARRANTY GIVES YOU SPECIFIC RIGHTS, AND YOU MAY ALSO HAVE OTHER LEGAL RIGHTS WHICH MAY VARY FROM STATE TO STATE, OR PROVINCE TO PROVINCE.

Neither the distributor, any BRP dealer nor any other person has been authorized to make any affirmation, representation or warranty regarding the product, other than those contained in this limited warranty, and if made, shall not be enforceable against BRP. BRP reserves the right to modify this warranty at any time, being understood that such modification will not alter the warranty conditions applicable to the products sold while this warranty is in effect.

## **3) EXCLUSIONS – ARE NOT WARRANTED**

The following are not warranted under any circumstances:

- Normal wear and tear;
- Routine maintenance items, tune-ups, adjustments;
- Damage caused by failure to provide proper maintenance and/or storage, as described in the Operator's Guide;
- Damage resulting from removal of parts, improper repairs, service, maintenance, modifications or use of parts not manufactured or approved by BRP or resulting from repairs done by a person that is not an authorized servicing BRP dealer;
- Damage caused by abuse, misuse, abnormal use, neglect, racing, improper operation or operation of the boat in a manner inconsistent with the recommended operation described in the Operator's Guide;

- Damage resulting from external damage, submersion, water or foreign object ingestion, accident, fire, theft, vandalism or any act of God;
- Operation with fuels, oils or lubricants which are not suitable for the boat (see Operator’s Guide);
- Damage from rust, corrosion or exposure to the elements;
- Damage from cooling system or jet pump blockage by foreign material;
- Damage to gel coat finish including but not limited to cosmetic gel coat finish defects, blisters, starrng, crazing; and fiberglass delaminating caused by blisters, crazing, spyder or hairline cracks or exposure to the elements; and
- Incidental or consequential damages, or damages of any kind including without limitation towing, storage, telephone, rental, taxi, inconvenience, insurance coverage, loan payments, loss of time, loss of income.

#### **4) WARRANTY COVERAGE DURATION**

This limited warranty will be in effect from the date of delivery to the first retail consumer or the date the boat is first put into use, whichever occurs first and for a period of:

1. TWELVE (12) CONSECUTIVE MONTHS for private, recreational use, except that the deck and hull fiberglass structure are covered for SIXTY (60) CONSECUTIVE MONTHS.
2. POUR (4) CONSECUTIVE MONTHS for commercial use, except that the deck and hull fiberglass structure is covered for TWELVE (12) CONSECUTIVE MONTHS. A boat is used commercially when it is used in connection with generating income or any work or employment during any part of the warranty period. A boat is also used commercially when, at any point during the warranty period, it has commercial tags or is licensed for commercial use.
3. Emission-related components that are installed on EPA certified boats registered in the USA are covered for thirty (30) consecutive months or 175 hours of engine use whichever occurs first. If the 175 hours of engine use are reached during the regular warranty coverage period, the emission-related components are still covered by BRP’s standard warranty until the end of regular coverage period.
4. The list of the current warranted emission-related components is known by your authorized BRP dealer.
5. For boats produced by BRP for sale in the state of California, that are originally sold to a resident or subsequently warranty registered to a resident in the state of California, please also refer to the applicable California Emissions Control Warranty Statement.

The repair or replacement of parts or the performance of service under this warranty does not extend the life of this warranty beyond its original expiration date.

#### **5) CONDITIONS TO HAVE WARRANTY COVERAGE**

This warranty coverage is available **only** if **each** of the following conditions has been fulfilled:

- The 2011 Sea-Doo® boat must be purchased as new and unused by its first owner from a BRP dealer authorized to distribute Sea-Doo® boats products in the country in which the sale occurred (“BRP dealer”);

- The BRP specified pre-delivery inspection process must be completed and documented and signed by the purchaser;
- The product must have undergone proper registration by an authorized BRP dealer;
- The 2011 Sea-Doo® boat must be purchased in the country in which the purchaser resides and
- Routine maintenance outlined in the Operator's Guide must be timely performed in order to maintain warranty coverage. BRP reserves the right to make warranty coverage contingent upon proof of proper maintenance.

BRP will not honor this limited warranty to any private use owner or commercial use owner if one of the preceding conditions has not been met. Such limitations are necessary in order to allow BRP to preserve both the safety of its products, and also that of its consumers and the general public.

## **6) WHAT TO DO TO OBTAIN WARRANTY COVERAGE**

The customer must cease using the boat upon the appearance of an anomaly. The customer must notify a servicing BRP dealer within two (2) days of the appearance of a defect, and provide it with reasonable access to the product and reasonable opportunity to repair it. The customer must also present to the authorized BRP dealer, proof of purchase of the product and must sign the repair/work order prior to starting the repair in order to validate the warranty repair. All parts replaced under this limited warranty become the property of BRP.

## **7) WHAT BRP WILL DO**

BRP's obligations under this warranty are limited to, at its sole discretion, repairing parts found defective under normal use, maintenance and service, or replacing such parts with new genuine BRP parts without charge for parts and labor, at any authorized BRP dealer during the warranty coverage period under the conditions described herein. BRP's responsibility is limited to making the required repairs or replacements of parts. No claim of breach of warranty shall be cause for cancellation or rescission of the sale of the boat to the owner.

In the event that service is required outside of the country of original sale, the owner will bear responsibility for any additional charges due to local practices and conditions, such as, but not limited to, freight, insurance, taxes, license fees, import duties, and any and all other financial charges, including those levied by governments, states, territories and their respective agencies.

BRP reserves the right to improve or modify products from time to time without assuming any obligation to modify products previously manufactured.

## **8) SUPPLIER WARRANTIES**

Jensen+ audio components installed as original equipment on boats are warranted separately by ASA Electronics<sup>†</sup>. If such an audio component is installed on your Sea-Doo® boat, please contact your authorized BRP dealer for warranty coverage information and assistance.

If you cannot resolve the issue through your authorized BRP dealer, you can find all the contact information for ASA Electronics on their company website:

[www.asaelectronics.com](http://www.asaelectronics.com).

## 9) TRANSFER

If the ownership of a product is transferred during the warranty coverage period, this warranty shall also be transferred and be valid for the remaining coverage period provided that BRP is notified of such transfer of ownership in the following way:

1. The former owner contacts BRP (at the phone number provided below) or an authorized BRP dealer and gives the coordinates of the new owner; or
2. BRP or an authorized BRP dealer receives a proof that the former owner agreed to the transfer of ownership, in addition to the coordinates of the new owner.

## 10) CONSUMER ASSISTANCE

In the event of a controversy or a dispute in connection with this limited warranty, BRP suggests that you try to resolve the issue at the dealership level. We recommend discussing the issue with the authorized BRP dealer's service manager or owner.

If the issue has not yet been resolved, please submit your complaint in writing or call the appropriate number below:

### In Canada

**BOMBARDIER RECREATIONAL PRODUCTS INC.**  
SEA-DOO  
Customer Assistance Center  
75 J.A. Bombardier street  
Sherbrooke QC J1L 1W3  
Tel.: 819 566-3366

### In USA

**BRP US INC.**  
SEA-DOO  
Customer Assistance Center  
7575 Bombardier COURT  
Wausau WI 54401  
Tel.: 715 848-4957

\*In Canada, products are distributed and serviced by Bombardier Recreational Products Inc  
© 2010 Bombardier Recreational Products Inc. All rights reserved.

® Registered trademark of Bombardier Recreational Products Inc. or its subsidiaries.

+ is the trademark of its owner.

‡ is the trademark of its owner.

---

# CALIFORNIA EMISSION CONTROL WARRANTY STATEMENT FOR MODEL-YEAR 2011 SEA-DOO® BOATS WITH 4-TEC® ENGINES OR 4-TEC® IC ENGINES

For California, your 2011 Sea-Doo® boat ("boat") has a special environmental label required by the California Air Resources Board. The label has 1, 2, 3 or 4 stars. A hangtag, provided with your boat, describes the meaning of the star rating system.

## The Star Label Means Cleaner Marine Engines

The Symbol for Cleaner Marine Engines:



F18L3CQ

### Cleaner Air and Water

For a healthier lifestyle and environment.

### Better Fuel Economy

Burns up to 30 - 40 percent less gas and oil than conventional carbureted two-stroke engines, saving money and resources.

### Longer Emission Warranty

Protects consumer for worry free operation.

### One Star – Low Emission

The one-star label identifies personal watercraft, outboard, stern drive and inboard engines that meet the Air Resources Board's Personal Watercraft and Outboard marine engine 2001 exhaust emission standards. Engines meeting these standards have 75% lower emissions than conventional carbureted two-stroke engines. These engines are equivalent to the U.S. EPA's 2006 standards for marine engines.

### Two Stars - Very Low Emission

The two-star label identifies personal watercraft, outboard, stern drive and inboard engines that meet the Air Resources Board's Personal Watercraft and Outboard marine engine 2004 exhaust emission standards. Engines meeting these standards have 20% lower emissions than One Star - Low-Emission engines.

### Three Stars - Ultra Low Emission

The three-star label identifies engines that meet the Air Resources Board's Personal Watercraft and Outboard marine engine 2008 exhaust emission standards or the Stern drive and Inboard marine engine 2003 exhaust emission standards. Engines meeting these standards have 65% lower emissions than One Star – Low Emission engines.

## **Four Stars - Super Ultra Low Emission**

The four-star label identifies engines that meet the Air Resources Board's Stern-drive and Inboard marine engine 2011 exhaust emission standards. Personal Watercraft and Outboard marine engines may also comply with these standards. Engines meeting these standards have 90% lower emissions than One Star – Low Emission engines.

For more information: Cleaner Watercraft – Get the Facts  
1 800 END-SMOG  
[www.arb.ca.gov](http://www.arb.ca.gov)

## **Your Emission Control Warranty Rights and Obligations**

The California Air Resources Board and BRP US Inc. ("BRP") are pleased to explain the emission control system warranty on your Model Year 2011 Sea-Doo® boat. In California, new boat engines must be designed, built and equipped to meet the State's stringent anti-smog standards. BRP must warrant the emission control system on your boat engine for the period of time listed below provided there has been no abuse, neglect or improper maintenance of your boat engine.

Your emission control system may include parts such as the fuel injection system, the ignition system and catalytic converter. Also included may be hoses, belts, connectors and other emission related assemblies.

Where a warrantable condition exists, BRP will repair your boat engine at no cost to you including diagnosis, parts and labor provided that such work is performed by an authorized BRP dealer.

## **Manufacturer's Limited Warranty Coverage**

This emission limited warranty covers Model Year 2011 Sea-Doo® boats certified and produced by BRP for sale in California, that are originally sold in California to a California resident or subsequently warranty registered to a California resident. The BRP limited warranty conditions for Sea-Doo® boats are still applicable to these models with the necessary modifications. Select emission control parts of your 2011 Sea-Doo® boat are warranted from the date of delivery to the first retail consumer for a period of 4 years, or for 250 hours of use, whichever occurs first. However, warranty coverage based on the hourly period is only permitted for boat equipped with the appropriate hour meters or their equivalent. If any emission-related part on your engine is defective under warranty, the part will be repaired or replaced by BRP.

**Parts covered for Model Year 2011 Sea-Doo® boat equipped with 4-TEC® engines:**

Idle Bypass Valve	Fuel Filter
Throttle Position Sensor	Intake Manifold
Intake Manifold Air Pressure Sensor	Air Box
Intake Manifold Air Temperature Sensor	Air Intake Adapter
Engine Temperature Sensor	Spark Plugs
Knock Sensor	Ignition Coils
Emission Control Module ECM	Intake and Exhaust Valve and Seals
Throttle Body	Crankcase Ventilation Valve
Fuel Rail	Throttle Body Seal
Fuel Injectors	Wire Harness and Connectors
Fuel Pressure Regulator	Intake Manifold Seal
Fuel Pump	

The emission warranty covers damage to other engine components that is caused by the failure of a warranted part. The BRP Operator's Guide provided contains written instructions for the proper maintenance and use of your boat. All emission warranty parts are warranted by BRP for the entire warranty period of the boat, unless the part is scheduled for replacement as required maintenance in the Operator's Guide.

Emission warranty parts that are scheduled for replacement, as required maintenance, are warranted by BRP for the period of time before the first scheduled replacement date for that part. Emission warranty parts that are scheduled for regular inspection, but not regular replacement, are warranted by BRP for the entire warranty period of the boat. Any emission warranty part repaired or replaced under the terms of this warranty statement is warranted by BRP for the remainder of the warranty period of the original part. All parts replaced under this limited warranty become the property of BRP. Maintenance receipts and records should be transferred to each subsequent owner of the boat.



## **Owner's Warranty Responsibilities**

As the owner of a 2011 Sea-Doo® boat, you are responsible for the performance of the required maintenance listed in your Operator's Guide. BRP recommends that you retain all receipts covering maintenance your boat engine, but BRP cannot deny warranty solely for the lack of receipts or your failure to ensure the performance of all scheduled maintenance. As the owner of a Sea-Doo® boat, you should however be aware that BRP may deny you warranty coverage if your engine(s) or a part has failed due to abuse, neglect, improper maintenance or unapproved modifications. You are responsible for presenting your engine to an authorized BRP Dealer as soon as a problem exists. The warranty repairs will be completed in a reasonable amount of time, not to exceed 30 days. If you have any questions regarding your warranty rights and responsibilities or for the name and location of the nearest authorized BRP Dealer you should contact the Customer Assistance Center at 1-715-848-4957.

---

# **BRP INTERNATIONAL LIMITED WARRANTY FOR MODEL YEAR 2011 SEA-DOO® BOATS**

## **1) SCOPE**

BRP US Inc. ("BRP")\* warrants its new and unused Model Year 2011 Sea-Doo® boats ("Boat") sold by authorized BRP Distributors/Dealers ("Distributor/Dealer") outside of the United States, Canada and states members of the European Economic Area (which is comprised of the states member of the European Union plus Norway, Iceland and Liechtenstein) Turkey, and states members of the Commonwealth of the Independent States ("CIS") (which is comprised of the Russian Federation and ex-members states of the USSR), will be free from defects in material and workmanship for the period and under the conditions below. This limited warranty will become null and void if: (1) the boat was used for racing or any other competitive activity, at any point, even by a previous owner; or (2) the boat has been altered or modified in such a way so as to adversely affect its operation, performance or durability, or has been altered or modified to change its intended use.

All genuine BRP parts and accessories, installed by an authorized BRP Distributor/Dealer (as hereinafter defined) at the time of delivery of the 2011 Sea-Doo® Boat, carry the same warranty as that of the Boat.

## **2) LIMITATIONS OF LIABILITY**

THIS WARRANTY IS EXPRESSLY GIVEN AND ACCEPTED IN LIEU OF ANY AND ALL OTHER WARRANTIES, EXPRESSED OR IMPLIED, INCLUDING WITHOUT LIMITATION ANY WARRANTY OF MERCHANTABILITY OR FITNESS FOR A PARTICULAR PURPOSE. TO THE EXTENT THAT THEY CANNOT BE DISCLAIMED, THE IMPLIED WARRANTIES ARE LIMITED IN DURATION TO THE LIFE OF THE EXPRESS WARRANTIES. INCIDENTAL AND CONSEQUENTIAL DAMAGES ARE EXCLUDED FROM COVERAGE UNDER THIS WARRANTY. SOME STATES/PROVINCES DO NOT ALLOW FOR THE DISCLAIMERS, LIMITATIONS AND EXCLUSIONS IDENTIFIED ABOVE, AS A RESULT, THEY MAY NOT APPLY TO YOU. THIS WARRANTY GIVES YOU SPECIFIC RIGHTS, AND YOU MAY ALSO HAVE OTHER LEGAL RIGHTS WHICH MAY VARY FROM COUNTRY TO COUNTRY.

Neither the authorized BRP Distributor/Dealer, nor any other person has been authorized to make any affirmation, representation or warranty regarding the product, other than those contained in this limited warranty, and if made, shall not be enforceable against BRP. BRP reserves the right to modify this warranty at any time, being understood that such modification will not alter the warranty conditions applicable to the products sold while this warranty is in effect.

## **3) EXCLUSIONS – ARE NOT WARRANTED**

The following are not warranted under any circumstances:

- Replacement of parts due to normal wear and tear;
- Routine maintenance parts and services, including but not limited to adjustments, oil, lubricant and coolant changes, spark plug replacement, water pumps and the like;
- Damage caused by improper or lack of maintenance or storage, or failure to follow the procedures and recommendations in the Operator's Guide;

- Damage resulting from removal of parts, improper repairs, service, maintenance, or modification, or use of parts or accessories not manufactured or approved by BRP, which in its reasonable judgment, are either incompatible with Boats or adversely affect its operation, performance, or durability, or resulting from repairs done by a person that is not an authorized BRP Distributor/Dealer;
- Damage caused by abuse, misuse, abnormal use, neglect, racing, improper operation or operation of the Boat in a manner inconsistent with the recommended operation described in the Operator's Guide;
- Damages resulting from external damage, submersion, water or foreign object ingestion, accident, fire, theft, vandalism or any act of God;
- Operation with fuel, oils or lubricants that are not suitable for the Boat (see Operator's Guide);
- Damage from rust, corrosion or exposure to the elements;
- Damage from cooling system or jet pump blockage by foreign material;
- Incidental or consequential damages, or damages of any kind including without limitation towing, storage, telephone, rental, taxi, inconvenience, insurance coverage, loan payments, loss of time, loss of income; and,
- Damage to gel coat finish including but not limited to cosmetic gel coat finish defects, blisters, starring, crazing; and fiberglass delaminating caused by blisters, crazing, spider or hairline cracks or exposure to the elements.

#### **4) WARRANTY COVERAGE DURATION**

This limited warranty will be in effect from the date of delivery to the first retail consumer or the date the boat is first put to use, whichever occurs first, for a period of:

- TWELVE (12) CONSECUTIVE MONTHS for private, recreational use, except for the deck and hull fiberglass structure that are covered for SIXTY (60) CONSECUTIVE MONTHS;
- FOUR (4) CONSECUTIVE MONTHS for commercial use, except for the deck and hull fiberglass structure that are covered for TWELVE (12) CONSECUTIVE MONTHS. A boat is used commercially when it is used in connection with generating income or any work or employment during any part of the warranty period. A Boat is also used commercially when, at any point during the warranty period, it has commercial tags or is licensed for commercial use.

The repair or replacement of parts or the performance of service to a Boat under this warranty does not extend the life of this limited warranty beyond its original expiration date.

#### **5) CONDITIONS TO HAVE WARRANTY COVERAGE**

This warranty coverage is available **only** if **each** of the following conditions has been fulfilled:

- The 2011 Sea-Doo® boats must be purchased as new and unused by its first owner from a BRP Distributor/Dealer authorized to distribute SEA-DOO® BOAT products in the country in which the sale occurred;
- The BRP specified pre-delivery inspection process must be completed and documented;
- The product must have undergone proper registration by an authorized BRP Distributor/Dealer;

- The 2011 Sea-Doo® boats must be purchased in the country in which the purchaser resides; and,
- Routine maintenance outlined in the Operator's Guide must be timely performed in order to maintain warranty coverage. BRP reserves the right to make warranty coverage contingent upon proof of proper maintenance.

BRP will not honor this limited warranty to any private use owner or commercial use owner if one of the preceding conditions has not been met. Such limitations are necessary in order to allow BRP to preserve both the safety of its products, and that of its consumers and the general public.

## **6) WHAT TO DO TO OBTAIN WARRANTY COVERAGE**

The customer must notify a servicing BRP Distributor/Dealer within two (2) days of the appearance of a defect, and provide it with reasonable access to the product and reasonable opportunity to repair it. The customer must also present to the authorized BRP Distributor/Dealer, proof of purchase of the product and must sign the repair/work order prior to starting the repair in order to validate the warranty repair. All parts replaced under this limited warranty become the property of BRP.

## **7) WHAT BRP WILL DO**

BRP's obligations under this warranty are limited to, at its sole discretion, repairing parts found defective under normal use, maintenance and service, or replacing such parts with new genuine BRP parts without charge for parts and labor, at any authorized BRP Distributor/Dealer during the warranty coverage period under the conditions described herein. BRP's responsibility is limited to making the required repairs or replacements of parts. No claim of breach of warranty shall be cause for cancellation or rescission of the sale of the boat to the owner.

In the event that service is required outside of the country of original sale, the owner will bear responsibility for any additional charges due to local practices and conditions, such as, but not limited to, freight, insurance, taxes, license fees, import duties, and any and all other financial charges, including those levied by governments, states, territories and their respective agencies.

BRP reserves the right to improve or modify products from time to time without assuming any obligation to modify products previously manufactured.

## **8) TRANSFER**

If the ownership of a Product is transferred during the warranty coverage period, this warranty shall also be transferred and be valid for the remaining coverage period provided that BRP is notified of such transfer of ownership in the following way:

1. The former owner contacts BRP (at the phone number provided below) or an authorized Distributor/Dealer and gives the coordinates of the new owner; or
2. BRP or an authorized Distributor/Dealer receives a proof that the former owner agreed to the transfer of ownership, in addition to the coordinates of the new owner.

## **9) CONSUMER ASSISTANCE**

In the event of a controversy or a dispute in connection with this limited warranty, BRP suggests that you try to resolve the issue at the dealership level.

If further assistance is required, the Distributor's service department should be contacted in order to resolve the matter. You will find your distributor's coordinates on [www.brp.com](http://www.brp.com).

If the matter still remains unresolved then contact BRP by writing to us at the address listed below.

**For countries within Europe, Middle East and Africa, please contact our European office**

**BRP EUROPE N.V.**

Customer Assistance Center  
Skaldenstraat 125  
9042 Gent  
Belgique  
Tel.: +32-9-218-26-00

**For all other countries, please contact your local distributor or our North America office**

**BOMBARDIER RECREATIONAL PRODUCTS INC.**

Customer Assistance Center  
75 J.A. Bombardier Street  
Sherbrooke QC J1L 1W3  
Tel.: 1 819 566-3366

© 2010 Bombardier Recreational Products Inc. All rights reserved.

® Registered trademark of Bombardier Recreational Products Inc.

\* For the territory covered by this limited warranty, products are distributed and serviced by Bombardier Recreational Products Inc. or its affiliates.

© 2010 Bombardier Recreational Products Inc. All rights reserved.

® Registered trademark of Bombardier Recreational Products Inc. or its affiliates.

---

# **BRP LIMITED WARRANTY FOR THE EUROPEAN AND THE RUSSIAN ECONOMIC AREA AND TURKEY: MODEL YEAR 2011 SEA-DOO® BOATS**

## **1) SCOPE OF THE LIMITED WARRANTY**

BRP US Inc. ("BRP")\* warrants its new and unused model-year 2011 Sea-Doo® boats sold by authorized BRP distributors/dealers ("Distributors/Dealers") in member states of the European Economic Area ("EEA") (which is comprised of the state members of the European Union plus Norway, Iceland and Liechtenstein), in member states of the Commonwealth of the Independent States ("CIS") (which is comprised of the Russian Federation and ex-members states of the USSR), and Turkey from defects in material or workmanship for the period and under the conditions described below. This limited warranty will become null and void if: (1) the boat was used for racing or any other competitive activity, at any point, even by a previous owner; or (2) the boat has been altered or modified in such a way so as to adversely affect its operation, performance or durability, or has been altered or modified to change its intended use.

All genuine SEA-DOO® BOAT parts and accessories, installed by an authorized BRP Distributors/Dealers at the time of delivery of the 2011 Sea-Doo® boats, carry the same warranty as that of the boats.

## **2) LIMITATIONS OF LIABILITY**

THIS WARRANTY IS EXPRESSLY GIVEN AND ACCEPTED IN LIEU OF ANY AND ALL OTHER WARRANTIES, EXPRESSED OR IMPLIED, INCLUDING WITHOUT LIMITATION ANY WARRANTY OF MERCHANTABILITY OR FITNESS FOR A PARTICULAR PURPOSE. TO THE EXTENT THAT THEY CANNOT BE DISCLAIMED, THE IMPLIED WARRANTIES ARE LIMITED IN DURATION TO THE LIFE OF THE EXPRESS WARRANTY. INCIDENTAL AND CONSEQUENTIAL DAMAGES ARE EXCLUDED FROM COVERAGE UNDER THIS WARRANTY. SOME JURISDICTIONS DO NOT ALLOW FOR THE DISCLAIMERS, LIMITATIONS AND EXCLUSIONS IDENTIFIED ABOVE, AS A RESULT, THEY MAY NOT APPLY TO YOU. THIS WARRANTY GIVES YOU SPECIFIC RIGHTS, AND YOU MAY ALSO HAVE OTHER LEGAL RIGHTS WHICH MAY VARY FROM COUNTRY TO COUNTRY.

Neither the BRP Distributor/Dealer nor any other person has been authorized to make any affirmation, representation or warranty regarding the product, other than those contained in this limited warranty, and if made, shall not be enforceable against BRP.

BRP reserves the right to modify this warranty at any time, being understood that such modification will not alter the warranty conditions applicable to the products sold while this warranty is in effect.

## **3) EXCLUSIONS – ARE NOT WARRANTED**

The following are not warranted under any circumstances:

- Replacement of parts due to normal wear and tear;
- Routine maintenance parts and services, including but not limited to adjustments, oil, lubricant and coolant changes, spark plug replacement, water pumps and the like;
- Damage caused by improper or lack of maintenance or storage, or failure to follow the procedures and recommendations in the Operator's Guide;

- Damage resulting from removal of parts, improper repairs, service, maintenance, or modification, or use of parts or accessories not manufactured or approved by BRP, which in its reasonable judgment, are either incompatible with Boats or adversely affect its operation, performance, or durability, or resulting from repairs done by a person that is not an authorized BRP Distributor/Dealer;
- Damage caused by abuse, misuse, abnormal use, neglect, racing, improper operation or operation of the Boat in a manner inconsistent with the recommended operation described in the Operator's Guide;
- Damages resulting from external damage, submersion, water or foreign object ingestion, accident, fire, theft, vandalism or any act of God;
- Operation with fuel, oils or lubricants that are not suitable for the Boat (see Operator's Guide);
- Damage from rust, corrosion or exposure to the elements;
- Damage from cooling system or jet pump blockage by foreign material;
- Incidental or consequential damages, or damages of any kind including without limitation towing, storage, telephone, rental, taxi, inconvenience, insurance coverage, loan payments, loss of time, loss of income; and,
- Damage to gel coat finish including but not limited to cosmetic gel coat finish defects, blisters, starring, crazing; and fiberglass delaminating caused by blisters, crazing, spider or hairline cracks or exposure to the elements.

#### **4) WARRANTY COVERAGE PERIOD**

This limited warranty will be in effect from the date of delivery to the first retail consumer or the date the product is first put into use, whichever occurs first and for a period of:

TWENTY-FOUR (24) CONSECUTIVE MONTHS for private use owners except for the deck and hull fiberglass structure that are covered for SIXTY (60) CONSECUTIVE MONTHS;

FOUR (4) CONSECUTIVE MONTHS for commercial use owners except for the deck and hull fiberglass structure that are covered for TWELVE (12) CONSECUTIVE MONTHS.

A boat is used commercially when it is used in connection with generating income or any work or employment during any part of the warranty period. A boat is also used commercially when, at any point during the warranty period, it has commercial tags or is licensed for commercial use.

The repair or replacement of parts or the performance of service under this warranty does not extend the life of this warranty beyond its original expiration date.

Note that the duration and any other modalities of the warranty coverage are subject to the applicable national or local legislation in your country.

#### **5) CONDITIONS TO HAVE WARRANTY COVERAGE**

This warranty coverage is available **only** if **each** of the following conditions has been fulfilled:

- The 2011 Sea-Doo® boats must be purchased as new and unused by its first owner from a BRP Distributor/Dealer authorized to distribute SEA-DOO® BOAT products in the country in which the sale occurred;

- The BRP specified pre-delivery inspection process must be completed and documented;
- The product must have undergone proper registration by an authorized BRP Distributor/Dealer;
- The 2011 Sea-Doo® boats must be purchased within the EEA by an EEA resident, in the CIS for residents of the countries comprised in such area and in Turkey for residents of Turkey; and
- Routine maintenance outlined in the Operator's Guide must be timely performed in order to maintain warranty coverage. BRP reserves the right to make warranty coverage contingent upon proof of proper maintenance.

BRP will not honor this limited warranty to any private use owner or commercial use owner if one of the preceding conditions has not been met. Such limitations are necessary in order to allow BRP to preserve both the safety of its products, and also that of its consumers and the general public.

## **6) WHAT TO DO TO OBTAIN WARRANTY COVERAGE**

The customer must notify a servicing BRP Distributor/Dealer within two (2) months of the appearance of a defect, and provide it with reasonable access to the product and reasonable opportunity to repair it. The customer must also present to the authorized BRP Distributor/Dealer, proof of purchase of the product and must sign the repair/work order prior to starting the repair in order to validate the warranty repair. All parts replaced under this limited warranty become the property of BRP.

Note that the notification period is subject to the applicable national or local legislation in your country.

## **7) WHAT BRP WILL DO**

BRP's obligations under this warranty are limited to, at its sole discretion, repairing parts found defective under normal use, maintenance and service, or replacing such parts with new genuine boat parts without charge for parts and labor, at any authorized BRP Distributor/Dealer during the warranty coverage period under the conditions described herein. BRP's responsibility is limited to making the required repairs or replacements of parts. No claim of breach of warranty shall be cause for cancellation or rescission of the sale of the boat to the owner.

In the event that service is required outside of the country of original sale, the owner will bear responsibility for any additional charges due to local practices and conditions, such as, but not limited to, freight, insurance, taxes, license fees, import duties, and any and all other financial charges, including those levied by governments, states, territories and their respective agencies.

BRP reserves the right to improve or modify products from time to time without assuming any obligation to modify products previously manufactured.

## **8) TRANSFER**

If the ownership of a Product is transferred during the warranty coverage period, this warranty shall also be transferred and be valid for the remaining coverage period provided that BRP is notified of such transfer of ownership in the following way:

The former owner contacts BRP (at the phone number provided below) or an



authorized Distributor/Dealer and gives the coordinates of the new owner; or BRP or an authorized Distributor/Dealer receives proof that the former owner agreed to the transfer of ownership, in addition to the coordinates of the new owner.

## **9) CONSUMER ASSISTANCE**

In the event of a controversy or a dispute in connection with this limited warranty, BRP suggests that you try to resolve the issue at the dealership level. We recommend discussing the issue with the authorized Distributor/Dealer's service manager or owner.

- If further assistance is required, the distributor's service department should be contacted in order to resolve the matter. You will find your distributor's coordinates on [www.brp.com](http://www.brp.com).
- If the matter still remains unresolved then contact BRP at the address listed below.

**For countries within Europe, to the exception of the Scandinavian countries, and for countries within the CIS and Turkey, please contact our European office at:**

**BRP EUROPE N.V.**

Customer Assistance Center  
Skaldenstraat 125  
9042 Gent  
Belgium  
Tel.: +32-9-218-26-00

**For Scandinavian countries, please contact our office in Finland at:**

**BRP FINLAND OY**

Service Department  
Isoaavantie 7  
FIN-96320 Rovaniemi  
Finland  
Tel.: +358163208111

**For all other countries, please contact your local distributor or our North America office:**

**BOMBARDIER RECREATIONAL PRODUCTS INC.**

Customer Assistance Center  
75 J.A. Bombardier Street  
Sherbrooke QC J1L 1W3  
Tel.: 1 819 566-3366

\* For the territory covered by this limited warranty, products are distributed and serviced by Bombardier Recreational Products Inc. or its affiliates.

© 2010 Bombardier Recreational Products Inc. All rights reserved.

® Registered trademark of Bombardier Recreational Products Inc.

***This page is  
intentionally blank***

# ***CUSTOMER INFORMATION***

---

## PRIVACY INFORMATION

BRP wishes to inform you that your coordinates will be used for safety and warranty related purposes. Furthermore, BRP and its affiliates may use its customer list to distribute marketing and promotional information about BRP and related products.

To exercise your right to consult or correct your data, or to be removed from the addressee-list for direct marketing, please contact BRP.

By E-mail: [privacyofficer@brp.com](mailto:privacyofficer@brp.com)

By mail: BRP  
Senior Legal Counsel-Privacy Officer  
726 St-Joseph  
Valcourt QC  
Canada  
J0E 2L0

---

# CHANGE OF ADDRESS/OWNERSHIP

If your address has changed or if you are the new owner of the boat, be sure to notify BRP by either:

- Mailing one of the following card below;
- **North America only:** calling at 715 848-4957 (USA) or 819 566-3366 (Canada);
- Contacting an authorized BRP dealer.

In case of change of ownership, please join a proof that the former owner agreed to the transfer.

Notifying BRP, even after the expiration of the limited warranty, is very important as it enables BRP to reach the boat owner if necessary, like when safety recalls are initiated. It is the owner's responsibility to notify BRP.

**STOLEN UNITS:** In the event that your boat is stolen, you should notify your area's distributor warranty department of such. We will ask you to provide your name, address, phone number, Hull Identification Number and date it was stolen.

## **In North America**

### **BOMBARDIER RECREATIONAL PRODUCTS INC.**

Warranty Department  
75 J.-A. Bombardier Street  
Sherbrooke QC J1L 1W3  
Canada

## **Other areas in the world except Scandinavian countries**

### **BRP EUROPEAN DISTRIBUTION**

Warranty Department  
Chemin de Messidor 5-7  
1006 Lausanne  
Switzerland

## **Scandinavian countries**

### **BRP FINLAND OY**

Service Department  
Isoaavantie 7  
FIN-96320 Rovaniemi  
Finland  
Tel.: +358 16 3208 111

***This page is  
intentionally blank***







**BOAT MODEL No.** \_\_\_\_\_

**HULL IDENTIFICATION NUMBER (H.I.N.)** \_\_\_\_\_

**ROTAX ENGINE IDENTIFICATION NUMBER (E.I.N.)** \_\_\_\_\_

**Owner:** \_\_\_\_\_  
NAME

\_\_\_\_\_  
No. STREET APT

\_\_\_\_\_  
CITY STATE/PROVINCE ZIP/POSTAL CODE

**Purchase Date** \_\_\_\_\_  
YEAR MONTH DAY

**Warranty Expiry Date** \_\_\_\_\_  
YEAR MONTH DAY

To be completed by the dealer at the time of the sale.

DEALER IMPRINT AREA

F00A35LA

Please verify with your selling dealer to ensure your SEA-DOO boat has been registered with BRP.

264 000 066

CA

OPERATOR'S GUIDE, 200 SPEEDSTER / ENGLISH  
GUIDE DU CONDUCTEUR, 200 SPEEDSTER / ANGLAIS

FAIT AU / MADE IN CANADA

U/M:P.C.