

SEA-DOO®



2010

Sport Boats
**OPERATOR'S
GUIDE**
Includes,
SAFETY, VEHICLE
and MAINTENANCE
INFORMATION

150 SPEEDSTER™

⚠ WARNING

Read this guide thoroughly. It contains important safety information.
Minimum recommended operator's age: 16 years old.
Keep this Operator's Guide in the boat.

2 0 4 6 3 0 4 0 0

⚠ WARNING

Disregarding any of the safety precautions and instructions contained in this Operator's Guide, *SAFETY DVD* and on-product labels could cause injury including the possibility of death!

⚠ WARNING

This boat may exceed the performance of other boats you may have ridden in the past. Take time to familiarize yourself with your new boat.

CALIFORNIA PROPOSITION 65 WARNING

⚠ WARNING

This product contains or emits chemicals known to the state of California to cause cancer and birth defects or other reproductive harm.

In Canada, products are distributed by Bombardier Recreational Products Inc. (BRP).

In USA, products are distributed by BRP US Inc.

This is a non-exhaustive list of trademarks that are the property of Bombardier Recreational Products Inc. or its affiliates:

4-TEC™

ROTAX®

Speedster™

D.E.S.S.™

Sea-Doo®

XPST™

Flitz is a registered trademark of Flitz International.

Gelcote is a trademark of Gelcote International.

Spray Nine is a trademark of Spray Nine Corporation.

FOREWORD

Congratulations on your purchase of a new Sea-Doo® Sport Boats. It is backed by the Bombardier Recreational Products Inc. (BRP) warranty and a network of authorized Sea-Doo Sport Boats dealers ready to provide the parts, service or accessories you may require.

Your dealer is committed to your satisfaction. He has taken training to perform the initial setup and inspection of your boat as well as completed the final adjustment before you took possession. If you need more complete servicing information, please ask your dealer.

At delivery, you were also informed of the warranty coverage and signed the *PREDELIVERY CHECK LIST* to ensure your new boat was prepared to your entire satisfaction.

Know Before you Go

To learn how to reduce the risk for you or other persons being injured or killed, read the following sections before you operate the vehicle:

- SAFETY INFORMATION
- VEHICLE INFORMATION.

Also, read all safety labels on your sport boat and watch your *SAFETY DVD*.

We highly recommend that you take a safe boating course. Please check your dealer or local authorities for availability in your area.

In certain areas, an operator competency card is mandatory to operate a pleasure craft.

Failure to follow the warnings contained in this Operator's Guide can result in **SERIOUS INJURY** or **DEATH**.

Safety Messages

The types of safety messages, what they look like and how they are used in this guide are explained as follows:

 **DANGER**
Indicates a hazardous situation which, if not avoided, will result in death or serious injury.

 **WARNING**
Indicates a potential hazard which, if not avoided, could result in serious injury or death.

 **CAUTION** Indicates a hazard situation which, if not avoided, could result in minor or moderate injury.

NOTICE Indicates an instruction which, if not followed, could severely damage vehicle components or other property.

About this Operator's Guide

This Operator's Guide has been prepared to acquaint the owner and the operator of a new boat with the various controls, maintenance and safe operating instructions.

Keep this Operator's Guide in the boat as you can refer to it for things such as maintenance, troubleshooting and instructing others.

Note that this guide is available in several languages. In the event of any discrepancy, the English version shall prevail.

If you want to view and/or print an extra copy of your Operator's Guide, simply visit the following website www.operatorsguide.brp.com.

The informations contained in this document are correct at the time of publication. BRP, however, maintains a policy of continuous improvement of its products without imposing upon itself any obligation to install them on products previously manufactured. Due to late changes, some differences be-

tween the manufactured product and the descriptions and/or specifications in this guide may occur. BRP reserves the right at any time to discontinue or change specifications, designs, features, models or equipment without incurring any obligation upon itself.

This Operator's Guide and the *SAFETY DVD* should remain with the boat when it's sold.

TABLE OF CONTENTS

FOREWORD	1
Know Before you Go	1
Safety Messages.....	1
About this Operator's Guide	1

SAFETY INFORMATION

SPECIAL SAFETY MESSAGES	8
Reminders Regarding Operation	8
Carbon Monoxide and Boating.....	10
Water Sports	13
Hypothermia.....	17
Voluntary Inspections	17
Safe Boating Courses.....	17

SAFETY EQUIPMENT	18
Required Safety Equipment.....	18
Additional Recommended Equipment	21

SAFE BOATING PRACTICES	22
Drugs and Alcohol.....	22
Safe Operation	22

NAVIGATION RULES	24
Operating Rules	24

FUELING	26
Recommended Fuel	26
Fueling Procedure.....	26

TRAILERING INFORMATION	28
-------------------------------------	-----------

LOCATION OF IMPORTANT ON-PRODUCT LABELS	29
Hang Tag	29
Safety Labels	30
Compliance Labels.....	33
Technical Information Labels.....	33

PRE-RIDE INSPECTION	34
Hull	35
Jet Pump Water Intake	35
Bilge	35
Engine Compartment	35
Battery	35
Main Battery Cut-Off Switch	35
Engine Coolant	35
Engine Oil	35
Steering System	35
Throttle/Shifter System.....	36
D.E.S.S. Post and Engine Start/Stop Switch	36
Navigation Lights.....	36
Towing Tower (optional)	36

PRE-RIDE INSPECTION (cont'd)

Mandatory Safety Boating Equipment 36
Storage Compartment Covers 36
Fuel..... 36

VEHICLE INFORMATION

CONTROLS, INSTRUMENTS AND EQUIPMENT 38

1) D.E.S.S. Post 40
2) Steering Wheel 41
3) Throttle/Shifter Controller 41
4) Start/Stop Switch..... 41
5) Navigation Lights Switch 42
6) Bilge Pump Switch 42
7) Bilge Blower Switch..... 43
8) Information Center Gauge 43
9) Bilge Drain Plugs 45
10) Grab Handles 45
11) Rear Grab Handles 46
12) Swim Platform 46
13) Ladder 46
14) Seats 46
15) Front Boarding Step 47
16) Spotter Seat 47
17) Cup Holders 47
18) Front Storage Compartment..... 47
19) Deck Storage Compartment 48
20) Rear Storage Compartment..... 49
21) Bow Lights 49
22) Stern Light Socket 49
23) Mooring Cleats 50
24) Deck Drain 50
25) Bow and Stern Eyelets 51
26) Water Sport Towing Attachments 51
27) Main Battery Cut-Off Switch 53
28) AM/FM Radio/CD Player 54
29) 12-Volt Power Outlet 54

OPERATING INSTRUCTIONS 55

Operating During Break-In..... 55
Launching/Loading..... 55
Boarding from a Dock 55
Boarding from the Water 55
Starting..... 56
Throttle/Shifter Controller Operation 57
Steering Operation..... 58
Leaving the Shore 59
Rough Water or Poor Visibility Operation 59

OPERATING INSTRUCTIONS (cont'd)

Night Operation 59

Crossing Waves 59

Shutting Off the Engine 59

Stopping/Docking 59

Beaching 60

SPECIAL PROCEDURES 61

Jet Pump Water Intake and Impeller Cleaning 61

Towing the Boat in Water 61

Capsized Boat 62

Submerged Boat and Water-Flooded Engine 62

MAINTENANCE INFORMATION

MAINTENANCE SCHEDULE 64

10-HOUR INSPECTION 67

MAINTENANCE PROCEDURES 68

Throttle Body 68

Throttle Cable 68

Engine Oil 68

Engine Coolant 70

Exhaust System 71

Fuses 72

Bilge Blower 74

Navigation Lights 74

Deck Drain and Scupper Valve 75

Latches and Hinges 75

Reverse Gate 76

Ski Post 76

Sacrificial Anodes 76

Body and Hull 77

POST-OPERATION CARE 78

Exhaust System Flushing 78

Anticorrosion Treatment 78

Additional Care for Foul Water or Salt Water Use 78

STORAGE 79

Jet Pump Cleaning 79

Fuel System Protection 79

Throttle Body Lubrication 79

Engine Oil and Filter Replacement 79

Intercooler Draining 79

Exhaust System Flushing 80

Exhaust System Protection 80

Engine Internal Lubrication 80

Engine Coolant Test 81

Battery Removal and Storage 82

STORAGE (cont'd)
Boat Cleaning/Repair 82
Boat Protection..... 82
PRESEASON PREPARATION..... **83**

TECHNICAL INFORMATION

BOAT IDENTIFICATION **86**
Hull Identification Number 86
Engine Identification Number 86
ENGINE EMISSIONS INFORMATION..... **87**
Manufacturer's Responsibility 87
Dealer's Responsibility 87
Owner Responsibility 87
EPA Emission Regulations 87
EC DECLARATION OF CONFORMITY..... **88**
SPECIFICATIONS **89**

TROUBLESHOOTING

TROUBLESHOOTING GUIDELINES **94**
MONITORING SYSTEM **98**
Beeper Code Information 99

WARRANTY

BRP LIMITED WARRANTY FOR MODEL YEAR 2010 SEA-DOO® SPORT BOATS SOLD IN THE UNITED STATES AND CANADA **102**
CALIFORNIA AND NEW YORK EMISSION CONTROL WARRANTY STATEMENT FOR MODEL-YEAR 2010 SEA-DOO® SPORT BOATS WITH 4-TEC ENGINES OR 4-TEC IC ENGINES..... **106**
BRP INTERNATIONAL LIMITED WARRANTY FOR MODEL YEAR 2010 SEA-DOO® SPORT BOATS **110**
BRP LIMITED WARRANTY FOR THE EUROPEAN ECONOMIC AREA: MODEL YEAR 2010 SEA-DOO® SPORT BOATS **114**

CUSTOMER INFORMATION

PRIVACY INFORMATION **120**
CHANGE OF ADDRESS/OWNERSHIP..... **121**

SAFETY INFORMATION

SPECIAL SAFETY MESSAGES

Reminders Regarding Operation

- Engine exhaust contains carbon monoxide (CO), which can cause injury or death if inhaled in sufficient quantities. Educate all occupants about the risks and symptoms of CO accumulation and CO poisoning. For more information, refer to *CARBON MONOXIDE AND BOATING* section.
- Gasoline vapors can explode, resulting in injury or death. Always use blower for a minimum of 5 minutes before starting engine, then turn it OFF above idle speed. Use of the bilge blower should never replace "smelling" for gasoline vapor odors.
- If at any time, gasoline leaks/odors are found, do not start the engine. Have the boat serviced by an authorized Sea-Doo Sport Boats dealer.
- Always keep in mind that as the throttle lever is returned to the idle position, less directional control is available. To turn the boat, both steering and throttle are necessary.
- This boat has no brake. Stopping distance will vary depending on initial speed, load, wind, and water conditions. Practice stopping and docking in a safe, traffic-free area to have an idea of how long it will take to stop the boat under varying conditions. Do not release the throttle when trying to steer away from objects. You need throttle to steer. Do not use the boat's reverse to stop.
- Do not start or operate the boat if any person is not properly seated in a seat intended for use when underway (not the sun deck or swim platform) or if a person is nearby in the water.
- The boat's jet thrust can cause injury. Always accelerate slowly, and decelerate in a controlled fashion.
- Observe the instructions on all safety labels. They are there to help assure that you have a safe and enjoyable outing.
- Riding with passenger(s) or pulling other boats, tubes, a skier or a wake boarder makes the boat handle differently and requires greater skill.
- Certain boats may come equipped with tow eyelets, a ski pole or a wakeboard tower which can be used to attach a tow rope for a skier, tube or wakeboarder. Do not use these attachment points or any other portion of the boat to tow a parasail or another craft. Personal injury or severe damage may occur.
- In shallow water, proceed with caution and at very low speeds. Grounding or abrupt stops may result in injury to you, your passengers or others. The jet pump may pick up debris and throw it rearward causing a risk of injuring people or damaging the jet pump or other property.
- Combustion engines need air to operate; consequently this boat can not be totally watertight. Any maneuvers such as figure eights that cause the upper deck to be under water may cause severe engine problems due to water ingestion. Refer to the *SPECIAL PROCEDURES* and *WARRANTY* sections contained in this Operator's Guide.
- Respect no wake zones, the rights of other water users and the environment. As the "skipper" and owner of a boat, you are responsible for damage to other boats caused by the wake of your boat. Do not let anyone throw refuse overboard.
- Between sunset and sunrise, use the boat's navigation lights and reduce speed. Do not operate the boat in reduced visibility.

- Do not add accessories or equipment that may adversely affect visibility or alter control of the boat.
- The skipper should personally take the helm during storms.

Before Getting Underway

- Always perform the pre-ride inspection as specified in this Operator's Guide.
- Do not exceed the payload or passenger capacities for this boat, which are listed on the capacity plate and in the specifications. Overloading can affect maneuverability, stability and performance. Also, heavy seas reduce capacity. A payload or person capacity plate is not an excuse for failure to use common sense or good judgment.
- Regularly inspect the boat, the hull, engine, safety equipment, and all other boating gear and keep them in safe operating condition.
- Be sure you have the minimum required safety equipment, PFDs and any additional gear needed for your cruise.
- Check that all lifesaving equipment, including fire extinguisher, is in safe operating condition and easily accessible. Show all passengers where this equipment is, and make sure they know how to use it.
- Keep an eye on the weather. Check local weather broadcasts before departure. Be alert to changing conditions.
- Keep accurate and up-to-date charts of the boating area on board. Before getting underway, check water conditions in the planned boating area.

- Before departure, file a Float Plan with a responsible person ashore.
- Keep enough fuel on board for the planned trip. Always verify fuel level before use and during the ride. Apply the principle of 1/3 of the fuel to reach your destination, 1/3 to return, and keep 1/3 in reserve. Allow for changes due to adverse weather or other delays.

Operators and Passengers Awareness

- Each boat operator has a responsibility to ensure the safety of his/her passenger(s) and of other water users. Please follow all safety instructions and operate your boat with care.
- Never operate a boat while under the influence of drugs or alcohol they slow reaction time and impair judgement. It is also a Federal offense. Allow only qualified drivers to operate your boat.
- Remember that sun, wind, fatigue or illness may impair your judgement and reaction time.
- At least one passenger should be able to operate the boat in case the operator is unexpectedly unable to do so.
- Operation of this boat by a person under 16 years of age or a person with a disability that impairs vision, reaction time, judgment, or operation of the controls is NOT recommended.
- Always use the safety lanyard when operating the boat and ensure that all passengers are familiar with its use.
- Ensure that any operator and all passengers know how to swim and how to re-board the boat from the water. If a passenger does not know how to swim, ensure that passenger wears a PFD at all times and take extra precautions when boating.

Carbon Monoxide and Boating

Burning a material containing carbon produces carbon monoxide (CO), an odorless and colorless gas. Because CO weighs the same as air, it can spread throughout an enclosed space unnoticed because you cannot see it or smell it. Any device used to burn carbon-based materials on a boat can be a source of CO. Common sources of CO include internal combustion engines.

CO reacts with the blood to reduce the ability of the blood to carry oxygen. The reduced oxygen supply to body tissues results in death of the tissue. Prolonged exposure can cause brain damage or death. In high concentrations, CO can be fatal within minutes. The effects of CO in lower concentrations are cumulative and can be just as lethal over long periods of time.

Symptoms of CO poisoning include: Itchy and watering eyes, flushed appearance, throbbing temples, inability to think coherently, ringing in the ears, tightness across the chest, headaches, drowsiness, nausea, dizziness, fatigue, vomiting, collapse, and convulsions. If any of these symptoms are evident, begin treatment immediately. Prompt action can make the difference between life and death.

- Evacuate the area and move the victim to fresh air.

- Administer oxygen if available and get medical help.
- Open all canvas enclosures to ventilate the area.
- Investigate the source of CO and take immediate corrective action.
- Be especially aware of other CO sources which may be near boat.

Carbon Monoxide Accumulation

Following are examples of possible situations where CO may accumulate within your boat while docked, anchored, or underway. Become familiar with these examples and their precautions to prevent personal injury or death.

⚠ WARNING

Exhaust fumes! Generator or hull exhaust from other vessels while either docked or anchored can emit poisonous CO gas and cause excessive accumulation within cabin and cockpit areas. Be alert for generator exhaust from your vessel or other vessels alongside. Exhaust outlets near a pier, dock, seawall or outlets blocked by any other means can cause excessive accumulation of poisonous CO gas within cockpit area.

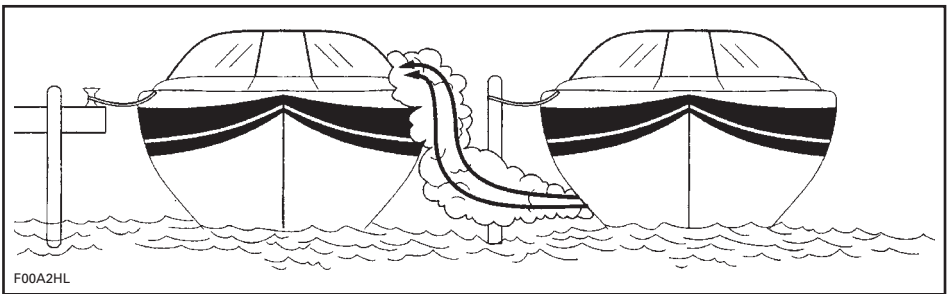

VESEL ALONGSIDE

⚠ WARNING

Engine exhaust fumes contain carbon monoxide (CO) which can accumulate in and around the boat (under bimini top, in cockpit, etc.). CO can be harmful or fatal if inhaled. Assure there is adequate ventilation whenever running engine(s).

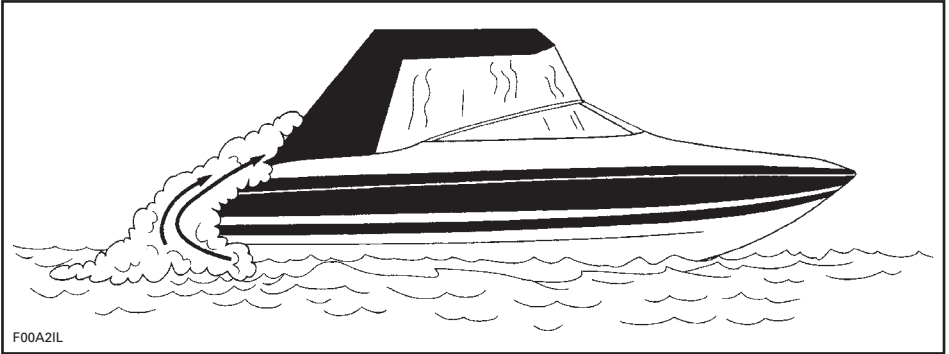
***WHILE UNDERWAY (BACKDRAFTING)***

While underway, CO concentrations can increase by backdrafting or “the station wagon effect”. Backdrafting is caused by factors such as relative wind direction, speed, or the bow being too high. To prevent this, open canvas whenever possible to provide positive airflow through the hull.

Boat houses, seawalls, and other boats in close proximity or confined areas can contribute to increased CO levels. Operators must be aware that operation, mooring, and anchoring in an area with other boats puts them in jeopardy of CO accumulation from other sources. Likewise, a boat operator must be aware of how exhaust from his boat will affect others. Operation of the engines while moored may cause CO accumulation in your boat and those around you.

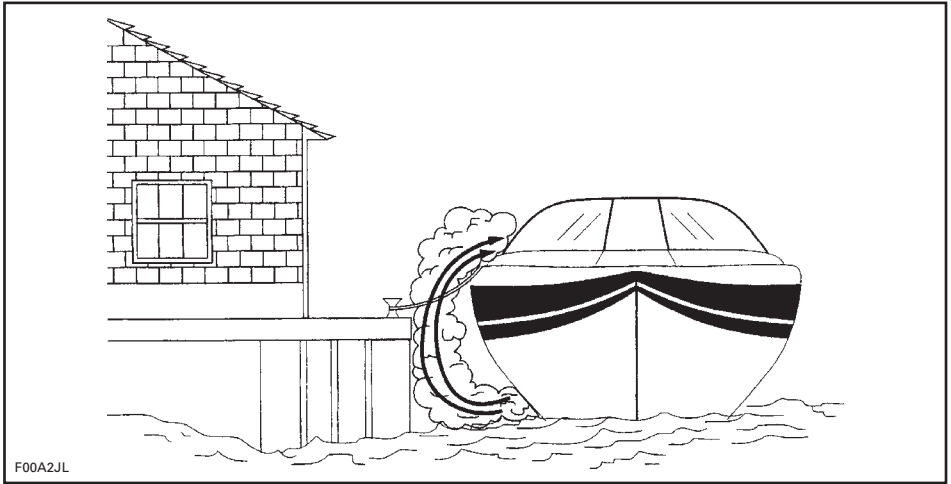

CONFINED AREAS

Be sure to provide adequate ventilation. If the windshield has vents, open them before getting underway to increase positive air flow and decrease the chances of CO accumulation.

⚠ WARNING

Backdrafting! Under certain conditions, moving air currents can direct poisonous CO fumes into boat. These fumes can accumulate to dangerous levels without proper airflow. Provide adequate ventilation, redistribute the load or bring boat out of high bow angle.

Even with the best boat design and construction, CO may still accumulate in enclosed or confined areas under certain conditions. Continually observe passengers for symptoms of CO poisoning.

CO Detector

It is strongly recommended that you have CO detectors installed in boats with canvas enclosures. Monitors are available from your dealer. Monitors should be professionally installed and calibrated.

NOTE: A CO detector is not a gas fuel vapor detector. Gas fuel vapor detectors do not monitor the buildup of CO in an enclosed area.

Do NOT Operate your Boat without Performing the Following Checklist

Each Boating Day

OPERATION	✓
Make sure you and your passengers know where exhaust outlets are located on the vessel	
Educate all passengers about the symptoms of CO poisoning and where CO may accumulate	
When docked or rafting with another boat, be aware of exhaust emissions from the other boat	
Confirm that water flows from the exhaust outlet when the engine(s) is (are) started	
Listen for any change in exhaust sound, which could indicate an exhaust component failure	
Test the operation of each CO alarm by pressing the test button (if so equipped)	

Water Sports

WARNING

Avoid personal injury! Your boat is not designed for and should not be used for pulling parasails, kites, gliders, or any device which can become airborne. Use boat only for appropriate water sports.

WARNING

Teak surfing is extremely dangerous to participants due to their proximity to the rear of the boat where direct contact with the exhaust fumes from the boat engine is the highest. Carbon monoxide poisoning can occur and result in mental disorientation, dizziness, drowsiness, and loss of consciousness. The combination of carbon monoxide exposure and non-use of a life jacket (PFD) make this new water recreation activity an incredibly dangerous and potentially deadly sport.

Water skiing, wakeboarding, or riding a towed, inflatable apparatus are some of the more popular water sports. Taking part in any water sport requires increased safety awareness by the participant and the boat operator. If you have never pulled someone behind your boat before, it is a good idea to spend some hours as an observer, working with and learning from an experienced driver. It is also important to be aware of the skill and experience of the person being pulled. Always have a second person on board to observe the person in the water so the driver can concentrate on operating the boat.

Both the boat operator and observer should monitor the location of the tow rope when participating in water sports. A slack tow rope can become entangled with person(s) or objects

in the boat or in the water, particularly when making a tight turn or circling, and cause serious personal injury.

Everyone participating in a water sport should observe these guidelines:

- Allow only capable swimmers to take part in any water sport.
- Always wear an approved personal flotation device (PFD). Wearing a properly designed PFD helps a stunned or unconscious person stay afloat. A Type-IV water-ski vest is an approved and practical PFD.
- Have a second person aboard to observe the person being towed and inform the driver about the participant's hand signals. The driver must give full attention to operating the boat and the waters ahead.
- Be considerate to others you share the water with.
- Never allow a person to "teak surf" behind your boat. Do not tow a person in any water sport on a short tow rope such that the person inhales exhaust fumes in concentration. Inhalation of concentrated exhaust fumes, which contain carbon monoxide, can result in CO poisoning, personal injury and death.
- Give immediate attention to a person who has fallen. He or she is vulnerable in the water alone and may not be seen by other boaters.
- Approach a person in the water from the lee side (opposite the direction of the wind). Turn off the motor before coming close to the person.
- Turn off engine and anchor the boat before swimming.
- Participate in water sports only in safe areas. Stay away from other boats, channels, beaches, restricted areas, swimmers, and heavily traveled waterways and underwater obstructions.
- Swim only in areas designated as safe for swimming. These are usually marked with a swim area buoy. Do not swim alone or at night.



SWIM AREA BUOY

1. Do not water ski between sunset and sunrise. It is illegal in most states.
2. Do not drive the boat directly behind a water skier, tuber or wakeboarder. At 40 km (25 mi) per hour, the boat will overtake a person who falls in the water 60 m (200 ft) in front of your boat in about 5 seconds.
3. Shut engine off and remove ignition key when anyone is in the water nearby.
4. Stay at least 45 m (150 ft) away from areas marked by a diver down float.

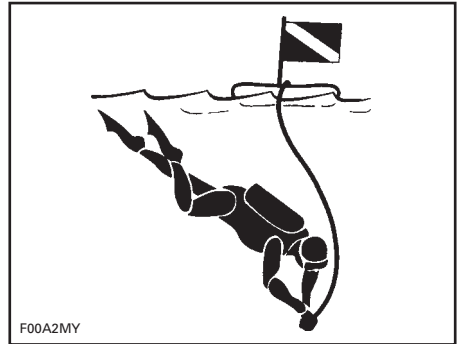

DIVER DOWN FLOAT

 **WARNING**

Avoid personal injury! Do not allow anyone near the jet pump or intake grate, even when the engine is off. Items such as long hair, loose clothing or personal flotation device straps can become entangled in moving parts resulting in serious injury or drowning. In shallow water, shells, sand, pebbles or other objects could be drawn up by the jet pump and be thrown rearward.

NOTE: For more information about water skiing, please contact your local Water Ski Association.

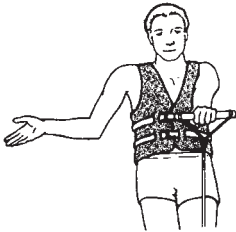

FASTER -
Palm of one hand pointing
upward.



SLOWER -
Palm pointing down.



SPEED OK -
Arm upraised with thumb and
finger joined to form circle.

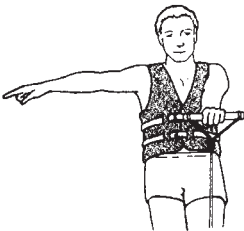

RIGHT TURN -
Arm outstretched pointing
to the right.

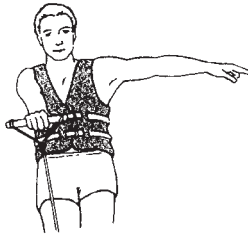

LEFT TURN -
Arm outstretched pointing
to the left.



RETURN TO DROP-OFF AREA -
Arm at 45 degree from body
pointing down to water and
swinging.



CUT MOTOR -
Finger drawn across
throat.

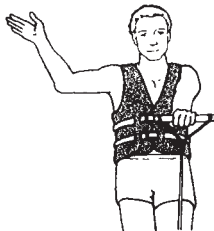

STOP -
Hand up, palm forward,
policeman style.



**SKIER OK.
AFTER THE FALL -**
Hands clenched
together overhead.

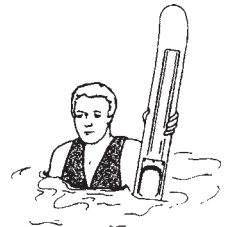

**PICK ME UP
OR FALLEN SKIER,
WATCH OUT -**
One ski extended
vertically out of water.

F00A2NL

SKIING SIGNALS

Hypothermia

Hypothermia, the loss of body heat to the water, is a significant cause of deaths in boating accidents. After an individual has succumbed to hypothermia, he or she will lose consciousness and then drown.

PFDs can increase survival time because of the insulation they provide.

Naturally, the warmer the water, the less insulation one will require. When operating in cold water (below 4.4°C (40°F)) consideration should be given to using a coat or jacket style PFD as they cover more of the body than the vest style PFDs.

Some points to remember about hypothermia protection:

1. While afloat in the water, do not attempt to swim unless it is to reach a nearby boat, fellow survivor, or a floating object on which you can lean or climb. Unnecessary swimming increases the rate of body heat loss. In cold water, drown-proof methods that require putting your head in the water are not recommended. Keep your head out of the water. This will greatly lessen heat loss and increase your survival time.
2. Keep a positive attitude about your survival and rescue. This will improve your chances of extending your survival time until rescue. Your will to live does make a difference!
3. If there is more than one person in the water, huddling is recommended while waiting to be rescued. This action tends to reduce the rate of heat loss and thus increase the survival time.
4. Always wear your PFD. It won't help you fight off the effects of hypothermia if you don't have it on when you go into the water.

Voluntary Inspections

Boating officials in many countries or their auxiliaries offer courtesy inspections to check out your boat. They will check for compliance with safety standards and required safety equipment. You may voluntarily consent to one of these inspections, and you are allowed time to make corrections without prosecution. Check with the competent authorities for details.

Safe Boating Courses

Many countries recommend or require a boating safety course. Check with your local competent authorities.

SAFETY EQUIPMENT

Required Safety Equipment

Operator and passenger(s) should have ready access to shatterproof glasses should riding conditions or personal preference warrant.

Wind, water spray and speed may cause a person's eyes to water and create blurred vision.

As the owner of the boat, you are responsible for assuring that all required safety equipment is aboard. You should also consider supplying additional equipment as needed for your safety and that of your passengers. Check local regulations about required safety equipment.

Safety equipment required by regulations is mandatory. Personal flotation devices must be fitted to the people wearing them. If local regulations require additional equipment, it must be approved by a competent authority. Minimum requirements include the following:

- Personal flotation devices (PFDs)
- Fire extinguisher (class B-1)
- Visual distress signals (VDS)
- Navigation lights
- Sound producing devices (horn, air horn or whistle).

A cellular telephone in a waterproof bag or container has also been found to be beneficial to boaters when in distress or just for contacting someone on shore.

Personal Flotation Devices (PFDs)

In many countries, regulations require that you have at least one approved personal flotation device (PFD) for each person in a recreational boat and require that all children under 13 years of age wear a PFD at all times when the boat is underway, except when below deck or in an enclosed cabin. You may not use your boat unless all PFDs are in serviceable condition, readily

accessible, legibly marked with the approval number, and of an appropriate size (within the weight range and chest size marked on the PFD) for each person on board.

A PFD provides buoyancy to help keep your head above the water and to help you remain in a satisfactory position while in the water. Body weight and age should be considered when selecting a PFD. The buoyancy provided by the PFD should support your weight in water. The size of the PFD should be appropriate for the wearer. Body weight and chest size are common methods used to size PFDs. It is your responsibility to ensure that you have the proper number and types of PFDs on board to comply with federal and local regulations and that your passengers know where they are and how to use them.

PFD Types

There are five types of approved PFDs.

PFD Type I, Wearable has the greatest required buoyancy. Its design allows for turning most unconscious persons in the water from face down position to a vertical or slightly backward, face-up position. It can greatly increase the chances of survival. Type I is most effective for all waters, especially offshore when rescue may be delayed. It is also the most effective in rough waters.

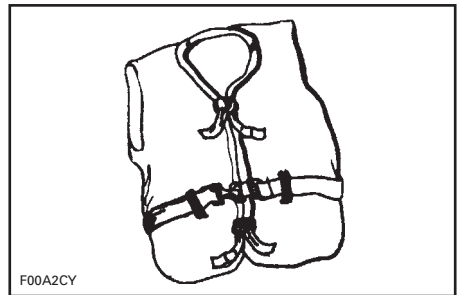

TYPE I — WEARABLE

PFD Type II, Wearable turns its wearer in the same way as Type I, but not as effectively. The Type II does not turn as many persons under the same conditions as a Type I. You may prefer to use this PFD where there is a probability of quick rescue such as in areas where other people are commonly involved in water activities.

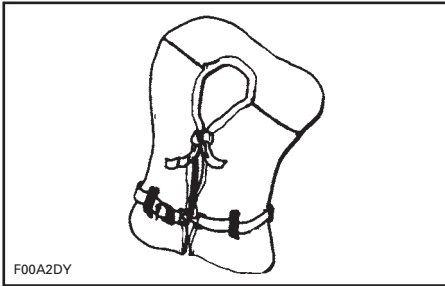

TYPE II — WEARABLE

PFD Type III, Wearable allows wearers to place themselves in a vertical or slightly backward position. It does not turn the wearer. It maintains the wearer in a vertical or slightly backward position and has no tendency to turn the wearer face down. It has the same buoyancy as a Type II PFD and may be appropriate in areas where other people are commonly involved in water activities.

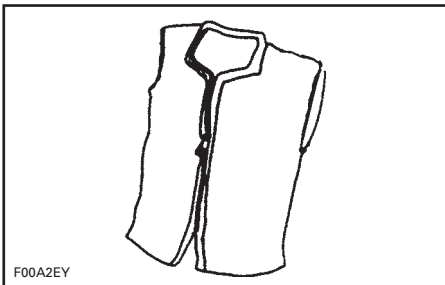

TYPE III — WEARABLE

PFD Type IV, Throwable is required in addition to the PFDs previously discussed. The most common Type IV PFD is a buoyant cushion or ring buoy. It is designed to be thrown to a per-

son in the water, grasped and held by the user until he or she is rescued. A Type IV PFD should always be in serviceable condition and immediately available for use. Grasping this PFD may be difficult if the rescue is delayed or if the user is overcome by hypothermia (loss of body heat).

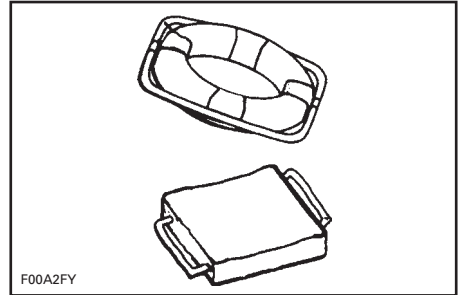

TYPE IV — THROWABLE

PFD Type V, Wearable must be worn. When inflated, it provides buoyancy equivalent to Type I, II or III PFDs. When it is deflated, however, it may not support some people.

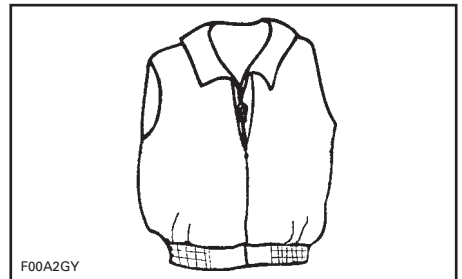

TYPE V — WEARABLE

PFD Pointers

The purpose of a PFD is to help save your life. If you want it to support you when you are in the water, it needs to fit, float, and be in good condition.

- Try the PFD on and adjust it until it fits comfortably in and out of the water. Mark your PFD if you are the only wearer.

- To make sure the PFD works, wear it in the water. This will show you how it works and give you confidence when you use it.
- Teach children how to put a PFD on and allow them to try it in the water. That way, they know what the PFD is for and how it works. They will feel more comfortable with it if they suddenly find themselves in the water.
- If the PFD is wet, allow it to dry thoroughly before storing it. Do not dry it in front of a radiator or heater. Store it in a well-ventilated area.
- Keep PFDs away from sharp objects which can tear the fabric or puncture the flotation pads.
- For their own safety and the safety of others, all non-swimmers, poor swimmers, and small children should wear PFD's at all times whether the boat is stationary or moving.
- Check the PFD frequently to make sure that it is not torn, that flotation pads have no leaks, and that all seams and joints are securely sewn.
- If a PFD contains kapok, the kapok fibers may become waterlogged and lose their buoyancy after the vinyl inserts are punctured. If the kapok becomes hard or if it is soaked with water, replace it. It may not work when you need it.

Fire Extinguishers

As the owner of the boat, you are responsible for supplying an approved fire extinguisher. Check with the local competent authorities. Boats less than 7.9 m (26 ft) are required to carry one (1) B-1 type hand portable fire extinguisher unless the boat is equipped with a fixed fire extinguishing system in the engine compartment.

Hand-held portable fire extinguishers should be mounted in readily accessible locations away from the engine

compartment. All persons aboard should know the location and proper operation of the fire extinguisher(s).

NOTE: Don't test fire extinguishers by squirting small amounts of the extinguishing compound. The extinguisher might not work when you really need it!

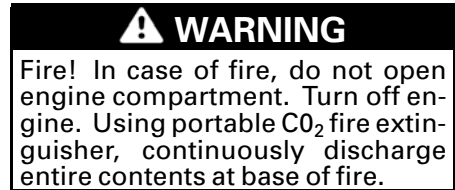

Visual Distress Signal Devices

Visual distress signal equipment may be of the pyrotechnic or non-pyrotechnic type. Regulations prohibit display of visual distress signals on the water under any circumstances except when assistance is required to prevent immediate or potential danger to persons on board a vessel. Check with the local authority to have proper equipment.

The equipment must be approved by the competent authorities, be in serviceable condition, and be stowed in a readily accessible location. Equipment having a date for serviceable life must be within the specified usage date shown.

Careful selection and proper stowage of visual distress equipment is very important if children are aboard.

DAY USE ONLY
Three orange smoke signals (one hand held and two floating) or one orange flag with black square and disk.
NIGHT USE ONLY
One S-O-S electric distress light.
DAY AND NIGHT USE
Three flares of the hand held, meteor or parachute type.

Sound Signaling Devices

NOTE: No single signaling device is appropriate for all purposes. Consider keeping various types of equipment on board.

Boats less than 7.9 m (26 ft) in length are required to carry a hand, mouth, or power operated horn or whistle. It must produce a blast of two second duration and audible at a distance of at least 800 m (1/2 mi).

Following are standard whistle signals:

- One prolonged blast (warning signal)
- One short blast (pass on my port side)
- Two short blasts (pass on my starboard side)
- Three short blasts (engines in reverse)
- Five or more blasts (danger signal).

Navigation Lights

Navigation lights are intended to keep other vessels informed of your presence and course. If you are out on the water between sunset and sunrise, you are required to display appropriate navigation lights.

Additional Recommended Equipment

It is recommended that you acquire additional equipment for safe, enjoyable cruising. This list, which is not all inclusive, includes items you should consider acquiring.

Basic Gear

- Flashlight
- Mooring lines
- Compass
- Oar or paddle
- Distress signals
- First aid kit
- Dock fenders
- VHF radio
- EPIRB (Electronic Position Indicating Radio Beacon)
- Boat hook
- Extra warm clothing
- Charts
- Sunblock
- Tow line
- Second anchor and line
- Dewatering device (pump or bailer)
- Emergency supply of drinking water and food.

Tools

- Screwdrivers
- Pocket knife
- Pliers
- Electrician's tape
- Adjustable wrench
- Duct tape.

Spare Parts

- Extra bulbs
- Extra fuses.

SAFE BOATING PRACTICES

YOU are responsible for your own safety, the safety of your passengers, and the safety of fellow boaters. Ride smart from the start and we all win!

Drugs and Alcohol

Do not use drugs or drink alcohol while operating a boat. Like driving a car, driving a boat requires sober, attentive care. Operating a boat while intoxicated or under the influence of drugs is not only dangerous, but it is also a Federal offense carrying a significant penalty. These laws are vigorously enforced. The use of drugs and alcohol, singly or in combination, decreases reaction time, impedes judgment, impairs vision, and inhibits your ability to safely operate a boat.

WARNING

Alcohol consumption and boating do not mix! Operating under the influence endangers the lives of your passengers and other boaters. Federal laws prohibit operating a boat under the influence of alcohol or drugs.

Safe Operation

For safety reasons and proper care, always perform *PRE-RIDE INSPECTION* as specified in your Operator's Guide before operating your boat. Safe operation means that you do not misuse your boat nor do you allow your passengers to do so. Safe operation means using good judgment at all times. It includes, without limitation, the following actions:

- Load the boat within the limits listed on the capacity plate. Balance loads bow to stern and port to starboard.
- Maintain boat speed at or below the local legal limit. Avoid excessive speed or speeds not appropriate for operating conditions.

- Do not use the boat in weather or sea conditions beyond the skill or experience of the operator or the comfortable capability of the boat or passengers.
- Be sure at least one other passenger is familiar with the operation and safety aspects of the boat in case of an emergency.
- Make sure that passengers and gear do not obstruct the operator's view or ability to move.
- Do not exceed the maximum engine power rating stated on the certification plate attached to the boat.
- Observe all safety signs and warnings both inside the boat and in the immediate boating area.
- While your boat has the capacity of operating at high speeds, it is strongly recommended that high speed operation only be applied when ideal conditions exist and are permitted. Higher speed operation requires a higher degree of skill and increases the risk of severe injuries.
- In shallow water, proceed with caution and at very low speeds. Grounding or abrupt stops may result in injury. Debris may also be picked up and be thrown rearward by the jet pump onto people or property.
- Do not use the boat's reverse, to stop. You or your passenger(s) could be violently ejected forward or even off the boat onto the hazard.

Maneuverability of the Boat and Towing

- Always keep in mind that as the throttle lever is returned to idle position, less directional control is available, and when the engine is off, directional control is lost. You need throttle to steer.

- Do not overload the boat or take on more passengers than designated for the particular boat. Overloading can affect maneuverability, stability and performance.
 - Avoid adding on accessories or equipment which may alter your control of the boat.
 - Riding with a passenger(s) or pulling a tube, skier or wakeboarder makes the boat handle differently and requires greater skill.
 - Always respect the safety and comfort of your passenger(s) and person being towed on skis, wakeboard or other towables.
 - Always carry an observer when pulling a tube, skier or wakeboarder, proceed with only as much speed as required and follow the observer's instructions. Unless absolutely necessary, do not make tight, sharp turns. Keep a safe distance from the docks, other swimmers, craft or objects.
 - Use a tow rope of sufficient length and size and make sure it is adequately secured to your boat. Some boats are equipped or can be fitted with a specially designed towing mechanism. It can become a hazard should someone fall on it.
- age wear a PFD when the boat is underway unless they are in an enclosed cabin or below deck.
- Do not start or operate the boat if anyone is seated on the sun deck or swim platform, or is nearby in the water. Water and/or debris exiting jet thrust nozzle can cause severe injury.
 - The operator and passenger(s) should be properly seated before starting or moving the boat. All passenger(s) should be instructed to use the handholds or seat straps provided.
 - When accelerating a boat with a passenger(s), whether from a complete stop or while underway, always do so progressively. Fast acceleration may cause your passenger(s) to lose their balance or grip and strike something in the boat or fall out of the boat. Make sure that your passenger(s) know of, or anticipate, any rapid acceleration.

Passenger Safety

Before getting underway, show all passengers where emergency and safety equipment is stowed, and explain how to use it. Everyone aboard should wear rubber-soled shoes which resist slipping on wet surfaces. While underway, passengers should remain seated inside the deck rails. Don't allow passengers to drag their feet or hands in the water. Always use handholds and other safety hardware to prevent falls. All non-swimmers, poor swimmers, and children should wear a PFD at all times. Federal regulations require that children under 13 years of

First Aid

As a boat operator, you should be familiar with basic first aid procedures that may be needed while you are far from help. Fish hook accidents or minor cuts and abrasions may be the most serious mishaps on board a boat, but you should also learn the proper procedures and be ready to deal with the truly serious problems like excessive bleeding, hypothermia, and burns. First aid literature and courses are available through most Red Cross chapters.

Operation by Minors

Minors should always be supervised by an adult whenever operating a boat. Many countries have laws regarding the minimum age and licensing requirements of minors. Be sure to contact competent authorities for information. BRP recommends a minimum operator age of 16 years old.

NAVIGATION RULES

Operating Rules

Operating a boat can be compared with driving unmarked highways and roads. To prevent collisions or avoid other boaters, a system of operating rules must be followed. It's not only common sense... it's the law!

Check local and federal boating laws applicable to the waterways where you intend to use your boat. Learn the local rules of the road. Know and understand the applicable navigation system (such as buoys and signs).

Know the waters in which the boat is to be operated. Current, tides, rapids, hidden obstacles, wakes and waves etc. can affect safe operation. It is not advisable to operate the boat in rough or inclement weather.

Generally keep to your right and safely avoid other craft by keeping a safe distance from other craft, people and objects.

The following illustration identifies different parts of the boat that are used as directional reference points, the bow being the front of the boat. The port side of boat (left side) is visually identifiable by a RED light off the bow, and the starboard side (right side) by a GREEN light.

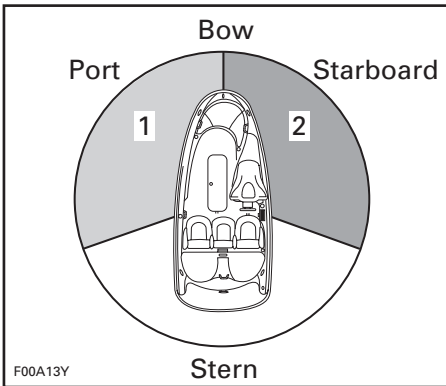

TYPICAL

1. RED light
2. GREEN light (yield zone)

Crossing

Give right of way to craft ahead and to your right. Never cross in front of another craft.

RED light (give way to the other craft).

GREEN light (you have the right of way).

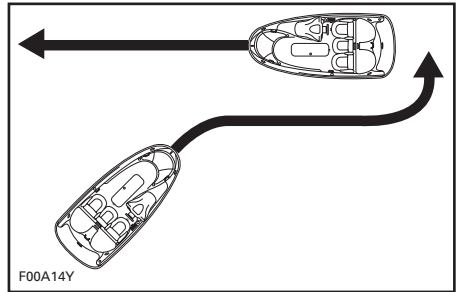

TYPICAL

Meeting Head-On

Keep right.

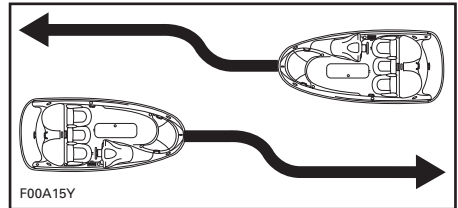

TYPICAL

Passing

Give right of way to other craft and keep clear.

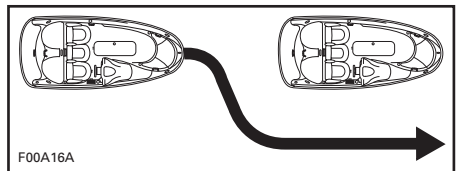

TYPICAL

Navigation System

Navigational aids, such as signs or buoys, can help you identify safe waters. Buoys will indicate whether you should keep to the right (starboard) or to the left (port) of the buoy or to which channel you can continue. They may also indicate whether you are entering a restricted or controlled area such as a no wake or speed zone. They may also indicate hazards or pertinent boating information. Markers may be located on shore or on the water. They can also indicate speed limits, no power craft or boating, anchorage and other useful information. (The shape of each type of marker will provide assistance).

Make sure you know and understand the navigation system applicable to the waterways where you intend to use the boat.

Collision Avoidance

- Do not decrease throttle when trying to steer away from objects. You need throttle to steer.
- Always keep a constant lookout for other water users, other craft or objects, especially when turning. Be alert for conditions that may limit your visibility or block your vision of others.
- Respect the rights of other recreationists and/or bystanders and always keep a safe distance from all other craft, people and objects.
- Do not wake or wave jump, ride the surf line or attempt to spray or splash others with your boat. You may misjudge the ability of the boat or your own driving skills and strike a boat or person.

- This boat has the capability of turning more sharply than other boats. However, unless in an emergency, do not negotiate sharp, high speed turns. Such maneuvers make it hard for others to avoid you or understand where you are going. Also, you and/or your passenger(s) could be thrown from the boat.
- This boat has no brake. Stopping distance will vary depending on initial speed, load, wind, and water conditions. Practice stopping and docking in a safe, traffic free area to have an idea of how long it will take to stop the boat under varying conditions.
- Maintaining or increasing speed may be necessary to avoid a collision.

FUELING

Recommended Fuel

Use unleaded gasoline or oxygenated fuel containing a maximum total of 10% of ethanol or methanol. The gasoline used must have the following recommended octane rating.

NOTICE Never experiment with other fuels or fuel ratios. The use of non-recommended fuel can result in boat performance deterioration and damage to critical parts in the fuel system and engine components.

Inside North America

MINIMUM OCTANE RATING		
87 (RON + MON)/2		
91 (RON + MON)/2	▼	▼
ENGINES	91	87
155 HP Naturally aspirated	—	X
255 HP Supercharged Intercooled	X ⁽¹⁾	X

⁽¹⁾ For optimum engine performance.

Outside North America

MINIMUM OCTANE RATING		
92 RON		
95 RON	▼	▼
ENGINES	95	92
155 HP Naturally aspirated	—	X
255 HP Supercharged Intercooled	X ⁽¹⁾	X

⁽¹⁾ For optimum engine performance.

Fueling Procedure

⚠ WARNING

Fuel is flammable and explosive under certain conditions. Do not smoke or allow open flames or sparks in the vicinity. Always have a fire extinguisher close at hand during fueling procedure.

Be very careful when fueling and adhere to the fueling procedures described below in this Operator's Guide and those given to you by the marina.

Know the capacity of the fuel tank. Avoid fueling at night except under well-lit conditions. Gas spills are not noticeable in the dark. Do not carry spare fuel or flammable liquids in any of the storage or engine compartments.

⚠ WARNING

Follow these safe boating fueling instructions explicitly.

On a Trailer

1. The boat should be level.
2. Ensure engine cover is closed to prevent fumes from entering the engine compartment.
3. Unscrew the cap counterclockwise and remove it slowly.



TYPICAL - FUEL TANK CAP

4. Insert the gas pump spout into the filler neck and fill up fuel tank.

⚠ WARNING

To prevent fuel back-flow, fill up tank slowly so the air can escape from the fuel tank.

5. Stop filling immediately after the release of the gas pump nozzle handle and wait a moment before removing the spout. Do not retract the gas pump nozzle to put more fuel in fuel tank.

⚠ WARNING

Do not overfill or top off the fuel tank and leave the boat in the sun. As temperature increases, fuel expands and may overflow.

6. Install and fully tighten the fuel tank cap.

⚠ WARNING

Always wipe off any fuel spillage from the boat.

In Water

1. Turn off engine.
2. Tie boat securely to the fueling pier.
3. Do not allow anyone to remain on the boat.
4. Ensure engine cover is closed to prevent fumes from entering the engine compartment.
5. Unscrew the cap counterclockwise and remove it slowly.



TYPICAL - FUEL TANK CAP

6. Insert the gas pump spout into the filler neck and fill up fuel tank.

⚠ WARNING

To prevent fuel back-flow, fill up tank slowly so the air can escape from the fuel tank.

7. Stop filling immediately after the release of the gas pump nozzle handle and wait a moment before removing the spout. Do not retract the gas pump nozzle to put more fuel in fuel tank.

⚠ WARNING

Do not overfill or top off the fuel tank and leave boat in the sun. As temperature increases, fuel expands and might overflow.

8. Install and fully tighten the fuel tank cap.

⚠ WARNING

Always wipe off any spillage from the boat.

TRAILERING INFORMATION

Refer to the trailer instructions for proper capacity, operation, maintenance, accessories and warranty.

Check the regulations in your area concerning towing a trailer, especially the following rules:

- Brake system
- Tow vehicle weight
- Mirrors.

NOTE: An optional brake system is available for your trailer, contact Karavan Trailers at www.karavantrailers.com.

Take the following precautions when trailering the boat:

1. Tie the boat to both bow and stern (front/rear) eyelets so that it is firmly retained on the trailer.
2. Remove stern light (if installed).
3. Ensure that ski post is pushed down (**on so equipped models**).
4. Ensure all storage compartment covers are properly latched.
5. A Sea-Doo cover can protect the boat, particularly before driving on dirt roads, to prevent dirt entry through the air intake openings.

Observe trailering safety precautions.

NOTICE Always ensure rear storage compartment lid is closed and securely fastened **before** trailering.

LOCATION OF IMPORTANT ON-PRODUCT LABELS

The labels illustrated on the following pages are on your boat. If missing or damaged, they can be replaced free of charge. See an authorized Sea-Doo Sport Boats dealer.

Please read the following labels carefully before operating your boat.

NOTE: The illustration of the boat indicates the approximate locations of the various labels. A dotted line indicates that the label is not on the outer surface, and that the seat or a cover of some type must be opened to see the label.

Hang Tag

The Star Label means Cleaner Marine Engines
This engine has been certified as:













The Symbol for Cleaner Marine Engines:
Cleaner Air and Water
For a healthier lifestyle and environment.

Better Fuel Economy
Burns up to 30-40 percent less gas and oil than conventional carbureted two-stroke engines, saving money and resources.

Longer Emission Warranty
Protects consumer for worry-free operation.

One Star-Low emission
The one-star label identifies personal watercraft, outboard, sterndrive and inboard engines that meet the Air Resources Board's Personal Watercraft and Outboard marine engine 2001 exhaust emission standards. Engines meeting these standards have 75% lower emissions than conventional carbureted two-stroke engines. These engines are equivalent to the U.S. EPA's 2006 standards for marine engines.

 **Two Stars-Very Low emission**
The two-star label identifies personal watercraft, outboard, sterndrive and inboard engines that meet the Air Resources Board's Personal Watercraft and Outboard marine engine 2004 exhaust emission standards. Engines meeting these standards have 20% lower emissions than One Star – Low-Emission engines.

 **Three Stars-Ultra Low emission**
The three-star label identifies engines that meet the Air Resources Board's Personal Watercraft and Outboard marine engine 2008 exhaust emission standards or the Sterndrive and Inboard marine engine 2003 exhaust emission standards. Engines meeting these standards have 65% lower emissions than One Star – Low Emission engines.

 **Four Stars-Super Ultra Low emission**
The four-star label identifies engines that meet the Air Resources Board's Sterndrive and Inboard marine engine 2009 exhaust emission standards. Personal Watercraft and Outboard marine engines may also comply with these standards. Engines meeting these standards have 90% lower emissions than One Star – Low Emission engines.

BOMBARDIER RECREATIONAL PRODUCTS INC.
VALCOURT, QUÉBEC, CANADA
Cleaner Watercraft - Get the facts 1-800-END-SMOG
www.arb.ca.gov

219902678

Safety Labels

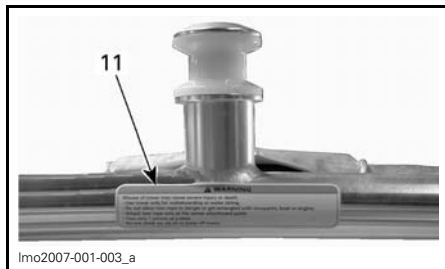
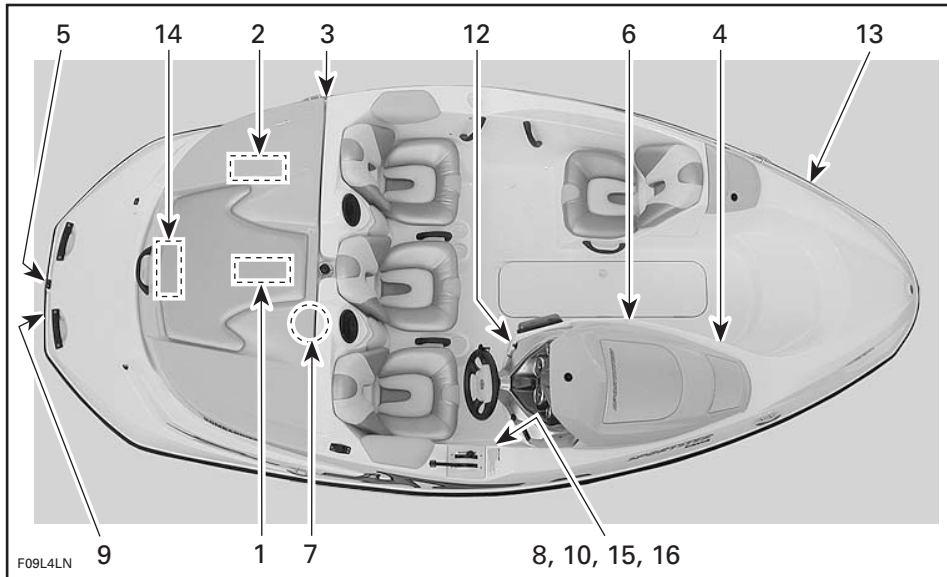

WAKE TOWER — OPTIONAL



LABEL 1

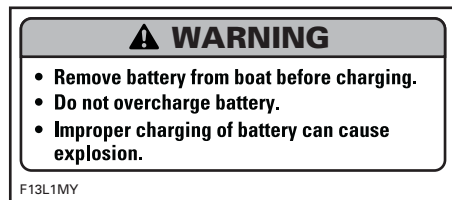

LABEL 2

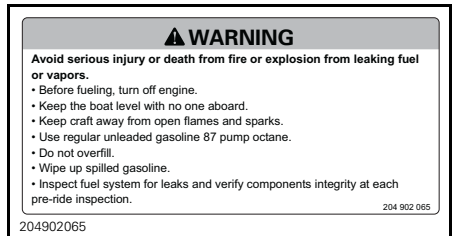

LABEL 3



LABEL 4



LABEL 6

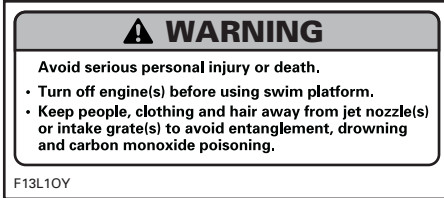



LABEL 5



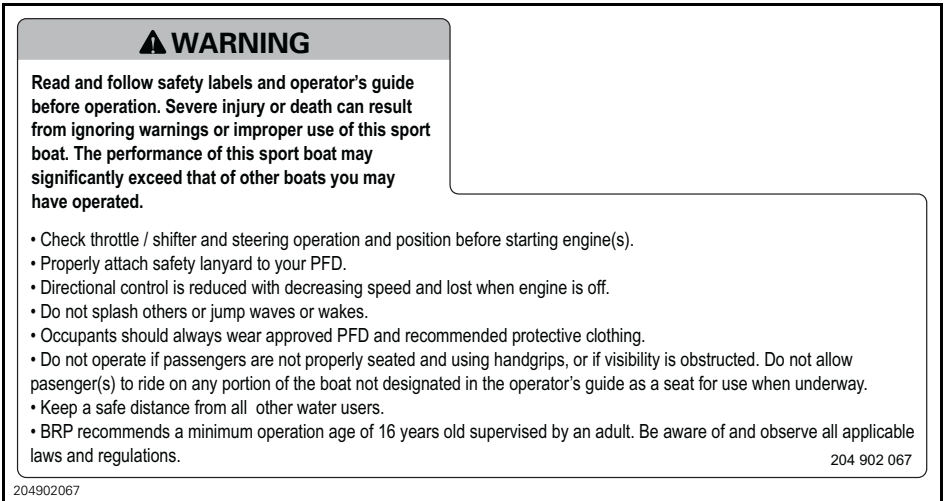

LABEL 7



LABEL 8

 WARNING	
	<p>Carbon monoxide (CO) can cause brain damage or death.</p> <p>Engine and generator exhaust contains odorless and colorless carbon monoxide gas.</p> <p>Signs of carbon monoxide poisoning include nausea, headache, dizziness, drowsiness, and lack of consciousness.</p> <p>Get fresh air if anyone shows signs of carbon monoxide poisoning.</p> <p>See Owner's Manual for information regarding carbon monoxide poisoning.</p>
204901625	204901625

LABEL 9

 DANGER	
	<p>Carbon monoxide (CO) can cause brain damage or death.</p> <p>Engine and generator exhaust contains odorless and colorless carbon monoxide gas.</p> <p>Carbon monoxide will be around the back of the boat when engines or generators are running.</p> <p>Move to fresh air if you feel nausea, headache, dizziness, or drowsiness.</p>
204901626	204901626

LABEL 10

 WARNING	
<p>Misuse of tower may cause severe injury or death.</p> <ul style="list-style-type: none"> • Use tower only for wakeboarding or water skiing. • Do not allow tow rope to dangle or get entangled with occupants, boat or engine. • Attach tow rope only at the center attachment point. • Tow only 1 person at a time. • Do not climb on, sit on or jump off tower. • Never add accessories to the tower unless approved by BRP. 	
204902068	204 902 068

LABEL 11

 WARNING	
<p>Gasoline vapor may cause fire or explosion, resulting in serious injury or death.</p> <p>Inspect fuel system for leaks and verify components integrity at each pre-ride inspection.</p> <p><u>Before starting engine</u></p> <p>ALWAYS:</p> <ul style="list-style-type: none"> • Operate the bilge blower for 5 minutes. • Open engine cover and check for gasoline vapor odor inside the engine compartment. • Close the engine cover before starting the engine. <p>NEVER:</p> <ul style="list-style-type: none"> • Start the engine if gasoline vapor odor is present in the engine compartment. 	
204902066	204 902 066

LABEL 12

Compliance Labels



219902679

LABEL 13 – EMISSION CONTROL

BOMBARDIER RECREATIONAL PRODUCTS INC. EMISSION CONTROL INFORMATION THIS ENGINE IS CERTIFIED TO OPERATE ON UNLEADED GASOLINE AND CONFORMS TO 2010 U.S. EPA & CALIFORNIA EMISSIONS/EVAP REGULATIONS FOR MARINE S1 ENGINES.	ENGINE FAMILY	8BCXM1.506GN	FAMILLE DE MOTEUR
	FEL	16.44 g/kW-hr HC+NOx	LIMITE DES ÉMISSIONS DE LA FAMILLE
BOMBARDIER PRODUITS RÉCRÉATIFS INC. RENSEIGNEMENTS SER LE DISPOSITIF ANTIPOLLUTION CE MOTEUR EST CERTIFIÉ POUR FONCTIONNER À L'ESSENCE SANS PLOMB ET IL RÉPOND AUX NORMES 2010 DE L'EPA DES É.-U. & RÉGLEMENTATIONS CALIFORNIENNES POUR LES MOTEURS MARINS À ALLUMAGE COMMANDE.	ENGINE DISPLACEMENT	1493.0 cc	CYLINDREE
	EXHAUST EMISSION CONTROL SYSTEM	MF1, SC CAC	SYSTÈME DE CONTRÔLE DES ÉMISSIONS
SEE OPERATORS GUIDE FOR MAINTENANCE SPECIFICATIONS. VOIR MANUEL DE L'OPÉRATEUR LES SPÉCIFICATIONS DE MAINTENANCE.	SPARK PLUG TYPE	NGK-DCPR6E	TYPE DE BOUGIE
	SPARK PLUG GAP	0.030 in. / 0.7-0.8 mm	ÉCARTEMENT DES ÉLECTRODES
	POWER	116 kW	PUISSANCE
	FUEL LINE	9TDORPLINE365-A15	BOTEAU ESSENCE
			DATE / NA

204901998

LABEL 14 – EPA COMPLIANCE

Technical Information Labels

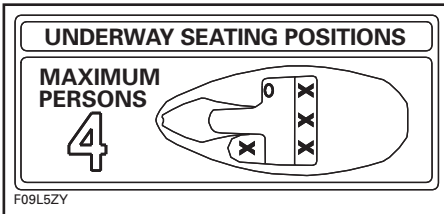

F09L5ZY

LABEL 15

PRE-RIDE INSPECTION

WARNING

The pre-ride inspection is very important before operating the boat. Always check the proper operation of critical controls, safety features and mechanical components before starting. If not done as specified here, severe injury or death might occur. Bring all safety equipment required by local laws.

For more detailed information on these items, refer to the applicable sections.

WARNING

Engines should be off and the D.E.S.S.™ key must always be removed from D.E.S.S. post before verifying any of the following. Only start boat once all items have been checked and operate properly.

SUMMARY

ITEM	OPERATION	✓
Hull	Inspect for damage.	
Jet pump water intake	Inspect/clean.	
Bilge	Ensure drain plug is properly secured.	
Engine compartment	Verify for leaks or gasoline vapor odor. Verify fuel exhaust components integrity.	
Battery	Inspect tightness of cables and retaining straps.	
Main battery cut-off switch	Ensure it is in the ON position.	
Engine coolant level	Check engine coolant level. Refill as needed.	
Engine oil level	Check engine oil level. Refill as needed.	
Steering	Check operation.	
Throttle/shifter system	Check operation.	
D.E.S.S. post and engine start/stop switches	Check operation.	
Navigation lights	Check operation.	
Towing tower (optional)	Check tightness of mounting points fasteners.	
Mandatory safety boating equipment	Ensure all required safety equipment is on board.	
Storage compartment covers	Ensure they are closed and latched.	
Fuel tank	Refill.	

Hull

Inspect hull for cracks or damage.

Jet Pump Water Intake

Remove weeds, shells, debris or anything else that could restrict the flow of water and damage the cooling system or propulsion unit. Clean as necessary. If any obstruction cannot be removed, refer to an authorized Sea-Doo Sport Boats dealer for servicing.

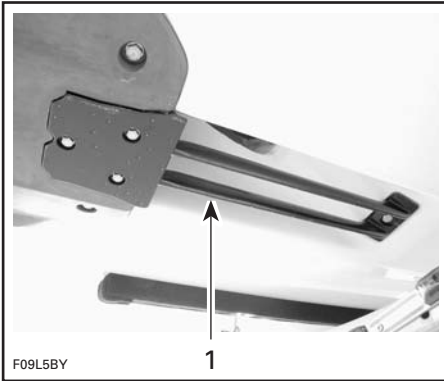

TYPICAL

1. Inspect this area

Inspect leading edges of the impeller for nicks or bends, which will greatly reduce performance of the boat.

Bilge

⚠ WARNING

Make sure drain plugs are properly secured before launching the boat in water.

Engine Compartment

Ensure that the engine compartment is free of gasoline vapor odors and visually, inspect fuel lines for deterioration and the condition of the fuel tank straps and their fasteners.

⚠ WARNING

If any leaks or gasoline vapor odors are present, DO NOT start engine or use electrical accessories. Consult an authorized Sea-Doo Sport Boats dealer.

Battery

⚠ WARNING

Verify tightness of battery cables to their posts and condition of retaining straps and fasteners. Do not charge or boost battery while installed in engine compartment.

Main Battery Cut-Off Switch

Turn switch in the ON position to allow starting engine and use accessories.

Engine Coolant

Check the engine coolant level and refill as necessary as per *MAINTENANCE PROCEDURES* section.

⚠ WARNING

In order to avoid potential burns, do not remove the coolant reservoir cap if engine is still hot.

Engine Oil

Check the oil level and refill as necessary as per *MAINTENANCE PROCEDURES* section.

Steering System

Have another person help check steering operation for free movement. When the steering is centered, the jet pump nozzle should be in the straight ahead position. Ensure the jet pump nozzle pivots easily while steering is turned.

⚠ WARNING

Check steering and corresponding steering nozzle operation before starting engine.

Throttle/Shifter System**Throttle System**

Check throttle lever for free and smooth operation.

⚠ WARNING

Check throttle lever operation before starting the engine.

Shifter System

Check that reverse gate moves freely. With shifter lever in forward position, the gate must be in upward position. With the shifter lever in neutral position, gate must be in middle position. With shifter lever in reverse position, gate must be in downward position.

⚠ WARNING

Verify the reverse gate lock.

To verify the reverse gate lock, move shifter to FORWARD position.

Pull backwards on the reverse gate.

The reverse gate lock is working if the reverse gate stays in the up position.

NOTICE If the reverse gate does not stay in the up position when the shifter is at FORWARD, do not operate the boat further, see an authorized Sea-Doo Sport Boats dealer.

D.E.S.S. Post and Engine Start/Stop Switch

Ensure that switches operate properly.

⚠ WARNING

If engine does not shut-off when pushing engine start/stop switch or by disconnecting the D.E.S.S. key from the D.E.S.S. post, do not operate the boat further, see an authorized Sea-Doo Sport Boats dealer. Only start boat once all items have been checked and operate properly.

Navigation Lights

Ensure all navigation lights are operational and replace any defective light before using the boat.

Towing Tower (optional)

Check that all retaining bolts are in place and tight.

Mandatory Safety Boating Equipment

Make sure to have all safety equipment required by the local regulations (fire extinguisher, PFDs, visual distress signal devices, etc.). Check with a local competent authority for a complete list.

Storage Compartment Covers

Ensure they are closed and latched.

Fuel

Fill the fuel tank.

⚠ WARNING

Strictly adhere to instructions in the *FUELING PROCEDURE*.

VEHICLE INFORMATION

CONTROLS, INSTRUMENTS AND EQUIPMENT

NOTE: Some controls, instruments or equipment do not apply or are optional on some models. In these cases their reference numbers are deliberately missing in the illustrations.



lmo2009-001-001_a

COCKPIT VIEW

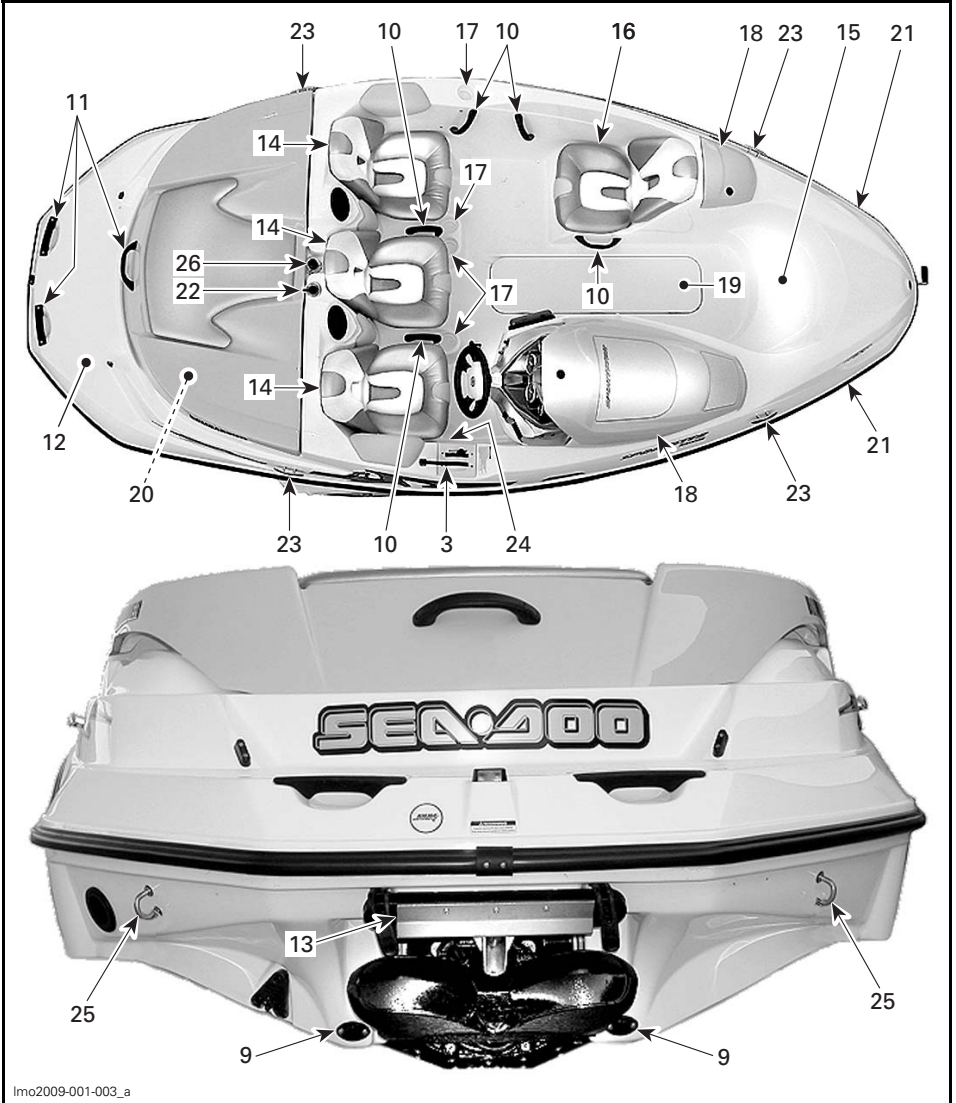

lmo2009-001-003_a

TYPICAL



TYPICAL - OPTIONAL

1) D.E.S.S. Post

⚠ WARNING

Keep D.E.S.S. post free from obstructions that could interfere with its operation. The proper use of the safety lanyard can prevent a runaway boat situation which otherwise could cause severe personal injury or death. Remove the D.E.S.S. key when stopped to help prevent accidental starting.

The D.E.S.S. key should be securely snapped onto the Digitally Encoded Security System (D.E.S.S.) post to allow engine starting.

Two short beeps should sound indicating the system is ready to allow engine starting. Otherwise, refer to the *MONITORING SYSTEM* section.

Pulling the key from the D.E.S.S. post stops the engine.

⚠ WARNING

Should the D.E.S.S. key become loose or fails to remain on the D.E.S.S. post, replace it immediately.

Always attach the safety lanyard to the operator using its Personal Flotation Device or a wrist strap and snap the key to the D.E.S.S. post to be able to start the engine.

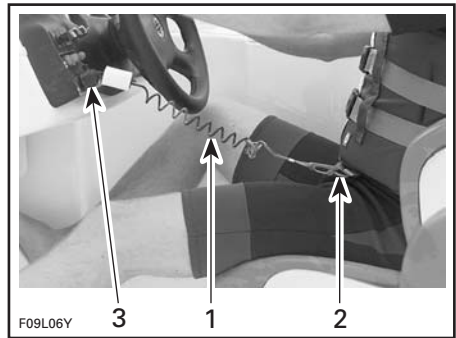

TYPICAL

1. Safety lanyard
2. Secure lanyard clip to PFD
3. Snap key to D.E.S.S. post

⚠ WARNING

Directional control is reduced when throttle is decreased and lost when engine is off. Always remove D.E.S.S. key when boat is not in operation.

⚠ WARNING

Do not lubricate the D.E.S.S. post.

⚠ WARNING

While the engine can be stopped using the start/stop switch, good driving habits recommend that the D.E.S.S. key also be disconnected when stopped.

Additional Information on the Digitally Encoded Security System (D.E.S.S.)

The D.E.S.S. key contains an electronic circuit that gives it a unique electronic serial number.

To have additional D.E.S.S. keys programmed for your boat, refer to an authorized Sea-Doo Sport Boats dealer.

If the engine is stopped with the start/stop switch while the key remains on the D.E.S.S. post, it can be restarted anytime by only pressing the start/stop switch during a period of

approximately 10 minutes while the system remains under power. After this delay, it is necessary to remove and reinstall the key on the D.E.S.S. post to restart the engine.

2) Steering Wheel

The steering wheel controls the direction of the boat. Turning the steering wheel clockwise steers the boat to the right and inversely.

3) Throttle/Shifter Controller

Throttle Lever

When pushed forward, the boat accelerates. When fully pulled back, engine returns to idle speed and the boat is gradually stopped by water drag.

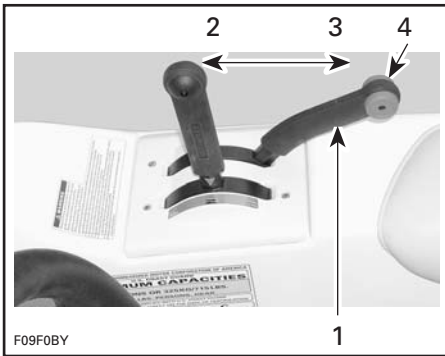

TYPICAL

1. Throttle lever
2. Increase speed
3. Decrease speed
4. Idle speed position

Shifter Lever

A 3-position lever:

- Forward
- Neutral
- Reverse.

In order to shift, throttle lever must be fully pulled back to idle speed position.

NOTE: Shifter must be in neutral position to allow engine starting.

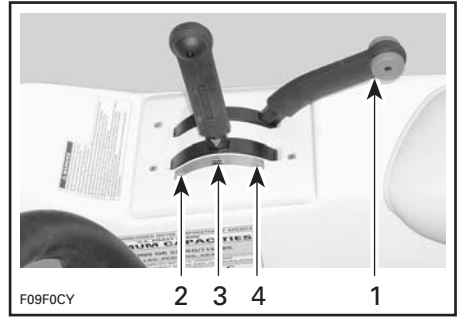

TYPICAL

1. Throttle lever must be fully pulled back (idle speed) to shift
2. Forward
3. Neutral
4. Reverse

NOTICE Do not force lever. Insure throttle lever is in idle position.

⚠ WARNING

Shifter lever should only be used when the engine is idling and boat is completely stopped.

⚠ WARNING

Only use reverse at slow speed and for the shortest time possible. Always ensure the path behind is clear of objects and persons including children playing in shallow water.

NOTICE Never rev the engine at high RPM in reverse.

4) Start/Stop Switch

Dual function START/STOP switch, used to start as well as to stop engine.

This switch is located on driver's console at the left of steering wheel.

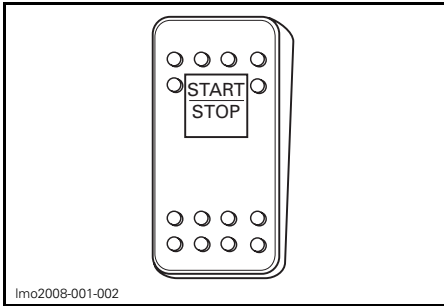

START/STOP SWITCH

Engine Starting and Stopping

Refer to *OPERATING INSTRUCTIONS* for complete procedure to start and stop the engine.

5) Navigation Lights Switch

A 3-position NAV/OFF/ANC switch.

This switch is located on driver's console at the right of steering wheel.

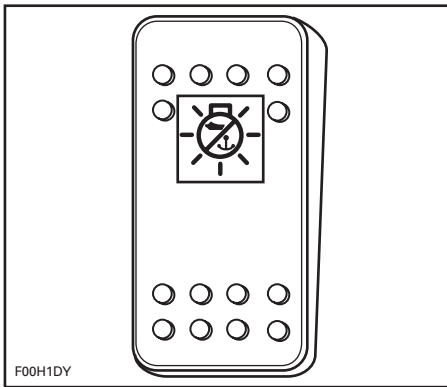

NAVIGATION LIGHTS SWITCH

ANC: Turns on the anchorage light when the boat is anchored. Only the stern light is lit.

OFF: Turns off all lights.

NAV: Turns on both bow and stern lights and illuminates the gauges.

6) Bilge Pump Switch

A 2-position OFF/ON switch.

This switch is located on driver's console at the right of steering wheel.

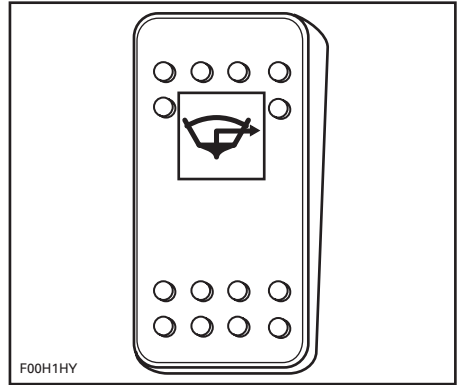

BILGE PUMP SWITCH

Turn to ON position when manual operation of the bilge pump is required (after cleaning, storage, etc.).

Turn switch to OFF when finished.

NOTICE Do not operate for prolonged time if the bilge is dry: battery drainage will occur and pump will be damaged.

The bilge pump may be operated without the D.E.S.S. key on its post.

NOTICE Always turn pump OFF when bilge is dry or before operating the engine above idle. Bilge pump will then switch to automatic mode.

Automatic Bilge Pump

The automatic bilge pump evacuates water from the bilge. A water sensor detects the water, activating the pump. After the water is pumped out, the pump shuts-off automatically. This automatic mode is working at all times: with/without D.E.S.S. key on its post and with/without engine running.

NOTICE When the main battery cut-off switch is turned OFF while boat is moored, the automatic bilge pump will start if water comes up in the bilge.

7) Bilge Blower Switch

A 2-position OFF/ON switch.

This switch is located on driver's console at the right of steering wheel.

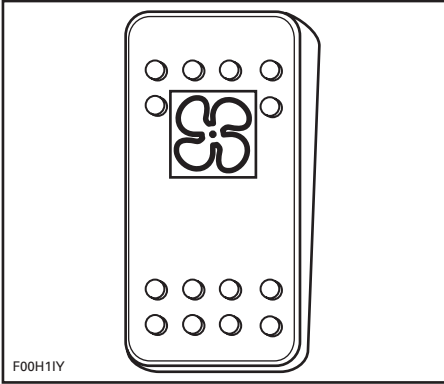

BILGE BLOWER SWITCH

When turned on, the blower ventilates the engine compartment.

⚠ WARNING

Gasoline vapors can explode, resulting in injury or death. Always use blower for a minimum of 5 minutes before starting engine, then turn it OFF above idle speed. Use of the bilge blower should never replace "smelling" for gasoline vapor odors.

⚠ WARNING

If any leaks or gasoline vapor odors are present, do not start the engine. Consult an authorized Sea-Doo Sport Boats dealer.

NOTE: Using the bilge blower for a prolonged time when the engine is not running will discharge the battery.

Blower should be turned off during boat operation.

8) Information Center Gauge

This is a multifunction gauge that supplies several real time useful information to the driver either in English, French or Spanish. See an authorized Sea-Doo Sport Boats dealer for unit settings.

At start-up, all LCD segments and indicator lights will turn on for 3 seconds each time the information center is activated (when D.E.S.S. key is installed). This allows the driver to validate they are all working properly.

NOTE: Gauge is illuminated whenever the navigation lights are used.

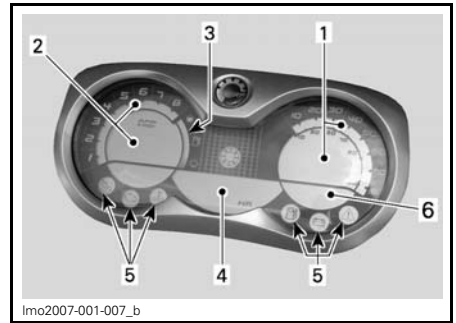

1. Speedometer
2. Tachometer
3. Fuel level
4. Information display
5. Indicator lights
6. Water temperature display

Speedometer

Speedometer indicates the speed of the boat in miles per hour (MPH) or kilometers per hour (km/h).

Tachometer

Tachometer indicates the revolutions per minute (RPM) of the engine. Multiply by 1000 to obtain the actual revolutions.

Fuel Level

Bar gauge that continuously indicates the amount of fuel left in the fuel tank while riding.

Information Display

Compass

Displays the cardinal points to indicate the orientation of the boat.

WARNING

Use the compass as a guide only. Not to be used for navigation purposes.

Hourmeter (HR)

Displays the time in hours of the boat usage.

Water Temperature Display

Displays the water temperature of the water surface in degrees Celsius (°C) or Fahrenheit (°F).

Water Depth Display

Display the water depth under the hull within 0 m to 50 m (0 ft to 170 ft).

NOTE: Under certain conditions, the gauge may stop displaying. The gauge ability to display the depth depends on the usage conditions.

Message Code

Displays a message code whenever one of the following circumstances occurs. The abbreviations between parenthesis here are the codes displayed.

(H-TEMP)

Engine or exhaust system overheating.

NOTICE If the monitoring beeper continuously sounds, stop engine as soon as possible.

Turn off engine as soon as possible. Check oil and coolant levels and refill if necessary. Refer to *MAINTENANCE PROCEDURES*.

If engine still overheats, refer to *ENGINE OVERHEATING* in *TROUBLESHOOTING*.

(OIL)

Low or high oil pressure in the engine.

Check oil level as soon as possible.

If lamp remains ON contact an authorized Sea-Doo Sport Boats dealer.

NOTICE Never run engine out of oil. Serious engine damage will occur.

(12 V LOW)

Low battery voltage.

Before the battery becomes too discharged to start the engines, the **low/high battery voltage** indicator light will come on.

When the indicator light is ON, you should discontinue all use of electrical accessories immediately and start the engine in order to recharge the battery.

(12 V HI)

High battery voltage.

See an authorized Sea-Doo Sport Boats dealer.

(FUEL-LOW)

Low fuel level.

Fill up fuel tank as soon as possible.

(MAINT)

Maintenance reminder.

NOTE: When the boat is due for a maintenance inspection, the message MAINT will blink. After servicing, your authorized Sea-Doo Sport Boats dealer will clear it.

(CHK ENG)

Check engine.

NOTE: If a fault occurs, this system generates numbered fault codes (P-XXXX) that are displayed through the information center. In case of a failure, you may call your authorized Sea-Doo Sport Boats dealer and he would be able to assist you to obtain the code descriptions to help troubleshooting.

(SENSOR)

Sensor failure (boat electronic equipment).

See an authorized Sea-Doo Sport Boats dealer.

(KEY)

Invalid D.E.S.S. key.

Indicates that you have used the wrong D.E.S.S. key, use the proper key for this boat.







Additional Information

A beeper will sound and indicator light will blink depending on the fault occurring to catch the driver attention when necessary.

Except for low liquid levels, which can be corrected by refilling, it is recommended to see an authorized Sea-Doo Sport Boats dealer when other messages occur.

Indicator Lights

NOTE: Refer to *MESSAGE CODE* above for additional information regarding messages.

	Low oil pressure (OIL)
	Check engine (CHK ENG)
	Engine or exhaust system overheating (H-TEMP)
	Low fuel level (FUEL-LOW)
	Low/high battery voltage (12 V LOW/HI)
	Maintenance reminder (MAINT)

9) Bilge Drain Plugs

Once boat is on trailer, unscrew the drain plugs, block the wheels and raise the bow slightly with the trailer jack (if so equipped) so that the water can flow out of the bilge.

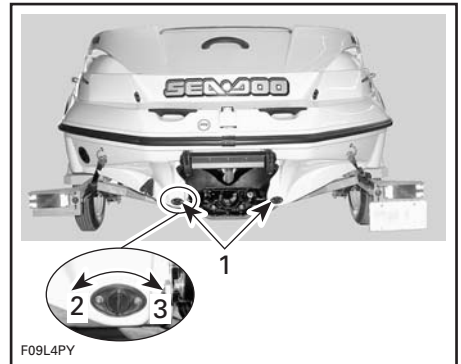

- TYPICAL**
1. Drain plugs
 2. Loosen
 3. Tighten

10) Grab Handles

Grab handles provide a handhold for the passengers.

Although grab handles are provided, never perform maneuvers that place a passenger or the driver at risk for being ejected or thrown out of their seat.

NOTICE Never use the grab handles to pull anything or to lift the boat.

Refer to components location illustrations at the beginning of this section for grab handle locations.

11) Rear Grab Handles

Provide a handhold for boarding when needed.

NOTICE Never use the grab handle to tow anything or to lift the boat.

12) Swim Platform

Provides an anti-skid surface for easy boarding from rear of the boat.

⚠ WARNING

Do not start or operate the boat if a person is seated on the platform. Engine must be off when using swim platform. Keep away from jet or intake grate.

13) Ladder



TYPICAL
1. Retractable ladder

Located under the swim platform, the ladder helps in re-boarding the boat.

⚠ WARNING

Engine should be OFF when using ladder. Keep limbs away from jet or intake grate. Only one person at a time on the ladder. Never use the ladder for pulling, towing, diving or jumping, boarding a boat that is out of the water or any other purpose other than a ladder.

Pull latches to unlock the ladder.

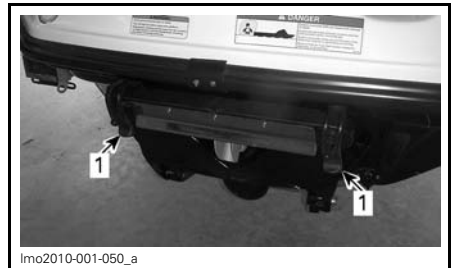

TYPICAL
1. Latches

Slide ladder toward rear, then push down.



TYPICAL — LADDER LOWERED

To store ladder, lift horizontally, slide toward front and refasten latch.

14) Seats

Each occupant should be seated while underway.

⚠ WARNING

Allow no one to sit on edge of the boat or to stand up while in operation. Seat and grab handles should be used in rough waters.

15) Front Boarding Step

Located at front of boat, it is provided as a boarding step.

⚠ WARNING

Avoid serious or fatal injury. No passenger should be seated on the boarding step when speed exceeds 8 km/h (5 MPH).

16) Spotter Seat

Located on the port side, rearward facing, this seat is provided to be used by the observer when towing a tube, skier or wakeboarder.

Use grab handles as necessary.

⚠ WARNING

When pulling a tube, skier or wakeboarder, always have an observer while towing, proceed with only as much speed as required, and follow the observer's instructions.

17) Cup Holders

Convenient locations for non-alcoholic beverages.

⚠ WARNING

Never operate boat while under the influence of alcoholic beverages while aboard. Do not keep bottles, cans etc. in cup holders while riding at high speed and/or on rough water.

18) Front Storage Compartment

A convenient watertight, lockable storage compartment with a removable basket. The basket is the ideal location for spare spark plugs, first aid kit, etc.

⚠ WARNING

Never leave any heavy or loose breakable objects in the storage basket. Never operate the boat with the storage compartment cover open.

Push the latch button downward to unlock storage compartment cover. Raise cover until stopped by the retaining device. The cover will remain in this position on calm water.

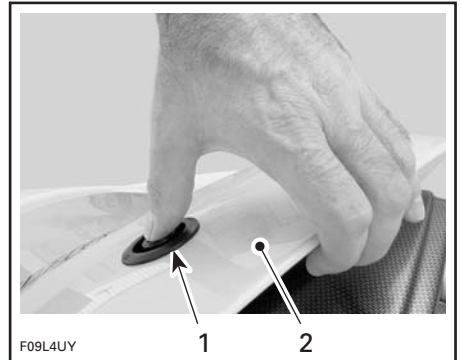
**TYPICAL**

1. Push lock button in
2. Lift up

The driver-side front compartment is provided with a holder to store an approved fire extinguisher.

The fire extinguisher (sold separately) should not be loose in the storage compartment.

This Operator's Guide should be kept in a waterproof bag and remain with the boat at all times.

⚠ WARNING

Do not remove the basket to use as additional storage area. Components can become entangled and cause serious operational hazards.

Push cover down to release mechanism then move down slowly. When bottomed on latch, firmly push cover to lock.

Periodically verify the lock pin tightness of storage cover. Tighten if needed and make sure storage cover latches properly.



1. Lock

⚠ WARNING

Never leave any heavy or loose breakable objects in the storage basket. Never operate the boat with the storage compartment cover open.



TYPICAL — SPOTTER SEAT STORAGE COMPARTMENT

19) Deck Storage Compartment

The deck storage compartment is a convenient lockable location for water-skis, paddles, anchor and rope, etc.

Use the provided key to unlock the compartment if needed.



TYPICAL
Step 1: Pull latch and lift cover

Lift the latch ring and open cover gently until the gas assist cylinder is fully extended.

When completely opened, the cover remains in that position on calm water.

To close, gently lower the cover.

Lock if desired.

20) Rear Storage Compartment

Convenient location to be used to carry large personal articles. Ideal location for spare Personal Flotation Device (PFD), towels, lunch etc.

Pull the latch lever located beneath the front storage compartment lid upward to release engine cover latch, and open storage compartment cover gently until stopped.

The gas assist cylinder will complete the opening and hold cover open.

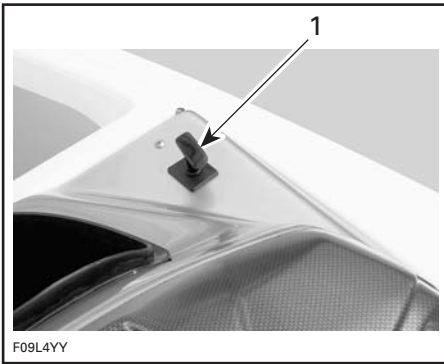

TYPICAL

1. Pull latch handle upward

Storage Tray

NOTICE In order to avoid damage, **MAXIMUM LOAD** on storage tray must not exceed 22.5 kg (50 lb).

The storage tray is removable to give access to the engine compartment. Grab the handle and lift in a rearward movement until opposite holders release.

⚠ WARNING

When storage tray is lifted or removed, never touch any electrical part when starting engine or while in operation. Never leave any object, rag, tool, etc., in the engine compartment or in the bilge.

When reinstalling storage tray, ensure to properly locate it just below holders, gently lower tray then push it downward to lock.

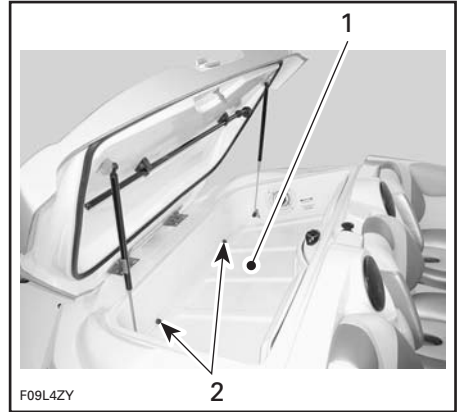

TYPICAL

1. Rear storage compartment tray
2. Tray under holders

Firmly close storage compartment cover to latch.

⚠ WARNING

Never leave any heavy or breakable objects in the storage compartment. Never operate the boat with the rear storage compartment cover open.

21) Bow Lights

Mandatory red/green lights. See *NAVIGATION LIGHT SWITCH* as mentioned earlier in this section.

22) Stern Light Socket

The stern light socket is provided for the mandatory white stern light.

The stern light is stored in the rear storage compartment.

NOTE: It is recommended to keep stern light in rear storage compartment at all times except when needed.

Stern Light Removal

To remove from storage cover, pull it out. Snap in place to store.

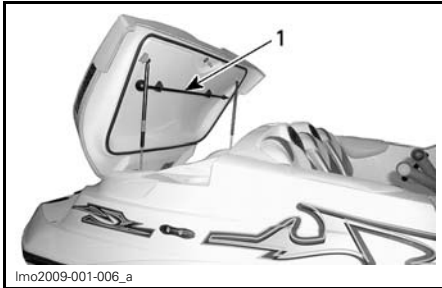

TYPICAL

1. Stern light storage location

Stern Light Installation

1. Lift connector cap.



1. Connector cap

2. Insert post in connector hole. Ensure to align hole keyway with post screw head.

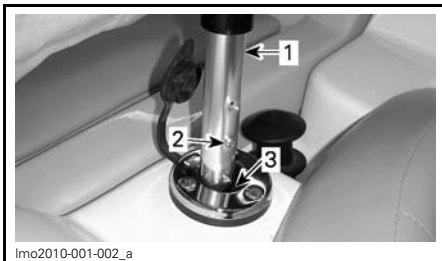

1. Stern light post
2. Post screw head
3. Hole keyway

3. Firmly push downward to engage terminals.
4. Push lock ring downward. Turn until locked. It may be necessary to slightly turn it to allow its insertion in the hole.



- Step 1: Push downward
Step 2: Turn clockwise to lock

5. Check light operation. See *NAVIGATION LIGHT SWITCH* as mentioned earlier in this section.

NOTICE Ensure DIELECTRIC GREASE (P/N 293 550 004) is present in connector area of light to prevent corrosion.

Removal and storage of light is the reverse of installation.

23) Mooring Cleats

When mooring to a dock, it is recommended to secure the boat with both front and rear cleats. The use of dock lines with sealed air fenders is recommended to protect your boat.

NOTICE Never use mooring cleats to pull anything or to lift the boat.

24) Deck Drain

Located below the driver's seat, the deck drain provides water drainage from rain, deck washing, water splashing, etc. Keep clean to avoid clogging.

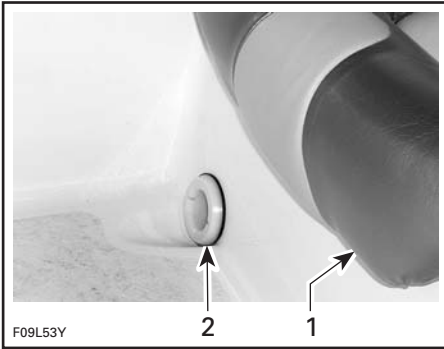

1. Driver's seat
2. Deck drain

25) Bow and Stern Eyelets

Eyelets can be used for mooring, towing and as a tie-down point during transportation.



- TYPICAL**
1. Stern eyelet
 2. Bow eyelet

26) Water Sport Towing Attachments

Please read and often refer to *WATER SPORTS* information in the *SAFETY INFORMATION* section at the front of this guide.

⚠ WARNING

“Teak Surfing” is extremely dangerous to participants due to their proximity to the rear of the boat where direct contact with the exhaust fumes from the boat engine is the highest. Carbon monoxide poisoning can occur and result in mental disorientation, dizziness, drowsiness, and loss of consciousness. The combination of carbon monoxide exposure and non-use of a life jacket (PFD) make this new water recreation activity an incredibly dangerous and potentially deadly sport.

⚠ WARNING

When pulling a tube, skier or wakeboarder, always have an observer, proceed with only as much speed as required, and follow the observer's instructions.

⚠ WARNING

Pulling a tube, skier or wakeboarder makes the boat handle differently and requires greater skill. Unless absolutely necessary, do not make tight, sharp turns. Keep a safe distance from the docks, swimmers, other craft or objects. Be advised that serious injury can result if the tow rope becomes slack during a tight turn or when circling. The rope could become wrapped around the neck or limbs of a person.

Ski Post

This boat comes equipped with a ski post. Use this post to pull a tube, water skier or wakeboarder.

Pull up the post to allow hooking a ski rope or other towables.

WARNING

Always have observer watch skier. Ensure ski post is fully extended and locked before use. Completely retract when not used.

NOTICE Never use the ski post to tow any other craft.

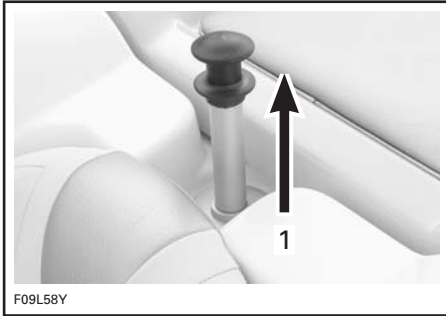

1. Lift ski post to use

Push down when finished.

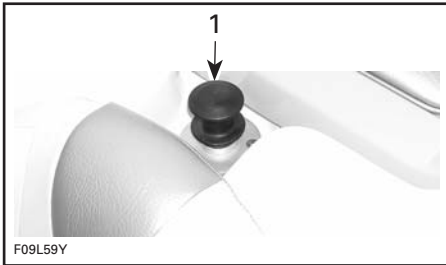

1. Ski post position when not used

Towing Tower (Optional)

NOTICE Do NOT fold tower forward. Attempting to fold the tower forward will damage the front tower mounts.

The towing tower is for skiing or wakeboarding.

NOTICE To avoid damage to the boat the tower must be secured and bolted in upright position when boat is operated or trailered. Periodically check that bolts are in place and tight. Check clearance height around docks, shore, overhanging objects, bridges and power lines. The tower must not be used as a tie-down or tie-off point. Never add accessories to the tower unless approved by BRP.

Lowering Tower for Boat Storage

On each side, loosen bolt securing rear leg of tower to boat.

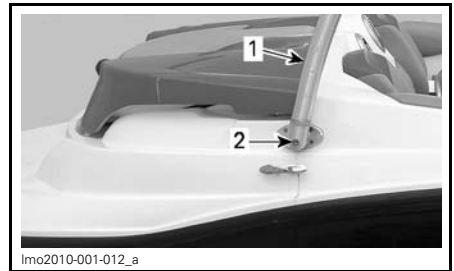

RIGHT SIDE SHOWN

- 1. Rear leg
- 2. Loosen this bolt

On each side, remove knob at the breakaway and loosen remaining bolt.

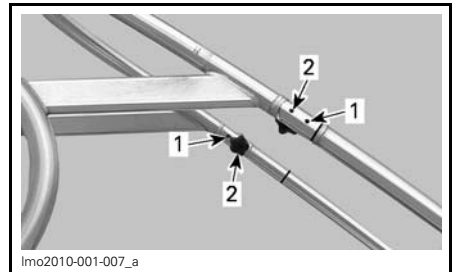

- 1. Loosen remaining bolts
- 2. Remove knobs

On each side, hold the front leg of tower and remove knob.

⚠ CAUTION To avoid injury or vehicle damages, never lower or raise the tower alone.



RIGHT SIDE SHOWN

1. Front leg
2. Knob

Carefully lower the tower rearward and rest it on the swim platform.

Fold both front legs down.

Place knobs in front storage compartment for later use.

Erection of tower is reverse of this procedure.

Tighten the 8 mm Allen socket bolts to 35 N•m (26 lbf•ft).

Tower Removal

Lower tower in storage position, refer to *LOWERING TOWER FOR BOAT STORAGE*.

On each side, remove Allen socket bolt retaining the rear leg of tower to boat.

Remove the tower from the boat.

Save knobs and bolts for later reinstallation.

Tower Installation (from off boat)

With the help of another person, place the tower on the swim platform.

⚠ CAUTION To avoid injury or vehicle damages, never handle the tower alone.

Apply LOCTITE 243 (BLUE) (P/N 293 800 060) on threads of 2 Allen socket bolts.

Using these bolts, secure the rear legs of tower to boat.

Carefully lift tower assembly.

Hold the tower in this position and using 2 knobs, secure the front legs to boat.

Install 2 knobs to secure the tower at the breakaway.

Tighten all retaining bolts to 35 N•m (26 lbf•ft).

27) Main Battery Cut-Off Switch

The switch allows a complete power cut-out of the electrical system.

The switch is located on starboard side, under the driver's console.

When in OFF position, ALL electrical equipment and electronics will be OFF, **except** the bilge pump. The bilge pump will operate automatically with the battery switch in the OFF position.

Switch must be in the ON position to allow the use of other accessories and to start the engine.

NOTICE Stop engine before switching to the OFF position.



MAIN BATTERY CUT-OFF SWITCH

1. Battery cut-off switch in OFF position

It is recommended to set this switch to the OFF position whenever performing maintenance in the engine compartment, on the electrical system, for transportation or during short term storage.

NOTICE When the main battery cut-off switch is turned OFF while boat is moored, the automatic bilge pump will start if water comes up in the bilge.

28) AM/FM Radio/CD Player



TYPICAL — RADIO/CD PLAYER

Refer to *MANUFACTURER'S GUIDE* for complete explanation of features and controls.

NOTICE Using the radio/CD player for a prolonged time without engine running may discharge the battery.

29) 12-Volt Power Outlet

A 12-volt power outlet is provided to power temporary accessories such as a cellular phone or other 12-volt portable devices.

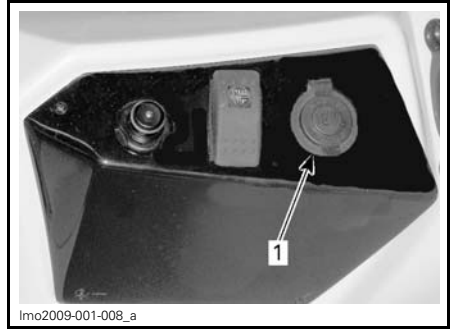

LOCATED ON DRIVER'S CONSOLE
1. 12-volt power outlet

Lift protective cap to expose jack.

NOTICE Using the accessory jack for a prolonged time without engine running may discharge the battery.

NOTICE Close protective cap when jack is not in use to protect against weather.

OPERATING INSTRUCTIONS

⚠ WARNING

Always perform *PRE-RIDE INSPECTION* before operating the boat. Become thoroughly familiar with all controls and the function of each. Should any control or instruction be not fully understood, refer to an authorized Sea-Doo Sport Boats dealer.

Operating During Break-In

NOTICE Carefully follow the instructions of this section. Failure to do so may reduce the engine's life and/or performance.

A break-in period of 10 hours is required before continuous operation at full throttle.

To achieve a good break-in, throttle lever should not be advanced more than 3/4 opening, however, brief acceleration and speed variations contribute to a good break-in.

NOTICE Continued wide open throttle runs and prolonged cruising without speed variations should be avoided. This can cause engine damage during the break-in period.

Launching/Loading

NOTICE Before launching the boat, ensure the main battery cut-off switch is turned ON and the bilge plugs are fully screwed into place.

When finished loading the boat on trailer, turn the main battery cut-off switch to OFF.

Remove bilge plugs to drain bilge when boat is on trailer.

Boarding from a Dock

As with any boat, boarding should be done carefully and engine must not be running.

When boarding from a dock, slowly place one foot on the boat deck nearest to the dock and then move the other foot inside the boat. Push the boat away from the dock.



TYPICAL

NOTICE Although the boat requires only 30 cm (1 ft) of water to float, the engine should be started with at least 90 cm (3 ft) of water below the hull. If the depth of water is less than 90 cm (3 ft) and the engine is running, the impeller is turning and debris can be drawn from the bottom and damage the propulsion system.

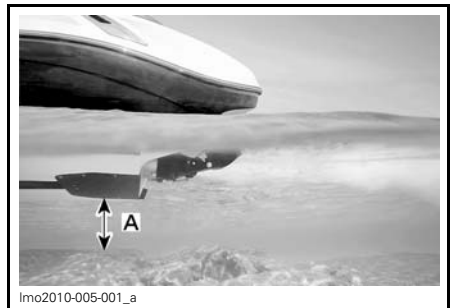

TYPICAL

A. 90 cm (3 ft)

Boarding from the Water

⚠ WARNING

Inexperienced riders should practice how to get aboard close to shore first before venturing into deep water.

⚠ WARNING

Engine should not be running while boarding. Never use propulsion components as a supporting point to board the boat.

Swim to the rear of the boat.

Release the rubber stays on one-step ladder pulling ladder out and down into boarding position. Grip the grab handle and pull yourself up until your knee can reach the swim platform.



TYPICAL

When you can reach the engine cover grab handle, grip it and continue to pull yourself upward to place your knee on the swim platform.



TYPICAL

Continue to climb on engine cover to reach the deck.



TYPICAL

NOTE: The last boarded person must secure the ladder using the retaining latch prior to reach its seat.

NOTICE Do not leave ladder hanging when operating the boat. Before operating the boat, always fasten the ladder in place using the latch.

⚠ WARNING

Do not start engine until all passengers are properly seated.

Starting

NOTE: Before starting engine for the first time during the day, perform the complete pre-ride inspection as described in *PRE-RIDE INSPECTION*.

Open the engine compartment cover and ensure engine compartment is free of gasoline vapor odors.

⚠ WARNING

If any leaks or gasoline vapor odors are present, **DO NOT** start the engine and communicate with your authorized Sea-Doo Sport Boats dealer.

Close the engine compartment cover.

Turn on bilge blower for 5 minutes then turn bilge blower switch off.

⚠ WARNING

Always activate bilge blower 5 minutes minimum before starting the engine to ventilate the bilge.

Attach the safety lanyard to your PFD or to a wrist strap.

⚠ WARNING

The safety lanyard must be attached to the operator all the time when engine is running.

Install the D.E.S.S. key on the D.E.S.S. post.

NOTE: The safety lanyard clip must be securely attached to the operator's PFD, clothing, arm, or leg. Be sure to attach the lanyard clip to a place where it is free of obstructions and to something that will move with the operator if he or she leaves the helm station. If the engine shuts down because the D.E.S.S. key attached to the safety lanyard was removed, the key must be reinstalled on the D.E.S.S. post before the engine can be restarted.

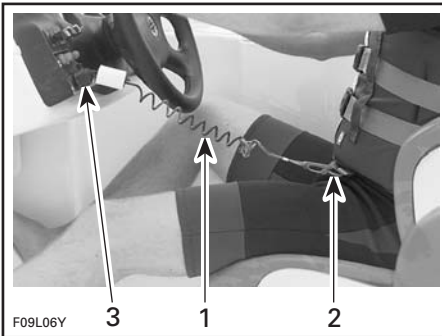

TYPICAL

1. Safety lanyard
2. Secure lanyard clip to PFD
3. Snap key to D.E.S.S. post

NOTE: If you hear some beeper signals other than 2 short beeps, it indicates a particular condition that must be corrected. Refer to chart in the *MONITORING SYSTEM* section for the meaning of the coded signal.

Ensure all passengers are properly seated in accordance with the seating label. Refer to *SAFETY LABELS* section.

⚠ WARNING

Before starting, the operator and passengers should always be properly seated. Do not touch electrical parts or jet pump area when engine is running.

Ensure shifter is in neutral position and throttle lever in idle position.

Press and hold the start/stop switch. Release immediately after engine is started.

NOTICE To avoid starter motor overheating, the cranking period should not exceed 5 - 10 seconds and a rest period of 30 seconds should be observed between cranking cycles to let the starter cool down and its mechanism disengage.

Check tachometer to monitor engine.

Throttle/Shifter Controller Operation

When selecting the neutral or reverse position with the shifter lever, the reverse gate moves up or down to the desired position.

Forward

The shifter lever should be in the forward position in order for the boat to advance.

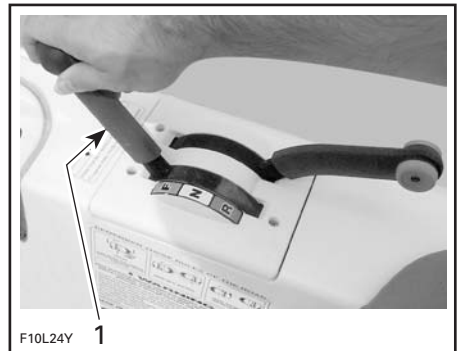

TYPICAL

1. Shifter lever in forward position

NOTICE Do not force lever, insure throttle lever is in idle position before shifting.

Neutral

To obtain neutral, pull shifter lever to the upright position. Reverse gate will be in the middle position, directing half of the thrust toward the front of the boat to minimize movement.

⚠ WARNING

When the shifter is in neutral position, the impeller is turning.

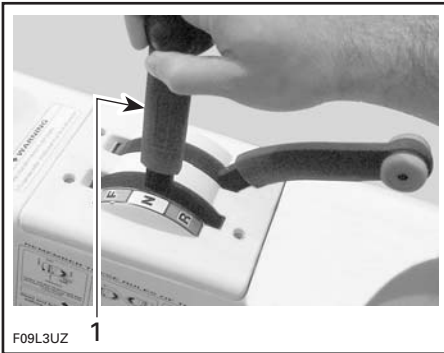

TYPICAL
1. Shifter lever in neutral position

Reverse

To obtain reverse, pull shifter lever completely to the rear. Reverse gate will be in downward position, directing all the thrust toward the front of the boat.



TYPICAL — SHIFTER LEVER IN REVERSE POSITION

NOTE: To obtain maximum efficiency and control from the reverse, increase engine speed to slightly above idle. Too much RPM will create water turbulence and reduce reverse efficiency.

The boat behaves differently when using reverse. At first outing, carefully practice this maneuver away from anything with which you might collide.

⚠ WARNING

Become fully familiar with the reverse operation during your first ride and before carrying passengers.

Steering Operation

Turning the steering pivots the jet pump nozzle which controls the boat direction. Turning the steering wheel clockwise will turn the boat to the right and inversely.

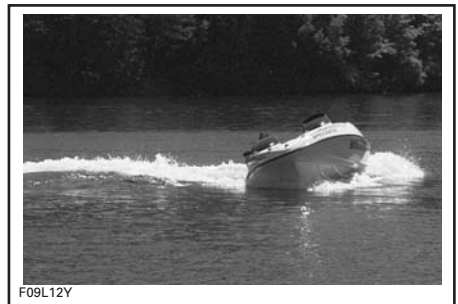

TYPICAL — RIGHT-HAND TURN

Above idle speed, throttle must be applied to turn the boat.

WARNING

Throttle must be applied and steering turned to change the direction of the boat at speed. Steering efficiency will differ depending on the number of passengers, load and water conditions.

A jet propelled boat needs some throttle applied in order to turn. Practice in a safe area applying the throttle and turning away from an imaginary object. This is a good collision avoidance practice.

Leaving the Shore

With throttle lever at idle position, move shifter lever to the desired direction.

Slowly accelerate to reach deeper water. Do not apply full throttle until engine is warm.

WARNING

In shallow water, shells, sand, pebbles or other objects could be drawn up by the jet pump and thrown rearward.

Rough Water or Poor Visibility Operation

Avoid operation in these conditions. If you must do so, proceed with caution and prudence using minimum speed. Turn on navigation lights if necessary.

Night Operation

Between sunset and sunrise, use the navigation lights and reduce speed.

WARNING

Navigation lights should always be used between sunset and sunrise. Ensure the stern light is installed. See *STERN LIGHT SOCKET* in this section for location and installation.

Crossing Waves

Reduce speed when crossing waves. Always be prepared to steer and balance as necessary.

When crossing wakes, always keep a safe distance from boat ahead.

WARNING

When crossing wakes, slow down. Operator and passenger(s) can brace themselves by posting. Do not jump waves or wakes.

Shutting Off the Engine

To shut off the engine, completely pull back throttle lever then remove the D.E.S.S. key or press the engine start/stop switch.

Always remove the D.E.S.S. key from the D.E.S.S. post.

WARNING

Should the engine be shut off, boat directional control is not available. Never leave the D.E.S.S. key connected on the D.E.S.S. post when boat is not in operation to avoid unauthorized use by children, theft or others.

Stopping/Docking

The boat is slowed by water drag. The stopping distance will vary depending on weight, speed, water surface condition, presence and direction of wind and current.

The operator should become familiarized with the stopping distance under different conditions.

Reduce speed to idle. Shift to neutral, reverse or forward as required when approaching a dock then shut off the engine just before coming alongside.

⚠ WARNING

While engine can be stopped by pressing the start/stop switch, we strongly recommend the engine be stopped by removing the D.E.S.S. key. This will install good habits.

Pressing switch when engine is running will stop the engine.

⚠ WARNING

Directional control is reduced when throttle is decreased and lost when engine is off.

Beaching

NOTICE It is not recommended to run the boat onto the beach.

Come slowly to the beach and shut off the engine using the D.E.S.S. key when water depth is 90 cm (3 ft) under the hull, then pull the boat to the beach. Ensure that all accessories are OFF.

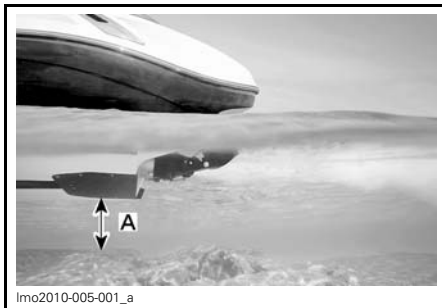

A. 90 cm (3 ft) of water under the hull

⚠ WARNING

In shallow water, shells, sand, pebbles or other objects could be drawn up by the jet pump and thrown rearward.

As necessary, the exhaust system should be flushed before restarting, in order to remove sand or shell accumulation which may clog the water passages. Refer to *EXHAUST SYSTEM FLUSHING* in the *MAINTENANCE PROCEDURES* section.

SPECIAL PROCEDURES

Jet Pump Water Intake and Impeller Cleaning

Water is drawn up by the impeller through this opening. The grate minimizes entry of foreign objects into the propulsion system.

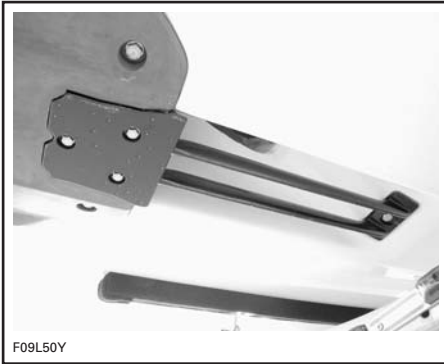

TYPICAL

⚠ WARNING

Keep away from intake grate while engine is on. Items such as long hair, loose clothing or personal flotation device straps can become entangled in moving parts resulting in severe injury or drowning.

Weeds, shells or debris can get caught on the intake grate, drive shaft and/or impeller. A clogged water intake may cause troubles such as:

1. **Cavitation:** Engine speed is high but boat moves slowly due to reduced jet thrust; jet pump components may be damaged.
2. **Overheating:** Since the jet pump operation controls the flow of water to cool the exhaust system, a clogged intake will cause the engine to overheat and damage internal engine components.

The clogged area can be cleaned as follows:

In-water cleaning: Pull the D.E.S.S. key from D.E.S.S. post to stop engine. Let the boat stop by itself. Wait a while to allow weeds or other debris to escape from grate. It may be necessary to repeat the procedure.

In severe conditions if the above method does not work, the following can be performed:

1. With engine running, put shifter lever in reverse position and vary throttle setting quickly several times.
2. Try accelerating again.

Most of the time, debris will escape from the propulsion system.

Out of water cleaning: If the system is still clogged, shut off the engine by removing the D.E.S.S. key.

⚠ WARNING

Always remove the D.E.S.S. key from the D.E.S.S. post to prevent accidental engine starting before cleaning the jet pump area.

From underneath boat, manually clean water intake area. If the system is still clogged, refer to an authorized Sea-Doo Sport Boats dealer for servicing.

NOTICE Avoid operation in weeded areas. If unavoidable, vary speed. Weeds tend to entangle more at steady and slow speeds. Inspect water intake grate for damage. Refer to an authorized Sea-Doo Sport Boats dealer for repair as necessary.

Towing the Boat in Water

Special precautions should be taken when towing a Sea-Doo Sport Boats in water.

Maximum recommended towing speed is 24 km/h (15 MPH).

When towing your Sport Boats in water, pinch the exhaust manifold water outlet hose with a LARGE HOSE PINCHER (P/N 529 032 500).

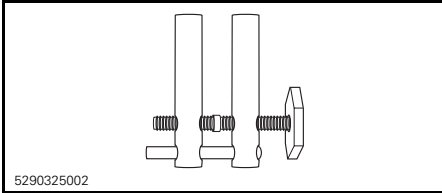

This will prevent the exhaust system from filling which may lead to water being injected into the engine. Without the engine running there isn't any exhaust pressure to carry the water out the exhaust outlet.

NOTICE Failure to do this may result in damage to the engine. If your Sea-Doo Sport Boats must be towed in water and you do not have a hose pincher, be sure to stay well below the maximum towing speed of 24 km/h (15 MPH).

Install the hose pincher on the exhaust manifold water outlet hose as shown.

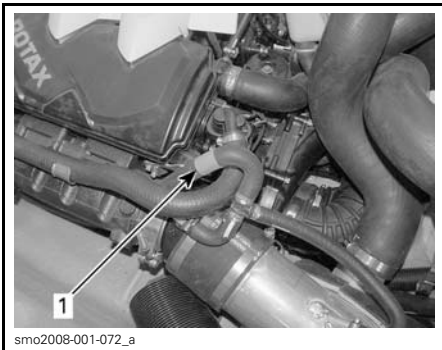

TYPICAL

1. Install hose pincher here

NOTICE When finished towing the Sport Boats, hose pincher must be removed before operating it. Failure to do so will result in engine damage.

Capsized Boat

This boat is designed so that it should not turn over easily due to its long and wide dimensions. If the boat ever capsizes, remember that it will continue to float. It is usually best to remain with it, so you will be more easily located by others.

⚠ WARNING

When boat is capsized, do not attempt to restart the engine. Operator and passengers should always wear approved personal flotation devices.

Submerged Boat and Water-Flooded Engine

To limit damages to the engine, perform the following procedure as soon as possible.

Drain bilge.

If it was submerged in salt water, spray bilge and all components with fresh water using a garden hose to stop the salt corroding effect.

NOTICE Never try to crank or start the engine. Water trapped in intake manifold would flow towards the engine and may cause severe damage to the engine.

Bring the boat to be serviced by an authorized Sea-Doo Sport Boats dealer as soon as possible.

NOTICE The longer the delay before you have the engine serviced, the greater the damage will be to the engine. Failure to have the engine properly serviced **will** cause severe engine damage.

MAINTENANCE INFORMATION

MAINTENANCE SCHEDULE

Maintenance is very important for keeping your boat in safe operating condition. Proper maintenance is the owner's responsibility. The maintenance schedule does not exempt the pre-ride inspection.

WARNING

Failure to properly maintain the boat according to the maintenance schedule can make it unsafe to operate.

The schedule should be adjusted according to operating conditions and use. Intensive use of boat will require greater frequency of inspection and maintenance.

We encourage you to have an Annual Safety Inspection of your boat.

PART/TASK	FIRST 10 HOURS										TO BE PERFORMED BY	LEGEND	
	EVERY 25 HOURS					EVERY 50 HOURS							
EVERY 100 HOURS OR Preseason										EVERY 200 HOURS OR 2 YEARS			
ENGINE													
Engine oil and filter	R				R ⁽¹⁾						D	(1) At storage period or after 100 hours of use whichever comes first. (2) Inspect slipping moment. (3) Every 10 hours in salt water use.	
Rubber mounts	I			I							D		
Supercharger clutch (if so equipped)								I ⁽²⁾			D		
Corrosion protection	L				L ⁽³⁾						O		
EXHAUST SYSTEM													
Exhaust system fasteners, hoses and components condition	I ⁽⁴⁾				I ⁽⁴⁾						D	(1) At storage period or after 100 hours of use whichever comes first. (4) Also inspect for leaks. (5) Daily flushing in salt water or foul water use.	
Exhaust system flushing					(1) (5)						O		
COOLING SYSTEM													
Hose and fasteners	I				I						D		
Coolant	I							R			D		

A: ADJUST C: CLEAN I: INSPECT L: LUBRICATE R: REPLACE D: DEALER O: OPERATOR	FIRST 10 HOURS										
	EVERY 25 HOURS										
	EVERY 50 HOURS										
	EVERY 100 HOURS OR Preseason										
	EVERY 200 HOURS OR 2 YEARS										
	TO BE PERFORMED BY										
PART/TASK	LEGEND										
FUEL SYSTEM											
Throttle cable	I				I (3)					D	(3) Every 10 hours in salt water use.
Throttle body	I				I, L (3)					O/D	
Fuel lines, connections, pressure relief valve and fuel system leak test	I				I					D	
Fuel tank straps	I				I					D	
ENGINE MANAGEMENT SYSTEM (EMS)											
EMS sensors	I				I					D	—
EMS fault codes	I				I					D	
AIR INTAKE SYSTEM											
Air filter					I (6)					D	(6) Replace if required.
ELECTRICAL SYSTEM											
Spark plugs	I				I	R				D	(3) Every 10 hours in salt water use.
Electrical connections (ignition system, starting system, fuel injectors etc.)	I				I					D	
ECM and VCM connectors (visual inspection without disconnecting)					I (3)					O	
Digitally Encoded Security System (D.E.S.S.)	I				I					D	
Main battery cut-off switch	I				I					D	
Battery support	I				I					D	
Battery					I					D	
Battery posts					L					D	
Stern light connectors					L					O	

MAINTENANCE SCHEDULE

A: ADJUST C: CLEAN I: INSPECT L: LUBRICATE R: REPLACE D: DEALER O: OPERATOR	FIRST 10 HOURS					
	EVERY 25 HOURS					
	EVERY 50 HOURS					
	EVERY 100 HOURS OR Preseason					
	EVERY 200 HOURS OR 2 YEARS					
	TO BE PERFORMED BY					
PART/TASK	LEGEND					
STEERING SYSTEM						
Steering cable and connections	I			I		D
Steering nozzle bushings	I			I		D
PROPULSION SYSTEM						
Drive shaft				L (3) (7)		D
Carbon ring and rubber boot (drive shaft)	I		I			D
Shifter system, cable and connections	I			I		D
Reverse gate			L (3)			O
Drive shaft/impeller splines				I, L		D
Impeller boot	I			I		D
Impeller shaft seal, sleeve and O-ring				I (3)		D
Impeller and wear ring	I		I			D
Sacrificial anode				(8)		O
HULL/BODY						
Storage compartment cover(s) locks, latch(es) and hinge(s)				I, L (3)		O
Deck drains/scupper valve				I		O
Drain plug (inside bilge)	I (9)			I (9)		O
Ski/wakeboard post and fasteners	I			I, L (4)		O

(3) Every 10 hours in salt water use.
 (7) Lubricate for corrosion protection.
 (8) Inspect each month (every two weeks in salt water) and change when necessary.

(3) Every 10 hours in salt water use.
 (9) Check for obstructions.

10-HOUR INSPECTION

We suggest that after the first 10 hours of operation, the boat be checked by an authorized Sea-Doo Sport Boats dealer. The initial maintenance is very important and must not be neglected.

NOTE: The 10-hour inspection is at the expense of the boat owner.

We recommend that this inspection be signed by an authorized Sea-Doo Sport Boats dealer.

Date of 10-hour inspection

Authorized dealer signature

Dealer name

MAINTENANCE PROCEDURES

This section includes instructions for basic maintenance procedures. If you have the necessary mechanical skills and the required tools, you can perform these procedures. If not, see your authorized Sea-Doo Sport Boats dealer.

Other important items in the maintenance schedule that are more difficult and require special tools are best performed by your authorized Sea-Doo Sport Boats dealer.

⚠ WARNING

Turn off the engine and follow these maintenance procedures when performing maintenance. If you do not follow proper maintenance procedures you can be injured by hot parts, moving parts, electricity, chemicals or other hazards.

⚠ WARNING

Should removal of a locking device (e.g. lock tabs, self-locking fasteners, etc.) be required when undergoing disassembly/assembly, always replace it with a new one.

⚠ CAUTION Some components in the engine compartment may be very hot.

Throttle Body

Throttle Body Lubrication

Lubricate throttle body with XPS LUBE (P/N 293 600 016) or an equivalent.

Use the lubrication fitting located on top of engine cover.

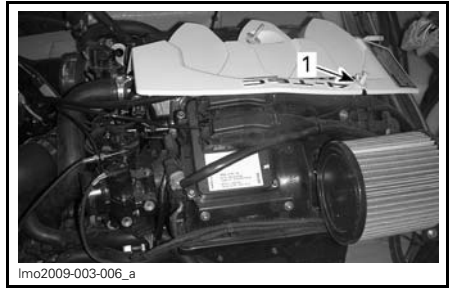

REMOVE CAP

1. Lubrication fitting

With the engine **not** running, make sure to spray lubricant at least 3 to 5 seconds for proper lubrication.

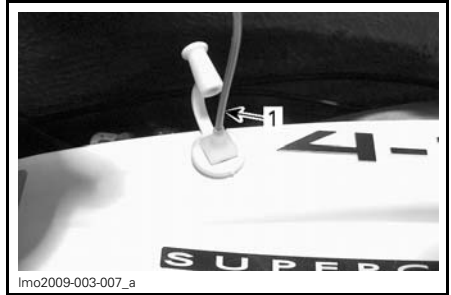

1. Can needle into lubrication fitting

Throttle Cable

Throttle Cable Inspection

Move the throttle lever forward and rearward once. It must operate smoothly. Refer to an authorized Sea-Doo Sport Boats dealer if adjustment is necessary.

⚠ WARNING

Do not alter or tamper with throttle cable adjustment or routing.

Engine Oil

Recommended Engine Oil (155 HP Engine)

Use XPS SYNTHETIC BLEND OIL (SUMMER GRADE) (P/N 293 600 121).

If XPS™ engine oil is not available, use a 10W40 meeting the requirements for API service classification SM, SL or SJ. Always check the API service label certification on the oil container, it must contain at least one of the above standards.

Synthetic Oil

A synthetic oil meeting the same requirements may be used.

The XPS 10W 40 SYNTHETIC 4-STROKE OIL (P/N 293 600 054) is suitable.

Recommended Engine Oil 255 HP Engines)

Use XPS SYNTHETIC BLEND OIL (SUMMER GRADE) (P/N 293 600 121).

If XPS™ engine oil is not available, use a 10W40 mineral engine oil compatible with wet clutches.

NOTE: The XPS engine oil has been thoroughly tested to be free of any additives that could impair the functionality of the supercharger clutch.

NOTICE NEVER use synthetic oil. This would impair the proper operation of the supercharger clutch. Do not add any additives to the recommended oil. Mineral oils not recommended by BRP may also contain additives (friction modifiers) that may cause inappropriate slippage of the supercharger and eventually lead to premature wear. For this reason, XPS Summer Grade oil or a BRP approved equivalent are the only recommended oils. Use of any oil not recommended by BRP may void BRP's limited warranty.

Engine Oil Level

NOTICE Check level frequently and refill if necessary. Operating the engine with an improper oil level may severely damage engine.

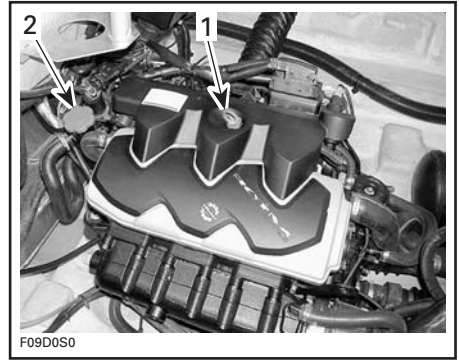

TYPICAL
1. Dipstick
2. Oil cap

Boat must be level.

Oil level can be checked either with boat in water or out of water.

If Boat is Out of the Water

If the boat is out of the water and on a trailer, block the wheels and raise the bow slightly with the trailer jack (if so equipped) until the bumper rail is level.

Install a garden hose to the flushing connector. Refer to *EXHAUST SYSTEM FLUSHING* in *MAINTENANCE PROCEDURES* and follow the procedure.

NOTICE Never run engine without supplying water to the exhaust system when boat is out of water. Failure to supply water to the exhaust system may severely damage exhaust system.

NOTICE Never run engine longer than 2 minutes. Drive line seal has no cooling when boat is out of water.

Procedure Continuation (Boat Out or In Water)

It is of the utmost importance to follow this procedure in order to obtain an accurate reading of the engine oil level.

⚠ CAUTION Engine oil may be hot. Certain components in the engine compartment may be very hot. Direct contact may result in skin burn.

1. Ensure engine is at normal operating temperature.
2. Let engine idle for 30 seconds before stopping.
3. Stop engine.
4. Wait at least 30 seconds.
5. Pull dipstick out and wipe clean.

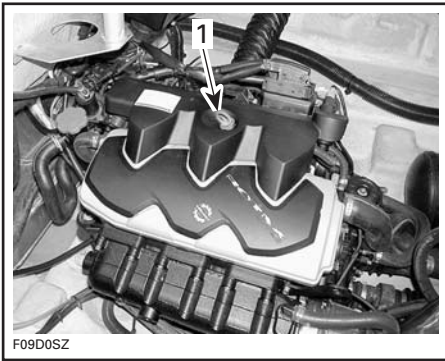

TYPICAL
1. Dipstick

6. Reinstall dipstick, push in completely.
7. Remove dipstick and read oil level. It should be between marks.

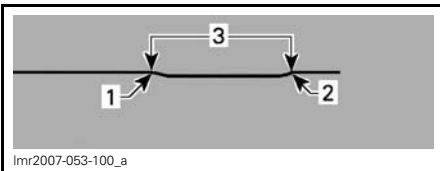

1. Full
2. Add
3. Operating range

8. If needed, add oil up to have the level between marks as required.
 - 8.1 Unscrew oil cap.

- 8.2 Place a funnel into the opening and add the recommended oil to the proper level.

NOTE: Do not overfill.

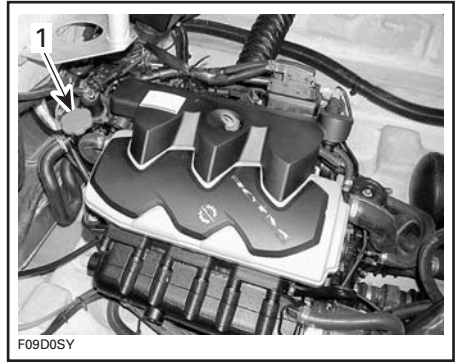

TYPICAL
1. Oil cap

NOTE: Every time oil is added in engine, the complete procedure explained above must be done. Otherwise, you will have a false oil level reading.

9. Properly reinstall oil cap and dipstick.
10. Wipe off any oil spillage.

Engine Oil Change and Oil Filter Replacement

The oil change and filter replacement should be performed by an authorized Sea-Doo Sport Boats dealer.

Engine Coolant

Recommended Engine Coolant

Always use ethylene-glycol antifreeze containing corrosion inhibitors specifically for internal combustion aluminum engines.

NOTE: When available, it is recommended to use biodegradable antifreeze compatible with internal combustion aluminum engines. This will contribute to protect the environment.

Cooling system must be filled with BRP PREMIXED COOLANT (P/N 219 700 362) or with a water and antifreeze solution (50% distilled water, 50% antifreeze).

To prevent antifreeze deterioration, always use the same brand. Never mix different brands unless cooling system is completely flushed and refilled. Refer to an authorized Sea-Doo Sport Boats dealer.

Engine Coolant Level

With boat on a level surface, coolant should be between MIN. and MAX. level marks of coolant reservoir when engine is cold.

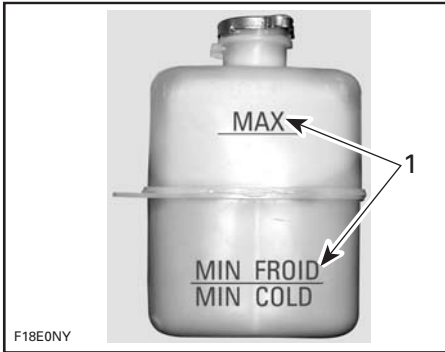

1. Level between marks when engine is cold

⚠ WARNING

Check coolant level with cold engine. Never add coolant in cooling system when engine is hot.

NOTE: The boat is considered level when it is in water. When on a trailer, block the wheels and raise the bow slightly with the trailer jack (if so equipped) until the bumper rail is level.

Add coolant to have the level between marks as required. Use a funnel to avoid spillage. **Do not overfill.**

Properly reinstall and tighten filler cap.

NOTE: A cooling system that frequently requires coolant is the indication of leaks or engine problems. See an authorized Sea-Doo Sport Boats dealer.

Engine Coolant Replacement

The coolant replacement should be performed by an authorized Sea-Doo Sport Boats dealer.

Exhaust System

Exhaust System Flushing

Flushing the exhaust system and intercooler with fresh water is essential to neutralize corroding effects of salt or other chemical products present in water. It will help to remove sand, salt, shells or other particles in water jackets and/or hoses.

⚠ WARNING

Perform this operation in a well ventilated area.

Proceed as follows:

1. Clean jet pump by spraying water in its inlet and outlet and then apply a coating of XPS LUBE (P/N 293 600 016) or equivalent.

⚠ WARNING

When operating the engine while the boat is out of the water, the heat exchanger in the ride plate may become very hot. Avoid any contact with ride plate as burns may occur.

2. Connect a garden hose to the connector located at the rear of boat on jet pump support. Do not open water tap at this time.

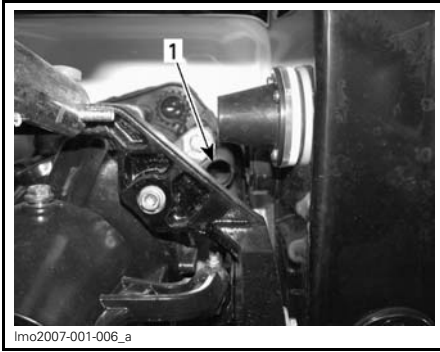

TYPICAL

1. Flushing connector

NOTE: Use the optional FLUSHING CONNECTOR ADAPTER (P/N 295 500 473) with a quick connect adapter to ease garden hose installation.

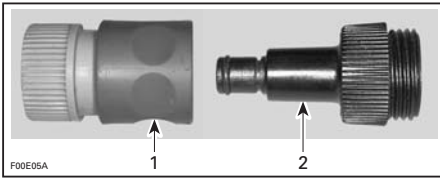

1. Quick connect adapter
2. Flushing connector adapter

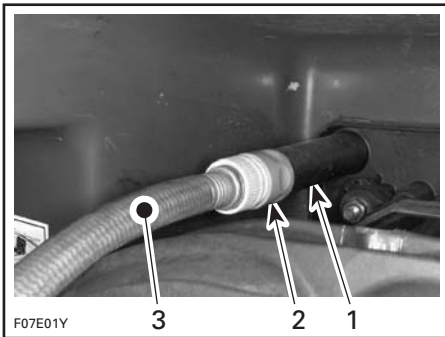

TYPICAL

1. Flushing connector
2. Quick connect adapter and flushing connector adapter (optional, not mandatory)
3. Garden hose

3. To flush, start engine then immediately open the water tap.

CAUTION Certain components in the engine compartment may be very hot. Direct contact may result in skin burn. Do not touch any electrical parts or jet pump area when engine is running.

NOTICE Never flush a hot engine. Always start the engine before opening the water tap. Open water tap immediately after engine is started to prevent overheating.

4. Run the engine about 20 seconds at a fast idle between 4000 - 5000 RPM.

NOTICE Never run engine without supplying water to the exhaust system when boat is out of water.

5. Ensure water flows out of jet pump while flushing. Otherwise, refer to an authorized Sea-Doo Sport Boats dealer for servicing.

NOTICE Never run engine longer than 2 minutes. Drive line seal has no cooling when boat is out of water.

6. Close the water tap, then stop the engine.

NOTICE Always close the water tap before stopping the engine.

NOTICE Remove quick connect adapter after flushing operation (if used).

Fuses

Fuse Inspection and Replacement

The electrical system is protected with fuses.

To remove fuse from box or holder, pull fuse out. Check if filament is melted.

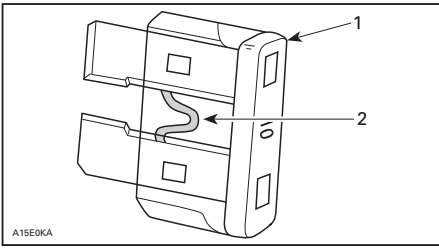

A15E0KA

1. Fuse
2. Check if melted

If a fuse is defective, replace by one of the same rating.

NOTE: If the entire electrical system is down, make sure the main battery cut-off switch is properly turned on. Refer to *MAIN BATTERY CUT-OFF SWITCH* in this section.

NOTICE Do not use a higher rated fuse as this can cause severe damage. If a fuse has blown, the source of malfunction should be determined and corrected before restarting. See an authorized Sea-Doo Sport Boats dealer for servicing.

Fuse Boxes 1 and 2 Location

The fuse box 1 and the fuse box 2 are located in the engine compartment on port side.

Refer to the covers decals or the *SPECIFICATIONS* section of this guide for fuses identification.

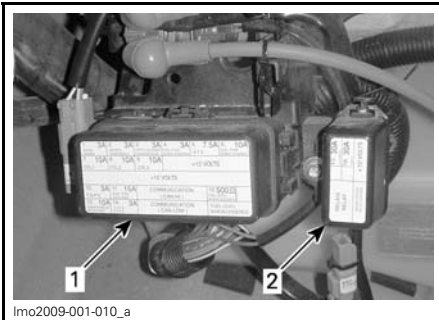

lmo2009-001-010_a

1. Fuse box 1
2. Fuse box 2

To remove a fuse box cover, unlock the tabs and pull cover off.

Front Fuse Box Location

The front fuse box is located in the front storage compartment.

To access the front fuse box, open the storage compartment lid, refer to *FRONT STORAGE* in this section then remove the basket.

Refer to the cover decal or the *SPECIFICATION* section of this guide for fuses identification.



lmo2009-001-009

FRONT FUSE BOX

To open the fuse box cover, simply pull it off.

Automatic Bilge Pump Fuse

The automatic bilge pump fuse is located on the positive battery cable near the post.

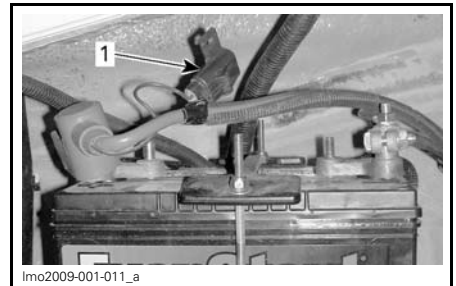

lmo2009-001-011_a

1. Battery in line fuse

Bilge Blower

Bilge Blower Operation Check

Verify bilge blower for proper operation. It is located beneath starboard ventilation duct in engine compartment.

Make sure that the blower ducts are not obstructed.

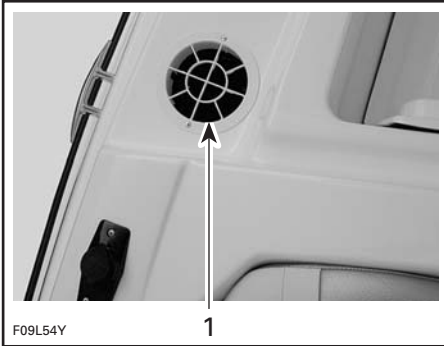

1. Blower duct

⚠ WARNING

If bilge blower does not operate properly, refer to an authorized Sea-Doo Sport Boats dealer before starting the boat.

Navigation Lights

Bow Light Bulb Replacement

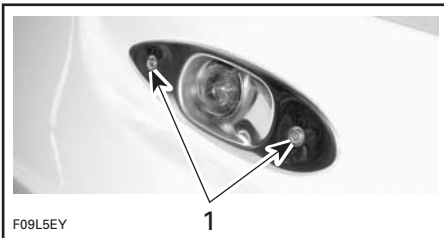

TYPICAL
1. Remove these screws

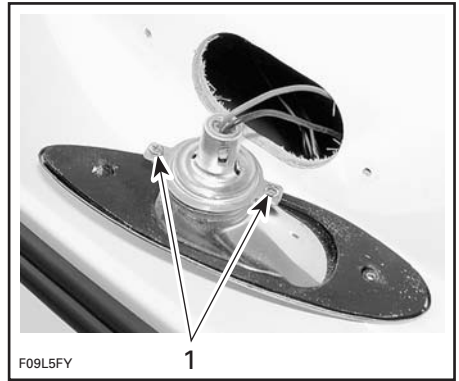

TYPICAL
1. Remove these screws



TYPICAL — PUSH IN, TWIST AND REMOVE BULB

Assembly is essentially the reverse of removal procedures. However, pay particular attention to the following:

Apply DIELECTRIC GREASE (P/N 293 550 004) on bulb contact surface.

Stern Light Bulb Replacement

Unscrew lens counterclockwise and pull it out.

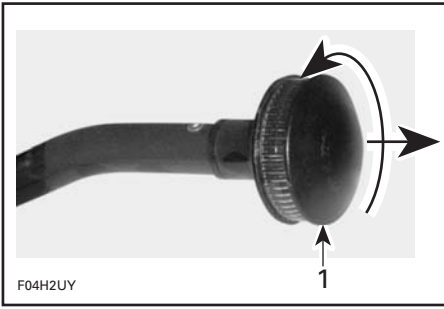

1. Unscrew then pull

Pull bulb to remove it.

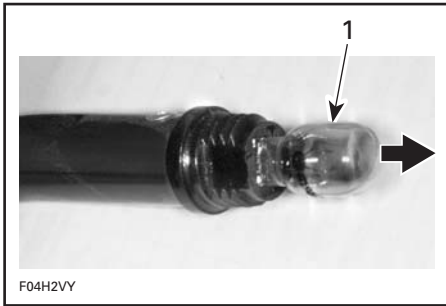

1. Pull bulb out

Apply DIELECTRIC GREASE (P/N 293 550 004) on new bulb contact surface.

Assembly is the reverse of removal procedure.

Stern Light Connector Lubrication

Apply DIELECTRIC GREASE (P/N 293 550 004) on stern light connectors as needed.

Deck Drain and Scupper Valve

Deck Drain Cleaning

The purpose of this drain is to evacuate water from the deck.

Remove any obstruction(s) from deck drain outlet.

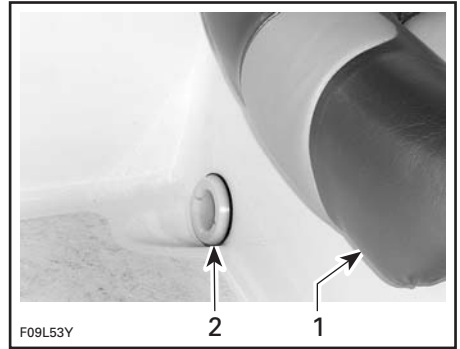

1. Driver's seat
2. Deck drain hole

Water drains out though the scupper valve located near the jet pump nozzle.

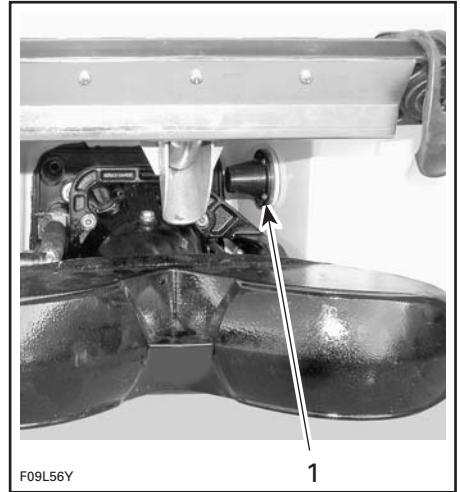

TYPICAL

1. Scupper valve

Keep it clean to avoid clogging.

Latches and Hinges

The application of XPS LUBE (P/N 293 600 016) lubricant will help to prevent corrosion and keep proper operation of moving mechanisms.

Latches and Hinges Lubrication

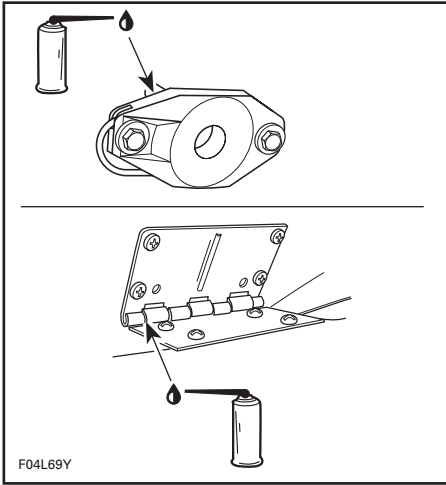

TYPICAL

Reverse Gate

Reverse Gate Lubrication

Lubricate pivot points and mechanism on both sides of reverse gate with XPS LUBE (P/N 293 600 016) lubricant or equivalent.

Ski Post

Ski Post Lubrication

Lubricate ski post through all its length with XPS LUBE (P/N 293 600 016) or equivalent. Pull out then push in several times to distribute the lubricant.

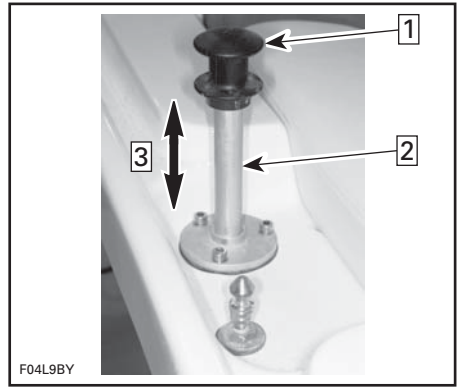

TYPICAL

Step 1: Lift ski post to lubricate

Step 2: Lubricate here

Step 3: Move post up and down several times to distribute lubricant

Sacrificial Anodes

Sacrificial Anodes Inspection

Corrosion of metal parts, especially those exposed to saltwater, is common for boats. Corrosion can be caused by stray electric currents from shore power installations, improperly grounded AC lines and circuits, and poorly insulated DC powered equipment from boats moored nearby. Corrosion is accelerated when electric current is present.

Sacrificial anodes are attached to certain parts of this boat to reduce corrosion. The anode corrodes, rather than the part to which the anode is attached.

Change each anode when 50% by weight has corroded away.

Anodes are attached at the following locations:

- Ride shoe/cooling plate
- Pump housing
- Reverse gate support
- Steering nozzle
- Reverse gate.

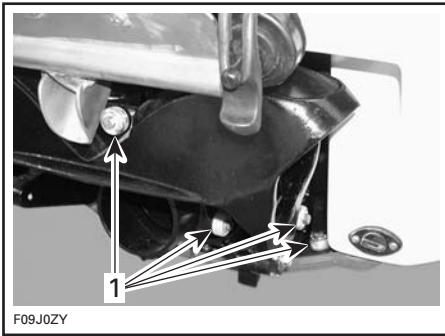
**TYPICAL**

1. Anode installation shown

NOTICE Inspect anodes each time boat is to be launched. Do **NOT** paint anodes or apply protective coatings.

Body and Hull

Inspect muffler, battery and fuel tank.

Cleaning

Twice a year, the bilge should be cleaned with hot water and detergent or bilge cleaner to remove any possible fuel/oil/electrolyte deposits and mildew.

Occasionally, wash the body with hot water and soap (only use mild detergent). Remove any marine organisms from engine and/or hull. Apply a marine wax containing no abrasive.

NOTICE Never clean fiberglass and plastic parts with strong detergent, degreasing agent, paint thinner, acetone, etc.

Wash windscreen with BRP HEAVY DUTY CLEANER (P/N 293 110 001) and water. For fine scratches and scuff marks removal, use a windshield polisher for acrylic, lucite, polycarbonate and similar materials.

Stains may be removed from seats and fiberglass with Spray Nine or the equivalent.

Stainless Steel and Chrome

To clean or polish stainless steel or chrome parts, always use a product specially developed for marine environment such as the Flitz Stainless Steel & Chrome Cleaner.

Corrosion Protection

Protect engine compartment metallic parts from corrosion using XPS LUBE (P/N 293 600 016) or an equivalent.

POST-OPERATION CARE

Remove the boat from the water every day to prevent growth of marine organisms.

WARNING

Allow engine to cool before performing any maintenance.

Exhaust System Flushing

The exhaust system should be flushed daily when boat is used in salt or foul water.

Refer to *MAINTENANCE PROCEDURES*.

NOTE: On supercharged models, the intercooler is flushed at the same time.

Anticorrosion Treatment

To prevent corrosion, spray a corrosion inhibitor (salt water resistant) such as XPS LUBE (P/N 293 600 016) or equivalent over metallic components in engine compartment.

NOTE: Engine fogging should be done with XPS LUBE (P/N 293 600 016) whenever the boat is to be stored for few days or a long period.

Apply DIELECTRIC GREASE (P/N 293 550 004) (salt water resistant) on battery posts and cable connectors.

NOTICE Never leave rags or tools in the engine compartment or in the bilge.

Additional Care for Foul Water or Salt Water Use

When the boat is operated in foul water and particularly in salt water, additional care must be taken to protect the boat and its components.

Rinse trailer and boat's hull/bilge area with fresh water.

Never use a high pressure washer to clean the bilge. **USE LOW PRESSURE ONLY (such as a garden hose)**. High pressure can cause damages to electrical or mechanical systems.

NOTICE Failure to perform proper care such as: boat rinsing, exhaust system flushing and anticorrosion treatment, when used in salt water, will result in damage to the boat and its components. Never leave the boat stored in direct sunlight.

In coastal areas, special care should also be taken on stainless steel or chrome parts like grab handles, mooring cleats, fuel cap and navigation lights. Rinse with fresh water. Clean with a good car chrome polish. Protect with a good car or fiberglass wax.

STORAGE

It is recommended that the boat be taken to an authorized Sea-Doo Sport Boats dealer for proper storage, however you can perform the following operations with a minimum of tools.

NOTE: Leave drain plug(s) out during storage period.

NOTICE Do not run the engine during the storage period.

⚠ WARNING

Because fuel and oil are flammable, have an authorized Sea-Doo Sport Boats dealer to pressurize and inspect the fuel and oil systems integrity as specified in the *MAINTENANCE SCHEDULE*.

Jet Pump Cleaning

Clean jet pump by spraying water in its inlet and outlet and then apply a coating of XPS LUBE (P/N 293 600 016) or equivalent.

⚠ WARNING

Always remove safety lanyard cap from D.E.S.S. post to prevent unexpected engine starting before cleaning the jet pump area. Engine must not be running for this operation.

Fuel System Protection

BRP FUEL STABILIZER (P/N 413 408 600) (or equivalent) can be added in fuel tank to prevent fuel deterioration and fuel system gumming. Follow stabilizer manufacturer's instructions for proper use.

NOTICE It is highly recommended to add fuel stabilizer at storage in order to maintain fuel system in good condition.

Throttle Body Lubrication

Lubricate throttle body. Refer to *MAINTENANCE PROCEDURES* for details.

Engine Oil and Filter Replacement

The oil and oil filter change should be performed by an authorized Sea-Doo Sport Boats dealer.

Intercooler Draining

255 HP Models

It is important to expel any trapped water that may have accumulated from condensation in the intercooler.

Proceed as follows:

1. Open the engine cover.
2. Ensure there is an alignment line drawn on the intercooler outlet hose. This will ensure the hose is not twisted or kinked on reinstallation.
3. Loosen the clamp retaining the intercooler outlet hose.
4. Remove the intercooler outlet hose from the intercooler.

NOTE: This hose feeds the inlet of the supercharger.

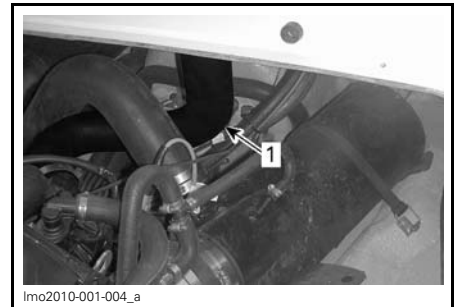

1. Intercooler outlet hose

5. Start and rev the engine up to 4000 RPM several times.

NOTE: Prevent air intake system from aspirating foreign objects which may cause severe engine or damage.

6. Stop engine.
7. Reinstall the intercooler air outlet hose, ensure it is properly aligned as prior to removal to ensure proper engine operation.

Exhaust System Flushing

Perform procedure as described in *MAINTENANCE PROCEDURES* section.

Exhaust System Protection

In areas where temperature may freeze, water trapped in the exhaust system and intercooler must be removed.

Using the flushing connector on jet pump support, inject pressurized air (around 689 kPa (100 PSI)) into system until there is no more water flowing from the jet pump.

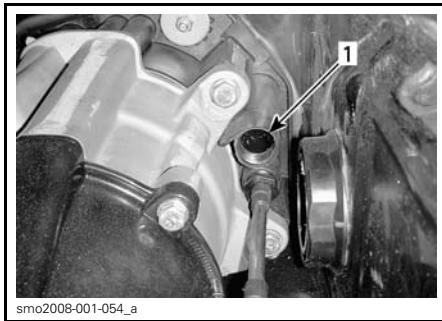

1. Flushing connector — location may differ

To ease the procedure, a custom hose can be assembled. See the following illustration.

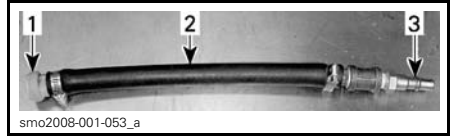

TYPICAL

1. Flushing connector adapter (P/N 295 500 473)
2. Hose 13 mm (1/2 in)
3. Air hose male adapter

NOTICE Failure to drain the exhaust system may cause severe damage to exhaust manifold and the intercooler (255HP models).

Remove the tool.

Engine Internal Lubrication

Open the engine cover and remove storage tray.

Remove dipstick.

Remove engine cover.

Reinstall dipstick.

Disconnect ignition coil connectors.

⚠ WARNING

When disconnecting coil from spark plug, always disconnect coil from main harness first. Never check for engine ignition spark from an open coil and/or spark plug in the engine compartment as spark may cause fuel vapor to ignite.

IMPORTANT: Never cut the locking ties of ignition coil connectors. This would allow mixing the wires between cylinders.

Remove ignition coils.

NOTICE Ensure there is no dirt in coil holes before removing the spark plugs. Otherwise, dirt would fall into cylinder and will damage the internal components.

Remove spark plugs.

NOTE: After loosening the spark plugs, a coil may be used to pull the spark plugs out. Simply bring the coil down to spark plug and “hook” it to then extract spark plug.

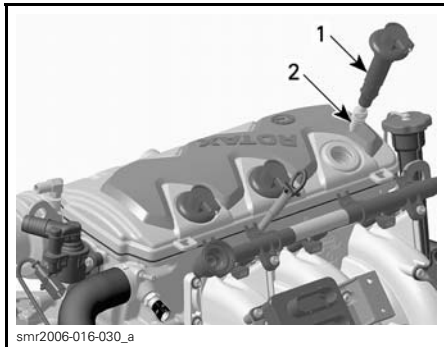

1. Ignition coil
2. Spark plug

Spray XPS LUBE (P/N 293 600 016) or equivalent, in spark plug holes.

To prevent fuel to be injected and also to cut the ignition at the engine cranking, proceed as follows.

From the engine compartment, have a second person hold throttle bell crank in fully opened position.

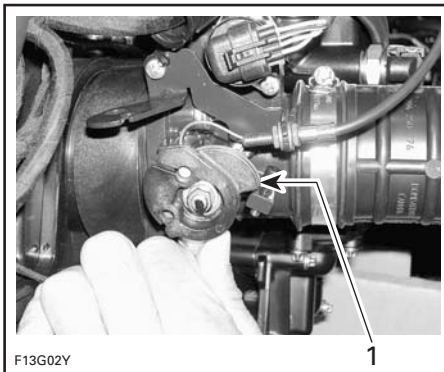

TYPICAL

1. Fully-opened position

Crank the engine a few turns to distribute the oil on cylinder wall.

Apply LOCTITE 767 (ANTISEIZE LUBRICANT) (P/N 293 800 070) on spark plug threads then reinstall them.

Reinstall ignition coils. Reconnect ignition coil connectors.

NOTE: Prior to inserting the ignition coils onto the spark plugs, apply some DOW CORNING 111 (P/N 413 707 000) grease around the seal area that touches the spark plug hole. After installation, ensure the seal seats properly with the top surface of the engine.

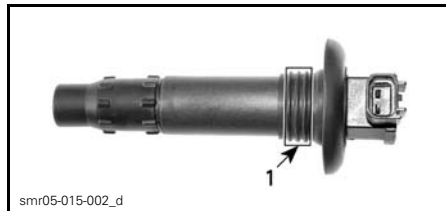

1. Apply product here

To reinstall engine cover, remove dipstick, push engine cover downward until it snaps.

Reinstall dipstick.

Engine Coolant Test

If antifreeze is not replaced, test its density.

The antifreeze replacement and a density test should be performed by an authorized Sea-Doo Sport Boats dealer.

NOTE: Antifreeze should be replaced every 200 hours or every 2 years to prevent antifreeze deterioration.

NOTICE Improper antifreeze density may allow freezing of the liquid in the cooling system if the vehicle is stored in an area where the freezing point is attained. This would seriously damage the engine.

Battery Removal and Storage

For battery removal, cleaning and storage, contact your authorized Sea-Doo Sport Boats dealer.

Boat Cleaning/Repair

Wash the body and the trailer with soap and water solution (only use mild detergent). Rinse thoroughly with fresh water. Remove any marine organisms from the hull.

NOTICE Never clean apparent fiberglass and plastic parts with strong detergent, degreasing agent, paint thinner, acetone, etc.

Stains may be removed from seats and fiberglass with Spray Nine or the equivalent.

If repairs are needed to the body or to the hull contact your authorized Sea-Doo Sport Boats dealer. For minor Gelcote repairs, a repair kit is available from Gelcote International at www.gelcote.com.

Replace damaged labels and decals.

Once boat is on trailer, unscrew the drain plug, block the wheels and raise the bow slightly with the trailer jack (if so equipped) to allow water to drain. Clean the bilge with hot water and detergent or with bilge cleaner.

Boat Protection

Apply a marine wax containing no abrasive.

Remove storage tray. Place it on deck.

Using a flat screwdriver, lift tab as shown below.



TYPICAL — LIFT TAB

Detach cylinder end. Detach other side.

Block and leave engine cover lid open slightly.

This will avoid engine compartment condensation and possible corrosion.

Reattach cylinder ends to engine cover lid before operating boat.

If the boat is to be stored outside, cover it with a vented opaque tarpaulin to prevent UV (ultraviolet) rays and grime from affecting the plastic components, boat finish, as well as preventing dust accumulation.

NOTICE Never leave the boat stored in direct sunlight. UV radiation will dull finishes. The boat must never be left in water for storage.

For the storage period, it is necessary to make certain the drain plugs are unscrewed and unobstructed, then block the wheels and slightly raise the bow with the trailer jack (if so equipped) so drainage can take place.

PRESEASON PREPARATION

Maintenance preparation must be performed in conjunction with *MAINTENANCE SCHEDULE*.

Ensure to perform all tasks included in the **100 HOURS OR 1 YEAR** column.

Since technical skills and special tools are required, some operations should be performed by an authorized Sea-Doo Sport Boats dealer.

NOTE: It is highly recommended that an authorized Sea-Doo Sport Boats dealer perform factory campaigns in addition to the preseason preparation all at the same time.

WARNING

Only perform procedures as detailed in the *MAINTENANCE SCHEDULE*. It is recommended that the assistance of an authorized Sea-Doo Sport Boats dealer be periodically obtained on other components and systems not covered in this guide.

NOTICE When component conditions seem less than satisfactory, replace using only genuine BRP parts, or approved equivalents.

TECHNICAL INFORMATION

BOAT IDENTIFICATION

The main components of the boat (hull and engine) are identified by different serial numbers. It may sometimes become necessary to locate these numbers for warranty purposes or to trace the boat in the event of theft.

Hull Identification Number

The Hull Identification Number (H.I.N.) is located on the right side of the transom.



TYPICAL

1. Hull Identification Number (H.I.N.)

Engine Identification Number

The Engine Identification Number (E.I.N.) is located on the upper crankcase on MAGNETO side.



1. Engine Identification Number (E.I.N.)

ENGINE EMISSIONS INFORMATION

Maintenance, replacement, or repair of the emission control devices and systems may be performed by any marine SI (spark ignition) engine repair establishment or individual.

Manufacturer's Responsibility

Beginning with 1999 model year engines, manufacturers of marine engines must determine the exhaust emission levels for each engine horsepower family and certify these engines with the United States of America Environmental Protection Agency (EPA). An emissions control information label, showing emission levels and engine specifications, must be placed on each boat at the time of manufacture.

Dealer's Responsibility

When performing service on all 1999 and more recent Sea-Doo Sport Boats carrying an emissions control information label, adjustments must be kept within published factory specifications.

Replacement or repair of any emission related component must be executed in a manner that maintains emission levels within the prescribed certification standards.

Dealers are not to modify the engine in any manner that would alter the horsepower or allow emission levels to exceed their predetermined factory specifications.

Exceptions include manufacturer's prescribed changes, such as altitude adjustments for example.

Owner Responsibility

The owner/operator is required to have engine maintenance performed to maintain emission levels within prescribed certification standards.

The owner/operator is not to, and should not allow anyone to modify any engine in a manner that would alter the horsepower or allow emission levels to exceed predetermined factory specifications.

EPA Emission Regulations

All new 1999 and more recent Sea-Doo Sport Boats manufactured by BRP are certified to the EPA as conforming to the requirements of the regulations for the control of air pollution from new boat engines. This certification is contingent on certain adjustments being set to factory standards. For this reason, the factory procedure for servicing the product must be strictly followed and, whenever practicable, returned to the original intent of the design.

The responsibilities listed above are general and in no way a complete listing of the rules and regulations pertaining to the EPA requirements on exhaust emissions for marine products. For more detailed information on this subject, you may contact the following locations:

MAIL:

U.S. Environmental Protection Agency
Office of Transportation and Air Quality
1200 Pennsylvania Ave. NW
Mail Code 6403J
Washington D.C. 20460

INTERNET WEB SITE:

<http://www.epa.gov/otaq/>

The EC-Declaration of Conformity does not appear in this version of the Operator's Guide.

Please refer to the printed version that was delivered with your vehicle.

SPECIFICATIONS

MODEL		150 SPEEDSTER 155 HP	150 SPEEDSTER 255 HP
ENGINE			
Engine type		Rotax 1503 4-TEC™, 4-stroke, Single Over Head Camshaft (SOHC)	
Exhaust system		Water cooled/water injected (opened loop). Direct flow from jet pump	
Lubrication	Type	Dry sump (2 oil pumps). Replaceable oil filter. Water-cooled oil cooler	
	Oil type	XPS summer grade oil Refer to <i>MAINTENANCE PROCEDURES</i> section for more information	
Number of cylinders		3	
Displacement		1 493.8 cm ³ (91 in ³)	
Induction type		Naturally-aspirated	Supercharger intercooled
Maximum HP RPM		7300 ± 50 RPM	8000 ± 50 RPM
COOLING			
Type		Liquid cooled. Closed-loop system (see also <i>EXHAUST SYSTEM</i>)	
Coolant		Ethylene-glycol and distilled water (50%/50%). Use premix coolant from BRP or a coolant specially formulated for aluminum engines	
ELECTRICAL			
Magneto generator output		360 W @ 6000 RPM	
Ignition system type		DI (Digital Inductive)	
Spark plugs	Make and type	NGK DCPR8E	
	Gap	0.7 mm - 0.8 mm (.028 in - .031 in)	
Starting system		Electric starter	
Engine RPM limiter setting		7650 RPM	8000 RPM
Battery		Not supplied ⁽¹⁾ . 12 V group 24, marine starting battery with top-mounted, round taper type battery post	

SPECIFICATIONS

MODEL		150 SPEEDSTER 155 HP	150 SPEEDSTER 255 HP
ELECTRICAL (CONT'D)			
Fuse box 1	F1: Gauge	3 A	
	F2: Beeper	3 A	
	F3: Depth sounder	3 A	
	F4: Fuel level	3 A	
	F5: Unused	-	
	F6: Fuel pump	10 A	
	F7: Cylinder 1	10 A	
	F8: Cylinder 2	10A	
	F9: Cylinder 3	10 A	
	F11: Diagnostic tool	15 A	
	F13: Starter relay	10 A	
	F14: CAPS	3 A	
	Fuse box 2	F15: Charge	30 A
F16: Battery		30 A	
Front fuse box	F1: Blower	5 A	
	F2: bilge pump	3 A	
	F3: Navigation/anchor light	3 A	
	F4: Unused	-	
	F5: Stereo	10 A	
	F6: 12-Volt power outlet	10 A	
Automatic bilge pump		3 A	

MODEL		150 SPEEDSTER 155 HP	150 SPEEDSTER 255 HP
FUEL SYSTEM			
Fuel injection type		Multipoint Fuel Injection. Single throttle body (52 mm)	
Fuel	MINIMUM OCTANE RATING		
	Type	Regular unleaded gasoline	
	Octane rating	Inside North America: 87 (RON + MON)/2 Outside North America: 92 RON	
	OCTANE RATING (OPTIMUM PERFORMANCE)		
	Type	—	Premium unleaded gasoline
	Octane rating	—	Inside North America: 91 (RON + MON)/2 Outside North America: 95 RON
PROPULSION			
Jet pump type		Axial flow single stage	
Jet pump grease type		Jet pump bearing grease (P/N 293 550 032) sold by BRP	
Transmission		Direct drive	
Pivoting angle of direction (nozzle)		20°	
Minimum required water level for jet pump		90 cm (3 ft) underneath the lowest rear portion of hull	
DIMENSIONS			
Overall length		4.67 m (15.3 ft)	
Beam		2.16 m (7.1 ft)	
Draft		30.5 cm (1 ft)	
Deadrise		20°	

SPECIFICATIONS

MODEL		150 SPEEDSTER 155 HP	150 SPEEDSTER 255 HP
DIMENSIONS (ON TRAILER)			
Length		5.6 m (18.4 ft)	
Width		2.16 m (7.1 ft)	
Height	No tower	1.5 m (4.9 ft)	
	Tower down	1.97 m (6.5 ft)	
	Tower up	2.46 m (8.1 ft)	
WEIGHT AND LOADING CAPACITY			
Weight	No tower	659 kg (1,453 lb)	
	With tower	669 kg (1,475 lb)	
Seating capacity		4	
Load limit (passengers + luggage) (based on calm water operation)		4 passengers OR 324 kg (715 lb)	
Gross weight (on trailer)		952 kg (2,100 lb)	
CAPACITIES			
Engine oil		3 L (3.2 qt (U.S. liq.)) oil change with filter	
Engine cooling system		5.5 L (5.8 qt (U.S. liq.)) total	
Fuel tank (including reserve)		79.5 L (21 U.S. gal.)	

(1) Recommended: Exide R-24-130, 12 V, 25 A•h (130 minutes reserve) or R-24-160 (160 minutes) or equivalent.

TROUBLESHOOTING

TROUBLESHOOTING GUIDELINES

The following information is provided to help in diagnosing the probable source of simple troubles. You may be able to solve many of these problems rather quickly, but others may require the skills of a mechanical technician. In such a case, consult an authorized Sea-Doo Sport Boats dealer for servicing.

BATTERY IS REGULARLY DISCHARGED

1. Check battery condition.

- *Have the battery charged or replaced by an authorized Sea-Doo Sport Boats dealer.*

2. Check charging system fuse.

- *Replace fuse if necessary and have charging system checked by an authorized Sea-Doo Sport Boats dealer.*

WARNING

See your authorized Sea-Doo Sport Boats dealer to have the battery charged or replaced. Do not charge or boost the battery while installed in the engine compartment. Electrolyte is poisonous and capable of causing severe burns.

NO BEEPS ARE HEARD WHEN INSTALLING THE D.E.S.S. KEY ON D.E.S.S. POST

1. Main battery cut-off switch is turned OFF.

- *Verify and turn ON.*

2. Battery discharged.

- *Have the battery charged or replaced by authorized Sea-Doo Sport Boats dealer.*

ENGINE DOES NOT TURN OVER AND THE MONITORING BEEPER SOUNDS

1. Refer to *MONITORING SYSTEM* below.

ENGINE WILL NOT START

1. D.E.S.S. key removed.

- *Install D.E.S.S. key over D.E.S.S. post.*

2. Engine management system does not recognize the D.E.S.S. key (2 beeps are not heard when installing the D.E.S.S. key).

- *Refer to an authorized Sea-Doo Sport Boats dealer.*

3. Burnt fuse.

- *Check fuse(s). See an authorized Sea-Doo Sport Boats dealer if problem is repetitive.*

4. Discharged battery.

- *Have the battery charged or replaced by an authorized Sea-Doo Sport Boats dealer.*

5. Battery connections, corroded or loose.

- *Contact an authorized Sea-Doo Sport Boats dealer.*

6. Water flooded engine.

- *Contact an authorized Sea-Doo Sport Boats dealer.*

ENGINE WILL NOT START (cont'd)

7. Obstructed jet pump.

- *Try to clean. Otherwise, refer to an authorized Sea-Doo Sport Boats dealer.*

8. Faulty engine management system.

- *Refer to an authorized Sea-Doo Sport Boats dealer.*

ENGINE TURNS SLOWLY

1. Loose battery cable connections.

- *Check/clean/tighten.*

2. Discharged or weak battery.

- *Have the battery charged or replaced by an authorized Sea-Doo Sport Boats dealer.*

3. Bad ground(s).

- *Refer to an authorized Sea-Doo Sport Boats dealer.*

4. Worn starter or related parts.

- *Refer to an authorized Sea-Doo Sport Boats dealer.*

ENGINE TURNS NORMALLY BUT WILL NOT START

1. Fuel tank empty or water contaminated.

- *Refill or siphon and fill with fresh fuel.*

2. Fouled/defective spark plugs.

- *Replace.*

3. Burnt fuse.

- *Check fuse(s). See an authorized Sea-Doo Sport Boats dealer if problem is repetitive.*

4. Water-flooded engine.

- *Refer to WATER-FLOODED ENGINE in SPECIAL PROCEDURES.*

5. Engine management system fault detected (check if engine pilot lamp is ON).

- *Refer to an authorized Sea-Doo Sport Boats dealer.*

6. Faulty fuel pump.

- *Refer to an authorized Sea-Doo Sport Boats dealer.*

ENGINE MISFIRES, RUNS IRREGULARLY

1. Fouled/defective/worn spark plugs.

- *Replace.*

2. Faulty ignition coil(s).

- *Contact an authorized Sea-Doo Sport Boats dealer.*

3. Fuel: Level too low, stale or water contaminated.

- *Siphon and/or refill.*

4. Clogged injectors.

- *Refer to an authorized Sea-Doo Sport Boats dealer.*

ENGINE MISFIRES, RUNS IRREGULARLY (cont'd)

5. Engine management system fault detected (check if engine pilot lamp is ON).
 - Refer to an authorized Sea-Doo Sport Boats dealer.

ENGINE SMOKE

1. Oil level too high.
 - Refer to an authorized Sea-Doo Sport Boats dealer.
2. Water ingestion, coolant leak or damaged cylinder head gasket.
 - Refer to an authorized Sea-Doo Sport Boats dealer.
3. Internal engine damage.
 - Refer to an authorized Sea-Doo Sport Boats dealer.

ENGINE OVERHEATING OR IMPROPER OIL PRESSURE (MONITORING BEEPER CONTINUOUSLY SOUNDS)

NOTICE If beeper continuously sounds, stop engine as soon as possible.

1. Check oil and coolant levels.
 - Refer to MAINTENANCE PROCEDURES. Refill if necessary.
2. Clogged jet pump water intake.
 - Perform the JET PUMP WATER INTAKE AND IMPELLER CLEANING PROCEDURE in SPECIAL PROCEDURES.
3. Clogged exhaust system.
 - Flush exhaust system.

NOTICE If these actions do not correct the problem, discontinue use and contact an authorized Sea-Doo Sport Boats dealer.

ENGINE LACKS ACCELERATION OR POWER

1. Jet pump water intake clogged.
 - Clean. Refer to JET PUMP WATER INTAKE AND IMPELLER CLEANING in SPECIAL PROCEDURES section.
2. Damaged impeller or worn-out wear ring.
 - Replace. Refer to an authorized Sea-Doo Sport Boats dealer.
3. Faulty supercharger or intercooler (255 engine).
 - Refer to an authorized Sea-Doo Sport Boats dealer.
4. Supercharger clutch slipping.
 - Refer to an authorized Sea-Doo Sport Boats dealer.
5. Weak spark.
 - Refer to ENGINE MISFIRES, RUNS IRREGULARLY in this section.
6. Engine management system fault detected (check if engine pilot lamp is ON).
 - Refer to an authorized Sea-Doo Sport Boats dealer.

ENGINE LACKS ACCELERATION OR POWER (cont'd)

- 7. Clogged injectors.**
 - *Refer to an authorized Sea-Doo Sport Boats dealer.*
- 8. Low fuel pressure.**
 - *Refer to an authorized Sea-Doo Sport Boats dealer.*
- 9. Water in fuel.**
 - *Siphon and replace.*

BOAT CANNOT REACH TOP SPEED

- 1. Jet pump water intake clogged.**
 - *Perform the JET PUMP WATER INTAKE AND IMPELLER CLEANING PROCEDURE in SPECIAL PROCEDURES.*
- 2. Damaged impeller or worn-out wear ring.**
 - *Contact an authorized Sea-Doo Sport Boats dealer.*
- 3. Faulty supercharger or intercooler (255 engine).**
 - *Refer to an authorized Sea-Doo Sport Boats dealer.*
- 4. Engine management system fault detected (check if engine pilot lamp is ON).**
 - *Refer to an authorized Sea-Doo Sport Boats dealer.*

ABNORMAL NOISE FROM PROPULSION SYSTEM

- 1. Weeds or debris jammed around impeller.**
 - *Perform the JET PUMP WATER INTAKE AND IMPELLER CLEANING PROCEDURE in SPECIAL PROCEDURES.*
- 2. Damaged impeller shaft or drive shaft.**
 - *Contact an authorized Sea-Doo Sport Boats dealer.*

WATER FOUND IN BILGE

- 1. Drain plug(s) not tighten.**
 - *Tighten drain plugs.*
- 2. Defective scupper valve.**
 - *Refer to an authorized Sea-Doo Sport Boats dealer.*
- 3. Exhaust system leak.**
 - *Refer to an authorized Sea-Doo Sport Boats dealer.*
- 4. Carbon ring at drive shaft worn.**
 - *Refer to an authorized Sea-Doo Sport Boats dealer.*

MONITORING SYSTEM

A system monitors the electronic components of the EMS (engine management system) and other components of the electrical system. When a fault occurs, it sends visual messages through the information center and/or audible signals through a beeper to inform you of a particular condition.

A fault code may also be recorded.

When a minor or transient fault occurs, the fault message and beeper will cease automatically if the condition that caused the fault does not exist anymore.

Releasing the throttle and letting the engine return to idle speed may allow normal operation to come back. If this does not work, try removing and reinstalling the D.E.S.S. key on its post.

The electronic system will react differently depending on the fault type. In severe failure, the engine may not be allowed to be started. In other cases, the engine will operate in limp home mode (reduced speed).

When a fault occurs, see an authorized Sea-Doo Sport Boats dealer as soon as possible for inspection.

Beeper Code Information

BEEPER CODE ⁽¹⁾	DESCRIPTION
2 short Beeps while installing D.E.S.S. key on D.E.S.S. post	Normal condition of D.E.S.S.. Right key installed correctly.
1 long Beep while installing D.E.S.S. key on D.E.S.S. post or when pressing start/stop switch	Shifter lever not in Neutral position. Move shifter to Neutral.
	Unable to read key (wrong installation or dirty key). Remove D.E.S.S. key, make sure it's clean and reinstall.
	Invalid key or D.E.S.S. fault. Make sure to use the proper key for the vehicle. If it does not work, Contact an authorized Sea-Doo Sport Boats dealer.
4 Short Beeps while pressing Start/Stop switch with D.E.S.S. key installed	Shifter is not in Neutral. Move shifter to Neutral.
1 Short Beep while moving shifter to neutral	Confirms that shifter is now in Neutral.
4 Short Beeps at Different Interval	D.E.S.S. key has been left on its post without the engine running. Remove D.E.S.S. key to prevent battery discharge.
Continuous Beep	High engine coolant temperature. Refer to <i>ENGINE OVERHEATING</i> in <i>TROUBLESHOOTING GUIDELINES</i> .
	High exhaust temperature. Refer to <i>ENGINE OVERHEATING</i> in <i>TROUBLESHOOTING GUIDELINES</i> .
	Low or high engine oil pressure. Check oil level as soon as possible. If level good, discontinue use and contact an authorized Sea-Doo Sport Boats dealer.

⁽¹⁾ Some beeper codes go with messages on the information display, refer to *CONTROLS, INSTRUMENTS AND EQUIPMENT* for details.

NOTICE If the monitoring beeper continuously sounds, stop engine as soon as possible.

WARRANTY

BRP LIMITED WARRANTY FOR MODEL YEAR 2010 SEA-DOO® SPORT BOATS SOLD IN THE UNITED STATES AND CANADA

1) SCOPE

BRP US Inc.* ("BRP") warrants its new and unused Model Year 2010 Sea-Doo® sport boats ("sport boat") sold by authorized BRP dealers (as hereinafter defined) in the fifty United States and Canada ("dealer") from defects in material and workmanship for the period and under the conditions described below. This limited warranty will become null and void if: (1) the sport boat was used for racing or any other competitive activity, at any point, even by a previous owner; or (2) the sport boat has been altered or modified in such a way so as to adversely affect its operation, performance or durability, or has been altered or modified to change its intended use.

All genuine BRP parts and accessories, installed by an authorized BRP dealer at the time of delivery of the 2010 Sea-Doo® sport boat, carry the same warranty as that of the sport boat.

2) LIMITATIONS OF LIABILITY

THIS WARRANTY IS EXPRESSLY GIVEN AND ACCEPTED IN LIEU OF ANY AND ALL OTHER WARRANTIES, EXPRESSED OR IMPLIED, INCLUDING WITHOUT LIMITATION ANY WARRANTY OF MERCHANTABILITY OR FITNESS FOR A PARTICULAR PURPOSE. TO THE EXTENT THAT THEY CANNOT BE DISCLAIMED, THE IMPLIED WARRANTIES ARE LIMITED IN DURATION TO THE LIFE OF THE EXPRESS WARRANTY. INCIDENTAL AND CONSEQUENTIAL DAMAGES ARE EXCLUDED FROM COVERAGE UNDER THIS WARRANTY. SOME STATES/ PROVINCES DO NOT ALLOW FOR THE DISCLAIMERS, LIMITATIONS AND EXCLUSIONS IDENTIFIED ABOVE, AS A RESULT, THEY MAY NOT APPLY TO YOU. THIS WARRANTY GIVES YOU SPECIFIC RIGHTS, AND YOU MAY ALSO HAVE OTHER LEGAL RIGHTS WHICH MAY VARY FROM STATE TO STATE, OR PROVINCE TO PROVINCE.

Neither the distributor, any BRP dealer nor any other person has been authorized to make any affirmation, representation or warranty regarding the product, other than those contained in this limited warranty, and if made, shall not be enforceable against BRP. BRP reserves the right to modify this warranty at any time, being understood that such modification will not alter the warranty conditions applicable to the products sold while this warranty is in effect.

3) EXCLUSIONS – ARE NOT WARRANTED

The following are not warranted under any circumstances:

- Normal wear and tear;
- Routine maintenance items, tune-ups, adjustments;
- Damage caused by failure to provide proper maintenance and/or storage, as described in the Operator's Guide;
- Damage resulting from removal of parts, improper repairs, service, maintenance, modifications or use of parts not manufactured or approved by BRP or resulting from repairs done by a person that is not an authorized servicing BRP dealer;

- Damage caused by abuse, misuse, abnormal use, neglect, racing, improper operation or operation of the sport boat in a manner inconsistent with the recommended operation described in the Operator's Guide;
- Damage resulting from external damage, submersion, water or foreign object ingestion, accident, fire, theft, vandalism or any act of God;
- Operation with fuels, oils or lubricants which are not suitable for the sport boat (see Operator's Guide);
- Damage from rust, corrosion or exposure to the elements;
- Damage from cooling system or jet pump blockage by foreign material;
- Incidental or consequential damages, or damages of any kind including without limitation towing, storage, telephone, rental, taxi, inconvenience, insurance coverage, loan payments, loss of time, loss of income; and
- Damage to gel coat finish including but not limited to cosmetic gel coat finish defects, blisters, starring, crazing; and fiberglass delaminating caused by blisters, crazing, snyder or hairline cracks or exposure to the elements.

4) WARRANTY COVERAGE DURATION

This limited warranty will be in effect from the date of delivery to the first retail consumer or the date the sport boat is first put into use, whichever occurs first and for a period of:

- TWELVE (12) CONSECUTIVE MONTHS for private, recreational use, except for the deck and hull fiberglass structure are covered for SIXTY (60) CONSECUTIVE MONTHS;
- FOUR (4) CONSECUTIVE MONTHS for commercial use, except for the deck and hull fiberglass structure are covered for TWELVE (12) CONSECUTIVE MONTHS. A sport boat is used commercially when it is used in connection with generating income or any work or employment during any part of the warranty period. A sport boat is also used commercially when, at any point during the warranty period, it has commercial tags or is licensed for commercial use.

Emission-related components that are installed on EPA certified sport boats registered in the USA are covered for thirty (30) consecutive months or 175 hours of engine use whichever occurs first. If the 175 hours of engine use are reached during the regular warranty coverage period, the emission-related components are still covered by BRP's standard warranty until the end of regular coverage period.

The list of the current warranted emission-related components is known by your authorized BRP dealer.

The repair or replacement of parts or the performance of service under this warranty does not extend the life of this warranty beyond its original expiration date.

For sport boats produced by BRP for sale in the states of California or New York, that are originally sold to a resident or subsequently warranty registered to a resident in the state of California or New York, please also refer to the applicable California and New York Emissions Control Warranty Statement.

5) CONDITIONS TO HAVE WARRANTY COVERAGE

This warranty coverage is available only if each of the following conditions has been fulfilled:

- The 2010 Sea-Doo® sport boat must be purchased as new and unused by its first owner from a BRP dealer authorized to distribute Sea-Doo® sport boats products in the country in which the sale occurred ("BRP dealer");
- The BRP specified pre-delivery inspection process must be completed and documented;
- The product must have undergone proper registration by an authorized BRP dealer;
- The 2010 Sea-Doo® sport boat must be purchased in the country in which the purchaser resides.
- Routine maintenance outlined in the Operator's Guide must be timely performed in order to maintain warranty coverage. BRP reserves the right to make warranty coverage contingent upon proof of proper maintenance.

BRP will not honor this limited warranty to any private use owner or commercial use owner if the preceding conditions have not been met. Such limitations are necessary in order to allow BRP to preserve both the safety of its products, and also that of its consumers and the general public.

6) WHAT TO DO TO OBTAIN WARRANTY COVERAGE

The customer must cease using the sport boat upon the appearance of an anomaly. The customer must notify a servicing BRP dealer within two (2) days of the appearance of a defect, and provide it with reasonable access to the product and reasonable opportunity to repair it. The customer must also present to the authorized BRP dealer, proof of purchase of the product and must sign the repair/work order prior to starting the repair in order to validate the warranty repair. All parts replaced under this limited warranty become the property of BRP.

7) WHAT BRP WILL DO

BRP's obligations under this warranty are limited to, at its sole discretion, repairing parts found defective under normal use, maintenance and service, or replacing such parts with new genuine BRP parts without charge for parts and labor, at any authorized BRP dealer during the warranty coverage period under the conditions described herein. BRP's responsibility is limited to making the required repairs or replacements of parts. No claim of breach of warranty shall be cause for cancellation or rescission of the sale of the sport boat to the owner.

In the event that service is required outside of the country of original sale, the owner will bear responsibility for any additional charges due to local practices and conditions, such as, but not limited to, freight, insurance, taxes, license fees, import duties, and any and all other financial charges, including those levied by governments, states, territories and their respective agencies.

BRP reserves the right to improve or modify products from time to time without assuming any obligation to modify products previously manufactured.

8) SUPPLIER WARRANTIES

Jensen+ audio components installed as original equipment on sport boats are warranted separately by ASA Electronics[‡]. If such an audio component is installed on your Sea-Doo[®] sport boat, please contact your authorized BRP dealer for warranty coverage information and assistance.

If you cannot resolve the issue through your authorized BRP dealer, you can find all the contact information for ASA Electronics on their company website: www.asaelectronics.com.

9) TRANSFER

If the ownership of a product is transferred during the warranty coverage period, this warranty shall also be transferred and be valid for the remaining coverage period provided that BRP is notified of such transfer of ownership in the following way:

1. The former owner contacts BRP (at the phone number provided below) or an authorized BRP dealer and gives the coordinates of the new owner; or
2. BRP or an authorized BRP dealer receives a proof that the former owner agreed to the transfer of ownership, in addition to the coordinates of the new owner.

10) CONSUMER ASSISTANCE

In the event of a controversy or a dispute in connection with this limited warranty, BRP suggests that you try to resolve the issue at the dealership level. We recommend discussing the issue with the authorized BRP dealer's service manager or owner.

If the issue has not yet been resolved, please submit your complaint in writing or call the appropriate number below:

In Canada

BOMBARDIER RECREATIONAL
PRODUCTS INC.
SEA-DOO
CUSTOMER ASSISTANCE CENTER
75 J.A. BOMBARDIER STREET
SHERBROOKE QC J1L 1W3
Tel.: 819 566-3366

In USA

BRP US INC.
SEA-DOO
CUSTOMER ASSISTANCE CENTER
7575 BOMBARDIER COURT
WAUSAU WI 54401
Tel.: 715 848-4957

* In Canada, products are distributed and serviced by Bombardier Recreational Products Inc.

© 2009 Bombardier Recreational Products Inc. All rights reserved.

® Registered trademark of Bombardier Recreational Products Inc. or its subsidiaries.

+ is the trademark of its owner.

‡ is the trademark of its owner.

CALIFORNIA AND NEW YORK EMISSION CONTROL WARRANTY STATEMENT FOR MODEL-YEAR 2010 SEA-DOO® SPORT BOATS WITH 4-TEC ENGINES OR 4-TEC IC ENGINES

For California, your 2010 Sea-Doo® sport boat ("sport boat") has a special environmental label required by the California Air Resources Board. The label has 1, 2, 3 or 4 stars. A hangtag, provided with your sport boat, describes the meaning of the star rating system.

The Star Label Means Cleaner Marine Engines

The Symbol for Cleaner Marine Engines:



F18L3CQ

Cleaner Air and Water

For a healthier lifestyle and environment.

Better Fuel Economy

Burns up to 30 - 40 percent less gas and oil than conventional carbureted two-stroke engines, saving money and resources.

Longer Emission Warranty

Protects consumer for worry free operation.

One Star – Low Emission

The one-star label identifies personal watercraft, outboard, stern drive and inboard engines that meet the Air Resources Board's Personal Watercraft and Outboard marine engine 2001 exhaust emission standards. Engines meeting these standards have 75% lower emissions than conventional carbureted two-stroke engines. These engines are equivalent to the U.S. EPA's 2006 standards for marine engines.

Two Stars - Very Low Emission

The two-star label identifies personal watercraft, outboard, stern drive and inboard engines that meet the Air Resources Board's Personal Watercraft and Outboard marine engine 2004 exhaust emission standards. Engines meeting these standards have 20% lower emissions than One Star - Low-Emission engines.

Three Stars - Ultra Low Emission

The three-star label identifies engines that meet the Air Resources Board's Personal Watercraft and Outboard marine engine 2008 exhaust emission standards or the Stern drive and Inboard marine engine 2003 exhaust emission standards. Engines meeting these standards have 65% lower emissions than One Star – Low Emission engines.

Four Stars - Super Ultra Low Emission

The four-star label identifies engines that meet the Air Resources Board's Stern-drive and Inboard marine engine 2010 exhaust emission standards. Personal Watercraft and Outboard marine engines may also comply with these standards. Engines meeting these standards have 90% lower emissions than One Star – Low Emission engines.

For more information: Cleaner Watercraft – Get the Facts 1 800 END-SMOG
www.arb.ca.gov

Your Emission Control Warranty Rights and Obligations

The California Air Resources Board and BRP US Inc. ("BRP") are pleased to explain the emission control system warranty on your Model Year 2010 Sea-Doo® Sport boat. In California, new sport boat engines must be designed, built and equipped to meet the State's stringent anti-smog standards. BRP must warrant the emission control system on your sport boat engine for the periods of time listed below provided there has been no abuse, neglect or improper maintenance of your sport boat engine.

Your emission control system may include parts such as the fuel injection system, the ignition system and catalytic converter. Also included may be hoses, belts, connectors and other emission related assemblies.

Where a warrantable condition exists, BRP will repair your sport boat engine at no cost to you including diagnosis, parts and labor provided that such work is performed by an authorized BRP dealer.

Manufacturer's Limited Warranty Coverage

This emission limited warranty covers Model Year 2010 Sea-Doo® sport boats certified and produced by BRP for sale in California, that are originally sold in California to a California resident or subsequently warranty registered to a California resident. The BRP limited warranty conditions for Sea-Doo® sport boats are still applicable to these models with the necessary modifications. Select emission control parts of your 2010 Sea-Doo® sport boat are warranted from the date of delivery to the first retail consumer for a period of 4 years, or for 250 hours of use, whichever occurs first. However, warranty coverage based on the hourly period is only permitted for sport boat equipped with the appropriate hour meters or their equivalent. If any emission-related part on your engine is defective under warranty, the part will be repaired or replaced by BRP.

Parts covered for Model Year 2010 Sea-Doo® sport boat equipped with 4-TEC engines:

Idle Bypass Valve	Fuel Filter
Throttle Position Sensor	Intake Manifold
Intake Manifold Air Pressure Sensor	Air Box
Intake Manifold Air Temperature Sensor	Air intake Adapter
Engine Temperature Sensor	Spark Plugs
Knock Sensor	Ignition Coils
Emission Control Module ECM	Intake and Exhaust Valve and Seals
Throttle Body	Crankcase Ventilation Valve
Fuel Rail	Throttle Body Seal
Fuel Injectors	Wire Harness and Connectors
Fuel Pressure Regulator	Intake Manifold Seal
Fuel Pump	

The emission warranty covers damage to other engine components that is caused by the failure of a warranted part. The BRP Operator's Guide provided contains written instructions for the proper maintenance and use of your sport boat. All emission warranty parts are warranted by BRP for the entire warranty period of the sport boat, unless the part is scheduled for replacement as required maintenance in the Operator's Guide. Emission warranty parts that are scheduled for replacement, as required maintenance, are warranted by BRP for the period of time before the first scheduled replacement date for that part. Emission warranty parts that are scheduled for regular inspection, but not regular replacement, are warranted by BRP for the entire warranty period of the sport boat. Any emission warranty part repaired or replaced under the terms of this warranty statement is warranted by BRP for the remainder of the warranty period of the original part. All parts replaced under this limited warranty become the property of BRP. Maintenance receipts and records should be transferred to each subsequent owner of the sport boat.

Owner's Warranty Responsibilities

As the owner of a 2010 Sea-Doo® sport boat, you are responsible for the performance of the required maintenance listed in your *Operator's Guide*. BRP recommends that you retain all receipts covering maintenance your sport boat engine, but BRP cannot deny warranty solely for the lack of receipts or your failure to ensure the performance of all scheduled maintenance. As the owner of a Sea-Doo® sport boat, you should however be aware that BRP may deny you warranty coverage if your engine(s) or a part has failed due to abuse, neglect, improper maintenance or unapproved modifications. You are responsible for presenting your engine to an authorized BRP Dealer as soon as a problem exists. The warranty repairs will be completed in a reasonable amount of time, not to exceed 30 days. If you have any questions regarding your warranty rights and responsibilities or for the name and location of the nearest authorized BRP Dealer you should contact the Customer Assistance Center at 1 715 848-4957.

BRP INTERNATIONAL LIMITED WARRANTY FOR MODEL YEAR 2010 SEA-DOO® SPORT BOATS

1) SCOPE

BRP US Inc. ("BRP")* warrants its new and unused Model Year 2010 Sea-Doo® sport boats ("Sport Boat") sold by authorized BRP Distributors/Dealers ("Distributor/Dealer") outside of the fifty United States, Canada and states members of the European Economic Area (which is comprised of the states member of the European Union plus Norway, Iceland and Liechtenstein), will be free from defects in material and workmanship for the period and under the conditions below. This limited warranty will become null and void if: (1) the sport boat was used for racing or any other competitive activity, at any point, even by a previous owner; or (2) the sport boat has been altered or modified in such a way so as to adversely affect its operation, performance or durability, or has been altered or modified to change its intended use.

All genuine BRP parts and accessories, installed by an authorized BRP dealer (as hereinafter defined) at the time of delivery of the 2010 Sea-Doo® Sport Boat, carry the same warranty as that of the Sport Boat.

2) LIMITATIONS OF LIABILITY

THIS WARRANTY IS EXPRESSLY GIVEN AND ACCEPTED IN LIEU OF ANY AND ALL OTHER WARRANTIES, EXPRESSED OR IMPLIED, INCLUDING WITHOUT LIMITATION ANY WARRANTY OF MERCHANTABILITY OR FITNESS FOR A PARTICULAR PURPOSE. TO THE EXTENT THAT THEY CANNOT BE DISCLAIMED, THE IMPLIED WARRANTIES ARE LIMITED IN DURATION TO THE LIFE OF THE EXPRESS WARRANTIES. INCIDENTAL AND CONSEQUENTIAL DAMAGES ARE EXCLUDED FROM COVERAGE UNDER THIS WARRANTY. SOME STATES/ PROVINCES DO NOT ALLOW FOR THE DISCLAIMERS, LIMITATIONS AND EXCLUSIONS IDENTIFIED ABOVE, AS A RESULT, THEY MAY NOT APPLY TO YOU. THIS WARRANTY GIVES YOU SPECIFIC RIGHTS, AND YOU MAY ALSO HAVE OTHER LEGAL RIGHTS WHICH MAY VARY FROM STATE TO STATE, OR PROVINCE TO PROVINCE.

Neither the distributor, any BRP Distributor/Dealer, nor any other person has been authorized to make any affirmation, representation or warranty regarding the product, other than those contained in this limited warranty, and if made, shall not be enforceable against BRP.

BRP reserves the right to modify this warranty at any time, being understood that such modification will not alter the warranty conditions applicable to the products sold while this warranty is in effect.

3) EXCLUSIONS – ARE NOT WARRANTED

The following are not warranted under any circumstances:

- Replacement of parts due to normal wear and tear;
- Routine maintenance parts and services, including but not limited to adjustments, oil, lubricant and coolant changes, spark plug replacement, water pumps and the like;
- Damage caused by improper or lack of maintenance or storage, or failure to follow the procedures and recommendations in the Operator's Guide;

- Damage resulting from removal of parts, improper repairs, service, maintenance, or modification, or use of parts or accessories not manufactured or approved by BRP, which in its reasonable judgment, are either incompatible with Sport Boats or adversely affect its operation, performance, or durability, or resulting from repairs done by a person that is not an authorized BRP Distributor/Dealer;
- Damage caused by abuse, misuse, abnormal use, neglect, racing, improper operation or operation of the Sport Boat in a manner inconsistent with the recommended operation described in the Operator's Guide;
- Damages resulting from external damage, submersion, water or foreign object ingestion, accident, fire, theft, vandalism or any act of God;
- Operation with fuel, oils or lubricants that are not suitable for the Sport Boat (see Operator's Guide);
- Damage from rust, corrosion or exposure to the elements;
- Damage from cooling system or jet pump blockage by foreign material;
- Incidental or consequential damages, or damages of any kind including without limitation towing, storage, telephone, rental, taxi, inconvenience, insurance coverage, loan payments, loss of time, loss of income; and
- Damage to gel coat finish including but not limited to cosmetic gel coat finish defects, blisters, starring, crazing; and fiberglass delaminating caused by blisters, crazing, spider or hairline cracks or exposure to the elements.

4) WARRANTY COVERAGE DURATION

This limited warranty will be in effect from the date of delivery to the first retail consumer or the date the Sport Boat is first put to use, whichever occurs first, for a period of:

- TWELVE (12) CONSECUTIVE MONTHS for private, recreational use, except for the deck and hull fiberglass structure are covered for SIXTY (60) CONSECUTIVE MONTHS;
- FOUR (4) CONSECUTIVE MONTHS for commercial use, except for the deck and hull fiberglass structure are covered for TWELVE (12) CONSECUTIVE MONTHS.

A Sport Boat is used commercially when it is used in connection with generating income or any work or employment during any part of the warranty period. A Sport Boat is also used commercially when, at any point during the warranty period, it has commercial tags or is licensed for commercial use.

The repair or replacement of parts or the performance of service to a Sport Boat under this warranty does not extend the life of this limited warranty beyond its original expiration date.

5) CONDITIONS TO HAVE WARRANTY COVERAGE

This warranty coverage is available only if each of the following conditions has been fulfilled:

- The 2010 Sea-Doo® sport boats must be purchased as new and unused by its first owner from a BRP Distributor / Dealer authorized to distribute SEA-DOO® SPORT BOAT products in the country in which the sale occurred;
- The BRP specified pre-delivery inspection process must be completed and documented;

- The product must have undergone proper registration by an authorized BRP Distributor/Dealer;
- The 2010 Sea-Doo® sport boats must be purchased in the country or union of countries in which the purchaser resides.
- Routine maintenance outlined in the Operator's Guide must be timely performed in order to maintain warranty coverage. BRP reserves the right to make warranty coverage contingent upon proof of proper maintenance.

BRP will not honor this limited warranty to any private use owner or commercial use owner if the preceding conditions have not been met. Such limitations are necessary in order to allow BRP to preserve both the safety of its products, and also that of its consumers and the general public.

6) WHAT TO DO TO OBTAIN WARRANTY COVERAGE

The customer must notify a servicing BRP Distributor/Dealer within two (2) days of the appearance of a defect, and provide it with reasonable access to the product and reasonable opportunity to repair it. The customer must also present to the authorized BRP Distributor/Dealer, proof of purchase of the product and must sign the repair/work order prior to starting the repair in order to validate the warranty repair. All parts replaced under this limited warranty become the property of BRP.

7) WHAT BRP WILL DO

BRP's obligations under this warranty are limited to, at its sole discretion, repairing parts found defective under normal use, maintenance and service, or replacing such parts with new genuine BRP parts without charge for parts and labor, at any authorized BRP Distributor/Dealer during the warranty coverage period under the conditions described herein. BRP's responsibility is limited to making the required repairs or replacements of parts. No claim of breach of warranty shall be cause for cancellation or rescission of the sale of the sport boat to the owner.

In the event that service is required outside of the country of original sale, the owner will bear responsibility for any additional charges due to local practices and conditions, such as, but not limited to, freight, insurance, taxes, license fees, import duties, and any and all other financial charges, including those levied by governments, states, territories and their respective agencies.

BRP reserves the right to improve or modify products from time to time without assuming any obligation to modify products previously manufactured.

8) TRANSFER

If the ownership of a Products is transferred during the warranty coverage period, this warranty shall also be transferred and be valid for the remaining coverage period provided that BRP is notified of such transfer of ownership in the following way:

1. The former owner contacts BRP (at the phone number provided below) or an authorized Distributor/Dealer and gives the coordinates of the new owner; or
2. BRP or an authorized Distributor/Dealer receives a proof that the former owner agreed to the transfer of ownership, in addition to the coordinates of the new owner.

9) CONSUMER ASSISTANCE

In the event of a controversy or a dispute in connection with this limited warranty, BRP suggests that you try to resolve the issue at the dealership level.

If further assistance is required, the distributor's service department should be contacted in order to resolve the matter.

If the matter still remains unresolved then contact BRP by writing to us at the address listed below.

For countries within Europe, Middle East, Africa, Russia & CIS, please contact our European office

BRP EUROPE N.V.

Customer Assistance Center
Skaldenstraat 125
9042 Gent
Belgique
Tel.: +32-9-218-26-00

For Scandinavian countries, please contact our Finland office:

BRP FINLAND OY

Service Department
Ahjotie 30
FIN-96320 Rovaniemi
Finland
Tel.: +358163208111

For all other countries, please contact your local distributor or our North America office

Bombardier Recreational Products Inc.

Customer Assistance Center
75 J.A. Bombardier Street
Sherbrooke QC J1L 1W3
Tel.: 1 819 566-3366

You will find your distributor's coordinates on www.brp.com.

© 2009 Bombardier Recreational Products Inc. All rights reserved.

® Registered trademark of Bombardier Recreational Products Inc.

* For the territory covered by this limited warranty, products are distributed and serviced by Bombardier Recreational Products Inc. or its affiliates.

© 2009 Bombardier Recreational Products Inc. All rights reserved.

® Registered trademark of Bombardier Recreational Products Inc. or its affiliates.

BRP LIMITED WARRANTY FOR THE EUROPEAN ECONOMIC AREA: MODEL YEAR 2010 SEA-DOO® SPORT BOATS

1) SCOPE OF THE LIMITED WARRANTY

BRP US Inc. ("BRP")* warrants its new and unused model-year 2010 Sea-Doo® sport boats sold by authorized BRP distributors/dealers ("Distributors/Dealers") in member states of the European Economic Area ("EEA") (which is comprised of the states member of the European Union plus Norway, Iceland and Liechtenstein) from defects in material or workmanship for the period and under the conditions described below. This limited warranty will become null and void if: (1) the sport boat was used for racing or any other competitive activity, at any point, even by a previous owner; or (2) the sport boat has been altered or modified in such a way so as to adversely affect its operation, performance or durability, or has been altered or modified to change its intended use.

All genuine SEA-DOO® SPORT BOAT parts and accessories, installed by an authorized BRP Distributors/Dealers at the time of delivery of the 2010 Sea-Doo® sport boats, carry the same warranty as that of the Sport boats.

2) LIMITATIONS OF LIABILITY

THIS WARRANTY IS EXPRESSLY GIVEN AND ACCEPTED IN LIEU OF ANY AND ALL OTHER WARRANTIES, EXPRESSED OR IMPLIED, INCLUDING WITHOUT LIMITATION ANY WARRANTY OF MERCHANTABILITY OR FITNESS FOR A PARTICULAR PURPOSE. TO THE EXTENT THAT THEY CANNOT BE DISCLAIMED, THE IMPLIED WARRANTIES ARE LIMITED IN DURATION TO THE LIFE OF THE EXPRESS WARRANTY. INCIDENTAL AND CONSEQUENTIAL DAMAGES ARE EXCLUDED FROM COVERAGE UNDER THIS WARRANTY. SOME JURISDICTIONS DO NOT ALLOW FOR THE DISCLAIMERS, LIMITATIONS AND EXCLUSIONS IDENTIFIED ABOVE, AS A RESULT, THEY MAY NOT APPLY TO YOU. THIS WARRANTY GIVES YOU SPECIFIC RIGHTS, AND YOU MAY ALSO HAVE OTHER LEGAL RIGHTS WHICH MAY VARY FROM COUNTRY TO COUNTRY.

Neither the distributor, any BRP Distributor/Dealer nor any other person has been authorized to make any affirmation, representation or warranty regarding the product, other than those contained in this limited warranty, and if made, shall not be enforceable against BRP.

BRP reserves the right to modify this warranty at any time, being understood that such modification will not alter the warranty conditions applicable to the products sold while this warranty is in effect.

3) EXCLUSIONS – ARE NOT WARRANTED

The following are not warranted under any circumstances:

- Replacement of parts due to normal wear and tear;
- Routine maintenance parts and services, including but not limited to adjustments, oil, lubricant and coolant changes, spark plug replacement, water pumps and the like;
- Damage caused by improper or lack of maintenance or storage, or failure to follow the procedures and recommendations in the Operator's Guide;

- Damage resulting from removal of parts, improper repairs, service, maintenance, or modification, or use of parts or accessories not manufactured or approved by BRP, which in its reasonable judgment, are either incompatible with Sport Boats or adversely affect its operation, performance, or durability, or resulting from repairs done by a person that is not an authorized BRP Distributor/Dealer;
- Damage caused by abuse, misuse, abnormal use, neglect, racing, improper operation or operation of the Sport Boat in a manner inconsistent with the recommended operation described in the Operator's Guide;
- Damages resulting from external damage, submersion, water or foreign object ingestion, accident, fire, theft, vandalism or any act of God;
- Operation with fuel, oils or lubricants that are not suitable for the Sport Boat (see Operator's Guide);
- Damage from rust, corrosion or exposure to the elements;
- Damage from cooling system or jet pump blockage by foreign material;
- Incidental or consequential damages, or damages of any kind including without limitation towing, storage, telephone, rental, taxi, inconvenience, insurance coverage, loan payments, loss of time, loss of income; and
- Damage to gel coat finish including but not limited to cosmetic gel coat finish defects, blisters, starrng, crazing; and fiberglass delaminating caused by blisters, crazing, spider or hairline cracks or exposure to the elements.

4) WARRANTY COVERAGE PERIOD

This warranty will be in effect from the date of delivery to the first retail consumer or the date the product is first put into use, whichever occurs first and for a period of:

TWENTY-FOUR (24) CONSECUTIVE MONTHS for private use owners except for the deck and hull fiberglass structure are covered for SIXTY (60) CONSECUTIVE MONTHS.

FOUR (4) CONSECUTIVE MONTHS for commercial use owners except for the deck and hull fiberglass structure are covered for TWELVE (12) CONSECUTIVE MONTHS.

A Sport Boat is used commercially when it is used in connection with generating income or any work or employment during any part of the warranty period. A Sport Boat is also used commercially when, at any point during the warranty period, it has commercial tags or is licensed for commercial use.

The repair or replacement of parts or the performance of service under this warranty does not extend the life of this warranty beyond its original expiration date.

Note that the duration and any other modalities of the warranty coverage are subject to the applicable national or local legislation in your country.

5) CONDITIONS TO HAVE WARRANTY COVERAGE

This warranty coverage is available only if each of the following conditions has been fulfilled:

- The 2010 Sea-Doo® sport boats must be purchased as new and unused by its first owner from a BRP Distributor/Dealer authorized to distribute SEA-DOO® SPORT BOAT products in the country in which the sale occurred;

- The BRP specified pre-delivery inspection process must be completed and documented;
- The product must have undergone proper registration by an authorized BRP Distributor/Dealer;
- The 2010 Sea-Doo® sport boats must be purchased within the EEA by an EEA resident.
- Routine maintenance outlined in the Operator's Guide must be timely performed in order to maintain warranty coverage. BRP reserves the right to make warranty coverage contingent upon proof of proper maintenance.

BRP will not honor this limited warranty to any private use owner or commercial use owner if the preceding conditions have not been met. Such limitations are necessary in order to allow BRP to preserve both the safety of its products, and also that of its consumers and the general public.

6) WHAT TO DO TO OBTAIN WARRANTY COVERAGE

The customer must notify a servicing BRP Distributor/Dealer within two (2) months of the appearance of a defect, and provide it with reasonable access to the product and reasonable opportunity to repair it. The customer must also present to the authorized BRP Distributor/Dealer, proof of purchase of the product and must sign the repair/work order prior to starting the repair in order to validate the warranty repair. All parts replaced under this limited warranty become the property of BRP.

Note that the notification period is subject to the applicable national or local legislation in your country.

7) WHAT BRP WILL DO

BRP's obligations under this warranty are limited to, at its sole discretion, repairing parts found defective under normal use, maintenance and service, or replacing such parts with new genuine sport boat parts without charge for parts and labor, at any authorized BRP Distributor/Dealer during the warranty coverage period under the conditions described herein. BRP's responsibility is limited to making the required repairs or replacements of parts. No claim of breach of warranty shall be cause for cancellation or rescission of the sale of the sport boat to the owner.

In the event that service is required outside of the country of original sale, the owner will bear responsibility for any additional charges due to local practices and conditions, such as, but not limited to, freight, insurance, taxes, license fees, import duties, and any and all other financial charges, including those levied by governments, states, territories and their respective agencies.

BRP reserves the right to improve or modify products from time to time without assuming any obligation to modify products previously manufactured.

8) TRANSFER

If the ownership of a Products is transferred during the warranty coverage period, this warranty shall also be transferred and be valid for the remaining coverage period provided that BRP is notified of such transfer of ownership in the following way:

1. The former owner contacts BRP (at the phone number provided below) or an authorized Distributor/Dealer and gives the coordinates of the new owner; or

2. BRP or an authorized Distributor/Dealer receives a proof that the former owner agreed to the transfer of ownership, in addition to the coordinates of the new owner.

9) CONSUMER ASSISTANCE

In the event of a controversy or a dispute in connection with this limited warranty, BRP suggests that you try to resolve the issue at the dealership level. We recommend discussing the issue with the authorized Distributor/Dealer's service manager or owner.

- If further assistance is required, the distributor's service department should be contacted in order to resolve the matter.
- If the matter still remains unresolved then contact BRP at the address listed below.

For countries within Europe, Middle East, Africa, Russia & CIS, please contact our European office

BRP EUROPE N.V.

Customer Assistance Center
SKALDENSTRAAT 125
9042 GENT
Belgium
Tel.: +32-9-218-26-00

For Scandinavian countries, please contact our Finland office:

BRP FINLAND OY

Service Department
Ahjotie 30
FIN-96320 Rovaniemi
Finland
Tel.: +358163208111

For all other countries, please contact your local distributor or our North America office:

Bombardier Recreational Products Inc.

Customer Assistance Center
75 J.A. Bombardier Street
Sherbrooke QC J1L 1W3
Tel.: 1 819 566-3366

You will find your distributor's coordinates on www.brp.com.

* For the territory covered by this limited warranty, products are distributed and serviced by Bombardier Recreational Products Inc. or its affiliates.

© 2009 Bombardier Recreational Products Inc. All rights reserved.

® Registered trademark of Bombardier Recreational Products Inc.

CUSTOMER INFORMATION

PRIVACY INFORMATION

BRP wishes to inform you that your coordinates will be used for safety and warranty related purposes. Furthermore, BRP and its affiliates may use its customer list to distribute marketing and promotional information about BRP and related products.

To exercise your right to consult or correct your data, or to be removed from the addressee-list for direct marketing, please contact BRP.

By E-mail: privacyofficer@brp.com

By mail: BRP
Senior Legal Counsel-Privacy Officer
726 St-Joseph
Valcourt QC
Canada
J0E 2L0

CHANGE OF ADDRESS/OWNERSHIP

If your address has changed or if you are the new owner of the boat, be sure to notify BRP by either:

- Mailing one of the following card below;
- **North America only:** calling at 715 848-4957 (USA) or 819 566-3366 (Canada);
- Contacting an authorized BRP dealer.

In case of change of ownership, please join a proof that the former owner agreed to the transfer.

Notifying BRP, even after the expiration of the limited warranty, is very important as it enables BRP to reach the boat owner if necessary, like when safety recalls are initiated. It is the owner's responsibility to notify BRP.

STOLEN UNITS: In the event that your boat is stolen, you should notify your area's distributor warranty department of such. We will ask you to provide your name, address, phone number, Hull Identification Number and date it was stolen.

In North America

BOMBARDIER RECREATIONAL PRODUCTS INC.

Warranty Department
75 J.-A. Bombardier Street
Sherbrooke QC J1L 1W3
Canada

Other areas in the world except Scandinavian countries

BRP EUROPEAN DISTRIBUTION

Warranty Department
Chemin de Messidor 5-7
1006 Lausanne
Switzerland

Scandinavian countries

BRP FINLAND OY

Service Department
Isoaavantie 7
FIN-96320 Rovaniemi
Tel.: +358 16 3208 111

CHANGE OF ADDRESS CHANGE OF OWNERSHIP 

VEHICLE IDENTIFICATION NUMBER

Model Number

Vehicle Identification Number (V.I.N.)

OLD ADDRESS
OR PREVIOUS OWNER:

NAME

NO.

STREET

APT

CITY

STATE/PROVINCE

ZIP/POSTAL CODE

COUNTRY

TELEPHONE

NEW ADDRESS
OR NEW OWNER:

NAME

NO.

STREET

APT

CITY

STATE/PROVINCE

ZIP/POSTAL CODE

COUNTRY

TELEPHONE

E-MAIL ADDRESS

V00A2F

CHANGE OF ADDRESS CHANGE OF OWNERSHIP 

VEHICLE IDENTIFICATION NUMBER

Model Number

Vehicle Identification Number (V.I.N.)

OLD ADDRESS
OR PREVIOUS OWNER:

NAME

NO.

STREET

APT

CITY

STATE/PROVINCE

ZIP/POSTAL CODE

COUNTRY

TELEPHONE

NEW ADDRESS
OR NEW OWNER:

NAME

NO.

STREET

APT

CITY

STATE/PROVINCE

ZIP/POSTAL CODE

COUNTRY

TELEPHONE

E-MAIL ADDRESS

V00A2F

BOAT MODEL No. _____

HULL IDENTIFICATION NUMBER (H.I.N.) _____

ROTAX ENGINE IDENTIFICATION NUMBER (E.I.N.) _____

Owner: _____
NAME

No. STREET APT

CITY STATE/PROVINCE ZIP/POSTAL CODE

Purchase Date _____
YEAR MONTH DAY

Warranty Expiry Date _____
YEAR MONTH DAY

To be completed by the dealer at the time of the sale.

DEALER IMPRINT AREA

F00A35L

Please verify with your selling dealer to ensure your SEA-DOO sport boat has been registered with BRP.

204 630 400

CA

OPERATOR'S GUIDE, 150 SPEEDSTER / ENGLISH
GUIDE DU CONDUCTEUR, 150 SPEEDSTER / ANGLAIS

FAIT AU / MADE IN CANADA

U/M:P.C.