

SEA-DOO®



Sport Boats
OPERATOR'S GUIDE
Includes SAFETY, VEHICLE
and MAINTENANCE INFORMATION

2008

205 UTOPIA™
205 UTOPIA™ SE

⚠ WARNING

Read this guide thoroughly. It contains important safety information.
Minimum recommended operator's age: 16 years old.
Do not remove this *Operator's Guide* from the boat.

2 0 4 6 3 0 3 6 9

SAFETY WARNING

Disregarding any of the safety precautions and instructions contained in this Operator's Guide, the *SAFETY VIDEO* and the on-product warning labels could cause injury, including the possibility of death. The operator has the responsibility to inform passenger(s) of safety precautions.

This Operator's Guide and *SAFETY VIDEO* should remain with the boat at the time of resale.



The following trademarks are the property of Bombardier Recreational Products Inc. or its affiliates.

Sea-Doo®

ROTAX™

Utopia™

DOIN'IT ON YOUR NEW SEA-DOO SPORT BOATS

Congratulations, you are now the proud owner of a Sea-Doo Sport Boats. Whether you are an experienced boater or are new to the sport of boating, we ask you to take the time to view the *SAFETY VIDEO* provided with the boat, to read this Operator's Guide on-product warning/caution labels and familiarize yourself with the contents. This guide contains pertinent information which, if followed, will provide you with the necessary knowledge to help you fully enjoy the pleasures of this boat.

We strongly recommend that any boat operator complete a safety boating course. Check with your local Coast Guard or Power and Sail Squadron in your area for course availability. More serious boaters may want to obtain *CHAPMAN PILOTING* by Elbert S. Maloney, available at most book stores.

When introducing your family or friends to the sport, be sure they fully understand the controls and operation of the boat and the importance of courteous, responsible riding.

Each boat operator has a responsibility to ensure the safety of his/her passenger(s) and of other water users. Please follow all safety instructions and operate your boat with care.

We encourage you to have an Annual Safety Inspection of your boat. Please contact your authorized Sea-Doo Sport Boats dealer for further details.

Finally, we invite you to visit your authorized Sea-Doo Sport Boats dealer for regular safety maintenance as well as any boating accessories you may require.

Have fun and... Bon Voyage.

Please keep this guide on board. This guide should remain with the boat at time of resale.

If you want to view and/or print an extra copy of your Operator's Guide, simply visit the following website www.operatorsguide.brp.com. Also note that the guide is available in several languages.

TABLE OF CONTENTS

FOREWORD	7
----------------	---

SAFETY INFORMATION

GENERAL	10
TRAILERING	11
SAFE BOATING CHECKLIST	12
SAFETY EQUIPMENT	15
CARBON MONOXIDE AND BOATING	21
SAFETY LANYARD	25
SAFE BOATING PRACTICES	26
PASSENGER SAFETY	27
RULES OF THE ROAD	28
FUELING PROCEDURE	31
VOLUNTARY INSPECTIONS	32
SAFE BOATING COURSES	33
WATER SPORTS	34

VEHICLE INFORMATION

REGISTRATION NUMBER LOCATION	38
LOCATION OF THE IMPORTANT LABELS	39
IDENTIFICATION NUMBERS	44
CONTROLS, COMPONENTS AND INSTRUMENTS	45
Overview	45
1) DESS™ Post (engine cut-out switch)	48
2) Steering Wheel	49
3) Throttle/Shifter Controller	49
4) Start/Stop Switches	49
5) Bilge Air Blower Switch	50
6) Bilge Pump Switch	50
7) Navigation Lights Switch	51
8) Deck Lights Switch	51
9) Horn Switch	51
10) Fuel Gauge	52
11) Tachometers	52
12) Speedometer	52
13) Monitoring Gauges	52
14) Bilge Drain Plugs	53
15) Grab Handles	53
16) Rear Grab Handles	53

17) Ladder	53
18) Swim Platform	54
19) Driver/Passenger Seats	54
20) Bow Seats	55
21) Rear Seats	56
22) Sun Deck	56
23) Cup Holders	56
24) Glove Box	57
25) AM/FM Radio/CD Player	57
26) 12-Volt Accessory Jack	57
27) Deck Storage Compartment	57
28) Rear Storage Compartment (engine cover)	58
29) Jet Pump Water Intakes	59
30) Bow Lights	59
31) Stern Light Socket	59
32) Mooring Cleats	60
33) Deck	61
34) Fuel Tank Cap	61
35) Deck Drain	61
36) Flushing Connectors	61
37) Ventilation Ducts	61
38) Bow/Stern Eyelets	61
39) Jet Pump Nozzles	62
40) Reverse Gates	62
41) Scupper Valve	62
42) Fuel Tank Vent	62
43) Water Sport Towing Attachments	63
44) Main Battery Cut-Off Switch	65
45) Fuses	65
46) Bimini Top	65
47) Side Panel/Tray Storage	67
48) Cockpit Table	68
49) Windshield	69
50) Depth Finder	69
51) Deck Lights	69
52) AM/FM Radio/CD Player Remote Control	69
LIQUIDS	71
Recommended Fuel	71
Recommended Engine Oil	71
Engine Oil Level	71
Engine Coolant	73
BREAK-IN PERIOD	74
PRE-OPERATION CHECKS	75
Hull	76
Jet Pump Water Intakes	76
Bilge	76
Battery	76

Fuel Tank and Engine Oil Levels	76
Engine Compartment.....	76
Fire Extinguisher	76
Steering System	76
Throttle/Shifter Controller	77
DESS Post and Engine Start/Stop Switches	77
Storage Compartment Covers.....	77
OPERATING INSTRUCTIONS.....	78
Launching/Loading.....	78
Principle of Operation	78
Boarding from a Dock	80
Boarding from the Water.....	80
Starting.....	81
Rough Water or Poor Visibility Operation	82
Crossing Waves.....	82
Stopping/Docking	82
Beaching.....	82
Shutting Off the Engines.....	83
Post-Operation Care	83
Additional Care for Foul Water or Salt Water Use.....	83
SPECIAL PROCEDURES	85
Jet Pump Water Intake and Impeller Cleaning	85
Capsized Boat	85
Submerged Boat/Water-Flooded Engine	85
Fuel-Flooded Engines	86
Towing the Boat in Water	87
TROUBLESHOOTING	89
SPECIFICATIONS	94

MAINTENANCE INFORMATION

10-HOUR INSPECTION	100
PERIODIC INSPECTION CHART	101
MAINTENANCE PROCEDURES	104
General.....	104
Engine Emissions Information.....	104
Lubrication.....	105
Throttle/Shifter Controller Cables	106
Engine Oil Change and Oil Filter Replacement.....	106
Coolant Replacement	107
Fuel Injection System	107
Steering Alignment	107
Throttle/Shifter Controller	107
Deck Drain.....	107
Fuses.....	107
Bilge Air Blower.....	109

Navigation Light Bulb Replacement	109
Sacrificial Anodes	111
General Inspection and Cleaning	111
STORAGE AND PRESEASON PREPARATION	113

WARRANTY INFORMATION

BRP LIMITED WARRANTY FOR MODEL YEAR 2008 SEA-DOO® SPORT BOATS SOLD IN THE UNITED STATES AND CANADA	120
CALIFORNIA AND NEW YORK EMISSION CONTROL WARRANTY STATEMENT FOR MODEL-YEAR 2008 SEA-DOO® SPORT BOATS WITH 4-TEC™ 1503 NORMALLY ASPIRATED (NA) AND 4-TEC™ 1503 SUPERCHARGED INTERCOOLED (SCIC) ENGINE(S)	125
BRP INTERNATIONAL LIMITED WARRANTY FOR MODEL YEAR 2008 SEA-DOO® SPORT BOATS	129
BRP EUROPEAN UNION MEMBER STATES LIMITED WARRANTY FOR MODEL YEAR 2008 SEA-DOO® SPORT BOATS	133
DECLARATION CE OF CONFORMITY	137
PRIVACY OBLIGATION/DISCLAIMER	139
CHANGE OF ADDRESS/OWNERSHIP	141

FOREWORD

This Operator's Guide has been prepared to acquaint the owner/operator or passenger of this boat with the various controls, maintenance and safe riding instructions. It is indispensable for the proper use of the product, and should be kept in a waterproof bag in the boat at all times. Make sure you read and understand the content of this document.

For any questions pertaining to the warranty and its application, please consult an authorized Sea-Doo Sport Boats dealer.

Hazard Statements

As you read this Operator's Guide, please note the hazard warnings which alert you to safety precautions related to unsafe conditions or operating procedures.

This guide uses the following symbols and words to emphasize particular information.



The safety alert symbol is recognized around the world. In this manual, it means read this information carefully! Be sure you understand the consequences of the hazards and how to avoid them. Failure to follow the recommendations in a hazard communication statement may result in property damage, personal injury, or death.

People often refer to a hazard statement as a warning in a general sense. This manual uses three kinds of "warnings" depending on the likely effect of a hazard (minor injury, severe injury, death).

WARNING

Identifies a potentially or imminently hazardous situation which, if not avoided, **COULD** result in serious personal injuries including the possibility of death or substantial property damage.

CAUTION: This signal word indicates a potentially hazardous situation which, if not avoided, may result in minor or moderate personal injury or property damage. It may also be used to alert against unsafe practices.

NOTE: Indicates supplementary information needed to fully complete an instruction relating to equipment operation and/or maintenance procedures.

Although the mere reading of such information does not eliminate the hazard, the understanding and application of the information will promote correct and safe use of the boat.

The warnings in this supplement do not and cannot address every conceivable situation. Always use common sense! If a procedure, method, tool, or part is not specifically recommended, you must satisfy yourself that it is safe for you and others and that your boat will not be damaged or made unsafe as a result of your decision.

Advisory Statements

Advisory statements alert you to conditions that affect equipment operation, maintenance, and servicing practices.

An **IMPORTANT** statement indicates a procedure intended to prevent damage to equipment or associated components.

The information and components/system descriptions contained in this supplement are correct at the time of publication. Bombardier Recreational Products (BRP) however, maintains a policy of continuous improvement of its products without imposing upon itself any obligation to install them on products previously manufactured.

Because of our ongoing commitment to product quality and innovation, BRP reserves the right at any time to discontinue or change specifications, designs, features, models or equipment without incurring obligation.

The illustrations in this document show the typical construction of the different assemblies and may not reproduce the full detail or exact shape of the parts. However, they represent parts that have the same or similar function.

It is understood that this guide may be translated into another language. In the event of any discrepancy, the English version shall prevail.

Specifications are given in the SI metric system with the SAE U.S. equivalent in parenthesis. Where precise accuracy is not required, some conversions are rounded off for easier use.

A *SHOP MANUAL* can be obtained for complete service, maintenance and more repair information.

SAFETY INFORMATION

GENERAL

Your safety and that of your passengers and fellow boaters is YOUR responsibility. Before launching your boat, you should completely read and understand this Operator's Guide, product warnings and labels, the *SAFETY VIDEO* and other information provided with your boat or by your dealer. Heed and follow all warnings, safety precautions and operating procedures.

BRP strongly recommends that you take an approved boating safety course. Always operate your boat in compliance with safe boating rules, and with consideration, courtesy and common sense. Failure to do so could result in injury, including the possibility of death, to you, your passengers, others you lend your boat to, or other water users.

TRAILERING

Refer to the trailer instructions for proper capacity, operation, maintenance, accessories and warranty.

Check the regulations in your area concerning towing a trailer, especially the following rules:

- brake system
- tow vehicle weight
- mirrors.

NOTE: An optional brake system is available for your trailer, contact Karavan Trailers (www.karavantrailers.com).

Take the following precautions when trailering the boat:

Tie the boat to both bow and stern (front/rear) eyelets so that it is firmly retained on the trailer.

- Remove stern light (if installed).
- Ensure all storage compartment covers are properly latched.
- Ensure windshield door is securely locked in the closed position.
- Close bimini top.
- A Sea-Doo cover can protect the boat, particularly before driving on dirt roads, to prevent dirt entering through the air intake openings.

Observe trailering safety precautions.

CAUTION: Always close and securely fasten rear storage compartment lid **before** trailering.

SAFE BOATING CHECKLIST

When leaving on a cruise, whether for an hour or for several days, go through the following *SAFE BOATING CHECKLIST*.

Reminders Regarding Operation...

- The performance of this boat may significantly exceed that of other boats you may have operated. Become completely familiar with the controls and operation of this boat before embarking on your first trip or taking on a passenger(s). If you have not had the opportunity to do so, practice driving solo in a suitable traffic-free area and feel the response of each control. Be fully familiar with all controls before accelerating above idle speed. Do not assume that all boats handle identically. Each model differs, often substantially.
- Always keep in mind that as the throttle lever is returned to the idle position, less directional control is available. To turn the boat, both steering and throttle are necessary.
- Like any other boat, this boat has no brake. Stopping distance will vary depending on initial speed, load, wind, and water conditions. Practice stopping and docking in a safe, traffic-free area to have an idea of how long it will take to stop the boat under varying conditions. Do not release the throttle when trying to steer away from objects. You need throttle to steer. Do not use the boat's reverse to stop.
- Do not start or operate the boat if any person is not properly seated in a seat intended for use when underway (not the sun deck or swim platform) or if a person is nearby in the water.
- The boat's jet thrust can cause injury. Always accelerate slowly, and decelerate in a controlled fashion.
- Observe the instructions on all safety labels. They are there to help assure that you have a safe and enjoyable outing.
- Riding with passenger(s) or pulling other boats, tubes, a skier or a wake boarder makes the boat handle differently and requires greater skill.
- Certain boats may come equipped with tow eyelets, a ski pole or a wakeboard tower which can be used to attach a tow rope for a skier, tube or wakeboarder. Do not use these attachment points or any other portion of the boat to tow a parasail or another craft. Personal injury or severe damage may occur.
- In shallow water, proceed with caution and at very low speeds. Grounding or abrupt stops may result in injury to you, your passengers or others. The jet pump may pick up debris and throw it rearward causing a risk of injuring people or damaging the jet pump or other property.
- Engine exhaust contains carbon monoxide (CO), which can cause injury or death if inhaled in sufficient quantities. Do not operate the boat in a confined area or allow CO to accumulate in or around the boat, or in enclosed or sheltered areas. Such as when docked, or when rafting. Be aware of risk of CO from exhaust of other boats.
- Educate all occupants about the risks and symptoms of CO accumulation and CO poisoning, particularly from engine and generator exhaust. Educate them about where engine exhaust outlets (and generator outlets if so equipped) are located. Regularly inspect exhaust and generator system and outlets for component failures or obstructions.

- Combustion engines need air to operate; consequently this boat can not be totally watertight. Any maneuvers such as figure eights that cause the upper deck to be under water may cause severe engine problems due to water ingestion. Refer to the *SPECIAL PROCEDURES* and *WARRANTY INFORMATION* sections contained in this Operator's Guide.
- Respect no wake zones, the rights of other water users and the environment. As the "skipper" and owner of a boat, you are responsible for damage to other boats caused by the wake of your boat. Do not let anyone throw refuse overboard.
- Between sunset and sunrise, use the boat's navigation lights and reduce speed. Do not operate the boat in reduced visibility.
- Do not add accessories or equipment that may adversely affect visibility or alter control of the boat.
- The skipper should personally take the helm during storms.
- Be sure you have the minimum required safety equipment, PFDs and any additional gear needed for your cruise.
- Check that all lifesaving equipment, including fire extinguisher, is in safe operating condition and easily accessible. Show all passengers where this equipment is, and make sure they know how to use it.
- Keep an eye on the weather. Check local weather broadcasts before departure. Be alert to changing conditions.
- Keep accurate and up-to-date charts of the boating area on board. Before getting underway, check water conditions in the planned boating area.
- Before departure, file a Float Plan with a responsible person ashore.
- Keep enough fuel on board for the planned trip. Always verify fuel level before use and during the ride. Apply the principle of 1/3 of the fuel to reach your destination, 1/3 to return, and keep 1/3 in reserve. Allow for changes due to adverse weather or other delays.

Before Getting Underway...

- Always perform the pre-operation checks as specified in this Operator's Guide.
- Do not exceed the payload or passenger capacities for this boat, which are listed on the capacity plate and in the specifications. Overloading can affect maneuverability, stability and performance. Also, heavy seas reduce capacity. A payload or person capacity plate is not an excuse for failure to use common sense or good judgment.
- Regularly inspect the boat, the hull, engine, safety equipment, and all other boating gear and keep them in safe operating condition.

Operators and Passengers...

- Never operate a boat while under the influence of drugs or alcohol. It is a Federal offense. Allow only qualified drivers to operate your boat. Remember that sun, wind, alcohol, drugs, fatigue or illness may impair your judgement and reaction time.
- At least one passenger should be able to operate the boat in case the operator is unexpectedly unable to do so.
- Operation of this boat by a person under 16 years of age or a person with a disability that impairs vision, reaction time, judgment, or operation of the controls is NOT recommended.

- Always use the safety lanyard when operating the boat and ensure that all passengers are familiar with its use.
- Ensure that any operator and all passengers know how to swim and how to re-board the boat from the water. If a passenger does not know how to swim, ensure that passenger wears a PFD at all times and take extra precautions when boating.

SAFETY EQUIPMENT

An operator and the boat's passenger(s) should have ready access to shatterproof glasses should riding conditions or personal preference warrant.

Wind, water spray and speed may cause a person's eyes to water and create blurred vision.

As the owner of the boat, you are responsible for assuring that all required safety equipment is aboard. You should also consider supplying additional equipment as needed for your safety and that of your passengers. Check state and local regulations and call the U.S. Coast Guard Boating Safety Information Line at 1 800 368-5647 for information about required safety equipment.

Required Safety Equipment

Safety equipment required by federal regulations is mandatory. Personal flotation devices must be fitted to the people wearing them. If local regulations require additional equipment, it must be approved by the U.S. Coast Guard (USCG). Minimum requirements include the following:

- personal flotation devices (PFDs)
- fire extinguisher (class B-1)
- visual distress signals (VDS)
- navigation lights
- sound producing devices (horn, air horn or whistle).

A cellular telephone in a waterproof bag or container has also been found to be beneficial to boaters when in distress or just for contacting someone on shore.

Personal Flotation Devices (PFDs)

Federal regulations require that you have at least one Coast Guard approved personal flotation device (PFD) for each person in a recreational boat and require that all children under 13 years of age wear a PFD at all times when the boat is underway, except when below deck or in an enclosed cabin. You may not use your boat unless all PFDs are in serviceable condition, readily accessible, legibly marked with the Coast Guard approval number, and of an appropriate size (within the weight range and chest size marked on the PFD) for each person on board.

A PFD provides buoyancy to help keep your head above the water and to help you remain in a satisfactory position while in the water. Body weight and age should be considered when selecting a PFD. The buoyancy provided by the PFD should support your weight in water. The size of the PFD should be appropriate for the wearer. Body weight and chest size are common methods used to size PFDs. It is your responsibility to ensure that you have the proper number and types of PFDs on board to comply with federal and local regulations and that your passengers know where they are and how to use them.

PFD Types

Five types of PFDs have been approved by the U.S. Coast Guard.

PFD Type I, Wearable has the greatest required buoyancy. Its design allows for turning most unconscious persons in the water from face down position to a vertical or slightly backward, face-up position. It can greatly increase the chances of survival. Type I is most effective for all waters, especially offshore when rescue may be delayed. It is also the most effective in rough waters.

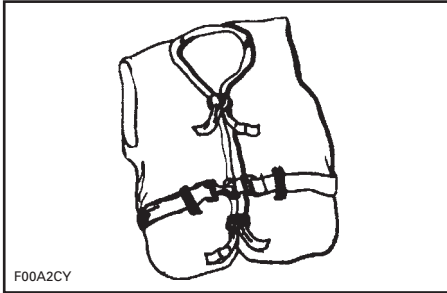

TYPE I — WEARABLE

PFD Type II, Wearable turns its wearer in the same way as Type I, but not as effectively. The Type II does not turn as many persons under the same conditions as a Type I. You may prefer to use this PFD where there is a probability of quick rescue such as in areas where other people are commonly involved in water activities.

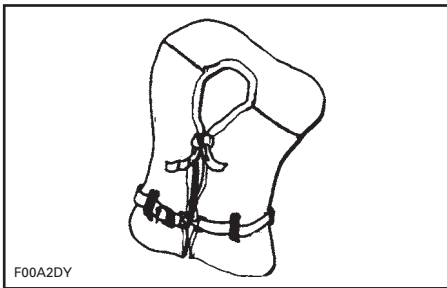

TYPE II — WEARABLE

PFD Type III, Wearable allows wearers to place themselves in a vertical or slightly backward position. It does not turn the wearer. It maintains the wearer in a vertical or slightly backward position and has no tendency to turn the wearer face down. It has the same buoyancy as a Type II PFD and may be appropriate in areas where other people are commonly involved in water activities.

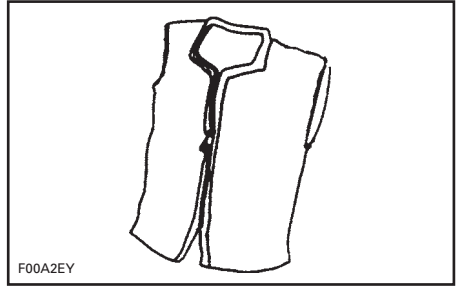

TYPE III — WEARABLE

PFD Type IV, Throwable is required in addition to the PFDs previously discussed. The most common Type IV PFD is a buoyant cushion or ring buoy. It is designed to be thrown to a person in the water, grasped and held by the user until he or she is rescued. A Type IV PFD should always be in serviceable condition and immediately available for use. Grasping this PFD may be difficult if the rescue is delayed or if the user is overcome by hypothermia (loss of body heat).

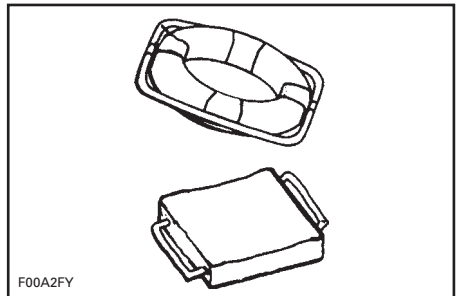

TYPE IV — THROWABLE

PFD Type V, Wearable must be worn. When inflated, it provides buoyancy equivalent to Type I, II or III PFDs. When it is deflated, however, it may not support some people.

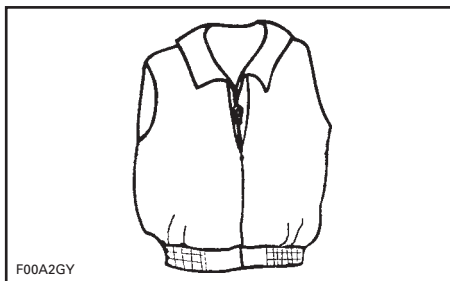

TYPE V — WEARABLE

PFD Pointers

The purpose of a PFD is to help save your life. If you want it to support you when you are in the water, it needs to fit, float, and be in good condition.

- Try the PFD on and adjust it until it fits comfortably in and out of the water. Mark your PFD if you are the only wearer.
- To make sure the PFD works, wear it in the water. This will show you how it works and give you confidence when you use it.
- Teach children how to put a PFD on and allow them to try it in the water. That way, they know what the PFD is for and how it works. They will feel more comfortable with it if they suddenly find themselves in the water.
- If the PFD is wet, allow it to dry thoroughly before storing it. Do not dry it in front of a radiator or heater. Store it in a well-ventilated area.
- Keep PFDs away from sharp objects which can tear the fabric or puncture the flotation pads.
- For their own safety and the safety of others, all non-swimmers, poor swimmers, and small children should wear PFD's at all times whether the boat is stationary or moving.

- Check the PFD frequently to make sure that it is not torn, that flotation pads have no leaks, and that all seams and joints are securely sewn.
- If a PFD contains kapok, the kapok fibers may become waterlogged and lose their buoyancy after the vinyl inserts are punctured. If the kapok becomes hard or if it is soaked with water, replace it. It may not work when you need it.

Hypothermia

Hypothermia, the loss of body heat to the water, is a significant cause of deaths in boating accidents. After an individual has succumbed to hypothermia, he or she will lose consciousness and then drown.

PFDs can increase survival time because of the insulation they provide.

Naturally, the warmer the water, the less insulation one will require. When operating in cold water (below 4.4°C (40°F)) consideration should be given to using a coat or jacket style PFD as they cover more of the body than the vest style PFDs.

Some points to remember about hypothermia protection:

1. While afloat in the water, do not attempt to swim unless it is to reach a nearby boat, fellow survivor, or a floating object on which you can lean or climb. Unnecessary swimming increases the rate of body heat loss. In cold water, drown-proof methods that require putting your head in the water are not recommended. Keep your head out of the water. This will greatly lessen heat loss and increase your survival time.
2. Keep a positive attitude about your survival and rescue. This will improve your chances of extending your survival time until rescue. Your will to live does make a difference!

3. If there is more than one person in the water, huddling is recommended while waiting to be rescued. This action tends to reduce the rate of heat loss and thus increase the survival time.
4. Always wear your PFD. It won't help you fight off the effects of hypothermia if you don't have it on when you go into the water.

Fire Extinguishers

As the owner of the boat, you are responsible for supplying a fire extinguisher approved by the U.S. Coast Guard. Boats (less than 7.9 m (26 ft)) are required to carry one (1) B-1 type hand portable fire extinguisher unless the boat is equipped with a fixed fire extinguishing system in the engine compartment.

Hand-held portable fire extinguishers should be mounted in readily accessible locations away from the engine compartment. All persons aboard should know the location and proper operation of the fire extinguisher(s).

NOTE: Don't test fire extinguishers by squirting small amounts of the extinguishing compound. The extinguisher might not work when you really need it!

Visual Distress Signal Devices

Visual distress signal devices approved by the U.S. Coast Guard are required on all recreational boats operating on coastal waters and on boats owned in the United States when they are operating on the high seas. Coastal waters include territorial seas and those waters directly connected to the Great Lakes and the territorial seas up to a point where the waters are less than 3.2 km (2 mi) wide. Visual distress signal equipment may be of the pyrotechnic or non-pyrotechnic type. Regulations prohibit display of visual distress signals on the water under any circumstances except when assistance is required to prevent immediate or potential danger to persons on board a vessel.

The equipment must be approved by the U.S. Coast Guard, be in serviceable condition, and be stowed in a readily accessible location. Equipment having a date for serviceable life must be within the specified usage date shown.

Careful selection and proper stowage of visual distress equipment is very important if children are aboard.

WARNING

Fire! In case of fire, do not open engine compartment. Turn off engine. Using portable CO₂ fire extinguisher, continuously discharge entire contents at base of fire.

DAY USE ONLY
Three orange smoke signals (one hand held and two floating) or one orange flag with black square and disk
NIGHT USE ONLY
One S-O-S electric distress light
DAY AND NIGHT USE
Three flares of the hand held, meteor or parachute type

Sound Signaling Devices

NOTE: No single signaling device is appropriate for all purposes. Consider keeping various types of equipment on board.

Boats less than 7.9 m (26 ft) in length are required to carry a hand, mouth, or power operated horn or whistle. It must produce a blast of two second duration and audible at a distance of at least 800 m (1/2 mi).

Following are standard whistle signals:

- one prolonged blast (warning signal)
- one short blast (pass on my port side)
- two short blasts (pass on my starboard side)
- three short blasts (engines in reverse)
- five or more blasts (danger signal).

Navigation Lights

Navigation lights are intended to keep other vessels informed of your presence and course. If you are out on the water between sunset and sunrise, you are required to display appropriate navigation lights.

Additional Recommended Equipment

It is recommended that you acquire additional equipment for safe, enjoyable cruising. This list, which is not all inclusive, includes items you should consider acquiring.

Basic Gear

- flashlight
- mooring lines
- compass
- oar or paddle
- distress signals
- first aid kit
- dock fenders
- VHF radio
- EPIRB (Electronic Position Indicating Radio Beacon)
- boat hook
- extra warm clothing
- charts
- sunblock
- tow line
- second anchor and line
- dewatering device (pump or bailer)
- emergency supply of drinking water and food.

Tools

- spark plug wrench
- hammer
- screwdrivers
- jackknife
- pliers
- electrician's tape
- adjustable wrench
- lubricating oil
- duct tape.

For additional tools, see your dealer.

Spare Parts

- extra bulbs
- extra fuses
- extra drain plug
- spark plugs
- spare wire.

For additional parts, see your dealer.

CARBON MONOXIDE AND BOATING

Burning a material containing carbon produces carbon monoxide (CO), an odorless and colorless gas. Because CO weighs the same as air, it can spread throughout an enclosed space unnoticed because you cannot see it or smell it. Any device used to burn carbon-based materials on a boat can be a source of CO. Common sources of CO include internal combustion engines.

CO reacts with the blood to reduce the ability of the blood to carry oxygen. The reduced oxygen supply to body tissues results in death of the tissue. Prolonged exposure can cause brain damage or death. In high concentrations, CO can be fatal within minutes. The effects of CO in lower concentrations are cumulative and can be just as lethal over long periods of time.

Symptoms of CO poisoning include: Itchy and watering eyes, flushed appearance, throbbing temples, inability to think coherently, ringing in the ears, tightness across the chest, headaches, drowsiness, nausea, dizziness, fatigue, vomiting, collapse, and convulsions. If any of these symptoms are evident, begin treatment immediately. Prompt action can make the difference between life and death.

- Evacuate the area and move the victim to fresh air.
- Administer oxygen if available and get medical help.
- Open all canvas enclosures to ventilate the area.
- Investigate the source of CO and take immediate corrective action.
- Be especially aware of other CO sources which may be near boat.

Carbon Monoxide Accumulation

Following are examples of possible situations where CO may accumulate within your boat while docked, anchored, or underway. Become familiar with these examples and their precautions to prevent personal injury or death.

WARNING

Exhaust Fumes! Generator or hull exhaust from other vessels while either docked or anchored can emit poisonous CO gas and cause excessive accumulation within cabin and cockpit areas. Be alert for generator exhaust from your vessel or other vessels alongside. Exhaust outlets near a pier, dock, seawall or outlets blocked by any other means can cause excessive accumulation of poisonous CO gas within cockpit area.

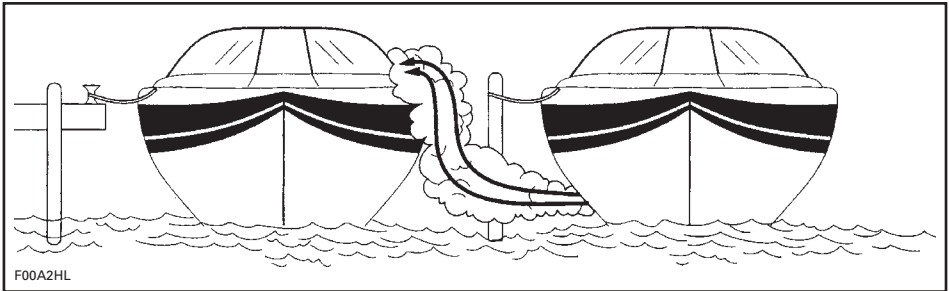

VESSEL ALONGSIDE

WARNING

Engine exhaust fumes contain carbon monoxide (CO) which can accumulate in and around the boat (under bimini top, in cockpit, etc.). CO can be harmful or fatal if inhaled. Assure there is adequate ventilation whenever running engine(s).

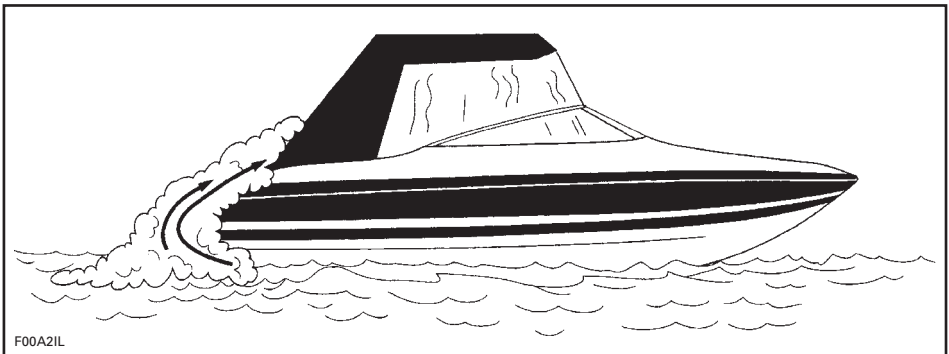

WHILE UNDERWAY (BACKDRAFTING)

While underway, CO concentrations can increase by backdrafting or “the station wagon effect”. Backdrafting is caused by factors such as relative wind direction, speed, or the bow being too high. To prevent this, open canvas whenever possible to provide positive airflow through the hull.

Boat houses, seawalls, and other boats in close proximity or confined areas can contribute to increased CO levels. Operators must be aware that operation, mooring, and anchoring in an area with other boats puts them in jeopardy of CO accumulation from other sources. Likewise, a boat operator must be aware of how exhaust from his boat will affect others. Operation of the engines while moored may cause CO accumulation in your boat and those around you.

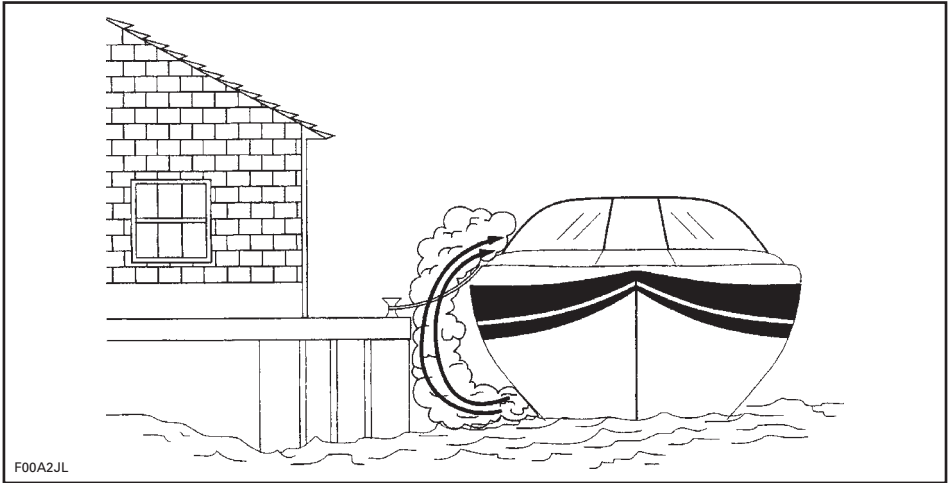

CONFINED AREAS

Be sure to provide adequate ventilation. If the windshield has vents, open them before getting underway to increase positive air flow and decrease the chances of CO accumulation.

⚠ WARNING

Backdrafting! Under certain conditions, moving air currents can direct poisonous CO fumes into boat. These fumes can accumulate to dangerous levels without proper airflow. Provide adequate ventilation, redistribute the load or bring boat out of high bow angle.

Even with the best boat design and construction, CO may still accumulate in enclosed or confined areas under certain conditions. Continually observe passengers for symptoms of CO poisoning.

Do NOT Operate your Boat without Performing the Following Checklist:

Each Boating Day

OPERATION	✓
Make sure you and your passengers know where exhaust outlets are located on the vessel	
Educate all passengers about the symptoms of co poisoning and where CO may accumulate	
When docked or rafting with another boat, be aware of exhaust emissions from the other boat	
Confirm that water flows from the exhaust outlet when the engine(s) is (are) started	
Listen for any change in exhaust sound, which could indicate an exhaust component failure	
Test the operation of each CO alarm by pressing the test button (if so equipped)	

CO Detector

It is strongly recommended that you have CO detectors installed in boats with canvas enclosures. Monitors are available from your dealer. Monitors should be professionally installed and calibrated.

NOTE: A CO detector is not a gas fuel vapor detector. Gas fuel vapor detectors do not monitor the buildup of CO in an enclosed area.

SAFETY LANYARD

This safety device automatically stops the engines if the lanyard is attached to the operator and the operator falls from the control station.

The safety lanyard clip must be securely attached to the operator's PFD, clothing, arm, or leg. Be sure to attach the lanyard clip to a place where it is free of obstructions and to something that will move with the operator if he or she leaves the helm station. If the engine shuts down because the DESS key attached to the safety lanyard was removed, the key must be reinstalled on the DESS post before the engine can be restarted.

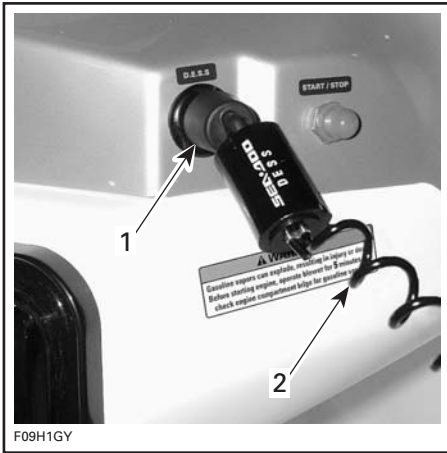

TYPICAL

- 1. DESS key installed on DESS post
- 2. Safety lanyard attached to operator

WARNING

Always use the safety lanyard when operating your boat. Keep DESS post free from obstructions that could interfere with its operation. Do not modify or bypass its safety features. The proper use of the safety lanyard can prevent a runaway boat situation which otherwise could cause severe personal injury or death.

SAFE BOATING PRACTICES

YOU are responsible for your own safety, the safety of your passengers, and the safety of fellow boaters.

Drugs and Alcohol

Do not use drugs or drink alcohol while operating a boat. Like driving a car, driving a boat requires sober, attentive care. Operating a boat while intoxicated or under the influence of drugs is not only dangerous, but it is also a Federal offense carrying a significant penalty. These laws are vigorously enforced. The use of drugs and alcohol, singly or in combination, decreases reaction time, impedes judgment, impairs vision, and inhibits your ability to safely operate a boat.

- Do not use the boat in weather or sea conditions beyond the skill or experience of the operator or the comfortable capability of the boat or passengers.
- Be sure at least one other passenger is familiar with the operation and safety aspects of the boat in case of an emergency.
- Make sure that passengers and gear do not obstruct the operator's view or ability to move.
- Do not exceed the maximum engine power rating stated on the certification plate attached to the boat.
- Observe all safety signs and warnings both inside the boat and in the immediate boating area.

WARNING

Alcohol consumption and boating do not mix! Operating under the influence endangers the lives of your passengers and other boaters. Federal laws prohibit operating a boat under the influence of alcohol or drugs.

Safe Operation

For safety reasons and proper care, always perform daily *PRE-OPERATION CHECKS* as specified in your Operator's Guide before operating your boat. Safe operation means that you do not misuse your boat nor do you allow your passengers to do so. Safe operation means using good judgment at all times. It includes, without limitation, the following actions:

- Load the boat within the limits listed on the capacity plate. Balance loads bow to stern and port to starboard.
- Maintain boat speed at or below the local legal limit. Avoid excessive speed or speeds not appropriate for operating conditions.

PASSENGER SAFETY

Before getting underway, show all passengers where emergency and safety equipment is stowed, and explain how to use it. Everyone aboard should wear rubber-soled shoes which resist slipping on wet surfaces. While underway, passengers should remain seated inside the deck rails. Don't allow passengers to drag their feet or hands in the water. Always use handholds and other safety hardware to prevent falls. All non-swimmers, poor swimmers, and children should wear a PFD at all times. Federal regulations require that children under 13 years of age wear a PFD when the boat is underway unless they are in an enclosed cabin or below deck.

First Aid

As a boat operator, you should be familiar with basic first aid procedures that may be needed while you are far from help. Fish hook accidents or minor cuts and abrasions may be the most serious mishaps on board a boat, but you should also learn the proper procedures and be ready to deal with the truly serious problems like excessive bleeding, hypothermia, and burns. First aid literature and courses are available through most Red Cross chapters.

Operation by Minors

Minors should always be supervised by an adult whenever operating a boat. Many states have laws regarding the minimum age and licensing requirements of minors. Be sure to contact the state boating authorities for information. BRP recommends a minimum operator age of 16 years old.

RULES OF THE ROAD

As a responsible boater, you will comply with the *RULES OF THE ROAD*, the marine traffic laws enforced by the U.S. Coast Guard. Navigating a boat is much the same as driving an automobile. Operating either one responsibly means complying with a set of rules intended to prevent accidents. Just as you assume other car drivers know what they are doing, other boaters assume you know what you are doing.

Operating a boat can be compared with driving unmarked highways and roads. To prevent collisions or avoid other boaters, a system of operating rules must be followed. It's not only common sense... it's the law!

Check local and federal boating laws applicable to the waterways where you intend to use your boat. Learn the local rules of the road. Know and understand the applicable navigation system (such as buoys and signs).

Know the waters in which the boat is to be operated. Current, tides, rapids, hidden obstacles, wakes and waves etc. can affect safe operation. It is not advisable to operate the boat in rough or inclement weather.

Generally keep to your right and safely avoid other craft by keeping a safe distance from other craft, people and objects.

Crossing

Give right of way to craft ahead and to your right. Never cross in front of another craft.

RED light (give way to the other craft).

GREEN light (you have the right of way).

Meeting Head-On

Keep right.

Passing

Give right of way to other craft and keep clear.

Navigation System

Navigational aids, such as signs or buoys, can help you identify safe waters. Buoys will indicate whether you should keep to the right (starboard) or to the left (port) of the buoy or to which channel you can continue. They may also indicate whether you are entering a restricted or controlled area such as a no wake or speed zone. They may also indicate hazards or pertinent boating information. Markers may be located on shore or on the water. They can also indicate speed limits, no power craft or boating, anchorage and other useful information. (The shape of each type of marker will provide assistance.)

Make sure you know and understand the navigation system applicable to the waterways where you intend to use the boat.

Collision Avoidance

- Do not decrease throttle when trying to steer away from objects. You need throttle to steer.
- Always keep a constant lookout for other water users, other craft or objects, especially when turning. Be alert for conditions that may limit your visibility or block your vision of others.
- Respect the rights of other recreationists and/or bystanders and always keep a safe distance from all other craft, people and objects.
- Do not wake or wave jump, ride the surf line or attempt to spray or splash others with your boat. You may misjudge the ability of the boat or your own driving skills and strike a boat or person.

- This boat has the capability of turning more sharply than other boats. However, unless in an emergency, do not negotiate sharp, high speed turns. Such maneuvers make it hard for others to avoid you or understand where you are going. Also, you and/or your passenger(s) could be thrown from the boat.
- Like any other boat, this boat has no brake. Stopping distance will vary depending on initial speed, load, wind, and water conditions. Practice stopping and docking in a safe, traffic free area to have an idea of how long it will take to stop the boat under varying conditions.
- Maintaining or increasing speed may be necessary to avoid a collision.

Safe Riding

- Always keep in mind that as the throttle lever is returned to idle position, less directional control is available, and when the engine is off, directional control is lost. You need throttle to steer.
- While your boat has the capacity of operating at high speeds, it is strongly recommended that high speed operation only be applied when ideal conditions exist and are permitted. Higher speed operation requires a higher degree of skill and increases the risk of severe injuries.
- In shallow water, proceed with caution and at very low speeds. Grounding or abrupt stops may result in injury. Debris may also be picked up and be thrown rearward by the jet pump onto people or property.
- Do not use the boat's reverse, to stop. You or your passenger(s) could be violently ejected forward or even off the boat onto the hazard.

Operator/Passenger Awareness

- Do not start or operate the boat if anyone is seated on the sun deck or swim platform, or is nearby in the water. Water and/or debris exiting jet thrust nozzle can cause severe injury.
- The operator and passenger(s) should be properly seated before starting or moving the boat. All passenger(s) should be instructed to use the handholds or seat straps provided.
- When accelerating a boat with a passenger(s), whether from a complete stop or while underway, always do so progressively. Fast acceleration may cause your passenger(s) to lose their balance or grip and strike something in the boat or fall out of the boat. Make sure that your passenger(s) know of, or anticipate, any rapid acceleration.

Maneuverability of the Boat/Towing

- Do not overload the boat or take on more passengers than designated for the particular boat. Overloading can affect maneuverability, stability and performance.
- Avoid adding on accessories or equipment which may alter your control of the boat.
- Riding with a passenger(s) or pulling a tube, skier or wakeboarder makes the boat handle differently and requires greater skill.
- Always respect the safety and comfort of your passenger(s) and person being towed on skis, wakeboard or other towables.

- Always carry an observer when pulling a tube, skier or wakeboarder, proceed with only as much speed as required and follow the observer's instructions. Unless absolutely necessary, do not make tight, sharp turns. Keep a safe distance from the docks, other swimmers, craft or objects.
- Use a tow rope of sufficient length and size and make sure it is adequately secured to your boat. Some boats are equipped or can be fitted with a specially designed towing mechanism. It can become a hazard should someone fall on it.

Don't Forget:

- Ride smart from the start and we all win!

FUELING PROCEDURE

Regarding Fuel

- Remember that fuel and gasoline fumes are flammable and explosive under certain conditions. Be very careful when fueling and adhere to the fueling procedures described below in this Operator's Guide and those given to you by the marina. Always stop the engine before fueling and never allow anyone to remain in the boat while fueling. Each time you fill up, assure that the engine compartment is free of gasoline vapors, and inspect fuel lines for leaks and hose deterioration.
- Do not smoke or allow open flames or sparks in the vicinity.
- Know the capacity of the fuel tank. Avoid fueling at night except under well-lit conditions. Gas spills are not noticeable in the dark. Do not carry spare fuel or flammable liquids in any of the storage or engine compartments.

Procedure

WARNING

Follow these safe boating fueling instructions explicitly.

- Turn off engines.
- Do not allow anyone to remain in or on the boat.
- Tie boat securely to the fueling pier.
- Use bilge blower for a minimum of 5 minutes.
- Turn off bilge air blower, bilge pump and any other devices that could produce a spark.
- Ensure engine cover is closed to prevent fumes from entering the engine compartment.
- Have a fire extinguisher close at hand.
- Insert the spout into the filler neck.

- Pour fuel slowly so that air can escape from the tank and prevent fuel flowback. Be careful not to spill fuel.
- Stop filling when the fuel reaches the bottom of filler neck. **Do not overfill.** Fully tighten fuel tank cap.

WARNING

Always stop the engines before refueling. Fuel is flammable and explosive under certain conditions. Always work in a well ventilated area. Do not smoke or allow open flames or sparks in the vicinity. Fuel tank may be pressurized. Slowly turn cap when opening. Never use an open flame to check fuel level. When fueling, keep boat level. Do not overfill or top off the fuel tank and leave boat in the sun. As temperature increases, fuel expands and might overflow. Always wipe off any fuel spillage from the boat. Periodically verify fuel system.

VOLUNTARY INSPECTIONS

State boating officials in many states or the U.S. Coast Guard Auxiliaries offer courtesy inspections to check out your boat. They will check for compliance with safety standards and required safety equipment. You may voluntarily consent to one of these inspections, and you are allowed time to make corrections without prosecution. Check with the appropriate state agency or the Coast Guard Auxiliary for details.

SAFE BOATING COURSES

The local U.S. Coast Guard Auxiliary and the U.S. Power Squadrons offer comprehensive safe boating classes several times a year. You may contact the BOAT/U.S. Foundation at 1 800 336-BOAT (2628) or, in Virginia, 1 800 245-BOAT (2628), for a course schedule in your area. Also contact the local U.S. Coast Guard Auxiliary or Power Squadron Flotilla for the time and place of their next scheduled class. A boating safety course is recommended and may be required in your province or state.

WATER SPORTS

WARNING

Avoid Personal Injury! Your boat is not designed for and should not be used for pulling parasails, kites, gliders, or any device which can become airborne. Use boat only for appropriate water sports.

WARNING

Teak Surfing is extremely dangerous to participants due to their proximity to the rear of the boat where direct contact with the exhaust fumes from the boat engine is the highest. Carbon monoxide poisoning can occur and result in mental disorientation, dizziness, drowsiness, and loss of consciousness. The combination of carbon monoxide exposure and non-use of a life jacket (PFD) make this new water recreation activity an incredibly dangerous and potentially deadly sport.

Water skiing, wakeboarding, or riding a towed, inflatable apparatus are some of the more popular water sports. Taking part in any water sport requires increased safety awareness by the participant and the boat operator. If you have never pulled someone behind your boat before, it is a good idea to spend some hours as an observer, working with and learning from an experienced driver. It is also important to be aware of the skill and experience of the person being pulled. Always have a second person on board to observe the person in the water so the driver can concentrate on operating the boat.

Both the boat operator and observer should monitor the location of the towrope when participating in water sports. A slack tow rope can become entangled with person(s) or objects in the boat or in the water, particularly when making a tight turn or circling, and cause serious personal injury.

Everyone participating in a water sport should observe these guidelines:

- Allow only capable swimmers to take part in any water sport.
- Always wear a personal flotation device (PFD) approved by the U.S. Coast Guard. Wearing a properly designed PFD helps a stunned or unconscious person stay afloat. A Type-IV water-ski vest is an approved and practical PFD.
- Have a second person aboard to observe the person being towed and inform the driver about the participant's hand signals. The driver must give full attention to operating the boat and the waters ahead.
- Be considerate to others you share the water with.
- Never allow a person to "teak surf" behind your boat. Do not tow a person in any water sport on a short tow rope such that the person inhales exhaust fumes in concentration. Inhalation of concentrated exhaust fumes, which contain carbon monoxide, can result in CO poisoning, personal injury and death.
- Give immediate attention to a person who has fallen. He or she is vulnerable in the water alone and may not be seen by other boaters.
- Approach a person in the water from the lee side (opposite the direction of the wind). Turn off the motor before coming close to the person.
- Turn off engine and anchor the boat before swimming.

- Participate in water sports only in safe areas. Stay away from other boats, channels, beaches, restricted areas, swimmers, and heavily traveled waterways and underwater obstructions.
- Swim only in areas designated as safe for swimming. These are usually marked with a swim area buoy. Do not swim alone or at night.



SWIM AREA BUOY

- Do not water ski between sunset and sunrise. It is illegal in most states.
- Do not drive the boat directly behind a water skier, tuber or wakeboarder. At 40 km (25 mi) per hour, the boat will overtake a person who falls in the water 60 m (200 ft) in front of your boat in about 5 seconds.
- Shut engine off and remove ignition key when anyone is in the water nearby.
- Stay at least 45 m (150 ft) away from areas marked by a diver down float.

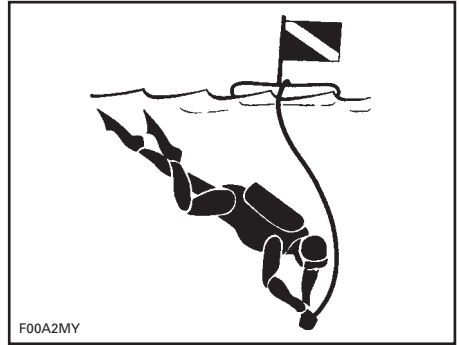

DIVER DOWN FLOAT

⚠ WARNING

Avoid Personal Injury! Do not allow anyone near the jet pump or intake grate, even when the engine is off. Items such as long hair, loose clothing or personal flotation device straps can become entangled in moving parts resulting in serious injury or drowning. In shallow water, shells, sand, pebbles or other objects could be drawn up by the jet pump and be thrown rearward.

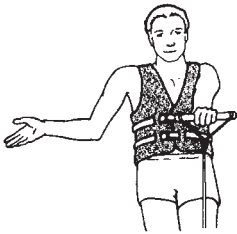

FASTER -
Palm of one hand pointing upward.



SLOWER -
Palm pointing down.



SPEED OK -
Arm upraised with thumb and finger joined to form circle.

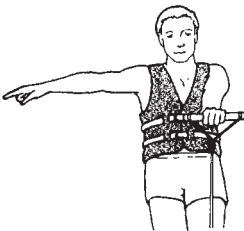

RIGHT TURN -
Arm outstretched pointing to the right.

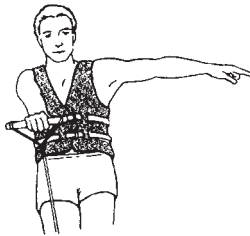

LEFT TURN -
Arm outstretched pointing to the left.



RETURN TO DROP-OFF AREA -
Arm at 45 degree from body pointing down to water and swinging.



CUT MOTOR -
Finger drawn across throat.

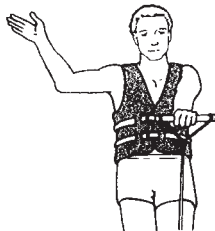

STOP -
Hand up, palm forward, policeman style.



SKIER OK. AFTER THE FALL -
Hands clenched together overhead.

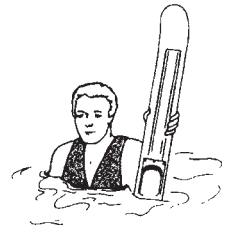

PICK ME UP OR FALLEN SKIER, WATCH OUT -
One ski extended vertically out of water.

F00A2NL

SKIING SIGNALS

For more information about water skiing, please contact the American Water Ski Association, 1251 Holy Cow Road, Polk City, FL 33868 (1 863 324-4341).

INTERNET WEB SITE: www.usawaterski.org/

E-MAIL: usawaterski@usawaterski.org

VEHICLE INFORMATION

REGISTRATION NUMBER LOCATION

All boats are required by federal law to be registered and legally numbered.

Due to space availability for proper display of registration number, refer to the following illustration for location. The registration number must appear on each side of the boat.



F10L36L

TYPICAL

1. Registration number location

LOCATION OF THE IMPORTANT LABELS

The following labels are on your boat. If missing or damaged, they can be replaced free of charge. See an authorized Sea-Doo Sport Boats dealer.

Please read the following labels carefully before operating your boat.

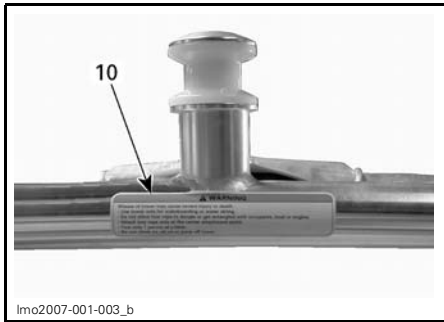
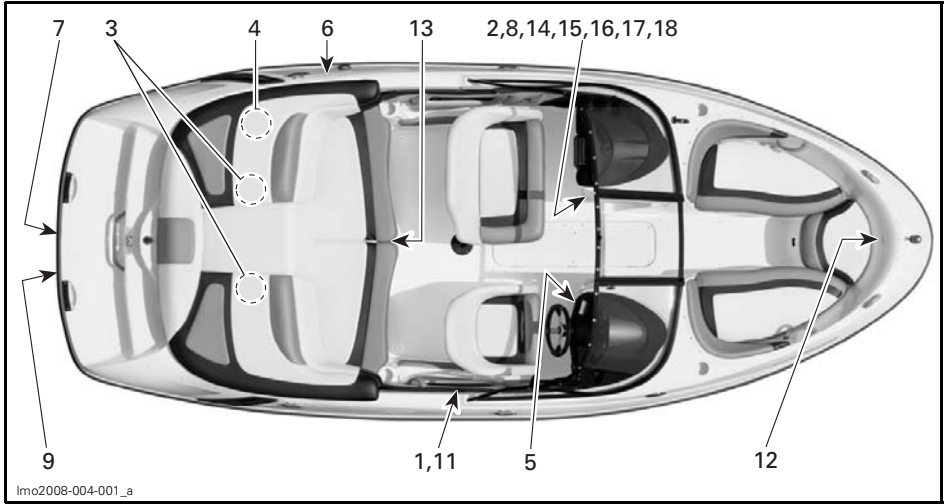

WAKE TOWER — OPTIONAL

Label 1

⚠ WARNING

Read and follow warning labels and operator's guide before operation. Severe injury or death can result from ignoring warnings or improper use of this sport boat. The performance of this sport boat may significantly exceed that of other boats you may have operated.

- Check throttle/shifter and steering operation and position before starting engine(s).
- Directional control is reduced with decreasing speed and lost when engine is off.
- Do not splash others or jump waves or wakes.
- Occupants should always wear approved PFD and recommended protective clothing.
- Do not operate if passengers are not properly seated and using handgrips, or if visibility is obstructed. Do not allow passenger(s) to ride on any portion of the boat not designated in the operator's guide as a seat for use when underway.
- Properly attach safety lanyard to your PFD.
- Keep a safe distance from all other water users. Be aware of and observe all applicable laws and regulations.

F13L1UL

Label 2

MADE IN U.S.A., BOMBARDIER MOTOR CORPORATION OF AMERICA
U.S. COAST GUARD
MAXIMUM CAPACITIES
8 PERSONS OR xxx KG/xxxx LBS.
xxx KG/xxxx LBS. PERSONS, GEAR
THIS BOAT COMPLIES WITH U.S. AND CANADIAN COAST GUARD
SAFETY STANDARDS IN EFFECT ON THE DATE OF CERTIFICATION
CE BOAT DESIGN CATEGORY: **C**

mo2008-002-010_en

Label 4

⚠ WARNING

- Remove battery from boat before charging.
- Do not overcharge battery.
- Improper charging of battery can cause explosion.

F13L1MY

Label 3

⚠ WARNING / AVERTISSEMENT

CHECKING ENGINE OIL LEVEL

Vehicle must be level to perform verification. Bring engine to normal operating temperature then let idle for 30 seconds. Stop engine, wait for at least 30 sec, and check oil level using the dipstick. **Caution:** Never let the engine run out of the water without cooling through the flush kit connection as it may damage the engine. Oil may be hot.

VÉRIFICATION DU NIVEAU D'HUILE DU MOTEUR

Avec la motomarine à niveau et à température normale d'utilisation, laissez le moteur tourner au ralenti 30 secondes. Arrêtez le moteur, attendez au moins 30 sec, et vérifiez le niveau d'huile. **Attention:** Ne pas laisser tourner le moteur hors de l'eau sans faire circuler de l'eau par le raccord de rinçage. L'huile peut être chaude.

F18L10Y

TYPICAL

Label 5

⚠ WARNING

Gasoline vapors can explode, resulting in injury or death. Before starting engine, operate blower for 5 minutes and check engine compartment bilge for gasoline vapors.

F13L1SY

Label 6

⚠ WARNING

- Avoid serious injury or death from fire or explosion.
- Before fueling, stop engine and keep boat level.
- Open fuel cap slowly to relieve pressure.
- Do not overfill.
- Regularly inspect fuel system for leaks.
- Use regular unleaded gasoline and check oil level.

F13L1NY

Label 7

⚠ WARNING

Avoid serious personal injury or death.

- Turn off engine(s) before using swim platform.
- Keep people, clothing and hair away from jet nozzle(s) or intake grate(s) to avoid entanglement, drowning and carbon monoxide poisoning.

F13L10Y

Label 8

⚠ WARNING

Lock driver seat in forward position so that seat faces steering wheel during operation and does not swivel.

F13L1TY

Label 9

⚠ WARNING



Carbon monoxide (CO) can cause brain damage or death.

Engine and generator exhaust contains odorless and colorless carbon monoxide gas.

Signs of carbon monoxide poisoning include nausea, headache, dizziness, drowsiness, and lack of consciousness.

Get fresh air if anyone shows signs of carbon monoxide poisoning.

See Owner's Manual for information regarding carbon monoxide poisoning.

204901625

Imo2007-002-001

Label 10

⚠ WARNING

Misuse of tower may cause severe injury or death.

- Use tower only for wakeboarding or water skiing.
- Do not allow tow rope to dangle or get entangled with occupants, boat or engine.
- Attach tow rope only at the center attachment point.
- Tow only 1 person at a time.
- Do not climb on, sit on or jump off tower.

F13L1PL

WAKE TOWER — OPTIONAL

Label 11

⚠ CAUTION

- Do not use bimini top as a support.
- Operate boat only at low speeds if bimini top is in use.
- Top can break or dislodge causing a risk of personal injury or interference with boat operation.

F04LCYY

BIMINI TOP

Label 12

⚠ WARNING

**Avoid Serious Or Fatal Injury.
Do Not Occupy Seat When Speed
Exceeds 5 M.P.H.**

F00L3BY

Label 13



F10L3EY

Label 14

⚠ WARNING

Securely lock windshield door in the opened or closed position before getting underway and at all times while boat is in motion.

F21L25L

Label 15

⚠ CAUTION

Latch engine cover before operating or towing boat. Open cover may be damaged or obstruct driver visibility.

F21L26L

Label 16

BRP US Inc.

EMISSION CONTROL INFORMATION

This vehicle is certified to operate on unleaded gasoline and conforms to 20XX U.S. EPA & CALIFORNIA EMISSION regulations for marine SI engines.

BRP US Inc.

RENSEIGNEMENTS SUR LE DISPOSITIF ANTIPOLLUTION

Ce véhicule est certifié pour fonctionner à l'essence sans plomb et il répond aux normes 20XX de l'EPA des É.-U. & RÉGLEMENTATIONS CALIFORNIENNES pour les moteurs marins à étincelles (SI).

SEE OPERATORS GUIDE FOR MAINTENANCE SPECIFICATIONS.

VOIR MANUEL DE L'OPÉRATEUR POUR LES SPÉCIFICATIONS DE MAINTENANCE.

Engine family	XXXX	Famille de moteur
FEL	XX g/kW-hr HC+NOx	Limite des émissions de la famille
Engine displacement	XXX cc	Cylindrée
Exhaust emission control system:		Système de contrôle des Émissions
Spark plug type	NGK	Type de bougie
Spark plug gap	XX mm	Écartement des électrodes
Power	XX kw	Puissance

smo2006-002-014_a

Label 17

 **DANGER**



Carbon monoxide (CO) can cause brain damage or death.

Engine and generator exhaust contains odorless and colorless carbon monoxide gas.

Carbon monoxide *will* be around the back of the boat when engines or generators are running.

Move to fresh air if you feel nausea, headache, dizziness, or drowsiness.

204901626

Imo2007-002-002

Label 18

UNDERWAY SEATING POSITIONS

MAXIMUM PERSONS



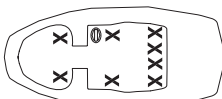

F23L04Y

IDENTIFICATION NUMBERS

The main components of the boat (hull and engines) are identified by different serial numbers. It may sometimes become necessary to locate these numbers for warranty purposes or to trace the boat in the event of theft.

Hull

The Hull Identification Number (H.I.N.) is located on the right side of the transom.



1. Hull Identification Number (H.I.N.)

Engines

The Engine Identification Number (E.I.N.) is located on the upper crankcase on MAGNETO side of each engine.



1. Engine Identification Number (E.I.N.)

CONTROLS, COMPONENTS AND INSTRUMENTS

NOTE: Some controls/instruments/equipment do not apply or are optional on some models. In these cases their reference numbers are deliberately missing in the illustrations.

Overview

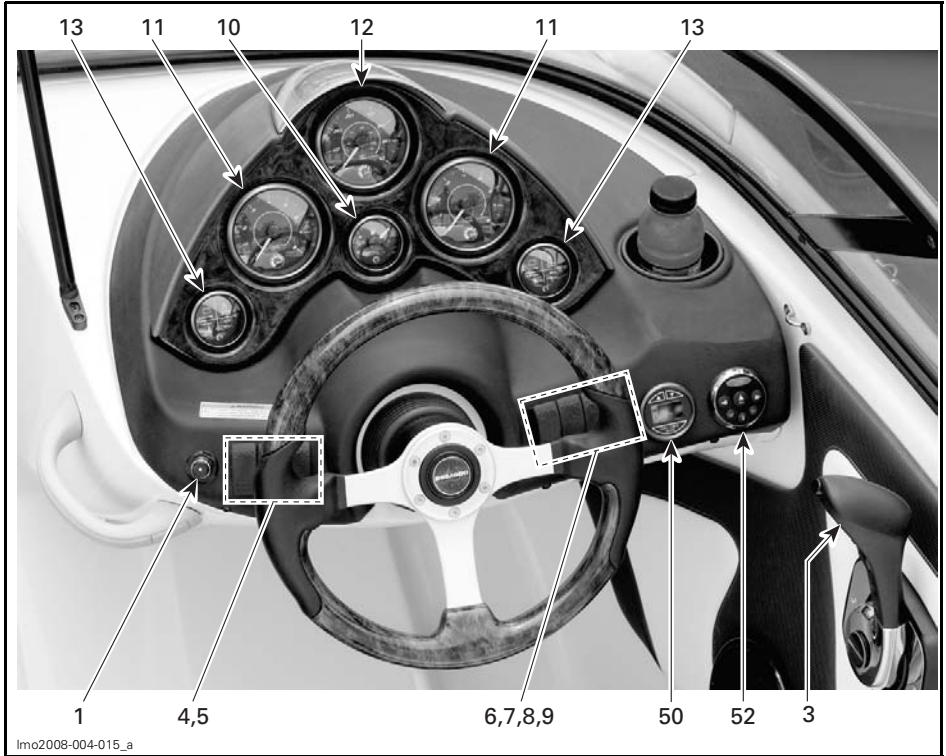

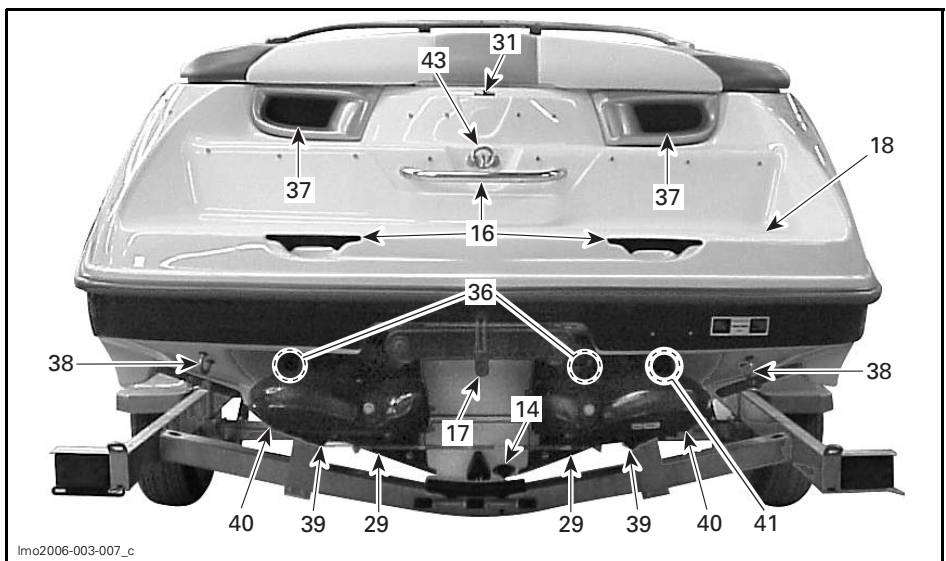
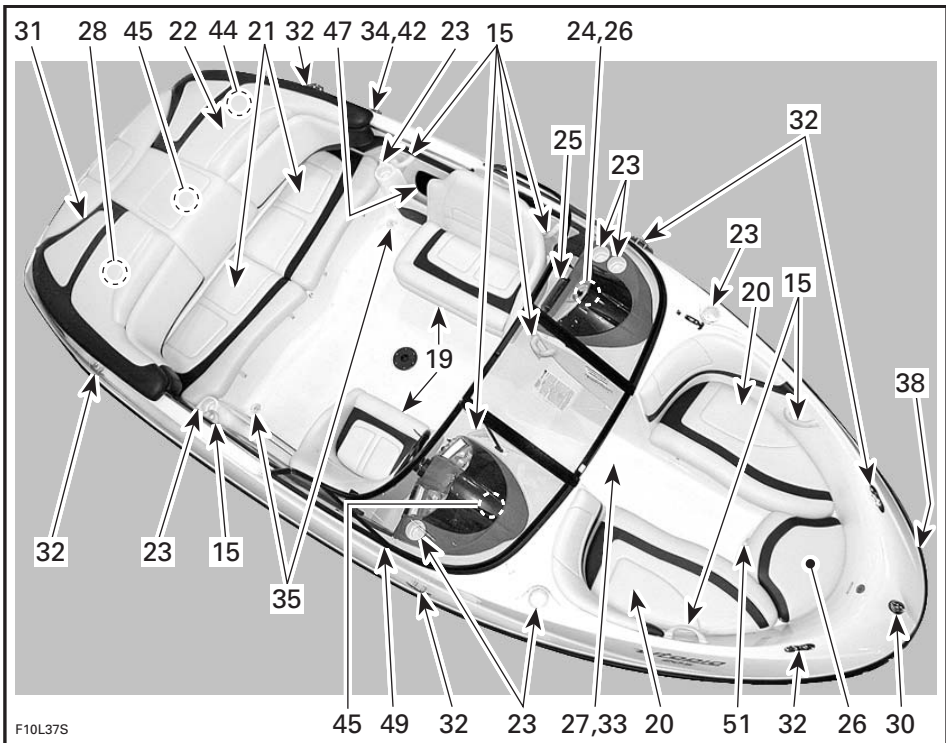

TYPICAL — REAR VIEW



1. DESS Post (engine cut-out switch)
2. Steering Wheel
3. Throttle/Shifter Controller
4. Start/Stop Switches
5. Bilge Air Blower Switch
6. Bilge Pump Switch
7. Navigation Lights Switch
8. Deck Lights Switch
9. Horn Switch
10. Fuel Gauge
11. Tachometers
12. Speedometer
13. Monitoring Gauges
14. Bilge Drain Plugs
15. Grab Handles
16. Rear Grab Handles
17. Ladder
18. Swim Platform
19. Driver/Passenger Seats
20. Bow Seats
21. Rear Seats
22. Sun Deck
23. Cup Holders
24. Glove Box
25. AM/FM Radio/CD Player
26. 12-Volt Accessory Jack
27. Deck Storage Compartment
28. Rear Storage Compartment (engine cover)
29. Jet Pump Water Intakes
30. Bow Lights
31. Stern Light Socket
32. Mooring Cleats
33. Deck
34. Fuel Tank Cap
35. Deck Drain
36. Flushing Connectors
37. Ventilation Ducts
38. Bow/Stern Eyelets
39. Jet Pump Nozzles
40. Reverse Gates
41. Scupper Valve
42. Fuel Tank Vent
43. Water Sport Towing Attachments
44. Main Battery Cut-Off Switch
45. Fuses
46. Bimini Top
47. Side Panel/Tray Storage
48. Cockpit Table
49. Windshield
50. Depth Finder
51. Deck Lights
52. AM/FM Radio/CD Player Remote Control

1) DESS™ Post (engine cut-out switch)

WARNING

Always use the safety lanyard when operating your boat to help prevent a runaway boat and reduce the risk of personal injury or death. Remove the DESS key when stopped to help prevent accidental starting.

The DESS key should be securely snapped onto the Digitally Encoded Security System (DESS) post to allow engine starting.

Two short beeps should sound indicating the system is ready to allow engines starting. Otherwise, refer to *TROUBLESHOOTING* section for the *MONITORING SYSTEM CODED SIGNALS*.

Pulling the key from the DESS post stops engines.

WARNING

Should the DESS key become loose or fail to remain on DESS post, replace it immediately.

Always attach the safety lanyard to the operator's Personal Flotation Device and snap the key to the DESS post to be able to start each engine.

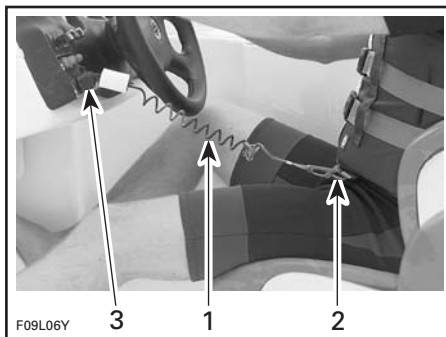

TYPICAL

1. Safety lanyard
2. Secure lanyard clip to PFD
3. Snap key to DESS post

WARNING

Directional control is reduced when throttle is decreased and lost when engine is off. Always remove DESS key when boat is not in operation.

WARNING

Do not lubricate the DESS post.

WARNING

While the engines can be stopped using the start/stop switches, good driving habits recommend that the DESS key also be disconnected when stopped.

Additional Information on the Digitally Encoded Security System (DESS)

The DESS key contains an electronic circuit that gives it a unique electronic serial number.

To have additional DESS keys programmed for your boat, refer to an authorized Sea-Doo Sport Boats dealer.

If the engines are stopped with the start/stop switches while the key remains on the DESS post, they can be restarted anytime by only pressing the start/stop switches during a period of approximately 10 minutes while the system remains under power. After this delay, it is necessary to remove and reinstall the key on the DESS post.

2) Steering Wheel

The steering wheel controls the direction of the boat. Turning the steering wheel clockwise steers the boat to the right and inversely.

3) Throttle/Shifter Controller

This is a 3-position lever.

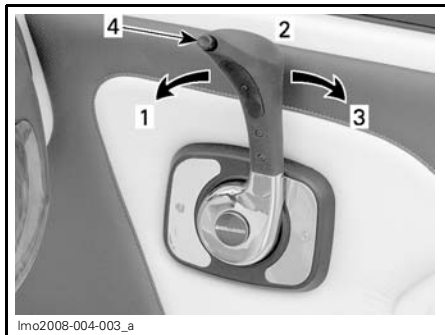

TYPICAL

1. Forward
2. Neutral
3. Reverse
4. Release button

CAUTION: Always push controller release button before shifting.

When pushed forward, the boat accelerates. When fully pulled into a vertical position, engines return to idle speed and the boat is gradually stopped by water drag.

To obtain reverse, gradually pull lever backwards. The reverse gate will be in downward position, directing all the thrust toward the front of the boat.

WARNING

Only use reverse at slow speed and for the shortest time possible. Always ensure the path behind is clear of objects and persons including children playing in shallow water.

CAUTION: Never rev the engine at high RPM in reverse.

4) Start/Stop Switches

Dual function START/STOP switches. Used to start as well as to stop engines.

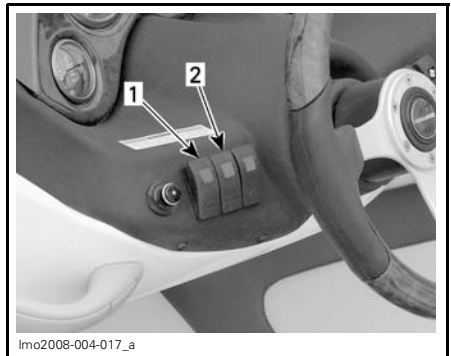

TYPICAL

1. For port engine
2. For starboard engine

Starting

WARNING

Engine exhaust fumes contain carbon monoxide (CO) which can accumulate in and around the boat (under bimini top, in cockpit, etc.). CO can be harmful or fatal if inhaled. Assure there is adequate ventilation whenever running engine(s).

Throttle/shifter controller must be in neutral position and the DESS key must be on the DESS post to allow starting engines.

To start engines, press and hold each switch. Release immediately after each engine is started. Proceed the same way for the other engine. Only one engine at a time can be started.

Stopping

WARNING

While engines can be stopped by pressing the start/stop switches, we strongly recommend stopping the engines by removing the DESS key. This will instill good habits.

Pressing either switch when engines are running will stop that engine.

WARNING

Directional control of the boat is not available when engines are stopped.

5) Bilge Air Blower Switch

A 2-position OFF/ON switch.

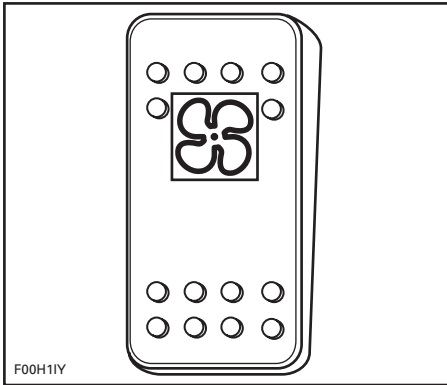

BILGE AIR BLOWER SWITCH

When turned on, the blower ventilates the engine compartment.

WARNING

Gasoline vapors can explode, resulting in injury or death. Always use blower for a minimum of 5 minutes before starting engine and turn it OFF above idle speed. Use of the bilge blower should never replace "smelling" for gasoline vapors.

CAUTION: Using the bilge blower for a prolonged time when the engines are not running will discharge the battery.

Blower should be turned off during boat operation.

6) Bilge Pump Switch

A 2-position OFF/ON switch.

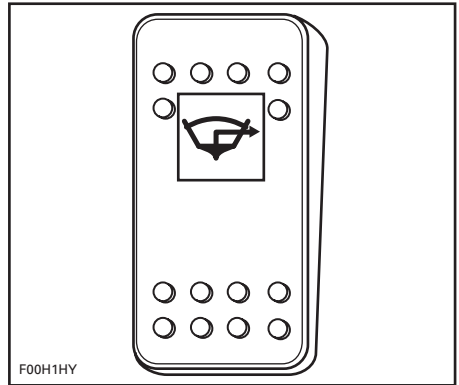

BILGE PUMP SWITCH

Turn to ON position when a manual operation of the bilge pump is required (after cleaning, storage, etc.).

Turn switch to OFF when finished.

CAUTION: Do not operate for a prolonged time if the bilge is dry: battery drainage will occur and pump will be damaged.

The bilge pump may be operated without the DESS key on its post.

CAUTION: Always turn pump OFF when bilge is dry or before operating the engines above idle. Bilge pump will then switch to automatic mode.

Automatic Bilge Pump

An automatic bilge pump evacuates water from the bilge. A water sensor detects the water, activating the pump. After the water is pumped out, the pump shuts-off automatically. This automatic mode is working at all times: with/without DESS key on its post and with/without engines running.

CAUTION: When the main battery cut-off switch is turned OFF while boat is moored, the bilge pump will start if water comes up in the bilge.

7) Navigation Lights Switch

A 3-position NAV/OFF/ANC switch.

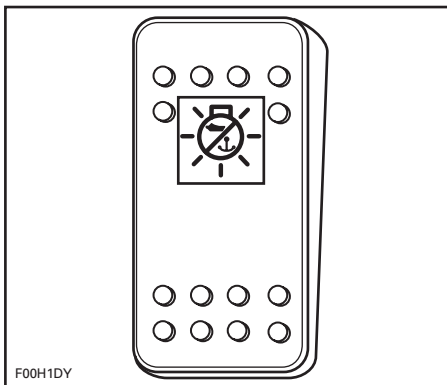

NAVIGATION LIGHTS SWITCH

ANC: Turns on the anchorage light when the boat is anchored. Only the stern light is lit.

OFF: Turns off all lights.

NAV: Turns on both bow and stern lights and illuminates the gauges.

WARNING

Navigation lights should always be used between sunset and sunrise. Ensure the stern light is installed. See *STERN LIGHT SOCKET* in this section for location and installation.

8) Deck Lights Switch

A 2-position OFF/ON switch.

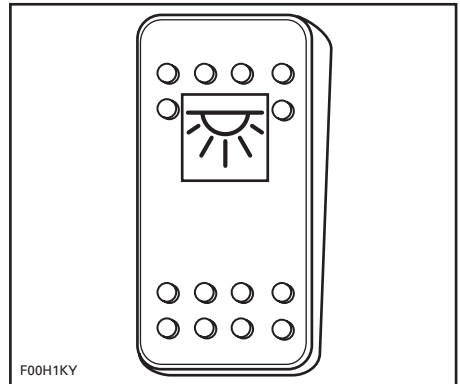

DECK LIGHTS SWITCH

Press switch to ON position to turn on the deck lights.

Press switch to OFF position to turn off the deck lights.

CAUTION: Using the deck lights for a prolonged time when the engine is not running will discharge the battery.

9) Horn Switch

A 2-position push type switch.

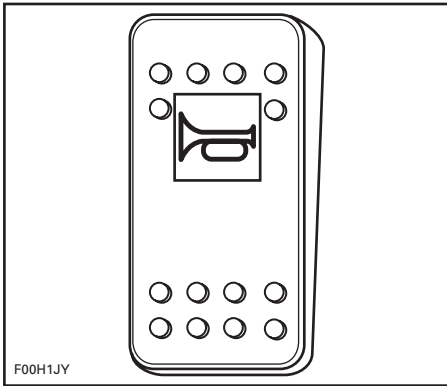

HORN SWITCH

Press and hold the switch to activate the horn.

Release the switch to stop horn.

10) Fuel Gauge

Located in dashboard, this gauge continuously indicates the amount of fuel left in fuel tank when engines are running.

The gauge is illuminated whenever the navigation lights are used.

The fuel level can also be verified without having engines running. With the safety lanyard removed from the DESS post, push either start/stop switch; the gauge will be activated for approximately 30 seconds.

11) Tachometers

The tachometers indicate the revolutions per minute (RPM) of the engines. Multiply reading by 1000 to obtain actual RPM.

The gauges are illuminated whenever the navigation lights are used.

12) Speedometer

The speedometer indicates the speed of the boat in miles per hour (MPH) and kilometers per hour (km/h).

The gauge is illuminated whenever the navigation lights are used.

13) Monitoring Gauges

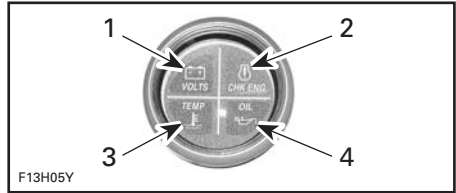

TYPICAL

1. Battery
2. Engine
3. Temperature
4. Oil

Low Battery Warning Light

Before the battery becomes too discharged to start the engines, the volts indicator light will come on.

When the indicator light is on, you should discontinue all use of electrical accessories immediately and start the engine(s) in order to recharge the battery.

Check Engine Light

When the ECM detects a fault code, the check engine light will come on and a beep may sound.

Turn engine(s) off. Wait one (1) minute. Restart engine(s). If light(s) remains lit, take boat to nearest authorized Sea-Doo Sport Boats dealer for servicing.

Engine Temperature Light

CAUTION: If the temperature indicator light comes on, stop engine(s) as soon as possible.

Turn off engine as soon as possible. Check oil level(s) and refill.

Check coolant levels. Refer to *LIQUIDS*. If engine(s) still overheats, continue the following procedure.

Perform *JET PUMP WATER INTAKE AND IMPELLER CLEANING* procedure described in *SPECIAL PROCEDURES*.

When back to shore, flush exhaust cooling system. Refer to *POST-OPERATION CARE*.

Restart the engine(s). If this does not correct the situation, do not run the engine(s) further. Refer to an authorized Sea-Doo Sport Boats dealer for servicing.

CAUTION: Running engine(s) with low oil pressure may severely damage the engine(s).

Oil Pressure Light

The oil light turns on when the oil pressure is low or high in the engine(s). Check oil as soon as possible. If lamp remains ON contact an authorized Sea-Doo Sport Boats dealer.

CAUTION: Never run engines out of oil. Serious engine damage will occur.

14) Bilge Drain Plugs

Once boat is on trailer, unscrew the drain plugs, block the wheels and raise the bow slightly with the trailer jack (if so equipped) to allow water to drain.

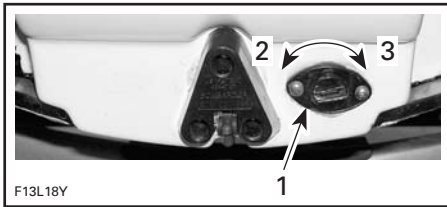

- TYPICAL**
1. Drain plug
 2. Loosen
 3. Tighten

15) Grab Handles

Grab handles provide a handhold for the passengers.

Although grab handles are provided, never perform maneuvers that place a passenger or the driver at risk for being ejected or thrown out of their seat.

CAUTION: Never use the grab handles to pull anything or to lift the boat.

Refer to components location illustrations at the beginning of this section for grab handle locations.

16) Rear Grab Handles

Provide a handhold for boarding when needed.

CAUTION: Never use the grab handle to tow anything or to lift the boat.

17) Ladder

⚠ WARNING

Engines should be OFF when using ladder. Keep limbs away from jets or intake grates. Only one person at a time on the ladder. Never use the ladder for pulling, towing, diving or jumping, boarding a boat that is out of the water or any other purpose other than a ladder.

Located under the swim platform, the ladder conveniently helps in reboarding the boat.

Pull latch to release the ladder.

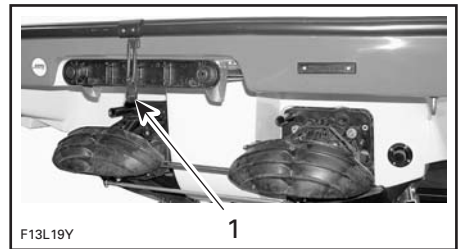

- TYPICAL**
1. Latch

Slide ladder toward rear, then push down.



TYPICAL — LADDER LOWERED

To store ladder, lift horizontally, slide toward front and secure latch.

CAUTION: In order to avoid damage to the ladder, they should not be used when the boat is out of the water.

18) Swim Platform

Provides an anti-skid surface for easy boarding from the rear of boat.

WARNING

Engines must be off when using swim platform. Keep away from jets or intake grates.

19) Driver/Passenger Seats

Each passenger should be seated while underway.

WARNING

Allow no one to sit on edge of the boat or to stand up while in operation. Seat/grab handles should be used in rough waters.

Swivel Adjustment

Both seats can swivel.

Pull and hold lever to swivel seat.

Release lever after adjustment is completed.

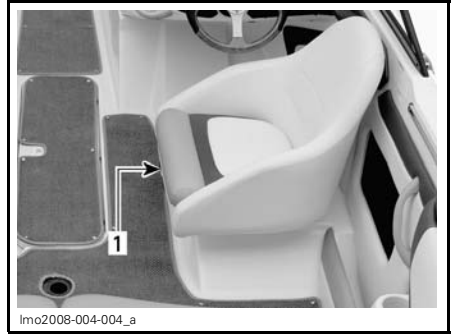

TYPICAL — PULL AND HOLD LEVER
1. Lever



TYPICAL — SWIVEL SEAT

WARNING

Always ensure drivers seat swivel is locked so that seat faces steering wheel before riding.

Forward and Backward Adjustment

Driver seat is adjustable forward and backward.

Push and hold lever down to unlock seat.

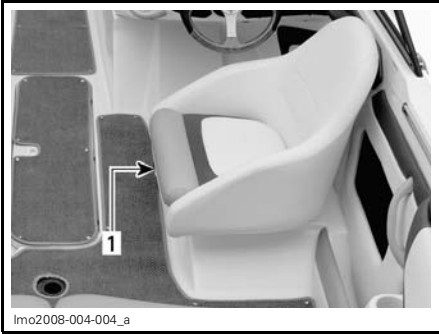

TYPICAL — PUSH AND HOLD LEVER
1. Lever

Move seat at the desired position.

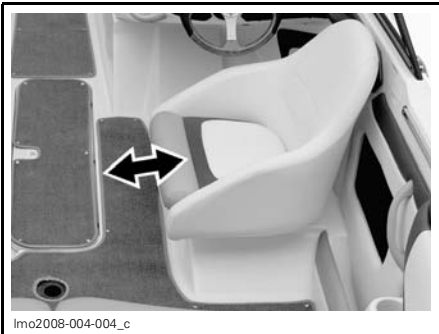

TYPICAL — ADJUST SEAT

Release lever after adjustment is completed.

20) Bow Seats

⚠ WARNING

Avoid serious or fatal injury. Do not occupy seat when speed exceeds 5 MPH.

⚠ WARNING

Never leave breakable objects in storage compartments. Never operate the boat with storage compartment covers opened.

Port and Starboard Seat Storage Compartment

Separate storage compartments are located under port and starboard cushions.

Release snaps, lift cushion up and away from position.

To reinstall seat, position L-bracket first, push seat down and fasten snaps.



TYPICAL
1. L-bracket

Center Seat Storage Compartment

Located under the forward bow cushion with storage for anchor and line.

Release snaps, lift cushion up and away from position.

To reinstall seat cushion, ensure to position L-bracket first then push seat down to snap into place.



1. L-bracket

21) Rear Seats

Each passenger should be seated while underway.

WARNING

Allow no one to sit on edge of the boat or to stand up while in operation. Seat/grab handles should be used in rough waters.

Storage Compartment

WARNING

Never leave any heavy or breakable objects in storage compartments. Never operate the boat with storage compartment covers opened.

Separate storage compartments are located under port and starboard cushions.

Release snaps, lift cushion up and away from position.

To reinstall seat, position L-bracket first, push seat down and fasten snaps.



TYPICAL
1. L-bracket

22) Sun Deck

A convenient space to rest or sunbathe while anchored.

WARNING

Do not start or operate the boat if a person is seated on the sun deck.

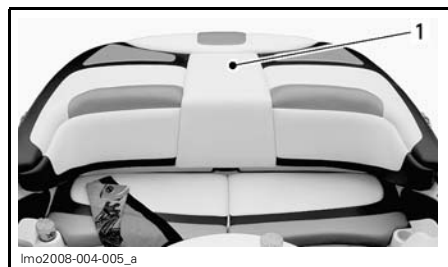

TYPICAL
1. Sun deck

23) Cup Holders

Convenient locations for non-alcoholic beverages.

WARNING

Do not drink alcoholic beverages while aboard. Do not keep bottles, cans etc. in cup holders while riding at speed and/or on rough water.

24) Glove Box

Convenient lockable storage location for carrying small personal articles.

NOTE: Always relatch glove box before operating boat.

WARNING

Never operate the boat with the glove box cover open.

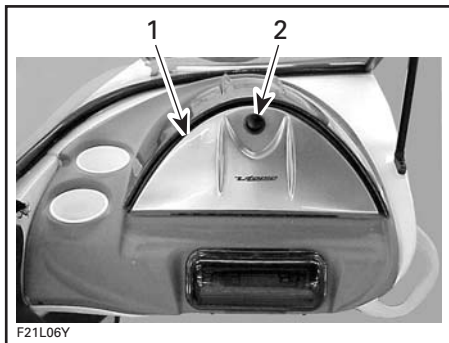

1. Glove box
2. Push button

25) AM/FM Radio/CD Player

Refer to manufacturer's guide for complete explanation of features and controls.

CAUTION: Using the AM/FM radio/CD player for a prolonged time without engines running may discharge the battery.

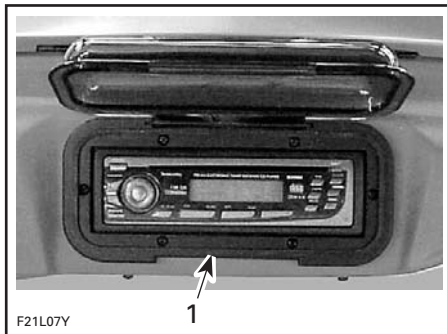

TYPICAL

1. AM/FM Radio/CD Player

26) 12-Volt Accessory Jack

A 12-volt jack is provided to power temporary accessories such as a cellular phone or other 12-volt portable devices.

CAUTION: Close protective cap when jack is not in use to protect against weather.

CAUTION: Using the radio or other 12-volt portable devices for a prolonged time without engine running may discharge the battery.

27) Deck Storage Compartment

The deck storage compartment is a convenient location for water-skis, paddles, anchor and rope, etc.

WARNING

Never leave any heavy or loose breakable objects in the deck storage compartment. Never operate the boat with the deck storage compartment cover open.

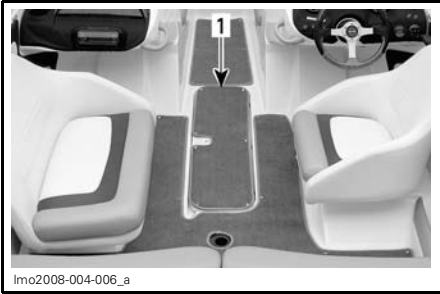

1. Deck storage compartment

Lift the latch ring and open cover gently until stopped by retaining spring.

When completely opened, the cover remains in that position on calm water.

To close, gently push on the side of the spring, gently release it and lower the cover.

Always close deck storage compartment cover before getting underway.

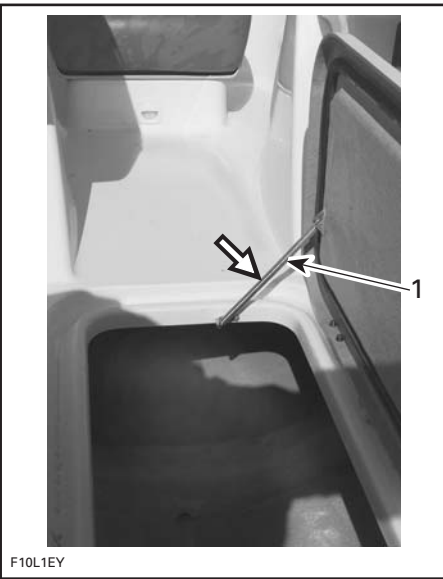

F10L1EY

TYPICAL

1. Gently push here to release the spring

28) Rear Storage Compartment (engine cover)

Convenient rear storage location for carrying large personal articles. Ideal location for spare Personal Flotation Device (PFD), towels, lunch etc.

CAUTION: In order to avoid damage, **MAXIMUM LOAD** on storage tray must not exceed 22.5 kg (50 lb).

Pull latch to open engine cover.

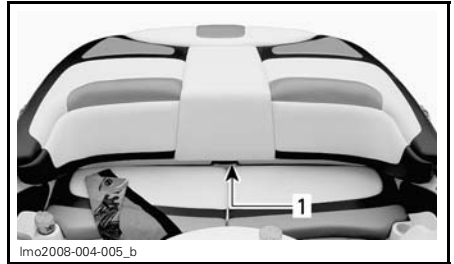

1. Latch

The gas assist cylinders will ease opening and hold engine cover open.

WARNING

Never leave any heavy or breakable objects in the storage compartment. Never operate the boat with the rear storage compartment cover open.



lmo2008-004-007_a

STORAGE COMPARTMENT

CAUTION: Always ensure rear storage compartment lid is closed and securely fastened before trailering.

Storage Tray

The storage tray can be lift and secured to engine cover, allowing access to the engine compartment.

Grab the handle and lift in a rearward movement.



STORAGE TRAY

1. Handle

Secure tray to engine cover using strap.



REAR STORAGE COMPARTMENT

1. Engine cover opened

WARNING

When storage tray is lifted or removed, never touch any electrical part when starting engines or while in operation. Never leave any object, rag, tool, etc., in the engine compartment or in the bilge.

29) Jet Pump Water Intakes

Water is drawn up by the impeller through these openings, minimizing entry of foreign objects into the propulsion system.



TYPICAL — BOTH SIDES

1. Jet Pump Water Intakes

WARNING

Keep away from intake grates while engine(s) is/are on. Items such as long hair, loose clothing or personal flotation device straps can become entangled in moving parts resulting in severe injury or drowning.

30) Bow Lights

Mandatory red and green lights. See *NAVIGATION LIGHTS SWITCH* as mentioned earlier in this section.

31) Stern Light Socket

Stern Light

Mandatory white stern light (white).

It is recommended to keep it in its storage compartment at all times except when needed.

To remove from storage cover, pull it out. Snap in place to store again.

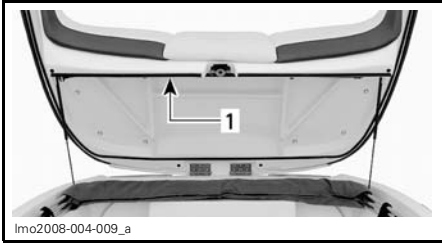

TYPICAL — STERN LIGHT LOCATION

CAUTION: Using the stern light for a prolonged time when the engine is not running will discharge the battery.

Stern Light Installation

- Lift connector cap.
- Insert post in connector hole. Ensure to align hole keyway with post screw head.
- Firmly push downward to engage terminals.
- Push lock ring downward. Turn until locked. It may be necessary to slightly turn it to allow its insertion in the hole.
- Check light operation. See *NAVIGATION LIGHTS SWITCH* as mentioned earlier in this section.

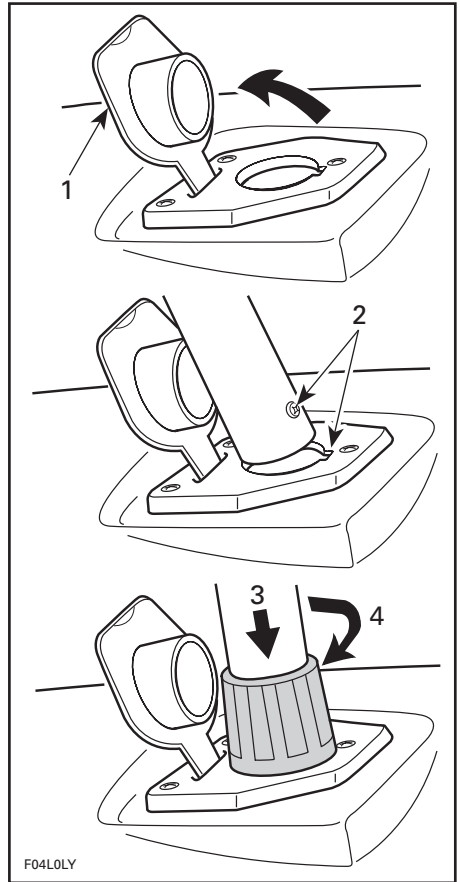

TYPICAL

1. Lift
2. Align screw in groove
3. Push downward
4. Turn to lock

CAUTION: Ensure dielectric grease is present in connector area of light to prevent corrosion.

Removal and storage of light is the reverse of installation.

32) Mooring Cleats

When mooring to a dock, it is recommended to secure with both front and rear cleats. The use of dock lines with sealed air fenders is recommended to protect your boat.

CAUTION: Never use mooring cleats to pull anything or to lift the boat.

33) Deck

Flat surface of boat, deck should be kept clean and clear.

34) Fuel Tank Cap

Unscrew the cap counterclockwise to allow fuel tank filling. Fully tighten when finished.

WARNING

Never use a lit match or open flame to check fuel level.

WARNING

Always stop the engines before refueling. Fuel is flammable and explosive under certain conditions. Always work in a well ventilated area. Do not smoke or allow open flames or sparks in the vicinity. Fuel tank may be pressurized. Slowly turn cap when opening. Never use an open flame to check fuel level. When fueling, keep boat level. Do not overfill or top off the fuel tank and leave boat in the sun. As temperature increases, fuel expands and might overflow. Always wipe off any fuel spillage from the boat. Periodically verify fuel system.

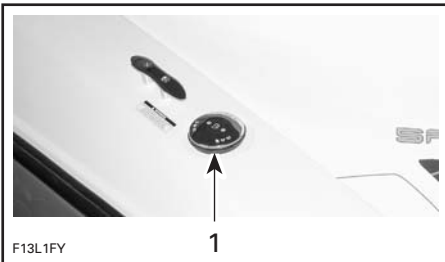

1. Fuel tank cap

35) Deck Drain

Deck drain provides drainage of water from rain, deck washing, water splashing, etc.

Keep clean to avoid clogging.

36) Flushing Connectors

Refer to *STORAGE AND PRESEASON PREPARATION* section for proper use.

NOTE: Each engine is provided with a flushing connector located on the jet pump support. Port connector is for port engine and starboard connector is for starboard engine.

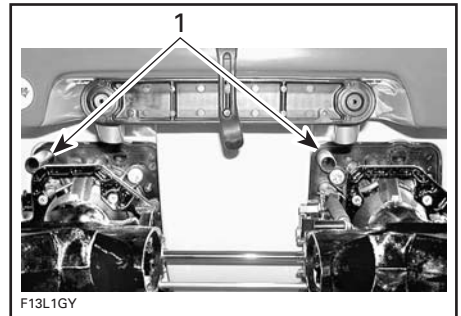

TYPICAL

1. Flushing connectors

37) Ventilation Ducts

The ventilation ducts allow air to flow to ventilate engine compartment and supply air to engine. Never obstruct ventilation ducts.

38) Bow/Stern Eyelets

Bow Eyelet

Eyelets can be used for mooring, towing and as a tie-down point during transportation.



1. Bow eyelet

Stern Eyelets

Eyelets can be used for mooring, towing and as a tie-down point during transportation.

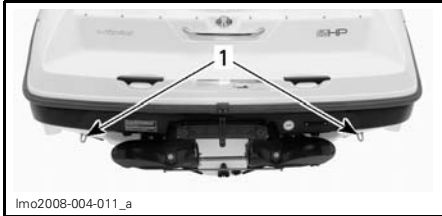

1. Stern eyelet

39) Jet Pump Nozzles

Jet pump nozzles provide directional control of boat when engines are running, turning side to side via input from the steering wheel.

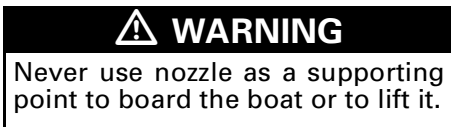

Refer to *PROPULSION* under *PRINCIPLE OF OPERATION*.

40) Reverse Gates

When selecting the neutral or reverse position with the throttle/shifter controller, the reverse gates move up or down, obtaining the desired position.

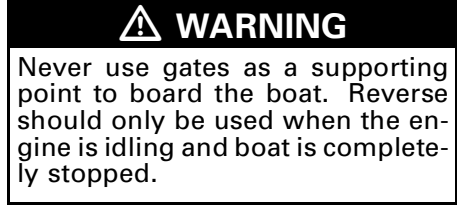

41) Scupper Valve

Location where water drains out from the deck. Keep clean to avoid clogging.

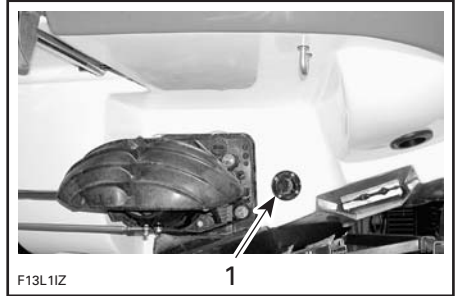

TYPICAL
1. Scupper valve

42) Fuel Tank Vent

The fuel tank vent is located in the fuel tank cap and allows fuel vapors and pressure to escape from fuel tank.

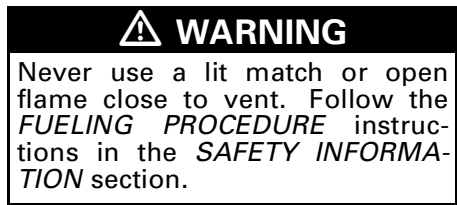

43) Water Sport Towing Attachments

Please read and often refer to *WATER SPORTS* information in the *SAFETY INFORMATION* section at the front of this guide.

WARNING

“Teak Surfing” is extremely dangerous to participants due to their proximity to the rear of the boat where direct contact with the exhaust fumes from the boat engine is the highest. Carbon monoxide poisoning can occur and result in mental disorientation, dizziness, drowsiness, and loss of consciousness. The combination of carbon monoxide exposure and non-use of a life jacket (PDF) make this new water recreation activity an incredibly dangerous and potentially deadly sport.

WARNING

When pulling a tube, skier or wakeboarder, always have an observer, proceed with only as much speed as required, and follow the observer's instructions.

WARNING

Pulling a tube, skier or wakeboarder makes the boat handle differently and requires greater skill. Unless absolutely necessary, do not make tight, sharp turns. Keep a safe distance from the docks, swimmers, other craft or objects. Be advised that serious injury can result if the tow rope becomes slack during a tight turn or when circling. The rope could become wrapped around the neck or limbs of a person.

Tow Hook

Used to pull skiers and other appropriate water toys.



1. Tow hook

CAUTION: Never use the tow hook to tow any other craft.

Towing Tower

If So Equipped

The towing tower is for skiing/wakeboarding.

CAUTION: Towing tower **MUST** be fastened in the upright position to avoid damage to the boat and towing vehicle while in transport or water operation.

NOTE: For the complete tower removal procedure from boat, refer to an authorized Sea-Doo Sport Boats dealer.

To Raise Tower for Transport and Use

Lift support arms from their storage positions and secure with previously removed knobs.

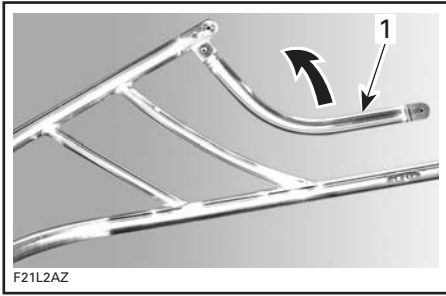

1. Support arms

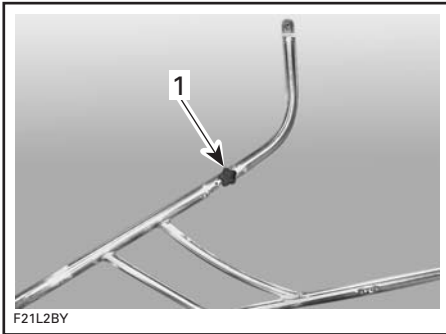

1. Secure with knob

Lift tower from its storage position.

With one person at center holding tower, install and secure port and starboard support arms to tower using previously removed knobs.

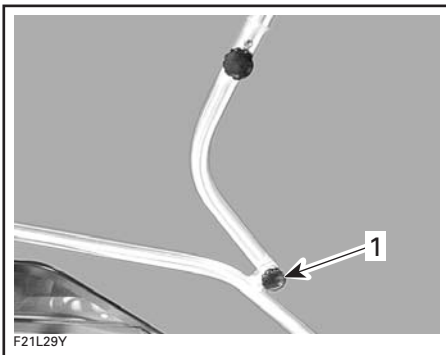

1. Secure with knob

Tower is ready for use or transport.

To Lower Tower for Storage

NOTE: To lower tower will require 2 people.

Remove knob from each side of tower.

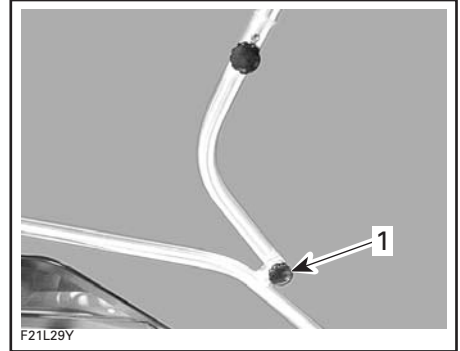

1. Remove this knob

Carefully fold tower forward until storage pad is in contact with bow.

Remove knobs from curved extensions on each side of tower.

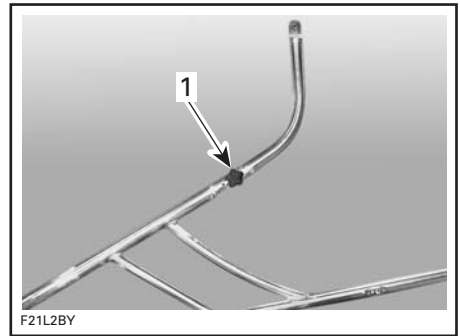

1. Remove this knob

Lower both supports arms into position show below.

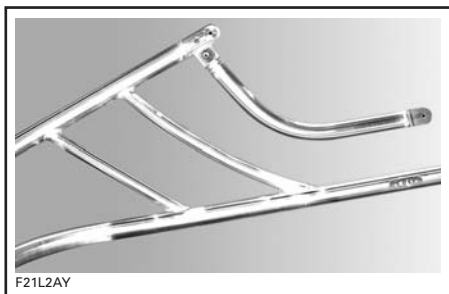

Place knobs in glove box or other secure storage for later use.

44) Main Battery Cut-Off Switch

This switch allows a complete power cut-out of the electrical system.

This switch is located in the rear storage compartment.



1. Main battery cut-off switch

When in OFF position, ALL electrical equipment and electronics will be OFF **except** bilge pump. The bilge pump will operate automatically with the battery switch on the OFF position.

Switch must be in the ON position to allow the use of electrical components and to start the engines.

CAUTION: Stop engines before switching to the OFF position.

It is recommended to set this switch to the OFF position whenever performing maintenance in the engine compartment, on the electrical system, for transportation or during short term storage.

CAUTION: When the main battery cut-off switch is turned OFF while boat is moored, the automatic bilge pump will start if water comes up in the bilge.

45) Fuses

The electrical system is protected with fuses. Refer to *MAINTENANCE INFORMATION* section for details.

46) Bimini Top

The bimini top is convenient for protection against inclement weather or sunshine.

⚠ WARNING

- Avoid body contact with bimini top.
- Hold down straps are under tension.
- Do not use bimini top as a support.
- Operate boat only at low speeds if bimini top is in use.
- Top can break or dislodge causing a risk of personal injury or interference with boat operation.

Opening Bimini Top

Lift rear storage compartment cover.

Slightly raise bimini top above engine storage compartment and slide all the way to front of side rails.



TYPICAL
1. Bimini pivot base pulled forward on rail

Unzip cover and remove. Store cover in a storage area.

Detach straps from bimini top frame.

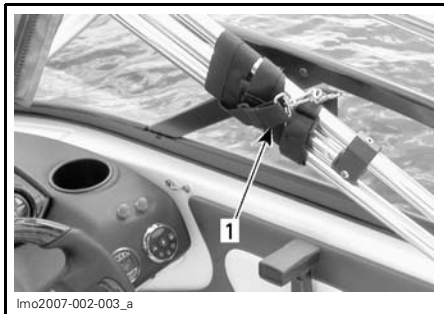

TYPICAL
1. Strap

Lift bimini top to vertical position and connect front straps to eyelets on body of boat.

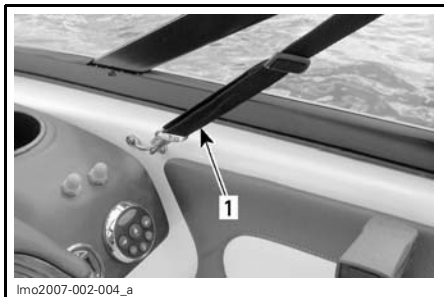

TYPICAL
1. Hook strap to body eyelet

Pull canvas back and fasten rear straps to eyelets on body of boat.



TYPICAL
1. Hook strap to body eyelet

Adjust strap tension as needed.

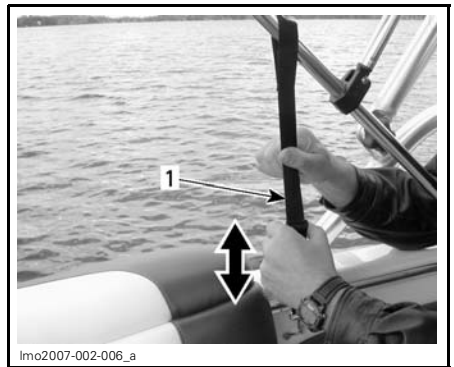

TYPICAL
1. Adjust strap accordingly

Close sun pad lid.

Closing/Storing Bimini Top

NOTE: If canvas of bimini top has been splashed by salt water, rinse canvas with cold fresh water. At any time when canvas is wet, let dry before installing cover and storage.

Open rear storage compartment cover.

Unhook rear straps.

Unhook front straps.

Before laying the bimini top down, hold the top/front tube and pull the second and third tubes toward the top/front tube.

Tilt bimini top back towards storage compartment.

Position the protective cover so that the zipper will be on the inner side of the bimini top and the starting end of the zipper will be on starboard side of boat.

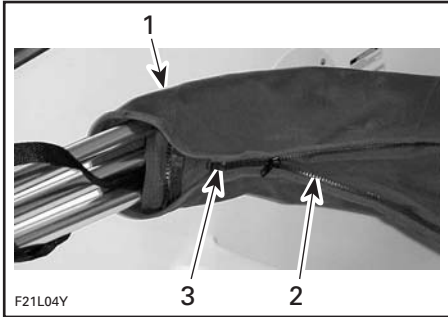

- TYPICAL**
1. Bimini top at rear storage compartment area
 2. Inner side of zipper
 3. Start of zipper

Place bimini top straps inside cover and slowly zip while packing canvas inside cover.

Slide bimini top to the rear of side rail to store bimini top underneath rear storage compartment cover.

Close rear storage compartment cover.

Removing Bimini Top from Boat

If it becomes necessary to remove bimini top from boat, proceed as follows:

Open rear storage compartment cover.

Remove fasteners at pivot point.

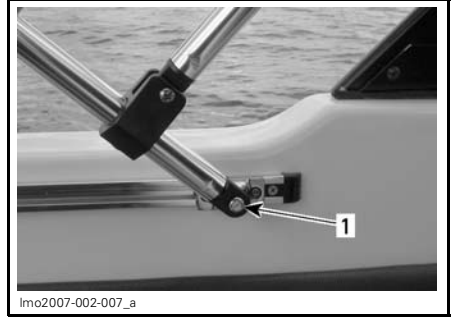

- TYPICAL**
1. Remove fasteners

With assistance, carefully lift bimini top and remove.

Reinstall pivot fasteners to prevent loss.

Installation is procedure in reverse, however, pay attention to bimini top orientation for proper positioning.

Close rear storage compartment cover.

47) Side Panel/Tray Storage

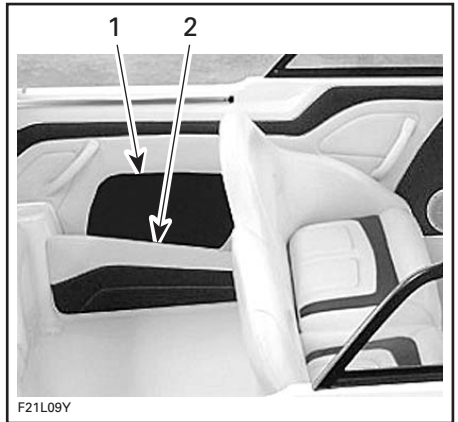

1. Side panel storage
2. Side tray storage

Located at the port and starboard sides of the boat, these storage areas provide quick, easy access for additional articles.

⚠ WARNING

Never leave any heavy or breakable objects in the storage compartment. Never operate the boat with the storage compartment cover open.

48) Cockpit Table

Conveniently stored atop the engine cover.



COCKPIT TABLE IN STORAGE POSITION

Swivel front seats into side-facing position.

Open rear storage compartment cover.

Unclip table post and place in floor receptacle. Twist gently to ensure proper fit.

⚠ WARNING

When front seats are in side facing position and table post is not installed, floor receptacle poses potential hazard. Use proper judgement.



- 1. Floor receptacle
- 2. Table post

Loosen bungee straps to remove table top, and connect with table post.



COCKPIT TABLE INSTALLED

Close rear storage compartment cover.

Cockpit Table Storage

Storage of cockpit table is the reverse of installation.

WARNING

Cockpit table must be properly stored before operating boat.

49) Windshield

For your convenience, a windscreen is provided to divert the air flow.

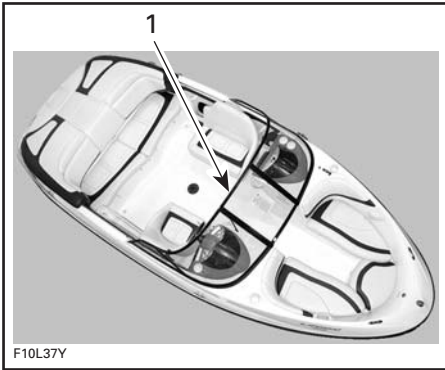

TYPICAL

1. Windshield

To open windshield door, unlock both latches then open door, as shown in the following photo.

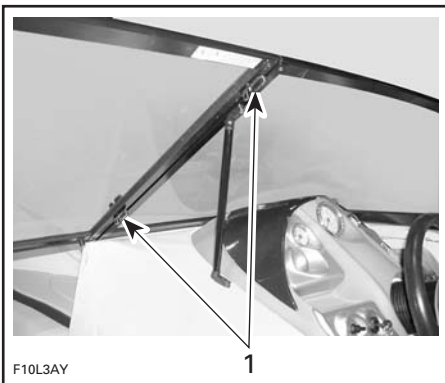

TYPICAL

1. Unlock both latches

50) Depth Finder

SE Models

A depth finder is included as standard equipment and is located on the dashboard.

Please refer to included *MANUFACTURER'S INSTRUCTION SHEET* for depth finder operation.

51) Deck Lights

Convenient lights to use between sunset and sunrise. These lights can assist passenger when boarding as well as creating a nice ambience.

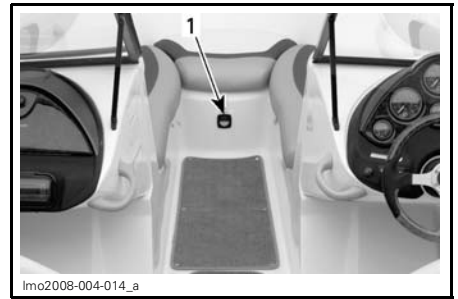

1. Deck light

CAUTION: Using the deck lights for a prolonged time when the engine is not running will discharge the battery.

52) AM/FM Radio/CD Player Remote Control

A remote control for the AM/FM Radio/CD Player is included as standard equipment and is located on the dashboard.



Imo2008-003-012

TYPICAL — RADIO REMOTE CONTROL

Please refer to included *MANUFACTURER'S INSTRUCTION SHEET* for remote control operation.

LIQUIDS

CAUTION: Carefully follow the instructions in this section. Failure to do so may reduce the life and/or performance of the engines.

Recommended Fuel

Use unleaded gasoline or oxygenated fuel containing a maximum total of 10% of ethanol or methanol or both. The gasoline used must have the following recommended octane number.

CAUTION: Never experiment with other fuels or fuel ratios. The use of unrecommended fuel can result in boat performance deterioration and damage to critical parts in the fuel system and engine components.

Inside North America

OCTANE NUMBER		
(87 (RON + MON)/2)		
(91 (RON + MON)/2)	▼	▼
ENGINES	91	87
310 HP Naturally-Aspirated	X	X

Outside North America

OCTANE NUMBER		
92 RON		
95 RON	▼	▼
ENGINES	95	92
310 HP Naturally-Aspirated	X	X

Recommended Engine Oil

310 HP Naturally-Aspirated Engines

Use SAE 10W 40 4-stroke motor oil meeting the requirements for API service classification SM, SL or SJ. Always check the API service label on the oil container, it must contain at least one of the above standards.

XP-S 10W 40 4-stroke oil (P/N 219 700 346) sold by authorized Sea-Doo Sport Boats dealers meets those requirements.

Synthetic Oil

A synthetic oil meeting the same requirements may be used.

The XP-S 5W 40 synthetic 4-stroke oil (P/N 293 600 039) is suitable.

Engine Oil Level

CAUTION: Check level frequently and refill if necessary. Do not overfill. Operating the engines with improper oil levels may severely damage engines. Wipe off any spillage.

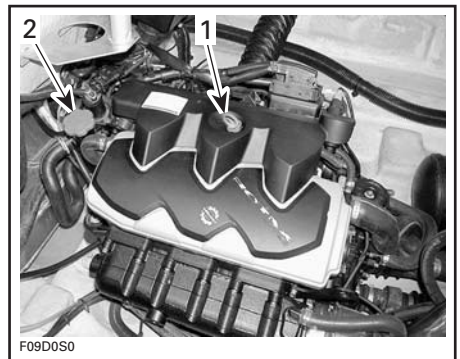

TYPICAL
1. Dipstick
2. Oil cap

Boat must be level.

Oil level can be checked either with boat in water or out of water.

If Boat Out of the Water

If the boat is out of the water and on a trailer, block the wheels and raise the bow slightly with the trailer jack (if so equipped) until the bumper rail is level.

Install a garden hose to the flushing connector. Refer to *EXHAUST SYSTEM FLUSHING* in *STORAGE AND PRESEASON PREPARATION* and follow the procedure.

CAUTION: Never run engine(s) without supplying water to the exhaust systems when boat is out of water. Failure to supply water to the exhaust systems may severely damage exhaust systems.

CAUTION: Never run engine(s) longer than 5 minutes. Drive line seals has no cooling when boat is out of water.

Procedure

NOTE: Procedure is the same for both engines.

It is of the utmost importance to follow this procedure in order to obtain an accurate reading of the engine oil level.

WARNING

Engine oil may be hot. Certain components in the engine compartment may be very hot. Direct contact may result in skin burn.

Ensure engine is at normal operating temperature.

Let engine **idle** for **30 seconds** before stopping.

Stop engine.

Wait at least 30 seconds.

Pull dipstick out and wipe clean.

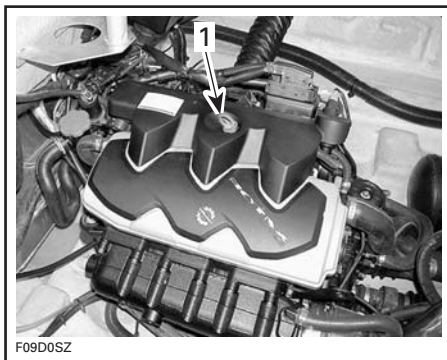

TYPICAL

1. Dipstick

Reinstall dipstick, push in completely. Remove dipstick and read oil level. It should be between marks.

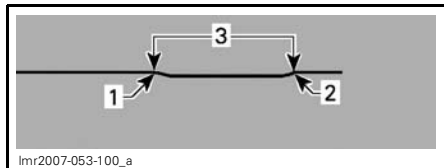

1. Full
2. Add
3. Operating range

Otherwise, add oil up to have the level between marks as required.

To add oil, unscrew oil cap. Place a funnel into the opening and add the recommended oil to the proper level.

Do not overfill.

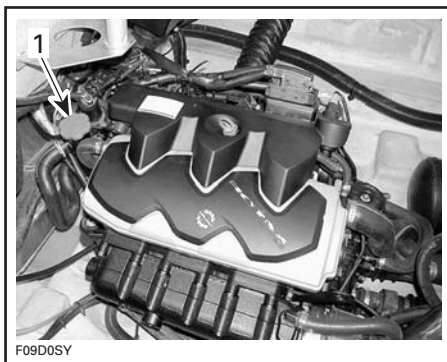

TYPICAL

1. Oil cap

NOTE: Every time oil is added in engine, the complete procedure explained above must be done. Otherwise, you will have a false oil level reading.

Properly reinstall oil cap and dipstick. Repeat procedure for the other engine.

Engine Coolant

Recommended Coolant

Always use ethylene-glycol antifreeze containing corrosion inhibitors specifically for internal combustion aluminum engines.

NOTE: When available, it is recommended to use biodegradable antifreeze compatible with internal combustion aluminum engines. This will contribute to protecting the environment.

Cooling system must be filled with water and antifreeze solution (50% water, 50% antifreeze).

BRP sells premixed coolant with freezing protection up to - 52°C (- 62°F) (P/N 219 700 362).

To prevent antifreeze deterioration, always use the same brand. Never mix different brands unless cooling system is completely flushed and refilled. Refer to an authorized Sea-Doo Sport Boats dealer.

Coolant Level

WARNING

Check coolant level with engine(s) cold. Never add coolant in cooling system when engine(s) is hot.

With boat on a level surface, liquid should be between MIN. and MAX. level marks of coolant reservoir when each engine is cold.



1. Level between marks when engine is cold

NOTE: The boat is considered level when it is in water. When boat is on a trailer, block the wheels and raise the bow slightly with the trailer jack (if so equipped) until the bumper rail is level.

Add coolant to have the level between marks as required. Use a funnel to avoid spillage. **Do not overfill.**

Properly reinstall and tighten filler cap.

NOTE: A cooling system that frequently requires coolant indicates leaks or engine problems. See an authorized Sea-Doo Sport Boats dealer.

BREAK-IN PERIOD

CAUTION: Carefully follow the instructions in this section. Failure to do so may reduce the life and/or performance of the engines.

With Sea-Doo Sport Boats powered by Rotax engines, a break-in period of 10 hours is required for each engine before continuous operation at full throttle.

To achieve a good break-in, throttle levers should not be advanced more than 3/4 opening, however, brief acceleration and speed variations contribute to a good break-in.

CAUTION: Continued wide open throttle runs and prolonged cruising without speed variations should be avoided. This can cause engine damage during the break-in period.

NOTE: Never add oil in fuel tank.

PRE-OPERATION CHECKS

WARNING

The pre-operation check is very important before operating the boat. Always check the proper operation of critical controls, safety features and mechanical components before starting. If not done as specified here, severe injury or death might occur. Bring all safety equipment required by local laws.

Some of the following items may not have been previously covered in this guide, however they will be described in the *MAINTENANCE INFORMATION* or *SPECIAL PROCEDURES* section. Please refer to these portions to have more detailed information.

WARNING

Engines should be off and the DESS key must always be removed from DESS post before verifying any of the following. Only start boat once all items have been checked and operate properly.

SUMMARY		
ITEM	OPERATION	✓
Hull	Inspect for damage.	
Jet pump water intakes	Inspect/clean.	
Bilge	Drain. Ensure plug is secured.	
Battery	Inspect tightness of cables and retaining straps and verify charge.	
Main battery cut-off switch	Ensure it is in the ON position.	
Navigation lights	Check operation.	
Fuel tank	Refill.	
Engine compartment	Verify fuel exhaust components.	
Fire extinguisher	Inspect condition/mounting.	
Steering	Check operation.	
Throttle/shifter system	Check operation.	
Bilge blower and bilge pump	Check operation.	
DESS post and engine start/stop switches	Check operation.	
Mandatory safety boating equipment	Check operation.	
Storage compartment covers	Ensure they are closed and latched.	
Engines oil level	Ensure proper level is in each engine. Refill as needed.	
Cooling system coolant level	Ensure proper level is in each engine. Refill as needed.	
Sacrificial anodes	Verify condition (replace when 50% corroded).	

Hull

Inspect hull for cracks or damage.

Jet Pump Water Intakes

Remove weeds, shells, debris or anything else that could restrict the flow of water and damage the cooling systems or propulsion units. Clean as necessary. If any obstruction cannot be removed, refer to an authorized Sea-Doo Sport Boats dealer for servicing.

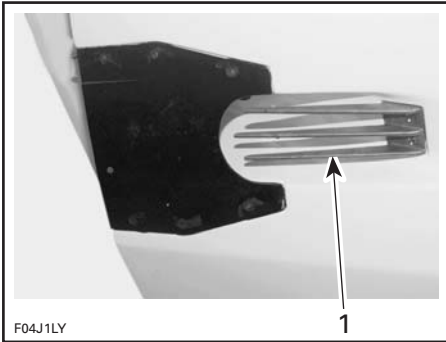

F04J1LY

TYPICAL
1. Inspect this area

Inspect leading edges of the impellers, for nicks or bends, which greatly reduce performance of the boat.

Bilge

If water is present in the bilge, turn on pump switch to empty the bilge.

When on a trailer, block the wheels, unscrew the drain plugs and raise the bow slightly with the trailer jack (if so equipped) so that water can flow out of the bilge.

⚠ WARNING

Make sure drain plug is properly secured before launching the boat in water.

Battery

⚠ WARNING

Verify tightness of battery cables to their posts and condition of retaining straps/fasteners. Do not charge or boost battery while installed in engine compartment.

Fuel Tank and Engine Oil Levels

With the boat level, fill the fuel tank.

Check the oil level in each engine and refill as necessary as per *LIQUIDS* section.

Check fuel tank retaining straps/fasteners.

Engine Compartment

⚠ WARNING

If any leaks or gasoline odors are present, do not start the engines. Consult an authorized Sea-Doo Sport Boats dealer.

⚠ WARNING

In order to avoid potential burns, do not remove the coolant reservoir caps if engines are still hot.

Fire Extinguisher

Make sure fire extinguisher is full, in good condition and well secured.

Steering System

Have another person help check steering operation for free movement. When the steering is centered, the jet pump nozzles should be in the straight ahead position. Ensure the jet pump nozzles pivot easily while steering is turned.

 **WARNING**

Check operation of steering and corresponding steering nozzles before starting engines.

Throttle/Shifter Controller

Check throttle/shifter controller for free and smooth operation.

 **WARNING**

Check operation of throttle/shifter controller before starting the engines.

Check that reverse gate moves freely. With throttle/shifter controller in forward position, the gates must be in upward position and locked. With the throttle/shifter controller in neutral position, gates must be in middle position. With throttle/shifter controller in reverse position, gates must be in downward position.

 **WARNING**

Verify the reverse gate lock.

To verify the reverse gate lock, move throttle/shifter controller to the FORWARD position.

Pull backwards on the starboard reverse gate.

The reverse gate lock is working if the reverse gate stays in the up position.

CAUTION: If the reverse gate does not stay in the up position when the throttle/shifter controller is at FORWARD, do not operate the boat further, see an authorized Sea-Doo Sport Boats dealer.

DESS Post and Engine Start/Stop Switches

Ensure switches operate properly. Start and stop each engine using each switch individually.

 **WARNING**

If engines do not shut-off when pushing engine start/stop switches or by disconnecting the DESS key from the DESS post, do not operate the boat further, see an authorized Sea-Doo Sport Boats dealer. Only start boat once all items have been checked and operate properly.

Storage Compartment Covers

Ensure they are closed and latched.

OPERATING INSTRUCTIONS

WARNING

Always perform *PRE-OPERATION CHECKS* before operating the boat. Become thoroughly familiar with all controls and the function of each. Should any control or instruction be not fully understood, refer to an authorized Sea-Doo Sport Boats dealer.

Launching/Loading

CAUTION: Before launching the boat, ensure the main battery cut-off switch is turned ON and the bilge plugs are fully screwed into place.

When finished loading the boat on trailer, turn the main battery cut-off switch to OFF.

Remove bilge plugs to drain bilge when boat is on trailer.

Principle of Operation

Propulsion

Each engine is directly coupled to a drive shaft which, in turn, rotates an impeller. This impeller rotates within a housing drawing water in from beneath the boat. Water is then forced by the impeller through a venturi. The venturi pressurizes and accelerates the water, producing thrust to move the boat. Pushing the throttle levers forward increases engine speed and therefore boat speed.

When throttle/shifter controller is pushed forward, the boat moves forward. Pulled back in the reverse position, the boat moves backwards. The middle position is neutral and the boat is at the minimum thrust for most conditions. Neutral and reverse are achieved by means of gates, which are installed on the jet pump venturi housings. These gates direct the water flow to obtain the desired direction.

CAUTION: Always push controller release button before shifting.

WARNING

When the throttle/shifter controller is in the neutral position, the impellers are turning.

WARNING

When an engine is started, the operator and passengers should always be sitting in the boat with the throttle/shifter controller in neutral position.

Throttle/Shifter Controller

FORWARD

The throttle/shifter controller should be in the forward position in order for the boat to advance.

To move forward, depress throttle/shifter controller release button then gradually push lever forward to increase boat speed.

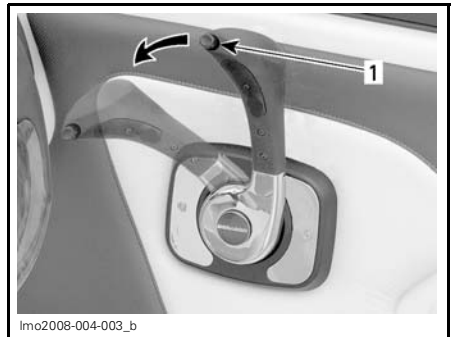

FORWARD FULL THROTTLE POSITION

1. Throttle/shifter controller release button

NEUTRAL

To obtain neutral, pull throttle/shifter controller to the upright position. Reverse gates will be in the middle position, directing half of the thrust toward the front of the boat to minimize movement.

WARNING

When the throttle/shifter controller is in neutral position, the impellers are turning.



NEUTRAL POSITION

REVERSE

To obtain reverse, depress throttle/shifter controller release button then gradually pull lever backwards. The reverse gates will be in downward position, directing all the thrust toward the front of the boat.



REVERSE FULL THROTTLE POSITION

NOTE: To obtain maximum efficiency and control from the reverse, increase engine speed to slightly above idle. Too much RPM will create water turbulence and reduce reverse efficiency.

Steering

Turning the steering pivots the jet pump nozzles which control the boat direction. Turning the steering clockwise will turn the boat to the right and inversely.



TYPICAL — RIGHT-HAND TURN

Above idle speed, the throttles must be applied to turn the boat.

WARNING

Throttle must be applied and steering turned to change the direction of the boat at speed. Steering efficiency will differ depending on the number of passengers, load and water conditions.

A jet propelled boat needs some throttle applied in order to turn. Practice in a safe area applying the throttle and turning away from an imaginary object. This is a good collision avoidance practice.

Using Reverse

The boat behaves differently when using reverse. The steering response is the opposite of forward operation. Turning the steering clockwise will turn the back of the boat to the left and inversely. Use throttle moderately. Too much RPM will create water turbulence and reduce reverse efficiency. At first outing, carefully practice this maneuver away from anything with which you might collide.

WARNING

Become fully familiar with this feature during your first ride and before carrying passengers.

In reverse position, turn the steering wheel in the opposite direction that you want to move the rear of the boat.

For example, to steer the rear of the boat to the left side, turn the steering wheel to the right side.

Boarding from a Dock

As with any boat, boarding should be done carefully and engines must not be running.

When boarding from a dock, slowly place one foot on the boat deck nearest to the dock and then move the other foot inside the boat. Push the boat away from the dock.

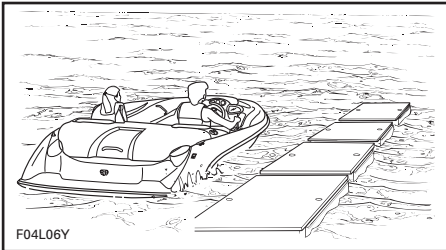

TYPICAL

CAUTION: Although the boat requires only 30 cm (1 ft) of water to float, the engines should be started with at least 90 cm (3 ft) of water below the hull. If the depth of the water is less than 90 cm (3 ft) and the engine is running, the impeller is turning and debris can be drawn from the bottom and damage the propulsion system.

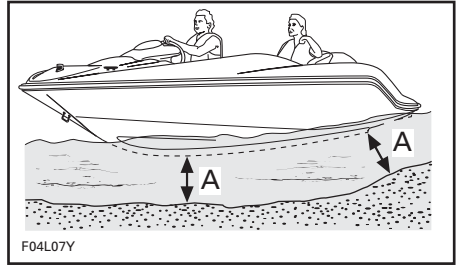

TYPICAL
A. 90 cm (3 ft)

Boarding from the Water

WARNING

Inexperienced riders should practice how to get aboard close to shore first before venturing into deep water.

WARNING

Engines should not be running while boarding. Never use propulsion components as a supporting point to board the boat.

Swim to the rear of the boat.

Release the retractable ladder, pulling ladder out and down into boarding position.

Climb the ladder and pull yourself upward using the swim platform grab handles.

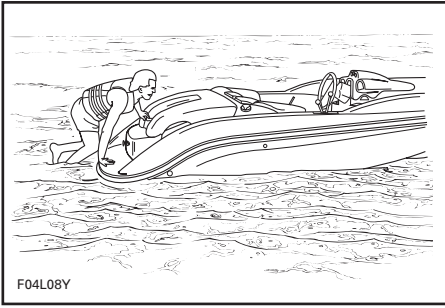

TYPICAL

When you can reach the engine cover grab handle, grip it and continue to pull yourself upward to place your knee on the swim platform.

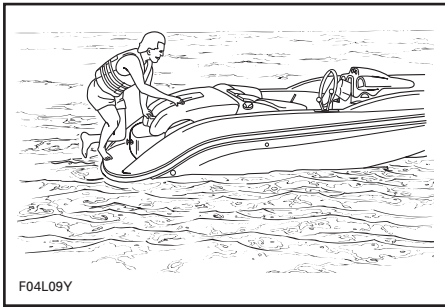

TYPICAL

Continue to climb on engine cover to reach the deck.

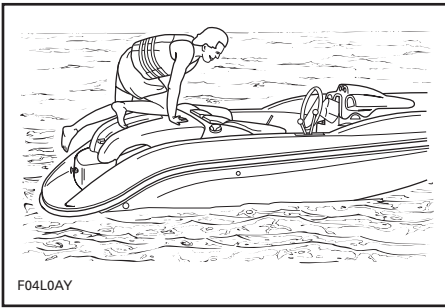

TYPICAL

CAUTION: Do not leave ladder hanging when operating the boat. Before operating the boat, always fasten the ladder in place using the latch.

⚠ WARNING

Do not start engines until all passengers are properly seated.

Starting

⚠ WARNING

Engine exhaust fumes contain carbon monoxide (CO) which can accumulate in and around the boat (under the bimini top, in cockpit, etc.). CO can be harmful or fatal if inhaled. Assure there is adequate ventilation whenever running engine(s).

⚠ WARNING

Always activate bilge blower 5 minutes minimum before starting the engines to allow the bilge blower to ventilate the bilge.

CAUTION: Bilge blower must be turned off during boat operation.

⚠ WARNING

Do not touch electrical parts or jet pump area when engines are running. Attach the safety lanyard to your PFD and snap the DESS key to the DESS post before starting the engine.

NOTE: If you hear beeper signals other than 2 short beeps, it indicates a particular condition that must be corrected. Refer to chart in the *TROUBLESHOOTING* section for the meaning of the coded signal.

Grip steering wheel with your right hand and place both feet on the floorboard. Turn off bilge blower.

Start one engine at a time. Check tachometers to monitor engines.

WARNING

Before starting, the operator and passengers should always be properly seated.

CAUTION: To avoid overheating the starter motor, the cranking period should not exceed 5 - 10 seconds. A rest period of 30 seconds should be observed between cranking cycles to let the starter cool down and disengage its mechanism.

Leaving the Shore

Move throttle/shifter controller to forward position.

Slowly accelerate to reach deeper water. Do not apply full throttle until the engines are warm.

WARNING

In shallow water, shells, sand, pebbles or other objects could be drawn up by the jet pumps and thrown rearward.

Rough Water or Poor Visibility Operation

Avoid operation in these conditions. If you must do so, proceed with caution and prudence using minimum speed. Turn on navigation lights if necessary.

Crossing Waves

Reduce speed when crossing waves. Always be prepared to steer and balance as necessary.

When crossing wakes, always keep a safe distance from boat ahead.

WARNING

When crossing wakes, slow down. Operator and passenger(s) can brace themselves by posting. Do not jump waves or wakes.

Stopping/Docking

The boat is slowed by water drag. The stopping distance will vary depending on the boat's size, speed, water surface condition, presence and direction of wind and current.

The operator should become familiarized with the stopping distance under different conditions.

Reduce throttle speed to idle. Shift to neutral, reverse or forward as required when approaching a dock then shut off the engines just before coming alongside.

WARNING

Directional control is reduced when throttle is decreased and lost when engines are off.

When close to the dock, shut off the engines.

Beaching

CAUTION: It is not recommended to run the boat onto the beach.

Slowly approach the beach and shut off the engines using the DESS key when water depth is 90 cm (3 ft) under the hull, then pull the boat to the beach. Ensure that all accessories are OFF.

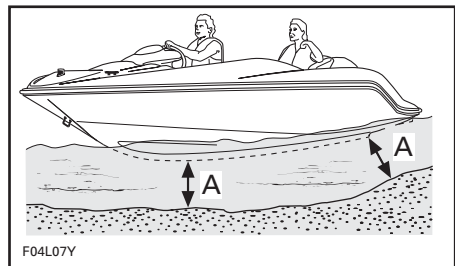

A. 90 cm (3 ft) of water under the hull

WARNING

In shallow water, shells, sand, pebbles or other objects could be drawn up by the jet pumps and be thrown rearward.

As necessary, the exhaust system of each engine should be flushed before restarting to remove sand or shell accumulation which may clog the water passages. Refer to *STORAGE AND PRESEASON PREPARATION* and look for *EXHAUST SYSTEM FLUSHING*.

Shutting Off the Engines

To shut off the engines, pull throttle/shifter controller to the upright position then remove the DESS key or press the engine start/stop switches.

Always remove the DESS key from the DESS post.

WARNING

If engines are shut off, directional control is not available. Never leave the DESS key connected on the DESS post when boat is not in operation to avoid unauthorized use by children, theft or others.

Post-Operation Care

WARNING

Allow engines to cool before performing any maintenance.

General Care

Once boat is on trailer, unscrew the drain plug, block the wheels and raise the bow slightly with the trailer jack (if so equipped) to allow water to drain.

Remove any remaining water that is left in the engine compartment (bilge, engines, etc.) with clean dry rags. This is particularly important in salt water use.

Remove the boat from the water every day to prevent growth of marine organisms.

Anticorrosion Treatment

To prevent corrosion, spray a corrosion inhibitor (salt water resistant) such as XP-S Lube lubricant or equivalent over metallic components in engine compartment.

NOTE: Engine fogging should be done with XP-S Lube lubricant whenever the boat is to be stored for few days or a long period.

Apply dielectric grease (salt water resistant) on battery posts and cable connectors.

CAUTION: Never leave rags or tools in the engine compartment or in the bilge.

Additional Care for Foul Water or Salt Water Use

When the boat is operated in foul water and particularly in salt water, additional care must be taken to protect the boat and its components. Rinse trailer and boat's hull/bilge area with fresh water.

Flushing the exhaust systems with fresh water is essential to neutralize corroding effects of salt or other chemical products present in water. It will help to remove sand, salt, shells or other particles in water jackets and/or hoses.

Flushing should be performed when the boat is not expected to be used further the same day or when the boat is stored for any extended time.

WARNING

Perform this operation in a well ventilated area.

Refer to *EXHAUST SYSTEM FLUSHING* in *STORAGE AND PRESEASON PREPARATION* section for procedure.

CAUTION: Failure to perform proper care such as: rinsing, cooling system flushing and anticorrosion treatment, when used in salt water, will result in damage to the boat and its components. Never leave the boat stored in direct sunlight.

In coastal areas, special care should also be taken on stainless steel or chrome parts like grab handles, mooring cleats, fuel cap and navigation lights. Rinse with fresh water. Clean with a good car chrome polish. Protect with a good car or fiberglass wax.

SPECIAL PROCEDURES

Jet Pump Water Intake and Impeller Cleaning

WARNING

Keep away from intake grates while engines are running. Items such as long hair, loose clothing or personal flotation device straps can become entangled in moving parts resulting in severe injury or drowning.

Weeds, shells or debris can get caught on the intake grates, drive shafts and/or impellers. A clogged water intake may cause troubles such as:

1. **Cavitation:** Engine speed is high but boat moves slowly due to reduced jet thrust; jet pump components may be damaged.
2. **Overheating:** Since the jet pump operation controls the flow of water to cool the exhaust system, a clogged intake will cause the engine to overheat and damage internal engine components.

The clogged area can be cleaned as follows:

In-water cleaning: Pull the DESS key from DESS post to stop engine(s). Let the boat stop by itself. Wait a while to allow weeds or other debris to escape from grate(s). It may be necessary to repeat the procedure.

In severe conditions if the above method does not work, the following can be performed:

- With engine(s) running, put throttle/shifter controller in reverse position and vary throttle setting quickly several times.
- Try accelerating again.

Most of the time, debris will escape from the propulsion system.

Out of water cleaning: If the system is still clogged, shut off the engine(s) by removing the DESS key.

WARNING

Always remove the DESS key from the DESS post to prevent accidental engines starting before cleaning the jet pumps area.

From underneath boat, manually clean water intakes area. If the system is still clogged, refer to an authorized Sea-Doo Sport Boats dealer for servicing.

CAUTION: Avoid operation in weeded areas. If unavoidable, vary speed. Weeds tend to entangle more at steady and slow speeds. Inspect water intake grates for damage. Refer to an authorized Sea-Doo Sport Boats dealer for repair as necessary.

Capsized Boat

This boat is designed so that it should not turn over easily due to its long and wide dimensions. If the boat ever capsizes, remember that it will continue to float. It is usually best to remain with it so you will be more easily located by others.

WARNING

When boat is capsized, do not attempt to restart the engines. Operator and passengers should always wear approved personal flotation devices.

Submerged Boat/ Water-Flooded Engine

To limit damages to the engines, perform the following procedure as soon as possible.

Drain bilge.

If it was submerged in **salt water**, spray bilge and all components with fresh water using a garden hose to stop the salt corroding effect.

CAUTION: Never try to crank or start the engines. Water trapped in intake manifolds would flow towards the engines and may cause severe damage to the engines.

Bring the boat to be serviced by an authorized Sea-Doo Sport Boats dealer as soon as possible.

CAUTION: The longer the delay before you have the engine serviced, the greater the damage will be to the engines. Failure to have the engines properly serviced **will** cause severe engine damage.

Fuel-Flooded Engines

If an engine is fuel-flooded and does not start, this special mode can be activated to prevent fuel injection and ignition while cranking. Proceed as follows to activate it.

- Stop the engine
- Set throttle/shifter controller in neutral position.
- Install DESS key on DESS post.
- From engine compartment, manually rotate throttle lever into fully opened position and HOLD.

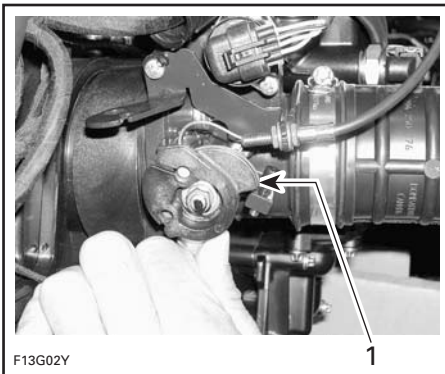

TYPICAL
1. Fully-open position

- Ask someone to press the start/stop switch to crank engine while still HOLDING the throttle lever in fully-opened position. The drowned mode is now on.
- Crank engine several times.

CAUTION: Do not hold the start/stop switch more than 30 seconds. A rest period should be observed between the cranking cycles to let the starter cool down. Pay attention not to discharge the battery.

- Release engine start/stop switch.
- Release throttle lever and start/crank engine again to allow starting.

NOTE: Releasing throttle lever will bring back to its normal mode.

If it does not work:

Disconnect ignition coil connectors.

All three ignition coils are located on the cylinder head directly on the spark plugs.

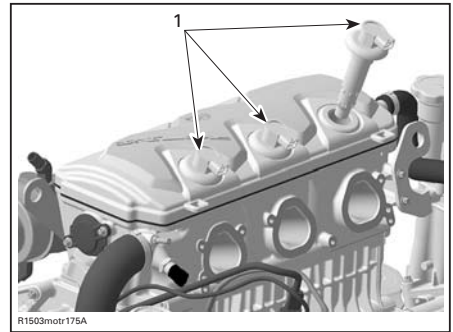

1. Ignition coils



DISCONNECT IGNITION COIL CONNECTORS

WARNING

When disconnecting coil from spark plug, always disconnect coil from main harness first. Never check for engine ignition spark from an open coil and/or spark plug in the engine compartment as spark may cause fuel vapor to ignite.

Remove ignition coils.

CAUTION: Ensure there is no dirt in coil holes before removing the spark plugs. Otherwise, dirt would fall into cylinder and will damage the internal components.

Remove spark plugs.

NOTE: After loosening the spark plugs, a coil may be used to pull the spark plugs out. Simply bring the coil down to spark plug and "hook" it to then extract spark plug.

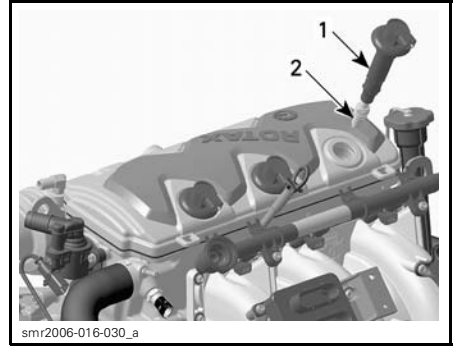

1. Ignition coil
2. Spark plug

Install new spark plugs if available or dry spark plugs using a rag.

Reinstall spark plugs and ignition coils. Reconnect ignition coil connector.

NOTE: After installation, ensure the seal seats properly with the engine top surface.

Start engine(s) as explained above. If engine(s) continue to flood, see an authorized Sea-Doo Sport Boats dealer.

CAUTION: Never run an engine without supplying water to the exhaust system when boat is out of water.

Towing the Boat in Water

Special precautions should be taken when towing a Sea-Doo Sport Boats in water.

Maximum recommended towing speed is 24 km/h (15 MPH).

When towing your boat in water, pinch the water supply hose on each engine from the impeller housing to the exhaust manifold with a large hose pincher (P/N 529 032 500).

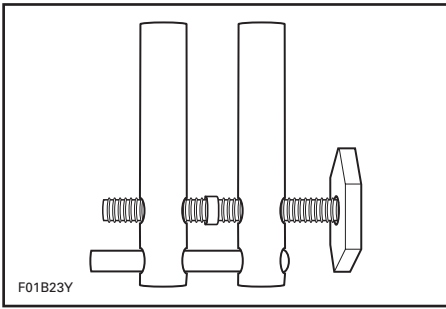

This will prevent the exhaust systems from filling which may lead to water being injected into and filling the engines. Without the engines running there isn't any exhaust pressure to carry the water out the exhaust outlet.

CAUTION: Failure to do this may result in damage to the engines. If your Sea-Doo Sport Boats must be towed in water and you do not have hose pinchers, be sure to stay well below the maximum towing speed of 24 km/h (15 MPH).

Snugly install the hose pinchers on the water supply hoses as shown for each engine.

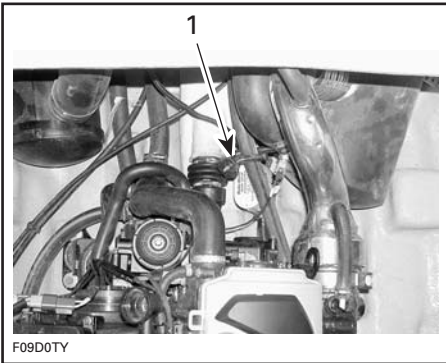

TYPICAL
1. Hose pincher

CAUTION: When finished towing the boat, hose pinchers must be removed before operation. Failure to do so will result in damage to the engines.

TROUBLESHOOTING

The following information is provided to help in diagnosing the probable source of simple troubles. You may be able to solve many of these problems rather quickly, but others may require the skills of a mechanical technician. In such a case, consult an authorized Sea-Doo Sport Boats dealer for servicing.

Monitoring System Coded Signals

2 SHORT (while installing DESS key on DESS post).

1. Everything is correct with the DESS Key (good contact and the right key).

- *Engine(s) can be started normally.*

1 LONG (while installing DESS key on DESS post or when pressing start/stop switch(es) in some cases).

1. Throttle/shifter controller not in Neutral position.

- *Move lever to Neutral position.*

2. Bad connection between DESS key and DESS post.

- *Remove and reinstall the DESS key on the DESS post. Two short beeps should be heard which indicate the system is ready again to allow engine starting.*

3. Wrong key.

- *Use the DESS key that has been programmed for the boat. If it does not work, refer to an authorized Sea-Doo Sport Boats dealer.*

4. Dirty DESS key.

- *Clean.*

5. Improper operation of Interface or defective wiring harness.

- *Refer to an authorized Sea-Doo Sport Boats dealer.*

4 SHORT BEEPS (while pressing start/stop switch(es) with DESS key already installed).

1. Throttle/shifter controller is NOT in neutral.

- *Place lever in neutral. While moving the lever, 1 short beep indicates you reached the neutral position.*

1 SHORT BEEP (while moving throttle/shifter controller to neutral).

1. Confirmation that lever is now in neutral.

- *Engine is now ready to be started.*

4 SHORT BEEPS EVERY 3 SECONDS INTERVAL.

1. DESS key has been left on its post without starting engine(s) or after engine(s) was stopped.

- *To prevent battery discharge, remove the key from its post.*

CONTINUOUSLY BEEPS.

1. High engine coolant temperature.

- *Refer to ENGINE OVERHEATS further in this section.*

CONTINUOUSLY BEEPS. (cont'd)

2. High exhaust temperature.

- Refer to *ENGINE OVERHEATS* further in this section.

3. Low or high engine oil pressure.

- Check oil level as soon as possible. If it does not work, contact an authorized Sea-Doo Sport Boats dealer.

Charging System

BATTERY IS REGULARLY DISCHARGED.

1. Check battery condition.

- Charge or install new battery.

2. Check charging system fuse.

- Replace fuse if necessary and have charging system checked by an authorized Sea-Doo Sport Boats dealer.

Nothing is Working in the Electrical System

NO BEEPS ARE HEARD WHEN INSTALLING THE DESS KEY ON DESS POST.

1. Main battery cut-off switch is turned OFF.

- Verify and turn ON.

2. Battery discharged or missing.

- Charge or install new battery.

WARNING

See your authorized Sea-Doo Sport Boats dealer to have the battery charged or replaced. Do not charge or boost the battery while installed in the engine compartment. Electrolyte is poisonous and capable of causing severe burns.

Engine will not Start

ENGINE DOES NOT TURN OVER AND THE MONITORING BEEPER SOUNDS.

1. Refer to *MONITORING SYSTEM CODED SIGNALS* above.

ENGINE DOES NOT TURN OVER.

1. Safety lanyard removed.

- Install cap over DESS post.

2. Burnt fuse.

- Check wiring then replace fuse.

3. Discharged battery.

- Refer to an authorized Sea-Doo Sport Boats dealer.

ENGINE DOES NOT TURN OVER. (cont'd)

4. Battery connections, corroded or loose.

- Refer to an authorized Sea-Doo Sport Boats dealer.

5. Water flooded engine.

- Refer to an authorized Sea-Doo Sport Boats dealer.

ENGINE SLOWLY TURNS.

1. Discharged or weak battery.

- Refer to an authorized Sea-Doo Sport Boats dealer.

ENGINE TURNS OVER.

1. Fuel tank empty or water contaminated.

- Refill or siphon and fill with fresh fuel.

2. Fuel filter clogged or water contaminated.

- Clean, check fuel tank for water.

3. Fuel flooded engine.

- Refer to FUEL-FLOODED ENGINE in SPECIAL PROCEDURE.

4. Fouled/defective spark plugs.

- Replace.

Engine Misfires, Runs Irregularly

WEAK SPARK.

1. Fouled worn spark plugs.

- Replace.

2. Faulty ignition component.

- Refer to an authorized Sea-Doo Sport Boats dealer.

LEAN FUEL MIXTURE.

1. Fuel: Level too low, stale or water contaminated.

- Siphon and/or refill.

2. Fuel filter, clogged or water contaminated.

- Refer to an authorized Sea-Doo Sport Boats dealer.

Engine Overheats

CAUTION: If the monitoring beeper continuously sounds, **stop engine immediately.**

MONITORING BEEPER CONTINUOUSLY SOUNDS.

1. Check oil and coolant levels.

- Refill if necessary.

2. Clogged jet pump water intake(s).

- Clean, perform the JET PUMP WATER INTAKE AND IMPELLER CLEANING PROCEDURE.

MONITORING BEEPER CONTINUOUSLY SOUNDS. (cont'd)

3. Incorrect type of fuel or oil.

- *Siphon and refill.*

4. Clogged exhaust system.

- *Flush exhaust system with garden hose. Perform the EXHAUST SYSTEM FLUSHING in STORAGE AND PRESEASON PREPARATION section.*

If engine still overheats, refer to an authorized Sea-Doo Sport Boats dealer for servicing.

Engine Continually Backfires

1. Faulty ignition component.

- *Refer to an authorized Sea-Doo Sport Boats dealer.*

2. Overheated engine(s).

- *See ENGINE OVERHEATS above.*

WEAK SPARK.

1. Fouled, worn spark plugs.

- *Replace.*

Engine Pinging or Knocking

1. Poor quality gasoline/low octane.

- *Use well known quality and recommended gasoline.*

2. Spark plug heat range too high.

- *Use recommended spark plugs.*

Engine Lacks Acceleration or Power

1. Weak spark/incorrect fuel mixture.

- *Refer to ENGINE MISFIRES above.*

2. Water in fuel.

- *Siphon and replace.*

3. Overheated engine(s).

- *See ENGINE OVERHEATS above.*

Sport Boats can not Reach Top Speed

1. Jet pump water intakes clogged.

- *Clean.*

2. Damaged impeller.

- *Replace. Refer to an authorized Sea-Doo Sport Boats dealer.*

Abnormal Noise from Propulsion System

1. Weeds or debris jammed around impeller.

- *Clean and check for damage.*

2. Damaged impeller shafts or drive shafts.

- *Refer to an authorized Sea-Doo Sport Boats dealer.*

SPECIFICATIONS

MODELS		205 UTOPIA
ENGINE		
Number of engines		2
Engine type		Rotax 1503 4-TEC, 4-stroke Single Over Head Camshaft (SOHC)
Exhaust system		Water cooled/water injected (opened loop). Direct flow from jet pump
Lubrication	Type	Dry sump (2 oil pumps). Replaceable oil filter. Water-cooled oil cooler
	Oil type	10W 40 4-stroke oil (API service classification SM, SL or SJ)
Number of cylinders		6 (3 per engine)
Displacement		1493.8 cm ³ (91 in ³)
Induction type		Naturally-aspirated
Maximum HP RPM ± 50 RPM		7300 RPM
COOLING		
Type		Liquid cooled. Closed circuit (see also <i>EXHAUST SYSTEM</i>)
Coolant		Ethylene-glycol and distilled water (50%/50%). Use premix coolant from BRP or a coolant specially formulated for aluminum engines
ELECTRICAL		
Magneto generator output		360 W @ 6000 RPM
Ignition system type		DI (Digital Inductive)
Ignition timing		Not adjustable
Spark plug	Make and type	NGK, DCPR8E
	Gap	0.7 - 0.8 mm (.028 to .031 in)
Starting system		Electric starter
Engine RPM limiter setting		7650 RPM
Battery		⁽¹⁾ Not supplied. 12 V group 24, marine starting battery with top-mounted, round taper type battery post

MODELS		205 UTOPIA
ELECTRICAL (cont'd)		
Fuses (engines)	F1: Fuel pump	10 A
	F2: Cylinder 3, ignition coil and injection	10 A
	F3: ECM	5 A
	F4: Cylinder 1, ignition coil and injection	10 A
	F5: Cylinder 2, ignition coil and injection	10 A
	F6: Gauges	2 A
Fuse (VCM)	F1: Accessories	10 A
	F2: Radio	10 A
	F3: Blower	10 A
	F4: Bilge pump	3 A
	F5: NAV lights	3 A
	F6: Courtesy lights	5 A
Fuse (boat)	VCM	2 x 20 A
	Charging system	2 x 30 A
	Automatic bilge pump	3 A
	Radio memory	1 A
	EFB	2 x 15 A
	Blower motor	2 x 5 A
	Ballast pump	20 A
FUEL SYSTEM		
Fuel injection type		Rotax EMS (engine management system). Multipoint Fuel Injection. Single throttle body (52 mm)
Fuel type/minimum octane	Inside North America	Unleaded gasoline with a minimum octane number of (87 (RON + MON)/2)
	Outside North America	Unleaded gasoline with a minimum octane number of 91 RON

MODELS		205 UTOPIA
PROPULSION		
Jet pump type	Axial flow single stage	
Jet pump grease	Jet pump bearing grease (P/N 293 550 032) sold by BRP	
Transmission	Direct drive	
Pivoting angle of direction (nozzle)	20°	
Minimum required water level for jet pump(s)	90 cm (36 in) underneath the lowest rear portion of hull	
DIMENSION		
Overall length	6.05 m (19 ft 10 in)	
Beam	2.44 m (8 ft)	
Draft	30.5 cm (12 in)	
Weight	1166 kg (2570 lb) SE: 1175 kg (2590 lb)	
Seating capacity	8	
Load limit (passengers + luggage)	8 passengers OR 598 kg (1320 lb) (based on calm water operation)	
Dead rise	20°	
DIMENSIONS (on trailer)		
Length (with swing-away tongue folded)	6.2 m (20 ft 4 in)	
Width	2.44 m (8 ft)	
Height	No tower	SE: 2.01 m (6 ft 7 in)
	Tower down	SE: 2.16 m (7 ft 1 in)
	Tower up	SE: 3.02 m (9 ft 11 in)
Gross weight	1665 kg (3670 lb) SE: 1674 kg (3690 lb)	
CAPACITIES		
Engine oil (per engine)	3 L (3.2 U.S. qt) oil change w/filter 4.5 L (4.8 U.S. qt) total	
Engine cooling system	5.5 L (5.8 U.S. qt) total	
Fuel tank (including reserve)	151 L (40 U.S. gal)	

MODELS		205 UTOPIA
MATERIALS		
Hull		Composite FRP
Fuel tank		Polyethylene
Seat	Base	Polyethylene
	Foam	Polyethylene
Windshield		Tinted, tempered glass

⁽¹⁾ Recommended: Exide R-24-130, 12 V, 25 A•h (130 minutes reserve) or R-24-160 (160 minutes) or equivalent.

BRP reserves the right to make changes in design and specifications and/or to make additions to, or improvements in its products without imposing any obligation upon itself to install them on its products previously manufactured.

MAINTENANCE INFORMATION

10-HOUR INSPECTION

NOTE: The 10-hour inspection is at the owner's expense.

It is highly recommended that after the first 10 hours of operation, the boat be checked by an authorized Sea-Doo Sport Boats dealer. This inspection will also provide the opportunity to discuss any unanswered questions you may have encountered during the first hours of operation.

We recommend that this inspection be signed by an authorized Sea- Doo Sport Boats dealer.

Date of 10-hour inspection

Authorized dealer signature

Dealer code

PERIODIC INSPECTION CHART

A: ADJUST C: CLEAN I: INSPECT L: LUBRICATE R: REPLACE O: OPERATOR D: DEALER	FIRST 10 HOURS										TO BE PERFORMED BY LEGEND	
	EVERY 25 HOURS											
	EVERY 50 HOURS											
	EVERY 100 HOURS OR PRESEASON											
	EVERY 200 HOURS OR 2 YEARS											
	PART/TASK											
GENERAL												
Corrosion protection	L			L	L						O	(1) Every 10 hours in salt water use.
Fire extinguisher	Daily inspection									O		
ENGINE												
Engine oil and filter (including cover's O-rings)	R									R	D	(2) Replace for storage period or after 100 hours of use whichever comes first.
Engine oil level (refill as needed)	Daily inspection									O		
Rubber mounts	I			I							D	
EXHAUST SYSTEM												
Exhaust system fasteners, hoses and components condition ⁽³⁾	I	I			I						D	(3) Emission-related component. (5) Daily flushing in salt water or foul water use. (6) Perform at storage period of after 100 hours of use whichever comes first (more often in salt water use).
Exhaust system flushing	(5) (6)									O		
Leak from exhaust system components (such as rust and/or black streaking, water leaks or corroded/cracked fittings)		I									O	
COOLING SYSTEM												
Hose and fasteners	I			I	I						D	—
Coolant	I							R			D	
Coolant level	Daily inspection									O		

A: ADJUST C: CLEAN I: INSPECT L: LUBRICATE R: REPLACE O: OPERATOR D: DEALER	FIRST 10 HOURS										TO BE PERFORMED BY LEGEND	
	EVERY 25 HOURS											
	EVERY 50 HOURS											
	EVERY 100 HOURS OR PRESEASON											
	EVERY 200 HOURS OR 2 YEARS											
	PART/TASK											
FUEL SYSTEM												
Throttle cable	I				I					(6)	D	(3) Emission-related component. (6) Perform at storage period of after 100 hours of use whichever comes first (more often in salt water use). (7) IMPORTANT: When use in salt water, the throttle body lubrication is highly recommended after every 10 hours of use. Failure to perform lubrication will result in damage to the throttle body.
Fuel injection system sensors	I				I						D	
Throttle body and fuel lines fastener tightening	I			I	I						D	
Throttle position sensor (TPS) ⁽³⁾	I				I						D	
Throttle body (IMPORTANT: see ⁽⁷⁾)	I				L						O/D	
Fuel lines, connections, pressure relief valve and fuel system leak test ⁽³⁾	I				I						D	
Fuel tank straps	I				I						O	
AIR INTAKE SYSTEM												
Air intake silencer fit/tightness	I				I						O	—
ELECTRICAL SYSTEM												
Spark plug ⁽³⁾	I				I	R					D	(1) Every 10 hours in salt water use. (3) Emission-related component. (8) Daily checked.
Electrical connections and fastening (ignition system, starting system, fuel injectors etc.)	I				I						D	
ECM and VCM connectors (visual inspection without disconnecting)					I					(1)	O	
EMS fault code reading ⁽³⁾	I				I						D	
Digitally Encoded Security System (DESS)	I				I						D	
Monitoring beeper	Daily inspection										O	
Battery and fasteners ⁽⁸⁾	I				I						O/D	
Main battery cut-off switch	I	I			I						D	
Operation and condition of lights	Daily inspection										O	
Bilge blower and bilge pump operation	Daily inspection										O	
Battery condition/charging and installation					I						D	

A: ADJUST C: CLEAN I: INSPECT L: LUBRICATE R: REPLACE O: OPERATOR D: DEALER	FIRST 10 HOURS										
	EVERY 25 HOURS										
	EVERY 50 HOURS										
	EVERY 100 HOURS OR PRESEASON										
	EVERY 200 HOURS OR 2 YEARS										
	TO BE PERFORMED BY										
PART/TASK	LEGEND										
STEERING SYSTEM											
Steering cable and connections	I				I					D	—
Steering nozzle bushings	I				I					D	
PROPULSION SYSTEM											
Drive shaft corrosion protection					L (6)					D	(4) Inspect each month (more often in salt water) and change when necessary. (6) Perform at storage period of after 100 hours of use whichever comes first (more often in salt water use).
Carbon ring and rubber boot (drive shaft)	I			I						D	
Shifter system, cable and connections	I				I					D	
Drive shaft/impeller splines					I, L					D	
Impeller boot	I				I					D	
Impeller shaft seal, sleeve and O-ring					I (6)					D	
Impeller and wear ring clearance	I			I						D	
Sacrificial anode					(4)					O	
HULL/BODY											
Ride plate and water intake grate	Daily inspection									O	(1) Every 10 hours in salt water use.
Windscreen and fasteners	I	I			I					O	
Ride shoes condition	I				I					O	
Storage compartment cover locks	(1)				I, L					O	
Deck drains/scupper valve	Daily inspection									O	
Drain plug (inside bilge), check for obstructions	I				I					O	
Hull	Daily inspection									O/D	
Towing tower, ensure all mounting points and connections are fastened and tight.	Before each use									O	

NOTE: Some items are included in the *PRE-OPERATION CHECKS* and not necessarily repeated in this chart.

MAINTENANCE PROCEDURES

General

- ⚠ Only perform servicing procedures which are detailed in this guide. Further assistance or information can be obtained from your authorized Sea-Doo Sport Boats dealer. In many instances proper tools and training are required for certain servicing or repair procedures.
- ⚠ Maintain the boat and equipment in top condition at all times. Adhere to the prescribed maintenance schedules. An annual inspection of the boat is always a good recommendation to follow.
- ⚠ The bilge must be kept clean of oil, water or other foreign materials.
- ⚠ Do not attempt to lift the boat without special equipment and training.
- ⚠ The engine and the corresponding components identified in this guide should not be utilized on product(s) other than for those they were designed. Maintenance procedures and specified tightening torque must be strictly adhered to. Never attempt repairs unless the appropriate tools are available. Each boat is designed with parts dimensioned in both the metric and the imperial systems. When replacing fasteners, make sure to use only those recommended by BRP. If required, contact your authorized Sea-Doo Sport Boats dealer for further servicing information.
- ⚠ Operate your boat prudently and have fun. Don't forget that all persons must assist other boaters in an emergency.

Engine Emissions Information

Maintenance, replacement, or repair of the emission control devices and systems may be performed by any marine SI (spark ignition) engine repair establishment or individual.

Manufacturer's Responsibility

Beginning with 1999 model year engines, manufacturers of marine engines must determine the exhaust emission levels for each engine horsepower family and certify these engines with the United States of America Environmental Protection Agency (EPA). An emissions control information label, showing emission levels and engine specifications, must be placed on each boat at the time of manufacture.

Dealer's Responsibility

When performing service on all 1999 and more recent Sea-Doo Sport Boats carrying an emissions control information label, adjustments must be kept within published factory specifications.

Replacement or repair of any emission related component must be executed in a manner that maintains emission levels within the prescribed certification standards.

Dealers are not to modify the engine in any manner that would alter the horsepower or allow emission levels to exceed their predetermined factory specifications.

Exceptions include manufacturer's prescribed changes, such as altitude adjustments for example.

Owner Responsibility

The owner/operator is required to have engine maintenance performed to maintain emission levels within prescribed certification standards.

The owner/operator is not to, and should not allow anyone to modify any engine in a manner that would alter the horsepower or allow emission levels to exceed predetermined factory specifications.

EPA Emission Regulations

All new 1999 and more recent Sea-Doo Sport Boats manufactured by BRP are certified to the EPA as conforming to the requirements of the regulations for the control of air pollution from new boat engines. This certification is contingent on certain adjustments being set to factory standards. For this reason, the factory procedure for servicing the product must be strictly followed and, whenever practicable, returned to the original intent of the design.

The responsibilities listed above are general and in no way a complete listing of the rules and regulations pertaining to the EPA requirements on exhaust emissions for marine products. For more detailed information on this subject, you may contact the following locations:

REGULAR US POSTAL MAIL:

1200 Pennsylvania Ave. NW
Mail Code 6403J
Washington D.C. 20460

FOR ALL COURIER SERVICES:

U.S. Environmental Protection Agency
Office of Transportation and Air Quality
1310 L Street NW
Washington D.C. 20005

INTERNET WEB SITE:

<http://www.epa.gov/otaq/>

E-MAIL:

otaqpublicweb@epa.gov

WARNING

Only perform procedures as detailed in this guide. It is recommended that the assistance of an authorized Sea-Doo Sport Boats dealer be periodically obtained on other components/systems not covered in this guide. Unless otherwise specified, engine must not be running, the DESS key must be removed from the DESS post and the main battery cut-off switch must be turned OFF for all maintenance procedures. Never use jet pump components to lift the boat. Certain components in the engine compartment may be very hot. Direct contact may result in skin burn. When operating the engine while the boat is out of the water, the heat exchangers may become very hot. Avoid any contact with heat exchangers as burns may occur.

NOTE: Where applicable, maintenance procedures apply for both engine systems.

Lubrication

Throttle Body

Lubricate throttle body with XP-S Lube or an equivalent.

Use fitting for that purpose provided on the throttle body.

Make sure to spray lubricant at least 3 to 5 seconds for proper lubrication.

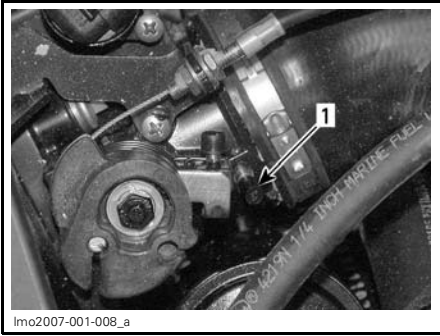

REMOVE CAP
1. Plastic cap

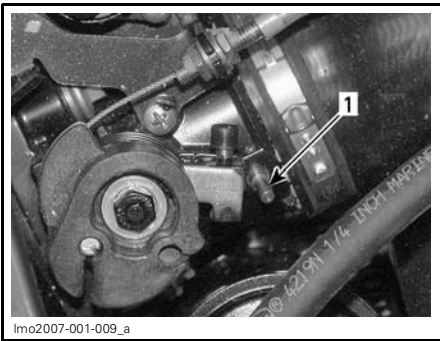

1. Lubrication fitting

Electrical Connections

As necessary, apply dielectric grease on battery posts and all exposed cable connectors including stern light connectors on mast and boat as needed.

CAUTION: Do not lubricate connectors of the VCM (Vehicle Control Module), the EFB (Engine Fuse Block) and the ECM (Engine Control Module).

Additional Moving Mechanism

XP-S Lube lubricant will help to prevent corrosion and keep proper operation of moving mechanisms.

Lubrication of the following items should be performed every 50 hours in fresh water use but every 10 hours in salt water use.

Storage Compartments Cover Mechanism and Hinges

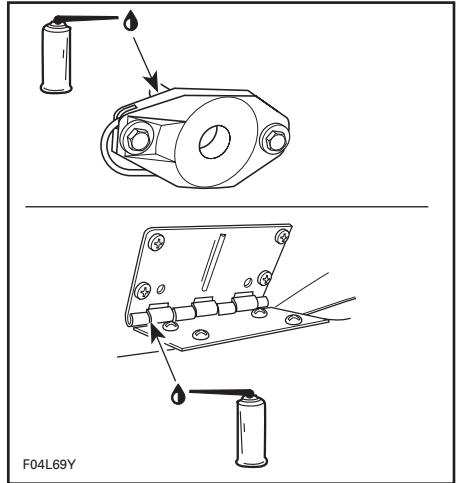

TYPICAL

Reverse Gates

Lubricate pivoting points and mechanism on both sides of each gate.

Rear Storage Compartment Cover Cylinders

Lubricate rod of cylinders.

Throttle/Shifter Controller Cables

Move the throttle/shifter controller forward and rearward once. It must operate smoothly. Refer to an authorized Sea-Doo Sport Boats dealer if adjustment is necessary.

⚠ WARNING

Do not alter or tamper with cables adjustment or routing.

Engine Oil Change and Oil Filter Replacement

The oil change and filter replacement should be performed by an authorized Sea-Doo Sport Boats dealer.

Coolant Replacement

The coolant replacement should be performed by an authorized Sea-Doo Sport Boats dealer.

Fuel Injection System

The fuel injection system inspection should be performed by an authorized Sea-Doo Sport Boats dealer. Fuel system pressurization should be conducted at the same time.

Steering Alignment

When the steering is aimed in straight ahead position, the jet pump nozzles should be in the same direction to allow the boat to run in a straight line.

Refer to an authorized Sea-Doo Sport Boats dealer if an adjustment is necessary.

WARNING

Ensure the steering operate freely from side to side.

Throttle/Shifter Controller

When throttle/shifter controller is in forward position, reverse gates should be in an upward position and locked. With the throttle/shifter controller in neutral position, reverse gates should be in intermediate position. When throttle/shifter controller is in reverse position, reverse gates should be in downward position. Refer to an authorized Sea-Doo Sport Boats dealer if an adjustment is necessary.

WARNING

Ensure the throttle/shifter controller operate freely.

Deck Drain

Remove any obstructions from deck drain outlet.

Fuses

If a fuse is defective, replace by one of the same rating.

CAUTION: Do not use a higher rated fuse as this can cause a fire or severe damage. If a fuse has blown, the source of the malfunction should be determined and corrected before restarting. See an authorized Sea-Doo Sport Boats dealer for servicing.

Main Fuses

If nothing at all is working, check that main battery cut-off switch is in ON position.

Also, check main fuses connected to the main battery cut-off switch inside gunwale.

NOTE: There are spare fuses inside Engines Fuse Block (EFB) and Vehicle Control Module (VCM) fuse cover.

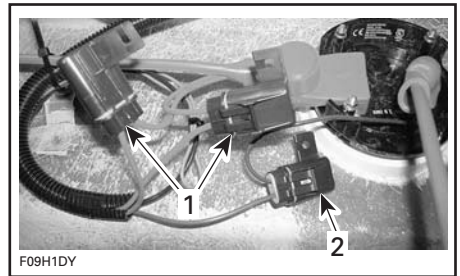

**TYPICAL — BEHIND BATTERY
CUT-OFF SWITCH**

1. 2 x 20A: VCM
2. 3A: automatic bilge pump
3. 1A: radio memory (not shown)

Engines Accessory Fuses

NOTE: Typical for both engines.

Fuses for engine-related components, Engine Control Module (ECM) or gauges are integrated in the Engine Fuse Block (EFB), which is located in the engine compartment.

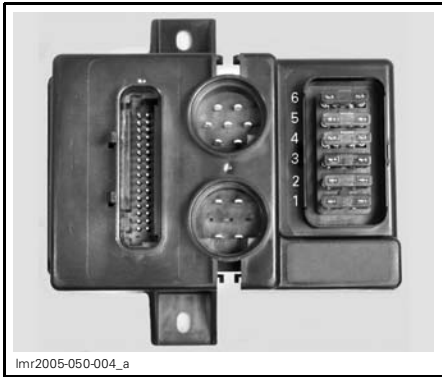

EFB

1. 10A: Fuel pump
2. 10A: Cylinder 3, ignition coil and injection
3. 5A: ECM
4. 10A: Cylinder 1, ignition coil and injection
5. 10A: Cylinder 2, ignition coil and injection
6. 2A: Gauges

To remove fuse cover, squeeze cover locking tabs and pull cover out to access fuses.

Use the cover tabs to remove the fuse.

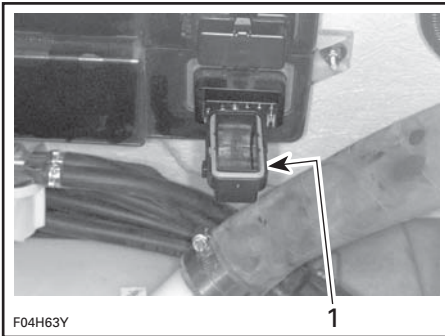

TYPICAL

1. Slide cover tabs each side of fuse then pull fuse out

When finished, ensure seal is properly placed in cover.

Carefully position cover on fuse block then firmly push until you hear a snapping sound for each locking tab.

The main fuses for the engine electrical system are located near each engine solenoid.

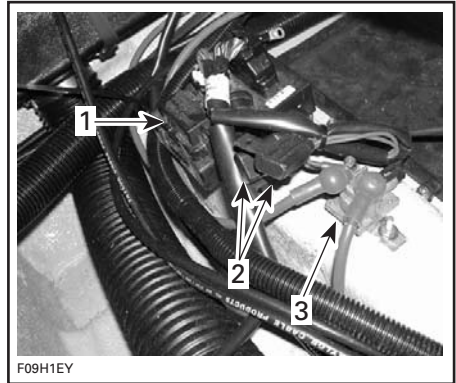

F09H1EY

TYPICAL

1. EFB
2. Engine electrical system main fuses
30A: Charging system
15A: EFB
3. Solenoid

Vehicle Accessory Fuses

Fuses for the vehicle electrical system are integrated in the Vehicle Control Module (VCM), which is located in the driver console ahead of the dash.

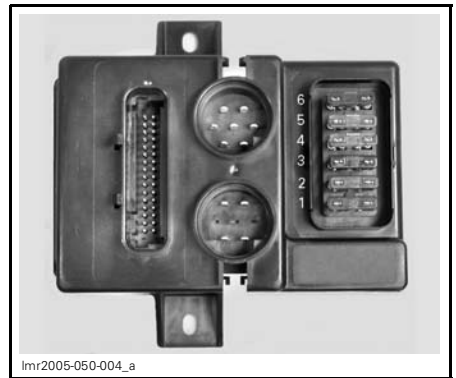

VCM

1. 10A: Accessories
2. 10A: Radio
3. 7.5A: Blower
4. 3A: Bilge pump
5. 3A: NAV lights
6. 5A: Courtesy lights

To remove fuse cover, squeeze cover locking tabs and pull cover out to access fuses.

Use the cover tabs to remove the fuse.

Navigation Light Bulb Replacement

Bow Light

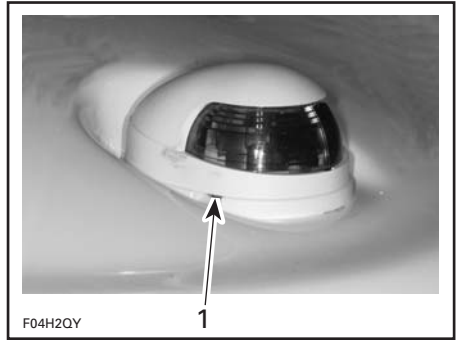

TYPICAL

1. Gently pry here with a screwdriver

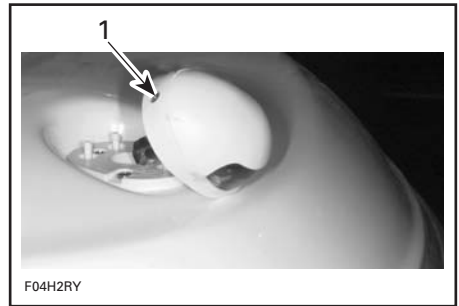

TYPICAL

1. Remove this screw

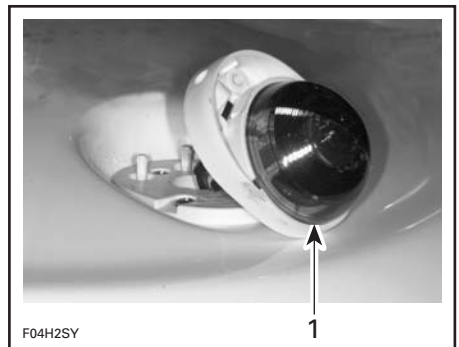

TYPICAL

1. Pull lens out

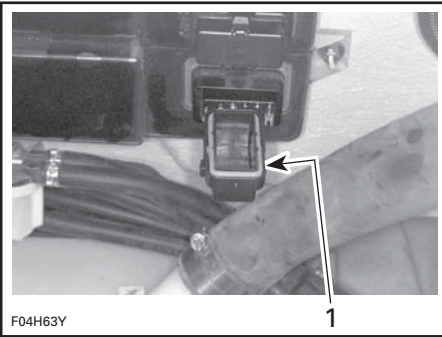

TYPICAL

1. Slide cover tabs each side of fuse then pull fuse out

When finished, ensure seal is properly placed in cover.

Carefully position cover on fuse block then firmly push until you hear a snapping sound for each locking tab.

Bilge Air Blower

Verify each bilge air blower for proper operation.



TYPICAL

1. Blower duct

WARNING

If bilge blower does not operate properly, refer to an authorized Sea-Doo Sport Boats dealer before starting the boat.

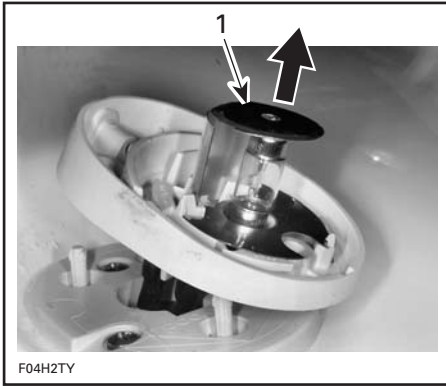

TYPICAL
1. Lift and remove bulb

Assembly is essentially the reverse of removal procedures. However, pay particular attention to the following:

Apply dielectric grease on new bulb contact surface.

When installing the bulb under the upper terminal plate, it is possible that the bulb remains loose. The cover will compress the terminal plate against the bulb at reinstallation.

Stern Light

Unscrew lens counterclockwise and pull it out.

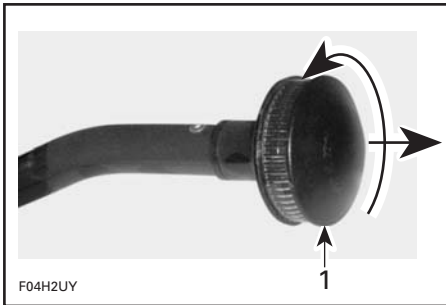

TYPICAL
1. Unscrew then pull

Pull bulb to remove it.

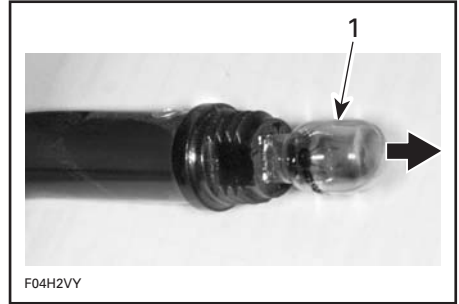

TYPICAL
1. Pull bulb out

Apply dielectric grease on new bulb contact surface.

Assembly is the reverse of removal procedure.

Deck Light

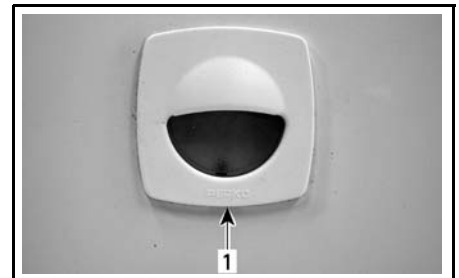

1. Gently pry here with a screwdriver



1. Pull and remove bulb

Sacrificial Anodes

Corrosion of metal parts, especially those exposed to saltwater, is common for boats. Corrosion can be caused by stray electric currents from shorepower installations, improperly grounded A.C. lines and circuits, and poorly insulated D.C. powered equipment from boats moored nearby. Corrosion is accelerated when electric current is present.

Sacrificial anodes are attached to certain parts of this boat to reduce corrosion. The anode corrodes, rather than the part to which the anode is attached.

Change each anode when 50% by weight has corroded away.

Anodes are attached at the following locations:

- ride shoe(s)/cooling plate(s)
- pump housing(s)
- reverse gate support(s)
- steering nozzle(s)
- reverse gate(s).

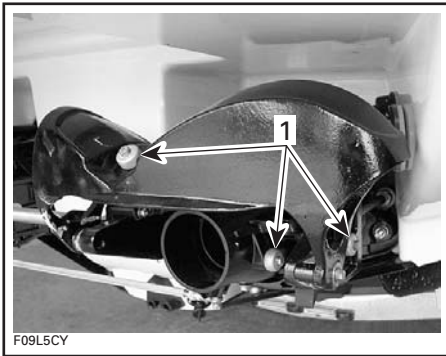

TYPICAL
1. Sacrificial anodes

NOTE: Inspect anodes each time boat is to be launched. Do **NOT** paint anodes or apply protective coatings.

General Inspection and Cleaning

Inspection

Check engine compartment for any damage and the fuel systems for leaks. Also check battery for electrolyte leaks. Ensure all hose clamps are properly secured and no hose is cracked, kinked or presenting any other damage.

WARNING

If at any time, gasoline leaks/odors are found, do not start the engines. Have the boat serviced by an authorized Sea-Doo Sport Boats dealer.

Inspect mufflers, battery and reservoir fastening devices. Check electrical connections for corrosion and tightness.

Inspect hull and jet pump water intake grates for damage. Replace or have damaged parts repaired.

Cleaning

Twice a year, the bilge should be cleaned with hot water and detergent or bilge cleaner to remove any possible fuel/oil/electrolyte deposits and mildew.

Occasionally, wash the body with hot water and soap (only use mild detergent). Remove any marine organisms from engines and/or hull. Apply non-abrasive wax.

CAUTION: Never clean fiberglass and plastic parts with strong detergent, degreasing agent, paint thinner, acetone, etc.

Wash windscreen with Heavy Duty Cleaner (P/N 293 110 001) and water. For fine scratches and scuff mark removal, use a windshield polisher for acrylic, lucite, polycarbonate and similar materials.

Stains may be removed from seats and fiberglass with Knight's Spray-Nine[†] or the equivalent.

Respect the environment by ensuring fuel, oil or cleaning solutions do not drain into the waterways.

[†] Knight's Spray Nine is a registered trademark of Knight Oil Corporation.

STORAGE AND PRESEASON PREPARATION

It is recommended that the boat be taken to an authorized Sea-Doo Sport Boats dealer for proper storage, however you can perform the following operations with a minimum of tools.

NOTE: Leave drain plug out during storage period.

CAUTION: Do not run the engine during the storage period.

WARNING

Because fuel and oil are flammable, have an authorized Sea-Doo Sport Boats dealer inspect the fuel and oil systems integrity as specified in the *PERIODIC INSPECTION CHART*.

Propulsion System

Jet Pump

Clean jet pump by spraying water in its inlet and outlet and then apply a coating of XP-S Lube (P/N 293 600 016) or equivalent.

WARNING

Always remove safety lanyard cap from post to prevent unexpected engine starting before cleaning the jet pump area. Engine must not be running for this operation.

Fuel System

Fuel Stabilizer

BRP fuel stabilizer (P/N 413 408 600) (or equivalent) can be added in fuel tank to prevent fuel deterioration and fuel system gumming. Follow stabilizer manufacturer's instructions for proper use.

CAUTION: Fuel stabilizer should be added before engine lubrication to protect fuel system components against varnish deposits.

Fill up fuel tank completely. Ensure there is no water inside fuel tank.

CAUTION: Should any water be trapped inside fuel tank, severe internal damage will occur to the fuel injection system.

WARNING

Always stop the engines before refueling. Fuel is flammable and explosive under certain conditions. Always work in a well ventilated area. Do not smoke or allow open flames or sparks in the vicinity. Fuel tank may be pressurized. Slowly turn cap when opening. Never use an open flame to check fuel level. When fueling, keep boat level. Do not overfill or top off the fuel tank and leave boat in the sun. As temperature increases, fuel expands and might overflow. Always wipe off any fuel spillage from the boat. Periodically verify fuel system.

Throttle Body Lubrication

Lubricate throttle body with XP-S Lube or an equivalent.

Use fitting for that purpose provided on the throttle body.

Make sure to spray lubricant at least 3 to 5 seconds for proper lubrication.

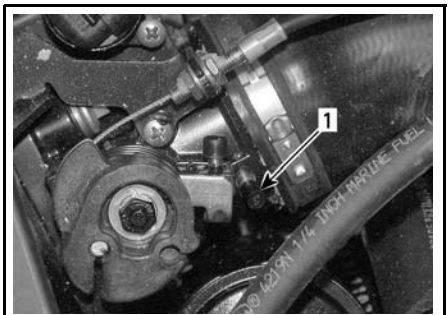

Imo2007-001-008_a

REMOVE CAP

1. Plastic cap

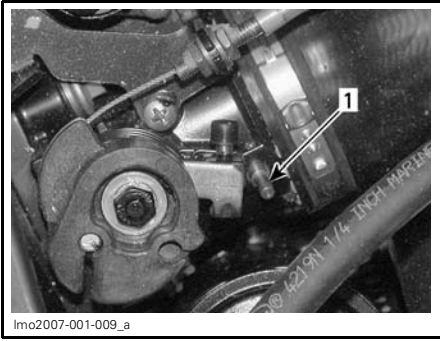

1. Lubrication fitting

Engine Oil and Filter Replacement

The oil change and filter should be performed by an authorized Sea-Doo Sport Boats dealer.

Exhaust System Flushing

Flushing the exhaust system of each engine with fresh water is essential to neutralize corroding effects of salt or other chemical products present in water. It will help to clean up sand, salt, shells or other particles in water jackets (exhaust system and intercooler (if so equipped)) and/or hoses.

CAUTION: Failure to flush the system, when necessary, will severely damage engine(s) intercooler and/or exhaust system. Make sure engine(s) operates during entire procedure.

WARNING

Perform these operations in a well ventilated area. Certain components in the engine compartment may be very hot. Direct contact may result in skin burn. Do not touch any electrical part or jet pump area when engine is running.

WARNING

When operating the engines while the boat is out of the water, the heat exchangers become very hot. Avoid any contact with heat exchangers as burns may occur.

Connect a garden hose to connector located at the rear of boat on jet pump support. **Do not open water tap yet.**

NOTE: The optional flushing connector adapter (P/N 295 500 473) can be used with a quick connect adapter to ease garden hose installation.

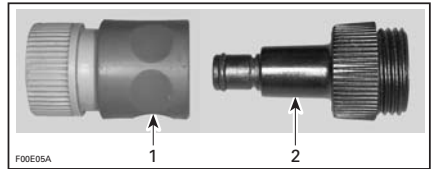

1. Quick connect adapter
2. Flushing connector adapter

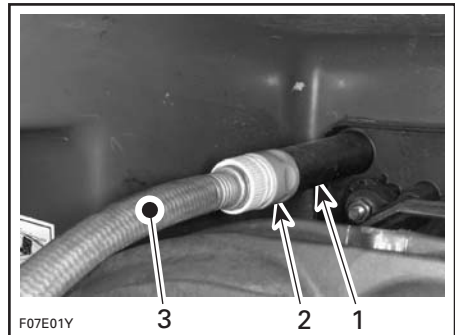

TYPICAL

1. Flushing connector
2. Quick connect adapter and flushing connector adapter (optional, not mandatory)
3. Garden hose

To flush the exhaust systems, start each engine **then** immediately open the water tap.

CAUTION: Always start each engine before opening the water tap. Open water tap immediately after each engine is started to prevent overheating.

CAUTION: Never run engines without supplying water to the exhaust systems when boat is out of water.

Run each engine about 20 seconds at a fast idle between 4000 - 5000 RPM.

CAUTION: Never run engines longer than 5 minutes. Drive line seals have no cooling when the boat is out of water.

Ensure water flows out of jet pumps while flushing. Otherwise, refer to an authorized Sea-Doo Sport Boats dealer for servicing.

Close the water tap, then stop the engine.

CAUTION: Always close the water tap before stopping the engine.

Disconnect the garden hose.

CAUTION: Remove flushing connector adapter after operation (if used).

Leave all compartments open to air dry.

Engine Internal Lubrication

Connect a garden hose to cool the exhaust system as explained in *EXHAUST SYSTEM FLUSHING* above.

Bring engine(s) to normal operating temperature.

CAUTION: Properly follow the instructions given in the *EXHAUST SYSTEM FLUSHING* procedure.

Close the water tap, then stop the engine.

Open the engine compartment lid.

Remove storage tray.

NOTE: Perform for each engine.

Remove dipstick.

Remove engine cover.

Reinstall dipstick.

Disconnect ignition coil connectors.

WARNING

When disconnecting coil from spark plug, always disconnect coil from main harness first. Never check for engine ignition spark from an open coil and/or spark plug in the engine compartment as spark may cause fuel vapor to ignite.

IMPORTANT: Never cut the locking ties of ignition coil connectors. This would allow mixing the wires between cylinders.

Remove ignition coils.

CAUTION: Ensure there is no dirt in coil holes before removing the spark plugs. Otherwise, dirt would fall into cylinder and will damage the internal components.

Remove spark plugs.

NOTE: After loosening the spark plugs, a coil may be used to remove the spark plugs. Simply bring the coil down to spark plug and "hook" it to then extract spark plug.

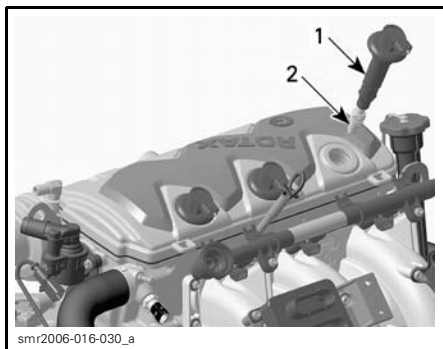

1. Ignition coil
2. Spark plug

Spray XP-S Lube lubricant or equivalent, into spark plug holes.

To prevent fuel to be injected and also cut the ignition at the engine cranking, proceed as follows.

From the engine compartment, have a second person hold throttle bell crank in fully opened position.

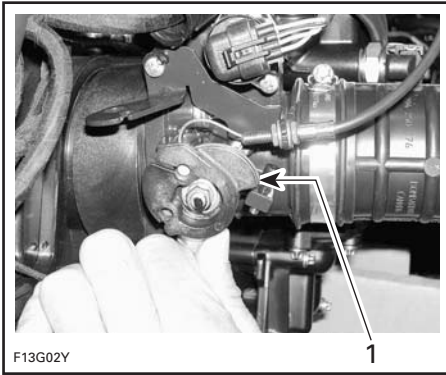

TYPICAL

1. Fully-opened position

Crank each engine a few turns to distribute the oil on cylinder wall.

Apply anti-seize lubricant on spark plug threads then reinstall them.

NOTE: After installation, ensure the seal seats properly with the engine top surface.

Reinstall ignition coils. Reconnect ignition coil connectors.

To reinstall engine cover, remove dipstick, push engine cover downward until it snaps.

Reinstall dipstick.

NOTE: It is recommended to fog the engine valves with XP-S Lube lubricant. Contact your authorized Sea-Doo Sport Boats dealer.

Exhaust Manifold

NOTE: The following procedure is applicable for both engines.

The exhaust system is self draining, but the exhaust manifold need the following protection.

- Disconnect the manifold top water outlet hose from the exhaust pipe.

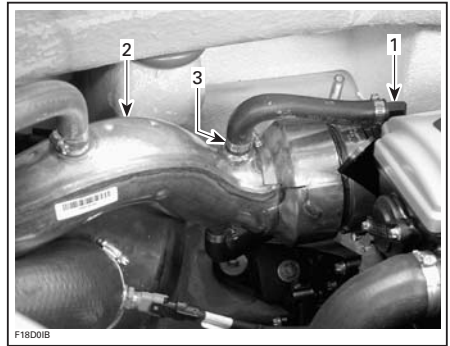

1. Exhaust manifold
2. Exhaust pipe
3. Water outlet hose clamp (reusable)

- Install a funnel at the end of water outlet hose, then pour approximately 300 mL (10.14 oz U.S.) of antifreeze into the exhaust manifold.
- Reconnect the upper water outlet hose and secure with existing clamp.

CAUTION: It is highly recommended to pour antifreeze into the exhaust manifold. Failure to do so, may cause severe damage to this component.

CAUTION: Use only **undiluted antifreeze (100% concentration)**. The premixed antifreeze available from BRP is **NOT** suitable for this particular application. Its concentration will be reduced when mixed with remaining water trapped in water jackets.

NOTE: When available, it is recommended to use biodegradable antifreeze compatible with internal combustion aluminum engines. This will contribute to protect the environment.

NOTE: The engine will not have to run during this operation but should have been ran before, to exhaust as much water as possible, from cooling system components.

Battery

For battery removal, cleaning and storage, contact your authorized Sea-Doo Sport Boats dealer.

Engine Cooling System

Antifreeze of each engine should be replaced every 200 hours or every 2 years to prevent antifreeze deterioration.

A density test and/or antifreeze replacement should be performed by an authorized Sea-Doo Sport Boats dealer.

CAUTION: Improper antifreeze mixture might allow freezing of the liquid in the cooling system if boat is stored in area where freezing point is reached. This would seriously damage the engine. Failure to replace the antifreeze every 200 hours or every 2 years may allow its degradation that could result in poor cooling when engine will be used.

WARNING

In order to avoid potential burns, do not remove the coolant reservoir cap if engine is still hot.

Boat Cleaning/Repair

Wash the body and the trailer with soap and water solution (only use mild detergent). Rinse thoroughly with fresh water. Remove any marine organisms from the hull.

CAUTION: Never clean apparent fiberglass and plastic parts with strong detergent, degreasing agent, paint thinner, acetone, etc.

Stains may be removed from seats and fiberglass with Knight's Spray-Nine or the equivalent.

If repairs are needed to the body or to the hull contact your authorized Sea-Doo Sport Boats dealer. For paint touch up to mechanical parts use BRP spray paint. For minor gel-coat repairs, a Gelcote[†] repair kit is available from Gelcote International (www.gelcote.ca). Replace damaged labels/decals.

Once boat is on trailer, unscrew the drain plug, block the wheels and raise the bow slightly with the trailer jack (if so equipped) to allow water to drain. Clean the bilge with hot water and detergent or with bilge cleaner. Rinse thoroughly. Leave all compartments open to air dry.

Finalizing Storage Preparation

Apply a non-abrasive wax to body.

The engine storage cover should be left partially opened during storage (detach the gas shocks from the cover to prevent full opening).

Remove storage tray. Place it on deck.

Using a flat screwdriver, lift tab as shown below.

[†] Gelcote is a registered trademark of Gelcote International.



TYPICAL — LIFT TAB

Detach shock end. Detach other side. Block and leave engine cover lid open slightly.

This will avoid engine compartment condensation and possible corrosion.

Reattach shock ends to engine cover lid before operating boat.

If the boat is to be stored outside, cover it with a vented opaque tarpaulin to prevent UV (ultraviolet) rays and grime from affecting the plastic components, boat finish, as well as preventing dust accumulation.

CAUTION: Never leave the boat stored in direct sunlight. UV radiation will dull finishes. The boat must never be left in water for storage. Make sure to turn off main battery cut-off switch.

For the storage period, block the wheels and raise the bow slightly with the trailer jack (if so equipped) so drainage can take place. Ensure the drain plug is unscrewed and unobstructed.

Preseason Preparation

Use the *PERIODIC INSPECTION CHART* at the beginning of *MAINTENANCE INFORMATION* section and refer to the *PRESEASON* column.

Since technical skills and special tools are required, some operations should be performed by an authorized Sea-Doo Sport Boats dealer.

WARNING

Observe all **WARNINGS** and **CAUTIONS** mentioned throughout this guide which are pertinent to the item being checked. When component conditions seem less than satisfactory, replace with genuine BRP parts or approved equivalents.

NOTE: It is highly recommended that an authorized Sea-Doo Sport Boats dealer perform the annual safety inspection and factory campaigns in addition to the preseason preparation all at the same time.

WARNING

Only perform procedure as detailed in this guide. It is recommended that the assistance of an authorized dealer be periodically obtained on other components/systems not covered in this guide. Unless otherwise specified, engine must not be running and the main battery cut-off switch must be turned OFF for all maintenance procedures.

WARRANTY INFORMATION

BRP LIMITED WARRANTY FOR MODEL YEAR 2008 SEA-DOO® SPORT BOATS SOLD IN THE UNITED STATES AND CANADA

1) SCOPE

BRP US Inc.* ("BRP") warrants its new and unused Model Year 2008 Sea-Doo® Sport Boats ("Sport Boat") sold by authorized BRP dealers in the fifty United States and Canada ("dealer") from defects in material and workmanship for the period and under the conditions below.

All genuine BRP parts and accessories, installed by an authorized BRP dealer (as hereinafter defined) at the time of delivery of the 2008 Sea-Doo® Sport Boat, carry the same warranty as that of the Sport Boat.

Clarion[†] audio components installed as original equipment on Sport Boats are warranted separately by Clarion. If such an audio component is installed on your Sea-Doo® Sport Boat, please contact the manufacturer or ask your authorized BRP dealer for warranty coverage information and assistance.

For USA:

Clarion Corporation of America
661 West Redondo Beach Boulevard
Gardena, CA 90247
Phone: 800 347-8933
Fax: 310 217-4380

For Canada:

Clarion Canada Inc.
2239 Winston Park Drive
Oakville, ON L6H 5R1
Phone: 800 668-5612
Fax: 800 387-7122

Use of the product for racing or any other competitive activity, at any point, even by a previous owner, will render this warranty null and void.

2) EXCLUSIONS – ARE NOT WARRANTED

The following are not warranted under any circumstances:

- Replacement of parts due to normal wear and tear;
- Routine maintenance parts and services, including but not limited to adjustments, oil, lubricant and coolant changes, spark plug replacement, water pumps and the like;
- Damage caused by improper or lack of maintenance or storage, or failure to follow the procedures and recommendations in the Operator's Guide;
- Damage resulting from removal of parts, improper repairs, service, maintenance, or modification, or use of parts or accessories not manufactured or approved by BRP, which in its reasonable judgement, are either incompatible with Sport Boats or adversely affect its operation, performance, or durability, or resulting from repairs done by a person that is not an authorized BRP dealer;
- Damage caused by abuse, misuse, abnormal use, neglect, racing, improper operation or operation of the Sport Boat in a manner inconsistent with the recommended operation described in the Operator's Guide;
- Damages resulting from external damage, submersion, water or foreign object ingestion, accident, fire, theft, vandalism or any act of God;
- Operation with fuel, oils or lubricants that are not suitable for the Sport Boat (see Operator's Guide);
- Damage from rust, corrosion or exposure to the elements;

- Damage from cooling system or jet pump blockage by foreign material;
- Incidental or consequential damages, or damages of any kind including without limitation towing, storage, telephone, rental, taxi, inconvenience, insurance coverage, loan payments, loss of time, loss of income; and
- Damage to gel coat finish including but not limited to cosmetic gel coat finish defects, blisters, starrng, crazing; and fiberglass delaminating caused by blisters, crazing, spyder or hairline cracks or exposure to the elements.

3) LIMITATIONS OF LIABILITY

THIS WARRANTY IS EXPRESSLY GIVEN AND ACCEPTED IN LIEU OF ANY AND ALL OTHER WARRANTIES, EXPRESSED OR IMPLIED, INCLUDING WITHOUT LIMITATION ANY WARRANTY OF MERCHANTABILITY OR FITNESS FOR A PARTICULAR PURPOSE. TO THE EXTENT THAT THEY CANNOT BE DISCLAIMED, THE IMPLIED WARRANTIES ARE LIMITED IN DURATION TO THE LIFE OF THE EXPRESS WARRANTY. INCIDENTAL AND CONSEQUENTIAL DAMAGES ARE EXCLUDED FROM COVERAGE UNDER THIS WARRANTY. SOME STATES/PROVINCES DO NOT ALLOW FOR THE DISCLAIMERS, LIMITATIONS AND EXCLUSIONS IDENTIFIED ABOVE, AS A RESULT, THEY MAY NOT APPLY TO YOU. THIS WARRANTY GIVES YOU SPECIFIC RIGHTS, AND YOU MAY ALSO HAVE OTHER LEGAL RIGHTS WHICH MAY VARY FROM STATE TO STATE, OR PROVINCE TO PROVINCE.

Neither the distributor, any BRP dealer nor any other person has been authorized to make any affirmation, representation or warranty regarding the product, other than those contained in this limited warranty, and if made, shall not be enforceable against BRP.

BRP reserves the right to modify this warranty at any time, being understood that such modification will not alter the warranty conditions applicable to the products sold while this warranty is in effect.

4) WARRANTY COVERAGE DURATION

This limited warranty will be in effect from the date of delivery to the first retail consumer or the date the Sport Boat is first put to use, whichever occurs first, for a period of:

- TWELVE (12) CONSECUTIVE MONTHS for private, recreational use, except that the deck and hull fiberglass structure are covered for SIXTY (60) CONSECUTIVE MONTHS;
- FOUR (4) CONSECUTIVE MONTHS for commercial use, except that the deck and hull fiberglass structure is covered for TWELVE (12) CONSECUTIVE MONTHS. A Sport Boat is used commercially when it is used in connection with generating income or any work or employment during any part of the warranty period. A Sport Boat is also used commercially when, at any point during the warranty period, it has commercial tags or is licensed for commercial use.

The emission-related components included in the chart below, that are installed on EPA certified Sea-Doo® Sport Boats (see list below) registered in the USA are covered for TWENTY-FOUR (24) CONSECUTIVE MONTHS OR 200 HOURS OF ENGINE USE, whichever occurs first. If the 200 hours of engine use are reached during the regular warranty coverage period, the emission-related components are still covered by BRP's standard warranty until the end of regular coverage period.

The EPA certified 2008 Sea-Doo® Sport Boats are those equipped with:

- 4-TEC™ 1503 normally aspirated (NA) engine(s)
- 4-TEC™ 1503 supercharged intercooled (SCIC) engine(s).

Emission-related components:

- Throttle Position Sensor (TPS)
- Air Temperature Sensor (ATS)
- Air Pressure Sensor (APS)

For Sport Boats produced by BRP for sale in the states of California or New York, that are originally sold to a resident or subsequently warranty registered to a resident in the state of California or New York, please also refer to the applicable California and New York Emissions Control Warranty Statement.

The repair or replacement of parts or the performance of service to a Sport Boat under this warranty does not extend the life of this limited warranty beyond its original expiration date.

5) CONDITIONS TO HAVE WARRANTY COVERAGE

This warranty coverage is available only if each of the following conditions has been fulfilled:

- a) The 2008 Sea-Doo® Sport Boats must be purchased as new and unused by its first owner from a BRP distributor/dealer authorized to distribute Sea-Doo® Sport Boats products in the country in which the sale occurred ("BRP distributor/dealer");
- b) The BRP specified pre-delivery inspection process must be completed and documented;
- c) The product must have undergone proper registration by an authorized BRP distributor/dealer;
- d) The 2008 Sea-Doo® Sport Boats must be purchased in the country or union of countries in which the purchaser resides.
- e) Routine maintenance outlined in the Operator's Guide must be timely performed in order to maintain warranty coverage. BRP reserves the right to make warranty coverage contingent upon proof of proper maintenance.

BRP will not honor this limited warranty to any private use owner or commercial use owner if the preceding conditions have not been met. Such limitations are necessary in order to allow BRP to preserve both the safety of its products, and also that of its consumers and the general public.

6) WHAT TO DO TO OBTAIN WARRANTY COVERAGE

The customer must notify a servicing BRP dealer within two (2) days of the appearance of a defect, and provide it with reasonable access to the product and reasonable opportunity to repair it. The customer must also present to the authorized BRP dealer, proof of purchase of the product and must sign the repair/work order prior to starting the repair in order to validate the warranty repair. All parts replaced under this limited warranty become the property of BRP.

7) WHAT BRP WILL DO

BRP's obligations under this warranty are limited to, at its sole discretion, repairing parts found defective under normal use, maintenance and service, or replacing such parts with new genuine BRP parts without charge for parts and labor, at any authorized BRP dealer during the warranty coverage period.

BRP reserves the right to improve or modify products from time to time without assuming any obligation to modify products previously manufactured.

8) TRANSFER

If the ownership of a product is transferred during the warranty coverage period, this warranty shall also be transferred and be valid for the remaining coverage period provided that BRP is notified of such transfer of ownership in the following way:

- a) The former owner contacts BRP (at the phone number provided below) or an authorized BRP dealer and gives the coordinates of the new owner; or
- b) BRP or an authorized BRP dealer receives a proof that the former owner agreed to the transfer of ownership, in addition to the coordinates of the new owner.

9) CONSUMER ASSISTANCE

- a) In the event of a controversy or a dispute in connection with this limited warranty, BRP suggests that you try to resolve the issue at the dealership level. We recommend discussing the issue with the authorized BRP Dealer's service manager or owner.
- b) If the issue has not yet been resolved, please submit your complaint in writing or call the appropriate number below:

In Canada

BOMBARDIER RECREATIONAL PRODUCTS INC.

Consumer Services Group
75, J.-A. Bombardier Street
Sherbrooke, Québec J1L 1W3
Tel.: 819 566-3366

In USA

BRP US INC.

Consumer Services Group
7575 Bombardier Court
Wausau WI 54401
Tel.: 715 848-4957

*In Canada, products are distributed and serviced by Bombardier Recreational Products Inc.

© 2007 Bombardier Recreational Products Inc. All rights reserved.

® Registered trademark of Bombardier Recreational Products Inc. or its affiliates.

‡ is a trademark of Clarion.

CALIFORNIA AND NEW YORK EMISSION CONTROL WARRANTY STATEMENT FOR MODEL-YEAR 2008 SEA-DOO® SPORT BOATS WITH 4-TEC™ 1503 NORMALLY ASPIRATED (NA) AND 4-TEC™ 1503 SUPERCHARGED INTERCOOLED (SCIC) ENGINE(S)

For California, your 2008 Sea-Doo® Sport Boat ("Sport Boat") has a special environmental label required by the California Air Resources Board. The label has 1, 2, 3 or 4 stars. A hangtag, provided with your Sport Boat, describes the meaning of the star rating system.

The Star Label Means Cleaner Marine Engines

The symbol for cleaner marine engines:



F18L3CQ

Cleaner Air and Water

For a healthier lifestyle and environment.

Better Fuel Economy

Burns up to 30 - 40 percent less gas and oil than conventional carbureted two-stroke engines, saving money and resources.

Longer Emission Warranty

Protects consumer for worry free operation.

One Star - Low Emission

The one-star label identifies personal watercraft, outboard, stern drive and in-board engines that meet the Air Resources Board's Personal Watercraft and Outboard marine engine 2001 exhaust emission standards. Engines meeting these standards have 75% lower emissions than conventional carbureted two-stroke engines. These engines are equivalent to the U.S. EPA's 2006 standards for marine engines.

Two Stars - Very Low Emission

The two-star label identifies personal watercraft, outboard, stern drive and in-board engines that meet the Air Resources Board's Personal Watercraft and Outboard marine engine 2004 exhaust emission standards. Engines meeting these standards have 20% lower emissions than One Star - Low-Emission engines.

Three Stars - Ultra Low Emission

The three-star label identifies engines that meet the Air Resources Board's Personal Watercraft and Outboard marine engine 2008 exhaust emission standards or the Stern drive and Inboard marine engine 2003 exhaust emission standards. Engines meeting these standards have 65% lower emissions than One Star – Low Emission engines.

Four Stars - Super Ultra Low Emission

The four-star label identifies engines that meet the Air Resources Board's Stern-drive and Inboard marine engine 2009 exhaust emission standards. Personal Watercraft and Outboard marine engines may also comply with these standards. Engines meeting these standards have 90% lower emissions than One Star – Low Emission engines.

For more information: Cleaner Watercraft - Get the Facts 1 800 END-SMOG
www.arb.ca.gov

Your Emission Control Warranty Rights and Obligations

The California Air Resources Board and BRP US Inc. ("BRP") are pleased to explain the emission control system warranty on your Model Year 2008 Sea-Doo® Sport Boat. In California, new Sport Boat engines must be designed, built and equipped to meet the State's stringent anti-smog standards. BRP must warrant the emission control system on your Sport Boat engine for the periods of time listed below provided there has been no abuse, neglect or improper maintenance of your Sport Boat engine.

Your emission control system may include parts such as the fuel injection system, the ignition system and catalytic converter. Also included may be hoses, belts, connectors and other emission related assemblies.

Where a warrantable condition exists, BRP will repair your Sport Boat engine at no cost to you including diagnosis, parts and labor provided that such work is performed by an authorized BRP dealer.

Manufacturer's Limited Warranty Coverage

This emission limited warranty covers Model Year 2008 Sea-Doo® Sport Boats certified and produced by BRP for sale in California, that are originally sold in California to a California resident or subsequently warranty registered to a California resident. The BRP limited warranty conditions for Sea-Doo® Sport Boats are still applicable to these models with the necessary modifications. Select emission control parts of your 2008 Sea-Doo® Sport Boat are warranted from the date of delivery to the first retail consumer for a period of 4 years, or for 250 hours of use, whichever occurs first. However, warranty coverage based on the hourly period is only permitted for Sport Boat equipped with the appropriate hour meters or their equivalent. If any emission-related part on your engine is defective under warranty, the part will be repaired or replaced by BRP.

Parts Covered for a Model Year 2008 Sea-Doo® Sport Boat Equipped with 4-TEC™ 1503 normally aspirated (NA) and 4-TEC™ 1503 supercharged intercooled (SCIC) engine(s):

Digital Linear Actuator (low idle control)	All Fuel System Components
Throttle Position Sensor	Spark Plugs
Intake Manifold Air Pressure Sensor	Ignition Coils
Intake Manifold Air Temperature Sensor	Piston and Rings
Engine Temperature Sensor	Intake and Exhaust Valve Gear/Train
Knock Sensor	Valves, Valve Guides and Valve Guide Sealing
Emission Control Unit	Crankcase Ventilation Valve
Injectors	Wire Harness and Connectors
Fuel Pressure Regulator	Emission Related Seals, Gaskets and Hoses
Intake Manifold	Exhaust Manifold
Intercooler (if equipped)	Supercharger (if equipped)

The emission warranty covers damage to other engine components that is caused by the failure of a warranted part. The BRP Operator's Guide provided contains written instructions for the proper maintenance and use of your sport boat. All emission warranty parts are warranted by BRP for the entire warranty period of the sport boat, unless the part is scheduled for replacement as required maintenance in the Operator's Guide.

Emission warranty parts that are scheduled for replacement, as required maintenance, are warranted by BRP for the period of time before the first scheduled replacement date for that part. Emission warranty parts that are scheduled for regular inspection, but not regular replacement, are warranted by BRP for the entire warranty period of the sport boat. Any emission warranty part repaired or replaced under the terms of this warranty statement is warranted by BRP for the remainder of the warranty period of the original part. All parts replaced under this limited warranty become the property of BRP. Maintenance receipts and records should be transferred to each subsequent owner of the Sport Boat.

Owner's Warranty Responsibilities

As the owner of a 2008 Sea-Doo® Sport Boat, you are responsible for the performance of the required maintenance listed in your Operator's Guide. BRP recommends that you retain all receipts covering maintenance your sport boat engine, but BRP cannot deny warranty solely for the lack of receipts or your failure to ensure the performance of all scheduled maintenance. As the owner of a Sea-Doo® Sport Boat, you should however be aware that BRP may deny you warranty coverage if your engine(s) or a part has failed due to abuse, neglect, improper maintenance or unapproved modifications. You are responsible for presenting your engine to an authorized BRP Dealer as soon as a problem exists. The warranty repairs will be completed in a reasonable amount of time, not to exceed 30 days. If you have any questions regarding your warranty rights and responsibilities or for the name and location of the nearest authorized BRP Dealer you should contact the Customer Assistance Center at 1 715 848-4957.

BRP INTERNATIONAL LIMITED WARRANTY FOR MODEL YEAR 2008 SEA-DOO® SPORT BOATS

1) SCOPE

BRP US Inc. ("BRP")* warrants its new and unused Model Year 2008 Sea-Doo® Sport Boats ("Sport Boat") sold by authorized BRP distributors/dealers outside of the fifty United States, Canada and states members of the European Union ("distributor/dealer"), will be free from defects in material and workmanship for the period and under the conditions below.

All genuine BRP parts and accessories, installed by an authorized BRP dealer (as hereinafter defined) at the time of delivery of the 2008 Sea-Doo Sport Boat, carry the same warranty as that of the Sport Boat.

Use of the product for racing or any other competitive activity, at any point, even by a previous owner, will render this warranty null and void.

2) EXCLUSIONS – ARE NOT WARRANTED

The following are not warranted under any circumstances:

- Replacement of parts due to normal wear and tear;
- Routine maintenance parts and services, including but not limited to adjustments, oil, lubricant and coolant changes, spark plug replacement, water pumps and the like;
- Damage caused by improper or lack of maintenance or storage, or failure to follow the procedures and recommendations in the Operator's Guide;
- Damage resulting from removal of parts, improper repairs, service, maintenance, or modification, or use of parts or accessories not manufactured or approved by BRP, which in its reasonable judgment, are either incompatible with Sport Boats or adversely affect its operation, performance, or durability, or resulting from repairs done by a person that is not an authorized BRP distributor/dealer;
- Damage caused by abuse, misuse, abnormal use, neglect, racing, improper operation or operation of the Sport Boat in a manner inconsistent with the recommended operation described in the Operator's Guide;
- Damages resulting from external damage, submersion, water or foreign object ingestion, accident, fire, theft, vandalism or any act of God;
- Operation with fuel, oils or lubricants that are not suitable for the Sport Boat (see Operator's Guide);
- Damage from rust, corrosion or exposure to the elements;
- Damage from cooling system or jet pump blockage by foreign material;
- Incidental or consequential damages, or damages of any kind including without limitation towing, storage, telephone, rental, taxi, inconvenience, insurance coverage, loan payments, loss of time, loss of income; and
- Damage to gel coat finish including but not limited to cosmetic gel coat finish defects, blisters, starring, crazing; and fiberglass delaminating caused by blisters, crazing, spyder or hairline cracks or exposure to the elements.

3) LIMITATIONS OF LIABILITY

THIS WARRANTY IS EXPRESSLY GIVEN AND ACCEPTED IN LIEU OF ANY AND ALL OTHER WARRANTIES, EXPRESSED OR IMPLIED, INCLUDING WITHOUT LIMITATION ANY WARRANTY OF MERCHANTABILITY OR FITNESS FOR A PARTICULAR PURPOSE. TO THE EXTENT THAT THEY CANNOT BE DISCLAIMED, THE IMPLIED WARRANTIES ARE LIMITED IN DURATION TO THE LIFE OF THE EXPRESS WARRANTIES. INCIDENTAL AND CONSEQUENTIAL DAMAGES ARE EXCLUDED FROM COVERAGE UNDER THIS WARRANTY. SOME STATES/PROVINCES DO NOT ALLOW FOR THE DISCLAIMERS, LIMITATIONS AND EXCLUSIONS IDENTIFIED ABOVE, AS A RESULT, THEY MAY NOT APPLY TO YOU. THIS WARRANTY GIVES YOU SPECIFIC RIGHTS, AND YOU MAY ALSO HAVE OTHER LEGAL RIGHTS WHICH MAY VARY FROM STATE TO STATE, OR PROVINCE TO PROVINCE.

Neither the distributor, any BRP Distributor/Dealer nor any other person has been authorized to make any affirmation, representation or warranty regarding the product, other than those contained in this limited warranty, and if made, shall not be enforceable against BRP.

BRP reserves the right to modify this warranty at any time, being understood that such modification will not alter the warranty conditions applicable to the products sold while this warranty is in effect.

4) WARRANTY COVERAGE DURATION

This limited warranty will be in effect from the date of delivery to the first retail consumer or the date the Sport Boat is first put to use, whichever occurs first, for a period of:

- TWELVE (12) CONSECUTIVE MONTHS for private, recreational use, except for the deck and hull fiberglass structure are covered for SIXTY (60) CONSECUTIVE MONTHS;
- FOUR (4) CONSECUTIVE MONTHS for commercial use, except for the deck and hull fiberglass structure is covered for TWELVE (12) CONSECUTIVE MONTHS. A Sport Boat is used commercially when it is used in connection with generating income or any work or employment during any part of the warranty period. A Sport Boat is also used commercially when, at any point during the warranty period, it has commercial tags or is licensed for commercial use.

The repair or replacement of parts or the performance of service to a Sport Boat under this warranty does not extend the life of this limited warranty beyond its original expiration date.

5) CONDITIONS TO HAVE WARRANTY COVERAGE

This warranty coverage is available only if each of the following conditions has been fulfilled:

- a) The 2008 Sea-Doo® Sport Boats must be purchased as new and unused by its first owner from a BRP distributor/dealer authorized to distribute Sea-Doo® Sport Boats products in the country in which the sale occurred ("BRP distributor/dealer");
- b) The BRP specified pre-delivery inspection process must be completed and documented;

- c) The product must have undergone proper registration by an authorized BRP distributor/dealer;
- d) The 2008 Sea-Doo® Sport Boats must be purchased in the country or union of countries in which the purchaser resides.
- e) Routine maintenance outlined in the Operator's Guide must be timely performed in order to maintain warranty coverage. BRP reserves the right to make warranty coverage contingent upon proof of proper maintenance.

BRP will not honor this limited warranty to any private use owner or commercial use owner if the preceding conditions have not been met. Such limitations are necessary in order to allow BRP to preserve both the safety of its products, and also that of its consumers and the general public.

6) WHAT TO DO TO OBTAIN WARRANTY COVERAGE

The customer must notify a servicing BRP Distributor/Dealer within two (2) days of the appearance of a defect, and provide it with reasonable access to the product and reasonable opportunity to repair it. The customer must also present to the authorized BRP Distributor/Dealer, proof of purchase of the product and must sign the repair/work order prior to starting the repair in order to validate the warranty repair. All parts replaced under this limited warranty become the property of BRP.

7) WHAT BRP WILL DO

BRP's obligations under this warranty are limited to, at its sole discretion, repairing parts found defective under normal use, maintenance and service, or replacing such parts with new genuine BRP parts without charge for parts and labor, at any authorized BRP Distributor/Dealer during the warranty coverage period.

BRP reserves the right to improve or modify products from time to time without assuming any obligation to modify products previously manufactured.

8) TRANSFER

If the ownership of a product is transferred during the warranty coverage period, this warranty shall also be transferred and be valid for the remaining coverage period provided BRP or an authorized BRP Distributor/Dealer receives a proof that the former owner agreed to the transfer of ownership, in addition to the co-ordinates of the new owner.

9) CONSUMER ASSISTANCE

- a) In the event of a controversy or a dispute in connection with this limited warranty, BRP suggests that you try to resolve the issue at the dealership level. We recommend discussing the issue with the authorized dealer's service manager or owner.
- b) If further assistance is required, the distributor's service department should be contacted in order to resolve the matter. You will find your distributor's coordinates on www.brp.com.
- c) If the matter still remains unresolved then contact BRP by writing to us at the address listed below.

For countries within Europe, Middle East, Africa, Russia & CIS, please contact our European office:

BRP EUROPE N.V.

Consumer Service Center
Skaldenstraat 125
9042 Gent
Belgium
Tel.: + 32-9-218-26-00

For Scandinavian countries, please contact our Finland office:

BRP FINLAND OY

Service Department
Ahjotie 30
Fin-96320 Rovaniemi
Finland
Tel.: + 358 16 3208 111

For all other countries, please contact your local distributor or our North America office:

BOMBARDIER RECREATIONAL PRODUCTS INC.

Consumer Services Group
75, J.-A. Bombardier Street
Sherbrooke, Québec J1L 1W3
Tel.: 819 566-3366

* For the territory covered by this limited warranty, products are distributed and serviced by Bombardier Recreational Products Inc. or its affiliates.

© 2007 Bombardier Recreational Products Inc. All rights reserved.

® Registered trademark of Bombardier Recreational Products Inc. or its affiliates.

BRP EUROPEAN UNION MEMBER STATES LIMITED WARRANTY FOR MODEL YEAR 2008 SEA-DOO® SPORT BOATS

1) SCOPE OF THE LIMITED WARRANTY

BRP US Inc. ("BRP")* warrants its new and unused model-year 2008 Sea-Doo® Sport Boats sold by authorized BRP distributors/dealers ("Distributors/Dealers") in the European Union member states from defects in material or workmanship for the period and under the conditions described below.

All genuine Sea-Doo® Sport Boats parts and accessories, installed by an authorized BRP Distributors/Dealers at the time of delivery of the 2008 Sea-Doo® sport boats, carry the same warranty as that of the Sport boats.

Use of the product for racing or any other competitive activity, at any point, even by a previous owner, will render this warranty null and void.

2) EXCLUSIONS – ARE NOT WARRANTED

The following are not warranted under any circumstances:

- Replacement of parts due to normal wear and tear;
- Routine maintenance parts and services, including but not limited to adjustments, oil, lubricant and coolant changes, spark plug replacement, water pumps and the like;
- Damage caused by improper or lack of maintenance or storage, or failure to follow the procedures and recommendations in the Operator's Guide;
- Damage resulting from removal of parts, improper repairs, service, maintenance, or modification, or use of parts or accessories not manufactured or approved by BRP, which in its reasonable judgment, are either incompatible with Sport Boats or adversely affect its operation, performance, or durability, or resulting from repairs done by a person that is not an authorized BRP distributor/dealer;
- Damage caused by abuse, misuse, abnormal use, neglect, racing, improper operation or operation of the Sport Boat in a manner inconsistent with the recommended operation described in the Operator's Guide;
- Damages resulting from external damage, submersion, water or foreign object ingestion, accident, fire, theft, vandalism or any act of God;
- Operation with fuel, oils or lubricants that are not suitable for the Sport Boat (see Operator's Guide);
- Damage from rust, corrosion or exposure to the elements;
- Damage from cooling system or jet pump blockage by foreign material;
- Incidental or consequential damages, or damages of any kind including without limitation towing, storage, telephone, rental, taxi, inconvenience, insurance coverage, loan payments, loss of time, loss of income; and
- Damage to gel coat finish including but not limited to cosmetic gel coat finish defects, blisters, starrng, crazing; and fiberglass delaminating caused by blisters, crazing, spyder or hairline cracks or exposure to the elements.

3) LIMITATIONS OF LIABILITY

THIS WARRANTY IS EXPRESSLY GIVEN AND ACCEPTED IN LIEU OF ANY AND ALL OTHER WARRANTIES, EXPRESSED OR IMPLIED, INCLUDING WITHOUT LIMITATION ANY WARRANTY OF MERCHANTABILITY OR FITNESS FOR A PARTICULAR PURPOSE. TO THE EXTENT THAT THEY CANNOT BE DISCLAIMED, THE IMPLIED WARRANTIES ARE LIMITED IN DURATION TO THE LIFE OF THE EXPRESS WARRANTY. INCIDENTAL AND CONSEQUENTIAL DAMAGES ARE EXCLUDED FROM COVERAGE UNDER THIS WARRANTY. SOME JURISDICTIONS DO NOT ALLOW FOR THE DISCLAIMERS, LIMITATIONS AND EXCLUSIONS IDENTIFIED ABOVE, AS A RESULT, THEY MAY NOT APPLY TO YOU. THIS WARRANTY GIVES YOU SPECIFIC RIGHTS, AND YOU MAY ALSO HAVE OTHER LEGAL RIGHTS WHICH MAY VARY FROM COUNTRY TO COUNTRY.

Neither the distributor, any BRP distributor/dealer nor any other person has been authorized to make any affirmation, representation or warranty regarding the product, other than those contained in this limited warranty, and if made, shall not be enforceable against BRP.

BRP reserves the right to modify this warranty at any time, being understood that such modification will not alter the warranty conditions applicable to the products sold while this warranty is in effect.

4) WARRANTY COVERAGE PERIOD

This warranty will be in effect from the date of delivery to the first retail consumer or the date the product is first put into use, whichever occurs first and for a period of:

TWENTY-FOUR (24) CONSECUTIVE MONTHS for private use owners and TWELVE (12) CONSECUTIVE MONTHS for commercial use owners.

The repair or replacement of parts or the performance of service under this warranty does not extend the life of this warranty beyond its original expiration date.

Note that the duration and any other modalities of the warranty coverage are subject to the applicable national or local legislation in your country.

5) CONDITIONS TO HAVE WARRANTY COVERAGE

This warranty coverage is available only if each of the following conditions has been fulfilled:

- a) The 2008 Sea-Doo® Sport Boats must be purchased as new and unused by its first owner from a BRP distributor/dealer authorized to distribute Sea-Doo® Sport Boats products in the country in which the sale occurred ("BRP distributor/dealer");
- b) The BRP specified pre-delivery inspection process must be completed and documented;
- c) The product must have undergone proper registration by an authorized BRP distributor/dealer;
- d) The 2008 Sea-Doo® Sport Boats must be purchased in the country or union of countries in which the purchaser resides.
- e) Routine maintenance outlined in the Operator's Guide must be timely performed in order to maintain warranty coverage. BRP reserves the right to make warranty coverage contingent upon proof of proper maintenance.

BRP will not honor this limited warranty to any private use owner or commercial use owner if the preceding conditions have not been met. Such limitations are necessary in order to allow BRP to preserve both the safety of its products, and also that of its consumers and the general public.

6) WHAT TO DO TO OBTAIN WARRANTY COVERAGE

The customer must notify a servicing BRP distributor/dealer within two (2) months of the appearance of a defect, and provide it with reasonable access to the product and reasonable opportunity to repair it. The customer must also present to the authorized BRP distributor/dealer, proof of purchase of the product and must sign the repair/work order prior to starting the repair in order to validate the warranty repair. All parts replaced under this limited warranty become the property of BRP.

Note that the notification period is subject to the applicable national or local legislation in your country.

7) WHAT BRP WILL DO

BRP's obligations under this warranty are limited to, at its sole discretion, repairing parts found defective under normal use, maintenance and service, or replacing such parts with new genuine sport boat parts without charge for parts and labor, at any authorized BRP distributor/dealer during the warranty coverage period.

BRP reserves the right to improve or modify products from time to time without assuming any obligation to modify products previously manufactured.

8) TRANSFER

If the ownership of a product is transferred during the warranty coverage period, this warranty shall also be transferred and be valid for the remaining coverage period provided BRP or an authorized BRP distributor/dealer receives a proof that the former owner agreed to the transfer of ownership, in addition to the coordinates of the new owner.

9) CONSUMER ASSISTANCE

- a) In the event of a controversy or a dispute in connection with this limited warranty, BRP suggests that you try to resolve the issue at the dealership level. We recommend discussing the issue with the authorized Distributor/Dealer's service manager or owner.
- b) If further assistance is required, the distributor's service department should be contacted in order to resolve the matter. You will find your distributor's coordinates on www.brp.com.
- c) If the matter still remains unresolved then contact BRP at the address listed below.

For countries within Europe, Middle East, Africa, Russia & CIS, please contact our European office:

BRP EUROPE N.V.

Consumer Service Center
Skaldenstraat 125
9042 Gent
Belgium
Tel.: + 32-9-218-26-00

For Scandinavian countries, please contact our Finland office:

BRP FINLAND OY

Service Department
Ahjotie 30
Fin-96320 Rovaniemi
Finland
Tel.: + 358 16 3208 111

For all other countries, please contact your local distributor or our North America office:

BOMBARDIER RECREATIONAL PRODUCTS INC.

Consumer Services Group
75, J.-A. Bombardier Street
Sherbrooke, Québec J1L 1W3
Tel.: 819 566-3366

* For the territory covered by this limited warranty, products are distributed and serviced by Bombardier Recreational Products Inc. or its affiliates.

© 2007 Bombardier Recreational Products Inc. All rights reserved.

® Registered trademark of Bombardier Recreational Products Inc. or its affiliates.

The EC-Declaration of Conformity does not appear in this version of the Operator's Guide.

Please refer to the printed version that was delivered with your vehicle.

Homologation and Certification

These boats comply with the following standards:

STANDARD	TYPE OF CERTIFICATION
United States Coast Guard	Self certification
Canadian Coast Guard	Self certification
Russian Maritime Register of Shipping	Certify by Russian Maritime Register of Shipping 8, Dvortsovaya Nab., 191186 St. Petersburg, Russia
Directive 89/336/CEE of the council relating to electromagnetic compatibility	Internal production control plus control carried out on the responsibility of a competent body. Competent body: UTAC Autodrome de Linas-Montlhéry, B.P. 212 91311 Montlhéry cedex, France
Directive 2003/44/EC of the European Parliament and of the council relating to recreational craft	Internal production control plus control carried out on the responsibility of a notified body. Notified body: International Marine Certification Institute Trèves centre, rue de Trèves 45 1040 Brussels, Belgium

PRIVACY OBLIGATION/DISCLAIMER

We wish to inform you that your coordinates will be used for safety and warranty purposes. Sometimes, we also use the coordinates of our clients to inform them about our products and to present them offers. Should you prefer not to receive information on our products, services and offers, please let us know by writing to the address below.

Also note that, from time to time, carefully selected and trustworthy organizations may be permitted to use the coordinates of our clients to promote quality products and services. If you prefer not to have your name and address released, please let us know by writing to the address below:

In Canada

BOMBARDIER RECREATIONAL PRODUCTS INC.

Warranty Department
75, J.-A. Bombardier Street
Sherbrooke, Québec J1L 1W3
Fax Number: 819 566-3590

In USA

BRP US INC.

Warranty Department
7575 Bombardier Court
Wausau WI 54401
Tel.: 715 848-4957

Other countries in the world

BRP EUROPEAN DISTRIBUTION

Warranty Department
Chemin de Messidor 5-7
1006 Lausanne Switzerland
Fax Number: + 41213187801

CHANGE OF ADDRESS/OWNERSHIP

If your address has changed or if you are the new owner of the boat, be sure to notify BRP by either:

- mailing one of the following card below;
- **North America only:** calling at 715 848-4957 (USA) or 819 566-3366 (Canada);
- contacting an authorized BRP distributor/dealer.

In case of change of ownership, please join a proof that the former owner agreed to the transfer.

Notifying BRP, even after the expiration of the limited warranty, is very important as it enables BRP to reach the boat owner if necessary, like when safety recalls are initiated. It is the owner's responsibility to notify BRP.

STOLEN UNITS: In the event that your boat is stolen, you should notify your area's distributor warranty department of such. We will ask you to provide your name, address, phone number, Hull Identification Number and date it was stolen.

In North America

BOMBARDIER RECREATIONAL PRODUCTS INC.

Warranty Department
75, J.-A. Bombardier Street
Sherbrooke, Québec J1L 1W3
Canada

Other countries in the world

BRP EUROPEAN DISTRIBUTION

Warranty Department
Chemin de Messidor 5-7
1006 Lausanne
Switzerland



CHANGE OF ADDRESS

CHANGE OF OWNERSHIP

VEHICLE IDENTIFICATION NUMBER

Model Number

Vehicle Identification Number (V.I.N.)

OLD ADDRESS
OR PREVIOUS OWNER:

NAME

NO.

STREET

APT

CITY

STATE/PROVINCE

ZIP/POSTAL CODE

COUNTRY

TELEPHONE

NEW ADDRESS
OR NEW OWNER:

NAME

NO.

STREET

APT

CITY

STATE/PROVINCE

ZIP/POSTAL CODE

COUNTRY

TELEPHONE

CHANGE OF ADDRESS/OWNERSHIP

If your address has changed or if you are the new owner of the boat, be sure to notify BRP by either:

- mailing one of the following card below;
- **North America only:** calling at 715 848-4957 (USA) or 819 566-3366 (Canada);
- contacting an authorized BRP distributor/dealer.

In case of change of ownership, please join a proof that the former owner agreed to the transfer.

Notifying BRP, even after the expiration of the limited warranty, is very important as it enables BRP to reach the boat owner if necessary, like when safety recalls are initiated. It is the owner's responsibility to notify BRP.

STOLEN UNITS: In the event that your boat is stolen, you should notify your area's distributor warranty department of such. We will ask you to provide your name, address, phone number, Hull Identification Number and date it was stolen.

In North America

BOMBARDIER RECREATIONAL PRODUCTS INC.
Warranty Department
75, J.-A. Bombardier Street
Sherbrooke, Québec J1L 1W3
Canada

Other countries in the world

BRP EUROPEAN DISTRIBUTION
Warranty Department
Chemin de Messidor 5-7
1006 Lausanne
Switzerland



CHANGE OF ADDRESS <input type="checkbox"/>					CHANGE OF OWNERSHIP <input type="checkbox"/>				
VEHICLE IDENTIFICATION NUMBER									
Model Number			Vehicle Identification Number (V.I.N.)						
OLD ADDRESS OR PREVIOUS OWNER:					NAME				
NO.		STREET			APT				
CITY			STATE/PROVINCE		ZIP/POSTAL CODE				
COUNTRY					TELEPHONE				
NEW ADDRESS OR NEW OWNER:					NAME				
NO.		STREET			APT				
CITY			STATE/PROVINCE		ZIP/POSTAL CODE				
COUNTRY					TELEPHONE				

V00A2F

BOAT MODEL No. _____

HULL IDENTIFICATION NUMBER (H.I.N.) _____

ROTAX ENGINE IDENTIFICATION NUMBER (E.I.N.) _____

Owner: _____
NAME

No. STREET APT

CITY STATE/PROVINCE ZIP/POSTAL CODE

Purchase Date _____
YEAR MONTH DAY

Warranty Expiry Date _____
YEAR MONTH DAY

To be completed by the dealer at the time of the sale.

DEALER IMPRINT AREA

F00A35L

Please verify with your selling dealer to ensure your SEA-DOO sport boat has been registered with BRP.

204 630 369

CA

OPERATOR'S GUIDE, 205 UTOPIA, SE / ENGLISH
GUIDE DU CONDUCTEUR, 205 UTOPIA, SE / ANGLAIS

FAIT AU / MADE IN CANADA

U/M:P.C.