

can-am™



2009

**Operator's
Guide**

**Includes
Safety, Vehicle
and Maintenance Information**

RENEGADE™

⚠ WARNING

Read this guide thoroughly. It contains important safety information.

Minimum recommended operator age: 16 years. Do not remove this Operator's Guide from the vehicle.

2 1 9 0 0 0 6 1 4

CALIFORNIA PROPOSITION 65 WARNING

WARNING

This product contains or emits chemicals known to the state of California to cause cancer and birth defects or other reproductive harm.

WARNING

YOUR VEHICLE CAN BE HAZARDOUS TO OPERATE. A collision or rollover can occur quickly, even during routine maneuvers such as turning and driving on hills or over obstacles, if you fail to take proper precautions. For your safety, understand and follow all the warnings contained in this Operator's Guide and the labels on your vehicle. **Failure to follow these warnings can result in SEVERE INJURY OR DEATH!**
Keep this Operator's Guide with the vehicle at all times.

WARNING

Disregarding any of the safety precautions and instructions contained in this Operator's Guide, *SAFETY VIDEO* and on-product labels could cause injury including the possibility of death!

WARNING

This vehicle may exceed the performance of other vehicles you may have ridden in the past. Take time to familiarize yourself with your new vehicle.

In Canada, products are distributed by Bombardier Recreational Products Inc. (BRP).

In USA, products are distributed by BRP US Inc.

The following trademarks are the property of Bombardier Recreational Products Inc.:

Can-Am™

Renegade™

Rotax®

XP-S™

TTI™

DESS™

FOREWORD

Congratulations on your purchase of a new Can-Am™ ATV. It's backed by the BRP warranty and a network of authorized Can-Am dealers ready to provide the parts, accessories or service you may require.

Your dealer is committed to your satisfaction. He has taken training to perform the initial setup and inspection of your vehicle as well as completed the final adjustment before you took possession. If you need more complete servicing information, please ask your dealer.

At delivery, you were also informed of the warranty coverage and signed the *PREDELIVERY CHECK LIST* to ensure your new vehicle was prepared to your entire satisfaction.

Know Before You Go

To learn how to reduce the risk for you or bystanders being hurt or killed, read the following sections before you operate the vehicle:

- SAFETY INFORMATION
- VEHICLE INFORMATION

We highly recommend that you take a safety riding course. Please check with your dealer or local authorities for availability in your area.

Keep this Operator's Guide in the vehicle as you can refer to it for things such as maintenance, troubleshooting and instructing others.

Safety Messages

The types of safety messages, what they look like and how they are used in this guide are explained as follows:

WARNING

Indicates a hazardous situation which, if not avoided, could result in death or serious injury.

 CAUTION Indicates a hazard situation which, if not avoided, could result in minor or moderate injury.

NOTICE Indicates an instruction which, if not followed, could severely damage vehicle components or other property.

About This Operator's Guide

This Operator's Guide has been prepared to acquaint the owner/operator of a new vehicle with the various vehicle controls, maintenance and safe operating instructions. They are indispensable for the proper use of the product.

Note that this guide is available in several languages. In the event of any discrepancy, the English version shall prevail.

If you want to view and/or print an extra copy of your Operator's Guide, simply visit the following website www.operatorsguide.brp.com.

The informations contained in this document are correct at the time of publication. BRP, however, maintains a policy of continuous improvement of its products without imposing upon itself any obligation to install them on products previously manufactured. Due to late changes, some differences between the manufactured product and the descriptions and/or specifications in this guide may occur. BRP reserves the right at any time to discontinue or

change specifications, designs, features, models or equipment without incurring any obligation upon itself.

This Operator's Guide and the *SAFETY VIDEO* should remain with the vehicle when it is sold.

While reading this Operator's Guide, reminder that:

 **WARNING**

Indicates a potential hazard that, if not avoided, could result in serious injury or death.

TABLE OF CONTENTS

| | |
|-----------------------------------|----------|
| FOREWORD | 1 |
| Know Before You Go | 1 |
| Safety Messages..... | 1 |
| About This Operator's Guide | 1 |

SAFETY INFORMATION

| | |
|--|----------|
| GENERAL PRECAUTIONS | 8 |
| Avoid Carbon Monoxide Poisoning | 8 |
| Avoid Gasoline Fires and Other Hazards | 8 |
| Avoid Burns from Hot Parts | 8 |
| Accessories and Modifications | 8 |

| | |
|--------------------------------------|----------|
| SPECIAL SAFETY MESSAGES | 9 |
|--------------------------------------|----------|

| | |
|---------------------------------|-----------|
| OPERATION WARNINGS | 12 |
|---------------------------------|-----------|

| | |
|--|-----------|
| RIDING THE VEHICLE | 38 |
| Pre-Ride Inspection | 39 |
| Clothing | 39 |
| Carrying Loads | 40 |
| Hauling a Trailer..... | 41 |
| Working with your Vehicle..... | 41 |
| Recreational Riding | 41 |
| Environment..... | 42 |
| Design Limitation | 42 |
| Off-Highway Operation..... | 43 |
| General Operating and Safety Precautions | 43 |
| Uphill Driving | 43 |
| Downhill Driving..... | 44 |
| Side Hilling | 44 |
| Drop-Offs | 44 |
| Riding Techniques..... | 44 |
| Routine Maintenance | 49 |

| | |
|-----------------------|-----------|
| HANG TAG | 51 |
|-----------------------|-----------|

| | |
|--|-----------|
| IMPORTANT ON-PRODUCT LABELS | 52 |
|--|-----------|

VEHICLE INFORMATION

| | |
|--|-----------|
| CONTROLS/INSTRUMENTS/EQUIPMENTS | 58 |
| 1) Throttle Lever | 60 |
| 2) 2WD/4WD Selector | 61 |
| 3) Rear Brake Lever | 62 |
| 4) Front Brake Lever | 62 |

| | |
|--|-----------|
| CONTROLS/INSTRUMENTS/EQUIPMENTS (cont'd) | |
| 5) Parking Brake | 62 |
| 6) Transmission Lever | 63 |
| 7) Multifunction Switch | 64 |
| 8) Multifunction Gauge | 66 |
| 9) 12-Volt Power Outlet | 69 |
| 10) Ignition Switch | 69 |
| 11) Rear Brake Pedal | 70 |
| 12) Rear Storage Compartment | 70 |
| 13) Seat Latch | 71 |
| 14) Rear Cargo Area | 71 |
| 15) Recovery Hook | 72 |
| 16) Tool Kit | 72 |
| FUEL | 73 |
| Recommended Fuel | 73 |
| Fueling Procedure | 73 |
| OPERATING INSTRUCTIONS | 74 |
| Operating During Break-In | 74 |
| Starting the Engine | 74 |
| Shifting the Transmission | 74 |
| Stopping the Engine | 75 |
| Post-Operation Care | 75 |
| What to Do if Vehicle is Turned Over | 75 |
| What to Do if Vehicle is Immersed in Water | 75 |
| TUNE YOUR RIDE | 76 |
| Suspension Adjustment | 76 |
| VEHICLE TRANSPORTATION | 79 |

MAINTENANCE INFORMATION

| | |
|-------------------------------------|-----------|
| MAINTENANCE SCHEDULE | 82 |
| 10-HOUR INSPECTION | 88 |
| MAINTENANCE PROCEDURES | 89 |
| Air Filter | 89 |
| Engine Oil | 90 |
| Radiator | 92 |
| Engine Coolant | 93 |
| Spark Arrester | 95 |
| CVT Air Filter | 96 |
| CVT Cover Drain Screw | 98 |
| Gearbox Oil | 98 |
| Throttle Cable | 99 |

| | |
|--|------------|
| MAINTENANCE PROCEDURES (cont'd) | |
| Throttle Lever | 100 |
| Spark Plug | 101 |
| Battery | 102 |
| Fuses..... | 102 |
| Lights..... | 104 |
| Drive Shaft Boot/Protector | 105 |
| Wheel and Tires | 105 |
| Suspension | 107 |
| Brake | 107 |
| Body..... | 109 |
| Frame | 110 |
| STORAGE AND PRESEASON PREPARATION | 111 |

TECHNICAL INFORMATION

| | |
|---|------------|
| VEHICLE IDENTIFICATION | 114 |
| Vehicle Identification Number..... | 114 |
| Engine Identification Number | 114 |
| Compliance Label | 114 |
| NOISE EMISSION CONTROL SYSTEM REGULATION | 115 |
| SPECIFICATIONS | 116 |

TROUBLESHOOTING

| | |
|--|------------|
| TECHNICAL GUIDELINES | 122 |
| MESSAGES IN MULTIFUNCTION GAUGE | 126 |

WARRANTY

| | |
|--|------------|
| BRP LIMITED WARRANTY USA AND CANADA: 2009 CAN-AM™ ATV .. | 128 |
| BRP INTERNATIONAL LIMITED WARRANTY: 2009 CAN-AM™ ATV | 133 |
| BRP LIMITED WARRANTY FOR THE EUROPEAN ECONOMIC AREA: 2009 CAN-AM™ ATV | 137 |
| PRIVACY OBLIGATION/DISCLAIMER | 141 |
| CHANGE OF ADDRESS/OWNERSHIP | 142 |

SAFETY INFORMATION

GENERAL PRECAUTIONS

Avoid Carbon Monoxide Poisoning

All engine exhaust contains carbon monoxide, a deadly gas. Breathing carbon monoxide can cause headaches, dizziness, drowsiness, nausea, confusion and eventually death.

Carbon monoxide is a colorless, odorless, tasteless gas that may be present even if you do not see or smell any engine exhaust. Deadly levels of carbon monoxide can collect rapidly, and you can quickly be overcome and unable to save yourself. Also, deadly levels of carbon monoxide can linger for hours or days in enclosed or poorly ventilated areas. If you experience any symptoms of carbon monoxide poisoning, leave the area immediately, get fresh air and seek medical treatment.

To prevent serious injury or death from carbon monoxide:

- Never run the vehicle in poorly ventilated or partially enclosed areas such as garages, carports or barns. Even if you try to ventilate engine exhaust with fans or open windows and doors, carbon monoxide can rapidly reach dangerous levels.
- Never run the vehicle outdoors where engine exhaust can be drawn into a building through openings such as windows and doors.

Avoid Gasoline Fires and Other Hazards

Gasoline is extremely flammable and highly explosive. Fuel vapors can spread and be ignited by a spark or

flame many feet away from the engine. To reduce the risk of fire or explosion, follow these instructions:

- Refuel outdoors in a well ventilated area away from flames, sparks, anyone smoking and other sources of ignition.
- Never add fuel with engine running.
- Never top off the fuel tank. Leave some room for the fuel to expand with temperature changes.
- Wipe up any spilled fuel.
- Never start or operate the engine with the fuel cap removed.
- Use only an approved red gasoline container to store fuel.

Gasoline is poisonous and can cause injury or death.

- Never siphon gasoline by mouth.
- If you swallow gasoline, get any in your eye or inhale gasoline vapor, see your doctor immediately.

If gasoline spills on you, wash with soap and water and change your clothes.

Avoid Burns from Hot Parts

The exhaust system and engine become hot during operation. Avoid contact during and shortly after operation to avoid burns.

Accessories and Modifications

Do not make unauthorized modifications, or use attachments or accessories that are not approved by BRP. Since these changes have not been tested by BRP, they may increase the risk of crashes or injuries, and they can make the vehicle illegal.

See your authorized Can-Am dealer for available accessories for your vehicle.

SPECIAL SAFETY MESSAGES

WARNING

THIS VEHICLE IS NOT A TOY AND CAN BE HAZARDOUS TO OPERATE. This vehicle handles differently from other vehicles. A collision or rollover can occur quickly, even during routine maneuvers such as turning and driving on hills or over obstacles, if you fail to take proper precautions.

WARNING

SEVERE INJURY OR DEATH can result if you do not follow these instructions:

- Read this Operator's Guide and all on-product warning labels carefully and follow the operating procedures described. Watch and pay attention to the *SAFETY VIDEO* before operation.
- Never operate this vehicle without proper instruction. Take a training course. All operators should receive training from a certified instructor. Contact an authorized Can-Am dealer for more information.
USA and Canada only: to find out about available training course nearest you, call the Specialty Vehicle Institute of America (SVIA) at 1 800 887-2887 or in Canada, the Canada safety Council (CSC) at 1 613 739-1535 ext. 227.
- Always follow this age recommendation: A person under 16 years old should never operate this vehicle.
- Never carry a passenger on this vehicle.
- Never operate this vehicle on any paved surfaces, including sidewalks, driveways, parking lots and streets.
- Never operate this vehicle on any public street, road or highway, even a dirt or gravel one.
- Never take place on this vehicle without wearing an approved helmet that fits properly. You should also wear eye protection (goggles or face shield), gloves, boots, long sleeved shirt or jacket, and long pants.
- Never ride this vehicle under influence of alcohol or drugs. They slow reaction time and impair judgement.
- Never operate at excessive speeds. Always go at a speed that is proper for the terrain, visibility, and operating conditions, and your experience.
- Never attempt wheelies, jumps, or other stunts.
- Always inspect and confirm the safe operating condition of your vehicle prior to ride. Always follow the inspection and maintenance procedures and schedules described in this Operator's Guide.
- Always keep both hands on the handlebars and both feet on the footrests of the vehicle during operation.
- Always go slowly and be extra careful when operating on unfamiliar terrain. Always be alert to changing terrain conditions when operating this vehicle.

⚠ WARNING

- Never operate on excessively rough, slippery or loose terrain until you have learned and practiced the skills necessary to control this vehicle on such terrain. Always be especially cautious on these kinds of terrain.
- Always follow proper procedures for turning as described further in this Operator's Guide. Practice turning at low speeds before attempting to turn at faster speeds. Do not turn at excessive speed.
- Never operate this vehicle on hills too steep for the vehicle or for your abilities. Practice on smaller hills before attempting larger hills.
- Always follow proper procedures for climbing hills as described further in this Operator's Guide. Check the terrain carefully before you start up any hill. Never climb hills with excessively slippery or loose surfaces. Shift your weight forward. Never open the throttle suddenly or make sudden gear changes. Never go over the top of any hill at high speed.
- Always follow proper procedures for going down hills and for braking on hills as described further in this Operator's Guide. Check the terrain carefully before you start down any hill. Shift your weight backward. Never go down a hill at high speed. Avoid going down a hill at an angle that would cause the vehicle to lean sharply to one side. Go straight down the hill where possible.
- Always follow proper procedures for crossing the side of a hill as described further in this Operator's Guide. Avoid hills with excessively slippery or loose surfaces. Shift your weight to the uphill side of the vehicle. Never attempt to turn the vehicle around on any hill until you have mastered the turning technique described in this Operator's Guide on level ground. Avoid crossing the side of a steep hill if possible.
- Always use proper procedures if you stall or roll backwards when climbing a hill. To avoid stalling, use proper gear and maintain a steady speed when climbing a hill. If you stall or roll backwards, follow the special procedure for braking described in this Operator's Guide. Dismount on the uphill side or to a side if pointed straight uphill. Turn the vehicle around and remount, following the procedure described further in this Operator's Guide.
- Always check for obstacles before operating in a new area. Never attempt to operate over large obstacles, such as large rocks or fallen trees. Always follow proper procedures when operating over obstacles as described further in this Operator's Guide.
- Always be careful when skidding or sliding. Learn to safely control skidding or sliding by practicing at low speeds and on level smooth terrain. On extremely slippery surfaces, such as ice, go slowly and be very cautious in order to reduce the chance of skidding out of control.
- Never operate this vehicle in fast flowing water or in water deeper than that specified in this Operator's Guide. Remember that wet brakes may have reduced stopping ability. Test your brakes after leaving water. If necessary, apply them several times to let friction dry out the pads.

 **WARNING**

- Always be sure there are no obstacles or people behind the vehicle when you operate in reverse. When it is safe to proceed in reverse, go slowly.
- Always use the size and type tires specified further in this Operator's Guide. Always maintain proper tire pressure as described further in this Operator's Guide.
- Never modify this vehicle through improper installation or use of accessories. Only use BRP's approved accessories. NEVER install passenger seat or use the cargo area to carry a passenger.
- Never exceed the stated load limits for this vehicle including operator, all other loads and added accessories. Cargo should be properly distributed and securely attached. Reduce speed and follow instructions in this manual for carrying cargo or pulling a trailer. Allow greater distance for braking.

OPERATION WARNINGS

The following warning and their format have been requested by the United States Consumer Product Safety Commission and are required to be in the Operator's Guide for all ATVs.

NOTE: The following illustrations are general representations only. Your model may differ.

WARNING



V00A0AQ

POTENTIAL HAZARD

Operating this vehicle without proper instruction.

WHAT CAN HAPPEN

The risk of an accident is greatly increased if the operator does not know how to operate this vehicle properly in different situations and on different types of terrain.

HOW TO AVOID THE HAZARD

Beginning and inexperienced operators should complete a training course. They should then regularly practice the skills learned in the course and the operating techniques described in this Operator's Guide.

For more information about the training course, contact an authorized Can-Am dealer.

⚠ WARNING

V00A01Q

POTENTIAL HAZARD

Failure to follow the age recommendations for this vehicle.

WHAT CAN HAPPEN

A lack of respect for this age recommendation can lead to severe injury or death of the child.

Even though a child may be within the age group for which this vehicle is recommended, he may not have the skills, abilities, or judgment needed to operate this vehicle safely and may be involved in a serious accident.

HOW TO AVOID THE HAZARD

No one under 16 should operate this vehicle.

⚠ WARNING



V00A02Q

POTENTIAL HAZARD

Carrying a passenger on this vehicle.

WHAT CAN HAPPEN

Greatly reduces your ability to balance and control this vehicle.

Could cause an accident, resulting in harm to you and/or your passenger.

HOW TO AVOID THE HAZARD

Never carry passenger. Even with a long seat that provides unrestricted operator movement, it is not designed nor intended to carry passenger(s).

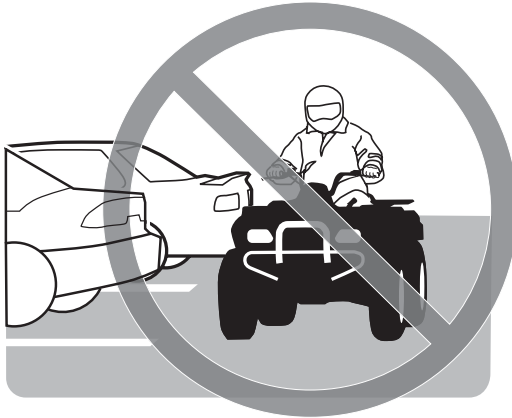
⚠ WARNING

V00A03Q

POTENTIAL HAZARD

Operating this vehicle on paved surfaces.

WHAT CAN HAPPEN

The tires are designed for off-road use only, not for use on pavement. Paved surfaces may seriously affect handling and control of this vehicle, and may cause the vehicle to go out of control.

HOW TO AVOID THE HAZARD

Never operate this vehicle on any paved surfaces, including sidewalks, driveways, parking lots and streets.

⚠ WARNING



V00A04Q

POTENTIAL HAZARD

Operating this vehicle on public streets, roads or highways.

WHAT CAN HAPPEN

You can collide with another vehicle.

HOW TO AVOID THE HAZARD

Never operate this vehicle on any public street, road or highway, even a dirt or gravel one. In many states or provinces it is illegal to operate this vehicle on public streets, roads or highways.

⚠ WARNING

V00A06Q

POTENTIAL HAZARD

Riding this vehicle without wearing an approved helmet, eye protection and protective clothing.

WHAT CAN HAPPEN

The following items concern all ATV's operator:

- Riding without an approved helmet increases the chances of a severe head injury or death in the event of an accident.
- Riding without eye protection can result in an accident and increases the chances of a severe injury in the event of an accident.
- Riding without protective clothing increases the chances of severe injury in the event of an accident.

HOW TO AVOID THE HAZARD

Always wear an approved helmet that fits properly. You should also wear:

- Eye protection (goggles or face shield)
- Gloves and boots
- Long sleeved shirt or jacket
- Long pants.

⚠ WARNING



V00A07Q

POTENTIAL HAZARD

Riding this vehicle after consuming alcohol or drugs.

WHAT CAN HAPPEN

- Could seriously affect your judgment.
- Could cause you to react more slowly.
- Could affect your balance and perception.
- Could result in an accident or death.

HOW TO AVOID THE HAZARD

Never consume alcohol or drugs before or while riding this vehicle.

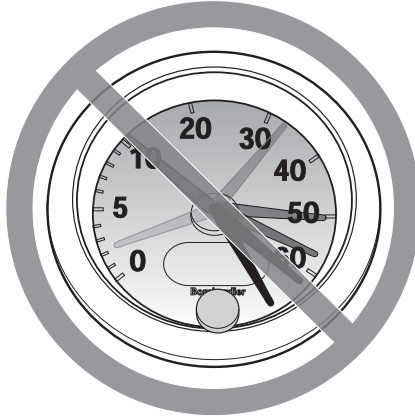
⚠ WARNING

V00A08Q

POTENTIAL HAZARD

Operating this vehicle at excessive speeds.

WHAT CAN HAPPEN

Increases your chances of losing control of the vehicle, which can result in an accident.

HOW TO AVOID THE HAZARD

Always travel at a speed which is proper for the terrain, visibility and operating conditions, and your experience.

⚠ WARNING



V00A09Q

POTENTIAL HAZARD

Attempting wheelies, jumps and other stunts.

WHAT CAN HAPPEN

Increases the chance of an accident, including an overturn.

HOW TO AVOID THE HAZARD

Never attempt stunts, such as wheelies or jumps. Do not try to show off.

⚠ WARNING

POTENTIAL HAZARD

Failure to inspect the vehicle before operating.

Failure to properly maintain the vehicle.

WHAT CAN HAPPEN

Increases the possibility of an accident or equipment damage.

HOW TO AVOID THE HAZARD

Inspect your vehicle every time prior you use it to make sure the vehicle is in safe operating condition.

Always follow the inspection and maintenance procedures and schedules described further in this Operator's Guide.

⚠ WARNING

POTENTIAL HAZARD

Riding on frozen waterways.

WHAT CAN HAPPEN

Breaking through the ice can lead to severe injury or death.

HOW TO AVOID THE HAZARD

Never ride this vehicle on a frozen surface before you are sure the ice is thick enough and sound enough to support the vehicle and its load, as well as the force that is created by a moving vehicle.

⚠ WARNING



V00A0BQ

POTENTIAL HAZARD

Removing hands from handlebar or feet from the footrests during operation.

WHAT CAN HAPPEN

Removing even one hand or foot can reduce your ability to control the vehicle or could cause you to lose your balance and fall off the vehicle. If you remove a foot from the footrests, your foot or leg may come into contact with the rear wheels, which could injure you or cause an accident.

HOW TO AVOID THE HAZARD

Always keep both hands on the handlebar and both feet on the footrests during vehicle operation.

⚠ WARNING

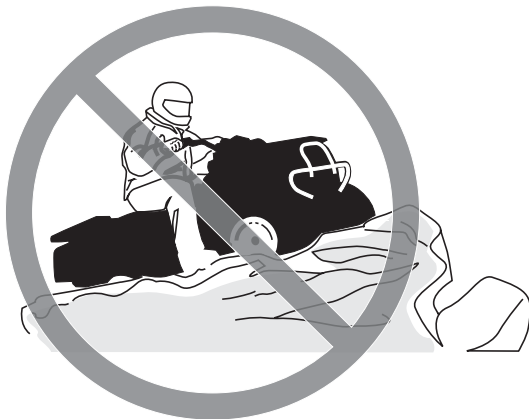

V00A0CQ

POTENTIAL HAZARD

Failure to use extra care when operating this vehicle on unfamiliar terrain.

WHAT CAN HAPPEN

You can come upon hidden rocks, bumps, or holes, without enough time to react.

Could result in the vehicle overturning or loss of control.

HOW TO AVOID THE HAZARD

Go slowly and be extra careful when operating on unfamiliar terrain.

Always be alert to changing terrain conditions when operating the vehicle.

⚠ WARNING

V00A0DQ

POTENTIAL HAZARD

Failure to use extra care when operating on excessively rough, slippery or loose terrain.

WHAT CAN HAPPEN

Could cause loss of traction or vehicle control, which could result in an accident, including an overturn.

HOW TO AVOID THE HAZARD

Do not operate on excessively rough, slippery or loose terrain until you have learned and practiced the skills necessary to control this vehicle on such terrain.

Always be especially cautious on these kinds of terrain.

⚠ WARNING



V00A0EQ

POTENTIAL HAZARD

Turning improperly.

WHAT CAN HAPPEN

Vehicle could go out of control, causing a collision or overturn.

HOW TO AVOID THE HAZARD

Always follow proper procedures for turning as described further in this Operator's Guide. Practice turning at low speeds before attempting to turn at faster speeds.

Do not turn at excessive speed.

⚠ WARNING

V00AQQ

POTENTIAL HAZARD

Operating on excessively steep hills.

WHAT CAN HAPPEN

The vehicle can overturn more easily on extremely steep hills than on level surfaces or small hills.

HOW TO AVOID THE HAZARD

Never operate this vehicle on hills too steep for the vehicle or for your abilities.

Practice on smaller hills before attempting larger hills.

⚠ WARNING



V00A0FQ

POTENTIAL HAZARD

Climbing hills improperly.

WHAT CAN HAPPEN

Could cause loss of control or cause vehicle to overturn.

HOW TO AVOID THE HAZARD

Always follow proper procedures for climbing hills as described further in this Operator's Guide.

Always check the terrain carefully before you start up any hill.

Never climb hills with excessively slippery or loose surfaces.

Shift your weight forward.

Never open the throttle suddenly or make sudden gear changes. The vehicle could flip over backwards.

Never go over the top of any hill at high speed. An obstacle, a sharp drop, or another vehicle or person could be on the other side of the hill.

⚠ WARNING

V00A0GQ

POTENTIAL HAZARD

Going down a hill improperly.

WHAT CAN HAPPEN

Could cause loss of control or cause vehicle to overturn.

HOW TO AVOID THE HAZARD

Always follow proper procedures for going down hills as described further in this Operator's Guide.

NOTE: A special technique is required when braking as you go down a hill.

Always check the terrain carefully before you start down any hill.

Shift your weight backward.

Never go down a hill at high speed.

Avoid going down a hill at an angle which would cause the vehicle to lean sharply to one side. Go straight down the hill where possible.

⚠ WARNING



V00A0HQ

POTENTIAL HAZARD

Improperly crossing hills or turning on hills.

WHAT CAN HAPPEN

Could cause loss of control or cause vehicle to overturn.

HOW TO AVOID THE HAZARD

Never attempt to turn the vehicle around on any hill until you have mastered the turning technique as described further in this Operator's Guide on level ground. Be very careful when turning on any hill.

Avoid crossing the side of a steep hill if possible.

When crossing the side of a hill:

Always follow proper procedures as described further in this Operator's Guide.

Avoid hills with excessively slippery or loose surfaces.

Shift your weight to the uphill side of the vehicle.

⚠ WARNING



V00A01Q

POTENTIAL HAZARD

Stalling, rolling backwards or improperly dismounting while climbing a hill.

WHAT CAN HAPPEN

Could result in vehicle overturning.

HOW TO AVOID THE HAZARD

Use proper gear and maintain steady speed when climbing a hill.

If you lose all forward speed:

Keep your weight uphill. Never open the throttle suddenly or make sudden gear changes. The vehicle could flip over backwards.

Apply the brakes.

Lock parking brake after you have stopped.

Dismount on uphill side, or to a side if pointed straight uphill.

If you begin rolling backwards:

Keep your weight uphill. Never open the throttle suddenly or make sudden gear changes. The vehicle could flip over backwards.

Never apply the rear brake while rolling backwards.

Apply the front brake gradually.

When fully stopped, apply rear brake as well and lock parking brake.

Dismount on uphill side, or to a side if pointed straight uphill.

Turn the vehicle around and remount, following the procedure described further in this Operator's Guide.

⚠ WARNING



V00A0JQ

POTENTIAL HAZARD

Improperly operating over obstacles.

WHAT CAN HAPPEN

Could cause loss of control or a collision.

Could cause the vehicle to overturn.

HOW TO AVOID THE HAZARD

Before operating in a new area, check for obstacles.

Never attempt to ride over large obstacles, such as large rocks or fallen trees.

When you go over obstacles, always follow proper procedures as described further in this Operator's Guide.

⚠ WARNING

V00A0KQ

POTENTIAL HAZARD

Skidding or sliding improperly.

WHAT CAN HAPPEN

You may lose control of this vehicle.

You may also regain traction unexpectedly, which may cause the vehicle to overturn.

HOW TO AVOID THE HAZARD

Learn to safely control skidding or sliding by practicing at low speeds and on level smooth terrain.

On extremely slippery surfaces, such as ice, go slowly and be very cautious in order to reduce the chance of skidding or sliding out of control.

⚠ WARNING



V00A0LQ

POTENTIAL HAZARD

Operating this vehicle through deep or fast flowing water.

WHAT CAN HAPPEN

Tires may float, causing loss of traction and loss of control, which could lead to an accident.

HOW TO AVOID THE HAZARD

Never operate this vehicle in fast flowing water or in water deeper than that specified further in this Operator's Guide.

Check water depth and current before you attempt to cross any water. Water should not go above footrests.

Remember that wet brakes may have reduced stopping ability. Test your brakes after leaving water. If necessary, apply them several times to let friction dry out the pads.

⚠ WARNING

V00A0MQ

POTENTIAL HAZARD

Improperly operating in reverse.

WHAT CAN HAPPEN

You could hit an obstacle or person behind the vehicle, resulting in serious injury.

HOW TO AVOID THE HAZARD

When you select reverse gear, make sure there are no obstacles or people behind the vehicle. When it is safe to proceed, go slowly.

⚠ WARNING



V00A00Q

POTENTIAL HAZARD

Operating this vehicle with improper tires, or with improper or uneven tire pressure.

WHAT CAN HAPPEN

Use of improper tires on this vehicle, or operation of this vehicle with improper or uneven tire pressure, may cause loss of control, tire blow outs, tire to move around on its rim and increases the risk of an accident.

HOW TO AVOID THE HAZARD

Always use the size and type of tires specified further in this Operator's Guide for this vehicle.

Always maintain proper tire pressure as described further in this Operator's Guide.

Always replace wheels or tires that are damaged.

⚠ WARNING

V00A0NQ

POTENTIAL HAZARD

Operating this vehicle with improper modifications.

WHAT CAN HAPPEN

Improper installation of accessories or modification of this vehicle may cause changes in handling which in some situations could lead to an accident.

HOW TO AVOID THE HAZARD

Never modify this vehicle through improper installation or use of accessories. All parts and accessories added to this vehicle should be approved by BRP and should be installed and used according to instructions. If you have questions, consult an authorized Can-Am dealer.

NEVER install passenger seat or use the cargo area to carry a passenger.

Modification of the vehicle to increase speed and performance may violate the terms and conditions of your vehicle's limited warranty. In addition, certain modifications including the removal of engine or exhaust components are illegal under most laws.

⚠ WARNING



V00A0PQ

POTENTIAL HAZARD

Overloading this vehicle or carrying or towing cargo improperly.

WHAT CAN HAPPEN

Could cause changes in vehicle handling which could lead to an accident.

HOW TO AVOID THE HAZARD

Never exceed the stated load capacity for this vehicle including operator, as well as other loads and added accessories.

Cargo should be properly distributed and securely attached.

Reduce speed when carrying cargo or pulling a trailer. Allow greater distance for braking.

Always follow the instructions in this Operator's Guide for carrying cargo or pulling a trailer.

⚠ WARNING

V03M01Q

POTENTIAL HAZARD

Transporting flammable or dangerous material can lead to explosions.

WHAT CAN HAPPEN

This can cause serious injury or death.

HOW TO AVOID THE HAZARD

Never transport flammable or dangerous material.

While reading this Operator's Guide, reminder that:

⚠ WARNING

Indicates a potential hazard that, if not avoided, could result in serious injury or death.

RIDING THE VEHICLE

To fully appreciate the pleasures and excitement of riding this vehicle, there are some basic rules and tips that you **MUST** follow. Some may be new to you while others may be common sense or obvious.

Please take the time to study this Operator's Guide and all on-product warning labels as well as the *SAFETY VIDEO* that came with this vehicle. They more completely describe what you should know about this vehicle before riding it.

Whether you are a new user or an experienced rider, it is important for your personal safety that you know the controls and features of this vehicle. Equally important is knowing how to properly ride.

Information in this Operator's Guide is limited. It is strongly recommended that you obtain further information and training from your local authorities, ATV clubs, a recognized ATV training organization or contact an authorized Can-Am dealer.

USA and Canada only: to find out about available training course nearest you, call the Specialty Vehicle Institute of America (SVIA) at 1 800 887-2887 or in Canada, the Canada safety Council (CSC) at 1 613 739-1535 ext. 227.

The U.S. Consumer Product Safety Commission and all ATV manufacturers recommends that no one under the age of 16 drives an ATV having an engine higher than 90 cc. For the child's safety, we strongly recommend you also follow and enforce this recommendation. You are the sole judge of a rider's capability to understand the risks and operate a vehicle safely.

Persons with cognitive or physical impairments or who are high risk takers have an increased exposure to overturns or collisions which may result in injury including death.

Not all vehicles are the same. Each has its own unique performance characteristics, controls and features. Each will ride and handle differently.

Become completely familiar with the operational controls and the general operation of the vehicle before venturing into off road conditions. Practice driving in a suitable area free of hazards and feel the response of each control. Drive at low speeds. Higher speeds require greater experience, knowledge and suitable riding conditions.

Riding conditions vary from place to place. Each is subject to weather conditions which may radically change from time to time and from season to season.

Riding on sand is different than riding on snow or through forests or marshes. Each location may require a greater degree of awareness and skill. Show good judgement. Always proceed with caution. Please do not take any unnecessary risks that could leave you stranded or possibly injured.

Never assume that the vehicle will go everywhere safely. Sudden changes in terrain caused by holes, depressions, banks, softer or harder "ground" or other irregularities may cause the vehicle to topple or become unstable. To avoid this, slow down and always observe the terrain ahead. If the vehicle does begin to topple or tipover, the best advice is to immediately get off... **AWAY** from the direction of the tipover!

Pre-Ride Inspection

WARNING

Perform a pre-ride inspection before each ride to detect potential problems during operation. The pre-ride inspection can help you monitor wear and deterioration before they become a problem. Correct any problems that you discover to reduce the risk of a breakdown or crash. See an authorized Can-Am dealer as necessary.

Before using this vehicle, the operator should always:

- Apply parking brake and check if it operates properly.
- Check tire pressure and condition.
- Check wheels and bearings for wear and damage.
- Check location of controls and ensure they work properly.
- Verify if steering operates freely.
- Activate throttle control lever several times to ensure it operates freely. It must return to idle position when released.
- Activate the brake levers and brake pedal to make sure the brakes fully apply. Levers and pedal must fully return when released.
- Ensure transmission lever is working then reset in PARK position.
- Check fuel, oil and coolant levels.
- Check for oil leaks on the engine/gearbox and drive system components.
- Clean headlights and taillight.
- Ensure front central panel and rear storage compartment cover are properly latched.
- Ensure seat is properly latched.
- If you transport cargo, respect load capacity. Ensure cargo is properly secured to the cargo area eyelets.
- Look and feel for loose parts while engine is off. Check fasteners.
- Ensure the path of travel is free of persons and obstacles.
- Check operation of ignition switch, engine start button, engine stop switch, headlights, taillight and indicator lamps.
- Start engine, remove parking brake and drive forward slowly a few feet then apply all brakes individually to test them.
- Check operation of 2WD/4WD selector.

NOTICE Correct any problem you may have found before riding. See an authorized Can-Am dealer as necessary.

Clothing

Actual weather conditions should help you decide how to dress. However, it is important that the operator always wears the appropriate protective clothing and apparel, including an approved helmet, eye protection, boots, gloves, a long sleeved

shirt and pants. This type of clothing will provide you protection from some of the minor hazards you may encounter en route. The operator must never wear loose clothing such as a scarf that may get entangled in the vehicle or on tree branches and shrubs. Depending on conditions, antifogging goggles or sunglasses may be required. Different colored lenses available for goggles or sunglasses help you distinguish terrain variations. Sunglasses should only be worn during the daytime.

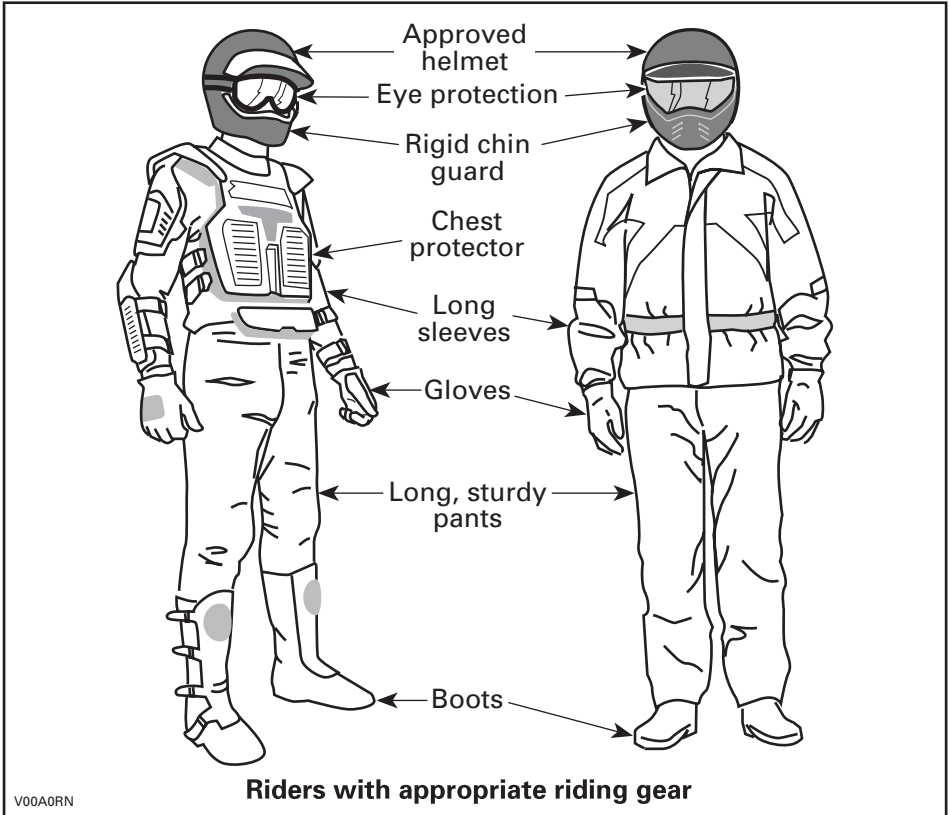

Carrying Loads

Any load carried on the vehicle will affect the handling, stability and braking distance of the vehicle. For this reason, do not exceed the load limits of the vehicle's manufacturer. Refer to table below. Always make sure the load is secured, properly distributed and cannot interfere with your proper control. Always be aware that the "load" may slide or fall off and create an accident. Avoid loads that may protrude sideways and get snagged or caught in brush or other obstacles. Avoid covering and obstructing the headlights or brakelight with the cargo.

Safely reduce speed according to terrain conditions when carrying cargo or pulling a trailer. Allow greater distance for braking. Always secure cargo as low as possible on the rack(s) to reduce the effect of a higher center of gravity.

This vehicle is designed specifically to carry an operator only. Even with a long seat that provides unrestricted operator movements, they are not designed nor intended to carry passenger(s). NEVER install passenger seat or use the cargo area to carry passenger(s). Carrying passenger(s) may affect the stability and your control of the vehicle.

| MAXIMUM LOADS | | |
|--------------------|-----------------|---|
| Total load allowed | 141 kg (310 lb) | Includes driver, all other loads and added accessories. |
| Rear cargo area | 16 kg (35 lb) | Evenly distributed. |

Hauling a Trailer

Riding this vehicle with a trailer substantially increases the risk of toppling, especially on inclined slopes. If a trailer is used behind the vehicle make sure that its hitch is compatible with the one on the vehicle. Make sure the trailer is horizontal with the vehicle. (In some instances a special extension may have to be installed on the vehicle hitch). Use security chains to secure the trailer with the vehicle. This vehicle may require additional stopping distance if hauling heavy loads, especially on inclined surfaces. Be careful not to skid or slide. When stopped or parked, block the vehicle and trailer wheels from possible movement. Always make sure load is evenly distributed on the trailer. Use caution when disconnecting a loaded trailer; it or its load may topple on you or others. Do not turn at high speeds.

Working with your Vehicle

Your vehicle can help you perform a number of different LIGHT tasks ranging from snow removal to pulling wood or carrying cargo. A variety of accessories are available from your authorized Can-Am dealer. However, always respect the load and capacities of the vehicle. Overloading of the vehicle can overstress the components and cause failure. To prevent possible injury, it is equally important to follow the instructions and warnings that accompany the accessory. Avoid any physical exertion through lifting or pulling of heavy loads or manpowering the vehicle. (Continue to read *RECREATIONAL RIDING* below).

Recreational Riding

Respect the rights and limitations of others. Stay away from areas designated for other types of off road use. This includes snowmobile trails, equestrian trails, cross country ski trails, mountain bike trails, etc. Never assume there are no other users on the trail. Always stay to the complete right of the trail and do not zig zag to one side of the trail then the other. Be prepared to stop or pull off to the side if another trail user appears in front of you.

Join a local ATV club. It will provide you with a map and advice or inform you where you can ride. If a club does not exist in your area, help to start one. Group riding and club activities provide a pleasurable, social experience.

Always keep a safe distance from other riders. Your judgment of speed, terrain conditions, weather, mechanical condition of your vehicle and the "trust in judgment" you have in others around you will help you make a better choice of appropriate safe distance. This vehicle, like any other motorized vehicle, cannot stop "on a dime".

Before you ride, tell someone where you are planning to travel and your expected time of return. Never consume alcohol or drugs before or while riding!

Depending on the length of your ride, carry additional tools or emergency equipment. Find out where you can get additional gasoline and oil. Be prepared for the possible conditions you may encounter. An emergency first aid kit should always be a consideration.

Environment

One of the benefits of this vehicle is that it can take you off the beaten path away from most communities. However, you should always respect nature and the rights of others to enjoy it. Do not ride in environmentally sensitive areas. Do not drive over forest crops or shrubs... nor cut down trees or take down fencing... nor spin your wheels and destroy the terrain. "Tread Lightly".

Chasing wildlife is in many areas illegal. Wildlife can die of exhaustion after being chased by a motorized vehicle. If you encounter animals on the trail, stop and observe quietly and with caution. It will be one of the better memories of your life.

Observe the rule... "what you take in, carry out". Do not litter. Do not start campfires unless you have permission to do so... and then only ... away from dry areas. The hazards you may create on the trail may cause injury to others or yourself, even at a later date.

Respect farm lands. Always obtain the permission of the landowner before riding on private land. Respect crops, farm animals and property lines. If you come to a closed a gate, close it again behind you.

Finally, do not pollute streams, lakes or rivers and do not modify the engine or muffling system, or remove any of its components.

Design Limitation

Although the vehicle is exceptionally rugged for its class, it is still a light vehicle by definition and its operation must be restricted to its proper purpose.

The addition of weight to any part of the vehicle changes its gravitational stability and modifies its performance.

Off-Highway Operation

The very nature of off-highway operation is dangerous. Any terrain, which has not been specially prepared to carry vehicles, presents an inherent danger where angularity, terrain substance and exact steepness are unpredictable. The terrain itself presents a continual element of danger, which must be knowingly accepted by anyone venturing over it.

An operator who takes a vehicle off-road should always exercise the utmost care in selecting the safest path and keeping close watch on the terrain ahead of him. On no account should the vehicle be operated by anyone who is not completely familiar with the driving instructions applicable to the vehicle, nor should it be operated on steep or treacherous terrain.

General Operating and Safety Precautions

Care, caution, experience and driving skill are the best precautions against the hazards of vehicle operation.

Whenever there is the slightest doubt that the vehicle can safely negotiate an obstacle or a particular piece of terrain, always choose an alternate route.

In off-road operation, power and traction, not speed, are important. Never drive faster than visibility and your own ability to select a safe route permit.

Constantly watch the terrain ahead for sudden changes in slopes or obstacles, such as rocks or stumps, that may cause loss of stability, resulting in tipover or rollover.

Never operate the vehicle if the controls do not function normally.

When operating in reverse, check that the path behind the vehicle is free of people or obstacles. Proceed slowly and avoid sharp turns.

When stopped or parked, always apply the parking brake. This is especially important when parking on a slope. On very steep inclines or if the vehicle is carrying cargo, the wheels should be blocked using rocks or bricks.

Uphill Driving

Due to configuration, this vehicle has excellent climbing ability, so much so that tipover is possible before traction is lost. For example, it is common to encounter terrain situations where the top of the hill has eroded to a point that the hill peak rises very sharply. The vehicle can readily negotiate such a condition, however, in doing so, when the front of the vehicle is driven to a point that the vehicle's balance changes rearward tipover can occur.

The same situation may apply if an embedded object causes the front of the vehicle to climb more than desired. If such a situation occurs take an alternate route. Be aware of side hilling dangers when doing so.

It is also wise to know the terrain condition on the other side of the hill or bank. All too often there exists a sharp drop-off that is impossible to negotiate or descend.

Downhill Driving

This vehicle can climb steeper ropes than it can descend safely. Therefore, it is essential to assure that a safe route exists to descend a slope before you climb it.

Decelerating while negotiating a slippery downhill slope could “toboggan” the vehicle. Maintain steady speed and/or accelerate slightly to regain control.

Side Hilling

Whenever possible, such operation should be avoided. If necessary, do so with extreme caution. Side hilling on steep inclines could result in rollover. In addition, slippery or unfirm surfaces could result in uncontrollable side sliding. Do not attempt to turn the vehicle downhill with the slide. Avoid all objects or depressions that will intensify the raising of one side of the vehicle higher than the other, thus causing rollover.

Drop-Offs

This vehicle will “bottom-out” and usually stop if either the front or rear wheels are driven over a drop-off. If the drop is sharp or deep, the vehicle will nose dive and tipover.

WARNING

Avoid negotiating drop-offs. Reverse and select an alternate route.

Riding Techniques

Riding your vehicle too fast for the conditions may result in injury. Apply only enough throttle to proceed safely. Statistics show that high speed turns usually result in mishaps and injury. Always remember that this vehicle is heavy! Its pure weight alone may entrap you should it fall and pin you down.

This vehicle is not designed for jumping nor can it, or you, absorb the energy of high impacts such as jumping. Performing “wheelies” can cause the vehicle to flip over onto you. Both practices have a high risk for you and should be avoided at all times.

To maintain proper control it is strongly advised that you keep your hands on the handlebar and within easy reach of all controls. The same holds true for your feet. To minimize the possibility of any leg or foot injury, keep your feet on the footrests at all times. Do not direct your toes outwards nor place your foot out to assist turning as they can be hit or snagged by passing obstacles or may contact the wheels.



Even though there is an adequate suspensions system on this vehicle there are “washboard” or rough terrain conditions that will make you feel uncomfortable and even cause back injury. “Posting” or riding in a crouched position will often be required. Slow down and allow your flexed legs to absorb impact.

This vehicle is not designed for riding on roads or highways. In most places it is an illegal practice. Riding your vehicle on roads or highways could cause a collision to occur with another vehicle. The tires of this vehicle are not suited for paved road use. Pavement may seriously affect the handling and control of the vehicle. Riding on roads or soft shoulders may confuse other road users, especially if your lights are on. If you have to cross a road, the lead driver should get off his vehicle, then observe and give directions to the other riders. The last person after crossing then assists the lead driver to cross. Do not travel sidewalks. They are designated for pedestrian use.

Water can be a unique hazard. If it is too deep the vehicle may “float” and topple. Check the water depth and current before you attempt to cross any water. Water should not go above the footrest. Be wary of slippery surfaces such as rocks, grass, logs, etc., both in the water and on its banks. A loss of traction may occur. Do not attempt to enter the water at high speed. The water will act as a brake and could throw you off the vehicle, on the ground.

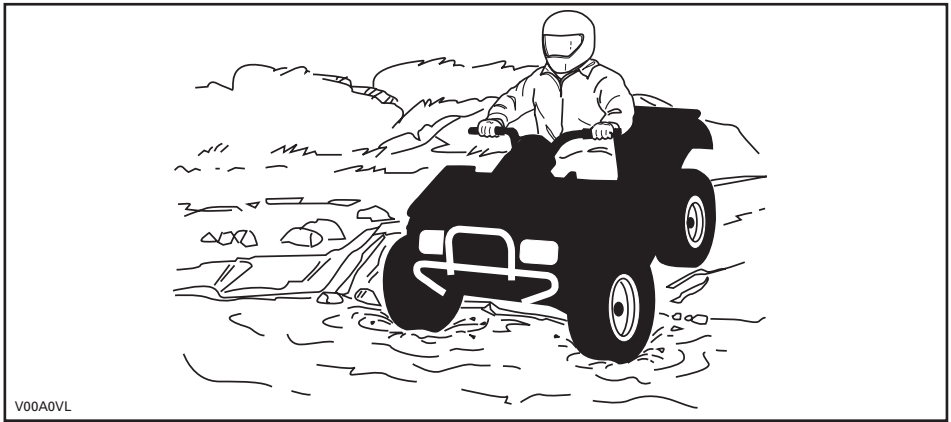

Water will affect the braking ability of your vehicle. Make sure you dry the brakes by applying them several times after the vehicle leaves the water.

Mud or marsh lands may be encountered near water. Be prepared for sudden “holes” or changes in depth. Similarly so, be watchful of hazards such as rocks, logs, etc., partially covered by vegetation.

If your trip crosses frozen waterways, make sure that the ice is thick enough and sound enough to support the total weight of yourself, the vehicle and its load. Be ever watchful of open water... it is a sure indication that the ice thickness will vary. If in doubt, do not attempt to cross.

Ice will also affect the control of the vehicle. Slow down and do not “gun” the throttle. This will only result in spinning of the tires and possible tipover of the vehicle. Avoid rapid braking. This again will possibly result in an uncontrolled slide and tipover of the vehicle. Slush should be avoided at all times since it could block the operation or controls of the vehicle.

Riding in snow may affect the brakes stopping ability. Safely reduce speed and allow greater distance for braking. Snow projection may cause ice build up or snow accumulation on brake components and controls. Apply brakes frequently to prevent ice or snow accumulation. Carefully inspect the brake system before each ride and always keep brake pedal, footrests, floor boards and brake levers free of snow and ice.

Sand and riding on sand dunes or on snow is another unique experience but there are some basic precautions that should be observed. Wet, deep or fine sand/snow may create a loss of traction and cause the vehicle to slide, drop off or become “bogged” down. If this occurs look for a firmer base. Again, the best advice is to slow down and be watchful of the conditions.

When riding in sand dunes it is advisable to equip the vehicle with an antenna type safety flag. This will help make your location more visible to others over the next sand dune. Proceed carefully should you see another safety flag ahead. Since the antenna type safety flag can snag and rebound on your body if caught, do not use it in areas where there are low hanging branches or obstacles.

Riding on loose stones or gravel is very similar to riding on ice. They will affect the steering of vehicle... possibly causing it to slide and tipover especially at high speeds. In addition, braking distance may be affected. Remember that "gunning" the throttle or sliding may cause loose stones to be ejected rearwards into the path of another rider's way. Never do it deliberately.

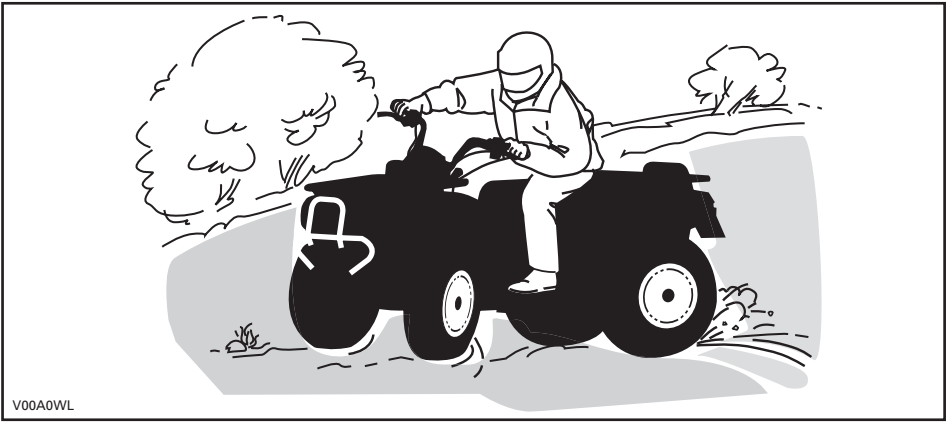

If you do get into a slide or skid, it may help to turn the handlebar into the direction of the skid until you regain control. Never jam the brakes and lock the wheels.

Respect and follow all posted trail signs. They are there to help you and others.

Obstacles in the "trail" should be traversed with caution. This includes loose rocks, fallen trees, slippery surfaces, fences, posts, and embankments and depressions. You should avoid them whenever possible. Remember that some obstacles are too large or dangerous to cross and should be avoided. Small rocks or fallen trees may be safely crossed... approach at a 90° angle. Stand on the footrests while keeping your knees flexed. Adjust speed without losing momentum and do not "gun" the throttle. Hold handlebar firmly. Place your body weight rearwards and proceed. Do not try to lift the vehicle front wheels off the ground. Be aware that the object may be slippery or may move while crossing.

When driving on hills or slopes two things are highly important... be prepared for slippery surfaces or terrain variations and obstacles and... use proper body positioning.

Uphill

Keep your body weight forward towards the top of the hill. Keep your feet on the footpegs and shift into low gear then accelerate and when necessary, change gear quickly as you climb. Do not over-speed since this may cause the front of the vehicle to lift from the ground and fall back on you. If the hill is too steep and you cannot proceed or the vehicle begins to roll backwards, apply the brake, being careful not to slide. Dismount then use the "U" turn or "K" turn (while walking back, next to the vehicle on the up hill side and with a hand on the brake lever, slowly back the rear of the vehicle toward the top of the hill then drive downhill). Always walk or dismount on the upside of the slope while keeping clear of the vehicle and its rotating wheels. Do not try to hold on to the vehicle if it begins to topple. Stay clear. Do not ride over the crest of the hill at high speed. Obstacles, including sharp drop-offs, may exist.

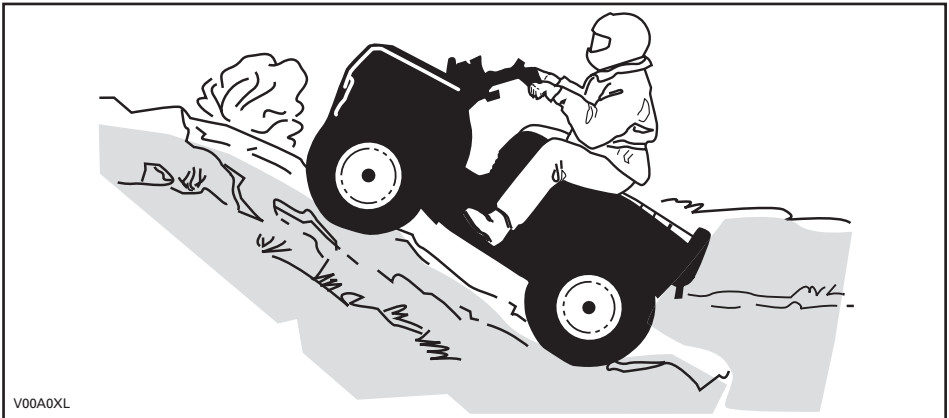

Downhill

Keep your body weight rearwards. Apply the brake gradually to prevent skidding. Do not "coast" down the slope using solely engine compression or in neutral gear.

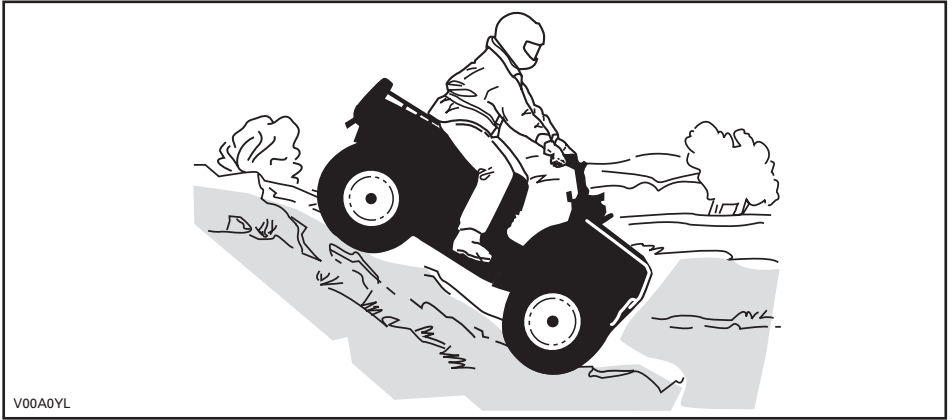

Side Hilling

This is one of the **most risky** types of riding since it may drastically change the balance of the vehicle. It should be avoided wherever possible. If it is necessary to do so however, it is important that you **ALWAYS** keep your body weight on the upside of the slope... and be prepared to dismount on that side should the vehicle begin to topple. **Do not try to stop or save the vehicle from damage.**



Routine Maintenance

Once your ride completed, it is wise to remove any build up of snow, ice, mud and grime. Not only will this help you keep your vehicle longer and in good condition for resale but will eliminate potential hazards the next time you use the vehicle. Wash

your vehicle in warm soapy water then allow it to dry. (A towel may help). Do not wash your vehicle outside during freezing weather. Apply appropriate lubrication as described in the *MAINTENANCE INFORMATION* section.

Part of your responsibility towards safety is to respect the contents of this Operator's Guide. It provides valuable advice on how to properly take care of your vehicle. If further assistance is required your authorized Can-Am dealer is always willing to help.

Modification of the vehicle to increase speed and performance may violate the terms and conditions of your vehicle's limited warranty. In addition, certain modifications including the removal of engine or exhaust components are illegal under most laws.

Changing the wheel and/or tire size may affect the stability of the vehicle. Incorrect tire pressure may lead to blow outs or cause a tire to move around on its rim and become lost or damaged. Wheels or tires which are damaged should always be replaced.

HANG TAG

This vehicle comes with a hang tag and labels containing important safety information.

Any person who rides this vehicle should read and understand this information before riding.

S SPORT MODEL

THIS ATV IS FOR
RECREATIONAL USE
BY EXPERIENCED OPERATORS ONLY.

OPERATOR ONLY-NO PASSENGERS

NO OPERATOR UNDER AGE 16

THIS CATEGORY S (SPORT) ATV IS A HIGH PERFORMANCE ATV FOR OFF ROAD USE ONLY. IT IS FOR SPORT TYPE RECREATIONAL AND COMPETITIVE USE BY OPERATORS WITH ADVANCED SKILLS AND SUBSTANTIAL EXPERIENCE.

TRAINING COURSES TO TEACH ATV RIDING SKILLS ARE AVAILABLE. FOR INFORMATION CONTACT YOUR DEALER.

CHECK WITH YOUR DEALER TO FIND OUT ABOUT STATE OR LOCAL LAWS REGARDING ATV OPERATION.

THIS HANGTAG IS NOT TO BE REMOVED BEFORE SALE.

vmo2009-005-003_en

! WARNING

Improper ATV use can result in SEVERE INJURY or DEATH.



ALWAYS USE AN APPROVED HELMET AND PROTECTIVE GEAR.



NEVER USE ON PUBLIC ROADS.



NEVER CARRY PASSENGERS.



NEVER USE UNDER THE INFLUENCE OF DRUGS OR ALCOHOL.

NEVER operate:

- without proper training or instructions.
- at speeds too fast for your skills or the conditions.
- on public roads - a collision can occur with another vehicle.
- with a passenger - passengers affect balance and steering and increase risk of losing control.

ALWAYS:

- use proper riding techniques to avoid vehicle overturns on hills and rough terrain and in turns.
- avoid paved surfaces - pavement may seriously affect handling and control.

LOCATE AND READ OPERATOR'S GUIDE.
FOLLOW ALL INSTRUCTIONS & WARNINGS.

USA and Canada Only

VEHICLE ENGINE DESCRIPTION:

XXXXX

EPA CERTIFIED

NER (NORMALIZED EMISSION RATE) =

ON A 0 TO 10 SCALE, 0 BEING THE CLEANEST

***NOT TO BE REMOVED PRIOR TO SALE**



704901107

vmo2006-005-009_en

IMPORTANT ON-PRODUCT LABELS

The following labels are on your vehicle and they should be considered permanent parts of the vehicle. If missing or damaged, they can be replaced free of charge. See an authorized Can-Am dealer.

NOTE: The following illustrations used in this Operator's Guide are a general representation only. Your model may differ.

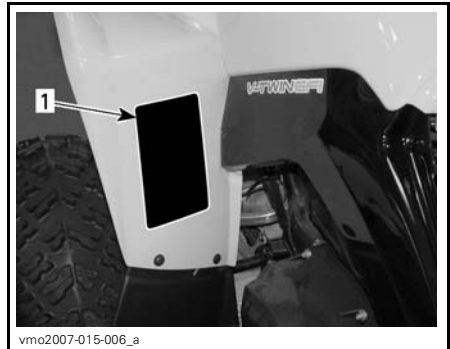
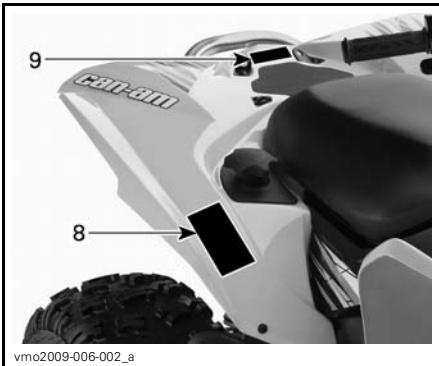
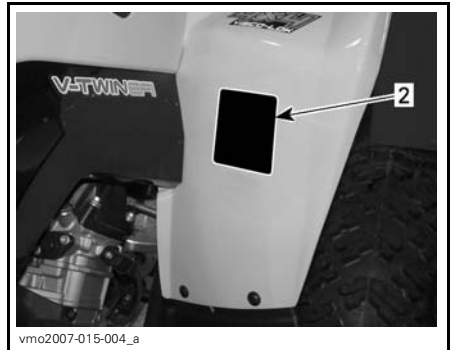
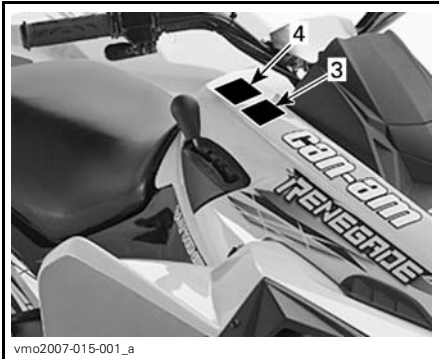
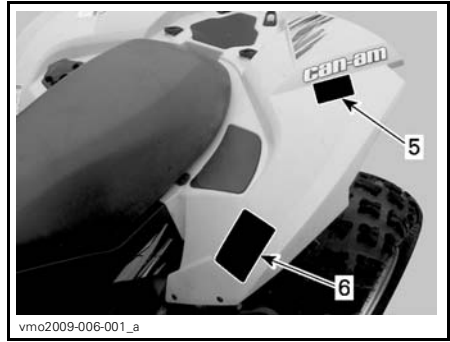

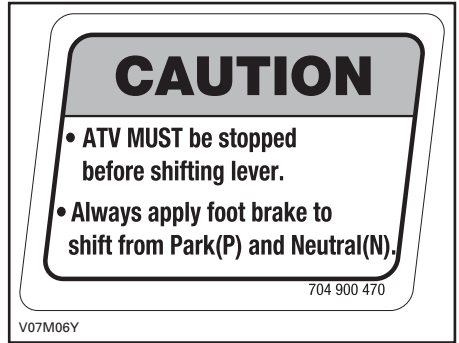
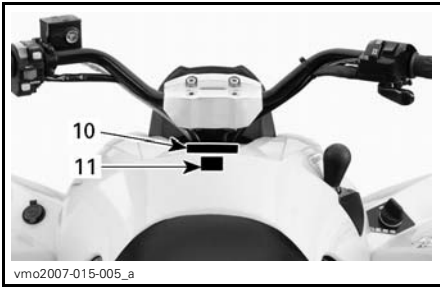

LABEL 3

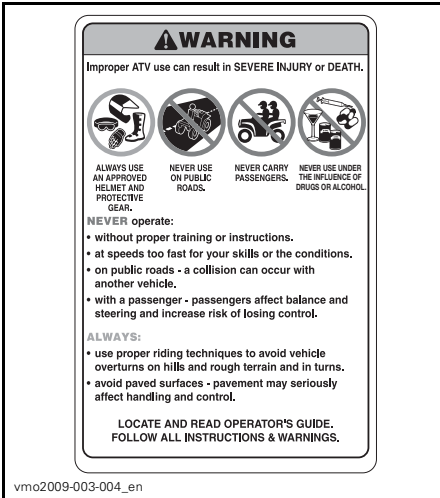

LABEL 1

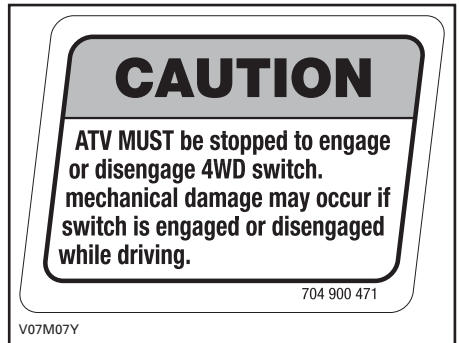

LABEL 4

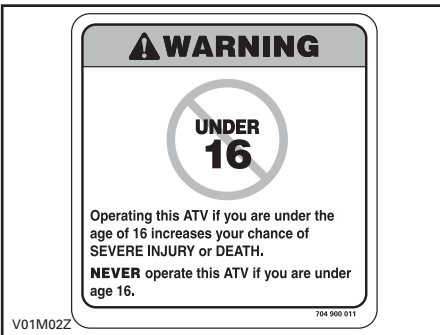

LABEL 2



LABEL 5

WARNING

Improper tire pressure or overloading can cause loss of control, resulting in SEVERE INJURY or DEATH.

| LOAD | COLD TIRE PRESSURE |
|-----------------------------|---|
| | FRONT |
| UP TO XXX kg (XXX lb) | MAX: XXX kPa (XX psi) MIN: XX.X kPa (XX psi) |
| | REAR |
| | MAX: XXX kPa (XX psi) MIN: XX.X kPa (XX psi) |

ALWAYS maintain proper tire pressure as shown.

NEVER set tire pressure below minimum. It could cause the tire to dislodge from the rim.

NEVER exceed the vehicle load capacity of XXX kg(XXX lb) including weight of operator, cargo, accessories and trailer tongue weight.

704 901 239

vmo2007-015-019_en

LABEL 6

EMISSION CONTROL INFORMATION

THIS VEHICLE IS CERTIFIED TO OPERATE ON UNLEADED GASOLINE AND MEETS TO [XXXX] U.S. EPA AND CALIFORNIA REGULATIONS FOR ATV SI ENGINES.

ENGINE FAMILY: [XXXXXXXXXXXX]

CERTIFICATION STANDARD (FEL): [XXXXXXXXXXXXXXXX]

ENGINE DISPLACEMENT: [XXXXXXXXXX]

EXHAUST EMISSION CONTROL SYSTEM: [XXXXX]

FAMILIE DE MOTEUR: [XXXXXXXXXXXX]

LIMITE DES ÉMISSIONS DE LA FAMILIE: [XXXXXXXXXXXXXXXX]

CYLINDRÉE: [XXXXXXXXXX]

SYSTÈME DE CONTRÔLE DES ÉMISSIONS: [XXXXX]

RENSEIGNEMENTS SUR LE DISPOSITIF ANTIPOLLUTION

CE VÉHICULE EST CERTIFIÉ POUR FONCTIONNER À L'ESSENCE SANS PLOMB ET IL RÉPOND AUX NORMES [XXXXX] DE L'EPA ET RÉGLEMENTATIONS CALIFORNIENNES POUR LES VTT À MOTEUR SI.

SEE OPERATOR'S GUIDE FOR MAINTENANCE SPECIFICATIONS
VOIR GUIDE DU CONDUCTEUR POUR LES SPÉCIFICATIONS D'ENTRETIENS
BOMBARDIER RECREATIONAL PRODUCTS INC.

vmo2007-002-002

LABEL 7: LOCATED UNDER SEAT ON THE UPPER BAR OF FRAME

DA

NL

FR

FI

DE

EL

IT

PT

ES

SV

FIND OG LÆS BRUGERVEJLEDNINGEN, OVERHOLD ALLE INSTRUKTIONER OG ADVARSLER.

ZOEK DE GEBRUIKERSHANDLEIDING OP EN LEES HEM. HOUD U AAN ALLE AANWIJZINGEN EN WAARSCHUWINGEN.

LOCALISER ET LIRE LE GUIDE DE L'OPÉRATEUR. SUIVRE TOUS LES CONSIGNES ET AVERTISSEMENTS.

PAIKANNA JA LUE KÄYTTÄJÄN OPAS. NOUTATA KÄYTTÖOHJEITA JA VAROITUKSIA.

BETRIEBSANLEITUNG AUSFINDIG MACHEN UND LESEN. ALLE ANWEISUNGEN UND WAHRNUNGEN BEFOLGEN.

ΒΡΕΤΕ ΚΑΙ ΔΙΑΒΑΣΤΕ ΤΟΝ ΟΔΗΓΟ ΧΡΗΣΤΗ. ΑΚΟΛΟΥΘΕΤΕ ΟΛΕΣ ΤΙΣ ΟΔΗΓΙΕΣ ΚΑΙ ΠΡΟΕΙΔΟΠΟΙΗΣΕΙΣ.

LEGGERE IL MANUALE DELL'OPERATORE. SEGUIRE TUTTE LE ISTRUZIONI E AVVERTENZE.

LOCALIZAR E LER O GUIA DE OPERAÇÃO. OBSERVAR TODAS AS INSTRUÇÕES E MENSAGENS DE AVISO.

UBICAR Y LEER LA GUÍA DEL OPERADOR. ATENDERSE A TODAS LAS INSTRUCCIONES Y MENSAJES DE ADVERTENCIA.

TA REDA PÅ INSTRUKTIONSBOKEN OCH LÄS DEN. UPPMÄRKSAMMA ALLA ANVÄNINGAR OCH VARNINGAR.

704 901 177

vmo2006-014-003_a

LABEL 8

WARNING

- NEVER carry a passenger on this cargo area
- MAXIMUM REAR LOAD : XX lb (XX kg) evenly distributed.

704 901 333

vmo2007-015-020_en

LABEL 9

WARNING

This ATV may exceed the performance of other ATVs you may have ridden in the past.

This category S (sport) is a high performance ATV for off road use only. It is for sport type recreational and competitive use by operators with advanced skills and substantial experience.

704 900 085

V02M05Y

LABEL 10

THIS VEHICLE IS AN ALL
TERRAIN VEHICLE AND
IS NOT INTENDED FOR
USE ON PUBLIC ROADS.
CE VÉHICULE EST UN VÉHICULE
TOUT TERRAIN QUI N'EST PAS
DESTINÉ À ÊTRE UTILISÉ SUR
LES VOIES PUBLIQUES.

vmo2008-014-001

LABEL 11

VEHICLE INFORMATION

CONTROLS/INSTRUMENTS/EQUIPMENTS

NOTE: Some controls/instruments/equipment are optional.

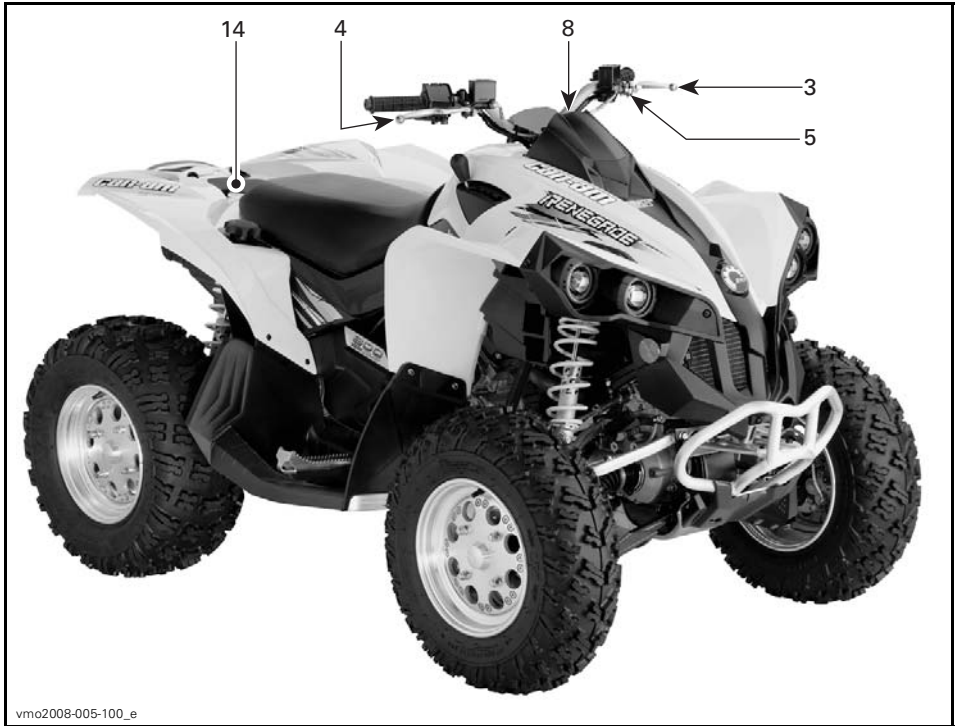

TYPICAL

While reading this Operator's Guide, reminder that:

WARNING

Indicates a potential hazard that, if not avoided, could result in serious injury or death.



TYPICAL

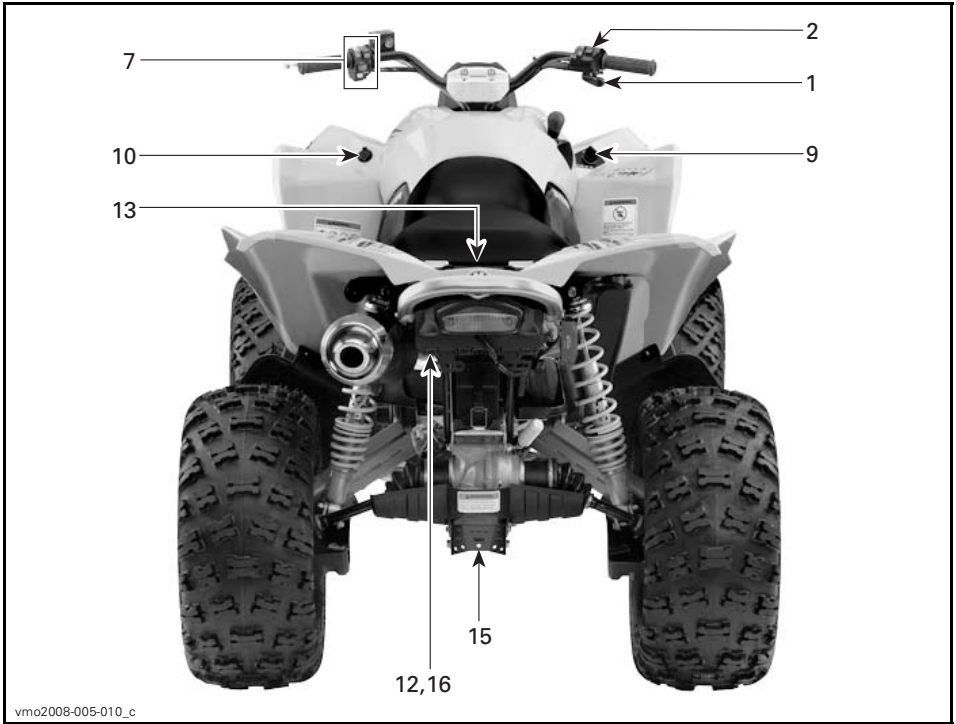

vmo2008-005-010_c

TYPICAL

1) Throttle Lever

When pushed, it increases the engine speed that allows the engagement of the transmission on the selected gear.

When released, the engine speed should return automatically to idle and the vehicle will gradually slow down.

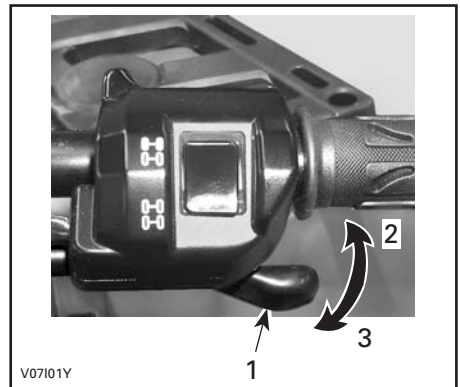

V07101Y

TYPICAL

1. Throttle lever
2. To accelerate
3. To decelerate

2) 2WD/4WD Selector

This selector allow to choose between 2WD or 4WD when the vehicle is stopped.

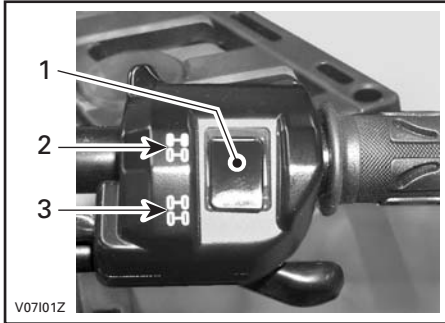

TYPICAL

1. Selector
2. 2WD position
3. 4WD position

NOTICE The vehicle must be stopped to engage or disengage 2WD/4WD selector. Mechanical damage may occur if selector is engaged or disengaged while driving.

NOTICE If the rear wheels are spinning, release the throttle and wait engine return to the idle before selecting the 4WD mode.

The 4WD mode is engaged when the selector is pushed downwards.



4WD MODE

To deselect the 4WD mode, press the selector on 2WD.



2WD MODE

When the selector is located on the 2WD, the vehicle is in 2 wheel drive at all time.

3) Rear Brake Lever

When compressed, the rear brake is applied. When released, the brake lever should automatically return to its original position. Braking effect is proportional to the force applied on the lever and to the type and condition of the terrain.

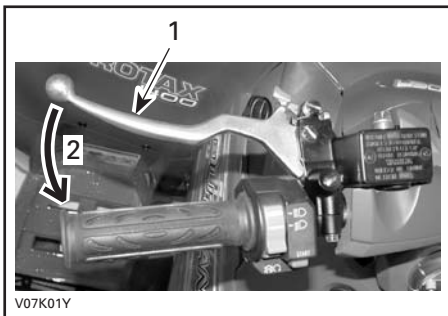

V07K01Y

TYPICAL

1. Brake lever
2. To apply brake

4) Front Brake Lever

When compressed, the front brakes are applied. When released, the brake lever should automatically return to its original position. Braking effect is proportional to the force applied on the lever and to the type and condition of the terrain.

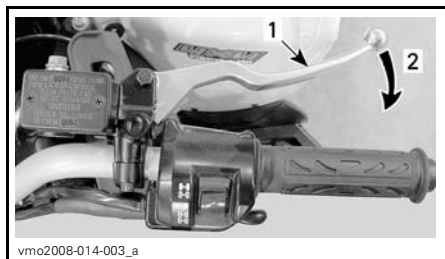

vmo2008-014-003_a

TYPICAL

1. Brake lever
2. To apply brakes

5) Parking Brake

When applied, it prevents the vehicle from moving. Useful when the brake needs to be locked for example when doing a K-turn, during transportation or when the vehicle is not in operation.

⚠ WARNING

Always use the parking brake **and** engage the PARK position on the transmission lever when the vehicle is not in operation.

⚠ WARNING

Make sure parking brake is fully disengaged before operating the vehicle.

When you ride the vehicle, brakes that are caused to drag by a continuous pressure on the lever may cause damage to the brake system and cause loss of braking capacity and/or fire.

To engage mechanism: Squeeze brake lever and maintain while moving lever lock. Brake lever is now compressed and applying the rear brake.

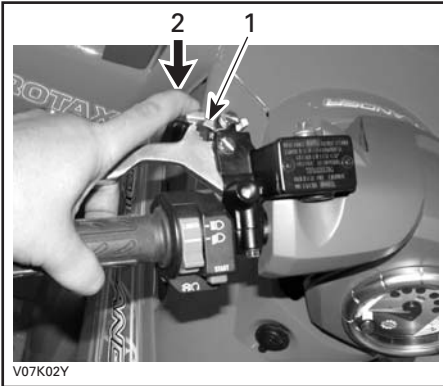
**TYPICAL**

1. Brake lever lock
2. Press to apply parking brake

⚠ WARNING

Ensure when the parking brake is applied that the vehicle stays securely in place. If not, have braking system inspect by an authorized Can-Am dealer as soon as possible.

To release mechanism: Squeeze brake lever. Lever lock should automatically return to its original position. Brake lever should return to rest position. Always release parking brake before riding.

6) Transmission Lever

A 5-position lever: P, R, N, H and L.

To change the transmission position, completely stop vehicle then move lever to the desired position. Do not force lever. If unable to shift, rock the vehicle back and forth to move the gears in the transmission and try again.

**SHIFT PATTERN**

NOTICE Always completely stop the vehicle and apply the brake prior to moving the transmission lever.

P: Park

This position locks the transmission to help prevent vehicle movement. Always use when the vehicle is not in operation. In some circumstances, it may be necessary to rock the vehicle back and forth to move the gears in the transmission to allow the park to be engaged.

R: Reverse

This allows the vehicle to go backward. The vehicle speed is limited.

⚠ WARNING

Before moving vehicle in reverse, ensure the path behind is clear of obstacles or bystanders. Remain seated.

N: Neutral

This position disengages the transmission to allow manual vehicle movement.

H: High gear

This selects the high speed range of the transmission in the gear box. It is the normal driving speed range. It allows the vehicle to reach its maximum speed.

L: Low gear

This selects the low speed range of the transmission in the gear box. It is the working position. It allows the vehicle to move slowly with the maximum traction and power.

NOTE: Use the low speed range to pull any load or to climb a steep incline.

7) Multifunction Switch

The controls located on this multifunction switch are:

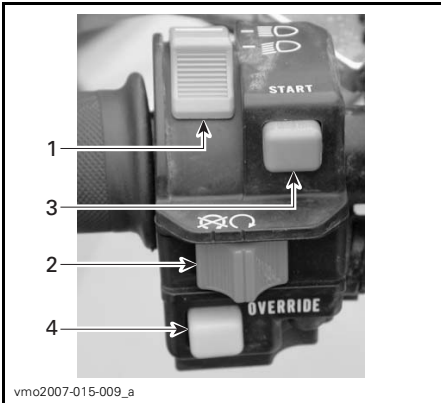

TYPICAL — MULTIFUNCTION SWITCH

1. Headlights switch
2. Engine stop switch
3. Engine start button
4. Override button

Headlights Switch

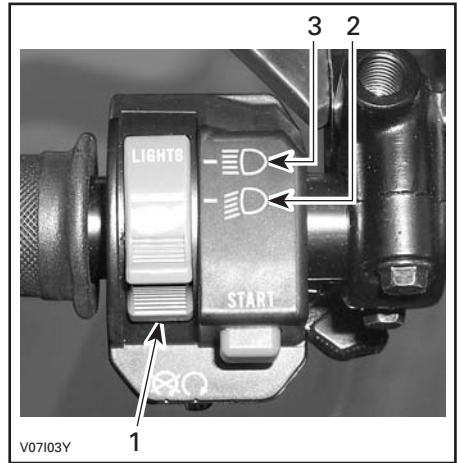

HEADLIGHTS SWITCH FUNCTIONS

1. Headlights switch
2. Low beam and taillight
3. High beam and taillight

NOTE: Place ignition switch to ON "without light" position to close the headlights.

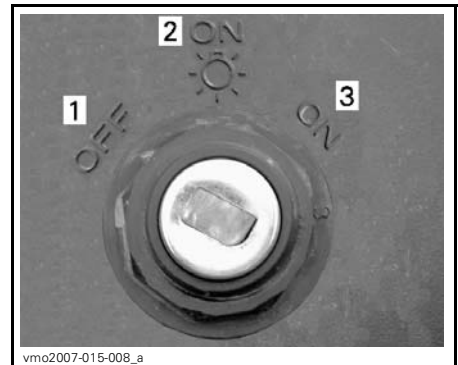

IGNITION SWITCH POSITIONS

1. OFF
2. ON "with light"
3. ON "without light"

Engine Stop Switch

This switch can be used to stop the engine and as an emergency control.

To stop engine, fully release throttle lever then use the engine stop switch.

NOTE: While engine can be stopped by turning ignition key to OFF position, we recommend the engine be stopped by the engine stop switch.

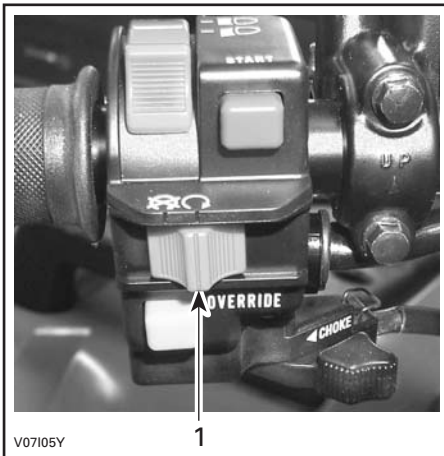

V07105Y

1

TYPICAL

1. Engine stop switch

Engine Start Button

To start engine, place the engine stop switch to RUN.

Press and hold the engine start button. Release immediately after engine is started.

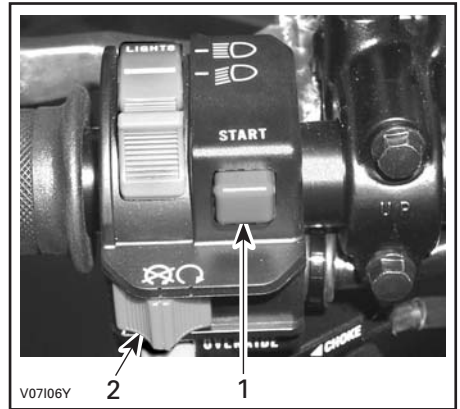

V07106Y

2

1

TYPICAL

1. Engine start button
2. Engine stop switch

NOTE: The engine will not turn over if the engine stop switch and/or ignition switch are turned to the OFF position.

Override Button

This button is used to override the reverse speed limiter system while power backing up. Press and hold the override button then depress throttle lever gradually.

WARNING

Never activate the override button if throttle lever is already depressed as a loss of control may result, causing severe personal injury or death.

While reading this Operator's Guide, reminder that:

WARNING

Indicates a potential hazard that, if not avoided, could result in serious injury or death.

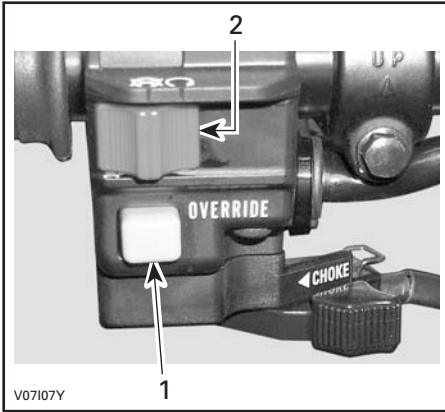

V07107Y

TYPICAL

1. Override button
2. Engine stop switch

8) Multifunction Gauge

⚠ WARNING

Never adjust or set functions on the multifunction gauge while riding the vehicle.

This vehicle is equipped with an electronic multifunction gauge.

The functions on this gauge are:

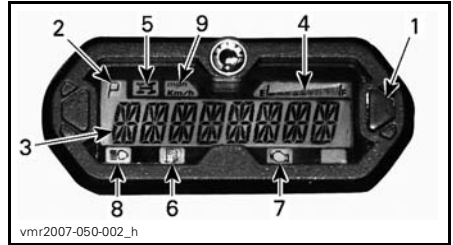

vmr2007-050-002_h

1. Multifunction display selector button
2. Transmission position display
3. Multifunction display
4. Fuel level display
5. 4WD indicator lamp
6. Low fuel level indicator lamp
7. Check engine indicator lamp
8. High beam indicator lamp
9. MPH, Km/h indicator lamp

Unit Selection (MPH vs km/h)

The speedometer, odometer and trip meter are factory preset in miles but it is possible to change them to kilometer reading. Contact an authorized Can-Am dealer.

Multifunction Display (normal display mode)

After vehicle startup, the normal display mode shows either:

- Vehicle speed
- Engine revolution per minute (RPM)
- Both parameters simultaneously (combined mode).

Speed Mode

In this mode, the display shows the speed of the vehicle either in km/h or in MPH.



vdd2008-001-084

RPM Mode

In this mode, the display shows the engine RPM.



Combined Mode

In this mode, the display shows the speed of the vehicle and the engine RPM.

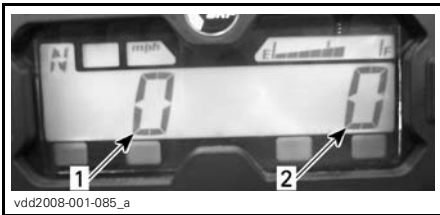

1. Vehicle speed
2. Engine RPM

Mode Change

To change from one display to the other, proceed as follows.

1. Turn ignition key to ON to power the system up.
2. Wait until "greeting message" is finished.
3. Press and release selector button once to display OD (odometer).
4. Press the selector button again, this time for 2 seconds.

This will change the Mode to either Speed, RPM or Combined.



5. To select another mode, repeat steps 3 and 4 until you get the mode desired.

Multifunction Display (temporary display mode)

Press and release selector button to change the normal display mode to the following temporary mode:

- Odometer
- Trip meter (resettable)
- Hour meter (resettable)
- Vehicle hour meter.



1. Selector button

The gauge will display the selected mode for 10 seconds then will return to the normal display mode.

While in a resettable mode, push and HOLD selector button for 2 seconds to reset it.

Odometer (ODO)

Odometer records the total distance travelled either in miles or kilometers.

Trip Meter (trip)

The trip meter records the travelled distance since it has been reset. Distance travelled is displayed either in miles or kilometers.

It can be used to establish a fuel tank range or distance between 2 way points for instance.

Push and HOLD display selection button for 2 seconds to reset the trip meter.

Hour Meter (trip time)

The hour meter records vehicle running time when the electrical system is activated. It can be used to establish traveling time between 2 way points for instance.

Push and HOLD display selection button for 2 seconds to reset the hour meter.

Hour Meter (engine hours)

The hour meter records engine running time.

Transmission Position Display

This display will show transmission position.



1. Transmission position

| DISPLAY | FUNCTION |
|---------|-----------|
| P | Park |
| R | Reverse |
| N | Neutral |
| H | High Gear |
| L | Low Gear |

NOTE: If the letter “E” is displayed in the transmission position display, it means that there is a electrical communication error. Contact an authorized Can-Am dealer.

Fuel Level Display

Bar gauge continuously indicates the amount of fuel in the fuel tank while riding.

When the low fuel indicator lamp is ON, it indicates that there is only 30% of fuel left in fuel tank, approximately 6 L (1.6 U.S. gal).

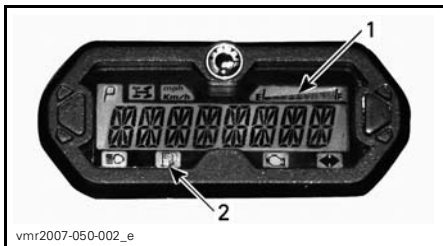

1. Fuel level display
2. Low fuel indicator lamp

Indicator Lamps

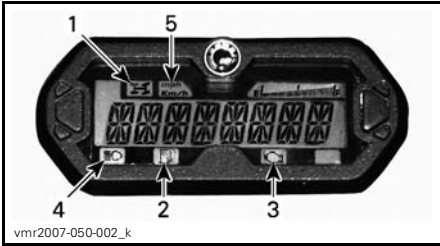

1. 4WD indicator lamp
2. Low fuel level indicator lamp
3. Check engine indicator lamp
4. High beam indicator lamp
5. MPH or km/h indicator lamp



When this indicator is ON, it indicates the 4WD system is activated.



When this indicator is ON, it indicates that there is only 30% of fuel left in fuel tank, approximately 6 L (1.6 U.S. gal).



When this indicator is ON, it indicates an engine fault code, look for a message at the multifunction display.

When this indicator blinks, it indicates that the LIMP HOME mode is activated, refer to *TROUBLESHOOTING* for more details.



When this indicator is ON, it indicates that high intensity is selected on the headlights and that ignition key is in LIGHTS position.



The proper lamp turns on to indicate the unit the speedometer uses.

Multifunction Display Messages

Refer to *TROUBLESHOOTING* section for details.

9) 12-Volt Power Outlet

Convenient for handheld spotlight or other portable equipment.

Remove protective cap to use. Always reinstall it after use to protect against weather.

Do not exceed the rating capacity. See *SPECIFICATIONS*.

An auxiliary supply is available to connect additional accessories. Two wires are hidden in the wiring harness at the front of vehicle underneath dash board. See an authorized Can-Am dealer for more details.

10) Ignition Switch

Key-operated 3-position switch.



IGNITION SWITCH POSITIONS

1. OFF
2. ON "with light"
3. ON "without light"

Insert key in switch and turn to the desired position. To remove key, turn key to OFF position then pull it out.

NOTE: When turning the key to OFF position and removing the key, the vehicle electrical system will take a few seconds to shut down.

The ON with lights position, turns on all lights with either the engine running or not. Remember that having the lights on without the engine running discharges the battery. Always turn ignition key to OFF position after engine has been stopped.

NOTE: While engine can be stopped by turning ignition key to OFF position, we recommend the engine be stopped by the engine stop switch.

Digitally Encoded Security System (DESS)

The ignition key specifically contains an electronic circuit that gives it a unique electronic serial number.

This ignition key cannot be used on another vehicle and conversely, the one from another vehicle cannot be used on your vehicle except if it was programmed this way.

However, the DESS brings a great flexibility. You can buy an additional ignition key and have it programmed for your vehicle.

To have additional ignition key, refer to an authorized Can-Am dealer.

11) Rear Brake Pedal

When pressed down, the rear brake is applied. When released, the brake pedal should return to its original position. Braking effect is proportional to the force applied on the pedal and to the type and condition of the terrain.



1. Brake pedal

12) Rear Storage Compartment

Convenient location to carry personal articles such as a tool kit, Operator's Guide, spare spark plugs, first aid kit, etc. Stretch and unhook latches to open storage compartment cover.

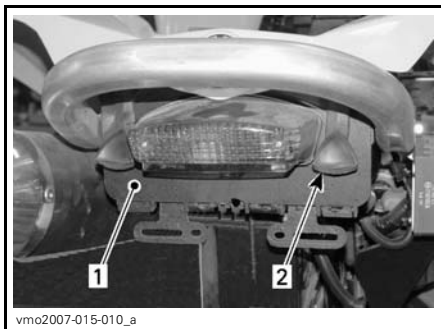

1. Rear storage compartment cover
2. Latch

⚠ WARNING

When engine is running, always engage the PARK position on the transmission lever before opening cover. Never leave any heavy or loose breakable objects in the storage compartment. Always latch cover before riding.

13) Seat Latch

It allows the removal of seat to give access to engine compartment.



vmo2008-005-003_a

1. Seat latch

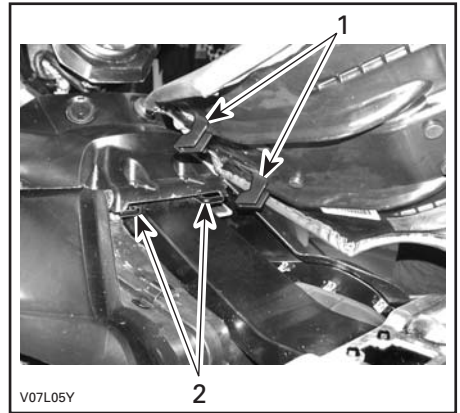

V07L05Y

1. Insert these tabs in hooks
2. Hooks

Seat Removal

Push latch forward while gently lifting rear of seat. Pull seat rearward. Continue lifting movement until you can release the front retaining device then completely remove seat.

Seat Installation

Insert front tabs of seat into frame hook. When seat rests in its position, firmly push seat down to latch.

NOTE: A distinctive snap will be felt. Double check that the seat is secure by giving it a tug to confirm proper latching.

WARNING

Make sure seat is securely latched before riding.

14) Rear Cargo Area

Convenient location to carry small articles.

Secure articles to rear fender by using the plastic eyelets provided.

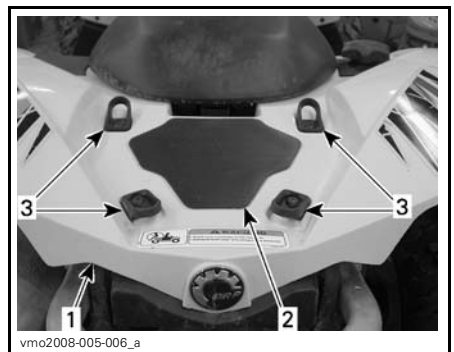

vmo2008-005-006_a

1. Rear fender
2. Cargo area
3. Plastic eyelets

 **WARNING**

MAXIMUM load for cargo area is 16 kg (35 lb). Ensure to properly secure articles to rear fender. Do not overload. Ensure load does not interfere with visibility. Do not carry passenger(s).

Refer to *SPECIFICATIONS* for carrying loads and cargo weight distribution recommendations.

15) Recovery Hook

Convenient hook that can be use to recover a stuck ATV.

16) Tool Kit

The tool kit is located in the rear storage compartment. It contains tools for basic maintenance and this Operator's Guide.

Spare fuses are also provided in the kit.

FUEL

Recommended Fuel

Use regular unleaded gasoline, available from most service stations or oxygenated fuel containing a maximum total of 10% of ethanol or methanol or both. The gasoline used must have the following recommended minimum octane number.

| OCTANE NUMBER | |
|-----------------------|----------------|
| Inside North America | (87 (R + M))/2 |
| Outside North America | 92 RON |

NOTICE Never experiment with other fuels. The use of unrecommended fuel can result in vehicle performance deterioration and damage to critical parts in the fuel system and engine components.

Fueling Procedure

Unscrew counterclockwise and remove cap to allow fuel tank filling then fully tighten clockwise.

NOTICE Never place anything over fuel tank cap because the vent hole on the top of fuel tank cap can be blocked and the engine could misfire.

WARNING

Always stop engine before refueling. Open cap slowly. If a differential pressure condition is noticed (whistling sound heard when loosening fuel tank cap) have vehicle inspected and/or repaired before further operation. Fuel is flammable and explosive under certain conditions. Never use an open flame to check fuel level. Never smoke or allow flame or spark in vicinity. Always work in a well-ventilated area. Never top up the fuel tank before placing the vehicle in a warm area. As temperature increases, fuel expands and may overflow. Always wipe off any fuel spillage from the vehicle.

OPERATING INSTRUCTIONS

Operating During Break-In

Engine

A break-in period of 10 operating hours is required before running the vehicle at sustained full throttle.

During this period, maximum throttle should not exceed 3/4. However, brief full acceleration and speed variations contribute to a good break-in. Continued wide open throttle accelerations, prolonged cruising speeds and engine overheating are detrimental during the break-in period.

Belt

A new belt requires a break-in period of 50 km (30 miles). Avoid strong acceleration/deceleration, pulling a load or high speed cruising.

10-Hour Inspection

NOTE: The 10-hour inspection is at the expense of the vehicle owner.

We suggest that after the first 10 hours or 300 km (185 mi) of riding, your vehicle be inspected by an authorized Can-Am dealer. Refer to *MAINTENANCE* section.

Starting the Engine

The transmission lever must be on PARK or NEUTRAL to allow engine to start.

NOTE: For your convenience, an override mode allows the engine to be started with the transmission lever in any position. Press and hold the brake lever(s) or the brake pedal while pressing the engine start button.

Insert key in ignition switch and turn to ON position.

Place the engine stop switch to RUN.

Press the engine start button and hold until the engine starts.

NOTICE Do not hold the engine start button more than 30 seconds. A rest period should be observed between the cranking cycles to let the starter cool down. Pay attention not to discharge the battery.

Release the engine start button immediately when the engine has started.

NOTE: If the battery is dead, engine cannot be started. Have the battery recharged or replaced.

Shifting the Transmission

Let engine idle to warm up.

Apply brakes and select the desired gear range H or L.

NOTE: The brake must be applied when the transmission lever is engaged in the park position.

Release brakes.

NOTICE Make sure parking brake is fully disengaged before operating the vehicle.

Gradually press the throttle lever to increase engine speed and thus engaging the continuously variable transmission (CVT).

At the opposite, when the throttle lever is released, the engine speed decreases.

Using the Reverse

NOTICE When changing from forward to reverse, or vice-versa, always completely stop the vehicle and apply the brake prior to moving the transmission lever.

The same procedures as *SHIFTING THE TRANSMISSION* above apply except for the following.

Set the transmission lever in REVERSE position.

Stopping the Engine

WARNING

Avoid parking on slope.

Release throttle and completely stop the vehicle.

Apply the parking brake.

Set transmission lever in PARK position.

Push the engine stop switch in OFF position.

Turn key in ignition switch to OFF position.

Remove key from ignition switch.

Post-Operation Care

When vehicle is used in salt-water environment (beach area, launching/loading boats etc.), rinsing the vehicle with fresh water is necessary to preserve vehicle and its components. Metallic parts lubrication is highly recommended. Use XP-S Lube (P/N 293 600 016) or an equivalent. This must be performed at the end of each operating day.

When vehicle is operated in muddy conditions, rinsing the vehicle is recommended to preserve vehicle and its components and to keep lights clean.

NOTE: Never use a high pressure washer to clean the vehicle. **USE LOW PRESSURE ONLY (like a garden hose).** High pressure can cause electrical or mechanical damages.

What to Do if Vehicle is Turned Over

When vehicle is turned over or stays tilted on the side, put the vehicle back on its wheels, then wait 3 to 5 minutes before starting the engine. Refer to *MAINTENANCE INFORMATION* and inspect the following.

- Inspect air filter housing for oil accumulation, if any oil is found, clean air filter and air filter housing.
- Check engine oil level and refill if necessary.
- Check engine coolant level and refill if necessary.
- Start engine. If the oil pressure light stays on, stop engine immediately. See an authorized Can-Am dealer.

What to Do if Vehicle is Immersed in Water

Should the vehicle become immersed, it will be necessary to take it to an authorized Can-Am dealer as soon as possible. **NEVER START THE ENGINE!**

NOTICE Immersion of the vehicle can cause serious damage if the correct restart procedure is not followed.

TUNE YOUR RIDE

⚠ WARNING

Suspension adjustment could affect vehicle handling. Always take time to familiarize yourself with the vehicle's behavior after any suspension adjustment have been made.

Suspension Adjustment

Your vehicle handling and comfort depend upon suspension adjustments.

Choice of suspension adjustments vary with driver's weight, personal preference, riding speed and field condition.

The best way to set up the suspension, is to start from factory settings, then customize each adjustment one at a time.

Front and rear adjustments are interrelated. It may be necessary to readjust the rear shock absorbers after adjusting front shock absorbers for instance.

Test run the vehicle under the same conditions; trail, speed, driver riding position, etc. Change one adjustment and retest. Proceed methodically until you are satisfied.

Following are guidelines to fine-tune suspension.

Spring Preload Adjustment

Shorten the spring for a firmer ride and rough road condition.

Lengthen the spring for a softer ride and smooth road condition.

Adjust by turning adjusting cam or ring accordingly. Use tool from vehicle tool kit.

Renegade 800 X

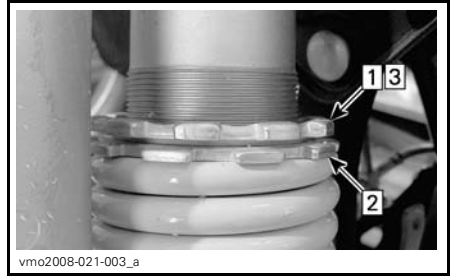

TYPICAL

- Step 1: Loosen top locking ring
- Step 2: Turn adjusting ring accordingly
- Step 3: Tighten top locking ring

Renegade 500/800

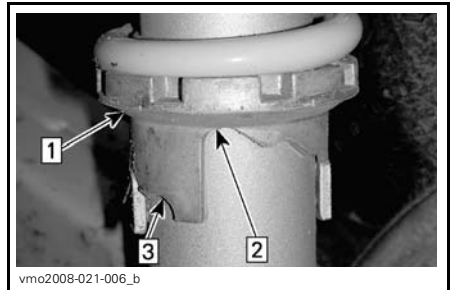

TYPICAL

- Step 1: Turn adjusting cams
- Step 2: Smooth adjustment
- Step 3: Hard adjustment

⚠ WARNING

The left and right shock adjustment on front or rear suspension must always be set to the same position. Never adjust one shock only. Uneven adjustment can cause poor handling and loss of stability, which could lead to an accident.

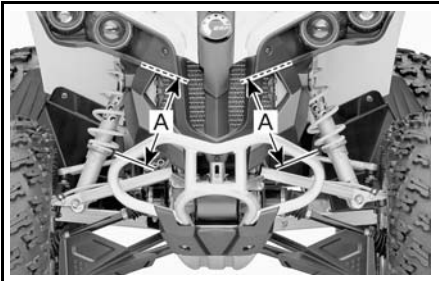

vmo2008-021-001_a

TYPICAL — FRONT PRELOAD ADJUSTMENT
A. Same length

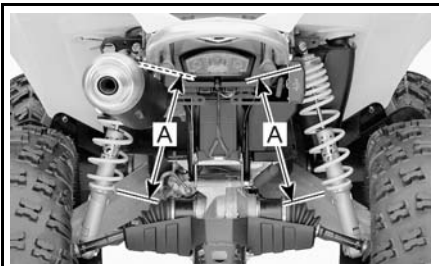

vmo2008-021-002_a

TYPICAL — REAR PRELOAD ADJUSTMENT
A. Same length

Shock Damping Strength Adjustment

Renegade 800 X

Perform adjustments **one** position (click) at a time. Test run the vehicle under the same conditions; trail, speed, driver riding position, etc. Proceed methodically until you are satisfied.

Compression (Low Speed)

Use a flat screwdriver to adjust it.

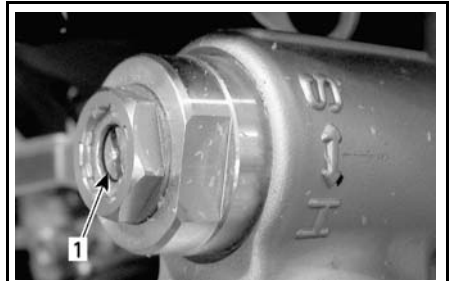

vmo2008-021-004_a

TYPICAL

1. Compression adjuster (flat screwdriver)

Turning it clockwise (H) **increases** shock damping action (stiffer).

Turning it counterclockwise (S) **decreases** shock damping action (softer).

Compression (High Speed)

Use a 17 mm wrench to adjust it.



vmo2008-021-004_b

TYPICAL

1. High speed compression adjuster

Turning it clockwise (H) **increases** shock damping action (stiffer).

Turning it counterclockwise (S) **decreases** shock damping action (softer).

Rebound

Use a flat screwdriver to adjust it.

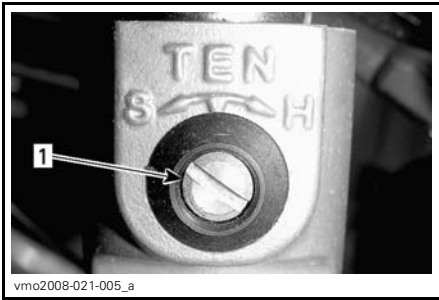

1. Rebound adjuster

Turning it clockwise (H) **increases** shock damping action (stiffer).

Turning it counterclockwise (S) **decreases** shock damping action (softer).

While reading this Operator's Guide, reminder that:

⚠ WARNING

Indicates a potential hazard that, if not avoided, could result in serious injury or death.

VEHICLE TRANSPORTATION

When transporting a vehicle, secure vehicle to trailer or in pickup box with suitable tie-downs. Using ordinary ropes is not recommended.

⚠ WARNING

Never tip this vehicle on end for transporting. We recommend that you carry the vehicle in its normal operating position (on all four wheels).

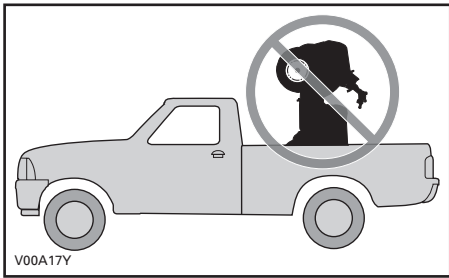

Remember to:

- Unload vehicle racks before transportation.
- Set transmission lever to PARK position.
- Set the parking brake.
- Secure the vehicle by the front bumper and rear bumper.

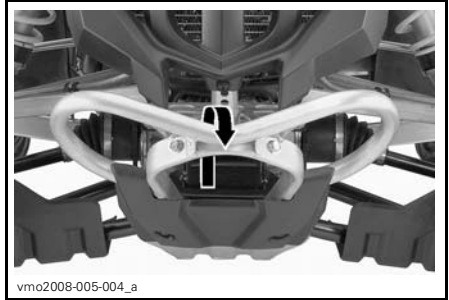

TYPICAL — FRONT ATTACHMENT LOCATION

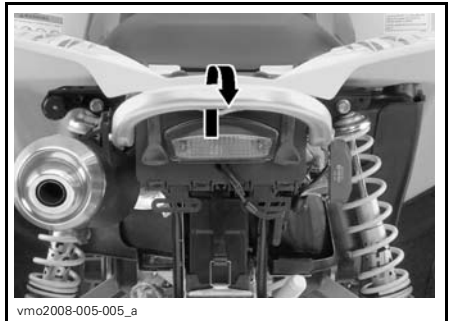

TYPICAL — REAR ATTACHMENT LOCATION

NOTICE Attaching vehicle at other locations may damage the vehicle.

⚠ WARNING

Do not tow this vehicle behind a car or other vehicle. Use a trailer.

MAINTENANCE INFORMATION

MAINTENANCE SCHEDULE

Maintenance is very important for keeping your vehicle in safe operating condition. Proper maintenance is the owner's responsibility. Perform periodic checks and follow the maintenance schedule.

WARNING

Failure to properly maintain the vehicle according to the maintenance schedule and procedures can make it unsafe to operate.

This section includes instructions for basic maintenance procedures. If you have the necessary mechanical skills and the required tools, you can perform these procedures. If not, see your authorized Can-Am dealer.

Other important items in the maintenance schedule that are more difficult and require special tools are best performed by your authorized Can-Am dealer.

WARNING

Turn off the engine and follow these maintenance procedures when performing maintenance. If you do not follow proper maintenance procedures you can be injured by hot parts, moving parts, electricity, chemicals or other hazards.

PERIODIC MAINTENANCE CHART

A: ADJUST
 C: CLEAN
 I: INSPECT
 L: LUBRICATE
 R: REPLACE

INITIAL INSPECTION 10 H OR 30 DAYS OR 300 km (185 mi)

(To be performed by an authorized Can-Am dealer. The initial maintenance is very important and must not be neglected.)

25 H OR 750 km (470 mi)

50 H OR 1500 km (930 mi)

100 H OR 1 YEAR OR 3000 km (1865 mi)

200 H OR 2 YEARS OR 6000 km (3730 mi)

TO BE PERFORMED BY

PART/TASK

LEGEND

ENGINE

| | EVERY RIDE | | | | | | |
|---|------------|------------------|------------------|------------------|---|--|----------|
| Engine oil level ⁽²⁾ | | | | | | | Customer |
| Engine oil and filter | R | | | R | | | Customer |
| Valve adjustment | I, A | | | I, A | | | Dealer |
| Condition of engine seals | I | | | I | | | Dealer |
| Engine mounting fasteners | I | | | I | | | Dealer |
| Air filter ⁽²⁾ | | C ⁽⁴⁾ | R ⁽⁴⁾ | | | | Customer |
| Exhaust system | I | | | I | | | Dealer |
| Muffler spark arrester | | | | C | | | Customer |
| Engine coolant ⁽²⁾ | I | | | I ⁽³⁾ | R | | Customer |
| Radiator cap/cooling system pressure test | I | | | | I | | Dealer |
| Radiator condition/cleanliness ⁽⁴⁾ | I | | I | | | | Customer |

(2) Pre-ride inspection item.
 (3) Every 100 hours, check coolant strength.
 (4) More often under severe use such as dusty area, sand, snow, wet or muddy conditions.

ENGINE MANAGEMENT SYSTEM

| | | | | | | | |
|------------------------|---|--|--|---|--|--|--------|
| EMS sensors | I | | | I | | | Dealer |
| EMS fault code reading | I | | | I | | | Dealer |

PERIODIC MAINTENANCE CHART

INITIAL INSPECTION 10 H OR 30 DAYS OR 300 km (185 mi)

(To be performed by an authorized Can-Am dealer. The initial maintenance is very important and must not be neglected.)

25 H OR 750 km (470 mi)

50 H OR 1500 km (930 mi)

100 H OR 1 YEAR OR 3000 km (1865 mi)

200 H OR 2 YEARS OR 6000 km (3730 mi)

TO BE PERFORMED BY

A: ADJUST
C: CLEAN
I: INSPECT
L: LUBRICATE
R: REPLACE

PART/TASK

LEGEND

FUEL SYSTEM

| | | | | | | | |
|---|------|--|-----------|-----|---|---------------------|-------------------------------|
| Throttle body | I | | | I,L | | Dealer | (2) Pre-ride inspection item. |
| Throttle cable (2) | I, A | | I,A, L | | | Dealer/ Customer | |
| Fuel lines, fuel rails, connections, check valves and fuel tank pressure test | I | | | | I | Dealer | |
| In-line fuel filter | | | | R | | Dealer | |
| Fuel pump pressure test | | | | | I | Dealer | |

ELECTRICAL SYSTEM

| | | | | | | | |
|--|---|--|---|---|---|----------|--|
| Spark plug (5) | I | | | | R | Customer | (2) Pre-ride inspection item. (5) Make sure the spark plug is correctly gapped. |
| Battery connections | I | | I | | | Customer | |
| ECM connectors (visual inspection without disconnecting) | | | | I | | Dealer | |
| Electrical connections and fastening (ignition system, starting system, fuel injectors etc.) | I | | | I | | Dealer | |
| Digitally Encoded Security System (DESS) | I | | | I | | Dealer | |
| Condition of ignition switch, engine start button and engine stop switch (2) | I | | | I | | Customer | |
| Condition of lighting system (HI/LO intensity, brakelight, taillight, headlights aiming, etc.) (2) | I | | | I | | Customer | |

| PERIODIC MAINTENANCE CHART | | | | | | | |
|---|--|-----|------|-------|---|----------|---|
| A: ADJUST C: CLEAN I: INSPECT L: LUBRICATE R: REPLACE | INITIAL INSPECTION 10 H OR 30 DAYS OR 300 km (185 mi) (To be performed by an authorized Can-Am dealer. The initial maintenance is very important and must not be neglected.) | | | | | | |
| | 25 H OR 750 km (470 mi) | | | | | | |
| | 50 H OR 1500 km (930 mi) | | | | | | |
| | 100 H OR 1 YEAR OR 3000 km (1865 mi) | | | | | | |
| | 200 H OR 2 YEARS OR 6000 km (3730 mi) | | | | | | |
| | TO BE PERFORMED BY | | | | | | |
| PART/TASK | | | | | | | LEGEND |
| CVT TRANSMISSION | | | | | | | |
| Drive belt | | | | I | | Dealer | — |
| Drive and driven pulleys (including one-way bearing) | | | | I,C,L | | Dealer | |
| CVT air inlet | I | | I,C | | | Dealer | |
| CVT air filter (800R engine) | I | I,C | | | | Customer | |
| GEARBOX | | | | | | | |
| Gearbox oil ⁽⁴⁾ | R | | | I | R | Dealer | (4) More often under severe use such as dusty area, sand, snow, wet or muddy conditions. |
| Speed sensor | C | | | | C | Dealer | |
| 4 x 4 coupling unit | I | | | I | | Dealer | |
| Front/rear differentials (oil level, seals and vents) | I | | I | | R | Dealer | |
| DRIVE SYSTEM | | | | | | | |
| Drive shaft boots and protectors ⁽²⁾ | I | I | | | | Customer | (2) Pre-ride inspection item. (4) More often under severe use such as dusty area, sand, snow, wet or muddy conditions. |
| Drive shaft joints | | | I | | | Dealer | |
| Rear propeller shaft joint ⁽⁴⁾ | I | | I, L | | | Dealer | |
| WHEEL/TIRES | | | | | | | |
| Wheel bearings | | | | I | | Customer | (2) Pre-ride inspection item. |
| Wheel nuts/studs | I | | I | | | Customer | |
| Tires pressure and wear ⁽²⁾ | EVERY RIDE | | | | | Customer | |

PERIODIC MAINTENANCE CHART

INITIAL INSPECTION 10 H OR 30 DAYS OR 300 km (185 mi)

(To be performed by an authorized Can-Am dealer. The initial maintenance is very important and must not be neglected.)

25 H OR 750 km (470 mi)

50 H OR 1500 km (930 mi)

100 H OR 1 YEAR OR 3000 km (1865 mi)

200 H OR 2 YEARS OR 6000 km (3730 mi)

TO BE PERFORMED BY

A: ADJUST
C: CLEAN
I: INSPECT
L: LUBRICATE
R: REPLACE

PART/TASK

LEGEND

STEERING SYSTEM

| | | | | | | | |
|---|---|--|---|------|--|--------|--|
| Handlebar fasteners | | | | I | | Dealer | (4) More often under severe use such as dusty area, sand, snow, wet or muddy conditions. |
| Steering system (column, bearing, etc.) (4) | I | | | I | | Dealer | |
| Tie rod ends | | | I | | | Dealer | |
| Front wheels alignment | I | | | I, A | | Dealer | |

SUSPENSION

| | | | | | | | |
|-----------------------|--|---|------|---|---|----------|---|
| Trailing arms | | | | I | | Dealer | — |
| Trailing arm bearings | | | | | I | Dealer | |
| Shock absorbers | | | I | | | Dealer | |
| A-arms | | | I, L | | | Customer | |
| Ball joints | | I | | | | Dealer | |

BRAKES

| | | | | | | | |
|-----------------------------------|---|-------|--|---|-------|---------------------|--|
| Brake fluid (2) | I | I | | | R (1) | Dealer/ Customer | (1) Brake fluid replacement or any brake system repairs must be performed by an authorized Can-Am dealer. (2) Pre-ride inspection item. (4) More often under severe use such as dusty area, sand, snow, wet or muddy conditions. |
| Brake pads | | I (4) | | | | Dealer | |
| Brake system (discs, hoses, etc.) | | | | I | | Customer | |

| PERIODIC MAINTENANCE CHART | | | | | | |
|---|--|--|----------|---|--|----------|
| A: ADJUST C: CLEAN I: INSPECT L: LUBRICATE R: REPLACE | INITIAL INSPECTION 10 H OR 30 DAYS OR 300 km (185 mi) (To be performed by an authorized Can-Am dealer. The initial maintenance is very important and must not be neglected.) | | | | | |
| | 25 H OR 750 km (470 mi) | | | | | |
| | 50 H OR 1500 km (930 mi) | | | | | |
| | 100 H OR 1 YEAR OR 3000 km (1865 mi) | | | | | |
| | 200 H OR 2 YEARS OR 6000 km (3730 mi) | | | | | |
| | TO BE PERFORMED BY | | | | | |
| PART/TASK | | | | | | LEGEND |
| CHASSIS | | | | | | |
| Frame fastener | | | I | | | Customer |
| Frame | | | | I | | Dealer |
| Chassis fasteners | | | I | | | Customer |
| Seat fasteners | EVERY RIDE | | | | | Customer |
| Vehicle cleaning and protection | | | C (4) | | | Customer |

(4) More often under severe use such as dusty area, sand, snow, wet or muddy conditions.

While reading this Operator’s Guide, reminder that:

 WARNING

Indicates a potential hazard that, if not avoided, could result in serious injury or death.

10-HOUR INSPECTION

NOTE: The 10-hour inspection is at the expense of the vehicle owner.

As with any precision piece of mechanical equipment, we suggest that after the first 10 hours or 300 km (185 mi) of operation, whichever comes first, your vehicle be inspected by an authorized Can-Am dealer. This inspection will give you the opportunity to discuss the unanswered questions you may have encountered during the first hours of operation.

We recommend that this inspection be signed by an authorized Can-Am dealer.

Date of 10-hour inspection

Authorized dealer signature

Dealer name

MAINTENANCE PROCEDURES

Air Filter

Air Filter Removal

NOTICE Never remove or modify any component in the air filter housing. Otherwise, engine performance degradation or damage can occur. The engine is calibrated to operate specifically with these components.

Remove seat and central panel. Refer to *BODY* section.

Release clamps and remove air filter box cover.

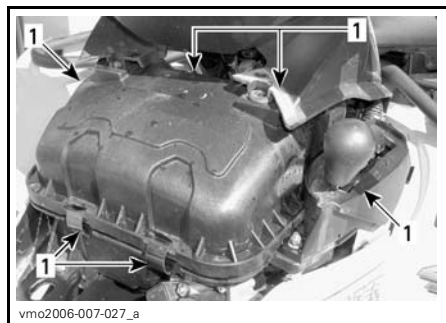

1. Release clamps

500 EFI Models

Loosen clamp and remove air filter.



500 EFI MODELS

1. Clamp
2. Air filter

Remove foam prefilter by carefully pulling it outwards.

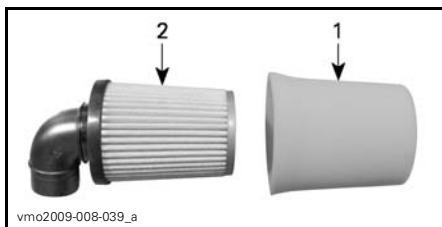

1. Foam prefilter
2. Filter

800R EFI Models

Loosen clamp and remove air filter.



800R EFI MODELS

1. Clamp
2. Air filter

Remove foam prefilter by carefully pushing the extremities toward the inside.

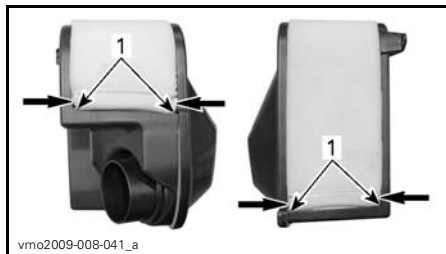

1. Foam prefilter extremities



1. Foam prefilter
2. Filter

Air Filter Cleaning

Foam Prefilter Cleaning

Pour cleaning solution (P/N 219 700 341) or an equivalent into a bucket.

Put the foam prefilter in to soak.

While foam prefilter soaks, clean inside the air filter housing.

Rinse the foam prefilter with warm water until all cleaning solution disappears.

Let the foam prefilter dry completely.

Filter Cleaning

Blow low pressure compressed air on filter element to clean it.

NOTICE Do not wash the paper filter with any cleaning solution.

Air Filter Installation

Properly reinstall removed parts in the reverse order of their removal.

Engine Oil

Engine Oil Level

NOTICE Check level frequently and refill if necessary. **Do not overfill.** Operating the engine with an improper level may severely damage engine. Wipe off any spillage.

NOTE: While checking the oil level, visually inspect engine area for leaks.

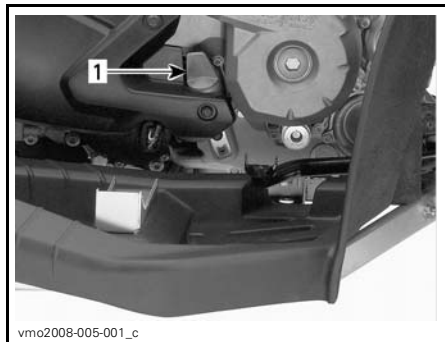

RH SIDE OF ENGINE

1. Dipstick

With vehicle on a level surface and engine cold, not running, check the oil level as follows:

1. Unscrew dipstick then remove it and wipe clean.
2. Reinstall dipstick, screw in it completely.
3. Remove and check oil level. It should be near or equal to the upper mark.

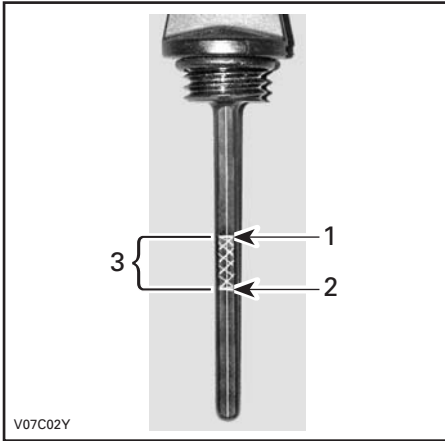

V07C02Y

TYPICAL

1. Full
2. Add
3. Operating range

To add oil, remove the dipstick. Place a funnel into the dipstick tube to avoid spillage.

Add a small amount of recommended oil and recheck oil level.

Repeat the above procedures until oil level reaches the dipstick's upper mark. **Do not overfill.**

Properly tighten dipstick.

Recommended Engine Oil

Use 4-stroke engine SAE 5W 30 oil that meets or exceeds the requirements for API service classification SM, SL or SJ. Always check the API service label certification on the oil container, it must contain at least one of the above standards.

During the hottest days of the summer the BRP XP-S™ 10W 40 mineral oil (P/N 219 700 346) can be used.

NOTE: For improved overall performance and all season applications, use XP-S 5W 40 synthetic oil (P/N 293 600 039).

Engine Oil Viscosity Chart

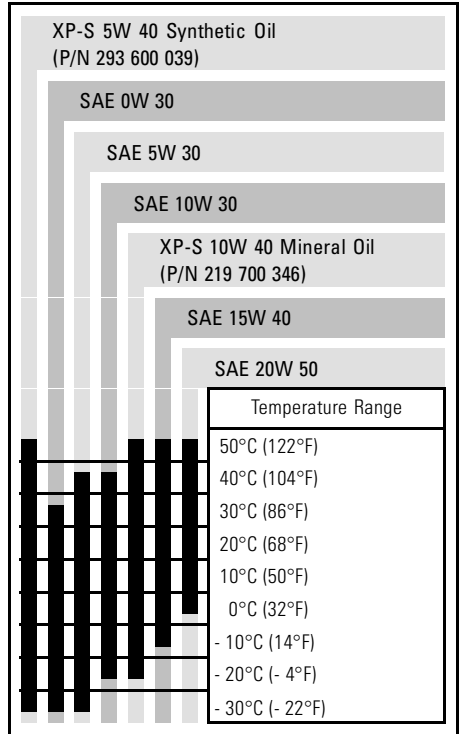

Engine Oil Change and Oil Filter Replacement

Oil and filter are to be replaced at the same time. Oil change should be done with a warm engine.

⚠ WARNING

The engine oil can be very hot. In order to avoid potential burns, do not remove the engine drain plug or the filter cover if the engine is hot. Wait until engine oil is warm.

- Ensure vehicle is on a level surface.
- Remove dipstick.
- Clean the oil drain plug area.
- Place a drain pan under the oil drain plug area.
- Unscrew oil drain plug.

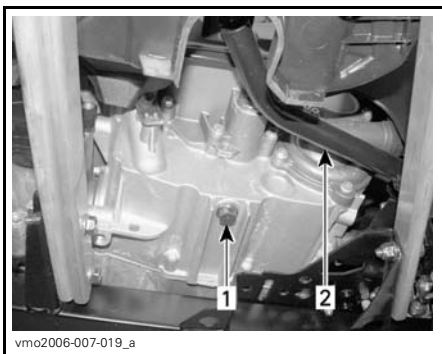

TYPICAL
1. Oil drain plug
2. Brake pedal

- Allow enough time for oil to flow out of oil filter.
- Remove the right side panel.
- Unscrew the oil filter cover.



1. Oil filter cover

- Remove the oil filter and replace with a new filter.

Check the cover O-ring and change it if necessary.

Screw oil filter cover in place.

Wipe off any oil spillage on engine.

Change gasket on oil drain plug. Clean gasket area on engine and oil drain plug then reinstall plug. Refill engine at the proper level with the recommended oil. Refer to *SPECIFICATIONS* for capacity.

Start engine and let idle for a few minutes. Ensure oil filter area and oil drain plug areas are not leaking.

Stop engine. Wait a while to allow oil to flow down to crankcase then check oil level. Refill as necessary.

Dispose of oil as per your local environmental regulations.

Radiator

Radiator Inspection

Periodically check the radiator area for cleanliness.



1. Radiator

Inspect radiator and hoses for leaks or any damage.

Inspect radiating fins. They must be clean, free of mud, dirt, leaves and any other deposit that would prevent the radiator to cool properly.

Remove as much deposits as you can with your hands. If water is available in proximity, try rinsing the radiating fins.

If available, use a garden hose to rinse the radiating fins.

⚠ WARNING
 Never clean radiator with your hands when it is hot. Let the radiator cool down before cleaning.

NOTICE Be careful not to damage the radiating fins when cleaning. Do not use any object/tool that could damage the fins. The fins are purposely thin parts to allow efficient cooling. **WHEN HOSING, USE LOW PRESSURE ONLY, NEVER USE A HIGH PRESSURE WASHER.**

See an authorized Can-Am dealer to check the performance of the cooling system.

Engine Coolant

Engine Coolant Level

⚠ WARNING
 Check coolant level with engine cold. Never add coolant in cooling system when engine is hot.

NOTE: While checking the coolant level, visually inspect engine area for leaks.

Remove access panel.



1. Coolant reservoir

With vehicle on a level surface, liquid should be between MIN. and MAX. level marks of coolant reservoir.

NOTE: When checking level at temperature lower than 20°C (68°F), it may be slightly lower than MIN. mark.

Add coolant up to MAX. mark if required. Use a funnel to avoid spillage. **Do not overfill.**

Properly reinstall and tighten filler cap and reinstall access panel.

If the coolant is added in the coolant reservoir, check the level in the radiator too. Add coolant if necessary.

⚠ WARNING
 In order to avoid getting burned, do not remove the radiator cap if the engine is hot.

NOTE: A cooling system that frequently requires coolant is the indication of leaks or engine problems. See an authorized Can-Am dealer.

Recommended Engine Coolant

Always use ethylene-glycol antifreeze containing corrosion inhibitors specifically for internal combustion aluminum engines.

Cooling system must be filled with BRP premixed coolant (P/N 219 700 362) or with distilled water and antifreeze solution (50% distilled water, 50% antifreeze).

Engine Coolant Replacement

⚠ WARNING

In order to avoid potential burns, do not remove the radiator cap or loosen the coolant drain plug if the engine is hot.

Open the front access panel and remove the radiator cap.



1. Radiator cap

Unscrew the coolant drain plug and drain the coolant into a suitable container.

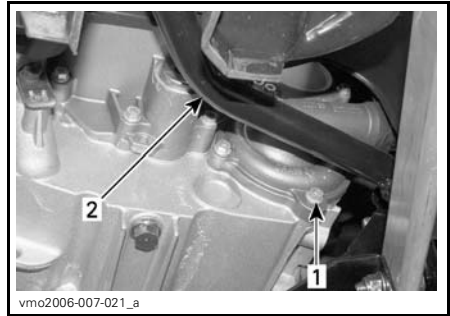

1. Coolant drain plug
2. Brake pedal

NOTE: Do not unscrew the coolant drain plug completely.

Remove the RH side panel.

Unscrew the bleeding screw on the top of thermostat housing.



1. Bleeding screw

Drain the system completely and reinstall the coolant drain plug.

Pinch hose between radiator and thermostat housing with a large hose pincher (P/N 529 032 500) or an equivalent.

NOTICE Do not use vise-grip pliers to pinch hose.

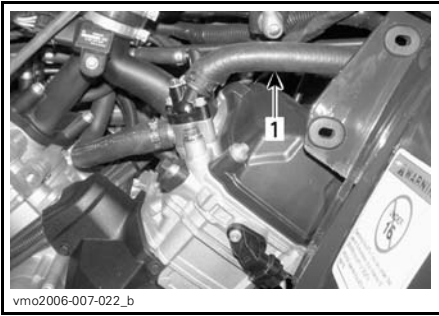

1. Hose pincher

Fill the radiator until the coolant comes out by the thermostat housing hole.

Install the bleeding screw.

Remove the hose pincher.

Complete the radiator filling.

Check the level in the coolant reservoir and refill if necessary.

Run engine at idle with the radiator cap off. Slowly add coolant if necessary.

At this point, wait until engine reaches normal operating temperature. Depress the throttle lever two or three times; then add coolant if required.

Install radiator cap.

Inspect all connections for leaks and check coolant level in the reservoir.

Spark Arrester

Spark Arrester Cleaning

The muffler must be periodically purged of accumulated carbon.

⚠ WARNING

Never run engine in an enclosed area. Never perform this operation immediately after the engine has been run because exhaust system is very hot. Make sure that there are no combustible materials in the area. Wear eye protection and gloves. Never stand behind the vehicle while purging exhaust system. Respect all applicable laws and regulations.

Select a well-ventilated area and make sure the muffler is cool.

Place transmission on PARK position.

Remove the cleanout plug of the muffler.

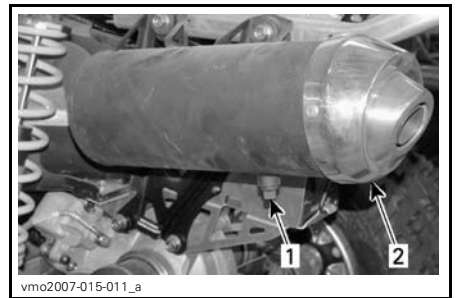

1. Cleanout plug
2. Muffler

Block the end of the muffler with a shop rag and start engine.

Momentarily increase engine RPM several times to purge accumulated carbon out of the muffler.

Stop engine and allow muffler to cool.

Reinstall the cleanout plug.

CVT Air Filter

800R EFI Only

CVT Air Filter Removal

1. Remove seat and central panel. Refer to *BODY* section.
2. Locate access cover on LH side of vehicle underneath front fender.
3. Remove plastic darts that hold access cover.
4. Remove access cover.

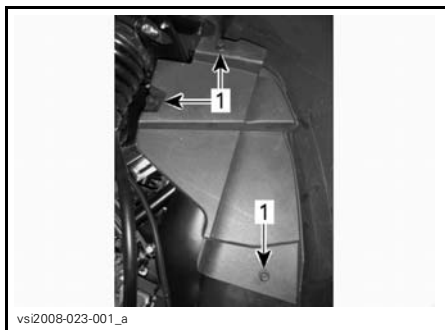

ACCESS COVER

1. Plastic darts

5. Locate CVT filter.



1. CVT filter

6. Stretch CVT filter elastic.
7. Remove CVT filter by pulling it outward.

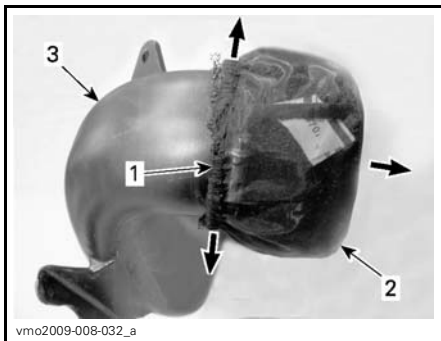

CVT AIR INLET REMOVED FOR CLARITY PURPOSE

1. CVT filter elastic
2. CVT filter
3. CVT air inlet

8. Unscrew foam clamp.
9. Remove foam with clamp.

CVT Air Filter Cleaning

1. Pour cleaning solution (P/N 219 700 341) or an equivalent into a bucket.
2. Put filter and foam in to soak.
3. While filter and foam soak, clean inside the CVT air inlet end.
4. Rinse filter and foam with warm water until all cleaning solution disappears.
5. Let filter and foam dry completely.

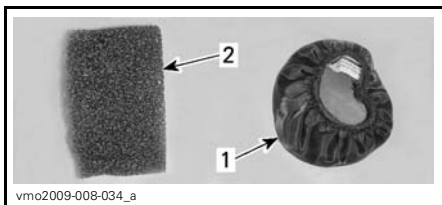

1. CVT filter
2. Foam

CVT Air Filter Installation

1. Unscrew clamp completely.
2. Pre-install clamp on foam.



vmo2009-008-035

CLAMP PRE-INSTALLATION

3. Insert foam with clamp on CVT air inlet as per the following illustration.
4. Ensure that the clamp is properly positioned on the air inlet edge and clamp nut is positioned upwards.
5. Tighten clamp completely.

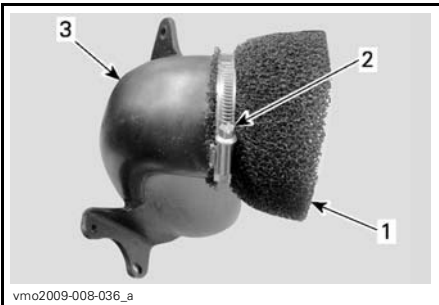

vmo2009-008-036_a

CVT AIR INLET REMOVED FOR CLARITY PURPOSE

1. Foam
2. Clamp nut
3. CVT air inlet

6. Install filter elastic around clamp.



vmo2009-008-037_a

CVT AIR INLET REMOVED FOR CLARITY PURPOSE

1. Filter elastic
2. Clamp

The following illustration shows the final assembly.



vmo2009-008-038

CVT AIR INLET REMOVED FOR CLARITY PURPOSE

7. Install CVT access cover using plastic darts.
8. Install central panel.
9. Install seat.

While reading this Operator's Guide, reminder that:

⚠ WARNING

Indicates a potential hazard that, if not avoided, could result in serious injury or death.

CVT Cover Drain Screw

Any time you suspect that water has entered the CVT cover, drain the CVT housing by removing the drain screw.

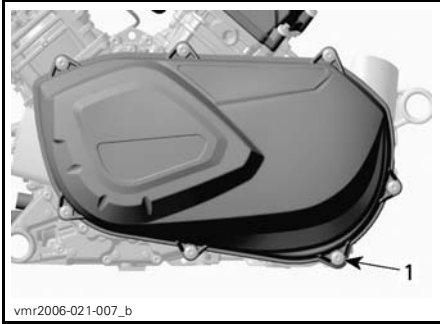

BEHIND LH FOOTREST

1. Drain screw

Gearbox Oil

Gearbox Oil Level

NOTICE Check level and refill if necessary. **Do not overfill.** Operating the gearbox with an improper level may severely damage gearbox. Wipe off any spillage.

Place the vehicle on a level surface. Select NEUTRAL position then apply parking brake.

Check the gearbox oil level by removing the gearbox oil level plug.

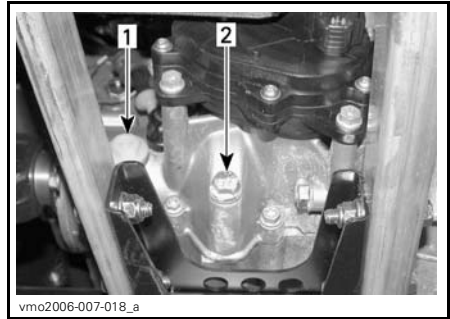

1. Oil level plug
2. Oil drain plug

The oil should be level with the bottom of the oil level hole. Refill as required until gearbox oil level flows through oil level hole.

Gearbox Recommended Oil

Use XP-S chaincase oil (P/N 413 801 900) or an equivalent.

NOTICE Do not use unrecommended other types of oil when servicing. Do not mix with other types of oil.

Gearbox Oil Change

Place the vehicle on a level surface.

Clean drain plug area and oil level plug then remove the gearbox drain plug.

NOTE: To completely drain the gearbox, place a jack under the left footrest and tilt the vehicle toward the right side. When the gearbox is empty, install the drain plug and replace the vehicle on the ground.

Refill gearbox, using XP-S chaincase oil (P/N 413 801 900) or an equivalent.

NOTICE Do not use other unrecommended types of oil when servicing. Do not mix with other types of oil.

The oil should be level with the bottom of the oil level hole. Refill as required until gearbox oil level flows through oil level hole.

Reinstall oil level plug.

Throttle Cable

Throttle Cable Lubrication

The throttle cable must be lubricated with silicone lubricant (P/N 293 600 041) or an equivalent.

WARNING

Always use a silicone-based lubricant. Using another lubricant (like a water-based lubricant) could cause the throttle lever/cable to become sticky and stiff.

Open the throttle lever housing.

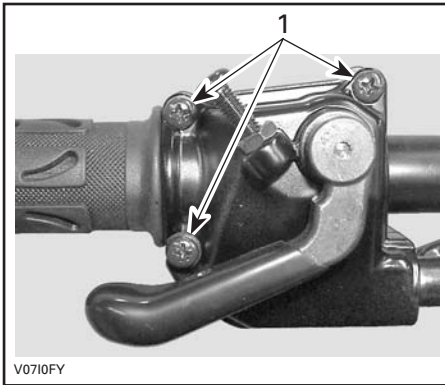

1. Remove these screws

Separate the housing. Slide rubber protector back to expose throttle cable adjuster.

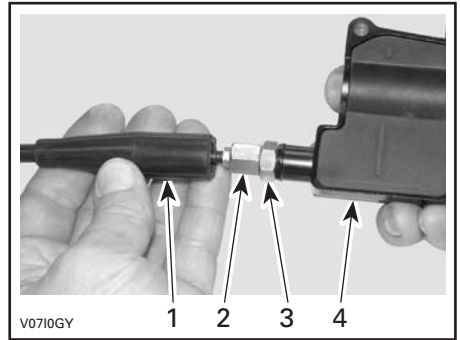

1. Cable protector
2. Throttle cable adjuster
3. Lock nut
4. Throttle lever housing

Screw in the throttle cable adjuster.
Remove inner housing protector.

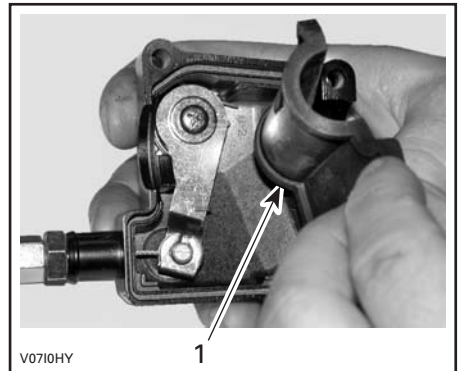

1. Inner housing protector

Remove the cable from the throttle lever housing.

NOTE: Slide cable in clip slot and remove the end of cable from clip.

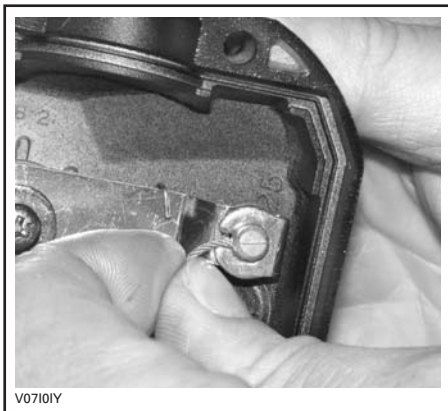

V0710IY

Remove the throttle body side cover.

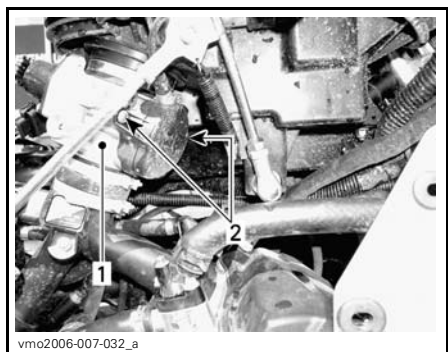

vmo2006-007-032_a

1. Throttle body
2. Side cover screws

Insert the needle of the lubricant can in the end of the throttle cable adjuster.



V0710JY

TYPICAL

NOTE: Place a rag around the throttle cable adjuster to prevent the lubricant from splashing.

Add lubricant until it runs out at throttle body end of the throttle cable.

Reinstall and adjust the cable.

Throttle Lever

Throttle Lever Adjustment

Slide rubber protector back to expose throttle cable adjuster.

Loosen lock nut then turn the adjuster to obtain correct throttle lever free play.

NOTE: Measure throttle free play at the tip of throttle lever.

Tighten lock nut and reinstall protector.

⚠ WARNING

Always wear eye protection and gloves when you lubricate a cable.

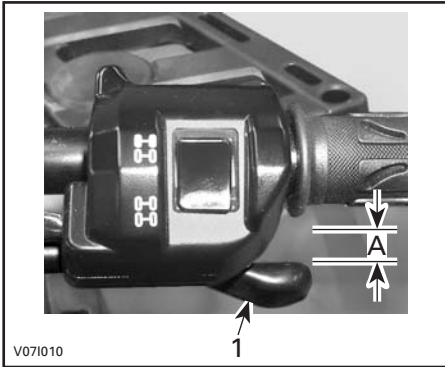

V071010

TYPICAL

1. Throttle lever

A. 3 to 6 mm (1/8 to 7/32 in)

With the transmission lever on PARK position, start the engine. Check if the throttle cable is adjusted correctly by turning handlebar fully right then fully left. If the engine RPM increases, readjust the throttle lever free play.

Spark Plug

Spark Plug Removal

⚠ WARNING

Unless otherwise indicated, always turn ignition switch to the OFF position before performing any maintenance or repair on electrical system.

Remove side panels.

Unplug spark plug cables.

Unscrew spark plugs one turn.

Clean spark plugs and cylinder heads with pressurized air if possible.

⚠ WARNING

Always wear safety goggles when using pressurized air.

Unscrew spark plugs completely then remove them.

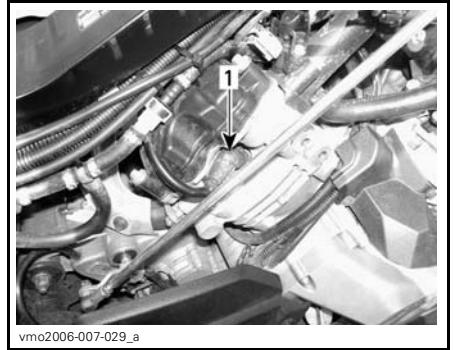

vmo2006-007-029_a

RH SIDE — REAR CYLINDER

1. Spark plug

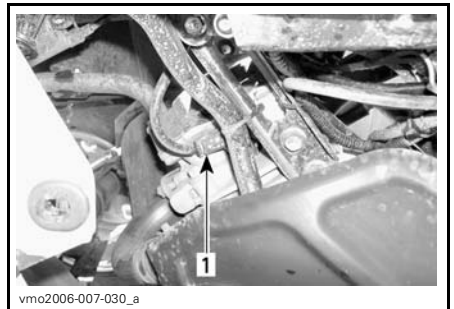

vmo2006-007-030_a

LH SIDE — FRONT CYLINDER

1. Spark plug

Spark Plug Installation

Prior to installation make sure that contact surfaces of cylinder heads and spark plugs are free of grime.

Using a feeler gauge, set the spark plug gap between 0.6 to 0.7 mm (0.024 to 0.027 in).

Apply anti-seize lubricant over spark plug threads to prevent a possible seizure.

Screw spark plugs into cylinder heads by hand and tighten with a torque wrench and a proper socket.

Torque spark plugs to 20 N•m (15 lbf•ft).

Battery

⚠ WARNING

Unless otherwise indicated, always turn ignition switch to the OFF position before performing any maintenance or repair on electrical system.

⚠ WARNING

Never charge a battery while installed in vehicle.

These vehicles are equipped with a VRLA battery (Valve Regulated Lead Acid). It is a maintenance-free type battery, there is no need to add water to adjust electrolyte level.

NOTICE Never remove the battery sealing cap.

Battery Removal

Remove storage box.

Disconnect BLACK (-) cable first then RED (+) cable.

⚠ WARNING

Always respect this order for disassembly; disconnect BLACK (-) cable first.

Unfasten retaining rod.



Pull out top bracket.

Remove battery.

Battery Cleaning

Clean battery, battery casing and battery posts using a solution of baking soda and water.

Remove corrosion from battery cable terminals and battery posts using a firm wire brush. Battery casing should be cleaned by soft brush and baking soda solution.

Battery Installation

Reinstall battery in vehicle.

⚠ WARNING

Connect RED (+) cable first then BLACK (-) cable. Always connect RED (+) cable first.

Fuses

⚠ WARNING

Always turn the ignition switch to OFF position before replacing a defective fuse.

The electrical system is protected with fuses.

If a fuse is damaged, replace it by one of the same rating.

NOTICE Do not use a higher rated fuse as this can cause severe damage.

Fuse Inspection

To remove fuse from holder, remove the fuse holder cover then pull fuse out. Check if filament is melted.

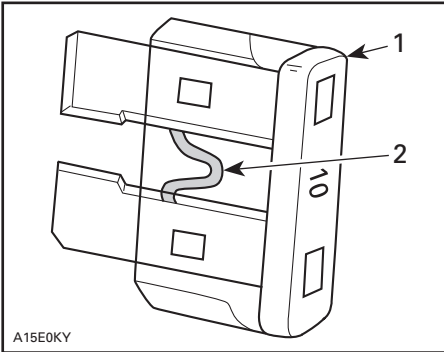

A15E0KY

TYPICAL

1. Fuse
2. Check if melted

Front Fuses Location

fuses holder is located in the front service compartment Refer to *BODY*.

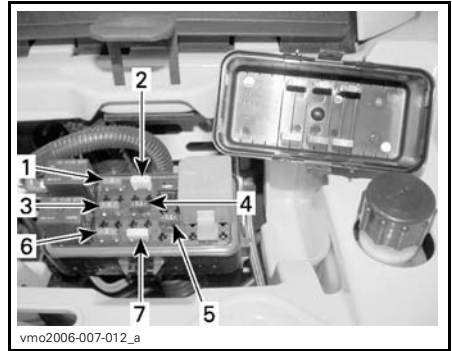

vmo2006-007-012_a

TYPICAL — FRONT FUSES LOCATION

1. (F1) Ignition coils (5 A)
2. (F2) Fan (20 A)
3. (F3) Fuel injectors (5 A)
4. (F4) Speedometer/speed sensor/taillight (7.5 A)
5. (F5) Fuel pump (7.5 A)
6. (F6) Engine Control Module (ECM) (5 A)
7. (F7) Accessories (20 A)

Rear Fuses Location

fuse are located at the back near battery behind thread cover.



vmo2006-007-031_a

TYPICAL — REAR FUSES LOCATION

1. (F8) Main (30 A)
(F9) Main accessories (30 A)

Lights

⚠ WARNING

Always turn the ignition switch to OFF position before replacing a defective bulb.

Always check light operation after replacement.

Headlight Bulb Replacement

NOTICE Never touch glass portion of a halogen bulb with bare fingers, it shortens its operating life. If glass is touched, clean it with isopropyl alcohol which will not leave a film on the bulb.

To replace the headlight bulb, proceed as follows.

NOTE: The same headlight is used on both sides of vehicle and for LO and HI beams.

Unplug connector from bulb.



Pull out bulb.

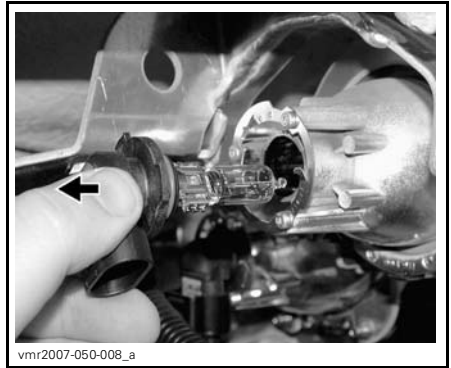

Properly reinstall removed parts in the reverse order of their removal.

Validate headlights operation.

Headlight Beam Aiming

Adjust beam aiming as follows:

Turn adjustment screws to adjust beam height to your convenience. Adjust headlights evenly.

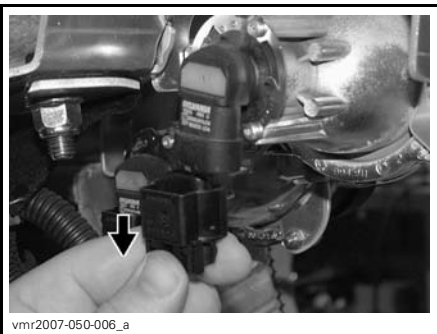

Rotate bulb.

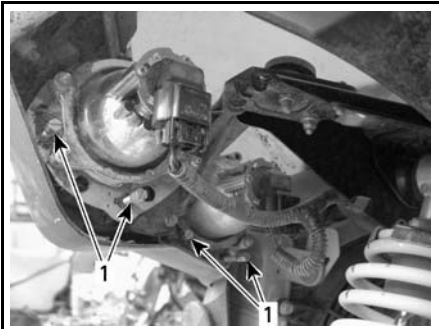

vmo2008-005-008_a

TYPICAL

1. Adjustment screws

Taillight Bulb Replacement

Unscrew lens screws to expose bulbs.

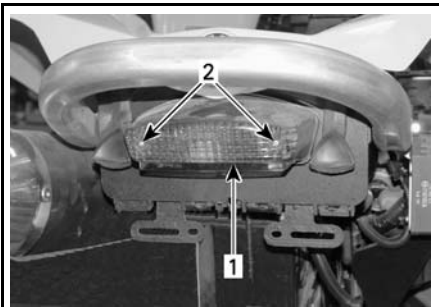

vmo2007-015-010_b

1. Lens
2. Screws

Push the bulb in and hold while turning counterclockwise to release.

Install the new bulb by pushing in while turning clockwise.

Drive Shaft Boot/Protector

Drive Shaft Boot/Protector Inspection

Visually inspect drive shaft protectors and boots conditions. Check protectors for damage or rubbing against

shafts. Check boots for cracks, tears, leaking grease etc. Repair or replace damaged parts as necessary.

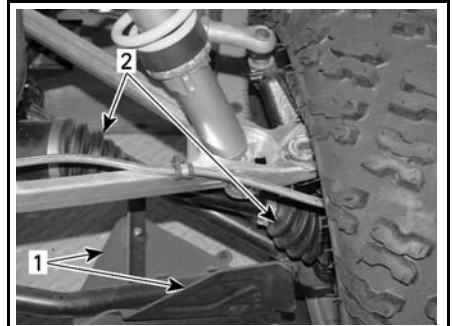

vmo2007-015-013_a

FRONT OF VEHICLE

1. Drive shaft protector
2. Drive shaft boots

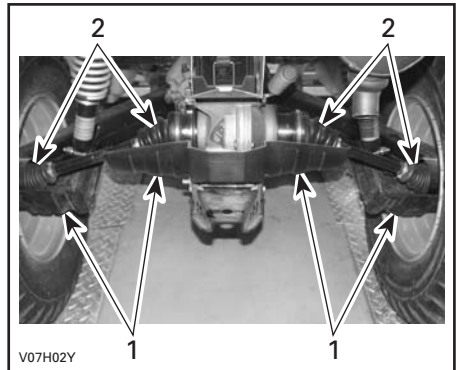

V07H02Y

TYPICAL — REAR OF VEHICLE

1. Drive shaft protector
2. Drive shaft boots

Wheel and Tires

Wheel Bearing Inspection

Push and pull the wheels from the upper edge to feel the play. See an authorized Can-Am dealer if there is any play.

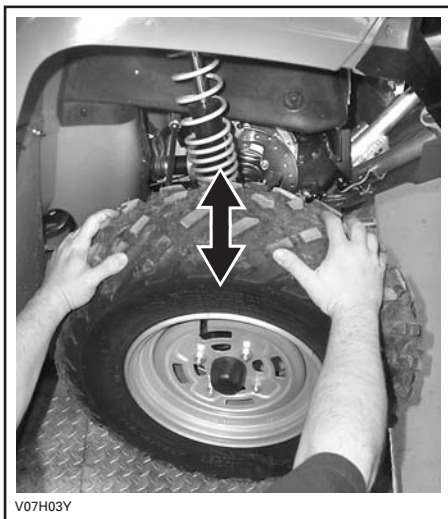

V07H03Y

TYPICAL

Wheel Removal/Installation

Loosen nuts then lift vehicle. Place a support under vehicle. Remove nuts then remove wheel.

At installation, it is recommended to apply anti-seize lubricant on threads.

The tires are directional and their rotation must be kept in a specific direction for proper operation.

Torque wheel nuts in accordance with the following illustration.

Torque to 100 N•m (74 lbf•ft).

NOTE: Occasionally, wheel nuts should be removed to apply anti-seize lubricant on studs to ease future removal. This is particularly important when vehicle is used in salt-water environment or in mud. Remove one nut at a time, lubricate then retorque.



TIGHTENING SEQUENCE

NOTICE Always use the recommended wheel nuts (P/N 250 100 082). Using a different nut could cause damages to the rim.

Tire Pressure

⚠ WARNING

Tire pressure greatly affects vehicle handling and stability. Under-pressure may cause tire to deflate and rotate on wheel. Overpressure may burst the tire. Always follow recommended pressure. Since tires are low-pressure types, a manual pump should be used.

Check pressure when tires are cold before using the vehicle. Tire pressure changes with temperature and altitude. Recheck pressure if one of these conditions has changed.

For your convenience, a pressure gauge is supplied in tool kit.

| TIRE PRESSURE | | | |
|-----------------------------|------|---------------------|---------------------|
| UP to 141 kg (310 lb) | MAX. | FRONT | REAR |
| | | 48 kPa (7 PSI) | 48 kPa (7 PSI) |
| | MIN. | 34.5 kPa (5 PSI) | 38 kPa (5.5 PSI) |

NOTE: Although the tires are specifically designed for off-road use, a flat may still occur. Therefore, it is recommended to carry a tire pump and a repair kit.

Tire Inspection

Check tire for damage and wear. Replace if necessary.

Do not rotate tires. The front and rear tires have a different size. The tires are directional and their rotation must be kept in a specific direction for proper operation.

Tire Replacement

WARNING

When the tires are replaced, never install a bias tire with a radial tire. Such a combination could create handling and/or stability problems.

Do not mix tires of different size and/or design on the same axle.

Front and rear tire pairs must have an identical model and manufacturer.

For unidirectional tread pattern, ensure that the tires are installed in the correct direction of rotation. The radial tires must be installed as a complete set.

Severe injury or death can result if you do not follow these instructions.

Suspension

Suspension Lubrication

Lubricate front A-arms. Use suspension synthetic grease (P/N 293 550 033) or an equivalent. There is two grease fittings on each A-arm.

Front Suspension Inspection

Inspect shock absorber for leaks or other damages. Check tightness of fasteners. See an authorized Can-Am dealer as necessary.

A-Arms

Check A-arms for cracks, bending or other damages. See an authorized Can-Am dealer as necessary.

Rear Suspension Inspection

Inspect shock absorber for leaks or other damages. Check tightness of fasteners. See an authorized Can-Am dealer as necessary.

Trailing Arms

Check trailing arms for distortion, cracks or bending. See an authorized Can-Am dealer if any problem is detected.

Brake

Brake Fluid Level

With vehicle on a level surface, check brake fluid in reservoirs for proper level. They should be above MIN. mark.

Add fluid as required. **Do not overfill.**

Clean filler cap before removing.

NOTICE Use only DOT 4 brake fluid from a sealed container. Do not use brake fluid taken from old or already opened containers.

NOTE: A low level may indicate leaks or worn brake pads. See an authorized Can-Am dealer.

Front and Rear Brake Lever Fluid Reservoir

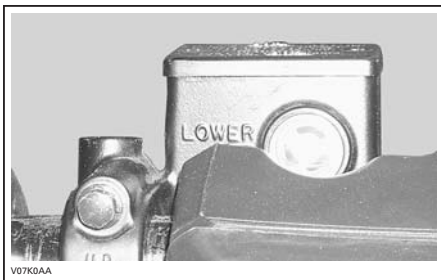

TYPICAL

Turn steering in the straight-ahead position to ensure reservoir is level.

Check the brake fluid level, the reservoir is full when the fluid reaches of the top of window.

Visually inspect lever boot condition. Check for cracks, tears, etc. Replace if damaged.

Repeat the same procedure for the other reservoir.

Rear Brake Pedal Fluid Reservoir

With vehicle on a level surface, brake fluid should be between MIN. and MAX. level marks.



Recommended Brake Fluid

Always use brake fluid meeting the specification DOT 4 only.

NOTICE To avoid serious damage to the braking system, do not use fluids other than the recommended one, nor mix different fluids for topping up.

Brake Inspection

The braking system is an hydraulic type and no adjustment is required.

Check the following to keep the brakes in a good operating condition:

- Brake fluid level
- Brake system for fluid leaks
- Brake for spongy feel
- Brake cleanliness
- Brake discs for excessive wear and surface condition
- Brake pads for wear, damage or looseness.

| SERVICE LIMITS | |
|-----------------------|------------------|
| Brake pads thickness | 1 mm (.040 in) |
| Front discs thickness | 3.5 mm (.138 in) |
| Rear disc thickness | 4.3 mm (.170 in) |
| Maximum discs warpage | 0.3 mm (.010 in) |

See your authorized Can-Am dealer if a problem is detected concerning the brake system.

⚠ WARNING

The brake fluid replacement or brake system maintenance and repairs should be performed by an authorized Can-Am dealer.

Body

Central Panel Removal

Remove seat.

Lift the front part of the central panel.

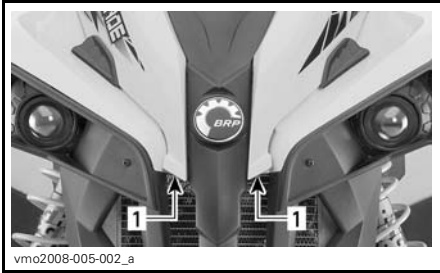

1. Lift here

Come off the plastic studs from the grommets.



Remove central panel.

This panel allows an easier access to the air filter box and, if the console is removed, to the service compartment. The service compartment contains different maintenance items

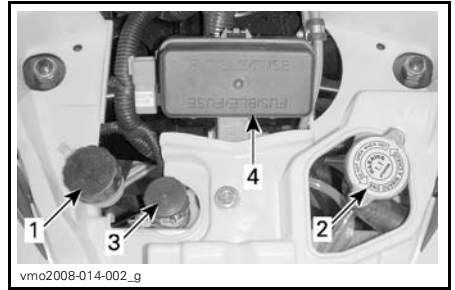

1. Rear brake pedal fluid reservoir
2. Radiator cap
3. Coolant reservoir
4. Fuse holders

Seat Fasteners

Remove seat and check latch mechanism and pin for wear. See an authorized Can-Am dealer for parts replacement if damaged.

Vehicle Cleaning and Protection

Never use a high pressure washer to clean the vehicle. **USE LOW PRESSURE ONLY** (like a garden hose). High pressure can cause electrical or mechanical damages.

Painted parts which are damaged should be properly repainted to prevent rust.

When required, wash the body with hot water and soap (only use mild detergent). Apply non-abrasive wax.

NOTICE Never clean plastic parts with strong detergent, degreasing agent, paint thinner, acetone, etc.

Frame

Recovery Hook Condition

Check tightness of fasteners. Properly retighten as necessary.

Frame Fasteners

Check fastener condition and tightness on the vehicle. Retighten as required.

While reading this Operator's Guide, reminder that:

 **WARNING**

Indicates a potential hazard that, if not avoided, could result in serious injury or death.

STORAGE AND PRESEASON PREPARATION

WARNING

Have an authorized Can-Am dealer inspect fuel system integrity as specified in *MAINTENANCE CHART*.

When a vehicle is not in use for more than 4 months, proper storage is a necessity.

See an authorized Can-Am dealer for proper procedures.

When using your vehicle after storage, a preparation is required. See an authorized Can-Am dealer for proper procedures.

TECHNICAL INFORMATION

VEHICLE IDENTIFICATION

The main components of your vehicle (engine and frame) are identified by different serial numbers. It may sometimes become necessary to locate these numbers for warranty purposes or to trace your vehicle in the event of loss. These numbers are required by the authorized Can-Am dealer to complete warranty claims properly. No warranty will be allowed by BRP Inc. if the engine identification number (EIN) or vehicle identification number (VIN) is removed or mutilated in any way. We strongly recommend that you take note of all the serial numbers on your vehicle and supply them to your insurance company.

Vehicle Identification Number

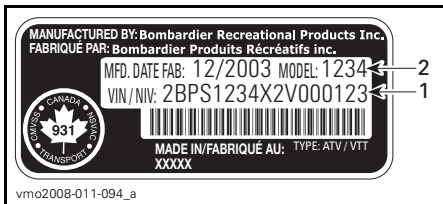

TYPICAL — VEHICLE SERIAL NUMBER LABEL

1. VIN (Vehicle Identification Number)
2. Model number



1. Vehicle serial number label location

Engine Identification Number

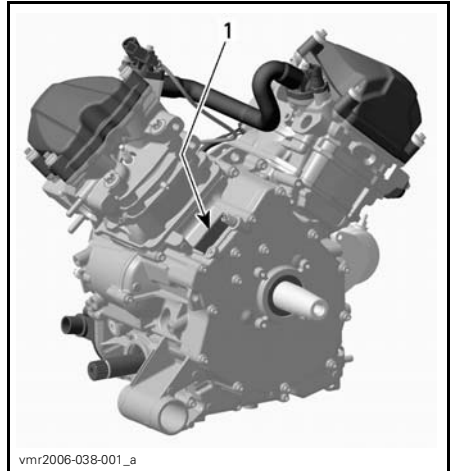

TYPICAL — ENGINE SERIAL NUMBER LABEL

1. EIN (Engine Identification Number)

Compliance Label

This label indicates vehicle's compliance in many countries.

| LABEL LOCATION | |
|----------------|---------------------------------------|
| Renegade™ | Under seat, on the upper bar of frame |



NOISE EMISSION CONTROL SYSTEM REGULATION

USA and Canada Only

Tampering with Noise Control System Is Prohibited!

U.S. Federal law and Canadian provincial laws may prohibit the following acts or the causing there of:

1. The removal or rendering inoperative by any person other than for purposes of maintenance, repair or replacement of any device or element of design incorporated into any new vehicle for the purpose of noise control prior to its sale or delivery to the ultimate purchaser or while it is in use or
2. The use of the vehicle after such device or element of design has been removed or rendered inoperative by any person.

Among those Acts Presumed to Constitute Tampering Are the Acts Listed Below:

1. Removal or alteration or the puncturing of the muffler or any engine component which conducts removal of engine exhaust gases.
2. Removal or alteration or the puncturing of any part of the intake system.
3. Replacing any moving parts of the vehicle or parts of the exhaust or intake system, with parts other than those specified by the manufacturer.
4. Lack of proper maintenance.

SPECIFICATIONS

| MODEL | | RENEGADE 500 | RENEGADE 800/800 X |
|----------------------------|---------------|---|--|
| ENGINE | | | |
| Engine type | | 4-stroke, Single Over Head Camshaft (SOHC), liquid cooled | |
| Number of cylinders | | 2 | |
| Number of valves | | 8 valves (mechanical adjustment) | |
| Bore | mm (in) | 82 (3.23) | 91 (3.58) |
| Stroke | mm (in) | 47 (1.85) | 61.5 (2.42) |
| Displacement | | 500 cm ³ (30.51 in ³) | 800 cm ³ (48.82 in ³) |
| Compression ratio | | 10.3:1 | |
| Maximum Horsepower RPM | | RPM | 7250 |
| | | | 6750 |
| Lubrication | Type | | Wet sump. Replaceable oil filter |
| | Oil filter | | BRP Rotax paper type, replaceable |
| | Engine oil | Capacity (oil change with filter) | 2 L (2.11 quarts) |
| | | Recommended | SAE 5W 30 API classification SM, SL or SJ see <i>OIL VISCOSITY CHART</i> |
| Exhaust system | | Spark arrestor approved by USDA Forest Service | |
| Air filter | | Synthetic paper filter with foam | |
| COOLING SYSTEM | | | |
| Coolant | Type | | Ethyl glycol/water mix (50% coolant, 50% water). Use premixed coolant sold by BRP (P/N 219 700 362) or coolant specifically designed for aluminum engines |
| | Capacity | | 2.5 L (2.65 quarts) |
| ELECTRICAL SYSTEM | | | |
| Magneto generator output | | 400 W @ 6000 RPM | |
| Ignition system type | | IDI (Inductive Discharge Ignition) | |
| Ignition timing | | Not adjustable | |
| Spark plug | Quantity | | 2 |
| | Make and type | | NGK DCPR8E |
| | Gap | | 0.6 to 0.7 mm (.024 to .027 in) |
| Engine RPM limiter setting | Forward | RPM | 8000 |
| | Reverse | RPM | 3200 |

| MODEL | | RENEGADE 500 | RENEGADE 800/800 X |
|---|---------------------------------------|---|--------------------|
| ELECTRICAL SYSTEM (cont'd) | | | |
| Battery | Type | Dry battery type | |
| | Voltage | 12 volts | |
| | Nominal rating | 18 A•h | |
| | Power starter output | 0.7 KW | |
| headlights | W | 4 x 60 | |
| taillight | W | 8/26 | |
| Director indicator (European models only) | W | 10 | |
| Fuses | Accessories | 20 A | |
| | Fan | 20 A | |
| | Main | 30 A | |
| | Ignition coils | 5 A | |
| | Fuel injectors | 5 A | |
| | Speedometer/speed sensor/taillight | 7.5 A | |
| | Fuel pump | 7.5 A | |
| | Engine control module (ECM) | 5 A | |
| | Main accessories | 30 A | |
| FUEL SYSTEM | | | |
| Fuel delivery | Type | Electronic Fuel Injection (EFI), Dell'Orto 46 mm throttle body, 1 injector per cylinder | |
| Fuel pump | Type | Bosch | |
| | Model | Electrical (in fuel tank) | |
| Idle speed | ± 50 RPM | 1250 (not adjustable) | |
| Fuel | Type | Regular unleaded gasoline | |
| | Octane no. | Inside North America (R+M)/2 | 87 or higher |
| | | Outside North America RON | 92 or higher |
| Fuel tank capacity | | 20 L (5.3 U.S. gal) | |
| Remaining fuel in fuel tank when display light turns ON | | ± 6 L (1.6 U.S. gal) | |

SPECIFICATIONS

| MODEL | | RENEGADE 500 | RENEGADE 800/800 X |
|-------------------------------|-------------|--|--|
| CVT TRANSMISSION | | | |
| Type | | CVT (Continuously Variable Transmission) | |
| Engagement RPM | | ± 100 RPM 1600 | |
| GEARBOX | | | |
| Type | | Dual range (HI-LO) with park, neutral and reverse | |
| Gearbox oil | Capacity | | 400 ml (14 U.S. oz) |
| | Recommended | | XP-S chaincase oil (P/N 413 801 900) |
| DRIVE SYSTEM | | | |
| Differential oil | Capacity | Front | 500 ml (17 U.S. oz) |
| | | Rear | 250 ml (8.5 U.S. oz) |
| | Recommended | | BRP differential oil (P/N 293 600 043) or synthetic oil 75W 90 (API GL5) |
| Front drive | | Shaft driven/single Auto-lock differential (pump driven) | |
| Front drive ratio | | 3.6:1 | |
| Rear drive | | Shaft driven/single differential | |
| Rear drive ratio | | 3.6:1 | |
| CV joint grease | | CV joint grease (P/N 293 550 019) | |
| Propeller shaft grease | | XP-S synthetic grease (P/N 293 550 010) | |
| STEERING | | | |
| Turning radius | | 2.16 m (7 ft) | |
| Total toe (vehicle on ground) | | 0 mm (0 in) | |
| Camber angle | | 0° | |
| SUSPENSION | | | |
| <i>FRONT</i> | | | |
| Suspension type | | Double A-Arm | |
| Suspension travel | | mm (in) 216 (8.5) | |
| Shock absorber | Qty | | 2 |
| | Type | | Oil 5 settings HPG X: HPG Clicker |

| MODEL | | RENEGADE 500 | RENEGADE 800/800 X |
|------------------------------|----------|--|-----------------------|
| SUSPENSION (cont'd) | | | |
| <i>REAR</i> | | | |
| Suspension type | | TTI™ independent | |
| Suspension travel | | mm (in) | |
| | | 229 (9) | |
| Shock absorber | Qty | 2 | |
| | Type | Oil 5 settings | HPG X: HPG Clicker |
| BRAKES | | | |
| Front brake | Type | Hydraulic, 2 discs | |
| Rear brake | Type | Hydraulic, single disc | |
| Brake fluid | Capacity | 125 ml (4.3 U.S. oz) | |
| | Type | DOT 4 | |
| Parking brake | | LH brake lever includes a lock on rear wheels | |
| Caliper | | Floating | |
| Brake pad material | Front | Organic | |
| | Rear | Metallic | |
| Minimum bake pad thickness | | mm (in) | |
| | | 1 (.04) | |
| Minimum brake disc thickness | Front | mm (in) | |
| | Rear | mm (in) | |
| | | 3.5 (.138) | |
| | | 4.3 (.17) | |
| Maximum brake disc warp | | mm (in) | |
| | | 0.2 (.01) | |
| TIRES AND WHEELS | | | |
| <i>TIRES</i> | | | |
| Pressure | Front | Maximum: 48 kPa (7 PSI) Minimum: 34.5 kPa (5 PSI) | |
| | Rear | Maximum: 48 kPa (7 PSI) Minimum: 38 kPa (5.5 PSI) | |
| Minimum tire thread depth | | mm (in) | |
| | | 3 (0.118) | |
| Size | Front | 25 x 8 x 12 | |
| | Rear | 25 x 10 x 12 | |

SPECIFICATIONS

| MODEL | | RENEGADE 500 | RENEGADE 800/800 X |
|--|---------------|---------------------|---------------------------|
| TIRES AND WHEELS (cont'd) | | | |
| <i>WHEELS</i> | | | |
| Size | Front | 12 x 6 | |
| | Rear | 12 x 7.5 | |
| Wheel nuts torque | | 100 N•m (74 lbf•ft) | |
| WEIGHT AND DIMENSION | | | |
| Overall length | m (in) | 2.18 (86) | |
| Overall width | m (in) | 1.17 (46) | |
| Overall height | m (in) | 1.14 (45) | |
| Dry weight | kg (lb) | 275 (607) | |
| Wheel base | m (in) | 1.30 (51) | |
| Wheel track | Front | mm (in) | 965 (38) |
| | Rear | mm (in) | 914 (36) |
| Ground clearance | mm (in) | 305 (12) | |
| LOADING CAPACITY | | | |
| Weight distribution | Front/rear | % | 51/49 |
| Rear storage box | L (U.S. gal) | | 3.7 (1) |
| Rack | Rear | kg (lb) | 16 (35) |
| Total vehicle load allowed (including driver, all other loads and added accessories) | | kg (lb) | 141 (310) |
| Gross vehicle weight rating | | kg (lb) | 476 (1050) |
| Towing capacity | | kg (lb) | 591 (1300) |

TROUBLESHOOTING

TECHNICAL GUIDELINES

ENGINE DOES NOT TURN

1. Ignition switch is in the OFF position.
 - Place switch to the ON position.
2. Engine stop switch.
 - Make sure that engine stop switch is in ON position.
3. Transmission is not set on PARK or NEUTRAL.
 - Set transmission either in PARK or in NEUTRAL or press the brake lever(s).
4. Burnt fuse.
 - Check main fuse condition.
5. Weak battery or loose connections.
 - Check charging system fuse.
 - Check connections and terminals condition.
 - Have the battery checked.
 - Contact an authorized Can-Am dealer.
6. Wrong ignition key, multifunction gauge display shows INVALID KEY.
 - Use the proper key for this vehicle.

ENGINE TURNS OVER BUT FAILS TO START

1. Flooded engine (spark plug wet when removed).
 - (Drowned mode) If the engine does not start and it is fuel-flooded, this special mode can be activated to prevent fuel injection and to cut ignition while cranking. Proceed as follows:
 - Insert key in ignition switch and turn to ON position.
 - Press completely and HOLD throttle lever.
 - Press the engine START button.The engine should be cranked for 20 seconds. Release engine START button.
Release throttle lever and start/crank engine again to allow starting.
 - If it does not work:**
 - Clean the spark plug caps area then remove them.
 - Remove the spark plugs (tools are supplied in tool kit).
 - Crank engine several times.
 - Install new spark plugs if possible or clean and dry spark plugs.
 - Start engine as explained above.If engine continues to flood, see an authorized Can-Am dealer.
 - NOTE:** Make sure to verify that there is no fuel in engine oil, if so, replace engine oil.
2. No fuel to the engine (spark plug dry when removed).
 - Check fuel tank level.
 - A failure of the fuel pump may have occurred.
 - Contact an authorized Can-Am dealer.

ENGINE TURNS OVER BUT FAILS TO START (cont'd)

3. Spark plug/ignition (no spark).

- *Check main fuse condition.*
- *Remove spark plug then reconnect to ignition coil.*
- *Check that ignition switch and/or engine stop switch is/are at the ON position.*
- *Start engine with spark plug grounded to the engine away from spark plug hole. If no spark appears, replace spark plug.*
- *If trouble persists, contact an authorized Can-Am dealer.*

4. Multifunction gauge CHECK ENGINE indicator lamp is on and display shows CHECK ENGINE.

- *Contact an authorized Can-Am dealer.*

5. Engine is under a protection mode.

- *Multifunction gauge CHECK ENGINE indicator lamp is on and display shows CHECK ENGINE, contact an authorized Can-Am dealer.*

ENGINE LACKS ACCELERATION OR POWER

1. Fouled or damaged spark plug.

- *Check item ENGINE TURNS OVER BUT FAILS TO START.*

2. Lack of fuel to engine.

- *Check item ENGINE TURNS OVER BUT FAILS TO START.*

3. Engine is overheating.

- *Check ENGINE OVERHEATS.*

4. Air filter/housing plugged or dirty.

- *Check air filter and clean if necessary.*
- *Check deposits in air filter housing drain.*
- *Check the position of the air intake tube.*

5. CVT dirty or worn-out.

- *Contact an authorized Can-Am dealer.*

6. Engine is under a protection mode.

- *Check multifunction gauge display for messages.*
- *Multifunction gauge CHECK ENGINE indicator lamp is on and display shows CHECK ENGINE or LIMP HOME, contact an authorized Can-Am dealer.*

ENGINE OVERHEATS

1. **CHECK ENGINE indicator light will turn on and HI TEMP will appear in the multifunction display.**
 - *Reduce vehicle speed but try to keep vehicle moving to supply air to radiator. If engine is still overheating after approximately one minute, stop vehicle and set transmission to PARK. Stop engine.*
 - *Place the ignition switch to ON position (DO NOT RESTART ENGINE YET). The radiator fan will cool the radiator.*
 - *Let engine cool down.*
2. **Cooling fan is not working.**
 - *Ensure cooling fan is not jammed and working properly.*
 - *Check fan fuse. See FUSES section.*
 - *See an authorized Can-Am dealer as soon as possible.*
3. **Dirty radiators fins.**
 - *Check and clean radiator fins. See MAINTENANCE PROCEDURES section.*
4. **Low coolant level in cooling system.**
 - *Check coolant level and refill if possible. See MAINTENANCE PROCEDURES.*
 - *See an authorized Can-Am dealer as soon as possible.*

ENGINE BACKFIRE

1. **Exhaust system leakage.**
 - *Contact an authorized Can-Am dealer.*
2. **Engine is running too hot.**
 - *See ENGINE LACKS ACCELERATION OR POWER.*
3. **Ignition timing is incorrect or there is an ignition system failure.**
 - *Contact an authorized Can-Am dealer.*

ENGINE MISFIRE

1. **Fouled/damaged/worn spark plug.**
 - *Clean/verify spark plug and heat range. Replace as required.*
2. **Water in fuel.**
 - *Drain fuel system and refill with fresh fuel.*

VEHICLE CANNOT REACH FULL SPEED

1. **Engine.**
 - *See ENGINE LACKS ACCELERATION OR POWER.*
2. **Parking brake.**
 - *Ensure parking brake is completely removed.*

VEHICLE CANNOT REACH FULL SPEED (cont'd)

3. Air filter/housing plugged or dirty.

- *Check air filter and clean if necessary.*
- *Check deposits in air filter housing drain.*
- *Check the position of the air intake tube.*

4. CVT dirty or worn-out.

- *Contact an authorized Can-Am dealer.*

5. Engine is under a protection mode.

- *Check multifunction gauge display for messages.*
- *Multifunction gauge CHECK ENGINE indicator lamp is on and display shows CHECK ENGINE or LIMP HOME, contact an authorized Can-Am dealer.*

TRANSMISSION LEVER IS HARD TO MOVE

1. Transmission gears are in a position that prevents the transmission lever to work.

- *Rock the vehicle back and forth to move the gears in the transmission and allow the transmission lever to be set.*

2. CVT dirty or worn-out.

- *Contact an authorized Can-Am dealer.*

THE RPM INCREASES BUT THE VEHICLE DOES NOT MOVE

1. The transmission is on PARK or NEUTRAL position.

- *Select the R, HI or LO position.*

2. CVT dirty or worn-out.

- *Contact an authorized Can-Am dealer.*

3. Water in the CVT housing.

- *Contact an authorized Can-Am dealer.*

MESSAGES IN MULTIFUNCTION GAUGE

| MESSAGE | DESCRIPTION |
|---------------------------------|---|
| INVALID KEY | Indicates that you have used the wrong ignition key, use the proper key for this vehicle. It is also possible that the ignition key has a bad contact, remove and clean key. |
| BRAKE | Is displayed when parking brake is applied for more than 15 seconds. |
| LO BATT | Low battery voltage, check battery voltage and charging system. |
| HI BATT | High battery voltage, check battery voltage and charging system. |
| LOW OIL ⁽¹⁾ | Engine low oil pressure, stop engine immediately and check oil level. |
| LOW FUEL | LOW FUEL indicator lamp also turns on. Refer to <i>INDICATOR LAMPS</i> . |
| HI TEMP ⁽²⁾ | Engine is overheating, refer to <i>ENGINE OVERHEAT</i> in <i>TROUBLESHOOTING</i> . |
| LIMP HOME | Serious fault on the engine that can change the normal operation of the engine, CHECK ENGINE indicator lamp will also blink, refer to <i>TROUBLESHOOTING</i> for more details. |
| CHECK ENGINE | Engine fault, CHECK ENGINE indicator lamp will also be ON, see an authorized Can-Am dealer. |
| MAINTENANCE SOON ⁽³⁾ | Periodic maintenance required. See an authorized Can-Am dealer. |
| NO ECM COMMUNICATION | Communication error between gauge and engine control module (ECM), contact an authorized Can-Am dealer. |

NOTICE ⁽¹⁾ If the light does not cut out right after engine starting, stop engine. Check engine oil level. Refill if necessary. If the oil level is good, see an authorized Can-Am dealer. Do not use the vehicle until repaired.

NOTICE ⁽²⁾ If the light does not turn off right after engine starting, stop engine. See an authorized Can-Am dealer. Do not use the vehicle until repaired.

⁽³⁾ Message must be erased by an authorized Can-Am dealer.

WARRANTY

BRP LIMITED WARRANTY USA AND CANADA: 2009 CAN-AM™ ATV

1) SCOPE OF THE LIMITED WARRANTY

Bombardier Recreational Products Inc. ("BRP")* warrants its 2009 Can-Am ATV sold by authorized BRP dealers (as hereinafter defined) in the fifty United States and Canada from defects in material or workmanship for the period and under the conditions described below.

All genuine Can-Am ATV parts and accessories, installed by an authorized BRP dealer at the time of delivery of the 2009 Can-Am ATV, carry the same warranty as that of the Can-Am ATV.

This limited warranty will become null and void if: (i) the ATV was used for racing or any other competitive activity, at any point, even by a previous owner; or (ii) the ATV has been altered or modified in such a way so as to adversely affect its operation, performance or durability, or has been altered or modified to change its intended use.

2) LIMITATIONS OF LIABILITY

THIS WARRANTY IS EXPRESSLY GIVEN AND ACCEPTED IN LIEU OF ANY AND ALL OTHER WARRANTIES, EXPRESSED OR IMPLIED, INCLUDING WITHOUT LIMITATION ANY WARRANTY OF MERCHANTABILITY OR FITNESS FOR A PARTICULAR PURPOSE. TO THE EXTENT THAT THEY CANNOT BE DISCLAIMED, THE IMPLIED WARRANTIES ARE LIMITED IN DURATION TO THE LIFE OF THE EXPRESS WARRANTY. INCIDENTAL AND CONSEQUENTIAL DAMAGES ARE EXCLUDED FROM COVERAGE UNDER THIS WARRANTY. SOME STATES/PROVINCES DO NOT ALLOW FOR THE DISCLAIMERS, LIMITATIONS AND EXCLUSIONS IDENTIFIED ABOVE, AS A RESULT, THEY MAY NOT APPLY TO YOU. THIS WARRANTY GIVES YOU SPECIFIC RIGHTS, AND YOU MAY ALSO HAVE OTHER LEGAL RIGHTS WHICH MAY VARY FROM STATE TO STATE, OR PROVINCE TO PROVINCE.

Neither the distributor, any BRP dealer nor any other person has been authorized to make any affirmation, representation or warranty regarding the product, other than those contained in this limited warranty, and if made, shall not be enforceable against BRP.

BRP reserves the right to modify this warranty at any time, being understood that such modification will not alter the warranty conditions applicable to the products sold while this warranty is in effect.

3) EXCLUSIONS – ARE NOT WARRANTED

The following are not warranted under any circumstances:

- Normal wear and tear;
- Routine maintenance items, tune ups, adjustments;
- Damage caused by failure to provide proper maintenance and/or storage, as described in the Operator's Guide;

- Damage resulting from removal of parts, improper repairs, service, maintenance, modifications or use of parts not manufactured or approved by BRP or resulting from repairs done by a person that is not an authorized servicing BRP dealer;
- Damage caused by abuse, abnormal use, neglect or operation of the product in a manner inconsistent with the recommended operation described in the Can-Am ATV Operator's Guide;
- Damage resulting from accident, submersion, fire, theft, vandalism or any act of God;
- Operation with fuels, oils or lubricants which are not suitable for use with the product (see the Operator's Guide);
- Water or snow ingestion;
- Incidental or consequential damages, or damages of any kind including without limitation towing, storage, telephone, rental, taxi, inconvenience, insurance coverage, loan payments, loss of time, loss of income.

4) WARRANTY COVERAGE PERIOD

This warranty will be in effect from the date of delivery to the first retail consumer or the date the product is first put into use, whichever occurs first and for a period of:

SIX (6) CONSECUTIVE MONTHS, for private use or commercial use owners.

The emission-related components included in the chart below that are installed on EPA certified Can-Am ATVs registered in the USA are covered for thirty (30) consecutive months.

| EMISSION-RELATED COMPONENTS | 500/800 EFI |
|--|--------------------|
| TPS (Throttle Position Sensor) | X |
| TMAPS (Temperature and Manifold Air Pressure Sensor) | X |
| Fuel pressure regulator | X |
| Fuel injectors | X |
| ECM (Engine Control Module) | X |
| Crankcase ventilation system | X |
| Cylinder head gasket | X |
| Intake runner seal | X |

The repair or replacement of parts or the performance of service under this warranty does not extend the life of this warranty beyond its original expiration date.

5) CONDITIONS TO HAVE WARRANTY COVERAGE

This warranty coverage is available **only** if **each** of the following conditions has been fulfilled:

- The 2009 Can-Am ATV must be purchased as new and unused by its first owner from a BRP dealer authorized to distribute Can-Am ATVs in the country in which the sale occurred ("BRP dealer");
- The BRP specified pre-delivery inspection process must be completed and documented;
- The 2009 Can-Am ATV must have undergone proper registration by an authorized BRP dealer;
- The 2009 Can-Am ATV must be purchased in the country in which the purchaser resides;
- Routine maintenance outlined in the Operator's Guide must be timely performed in order to maintain warranty coverage. BRP reserves the right to make warranty coverage contingent upon proof of proper maintenance.

BRP will not honor this limited warranty to any private use owner or commercial use owner if the preceding conditions have not been met. Such limitations are necessary in order to allow BRP to preserve both the safety of its products, and also that of its consumers and the general public.

6) WHAT TO DO TO OBTAIN WARRANTY COVERAGE

The customer must cease using the ATV upon the appearance of an anomaly. The customer must notify a servicing BRP dealer within two (2) days of the appearance of a defect, and provide it with reasonable access to the product and reasonable opportunity to repair it. The customer must also present to the authorized BRP dealer, proof of purchase of the product and must sign the repair/work order prior to starting the repair in order to validate the warranty repair. All parts replaced under this limited warranty become the property of BRP.

7) WHAT BRP WILL DO

BRP's obligations under this warranty are limited to, at its sole discretion, repairing parts found defective under normal use, maintenance and service, or replacing such parts with new genuine Can-Am ATV parts without charge for parts and labor, at any authorized BRP dealer during the warranty coverage period under the conditions described herein. BRP's responsibility is limited to making the required repairs or replacements of parts. No claim of breach of warranty shall be cause for cancellation or rescission of the sale of the ATV to the owner.

In the event that service is required outside of the country of original sale, the owner will bear responsibility for any additional charges due to local practices and conditions, such as, but not limited to, freight, insurance, taxes, license fees, import duties, and any and all other financial charges, including those levied by governments, states, territories and their respective agencies.

BRP reserves the right to improve or modify products from time to time without assuming any obligation to modify products previously manufactured.

8) SUPPLIER WARRANTIES

A GPS receiver may be supplied by BRP as standard equipment on certain 2009 Can-Am ATV's. The GPS receiver is covered by the limited warranty issued by the GPS receiver's manufacturer and is not covered by this limited warranty. Please contact the following distributors:

In the USA:

Garmin International Inc.
1200 East 151st Street Olathe
KS 66062
(Kansas City metro area)
Tel.: 913 397-8200
Fax Number: 913 397-8282

In Canada (one or the other):

Raytech Électronique
1451, Boul. des Laurentides
Vimont, Laval, Qc
H7M 2Y3
Tél.: 450 975-1015
Télec.: 800 975-0025 / 450 975-0817
Contact: raytech@raytech.qc.ca
Web Site: www.raytech.qc.ca
Coord. GPS: N45o35.25' - W73o42.95'

Naviclub Ltée
5054, St-Georges
Lévis, Qc
G6V 4P2
Tél.: 418 835-9279
Télec.: 418 835-6681
Contact: naviclub@naviclub.com
Web Site: www.naviclub.com

Your 2009 Can-Am ATV could be originally equipped with Carlisle⁺ or ITP⁺ branded ATV tires. The tires are warranted separately by the tire manufacturer. Please contact the manufacturer or ask your authorized BRP dealer for warranty coverage and assistance.

Carlisle Tire & Wheel Company

23, Windham Boulevard
Aiken, SC 29805
Warranty Information:
in USA 1 800 260-7959
in Canada 1 800 265-6155
in Quebec 1 877 997-4999

9) TRANSFER

If the ownership of a product is transferred during the warranty coverage period, this warranty shall also be transferred and be valid for the remaining coverage period provided that BRP is notified of such transfer of ownership in the following way:

1. The former owner contacts BRP (at the phone number provided below) or an authorized BRP dealer and gives the coordinates of the new owner; or
2. BRP or an authorized BRP dealer receives a proof that the former owner agreed to the transfer of ownership, in addition to the coordinates of the new owner.

10) CONSUMER ASSISTANCE

In the event of a controversy or a dispute in connection with this limited warranty, BRP suggests that you try to resolve the issue at the dealership level. We recommend discussing the issue with the authorized dealer's service manager or owner.

If the issue has not yet been resolved, please submit your complaint in writing or call the appropriate number below:

In Canada

BOMBARDIER RECREATIONAL PRODUCTS INC.

CAN-AM VTT

Consumer Services Group

75, J.-A. Bombardier Street

Sherbrooke, Québec J1L 1W3

Tel.: 819 566-3366

In USA

BRP US INC.

CAN-AM VTT

Consumer Services Group

7575 Bombardier Court

Wausau WI 54401

Tel.: 715 848-4957

* In the USA, products are distributed and serviced by BRP US Inc.

© 2008 Bombardier Recreational Products Inc. All rights reserved.

™ trademarks of Bombardier Recreational Products Inc. or its affiliates.

† Carlisle and ITP are trademarks owned by or licensed to Carlisle Tire & Wheel Company.

BRP INTERNATIONAL LIMITED WARRANTY: 2009 CAN-AM™ ATV

1) SCOPE OF THE LIMITED WARRANTY

Bombardier Recreational Products Inc. ("BRP")* warrants its 2009 Can-Am ATV sold by authorized Can-Am distributors/dealers (as hereinafter defined) outside of the fifty United States, Canada and states members of the European Economic Area ("EEA") (which is comprised of the states member of the European Union plus Norway, Iceland and Liechtenstein) from defects in material or workmanship for the period and under the conditions described below.

All genuine Can-Am ATV parts and accessories, installed by an authorized Can-Am distributor/dealer (as hereinafter defined) at the time of delivery of the 2009 Can-Am ATV, carry the same warranty as that of the Can-Am ATV.

This limited warranty will become null and void if: (i) the ATV was used for racing or any other competitive activity, at any point, even by a previous owner; or (ii) the ATV has been altered or modified in such a way so as to adversely affect its operation, performance or durability, or has been altered or modified to change its intended use.

2) LIMITATIONS OF LIABILITY

THIS WARRANTY IS EXPRESSLY GIVEN AND ACCEPTED IN LIEU OF ANY AND ALL OTHER WARRANTIES, EXPRESSED OR IMPLIED, INCLUDING WITHOUT LIMITATION ANY WARRANTY OF MERCHANTABILITY OR FITNESS FOR A PARTICULAR PURPOSE. TO THE EXTENT THAT THEY CANNOT BE DISCLAIMED, THE IMPLIED WARRANTIES ARE LIMITED IN DURATION TO THE LIFE OF THE EXPRESS WARRANTIES. INCIDENTAL AND CONSEQUENTIAL DAMAGES ARE EXCLUDED FROM COVERAGE UNDER THIS WARRANTY. SOME JURISDICTIONS DO NOT ALLOW FOR THE DISCLAIMERS, LIMITATIONS AND EXCLUSIONS IDENTIFIED ABOVE, AS A RESULT, THEY MAY NOT APPLY TO YOU. THIS WARRANTY GIVES YOU SPECIFIC RIGHTS, AND YOU MAY ALSO HAVE OTHER LEGAL RIGHTS WHICH MAY VARY FROM COUNTRY TO COUNTRY.

Neither the distributor, any Can-Am dealer nor any other person has been authorized to make any affirmation, representation or warranty regarding the product, other than those contained in this limited warranty, and if made, shall not be enforceable against BRP.

BRP reserves the right to modify this warranty at any time, being understood that such modification will not alter the warranty conditions applicable to the products sold while this warranty is in effect.

3) EXCLUSIONS – ARE NOT WARRANTED

The following are not warranted under any circumstances:

- Normal wear and tear;
- Routine maintenance items, tune ups, adjustments;

- Damage caused by failure to provide proper maintenance and/or storage, as described in the Operator's Guide;
- Damage resulting from removal of parts, improper repairs, service, maintenance, modifications or use of parts not manufactured or approved by BRP or resulting from repairs done by a person that is not an authorized servicing Can-Am distributor/dealer;
- Damage caused by abuse, abnormal use, neglect or operation of the product in a manner inconsistent with the recommended operation described in the Operator's Guide;
- Damage resulting from accident, submersion, fire, theft, vandalism or any act of God;
- Operation with fuels, oils or lubricants which are not suitable for use with the product (see the Operator's Guide);
- Water or snow ingestion;
- Incidental or consequential damages, or damages of any kind including without limitation towing, storage, telephone, rental, taxi, inconvenience, insurance coverage, loan payments, loss of time, loss of income.

4) WARRANTY COVERAGE PERIOD

This warranty will be in effect from the date of delivery to the first retail consumer or the date the product is first put into use, whichever occurs first and for a period of:

SIX (6) CONSECUTIVE MONTHS, for private use or commercial use.

The repair or replacement of parts or the performance of service under this warranty does not extend the life of this warranty beyond its original expiration date.

5) CONDITIONS TO HAVE WARRANTY COVERAGE

This warranty coverage is available **only** if **each** of the following conditions has been fulfilled:

- The 2009 Can-Am ATV must be purchased as new and unused by its first owner from a Can-Am distributor/dealer authorized to distribute Can-Am ATVs in the country in which the sale occurred ("Can-Am distributor/dealer");
- The BRP specified pre-delivery inspection process must be completed and documented;
- The product must have undergone proper registration by an authorized Can-Am distributor/dealer;
- The 2009 Can-Am ATV must be purchased in the country or union of countries in which the purchaser resides;
- Routine maintenance outlined in the Operator's Guide must be timely performed in order to maintain warranty coverage. BRP reserves the right to make warranty coverage contingent upon proof of proper maintenance.

BRP will not honour this limited warranty to any private use owner or commercial use owner if the preceding conditions have not been met. Such limitations are necessary in order to allow BRP to preserve both the safety of its products, and also that of its consumers and the general public.

6) WHAT TO DO TO OBTAIN WARRANTY COVERAGE

The customer must cease using the ATV upon the appearance of an anomaly. The customer must notify a servicing Can-Am distributor/dealer within two (2) days of the appearance of a defect, and provide it with reasonable access to the product and reasonable opportunity to repair it. The customer must also present to the authorized Can-Am distributor/dealer, proof of purchase of the product and must sign the repair/work order prior to starting the repair in order to validate the warranty repair. All parts replaced under this limited warranty become the property of BRP.

7) WHAT BRP WILL DO

BRP's obligations under this warranty are limited to, at its sole discretion, repairing parts found defective under normal use, maintenance and service; or replacing such parts with new genuine Can-Am ATV parts without charge for parts and labour, at any authorized Can-Am distributor/dealer during the warranty coverage period under the conditions described herein. BRP's responsibility is limited to making the required repairs or replacements of parts. No claim of breach of warranty shall be cause for cancellation or rescission of the sale of the ATV to the owner.

In the event that service is required outside of the country of original sale, the owner will bear responsibility for any additional charges due to local practices and conditions, such as, but not limited to, freight, insurance, taxes, license fees, import duties, and any and all other financial charges, including those levied by governments, states, territories and their respective agencies.

BRP reserves the right to improve or modify products from time to time without assuming any obligation to modify products previously manufactured.

8) TRANSFER

If the ownership of a product is transferred during the warranty coverage period, this warranty shall also be transferred and be valid for the remaining coverage period provided BRP or an authorized Can-Am distributor/dealer receives a proof that the former owner agreed to the transfer of ownership, in addition to the coordinates of the new owner.

9) CONSUMER ASSISTANCE

1. In the event of a controversy or a dispute in connection with this limited warranty, BRP suggests that you try to resolve the issue at the dealership level. We recommend discussing the issue with the authorized dealer's service manager or owner.

2. If further assistance is required, the distributor's service department should be contacted in order to resolve the matter.
3. If the matter still remains unresolved then contact BRP by writing to us at the address listed below.

For countries within Europe, Middle East, Africa, Russia & CIS, please contact our European office:

BRP EUROPE N.V.

Consumer Service Center
Skaldenstraat 125
9042 Gent
Belgium
Tel.: + 32-9-218-26-00

For Scandinavian countries, please contact our Finland office:

BRP FINLAND OY

Service Department
Ahjotie 30
Fin-96320 Rovaniemi
Finland
Tel.: + 358 16 3208 111

For all other countries, please contact your local distributor or our North America office:

BOMBARDIER RECREATIONAL PRODUCTS INC.

Consumer Services Group
75, J.-A. Bombardier Street
Sherbrooke, Québec J1L 1W3
Tel.: 819 566-3366

You will find your distributor's coordinates on www.brp.com.

* For the territory covered by this limited warranty, products are distributed and serviced by Bombardier Recreational Products Inc. or its affiliates.
© 2008 Bombardier Recreational Products Inc. All rights reserved.
™ Trademark of Bombardier Recreational Products Inc. or its affiliates.

BRP LIMITED WARRANTY FOR THE EUROPEAN ECONOMIC AREA: 2009 CAN-AM™ ATV

1) SCOPE OF THE LIMITED WARRANTY

Bombardier Recreational Product Inc. ("BRP")* warrants its new and unused model-year 2009 Can-Am ATVs sold by authorized BRP distributors/dealers ("Distributors/Dealers") in the states members of the European Economic Area ("EEA") (which is comprised of the states member of the European Union plus Norway, Iceland and Liechtenstein) from defects in material or workmanship for the period and under the conditions described below.

All genuine Can-Am ATV parts and accessories, installed by an authorized BRP Distributors/Dealers at the time of delivery of the 2009 Can-Am ATV, carry the same warranty as that of the ATV.

This limited warranty will become null and void if: (i) the ATV was used for racing or any other competitive activity, at any point, even by a previous owner; or (ii) the ATV has been altered or modified in such a way so as to adversely affect its operation, performance or durability, or has been altered or modified to change its intended use.

2) LIMITATIONS OF LIABILITY

THIS WARRANTY IS EXPRESSLY GIVEN AND ACCEPTED IN LIEU OF ANY AND ALL OTHER WARRANTIES, EXPRESSED OR IMPLIED, INCLUDING WITHOUT LIMITATION ANY WARRANTY OF MERCHANTABILITY OR FITNESS FOR A PARTICULAR PURPOSE. TO THE EXTENT THAT THEY CANNOT BE DISCLAIMED, THE IMPLIED WARRANTIES ARE LIMITED IN DURATION TO THE LIFE OF THE EXPRESS WARRANTIES. INCIDENTAL AND CONSEQUENTIAL DAMAGES ARE EXCLUDED FROM COVERAGE UNDER THIS WARRANTY. SOME JURISDICTIONS DO NOT ALLOW FOR THE DISCLAIMERS, LIMITATIONS AND EXCLUSIONS IDENTIFIED ABOVE, AS A RESULT, THEY MAY NOT APPLY TO YOU. THIS WARRANTY GIVES YOU SPECIFIC RIGHTS, AND YOU MAY ALSO HAVE OTHER LEGAL RIGHTS WHICH MAY VARY FROM COUNTRY TO COUNTRY.

Neither the distributor, any BRP Distributor/Dealer nor any other person has been authorized to make any affirmation, representation or warranty regarding the product, other than those contained in this limited warranty, and if made, shall not be enforceable against BRP.

BRP reserves the right to modify this warranty at any time, being understood that such modification will not alter the warranty conditions applicable to the products sold while this warranty is in effect.

3) EXCLUSIONS – ARE NOT WARRANTED

The following are not warranted under any circumstances:

- Normal wear and tear;
- Routine maintenance items, tune ups, adjustments;

- Damage caused by failure to provide proper maintenance and/or storage, as described in the Operator's Guide;
- Damage resulting from removal of parts, improper repairs, service, maintenance, modifications or use of parts not manufactured or approved by BRP or resulting from repairs done by a person that is not an authorized servicing Distributor/Dealer;
- Damage caused by abuse, abnormal use, neglect or operation of the product in a manner inconsistent with the recommended operation described in the Operator's Guide;
- Damage resulting from accident, submersion, fire, theft, vandalism or any act of God;
- Operation with fuels, oils or lubricants which are not suitable for use with the product (see the Operator's Guide);
- Water or snow ingestion;
- Incidental or consequential damages, or damages of any kind including without limitation towing, storage, telephone, rental, taxi, inconvenience, insurance coverage, loan payments, loss of time, loss of income.

4) WARRANTY COVERAGE PERIOD

This warranty will be in effect from the date of delivery to the first retail consumer or the date the product is first put into use, whichever occurs first and for a period of:

TWENTY-FOUR (24) CONSECUTIVE MONTHS for private use.

SIX (6) CONSECUTIVE MONTHS, for commercial or rental use.

The product is used commercially when it is used in connection with any work or employment that generates income, during any part of the warranty period. The product is also used commercially when, at any point during the warranty period, it is licensed for commercial use.

The repair or replacement of parts or the performance of service under this warranty does not extend the life of this warranty beyond its original expiration date.

Note that the duration and any other modalities of the warranty coverage are subject to the applicable national or local legislation in your country.

5) CONDITIONS TO HAVE WARRANTY COVERAGE

This warranty coverage is available **only** if **each** of the following conditions has been fulfilled:

- The 2009 Can-Am ATV must be purchased as new and unused by its first owner from a Can-Am Distributor/Dealer authorized to distribute Can-Am ATVs in the country in which the sale occurred;
- The BRP specified pre-delivery inspection process must be completed and documented;
- The product must have undergone proper registration by an authorized Can-Am Distributor/Dealer;

- The 2009 Can-Am ATV must be purchased in the EEA;
- Routine maintenance outlined in the Operator's Guide must be timely performed in order to maintain warranty coverage. BRP reserves the right to make warranty coverage contingent upon proof of proper maintenance.

BRP will not honour this limited warranty to any private use owner or commercial use owner if the preceding conditions have not been met. Such limitations are necessary in order to allow BRP to preserve both the safety of its products, and also that of its consumers and the general public.

6) WHAT TO DO TO OBTAIN WARRANTY COVERAGE

The customer must cease using the ATV upon the appearance of an anomaly. The customer must notify a servicing BRP Distributor/Dealer within two (2) months of the appearance of a defect, and provide it with reasonable access to the product and reasonable opportunity to repair it. The customer must also present to the authorized BRP Distributor/Dealer, proof of purchase of the product and must sign the repair/work order prior to starting the repair in order to validate the warranty repair. All parts replaced under this limited warranty become the property of BRP.

Note that the notification period is subject to the applicable national or local legislation in your country.

7) WHAT BRP WILL DO

BRP's obligations under this warranty are limited to, at its sole discretion, repairing parts found defective under normal use, maintenance and service, or replacing such parts with new genuine Can-Am parts without charge for parts and labor, at any authorized BRP Distributor/Dealer during the warranty coverage period under the conditions described herein. BRP's responsibility is limited to making the required repairs or replacements of parts. No claim of breach of warranty shall be cause for cancellation or rescission of the sale of the ATV to the owner.

In the event that service is required outside of the EEA, the owner will bear responsibility for any additional charges due to local practices and conditions, such as, but not limited to, freight, insurance, taxes, license fees, import duties, and any and all other financial charges, including those levied by governments, states, territories and their respective agencies.

BRP reserves the right to improve or modify products from time to time without assuming any obligation to modify products previously manufactured.

8) TRANSFER

If the ownership of a product is transferred during the warranty coverage period, this warranty shall also be transferred and be valid for the remaining coverage period provided BRP or an authorized BRP Distributor/Dealer receives a proof that the former owner agreed to the transfer of ownership, in addition to the coordinates of the new owner.

9) CONSUMER ASSISTANCE

In the event of a controversy or a dispute in connection with this limited warranty, BRP suggests that you try to resolve the issue at the dealership level. We recommend discussing the issue with the authorized Distributor/Dealer's service manager or owner.

If further assistance is required, the distributor's service department should be contacted in order to resolve the matter.

If the matter still remains unresolved then contact BRP at the address listed below.

For countries within Europe, Middle East, Africa, Russia & CIS, please contact our European office:

BRP EUROPE N.V.

Consumer Service Center

Skaldenstraat 125

9042 Gent

Belgium

Tel.: + 32-9-218-26-00

For Scandinavian countries, please contact our Finland office:

BRP FINLAND OY

Service Department

Ahjotie 30

Fin-96320 Rovaniemi

Finland

Tel.: + 358 16 3208 111

For all other countries, please contact your local distributor or our North America office:

BOMBARDIER RECREATIONAL PRODUCTS INC.

Consumer Services Group

75, J.-A. Bombardier Street

Sherbrooke, Québec J1L 1W3

Tel.: 819 566-3366

You will find your distributor's coordinates on www.brp.com.

* For the territory covered by this limited warranty, products are distributed and serviced by Bombardier Recreational Products Inc. or its affiliates.

© 2008 Bombardier Recreational Products Inc. All rights reserved.

™ Trademark of Bombardier Recreational Products Inc. or its affiliates.

PRIVACY OBLIGATION/DISCLAIMER

We wish to inform you that your coordinates will be used for safety and warranty purposes. Sometimes, we also use the coordinates of our clients to inform them about our products and to present them offers. Should you prefer not to receive information on our product, services and offers, please let us know by writing to the address below.

Also note that, from time to time, carefully selected and trustworthy organizations may be permitted to use the coordinates of our clients to promote quality products and services. If you prefer not to have your name and address released, please let us know by writing to the address below.

In Canada

BOMBARDIER RECREATIONAL PRODUCTS INC.

Warranty Department
75, J.-A. Bombardier Street
Sherbrooke, Québec J1L 1W3
Fax Number: 819 566-3590

In USA

BRP US INC.

Warranty Department
7575 Bombardier Court
Wausau WI 54401
Tel.: 715 848-4957

Other countries in the world

BRP EUROPEAN DISTRIBUTION

Warranty Department
Chemin de Messidor 5-7
1006 Lausanne Switzerland
Fax Number: + 41213187801

CHANGE OF ADDRESS/OWNERSHIP

If your address has changed or if you are the new owner of the ATV, be sure to notify BRP by either:

- Mailing one of the following cards below
- **North America Only:** calling at 715 848-4957 (USA) or 819 566-3366 (Canada);
- Notifying an authorized Can-Am dealer.

In case of change of ownership, please join a proof that the former owner agreed to the transfer.

Notifying BRP, even after the expiration of the limited warranty, is very important as it enables BRP to reach the ATV owner if necessary, like when safety recalls are initiated. It is the owner's responsibility to notify BRP.

STOLEN UNITS: If your personal ATV is stolen, you should notify BRP or an authorized Can-Am dealer. We will ask you to provide your name, address, phone number, the vehicle identification number and the date it was stolen.

In North America

BOMBARDIER RECREATIONAL PRODUCTS INC.

Warranty Department
75, J.-A. Bombardier Street
Sherbrooke, Québec J1L 1W3
Canada

Other countries in the world

BRP EUROPEAN DISTRIBUTION

Warranty Department
Chemin de Messidor 5-7
1006 Lausanne
Switzerland

CHANGE OF ADDRESS CHANGE OF OWNERSHIP

VEHICLE IDENTIFICATION NUMBER

Model Number

Vehicle Identification Number (V.I.N.)

OLD ADDRESS
OR PREVIOUS OWNER:

NAME

NO.

STREET

APT

CITY

STATE/PROVINCE

ZIP/POSTAL CODE

COUNTRY

TELEPHONE

NEW ADDRESS
OR NEW OWNER:

NAME

NO.

STREET

APT

CITY

STATE/PROVINCE

ZIP/POSTAL CODE

COUNTRY

TELEPHONE

V00A2F

CHANGE OF ADDRESS CHANGE OF OWNERSHIP

VEHICLE IDENTIFICATION NUMBER

Model Number

Vehicle Identification Number (V.I.N.)

OLD ADDRESS
OR PREVIOUS OWNER:

NAME

NO.

STREET

APT

CITY

STATE/PROVINCE

ZIP/POSTAL CODE

COUNTRY

TELEPHONE

NEW ADDRESS
OR NEW OWNER:

NAME

NO.

STREET

APT

CITY

STATE/PROVINCE

ZIP/POSTAL CODE

COUNTRY

TELEPHONE

V00A2F

ATV MODEL No. _____

VEHICLE IDENTIFICATION NUMBER (V.I.N.) _____

ENGINE IDENTIFICATION NUMBER (E.I.N.) _____

Owner: _____
NAME

No. STREET APT

CITY STATE/PROVINCE ZIP/POSTAL CODE

Purchase Date _____
YEAR MONTH DAY

Warranty Expiry Date _____
YEAR MONTH DAY

To be completed by the dealer at the time of the sale.

DEALER IMPRINT AREA

V00A2IL

Please verify with your dealer to ensure your vehicle has been registered with BRP.

While reading this Operator's Guide, reminder that:

 **WARNING**

Indicates a potential hazard that, if not avoided, could result in serious injury or death.



WARNING

THIS VEHICLE CAN BE HAZARDOUS TO OPERATE.

A collision or rollover can occur quickly, even during routine maneuvers such as turning and driving on hills or over obstacles, if you fail to take proper precautions.

SEVERE INJURY OR DEATH can result if you do not follow these instructions:

- **BEFORE YOU OPERATE THIS VEHICLE, READ THIS *OPERATOR'S GUIDE* AND ALL ON-PRODUCT LABELS.**
- **NEVER OPERATE THIS VEHICLE WITHOUT PROPER INSTRUCTIONS.** Beginners should complete a certified training course.
- **NEVER CARRY A PASSENGER.** You increase your risk of losing control if you carry a passenger.
- **NEVER OPERATE THIS VEHICLE ON A PAVED SURFACE.** You increase your risk of losing control if you operate this vehicle on pavement.
- **NEVER OPERATE THIS VEHICLE ON PUBLIC ROADS.** You can collide with another vehicle if you operate this vehicle on a public road.
- **ALWAYS WEAR AN APPROVED HELMET,** eye protection, and protective clothing.
- **NEVER RIDE UNDER THE INFLUENCE OF ALCOHOL OR DRUGS.** They slow reaction time and impair judgment.
- **NEVER OPERATE THIS VEHICLE AT EXCESSIVE SPEEDS.** You increase your risk of losing control if you operate this vehicle at speeds too fast for the terrain, visibility conditions, or your experience.
- **NEVER ATTEMPT WHEELIES, JUMPS, OR OTHER STUNTS.**

219 000 614

CA

OPERATOR'S GUIDE, RENEGADE / ENGLISH
GUIDE DU CONDUCTEUR, RENEGADE / ANGLAIS

FAIT AU / MADE IN CANADA

U/M:P.C.