

**SEA·DOO®**  
**Sport Boats**



# OPERATOR'S GUIDE

Includes SAFETY, VEHICLE and  
MAINTENANCE INFORMATION

# CHALLENGER\* X

 **WARNING**

Read this guide thoroughly.  
It contains important safety information.  
Do not remove this *Operator's Guide* from the  
vehicle.

204 630 322

## SAFETY WARNING

Disregarding any of the safety precautions and instructions contained in this *Operator's Guide*, the *Safety Videocassette* and the on-product warning labels could cause injury, including the possibility of death. The operator has the responsibility to inform passenger(s) of safety precautions.

This *Operator's Guide* and *Safety Videocassette* should remain with the boat at the time of resale.



Gelcote<sup>†</sup> is a trademark of Gelcote International  
Knight's Spray-Nine<sup>†</sup> is a trademark of Korkay System Ltd

**The following trademarks are the property of Bombardier Recreational Products Inc. and/or its affiliates:**

SEA-DOO®  
ROTAX™  
BOMBARDIER\* LUBE  
Sea-Doo Synthetic Grease

## **Doin'it on your new Sea-Doo sport boat**

Congratulations, you are now the proud owner of a Sea-Doo sport boat. Whether you are an experienced boater or are new to the sport of boating, we ask you to take the time to view the *Safety Videocassette* provided with this boat, to read this *Operator's Guide*, on-product warning/caution labels and familiarize yourself with the contents. This guide contains pertinent information which, if followed, will provide you with the necessary knowledge to help you fully enjoy the pleasures of this boat.

We strongly recommend that any boat operator complete a safety boating course. Check with your local Coast Guard or Power and Sail Squadron in your area for course availability. More serious boaters may want to obtain *Chapman Piloting* by Elbert S. Maloney, available at most book stores.

When introducing your family or friends to the sport, be sure they fully understand the controls and operation of the boat and the importance of courteous, responsible riding.

Each operator has a responsibility to ensure the safety of his/her passenger(s) and of other water users. Please follow all safety instructions and operate your boat with care.

We encourage you to have an Annual Safety Inspection of your boat. Please contact your authorized Sea-Doo sport boat dealer for further details.

Finally, we urge you to visit your authorized Sea-Doo sport boat dealer regularly for regular and safety maintenance as well as any boating accessories you may require.

Have fun and... Bon Voyage.

**Please keep this guide on board. This guide should remain with the boat at time of resale.**

---

# TABLE OF CONTENTS

<b>FOREWORD .....</b>	<b>6</b>
Hazard Statements .....	6
Advisory Statements .....	7
<b><i>SAFETY INFORMATION</i></b>	
<b>SAFETY .....</b>	<b>10</b>
Safe Boating Checklist.....	10
Safety Equipment .....	12
Carbon Monoxide and Boating .....	17
Lanyard Stop Switch.....	20
Safe Boating Practices.....	21
Passenger Safety.....	21
Rules of the Road .....	22
Voluntary Inspections .....	24
Safe Boating Courses .....	24
Water Sports .....	24
<b><i>VEHICLE INFORMATION</i></b>	
<b>REGISTRATION NUMBER LOCATION .....</b>	<b>30</b>
<b>LOCATION OF THE IMPORTANT LABELS .....</b>	<b>31</b>
<b>IDENTIFICATION NUMBERS .....</b>	<b>35</b>
Hull .....	35
Engine.....	35
<b>CONTROLS, COMPONENTS AND INSTRUMENTS LOCATION ....</b>	<b>36</b>
Cockpit.....	36
Overview .....	37
<b>CONTROLS, COMPONENTS AND INSTRUMENTS FUNCTIONS..</b>	<b>40</b>
1) Ignition Switch and Safety Lanyard (engine cut-out switch) .....	40
2) Steering Wheel .....	40
3) Throttle/Shifter Lever .....	41
4) 12-Volt Accessory Jack .....	42
5) Navigation Light Switch.....	42
6) Bilge Pump Switch.....	42
7) Bilge Air Blower Switch.....	43
8) Horn Switch .....	43
9) Deck Light Switch .....	43
10) Fuel Gauge/Low Oil Level Pilot Lamp and Beeper .....	44
11) Tachometer .....	44
12) Speedometer .....	44
13) Wind Deflector .....	45
14) Bilge Drain Plugs.....	45

15) Grab Handles .....	45
16) Rear Grab Handles .....	45
17) Swim Platform .....	46
18) Sun Deck.....	46
19) Seats .....	46
20) Bow Seats.....	47
21) Cup Holders .....	47
22) Deck Storage Compartment .....	48
23) Rear Storage Compartment .....	49
24) Jet Pump Water Intake .....	50
25) Bow and Stern Eyelets .....	50
26) Bow Light.....	50
27) Removable Stern Light Socket .....	50
28) Mooring Cleats.....	51
29) Deck.....	52
30) Fuel Tank Cap .....	52
31) Deck Drain .....	52
32) Main Oil Reservoir Cap .....	52
33) Flushing Connector.....	53
34) Ventilation Ducts.....	53
35) Jet Pump Nozzle .....	53
36) Reverse Gate .....	53
37) Retractable Ladder.....	53
38) Scupper Valve .....	54
39) Hydro-Surge Grate System .....	54
40) Fuel Tank Vent .....	54
41) Water Sport Towing Attachments .....	54
42) Fuses .....	56
43) AM-FM Radio/CD Player .....	56
44) Glove Box.....	57
45) Water Bypass System .....	57
46) Main Battery Cut-Off Switch.....	57

**FUEL AND LUBRICATION .....** **59**

Fueling Procedure .....	59
Recommended Fuel .....	59
Recommended Oil .....	60
Main Oil Reservoir Level .....	60
Engine Mounted Oil Reservoir Level.....	60

**BREAK-IN PERIOD .....** **61**

Engine .....	61
10-Hour Inspection .....	61

<b>PRE-OPERATION CHECKS .....</b>	<b>62</b>
Hull .....	63
Jet Pump Water Intake.....	63
Bilge.....	63
Battery .....	63
Fuel Tank/Oil Reservoirs.....	63
Engine Compartment .....	63
Fire Extinguisher.....	63
Steering System .....	63
Throttle System.....	63
Shifter System.....	64
Inlet Grate.....	64
Ignition Switch and Safety Lanyard .....	64
Storage Compartment Covers.....	64
<b>OPERATING INSTRUCTIONS .....</b>	<b>65</b>
Launching/Loading.....	65
Trailing .....	65
Principle of Operation .....	65
Boarding from a Dock.....	67
Boarding from the Water.....	68
Starting .....	69
Rough Water or Poor Visibility Operation .....	69
Crossing Waves.....	69
Stopping/Docking .....	69
Beaching.....	70
Shutting Off the Engine.....	70
<b>POST-OPERATION CARE .....</b>	<b>71</b>
General Care.....	71
Additional Care for Foul Water or Salt Water .....	71
<b>SPECIAL PROCEDURE.....</b>	<b>72</b>
Engine Overheating .....	72
Jet Pump Water Intake and Impeller Cleaning .....	72
Capsized Boat.....	72
Submerged Boat/Water-Flooded Engine .....	72
Low-Charge Battery Condition .....	73
<b><i>MAINTENANCE INFORMATION</i></b>	
<b>MAINTENANCE .....</b>	<b>76</b>
Emission Component Maintenance .....	76
Engine Emissions Information.....	76
Lubrication .....	77
Periodic Inspection .....	78
Fuel and Oil Filters.....	78
Steering/Jet Pump Nozzle Adjustment.....	78

Reverse Gate.....	79
Deck Drain.....	79
Fuses.....	79
Bilge Air Blower.....	79
Navigation Light Bulb Replacement .....	79
General Inspection and Cleaning.....	80
<b>PERIODIC INSPECTION CHART .....</b>	<b>82</b>
<b>STORAGE AND PRESEASON PREPARATION .....</b>	<b>84</b>
Storage.....	84
Preseason Preparation .....	86
<b>SPECIFICATIONS .....</b>	<b>87</b>
<b>SI METRIC INFORMATION .....</b>	<b>89</b>
<b><i>WARRANTY INFORMATION</i></b>	
<b>BRP LIMITED WARRANTY FOR MODEL YEAR 2005 SEA-DOO® SPORT BOATS SOLD IN THE UNITED STATES AND CANADA .....</b>	<b>92</b>
<b>CALIFORNIA EMISSION CONTROL WARRANTY STATEMENT FOR MODEL YEAR 2005 SEA-DOO® SPORT BOATS EQUIPPED WITH A ROTAX™ ENGINE(S).....</b>	<b>96</b>
Your Emission Control Warranty Rights and Obligations .....	97
Manufacturer's Limited Warranty Coverage .....	97
Owner's Warranty Responsibilities .....	99
<b>BRP INTERNATIONAL LIMITED WARRANTY FOR MODEL YEAR 2005 SEA-DOO® SPORT BOATS .....</b>	<b>100</b>
<b>WEB SITES.....</b>	<b>104</b>
<b>LIST OF DISTRIBUTORS.....</b>	<b>106</b>
<b>DECLARATION CE OF CONFORMITY.....</b>	<b>107</b>
Homologation and Certification .....	108
Operator's Guide Confirmation of Receipt.....	109
<b>PRIVACY INFORMATION .....</b>	<b>110</b>
<b>CHANGE OF ADDRESS.....</b>	<b>111</b>

---

# FOREWORD

This *Operator's Guide* has been prepared to acquaint the owner/operator or passenger of this boat with the various controls, maintenance and safe riding instructions. It is indispensable for the proper use of the product, and should be kept in a waterproof bag in the boat at all times. Make sure you read and understand the content of this document.

For any questions pertaining to the warranty and its application, please consult an authorized Sea-Doo sport boat dealer.

## Hazard Statements

As you read this *Operator's Guide*, please note the hazard warnings which alert you to safety precautions related to unsafe conditions or operating procedures.

This guide uses the following symbols to emphasize particular information.



The safety alert symbol is recognized around the world. In this guide, it means read this information carefully! Be sure you understand the consequences of the hazards and how to avoid them. Failure to follow the recommendations in a hazard communication statement may result in property damage, personal injury, or death.

People often refer to a hazard statement as a warning in a general sense. This guide uses three kinds of "warnings" depending on the likely effect of a hazard (minor injury, severe injury, death).

## WARNING

Identifies a potentially or imminently hazardous situation which, if not avoided, **COULD** result in serious personal injuries including the possibility of death or substantial property damage.

**CAUTION:** This signal word indicates a potentially hazardous situation which, if not avoided, may result in minor or moderate personal injury or property damage. It may also be used to alert against unsafe practices.

**NOTE:** Indicates supplementary information needed to fully complete an instruction relating to equipment operation and/or maintenance procedures.

Although the mere reading of such information does not eliminate the hazard, the understanding and application of the information will promote correct and safe use of the boat.

The warnings in this guide do not and cannot address every conceivable situation. Always use common sense! If a procedure, method, tool, or part is not specifically recommended, you must satisfy yourself that it is safe for you and others and that your boat will not be damaged or made unsafe as a result of your decision.



## Advisory Statements

Advisory statements alert you to conditions that affect equipment operation, maintenance, and servicing practices.

An **IMPORTANT** statement indicates a procedure intended to prevent damage to equipment or associated components.

The information and components/system descriptions contained in this guide are correct at the time of publication. Bombardier Recreational Products (BRP) however, maintains a policy of continuous improvement of its products without imposing upon itself any obligation to install them on products previously manufactured.

Because of our ongoing commitment to product quality and innovation, BRP reserves the right at any time to discontinue or change specifications, designs, features, models or equipment without incurring obligation.

The illustrations in this document show the typical construction of the different assemblies and may not reproduce the full detail or exact shape of the parts. However, they represent parts that have the same or similar function.

It is understood that this guide may be translated into another language. In the event of any discrepancy, the English version shall prevail.

Specifications are given in the SI metric system with the SAE U.S. equivalent in parenthesis. Where precise accuracy is not required, some conversions are rounded off for easier use.

A *Shop Manual* can be obtained for complete service, maintenance and more repair information.

# ***SAFETY INFORMATION***

---

# SAFETY

Your safety and that of your passengers and fellow boaters is YOUR responsibility. Before launching your boat, you should completely read and understand this *Operator's Guide*, product warnings and labels, the *Safety Videocassette* and other information provided with your boat or by your dealer. Heed and follow all warnings, safety precautions and operating procedures.

BRP strongly recommends that you take an approved boating safety course. Always operate your boat in compliance with safe boating rules, and with consideration, courtesy and common sense. Failure to do so could result in injury, including the possibility of death, to you, your passengers, others you lend your boat to, or other water users.

## Safe Boating Checklist

When leaving on a cruise, whether for an hour or for several days, go through the following Safe Boating Checklist.

### Reminders Regarding Operation...

- The performance of this boat may significantly exceed that of other boats you may have operated. Become completely familiar with the controls and operation of this boat before embarking on your first trip or taking on a passenger(s). If you have not had the opportunity to do so, practice driving solo in a suitable traffic-free area and feel the response of each control. Be fully familiar with all controls before accelerating above idle speed. Do not assume that all boats handle identically. Each model differs, often substantially.
- Always keep in mind that as the throttle lever is returned to the idle position, less directional control is available. To turn the boat, both steering and throttle are necessary.

- Like any other boat, this boat has no brake. Stopping distance will vary depending on initial speed, load, wind, and water conditions. Practice stopping and docking in a safe, traffic-free area to have an idea of how long it will take to stop the boat under varying conditions. Do not release the throttle when trying to steer away from objects. You need throttle to steer. Do not use the boat's reverse to stop.
- Do not start or operate the boat if any person is not properly seated in a seat intended for use when underway (not the sun deck or swim platform) or if a person is nearby in the water.
- The boat's jet thrust can cause injury. Always accelerate slowly, and decelerate in a controlled fashion.
- Observe the instructions on all safety labels. They are there to help assure that you have a safe and enjoyable outing.
- Riding with passenger(s) or pulling other boats, tubes, a skier or a wakeboarder makes the boat handle differently and requires greater skill.
- Certain boats may come equipped with tow eyelets, a ski pole or a wakeboard tower which can be used to attach a tow rope for a skier, tuber or wakeboarder. Do not use these attachment points or any other portion of the boat to tow a parasail or another craft. Personal injury or severe damage may occur.
- In shallow water, proceed with caution and at very low speeds. Grounding or abrupt stops may result in injury to you, your passengers or others. The jet pump may pick up debris and throw it rearward causing a risk of injuring people or damaging the jet pump or other property.

- Engine exhaust contains carbon monoxide (CO), which can cause injury or death if inhaled in sufficient quantities. Do not operate the boat in a confined area or allow CO to accumulate in or around the boat, or in enclosed or sheltered areas. Such as when docked, or when rafting. Be aware of risk of CO from exhaust of other boats.
- Educate all occupants about the risks and symptoms of CO accumulation and CO poisoning, particularly from engine and generator exhaust. Educate them about where engine exhaust outlets (and generator outlets if so equipped) are located. Regularly inspect exhaust and generator system and outlets for component failures or obstructions.
- Combustion engines need air to operate; consequently this boat can not be totally watertight. Any maneuvers such as *figure eights* that cause the upper deck to be under water may cause severe engine problems due to water ingestion. Refer to the SPECIAL PROCEDURES and LIMITED WARRANTY sections contained in this *Operator's Guide*.
- Respect no wake zones, the rights of other water users and the environment. As the "skipper" and owner of a boat, you are responsible for damage to other boats caused by the wake of your boat. Do not let anyone throw refuse overboard.
- Between sunset and sunrise, use the boat's navigation lights and reduce speed. Do not operate the boat in reduced visibility.
- Do not add accessories or equipment that may adversely affect visibility or alter control of the boat.
- The skipper should personally take the helm during storms.

## **Before Getting Underway...**

- Always perform the pre-operation checks as specified in this *Operator's Guide*.
- Do not exceed the payload or passenger capacities for this boat, which are listed on the capacity plate and in the specifications. Overloading can affect maneuverability, stability and performance. Also, heavy seas reduce capacity. A payload or person capacity plate is not an excuse for failure to use common sense or good judgment.
- Regularly inspect the boat, the hull, engine, safety equipment, and all other boating gear and keep them in safe operating condition.
- Be sure you have the minimum required safety equipment, PFDs and any additional gear needed for your cruise.
- Check that all lifesaving equipment, including fire extinguisher, is in safe operating condition and easily accessible. Show all passengers where this equipment is, and make sure they know how to use it.
- Keep an eye on the weather. Check local weather broadcasts before departure. Be alert to changing conditions.
- Keep accurate and up-to-date charts of the boating area on board. Before getting underway, check water conditions in the planned boating area.
- Before departure, file a Float Plan with a responsible person ashore.
- Keep enough fuel on board for the planned trip. Always verify fuel level before use and during the ride. Apply the principle of 1/3 of the fuel to reach your destination, 1/3 to return, and keep 1/3 in reserve. Allow for changes due to adverse weather or other delays.

## **Operators and Passengers...**

- Never operate a boat while under the influence of drugs or alcohol. It is a Federal offense. Allow only qualified drivers to operate your boat. Remember that sun, wind, alcohol, drugs, fatigue or illness may impair your judgement and reaction time.
- At least one passenger should be able to operate the boat in case the operator is unexpectedly unable to do so.
- Operation of this boat by a person under 16 years of age or a person with a disability that impairs vision, reaction time, judgment, or operation of the controls is NOT recommended.
- Always use the lanyard stop switch when operating the boat and ensure that all passengers are familiar with its use.
- Ensure that any operator and all passengers know how to swim and how to re-board the boat from the water. If a passenger does not know how to swim, ensure that passenger wears a PFD at all times and take extra precautions when boating.

## **Regarding Fuel and Fueling...**

- Remember that fuel and gasoline fumes are flammable and explosive under certain conditions. Be very careful when fueling and adhere to the fueling procedures contained in this *Operator's Guide* and those given to you by the marina. Always stop the engine before fueling and never allow anyone to remain in the boat while fueling. Each time you fill up, assure that the engine compartment is free of gasoline vapors, and inspect fuel lines for leaks and hose deterioration.
- Do not smoke or allow open flames or sparks in the vicinity.

- Know the capacity of the fuel tank. Avoid fueling at night except under well-lit conditions. Gas spills are not noticeable in the dark. Do not carry spare fuel or flammable liquids in any of the storage or engine compartments.

## **Safety Equipment**

An operator and the boat's passenger(s) should have ready access to shatterproof glasses should riding conditions or personal preference warrant.

Wind, water spray and speed may cause a person's eyes to water and create blurred vision.

As the owner of the boat, you are responsible for assuring that all required safety equipment is aboard. You should also consider supplying additional equipment as needed for your safety and that of your passengers. Check state and local regulations and call the U.S. Coast Guard Boating Safety Hotline at 1 800 368-5647 for information about required safety equipment.

## **Required Safety Equipment**

Safety equipment required by federal regulations is mandatory. Personal flotation devices must be fitted to the people wearing them. If local regulations require additional equipment, it must be approved by the U.S. Coast Guard (USCG). Minimum requirements include the following:

- personal flotation devices
- fire extinguisher
- visual distress signal
- navigation lights
- bell or whistle.

A cellular telephone in a waterproof bag or container has also been found to be beneficial to boaters when in distress or just for contacting someone on shore.

## Personal Flotation Devices (PFDs)

Federal regulations require that you have at least one Coast Guard approved personal flotation device (PFD) for each person in a recreational boat and require that all children under 13 years of age wear a PFD at all times when the boat is underway, except when below deck or in an enclosed cabin. You may not use your boat unless all PFDs are in serviceable condition, readily accessible, legibly marked with the Coast Guard approval number, and of an appropriate size (within the weight range and chest size marked on the PFD) for each person on board.

A PFD provides buoyancy to help keep your head above the water and to help you remain in a satisfactory position while in the water. Body weight and age should be considered when selecting a PFD. The buoyancy provided by the PFD should support your weight in water. The size of the PFD should be appropriate for the wearer. Body weight and chest size are common methods used to size PFDs. It is your responsibility to ensure that you have the proper number and types of PFDs on board to comply with federal and local regulations and that your passengers know where they are and how to use them.

### PFD Types

Five types of PFDs have been approved by the U.S. Coast Guard.

PFD Type I, Wearable has the greatest required buoyancy. Its design allows for turning most unconscious persons in the water from face down position to a vertical or slightly backward, face-up position. It can greatly increase the chances of survival. Type I is most effective for all waters, especially offshore when rescue may be delayed. It is also the most effective in rough waters.

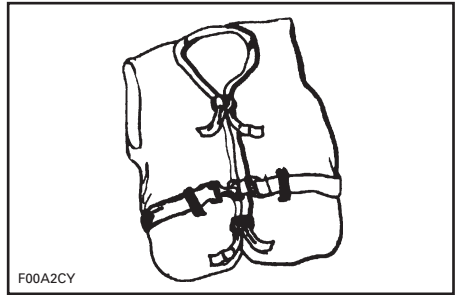

*TYPE I — WEARABLE*

PFD Type II, Wearable turns its wearer in the same way as Type I, but not as effectively. The Type II does not turn as many persons under the same conditions as a Type I. You may prefer to use this PFD where there is a probability of quick rescue such as in areas where other people are commonly involved in water activities.

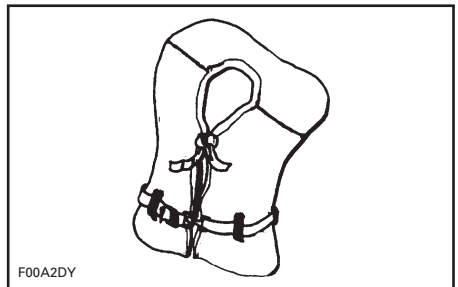

*TYPE II — WEARABLE*

PFD Type III, Wearable allows wearers to place themselves in a vertical or slightly backward position. It does not turn the wearer. It maintains the wearer in a vertical or slightly backward position and has no tendency to turn the wearer face down. It has the same buoyancy as a Type II PFD and may be appropriate in areas where other people are commonly involved in water activities.

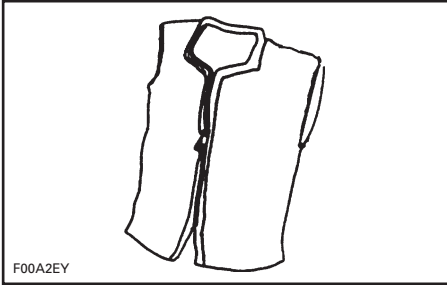

*TYPE III — WEARABLE*

PFD Type IV, Throwable is required in addition to the PFDs previously discussed. The most common Type IV PFD is a buoyant cushion or ring buoy. It is designed to be thrown to a person in the water, grasped and held by the user until he or she is rescued. A Type IV PFD should always be in serviceable condition and immediately available for use. Grasping this PFD may be difficult if the rescue is delayed or if the user is overcome by hypothermia (loss of body heat).

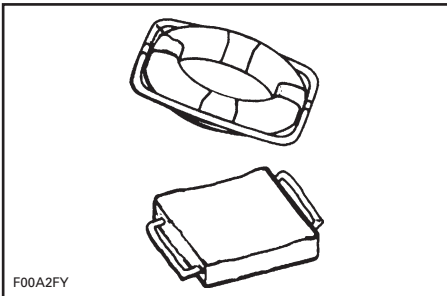

*TYPE IV — THROWABLE*

PFD Type V, Wearable must be worn. When inflated, it provides buoyancy equivalent to Type I, II or III PFDs. When it is deflated, however, it may not support some people.

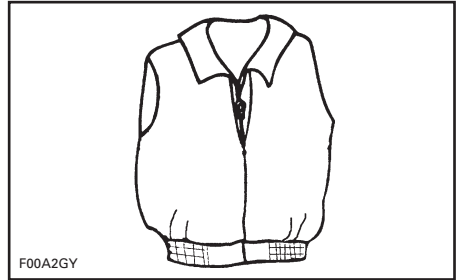

*TYPE V — WEARABLE*

### PFD Pointers

The purpose of a PFD is to help save your life. If you want it to support you when you are in the water, it needs to fit, float, and be in good condition.

- Try the PFD on and adjust it until it fits comfortably in and out of the water. Mark your PFD if you are the only wearer.
- To make sure the PFD works, wear it in the water. This will show you how it works and give you confidence when you use it.
- Teach children how to put a PFD on and allow them to try it in the water. That way, they know what the PFD is for and how it works. They will feel more comfortable with it if they suddenly find themselves in the water.
- If the PFD is wet, allow it to dry thoroughly before storing it. Do not dry it in front of a radiator or heater. Store it in a well-ventilated area.
- Keep PFDs away from sharp objects which can tear the fabric or puncture the flotation pads.

- For their own safety and the safety of others, all non-swimmers, poor swimmers, and small children should wear PFD's at all times whether the boat is stationary or moving.
  - Check the PFD frequently to make sure that it is not torn, that flotation pads have no leaks, and that all seams and joints are securely sewn.
  - If a PFD contains kapok, the kapok fibers may become waterlogged and lose their buoyancy after the vinyl inserts are punctured. If the kapok becomes hard or if it is soaked with water, replace it. It may not work when you need it.
2. Keep a positive attitude about your survival and rescue. This will improve your chances of extending your survival time until rescue. Your will-to-live does make a difference!
  3. If there is more than one person in the water, huddling is recommended while waiting to be rescued. This action tends to reduce the rate of heat loss and thus increase the survival time.
  4. Always wear your PFD. It won't help you fight off the effects of hypothermia if you don't have it on when you go into the water.

## Hypothermia

Hypothermia, the loss of body heat to the water, is a significant cause of deaths in boating accidents. After an individual has succumbed to hypothermia, he or she will lose consciousness and then drown.

PFDs can increase survival time because of the insulation they provide.

Naturally, the warmer the water, the less insulation one will require. When operating in cold water (below 4.4°C (40°F)) consideration should be given to using a coat or jacket style PFD as they cover more of the body than the vest style PFDs.

Some points to remember about hypothermia protection:

1. While afloat in the water, do not attempt to swim unless it is to reach a nearby craft, fellow survivor, or a floating object on which you can lean or climb. Unnecessary swimming increases the rate of body heat loss. In cold water, drown-proof methods that require putting your head in the water are not recommended. Keep your head out of the water. This will greatly lessen heat loss and increase your survival time.

## Fire Extinguishers

As the owner of the boat, you are responsible for supplying a fire extinguisher approved by the U.S. Coast Guard.

All Class 1 powerboats (4.8 to less than 7.9 m (16 - 26 ft)) are required to carry one (1) B-1 type hand portable fire extinguisher unless the boat is equipped with a fixed fire extinguishing system in the engine compartment.

Hand-held portable fire extinguishers should be mounted in readily accessible locations away from the engine compartment. All persons aboard should know the location and proper operation of the fire extinguisher(s).

**NOTE:** Don't test fire extinguishers by squirting small amounts of the extinguishing compound. The extinguisher might not work when you really need it!



## Visual Distress Signal Devices

Visual distress signal devices approved by the U.S. Coast Guard are required on all recreational boats operating on coastal waters and on boats owned in the United States when they are operating on the high seas. Coastal waters include territorial seas and those waters directly connected to the Great Lakes and the territorial seas up to a point where the waters are less than 3.2 km (2 m.) wide. Visual distress signal equipment may be of the pyrotechnic or non-pyrotechnic type. Regulations prohibit display of visual distress signals on the water under any circumstances except when assistance is required to prevent immediate or potential danger to persons on board a vessel.

The equipment must be approved by the U.S. Coast Guard, be in serviceable condition, and be stowed in a readily accessible location. Equipment having a date for serviceable life must be within the specified usage date shown.

Careful selection and proper stowage of visual distress equipment is very important if children are aboard.



### WARNING

**Fire!** In case of fire, do not open engine compartment. Turn off engine. Using portable CO<sub>2</sub> fire extinguisher, continuously discharge entire contents at base of fire.

#### DAY USE ONLY

- Three orange smoke signals (one hand held and two floating) or one orange flag with black square and disk

#### NIGHT USE ONLY

- One S-O-S electric distress light

#### DAY AND NIGHT USE

- Three flares of the hand held, meteor or parachute type

## Sound Signaling Devices

**NOTE:** No single signaling device is appropriate for all purposes. Consider keeping various types of equipment on board.

Boats less than 7.9 m (26 ft) in length are required to carry a hand, mouth, or power operated horn or whistle. It must produce a blast of two second duration and audible at a distance of at least 800 m (1/2 m.).

Following are standard whistle signals:

- one prolonged blast (warning signal)
- one short blast (pass on my port side)
- two short blasts (pass on my starboard side)
- three short blasts (engines in reverse)
- five or more blasts (danger signal).

## Navigation Lights

Navigation lights are intended to keep other vessels informed of your presence and course. If you are out on the water between sunset and sunrise, you are required to display appropriate navigation lights.

## Additional Recommended Equipment

It is recommended that you acquire additional equipment for safe, enjoyable cruising. This list, which is not all inclusive, includes items you should consider acquiring.

## BASIC GEAR

- flashlight
- mooring lines
- compass
- oar or paddle
- distress signals
- first aid kit
- dock fenders
- VHF radio
- EPIRB (Electronic Position Indicating Radio Beacon)
- boat hook
- extra warm clothing
- charts
- sunblock
- tow line
- second anchor and line
- dewatering device (pump or bailer)
- emergency supply of drinking water and food.

## TOOLS

- spark plug wrench
- hammer
- screwdrivers
- jackknife
- pliers
- electrician's tape
- adjustable wrench
- lubricating oil
- duct tape.

For additional tools, see your dealer.

## SPARE PARTS

- extra bulbs
- extra fuses
- extra drain plug
- spark plugs
- spare wire.

For additional parts, see your dealer.

## Carbon Monoxide and Boating

Burning a material containing carbon produces carbon monoxide (CO), an odorless and colorless gas. Because CO weighs the same as air, it can spread throughout an enclosed space unnoticed because you cannot see it or smell it. Any device used to burn carbon-based materials on a boat can be a source of CO. Common sources of CO include internal combustion engines.

CO reacts with the blood to reduce the ability of the blood to carry oxygen. The reduced oxygen supply to body tissues results in death of the tissue. Prolonged exposure can cause brain damage or death. In high concentrations, CO can be fatal within minutes. The effects of CO in lower concentrations are cumulative and can be just as lethal over long periods of time.

Symptoms of CO poisoning include: Itchy and watering eyes, flushed appearance, throbbing temples, inability to think coherently, ringing in the ears, tightness across the chest, headaches, drowsiness, nausea, dizziness, fatigue, vomiting, collapse, and convulsions. If any of these symptoms are evident, begin treatment immediately. Prompt action can make the difference between life and death.

- Evacuate the area and move the victim to fresh air.
- Administer oxygen if available and get medical help.
- Open all canvas enclosures to ventilate the area.
- Investigate the source of CO and take immediate corrective action.
- Be especially aware of other CO sources which may be near boat.

## Carbon Monoxide Accumulation

Following are examples of possible situations where CO may accumulate within your boat while docked, anchored, or underway. Become familiar with these examples and their precautions to prevent personal injury or death.

### WARNING

**Exhaust Fumes!** Generator or hull exhaust from other vessels while either docked or anchored can emit poisonous CO gas and cause excessive accumulation within cabin and cockpit areas. Be alert for generator exhaust from your vessel or other vessels alongside. Exhaust outlets near a pier, dock, seawall or outlets blocked by any other means can cause excessive accumulation of poisonous CO gas within cockpit area.

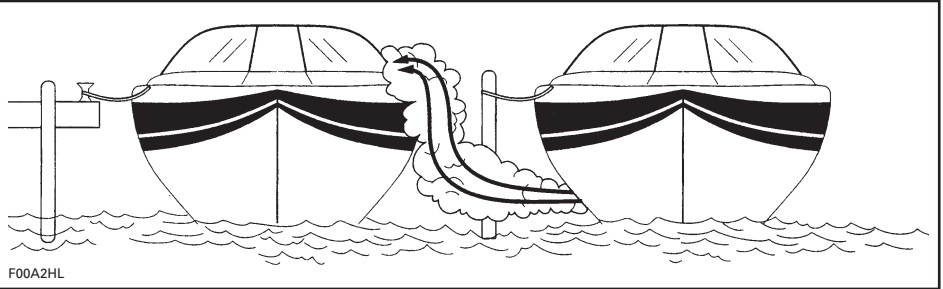

*VESSEL ALONGSIDE*

### WARNING

**Engine exhaust fumes contain carbon monoxide (CO)** which can accumulate in and around the boat (under bimini top, in cockpit, etc.). CO can be harmful or fatal if inhaled. Assure there is adequate ventilation whenever running engine(s).

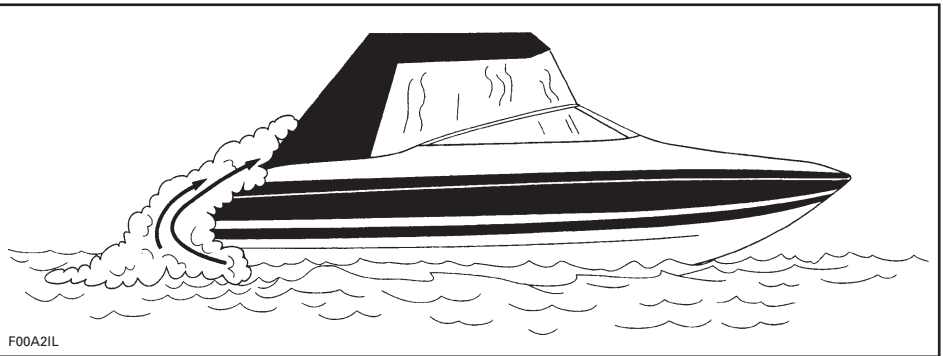

*WHILE UNDERWAY (BACKDRAFTING)*

While underway, CO concentrations can increase by backdrafting or “the station wagon effect”. Backdrafting is caused by factors such as relative wind direction, speed, or the bow being too high. To prevent this, open canvas whenever possible to provide positive airflow through the hull.

Boat houses, seawalls, and other boats in close proximity or confined areas can contribute to increased CO levels. Operators must be aware that operation, mooring, and anchoring in an area with other boats puts them in jeopardy of CO accumulation from other sources. Likewise, a boat operator must be aware of how exhaust from his boat will affect others. Operation of the engines while moored may cause CO accumulation in your boat and those around you.

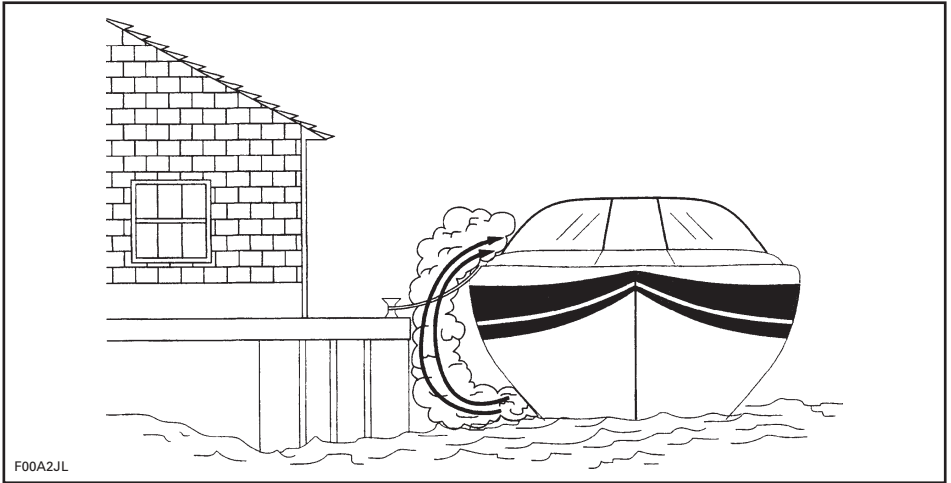

### CONFINED AREAS

Be sure to provide adequate ventilation. If the windshield has vents, open them before getting underway to increase positive air flow and decrease the chances of CO accumulation.

## WARNING

**Backdrafting!** Under certain conditions, moving air currents can direct poisonous CO fumes into boat. These fumes can accumulate to dangerous levels without proper airflow. Provide adequate ventilation, redistribute the load or bring boat out of high bow angle.

Even with the best boat design and construction, CO may still accumulate in enclosed or confined areas under certain conditions. Continually observe passengers for symptoms of CO poisoning.

**Do NOT Operate your Boat without Performing the Following Checklist:**

Each Boating Day

OPERATION	✓
Make sure you and your passengers know where exhaust outlets are located on the vessel	
Educate all passengers about the symptoms of CO poisoning and where CO may accumulate	
When docked or rafting with another boat, be aware of exhaust emissions from the other boat	
Confirm that water flows from the exhaust outlet when the engine(s) is(are) started	
Listen for any change in exhaust sound, which could indicate an exhaust component failure	
Test the operation of each CO alarm by pressing the test button	

**CO Detector**

It is strongly recommended that you have CO detectors installed in boats with canvas enclosures. Monitors are available from your dealer. Monitors should be professionally installed and calibrated.

**NOTE:** A CO detector is not a gas fuel vapor detector. Gas fuel vapor detectors do not monitor the buildup of CO in an enclosed area.

**Lanyard Stop Switch**

This safety device automatically stops the engine if the lanyard is attached to the operator and the operator falls from the control station. Refer to the engine manual for detailed information about using this switch.

The stop switch incorporates a shutoff switch, switch clip, lanyard, and lanyard clip. The lanyard clip must be securely attached to the operator's PFD, clothing, arm, or leg. Be sure to attach the lanyard to a place where it is free of obstructions and to something that will move with the operator if he or she leaves the helm station. If the engine shuts down because the lanyard cap was removed, the cap must be reinstalled on the lanyard stop switch before the engine can be restarted.

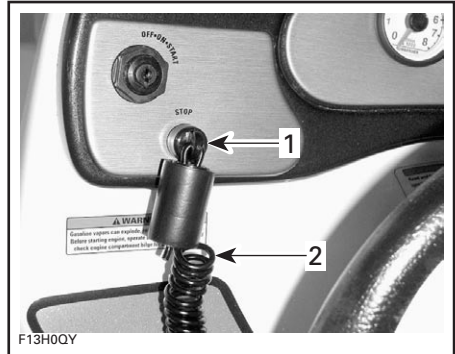

TYPICAL — IGNITION INTERRUPTER (STOP SWITCH) WITH LANYARD

1. Stop switch cap
2. Safety lanyard

**⚠ WARNING**

Always use the safety lanyard when operating your boat. Keep lanyard stop switch free from obstructions that could interfere with its operation. Do not modify or remove lanyard stop switch or bypass its safety features. The proper use of the lanyard stop switch can prevent a runaway boat situation which otherwise could cause severe personal injury or death.

## Safe Boating Practices

YOU are responsible for your own safety, the safety of your passengers, and the safety of fellow boaters.

### Drugs and Alcohol

Do not use drugs or drink alcohol while operating a boat. Like driving a car, driving a boat requires sober, attentive care. Operating a boat while intoxicated or under the influence of drugs is not only dangerous, but it is also a Federal offense carrying a significant penalty. These laws are vigorously enforced. The use of drugs and alcohol, singly or in combination, decreases reaction time, impedes judgment, impairs vision, and inhibits your ability to safely operate a boat.

#### **WARNING**

Alcohol consumption and boating do not mix! Operating under the influence endangers the lives of your passengers and other boaters. Federal laws prohibit operating a boat under the influence of alcohol or drugs.

### Safe Operation

For safety reasons and proper care, always perform "Daily Pre-Operation Checks" as specified in your *Operator's Guide* before operating your boat. Safe operation means that you do not misuse your boat nor do you allow your passengers to do so. Safe operation means using good judgment at all times. It includes, without limitation, the following actions:

- Load the boat within the limits listed on the capacity plate. Balance loads bow to stern and port to starboard.
- Maintain boat speed at or below the local legal limit. Avoid excessive speed or speeds not appropriate for operating conditions.

- Do not use the boat in weather or sea conditions beyond the skill or experience of the operator or the comfortable capability of the boat or passengers.
- Be sure that at least one other passenger is familiar with the operation and safety aspects of the boat in case of an emergency.
- Make sure that passengers and gear do not obstruct the operator's view or ability to move.
- Do not exceed the maximum engine power rating stated on the certification plate attached to the boat.
- Observe all safety signs and warnings both inside the boat and in the immediate boating area.

### Passenger Safety

Before getting underway, show all passengers where emergency and safety equipment is stowed, and explain how to use it. Everyone aboard should wear rubber-soled shoes which resist slipping on wet surfaces. While underway, passengers should remain seated inside the deck rails. Don't allow passengers to drag their feet or hands in the water. Always use handholds and other safety hardware to prevent falls. All non-swimmers, poor swimmers, and children should wear a PFD at all times. Federal regulations require that children under 13 years of age wear a PFD when the boat is underway unless they are in an enclosed cabin or below deck.

## **First Aid**

As a boat operator, you should be familiar with basic first aid procedures that may be needed while you are far from help. Fish hook accidents or minor cuts and abrasions may be the most serious mishaps on board a boat, but you should also learn the proper procedures and be ready to deal with the truly serious problems like excessive bleeding, hypothermia, and burns. First aid literature and courses are available through most Red Cross chapters.

## **Operation by Minors**

Minors should always be supervised by an adult whenever operating a boat. Many states have laws regarding the minimum age and licensing requirements of minors. Be sure to contact the state boating authorities for information. BRP recommends a minimum operator age of 16 years old.

## **Rules of the Road**

As a responsible boater, you will comply with the "Rules of the Road", the marine traffic laws enforced by the U.S. Coast Guard. Navigating a boat is much the same as driving an automobile. Operating either one responsibly means complying with a set of rules intended to prevent accidents. Just as you assume other car drivers know what they are doing, other boaters assume you know what you are doing.

Operating a boat can be compared with driving unmarked highways and roads. To prevent collisions or avoid other boaters, a system of operating rules must be followed. It's not only common sense...it's the law!

Check local and federal boating laws applicable to the waterways where you intend to use your boat. Learn the local rules of the road. Know and understand the applicable navigation system (such as buoys and signs).

Know the waters in which the boat is to be operated. Current, tides, rapids, hidden obstacles, wakes and waves etc. can affect safe operation. It is not advisable to operate the boat in rough or inclement weather.

## **Remember these Rules of the Road**

### **Know the Right of Way Rules**

Generally keep to your right and safely avoid other craft by keeping a safe distance from other craft, people and objects.

### **CROSSING**

Give right of way to craft ahead and to your right. Never cross in front of another craft.

RED light (give way to the other craft).

GREEN light (you have the right of way).

### **MEETING HEAD-ON**

Keep right.

### **PASSING**

Give right of way to other craft and keep clear.

## **Navigation System**

Navigational aids, such as signs or buoys, can help you identify safe waters. Buoys will indicate whether you should keep to the right (starboard) or to the left (port) of the buoy or to which channel you can continue. They may also indicate whether you are entering a restricted or controlled area such as a no wake or speed zone. They may also indicate hazards or pertinent boating information. Markers may be located on shore or on the water. They can also indicate speed limits, no power craft or boating, anchorage and other useful information. (The shape of each type of marker will provide assistance).

Make sure you know and understand the navigation system applicable to the waterways where you intend to use the boat.

## **Collision Avoidance**

- Do not decrease throttle when trying to steer away from objects. You need throttle to steer.
- Always keep a constant lookout for other water users, other craft or objects, especially when turning. Be alert for conditions that may limit your visibility or block your vision of others.
- Respect the rights of other recreationists and/or bystanders and always keep a safe distance from all other craft, people and objects.
- Do not wake or wave jump, ride the surf line or attempt to spray or splash others with your boat. You may misjudge the ability of the boat or your own driving skills and strike a craft or person.
- This boat has the capability of turning more sharply than other boats. However, unless in an emergency, do not negotiate sharp, high speed turns. Such maneuvers make it hard for others to avoid you or understand where you are going. Also, you and/or your passenger(s) could be thrown from the boat.
- Like any other boat, this boat has no brake. Stopping distance will vary depending on initial speed, load, wind, and water conditions. Practice stopping and docking in a safe, traffic free area to have an idea of how long it will take to stop the boat under varying conditions.
- Maintaining or increasing speed may be necessary to avoid a collision.

## **Safe Riding**

- Always keep in mind that as the throttle lever is returned to idle position, less directional control is available, and when the engine is off, directional control is lost. You need throttle to steer.

- While your boat has the capacity of operating at high speeds, it is strongly recommended that high speed operation only be applied when ideal conditions exist and are permitted. Higher speed operation requires a higher degree of skill and increases the risk of severe injuries.
- In shallow water, proceed with caution and at very low speeds. Grounding or abrupt stops may result in injury. Debris may also be picked up and be thrown rearward by the jet pump onto people or property.
- Do not use the boat's reverse to stop. You or your passenger(s) could be violently ejected forward or even off the boat onto the hazard.

## **Operator/Passenger Awareness**

- Do not start or operate the boat if anyone is seated on the sun deck or swim platform, or is nearby in the water. Water and/or debris exiting jet thrust nozzle can cause severe injury.
- The operator and passenger(s) should be properly seated before starting or moving the boat. All passenger(s) should be instructed to use the handholds or seat straps provided.
- When accelerating a boat with a passenger(s), whether from a complete stop or while underway, always do so progressively. Fast acceleration may cause your passenger(s) to lose their balance or grip and strike something in the boat or fall out of the boat. Make sure that your passenger(s) know of, or anticipate, any rapid acceleration.

## **Maneuverability of the Boat/ Towing**

- Do not overload the boat or take on more passengers than designated for the particular boat. Overloading can affect maneuverability, stability and performance.



- Avoid adding on accessories or equipment which may alter your control of the boat.
- Riding with a passenger(s) or pulling a tube, skier or wakeboarder makes the boat handle differently and requires greater skill.
- Always respect the safety and comfort of your passenger(s) and person being towed on skis, wakeboard or other towables.
- Always carry an observer when pulling a tube, skier or wakeboarder, proceed with only as much speed as required and follow the observer's instructions. Unless absolutely necessary, do not make tight, sharp turns. Keep a safe distance from the docks, other swimmers, craft or objects.
- Use a tow rope of sufficient length and size and make sure it is adequately secured to your boat. Some boats are equipped or can be fitted with a specially designed towing mechanism. It can become a hazard should someone fall on it.

#### Don't Forget:

- Ride smart from the start and we all win!

### Voluntary Inspections

State boating officials in many states or the U.S. Coast Guard Auxiliaries offer courtesy inspections to check out your boat. They will check for compliance with safety standards and required safety equipment. You may voluntarily consent to one of these inspections, and you are allowed time to make corrections without prosecution. Check with the appropriate state agency or the Coast Guard Auxiliary for details.

### Safe Boating Courses

The local U.S. Coast Guard Auxiliary and the U.S. Power Squadrons offer comprehensive safe boating classes several times a year. You may contact the BOAT/U.S. Foundation at 1 800 336-BOAT (2628) or, in Virginia, 1 800 245-BOAT (2628), for a course schedule in your area. Also contact the local U.S. Coast Guard Auxiliary or Power Squadron Flotilla for the time and place of their next scheduled class. A boating safety course is recommended and may be required in your province or state.

### Water Sports

#### **WARNING**

**Avoid Personal Injury!** Your boat is not designed for and should not be used for pulling parasails, kites, gliders, or any device which can become airborne. Use boat only for appropriate water sports.

#### **WARNING**

"Teak Surfing" is extremely dangerous to participants due to their proximity to the rear of the boat where direct contact with the exhaust fumes from the boat engine is the highest. Carbon monoxide poisoning can occur and result in mental disorientation, dizziness, drowsiness, and loss of consciousness. The combination of carbon monoxide exposure and non-use of a life jacket (PFD) make this new water recreation activity an incredibly dangerous and potentially deadly sport.

Water skiing, wakeboarding, or riding a towed, inflatable apparatus are some of the more popular water sports. Taking part in any water sport requires increased safety awareness by the participant and the boat operator. If you have never pulled someone behind your boat before, it is a good idea to spend some hours as an observer, working with and learning from an experienced driver. It is also important to be aware of the skill and experience of the person being pulled. Always have a second person on board to observe the person in the water so the driver can concentrate on operating the boat.

Both the boat operator and observer should monitor the location of the tow-rope when participating in water-sports. A slack tow rope can become entangled with person(s) or objects in the boat or in the water, particularly when making a tight turn or circling, and cause serious personal injury.

Everyone participating in a water sport should observe these guidelines:

1. Allow only capable swimmers to take part in any water sport.
2. Always wear a personal flotation device (PFD) approved by the U.S. Coast Guard. Wearing a properly designed PFD helps a stunned or unconscious person stay afloat. A Type-IV water-ski vest is an approved and practical PFD.
3. Have a second person aboard to observe the person being towed and inform the driver about the participant's hand signals. The driver must give full attention to operating the boat and the waters ahead.
4. Be considerate to others you share the water with.
5. Never allow a person to "teak surf" behind your boat. Do not tow a person in any water sport on a short tow rope such that the person inhales exhaust fumes in concentration. Inhalation of concentrated exhaust fumes, which contain carbon monoxide, can result in CO poisoning, personal injury and death.
6. Give immediate attention to a person who has fallen. He or she is vulnerable in the water alone and may not be seen by other boaters.
7. Approach a person in the water from the lee side (opposite the direction of the wind). Turn off the motor before coming close to the person.
8. Turn off engine and anchor the boat before swimming.
9. Participate in water sports only in safe areas. Stay away from other boats, channels, beaches, restricted areas, swimmers, and heavily traveled waterways and underwater obstructions.
10. Swim only in areas designated as safe for swimming. These are usually marked with a swim area buoy. Do not swim alone or at night.



**SWIM AREA BUOY**

11. Do not water ski between sunset and sunrise. It is illegal in most states.
12. Do not drive the boat directly behind a water skier, tuber or wakeboarder. At 40 km (25 m.) per hour, the boat will overtake a person who falls in the water 60 m (200 ft) in front of your boat in about 5 seconds.
13. Shut engine off and remove ignition key when anyone is in the water nearby.
14. Stay at least 45 m (150 ft) away from areas marked by a diver down float.

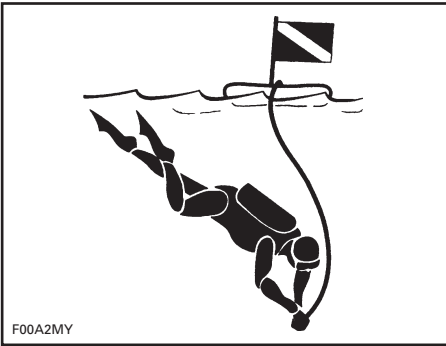

*DIVER DOWN FLOAT*

**⚠ WARNING**

**Avoid Personal Injury!** Do not allow anyone near the jet pump or intake grate, even when the engine is off. Items such as long hair, loose clothing or personal flotation device straps can become entangled in moving parts resulting in serious injury or drowning. In shallow water, shells, sand, pebbles or other objects could be drawn up by the jet pump and be thrown rearward.

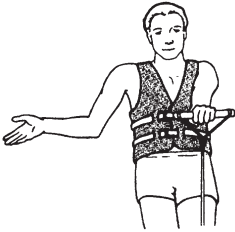

**FASTER -**  
Palm of one hand pointing upward.



**SLOWER -**  
Palm pointing down.



**SPEEK OK -**  
Arm upraised with thumb and finger joined to form circle.

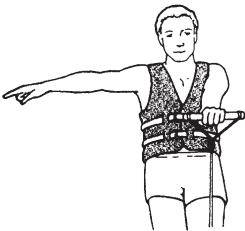

**RIGHT TURN -**  
Arm outstretched pointing to the right.

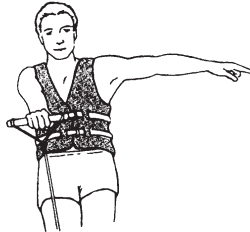

**LEFT TURN -**  
Arm outstretched pointing to the left.



**RETURN TO DROP-OFF AREA -**  
Arm at 45 degree from body pointing down to water and swinging.



**CUT MOTOR -**  
Finger drawn across throat.

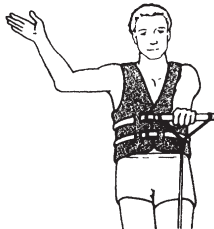

**STOP -**  
Hand up, palm forward, policeman style.



**SKIER OK. AFTER THE FALL -**  
Hands clenched together overhead.

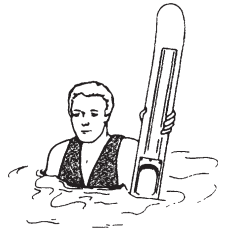

**PICK ME UP OR FALLEN SKIER, WATCH OUT -**  
One ski extended vertically out of water.

F00A2NL

### SKIING SIGNALS

For more information about water skiing, please contact the American Water Ski Association, 799 Overlook Drive, Winter Haven, FL 33884 (1 800 533-2972).

# ***VEHICLE INFORMATION***

---

## REGISTRATION NUMBER LOCATION

All boats are required by federal law to be registered and legally numbered.

Due to space availability for proper display of registration number, refer to the following illustration for location. The registration number should appear on each side of the boat.

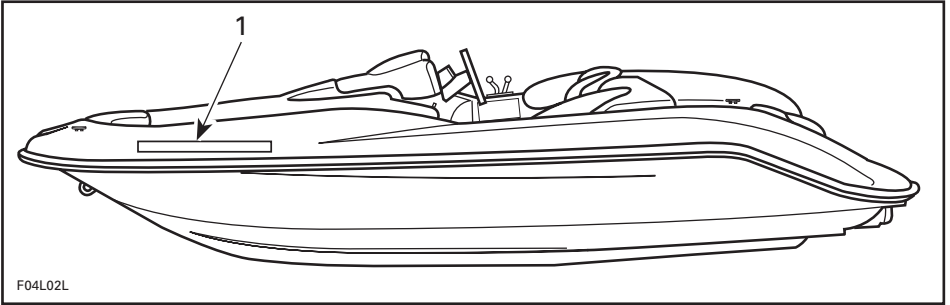

*TYPICAL*

1. *Registration number location*

# LOCATION OF THE IMPORTANT LABELS

The following labels are on your boat. If missing or damaged, they can be replaced free of charge. See an authorized Sea-Doo sport boat dealer.

Please read the following labels carefully before operating this boat.

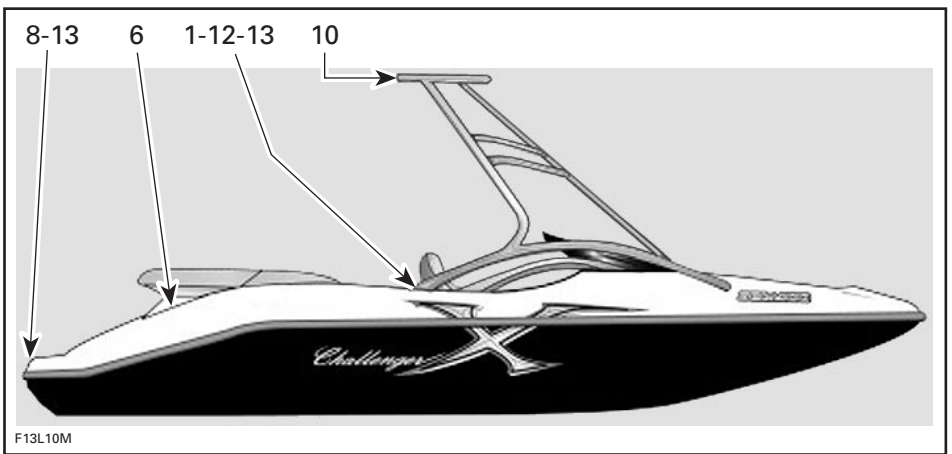
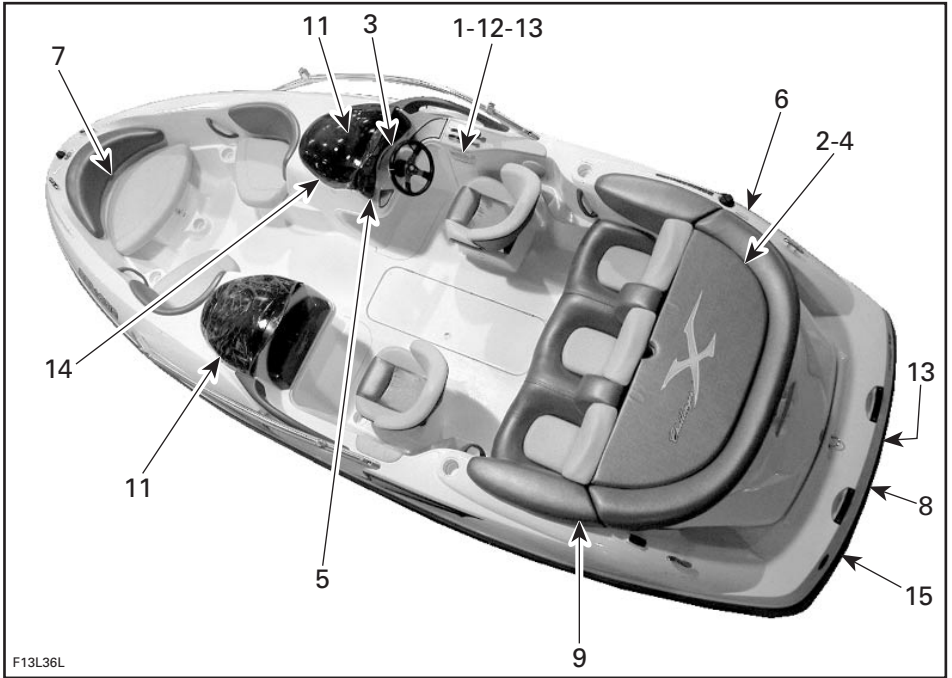

### Label 1

MADE IN U.S.A., BOMBARDIER MOTOR CORPORATION OF AMERICA  
U.S. COAST GUARD  
**MAXIMUM CAPACITIES**  
**8 PERSONS OR 653 KG/1440 LBS.**  
**653 KG/1440 LBS. PERSONS, GEAR**  
THIS BOAT COMPLIES WITH U.S. AND CANADIAN COAST GUARD  
SAFETY STANDARDS IN EFFECT ON THE DATE OF CERTIFICATION  
CE **BOAT DESIGN CATEGORY: C**  
F13L0DY

TYPICAL — REFER TO ACTUAL LABEL ON BOAT

### Label 2

**MAXIMUM ENGINE POWER  
CAPACITY RATING  
OF THE CRAFT:**  
**185 KW**  
F04LAFY

TYPICAL — REFER TO ACTUAL LABEL ON BOAT

### Label 3

**⚠ WARNING**  
Read and follow warning labels and operator's guide before operation. Severe injury or death can result from ignoring warnings or improper use of this sport boat. The performance of this sport boat may significantly exceed that of other boats you may have operated.  
\* Check throttle/shifter and steering operation and position before starting engine(s).  
\* Directional control is reduced with decreasing speed and lost when engine is off.  
\* Do not splash others or jump waves or wakes.  
\* Occupants should always wear approved PFD and recommended protective clothing.  
\* Do not operate if passengers are not properly seated and using handgrips, or if visibility is obstructed. Do not allow passenger(s) to ride on any portion of the boat not designated in the operator's guide as a seat for use when underway.  
\* Properly attach safety lanyard to your PFD.  
\* Keep a safe distance from all other water users. Be aware of and observe all applicable laws and regulations.  
F04LCUL

### Label 4

**⚠ WARNING**  
• Remove battery from boat before charging.  
• Do not overcharge battery.  
• Improper charging of battery can cause explosion.  
F13L1MY

### Label 5

**⚠ WARNING**  
Gasoline vapors can explode, resulting in injury or death. Before starting engine, operate blower for 5 minutes and check engine compartment bilge for gasoline vapors.  
F13L1SY

### Label 6

**⚠ WARNING**  
Avoid serious injury or death from fire or explosion.  
• Before fueling, stop engine and keep boat level.  
• Open fuel cap slowly to relieve pressure.  
• Do not overfill.  
• Regularly inspect fuel system for leaks.  
• Use regular unleaded gasoline and check oil level.  
F13L1NY

### Label 7

**⚠ WARNING**  
**Avoid Serious Or Fatal Injury.  
Do Not Occupy Seat When Speed  
Exceeds 5 M.P.H.**  
F00L3BY



### Label 8

#### **WARNING**

Avoid serious personal injury or death.

- Turn off engine(s) before using swim platform.
- Keep people, clothing and hair away from jet nozzle(s) or intake grate(s) to avoid entanglement, drowning and carbon monoxide poisoning.

F13L10Y

### Label 9

#### **OIL RECOMMENDATION**

##### **IMPORTANT!**

DO NOT USE ROTAX INJECTION OIL  
USE MERCURY PRECISION PREMIUM PLUS OR QUICKSILVER  
PREMIUM PLUS 2-CYCLE OIL (NINJA TC-W3 CERTIFIED)  
THESE OILS CONTAIN ADDITIONAL UNIQUE ADDITIVES  
SPECIFICALLY DESIGNED FOR USE WITH THE M<sup>2</sup> JET DRIVE  
TO INCREASE ENGINE DURABILITY AND SUBSTANTIALLY  
REDUCE CARBON BUILDUP.

(Refer to M<sup>2</sup> Jet Drive Operator's Manual for further information)

F00L21Y

### Label 10

#### **WARNING**

Misuse of tower may cause severe injury or death.

- Use tower only for wakeboarding or water skiing.
- Do not allow tow rope to dangle or get entangled with occupants, boat or engine.
- Attach tow rope only at the center attachment point.
- Tow only 1 person at a time.
- Do not climb on, sit on or jump off tower.

F13L1PL

### Label 11

#### **CAUTION**

Press down on rod before closing  
windshield to avoid breakage.

F10L3FY

### Label 12

#### **WARNING**

Lock driver seat in forward position so that seat  
faces steering wheel during operation and does not swivel.

F13L1TY

### Label 13

#### **WARNING**

Engine exhaust fumes contain carbon monoxide (CO) which can  
accumulate in and around the boat (under bimini top, in cockpit, etc.).  
CO can be harmful or fatal if inhaled. Assure there is adequate ventilation  
whenever running engine(s).

F13L1QL

## Label 14



## Label 15

This product may be covered by one or more of the following US applications and/or patents and their non-US equivalents: 20040031431A1; 20040031430A1; 20030000449A1; 6,702,629; 6,701,863; 6,672,240; 6,601,528; 6,568,376; 6,544,086; 6,482,055; 6,428,371; 6,418,890; 6,415,759; 6,405,669; 6,390,869; 6,336,833; 6,332,422; 6,283,099; 5,690,520; 5,369,360; D490,766; D489,311; D485,798; D485,526; D483,315; D482,649; D469,053; D468,254; D467,860; D467,859; D465,446; D465,194; D464,601; D459,693; D409,555; D400,844.

SEA-DOO, ISLANDIA, UTOPIA, SPEEDSTER, SPORTSTER, ROTAX, 4-TEC and their associated graphic designs are trademarks of Bombardier Recreational Products Inc. or their affiliates. BOMBARDIER, CHALLENGER are trademarks of Bombardier Inc. used under license. ORBITAL and the ORBITAL logo are registered trademarks of Orbital Engine Company (Australia) Pty. Limited, used under license.



© & © 2000-2004 Bombardier Recreational Products Inc. All rights reserved.

F00L3CL

---

# IDENTIFICATION NUMBERS

The main components of the boat (engine and hull) are identified by different serial numbers. It may sometimes become necessary to locate these numbers for warranty purposes or to trace the boat in the event of theft.

## Hull

The Hull Identification Number (H.I.N.) is located on the right side of the transom.



TYPICAL

1. Hull Identification Number (H.I.N.)

## Engine

Refer to *M<sup>2</sup> Jet Drive Operator's Guide*.

# CONTROLS, COMPONENTS AND INSTRUMENTS LOCATION

## Cockpit

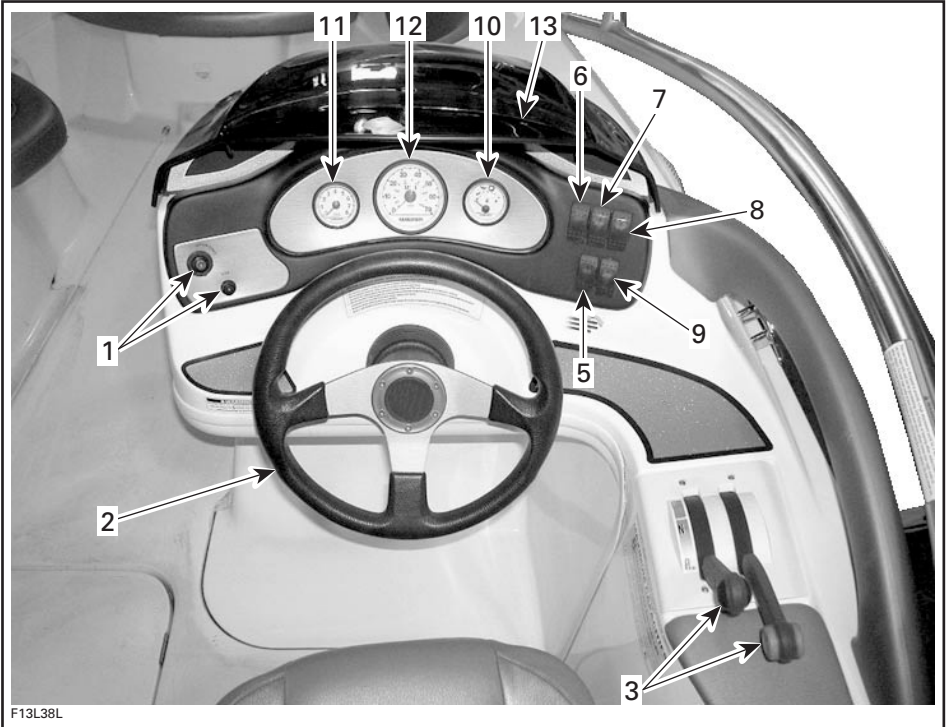

TYPICAL — COCKPIT VIEW

# Overview

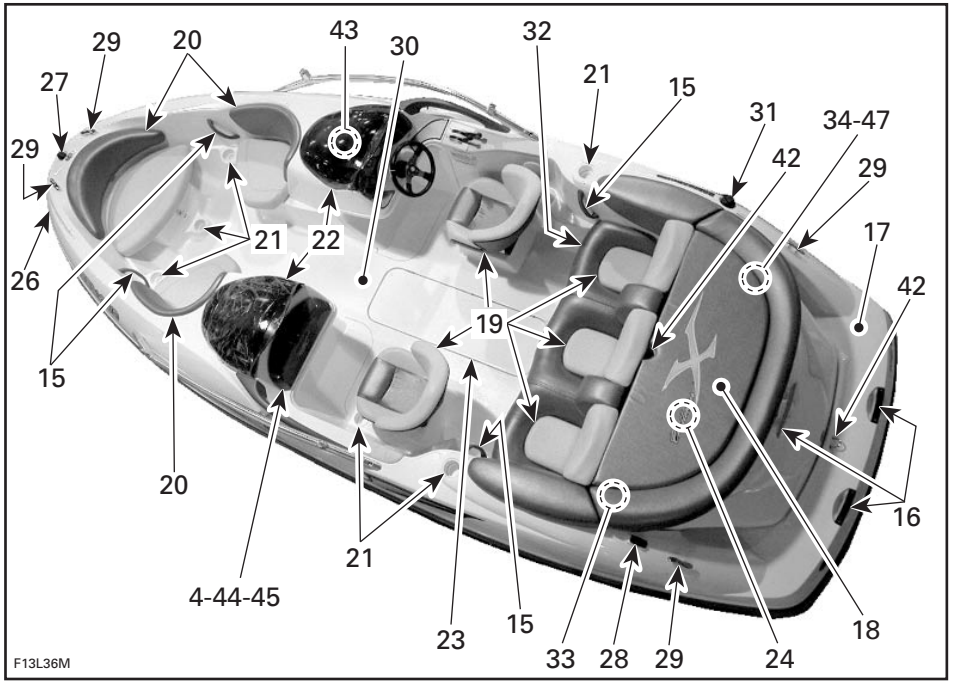

TYPICAL — TOP VIEW

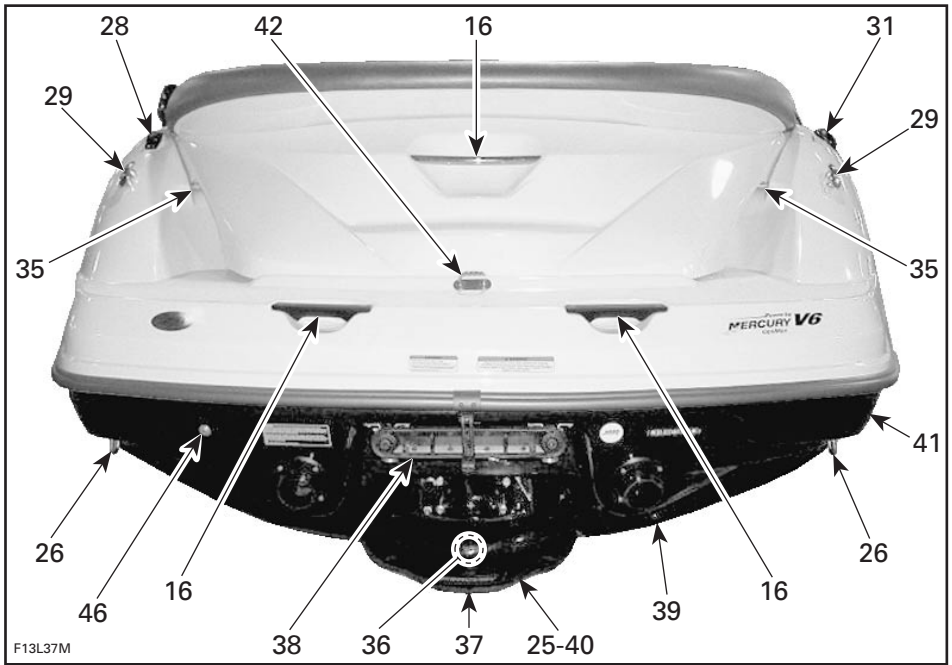

TYPICAL

1. Ignition Switch and Safety Lanyard
2. Steering Wheel
3. Throttle Lever/Shift Levers
4. 12-Volt Accessory Jack
5. Navigation Light Switch
6. Bilge Pump Switch
7. Bilge Air Blower Switch
8. Horn Switch
9. Deck Light Switch
10. Fuel Gauge/Low Oil Level Pilot Lamp and Beeper
11. Tachometer
12. Speedometer
13. Wind Deflector
14. Bilge Drain Plugs
15. Grab Handles
16. Rear Grab Handle(s)
17. Swim Platform
18. Sun Deck
19. Seats
20. Bow Seats
21. Cup Holders
22. Right/Left/Front Storage Compartment(s)
23. Deck Storage Compartment
24. Rear Storage Compartment
25. Jet Pump Water Intake
26. Bow and Stern Eyelets
27. Bow Light
28. Removable Stern Light Socket
29. Mooring Cleats
30. Deck
31. Fuel Tank Cap
32. Deck Drain
33. Main Oil Reservoir Cap
34. Flushing Connector
35. Ventilation Ducts
36. Jet Pump Nozzle
37. Reverse Gate
38. Retractable Ladder
39. Scupper Valve
40. Hydro-Surge Grate System
41. Fuel Tank Vent
42. Water Sport Towing Attachments
43. Fuses
44. AM-FM Radio/CD Player
45. Glove Box
46. Water Bypass System
47. Main Battery Cut-Off Switch

# CONTROLS, COMPONENTS AND INSTRUMENTS FUNCTIONS

## 1) Ignition Switch and Safety Lanyard (engine cut-out switch)

### **⚠ WARNING**

Always use the safety lanyard when operating your boat to help prevent a runaway boat and reduce the risk of personal injury or death. Disconnect the lanyard when stopped to help prevent accidental starting.

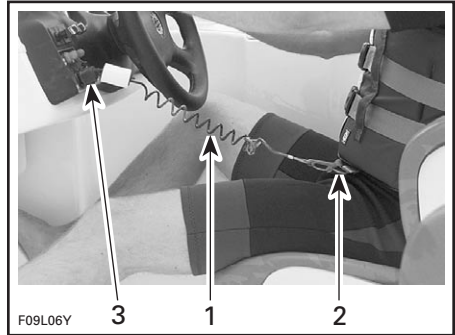

### TYPICAL

1. Safety lanyard
2. Secure to PFD
3. Snap to safety lanyard switch

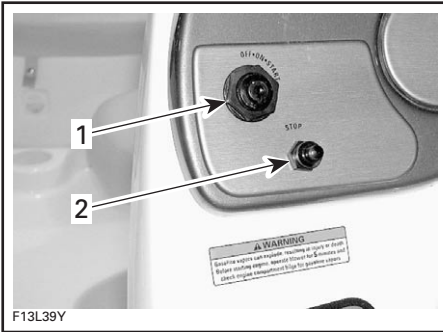

1. Ignition switch
2. Safety switch

The safety lanyard should be securely snapped onto its switch to be fully operational.

Pulling the safety lanyard cap from the switch stops the engine. Attach the safety lanyard to the operator's Personal Flotation Device (PFD) and snap the cap to the switch to be able to start the engine.

### **⚠ WARNING**

Should the safety lanyard cap become loose or fails to remain on its switch, replace it immediately.

### **⚠ WARNING**

Directional control is reduced when throttle is decreased and lost when engine is off. Always disconnect safety lanyard when boat is not in operation.

### **⚠ WARNING**

Do not lubricate the safety lanyard switch.

### **⚠ WARNING**

While the engine can be stopped using the ignition switch, good driving habits recommend that the safety lanyard also be disconnected when stopped.

## 2) Steering Wheel

The steering wheel controls the direction of the boat. Turning the steering wheel clockwise steers the boat to the right and inversely.



## Low-Speed Steering Control System

Whenever the throttle lever is in **idle position** and the steering wheel is approaching the end of its rotation, the engine speed will be slightly accelerated to increase the jet pump thrust and thus improving the steering control for low speed operation and when approaching/leaving a dock. Refer to OPERATING INSTRUCTIONS for more details.

### 3) Throttle/Shifter Lever

#### Throttle

When pushed forward boat accelerates. When fully pulled back, engine return to idle speed and the boat is gradually stopped by water drag.

**NOTE:** To activate throttle lever, shift lever must be in forward or reverse position.

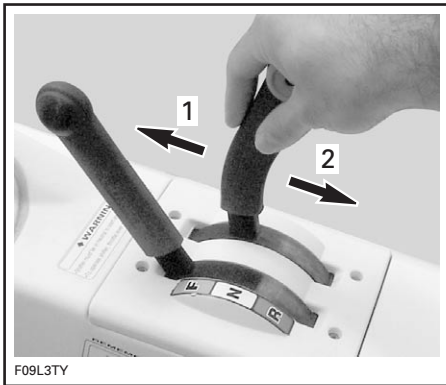

#### TYPICAL

1. Increase speed
2. Decrease speed

#### Shifter

A 3-position lever:

- forward
- neutral
- reverse.

In order to shift, throttle lever must be fully pulled back to idle speed.

Shift lever must be in neutral position to allow engine starting.

**NOTE:** With throttle lever at idle and shift lever in neutral position throttle lever should be locked.

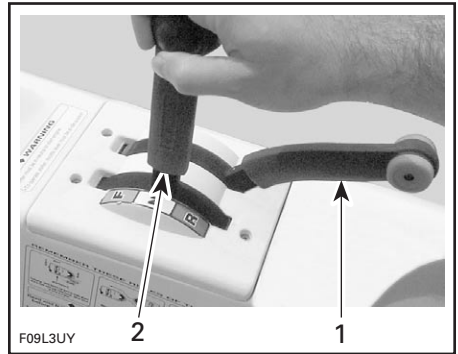

#### TYPICAL

1. Throttle lever back to idle position
2. Shift lever in neutral position

**NOTE:** To ease shifter use, line up the shifter arrow with the appropriate dot (Forward/Neutral/Reverse).

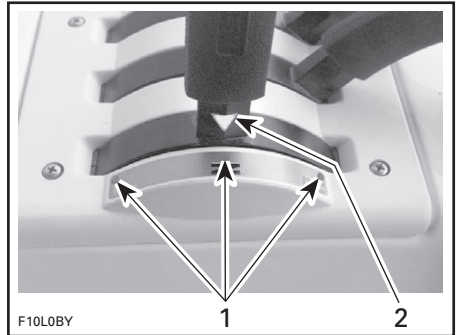

#### TYPICAL

1. Dots besides shifting position
2. Arrow on shifter

## ⚠ WARNING

Shift lever should only be used when the engine is idling and boat is completely stopped.

## **WARNING**

Only use reverse at slow speed and for the shortest time possible. Always ensure the path behind is clear of objects and persons including children playing in shallow water.

**CAUTION:** Never rev the engine at high RPM in reverse.

### **4) 12-Volt Accessory Jack**

A 12-Volt jack is located in the glovebox to power temporary accessories such as a cellular phone or other 12 Volt portable devices.

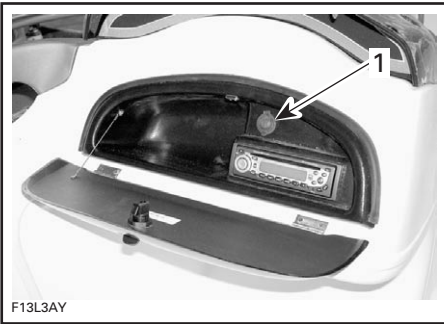

1. 12-Volt jack

Lift protective cap to expose jack.

**CAUTION:** Using the accessory jack for a prolonged time without engine running may discharge the battery.

Close protective cap when jack is not in use.

### **5) Navigation Light Switch**



A 3-position NAV/OFF/ANC push type switch.

Press switch to first position to turn on the stern light (anchorage position).

Press switch to second position to turn on the bow and stern lights.

Press to OFF position to turn off navigation lights.

**NOTE:** Switches and gauges are lit when navigation lights are turn on.

## **WARNING**

Navigation lights should always be used between sunset and sunrise. Ensure the stern light is installed. See **REMOVABLE STERN LIGHT** in this section for location and installation.

**NOTE:** The navigation lights may be operated without the safety lanyard on its switch.

### **6) Bilge Pump Switch**

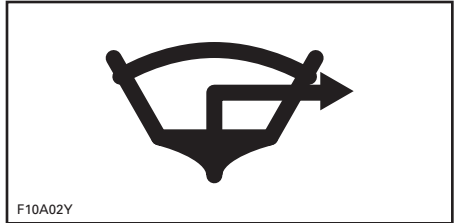

A 2-position OFF/ON switch.

Turn to ON position when manual operation of the bilge pump is required (after cleaning, storage, etc.).

Turn switch OFF when finished.

**CAUTION:** Do not operate for prolonged time once the bilge is empty. Battery drainage will occur and pump will be damaged.

**NOTE:** The bilge pump may be operated without the safety lanyard on its switch.

**CAUTION:** Always turn pump OFF when bilge is empty or before operating the engine above idle. Bilge pump will then switch to automatic mode.

### Automatic Bilge Pump

An automatic bilge pump evacuates water from the bilge. A water sensor detects the water, activating the bilge pump. After the water is pumped out, the pump shuts-off automatically. This automatic mode is working at all times: with/without safety lanyard on its switch and with/without engine running.

**CAUTION:** When the main battery cut-off switch is turned OFF while boat is moored, the bilge pump will start if water comes up in the bilge.

### 7) Bilge Air Blower Switch

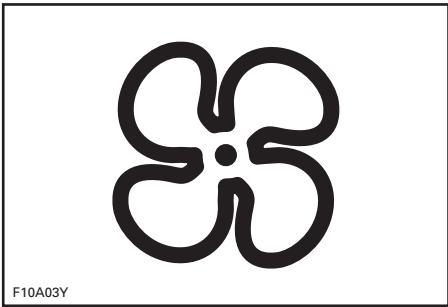

A 2-position OFF/ON switch. When ON, the blower ventilates the engine compartment.

Press switch to ON position to turn on the blower.

Press the switch to OFF to turn off the bilge blower.

**⚠ WARNING**

Always use blower for a minimum of 5 minutes before starting engine, then turn it OFF above idle speed. Use of the bilge blower should never replace "smelling" for gasoline vapors.

Using the bilge blower for a prolonged time when the engine is not running will discharge the battery.

Blower should be turned off during boat operation.

### 8) Horn Switch

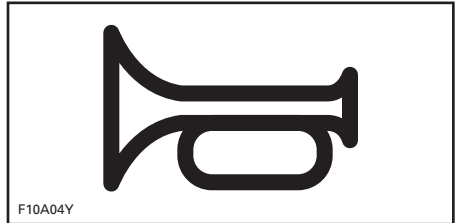

A 2-position push type switch.

Press and hold the switch to activate horn.

Release the switch to stop horn.

### 9) Deck Light Switch

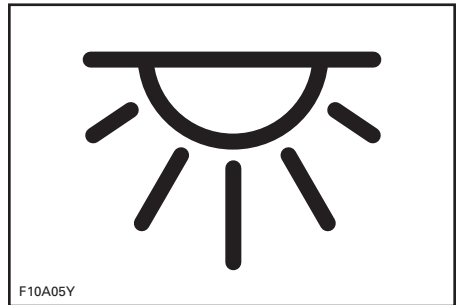

A 2-position push type switch.

Press switch to ON position to turn on the deck lights.

Press switch to OFF position to turn off the deck lights.

Using the deck lights for a prolonged time when the engine is not running will discharge the battery.

## 10) Fuel Gauge/Low Oil Level Pilot Lamp and Beeper

### Fuel Gauge

Located in dashboard, this gauge indicates the amount of fuel in fuel tank when engine is running.

The gauge is illuminated whenever the navigation lights are used.

**NOTE:** The fuel level can also be checked without engine running. With the safety lanyard removed from its switch, turn ignition switch to ON position; the gauge will be activated.

**CAUTION:** Always turn ignition switch to OFF position once fuel level has been checked.

### Low Oil Level Pilot Lamp and Beeper

The pilot lamp and the beeper turn on when the oil level is low in engine mounted oil reservoir or if a wire/connector of this electrical circuit is not properly connected. Fill reservoir as soon as possible or contact an authorized Sea-Doo sport boat dealer if light or beeper remain on.

**CAUTION:** Never run engine out of oil. Serious engine damage will occur.

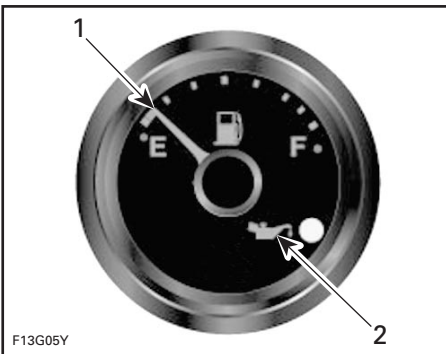

TYPICAL

1. Fuel level
2. Low injection oil level pilot lamp

## 11) Tachometer

The tachometer indicates the revolutions per minute (RPM) of the engine. Multiply reading by 1000 to obtain actual RPM.

The gauge is illuminated whenever the navigation lights are used.



TACHOMETER

## 12) Speedometer

The speedometer indicates the speed of the boat in miles per hour (MPH) and kilometers per hour (km/h).

The gauge is illuminated whenever the navigation lights are used.

A speed sensor mounted on the hull near *M<sup>2</sup> Jet Drive* sends the signal to the speedometer.



SPEEDOMETER

### 13) Wind Deflector

The movable deflector may be used to divert the air flow. Pull latch then lift the deflector until locked by the retaining device. When finished, lower deflector and push down to relatch.



TYPICAL

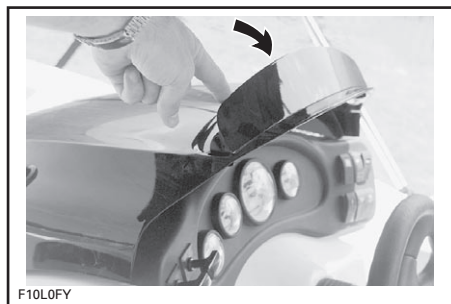

TYPICAL

### 14) Bilge Drain Plugs

Any water that is left in the bilge can be easily drained by unscrewing the drain plugs.

When on a trailer, block the wheels and raise the bow slightly with the trailer jack (if so equipped) so that the water can flow out of the bilge.

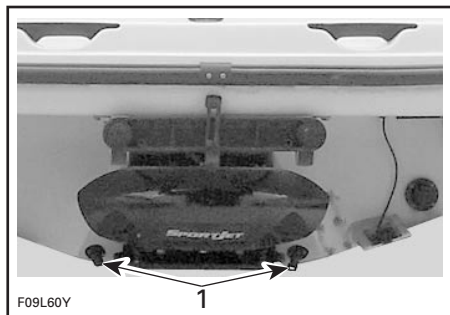

TYPICAL

1. Drain plugs

### 15) Grab Handles

Grab handles provide a handhold for the passengers.

Although grab handles are provided, never perform maneuvers that place a passenger or the driver at risk for being ejected or thrown out of their seat.

**CAUTION:** Never use the grab handles to pull anything or to lift the boat.

Refer to components location illustrations at the beginning of this section for grab handles location.

### 16) Rear Grab Handles



TYPICAL

1. Grab handles

Provides a handholds for boarding when needed.

**CAUTION:** Never use a grab handle to tow anything or to lift the boat.

## 17) Swim Platform

Provides an anti-skid surface for easy boarding from rear of boat.

### WARNING

Engine must be off when using swim platform. Keep away from jet or intake grate.

## 18) Sun Deck

A convenient space to rest or sunbathe while anchored.

### WARNING

Do not start or operate the boat if a person is seated on the sun deck.

## 19) Seats

Each passenger should be seated while underway.

### WARNING

Allow no one to sit on the edge of the boat or to stand up while in operation. Seat/grab handles should be used in rough waters.

For your convenience, front seats are provided with grab handles molded in the seat base.

Both front seats swivel.

To unlock swivel, pull lever toward front in a rotating movement. Turn seat at the desired position. The seat can be locked in steps of 45°. To lock swivel, release lever.

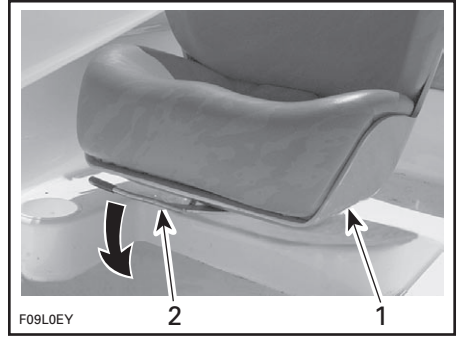

1. Grab handles molded in seat base
2. Swivel control lever

With this feature, the front passenger seat can be rotated backward to be used as a spotter seat.

### WARNING

Always ensure swivel is locked before riding. Seat must also face steering wheel.

Both front seats are adjustable fore and aft.

For the fore and aft adjustment, lift lever to unlock seat. Move seat at the desired position. Release lever after adjustment is completed.

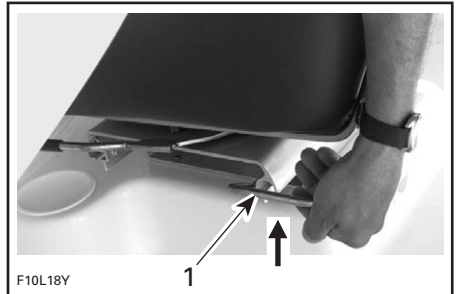

1. Fore and aft control lever

**NOTE:** It is necessary to move the seat completely forward to allow a rotation of 180° (half a turn).

## 20) Bow Seats

Located at front of boat, **seat (1) is not to be occupied while underway.** Seats (2) can be used while underway with caution and good operator judgment. **Never occupy front seating area if conditions are dangerous.**

### **WARNING**

Avoid serious or fatal injury. Do not occupy seat when speed exceeds 5 MPH.

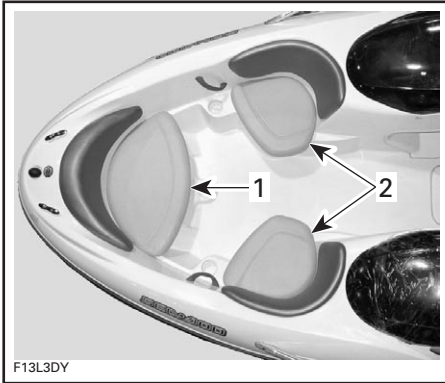

#### TYPICAL

1. Seat (1)
2. Seats (2)

## Storage Compartments

Unsnap and lift bow seat cushions to gain access to under seat storage compartments.

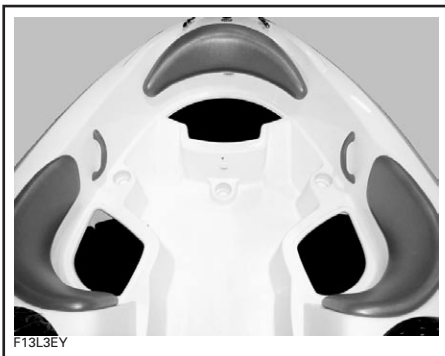

TYPICAL — BOW SEAT STORAGE

## 21) Cup Holders

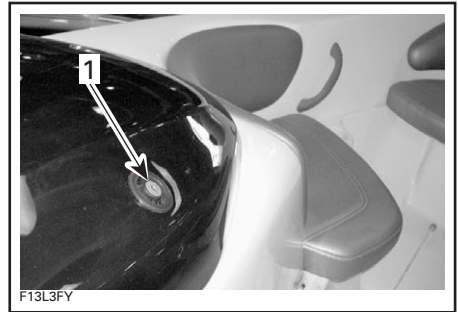

#### TYPICAL

1. Cup holder

Press the release button to open cover.

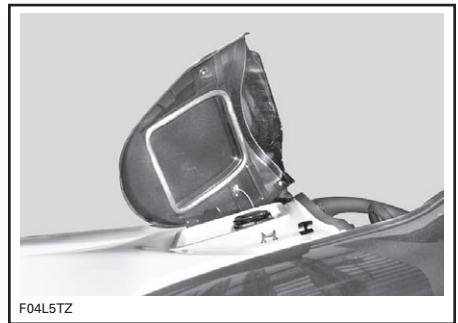

#### TYPICAL

Lift cover until retaining rod locks into open position.

The right side basket is provided with a holder to store an approved fire extinguisher.

The fire extinguisher (sold separately) should not be loose in the storage compartment.

The *Operator's Guides* should be kept in a waterproof bag and remains with the boat at all times.

### **WARNING**

Do not remove the basket to use as additional storage area. Components can become entangled and cause serious operational hazards.

Push retaining rod towards hinge to release mechanism then lower slowly. When bottomed on latch, firmly push cover to lock.



**TYPICAL**

Periodically verify the lock pin tightness of storage cover. Tighten if needed and make sure storage cover latches properly.

**⚠ WARNING**

Never leave any heavy or loose breakable objects in the storage basket. Never operate the boat with the storage compartment cover open.

## 22) Deck Storage Compartment

The deck storage compartment is a convenient location for water-skis, paddles, anchor and rope, etc.

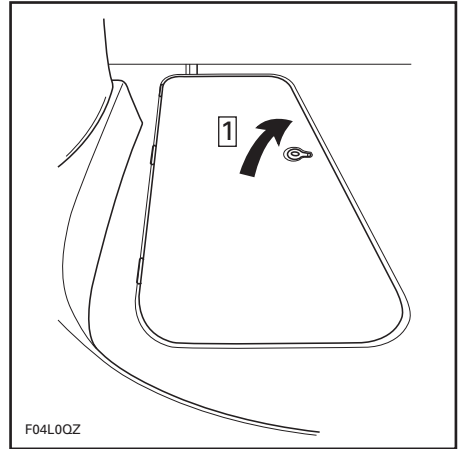

**TYPICAL**

Step **1**: Pull latch and lift cover

Lift the latch ring and open cover gently until stopped by retaining spring.

When completely opened, the cover remains in that position on calm water.

To close, gently push on the side of the spring to release it and lower the cover.

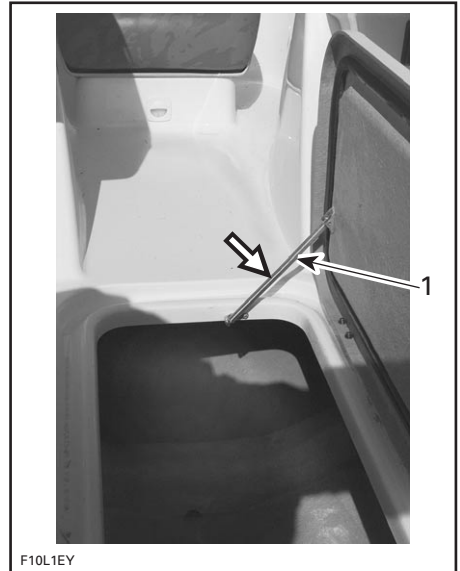

1. Gently push here to release the spring



**⚠ WARNING**

Never leave any heavy or breakable objects in the storage compartment. Never operate the boat with the storage compartment cover open.

### 23) Rear Storage Compartment

Convenient rear storage location for carrying large personal articles. Ideal location for spare Personal Flotation Device (PFD), towels, lunch etc.

To open engine cover, open the driver's console storage compartment cover and pull lever.

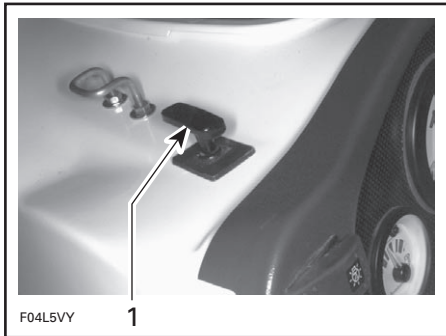

1. Lever

Gas assist cylinders will complete the opening and hold engine cover open.

**NOTE:** Access to the rear storage compartment is protected only when the driver's console storage compartment cover is locked.

### Storage Tray

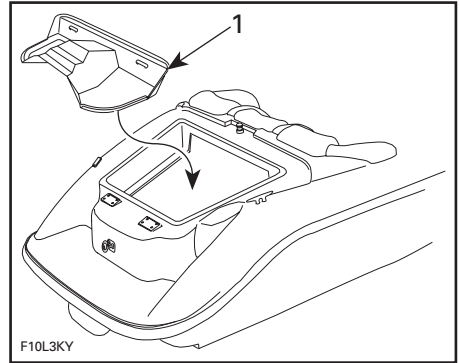

**TYPICAL**

1. Storage tray

**CAUTION:** In order to avoid damage, **MAXIMUM LOAD** on storage tray must not exceed 22.5 kg (50 lb).

The storage tray is removable to give access to the engine compartment. Grab the handle and lift in a rearward movement.

**⚠ WARNING**

When storage tray is lifted or removed, never touch any electrical part when starting engine or while in operation. Never leave any object, rag or tool in the engine compartment or in the bilge.

Reinstall storage tray.

Firmly close engine cover to relatch.

**⚠ WARNING**

Never leave any heavy or breakable objects in the storage compartment. Never operate the boat with the engine cover open.

## 24) Jet Pump Water Intake

The water is drawn up by the impeller through this opening. The grate minimizes entry of foreign objects into the propulsion system.

### **WARNING**

Keep away from intake grate while engine is on. Items such as long hair, loose clothing or personal flotation device straps can become entangled in moving parts resulting in severe injury or drowning.

Refer to *M<sup>2</sup> Jet Drive Operator's Guide* for more detailed information.

## 25) Bow and Stern Eyelets

### Bow Eyelet

Eyelets can be used for mooring, towing and as a tie-down point during transportation.

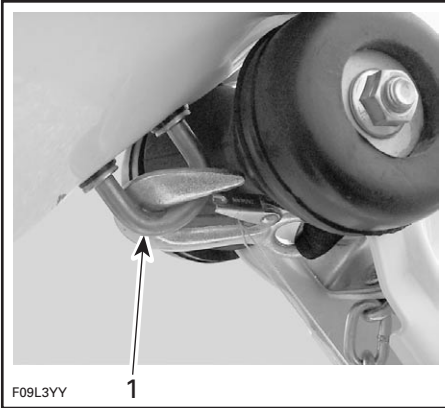

*TYPICAL*

1. Bow eyelet

### Stern Eyelets

Eyelets allows a rope with a hook, a closed end or an open end to be attached.

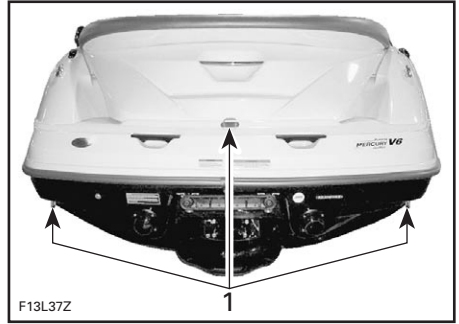

*TYPICAL*

1. Stern eyelets

## 26) Bow Light

Mandatory red/green light. See LIGHT SWITCH as mentioned earlier in this section.

## 27) Removable Stern Light Socket

Mandatory white stern light.

It is recommended to keep stern light in rear storage compartment at all times except when needed.

To remove from engine cover, pull it out. Snap in place to store.

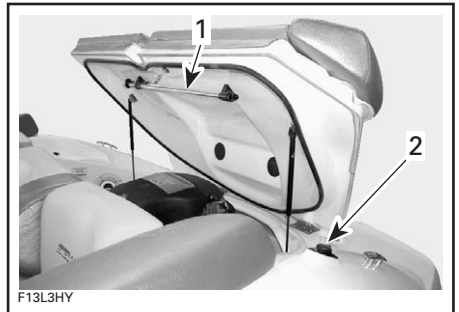

*TYPICAL*

1. Stern light storage location  
2. Stern light operation position

## Installation

- Release stern light storage lock as shown.

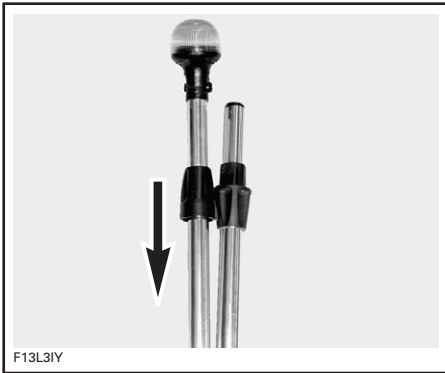

*SLIDE THIS DIRECTION*

- Thread onto folding joint.

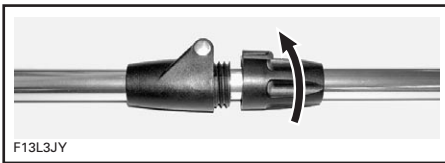

*TYPICAL*

- Lift connector cap.
- Insert post in connector hole. Ensure to align hole keyway with post screw head.
- Firmly push downward to engage terminals.
- Push lock ring downward. Turn until locked. It may be necessary to slightly turn it to allow its insertion in the hole.
- Check light operation. See NAVIGATION LIGHT SWITCH as mentioned earlier in this section.

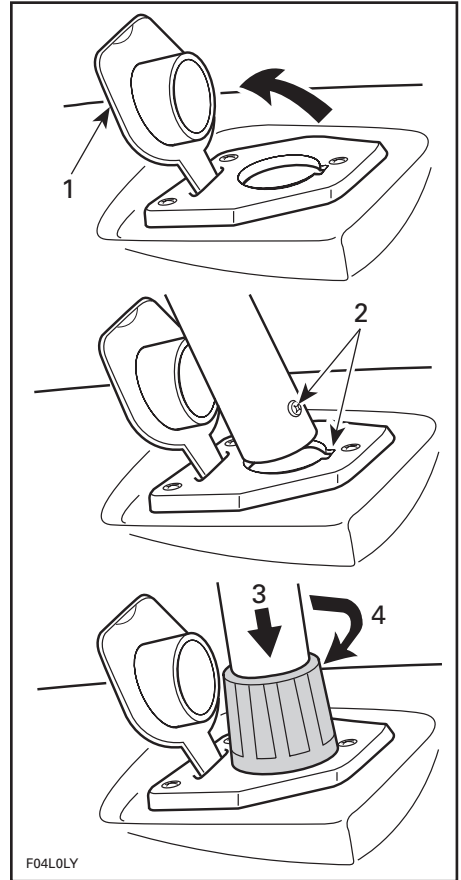

*TYPICAL*

1. Lift
2. Align screw in groove
3. Push downward
4. Turn to lock

**CAUTION:** Ensure dielectric grease is present in connector area of light to prevent corrosion.

Removal and storage of light is the reverse of installation.

## 28) Mooring Cleats

When mooring to a dock, it is recommended to secure with both front and rear cleats. The use of dock lines with sealed air fenders is recommended to protect your boat.

**CAUTION:** Never use mooring cleats to pull or lift the boat.

## 29) Deck

Flat surface of boat, should be kept clean and clear.

## 30) Fuel Tank Cap

Unscrew the cap counterclockwise. Reinstall cap and fully tighten after fueling.

### **WARNING**

Always stop the engine before refueling. Fuel is flammable and explosive under certain conditions. Always work in a well ventilated area. Do not smoke or allow open flames or sparks in the vicinity. Fuel tank may be pressurized. Slowly turn cap when opening. Never use an open flame to check fuel level. When fueling, keep boat level. Do not overfill or top off the fuel tank and leave boat in the sun. As temperature increases, fuel expands and might overflow. Always wipe off any fuel spillage from the boat. Periodically verify fuel system.

## 31) Deck Drain

Provides drainage of water from rain, deck washing, water splashing, etc. Keep clean to avoid clogging.

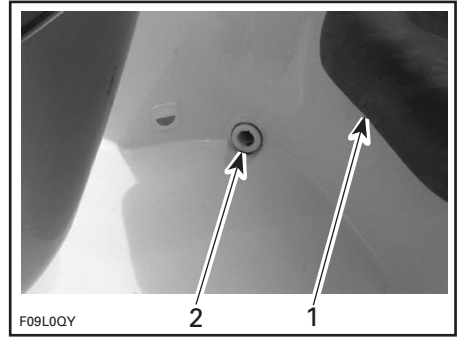

### **TYPICAL**

1. Rear seat
2. Deck drain

## 32) Main Oil Reservoir Cap

Open the engine cover to expose the oil cap. The cap is located under the engine cover.



To add injection oil in the reservoir, unscrew the cap counterclockwise.

### **WARNING**

Add oil to level mark. Do not overfill. Reinstall cap and fully tighten.

**CAUTION:** Oil system must be pressurized. Always ensure that reservoir caps are firmly tightened. Refer to *M<sup>2</sup> Jet Drive Operator's Guide* for recommended oil and complete reservoirs filling procedure.

### 33) Flushing Connector

Refer to *M<sup>2</sup> Jet Drive Operator's Guide* for proper use.

For your convenience, flushing connector is located under engine cover. Lift cover, the flushing connector is on starboard side of the storage compartment.

### 34) Ventilation Ducts

Located beneath the engine compartment lid, the ventilation ducts allow air to ventilate engine compartment and to supply air to engine. Never obstruct the ventilation ducts.

### 35) Jet Pump Nozzle

Turns side to side via input from the steering wheel. This provides directional control when engine is running.

**⚠ WARNING**

Never use nozzle as a supporting point to board the boat or to lift it.

Refer to PROPULSION under PRINCIPLE OF OPERATION.

### 36) Reverse Gate

When selecting the neutral or reverse position with the shift lever, the reverse gate moves up or down to obtain the desired position.

**⚠ WARNING**

Never use gate as a supporting point to board the boat. Shift lever should only be used when the engine is idling and boat is completely stopped.

### 37) Retractable Ladder

Located under swim platform.

A convenient ladder to help reboarding the boat.

**⚠ WARNING**

Engine should be OFF when using ladder. Keep limbs away from jet or intake grate. Stay on center of the ladder. Only one person at the time on the ladder. Never use the ladder for pulling, towing, diving or jumping, boarding a boat that is out of water or any other purpose other than a ladder.

Pull latch to unlock the ladder.

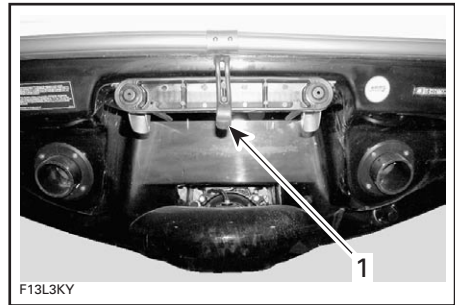

TYPICAL

1. Latch

Slide ladder toward rear, then push down.

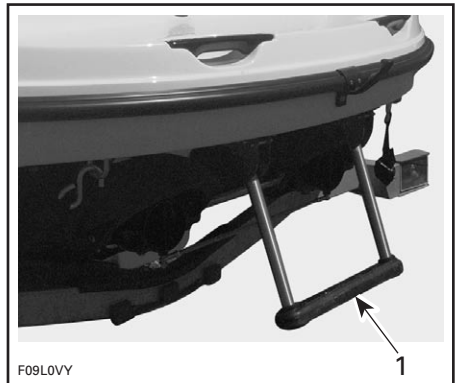

TYPICAL

1. Ladder lowered

To store ladder, lift horizontally completely then slide toward front.

### 38) Scupper Valve

Water from deck drains flows out through the scupper valve. Keep clean to avoid clogging.

### 39) Hydro-Surge Grate System

Refer to *M<sup>2</sup> Jet Drive Operator's Guide*.

### 40) Fuel Tank Vent

The fuel tank vent allows fuel vapors and pressure to escape from fuel tank.

#### WARNING

Never use a lit match or open flame close to vent. Follow the FUELING PROCEDURE instructions in the FUEL AND LUBRICATION section.

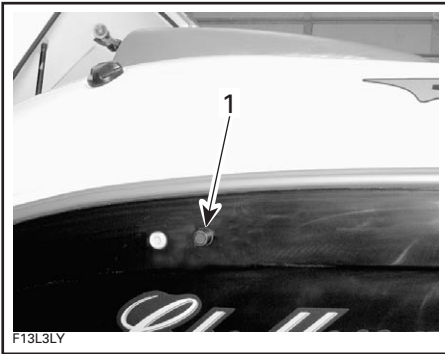

TYPICAL

1. Fuel tank vent

### 41) Water Sport Towing Attachments

Please read and often refer to WATER SPORTS information in the SAFETY SECTION at the front of this guide.

#### WARNING

"Teak Surfing" is extremely dangerous to participants due to their proximity to the rear of the boat where direct contact with the exhaust fumes from the boat engine is the highest. Carbon monoxide poisoning can occur and result in mental disorientation, dizziness, drowsiness, and loss of consciousness. The combination of carbon monoxide exposure and non-use of a life jacket (PFD) make this new water recreation activity an incredibly dangerous and potentially deadly sport.

#### Water Ballast Bag (if so equipped)

Placed in ski locker. User must follow the manufacturer's instructions that are supplied for filling.

#### Pump System (water ballast bag)

User must follow the instructions that are supplied for filling.

#### WARNING

Only use ballast bag for skiing/wakeboarding purposes. Ballast bag must always be in the ski locker when full.

**CAUTION:** Never tow or trailer boat with the ballast bag filled; always empty ballast bag before towing or trailering. Never empty ballast bag into bilge area of boat.

#### Ski Post

This boat comes equipped with a ski post. Use this post or the ski tow hook to pull a tube, water skier or wakeboarder.

## WARNING

When pulling a tube, skier or wakeboarder, always have an observer while pulling a skier, proceed with only as much speed as required, and follow the observer's instructions.

Pull up the post to allow hooking a ski rope or other towables.

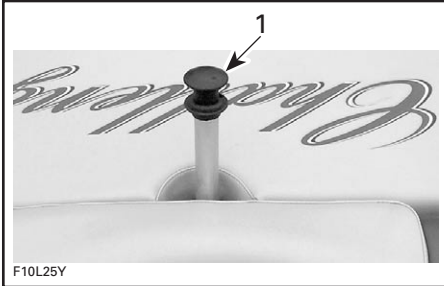

### TYPICAL

1. Lift ski post to use

Push down when finished.

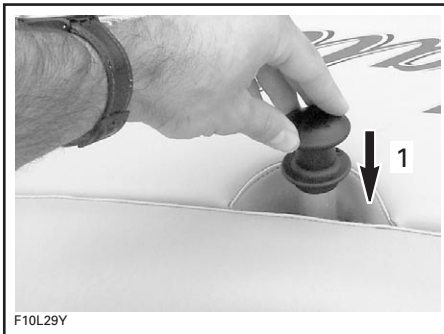

### TYPICAL

1. Push down when not in use

Always have one person other than the operator as an observer.

**CAUTION:** Never use the ski post or wakeboard extension to tow any other craft.

## WARNING

Pulling a tube, skier or wakeboarder makes the boat handle differently and requires greater skill. Unless absolutely necessary, do not make tight, sharp turns. Keep a safe distance from the docks, other swimmers, craft or objects. Be advised that serious injury can result if the tow rope become slack during a tight turn or when circling. The rope could become wrapped around the neck or limbs of a person.

### Wake Tower

Convenient tower for skiing/wakeboarding.

**CAUTION:** Always tow the vehicle with the towing tower fastened in the upright position to avoid damage to the boat and towing vehicle while in transport.

A storage pad is supplied to prevent damage to the deck.

The tower comes with an access hole for aftermarket wiring on the starboard side rail mounting flange of the boat.

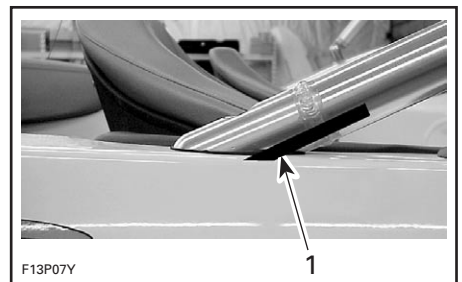

1. Black indicates wire access hole

To clean tower, use mineral spirits and a clean soft cloth.

## **⚠ WARNING**

**Misuse of tower may cause severe injury or death.**

- Use tower only for wakeboarding or water skiing.
- Do not allow tow rope to dangle or get entangled with occupants, boat or engine.
- Attach tow rope only at the center attachment point.
- Tow only 1 person at a time.
- Do not climb on, sit on or jump off tower.

F13L1PL

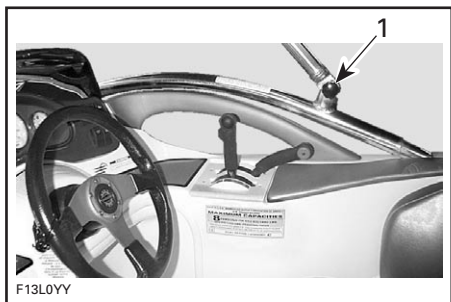

1. Remove from each side

To fold tower for storage, remove knobs from each side of tower.

Carefully fold tower forward until storage pad is in contact with bow.

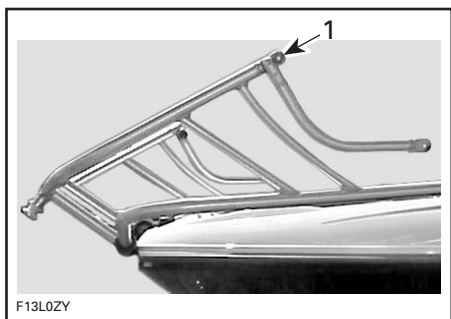

1. Remove knobs from each side

Remove knobs from curved extensions. Lower arms into storage position as shown.

Place knobs in glovebox or other secure storage for later use.

Raising of tower is reverse of this procedure.

## **42) Fuses**

Electrical system fuses are located inside starboard front storage compartment.

Refer to *M<sup>2</sup> Jet Drive Operator's Guide* for ENGINE ELECTRICAL SYSTEM.

## **43) AM-FM Radio/CD Player**

Refer to its guide for a complete explanation of the features and controls.

**CAUTION:** Using the radio/CD player for a prolonged time without engine running may discharge the battery.

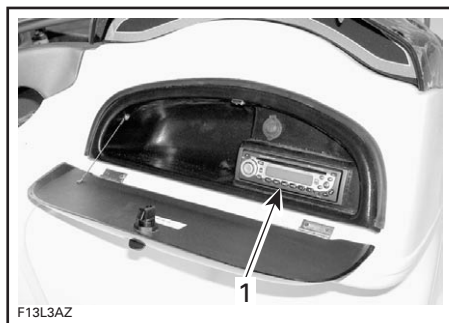

**TYPICAL**

1. Radio/CD player

Open glovebox to access radio/CD player.

Close glovebox door when underway, or when radio/CD player is not in use to protect against weather.

**NOTE:** The radio/CD player is better protected from theft when the glove box is locked.



## 44) Glove Box



TYPICAL

1. Glove box

Located on port console.

A small, convenient lockable storage compartment for keys, wallet, etc.

To access the glove box, unlock the release button using the provided key and press button.

NOTE: Always relatch and lock glove box.

### WARNING

Never operate the boat with the glove box cover open.

## 45) Water Bypass System

At idle speed, water does not flow through this outlet.

When engine is running above idle speed, water **must** flow through this hole. This allows air in engine water jacket to escape.

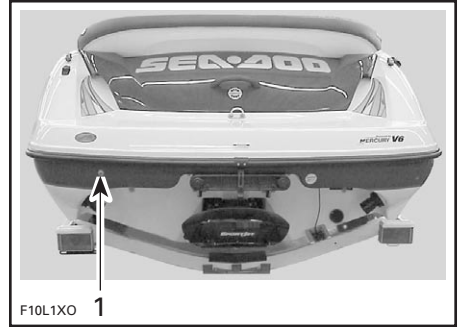

TYPICAL

1. Water bypass outlet

**CAUTION:** If water does not flow from the outlet a few seconds after engine starts and runs above idle, immediately stop engine and refer to **POST-OPERATION CARE** and look for **COOLING SYSTEM FLUSHING** or refer to an authorized Sea-Doo sport boat dealer for servicing.

## 46) Main Battery Cut-Off Switch

The switch is located in the engine compartment. It is provided to allow a complete cut-out of the electrical system.

When in OFF position, ALL electrical equipment and electronics will be OFF **except** bilge pump. It will operate automatically with the battery switch in the OFF position.

Switch must be in the ON position to allow the use of electrical components and to start the engine.

**CAUTION:** Stop engine before switching to the OFF position.



1. Main battery cut-off switch

It is recommended to set this switch to the OFF position whenever performing maintenance in the engine compartment, on the electrical system, for transportation or during short term storage.

**CAUTION:** When the main battery cut-off switch is turned OFF while boat is moored, the automatic bilge pump **will** start if water comes up in the bilge.

---

# FUEL AND LUBRICATION

**CAUTION:** Carefully follow the instructions of this section. Failure to do so may reduce the engine's life and/or performance.

## Fueling Procedure

### WARNING

Follow these safe boating fueling instructions explicitly.

Do not allow anyone to remain in or on the boat.

Tie boat securely to the fueling pier.

Use bilge blower for a minimum of 5 minutes.

Turn off bilge air blower, bilge pump and any other devices that could produce a spark.

Ensure engine cover is closed to prevent fumes from entering the engine compartment.

Have a fire extinguisher close at hand.

Insert the spout in filler neck.

Pour fuel slowly so that air can escape from the tank and prevent fuel flow-back.

Fill fuel tank to bottom of filler neck. **Do not overfill.** Fully tighten fuel tank cap.

### WARNING

Always stop the engine before refueling. Fuel is flammable and explosive under certain conditions. Always work in a well ventilated area. Do not smoke or allow open flames or sparks in the vicinity. Fuel tank may be pressurized. Slowly turn cap when opening. Never use an open flame to check fuel level. When fueling, keep boat level. Do not overfill or top off the fuel tank and leave boat in the sun. As temperature increases, fuel expands and might overflow. Always wipe off any fuel spillage from the boat. Periodically verify fuel system.

## Recommended Fuel

Use regular unleaded gasoline with 87 octane (Ron + Mon)/2 specification.

Outside North America use **90 RON**.

**NOTE:** This boat features an oil injection system which does not require manual fuel/oil mixing. Do not mix oil with fuel except at engine break-in. Refer to *M<sup>2</sup> Jet Drive Operator's Guide* BREAK-IN PERIOD. Always check oil reservoir level when refueling.

Refer to *M<sup>2</sup> Jet Drive Operator's Guide* for more detailed information.

**CAUTION:** The use of a fuel other than regular unleaded fuel can result in performance deterioration and damage to fuel system and engine components. Never experiment with other fuels or fuel ratios. Never use fuel containing alcohol, methanol or similar products including naphtha.

## Recommended Oil

### **WARNING**

Add oil to level mark. Do not overfill. Reinstall cap and fully tighten.

Use Quicksilver or Mercury Precision Premium-Plus lubricants NMMA/BIA certified TC-W3 2-cycle outboard oil or equivalent.

Refer to *M<sup>2</sup> Jet Drive Operator's Guide* specifications for more detailed information.

## Main Oil Reservoir Level

A sufficient amount of oil should be maintained in the reservoir.

**NOTE:** Always carry a spare 1 liter of oil.

The use of a funnel is recommended to pour the oil into the reservoir. Stop filling as soon as oil appears at approximately 13 mm (1/2 in) from top of reservoir. Do not overfill. Wipe off any oil spillage.

**CAUTION:** Always maintain a sufficient amount of oil in the oil reservoir. Check and refill every time you refuel. Do not overfill. If the engine runs out of oil, severe engine damage will occur. If the oil reservoir is found almost empty, refer to an authorized Sea-Doo sport boat dealer to have the oil injection system inspected.

**CAUTION:** Oil system must be pressurized. Always ensure that reservoir caps are firmly tighten. Refer to *M<sup>2</sup> Jet Drive Operator's Guide* for complete reservoirs filling procedure.

## Engine Mounted Oil Reservoir Level

Refer to *M<sup>2</sup> Jet Drive Operator's Guide*.

---

## BREAK-IN PERIOD

**CAUTION:** Carefully follow the instructions of this section. Failure to do so may reduce the engine's life and/or performance.

### Engine

Refer to *M<sup>2</sup> Jet Drive Operator's Guide*.

### 10-Hour Inspection

It is highly recommended that after the first 10 hours of operation, the boat be checked by an authorized Sea-Doo sport boat dealer. This inspection will also provide the opportunity to discuss any unanswered questions you may have encountered during the first hours of operation.

The following chart should be used in conjunction with Mercury chart. Refer to *M<sup>2</sup> Jet Drive Operator's Guide*.

---

**The 10-hour inspection is at the expense of the boat owner.**

---

10-HOUR INSPECTION CHECK LIST	✓
Pressure test fuel system and inspect lines and fasteners	
Adjust throttle cable (if required)	
Inspect oil lines and filter	
Inspect muffler, battery and reservoir fastening devices	
Retighten exhaust system hose clamps	
Inspect steering system and low-speed steering control system	
Adjust steering cable (if required)	
Adjust shifter cable (if required)	
Ensure that throttle levers keep the selected position. Adjust lever friction as necessary	
Inspect condition of hoses and clamps	
Verify operation of bilge pump and bilge blower	
Verify starter switch and safety lanyard stop button	
Monitoring beeper	
Inspect electrical connections (starter, battery, etc.)	
Inspect lighting system	
Inspect hull condition	
Inspect fasteners for tightness	

**We recommend that this inspection chart be signed by an authorized Sea-Doo sport boat dealer.**

---

Date of 10-hour inspection

---

Authorized dealer signature

---

Dealer code

# PRE-OPERATION CHECKS

## WARNING

The pre-operation check is very important before operating the boat. Always check the proper operation of critical controls, safety features and mechanical components before starting. If not done as specified here, severe injury or death might occur. Bring all safety equipment required by local laws.

Some of the following items may not have been previously covered in this guide, however they will be described in the MAINTENANCE or SPECIAL PROCEDURES section. Please refer to these portions to have more detailed information.

Before operating the boat, verify the following:

## WARNING

Engine should be off and the safety lanyard must always be removed from its switch before verifying any of the following. Only start boat once all items have been checked and operate properly.

### SUMMARY

ITEM	OPERATION	✓
Safety lanyard/ignition switch	Check operation.	
Hull	Inspect for damage.	
Jet pump water intakes	Inspect/clean.	
Bilge	Drain. Ensure plugs are secured.	
Battery	Inspect tightness of cables and retaining straps.	
Main battery cut-off switch	Ensure it is in the ON position.	
Navigation lights	Check operation.	
Fuel tank and oil reservoir	Refill.	
Engine compartment	Verify fuel/oil system and exhaust components.	
Steering	Check operation.	
Throttle/shifter system	Check operation.	
Bilge blower and bilge pump	Check operation.	
Mandatory safety boating equipment	Check operation.	
Storage compartment covers and engine cover	Ensure they are closed and latched.	
Wake tower	Inspect bolts and locking knobs.	

## Hull

Inspect hull for cracks or damage.

## Jet Pump Water Intake

Remove weeds, shells, debris or anything else that could restrict the flow of water and damage the cooling system or propulsion units. Clean as necessary. If any obstruction cannot be removed, refer to an authorized Sea-Doo sport boat dealer for servicing.

Inspect leading edges of the impellers for nicks or bends which will greatly reduce performance of the boat.

## Bilge

If water is present in the bilge, use bilge pump or block the wheels and raise the bow slightly with the trailer jack (if so equipped) and unscrew drain plugs if boat is out of the water, to empty the bilge.

Secure bilge drain plugs.

### WARNING

Make sure drain plugs are properly installed before launching the boat in water.

## Battery

### WARNING

Verify tightness of battery cables to their posts and condition of retaining straps/fasteners. Do not charge or boost battery while installed in the engine compartment.

## Fuel Tank/Oil Reservoirs

The boat is considered level when in the water. When on a trailer, block wheels and raise bow with trailer jack (if so equipped) with the bumper rail level. Fill the fuel tank to specified level.

Check the oil level and refill reservoir as necessary.

**CAUTION:** Oil system must be pressurized. Always ensure that reservoir caps are firmly tightened. Refer to *M<sup>2</sup> Jet Drive Operator's Guide* for complete filling procedure for reservoirs.

Check fuel tank/oil reservoirs retaining straps/fasteners.

## Engine Compartment

### WARNING

If any leaks or gasoline odors are present, do not start the engine. Consult an authorized Sea-Doo sport boat dealer before use.

## Fire Extinguisher

Make sure it is full, in good condition and well secured.

## Steering System

Have another person help check steering operation for free movement. When the steering is centered, the jet pump nozzle should be in the straight ahead position. Ensure the jet pump nozzle pivots easily when steering is turned.

### WARNING

Check operation of steering and corresponding steering nozzle before starting engine.

## Throttle System

Check throttle lever once for free and smooth operation.

**NOTE:** To activate throttle lever, shift lever must be in forward or reverse position.

### WARNING

Check operation of throttle lever before starting the engine.

## Shifter System

Check that reverse gate moves freely. With shift lever in forward position, the gate should be in upward position. With the shift lever in neutral position, gate should be in middle position. With shift lever in reverse position, gate should be in downward position.

## Inlet Grate

Ensure inlet grate is not blocked or obstructed by any weeds or debris. Refer to *M<sup>2</sup> Jet Drive Operator's Guide*.

## Ignition Switch and Safety Lanyard

Ensure that ignition switch and safety lanyard operates properly.

### **WARNING**

If engine does not shut-off when pushing engine start/stop button or by disconnecting the safety lanyard, do not operate the boat further, see an authorized Sea-Doo sport boat dealer. Only start boat once all items have been checked and operate properly.

Start and stop engine using the safety lanyard switch. See STARTING PROCEDURE.

## Storage Compartment Covers

Ensure they are closed and latched.



---

# OPERATING INSTRUCTIONS

## **WARNING**

Always perform PRE-OPERATION CHECKS before operating the boat. Become thoroughly familiar with all controls and the function of each. Should any control or instruction be not fully understood, refer to an authorized Sea-Doo sport boat dealer.

## **Launching/Loading**

**CAUTION:** Before launching the boat, ensure the main battery cut-off switch is turned ON and the bilge plugs are fully screwed into place.

Remove bilge plugs to drain bilge when boat is on trailer.

## **Trailing**

Refer to the trailer or implement manufacturer instructions for proper capacity, operation, maintenance, accessories and warranty.

Check the regulations in your area concerning towing a trailer, especially the following rules:

- brake system
- tow vehicle weight
- mirrors.

**NOTE:** An optional brake system is available for your trailer, contact Karavan Trailers ([www.karavantrailers.com](http://www.karavantrailers.com)).

Take the following precautions when trailering the boat:

Tie the boat to both bow and stern (front/rear) eyelets so that it is firmly retained on the trailer.

- Remove stern light (if installed).
- Ensure that ski post is pushed down.
- Ensure all storage compartment covers are properly latched.
- A SEA-DOO cover can protect the boat, particularly before driving on dirt roads, to prevent dirt entry through the air intake opening(s).

Observe trailering safety precautions.

## **Principle of Operation**

### **Propulsion**

The engine is directly coupled to a drive shaft which, in turn, rotates an impeller. This impeller rotates within a housing drawing water in from beneath the boat. Water is then forced by the impeller through a venturi. The venturi pressurizes and accelerates the water, producing thrust to move the boat. Pushing the throttle lever forward increases engine speed and therefore boat speed.

## **WARNING**

When an engine is to be started, the operator and passengers should always be sitting in the boat with the shift lever in neutral position and throttle lever in idle position.

## Shift Lever

### FORWARD

The shift lever should be in the forward position in order for the boat to advance.

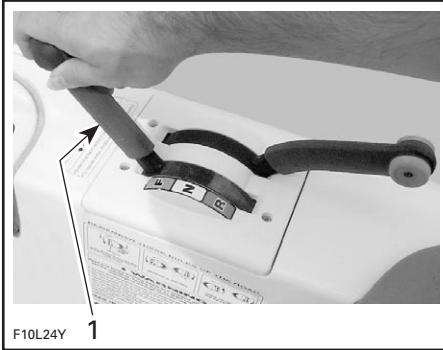

#### TYPICAL

1. Shift lever in forward position

### NEUTRAL

To obtain neutral, pull shift lever halfway. The reverse gate will be in the middle position, directing half of the thrust toward the front of the boat to minimize boat movement.

## WARNING

When the boat is in neutral position, the impeller is turning.

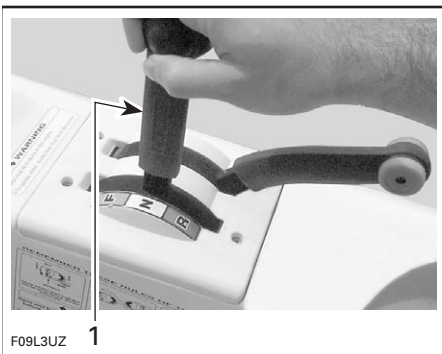

#### TYPICAL

1. Shift lever in neutral position

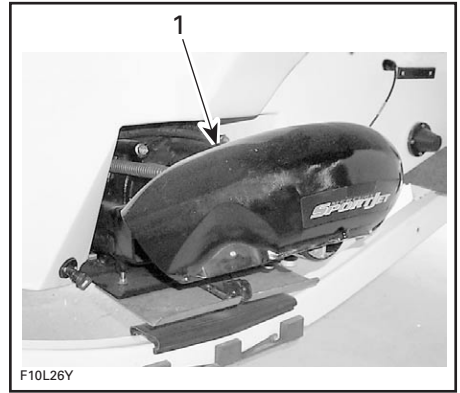

#### TYPICAL

1. Reverse gate in middle position

### REVERSE

To obtain reverse, pull shift lever completely to the rear. The reverse gate will be in downward position, directing all the thrust toward the front of the boat.



TYPICAL — SHIFT LEVER IN REVERSE POSITION

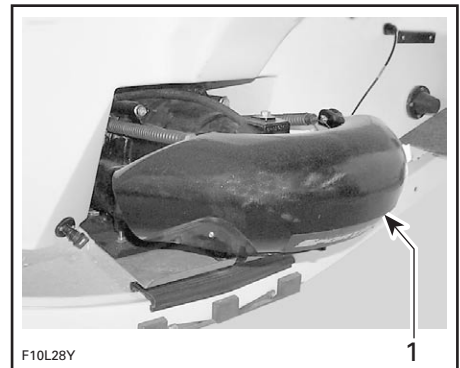

#### TYPICAL

1. Reverse gate in downward position

**NOTE:** To obtain maximum efficiency and control from the reverse setting, increase engine speed to slightly above idle. Too much RPM will create water turbulence and reduce reverse efficiency.

In reverse position, turn the steering wheel in the opposite direction that you want to move the back of the boat.

For example, to steer the rear of the boat to the left side, turn the steering wheel to the right side.

**⚠ WARNING**  
Shift lever should only be used when the engine is idling and boat is completely stopped.

### Steering

Turning the steering wheel pivots the jet pump nozzle which controls the boat direction. Turning the steering clockwise will turn the boat to the right and inversely.

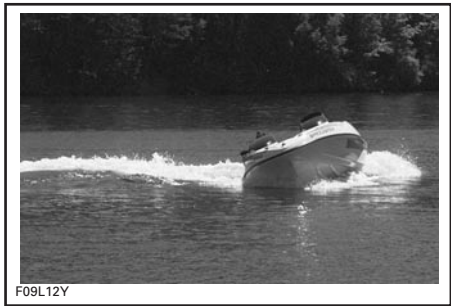

F09L12Y

*TYPICAL*

Above idle speed, the throttle must be applied to turn the boat.

**⚠ WARNING**  
Throttle must be applied and steering turned to change the direction of the boat at speed. Steering efficiency will differ depending on the number of passengers, load and water conditions.

A jet propelled boat needs some throttle applied in order to turn. Practice in a safe area applying the throttle and turning away from an imaginary object. This is a good collision avoidance practice.

### Using Reverse

The boat behaves differently when using reverse. The steering response is the opposite of forward operation. So, turning the steering wheel clockwise will turn the back of the boat to the left and inversely. Use throttle moderately. Too much RPM will create water turbulence and reduce reverse efficiency. At first outing, carefully practice this maneuver away from anything with which you might collide.

### Low-Speed Steering Control System

Whenever the throttle lever is in **IDLE position** and the steering wheel is approaching the end of its rotation, the engine speed will be slightly accelerated to increase the jet pump thrust. This helps steering control for low-speed navigation or when approaching/leaving a dock. For docking tips, refer to **STOPPING/DOCKING** section below.

**⚠ WARNING**  
Become fully familiar with this feature during your first ride and before carrying passengers.

### Boarding from a Dock

As with any boat, boarding should be done carefully and engine should not be running.

When boarding from a dock, slowly place one foot on the boat deck nearest to the dock and then move the other foot inside the boat. Push the boat away from the dock.

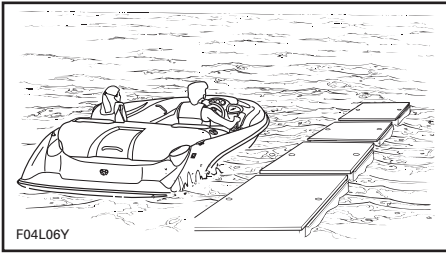

TYPICAL

**CAUTION:** Although the boat requires only 30 cm (1 ft) of water to float, the engine should be started with at least 90 cm (3 ft) of water below the hull. If the depth is less than 90 cm (3 ft), and the engine is running, the impeller is turning and debris can be drawn from the bottom and damage the propulsion system.

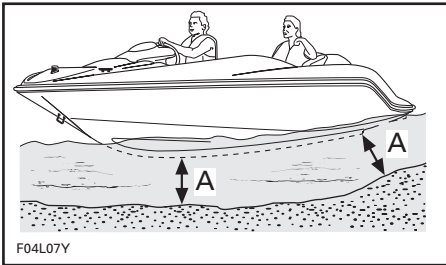

TYPICAL

A. 90 cm (3 ft)

## Boarding from the Water

### WARNING

Inexperienced riders should practice how to get aboard close to shore first before venturing into deep water.

### WARNING

Engine should not be running while boarding. Never use propulsion components as a supporting point to board the boat.

Swim to the rear of the boat.

Unlatch and pull ladder out and down into the boarding position.

Grip the grab handle, climb the ladder and pull yourself up using the swim platform grab handles.

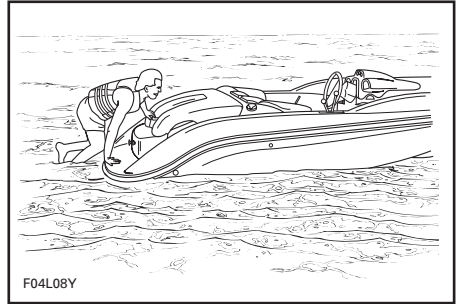

TYPICAL

When you can reach the engine cover grab handle, grip it and continue to pull yourself up to place your knee on the swim platform.

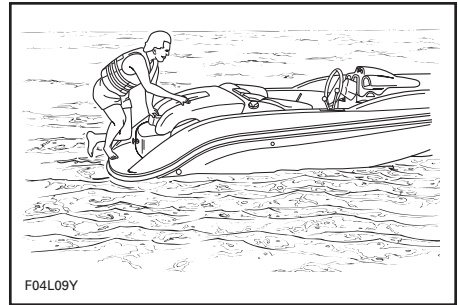

TYPICAL

Continue to climb on engine cover until you are able to reach the deck.

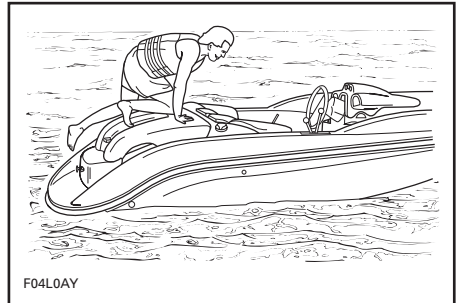

TYPICAL

To store ladder, lift horizontally completely then slide toward front and fasten the retaining latch.

**CAUTION:** Do not leave ladder hanging when operating the boat. Before operating the boat, always lock the ladder using the latch.

 **WARNING**

Do not start engine until all passengers are properly seated.

### Starting

 **WARNING**

Engine exhaust fumes contain carbon monoxide (CO) which can accumulate in and around the boat (under Bimini top, in cockpit, etc.). CO can be harmful or fatal if inhaled. Assure there is adequate ventilation whenever running engine(s).

 **WARNING**

Always activate bilge blower 5 minutes minimum before starting the engine to allow the bilge blower to ventilate the bilge.

**CAUTION:** Bilge blower must be turned off during boat operation.

 **WARNING**

Do not touch electrical parts or jet pump area when engine is running.

Attach the safety lanyard to your PFD and snap the cap to its switch before starting the engine.

 **WARNING**

Before starting, the operator and passengers should always be properly seated.

Grip steering wheel with your right hand and place both feet on the floorboard. Turn off bilge blower.

### Starting Procedure

Refer to *M<sup>2</sup> Jet Drive Operator's Guide* for complete detailed procedure.

### Rough Water or Poor Visibility Operation

Avoid operation in these conditions. If you must do so, proceed with caution and prudence using minimum speed. Turn on navigation lights if necessary.

### Crossing Waves

Reduce speed. Always be prepared to steer and balance as necessary.

When crossing wakes, always keep a safe distance from boat ahead.

 **WARNING**

When crossing wakes, slow down. Operator and passenger(s) can brace themselves by posting. Do not jump waves or wakes.

### Stopping/Docking

The boat is slowed by water drag. The stopping distance will vary depending on the boat size, weight, speed, water surface condition, presence and direction of wind and current.

The operator should become familiarized with the stopping distance under different conditions.

Reduce speed to idle. Shift to neutral, reverse or forward as required.

 **WARNING**

Directional control is reduced when throttle is decreased and lost when engine is off.

## Low-Speed Steering Control System

Reducing RPM to IDLE activates the low-speed steering control feature as described previously. For more details, refer to LOW-SPEED STEERING CONTROL SYSTEM in TURNING section above.

### WARNING

Become familiar with the LOW-SPEED STEERING CONTROL SYSTEM during your first ride and before carrying passengers.

## Beaching

**CAUTION:** It is not recommended to run the boat to the beach.

Come slowly to the beach and shut off the engine using the safety lanyard when water depth is 90 cm (3 ft) under the hull, then pull the boat to the beach. Ensure that all accessories are OFF.

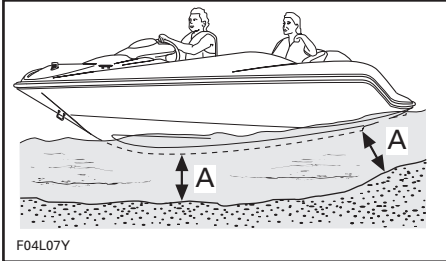

A. 90 cm (3 ft) of water under the hull

### WARNING

In shallow water, shells, sand, pebbles or other objects could be drawn up by the jet pump and be thrown rearward or could damage the engine.

As necessary, the cooling system of the engine should be flushed before restarting, to remove sand or shell accumulation which may clog the water passages. Refer to POST-OPERATION CARE and look for COOLING SYSTEM FLUSHING.

## Shutting Off the Engine

Refer to *M<sup>2</sup> Jet Drive Operator's Guide*.

### WARNING

When the engine is shut off, boat directional control is not available. Never leave the safety lanyard connected on its switch when boat is not in operation.

# POST-OPERATION CARE

## **WARNING**

Allow engine to cool before performing any maintenance.

### General Care

Once boat is on trailer, unscrew the drain plugs and raise the bow slightly with the trailer jack (if so equipped) to allow water to drain.

Wipe up any remaining fluid in the engine compartment (bilge, engine, etc.) with clean dry rags. This is particularly important in salt water use.

Remove the boat from the water every day to prevent growth of marine organisms.

### Additional Care for Foul Water or Salt Water

When the boat is operated in foul water and particularly in salt water, additional care must be taken to protect the boat and its components. Rinse trailer and boat's hull/bilge area with fresh water.

**CAUTION:** Failure to perform proper care such as: rinsing, cooling system flushing and anticorrosion treatment, when used in salt water, will result in damage to the boat and its components. Never leave the boat stored in direct sunlight.

### Cooling System Flushing

#### General

Flushing the cooling system with fresh water is essential to neutralize corroding effects of salt or other chemical products present in water. It will help to remove sand, salt, shells or other particles in water jackets (engine, exhaust manifold, tuned pipe) and/or hoses.

Flushing should be performed when the boat is not expected to be used further the same day or when the boat is stored for any extended time.

## **WARNING**

Perform this operation in a well ventilated area.

### Flushing

1. Clean jet pump by spraying water in its inlet and outlet and then apply a coating of BOMBARDIER LUBE lubricant or equivalent.
2. Open engine cover.
3. Connect a garden hose directly to the flushing connector, as shown in the next photo. Open the water tap.

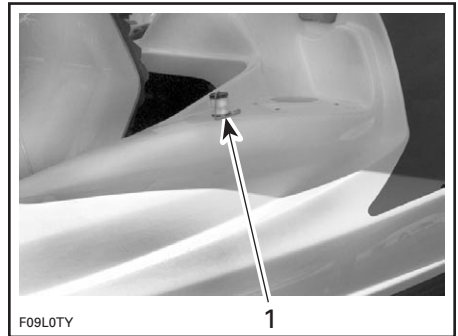

**TYPICAL — SPEEDSTER SHOWN**

1. Flushing connector with its cap

Refer to *M<sup>2</sup> Jet Drive Operator's Guide* for complete engine flushing procedure.

Leave all compartments open to air dry.

---

## SPECIAL PROCEDURE

### Engine Overheating

**CAUTION:** If the monitoring beeper continuously sounds, **stop engine immediately.**

Refer to *M<sup>2</sup> Jet Drive Operator's Guide*.

If engine still overheats, refer to an authorized Sea-Doo sport boat dealer for servicing.

### Jet Pump Water Intake and Impeller Cleaning

Weeds, shells or debris can get caught on the intake grate, drive shaft and/or impeller. A clogged water intake may cause troubles such as:

1. **Cavitation:** Engine speed is high but boat moves slowly due to reduced jet thrust; jet pump components may be damaged.
2. **Overheating:** Since the jet pump operation controls the flow of water to cool the engine, a clogged intake will cause the engine to overheat and damage internal engine components.

The clogged area can be cleaned as described in *M<sup>2</sup> Jet Drive Operator's Guide*.

#### **WARNING**

Always remove safety lanyard cap from switch to prevent accidental engine starting before cleaning the jet pump area.

**CAUTION:** Avoid operation in weed-ed areas. If unavoidable, vary speed. Weeds tend to entangle more at steady and slow speeds. Inspect water intake grate for damage. Refer to an authorized Sea-Doo sport boat dealer for repair as necessary.

### Capsized Boat

The boat is designed so that it should not turn over easily due to its length and width. If the boat ever capsizes, remember that it will continue to float. It is usually best to remain with it so you will be more easily located by others.

#### **WARNING**

When boat is capsized, do not attempt to restart the engine. Operator and passengers should always wear approved personal flotation devices.

### Submerged Boat/Water-Flooded Engine

#### **WARNING**

**DO NOT** attempt to restart engine. See an authorized Sea-Doo sport boat dealer as soon as possible to service the engine.

In the event the engine cannot be serviced within a few hours, remove spark plug cables and connect them on the grounding device.

#### **WARNING**

Never crank engine with spark plugs removed unless spark plug cables are connected to the grounding device.

Remove spark plugs and dry them with a clean and dry cloth.

Cover spark plug holes with a rag.



Crank engine for approximately 10 seconds to allow water to escape from spark plug openings.

Spray BOMBARDIER LUBE lubricant or equivalent into spark plug holes.

Crank engine again.

Reinstall spark plugs.

Start engine normally.

## **Low-Charge Battery Condition**

### **WARNING**

See your authorized Sea-Doo sport boat dealer to have it charged or replaced. Do not charge or boost the battery while installed in the engine compartment. Electrolyte is poisonous and dangerous.

# ***MAINTENANCE INFORMATION***

---

# MAINTENANCE

## Emission Component Maintenance

**Maintenance, replacement, or repair of the emission control devices and systems may be performed by any marine SI (spark ignition) engine repair establishment or individual.**

- ⚠ Only perform servicing procedures which are detailed in this guide. Further assistance or information can be obtained from your authorized Sea-Doo sport boat dealer. In many instances proper tools and training are required for certain servicing or repair procedures.
- ⚠ Maintain the boat and equipment in top condition at all times. Adhere to the prescribed maintenance schedules. An annual inspection of the boat is always a good recommendation to follow.
- ⚠ The bilge must be kept clean of oil, water or other foreign materials.
- ⚠ Do not attempt to lift the boat without special equipment and training.
- ⚠ The engine and the corresponding components identified in this guide should not be utilized on product(s) other than for those they were designed. Maintenance procedures and specified tightening torque must be strictly adhered to. Never attempt repairs unless the appropriate tools are available. Each boat is designed with parts dimensioned in both the metric and the imperial systems. When replacing fasteners, make sure to use only those recommended by BRP. If required, contact your authorized Sea-Doo sport boat dealer for further servicing information.
- ⚠ Operate your boat prudently and have fun. Don't forget that all persons must assist other boaters in an emergency.

## Engine Emissions Information

### Manufacturer's Responsibility

Beginning with 1999 model year engines, manufacturers of marine engines must determine the exhaust emission levels for each engine horsepower family and certify these engines with the United States of America Environmental Protection Agency (EPA). An emissions control information label, showing emission levels and engine specifications, must be placed on each boat at the time of manufacture.

### Dealer's Responsibility

When performing service on all 1999 and more recent Sea-Doo sport boats carrying an emissions control information label, adjustments must be kept within published factory specifications.

Replacement or repair of any emission related component must be executed in a manner that maintains emission levels within the prescribed certification standards.

Dealers are not to modify the engine in any manner that would alter the horsepower or allow emission levels to exceed their predetermined factory specifications.

Exceptions include manufacturer's prescribed changes, such as altitude adjustments for example.

### Owner Responsibility

The owner/operator is required to have engine maintenance performed to maintain emission levels within prescribed certification standards.

The owner/operator is not to, and should not allow anyone to modify the engine in any manner that would alter the horsepower or allow emission levels to exceed predetermined factory specifications.

### **EPA Emission Regulations**

All new 1999 and more recent Sea-Doo sport boats manufactured by BRP are certified to the EPA as conforming to the requirements of the regulations for the control of air pollution from new boat engines. This certification is contingent on certain adjustments being set to factory standards. For this reason, the factory procedure for servicing the product must be strictly followed and, whenever practicable, returned to the original intent of the design.

The responsibilities listed above are general and in no way a complete listing of the rules and regulations pertaining to the EPA requirements on exhaust emissions for marine products. For more detailed information on this subject, you may contact the following locations:

#### **VIA U.S. POSTAL SERVICE:**

US EPA Office of Transportation and Air Quality (6403J)  
Certification and Compliance  
Division/Engine Programs Group  
1200 Pennsylvania Avenue NW  
Washington, DC 20004

#### **EPA INTERNET WEB SITE:**

<http://www.epa.gov/otaq>

## **WARNING**

Only perform procedures as detailed in this guide. It is recommended that the assistance of an authorized Sea-Doo sport boat dealer be periodically obtained on other components/systems not covered in this guide. Unless otherwise specified, engine must not be running, the safety lanyard must be removed from its post and the main battery cut-off switch must be turned OFF for all maintenance procedures. Never use jet pump components to lift the boat. Certain components in the engine compartment may be very hot. Direct contact may result in skin burn. When operating the engine while the boat is out of the water, the heat exchangers may become very hot. Avoid any contact with heat exchangers as burns may occur.

### **Lubrication**

#### **Anticorrosion Protection**

##### **Throttle Cable**

Lubricate the throttle cable with BOMBARDIER LUBE lubricant or equivalent, every 25 hours of use (every 10 hours in salt water use).

#### **Electrical Connections**

As necessary, apply dielectric grease on battery posts and all exposed cable connectors including stern light connectors on mast and boat.

#### **Additional Lubrication**

BOMBARDIER LUBE lubricant or equivalent will help to prevent corrosion and maintain proper operation of moving mechanisms.

Lubrication of the following items should be performed every 50 hours in fresh water use but every 10 hours in salt water use.

### Engine Cover Mechanism and Hinges

Use BOMBARDIER LUBE lubricant or equivalent on metal parts.

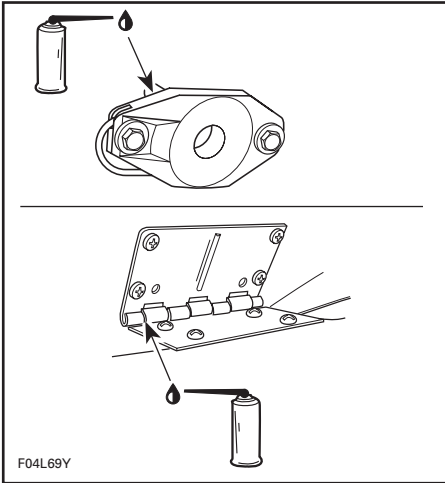

TYPICAL

### Ski Post

Lubricate ski post through all its length. Pull out then push in several times to distribute the lubricant.

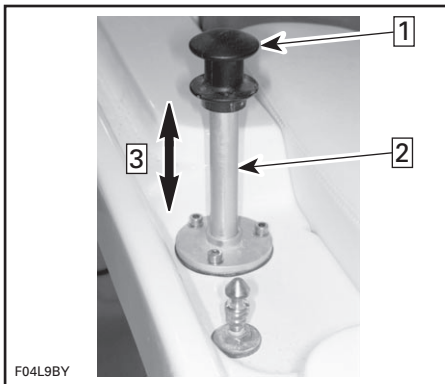

Step 1: Lift ski post to lubricate

Step 2: Lubricate here

Step 3: Move post up and down several times to distribute lubricant

### Locks

Lubricate locks of glove box, front storage compartment covers and deck storage compartment.

### Engine Cover Cylinders

Lubricate cylinder rods.

## Periodic Inspection

Routine maintenance is necessary for all mechanized products. A periodic inspection contributes to the products life span.

The following maintenance chart gives guidelines for regular boat servicing schedule to be performed by you and/or by an authorized Sea-Doo sport boat dealer. The schedule should be adjusted according to operating conditions and use.

Activate the throttle lever throughout its full range of motion. It must operate smoothly. Refer to an authorized Sea-Doo sport boat dealer if adjustment is necessary.

## ⚠ WARNING

Do not alter or tamper with throttle cable adjustment or routing.

## Fuel and Oil Filters

These filters should be replaced by an authorized Sea-Doo sport boat dealer or an authorized Mercury dealer annually.

Refer to *M<sup>2</sup> Jet Drive Operator's Guide*.

## Steering/Jet Pump Nozzle Adjustment

When the steering is directed in straight ahead position, the jet pump nozzle should be in the same direction to allow the boat to run in a straight line.

Refer to an authorized Sea-Doo sport boat dealer if an adjustment is necessary.

### **⚠ WARNING**

Ensure the steering/jet pump nozzle operates freely from side to side and is not stressing the steering cable.

## **Reverse Gate**

### **⚠ WARNING**

Ensure the shifter and reverse gate operate freely and are not stressing the reverse cable.

Refer to an authorized Sea-Doo sport boat dealer if an adjustment is necessary.

## **Deck Drain**

Remove any obstruction from deck drain and scupper valve.

## **Fuses**

### **Accessories, Boat Electrical System and Gauges**

Fuses are located inside the front starboard console, ahead of the dash.

If a fuse is defective, replace by one of the same rating.

### **⚠ WARNING**

Do not use a higher rated fuse as this can cause severe damage. If a fuse has blown, the source of the malfunction should be determined and corrected before restarting. See an authorized Sea-Doo sport boat dealer for servicing.

## **Engine**

Refer to *M<sup>2</sup> Jet Drive Operator's Guide*.

## **Bilge Air Blower**

Verify bilge air blower for proper operation. It is located inside engine compartment beneath port ventilation duct.

Do not obstruct ventilation ducts. Ensure that both openings are not obstructed.

### **⚠ WARNING**

If bilge blower does not operate refer to an authorized Sea-Doo sport boat dealer before starting the boat.

## **Navigation Light Bulb Replacement**

### **Bow Light**

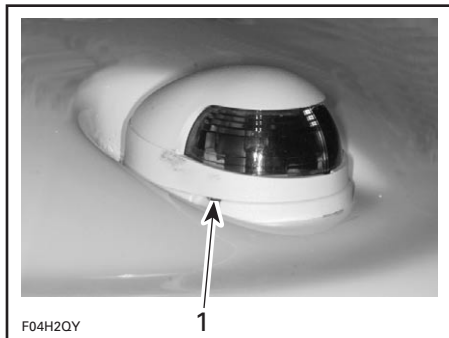

**TYPICAL**

1. Gently pry here with a screwdriver

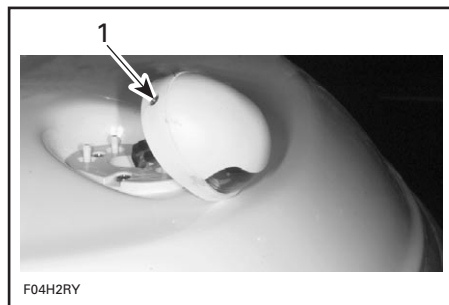

**TYPICAL**

1. Remove this screw

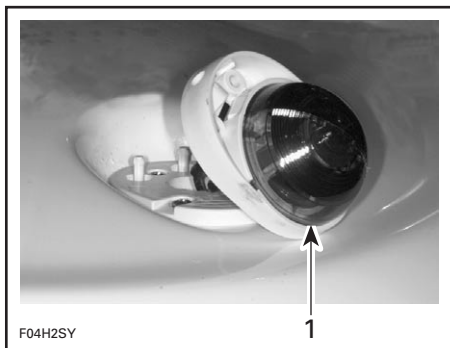

**TYPICAL**  
1. Pull lens out

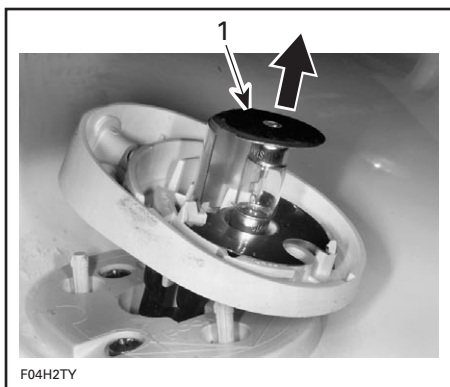

**TYPICAL**  
1. Lift and remove bulb

The assembly is essentially the reverse of removal procedures. However, pay particular attention to the following:

Apply dielectric grease on bulb contact surface.

When installing the bulb under the upper terminal plate, it is possible that the bulb remains loose. The cover will compress the terminal plate against the bulb at reinstallation.

### Stern Light

Unscrew lens counterclockwise and pull it out.

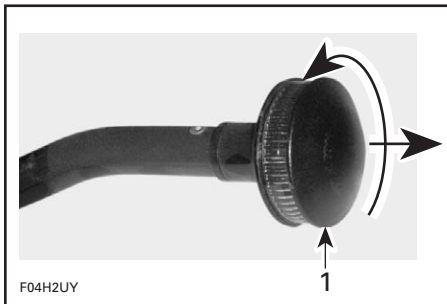

**TYPICAL**  
1. Unscrew then pull

Pull bulb to remove it.

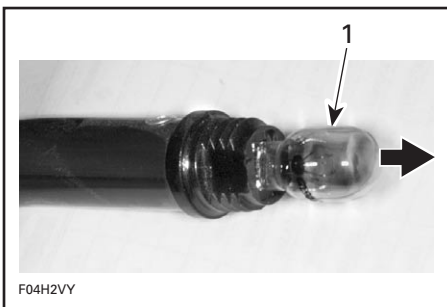

**TYPICAL**  
1. Pull bulb out

Apply dielectric grease on new bulb contact surface.

The assembly is the reverse of removal procedure.

## General Inspection and Cleaning

### Inspection

Check engine compartment for any damage. Ensure all hose clamps are properly secured and no hose is cracked, kinked or presenting any other damage.

### **WARNING**

If any gasoline leaks and/or odors are present, do not start the engine. Have the boat serviced by an authorized Sea-Doo sport boat dealer.

Inspect muffler, battery, fuel tank and oil reservoir fastening devices. Visually check electrical connections for corrosion and tightness.

Inspect hull and jet pump water intake grate for damage. Replace or have damaged parts repaired.

## **Cleaning**

The bilge should be cleaned by the dealer to remove any possible fuel/oil/electrolyte deposits and mildew.

Occasionally, wash the body with hot water and soap (only use mild detergent). Remove any marine organisms from engine and/or hull. Apply non-abrasive wax.

To clean tower, use mineral spirits and a clean soft cloth.

**CAUTION: Never clean fiberglass and plastic parts with strong detergent, degreasing agent, paint thinner, acetone, etc.**

Wash windscreen with Bombardier cleaner or equivalent (P/N 293 110 001 — 400 g (14 oz)) and water. For fine scratches and scuff marks removal, use a windshield polisher for acrylic, lucite, polycarbonate and similar materials.

Stains may be removed from seats and fiberglass with Knight's Spray-Nine\* from Korkay System Ltd or the equivalent.

Respect the environment by ensuring fuel, oil or cleaning solutions do not drain into the waterways.



# PERIODIC INSPECTION CHART

DESCRIPTION		FREQUENCY				
		FIRST 10 HOURS	EVERY 25 HOURS	EVERY 50 HOURS	EVERY 100 HOURS OR PRESEASON	TO BE PERFORMED BY
GENERAL	Check fire extinguisher condition/ mounting	✓			✓ <sup>②</sup>	O
	Verify lubrication/corrosion protection	①		✓	✓	O
ENGINE	Refer to <i>Mercury Owner's Manual</i> for complete engine maintenance information					
	Inspect exhaust system fasteners/hoses					O/D
	Inspect engine support condition					O/D
	Inspect, clean and adjust spark plugs					O/D
EXHAUST SYSTEM	Ensure exhaust clamps are in place and secure		✓			O
	Inspect for leaking exhaust system components (such as rust and/or black streaking, water leaks or corroded/ cracked fittings)		✓			O
	Inspect metal exhaust components for cracking, rusting, leaking or loosening. Check cylinder head gasket, exhaust manifold, water injection elbow, and the threaded adapter nipple between the manifold and the elbow <sup>④</sup>				✓	D
	Clean, inspect, and confirm proper operation of the generator cooling water anti-siphon valve (if equipped) <sup>④</sup>				✓	D
COOLING SYSTEM	Flushing		✓ <sup>③</sup>			O
	Inspect/clean engine drain tube	✓	✓			D
	Inspect hose and fasteners condition	✓		✓	✓	D
FUEL SYSTEM	Pressurize fuel system and inspect hoses, tank and fittings for cracks and leaks	✓			✓	D
	Inspect and lubricate and adjust throttle cable				✓	D
	Inspect/lubricate throttle/choke cables	①	✓		✓	D
	Inspect fuel filter and lines	✓	✓		✓	D
	Replace fuel filter				✓	D
	Inspect fuel tank vent line		✓		✓	D
	Inspect fuel tank straps	✓				O
LUBRICATION SYSTEM	Inspect oil lines	✓	✓			D
	Inspect oil reservoir straps	✓			✓	O
	Fill oil reservoir				✓ <sup>②</sup>	O

DESCRIPTION		FREQUENCY				
		FIRST 10 HOURS	EVERY 25 HOURS	EVERY 50 HOURS	EVERY 100 HOURS OR PRESEASON	TO BE PERFORMED BY
POTABLE WATER SYSTEM	Verify operation of main and fountain water pumps	✓			✓ ②	O
	Clean (or replace) water filter		✓		✓	O
	Rinse and disinfect potable water system				✓	D
	Inspect condition of hoses	✓			✓	D
ELECTRICAL SYSTEM	Test main battery cut-off switch	✓	✓		✓	D
	Verify operation and condition of lights	✓	✓		✓ ②	D
	Inspect bilge blower and bilge pump	✓	✓		✓ ②	D
	Inspect electrical connections (ignition system, electrical box(es), starting system, etc.)	✓	✓		✓	D
	Inspect safety lanyard cap/switch	✓			✓ ②	D
	Verify monitoring beeper	✓		✓	✓	D
	Verify battery cable tightness and battery hold down condition	✓		✓	✓ ②	D
	Charge battery				✓	D
Inspect sacrificial aluminum anode			✓		O	
STEERING SYSTEM	Inspect and adjust cable	✓		✓	✓	D
LOW-SPEED STEERING SYSTEM	Inspect and adjust throttle cable and sensors	✓			✓	D
PROPULSION SYSTEM	Refer to <i>Mercury Owner's Manual</i> for complete jet pump maintenance information					O/D
	Inspect and adjust shifter system/cable	✓			✓	D
HULL AND BODY	Adjust/lubricate convenience center storage trays	✓			✓	D
	Inspect hull condition	✓			✓ ②	O
	Inspect condition of windscreen and fasteners	✓	✓		✓	O
	Lubricate storage compartment cover locks	①		✓		O
	Clean deck drains/scupper valve	✓	✓		✓ ②	O

**NOTE:** Some items are included in the PRE-OPERATION CHECKS and not necessarily repeated in this chart. Refer to *M<sup>2</sup> Jet Drive Operator's Guide* for engine and jet pump checks.

D: Dealer

O: Operator

① Every 10 hours in salt water use.

② Daily checked.

③ Daily flushing in salt water or foul water use.

④ Safety item covered in the annual safety inspection (owner's expenses).

---

# STORAGE AND PRESEASON PREPARATION

## **WARNING**

Because fuel and oil are flammable, have an authorized Sea-Doo sport boat dealer inspect the fuel and oil systems integrity as specified in the periodic inspection chart.

## **Storage**

**NOTE:** Leave drain plug out during storage period.

It is recommended that the boat be taken to an authorized Sea-Doo sport boat dealer for proper storage but the following operations can be performed by you with a minimum of tools.

**CAUTION:** Do not run the engine during the storage period.

## **Fuel System**

Refer to *M<sup>2</sup> Jet Drive Operator's Guide*.

## **Cooling System Flushing and Engine Internal Lubrication**

Refer to *M<sup>2</sup> Jet Drive Operator's Guide*.

## **Propulsion System**

Refer to *M<sup>2</sup> Jet Drive Operator's Guide*.

## **Boat Cleaning/Repair**

Wash the body and the trailer with soap and water solution (only use mild detergent). Rinse thoroughly with fresh water. Remove any marine organisms from the hull.

**CAUTION:** Never clean apparent fiberglass and plastic parts with strong detergent, degreasing agent, paint thinner, acetone, etc.

Stains may be removed from seats and fiberglass with Knight's Spray-Nine\* from Korkay System Ltd or the equivalent.

If repairs are needed to the body or to the hull contact your dealer. For paint touch up to mechanical parts use Bombardier spray paint. For minor Gelcote\* repairs, a repair kit is available from Gelcote International ([www.gelcote.ca](http://www.gelcote.ca)). Replace damaged labels/decals.

When on a trailer, unscrew the drain plugs, block the wheels and raise the bow slightly with the trailer jack (if so equipped). Clean the bilge with hot water and detergent or with bilge cleaner. Rinse thoroughly. Leave drain plugs out during storage period.

## **Battery**

Contact your authorized Sea-Doo sport boat dealer.

## **Anticorrosion Treatment**

Wipe off any residual water in the engine compartment.

Lubricate the throttle cable with BOMBARDIER LUBE lubricant or equivalent.

## **Finalizing Storage Preparation**

Apply a non-abrasive wax to body.

The engine cover should be left partially opened during storage (detach the gas shocks from the cover to prevent full opening). Remove storage tray. Place it on deck.

Using a flat screwdriver, lift tabs as shown below.



*TYPICAL — LIFT TAB*

Detach shock end. Detach other side.

Block and leave engine cover lid open slightly.

This will avoid engine compartment condensation and possible corrosion.

Reattach shock ends to engine cover lid before operating boat.

If the boat is to be stored outside, cover it with a vented opaque tarpaulin to prevent sun rays and grime from affecting the plastic components, boat finish as well as preventing dust accumulation.

**CAUTION: Never leave the boat stored in direct sunlight. UV radiation will dull finishes. The boat must never be left in water for storage. Make sure to turn off main battery cut-off switch.**

For the storage period, it is necessary to block the wheels and raise the bow slightly with the trailer jack (if so equipped) so drainage can take place.

Ensure the drain plugs are unscrewed and unobstructed.

## Preseason Preparation

Use the following chart.

Since technical skills and special tools are required, some operations should be performed by an authorized Sea-Doo sport boat dealer.

### WARNING

Only perform procedure as detailed in this guide. It is recommended that the assistance of an authorized dealer be periodically obtained on other components/systems not covered in this guide and/or *M<sup>2</sup> Jet Drive Operator's Guide*. Unless otherwise specified, engine must not be running and the main battery cut-off switch must be turned OFF for all maintenance procedures.

### Preseason Preparation Chart

**NOTE:** It is highly recommended that the dealer perform at the same time the annual safety inspection in addition to the pre-season preparation.

OPERATIONS	TO BE PERFORMED BY
Verify lubrication/corrosion protection	OPERATOR
Inspect condition of safety lanyard cap and post	DEALER
Verify battery condition and charge and reinstall	DEALER
Verify starter connections and routing ①	DEALER
Fill oil reservoir	OPERATOR
Replace fuel filter	DEALER
Inspect condition of fuel line ①	DEALER
Pressure test fuel system ①	DEALER
Check fuel system fasteners	DEALER
Inspect steering system and low-speed steering control system ①	DEALER
Inspect throttle/shifter system ①	DEALER
Inspect deck drains/bilge pump/drain plugs	DEALER
Check fire extinguisher condition/mounting ①	OPERATOR

① Safety item covered in the annual safety inspection.

**CAUTION:** Only perform this operation in a well ventilated area. Garden hose must be installed or boat must be in water to cool engine. Running the engine without cooling water will damage exhaust hose interior and may damage engine.

# SPECIFICATIONS

ENGINE		CHALLENGER X
Number of engines		1
Engine type		V-6 Mercury Marine 2-stroke
Induction type		Reed valve
Exhaust system		Water cooled, water injected
Lubrication	Type	Refer to <i>M<sup>2</sup> Jet Drive Specifications</i>
	Oil type	Refer to <i>M<sup>2</sup> Jet Drive Specifications</i>
Number of cylinders		6
Displacement		3000 cm <sup>3</sup> (183.1 in <sup>3</sup> )
COOLING		
Type		Open circuit - Direct water flow
ELECTRICAL		
Ignition system type		Digital-CDI (Capacitor Discharge Ignition)
Spark plug	Make and type	Refer to <i>M<sup>2</sup> Jet Drive Specifications</i>
	Gap	Refer to <i>M<sup>2</sup> Jet Drive Specifications</i>
Starting system		Electric starter
Battery		Not supplied ①
Fuses	Courtesy lights	1 A (2)
	Bilge air blower	7.5 A
	Bilge pump	7.5 A
	Navigation lights	3 A
	Gauges/Low fuel	3 A
	Radio	5 A
	Horn system	5 A
12-Volt jack	10 A	
CARBURETION		
Refer to <i>M<sup>2</sup> Jet Drive Specifications</i> for more detailed information		
PROPULSION		
Propulsion system		Mercury Marine Sport Jet
Number of jet pumps		1
Jet pump type		Mixed flow, single stage
Pivoting angle of direction (nozzle)		~ 26°
Minimum required water level for jet pump		90 cm (35 in)

<b>DIMENSIONS</b>	<b>CHALLENGER X</b>	
Overall length	6 m (19 ft 8 in)	
Beam	2.44 m (8 ft)	
Draft	30 cm (12 in)	
Dead rise	19.5°	
Weight (dry)	939 kg (2070 lb)	1032 kg (2275 lb)
Load limit (passengers + luggage)	8 passengers 653 kg (1440 lb) (based on calm water operation)	
Maximum engine power capacity rating of the boat	186 kW (250 HP)	
Hull material	Composite (fiberglass)	
<b>CAPACITIES</b>		
Fuel tank (reserve included)	151 L (40 U.S. gal)	
Main oil reservoir	11 L (3 U.S. gal)	

① Recommended: See Mercury Marine recommendations.

Battery posts: On top. Round taper type.

Battery maximum allowed size: 267 mm (10-1/2 in) long x 172 mm (6-3/4 in) wide x 238 mm (9-3/8 in) high.

BRP reserves the right to make changes in design and specifications and/or to make additions to, or improvements in its products without imposing any obligation upon itself to install them on its products previously manufactured.

# SI\* METRIC INFORMATION

BASE UNITS			
DESCRIPTION	UNIT	SYMBOL	
length .....	meter .....	m	
mass .....	kilogram .....	kg	
force .....	newton .....	N	
liquid .....	liter .....	L	
temperature .....	Celsius .....	°C	
pressure .....	kilopascal.....	kPa	
torque .....	newton-meter .....	N•m	
land velocity .....	kilometer per hour.....	km/h	
navigation velocity.....	knot .....	kn	

PREFIXES			
PREFIX	SYMBOL	MEANING	VALUE
kilo .....	k .....	one thousand .....	1000
centi .....	c .....	one hundredth of .....	0.01
milli.....	m .....	one thousandth of.....	0.001
micro .....	μ .....	one millionth of .....	0.000001

CONVERSION FACTORS			
TO CONVERT	TO ①	MULTIPLY BY	
in .....	mm.....	25.4	
in .....	cm.....	2.54	
in <sup>2</sup> .....	cm <sup>2</sup> .....	6.45	
in <sup>3</sup> .....	cm <sup>3</sup> .....	16.39	
ft .....	m.....	0.3	
oz .....	g.....	28.35	
lb .....	kg .....	0.45	
lbf.....	N .....	4.4	
<b>lbf•in</b> .....	<b>N•m</b> .....	0.11	
<b>lbf•ft</b> .....	<b>N•m</b> .....	1.36	
<b>lbf•ft</b> .....	<b>lbf•in</b> .....	12	
PSI .....	kPa .....	6.89	
imp. oz .....	U.S. oz.....	0.96	
imp. oz .....	mL.....	28.41	
imp. gal .....	U.S. gal.....	1.2	
imp. gal .....	L .....	4.55	
U.S. oz.....	mL.....	29.57	
U.S. gal.....	L .....	3.79	
knot.....	MPH .....	1.15	
MPH.....	km/h .....	1.61	
Fahrenheit.....	Celsius .....	(°F - 32) ÷ 1.8	
Celsius .....	Fahrenheit .....	(°C x 1.8) + 32	
hp.....	kW.....	.75	

\* The international system of units abbreviates SI in all languages.

① To obtain the reverse sequence, divide by the given factor. Example: to convert millimeters to inches, divide by 25.4.

NOTE: Conversion factors are rounded off to 2 decimals for easier use.



# ***WARRANTY INFORMATION***

---

# **BRP LIMITED WARRANTY FOR MODEL YEAR 2005 SEA-DOO® SPORT BOATS SOLD IN THE UNITED STATES AND CANADA**

## **1. SCOPE**

BRP US Inc.\* ("BRP") warrants its new and unused Model Year 2005 Sea-Doo sport boats ("sport boat") sold by authorized BRP Dealers in the fifty United States and Canada ("Dealer") from defects in material and workmanship for the period and under the conditions below. If your sport boat comes equipped with a Rotax™ engine, the Rotax engine is also covered by this *Limited Warranty* under the terms hereof. If your sport boat came equipped with another engine, that engine is covered by the limited warranty issued by the manufacturer of that engine and is not covered by this *Limited Warranty*.

## **2. WARRANTY COVERAGE DURATION**

This limited warranty will be in effect from the date of delivery to the first retail consumer or the date the sport boat is first put to use, whichever occurs first, for a period of:

- TWELVE (12) CONSECUTIVE MONTHS for private, recreational use, except that the deck and hull fiberglass structure are covered for SIXTY (60) CONSECUTIVE MONTHS;
- FOUR (4) CONSECUTIVE MONTHS for commercial use, except that the deck and hull fiberglass structure is covered for TWELVE (12) CONSECUTIVE MONTHS. A sport boat is used commercially when it is used in connection with generating income or any work or employment during any part of the warranty period. A sport boat is also used commercially when, at any point during the warranty period, it has commercial tags or is licensed for commercial use.

The emission-related components included in the chart below, that are installed on EPA certified Sea-Doo sport boats (see list below) registered in the USA are covered for TWENTY-FOUR (24) CONSECUTIVE MONTHS OR 200 HOURS OF ENGINE USE, whichever occurs first. If the 200 hours of engine use are reached during the regular warranty coverage period, the emission-related components are still covered by BRP's standard warranty until the end of regular coverage period.

The EPA certified 2005 Sea-Doo sport boats are those equipped with: 947 DI engines, 4-TEC® engines, 4-TEC SC engines and 4-TEC IC engines.

Emission-related components:

- Throttle Position Sensor (TPS)
- Air Temperature Sensor (ATS)
- Air Pressure Sensor (APS)

For sport boats with Rotax engine(s) produced by BRP for sale in California that are originally sold in California to a California resident or subsequently warranty registered to a California resident, please also refer to *BRP's California Emission Control Warranty Statement*.

All genuine sport boat accessories installed by an authorized BRP Dealer at the time of delivery carry the same warranty as the sport boat. The repair or replacement of parts or the performance of service to a sport boat under this warranty does not extend the life of this limited warranty beyond its original expiration date.

### **3. CONDITIONS TO HAVE WARRANTY COVERAGE**

This warranty coverage is available only after the purchaser and Dealer have: (i) completed and documented the BRP specified predelivery inspection process; and (ii) properly registered the sport boat. Only the original purchaser and any subsequent owners who reside in the United States or Canada and have purchased the sport boat from a U.S. or Canadian Dealer are eligible for warranty coverage hereunder. Such limitations are necessary in order to allow BRP to protect the safety of its products, consumers, and the general public. As outlined in the Operator's Guide, timely required maintenance must be performed to maintain warranty coverage. BRP may require proof of proper maintenance prior to authorizing warranty coverage.

### **4. WHAT TO DO TO OBTAIN WARRANTY COVERAGE**

The owner must notify an authorized BRP Dealer within two (2) days of the appearance of the defect and must promptly bring the sport boat, including any defective part, to Dealer (in any event, within the warranty period) and must provide Dealer with reasonable opportunity to repair the defect. If the sport boat has not previously been registered, the owner may also be required to present proof of purchase to Dealer for warranty repairs. Owner is required to sign the repair/work order prior to the start of the repair in order to validate the warranty repair. All parts replaced under this warranty become the property of BRP.

### **5. WHAT BRP WILL DO**

BRP's obligations under this warranty are limited to, at its sole discretion, repairing or replacing parts of the sport boat found to be defective in material or workmanship, in the reasonable judgement of BRP. Such repair or replacement of parts will be done without charge for parts and labor, at any authorized BRP Dealer. BRP's responsibility is limited to making the required repairs or replacements of parts with genuine BRP parts. The expenses of transporting the sport boat to and from Dealer for warranty service are to be borne by the owner. No claim of breach of warranty shall be cause for cancellation or rescission of the sale of the sport boat to owner. In the event that warranty service is required outside of the fifty United States or Canada, owner will bear responsibility for any additional charges due to local practices and conditions, such as, but not limited to, freight, insurance, taxes, license fees, import duties, and any and all other financial charges, including those levied by governments, states, territories and their respective agencies. BRP reserves the right to improve, modify or change its sport boats from time to time without assuming any obligation to modify sport boats previously manufactured.

### **6. EXCLUSIONS**

**The following are not warranted under any circumstances:**

- Replacement of parts due to normal wear and tear;
- Routine maintenance parts and services, including but not limited to adjustments, oil, lubricant and coolant changes, spark plug replacement, water pumps and the like;

- Damage caused by improper or lack of maintenance or storage, or failure to follow the procedures and recommendations in the *Operator's Guide*;
- Damage resulting from removal of parts, improper repairs, service, maintenance, or modification, or use of parts or accessories not manufactured or approved by BRP, which in its reasonable judgement, are either incompatible with sport boats or adversely affect its operation, performance, or durability, or resulting from repairs done by a person that is not an authorized BRP Dealer;
- Damage caused by abuse, misuse, abnormal use, neglect, racing, improper operation or operation of the sport boat in a manner inconsistent with the recommended operation described in the *Operator's Guide*;
- Damages resulting from external damage, submersion, water or foreign object ingestion, accident, fire, theft, vandalism or any act of God;
- Operation with fuel, oils or lubricants that are not suitable for the sport boat (see *Operator's Guide*);
- Damage from rust, corrosion or exposure to the elements;
- Damage from cooling system or jet pump blockage by foreign material;
- Damage to gel coat finish including but not limited to cosmetic gel coat finish defects, blisters, starring, crazing; and fiberglass delamination caused by blisters, crazing, spyder or hairline cracks or exposure to the elements.

**This warranty will be voided in its entirety and rendered null and void where:**

- The sport boat has been altered or modified in such a way so as to adversely affect its operation, performance or durability, or has been altered or modified to change its intended use; or
- The sport boat is or has been used for racing at any point, even by a prior owner.

## **7. LIMITATIONS OF LIABILITY**

**ALL WARRANTIES, EXPRESSED OR IMPLIED, INCLUDING WITHOUT LIMITATION ANY WARRANTY OF MERCHANTABILITY OR FITNESS FOR A PARTICULAR PURPOSE ARE LIMITED IN DURATION TO THE LIFE OF THE EXPRESS LIMITED WARRANTY. ALL INCIDENTAL, CONSEQUENTIAL, DIRECT, INDIRECT OR OTHER DAMAGES OF ANY KIND ARE EXCLUDED FROM COVERAGE UNDER THIS WARRANTY INCLUDING, BUT NOT LIMITED TO: expense for gasoline, expense for transporting sport boat to and from Dealer, mechanic's travel time, in and out of water charges, slip or dock fees, trailering or towing, storage, telephone, cell phone, fax or telegram charges, rental of a like or replacement boat during warranty services or down time, taxi, travel, lodging, loss of or damage to personal property, inconvenience, cost of insurance coverage, loan payments, loss of time, loss of income, revenue or profits, or loss of enjoyment or use of sport boat. SOME STATES, PROVINCES, OR JURISDICTIONS DO NOT ALLOW FOR THE DISCLAIMERS, LIMITATIONS OF INCIDENTAL OR CONSEQUENTIAL DAMAGES, OR OTHER EXCLUSIONS IDENTIFIED ABOVE. AS A RESULT, THEY MAY NOT APPLY TO YOU. THIS WARRANTY GIVES YOU SPECIFIC RIGHTS, AND YOU MAY ALSO HAVE OTHER LEGAL RIGHTS WHICH MAY VARY FROM STATE TO STATE, OR PROVINCE TO PROVINCE.**

No distributor, Dealer or any other person is authorized to make any affirmation, representation or warranty regarding a sport boat other than those contained in this limited warranty and, if made, shall not be enforceable against BRP. BRP reserves the right to modify this warranty at any time, although such modification will not alter the warranty conditions applicable to the sport boats sold while this warranty was in effect.

### **8. TRANSFER**

If the ownership of a product is transferred during the warranty coverage period, this warranty shall also be transferred and be valid for the remaining coverage period provided that BRP is notified of such transfer of ownership in the following way:

- a) The former owner contacts BRP (at the phone number provided below) or an authorized BRP Dealer and gives the coordinates of the new owner; or
- b) BRP or an authorized BRP Dealer receives a proof that the former owner agreed to the transfer of ownership, in addition to the coordinates of the new owner.

### **9. CONSUMER ASSISTANCE**

- a) In the event of a controversy or a dispute in connection with this limited warranty, BRP suggests that you try to resolve the issue at the dealership level. We recommend discussing the issue with the authorized BRP Dealer's service manager or owner.
- b) If the issue has not yet been resolved, please submit your complaint in writing or call the appropriate number below:

**In Canada:**

**BOMBARDIER  
RECREATIONAL PRODUCTS INC.  
SEA-DOO  
CONSUMER SERVICES GROUP  
VALCOURT QC J0E 2L0  
Tel: (819) 566-3366**

**In USA:**

**BRP US Inc.  
SEA-DOO  
CONSUMER SERVICES GROUP  
7575 BOMBARDIER COURT  
WAUSAU WI 54401  
Tel: (715) 848-4957**

\* In Canada, products are distributed and serviced by Bombardier Recreational Products Inc.

© 2004 Bombardier Recreational Products Inc. All rights reserved.

® Registered trademark of Bombardier Recreational Products Inc. or its subsidiaries.

---

# **CALIFORNIA EMISSION CONTROL WARRANTY STATEMENT FOR MODEL YEAR 2005 SEA-DOO® SPORT BOATS EQUIPPED WITH A ROTAX™ ENGINE(S)**

If your Sea-Doo sport boat has an engine other than a Rotax engine, the warranty issued by that engine manufacturer will apply.

Your Model Year 2005 Sea-Doo sport boat ("sport boat") equipped with a Rotax engine(s) has a special environmental label required by the California Air Resources Board. The label has 1, 2, 3 or 4 stars. A hangtag, provided with your Sport Boat, describes the meaning of the star rating system.

## **The Star Label Means Cleaner Marine Engines**

The Symbol for Cleaner Marine Engines:



F18L3CQ

### **Cleaner Air and Water**

For a healthier lifestyle and environment.

### **Better Fuel Economy**

Burns up to 30 - 40 percent less gas and oil than conventional carbureted two-stroke engines, saving money and resources.

### **Longer Emission Warranty**

Protects consumer for worry free operation.

### **One Star - Low Emission**

The one-star label identifies personal watercraft, outboard, sterndrive and inboard engines that meet the Air Resources Board's Personal Watercraft and Outboard marine engine 2001 exhaust emission standards. Engines meeting these standards have 75% lower emissions than conventional carbureted two-stroke engines. These engines are equivalent to the U.S. EPA's 2006 standards for marine engines.

### **Two Stars - Very Low Emission**

The two-star label identifies personal watercraft, outboard, sterndrive and inboard engines that meet the Air Resources Board's Personal Watercraft and Outboard marine engine 2005 exhaust emission standards. Engines meeting these standards have 20% lower emissions than One Star - Low-Emission engines.

### **Three Stars - Ultra Low Emission**

The three-star label identifies engines that meet the Air Resources Board's Personal Watercraft and Outboard marine engine 2008 exhaust emission standards or the Sterndrive and Inboard marine engine 2003 exhaust emission standards. Engines meeting these standards have 65% lower emissions than One Star - Low Emission engines.

### **Four Stars - Super Ultra Low Emission**

The four-star label identifies engines that meet the Air Resources Board's Sterndrive and Inboard marine engine 2009 exhaust emission standards. Personal Watercraft and Outboard marine engines may also comply with these standards. Engines meeting these standards have 90% lower emissions than One Star - Low Emission engines.

**For more information: Cleaner Watercraft - Get the Facts**  
**1 800 END-SMOG**  
**[www.arb.ca.gov](http://www.arb.ca.gov)**

## **Your Emission Control Warranty Rights and Obligations**

The California Air Resources Board and BRP US Inc. ("BRP") are pleased to explain the emission control system warranty on your Model Year 2005 Sea-Doo Sport boat equipped with a Rotax engine(s). In California, new sport boat engines must be designed, built and equipped to meet the State's stringent anti-smog standards. BRP must warrant the emission control system on your sport boat engine for the periods of time listed below provided there has been no abuse, neglect or improper maintenance of your sport boat engine.

Your emission control system may include parts such as the fuel injection system, the ignition system and catalytic converter. Also included may be hoses, belts, connectors and other emission related assemblies.

Where a warrantable condition exists, BRP will repair your sport boat's Rotax engine at no cost to you, including diagnosis, parts and labor, provided that such work is performed by an authorized BRP Dealer.

## **Manufacturer's Limited Warranty Coverage**

This emission limited warranty covers Model Year 2005 Sea-Doo sport boats equipped with a Rotax engine(s) certified and produced by BRP for sale in California, that are originally sold in California to a California resident or subsequently warranty registered to a California resident. The BRP limited warranty conditions for Sea-Doo sport boats are still applicable to these models with the necessary modifications.

Select emission control parts of your 2005 Sea-Doo sport boat equipped with Rotax engines(s) are warranted from the date of delivery to the first retail consumer for a period of 4 years, or for 250 hours of use, whichever occurs first. However, warranty coverage based on the hourly period is only permitted for sport boat equipped with the appropriate hour meters or their equivalent. If any emission-related part on your engine is defective under warranty, the part will be repaired or replaced by BRP.

**Parts covered for a Model Year 2005 Sea-Doo sport boat equipped with 947 DI engines:**

Air Lines	Exhaust Manifold
Fuel Rail	Coolant Temp. Sensor
Rave Valve	Throttle Position Sensors
Reed Valve	Ignition Coil
Tuned Pipe	Manifold Temp. Sensor
High-Tension Ignition Wires	Manifold Air Press. Sensor
Electrical Harness	Crankshaft Posit. Sensor
Throttle Bodies	Air Pressure Regulator
Exhaust Hoses	Fuel Pressure Regulator
Fuel Lines	Fuel Injectors
Water Regulator	Electronic Control Module
Air Compressor	Fuel Pump
Cylinder Head	Air Injector
Detonation/Knock Sensor	Spark Plugs
Intake Manifold	All emission component related gaskets; Head, Base, Exhaust

**Parts covered for a Model Year 2005 Sea-Doo sport boat equipped with 4-TEC® engines, 4-TEC SC engines and 4-TEC IC engines:**

Digital Linear Actuator (low idle control)	All Fuel System Components
Throttle Position Sensor	Spark Plugs
Intake Manifold Air Pressure Sensor	Ignition Coils
Intake Manifold Air Temperature Sensor	Piston and Rings
Engine Temperature Sensor	Intake and Exhaust Valve Gear/Train
Knock Sensor	Valves, Valve Guides and Valve Guide Sealing
Emission Control Unit	Crankcase Ventilation Valve
Injectors	Wire Harness and Connectors
Fuel Pressure Regulator	Emission Related Seals, Gaskets and Hoses
Intake Manifold	Exhaust Manifold



The emission warranty covers damage to other engine components that is caused by the failure of a warranted part.

The BRP *Operator's Guide* provided contains written instructions for the proper maintenance and use of your sport boat. All emission warranty parts are warranted by BRP for the entire warranty period of the sport boat, unless the part is scheduled for replacement as required maintenance in the *Operator's Guide*.

Emission warranty parts that are scheduled for replacement, as required maintenance, are warranted by BRP for the period of time before the first scheduled replacement date for that part. Emission warranty parts that are scheduled for regular inspection, but not regular replacement, are warranted by BRP for the entire warranty period of the sport boat. Any emission warranty part repaired or replaced under the terms of this warranty statement is warranted by BRP for the remainder of the warranty period of the original part. All parts replaced under this limited warranty become the property of BRP.

Maintenance receipts and records should be transferred to each subsequent owner of the sport boat.

## **Owner's Warranty Responsibilities**

As the owner of a Sea-Doo sport boat equipped with a Rotax engine(s), you are responsible for the performance of the required maintenance listed in your *Operator's Guide*. BRP recommends that you retain all receipts covering maintenance on your Rotax engine, but BRP cannot deny warranty solely for the lack of receipts or your failure to ensure the performance of all scheduled maintenance.

As the owner of a Sea-Doo sport boat equipped with a Rotax engine(s), you should however be aware that BRP may deny you warranty coverage if your Rotax engine(s) or a part has failed due to abuse, neglect, improper maintenance or unapproved modifications.

You are responsible for presenting your Rotax engine to an authorized BRP Dealer as soon as a problem exists. The warranty repairs will be completed in a reasonable amount of time, not to exceed 30 days.

If you have any questions regarding your warranty rights and responsibilities or for the name and location of the nearest authorized BRP Dealer you should contact the Customer Assistance Center at 1 (715) 848-4957.

---

# **BRP INTERNATIONAL LIMITED WARRANTY FOR MODEL YEAR 2005 SEA-DOO® SPORT BOATS**

## **1. SCOPE**

BRP US Inc. ("BRP")\* warrants its new and unused Model Year 2005 Sea-Doo sport boats ("Sport Boat") sold by authorized BRP Distributors/Dealers outside of the fifty United States and Canada ("Distributor/Dealer") will be free from defects in material and workmanship for the period and under the conditions below. If your Sport Boat comes equipped with a Rotax™ engine, the Rotax engine is also covered by this limited warranty under the terms hereof. If your Sport Boat came equipped with another engine, that engine is covered by the *Limited Warranty* issued by the manufacturer of that engine and is not covered by this *Limited Warranty*.

## **2. WARRANTY COVERAGE DURATION**

This limited warranty will be in effect from the date of delivery to the first retail consumer or the date the Sport Boat is first put to use, whichever occurs first, for a period of:

- TWELVE (12) CONSECUTIVE MONTHS for private, recreational use, except that the deck and hull fiberglass structure are covered for SIXTY (60) CONSECUTIVE MONTHS;
- FOUR (4) CONSECUTIVE MONTHS for commercial use, except that the deck and hull fiberglass structure is covered for TWELVE (12) CONSECUTIVE MONTHS. A Sport Boat is used commercially when it is used in connection with generating income or any work or employment during any part of the warranty period. A Sport Boat is also used commercially when, at any point during the warranty period, it has commercial tags or is licensed for commercial use.

All genuine Sport Boat accessories installed by an authorized BRP Distributor/Dealer at the time of delivery carry the same warranty as the Sport Boat. The repair or replacement of parts or the performance of service to a Sport Boat under this warranty does not extend the life of this limited warranty beyond its original expiration date.

## **3. CONDITIONS TO HAVE WARRANTY COVERAGE**

This warranty coverage is available only in the country in which the sale occurred and only after the purchaser and Distributor/Dealer have: (i) completed and documented the BRP specified predelivery inspection process; and (ii) properly registered the Sport Boat. Only the original purchaser and any subsequent owners who reside in the country where the sale occurred are eligible for warranty coverage hereunder. Such limitations are necessary in order to allow BRP to protect the safety of its products, consumers, and the general public. As outlined in the *Operator's Guide*, timely required maintenance must be performed to maintain warranty coverage. BRP may require proof of proper maintenance prior to authorizing warranty coverage.

#### **4. WHAT TO DO TO OBTAIN WARRANTY COVERAGE**

The owner must notify an authorized BRP Distributor/Dealer within two (2) days of the appearance of the defect and must promptly bring the Sport Boat, including any defective part, to Distributor/Dealer (in any event, within the warranty period) and must provide Distributor/Dealer with reasonable opportunity to repair the defect. If the Sport Boat has not previously been registered, the owner may also be required to present proof of purchase to Distributor/Dealer for warranty repairs. Owner is required to sign the repair/work order prior to the start of the repair in order to validate the warranty repair. All parts replaced under this warranty become the property of BRP.

#### **5. WHAT BRP WILL DO**

BRP's obligations under this warranty are limited to, at BRP's sole discretion, repairing or replacing parts of the Sport Boat found to be defective in material or workmanship, in the reasonable judgment of BRP. Such repair or replacement of parts will be done without charge for parts and labor, at any authorized BRP Distributor/Dealer in the country where the Sport Boat was sold. BRP's responsibility is limited to making the required repairs or replacements of parts with genuine BRP parts. The expenses of transporting the Sport Boat to and from Distributor/Dealer for warranty service are to be borne by the owner. No claim of breach of warranty shall be cause for cancellation or rescission of the sale of the Sport Boat to owner. In the event that warranty service is required outside of the country where the Sport Boat was purchased, owner will bear responsibility for any additional charges due to local practices and conditions, such as, but not limited to, freight, insurance, taxes, license fees, import duties, and any and all other financial charges, including those levied by governments, states, territories and their respective agencies. BRP reserves the right to improve, modify or change its Sport Boats from time to time without assuming any obligation to modify Sport Boats previously manufactured.

#### **6. EXCLUSIONS**

**The following are not warranted under any circumstances:**

- Replacement of parts due to normal wear and tear;
- Routine maintenance parts and services, including but not limited to adjustments, oil, lubricant and coolant changes, spark plug replacement, water pumps and the like;
- Damage caused by improper or lack of maintenance or storage, or failure to follow the procedures and recommendations in the *Operator's Guide*;
- Damage resulting from removal of parts, improper repairs, service, maintenance, or modification, or use of parts or accessories not manufactured or approved by BRP, which in its reasonable judgement, are either incompatible with Sport Boats or adversely affect its operation, performance, or durability, or resulting from repairs done by a person that is not an authorized BRP Distributor/Dealer;
- Damage caused by abuse, misuse, abnormal use, neglect, racing, improper operation or operation of the Sport Boat in a manner inconsistent with the recommended operation described in the *Operator's Guide*;
- Damages resulting from external damage, submersion, water or foreign object ingestion, accident, fire, theft, vandalism or any act of God;

- Operation with fuel, oils or lubricants that are not suitable for the Sport Boat (see *Operator's Guide*);
- Damage from rust, corrosion or exposure to the elements;
- Damage from cooling system or jet pump blockage by foreign material;
- Damage to gel coat finish including but not limited to cosmetic gel coat finish defects, blisters, starring, crazing; and fiberglass delamination caused by blisters, crazing, splyder or hairline cracks or exposure to the elements.

**This warranty will be voided in its entirety and rendered null and void where:**

- The Sport Boat has been altered or modified in such a way so as to adversely affect its operation, performance or durability, or has been altered or modified to change its intended use; or
- The Sport Boat is or has been used for racing at any point, even by a prior owner.

## **7. LIMITATIONS OF LIABILITY**

ALL WARRANTIES, EXPRESSED OR IMPLIED, INCLUDING WITHOUT LIMITATION ANY WARRANTY OF MERCHANTABILITY OR FITNESS FOR A PARTICULAR PURPOSE ARE LIMITED IN DURATION TO THE LIFE OF THE EXPRESS LIMITED WARRANTY. ALL INCIDENTAL, CONSEQUENTIAL, DIRECT, INDIRECT OR OTHER DAMAGES OF ANY KIND ARE EXCLUDED FROM COVERAGE UNDER THIS WARRANTY INCLUDING, BUT NOT LIMITED TO: expense for gasoline, expense for transporting Sport Boat to and from Distributor/Dealer, mechanic's travel time, in-and-out of water charges, slip or dock fees, trailering or towing, storage, telephone, cell phone, fax or telegram charges, rental of a like or replacement boat during warranty services or down time, taxi, travel, lodging, loss of or damage to personal property, inconvenience, cost of insurance coverage, loan payments, loss of time, loss of income, revenue or profits, or loss of enjoyment or use of Sport Boat. **SOME JURISDICTIONS DO NOT ALLOW FOR THE DISCLAIMERS, LIMITATIONS OF INCIDENTAL OR CONSEQUENTIAL DAMAGES, OR OTHER EXCLUSIONS IDENTIFIED ABOVE. AS A RESULT, THEY MAY NOT APPLY TO YOU. THIS WARRANTY GIVES YOU SPECIFIC RIGHTS, AND YOU MAY ALSO HAVE OTHER LEGAL RIGHTS WHICH MAY VARY WITH THE JURISDICTION.**

No Distributor/Dealer or any other person is authorized to make any affirmation, representation or warranty regarding a Sport Boat other than those contained in this limited warranty and, if made, shall not be enforceable against BRP. BRP reserves the right to modify this warranty at any time, although such modification will not alter the warranty conditions applicable to Sport Boats sold while this warranty was in effect.

## **8. TRANSFER**

If the ownership of a product is transferred during the warranty coverage period, this warranty shall also be transferred and be valid for the remaining coverage period provided that BRP is notified of such transfer of ownership in the following way:

- a) The former owner contacts BRP (at the phone number provided below) or an authorized BRP Distributor/Dealer and gives the coordinates of the new owner; or
- b) BRP or an authorized BRP Distributor/Dealer receives a proof that the former owner agreed to the transfer of ownership, in addition to the coordinates of the new owner.

## **9. CONSUMER ASSISTANCE**

- a) In the event of a controversy or a dispute in connection with this limited warranty, BRP suggests that you try to resolve the issue at the dealership level. We recommend discussing the issue with the authorized distributor/dealer's service manager or owner.
- b) If further assistance is required, the distributor's service department should be contacted in order to resolve the matter.
- c) If the matter still remains unresolved then contact BRP by writing to us at the address listed below.

### **BOMBARDIER RECREATIONAL PRODUCTS INC.**

SEA-DOO  
CONSUMER SERVICES GROUP  
VALCOURT QC JOE 2L0  
Tel: 01 819-566-3366

\* For the territory covered by this limited warranty, products are distributed and serviced by Bombardier Recreational Products Inc. or its affiliates.

© 2004 Bombardier Recreational Products Inc. All rights reserved.

® Registered trademark of Bombardier Recreational Products Inc. or its affiliates.

---

## WEB SITES

### Bombardier Sea-Doo Website: [www.sea-doo.com](http://www.sea-doo.com)

Canadian Coast Guard	<a href="http://www.ccg-gcc.gc.ca/">www.ccg-gcc.gc.ca/</a>
United States Coast Guard	<a href="http://www.uscgboating.org/regulations/boating_laws.htm">www.uscgboating.org/regulations/boating_laws.htm</a>
Alabama	<a href="http://www.boat-ed.com">www.boat-ed.com</a>
Alaska	<a href="http://www.dnr.state.ak.us/parks/boating">www.dnr.state.ak.us/parks/boating</a>
Arizona	<a href="http://www.azgfd.com">www.azgfd.com</a>
Arkansas	<a href="http://www.boat-ed.com">www.boat-ed.com</a>
California	<a href="http://www.dbw.ca.gov">www.dbw.ca.gov</a>
Colorado	<a href="http://parks.state.co.us/boating/">http://parks.state.co.us/boating/</a>
Connecticut	<a href="http://dep.state.ct.us/rec/prgactiv.htm">http://dep.state.ct.us/rec/prgactiv.htm</a>
Delaware	<a href="http://www.boat-ed.com">www.boat-ed.com</a>
Florida (freshwater)	<a href="http://www.boat-ed.com">www.boat-ed.com</a>
Florida (saltwater)	<a href="http://www.boat-ed.com">www.boat-ed.com</a>
Georgia	<a href="http://www.boat-ed.com">www.boat-ed.com</a>
Hawaii	<a href="http://www.hawaii.gov/dlnr/dbor/dbor">www.hawaii.gov/dlnr/dbor/dbor</a>
Idaho	<a href="http://www.boat-ed.com">www.boat-ed.com</a>
Illinois	<a href="http://dnr.state.il.us/">http://dnr.state.il.us/</a>
Indiana	<a href="http://www.boat-ed.com">www.boat-ed.com</a>
Iowa	<a href="http://www.boat-ed.com">www.boat-ed.com</a>
Kansas	<a href="http://www.boat-ed.com">www.boat-ed.com</a>
Kentucky	<a href="http://www.boat-ed.com">www.boat-ed.com</a>
Louisiana	<a href="http://www.boat-ed.com">www.boat-ed.com</a>
Maine	<a href="http://www.state.me.us/">www.state.me.us/</a>
Maryland	<a href="http://www.dnr.state.md.us/boating">www.dnr.state.md.us/boating</a>
Massachusetts	<a href="http://www.boat-ed.com">www.boat-ed.com</a>
Michigan	<a href="http://www.michigan.gov/dnr">www.michigan.gov/dnr</a>
Minnesota	<a href="http://www.boat-ed.com">www.boat-ed.com</a>
Mississippi	<a href="http://www.boat-ed.com">www.boat-ed.com</a>
Missouri	<a href="http://www.boat-ed.com">www.boat-ed.com</a>
Montana	<a href="http://www.fwp.state.mt.us/education/outdoorskills.asp">www.fwp.state.mt.us/education/outdoorskills.asp</a>

Nebraska	<a href="http://www.ngpc.state.ne.us/boating">www.ngpc.state.ne.us/boating</a>
Nevada	<a href="http://www.boat-ed.com">www.boat-ed.com</a>
New Hampshire	<a href="http://www.boat-ed.com">www.boat-ed.com</a>
New Jersey	<a href="http://www.state.nj.us/mvs/boats.htm">www.state.nj.us/mvs/boats.htm</a>
New Mexico	<a href="http://www.emnrd.state.nm.us/nmparks/pages/boating/boating.htm">www.emnrd.state.nm.us/nmparks/pages/boating/boating.htm</a>
New York	<a href="http://www.nysparks.com">www.nysparks.com</a>
North Carolina	<a href="http://www.boat-ed.com">www.boat-ed.com</a>
North Dakota	<a href="http://www.state.nd.us/gnf/boating/">http://www.state.nd.us/gnf/boating/</a>
Ohio	<a href="http://www.boat-ed.com">www.boat-ed.com</a>
Oklahoma	<a href="http://www.boat-ed.com">www.boat-ed.com</a>
Oregon	<a href="http://www.boat-ed.com">www.boat-ed.com</a>
Pennsylvania	<a href="http://www.boat-ed.com">www.boat-ed.com</a>
Rhode Island	<a href="http://www.boat-ed.com">www.boat-ed.com</a>
South Carolina	<a href="http://www.boat-ed.com">www.boat-ed.com</a>
South Dakota	<a href="http://www.state.sd.us/gfp/divisionwildlife/boating/index.htm">www.state.sd.us/gfp/divisionwildlife/boating/index.htm</a>
Tennessee	<a href="http://www.boat-ed.com">www.boat-ed.com</a>
Texas	<a href="http://www.boat-ed.com">www.boat-ed.com</a>
Utah	<a href="http://www.boat-ed.com">www.boat-ed.com</a>
Vermont	<a href="http://www.boat-ed.com">www.boat-ed.com</a>
Virginia	<a href="http://www.boat-ed.com">www.boat-ed.com</a>
Washington	<a href="http://www.boat-ed.com">www.boat-ed.com</a>
West Virginia	<a href="http://www.dnr.state.wv.us/law/boating.htm">www.dnr.state.wv.us/law/boating.htm</a>
Wisconsin	<a href="http://www.dnr.state.wi.us/org/caer/cs/Registrations/Boats.htm">http://www.dnr.state.wi.us/org/caer/cs/Registrations/Boats.htm</a>
Wyoming	<a href="http://gf.state.wy.us">http://gf.state.wy.us</a>

NOTE: These web sites are for the information and education of the owner of this Sport Boat and are current as of June 2004. BRP makes no endorsement of or representation regarding these sites.

---

# LIST OF DISTRIBUTORS

## NORTH AMERICA

<b>USA</b> (Except Puerto Rico)	<b>BRP US INC.</b> 7575, Bombardier Court P.O. Box 8035 WAUSAU, WI. 54401 Phone: (715) 848-4957 Fax: (715) 847-6879 <a href="http://www.brp.com">http://www.brp.com</a>
<b>CANADA</b> Alberta British Columbia Manitoba North West Territories Ontario Quebec Saskatchewan Yukon New-Brunswick Nova Scotia Prince Edward Island Nunavut Newfoundland	<b>BOMBARDIER</b> <b>RECREATIONAL PRODUCTS INC.</b> 75, J.A. BOMBARDIER ST. SHERBROOKE, QC J1L 1W3 Phone: (819) 566-3366 Fax: (819) 566-3062 <a href="http://www.brp.com">http://www.brp.com</a>

If your Sea-Doo sport boat requires warranty service, you must take it to any authorized Sea-Doo sport boat dealer. Be sure to bring your warranty registration card or other valid proof of the original date of purchase. If a question or problem arises regarding warranty, first contact the service manager or owner of the Sea-Doo sport boat dealership.

To find the nearest authorized Sea-Doo sport boat dealer, dial: 1 800 882-2900.

**NOTE:** If outside Canada and USA, consult the local distributor.





**DECLARATION CE OF CONFORMITY**

**DECLARATION  OF CONFORMITY**

Application of Council Directives: 94/25/CE — Recreational craft  
89/336/CEE — Electromagnetic compatibility

Standards to which conformity is declared: ISO 7840, ISO 8469, ISO 8665, ISO 8846,  
ISO 8848, ISO 8849, ISO 9094, ISO 9097,  
ISO 10087, ISO 10088, ISO 10133, ISO 10240,  
ISO 11105, ISO 11591, ISO 11592, ISO 12215,  
ISO 12216, ISO 13592, COLREGS, ABYC H-5,  
ABYC H-8

Manufacturer's name: BRP US Inc.

Manufacturer's address: 451 E. Illinois Ave  
Benton, Illinois  
62812-0394

Importer's name: Société ANF — Industrie S.A.

Importer's address: 2, rue du Nouveau Bercy  
94220 Charenton  
Paris, France

Notified body for Directive 94/25/CE: International Marine Certification Institute  
Trèves centre, rue de Trèves 45  
1040 Brussels, Belgium

Competent body for Directive 89/336/CEE: UTAC  
Autodrome de Linas-Monthéry, B.P. 212  
91311 Monthéry cedex, France

Type of equipment: Sport boats, inshore category C

Model names and numbers: \_\_\_\_\_  
Model name

\_\_\_\_\_

I, the undersigned, hereby declare that the equipment specified above conforms to the above Directives and Standards.

Name of signatory: Fernando Garcia

Title of signatory on behalf of BRP US Inc.: Director - Public and Regulatory Affairs —  
Sea-Doo sport boats

## Homologation and Certification

These boats comply with the following standards:

STANDARD	TYPE OF CERTIFICATION
United States Coast Guard	Self certification
Canadian Coast Guard	Self certification
Russian Maritime Register of Shipping	Certify by Russian Maritime Register of Shipping 8, Dvortsovaya Nab., 191186 St. Petersburg, Russia
Directive 89/336/CEE of the council relating to electromagnetic compatibility	Internal production control plus control carried out on the responsibility of a competent body.  Competent body: UTAC Autodrome de Linas-Montlhéry, B.P. 212 91311 Montlhéry cedex, France
Directive 94/25/EC of the European Parliament and of the council relating to recreational craft	Internal production control plus control carried out on the responsibility of a notified body.  Notified body: International Marine Certification Institute Trèves centre, rue de Trèves 45 1040 Brussels, Belgium

# Operator's Guide Confirmation of Receipt

Your dealer

Name:	_____
	_____
Address:	_____
	_____
	_____

Will assist you and help you to resolve any problems you may have.

Upon delivery of your boat, complete and sign the form hereunder and forward it to your dealer in order to be covered by our warranty.

Warranty conditions are as detailed in the WARRANTY SECTION of this guide.

----- Cut here

Receipt	
Name:	_____
Address:	_____
Owner of _____	Sport Boat model No. _____
HIN (to be completed by customer or selling dealer) _____	
This warranty begins _____ (date).	
The dealer named on this document has instructed me on the operation, maintenance, safety features and warranty policy, all of which I understand and agree to be bound with. I am also satisfied with the predelivery set-up and inspection of my Sea-Doo sport boat. I have also received a copy of the <i>Operator's Guide and Safety Videocassette</i> for my Sea-Doo sport boat.	
Signature: _____	
Date: _____	

---

## **PRIVACY INFORMATION**

We wish to inform you that your coordinates will be used for safety and warranty purposes. Sometimes, we also use the coordinates of our clients to inform them about our products and to present them offers. Should you prefer not to receive information on our products, services and offers, please let us know by writing to the address below.

Also note that, from time to time, carefully selected and trustworthy organizations may be permitted to use the coordinates of our clients to promote quality products and services. If you prefer not to have your name and address released, please let us know by writing to the address below:

### **Bombardier Recreational Products Inc.**

Warranty Department  
75 J.A. Bombardier Street  
Sherbrooke (Quebec) J1L 1W3  
Canada

Fax Number: (819) 566-3590





AFFIX  
PROPER  
POSTAGE

**BOMBARDIER  
RECREATIONAL PRODUCTS INC.**

WARRANTY DEPARTMENT  
75, J.A. BOMBARDIER ST.  
SHERBROOKE (QUEBEC)  
CANADA J1L 1W3

**BOAT MODEL No.** \_\_\_\_\_

**HULL**

IDENTIFICATION NUMBER (H.I.N.) \_\_\_\_\_

**MERCURY OR ROTAX ENGINE**

IDENTIFICATION NUMBER (E.I.N.) \_\_\_\_\_

**Owner:** \_\_\_\_\_

NAME

No.

STREET

APT

CITY

STATE/PROVINCE

ZIP/POSTAL CODE

**Purchase Date** \_\_\_\_\_

YEAR

MONTH

DAY

**Warranty Expiry Date** \_\_\_\_\_

YEAR

MONTH

DAY

To be completed by the dealer at the time of the sale.

DEALER IMPRINT AREA

**Please verify with your selling dealer to ensure your SEA-DOO sport boat has been registered with BRP.**

204 630 322

CA

OPERATOR'S GUIDE, CHALLENGER X / ENGLISH  
GUIDE DU CONDUCTEUR, CHALLENGER X / ANGLAIS

FAIT AU / MADE IN CANADA

U/M:P.C.