

SEA-DOO

Sport Boats

OPERATOR'S GUIDE



219 000 124

ISLANDIA

SAFETY WARNING

Disregarding any of the safety precautions and instructions contained in this *Operator's Guide*, the *Safety Handbook*, the *Safety Videocassette* and the on-product *Warning Labels* could cause injury, including the possibility of death. The operator has the responsibility to inform passenger(s) of safety precautions.

This *Operator's Guide*, the *Safety Handbook* and Videocassette should remain with the craft at the time of resale.

BOMBARDIER
RECREATIONAL PRODUCTS



Gelcote[†] is a trademark of Gelcote International
Knight's Spray-Nine[†] is a trademark of Korkay System Ltd

The following trademarks are the property of Bombardier Inc. and/or its subsidiaries:

SEA-DOO®
BOMBARDIER-ROTAX®
BOMBARDIER LUBE®
Sea-Doo Synthetic Grease

Doin'it on your new Sea-Doo Sport Boat

Congratulations, you are now the proud owner of a Sea-Doo sport boat. Whether you are an experienced boater or are new to the sport of boating, we ask you to take the time to view the *Videocassette* provided with the craft, to read this *Operator's Guide*, the *Safety Handbook* and on-product warning/caution labels and familiarize yourself with the contents. These manuals contain pertinent information which, if followed, will provide you with the necessary knowledge to help you fully enjoy the pleasures of this craft.

We strongly recommend that any craft operator complete a safety boating course. Check with your local Coast Guard or Power and Sail Squadron in your area for course availability. More serious boaters may want to obtain *Chapman Piloting* by Elbert S. Maloney, available at most book stores.

When introducing your family or friends to the sport, be sure they fully understand the controls and operation of the craft and the importance of courteous, responsible riding.

Each operator has a responsibility to ensure the safety of his/her passenger(s) and of other water users. Please follow all safety instructions and operate your craft with care.

We encourage you to have an Annual Safety Inspection of your craft. Please contact your authorized Sea-Doo dealer for further details.

Finally, we urge you to visit your authorized Sea-Doo dealer regularly for regular and safety maintenance as well as any craft accessories you may require.

Have fun and... Bon Voyage.

Please keep this guide and *Safety Handbook* on board. These manuals should remain with the craft at time of resale.

TABLE OF CONTENTS

FOREWORD	6
△ SAFETY MEASURES	7
General	7
Operation	7
Maintenance	8
LIST OF DISTRIBUTORS	9
BOMBARDIER LIMITED WARRANTY NORTH AMERICA: SEA-DOO® SPORT BOAT	10
BOMBARDIER INTERNATIONAL LIMITED WARRANTY: SEA-DOO® SPORT BOAT	12
REGISTRATION NUMBER LOCATION	14
LOCATION OF THE IMPORTANT LABELS	15
IDENTIFICATION NUMBERS	18
Hull	18
Engine	18
CONTROLS, COMPONENTS AND INSTRUMENTS LOCATION	19
Cockpit	19
Overview	20
Front View	21
Rear View	22
CONTROLS, COMPONENTS AND INSTRUMENT FUNCTIONS....	24
1) Safety Lanyard (engine cut-out switch)	24
2) Steering Wheel	24
3) Throttle Lever	24
4) Shift Lever	25
5) Ignition Switch	26
6) 12-Volts Accessory Jack	26
7) Navigation Light Switch	26
8) Docking Light Switch	27
9) Boarding Light Switch	27
10) Engine Compartment Light Switch	27
11) Bilge Pump Switch	27
12) Bilge Air Blower Switch	28
13) Horn Switch	28
14) Deck Light Switch	28
15) Low-Fuel Warning System Switch (if so equipped)	29
16) Low-Battery Warning System Switch	29
17) Fuel Gauge/Low Oil Level Pilot Lamp and Beeper	31
18) Fountain Pump Switch	31
19) Main Water Pump Switch	32

20) Tachometer.....	32
21) Speedometer.....	32
22) Windscreen.....	32
23) Grab Handle(s).....	33
24) Rear Grab Handle(s).....	33
25) Front/Rear Swim Platform.....	33
26) Sun Deck/Rear Seat/Engine Cover.....	33
27) Front Seat(s).....	34
28) Bow Seat(s).....	35
29) Cup Holders.....	36
30) Deck Storage Compartment.....	37
31) Rear Storage Compartment.....	37
32) Rear Side Storage Compartment.....	38
33) Glovebox.....	38
34) Bow and Stern Eyelet(s).....	38
35) Docking Lights.....	39
36) Boarding Lights.....	39
37) Engine Compartment Light.....	39
38) Navigation Lights.....	39
39) Removable Stern Light.....	40
40) Deck Lights.....	41
41) Changing Room Light.....	41
42) Deck.....	41
43) Footwell.....	41
44) Fountain Jet.....	42
45) Wash Down Valve.....	43
46) Table.....	44
47) Fuel Tank Cap.....	44
48) Fuel Tank Vent.....	45
49) Main Oil Reservoir Cap.....	46
50) Potable Water Tank Cap.....	46
51) Flushing Connector.....	47
52) Ventilation Ducts.....	47
53) Jet Pump Nozzle.....	47
54) Jet Pump Water Intake.....	47
55) Hydro Surge Grate System.....	47
56) Reverse Gate.....	47
57) Bilge Drain Plug(s).....	47
58) Retractable Ladder(s).....	48
59) Mooring Cleat(s).....	48
60) Convenience Center.....	49
61) Changing Room with Toilet.....	50
62) Portable Toilet.....	50
63) Fuses.....	51
64) Ski Post (if so equipped).....	51

65) Radio	52
66) Speaker(s)	53
67) Transom Doors	53
68) Fire Port	53
69) Shower	53
70) Water Bypass System	54
71) Main Battery Cut-Off Switch.....	55
72) Bimini Top (not shown)	55
FUEL, WATER AND LUBRICATION	56
Fueling Procedure.....	56
Recommended Fuel	56
Recommended Oil.....	56
Main Oil Reservoir Level	56
Engine Mounted Oil Reservoir Level.....	57
Potable Water Tank	57
BREAK-IN PERIOD	58
Engine.....	58
10-Hour Inspection	58
PRE-OPERATION CHECKS	59
Safety Lanyard and Ignition Switch	60
Hull	60
Jet Pump Water Intake.....	60
Inlet Grate.....	60
Bilge.....	60
Battery	60
Fuel Tank/Potable Water Tank/Oil Reservoir	60
Engine Compartment	60
Steering System	60
Throttle System.....	61
Shifter System.....	61
Storage Compartment Covers.....	61
OPERATING INSTRUCTIONS	62
Launching/Loading.....	62
Trailing	62
Principle of Operation	62
Boarding from a Dock.....	64
Boarding from the Water.....	65
Starting	65
Rough Water or Poor Visibility Operation	65
Crossing Waves.....	65
Stopping/Docking	66
Beaching.....	66
Shutting Off the Engine.....	66

POST-OPERATION CARE 67
 General Care..... 67
 Additional Care for Foul Water or Salt Water 67

SPECIAL PROCEDURE 68
 Engine Overheating..... 68
 Potable Water System Disinfection 68
 Jet Pump Water Intake and Impeller Cleaning..... 69
 Capsized Boat..... 69
 Submerged Boat 69
 Low-Charge Battery Condition 69

MAINTENANCE 70
 Lubrication..... 70
 Periodic Inspection 71
 Throttle Cable..... 71
 Fuel and Oil Filters..... 71
 Potable Water Filter..... 71
 Steering/Jet Pump Nozzle Adjustment 71
 Reverse Gate..... 71
 Deck Drain(s)..... 71
 Fuses..... 71
 Bilge Air Blower..... 72
 Navigation Light Bulb Replacement 72
 General Inspection and Cleaning..... 74

STORAGE AND PRE-SEASON PREPARATION 76
 Storage..... 76
 Pre-Season Preparation 77

PERIODIC INSPECTION CHART 78

SPECIFICATIONS 80

SI METRIC INFORMATION GUIDE..... 82

DECLARATION CE OF CONFORMITY..... 83
 Homologation and Certification 84
 Operator’s Guide
 Confirmation of Receipt 85

CHANGE OF ADDRESS..... 87

FOREWORD

The *Operator's Guide* and *Safety Handbook* have been prepared to acquaint the owner/operator or passenger with this personal craft and its various controls, maintenance and safe riding instructions. Each is indispensable for the proper use of the product, and should be kept in a waterproof bag with the craft at all times. Make sure you read and understand the content of each document.

For any questions pertaining to the warranty and its application, consult the WARRANTY section in this guide, and/or an authorized SEA-DOO dealer.

The information contained in this guide should always be used in conjunction with the information included in *Mercury Marine (M²) Jet Drive Operator's Guide*.

This guide uses the following symbols to emphasize particular information.



WARNING

Identifies an instruction which, if not followed, may cause serious personal injuries including the possibility of death.

CAUTION: Denotes an instruction which, if not followed, may damage the craft and/or components.

NOTE: Indicates supplementary information needed to fully complete an instruction.

Although the mere reading of such information does not eliminate the hazard, the understanding and application of the information will promote its correct use.

The information and components/system descriptions contained in this guide are correct at the time of publication. Bombardier Motor Corporation of America (B.M.C.A.) however, maintains a policy of continuous improvement of its products without imposing upon itself any obligation to install them on products previously manufactured.

Because of our ongoing commitment to product quality and innovation, Bombardier reserves the right at any time to discontinue or change specifications, designs, features, models or equipment without incurring obligation.

The illustrations in this document show the typical construction of the different assemblies and may not represent the full detail or exact shape of the parts. However, they represent parts that have the same or similar function.

It is understood that this guide may be translated into another language. In the event of any discrepancy, the English version shall prevail.

Specifications are given in the SI metric system with the SAE U.S. equivalent in parenthesis. Where precise accuracy is not required, some conversions are rounded off for easier use.

A *Sea-Doo Sport Boat Shop Manual* can be obtained for complete service, maintenance and more repair information.

⚠ SAFETY MEASURES

General

- ⚠ To fully appreciate the pleasures, enjoyment and excitement of boating there are some basic rules that should be observed and followed by any boater. Some rules may be new to you or covered in the PWC/Sport boat *Safety Handbook* and *Safety Video*, others may be common sense or obvious... irrespective, we ask that you please take a few minutes of your time to completely read these safety instructions before you operate your craft. Failure to follow this safety information and safe boating rules could result in injury, including the possibility of death to you, your passenger(s), or other water users.
- ⚠ Become completely familiar with the controls and operation of the craft before embarking on your first trip or taking on a passenger(s). If you have not had the opportunity to do so with your dealer, practice driving solo in a suitable area and feel the response of each control. Be fully familiar with all controls before applying the throttle above idle speed. As the operator, you are in control and are responsible for the craft's safe operation.

Operation

- ⚠ Always perform the pre-operation checks as specified in this guide.
- ⚠ Always keep in mind that directional control is reduced with decreasing speed and lost when engine is off. To turn the craft, both steering and throttle are necessary.
- ⚠ Like any other boats, this craft has no brake. Stopping distance will vary depending on initial speed, load, wind, and water conditions. Practice stopping and docking in a safe, traffic free area to have an idea of how long it will take to stop the craft under varying conditions. Do not release throttle when trying to steer away from objects. You need throttle to steer. Do not use the craft's reverse, if so equipped, to stop.
- ⚠ Ensure that all passengers know how to swim and how to reboard the craft from the water.
- ⚠ The operator and passenger(s) should be properly seated and wearing an approved PFD before starting or moving the craft and at all times when craft is in motion.
- ⚠ Do not start or operate the craft if a person(s) is seated on the sun deck or swim platform, or are nearby in the water.
- ⚠ The craft's jet thrust can cause injury. Always accelerate slowly.
- ⚠ To prevent accidental starting or unauthorized use, always detach the safety lanyard from the craft especially when swimmers are boarding or nearby, or during removal of any weeds or debris from the intake grate.

⚠ Riding with a passenger(s) or pulling other boats, tubes, skier or wakeboarder makes the craft handle differently and requires greater skill. Do not overload the craft or take on more passengers than designated for the particular craft. Overloading can affect maneuverability, stability and performance. Avoid adding on accessories, or equipment which may alter your control of the craft. The craft may be fitted with tow eyelets which can be used to attach a ski rope. However, do not use these eyelets or the craft's cleats to tow a parasail. Severe craft damage may occur.

⚠ In shallow water, proceed with caution and at very low speeds. Grounding or abrupt stops may result in injury. Debris may also be picked up and be thrown rearward by the jet pump onto people or property.

⚠ Respect no wake zones, the rights of other water users and the environment. As the "skipper" and owner of a boat you are responsible for damage to other boats caused by the wake of your craft. Allow no one to throw refuse overboard.

⚠ This craft is equipped with navigation lights which should be used between sunset and sunrise. Reduce speed and do not operate the craft in reduced visibility.

⚠ Remember, gasoline fumes are inflammable and explosive. Always adhere to the fueling procedure contained in this guide and those given to you by the marina. Always verify fuel level before use and during the ride. Apply the principle of 1/3 fuel to destination, 1/3 back and 1/3 reserve fuel supply. Do not carry spare fuel or inflammable liquids in any of the storage or engine compartments.

⚠ Combustion engine needs air to operate; consequently this craft can not be totally watertight. Any maneuvers such as figure eights etc., that cause the upper deck to be under water may cause severe engine problems due to water ingestion. Refer to SPECIAL PROCEDURES and Limited Warranty contained in this guide.

Maintenance

⚠ Only perform servicing procedures which are detailed in this guide. Further assistance or information can be obtained from your authorized Sea-Doo dealer. In many instances proper tools and training is required for certain servicing or repair procedures.

⚠ Maintain the craft and equipment in top condition at all times. Adhere to the prescribed maintenance schedules. An annual inspection of the craft is always a good recommendation that should be followed.

⚠ The bilge must be kept clean of oil, water or other foreign materials.

⚠ Do not attempt to lift the craft without special equipment and training.

⚠ The engine and the corresponding components identified in this guide should not be utilized on product(s) other than for those they were designed. Maintenance procedures and specified tightening torque must be strictly adhered to. Never attempt repairs unless the appropriate tools are available. These craft are designed with parts dimensioned in both the metric and the imperial systems. When replacing fasteners, make sure to use only those recommended by Bombardier. If required, contact your authorized Sea-Doo dealer for further servicing information.

⚠ Operate your craft prudently and have fun. Don't forget that all persons must assist other boaters in a case of emergency.

LIST OF DISTRIBUTORS

NORTH AMERICA

USA (Except Puerto Rico)	BOMBARDIER MOTOR CORPORATION OF AMERICA 7575, Bombardier Court P.O. Box 8035 WAUSAU, WI. 54401 (or for P.O. Box 54402) Phone: (715) 848-4957 Fax: (715) 847-6879 http://www.bombardier.com
CANADA Alberta British Columbia Manitoba North West Territories Ontario Quebec Saskatchewan Yukon New-Brunswick Nova Scotia Prince Edward Island Nunavut Newfoundland	BOMBARDIER INC. RECREATIONAL PRODUCT 75, J.A. BOMBARDIER ST. SHERBROOKE, QC J1L 1W3 Phone: (819) 566-3366 Fax: (819) 566-3062 http://www.bombardier.com

If your SEA-DOO Sport Boat requires warranty service, you should take it to any authorized SEA-DOO Sport Boat dealer. Be sure to bring your warranty registration card or other valid proof of the original date of purchase. If a question or problem arises regarding warranty, first contact the service manager or owner of the SEA-DOO Sport Boat dealership.

To find the nearest authorized Sea-Doo Sport Boat dealer, dial: 1-800-882-2900.

NOTE: If outside Canada and USA, consult the local authorized Sea-Doo distributor.

BOMBARDIER LIMITED WARRANTY NORTH AMERICA: SEA-DOO® SPORT BOAT

1. WARRANTY COVERAGE PERIOD

In Canada, BOMBARDIER INC. ("Bombardier"), and in the USA, Bombardier on behalf of BOMBARDIER MOTOR CORPORATION OF AMERICA (BMCA), warrants FROM THE DATE OF DELIVERY TO THE FIRST CONSUMER that each SEA-DOO SPORT BOAT sold, as NEW and UNUSED and PREDELIVERED by an authorized North American SEA-DOO SPORT BOAT dealer, will be free from any defects in material and/or workmanship for a PERIOD of:

a) For private use:

TWELVE (12) CONSECUTIVE MONTHS, with the exception of the deck and hull fiberglass structure; and

SIXTY (60) CONSECUTIVE MONTHS for the deck and hull fiberglass structure.

b) For commercial use:

FOUR (4) CONSECUTIVE MONTHS, with the exception of the deck and hull fiberglass structure; and

TWELVE (12) CONSECUTIVE MONTHS for the deck and hull fiberglass structure.

All genuine Bombardier accessories, installed by an authorized SEA-DOO SPORT BOAT dealer at the time of delivery of the new and non-current new SEA-DOO SPORT BOAT, carry the same Warranty Coverage Period as for the SEA-DOO SPORT BOAT.

2. WHAT BOMBARDIER WILL DO

BOMBARDIER will repair or replace, at its option, all genuine BOMBARDIER part found defective in material and/or workmanship, under normal use, maintenance and service, with a genuine BOMBARDIER part without charge for parts and labor, at any authorized SEA-DOO SPORT BOAT dealer during the Warranty Coverage Period.

3. CONDITION TO HAVE WARRANTY WORK VALIDATED

The customer must notify an authorized SEA-DOO SPORT BOAT dealer within two (2) days of the appearance of the defect in material and/or workmanship and present to the servicing authorized SEA-DOO SPORT BOAT dealer the SEA-DOO Warranty Registration Card or a proof of purchase of the NEW and UNUSED SEA-DOO SPORT BOAT and must sign the repair/work order prior to the start of the repair in order to validate a warranty repair. All parts replaced under this limited warranty become the property of BOMBARDIER.

4. EXCLUSIONS - ARE NOT WARRANTED

- The engine and corresponding components which are warranted by Mercury Marine.
- Refer to *M² Jet Drive Operator's Guide*.
- Normal wear and tear items;
- Labor, parts and lubricant costs of all maintenance services.
- Damages caused by failure to provide proper maintenance and/or storage, as described in the "*SEA-DOO SPORT BOAT Operator's Guide*";
- Damages resulting from improper repairs, modifications or use of non-approved parts or, repairs not performed by an authorized SEA-DOO SPORT BOAT dealer;
- Damages resulting from abuse, misuse, neglect, racing;
- Damages resulting from accident, fire, theft, vandalism or any act of God;
- Incidental or consequential damages, or damages of any kind such as but not limited to towing charges, telephone calls or taxi;
- Water damages caused by water ingestion;

- Damages related to gel coat finish including but not limited to cosmetic gel coat finish, blisters or fiberglass delamination caused by blisters, crazing, spider or hairline cracks; and
- Damages resulting from improper service or maintenance.

5. LIMITATIONS OF LIABILITY

This warranty gives you specific rights, and you may also have other legal rights which may vary from state to state, or province to province. WHERE APPLICABLE, THIS WARRANTY IS EXPRESSLY GIVEN AND ACCEPTED IN LIEU OF ANY AND ALL OTHER WARRANTIES, EXPRESSED OR IMPLIED, INCLUDING WITHOUT LIMITATION ANY WARRANTY OF MERCHANTABILITY OR FITNESS FOR ANY PARTICULAR PURPOSE.

Neither the distributor, any authorized SEA-DOO SPORT BOAT dealer nor any other person has been authorized to make any affirmation, representation or warranty other than those contained in this warranty, and if made, such affirmation, representation or warranty shall not be enforceable against BOMBARDIER or any other person.

In no event shall BOMBARDIER be liable for special, consequential or incidental damages, including but not limited to loss of use and transportation costs. Some states or provinces do not allow the exclusion or limitation of incidental or consequential damages, or limitations on how long an implied warranty lasts, so the above limitation or exclusion may not apply.

BOMBARDIER reserves the right to modify this warranty at any time, being understood that such modification will not alter the warranty conditions applicable to the SEA-DOO SPORT BOAT sold while this warranty is in effect.

6. TRANSFER

If the customer sells the SEA-DOO SPORT BOAT guaranteed under the present, he shall assign and transfer this warranty, which shall be valid for the rest of the relevant PERIOD as defined in section 1 hereinabove, to the new customer.

7. CONSUMER ASSISTANCE

- In the event of a controversy or a dispute arising in connection with this BOMBARDIER LIMITED WARRANTY, BOMBARDIER suggests that you try to resolve the issue at the dealership level. We recommend discussing the issue with the authorized dealer's service manager or owner.
- If further assistance is required, Bombardier's service department should be contacted in order to resolve the matter in Canada and the USA.
- If the issue has still not been resolved, please submit in writing your complaint to:

In Canada and USA:

BOMBARDIER INC.
RECREATIONAL PRODUCTS
 CUSTOMER ASSISTANCE CENTER
 75, J.-A. BOMBARDIER STREET
 SHERBROOKE, QC
 J1L 1W3
 TEL.:

in CANADA: (819) 566-3366

in USA: (715) 848-4957



BOMBARDIER
RECREATIONAL PRODUCTS

APRIL 2000

® Trademark of Bombardier Inc. and/or subsidiaries

BOMBARDIER INTERNATIONAL LIMITED WARRANTY: SEA-DOO® SPORT BOAT

1. WARRANTY COVERAGE PERIOD

BOMBARDIER INC. ("Bombardier"), as manufacturer, warrants FROM THE DATE OF DELIVERY TO THE FIRST CONSUMER that each SEA-DOO SPORT BOAT sold anywhere in the world except the United States and Canada, as NEW and UNUSED and PREDELIVERED by an authorized SEA-DOO SPORT BOAT dealer, duly appointed by an authorized SEA-DOO International Distributor, will be free from any defects in material and/or workmanship for a PERIOD of:

a) For private use:

TWELVE (12) CONSECUTIVE MONTHS, with the exception of the deck and hull fiberglass structure; and

SIXTY (60) CONSECUTIVE MONTHS for the deck and hull fiberglass structure.

b) For commercial use:

FOUR (4) CONSECUTIVE MONTHS, with the exception of the deck and hull fiberglass structure; and

TWELVE (12) CONSECUTIVE MONTHS for the deck and hull fiberglass structure.

All genuine Bombardier accessories, installed by an authorized SEA-DOO SPORT BOAT dealer at the time of delivery of the new and non-current new SEA-DOO SPORT BOAT, carry the same Warranty Coverage Period as for the SEA-DOO SPORT BOAT.

2. WHAT BOMBARDIER WILL DO

BOMBARDIER through the local authorized SEA-DOO International Distributor will, during the Warranty Coverage Period, repair or replace, at its option, all genuine BOMBARDIER part found defective in material and/or workmanship, under normal use, maintenance and service, with a genuine BOMBARDIER part without charge for parts and labor, at any local authorized SEA-DOO SPORT BOAT dealer.

3. CONDITION TO HAVE WARRANTY WORK VALIDATED

The customer must notify a local authorized SEA-DOO SPORT BOAT dealer within two (2) days of the appearance of the defect in material and/or workmanship and present to the servicing authorized SEA-DOO SPORT BOAT dealer the SEA-DOO Warranty Registration Card or a proof of purchase of the NEW and UNUSED SEA-DOO SPORT BOAT and must sign the repair/work order prior to the start of the repair in order to validate a warranty repair. All parts replaced under this limited warranty become the property of the international SEA-DOO distributor of the specific territory and/or BOMBARDIER.

4. EXCLUSIONS - ARE NOT WARRANTED

- The engine and corresponding components which are warranted by Mercury Marine.
- Refer to *M² Jet Drive Operator's Guide*.
- Normal wear and tear items;
- Labor, parts and lubricant costs of all maintenance services;
- Damages caused by failure to provide proper maintenance and/or storage, as described in the "*SEA-DOO SPORT BOAT Operator's Guide*";
- Damages resulting from improper repairs, modifications or use of non-approved parts or, repairs not performed by a authorized SEA-DOO SPORT BOAT dealer;
- Damages resulting from abuse, misuse, neglect, racing;
- Damages resulting from accident, fire, theft, vandalism or any act of God;
- Incidental or consequential damages, or damages of any kind such as but not limited to towing charges, telephone calls or taxi;
- Water damages caused by water ingestion;

- Damages related to gel coat finish including but not limited to cosmetic gel coat finish, blisters or fiberglass delamination caused by blisters, crazing, spider or hairline cracks; and
- Damages resulting from improper service or maintenance.

5. LIMITATIONS OF LIABILITY

This warranty gives you specific rights, and you may also have other legal rights resulting from the application of mandatory national laws which may vary from country to country. WHERE APPLICABLE, THIS WARRANTY IS EXPRESSLY GIVEN AND ACCEPTED IN LIEU OF ANY AND ALL OTHER WARRANTIES, EXPRESSED OR IMPLIED, INCLUDING WITHOUT LIMITATION ANY WARRANTY OF MERCHANTABILITY OR FITNESS FOR ANY PARTICULAR PURPOSE.

In no event shall BOMBARDIER be liable for special, consequential or incidental damages, including but not limited to loss of use and transportation costs. Some countries do not allow the exclusion or limitation of incidental or consequential damages, or limitations on how long an implied warranty lasts, so the above limitation or exclusion may not apply.

Neither the distributor, any authorized SEA-DOO SPORT BOAT dealer nor any other person has been authorized to make any affirmation, representation or warranty other than those contained in this warranty, and if made, such affirmation, representation or warranty shall not be enforceable against BOMBARDIER or any other person.

Every SEA-DOO SPORT BOAT is sold with the English version of this warranty. Some authorized SEA-DOO International Distributor may elect to translate this warranty into local language, it is then understood and agreed that in the event of any discrepancies or inconsistencies between the two versions, the English version shall prevail.

It is the customer's responsibility to ensure that the SEA-DOO SPORT BOAT complies with all boating regulations and standards of any country, other than the original country of sale, where the SEA-DOO SPORT BOAT is intended to be used.

BOMBARDIER reserves the right to modify this warranty at any time, being understood that such modification will not alter the warranty conditions applicable to the SEA-DOO SPORT BOAT sold while this warranty is in effect.

6. TRANSFER

If the customer sells the SEA-DOO SPORT BOAT guaranteed under the present, he shall assign and transfer this warranty, which shall be valid for the rest of the relevant PERIOD as defined in section 1 hereinabove, to the new customer.

7. CONSUMER ASSISTANCE

- In the event of a controversy or a dispute arising in connection with this BOMBARDIER INTERNATIONAL LIMITED WARRANTY, BOMBARDIER suggests that you try to resolve the issue at the dealership level. We recommend discussing the issue with the authorized dealer's service manager or owner.
- If further assistance is required, the authorized local SEA-DOO INTERNATIONAL DISTRIBUTOR's Service Department should be contacted in order to resolve the matter.
- If the issue has still not been resolved, please submit in writing your complaint to:

BOMBARDIER INC.
RECREATIONAL PRODUCTS
 CUSTOMER ASSISTANCE CENTER
 75, J.-A. BOMBARDIER STREET
 SHERBROOKE, QUEBEC
 J1L 1W3
 PHONE: (819) 566-3366



BOMBARDIER
RECREATIONAL PRODUCTS

APRIL 2000

® Registered trademark of Bombardier Inc. and/or subsidiaries

REGISTRATION NUMBER LOCATION

All craft are required by federal law to be registered and legally numbered.

Due to space availability for proper display of registration number, refer to the following illustration for location. The registration number should appear on each side of the craft.



F14L01L

TYPICAL

1. *Registration number location*

LOCATION OF THE IMPORTANT LABELS

Please read the following labels carefully before operating this craft.

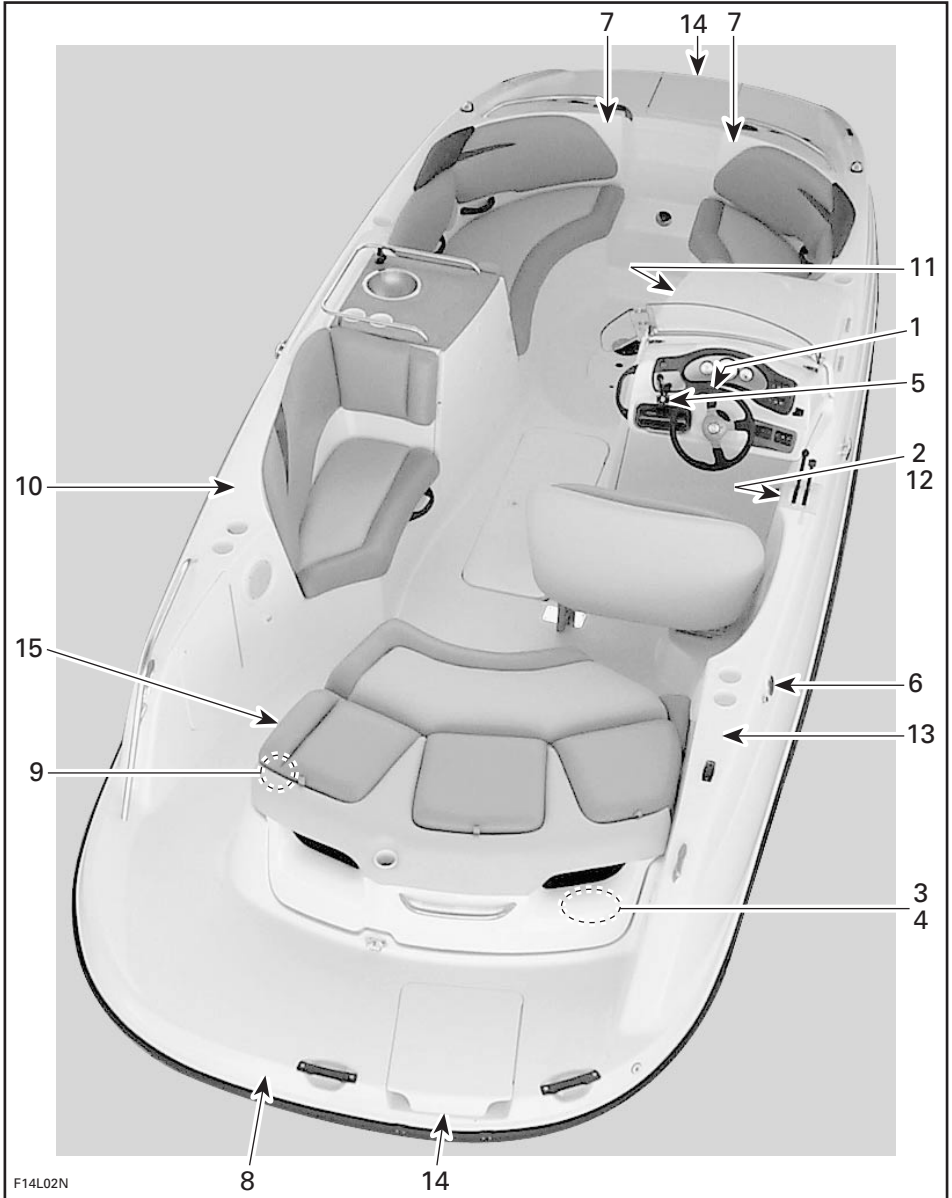

Label 1

⚠ WARNING

Read and follow warning labels, operator's guide and safety handbook before operation. Severe injury or death can result from ignoring warnings or through improper use of this sport boat. The performance of this sport boat may significantly exceed that of other boats you may have operated. Therefore, use of this sport boat by novice or inexperienced operators is not recommended.

- * Check throttle/shifter and steering operation and position before starting engine(s).
- * Directional control is reduced with decreasing speed and lost when engine is off.
- * Do not splash others or jump waves or wakes with this sport boat.
- * Operator and passengers should always wear approved PFD and recommended protective clothing.
- * Do not operate if passengers are not properly seated and using handgrips, or if visibility is obstructed. Do not allow passenger(s) on most forward bow seat(s) above idle speed.
- * Properly attach safety lanyard to your PFD.
- * Keep a safe distance from all other water users. Be aware of and observe all applicable boating laws and regulations.

F00L30L

Label 2

MADE IN U.S.A., BOMBARDIER MOTOR CORPORATION OF AMERICA
U.S. COAST GUARD
MAXIMUM CAPACITIES
12 PERSONS OR 805 KG/1775 LBS.
805 KG/1775 LBS. PERSONS, GEAR

THIS BOAT COMPLIES WITH U.S. AND CANADIAN COAST GUARD
SAFETY STANDARDS IN EFFECT ON THE DATE OF CERTIFICATION

CE BOAT DESIGN CATEGORY: **C**

F13L0GY

Label 3

**MAXIMUM ENGINE POWER
CAPACITY RATING
OF THE CRAFT:**
165 KW

F13L0EY

TYPICAL — REFER TO ACTUAL LABEL ON CRAFT

Label 4

⚠ WARNING

Do not boost battery.
Servicing of electrical components should be done by authorized dealer only.

F04LALY

Label 5

⚠ WARNING

Gasoline vapors can explode. Before starting engine, operate blower for **5** minutes and check engine compartment bilge for gasoline vapors.

F04LADY

Label 6

⚠ WARNING

While fueling, stop engine(s). Fuel tank may be pressurized. Slowly turn cap when opening. Keep watercraft level. Do not overfill. Use regular unleaded gasoline. Check oil level. Periodically, verify fuel system.

F04LAEY

Label 7

⚠ WARNING

Do not sit here above idle speed.

F04LAPY

Label 8

 **WARNING**

Engine(s) must be off when using platform.
Keep away from jet nozzle(s) or
intake grate(s).

F04LAVY

Label 9

OIL RECOMMENDATION
IMPORTANT!
DO NOT USE ROTAX INJECTION OIL
USE MERCURY PRECISION PREMIUM PLUS OR QUICKSILVER
PREMIUM PLUS 2-CYCLE OIL (NIMMA TC-W3 CERTIFIED)
THESE OILS CONTAIN ADDITIONAL UNIQUE ADDITIVES
SPECIFICALLY DESIGNED FOR USE WITH THE M² JET DRIVE
TO INCREASE ENGINE DURABILITY AND SUBSTANTIALLY
REDUCE CARBON BUILDUP.
(Refer to M² Jet Drive Operator's Manual for further information)

F00L21Y

Label 10

 **WARNING**

- Avoid body contact with bimini top.
- Operate this craft at a very low cruising speed with bimini top installed.
- Hold down straps are under tension.

F14L28Y

Label 11

 **WARNING**

Changing room should never be used when craft is in motion. Always close cover before operating craft.

F14L29Y

Label 12

 **WARNING**

Always ensure that Driver Seat swivel is locked in forward position so that seat faces steering wheel during operation.

F14L2AY

Label 13

 **WARNING**

All three rear seat backrests must always be in upper position when craft is underway.

F14L2BY

Label 14

 **WARNING**

Engine should be OFF when using ladder. It is easier and safer to deploy the ladder while aboard the craft. Therefore, ensure to do so prior to swimmer(s) entering the water.

F14L2DY

Label 15

 **WARNING**

Always close the transom door and fix the chain on top of it before operating this sport boat.

F14L2EY

IDENTIFICATION NUMBERS

The main components of the craft (engine and hull) are identified by different serial numbers. It may sometimes become necessary to locate these numbers for warranty purposes or to trace the craft in the event of theft.

Hull

The Hull Identification Number (H.I.N.) is located on the right side of the transom.

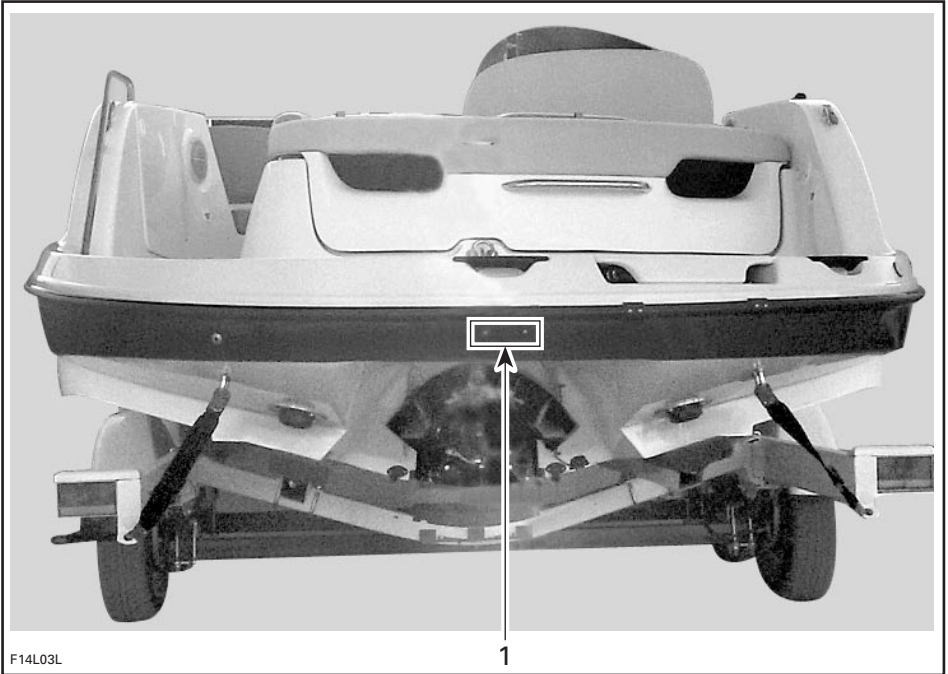

TYPICAL

1. Hull Identification Number (H.I.N.)

Engine

Refer to *M² Jet Drive Operator's Guide*.

CONTROLS, COMPONENTS AND INSTRUMENTS LOCATION

Cockpit

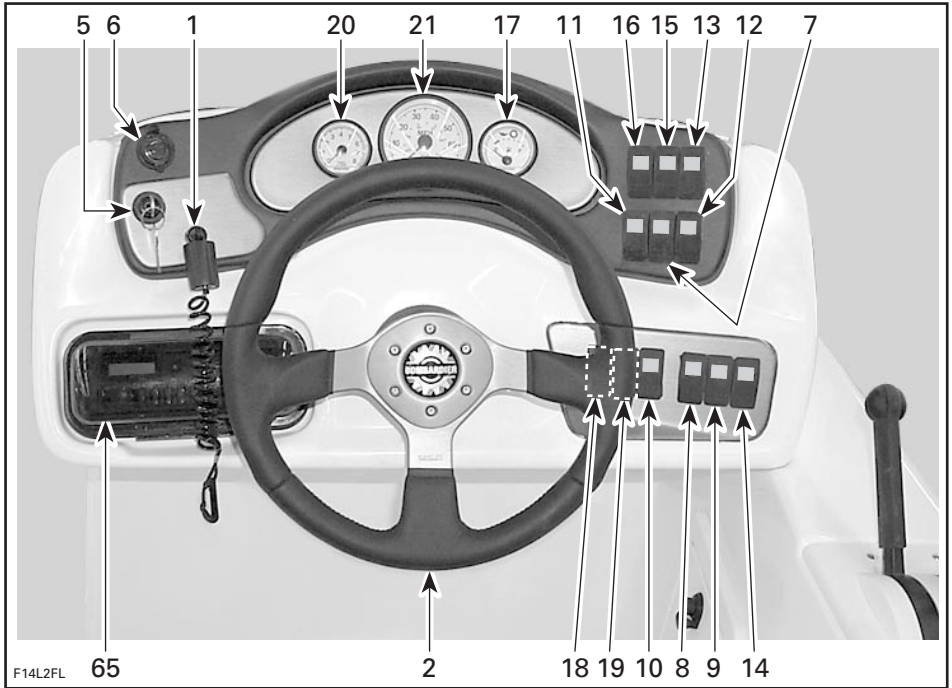

Overview

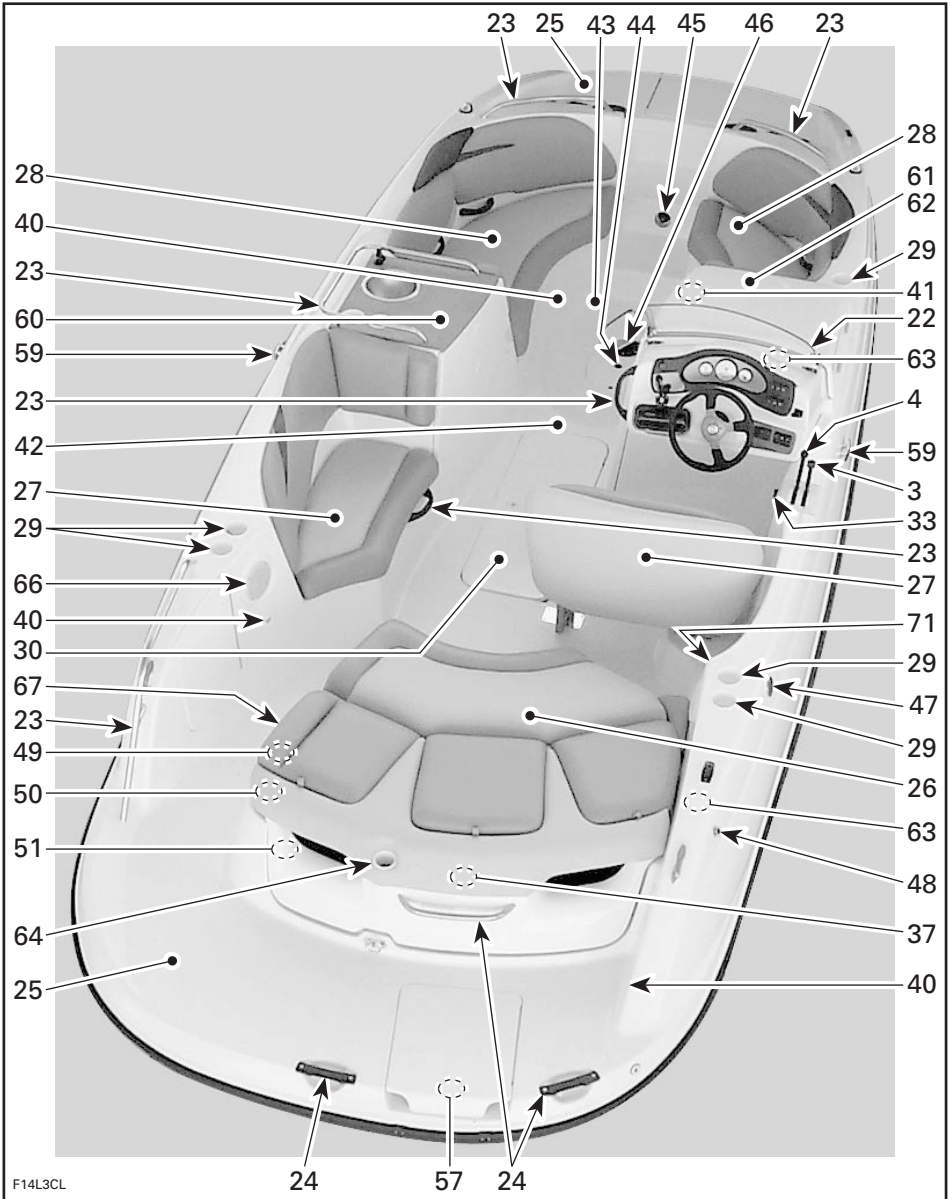

Front View

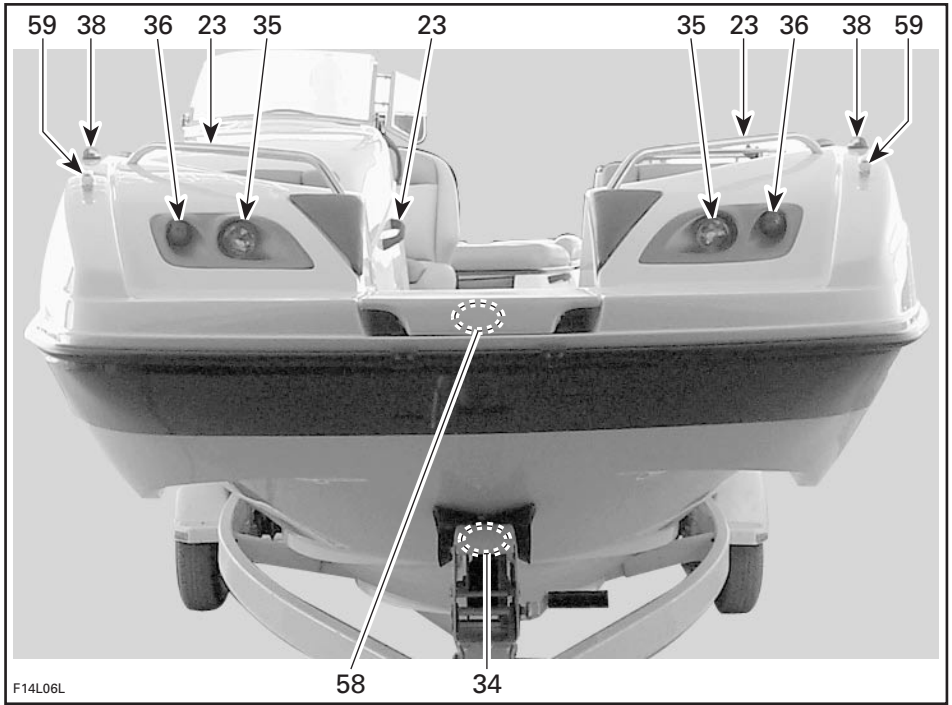

F14L06L

Rear View

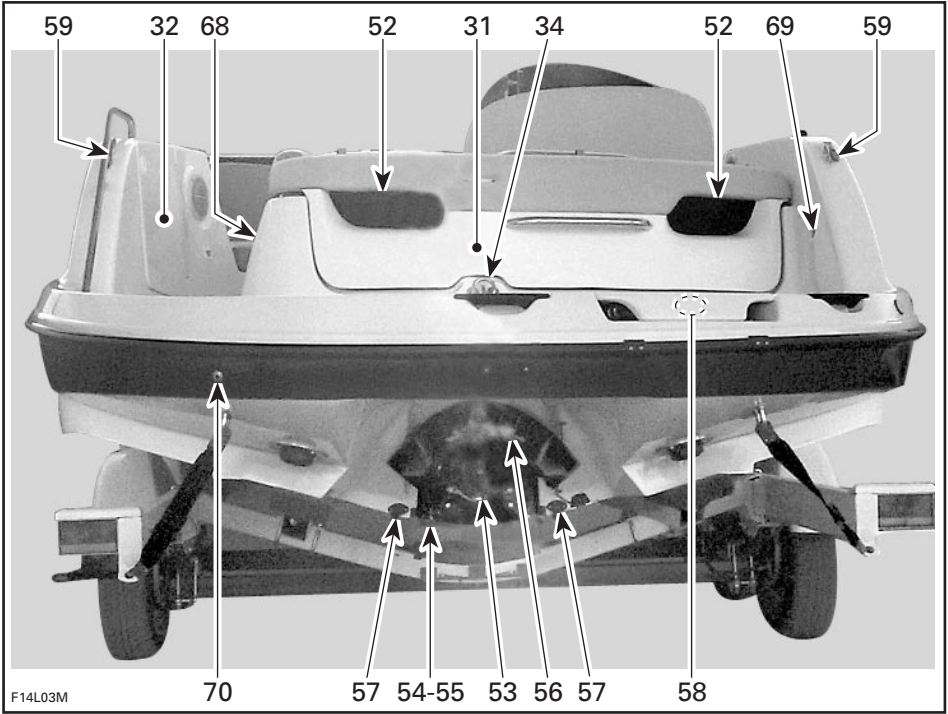

REAR VIEW

1. Safety Lanyard
2. Steering Wheel
3. Throttle Lever
4. Shift Lever
5. Ignition Switch
6. 12-Volts Accessory Jack
7. Navigation Light Switch
8. Docking Light Switch
9. Boarding Light Switch
10. Engine Compartment Light Switch
11. Bilge Pump Switch
12. Bilge Air Blower Switch
13. Horn Switch
14. Deck Light Switch
15. Low-Fuel Warning System Switch
16. Low-Battery Warning System Switch
17. Fuel Gauge/Low Oil Level Pilot Lamp and Beeper
18. Fountain Pump Switch
19. Main Water Pump Switch
20. Tachometer
21. Speedometer
22. Windscreen
23. Grab Handle(s)
24. Rear Grab Handle(s)
25. Front/Rear Swim Platform
26. Sun Deck/Rear Seat/Engine Cover
27. Front Seat(s)
28. Bow Seat(s)
29. Cup Holders
30. Deck Storage Compartment
31. Rear Storage Compartment
32. Rear Side Storage Compartment
33. Glovebox
34. Bow and Stern Eyelet(s)
35. Docking Lights
36. Boarding Lights
37. Engine Compartment Light
38. Navigation Lights
39. Removable Stern Light (not shown)
40. Deck Lights
41. Changing Room Ceiling Light
42. Deck
43. Footwell
44. Fountain Jet
45. Wash Down Valve
46. Table
47. Fuel Tank Cap
48. Fuel Tank Vent
49. Main Oil Reservoir Cap
50. Potable Water Tank Cap
51. Flushing Connector
52. Ventilation Ducts
53. Jet Pump Nozzle
54. Jet Pump Water Intake
55. Hydro Surge Grate System
56. Reverse Gate
57. Bilge Drain Plug(s)
58. Retractable Ladder(s)
59. Mooring Cleat(s)
60. Convenience Center
61. Changing Room with Toilet
62. Portable Toilet
63. Fuses
64. Ski Post (if so equipped)
65. Radio
66. Speaker(s)
67. Transom Door
68. Fire Port
69. Shower
70. Water Bypass System
71. Main Battery Cut-Off Switch

CONTROLS, COMPONENTS AND INSTRUMENT FUNCTIONS

1) Safety Lanyard (engine cut-out switch)

The safety lanyard cap should be securely snapped onto its switch to be fully operational.

Pulling the safety lanyard cap from the switch stops the engine operation. Attach the safety lanyard to the operator's Personal Flotation Device (PFD) and snap the cap to the switch to be able to start the engine.

WARNING

Should the safety lanyard cap become loose or fails to remain on its switch, replace it immediately.

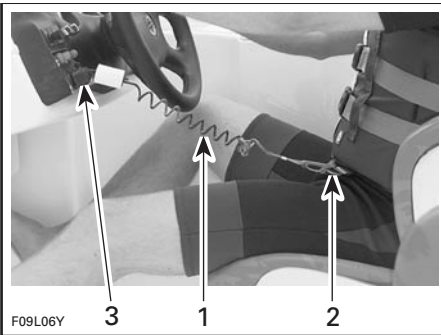

TYPICAL

1. Safety lanyard
2. Secure to PFD
3. Snap to safety lanyard switch

WARNING

Directional control is reduced when throttle is released and lost when engine is off. Always disconnect safety lanyard when craft is not in operation.

WARNING

Do not lubricate the safety lanyard switch.

WARNING

While engine can be stopped using the ignition switch, good driving habits recommend that the safety lanyard also be disconnected when stopping.

2) Steering Wheel

The steering wheel controls the direction of the craft. Turning the steering wheel clockwise steers the craft to the right and inversely.

Low-Speed Steering Control System

Whenever the throttle lever is in **idle position** and the steering wheel is approaching the end of its rotation, the engine speed will be slightly accelerated to increase the jet pump thrust and thus improving the steering control for low speed operation and when approaching/leaving a dock. Refer to OPERATING INSTRUCTIONS for more details.

3) Throttle Lever

When pushed forward craft accelerates. When fully pulled back, engine return to idle speed and the craft is gradually stopped by water drag.

NOTE: To activate throttle lever, shift lever must be in forward or reverse position.

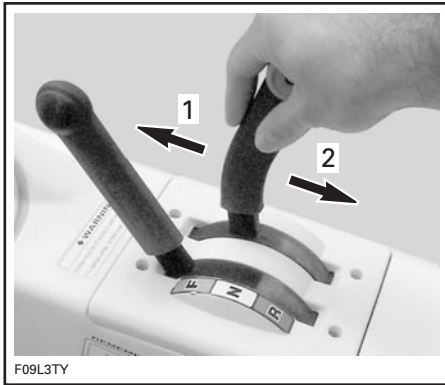

F09L3TY

TYPICAL

1. Increase speed
2. Decrease speed

NOTE: To ease shifter use, line up the shifter arrow with the appropriate dot (Forward/Neutral/Reverse).

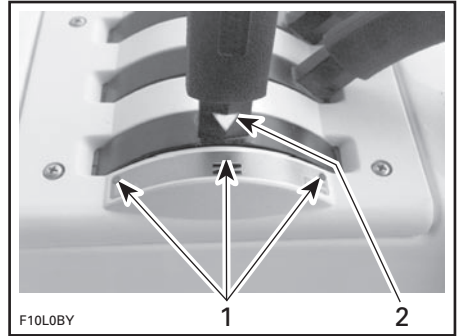

F10L0BY

TYPICAL

1. Dots besides shifting position
2. Arrow on shifter

4) Shift Lever

A 3-position lever:

- forward
- neutral
- reverse.

In order to shift, throttle lever must be fully pulled back to idle speed.

Shift lever must be in neutral position to allow engine starting.

NOTE: With throttle lever at idle and shift lever in neutral position throttle lever should be locked.

⚠ WARNING

Shift lever should only be used when the engine is idling and craft is completely stopped.

⚠ WARNING

Only use reverse at slow speed and for the shortest time possible. Always ensure the path behind is clear of objects and persons including children playing in shallow water.

CAUTION: Never rev the engine at high RPM in reverse.

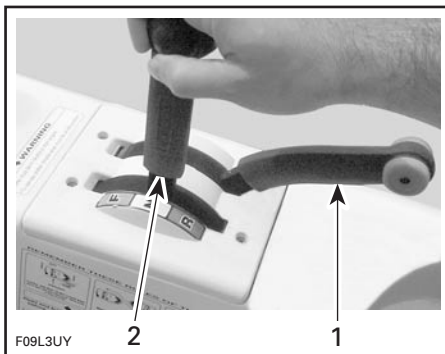

F09L3UY

TYPICAL

1. Throttle lever back to idle position
2. Shift lever in neutral position

5) Ignition Switch



TYPICAL

1. Ignition switch

Starting and Stopping

Refer to *M² Jet Drive Operator's Guide* for complete detailed procedure.

WARNING

Directional control is lost when engine is off.

6) 12-Volts Accessory Jack

A 12-volts jack to plug temporary accessories such as cellular phone or portable television.

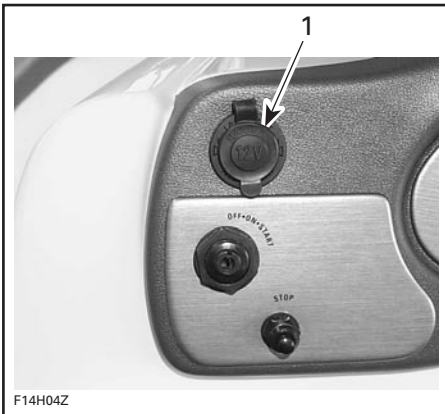

1. 12-volts jack

Lift protection cap to expose jack.

CAUTION: Using the accessory jack for a prolonged time without engine running may discharge the battery.

CAUTION: Close protection cap when jack is not in use to protect against weather inclemency.

7) Navigation Light Switch

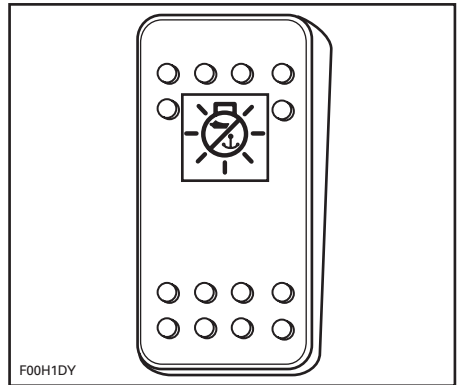

A 3-position NAV/OFF/ANC push type switch.

Press switch to first position to turn on the stern light (anchorage position).

Press switch to second position to turn on the bow and stern lights.

Press to OFF position to turn off navigation lights.

NOTE: Switches and gauges are lit when navigation lights are turn on. Lights may be operated without the safety lanyard on its switch.

WARNING

Navigation lights should always be used between sunset and sunrise. Ensure the stern light is installed. See **Removable Stern Light** in this section for location and installation.

CAUTION: Using the navigation lights for a prolonged time when the engine is not running will discharge the battery.

8) Docking Light Switch

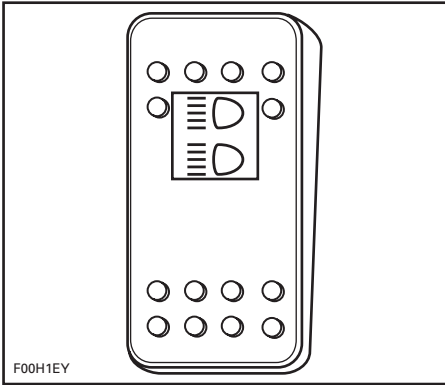

A 2-position ON/OFF push type switch.

Lights may be operated without the safety lanyard on its switch.

CAUTION: Using the docking lights for a prolonged time when the engine is not running will discharge the battery.

9) Boarding Light Switch

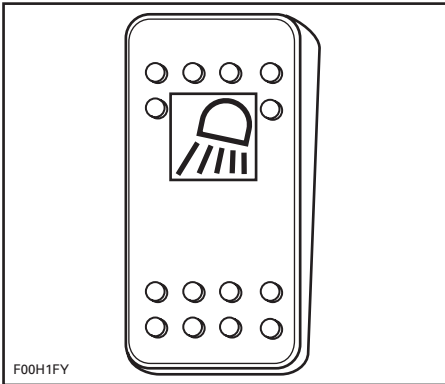

A 2-position ON/OFF push type switch.

Lights may be operated without the safety lanyard on its switch.

CAUTION: Using the boarding lights for a prolonged time when the engine is not running will discharge the battery.

10) Engine Compartment Light Switch

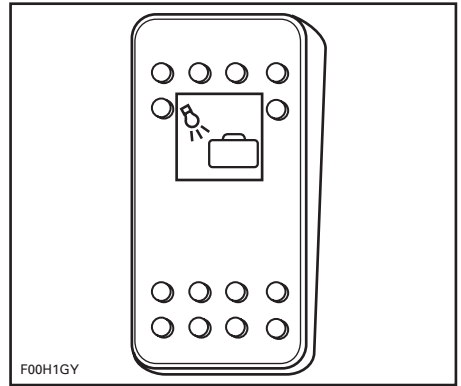

A 2-position ON/OFF push type switch.

CAUTION: Using the engine compartment light for a prolonged time when the engine is not running will discharge the battery.

11) Bilge Pump Switch

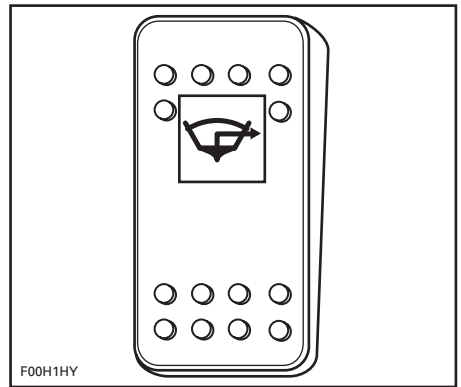

A 2-position ON/OFF push type switch.

Press switch to ON position when a manual operation is required (after cleaning, storage, etc.).

Press to OFF position when bilge is dry.

CAUTION: Using the bilge pump for a prolonged time when the engine is not running will discharge the battery.

NOTE: The bilge pump may be operated without the safety lanyard on its switch.

CAUTION: Ensure to always turn pump OFF when bilge is dry or before operating the engine above idle. Bilge pump will then switch to automatic mode.

Automatic Bilge Pump

An automatic bilge pump will evacuate water from the bilge. A water sensor detects the water which activates the bilge pump. After the water is pumped out, the pump shuts-off automatically. This automatic mode is working at all times: with/without safety lanyard on its switch and with/without engine running.

12) Bilge Air Blower Switch

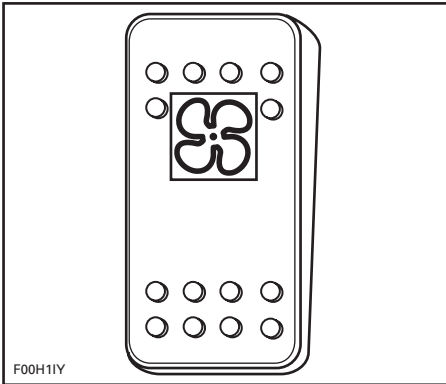

A 2-position ON/OFF push type switch. When ON, it ventilates the engine compartment.

⚠ WARNING

Always use blower for a minimum of 5 minutes prior to engine starting then, turn it OFF above idle speed. Use of the bilge blower should never replace "smelling" for gasoline vapors.

CAUTION: Using the bilge blower for a prolonged time when the engine is not running will discharge the battery.

Blower should be turned off during boat operation.

13) Horn Switch

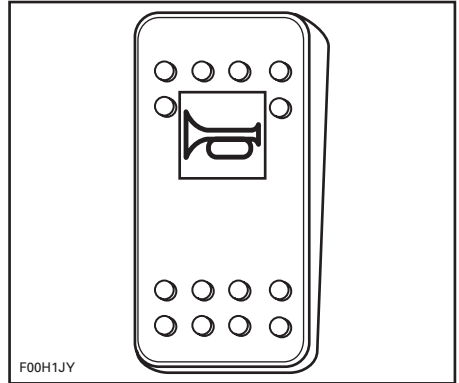

A 2-position ON/OFF push type switch. Press and hold the switch to activate horn.

Release the switch to stop horn.

14) Deck Light Switch

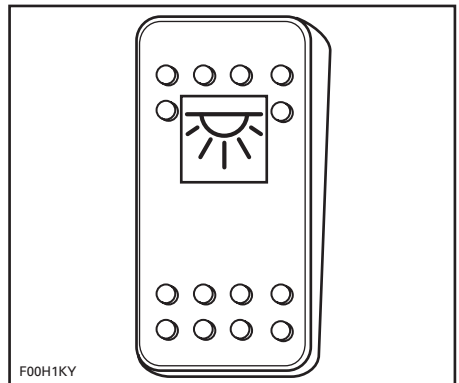

A 2-position ON/OFF push type switch.

CAUTION: Using the deck lights for a prolonged time when the engine is not running will discharge the battery.

15) Low-Fuel Warning System Switch (if so equipped)

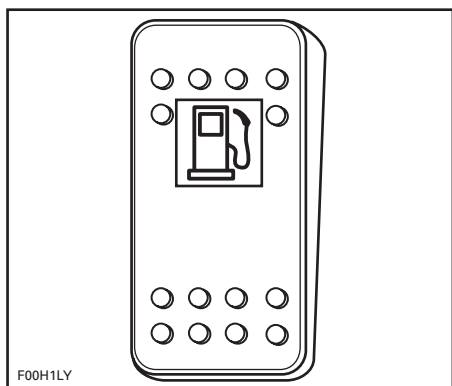

A 2-position push type switch.

When the fuel tank level is low, a beeper will sound and the pilot lamp on the switch will flash to advise the operator.

Press the switch to stop the beeper and turn off the pilot lamp.

From that point, approximately 20% of the fuel tank capacity is left.

WARNING

Always refill the fuel tank when low-fuel light comes on or before.

Refer to the table on next page for more details.

16) Low-Battery Warning System Switch

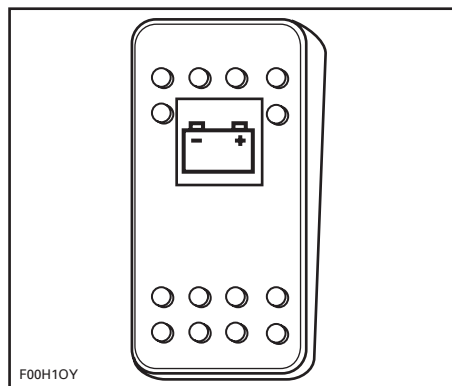

A 2-position ON/OFF push type switch.

This system is activated whenever the main battery cut-off switch is ON, and will monitor the charge level of the battery currently being used (see main battery cut-off switch).

Before the battery becomes too discharged to start the engine, a beeper will sound and the switch pilot lamp will flash to advise the operator.

Press the switch to stop the beeper.

When the beeper sounds, you should discontinue use of all electrical accessories immediately and start the engine to recharge the battery.

Refer to the table on next page for more details.

BATTERY SWITCH		
	NOT PRESSED	PRESSED
Engine OFF	<ul style="list-style-type: none"> LED will continue to flash for 5 minutes. Buzzer will continue to sound for 5 minutes. <p>After 5 minutes:</p> <ul style="list-style-type: none"> LED will stay on for 5 minutes with the buzzer off. Every 30 seconds the buzzer will come on and the LED will go off for 1 second as a reminder. <p>After 10 minutes:</p> <ul style="list-style-type: none"> LED and buzzer will go off. 	<ul style="list-style-type: none"> LED will stay on for 5 minutes with buzzer off. Every 30 seconds buzzer will come on and the LED will go off for 1 second as a reminder. Second switch press will terminate reminder cycle.
Engine ON	<ul style="list-style-type: none"> LED will flash and buzzer will sound, until voltage rises above minimum required for 5 seconds. 	<ul style="list-style-type: none"> Every 30 seconds buzzer will come on and the LED will go off for 1 second as a reminder.
Ignition	<ul style="list-style-type: none"> Both LED's will come on. After this start up routine the unit immediately begins monitoring the fuel level and the voltage condition. 	
Special	<ul style="list-style-type: none"> In the event of low fuel and low voltage, both LED's will come on with a continuous warning beep. Pressing either switch will cause the non-pressed switch to blink accompanied by a matching warning beep. Second switch press will turn off the buzzer with both LED's blinking alternately. Once voltage rises above minimum required unit will revert to the last active low fuel condition. 	

FUEL SWITCH (IF SO EQUIPPED)		
	NOT PRESSED	PRESSED
Engine OFF	N.A.	N.A.
Engine ON	<ul style="list-style-type: none"> LED will flash and buzzer will sound until ignition is turned off. 	<ul style="list-style-type: none"> LED will stay on with the buzzer off. Every 30 seconds the buzzer will come on and the LED will go off for 1 second as a reminder. Second button press will terminate reminder cycle.
Ignition	<ul style="list-style-type: none"> Both LED's will come on. After this start up routine the unit immediately begins monitoring the fuel level and the voltage condition. 	
Special	<ul style="list-style-type: none"> In the event of low fuel and low voltage, both LED's will come on with a continuous warning beep. Pressing either switch will cause the non-pressed switch to blink accompanied by a matching warning beep. Second switch press will turn off the buzzer with both LED's blinking alternately. Once voltage rises above minimum required unit will revert to the last active low fuel condition. 	

17) Fuel Gauge/Low Oil Level Pilot Lamp and Beeper

Fuel Gauge

Located in dashboard, the analog gauge continuously indicates the amount of fuel in fuel tank when engine is running.

The gauge is illuminated whenever the navigation lights are used.

NOTE: The fuel level can also be verified without having engine running. With the safety lanyard removed from its switch, turn ignition switch to ON position; the gauge will be activated.

CAUTION: Always turn ignition switch to OFF position once fuel level has been checked.

Low Oil Level Pilot Lamp and Beeper

The pilot lamp turn on and an intermittent audio warning will sound when the oil level is low in engine mounted oil reservoir or if a wire/connector of this electrical circuit is not properly connected. Fill reservoir as soon as possible or contact an authorized dealer if light or beeper remain on.

CAUTION: Never run engine out of oil. Serious engine damage will occur.

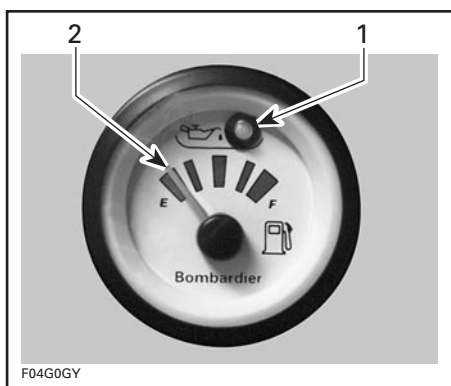

TYPICAL

1. Low injection oil level pilot lamp
2. Fuel level

18) Fountain Pump Switch

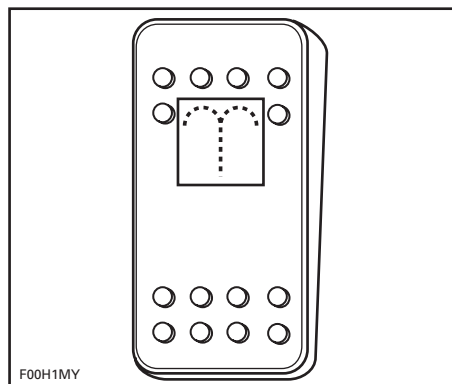

A 2-position ON/OFF push type switch.

Press switch to ON position to turn on the fountain pump and activate fountain.

To activate fountain, water must be added in fountain sump, as shown in the next photo. Also refer to **Wash Down Valve** (see item 45) for potable water supply.

NOTE: The fountain will not operate properly if the water level in the sump is too high.

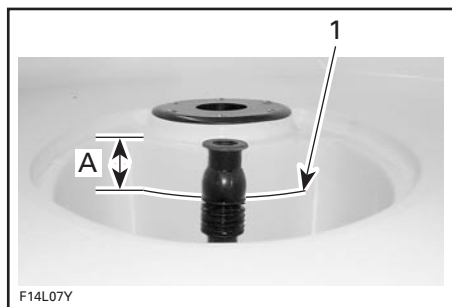

1. Maximum water level
- A. 5 cm (2 in) from the top

Press switch to OFF position to turn off the pump.

CAUTION: Using the pump for a prolonged time when the engine is not running will discharge the battery.

19) Main Water Pump Switch

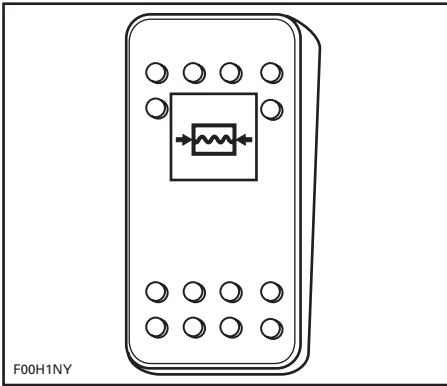

A 2-position ON/OFF push type switch.

Activate main water pump to supply potable water to sink faucet, shower (see item 69) and wash down valve (see item 45).

With the switch in the ON position, the pump will cycle ON and OFF automatically to maintain water pressure when the sink faucet, washdown valve or shower are used. For that reason main water pump can be turned ON at the beginning of the day and turned OFF at the end.

CAUTION: If potable water tank is empty and the main water pump switch is ON, the pump will run continuously and drain the battery. Always turn the switch to the OFF position when the water supply is depleted.

20) Tachometer

Analog tachometer indicates the revolutions per minute (RPM) of the engine. Multiply reading by 1000 to obtain actual RPM.

The gauge is illuminated whenever the navigation lights are used.

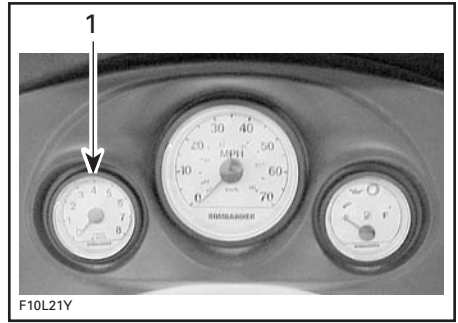

TYPICAL

1. Tachometer

21) Speedometer

Analog speedometer indicates the speed of the craft in miles per hour (MPH) and kilometers per hour (km/h). The gauge is illuminated whenever the navigation lights are used.

A speed sensor mounted on the hull near *M² Jet Drive* sends the signal to the speedometer.

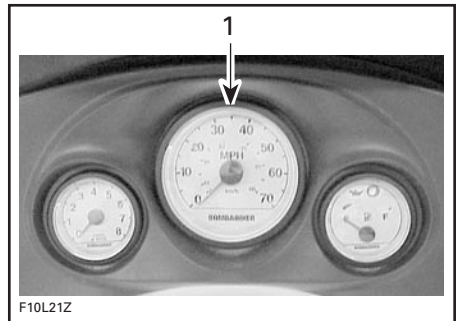

TYPICAL

1. Speedometer

22) Windscreen

For your convenience, a windscreen to divert the air flow.

23) Grab Handle(s)

Provide a handhold for the passengers.

CAUTION: Never use the grab handles to pull anything or to lift the craft.

Refer to components location illustrations at the beginning of this section for grab handles location.

24) Rear Grab Handle(s)

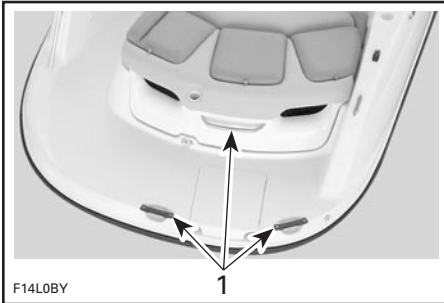

1. Grab handle

Provides a handhold for boarding when needed.

CAUTION: Never use the grab handle to tow anything or to lift the craft.

25) Front/Rear Swim Platform

Provides an anti-skid surface for easy boarding from rear of craft.

WARNING

Do not start or operate the craft if a person or more is seated on the platform. Engine must be off when using platform. Keep away from jet or intake grate.

26) Sun Deck/Rear Seat/Engine Cover

Sun Deck

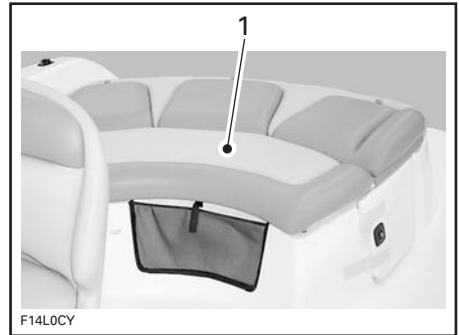

1. Sun deck

A convenient space to rest or take some sun while anchored.

WARNING

Do not start or operate the craft if a person or more is seated on the sun deck.

Rear Seat





F14L0EY

PULL UP BACKREST UNTIL IT LOCKS

⚠ WARNING

All three rear seat backrests must always be in upper position when craft is underway.



F14L0FY

PULL UP BRACKET TO UNLATCH

Engine Cover

Engine cover opening procedure is covered hereinafter. Refer to **Rear Storage Compartment** (item 31).

27) Front Seat(s)

Each passenger should be seated while underway.

⚠ WARNING

Allow no one to sit on edge of craft or stand up while in operation. Seat/grab handles should be used at all times.

Seat Storage Compartment



F14L0GY

LIFT THEN PULL SEAT TO GAIN ACCESS TO THIS STORAGE COMPARTMENT

Driver Seat

Swivel

Driver seat can swivel backward. With this feature, the driver seat can be used as a complement to the rear seat, as shown in the next photos.



PULL LEVER

Forward and Backward Adjustment

Driver seat is adjustable forward and backward.

Push lever to unlock seat. Move seat at the desired position. Release lever after adjustment is completed.

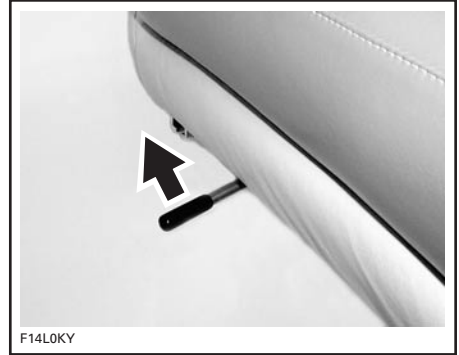

SWIVEL SEAT BACKWARD

28) Bow Seat(s)

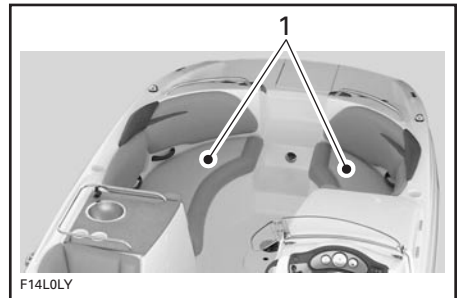

1. Bow seats

⚠ WARNING

Always ensure driver's seat swivel is locked so that seat faces steering wheel before riding.

⚠ WARNING

No passenger should use the most forward seat in the bow area if it faces backwards, except the craft is stopped or under idle speed.

Use grab handles as necessary.

Bow Seat Storage Compartment



F14L0MY
PORT SIDE — LIFT THE PULL SEAT TO GAIN ACCESS TO THIS STORAGE COMPARTMENT



F14L0NY
STARBOARD SIDE — LIFT THE PULL SEAT TO GAIN ACCESS TO THIS STORAGE COMPARTMENT

To reinstall seat, ensure to position L-bracket first then push seat down to snap it.



1. Position L-bracket first

29) Cup Holders

Convenient locations for non-alcoholic beverages.

WARNING

Do not drink alcoholic beverages while aboard. Do not keep bottles, cans etc. in cup holders while riding at speed and/or on rough waters.

30) Deck Storage Compartment

The deck storage compartment is a convenient location for water-skis, paddles, anchor and rope, etc.

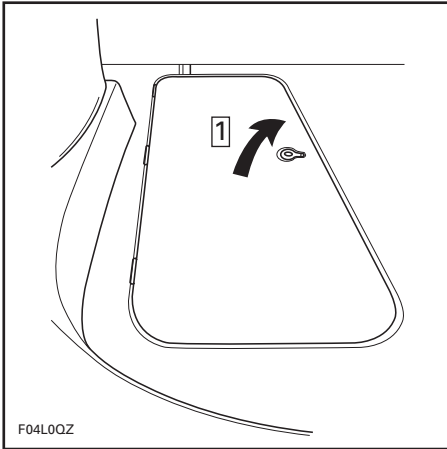

F04L0QZ

TYPICAL

Step 1: Pull latch and lift cover

Lift the latch ring and open cover gently until stopped by retaining spring.

To close, gently push on the side of the spring to release it and lower the cover.

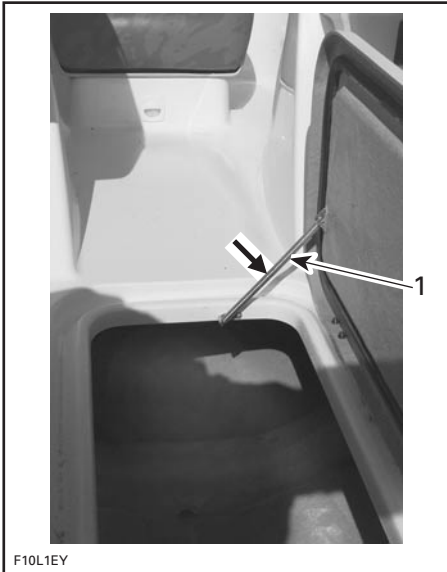

F10L1EY

TYPICAL

1. Gently push here to release the spring

⚠ WARNING

Never operate the craft with the storage compartment cover open.

31) Rear Storage Compartment

Convenient rear storage location to be used to carry large personal articles. Ideal location for wakeboards, kneeboards, spare Personal Flotation Device (PFD) etc.

To open engine cover, open the rear side storage compartment panel and pull lever.

⚠ WARNING

Never leave any heavy or loose breakable objects in the storage basket. Never operate the craft with the storage compartment cover open.

CAUTION: To avoid damage, driver seat must be rotated to forward position before opening engine cover.

NOTE: Unauthorized access to the rear storage compartment is prevented only when the rear side storage compartment is locked.

⚠ WARNING

When engine cover is lifted, never touch any electrical part when starting engine or while in operation. Never leave any object, rag or tool in the engine compartment or in the bilge.

Firmly close engine cover to reattach.

⚠ WARNING

Never operate the craft with the engine cover open.

32) Rear Side Storage Compartment

Convenient lockable storage location to be used to carry fire extinguisher, fishing rods, ski post (if so equipped), stern light, etc.

⚠ WARNING

Never leave any heavy or loose breakable objects in the storage compartment. Never operate the craft with the storage compartment cover open.



REAR SIDE STORAGE COMPARTMENT

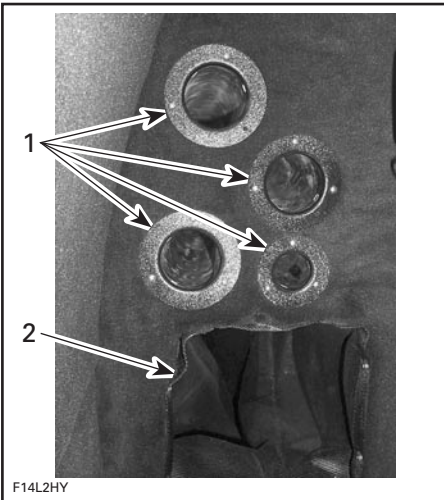

1. Storage for fishing rods
2. Additional storage compartment

33) Glovebox

Convenient lockable storage location to be used to carry small personal articles.



TO OPEN, PULL LATCH THEN PULL COVER

34) Bow and Stern Eyelet(s)

Bow Eyelet

Can be used for mooring, towing and as a tie-down point during transportation.

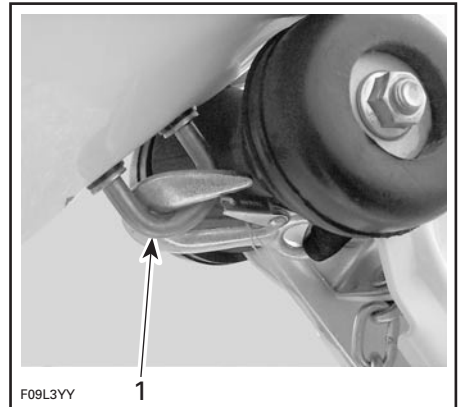

TYPICAL

1. Bow eyelet

Stern Eyelets

Allow a rope with a hook, a close end or an open end to be attached.

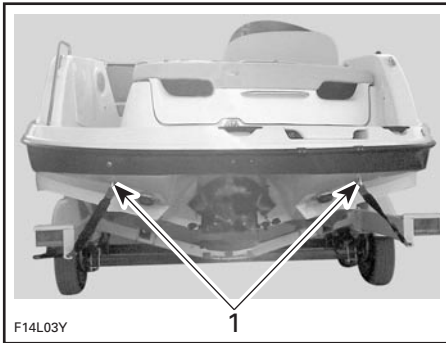

TYPICAL

1. Stern eyelets

35) Docking Lights

Convenient white lights that can be used between sunset and sunrise to assist when docking.

See Docking Light Switch (item 8).

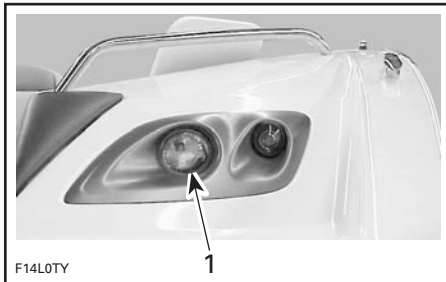

1. Docking light

CAUTION: Using the docking lights for a prolonged time when the engine is not running will discharge the battery.

36) Boarding Lights

Convenient lights that can be used between sunset and sunrise to assist passengers when boarding.

See Boarding Light Switch (item 9).

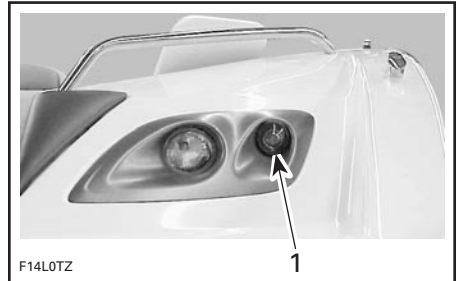

1. Boarding light

CAUTION: Using the boarding lights for a prolonged time when the engine is not running will discharge the battery.

37) Engine Compartment Light

Convenient light mounted inside engine cover.

See Engine Compartment Light Switch (item 10).

CAUTION: Using the engine compartment light for a prolonged time when the engine is not running will discharge the battery.

38) Navigation Lights

Mandatory red/green light. See Navigation Light Switch (item 7) as mentioned earlier in this section.

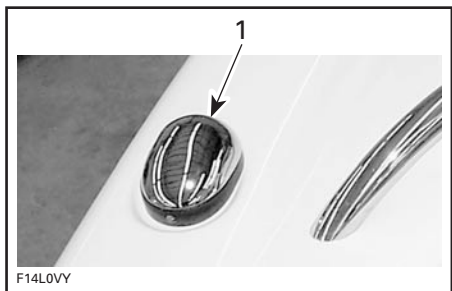

1. Nav light

CAUTION: Using the navigation lights for a prolonged time when the engine is not running will discharge the battery.

39) Removable Stern Light

Mandatory stern white light.

It is recommended to keep it in rear side storage compartment at all times except when needed.

To remove, pull it out. Snap in place to store again.

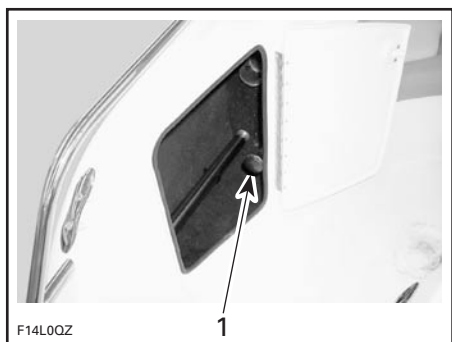

1. Removable stern light

CAUTION: Using the stern light for a prolonged time when the engine is not running will discharge the battery.

Installation

- Lift connector cap.
- Insert post in connector hole. Ensure to align hole keyway with post screw head.
- Firmly push downward to engage terminals.
- Push lock ring downward. Turn until locked. It may be necessary to slightly turn it to allow its insertion in the hole.
- Check light operation. See Navigation **Light Switch** as mentioned earlier in this section.

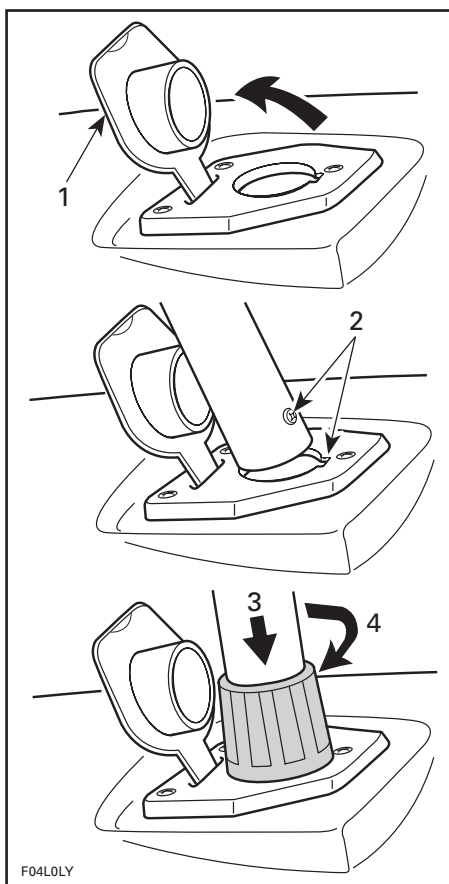

TYPICAL

1. Lift
2. Align screw in groove
3. Push downward
4. Turn to lock

CAUTION: Ensure dielectric grease is present in connector area of light to prevent corrosion.

40) Deck Lights

Convenient lights to use between sunset and sunrise. These lights can assist passenger when boarding as well as they can create a nice ambience.



1. Deck light

CAUTION: Using the deck lights for a prolonged time when the engine is not running will discharge the battery.

41) Changing Room Light

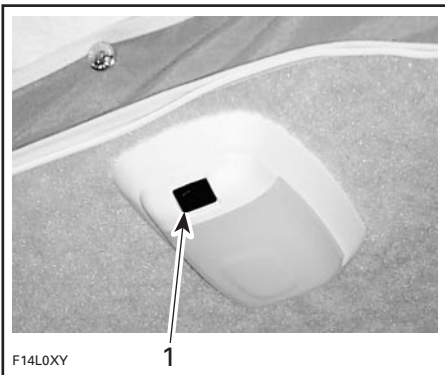

CHANGING ROOM LIGHT
1. 2-position ON/OFF switch

CAUTION: Using the changing room light for a prolonged time when the engine is not running will discharge the battery.

42) Deck

Flat surface of craft, should be kept clean and clear.

43) Footwell

Convenient basin where water can be added for passengers relaxation.



1. Footwell surface
2. Wash down valve

To add or drain water from footwell refer to To Fill or To Drain Fountain Sump or Footwell at item 45.

44) Fountain Jet

Convenient water fountain for passengers relaxation.



FOUNTAIN

To Activate Fountain

Add water into fountain sump. Refer to To Fill Fountain Sump or Footwell at item 45.



REMOVE FOUNTAIN SUMP COVER

1. Cover

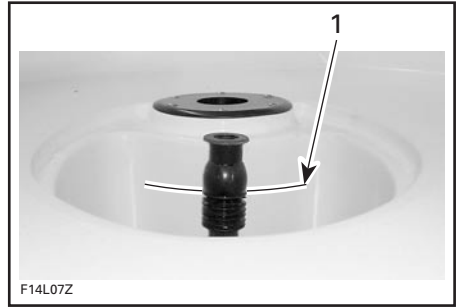

ADD WATER

1. Maximum specified water level

NOTE: The fountain will not operate properly if the water level in the sump is too high.



TURN VALVE TO THIS POSITION THEN REINSTALL COVER

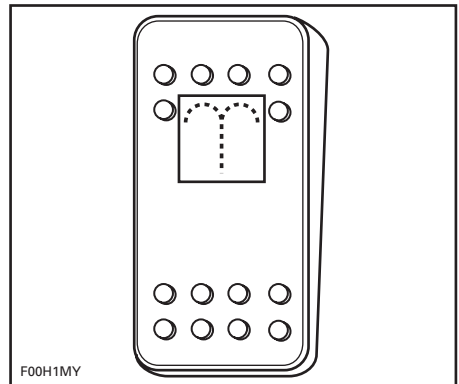

TURN ON FOUNTAIN PUMP SWITCH

45) Wash Down Valve

This valve supplies water to fountain sump and footwell. The valve can also be used to attach a garden hose which may be used to rinse the craft's deck.

WARNING

Splashed water will make the deck slippier than usual.

To Fill Fountain Sump or Footwell

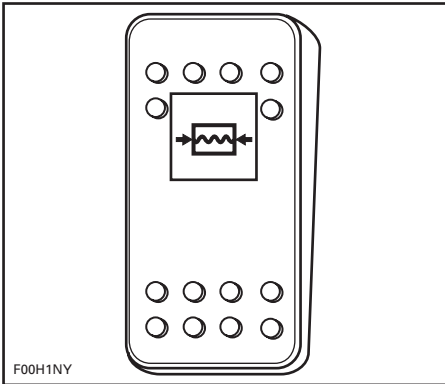

ENSURE MAIN WATER PUMP SWITCH IS TURNED ON

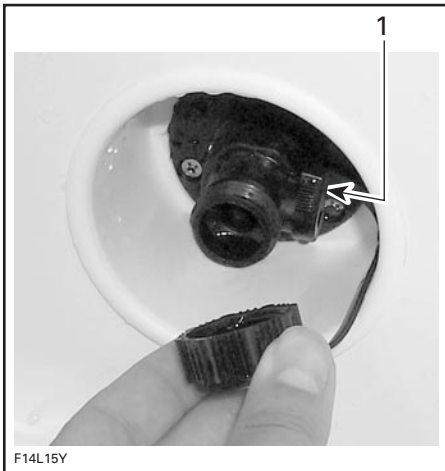

ENSURE WASH DOWN VALVE LEVER IS CLOSED THEN UNSCREW CAP

1. Wash down valve lever closed

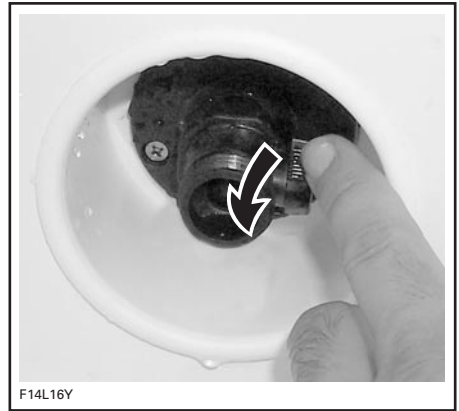

LOWER LEVER TO OPEN WASH DOWN VALVE AND LIFT TO CLOSE

To Drain Fountain Sump or Footwell



REMOVE FOUNTAIN SUMP COVER

1. Cover



TURN VALVE TO THIS POSITION



TABLE PROPERLY INSTALLED

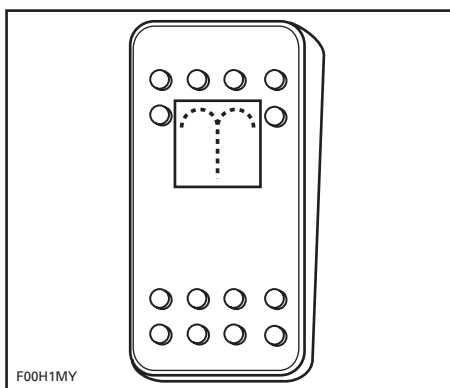

TURN ON FOUNTAIN PUMP SWITCH THEN TURN OFF WHEN SUMP IS DRAINED

NOTE: Any water not pumped overboard can be drained into the bilge by removing the drain plug in the bottom of the sump.

46) Table

Table and its post are stored inside rear side storage compartment.

To install table, first remove black plastic cap from table socket.

Insert table post into table socket. Apply pressure on post to make sure it is properly seated in socket.

Install table on post end. Apply pressure on table to ensure it is securely installed.

⚠ WARNING

Do not operate craft with table installed.

Reinstall black plastic cap in the table socket and properly store table and its post back in rear side storage compartment when table is not being used.

47) Fuel Tank Cap

⚠ WARNING

Always stop the engine before refueling. Fuel is inflammable and explosive under certain conditions. Always work in a well ventilated area. Do not smoke or allow open flames or sparks in the vicinity. Fuel tank may be pressurized, slowly turn cap when opening. Keep craft level. Do not overfill or top off the fuel tank and leave craft in the sun. As temperature increases, fuel expands and might overflow. Always wipe off any fuel spillage from the craft. Never use an open flame to check fuel level.



F14L13Y

USE FUEL TANK CAP KEY



F14L14Y

UNSCREW CAP



F14L18Y

REMOVE CAP

⚠ WARNING

Never use a lit match or open flame to check fuel level.

48) Fuel Tank Vent

It allows fuel vapors and pressure to escape from fuel tank.

⚠ WARNING

Never use a lit match or open flame close to vent. Follow the **Fueling Procedure** instructions in the **FUEL, WATER AND LUBRICATION** section.

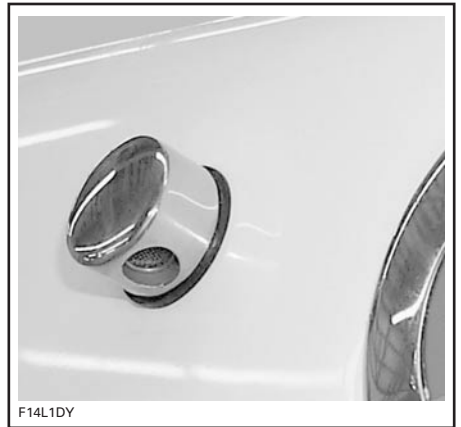

F14L1DY

FUEL TANK VENT

49) Main Oil Reservoir Cap

Open the engine cover to expose the oil cap. The cap is located under the engine cover.



MAIN OIL RESERVOIR CAP

To add injection oil in the reservoir, unscrew the cap counterclockwise.

WARNING

Add oil to level mark. Do not overfill. Reinstall cap and fully tighten.

CAUTION: Oil system must be pressurized. Always ensure that reservoir caps are firmly tighten. Refer to *M² Jet Drive Operator's Guide* for recommended oil and complete reservoirs filling procedure.

50) Potable Water Tank Cap



PUSH



PULL



UNSCREW

51) Flushing Connector

Use this connector to plug a garden hose when engine cooling system flushing is required.

For complete procedure refer to POST-OPERATION CARE.

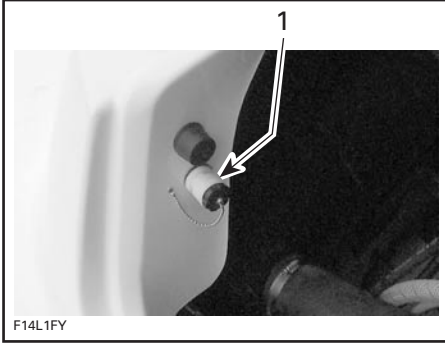

F14L1FY

ENGINE COVER MUST BE OPEN

1. Flushing connector

52) Ventilation Ducts

This is where air flows to supply engine and ventilate engine compartment. They should never be obstructed.

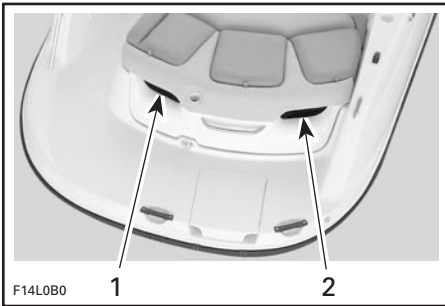

F14L0B0

1. Intake duct
2. Outlet duct

53) Jet Pump Nozzle

Turns side to side via input from the steering wheel. This provides directional control when engine is running.

⚠ WARNING

Never use nozzle as a supporting point to board the craft or to lift it.

54) Jet Pump Water Intake

The water is drawn up by the impeller through this opening. It minimizes entry of foreign objects into the propulsion system.

Refer to *M² Jet Drive Operator's Guide* for more detailed information.

55) Hydro Surge Grate System

Refer to *M² Jet Drive Operator's Guide*.

56) Reverse Gate

When selecting the neutral or reverse position with the shift lever, the reverse gate moves up or down to obtain the desired position.

⚠ WARNING

Never use gate as a supporting point to board the craft. Shift lever should only be used when the engine is idling and craft is completely stopped.

57) Bilge Drain Plug(s)

Should water be found in the bilge, it can be easily drained by unscrewing the drain plugs.

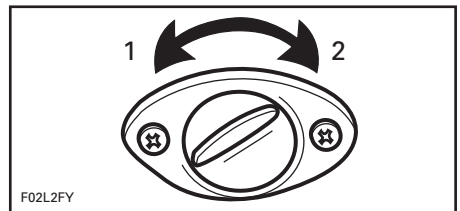

F02L2FY

1. Unscrew
2. Tighten

⚠ WARNING

Make sure drain plugs are properly secured prior launching the craft in water.

Tilt the craft slightly to the rear so that the water can completely flow out of the bilge.

58) Retractable Ladder(s)

WARNING

Engine should be OFF when using ladder. Keep limbs away from jet or intake grate. Stay on center of the ladder. Only one person at the time on the ladder. Never use the ladder for pulling, towing, diving or jumping, boarding a craft that is out of water or any other purpose other than a ladder.



FULLY EXTEND LADDER

CAUTION: In order to avoid damage to the ladders, they should not be used when the boat is out of the water.

To store ladder, completely retract it toward front.

To close cover, gently push on the side of the spring to release it and lower the cover.

59) Mooring Cleat(s)

When mooring to a dock, it is recommended to secure with cleats. The use of dock lines with sealed air fenders is recommended to protect your craft.

CAUTION: Never use mooring cleats to pull or lift the craft.



LIFT LADDER COVER UNTIL STOPPED BY RETAINING SPRING (SPRING NOT SHOWN)



GENTLY PULL LADDER

60) Convenience Center

CAUTION: In order to avoid damage, maximum load on lower storage tray must not exceed 27 kg (60 lb).

To Use Sink Faucet

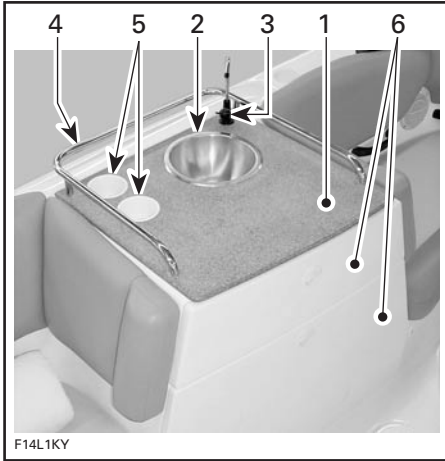

F14L1KY



F14L1MY

CONVENIENCE CENTER

1. Food preparation area
2. Sink
3. Faucet
4. Grab handle
5. Cup holder
6. Storage tray

INSTALL FAUCET TUBE



F14L36Y

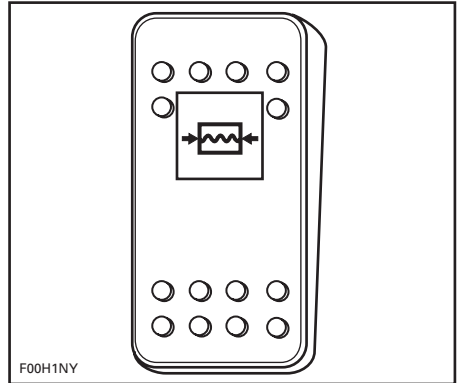

F00H1NY

ENSURE MAIN WATER PUMP SWITCH IS TURNED ON

LOWER STORAGE TRAY

1. Cooler
2. Trash container



F14L1NY

OPEN FAUCET VALVE

The pump consumes power only when water is being discharged.

CAUTION: Always remove faucet tube before installing mooring cover.

61) Changing Room with Toilet

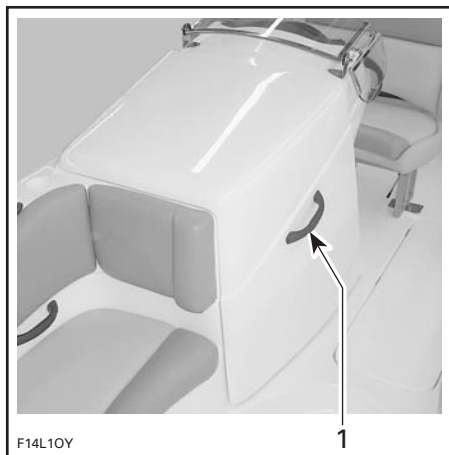

F14L10Y

1

GRAB HANDLE THEN LIFT COVER

1. Handle



F14L1PY

OPEN ZIPPER TO GAIN ACCESS TO CHANGING ROOM AND TOILET

1. Zipper

WARNING

Changing room should never be used when craft is in motion. Always close cover before operating craft.

62) Portable Toilet

To gain access to the toilet, open changing room as described in item 61.

CAUTION: Ensure toilet is securely latched to the floor while boat is underway. Refer to toilet manufacturer instructions.

Toilet Paper Holder

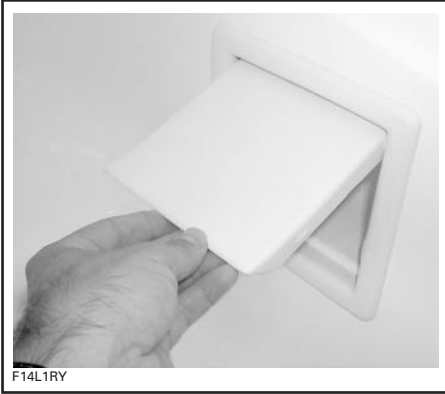

LIFT COVER THEN INSERT PAPER ROLL

63) Fuses

Fuse Block at Helm Location

Open changing room as described in item 61.

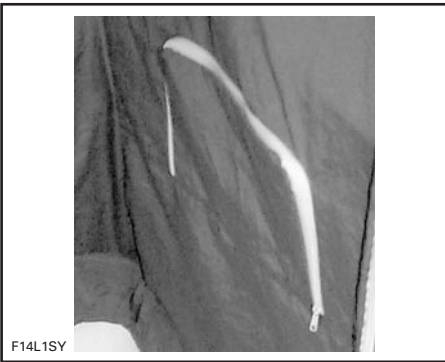

OPEN ZIPPER



PULL SNAP-BUTTONS

Fuses in Engine Compartment

These fuses are located on starboard side of engine compartment.

Refer to MAINTENANCE section for more details.

64) Ski Post (if so equipped)

Open rear side storage compartment as described at item 32.



PICK UP SKI POST

CAUTION: Ski post will not float if dropped in the water.



F14L1WY

THREAD POST IN PLACE



F14L1XY

PROPER INSTALLATION

Always have one person other than the operator as an observer.

CAUTION: Never use the ski post (if so equipped) to tow other boats.

WARNING

Riding when pulling a tub, skier or wakeboarder makes the craft handle differently and require greater skill. Unless absolutely necessary, do not make tight, sharp turns. Keep a safe distance from the docks, other swimmers, craft or objects. Be advised that serious injury can result if the tow rope become slack during a tight turn or when circling. The rope could become wrapped around the neck or limbs of a person.

65) Radio

Refer to its guide for a complete explanation of the features and controls.

CAUTION: Using the radio for a prolonged time without engine running may discharge the battery.



F14L1YY

LIFT COVER, TURN RADIO ON THEN CLOSE COVER

66) Speaker(s)

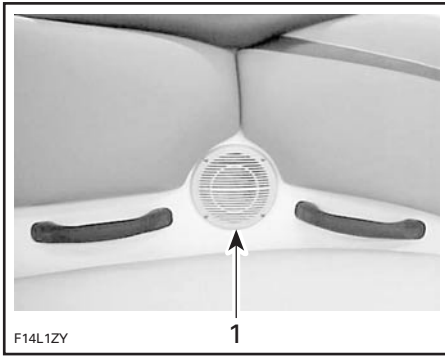

TYPICAL — REFER TO SUPPLIER INSTRUCTIONS

1. Port front speaker

67) Transom Doors

Convenient lockable door to prevent unauthorized craft access.

Transom door should also be closed when craft is underway.

WARNING

Always close the transom door and fix the chain on top of it before operating this sport boat.



TRANSOM DOOR CLOSED

68) Fire Port



IN CASE OF ENGINE COMPARTMENT FIRE, UNSCREW CAP THEN INSERT FIRE EXTINGUISHER

69) Shower

Convenient telephone shower connected to craft potable water system.

To Use Shower

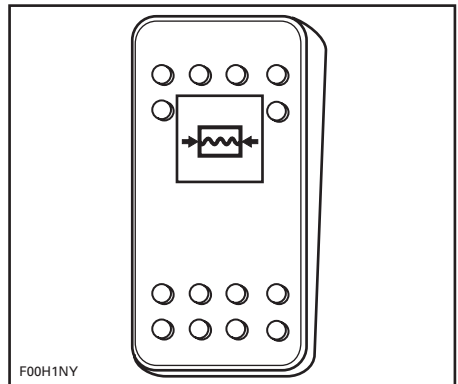

ENSURE MAIN WATER PUMP SWITCH IS TURNED ON

70) Water Bypass System

At idle speed, there will not be a water flow through this outlet.

When engine is running above idle speed, water must flow through this hole. This allows air in engine water jacket to escape.



F14L2JY

REMOVE PROTECTIVE CAP



F14L2KY

PULL SHOWER HEAD OUT



F14L2LY

PUSH BUTTON TO ACTIVATE

1. Button

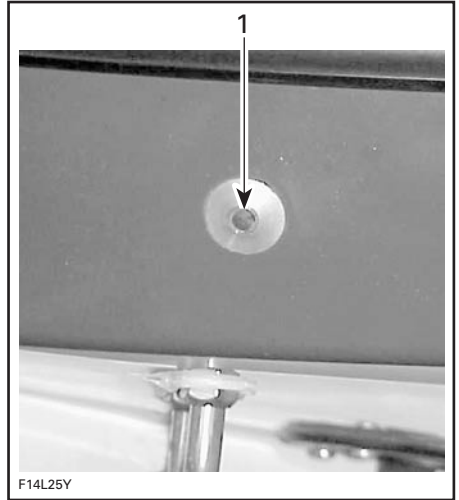

F14L25Y

1. Water bypass fitting

CAUTION: Should water not flow from the outlet a few seconds after engine starts and runs above idle, immediately stop engine and refer to POST-OPERATION CARE and look for Cooling System Flushing or refer to an authorized dealer for servicing.

71) Main Battery Cut-Off Switch

The switch is located near driver seat on the starboard side. It is provided to allow a complete cut-out of the electrical system.



When in OFF position, ALL electrical equipments and electronics will not be powered and not working.

It must be in the ON position to allow the use of electrical components and to start the engine.

CAUTION: Stop engine before switching OFF.

It is recommended to set in the OFF position whenever performing maintenance in the engine compartment, on the electrical system, for transportation and for short term storage on the trailer.

72) Bimini Top (not shown)

The bimini top is convenient for protection against weather inclemency or sunshine.

WARNING

Avoid body contact with bimini top. Operate this craft at a very low cruising speed with bimini top installed. Hold down straps are under tension.

FUEL, WATER AND LUBRICATION

CAUTION: Scrupulously follow the instructions of this section. Failure to do so may reduce the engine's life and/or performance.

Fueling Procedure

WARNING

Follow these safe boating fueling instructions explicitly.

Do not allow anyone to remain on the craft.

Tie craft securely to the fueling pier.

Use bilge blower for a minimum of 5 minutes.

Turn off bilge air blower, bilge pump and any other devices that could produce a spark.

Ensure engine cover is closed to prevent fumes from entering the engine compartment.

Have a fire extinguisher close at hand.

Do not insert the spout too far in filler neck.

Pour fuel slowly so that air can escape from the tank and prevent fuel flow-back.

Fill fuel tank to bottom of filler neck. Do not overfill. Fully tighten fuel tank cap.

WARNING

Always stop the engine before refueling. Fuel is inflammable and explosive under certain conditions. Always work in a well ventilated area. Do not smoke or allow open flames or sparks in the vicinity. Fuel tank may be pressurized. Slowly turn cap when opening. Keep craft level. Do not overfill or top off the fuel tank and leave craft in the sun. As temperature increases, fuel expands and might overflow. Always wipe off any fuel spillage from the craft.

Recommended Fuel

Use regular unleaded gasoline with 87 octane (Ron + Mon/2) specification.

NOTE: This craft features an oil injection system which does not require manual fuel/oil mixing. Do not mix oil with fuel except at engine break-in. Refer to *M² Jet Drive Operator's Guide* BREAK-IN PERIOD. Always check oil reservoir level when refueling.

Refer to *M² Jet Drive Operator's Guide* for more detailed information.

CAUTION: The use of a fuel other than regular unleaded fuel can result in craft performance deterioration and damage to fuel system and engine components. Never experiment with other fuels or fuel ratios. Never use fuel containing alcohol, methanol or similar products including naphtha.

Recommended Oil

WARNING

Add oil to level mark. Do not overfill. Reinstall cap and fully tighten.

Use Quicksilver or Mercury Precision Premium-Plus lubricants NMMA/BIA certified TC-W3 2-cycle outboard oil or equivalent.

Refer to *M² Jet Drive Operator's Guide* specifications for more detailed information.

Main Oil Reservoir Level

A sufficient amount of oil should be maintained in the reservoir.

NOTE: Always carry a spare 1 liter of oil.

The use of a funnel is recommended to pour the oil into the reservoir. Stop filling as soon as oil appears at approximately 13 mm (1/2 in) from top of reservoir. Do not overfill. Wipe off any oil spillage.

CAUTION: Always maintain a sufficient amount of oil in the oil reservoir. Check and refill every time you refuel. Do not overfill. If the engine runs out of oil, severe engine damage will occur. If the oil reservoir is found almost empty, refer to an authorized dealer to have the oil injection system inspected.

CAUTION: Oil system must be pressurized. Always ensure that reservoir caps are firmly tighten. Refer to *M² Jet Drive Operator's Guide* for complete reservoirs filling procedure.

Engine Mounted Oil Reservoir Level

Refer to *M² Jet Drive Operator's Guide*.

Potable Water Tank

Tank is located on port side of the craft inside engine compartment.

Open engine cover and check water level in tank. Add potable water as required.

NOTE: To avoid water system contamination, water should be regularly replaced in tank. Water system should also be disinfected, as described in SPECIAL PROCEDURE and STORAGE AND PRE-SEASON PREPARATION sections.

BREAK-IN PERIOD

CAUTION: Scrupulously follow the instructions of this section. Failure to do so may reduce the engine's life and/or performance.

Engine

Refer to *M² Jet Drive Operator's Guide* for more details.

10-Hour Inspection

It is highly recommended that after the first 10 hours of operation, the craft be checked by an authorized Sea-Doo dealer. This inspection will also provide the opportunity to discuss any unanswered questions you may have encountered during the first hours of operation.

The following chart should be used in conjunction with Mercury chart. Refer to *M² Jet Drive Operator's Guide*.

The 10-hour inspection is at the expense of the craft owner.

10-HOUR INSPECTION CHECK LIST	✓
Fuel system lines and fasteners	
Throttle cable adjustment if required	
Oil lines	
Muffler, battery and reservoir tank fastening devices	
Exhaust system hose clamps torque	
Steering system and low-speed steering control system	
Steering cable adjustment if required	
Shifter cable adjustment if required	
Ensure that throttle levers keep the selected position. Adjust levers friction as necessary	
Hose condition and fasteners	
Main and fountain water pumps	
Windscreen and fasteners	
Convenience center storage trays adjustment	
Bilge pump and bilge blower	
Safety lanyard switch	
Monitoring beeper	
Electrical connections (starter, battery, etc.)	
Lighting system inspection	
Hull condition	
Inspection of fasteners for tightness	

We recommend that this inspection chart be signed by an authorized dealer.

Date of 10-hour inspection

Authorized dealer signature

Dealer code

PRE-OPERATION CHECKS

WARNING

The pre-operation check is very important prior to operating the vehicle. Always check the proper operation of critical controls, safety features and mechanical components before starting. If not done as specified here, severe injury or death might occur. Bring all safety equipment required by local laws.

Some of the following items may not have been previously covered in this guide, however they will be described in the MAINTENANCE or SPECIAL PROCEDURES section. Please refer to these portions to have more detailed information.

Prior to operating the craft, verify the following:

WARNING

Engine should be off and the safety lanyard must always be removed from its switch prior to verifying any of the following. Only start craft once all items have been checked and operate properly.

SUMMARY

ITEM	OPERATION	✓
Safety lanyard ignition switch	Check operation.	
Hull	Inspect.	
Jet pump water intake/inlet grate	Inspect/clean.	
Bilge	Drain. Ensure plug is secured.	
Batteries	Inspect tightness of cables and retaining straps.	
Main battery cut-off switch	Ensure it is in the ON position.	
Navigation lights	Check operation.	
Fuel tank, potable water tank and oil reservoir	Refill.	
Engine compartment	Verify fuel/oil system components.	
Steering	Check operation.	
Throttle/shifter system	Check operation.	
Bilge blower and bilge pump	Check operation.	
Main and fountain water pumps	Check operation.	
Mandatory safety boating equipment	Check operation.	
Storage compartment covers and engine cover	Ensure they are closed and latched.	

Safety Lanyard and Ignition Switch

Ensure that ignition switch operates properly.

Start engine and stop it using switch. See STARTING PROCEDURE.

WARNING

Only start craft once all items have been checked and operate properly.

Hull

Inspect hull for cracks or damage.

Jet Pump Water Intake

Remove weeds, shells, debris or anything else that could restrict the flow of water and damage the cooling system or propulsion units. Clean as necessary. If any obstruction can not be removed, refer to an authorized Sea-Doo dealer for servicing.

Inspect leading edges of the impellers, if they have nicks or bends, performance will be greatly reduced.

Inlet Grate

Ensure inlet grate is not blocked or obstructed by any weeds or debris.

Refer to *M² Jet Drive Operator's Guide*.

Bilge

Should water be present in the bilge, use bilge pump or tilt the craft to the rear and unscrew drain plugs if craft is out of the water, as the case may be, to completely empty the bilge.

Secure bilge drain plugs.

WARNING

Make sure drain plugs are properly secured prior launching the craft in water.

Battery

WARNING

Verify tightness of battery cables to their posts and condition of retaining straps/fasteners. Do not boost battery while installed.

Fuel Tank/Potable Water Tank/Oil Reservoir

With the craft horizontal, fill the fuel tank to specified level.

Check the oil level and refill reservoir as necessary.

CAUTION: Oil system must be pressurized. Always ensure that reservoir caps are firmly tighten. Refer to *M² Jet Drive Operator's Guide* for complete reservoirs filling procedure.

Check the water level and refill as necessary.

Check fuel tank/potable water tank/oil reservoir retaining straps/fasteners.

Engine Compartment

WARNING

Should any leak or gasoline odor be present, do not start the engine. Consult an authorized Sea-Doo dealer before use.

Steering System

Assisted by another person, check steering operation for free movement. When the steering is centered, the jet pump nozzle should be in the straight ahead position. Ensure the jet pump nozzle pivots easily when steering is turned.

WARNING

Check steering and corresponding steering nozzle operation before starting.

Throttle System

Check throttle lever once for free and smooth operation.

NOTE: To activate throttle lever, shift lever must be in forward or reverse position.

WARNING

Check throttle lever operation before starting the engine.

Shifter System

Check reverse gate operation for free movement. With shift lever in forward position, the gate should be in upward position. With the shift lever in neutral position, gate should be in middle position. With shift lever in reverse position, gate should be in downward position.

WARNING

Verify the reverse gate lock.

Storage Compartment Covers

Ensure they are closed and latched.

OPERATING INSTRUCTIONS

WARNING

Always perform PRE-OPERATION CHECKS before operating the craft. Become thoroughly familiar with all controls and the function of each. Should any control or instruction be not fully understood, refer to an authorized Sea-Doo dealer.

Launching/Loading

CAUTION: Before launching the craft, ensure the main battery cut-off switch is turned ON and the bilge plugs are fully screwed.

After loading the craft, ensure the main battery cut-off switch is turned OFF and the bilge plugs are removed to drain bilge.

Trailing

Refer to the trailer or implement manufacturer instructions for proper capacity, operation, maintenance, accessories and warranty.

Check the regulations in your area concerning towing a trailer, especially the following rules:

- brake system
- tow vehicle weight
- mirrors.

NOTE: Brakes are standard on one axle of the Islandia trailer.

Take the following precautions when trailing the craft.

Tie the craft to both bow and stern (front/rear) eyelets so that it is firmly retained on the trailer. Use additional tie-downs if necessary.

- Remove stern light.
- Ensure that ski post (if so equipped) is removed.
- Ensure all storage compartment covers are properly latched.
- Pull down windscreen.
- Remove sink faucet tube.
- Close bimini top.
- A SEA-DOO cover can protect the craft, particularly before driving on dirt roads, to prevent dirt entry through the air intake opening(s).

Observe trailering safety precautions.

Principle of Operation

Propulsion

Engine is directly coupled to a drive shaft which, in turn, rotates an impeller. This impeller is accurately adjusted in a housing where the water is drawn up from underneath the craft. Then, the water flows through the impeller to a venturi. The venturi accelerates the water and produces thrust to move the craft. Pushing the throttle lever forward increase engine speed and therefore craft speed.

WARNING

Whenever an engine is to be started, the operator and passengers should always be sitting in the craft with the shift lever in neutral position and throttle lever in idle position.

WARNING

Keep away from intake grate while engine is on. Items such as long hair, loose clothing or personal flotation device straps can become entangle in moving parts resulting in severe injury or drowning.

Shift Lever

FORWARD

The shift lever should be in the forward position in order for the craft to advance.

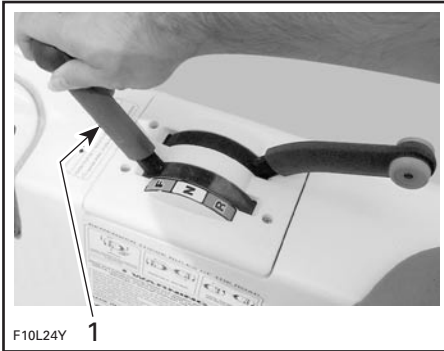

TYPICAL

1. Shift lever in forward position

NEUTRAL

To obtain neutral, pull shift lever halfway. The reverse gate will be in the middle position, directing half of the thrust toward the front of the craft to minimize craft movement.



WARNING

When the craft is in neutral position, the impeller is turning.

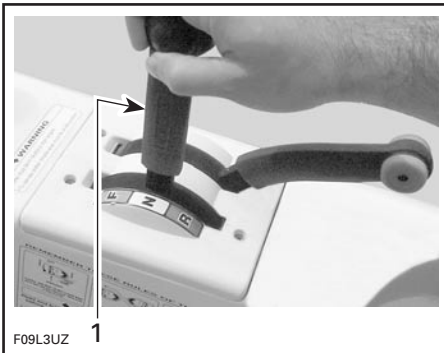

TYPICAL

1. Shift lever in neutral position

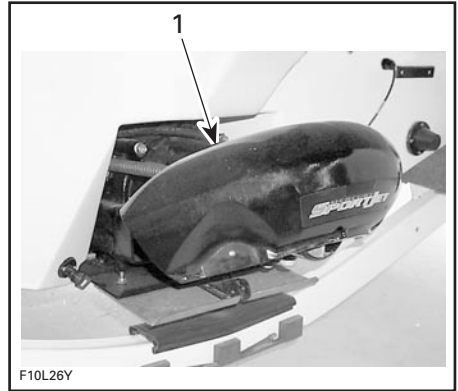

TYPICAL

1. Reverse gate in middle position

REVERSE

To obtain reverse, pull shift lever completely. The reverse gate will be in downward position, directing all the thrust toward the front of the craft.



TYPICAL — SHIFT LEVER IN REVERSE POSITION

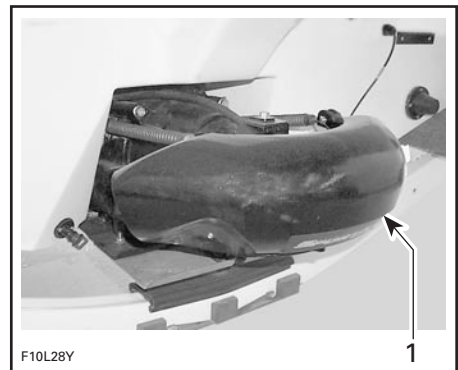

TYPICAL

1. Reverse gate in downward position

NOTE: To obtain maximum efficiency and control from the reverse, increase engine speed to slightly above idle. Too much RPM will create water turbulence and reduce reverse efficiency.

In reverse position, turn the steering wheel in the opposite direction that you want to move the rear of the craft.

For example, to steer the rear of the craft to the left side, turn the steering wheel to the right side.

⚠ WARNING

Shift lever should only be used when the engine is idling.

Steering

Turning the steering pivots the jet pump nozzle which control the craft direction. Turning the steering clockwise will turn the craft to the right and inversely.

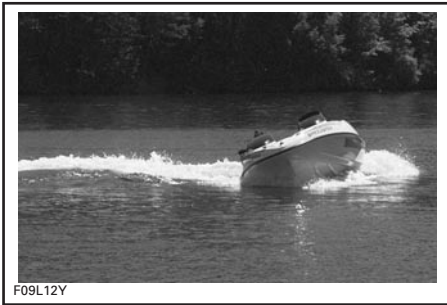

TYPICAL

Above idle speed, the throttle must be applied to turn the craft.

⚠ WARNING

Throttle must be applied and steering turned to change the direction of the craft at speed. Steering efficiency will differ depending on the number of passengers, load and water conditions.

A craft needs some throttle to turn. Practice in a safe area applying the throttle and turning away from an imaginary object. This is a good collision avoidance practice.

Low-Speed Steering Control System

Whenever the throttle lever is in **IDLE position AND** the steering wheel is approaching the end of its rotation, the engine speed will be slightly accelerated to increase the jet pump thrust. This helps steering control for low-speed navigation or when approaching/leaving a dock. For docking tips, refer to Stopping/Docking section below.

⚠ WARNING

Become fully familiar with this feature during your first ride and before carrying passengers.

Boarding from a Dock

As with any craft, boarding should be done carefully and engine should not be running.

When boarding from a dock, slowly place one foot on the craft deck nearest to the dock and then move the other foot inside the craft. Push the craft away from the dock.

CAUTION: Engine should be started with at least 90 cm (3 ft) of water below the hull.

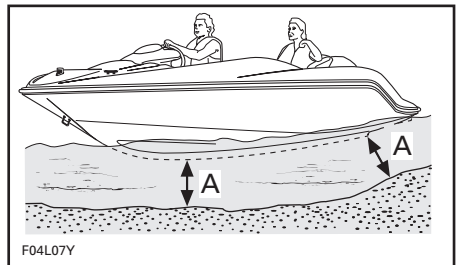

TYPICAL

A. 90 cm (3 ft)

Boarding from the Water

WARNING

Inexperienced riders should practice how to get aboard close to shore first before venturing into deep water.

WARNING

Engine should not be running while boarding. Never use propulsion components as a supporting point to board the craft.

Swim to the craft.

Come close to craft then lift cover and slide ladder toward rear. Close cover. Grip swim platform grab handles.

Climb the ladder and pull yourself upward using the swim platform grab handles.

When you can reach the engine cover/sun deck grab handle, grip it and continue to pull yourself upward to place one of your foot on the swim platform.

Open rear access door or continue to climb on engine cover/sun deck and go down on the deck.

To store ladder, lift horizontally, completely retract then slide toward front. Close cover.

CAUTION: Do not leave ladder hanging when operating the craft. Before operating the craft, always store ladder and close cover.

WARNING

Do not start engine until all passengers are properly seated.

Starting

Always activate bilge blower 5 minutes minimum before starting the engine. The bilge blower will ventilate the bilge.

WARNING

Bilge blower must be turned off above idle speed.

WARNING

Do not touch electrical parts or jet pump area when engine is running.

Attach the safety lanyard to your PFD and snap the cap to its switch before starting the engine.

WARNING

Before starting, the operator and passengers should always be properly seated.

Grip steering wheel with your right hand and place both feet on the deck. Turn off bilge blower.

Starting Procedure

Refer to *M² Jet Drive Operator's Guide* for complete detailed procedure.

Rough Water or Poor Visibility Operation

Avoid operation in these conditions. If you must do so, proceed with caution and prudence using minimum speed. Turn on navigation lights if necessary.

Crossing Waves

Reduce speed. Always be prepared to steer and balance as necessary.

When crossing wakes, always keep a safe distance from boat ahead.

WARNING

When crossing wakes, slow down. Operator and passenger(s) can brace themselves by posting. Do not jump waves or wakes.

Stopping/Docking

The craft is slowed by water drag. The stopping distance will vary depending on the craft size, weight, speed, water surface condition, presence and direction of wind and current.

The operator should become familiarized with the stopping distance under different conditions.

Between sunset and sunrise, turn on docking lights when docking.

Reduce speed to idle. Shift to neutral, reverse or forward as required.

WARNING

Directional control is reduced when throttle is released and lost when engine is off.

Low-Speed Steering Control System

Reducing RPM to IDLE activates the low-speed steering control feature as described previously. For more details, refer to Low-Speed Steering Control System above.

WARNING

Become familiar with this feature during your first ride.

Beaching

CAUTION: It is not recommended to run the craft to the beach.

Come slowly to the beach and shut off the engine using the safety lanyard when water depth is 90 cm (3 ft) under the hull, then pull the craft to the beach. Ensure that all accessories are OFF.

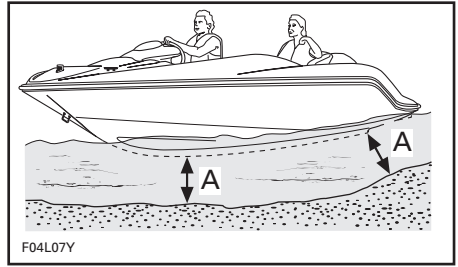

TYPICAL

A. 90 cm (3 ft) of water under the hull

WARNING

In shallow water, shells, sand, pebbles or other objects could be drawn up by the jet pump and be thrown rearward.

As necessary, the cooling system of the engine should be flushed before restarting, to remove sand or shell accumulation which may clog the water passages. Refer to POST-OPERATION CARE and look for Cooling System Flushing.

Shutting Off the Engine

Refer to *M² Jet Drive Operator's Guide*.

WARNING

Should the engine be shut off, craft directional control is not available. Never leave the safety lanyard connected on its switch when craft is not in operation.

POST-OPERATION CARE

WARNING

Allow engine to cool before performing any maintenance.

General Care

Should water be present in the bilge after use of bilge pump, unscrew the drain plug and tilt the craft to the rear in order to allow water to drain.

Wipe up any remaining fluid in the engine compartment (bilge, engine, etc.) with clean dry rags. This is particularly important in salt water use.

Remove the craft from the water every day to prevent marine organisms growth.

Additional Care for Foul Water or Salt Water

When the craft is operated in foul water and particularly in salt water, additional care must be taken to protect the craft and its components. Rinse trailer and craft's hull/deck and bilge area with fresh water.

NOTE: A garden hose plugged on wash down valve can be used to wash deck. See CONTROLS AND COMPONENTS LOCATION earlier in this guide.

CAUTION: Failure to perform proper care such as: craft rinsing, cooling system flushing and anticorrosion treatment, when used in salt water, will result in damage to the craft and its components. Never leave the craft stored in direct sunlight.

In coastal areas, a special care should also be taken on stainless steel or chrome parts like grab handles, mooring cleats, fuel cap, navigation lights and ski post (if so equipped). Rinse with fresh water. Clean with a good car chrome polish. Protect with a good car or fiberglass wax.

Cooling System Flushing

General

Flushing the cooling system with fresh water is essential to neutralize corroding effects of salt or other chemical products present in water. It will help to remove sand, salt, shells or other particles in water jackets (engine, exhaust manifold, tuned pipe) and/or hoses.

Flushing should be performed when the craft is not expected to be used further the same day or when the craft is stored for any extended time.

WARNING

Perform this operation in a well ventilated area.

Flushing

1. Clean jet pump by spraying water in its inlet and outlet and then apply a coating of BOMBARDIER LUBE lubricant or equivalent.
2. Open engine cover.
3. Connect a garden hose directly to the flushing connector, as shown in the next photo. **Do not open the water tap yet.**

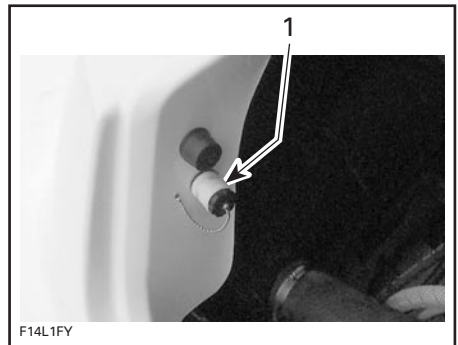

1. Flushing connector

Refer to *M² Jet Drive Operator's Guide* for complete engine flushing procedure.

SPECIAL PROCEDURE

Engine Overheating

CAUTION: If the monitoring beeper continuously sounds, stop engine immediately.

Refer to *M² Jet Drive Operator's Guide*.

If engine still overheats, refer to an authorized Sea-Doo dealer for servicing.

Potable Water System Disinfection

Potable water system disinfection should be performed at least once a year preferably at pre-season preparation.

Drainage

Remove both bilge drain plugs.

Open sink faucet and wash down valve.

Disconnect both hoses from main water pump by pulling black plastic tab on each side of the pump and pulling out the barb fitting on the outlet side and the filter fitting on the inlet side. See next photo.

Pull shower out of its receptacle completely then hold shower button until water is drained. Reinstall shower in its receptacle.

Water will drain in bilge.

Reconnect both hoses on pump by pushing both fittings back in place.

Disinfection

Fill potable water tank with approximately 15 L (4 U.S. gal) of potable water.

Add approximately 1 L (1/4 U.S. gal) of domestic liquid chlorine 1 percent then fill up tank with water.

NOTE: It is important to proceed in this order to allow proper mixing of the chlorine in the water.

Start main water pump.

Open sink faucet. As soon as chlorine solution starts flowing (chlorine is smelt), close faucet.

Repeat procedure for washdown valve and shower.

Stop pump.

Allow chlorine solution to stand in system for one hour.

Drain chlorine solution, as described herein before in **Drainage**.

Most of the chlorine solution will drain in the bilge. Use a container to recover it. **DISPOSE OF CHLORINE SOLUTION AS PER YOUR LOCAL LAWS AND REGULATIONS.**

Reconnect both fittings on pump.

Flushing

Fill potable water tank with fresh potable water.

Start main water pump.

Open sink faucet, shower and wash down valve to completely flush system.

Stop main pump when potable water tank is empty.

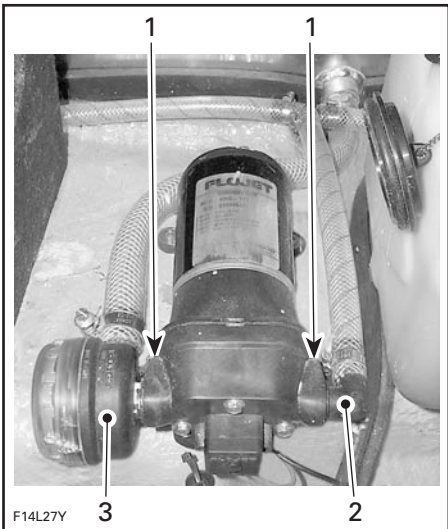

1. Pull black tabs here
2. Pull out barb fitting
3. Pull out filter fitting

Drain remaining water in system as described herein before in **Drainage**.

Reconnect both fittings on pump.

Refill

Fill system with fresh potable water.

Jet Pump Water Intake and Impeller Cleaning

WARNING

Keep away from intake grate while engine is on. Items such as long hair, loose clothing or personal flotation device straps can become entangle in moving parts resulting in severe injury or drowning.

Weeds, shells or debris can get caught on the intake grate, drive shaft and/or impeller. A clogged water intake may cause troubles such as:

1. **Cavitation:** Engine speed is high but craft moves slowly due to reduced jet thrust; jet pump components may be damaged.
2. **Overheating:** Since the jet pump operation controls the flow of water to cool the engine, a clogged intake will cause the engine to overheat and damage engine internal components.

The clogged area can be cleaned as described in *M² Jet Drive Operator's Guide*.

WARNING

Always remove safety lanyard cap from switch to prevent accidental engine starting before cleaning the jet pump area.

CAUTION: Avoid craft operation in weeded areas. If unavoidable, vary craft speed. Weeds tend to entangle more at steady and slow speeds. Inspect water intake grate for damage. Refer to an authorized Sea-Doo dealer for repair as necessary.

Capsized Boat

The boat is designed so that it should not turn over easily due to its long and wide dimensions. If the boat ever capsizes, remember that it will continue to float, and it is usually best to remain with it, you will be more easily located by others.

WARNING

When boat is capsized, do not attempt to restart the engine. Operator and passengers should always wear approved personal flotation devices.

Submerged Boat

WARNING

DO NOT attempt to restart engine. See an authorized dealer as soon as possible to service the engine.

Low-Charge Battery Condition

See your authorized Sea-Doo dealer to have it charged or replaced.

WARNING

See your authorized Sea-Doo dealer to have it charged or replaced. Do not charge or boost the battery while installed on the craft. Electrolyte is poisonous and dangerous.

MAINTENANCE

WARNING

Only perform procedure as detailed in this guide. It is recommended that the assistance of an authorized dealer be periodically obtained on other components/systems not covered in this guide and/or *M² Jet Drive Operator's Guide*. Unless otherwise specified, engine must not be running and the main battery cut-off switch must be turned OFF for all maintenance procedures.

Lubrication

Anticorrosion Protection

Throttle Cable

Lubricate the throttle cable with BOMBARDIER LUBE lubricant or equivalent, every 25 hours of use (every 10 hours in salt water use).

Electrical Connections

As necessary, apply dielectric grease on battery posts and all exposed cable connectors including stern light connectors on mat and craft.

Additional Lubrication

BOMBARDIER LUBE lubricant or equivalent will help to prevent corrosion and maintain proper operation of moving mechanisms.

Lubrication of the following items should be performed every 50 hours in fresh water use but every 10 hours in salt water use.

Engine Cover Mechanism and Hinges

Use BOMBARDIER LUBE lubricant or equivalent on metal parts.

Ski Post (if so equipped)



LUBRICATE SKI POST THREADS

1. Lubricate here

Convenience Center Storage Tray Rails

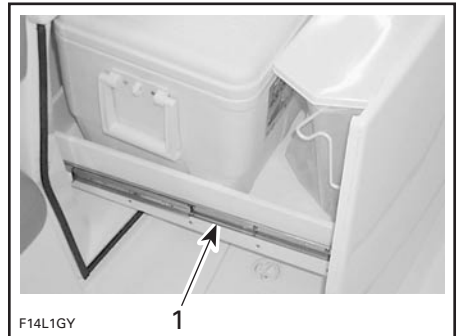

LUBRICATE ALL ALONG RAILS

1. Rails

Locks

Lubricate locks of glove box, convenience center storage trays, rear side storage compartment and deck storage compartment.

Engine Cover and Changing Room Cylinders

Lubricate rod of cylinders.

Periodic Inspection

Routine maintenance is necessary for all mechanized products. A periodic inspection contributes to the products life span.

Refer to the PERIODIC INSPECTION CHART at the end of this guide.

Throttle Cable

Activate the throttle lever throughout its full range of motion. It must operate smoothly. Refer to an authorized Sea-Doo dealer if adjustment is necessary.

⚠ WARNING

Do not alter or tamper with throttle cable adjustment or routing.

Fuel and Oil Filters

These filters should be replaced by an authorized dealer annually.

Refer to *M² Jet Drive Operator's Guide*.

Potable Water Filter

Pinch both hoses at pump location.

Unscrew clear cover from filter housing on water pump then clean filter.

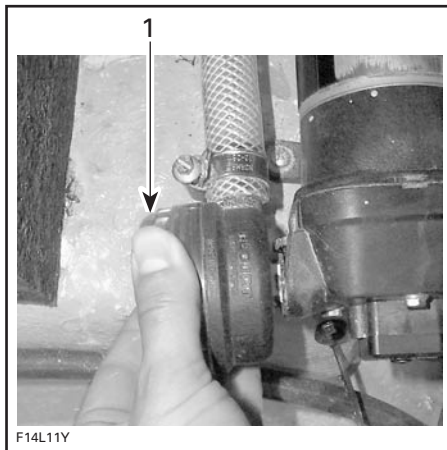

1. Remove this cover

Steering/Jet Pump Nozzle Adjustment

When the steering is directed in straight ahead position, the jet pump nozzle should be in the same direction to allow the craft to run in a straight line.

Refer to an authorized Sea-Doo dealer if an adjustment is necessary.

⚠ WARNING

Ensure the steering/jet pump nozzle operate freely from side to side and is not stressing the steering cable.

Reverse Gate

⚠ WARNING

Ensure the shifter and reverse gate operate freely and are not stressing the reverse cable.

Refer to an authorized Sea-Doo dealer if an adjustment is necessary.

Deck Drain(s)

Remove any obstruction from deck drain.

Fuses

Accessories, Craft Electrical System and Gauges

The main fuses and the bilge pump automatic switch fuse are located in engine compartment.

Main fuses feed the rest of the craft electrical system fuses on fuse block at helm location.

If a fuse is defective, replace by one of the same rating.

⚠ WARNING

Do not use a higher rated fuse as this can cause severe damage. If a fuse has burnt out. Source of malfunction should be determined and connected before restarting. See an authorized Sea-Doo sport boat dealer for servicing.

Squeeze cover locking tabs and pull cover out to access fuses.

Use the cover tabs to remove the fuse.

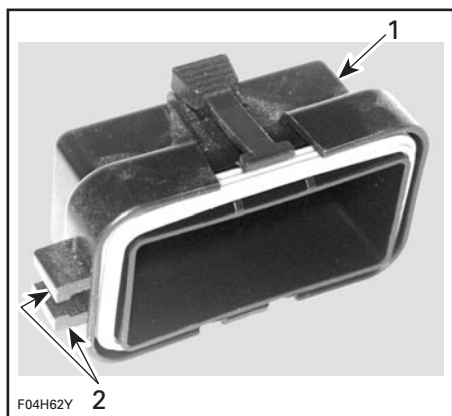

TYPICAL

1. Fuse block cover
2. Use these tabs as a fuse puller

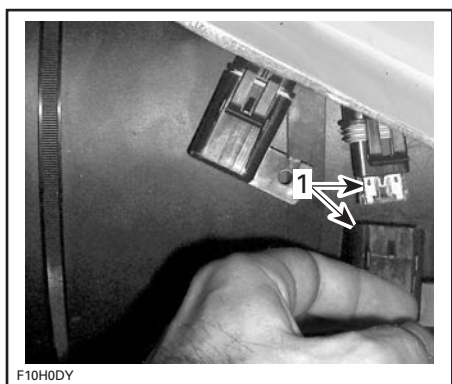

TYPICAL — ENGINE COMPARTMENT FUSES

1. Pull cap out then remove fuse

Engine

Refer to *M² Jet Drive Operator's Guide*.

Bilge Air Blower

Verify bilge air blower for proper operation. It is located inside engine compartment beneath ventilation duct.

Clean both openings. Ensure that both openings are not obstructed.

⚠ WARNING

If bilge blower does not operate refer to an authorized Sea-Doo dealer before starting the craft.

Navigation Light Bulb Replacement

Bow Light

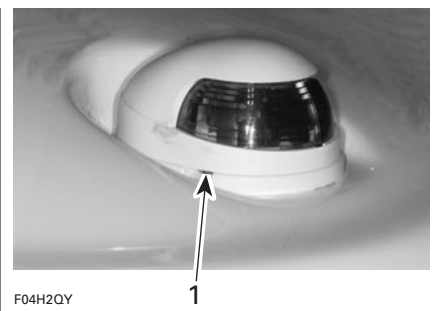

TYPICAL

1. Gently pry here with a screwdriver

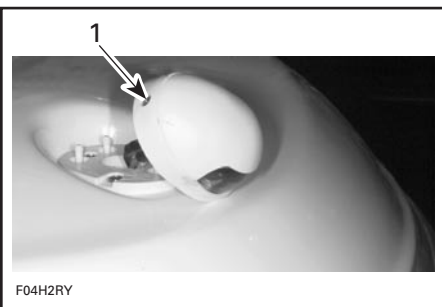

TYPICAL

1. Remove this screw

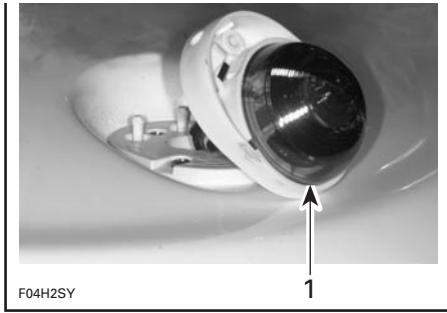

F04H2SY

TYPICAL

1. Pull lens out

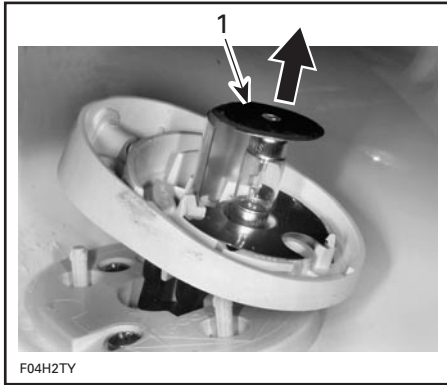

F04H2TY

TYPICAL

1. Lift and remove bulb

The assembly is essentially the reverse of removal procedures. However, pay particular attention to the following. Apply dielectric grease on bulb contact surface.

When installing the bulb under the upper terminal plate, it is possible that the bulb remains loose. The cover will compress the terminal plate against the bulb at reinstallation.

Stern Light

Unscrew lens counterclockwise and pull it out.

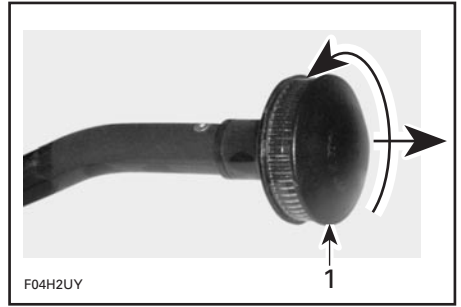

F04H2UY

TYPICAL

1. Unscrew then pull

Pull bulb to remove it.

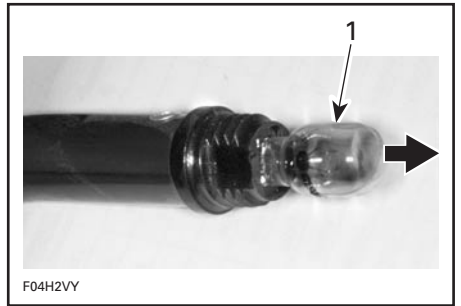

F04H2VY

TYPICAL

1. Pull bulb out

Apply dielectric grease on new bulb contact surface.

The assembly is the reverse of removal procedure.

Boarding Light

Remove both headlight screws to detach it from body.



1. Headlight cover

Pull rubber grommet out and then pull the blade type bulb out of its socket.

CAUTION: Do not use wires to pull rubber grommet.

Replace bulb with new one. Apply dielectric grease on contact surface.

To replace lens, simply loosen plastic nut then pull lens out of cover.

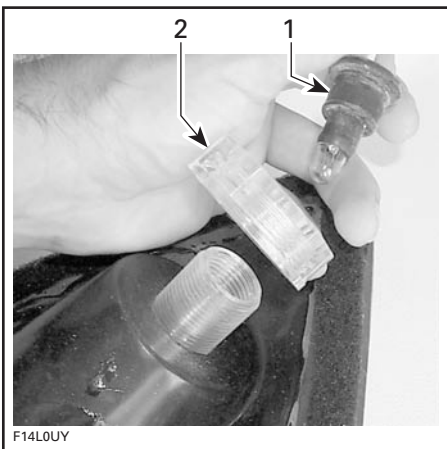

1. Grommet
2. Plastic nut

The assembly is the reverse of removal procedure.

Docking Light

Gently pull headlight cover to detach it from body. See **Boarding Light** hereinbefore

Remove light from its support.

Remove black metal cap on the back of the light held in place by two screws.

Remove burnt bulb and replace with new one.

CAUTION: Never touch glass portion of an halogen bulb with bare fingers, it shortens its operating life. If glass is touched, clean it using isopropyl alcohol which will remove film from bulb surface.

The assembly is the reverse of removal procedure.

Changing Room Light

Gently pull cover out and then replace bulb.

General Inspection and Cleaning

Inspection

Check engine compartment for any damage. Ensure all hose clamps are properly secured and no hose is cracked, kinked or presenting any other damage.

WARNING

If any gasoline leak and/or odors are present, do not start the engine. Have the craft serviced by an authorized Sea-Doo dealer.

Inspect muffler, battery, fuel tank and oil reservoir fastening devices. Visually check electrical connections for corrosion and tightness.

Inspect hull and jet pump water intake grate for damage. Replace or have damaged parts repaired.

Cleaning

The bilge should be cleaned by the dealer to remove any possible fuel/oil/electrolyte deposits and mildew.

Occasionally, wash the body with hot water and soap (only use mild detergent). Remove any marine organisms from engine and/or hull. Apply non-abrasive wax.

CAUTION: Never clean fiberglass and plastic parts with strong detergent, degreasing agent, paint thinner, acetone, etc.

Wash windscreen with Bombardier cleaner or equivalent (P/N 293 110 001 — 400 g) and water. For fine scratches and scuff marks removal, use a windshield polisher for acrylic, lucite, polycarbonate and similar materials.

Stains may be removed from seats, fiberglass surface with Knight's Spray-Nine* from Korkay System Ltd or the equivalent.

Respect the environment by ensuring fuel, oil or cleaning solutions do not drain into the waterways.

CONVENIENCE CENTER TOP AND TABLE TOP

When necessary, periodic washing with a liquid, general purpose, **non-abrasive** cleanser should keep most surfaces looking like new. For more stubborn stains, a **mild abrasive** cleanser can be used.

Avoid using cleansers that contain chlorine. Chlorine is a bleach and could discolor the surface.

General Washing Tips

- Remove dust from surface.
- Use a sponge versus a cloth to wash and rinse the surface.
- Change the wash and rinse solutions frequently.
- To avoid streaking when cleaning soiled areas, start with the adjacent clean area and clean into the soiled area.

STORAGE AND PRE-SEASON PREPARATION

WARNING

Because fuel and oil are flammable, have an authorized Sea-Doo sport boat dealer inspect the fuel and oil systems integrity as specified in the PERIODIC INSPECTION CHART.

Storage

It is recommended that the craft be taken to an authorized Sea-Doo dealer for proper storage but the following operations can be performed by you with a minimum of tools.

CAUTION: Do not run the engine during the storage period.

Fuel System

Refer to *M² Jet Drive Operator's Guide*.

Cooling System Flushing and Engine Internal Lubrication

Refer to *M² Jet Drive Operator's Guide*.

Potable Water System

Entire system must be drained and filled with biodegradable antifreeze solution, as follow:

DRAINAGE

Refer to **Drainage** in SPECIAL PROCEDURE section for complete detailed procedure.

ANTIFREEZING PROTECTION

In cool regions where freezing point temperature may be encountered, potable water system must be filled with a biodegradable antifreeze solution.

WARNING

Always use a biodegradable antifreeze solution specially formulated for potable water system protection. Refer to your authorized Sea-Doo dealer.

Add approximately 8 L (2 U.S. gal) of biodegradable antifreeze solution to potable water tank.

Start main water pump.

Open sink faucet. As soon as antifreeze solution starts flowing, close faucet.

Repeat procedure for washdown valve and shower.

Once all three items have been done, potable water system should now be completely filled.

Fountain Sump



F14L05Y

TURN VALVE TO THIS POSITION

Remove drain plug to completely drain sump.

Propulsion System

Refer to *M² Jet Drive Operator's Guide*.

Craft Cleaning/Repair

Wash the body and the trailer with soap and water solution (only use mild detergent). Rinse thoroughly with fresh water. Remove any marine organisms from the hull.

CAUTION: Never clean apparent fiberglass and plastic parts with strong detergent, degreasing agent, paint thinner, acetone, etc.

Stains may be removed from seats and fiberglass with Knight's Spray-Nine* from Korkay System Ltd or the equivalent.

If repairs are needed to the body or to the hull contact your dealer. For paint touch up to mechanical parts use Bombardier spray paint. For minor gelcoat repairs, a Bombardier repair kit is available. Replace damaged labels/decals.

Clean the bilge with hot water and detergent or with bilge cleaner. Rinse thoroughly. Unscrew drain plug(s) and lift front end of craft to completely drain bilge.

Battery

Contact your authorized Sea-Doo dealer.

Anticorrosion Treatment

Wipe off any residual water in the engine compartment.

Lubricate the throttle cable with BOMBARDIER LUBE lubricant or equivalent.

Finalizing Storage Preparation

Apply a non abrasive wax to body and stainless or chromed parts.

The engine cover should be left partially opened during storage. This will avoid engine compartment condensation and possible corrosion.

If the craft is to be stored outside, cover it with a vented opaque tarpaulin to prevent sun rays and grime from affecting the plastic components, craft finish as well as preventing dust accumulation.

CAUTION: Never leave the craft stored in direct sunlight. UV radiation will dull finishes. The craft must never be left in water for storage. Make sure to turn off main battery cut-off switch.

For the storage period, it is necessary to lift the bow up and safely block in this position so drainage can take place. Ensure the drain plugs are unscrewed.

Pre-Season Preparation

Use the PERIODIC INSPECTION CHART at the end of this document and refer to the pre-season column.

Since technical skills and special tools are required, some operations should be performed by an authorized dealer.

WARNING

Only perform procedure as detailed in this guide. It is recommended that the assistance of an authorized dealer be periodically obtained on other components/systems not covered in this guide and/or *M² Jet Drive Operator's Guide*. Unless otherwise specified, engine must not be running and the main battery cut-off switch must be turned OFF for all maintenance procedures.

PERIODIC INSPECTION CHART

	DESCRIPTION	FREQUENCY				
		FIRST 10 HOURS	EVERY 25 HOURS	EVERY 50 HOURS	EVERY 100 HOURS OR PRE-SEASON	TO BE PERFORMED BY
GENERAL	Fire extinguisher condition/mounting	✓			✓ ^②	O
	Lubrication/corrosion protection	①		✓	✓	O
ENGINE	Exhaust system fasteners/hoses	✓		✓	✓	D
COOLING SYSTEM	Flushing		✓ ^③			O
	Hose condition and fasteners	✓		✓	✓	D
FUEL SYSTEM	Throttle cable adjustments				✓	D
	Throttle/choke cables, inspection/lubrication	①	✓		✓	D
	Fuel filter and lines inspection	✓	✓		✓	D
	Fuel filter replacement				✓	D
	Fastener tightening (fuel lines)	✓		✓		D
	Fuel tank straps	✓				O
	Fuel tank Filling				✓ ^②	O
LUBRICATION SYSTEM	Oil lines inspection	✓	✓			D
	Oil reservoir straps	✓			✓	O
	Oil reservoir filling				✓ ^②	O
POTABLE WATER SYSTEM	Main and fountain water pumps operation	✓			✓ ^②	O
	Water filter cleaning		✓		✓	O
	Potable water system rinsing/disinfection				✓	D
	Hoses condition	✓			✓	D
ELECTRICAL SYSTEM	Main battery cut-off switch	✓	✓		✓	D
	Lights condition/operation	✓	✓		✓ ^②	D
	Bilge blower and bilge pump inspection	✓	✓		✓ ^②	D
	Electrical connections (ignition system, electrical box(es), starting system, etc.)	✓	✓		✓	D
	Safety lanyard cap/switch	✓			✓ ^②	D
	Monitoring beeper	✓		✓	✓	D
	Battery tightness	✓		✓	✓ ^②	D
	Battery charging				✓	D
	Sacrificial aluminum anode			✓		O
STEERING SYSTEM	Inspection and cable adjustment	✓		✓	✓	D

	DESCRIPTION	FREQUENCY				
		FIRST 10 HOURS	EVERY 25 HOURS	EVERY 50 HOURS	EVERY 100 HOURS OR PRE-SEASON	TO BE PERFORMED BY
LOW-SPEED STEERING SYSTEM	Inspection and throttle cable adjustment	✓		✓	✓	D
PROPULSION SYSTEM	Shifter system/cable adjustment	✓			✓	D
HULL AND BODY	Convenience center storage trays adjustment/lubrication	✓			✓	D
	Hull condition	✓			✓ ^②	O
	Windscreen and fasteners condition	✓	✓		✓	O
	Storage compartment cover locks lubrication	①		✓		O
	Deck drains/scupper valve cleaning	✓	✓		✓ ^②	O

NOTE: Some items are included in the PRE-OPERATION CHECKS and not necessarily repeated in this chart. Refer to *M² Jet Drive Operator's Guide* for engine and jet pump checks.

D: Dealer

O: Operator

① Every 10 hours in salt water use.

② Daily checked.

③ Daily flushing in salt water or foul water use.

④ Safety item covered in the annual safety inspection (owner's expenses).

SPECIFICATIONS

ENGINE		ISLANDIA
Number of engines		1
Engine type		V-6 Mercury engine, 2 stroke
Induction type		Reed valve
Exhaust system		Mercury type
Lubrication	Type	See Mercury specifications
	Oil type	See Mercury specifications
Number of cylinders		6
Displacement		2500 cm ³ (152.53 in ³)
COOLING		
Type		Water cooled
ELECTRICAL		
Ignition system type		Digital-CDI (Capacitor Discharge Ignition)
Spark plug	Make and type	See Mercury specifications
	Gap	See Mercury specifications
Starting system		Electric starter
Battery		Not supplied ①
Fuses (fuse block at helm location)	Courtesy lights	5 A
	Bilge air blower	7.5 A
	Bilge pump	7.5 A
	Navigation lights	3 A
	Gauges/Fuel/Battery	3 A
	Radio	5 A
	Horn system	3 A
	Jack system	10 A
	Boarding lights	4 A
	Docking lights	10 A
	Water pump	10 A
	Engine compartment light	2 A
Changing room light	2 A	
Fuses (engine compartment)	Fuse block feed	20 A (3 fuses)
	Bilge pump automatic switch	7.5 A
CARBURETION		
Fuel type		See Mercury specifications
Fuel system type		See Mercury specifications

PROPULSION	ISLANDIA
Propulsion system	Mercury Sport Jet
Number of jet pumps	1
Jet pump type	Mixed flow, single stage
Pivoting angle of direction (nozzle)	~ 26°
Minimum required water level for jet pumps	See Mercury specifications
DIMENSIONS	
Overall length	6.7 m (22 ft)
Beam	2.6 m (8 ft 6 in)
Draft	30 cm (12 in)
Dead rise	16°
Weight (dry)	1383 kg (3050 lb)
Load limit (passengers + luggage)	12 passengers
	805 kg (1775 lb) (based on calm water operation)
Hull material	Composite (fiberglass)
CAPACITIES	
Fuel tank (reserve included)	208 L (55 U.S. gal)
Main oil reservoir	11 L (3 U.S. gal)
Potable water tank	76 L (20 U.S. gal)

① Recommended Batteries:

TYPE	12 volt (deep cycle)
POST TYPE	On top round taper
MARIN CRANKING AMPS (MCA)	670 minimum
COLD CRANKING AMPS (CCA)	520 minimum
MAXIMUM ALLOWED SIZE	304 mm (12 in) long 171 mm (6-3/4 in) wide 238 mm (9-3/8 in) high
GROUP	27

BOMBARDIER reserves the right to make changes in design and specifications and/or to make additions to, or improvements in its products without imposing any obligation upon itself to install them on its products previously manufactured.

SI* METRIC INFORMATION GUIDE

BASE UNITS

DESCRIPTION	UNIT	SYMBOL
length	meter	m
mass	kilogram	kg
force	newton	N
liquid	liter	L
temperature	Celsius	°C
pressure	kilopascal	kPa
torque	newton-meter	N•m
land velocity	kilometer per hour	km/h
navigation velocity	knot	kn

PREFIXES

PREFIX	SYMBOL	MEANING	VALUE
kilo	k	one thousand	1000
centi	c	one hundredth of	0.01
milli	m	one thousandth of	0.001
micro	μ	one millionth of	0.000001

CONVERSION FACTORS

TO CONVERT	TO ①	MULTIPLY BY
in	mm	25.4
in	cm	2.54
in ²	cm ²	6.45
in ³	cm ³	16.39
ft	m	0.3
oz	g	28.35
lb	kg	0.45
lbf	N	4.4
lbf•in	N•m	0.11
lbf•ft	N•m	1.36
lbf•ft	lbf•in	12
PSI	kPa	6.89
imp. oz.	U.S. oz.	0.96
imp. oz.	mL	28.41
imp. gal.	U.S. gal.	1.2
imp. gal.	L	4.55
U.S. oz.	mL	29.57
U.S. gal.	L	3.79
knot	MPH	1.15
MPH	km/h	1.61
Fahrenheit	Celsius	(°F - 32) ÷ 1.8
Celsius	Fahrenheit	(°C x 1.8) + 32
hp	kW75

* The international system of units abbreviates SI in all languages.

① To obtain the reverse sequence, divide by the given factor. Example: to convert millimeters to inches, divide by 25.4.

NOTE: Conversion factors are rounded off to 2 decimals for easier use.



DECLARATION OF CONFORMITY

Application of Council Directives: 94/25/CE — Recreational craft
89/336/CEE — Electromagnetic compatibility

Standards to which conformity is declared: ISO 7840, ISO 8469, ISO 8665, ISO 8846,
ISO 8848, ISO 8849, ISO 9094, ISO 9097,
ISO 10087, ISO 10088, ISO 10133, ISO 10240,
ISO 11105, ISO 11591, ISO 11592, ISO 12215,
ISO 12216, ISO 13592, COLREGS, ABYC H-5,
ABYC H-8

Manufacturer's name: Bombardier Motor Corporation of America.

Manufacturer's address: 451 E. Illinois Ave
Benton, Illinois
62812-0394

Importer's name: Société ANF — Industrie S.A.

Importer's address: 2, rue du Nouveau Bercy
94220 Charenton
Paris, France

Notified body for Directive 94/25/CE: International Marine Certification Institute
Trèves centre, rue de Trèves 45
1040 Brussels, Belgium

Competent body for Directive 89/336/CEE: UTAC
Autodrome de Linas-Montlhéry, B.P. 212
91311 Montlhéry cedex, France

Type of equipment: Sport boats, inshore category C

Model names: _____
Model name

Model number(s)

I, the undersigned, hereby declare that the equipment specified above conforms to the above Directives and Standards.

Name of signatory: Fernando Garcia

Title of signatory on behalf of Bombardier Motor Corporation of America: Director - Public and Regulatory Affairs —
Sea-Doo sport boats

Homologation and Certification

These boats comply with the following standards:

STANDARD	TYPE OF CERTIFICATION
United States Coast Guard	Self certification
Canadian Coast Guard	Self certification
Russian Maritime Register of Shipping	Certify by Russian Maritime Register of Shipping 8, Dvortsovaya Nab., 191186 St. Petersburg, Russia
Directive 89/336/CEE of the council relating to electromagnetic compatibility	Internal production control plus control carried out on the responsibility of a competent body. Competent body: UTAC Autodrome de Linas-Montlhéry, B.P. 212 91311 Montlhéry cedex, France
Directive 94/25/EC of the European Parliament and of the council relating to recreational craft	Internal production control plus control carried out on the responsibility of a notified body. Notified body: International Marine Certification Institute Trèves centre, rue de Trèves 45 1040 Brussels, Belgium

Operator's Guide Confirmation of Receipt

Your dealer

Name:	_____

Address:	_____

Will assist you and help you to resolve any problems you may have.

Upon delivery of your sport boat, complete and sign the form hereunder and forward it to your dealer in order to be covered by our warranty.

Warranty conditions are as detailed in the Warranty Section of this guide.

----- Cut here

Receipt	
Name:	_____
Address:	_____
Owner of _____	Sport Boat model No. _____
HIN (to be completed by customer or selling dealer) _____	
This warranty begins _____ (date).	
The dealer named on this document has instructed me on the operation, maintenance, safety features and warranty policy, all of which I understand and agree to be bound with. I am also satisfied with the predelivery set-up and inspection of my Sea-Doo sport boat. I have also received a copy of the <i>Operator's Guide, Safety Handbook and Safety Videocassette</i> for my Sea-Doo sport boat.	
Signature: _____	
Date: _____	



BOMBARDIER
RECREATIONAL PRODUCTS



AFFIX
PROPER
POSTAGE

BOMBARDIER
RECREATIONAL PRODUCTS
WARRANTY DEPARTMENT
75, J.A. BOMBARDIER ST.
SHERBROOKE (QUEBEC)
CANADA J1L 1W3

SPORT BOAT MODEL No. _____

HULL IDENTIFICATION NUMBER (H.I.N.) _____

MERCURY OR ROTAX ENGINE IDENTIFICATION NUMBER (E.I.N.) _____

Owner: _____
NAME

No. STREET APT

CITY STATE/PROVINCE ZIP/POSTAL CODE

Purchase Date _____
YEAR MONTH DAY

Warranty Expiry Date _____
YEAR MONTH DAY

To be completed by the dealer at the time of the sale.

DEALER IMPRINT AREA

Please verify with your selling dealer to ensure your SEA-DOO craft has been registered with Bombardier.



BOMBARDIER
RECREATIONAL PRODUCTS

*Trademarks of Bombardier Inc. and/or its subsidiaries.
© 2000 Bombardier Inc. All right reserved.
Printed in Canada.

