

ski-doo®



2016

OPERATOR'S GUIDE

Includes
Safety, Vehicle
and Maintenance Information

Tundra™ Series

WARNING

Read this guide thoroughly.
It contains important safety information.
Minimum recommended operator's age: 16 years old.
Keep this Operator's Guide in the vehicle.

5 2 0 0 0 1 5 5 4

Original Instructions

WARNING

Disregarding any of the safety precautions and instructions contained in this Operator's Guide, *SAFETY DVD* video and on-product safety labels could cause injury including the possibility of death!

WARNING

This vehicle may exceed the performance of other vehicles you may have ridden. Take time to familiarize yourself with your new vehicle.

CALIFORNIA PROPOSITION 65 WARNING

WARNING

This vehicle contains or emits chemicals known to the state of California to cause cancer and birth defects or other reproductive harm.



In USA, products are distributed by BRP US Inc.

In Canada, products are distributed by Bombardier Recreational Products Inc.

The following are trademarks of Bombardier Recreational Products Inc. or its subsidiaries.

SKI-DOO®	RER™	ROTAX®	TRA™
HPG™	REV-XPT™	SCT™	XPS™
eDrive™	600 ACE™	D.E.S.S.™	Tundra™
E-TEC®	RAVE™		

Radio Frequency Digitally Encoded Security System (RF D.E.S.S.)

Industry Canada Certification:

This device complies with RSS-GEN and RSS-210 of Industry Canada.

FCC Certification:

FCC: 2ACERM01456

The following device is in compliance with FCC part 15C.

Warning to the user: Any changes /modifications not approved by the manufacturer could void the user's authority to operate the equipment.

European Conformity

The following device is in compliance with the following standards:

ETSI EN 300 330-2

ETSI EN 60950-1

FOREWORD

Deutsch	Dieses Handbuch ist möglicherweise in Ihrer Landessprache verfügbar. Bitte wenden Sie sich an Ihren Händler oder besuchen Sie: www.operatorsguide.brp.com .
English	This guide may be available in your language. Check with your dealer or go to: www.operatorsguide.brp.com .
Français	Ce guide peut être disponible dans votre langue. Vérifier avec votre concessionnaire ou aller à: www.operatorsguide.brp.com .
Italiano	Questa guida potrebbe essere disponibile nella propria lingua. Contattare il concessionario o consultare: www.operatorsguide.brp.com .
日本語	このガイドは、言語によって翻訳版が用意されています。ディーラーに問い合わせるか、次のアドレスでご確認ください： www.operatorsguide.brp.com .
Norsk	Denne boken kan finnes tilgjengelig på ditt eget språk. Kontakt din forhandler eller gå til: www.operatorsguide.brp.com .
Русский	Воспользуйтесь руководством на вашем языке. Узнайте о его наличии у дилера или на странице по адресу www.operatorsguide.brp.com .
Suomi	Käyttöohjekirja voi olla saatavissa omalla kielelläsi. Tarkista jälleenmyyjältä tai käy osoitteessa: www.operatorsguide.brp.com
Svenska	Denna bok kan finnas tillgänglig på ditt språk. Kontakta din återförsäljare eller gå till: www.operatorsguide.brp.com .

Congratulations on your purchase of a new Ski-Doo® snowmobile. Whatever model you have chosen, it is backed by the Bombardier Recreational Products Inc. (BRP) warranty and a network of authorized Ski-Doo snowmobile dealers ready to provide the parts, service or accessories you may require.

Your dealer is committed to your satisfaction. He has taken training to perform the initial set-up and inspection of your snowmobile as well as completed the final adjustment required to suit your specific weight and riding environment before you took possession.

At delivery, you were informed of the warranty coverage and signed the *PREDELIVERY CHECK LIST* to ensure your new vehicle was prepared to your entire satisfaction.

Know Before you Go

To learn how to reduce the risk for you, your passenger or bystanders being injured or killed, read the following sections before you operate the vehicle:

- *SAFETY INFORMATION*
- *VEHICLE INFORMATION*.

Also read all safety labels on your snowmobile and watch attentively your *SAFETY DVD* video.

We highly recommend that you take a safety riding course. Please check with your dealer or local authorities for availability in your area.

Failure to follow the warnings contained in this Operator's Guide can result in **SERIOUS INJURY** or **DEATH**.

Safety Messages

The types of safety messages, what they look like and how they are used in this guide are explained as follows:

The safety alert symbol  indicates a potential injury hazard.

 WARNING
Indicates a potential hazard, if not avoided, could result in serious injury or death.

 **CAUTION** Indicates a hazard situation which, if not avoided, could result in minor or moderate injury.

NOTICE Indicates an instruction which, if not followed, could severely damage vehicle components or other property.

About this Operator's Guide

This Operator's Guide has been prepared to acquaint the owner/operator and passenger with this snowmobile and its various controls, safe riding and maintenance instructions.

The following terminology in regards to operator, passenger and vehicle seat configuration is used as follows throughout this guide:

- **Operator:** refers to the person being behind the controls and driving the snowmobile.
- **Passenger:** refers to a person sitting behind the operator.
- **1-UP:** refers to a model designed for an operator only.
- **2-UP:** refers to a model designed to accommodate **one** passenger.

Keep this Operator's Guide in the vehicle as you can refer to it for things such as maintenance, troubleshooting and instructing others.

Note that this guide is available in several languages. In the event of any discrepancy, the English version shall prevail.

If you want to view and/or print an extra copy of your Operator's Guide, simply visit the following website www.operatorsguide.brp.com.

The informations contained in this document are correct at the time of publication. BRP, however, maintains a policy of continuous improvement of its products without imposing upon itself any obligation to install them on products previously manufactured. Due to late changes, some differences between the manufactured product and the descriptions and/or specifications in this guide may occur. BRP reserves the right at any time to discontinue or change specifications, designs, features, models or equipment without incurring any obligation upon itself.

This Operator's Guide and the *SAFETY DVD* video should remain with the vehicle when it's sold.

TABLE OF CONTENTS

FOREWORD	1
Know Before you Go	1
Safety Messages.....	2
About this Operator's Guide	2

SAFETY INFORMATION

GENERAL PRECAUTIONS	8
Avoid Carbon Monoxide Poisoning	8
Avoid Gasoline Fires and Other Hazards	8
Avoid Burns from Hot Parts	8
Accessories and Modifications	8
SPECIAL SAFETY MESSAGES	9
ACTIVE TECHNOLOGIES (iTc) (600 ACE)	13
Introduction.....	13
iTc (intelligent Throttle Control)	13
RIDING THE VEHICLE	14
Pre-Ride Inspection	14
How to Ride	15
Carrying a Passenger	17
Terrain/Riding Variations	18
Environment.....	22
TRACTION ENHANCING PRODUCTS	25
Manoeuvrability	25
Acceleration	26
Braking	26
Important Safety Rules	26
Effects of Having a Studded Track on the Life of the Snowmobile.....	27
Installation of Studs on BRP Approved Tracks	27
Inspection.....	28
IMPORTANT ON PRODUCT LABELS	29
Hang Tag(s)	29
Vehicle Safety Labels	29
Compliance Labels.....	36
Technical Information Labels.....	37

VEHICLE INFORMATION

CONTROLS, INSTRUMENTS AND EQUIPMENT	40
1) Handlebar	42
2) Throttle Lever.....	43
3) Brake Lever	44
4) Parking Brake Lever	44
5) Engine Cut-Off Switch	45
6) Emergency Engine Stop Switch	46

CONTROLS, INSTRUMENTS AND EQUIPMENT (cont'd)	
7) Ignition Switch (550F)	47
8) Choke Lever (550F)	47
9) Multifunction Switch (Sport, LT and Xtreme).....	47
10) Shift Lever (600 ACE)	48
11) Rewind Starter Handle	48
12) Operator's Guide.....	48
13) Seat	49
14) Tool Kit	50
15) Front and Rear Bumpers	50
16) Gauge (550F)	51
17) Gauge (600 ACE and 600 HO E-TEC).....	53
18) Mountain Strap.....	56
19) Rear Rack (All Models Except Tundra Xtreme)	56
20) Hitch	56
21) Spare Drive Belt.....	58
22) Drive Belt Guard.....	58
23) Hood	59
24) Side Panels	60
25) Passenger Handhold	61
FUEL.....	62
Fuel Requirements.....	62
Vehicle Fueling Procedure.....	63
INJECTION OIL (550F AND 600 HO E-TEC).....	64
Recommended Injection Oil	64
Injection Oil Level Verification.....	65
BREAK-IN PERIOD.....	66
Operation During Break-In.....	66
OPERATING MODES (600 ACE ONLY).....	67
ECO Mode (Fuel Economy Mode).....	67
Standard Mode	67
Sport Mode	67
Navigating Operating Modes	67
Learning Key Modes.....	68
BASIC PROCEDURES	69
Engine Starting Procedure (550F).....	69
Engine Starting Procedure (600 ACE and 600 HO E-TEC)	69
Emergency Starting.....	70
Vehicle Warm-Up.....	71
Shifting in Reverse or Forward.....	72
Shutting Off the Engine.....	73
RIDING CONDITIONS AND YOUR SNOWMOBILE	74
Altitude.....	74
Temperature	74
Hard Packed Snow	74

SPECIAL OPERATION **75**
 Towing an Accessory 75
 Towing Another Snowmobile 75

TUNE YOUR RIDE **76**
 Rear Suspension Adjustments 76
 Adjustment Tips According to Vehicle Behavior 82

VEHICLE TRANSPORTATION **83**

MAINTENANCE

FIRST INSPECTION **86**

MAINTENANCE SCHEDULE (550F) **89**

MAINTENANCE SCHEDULE (600 ACE) **91**

MAINTENANCE SCHEDULE (600 HO E-TEC) **93**

MAINTENANCE PROCEDURES **95**
 Air Filter 95
 Engine Coolant (600 ACE and 600 HO E-TEC) 95
 Engine Oil (600 ACE) 96
 Exhaust System 97
 Spark Plugs (550F) 97
 Spark Plugs (600 ACE and 600 HO E-TEC) 98
 Engine Stopper (600 HO E-TEC) 98
 Brake Fluid 99
 Chaincase Oil 100
 Drive Chain 101
 Drive Belt 103
 Drive Pulley 105
 Track 106
 Suspension 110
 Skis 111
 Fuses 111
 Lights 112

VEHICLE CARE **116**
 Post-Operation Care 116
 Vehicle Cleaning and Protection 116

STORAGE **117**
 Engine Lubrication 117

PRESEASON PREPARATION **120**

TECHNICAL INFORMATION

VEHICLE IDENTIFICATION **124**
 Vehicle Description Decal 124
 Identification Numbers 124

EC DECLARATION OF CONFORMITY	126
EPA CERTIFIED ENGINES	127
Engine Emissions Information	127
SPECIFICATIONS	128

TROUBLESHOOTING

TROUBLESHOOTING GUIDELINES (550F)	138
TROUBLESHOOTING GUIDELINES (600 ACE)	140
TROUBLESHOOTING GUIDELINES (600 HO E-TEC)	142
MONITORING SYSTEM (600 ACE AND 600 HO E-TEC)	145
Pilot Lamps, Messages and Beeper Codes.....	145

WARRANTY

BRP LIMITED WARRANTY USA AND CANADA: 2016 SKI-DOO® SNOWMOBILES	150
US EPA EMISSION-RELATED WARRANTY	154
BRP INTERNATIONAL LIMITED WARRANTY: 2016 SKI-DOO® SNOWMOBILES	157
BRP LIMITED WARRANTY FOR THE EUROPEAN AND THE COMMONWEALTH OF THE INDEPENDENT STATES (CIS) AREAS AND TURKEY: 2016 SKI-DOO® SNOWMOBILES	161

CUSTOMER INFORMATION

PRIVACY INFORMATION	168
CHANGE OF ADDRESS/OWNERSHIP	169

SAFETY INFORMATION

GENERAL PRECAUTIONS

Avoid Carbon Monoxide Poisoning

All engine exhaust contains carbon monoxide, a deadly gas. Breathing carbon monoxide can cause headaches, dizziness, drowsiness, nausea, confusion and eventually death.

Carbon monoxide is a colorless, odorless, tasteless gas that may be present even if you do not see or smell any engine exhaust. Deadly levels of carbon monoxide can collect rapidly, and you can quickly be overcome and unable to save yourself. Also, deadly levels of carbon monoxide can linger for hours or days in enclosed or poorly ventilated areas. If you experience any symptoms of carbon monoxide poisoning, leave the area immediately, get fresh air and seek medical treatment.

To prevent serious injury or death from carbon monoxide:

- Never run the vehicle in poorly ventilated or partially enclosed areas such as garages, carports or barns. Even if you try to ventilate engine exhaust with fans or open windows and doors, carbon monoxide can rapidly reach dangerous levels.
- Never run the vehicle outdoors where engine exhaust can be drawn into a building through openings such as windows and doors.

Avoid Gasoline Fires and Other Hazards

Gasoline is extremely flammable and highly explosive. Fuel vapors can spread and be ignited by a spark or flame many feet away from the engine. To reduce the risk of fire or explosion, follow these instructions:

- Use only an approved gasoline container to store fuel.
- Strictly adhere to instructions in *FUELING PROCEDURE*.
- Never start or operate the engine if the fuel cap is not properly installed.

Gasoline is poisonous and can cause injury or death.

- Never siphon gasoline by mouth.
- If you swallow gasoline, get any in your eye or inhale gasoline vapor, see your doctor immediately.

If gasoline spills on you, wash with soap and water and change your clothes.

Avoid Burns from Hot Parts

The exhaust system and engine become hot during operation. Avoid contact during and shortly after operation to avoid burns.

Accessories and Modifications

Do not make unauthorized modifications, or use attachments or accessories that are not approved by BRP. Since these changes have not been tested by BRP, they may increase the risk of crashes or injuries, and they can make the vehicle illegal.

Accessory passenger seats approved by BRP and conforming to SSCC standards may be available for certain models. If such a seat is used, you must follow the guidelines and recommendations in regards to a passenger in this guide.

WARNING

Passenger seat must have a strap or handholds and must meet SSCC standards.

See your authorized Ski-Doo dealer for available accessories for your vehicle.

SPECIAL SAFETY MESSAGES

SEVERE INJURY OR DEATH can result if you do not follow these instructions:

- Always make a pre-ride inspection **BEFORE** you start the engine.
- Throttle mechanism should be checked for free movement and return to idle position before starting engine.
- Always attach tether cord eyelet to clothing before starting the engine.
- Never operate the engine without belt guard and brake disk guard securely installed or, with hood or side panels opened or removed. Never run the engine without drive belt installed. Running an unloaded engine such as without drive belt or with track raised, can be dangerous.
- Always engage parking brake before starting the engine.
- Everyone is a beginner the first time he sits behind the controls of a snowmobile regardless of previous experience in driving any other type of vehicle. The safe use of your snowmobile depends on many conditions such as visibility, speed, weather, environment, traffic, vehicle condition and the condition of the operator.
- Basic training is required for the safe operation of any snowmobile. Study your Operator's Guide paying particular attention to cautions and warnings. Join your local snowmobile club: its social activities and trail systems are planned for both fun and safety. Obtain basic instructions from your snowmobile dealer, friend, fellow club member or enroll in your state or provincial safety training program.
- Any new operator must read and understand all safety labels on the snowmobile, the Operator's Guide and watch the *SAFETY DVD* video before operating the snowmobile. Only allow a new operator to operate the snowmobile in a restricted flat area, at least until he is completely familiar with its operation. If snowmobile operator's training course is offered in your area, have him enroll.
- The performance of some snowmobiles may significantly exceed that of other snowmobiles you have operated. Therefore, use by novice or inexperienced operators is not recommended.
- Snowmobiles are used in many areas and in many snow conditions. Not all models perform the same in similar conditions. Always consult your snowmobile dealer when selecting the snowmobile model for your particular needs and uses.
- Injury or death may result to the snowmobile operator, passenger or bystander if the snowmobile is used in risky conditions which are beyond the operator's, passenger's or snowmobile's capabilities or intended use.
- BRP recommends the operator has at least 16 years old of age. Verify also your local laws for age and training requirements.
- The novice operator should become familiar with the snowmobile through practice on a level area at slow speeds before venturing far afield.
- It is very important to inform any operator, regardless of his experience, of the handling characteristics of this snowmobile. The snowmobile configuration, such as ski stance, ski type, suspension type, track length, width and type vary from a model to another. The snowmobile handling is greatly influenced by these characteristics.

- Know your local laws. Federal, state, provincial and local government agencies have enacted laws and regulations pertaining to the safe use and operation of snowmobiles. It is your responsibility as a snowmobiler to learn and obey these laws and regulations. Respect and observance will result in safer snowmobiling for all. Be aware of the liability property damages and insurance laws regarding your equipment.
- Speeding can be fatal. In many cases, you cannot react or respond quickly enough to the unexpected. Always ride at a speed which is suitable to the trail, weather conditions and your own ability. Know your local rules. Speed limit may be in effect and meant to be observed.
- Always keep right hand side of the trail.
- Always keep a safe distance from other snowmobiles and bystanders.
- Remember, promotional material may show risky maneuvers performed by professional riders under ideal and/or controlled conditions. You should never attempt any such risky maneuvers if they are beyond your level of riding ability.
- Never use this vehicle with drugs or alcohol. They slow reaction time and impair judgement.
- Your snowmobile is not designed to be operated on public streets, roads or highways.
- Avoid road traveling. If you must do so, and it is permitted, reduce speed. The snowmobile is not designed to operate or turn on paving. When crossing a road, make a full stop, then look carefully in both directions before crossing at a 90° angle. Be wary of parked vehicles.
- Snowmobiling at night can be a delightful experience but because of reduced visibility, be extra cautious. Avoid unfamiliar terrain and be sure your lights are working. Always carry a flashlight and spare light bulbs.
- Never remove any original equipment from your snowmobile. Each vehicle has many built in safety features. Such features include various guards and consoles, plus reflective materials and safety labels.
- Nature is wonderful but don't let it distract your attention from driving. If you want to truly appreciate winter's scenery, stop your snowmobile on the side of the trail so that you don't become a hazard to others.
- Fences represent a very serious threat for both you and your snowmobile. Give a wide berth to telephone poles or posts.
- Hidden wires unseen from a distance can cause serious accidents.
- Always wear an approved safety helmet, eye protection and a face shield. This also applies to your passenger.
- Be aware of inherent risks associated with riding off trails, such as avalanche and other natural or man made hazards or obstacles.
- Tailgating another snowmobile should be avoided. If the snowmobile in front of you slows for any reason, its operator and passenger could be harmed through your neglect. Maintain a safe stopping distance between you and the snowmobile in front of you. Depending on the terrain condition, stopping may require a little more space than you think. Play it safe. Be prepared to use evasive driving.

- Venturing out alone with your snowmobile could also be hazardous. You could run out of fuel, have an accident, or damage your snowmobile. Remember, your snowmobile is capable of traveling further in half an hour than you may be able to walk in a day. Use the “buddy system”. Always ride with a friend or member of your snowmobile club. Even then, tell someone where you are going and the approximate time you plan to return.
- Meadows sometimes have low areas where water accumulate and freezes over in winter. This ice is usually glare ice. Attempting to turn or brake on this surface could cause your vehicle to spin out of control. Never brake or attempt speeding or turning on glare ice. If you do happen to travel over such a condition, reduce speed by carefully releasing the throttle.
- Never “jump” with your snowmobile.
- While on safari, do not “gun” the throttle. Snow and ice can be thrown back into the path of a following snowmobile. In addition, when “gunning” the throttle, the vehicle digs into and leaves an irregular snow surface for others.
- Safaris are both fun and enjoyable but don’t show off or overtake others in the group. A less experienced operator might try to do the same as you and fail. When riding with others, limit your abilities to the experience of others.
- In an emergency, the snowmobile engine can be stopped by pressing down on the emergency engine stop switch or by pulling the tether cord cap from the engine cut-off switch, then apply brake.
- Always engage parking brake when vehicle is not in use.
- Never run the engine in a non-ventilated area and/or if vehicle is left unattended.
- **Electric start models only:** Never charge or boost a battery while installed on snowmobile.
- E-TEC engines: Never attempt any fuel system or electrical system maintenance or repair. Any maintenance or repair of these systems must be performed by an authorized Ski-Doo dealer.
- Ensure the path behind is clear of obstacles or bystanders before proceeding in reverse.
- Always remove the tether cord cap and key when vehicle is not in operation in order to prevent accidental engine starting, to avoid unauthorized use by children or others or theft.
- NEVER stand behind or near a rotating track. Debris could be projected causing severe injuries. To remove packed snow or ice, stop engine, tilt and hold vehicle on its side and use screwdriver from tool kit.
- Do not stud the track unless it has been approved for studs. At speed, a studded track that has not been approved for studs could tear and separate from vehicle. See an authorized Ski-Doo dealer for current specific studding availability and applications.
- You may stud the track on this vehicle model. However, you MUST only use the BRP approved type stud for use on Ski-Doo snowmobiles. DO NOT EVER use conventional studs because the track thickness is thinner than our standard tracks. The stud could tear off of track and separate from vehicle.
- Always wear an approved helmet and follow the same dressing guidelines as those recommended for the operator and described in this guide.
- Make sure that you are able to achieve a stable stance, both feet resting positively on the footboards of footrests with good grip, and that you are able to hold on firmly to the handholds.

- Do not forget, with 2-UP models, the operator is responsible for the safety of the passenger. Always remember that the snowmobile handling, stability and braking distance may be affected when riding with a passenger.
- Before riding the vehicle, ask your passenger to inform you to slowdown or stop immediately if he feels uncomfortable or insecure during the ride. Keep a watchful eye on your passenger while riding.

ACTIVE TECHNOLOGIES (iTC) (600 ACE)

Introduction

NOTE: Some functions or features described in this section may not apply to every model, or may be available as an option.

The throttle is electronic and provides a command signal to an electronic module whose function is to assure proper operation of its system within set parameters.

It is extremely important for operators to read all information contained in this operator's guide so as to become familiar with this snowmobile, its systems, controls, capabilities and limitations.

iTC (intelligent Throttle Control)

The system uses an electronic throttle control (ETC) that provides command signals to the ECM (Engine Control Module). With this system, there is no need for a traditional throttle cable.

The iTC allows the following operating modes:

- ECO mode
- Standard mode
- Sport mode.

ECO Mode

When ECO mode is selected (fuel economy mode), vehicle torque and speed are limited whereby an optimal cruising speed is maintained in order to reduce fuel consumption.

Refer to *OPERATING MODES* subsection for detailed instructions.

Standard Mode

In standard mode, acceleration is reduced when accelerating from a complete stop and when operating in the low vehicle speed range under certain conditions.

Sport Mode

In sport mode, maximum engine power is available throughout the engine operational range.

Refer to *OPERATING MODES* subsection for detailed instructions.

Learning Key Modes

The Ski-Doo™ learning key limits the torque and speed of the snowmobile therefore enabling first time users and less experienced operators to learn how to operate the snowmobile while gaining the necessary confidence and control.

Limitations

The ability of a novice to operate the snowmobile can be exceeded even when a learning key is used.

Refer to *OPERATING MODES* subsection for details.

RIDING THE VEHICLE

Each operator has a responsibility to ensure the safety of other recreationists or bystanders.

You are responsible for proper operation of your vehicle as well as training those whom you allow to ride or drive. There may be noticeable handling and performance differences from one snowmobile to the other.

A snowmobile is relatively simple to operate but like any other vehicle or mechanical equipment, it can be hazardous if you or a passenger are reckless, thoughtless or inattentive. We encourage you to have an Annual Safety Inspection of your snowmobile. Please contact an authorized Ski-Doo dealer for further details. Though not required, it is recommended that an authorized Ski-Doo dealer performs the preseason preparation of your snowmobile. Each visit to your authorized Ski-Doo dealer is a great opportunity for your dealer to verify if your snowmobile is included in any safety campaign. We also urge you to visit your authorized Ski-Doo dealer in a timely manner if you become aware of any safety related campaigns.

See an authorized Ski-Doo dealer for available accessories you may require.

Before venturing on the trails, operate the snowmobile in a restricted flat area until you are completely familiar with its operation and feel comfortable that you can safely tackle a more demanding task. Have an enjoyable and safe ride.

Pre-Ride Inspection

WARNING

The pre-operation check is very important prior to operating the vehicle. Always check the proper operation of critical controls, safety features and mechanical components before starting.

Before Starting the Engine

1. Remove snow and ice from body including lights, seat, footrests, controls and instruments.
2. Verify that air filter is free of snow.
3. Verify that skis and steering operate freely. Check corresponding action of skis versus handlebar.
4. Check fuel and oil for levels and leaks. Replenish if necessary and in case of any leaks; you should seek service from an authorized Ski-Doo dealer, repair shop, or person of your own choosing for maintenance, repair, or replacement. Please refer to the *US EPA EMISSION-RELATED WARRANTY* contained herein for information about warranty claims.
5. All storage compartments must be properly latched and they must not contain any heavy or breakable objects. Hood and side panels must be also properly latched.
6. Activate the throttle control lever several times to check that it operates easily and smoothly. It must return to idle position when released.
7. Activate the brake lever and make sure the brake fully applies before the brake control lever touches the handlebar grip. It must fully return when released.
8. Apply parking brake and check if it operates properly. Leave parking brake applied.

After Engine is Started

For proper engine starting procedure, refer to the appropriate *ENGINE STARTING PROCEDURE* section.

1. Check headlights high beam and low beam, taillight, stop light and pilot lamps operation.

NOTE: You may need to detach tether cord from your clothes to check lights. In such a case, attach cord as soon as you get back at the controls of the snowmobile.

2. Check the engine cut-off switch (by pulling tether cord cap) and emergency engine stop switch operation.
3. Release parking brake.
4. Refer to the *VEHICLE WARM UP* section and follow instructions.

Pre-Ride Check List

ITEM	OPERATION	✓
Body including seat, footrests, lights, air filter, controls and instruments	Check condition and remove snow or ice.	
Skis and steering	Check for free movement and proper action.	
Fuel and oil	Check for proper level and no leaks.	
Coolant (if applicable)	Check for proper level and no leaks.	
Storage compartment	Check for proper latching and no heavy or breakable objects.	
Track	Check condition and remove snow or ice. For studded tracks, see <i>INSPECTION</i> in the <i>TRACTION ENHANCING PRODUCTS</i> subsection.	
Throttle lever	Check for proper operation.	
Brake lever	Check for proper operation.	
Parking brake	Check for proper action.	
Emergency engine stop switch and engine cut-off switch (tether cord cap)	Check for proper action. Tether cord must be attached to operator clothing eyelet.	
Lights	Check for proper operation.	

How to Ride

Riding Gear

Proper snowmobile clothing should be worn. It should be comfortable and not too tight. Always check the weather forecast before going on a ride. Dress for the coldest weather expected. Thermal underwear next to the skin also provides a good insulation.

Wear an approved helmet at all times for safety and comfort. They provide both warmth and reduce injury. A stocking type cap, balaclava and

face mask should always be carried or worn. Goggles or a face shield that attach to the helmet are indispensable.

Hands should be protected by a pair of snowmobile gloves or mitts which have sufficient insulation and allow use of thumbs and fingers for operation of controls.

Rubber bottom boots with either a nylon or a leather top, with removable felt liners are best suited for snowmobiling.

You should keep yourself as dry as possible when snowmobiling. When you come indoors, take your snowmobile suit and boots off and make certain they dry properly.

Do not wear a long scarf or loose apparel that could get caught in moving parts.

Carry colored lens goggles.

What to Bring

First aid kit	Provided tool kit
Mobile phone	Knife
Spare spark plugs	Flashlight
Friction tape	Trail map
Spare drive belt	Snack

Rider Position (Forward Operation)

Your riding position and balance are the two basic principles of making your snowmobile go where you want it to. When turning on the side of a hill, you and your passenger must be ready to shift body weight to help it turn in the desired direction. Operator and passenger(s) must never attempt this maneuvering by placing feet outside of the vehicle. Experience will teach you how much lean to put into turns at different speeds and how much you will have to lean into a slope to maintain proper balance.

Generally, the riding position for best balance and control is sitting. However, the posting, kneeling or standing positions are also used under certain conditions.

⚠ WARNING

Do not attempt any maneuvers if they are beyond your abilities.

Sitting

Feet on the running boards, body mid-way back on seat is an ideal position when operating the snowmobile over

familiar, smooth terrain. Knees and hips should remain flexible to absorb shocks.



Posting

A semi-sitting position with the body off the seat and the feet under the body in a sort of squatting posture, thus allowing the legs to absorb the shocks when traveling over uneven terrain. Avoid abrupt stops.



Kneeling

This position is achieved by placing one foot firmly on the running board and the opposite knee on the seat. Avoid abrupt stops.



Standing

Place both feet on the running boards. Knees should be flexed to absorb the shock from surface bumps. This is an effective position to see better and to shift weight as conditions dictate. Avoid abrupt stop.



Rider Position (Reverse Operation)

We recommend sitting on your snowmobile when operating in reverse.

Avoid standing up. Your weight could shift forward against throttle lever while operating in reverse, causing an unexpected acceleration.

⚠ WARNING

Unexpected acceleration when snowmobile operates in reverse can cause a loss of control.

Carrying a Passenger

Certain snowmobiles are designed for an operator only (1-UP), and others can allow one passenger (2-UP). Make sure to identify and respect the warnings according to your specific model.

Even when a passenger is allowed, this person must be physically fit for snowmobiling.

⚠ WARNING

Any passenger must be able to firmly lay his feet on the footrests and keep his hands on the handholds or seat strap at all times when seated. Respecting those physical criteria is important to ensure that the passenger is stable and to reduce the risks of ejection.

On snowmobiles allowing two passengers, if you have an adult and a child for passenger, BRP recommends that the child sits in the center location. This allows an adult sitting in the rear seat to keep a visual contact with the child and hold him if necessary. In addition, the child is best protected against the wind and cold temperature if seated in the center location.

The operator has a responsibility to ensure the safety of his passenger and should inform the passenger about snowmobiling basics.

⚠ WARNING

- Passenger must only sit on designated passenger seats. Never allow anyone to sit between the handlebar and the operator.
- Passenger and operators must always wear an approved helmets and warm clothing appropriate for snowmobiling. Make sure that no skin is exposed.
- Once underway, if a passenger feels uncomfortable or insecure for any reason, he must right away inform the operator to slowdown or stop.

Riding with a passenger on board is different than riding alone. The operator has the benefit of knowing what will be the next maneuver and is able to prepare himself accordingly. The operator also benefits from the support of his grip on the handlebar. In contrast, the passenger has to rely on the operator's careful and safe operation of the vehicle. In addition, "body english" is limited with a passenger, and the operator can sometimes see more of the trail ahead than the passenger. Therefore, smooth starting and stopping are required with a passenger, and the operator must slow down. The operator must also warn the passenger about side hills, bumps, branches, etc. An unforeseen bump can leave you passenger-less. Remind your passenger to lean into the turn with you, without causing the vehicle to topple. Be extremely careful, go more slowly and check the passenger frequently.

⚠ WARNING

When riding with a passenger:

- Braking ability and steering control are reduced. Decrease speed and allow extra space to maneuver.
- Adjust suspension according to weight.

For complete information on how to adjust the suspension, please refer to the *TUNE YOUR RIDE* subsection.

Use extra caution and go even more slowly with a young passenger. Check frequently to make certain the child has a firm grip and is properly positioned with his feet on the running boards.

Terrain/Riding Variations**Groomed Trail**

On a maintained trail, sitting is the most preferred riding position. Do not race and, above all, keep to the right hand side of the trail. Be prepared for the unexpected. Observe all trail signs. Do not zigzag from one side of the trail to the other.

Ungroomed Trail

Unless there has been a fresh snowfall you can expect "washboard" and snowdrift conditions. Taken at excessive speeds, such conditions can be physically harmful. Slow down. Hold on the handlebar and assume a posting position. Feet should be under the body assuming a crouched position to absorb any jarring effect. On longer stretches of "washboard" trails, the kneeling position of one knee on the seat can be adopted. This provides a certain amount of comfort, while at the same time keeps the body loose and capable of vehicle control. Beware of hidden rocks or tree stumps partially hidden by a recent snowfall.

Deep Snow

In deep "powder" snow, your vehicle could begin to "bog" down. If this occurs, turn in as wide an arc as possible and look for a firmer base. If you do get "bogged", and it happens to everyone, do not spin your track as this makes the vehicle sink deeper. Instead, turn the engine off, get off and move the back of the vehicle onto new snow. Then tramp a clear path ahead of the vehi-

cle. A few feet will generally suffice. Restart the engine. Assume the standing position and rock the vehicle gently as you steadily and slowly apply the throttle. Depending on whether the front or rear end of the vehicle is sinking, your feet should be placed on the opposing end of the running boards. Never place foreign material beneath the track for support. Do not allow anyone to stand in front of, or to the rear of, the snowmobile with the engine running. Stay away from the track. Personal injury will result if contact is made with the revolving track.

Frozen Water

Traveling frozen lakes and rivers can be fatal. Avoid waterways. If you are in an unfamiliar area, ask the local authorities or residents about the ice condition, inlets, outlets, springs, fast moving currents or other hazards. Never attempt to operate your snowmobile on ice that may be too weak to support you and the vehicle. Operating a snowmobile on ice or icy surfaces can be very dangerous if you do not observe certain precautions. The very nature of ice is foreign to good control of a snowmobile or any vehicle. Traction for starting, turning or stopping is much less than that on snow. Thus, these distances can be multiplied manyfold. Steering is minimal, and uncontrolled spins are an ever present danger. When operating on ice, drive slowly with caution. Allow yourself plenty of room for stopping and turning. This is especially true at night.

Hard Packed Snow

Don't underestimate hard packed snow. It can be difficult to negotiate as both skis and track do not have as much traction. Best advice is to slow down and avoid rapid acceleration, turning or braking.

Uphill

There are two types of hills you can encounter - the open hill on which there are few trees, cliffs or other obstacles, and a hill that can only be climbed directly. On an open hill, the approach is to climb it by side hilling or slaloming. Approach at an angle. Adopt a kneeling position. Keep your weight on the uphill side at all times. Maintain a steady, safe speed. Continue as far as you can in this direction, then switch to an opposite hill angle and riding position.

A direct climb could present problems. Choose the standing position, accelerate before you start the climb and then reduce throttle pressure to prevent track slippage.

In either case, vehicle speed should be as fast as the incline demands. Always slow down as you reach the crest. If you cannot proceed further, don't spin your track. Turn the engine off, free the skis by pulling them out and downhill, place the rear of the snowmobile uphill restart the engine and ease it out with slow even throttle pressure. Position yourself to avoid tipping over, then descend.

Downhill

Downhill driving requires that you have full control of your vehicle at all times. On steeper hills, keep your center of gravity low and both hands on the handlebar. Maintain slight throttle pressure and allow the machine to run downhill with the engine operating. If a higher than safe speed is reached, slow down by braking but apply the brake with frequent light pressure. Never jam the brake and lock the track.

Side Hill

When crossing a side hill or traversing up or downhill, certain procedures must be followed. All riders should lean towards the slope as required for stability. The preferred operating positions are the kneeling position, with

the knee of the down hill leg on the seat and the foot of the uphill leg on the running board, or the posting position. Be prepared to shift your weight quickly as needed. Side hills and steep slopes are not recommended for a beginner or a novice snowmobiler.

Avalanche Hazard

When riding on mountainous terrain, you should be aware of the risk of avalanches. Avalanches vary in size and shapes and generally occur in steep terrain and on unstable snow.

New snow, animals, people, wind and snowmobiles can all trigger an avalanche. Avoid high marking or traversing steep terrain when avalanche conditions are possible. When in unstable snow conditions, travel should be restricted to lower angle slopes. Wind formed cornices should be avoided. Staying off unstable conditions is the key to safe mountain riding. Probably most important is to be aware of the conditions and dangers on a daily basis when in the mountains. Check local avalanche forecasts and threats each day before heading out to ride and heed forecasters advice.

You should always carry a snow shovel, probe and avalanche beacon while riding on mountains. We recommend that all mountain riders take a local avalanche safety training course to become more familiar with snow conditions and learn how to properly use their equipment.

Here are some web sites that can help you finding important information:

- US: www.avalanche.org
- Europe: www.avalanches.org
- Canada: www.avalanche.ca

Slush

Slush should be avoided at all times. Always check for slush before starting across any lake or river. If dark spots appear in your tracks, get off the ice

immediately. Ice and water can be thrown rearward into the path of a following snowmobile. Getting a vehicle out of a slush area is strenuous and in some cases, impossible.

Fog or Whiteout Conditions

On land or water, fog or visibility-limiting snow can form. If you have to proceed into the fog or heavy snow, do so slowly with your lights on and watch intently for hazards. If you are not sure of your way, do not proceed. Keep a safe distance behind other snowmobilers to improve visibility and reaction time.

Unfamiliar Territory

Whenever you enter an area that is new to you, drive with extreme caution. Go slow enough to recognize potential hazards such as fences or fence posts, brooks crossing your path, rocks, sudden dips, guy wires and countless other obstacles which could result in a termination of your snowmobile ride. Even when following existing tracks, be cautious. Travel at a speed so you can see what is around the next bend or over the top of the hill.

Bright Sunshine

Bright sunny days can considerably reduce your vision. The glare from sun and snow may blind you to the extent that you cannot easily distinguish ravines, ditches or other obstacles. Goggles with colored lenses should always be worn under these conditions.

Unseen Obstruction

There may be obstructions hidden beneath the snow. Driving off established trails and in the woods requires reduced speed and increased vigilance. Driving too fast in an area can make even minor obstacles very hazardous. Even hitting a small rock or stump could throw your snowmobile out of control and cause injury to

its riders. Stay on established trails to reduce your exposure to hazards. Be safe, slow down and enjoy the scenery.

Hidden Wires

Always be on the lookout for hidden wires, especially in areas that may have been farmed at one time or another. Too many accidents have been caused by running into wires in the fields, guy wires next to poles and roads, and into chains and wires used as road closures. Slow speeds are a must.

Obstacles and Jumping

Unplanned jumps of snowdrifts, snowplow ridges, culverts or indistinguishable objects can be dangerous. You can avoid them by wearing the proper color lenses or face shields and by operating at a lower speed.

Jumping a snowmobile can be a hazardous situation. Be prepared before landing to absorb the shock and brace yourself for the impact. Knees must be flexed to act as shock absorbers. If the trail does suddenly drop away from you, crouch (stand) towards the rear of the vehicle and keep the skis up and straight ahead. Apply partial throttle and brace yourself for the impact. Knees must be flexed to act as shock absorbers.

Turning

Depending on terrain conditions, there are two preferred ways to turn or corner a snowmobile. For most snow surfaces, "body english" is the key to turning. Leaning towards the inside of the turn and positioning body weight on the inside foot will create a "banking" condition beneath the track. By adopting this position and positioning yourself as far forward as possible, weight will be transferred to the inside ski.

On occasion, you will find that the only way to turn the vehicle about in deep snow is to pull the snowmobile around. Do not over-exert yourself. Get assistance. Remember to always lift using your legs as opposed to your back.



Road Crossing

In some cases, you will be approaching the road from a ditch or snowbank. Choose a place where you know you can climb without difficulty. Use the standing position and proceed with only as much speed needed to crest the bank. Stop completely at the top of the bank and wait for all traffic to clear. Judge the drop to the roadway. Cross the road at a 90° angle. If you encounter another snowbank on the opposite side, position your feet near the rear of the vehicle. Remember, your snowmobile is not designed to operate on bare pavement and steering on this type of surface is more difficult.

Railroad Crossing

Never ride on railroad tracks. It is illegal. Railroad tracks and railroad rights-of-way are private property. A snowmobile is no match for a train. Before crossing a railroad track, stop, look and listen.

Night Rides

The amount of natural and artificial light at a given time can effect your ability to see or to be seen. Nighttime

snowmobiling is delightful. It can be a unique experience if you acknowledge your reduced visibility. Before you start, make certain your lights are clean and work properly. Drive at speeds that will allow you to stop in time when you see an unknown or dangerous object ahead. Stay on established trails and never operate in unfamiliar territory. Avoid rivers and lakes. Guy wires, barbed wire fences, cabled road entrances and other objects such as tree limbs are difficult to see at night. Never drive alone. Always carry a flashlight. Keep away from residential areas and respect the right of others to sleep.

Riding in a Group

Before starting out, designate a "trail boss" to lead the party and another person to follow-up at the end of the party. Ensure that all members of the party are aware of the proposed route and destination. Make certain that you are carrying all necessary tools and equipment and that you have sufficient fuel to complete the trip. Never overtake the trail boss or, for that matter, any other snowmobile. Use down-the-line hand signals to indicate hazards or intent of direction change. Assist others whenever necessary.

It is always IMPORTANT to keep a safe distance between each snowmobile. Always maintain a safe interval and allow sufficient stopping distance. Don't be a tailgater. Know the position of the machine ahead.

Signals

If you intend to stop, raise either hand straight above your head. A left turn is indicated by extending your left hand straight out in the proper direction. For right turns, extend the left arm and raise the hand to a vertical position so it forms a right angle at the elbow. Every snowmobiler should relay any signal to the ones behind.

Trail Stops

Whenever possible, pull off the trail when you stop. This will reduce the hazard to other snowmobilers using the trail.

Trails and Signs

Trail signs are used to control, direct or regulate the use of snowmobiles on trails. Become familiar with all signs used in the area where you are snowmobiling.

Environment

Wildlife compliments your snowmobiling day. Snowmobile tracks provide firm ground over which animals can travel from area to area. Do not violate this privilege by chasing or harassing wildlife. Fatigue and exhaustion can lead to animal's death. Avoid areas posted for the protection or feeding of wildlife.

If you happen to be fortunate enough to see an animal, stop your snowmobile and observe quietly.

The guidelines that we support are not designed to limit your snowmobiling fun, but to preserve the beautiful freedom that you can experience only on a snowmobile! These guidelines will keep snowmobilers healthy, happy and able to introduce others to what they know and enjoy about their favorite winter pastime. So, the next time you hit the trails on a cool, crisp and clear winter day, we ask you to remember that you are paving the way for the future of our sport. Help us lead it down the right path! From all of us at BRP, thank you for doing your share.

There is nothing more exhilarating than snowmobiling. Venturing onto snowmobile trails that cross wild areas is an exciting and healthy winter sport. However, as the number of people using these recreational parks increases, so does the potential for damage to the environment. Abuse of land, facilities

and resources inevitably leads to restrictions and closures of both private and public land.

In essence, the greatest threat to our sport, is all around us. Which leaves us with one logical choice. When we snowmobile, we must always ride responsibly.

The vast majority respect the law and the environment. Each of us must set an example for those who are new to the sport, young and old alike.

It is in every one's best interest to tread lightly into our recreational areas. Because, in the long run, to protect the sport we must preserve the environment.

Recognizing the importance of this issue and the need for snowmobilers to do their share in preserving areas that make it possible to enjoy our sport, BRP has developed the "Light Treading Is Smart Sledding" campaign for snowmobilers.

Light Treading refers to more than the thread of our tracks. It's a statement of concern, respect and willingness to take the lead and take action. It applies to the environment in general, its proper care and maintenance, its natural inhabitants and all enthusiasts and the public at large who enjoy the great outdoors. With this theme, we invite all snowmobilers to remember that respecting the environment is not only critical to the future of our industry but to future generations.

Light Treading in no way suggests you should curb your appetite for snowmobiling fun! It simply means tread with respect!

The fundamental objective of Light Treading is one of respect for where and how you ride a snowmobile. You're a light treader when you follow the principles below.

Become informed. Obtain maps, regulations and other information from the Forest Service or from other pub-

lic land agencies. Learn the rules and follow them and that goes for speed limits, too!

Avoid running over young trees, shrubs, and grasses and don't cut wood. On flatlands or areas where trail riding is popular, it's important to ride only where authorized. Remember, there is a link between protecting your environment and your own safety.

Respect wildlife and be particularly sensitive of animals that are rearing young or suffering from food shortage. Stress can sap scarce energy reserves. Refrain from riding in areas where only animals are intended to tread!

Obey gate closures and regulatory signs and remember, light treaders don't litter!

Stay out of wilderness areas. They're closed to all vehicles. Know where the boundaries are.

Obtain permission to travel across private land. Respect the rights of landowners and other people's privacy. Remember, snowmobile technology has lowered the noise factor considerably, but you still shouldn't rev your engines where quiet "is the order of the day".

Snowmobilers know all too well the efforts that have been made throughout the sport's history to enjoy access to areas where people can snowmobile safely and responsibly. This effort continues today, as strong as ever.

Respecting the areas where we ride... wherever they may be... is the only way to ensure their future enjoyment. That's one major reason why we know you'll agree that Light Treading is smart sledding! And there are more.

Enjoying the opportunity to see winter and all its natural majestic wonders, is an experience cherished by snowmobilers. Light Treading will preserve this opportunity and will make it possible for us to expose others to the

beauty of winter and the unique thrill of our sport! Light Treading will help our sport to grow!

Finally, Light Treading is the sign of a smart snowmobiler. You don't have to leave big tracks or careen through a virgin forest to show you can ride. So whether you're driving a high performance Ski-Doo, a sporty MX Z™ snowmobile or any other make or model, show you know what you're doing. Show you know how to send snow flying and make tracks with a light touch!

TRACTION ENHANCING PRODUCTS

NOTE: This section is applicable to snowmobiles equipped with a factory installed track that has been approved by BRP for special studs installation.

⚠ WARNING

Never stud a track that has not been approved for studs. Installing studs on an unapproved track could increase the risk of the track tearing or severing.

⚠ WARNING

You may stud the track on this vehicle model. However, you **MUST** only use the BRP approved type stud for use on these Ski-Doo snowmobiles. **DO NOT EVER** use conventional studs as the track thickness is thinner than other standard tracks. The stud could tear off of track and separate from vehicle. See an authorized Ski-Doo dealer for current specific studding availability and applications.

Using traction enhancing products such as, more aggressive ski carbide runners and/or studs on your snowmobile will change its behavior, particularly in terms of manoeuvrability, acceleration, and braking.

Using traction enhancing products gives a better grip on packed snow and ice, but has no noticeable effect on soft snow. For this reason, driving a snowmobile equipped with traction enhancing products requires a certain adaptation period. If your snowmobile is equipped with traction enhancing products, be sure to take plenty of time to get used to the way it handles when turning, accelerating, and braking.

Also, always check local regulations concerning the use of traction enhancing products on snowmobiles. Always

drive your snowmobile in a responsible manner, respecting the environment and other people's property.

Manoeuvrability

Using traction enhancing products such as, more aggressive ski carbide runners and/or studs makes the snowmobile grip the ground better at both the front and at the rear. The use of carbide runners is therefore required to give the skis a better grip, so that the front and rear of the snowmobile are in balance. While off-the-shelf carbide ski runners are adequate, they don't necessarily give you optimal control, since that depends on your personal preferences, your riding style, and how your suspension is adjusted.

⚠ WARNING

If the front and rear of the snowmobile are out of balance due to an incorrect combination of traction enhancing products, the snowmobile may tend to oversteer or understeer, which could lead to a loss of control.

Oversteering

In certain conditions, using more aggressive ski carbide runners without studs on the rear track could make the snowmobile prone to oversteering, see illustration.

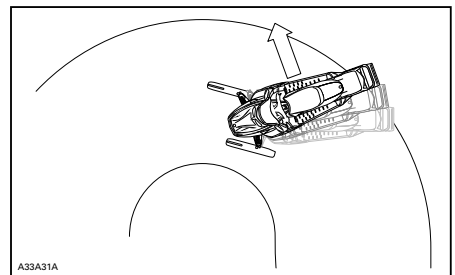

OVERSTEERING

Understeering

In certain conditions, the use of studs on the track could make the snowmobile prone to understeering if the skis are not equipped with more aggressive ski carbide runners, see illustration.

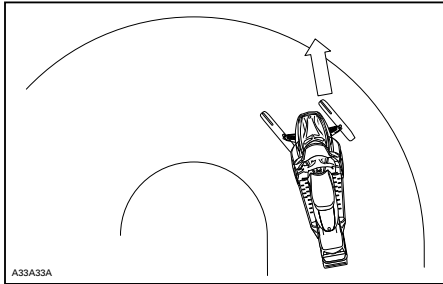

UNDERSTEERING

Controlled Driving

A balanced combination of carbide ski runners and studs on the track ensures adequate control and better handling, see illustration.

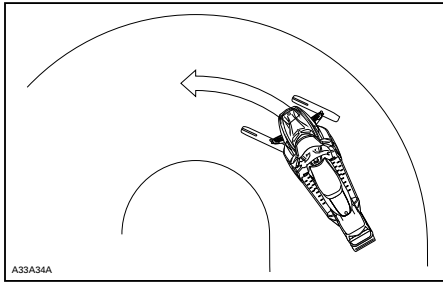

CONTROLLED DRIVING

Acceleration

Using studs on the track will allow your sled to accelerate better on packed snow and ice but will have no noticeable effect on soft snow. This can cause sudden variations in traction under certain conditions.

⚠ WARNING

To prevent surprises that could lead to a loss of control of the snowmobile:

- Always go easy on the throttle.
- NEVER try to spin the track to make the rear of the snowmobile skid.

This could cause debris or ice to be thrown violently backwards, possibly injuring others nearby or on snowmobiles behind you.

Braking

As in the case of acceleration, using studs on the track will give you better braking capacity on packed snow or ice but will have no noticeable effect on soft snow. Braking may thus vary suddenly under certain conditions. Be sure to use restraint in braking to keep from blocking the track in order to avoid surprises that could lead to a loss of control.

Important Safety Rules

⚠ WARNING

To prevent serious injury to individuals near the snowmobile:

- NEVER stand behind or near a moving track.
- Always use a wide-base snowmobile stand with a rear deflector panel if it is necessary to rotate track.
- When the track is raised off the ground, only run it at the lowest possible speed.

Centrifugal force could cause debris, damaged or loose studs, pieces of torn track, or an entire severed track to be violently thrown backwards out of the tunnel with tremendous force.

Effects of Having a Studded Track on the Life of the Snowmobile

The use of traction enhancing products can increase the load and the stress on certain snowmobile components, as well as the vibration level. This can cause premature wear on parts such as belts, brake linings, bearings, chain, chaincase sprocket, and on approved studded tracks, shorten track life. Always proceed with a visual inspection of your track before each use. For more information, refer to the *TRACK* section in *MAINTENANCE*.

Studs on the track can also cause serious damage to your snowmobile if it is not equipped with the tunnel protectors designed for your particular model. Damage to the electrical wiring or perforation of the heat exchangers are potential hazards, that could cause the engine to overheat and be severely damaged.

⚠ WARNING

If tunnel protectors are excessively worn or not installed, the gas tank could be punctured, causing a fire.

NOTICE Ask your dealer for the appropriate tunnel protectors model and kit number required for your snowmobile.

NOTE: Consult the BRP limited warranty to find out what warranty limitations are related to the use of studs.

Installation of Studs on BRP Approved Tracks

⚠ WARNING

Never stud a track that has not been approved for studs. Approved tracks can be identified by a stud symbol (see illustration below) molded into the track surface. Installing studs on an unapproved track could increase the risk of the track tearing or severing.

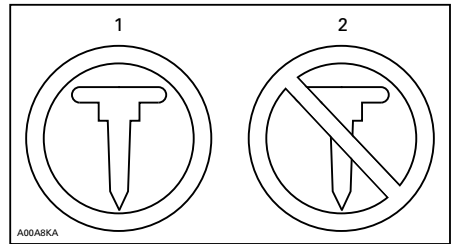

TRACK SYMBOLS

1. Approved
2. NOT Approved

To ensure safe and proper installation, BRP recommends to have the studs installed by your dealer.

- Use only the BRP approved special studs.
- Never use studs that exceed the height of your snowmobile's track profile by more than 9.5 mm (3/8 in).

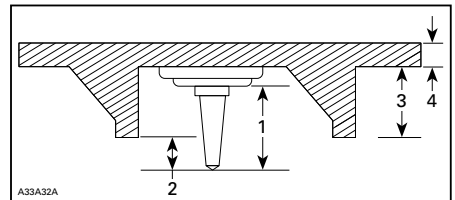

INSTALLATION OF STUDS

1. Stud size
2. Penetration range
6.4 mm to 9.5 mm (1/4 in to 3/8 in)
3. Track lug height
4. Track belt thickness

⚠ WARNING

- See an authorized Ski-Doo dealer for current specific stud-
ding availability and applica-
tions.
- **DO NOT EVER** use conventional
stud because, the track thick-
ness is thinner than our stan-
dard tracks and the stud could
tear off of track and separate
from vehicle.
- Studs should only be installed
in the locations indicated by
molded bulges in the track sur-
face.
- Never stud a track with a profile
of 35 mm (1.375 in) or more.
- The number of studs installed
must always perfectly match
the pattern of molded bulges in
the track.
- Always consult the traction
product manufacturer's instal-
lation instructions and recom-
mendations before having your
dealer install studs and runners.
It is very important to follow
the torque specifications for the
stud bolts.

**INSTALLING AN INCORRECT
NUMBER OF STUDS OR AN IM-
PROPER INSTALLATION CAN IN-
CREASE THE RISK OF THE TRACK
TEARING OR SEVERING.**

- Broken studs (studded tracks)
- Bent studs (studded tracks)
- Missing studs
- Studs that are torn off the track
- Missing track guide(s)
- Loose studs.

On approved studded tracks, replace broken or damaged studs immediately. If your track shows signs of deteriora-
tion, it must be replaced immediately. When in doubt, ask your dealer. Al-
ways proceed with a visual inspection of your track before each use.

⚠ WARNING

**Riding with a damaged track or
studs could lead to loss of control.**

Inspection



PROCEED WITH A VISUAL INSPEC-
TION OF YOUR TRACK BEFORE
EACH USE.

Look for any defects, such as:

- Perforations in the track
- Tears in the track (particularly
around traction holes on studded
tracks)
- Lugs that are broken or torn off, ex-
posing portions of rods
- Delamination of the rubber
- Broken rods

IMPORTANT ON PRODUCT LABELS

Hang Tag(s)

<p>DESCRIPTION DU MOTEUR DU VEHICULE: XXXXX</p> <p>EPA CERTIFIÉ</p> <p>TEN (TAUX D'EMISSION NORMALISÉ) = [X.X] SUR UNE ÉCHELLE DE 0 À 10, 0 ÉTANT LE PLUS PROPRE.</p> <p>*NE PAS ENLEVER AVANT LA VENTE.</p>  <p>512061127</p>	<p>VEHICLE ENGINE DESCRIPTION: XXXXX</p> <p>EPA CERTIFIED</p> <p>NER (NORMALIZED EMISSION RATE) = [X.X] ON A 0 TO 10 SCALE, 0 BEING THE CLEANEST</p> <p>*NOT TO BE REMOVED PRIOR TO SALE</p>  <p>! WARNING PROPOSITION 65</p> <p>Snowmobile engines discharge fuel and exhaust, which contain chemicals known to the State of California to cause cancer and birth defects or other reproductive harm, onto the snow on which they operate. Keep this engine properly tuned and avoid unnecessary idling and spillage during fueling.</p> <p>512061127</p>
--	--

TYPICAL

Vehicle Safety Labels

The following labels are on your vehicle and they should be considered permanent parts of the vehicle. If missing or damaged, the decals can be replaced free of charge. See an authorized Ski-Doo dealer.

NOTE: The following illustrations used in this Operator's Guide are a general representation only. Your model may differ.

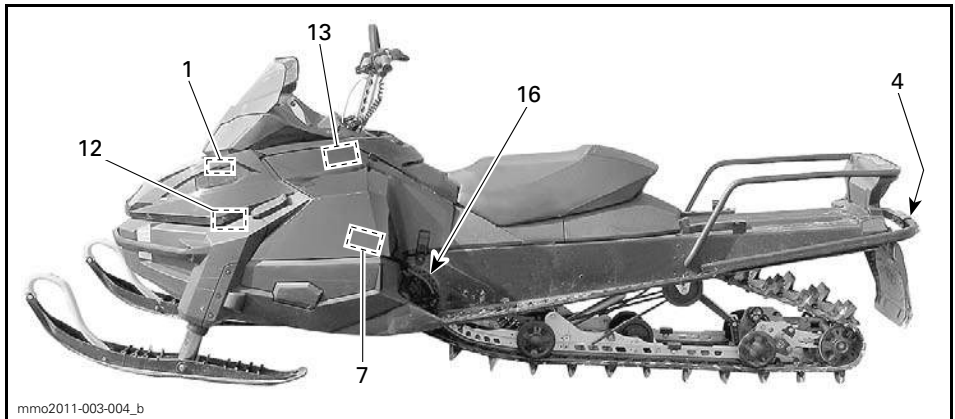
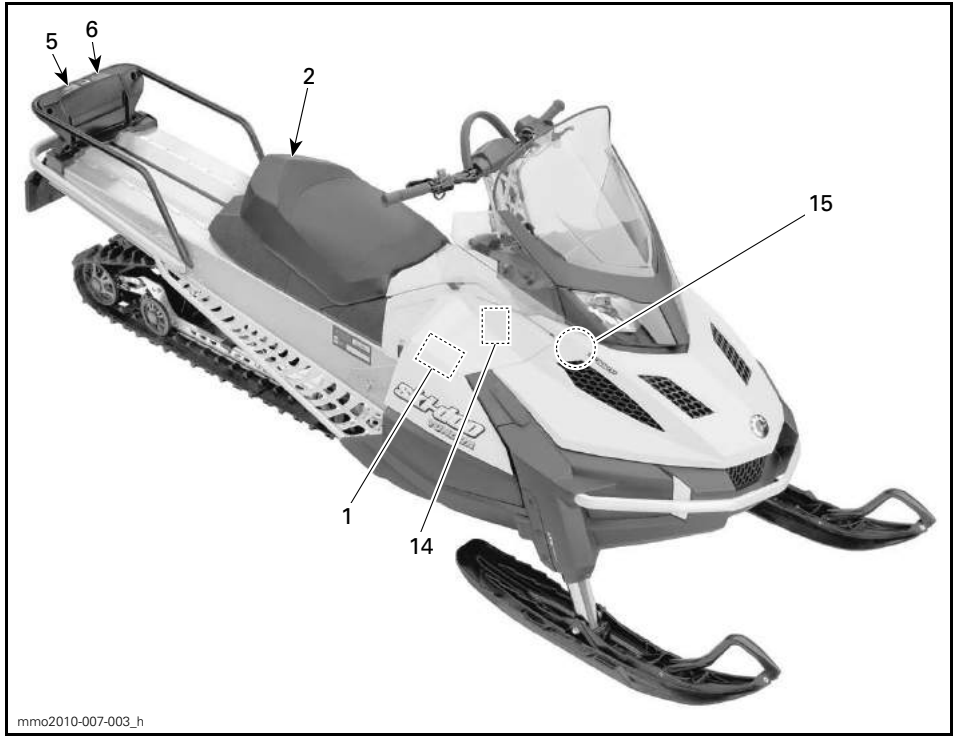

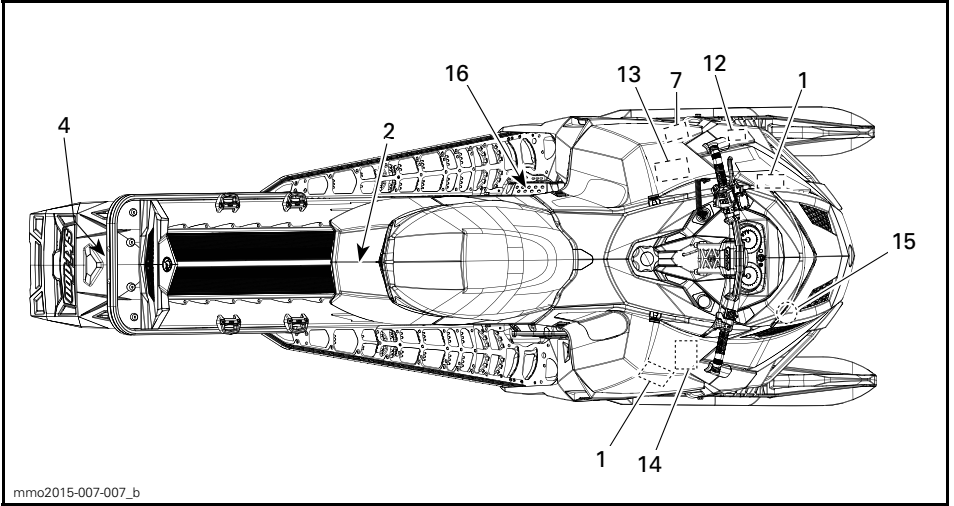

mmo2015-007-007_b

TYPICAL - TUNDRA XTREME

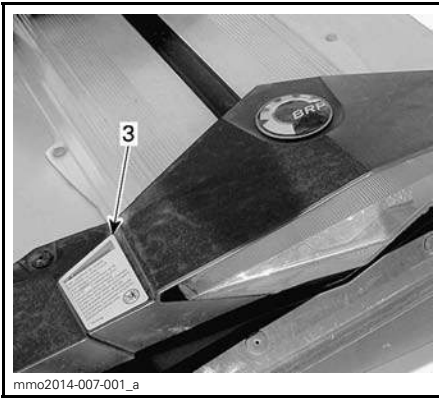

mmo2014-007-001_a

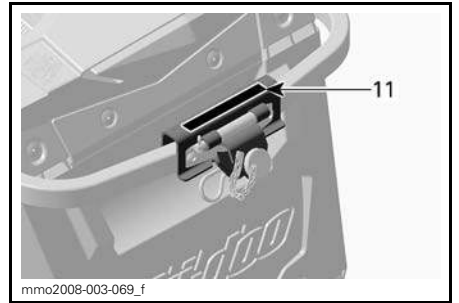

mmo2008-003-069_f

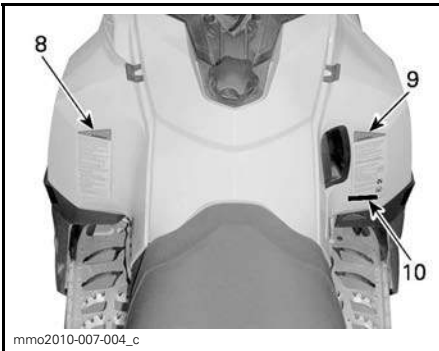

mmo2010-007-004_c

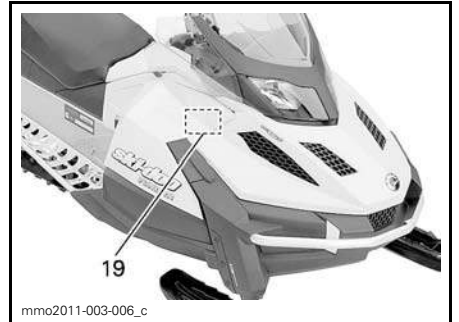

mmo2011-003-006_c

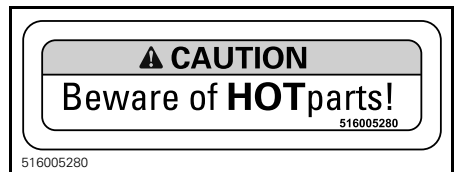

516005280

LABEL 1

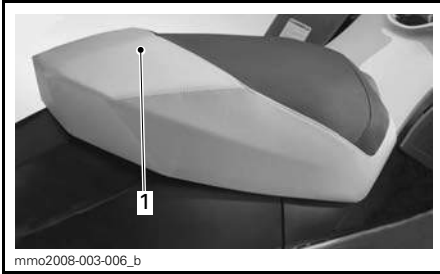

LABEL 2 - 1 UP MODELS
1. DO NOT SIT HERE

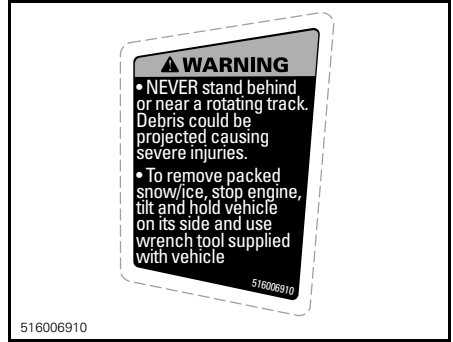

LABEL 3 - APPLICABLE MODELS

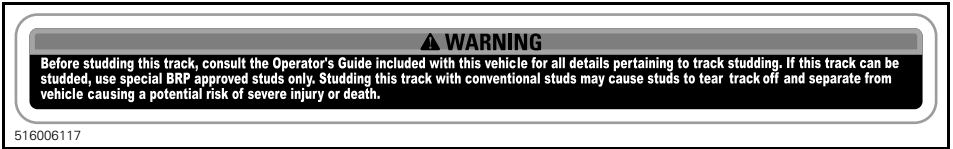

LABEL 4 - APPLICABLE MODELS



LABEL 5

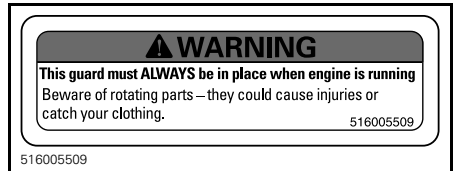

LABEL 7



LABEL 6

⚠ WARNING

- Read and understand all safety labels, operator's guide and watch your safety DVD before operation. Operator's guide is located either in the passenger seat or under the driver's seat. To access guide under driver's seat, pull front of seat cushion then pull tab to unlock seat (if applicable, passenger's seat needs to be removed first).
- Get familiar with your vehicle. Inexperienced riders may overlook risks and be surprised by vehicle's specific behavior and terrain conditions. Ride slowly.
- Excessive speed and reckless driving can kill!
ALWAYS adjust your speed according to snow conditions and circumstances.
- Steering control and braking ability may be reduced on hard-pack snow, ice or roads. Reduce speed & allow more space to stop or turn.
- Respect laws on minimum operator age. Manufacturer recommends a minimum operating age of 16 years old.
- Never open side panels or hood while engine is running or if vehicle is in motion. Ensure to remove DESS key before opening those.

BEFORE STARTING :

1. Attach tether cord to your clothing.
2. Check proper operation of the throttle and brake levers each time before starting. They must return to their initial position when released.
3. Apply parking brake.
4. Turn handlebars all the way in both directions to check for interference and insure free operation.

AFTER STARTING :

1. Pull-out tether cord to check if engine shuts off.
2. Re-start and push in the emergency engine stop switch to check if engine shuts off.
3. Disengage parking brake before riding to avoid brake fading.

516005227

LABEL 8

⚠ WARNING

This vehicle is designed for one (1) operator and as many passengers as there are seats with straps or handgrips installed on the vehicle conforming to SSSC standards.

Ce véhicule a été conçu pour un (1) conducteur et autant de passagers qu'il y a de sièges avec courroies ou poignées installés sur le véhicule et rencontrant la norme SSSC.

When riding with a passenger :

- Braking ability and steering control are reduced. Decrease speed and allow extra space to maneuver.
- Adjust suspensions according to weight.

REMEMBER : YOU ARE RESPONSIBLE FOR THE SAFETY OF YOUR PASSENGER!

ALL DRIVERS AND PASSENGERS MUST READ THE FOLLOWING:
Avoid surprises!
BE ON THE LOOK-OUT for the unexpected.



Operate defensively.

- Scan constantly for people, objects, conditions and upcoming vehicles.
- Avoid thin ice / open water.
- Use extra caution whenever off-trail.

ALWAYS wear a DOT approved HELMET and clothing appropriate for snowmobiling.



NEVER ride under the influence of alcohol or drugs even as a passenger.



516005228

LABEL 9

⚠ WARNING | ⚠ AVERTISSEMENT





516005226

LABEL 10 - EUROPEAN MODELS

⚠ WARNING

Towing a load may affect handling of your snowmobile. • Reduce speed. • Use rigid tow bar.
 • Ensure that the tow bar is securely fastened. Do not exceed the following loads:
TOWING WEIGHT 250Kg / 562 lbs Max. VERTICAL LOAD 10Kg / 23 lbs Max.

516004568A

516004568A

LABEL 11

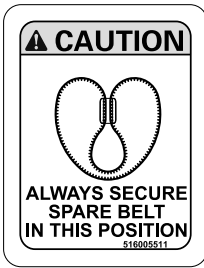

516005511

LABEL 12



LABEL 15

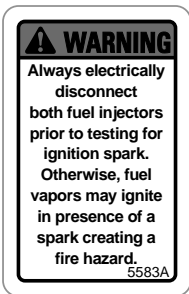

516005583A

LABEL 13 - E-TEC ONLY



LABEL 16 - ON BRAKE DISC GUARD (BARE METAL TUNNEL)

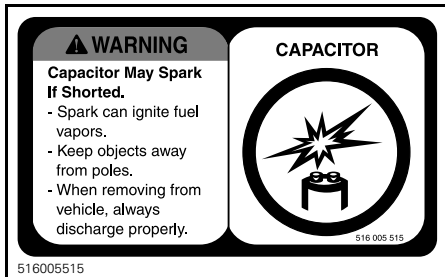

LABEL 14- E-TEC ONLY



LABEL 16 - ON BRAKE DISC GUARD (PAINTED TUNNEL)

⚠ WARNING

- This shock absorber is pressurized.
- An explosion may occur if heated or punctured.
- Do not disassemble.

mmo2010-003-101_en

LABEL 17 - ON GAS CHARGED SHOCK ABSORBERS

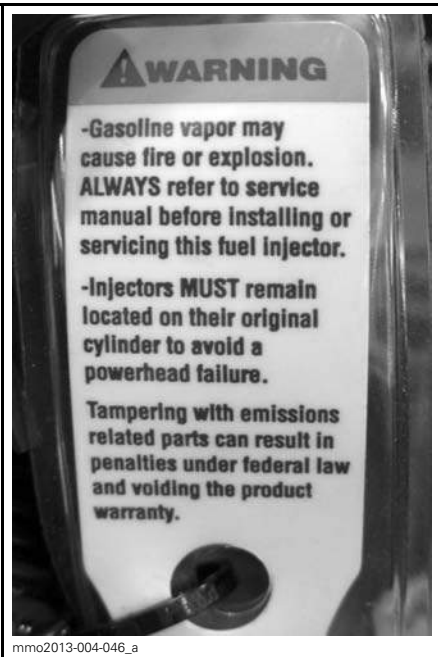

mmo2013-004-046_a

LABEL 18 - ON FUEL INJECTORS - E-TEC MODELS

⚠ CAUTION

ENGINE OIL AND CERTAIN COMPONENTS IN THE ENGINE COMPARTMENT MAY BE HOT. DIRECT CONTACT MAY RESULT IN SKIN BURN.

CHECKING ENGINE OIL LEVEL

- Make sure engine is at operating temperature.
 - Vehicle must be level to perform verification.
 - Let engine running at idle for at least 30 seconds.
 - Stop engine and wait at least 30 seconds.
 - Check oil level using the dipstick.
 - The engine of this snowmobile has been developed and validated using the BRP XPS™ Synthetic 4-stroke oil (293 600 112). BRP recommends the use of its XPS™ approved lubricant or equivalent.
- Damages caused by oil which is not suitable for this engine may not be covered by the BRP limited warranty. See operator's guide.



516007500

LABEL 19 - 600 ACE

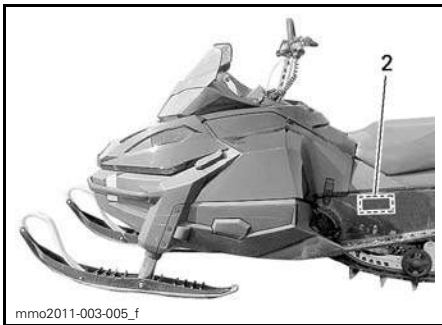
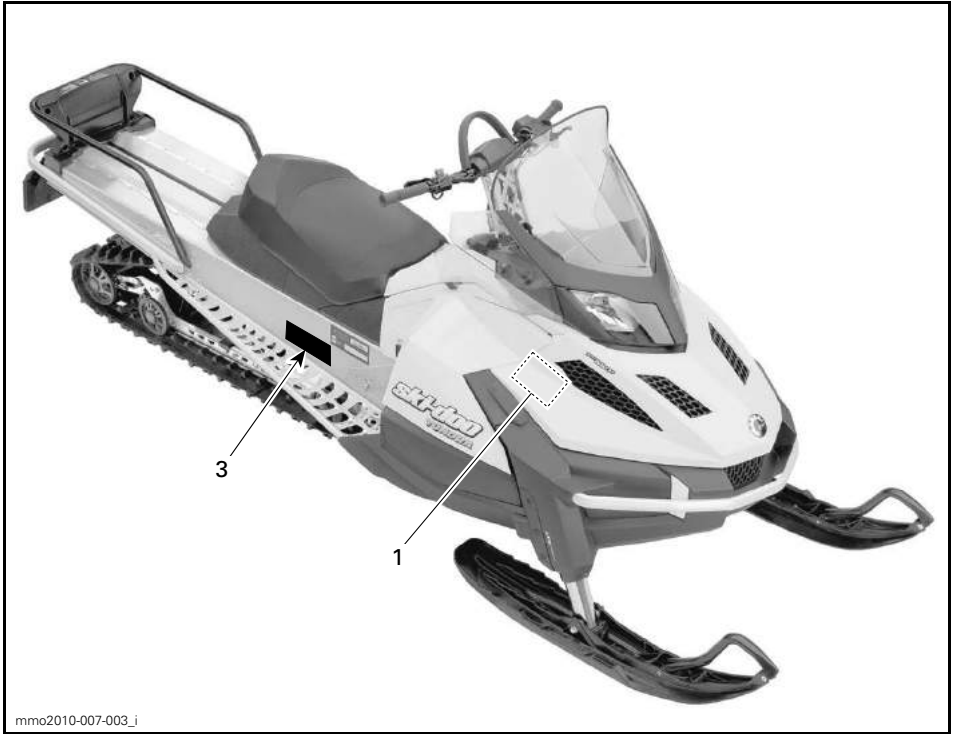
Compliance Labels



EPA Compliance Label

 EMISSION CONTROL INFORMATION THIS VEHICLE IS CERTIFIED TO OPERATE ON UNLEADED GASOLINE AND MEETS XXXX U.S. EPA REGULATIONS FOR SNOWMOBILE SI ENGINES. 121		
ENGINE FAMILY	XXXXXXXXXXXX	
PERMEATION FAMILY	XXXXXXXXXXXX	FAMILLE DE PERMEATION
FEL	XX g/kW-hr HC XX g/kW-hr CO XX g/m2 / day	LIMITE DES ÉMISSIONS DES FAMILLES
ENGINE DISPLACEMENT	XXX cm ³	CYLINDRÉE
EXHAUST EMISSION CONTROL SYSTEM	XXXX	SYSTÈME DE CONTRÔLE DES ÉMISSIONS

RENSEIGNEMENTS SUR LE DISPOSITIF ANTIPOLLUTION
 CE VÉHICULE EST CERTIFIÉ POUR FONCTIONNER À L'ESSENCE SANS PLOMB ET IL RÉPOND AUX NORMES **XXXX** DE L'EPA DES É.-U. POUR LES MOTONEIGES À MOTEUR SI.
 SEE OPERATOR'S GUIDE FOR MAINTENANCE SPECIFICATIONS
 VOIR GUIDE DU CONDUCTEUR POUR LES SPÉCIFICATIONS D'ENTRETIENS
BOMBARDIER RECREATIONAL PRODUCTS INC. 6865

516006865

TYPICAL: COMPLIANCE LABEL 1 - IN ENGINE COMPARTMENT

Technical Information Labels

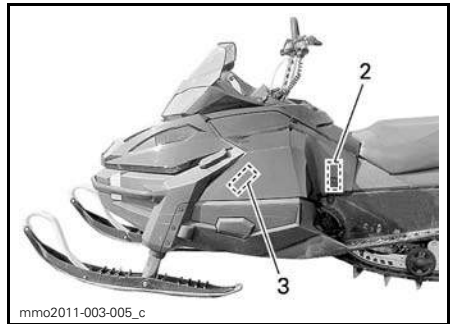
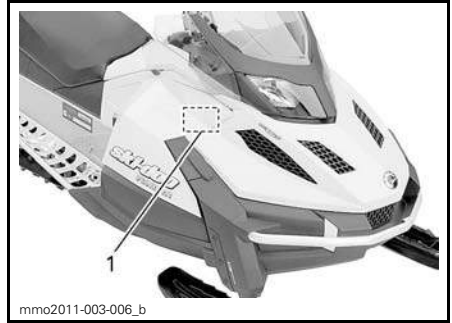

This snowmobile complies to National Park Service
New BAT Requirements

MY 2016 516007475

516007475

LABEL 2 - 600 ACE MODELS

SSCC Label

Safety standards for snowmobiles have been adopted by the Snowmobile Safety and Certification Committee (SSCC) of which BRP is a proud participating member. Assurance that your snowmobile meets these standards is easily checked by locating the Certification Label on a right vertical portion of the vehicle.

The following label shows that an independent testing laboratory has verified compliance with the SSCC safety standards.

CE MODÈLE A ÉTÉ ÉVALUÉ PAR UN LABORATOIRE D'ESSAIS INDÉPENDANT ET SATISFAIT TOUTES LES NORMES DE SÉCURITÉ DU SSCC EN VIGUEUR À LA DATE DE FABRICATION. PARÉCHÉ PAR LE COMITÉ DE SÉCURITÉ DE CERTIFICATION DE LA MOTONEIGE, INC.	CERTIFIED  CERTIFIÉ	THIS MODEL HAS BEEN EVALUATED BY AN INDEPENDENT TESTING LABORATORY AND IT MEETS ALL SSCC SAFETY STANDARDS IN EFFECT ON THE DATE OF ITS MANUFACTURE. SPONSORED BY THE SNOWMOBILE SAFETY AND CERTIFICATION COMMITTEE, INC.
--	--	---

A00A1MA

LABEL 3

NOTICE

The engine of this snowmobile has been developed and validated using the BRP XPS™ approved lubricant. BRP recommends the use of its XPS™ approved lubricant or equivalent.
 Damages caused by oil which is not suitable for this engine may not be covered by the BRP limited warranty. See the operator's guide.

516007443

LABEL 1

NOTICE

- To comply with noise regulations, this engine is designed to operate with an air intake silencer.
- Operation without air intake silencer or with one not properly installed may cause engine damage.

5876A

516005876

LABEL 2

IMPORTANT ON PRODUCT LABELS



LABEL 3



LOCATED ON FUEL CAP - ON 550F AND 600 ACE ENGINES (IN COUNTRIES USING PUMP POSTED AKI (RON+MON)/2 OCTANE RATINGS)



LOCATED ON FUEL CAP - ON 600 HO E-TEC ENGINE (IN COUNTRIES USING PUMP POSTED AKI (RON+MON)/2 OCTANE RATINGS)

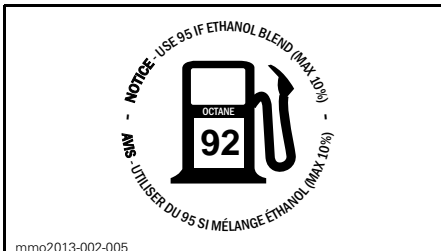

LOCATED ON FUEL CAP - ON 550F AND 600 ACE ENGINES (IN COUNTRIES USING RON OCTANE RATINGS)

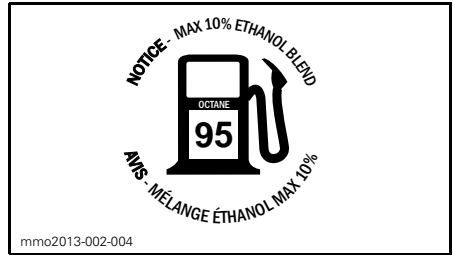

LOCATED ON FUEL CAP - ON 600 HO E-TEC ENGINE (IN COUNTRIES USING RON OCTANE RATINGS)

VEHICLE INFORMATION

CONTROLS, INSTRUMENTS AND EQUIPMENT

NOTE: Some features may not apply to your model or could be optional.

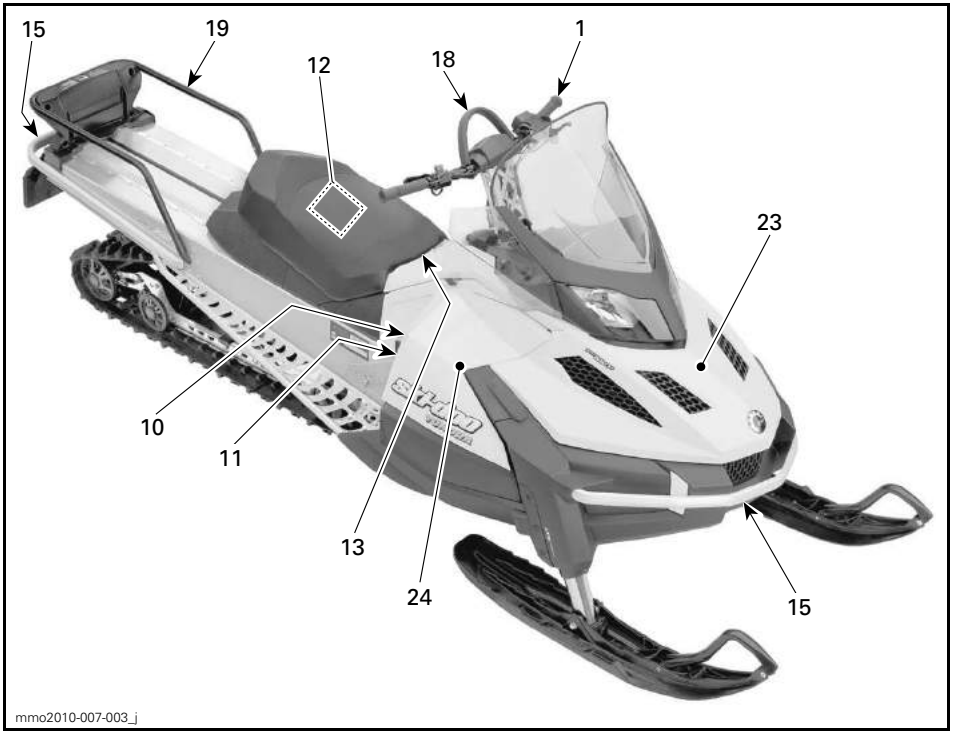

mme2010-007-003_j

TYPICAL - TUNDRA SPORT 1-UP

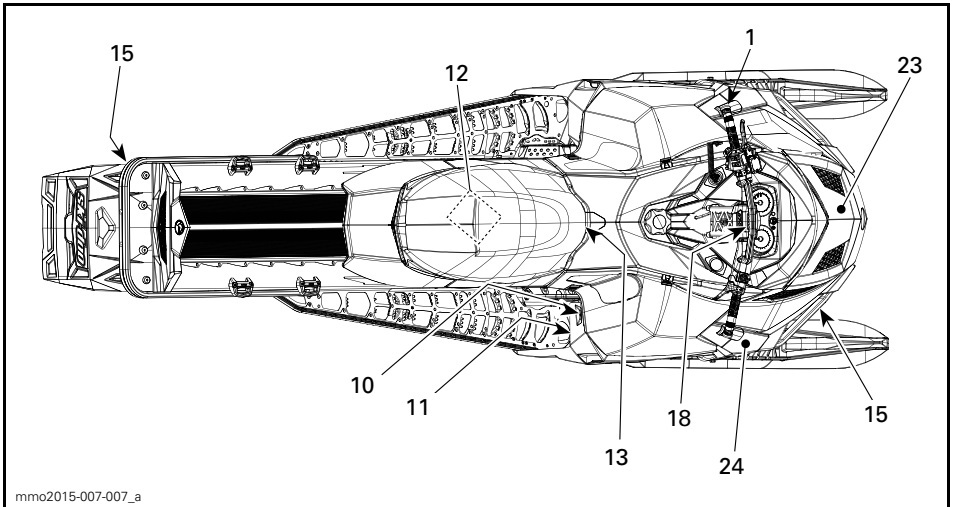

mme2015-007-007_a

TYPICAL - TUNDRA XTREME

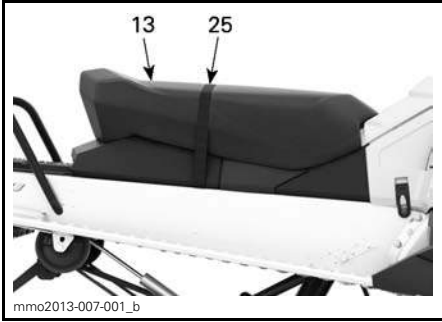

2-UP

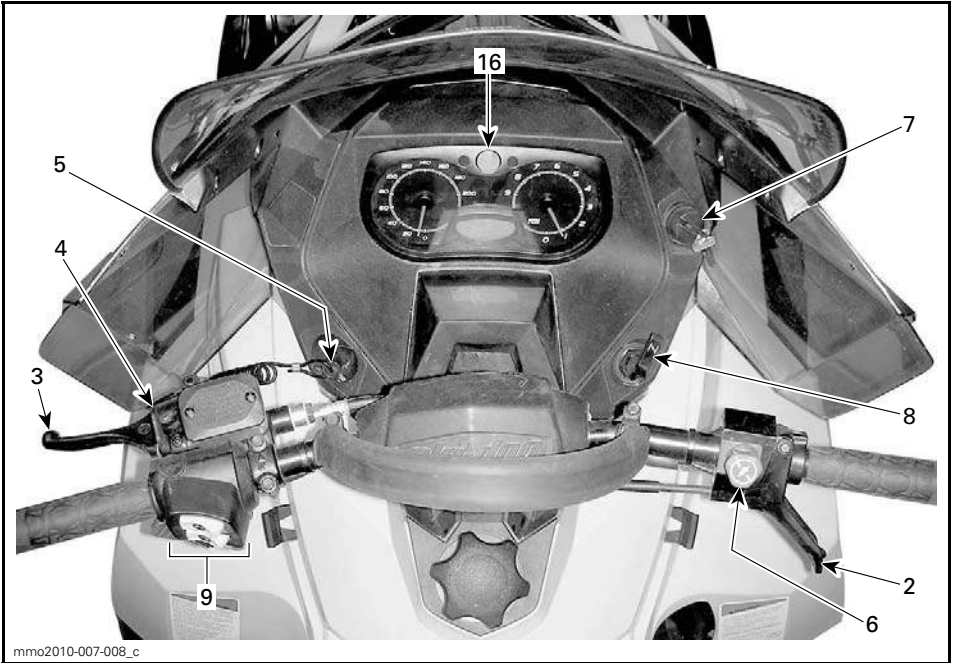

TYPICAL - 550F MODELS

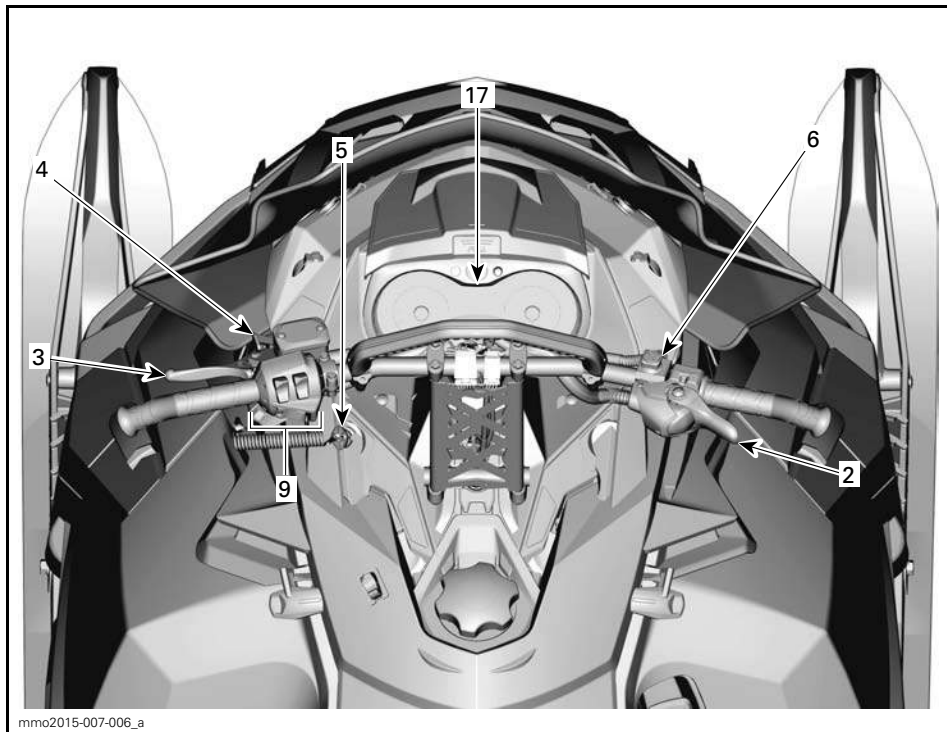

mmo2015-007-006_a

TYPICAL

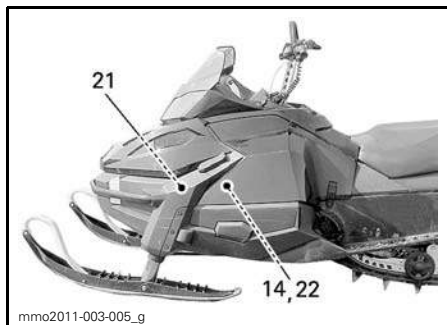

mmo2011-003-005_g

TYPICAL

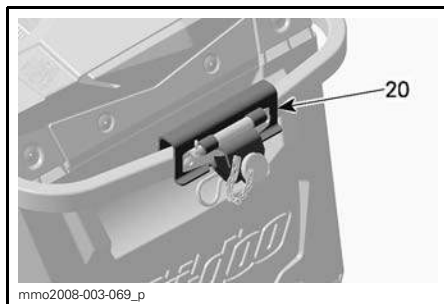

mmo2008-003-069_p

TUNDRA LT

1) Handlebar

The handlebar controls the steering of the snowmobile. As the handlebar is rotated to right or left, the skis are turned right or left to steer the snowmobile.

⚠ WARNING

Fast reverse while turning, could result in loss of stability and control.

2) Throttle Lever

Throttle lever is located on the RH side of handlebar.

Designed to be thumb activated. When squeezed, it increases the engine speed. When released, engine speed returns automatically to idle.

(All Except 600 ACE)

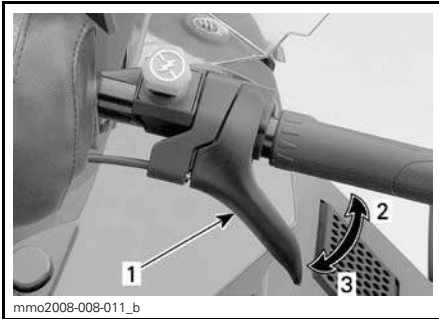
**TYPICAL**

1. Throttle lever
2. To accelerate
3. To decelerate

⚠ WARNING

Test the throttle lever operation each time before starting the engine. The lever must return to the rest position once released. Otherwise, do not start engine.

Throttle Lever (600 ACE)

Throttle lever is located on the RH side of handlebar.

Designed to be either thumb activated or finger activated. When squeezed, it increases the engine speed. When released, engine speed returns automatically to idle.

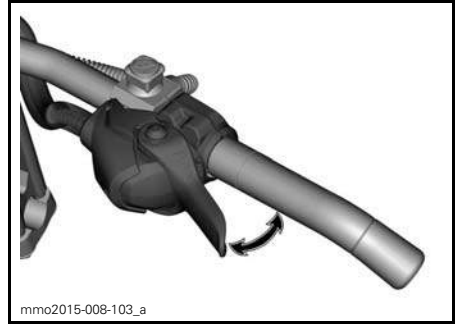
**TYPICAL****⚠ WARNING**

Test the throttle lever operation each time before starting the engine. The lever must return to its rest position once released. Otherwise, do not start engine.

Switching from Thumb to Finger Throttle Position

⚠ CAUTION It is highly recommended to immobilize the snowmobile before attempting any modification to the throttle position as it could lead to a hazardous situation.

There are mainly three positions to choose from when going from the thumb to the finger throttle position and the best one will be to the rider's preference and in direct relation with the riding style and conditions.

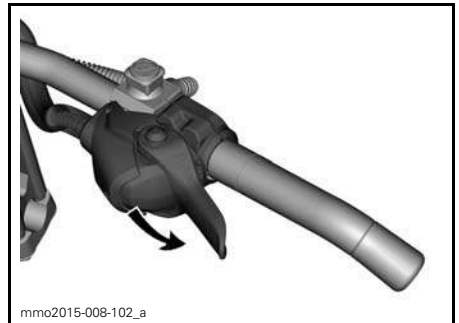

THUMB THROTTLE POSITION : PUSH DOWNWARD TO ROTATE THROTTLE HOUSING

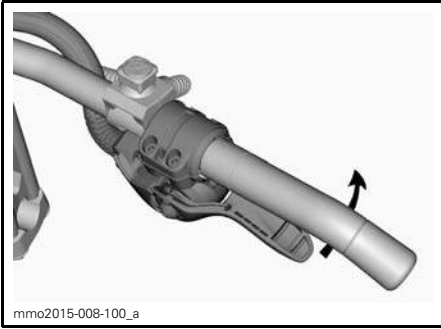

mmo2015-008-100_a

IF WANTED, CONTINUE TO ROTATE THE THROTTLE HOUSING

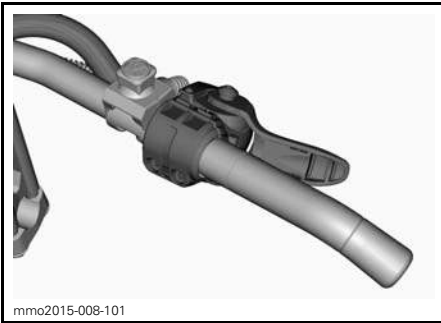

mmo2015-008-101

FINGER THROTTLE POSITION

⚠ CAUTION

- It is **HIGHLY** recommended to use gloves and **NOT** mitts when using the finger throttle position.
- It is not recommended to use the finger throttle position while riding in dense off trail areas.

The procedure to go back to the thumb throttle position is the reverse of the one shown above.

3) Brake Lever

Brake lever is located on the LH side of handlebar.

When squeezed, brake is applied. When released, it automatically returns to the rest position. Braking effect is proportional to the pressure applied on the lever and to the type of terrain and its snow coverage.

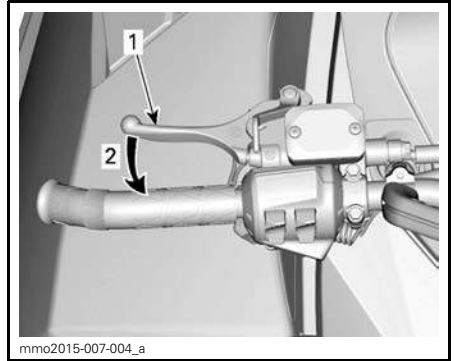

mmo2015-007-004_a

TYPICAL
 1. Brake lever
 2. To apply brake

4) Parking Brake Lever

Parking brake lever is located on the LH side of handlebar.

Parking brake should be used whenever snowmobile is parked.

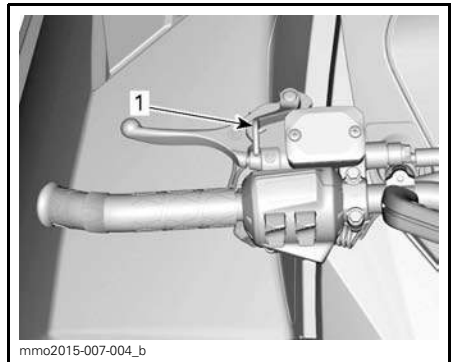

mmo2015-007-004_b

TYPICAL
 1. Parking brake lever

⚠ WARNING

Make sure parking brake is fully disengaged before operating the snowmobile. When you ride the vehicle, brake pads that are caused to drag by a continuous pressure on the lever may cause damage to the brake system and cause loss of braking capacity and/or fire.

To Engage Parking Brake

Apply and hold brake, then lock brake lever using the parking brake lever as shown.

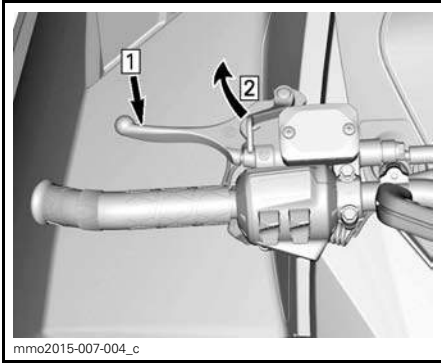

TYPICAL — ENGAGE MECHANISM

Step 1: Apply and hold brake

Step 2: Lock brake lever using parking brake lever

To Release Parking Brake

Squeeze brake lever. Parking brake lever will automatically return to its original position.

Always release parking brake before riding.

⚠ WARNING

Make sure parking brake is released before operating the vehicle. If parking brake is left ON while riding, it may cause damage to the brake system and cause loss of braking capacity and/or fire.

5) Engine Cut-Off Switch

The engine cut-off switch (tether cord) is located to on the LH side of console.

The tether cord cap must be securely snapped on the engine cut-off switch to allow vehicle operation.

Pulling the tether cord cap from the switch shuts the engine off.

⚠ WARNING

Always attach tether cord eyelet to clothing before starting the engine.

All Models Except 550F

After engine starting, 2 short beeps should be heard if a programmed D.E.S.S. key (tether cord cap) is correctly snapped on engine cut-off switch. If another beep code is heard, refer to *MONITORING SYSTEM* for D.E.S.S. malfunction codes information.

D.E.S.S. (Digitally Encoded Security System)

All Models Except 550F

D.E.S.S. stands for Digitally Encoded Security System.

The tether cord cap contains an electronic chip which features a unique permanently memorized digital code.

Your authorized Ski-Doo dealer has programmed the D.E.S.S. of your snowmobile to recognize the D.E.S.S. key in the tether cord cap to allow vehicle operation.

If another tether cord is used without programming the D.E.S.S., the engine will start but will not reach drive pulley engagement speed to move vehicle.

D.E.S.S. Flexibility

The D.E.S.S. of your snowmobile can be programmed by your authorized Ski-Doo dealer to accept up to 8 different keys.

We recommend the purchase of additional tether cords from your authorized Ski-Doo dealer. If you have more than one D.E.S.S. equipped Ski-Doo snowmobile, each can be programmed by your authorized Ski-Doo dealer to accept the other vehicles D.E.S.S. keys.

RF D.E.S.S. Key Types (600 ACE)

Two types of keys can be used:

- Normal key
- Learning key.

To ease key type recognition, the key comes in different colors.

KEY TYPE	COLOR
Normal	Black
Learning	Green

The Ski-Doo learning key, limits the speed of the snowmobile and the engine torque, therefore enabling first time users and less experienced operators to learn how to operate the snowmobile while gaining the necessary confidence and control.

NOTE: The initial learning key programming can limit the speed to 40 km/h (25 MPH) or 70 km/h (43 MPH). Refer to your authorized Ski-Doo dealer to modify this setting.

Refer to *OPERATING MODES* subsection for details.

6) Emergency Engine Stop Switch

The emergency engine stop switch is located on the RH side of handlebar.

Use the emergency stop switch to stop engine in a emergency situation.

To stop the engine, push switch down (OFF position).



OFF POSITION

To allow engine starting, the switch must be in the ON position (UP).



ON POSITION

All operators of the snowmobile should familiarize themselves with the function of the emergency engine stop switch by using it several times on first outing and whenever stopping the engine thereafter. This engine stopping procedure will become a reflex and will prepare operators for emergency situations requiring its use.

⚠ WARNING

If the switch has been used in an emergency caused by a suspected malfunction, the source of the malfunction should be determined and corrected before restarting engine. See an authorized Ski-Doo dealer for servicing.

7) Ignition Switch (550F)

Ignition switch is located on the RH side of gauge support.

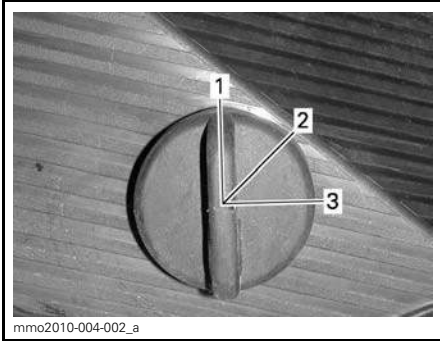

TYPICAL

1. OFF
2. ON
3. START

Turn key to ON position to allow manual engine starting.

On electric start models, turn key to START position to engage starter.

Refer to *ENGINE STARTING PROCEDURE* in the *BASIC PROCEDURES* section for detailed starting procedure.

8) Choke Lever (550F)

The choke lever has 3-positions.

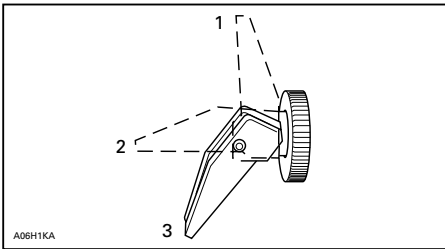

1. OFF
2. Position 2
3. Position 3

Refer to *CHOKE APPLICATION* in the *BASIC PROCEDURES* section for instructions on choke use.

9) Multifunction Switch (Sport, LT and Xtreme)

Multifunction switch is located on the LH side of handlebar.

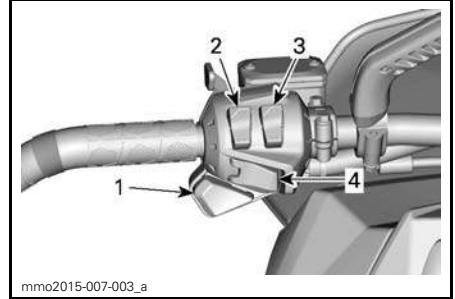

1. Headlights dimmer switch
2. Heated grips switch
3. Heated throttle lever switch
4. Electronic reverse button

Electronic Reverse/Start Button

600 ACE and 600 HO E-TEC Models

Press to engage electric starter.

Refer to *ENGINE STARTING PROCEDURE* in the *BASIC PROCEDURES* section for detailed starting procedure.

550F and 600 HO E-TEC Models

With engine running, press to engage the electronic reverse. Refer to *REVERSE (RER™)* in *BASIC PROCEDURES* section for procedure.

Headlights Dimmer Switch

Press to select HI or LOW beam. Lights are automatically ON when the engine is running.

Heated Grips Switch

NOTE: On 600 ACE and E-TEC models, the heated grips are enabled above 2000 RPM.

Select the switch position according to the desired heating intensity to keep your hands at a comfortable temperature.

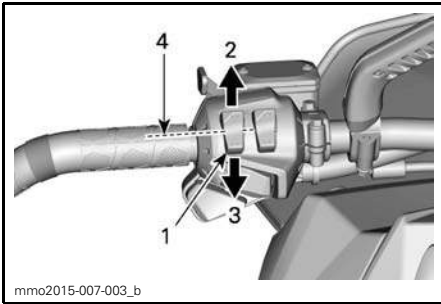

TYPICAL

1. Heated grip switch
2. Hot
3. Warm
4. Off

Heated Throttle Lever Switch

NOTE: On 600 ACE and E-TEC models, the heated throttle lever is enabled above 2000 RPM.

Select the switch position according to the desired heating intensity to keep your thumb at a comfortable temperature.

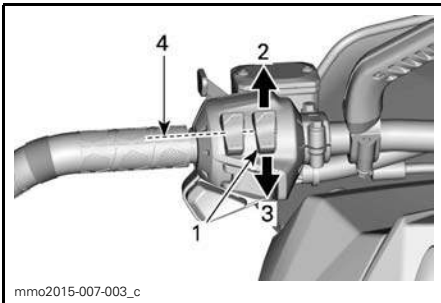

TYPICAL

1. Heated throttle lever switch
2. Hot
3. Warm
4. Off

10) Shift Lever (600 ACE)

Use this lever to shift in forward or reverse.



1. Reverse shift lever



PULL TO ENGAGE REVERSE GEAR

Refer to *OPERATING IN REVERSE* in *BASIC PROCEDURES* for details.

11) Rewind Starter Handle

Auto-rewind type located on right hand side of snowmobile. To engage mechanism, pull handle slowly until a resistance is felt then pull vigorously. Slowly release handle.

12) Operator's Guide

Underneath the seat.

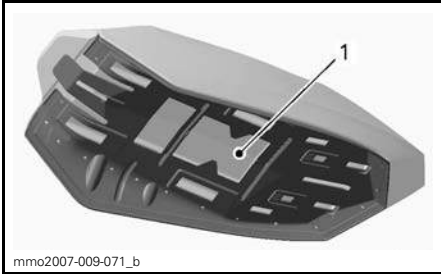

mmo2007-009-071_b

TYPICAL - SEAT

1. Operator's Guide location

Seat Latch (1-UP Only)

Use to remove seat to access the Operator's Guide or for maintenance purposes.

Seat latch is located at the front of the seat.

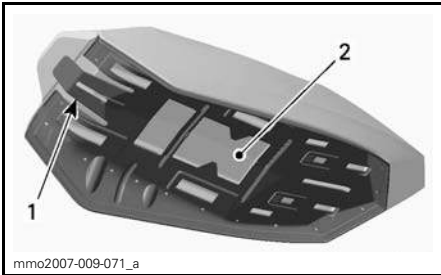

mmo2007-009-071_a

SEAT BASE

1. Seat latch
2. Operator's Guide location

13) Seat**Seat Removal**

To remove seat, pull front of seat cushion, firmly push seat forward to unload latch, then pull tab to unlock seat.

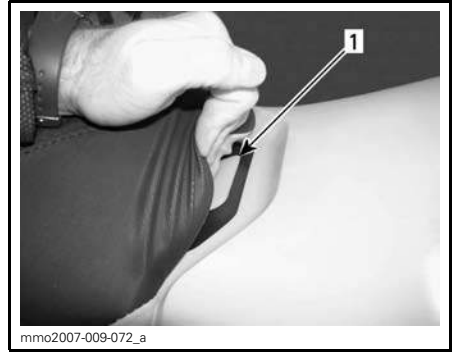

mmo2007-009-072_a

1. Seat latch

Pull and hold seat latch, then, pull seat with a rearward movement.

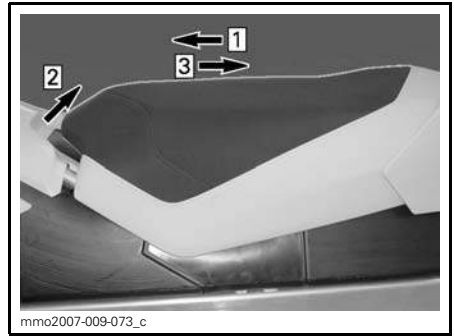

mmo2007-009-073_c

TYPICAL

- Step 1: Push seat forward
- Step 2: Pull and hold seat latch
- Step 3: Pull seat rearward

Seat Installation

NOTICE Riding the vehicle with any objects between the seat and the fuel tank could damage the fuel tank. NEVER place any objects between seat and fuel tank.

Position seat in place.

Push seat forward until it latch in its position.

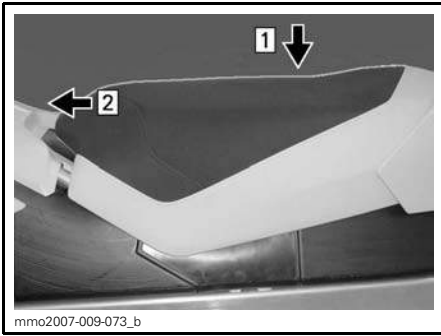

TYPICAL

- Step 1: Position seat in place
- Step 2: Push seat forward until it latch

NOTE: A distinctive snap will be felt. Double check that the seat is secure by giving it a tug to confirm proper latching.



TYPICAL - SEAT INSTALLED

⚠ WARNING

Make sure seat is securely latched before riding.

14) Tool Kit

A tool kit containing tools for basic maintenance is supplied with the vehicle.

The tool kit support is located in engine compartment on pulley guard.

NOTICE Make sure tool kit is secured properly to avoid contact with CVT (continuously variable transmission).

To remove the tool kit support from the pulley guard, unlock the tab from underneath the pulley guard and pull the tool kit support upwards to release it.



TYPICAL

- 1. Tool kit

15) Front and Rear Bumpers

To be used whenever snowmobile requires manual lifting.

⚠ CAUTION Use proper lifting techniques, notably using your legs force. Do not attempt to lift either end of the vehicle if it is above your limits. Use appropriate lifting device or have assistance to share lifting stress if possible.



FRONT

- 1. Front bumper

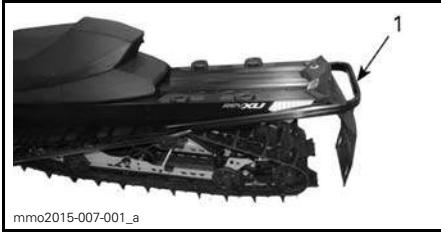

TYPICAL - REAR
1. Rear bumper

NOTICE Do not use skis to pull or lift snowmobile.

16) Gauge (550F)

⚠ WARNING

Reading the gauge digital display can distract from the operation of the vehicle, particularly from constantly scanning the environment.

Gauge Description

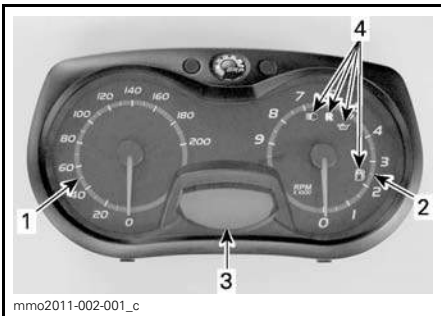

1. Speedometer
2. Tachometer
3. Digital display
4. Pilot lamps

NOTE: The gauge is factory preset in Imperial units but it is possible to change it to metric units, contact an authorized Ski-Doo dealer for unit settings.

1) Speedometer

Measures vehicle speed (in miles per hour or kilometers per hour depending on the setting).



LH PORTION OF GAUGE

2) Tachometer (RPM)

Measures engine revolution per minute (RPM). Multiply by 1000 to obtain the actual revolutions.



RH PORTION OF GAUGE

3) Digital Display

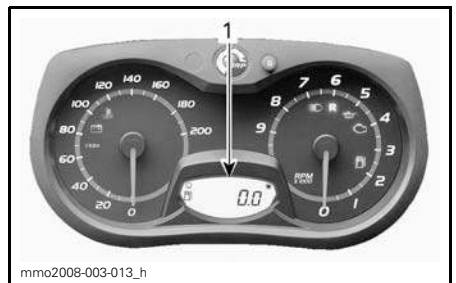

1. Digital display

The multifunction display is used to:

- Display the WELCOME message on power up
- Display the KEY recognition message
- Provide various indications as selected by the operator
- Activating or changing various functions or modes of operation
- Display scrolling messages of function activation or system faults
- Display fault codes.

4) Pilot Lamps and Messages



1. Pilot lamps

See table below for pilot lamps information.

PILOT LAMP(S) ON	BEEPER	DESCRIPTION
	—	Injection oil level is low. Stop vehicle in a safe place then, replenish injection oil reservoir.
	—	Low fuel level. Replenish fuel tank as soon as possible.
	Long beeps repeating slowly	Reverse is selected.
	—	High beam headlights are selected.

Gauge Features

AVAILABLE INDICATIONS IN DIGITAL DISPLAY	
FUNCTIONS	550F
A) Odometer	X
B) Fuel level	X
X = An X indicates a standard feature	

A) Odometer

Records the total distance travelled (in miles or kilometers depending on the setting).

The odometer is displayed on the digital display.

B) Fuel Level

Bar gauge that continuously indicates the amount of fuel left in the fuel tank. Displayed on the digital display.

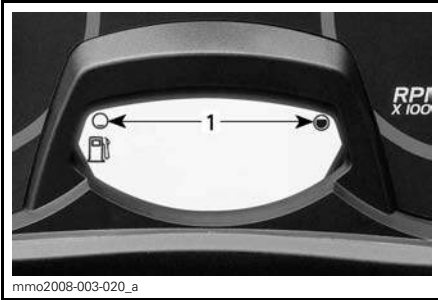

mmo2008-003-020_a

FUEL LEVEL

1. Operating range

17) Gauge (600 ACE and 600 HO E-TEC)

⚠ WARNING

Reading the gauge digital display can distract from the operation of the vehicle, particularly from constantly scanning the environment.

Gauge Description

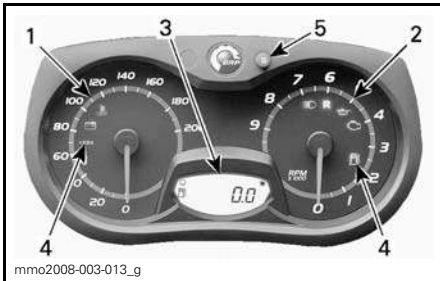

ANALOG/DIGITAL GAUGE (STANDARD)

1. Speedometer
2. Tachometer (RPM)
3. Gauge digital display
4. Gauge pilot lamps
5. Gauge SET (S) button

NOTE: The gauge is factory preset in Imperial units but it is possible to change it to metric units, contact an authorized Ski-Doo dealer for unit settings.

1) Speedometer

Measures vehicle speed (in miles per hour or kilometers per hour depending on the setting).



mmo2008-003-014

LH PORTION OF GAUGE

2) Tachometer (RPM)

Measures engine revolution per minute (RPM). Multiply by 1000 to obtain the actual revolutions.



mmo2008-003-019

RH PORTION OF GAUGE

3) Digital Display

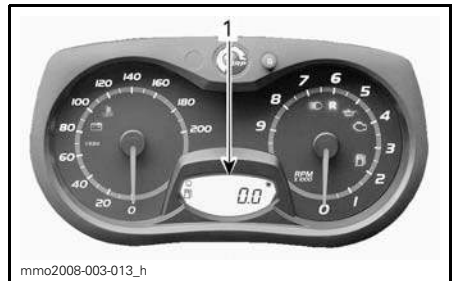

mmo2008-003-013_h

1. Digital display

The multifunction display is used to:

- Display the WELCOME message on power up
- Display the KEY recognition message
- Provide various indications as selected by the operator
- Activating or changing various functions or modes of operation
- Display scrolling messages of function activation or system faults
- Display fault codes.

4) Pilot Lamps and Messages







TYPICAL — PILOT LAMPS

See table below for usual pilot lamps information. Refer to *MONITORING SYSTEM* for details on malfunction pilot lamps.

WARNING

Never adjust or set functions on the multifunction gauge while riding the vehicle.

PILOT LAMP(S) ON	BEEPER	DESCRIPTION
	4 short beeps every 5 minutes	Two stroke engine: Injection oil level is low. Stop vehicle in a safe place then, replenish injection oil reservoir. Four stroke engine: Low engine oil pressure. Stop vehicle in a safe place then, check oil level. Fill to proper level. If oil level was correct, discontinue use and contact an authorized Ski-Doo dealer.
	—	Low fuel level. One (1) bar left in fuel level display. Replenish fuel tank as soon as possible.
	Long beeps repeating slowly	Reverse is selected.
	3 short beeps	Reverse did not engage, try again.
	—	High beam headlights are selected.

5) SET (S) Button

Button used to navigate, adjust or reset gauge multifunction display.

In order to memorize settings, engine must be running.

NOTE: SET (S) button on the multifunction switch has the same functions and can also be used.

Gauge Features

AVAILABLE INDICATIONS IN DIGITAL DISPLAY			
FUNCTIONS	550F	600 HO E-TEC	600 ACE
A) Odometer	X	X	X
B) Trip meter "A" or "B"	N.A.	X	X
C) Trip hour meter	N.A.	X	X
D) Fuel level	X	X	X
E) E-TEC engine storage mode	N.A.	X	N.A.

X = An X indicates a standard feature
N.A. = Not Available

A) Odometer

Records the total distance travelled.

Press the SET (S) button to select odometer mode.

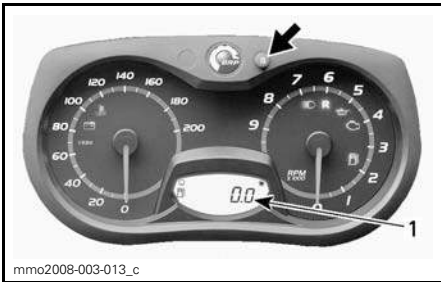

1. Odometer mode

B) Trip Meter "A" or "B"

Trip meters records distance travelled since it has been reset.

Press the SET (S) button to select trip meter (TRIP A/TRIP B) mode.

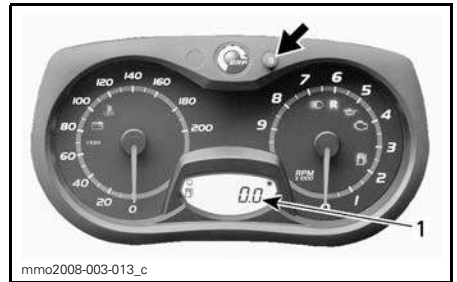

1. Trip meter (TRIP A/TRIP B) mode

Press and hold the SET (S) button to re-set.

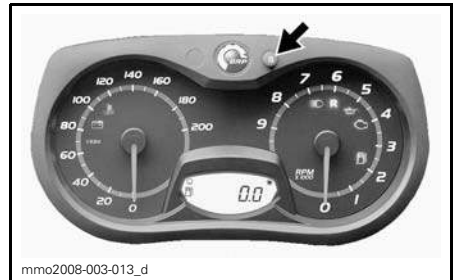

C) Trip Hour Meter

Records vehicle running time when the electrical system is activated since it has been reset.

Press the SET (S) button to select trip hour meter (HrTRIP) mode.

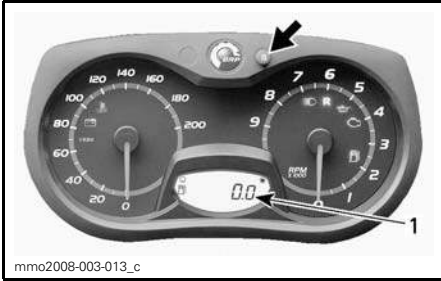

mmo2008-003-013_c

1. Trip hour meter (HrTRIP) mode

Press and hold the SET (S) button to re-set.

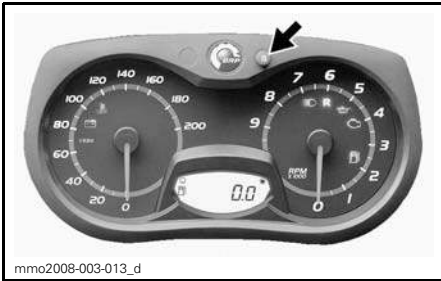

mmo2008-003-013_d

D) Fuel Level

Bar gauge that continuously indicates the amount of fuel left in the fuel tank.

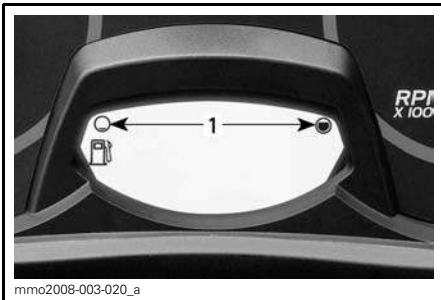

mmo2008-003-020_a

FUEL LEVEL

1. Operating range

E) E-TEC Engine Storage Mode

Displays OIL when the storage mode procedure is initiated.

18) Mountain Strap

Use the mountain strap to help weight transfer when riding at low speed.

⚠ WARNING

This strap is not for towing, lifting or other purpose than temporary use as a grab handle when a leverage is needed at very low speeds.

19) Rear Rack (All Models Except Tundra Xtreme)

⚠ WARNING

All objects in rear rack must be properly latched. Do not carry any breakable objects. Excessive weight in rack may reduce steering ability. Always readjust suspension according to the load. The capacity of this rack is limited, the MAXIMUM cargo load is 25 kg (55 lb). Ride at very low speed when loaded. Avoid speed over bumps.

20) Hitch

Tundra LT

Use the hitch in conjunction with a tow bar to tow an accessory.

NOTE: Refer to decal on vehicle for towing weight capacities.

⚠ WARNING

Never tow an accessory with a rope. Always use a rigid tow bar. Using a rope would result in a collision between the object and the snowmobile and possibly in a tip over in case of a rapid deceleration or on a downward slope.

Hitch (Tongue Type)

To attach an equipment to the hitch, secure the accessory tow bar to the hitch tongue using a lockable pin.



mmo2011-002-100_b

HITCH (TONGUE TYPE)

1. Tongue

Hitch (C Type)

To attach an equipment to the hitch:
Detach hitch from its support by removing the hairpin.

Secure rod to hitch using hairpin previously removed.

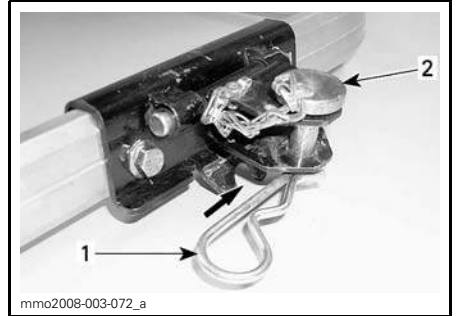

mmo2008-003-072_a

TYPICAL

1. Hairpin
2. Rod

NOTICE To avoid damages to the vehicle, always release hitch from its support. Ensure hitch moves freely when towing an accessory.

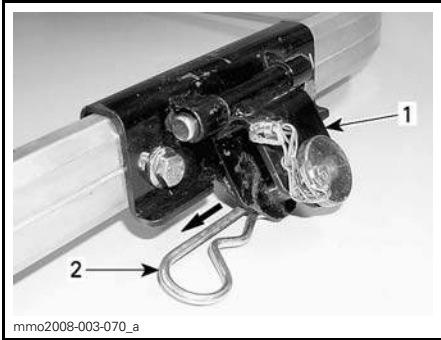

mmo2008-003-070_a

HITCH (C TYPE)

1. Hitch
2. Hairpin

Remove rod from hitch then attach rigid tow bar to hitch using the same rod.

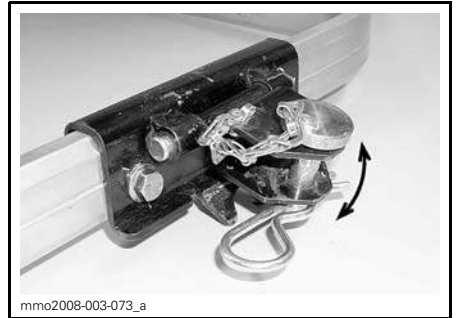

mmo2008-003-073_a

HITCH MOVES FREELY WHEN TOWING

To avoid noise from hitch when not in use, secure hitch to its support by using the hairpin.



mmo2008-003-071_a

TYPICAL

1. Rod

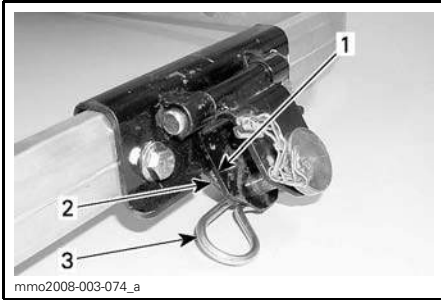

mmo2008-003-074_a

HITCH NOT IN USE

1. Hitch
2. Support
3. Hairpin

21) Spare Drive Belt

A spare drive belt (not provided with the vehicle) can be stored in the LH side of engine compartment.

Install belt in the holder as shown.

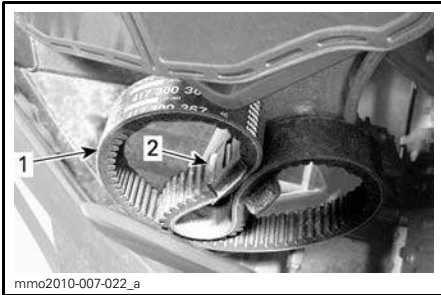

mmo2010-007-022_a

LH SIDE - BELOW AIR FILTER

1. Spare drive belt
2. Holder

NOTICE Install spare drive belt securely. Avoid contact with moving or hot parts.

22) Drive Belt Guard

Drive Belt Guard Removal

⚠ WARNING

NEVER operate engine:

- Without shields and belt guard securely installed.
- With hood and/or side panels opened or removed.

NEVER attempt to make adjustments to moving parts while engine is running.

1. Remove the tether cord cap and key.
2. Remove hood and LH side panel, see procedure in this subsection.
3. Remove tool kit.
4. Remove retaining pin.

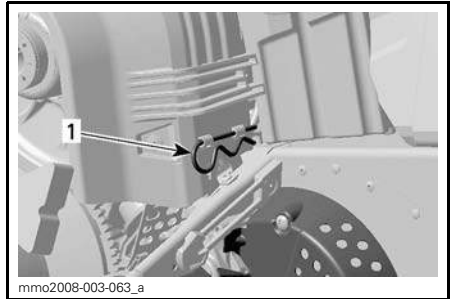

1. Retaining pin

5. Lift rear portion of guard then release from front tabs by pivoting the guard outwards.

Drive Belt Guard Installation

When reinstalling drive belt guard, position its cutaway toward front of snowmobile.

1. Place the front LH slot of the guard over the longest tab.
2. Pivot the guard inward to engage the shortest tab in the RH slot.



1. Tabs

3. Position the grommet over the retaining rod. It may be necessary to slightly lift the console to make room.

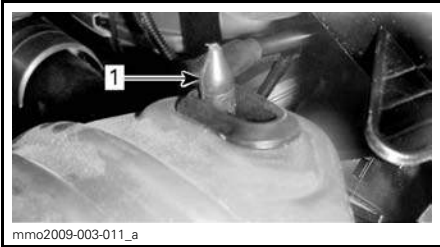

1. Retaining rod

4. Position rear portion of the belt guard over the retainer and secure it using the retaining pin.

NOTE: Belt guard is purposely made slightly oversize to maintain tension on its pins and retainers preventing undue noise and vibration. It is important that this tension be maintained when reinstalling.

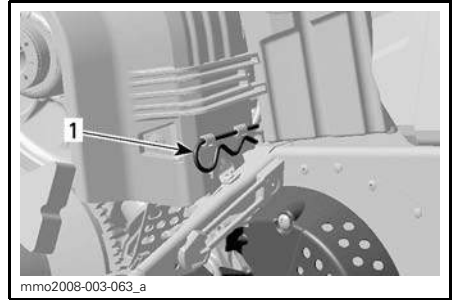

1. Retaining pin

23) Hood

⚠ WARNING
Never operate engine with hood removed from vehicle.

Hood Removal

1. Unlatch both front rubber ties, then rotate them in order to clear hood and side panels tabs.

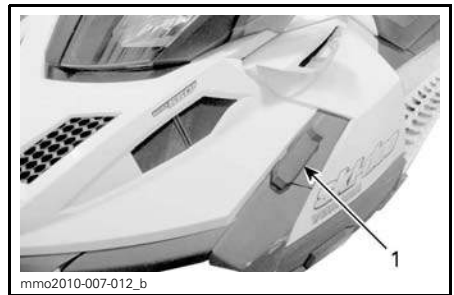

1. Front rubber tie

2. Detach rear of hood from console.
3. Slide hood towards front.

Hood Installation

1. Insert the hood front tab into the bottom pan slot while sliding hood towards rear.

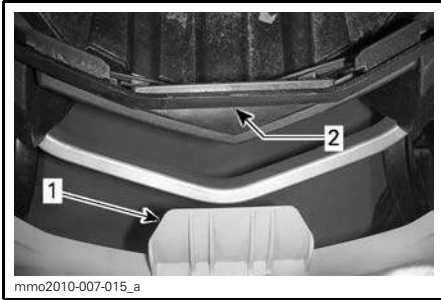

1. Hood front tab
2. Bottom pan slot

2. To secure rear of hood to the console, position the rear hood slots over the console tabs, then push down.

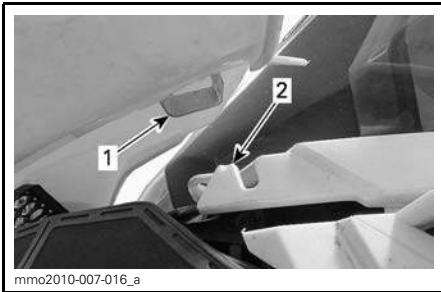

1. Rear hood slot
2. Console tab

3. Position hood outer tabs under the front rubber ties, then latch rubber ties.

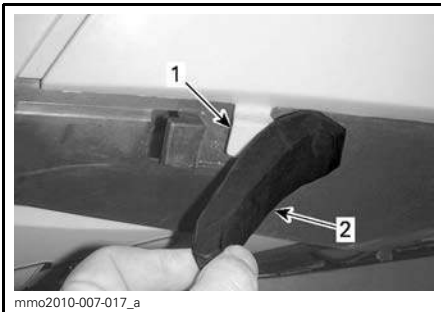

1. Hood outer tab
2. Front rubber tie

24) Side Panels

⚠ WARNING

Never operate engine with side panels opened or removed from vehicle.

Side Panel Removal

1. Unlatch front, upper and lower rubber ties.

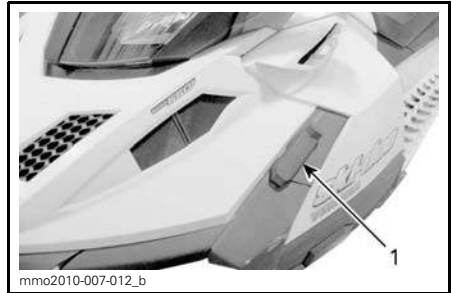

1. Front rubber tie



1. Lower rubber tie
2. Upper rubber tie

2. Pull panel backwards.

Side Panel Installation

1. Insert lower front tab into the bottom pan slot.

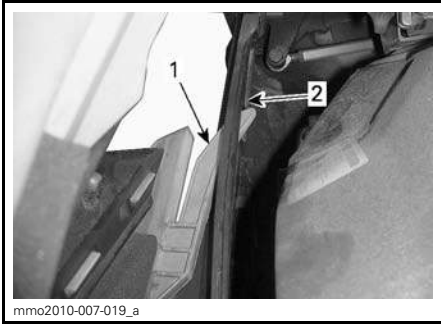

mmo2010-007-019_a

LH SIDE SHOWN

1. Lower front tab
2. Bottom pan slot

2. While pushing the panel towards front, insert rear lower tab and front upper tab into the bottom pan slots.

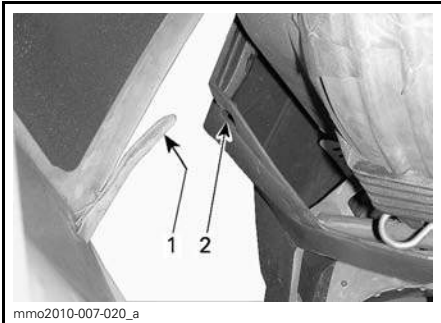

mmo2010-007-020_a

LH SIDE SHOWN

1. Rear lower tab
2. Bottom pan slot

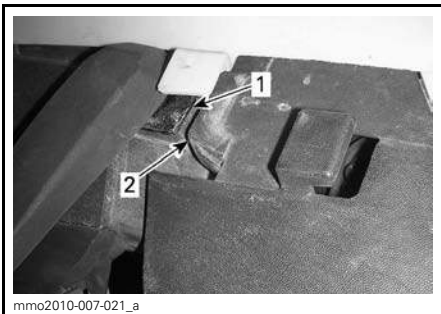

mmo2010-007-021_a

LH SIDE SHOWN

1. Bottom pan slots
2. Upper tab

3. Latch front, upper and lower rubber ties.

FUEL

Fuel Requirements

NOTICE Always use fresh gasoline. Gasoline will oxidize; the result is loss of octane, volatile compounds, and the production of gum and varnish deposits which can damage the fuel system.

Alcohol fuel blending varies by country and region. Your vehicle has been designed to operate using the recommended fuels, however, be aware of the following:

- Use of fuel containing alcohol above the percentage specified by government regulations is not recommended and can result in the following problems in the fuel system components:
 - Starting and operating difficulties.
 - Deterioration of rubber or plastic parts.
 - Corrosion of metal parts.
 - Damage to internal engine parts.
- Inspect frequently for the presence of fuel leaks or other fuel system abnormalities if you suspect the presence of alcohol in gasoline exceeds the current government regulations.
- Alcohol blended fuels attract and hold moisture which may lead to fuel phase separation and can result in engine performance problems or engine damage.

Recommended Fuel

Use unleaded gasoline containing MAXIMUM 10% ethanol. The gasoline must have the following minimum octane requirements:

FUEL TYPE	ENGINE	MINIMUM OCTANE RATING
Fuel with NO ethanol	550F 600 ACE	87 AKI (R+M)/2 92 RON
	600 HO E-TEC	91 AKI (R+M)/2 95 RON
Fuel which may contain up to 10% MAX ethanol	550F 600 ACE 600 HO E-TEC	91 AKI (R+M)/2 95 RON

NOTICE Never experiment with other fuels. Engine or fuel system damages may occur with the use of an inadequate fuel.

Inside North-America

NOTICE Do NOT use fuel from fuel pumps labeled E85.

Use of fuel labeled E15 is prohibited by U.S. EPA Regulations.

Fuel Antifreeze Additives

When using oxygenated fuel, additional gas line antifreeze or water absorbing additives are not required and should not be used. When using non oxygenated fuel, isopropyl base gas line antifreeze can be used in a proportion of 150 ml (5 U.S. oz) of gas line antifreeze added to 40 L (10.6 U.S. gal.) of gas.

NOTE: Use only methyl hydrate free gas line antifreeze.

Vehicle Fueling Procedure

⚠ WARNING

- Fuel is flammable and explosive under certain conditions.
- Never use an open flame to check fuel level.
- Never smoke or allow flame or spark in vicinity.
- Always work in a well-ventilated area.

1. Stop engine.

⚠ WARNING

Always stop engine before refueling.

2. Have operator and passenger get off vehicle.

⚠ WARNING

Do not allow anyone seated on the vehicle while fueling.

3. Unscrew slowly the fuel reservoir cap counterclockwise to remove it.

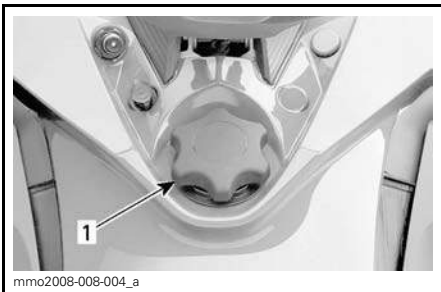

mmo2008-008-004_a

TYPICAL

1. Fuel tank cap

⚠ WARNING

If a differential pressure condition is noticed (whistling sound heard when loosening fuel reservoir cap) have vehicle inspected and/or repaired before further operation.

4. Insert the spout into the filler neck.
5. Pour fuel slowly so that air can escape from the tank and prevent fuel flow back. Be careful not to spill fuel.
6. Stop filling when the fuel reaches the bottom of filler neck. **Do not overfill.**

⚠ WARNING

Never top up the fuel tank before placing the vehicle in a warm area. As temperature increases, fuel expands and may overflow.

7. Fully tighten fuel reservoir cap clockwise.

⚠ WARNING

Always wipe off any fuel spillage from the vehicle.

NOTE: Do not sit or lean on seat when fuel tank cap is not properly installed.

INJECTION OIL (550F AND 600 HO E-TEC)

Recommended Injection Oil

550F

RECOMMENDED INJECTION OIL		
ENGINE	XPS INJECTION OIL (P/N 293 600 117)	XPS SYNTHETIC 2-STROKE OIL (P/N 293 600 132)
550F	✓	✓

NOTICE The engine of this snowmobile has been developed and validated using the recommended BRP XPS™ oil. BRP recommends the use of its recommended XPS oil or equivalent. Damages caused by oil which is not suitable for this oil injected 2-stroke engine may not be covered by the BRP limited warranty.

NOTICE Check level and refill every time you refuel.

600 HO E-TEC

RECOMMENDED INJECTION OIL	
ENGINE	XPS SYNTHETIC 2-STROKE OIL (P/N 293 600 132)
600 HO E-TEC	✓

NOTICE The engine of this snowmobile has been developed and validated using the recommended BRP XPS™ oil. BRP recommends the use of its recommended XPS oil or equivalent. Damages caused by oil which is not suitable for this oil injected 2-stroke direct fuel injection engine may not be covered by the BRP limited warranty.

NOTICE Check level and refill every time you refuel.

Injection Oil Level Verification

The injection oil reservoir is located behind the RH side panel. See *CONTROLS, INSTRUMENTS AND EQUIPMENT* for opening procedure.

Always maintain a sufficient amount of recommended injection oil in the injection oil reservoir.

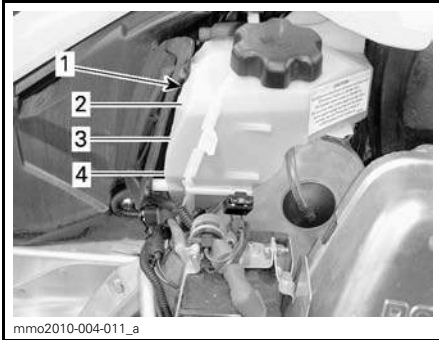

TIPICAL

1. Oil reservoir
2. 3/4 level
3. 1/2 level
4. 1/4 level

NOTICE Check level and refill every time you refuel.

To Add Injection Oil

Remove injection oil reservoir cap.

Add injection oil. Do not overfill.

NOTE: Do not exceed the maximum level tab in the oil tank neck.

Reinstall cap and fully tighten.

NOTICE Do not mismatch oil reservoir cap with fuel tank cap.

⚠ WARNING

Wipe off any oil spills. Oil is highly flammable when heated.

BREAK-IN PERIOD

Operation During Break-In

All Models

A break-in period of 10 operating hours or 500 km (300 mi) is required for the vehicle.

After the break-in period, the vehicle should be inspected by an authorized Ski-Doo dealer, repair shop or person, of your own choosing. Refer to *MAINTENANCE* section.

- Avoid pulling a load
- Avoid high speed cruising.

Engine

During the break-in period:

- Avoid prolonged full throttle operation
- Avoid sustained accelerations
- Avoid prolonged cruising speeds
- Avoid engine overheating.

However, brief accelerations and speed variations contribute to a good break-in.

During the first few hours of break-in, the engine management system controls some engine parameters which will slightly reduce the engine performance.

E-TEC Models

During a predetermined period, the engine management system controls some engine parameters.

The duration is based on fuel volume. It will take approximately two fuel tanks to complete the break-in.

During this period:

- The engine performance and behavior will not be optimal.
- The fuel and oil consumption will be higher.

Drive Belt

A new drive belt requires a break in period of 50 km (30 mi).

During the break-in period:

- Avoid strong acceleration and deceleration

OPERATING MODES (600 ACE ONLY)

⚠ WARNING

Whenever changing operating mode, make sure to maintain situational awareness while riding.

ECO Mode (Fuel Economy Mode)

When ECO mode is selected (fuel economy mode), vehicle torque and speed are limited whereby an optimal cruising speed is maintained in order to reduce fuel consumption.

Once activated, ECO mode will remain active until it is deactivated by the operator.

Standard Mode

A Standard mode indicator is ON in the multifunction gauge to confirm the active mode of operation.

Sport Mode

⚠ WARNING

Ensure passenger is advised to hold on tightly before activating Sport mode. Sport mode provides increased acceleration.

When selected, Sport mode provides for instant throttle response and more rapid accelerations than Standard or ECO mode.

Once activated, Sport mode will remain active until it is deactivated by the operator.

Navigating Operating Modes

Use ECO/Standard/Sport Mode switch to navigate between power levels, from ECO (reduced power) to Standard (full power) to Sport (increased response).

To increase power, press the switch upwards. To decrease power, press the switch downwards.



TYPICAL - LH SIDE OF FUEL TANK

1. Mode switch

To activate Standard mode when in Sport mode, press bottom end of switch once.

To activate ECO mode when in Sport mode, press bottom end of switch twice.

To activate ECO mode when in Standard mode, press bottom end of switch once.

⚠ WARNING

Ensure passenger is advised to hold on tightly before activating Sport mode. Sport mode provides increased acceleration.

To activate Sport mode when in Standard mode, press top end of switch once.

To activate Sport mode when in ECO mode, press top end of switch twice.

To activate Standard mode when in ECO mode, press top end of switch once.

⚠ WARNING

When adjusting modes, be sure to maintain situational awareness of other snowmobiles, obstacles, or persons.

Learning Key Modes

The learning key provides a mode of operation whereby engine torque and speed are limited.

NOTE: The initial learning key programming can limit the speed to 40 km/h (25 MPH) or 70 km/h (43 MPH). Refer to your authorized Ski-Doo dealer to modify this setting.

There are 3 levels available for the learning key mode.

Changing Learning Key Settings

To change learning key setting, carry out the following:

1. Press the START/electronic reverse button to wake up the electrical system and install the NORMAL key on the engine cut-off switch.
2. Wait for the information center to complete its self-test and display the key recognition message.
3. Press the SET button until ACCEL. is visible in the digital screen of the information center.
4. Use the heated grip switch to toggle the key setting between 1 and 3.

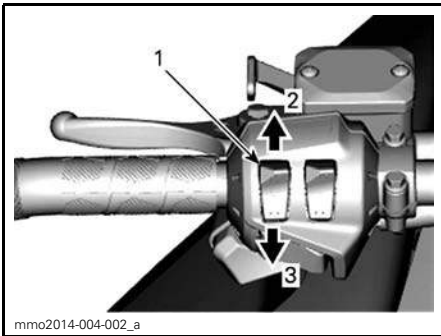

TYPICAL

1. Heated grip switch
2. Increase
3. Decrease

NOTE: Setting 1 is the lowest available torque, while setting 3 is the highest available torque for learning key.

5. After a few seconds, the setting is automatically confirmed and saved.

NOTE: The key speed setting is applicable to any key of the same type used on a specific snowmobile. The same key type used on a different snowmobile may therefore have a different key speed setting.

NOTE: Vehicle performance may vary depending on riding conditions.

BASIC PROCEDURES

Engine Starting Procedure (550F)

Procedure

1. Apply parking brake.
2. Recheck throttle control lever operation.
3. Put your helmet on.
4. Ensure that the tether cord cap is installed on the engine cut-off switch and that the cord attached to your clothing eyelet.
5. Ensure that the emergency engine stop switch is in the ON position (UP).
6. If engine is cold, activate the choke according to the temperature. Refer to *CHOKE APPLICATION PROCEDURE (550F)* further.
7. Start engine as explained below.

⚠ WARNING

Never depress throttle while starting engine.

Manual Start

Turn ignition key to ON position.

Grab rewind starter handle, pull handle slowly until a resistance is felt, then hold handle firmly and pull vigorously to start engine.

Electric Start

Turn key clockwise until starter engages.

NOTICE Do not engage electric starter for more than 10 seconds at a time. A rest period should be observed between the cranking cycles to allow electric starter to cool down.

8. Release parking brake.

NOTE: For an initial cold start, do not release parking brake. Perform the *VEHICLE WARM-UP* procedure as explained below.

Choke Application Procedure

Initial Cold Starting when Temperature is Below -10°C (14°F)

NOTE: Do not operate the throttle lever with the choke lever on.

Set the choke lever to position 3.

NOTE: After the engine is started, let engine warm up at fast idle until engine speed drops. Then, close off choke to ensure proper air-fuel mixture.

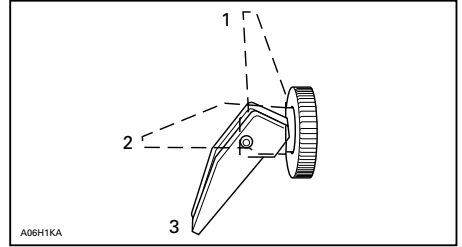

1. OFF
2. Position 2
3. Position 3

Initial Cold Starting When Temperature is Above -10°C (14°F)

Set the choke lever to position 2.

NOTE: If engine does not start after a few attempts, set choke lever to position 3.

After the engine is started, close off choke to ensure proper air-fuel mixture.

Engine Starting Procedure (600 ACE and 600 HO E-TEC)

Procedure

1. Apply parking brake.
2. Recheck throttle control lever operation.
3. Put your helmet on.

4. Ensure that the tether cord cap is installed on the engine cut-off switch and that the cord is attached to your clothing eyelet.
5. Ensure that the emergency engine stop switch is in the ON position (UP).
6. Depress the START/RER button.
7. Release button immediately when engine has started.

⚠ WARNING

Never depress throttle while starting engine.

NOTICE Do not engage electric starter for more than 10 seconds at a time. A rest period should be observed between the cranking cycles to allow electric starter to cool down.

8. Release parking brake.

NOTE: For an initial cold start, do not release parking brake. Perform the *VEHICLE WARM-UP* procedure as explained below.

Emergency Starting

600 ACE and 550F Models

Do not attempt an emergency starting procedure. Have the battery charged or replaced.

NOTE: Emergency manual engine start is not provided for 600 ACE and 550F models.

600 HO E-TEC Model

The engine can be started with the emergency starter rope supplied with the tool kit.

Remove belt guard.

⚠ WARNING

Do not wind starting rope around your hand. Hold rope by the handle only. Do not start the snowmobile by the drive pulley unless it is a true emergency situation. Have the snowmobile repaired as soon as possible.

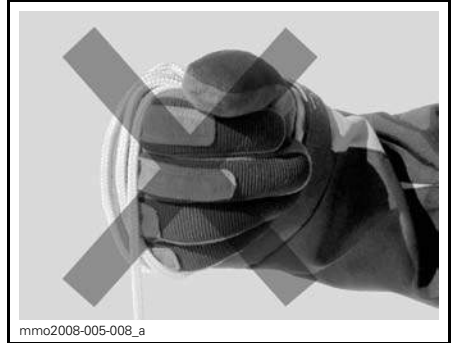

Attach one end of emergency rope to rewind handle.

NOTE: The spark plug socket can be used as an emergency handle.

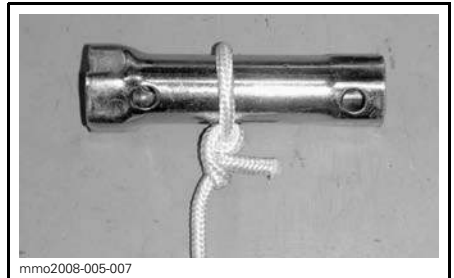

Attach the other end of emergency rope to the starter clip supplied in the tool kit.

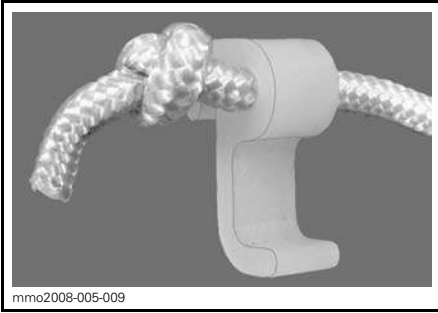

mmo2008-005-009

Hook up clip on drive pulley.

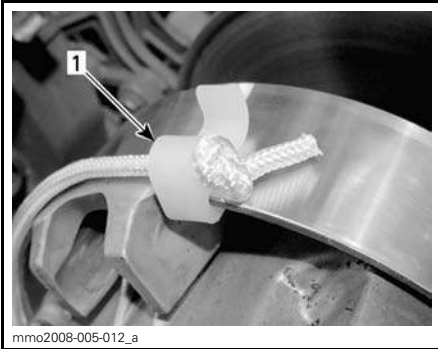

mmo2008-005-012_a

1. Clip installation location

Wind the rope tightly around drive pulley. When pulled, pulley must rotate counterclockwise.

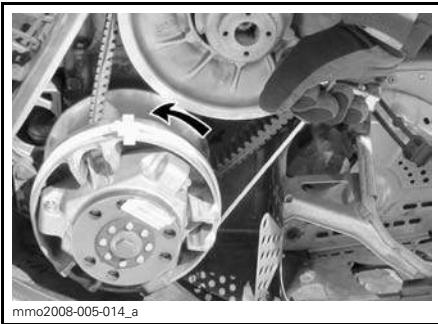

mmo2008-005-014_a

Pull the rope using a sharp, crisp pull so the rope comes free of the drive pulley. Start engine as per usual manual starting.

⚠ WARNING

When starting the snowmobile in an emergency situation, using drive pulley, do not reinstall the belt guard and return slowly to have snowmobile repaired.

Vehicle Warm-Up

Before every ride, vehicle has to be warmed up as follows.

1. Start engine as explained in *ENGINE STARTING PROCEDURE* above.
2. Allow engine to warm up one or two minutes at idle speed.

NOTICE It is not recommended to let engine running at idle speed for more than 10 minutes.

3. Disengage parking brake.
4. Apply throttle until drive pulley engages. Drive at low speed the first two or three minutes.

NOTICE If vehicle does not move when throttle is applied, stop engine, remove tether cord cap from the engine cut-off switch, then do the following.

- Check if skis are stuck on the ground. Lift one ski at a time by the handle, then put it down.
- Check if track is stuck on the ground. Lift rear of snowmobile enough to clear track from the ground, then drop.
- Check rear suspension for hard snow or ice accumulation that could interfere with track rotation. Clean the area.

⚠ CAUTION Use proper lifting techniques, notably using your legs force. Do not attempt to lift the either end of the vehicle if it is above your limits.

⚠ WARNING

Make sure tether cord cap and key are removed before standing in front the vehicle, getting close to the track or rear suspension components.

NOTE: On E-TEC models, warm-up is controlled by the engine management system. During this period (up to 10 minutes depending on ambient temperature), engine RPM is limited.

Shifting in Reverse or Forward**⚠ WARNING**

When shifting in reverse, wait until the reverse alarm sounds and the pilot lamp comes on in the analog/digital gauge before operating throttle. The reverse speed is not limited. Always proceed with caution as fast reverse could result in loss of vehicle stability. Come to complete stop before depressing engaging the reverse. Always remain seated and apply the brake before shifting. Ensure the path behind is clear of obstacles or bystanders before proceeding.

Reverse (Manual Shift)**Shifting in Reverse**

To engage reverse gear, proceed as follows:

1. Bring vehicle to a complete stop.
2. Apply and hold brake. Remain seated, refer to *RIDER POSITION (REVERSE OPERATION)* for posture information.
3. With engine at idle speed, pull the reverse shift lever all the way out.
4. Gently depress throttle lever.

Shifting in Forward

To engage forward gear, proceed as follows:

1. Bring vehicle to a complete stop.
2. Apply and hold brake.
3. With engine at idle speed, push the reverse shift lever all the way in.
4. Gently depress throttle lever.

Reverse (RER)

When the engine is running, depressing the RER button will slow down engine RPM to almost a stop and advance the ignition timing to invert crankshaft rotation.

- Engine will automatically shift into forward when restarting after stopping or stalling.
- Shifting procedure will take place only when the engine is running.
- If engine is running at a speed above 4300 RPM, the function of the RER button is disabled.
- It is recommended to warm up the engine to its normal operating temperature before shifting.

Shifting in Reverse

1. Bring vehicle to a complete stop.
2. Apply and hold brake. Remain seated, refer to *RIDER POSITION (REVERSE OPERATION)* for posture information.
3. With engine at idle speed, press and release the RER button.
4. Wait until reverse beeper sounds, then gently depress throttle lever.

Shifting in Forward

1. Bring vehicle to a complete stop.
2. Apply and hold brake.
3. Press and release the RER button.
4. RER pilot lamp will stop.
5. Apply throttle slowly and evenly. Allow drive pulley to engage then accelerate carefully.

Shutting Off the Engine

Release throttle lever and wait until engine has returned to idle speed.

Shut off the engine using either ignition switch (key), engine stop switch or by pulling off the tether cord cap from the engine cut-off switch.

WARNING

Always remove the tether cord cap and key when vehicle is not in operation in order to prevent accidental engine starting, theft or use by unauthorized persons.

RIDING CONDITIONS AND YOUR SNOWMOBILE

Altitude

All models covered in this Operator's Guide are calibrated for **SEA LEVEL** operation.

If your snowmobile is to be used at an altitude above 600 m (2,000 ft), have it calibrated accordingly by an authorized Ski-Doo dealer.

NOTICE An inappropriate altitude calibration would decrease performance and may cause serious damage to the snowmobile.

Temperature

550F Models

This engine has been calibrated for -20°C (-4°F). It can be operated at warmer winter temperatures without risk of problems.

For temperatures colder than -20°C (-4°F), carburetors must be re-calibrated. Refer to an authorized Ski-Doo dealer.

NOTICE Engine damage will occur if carburetors are not re-calibrated for temperatures below -20°C (-4°F).

600 ACE and 600 HO E-TEC Models

No adjustment is required. The engine management system adapts engine parameters to temperature changes.

Hard Packed Snow

Tundra Xtreme

This snowmobile is equipped with a high lug profile track which provides an optimum operation on loose snow.

BRP does **not recommend** to ride a snowmobile equipped with high lug profile track at **high speed** in a trail, on hard packed surfaces or ice for an extended period of time.

In the event that you have to, **reduce your speed**, then minimize the distance you ride on those surfaces.

NOTICE Running this type of track at high speed in a trail, on hard packed surfaces or ice put more stress on the lugs, which tend to heat. To avoid potential degradation or damage to the track, reduce your speed, then minimize the distance you ride on those surfaces.

For general instructions on maintenance of tracks, refer to the *TRACK* in *MAINTENANCE*.

SPECIAL OPERATION

Towing an Accessory

Always use a rigid tow bar to tow an accessory. Any towed accessory should have reflectors on both sides and at the rear. Check local laws for brake light(s) requirements.

WARNING

Never tow an accessory with a rope. Always use a rigid tow bar. Using a rope would result in a collision between the object and the snowmobile and possibly in a tip over in case of a rapid deceleration or on a downward slope.

Towing Another Snowmobile

If a snowmobile is disabled and must be towed use a rigid tow bar. Remove the drive belt from disabled snowmobile, refer to *DRIVE BELT* in the *MAINTENANCE PROCEDURES* subsection and tow at moderate speed.

NOTICE Always remove the drive belt of the snowmobile that is to be towed to prevent damage to its belt and drive system.

In an emergency situation only, if a rigid tow bar is not available, a rope can be used. Proceed with extra caution. In some areas, it may be illegal to do so. Check with state or local authorities.

Remove the drive belt, attach the rope to the ski legs (spindles), have someone sit on the towed snowmobile to activate the brake, and tow at low speed.

NOTICE In order to prevent damage to the steering system, never attach the tow rope to the ski loops (handles).

WARNING

Never ride at high speed when towing a disabled snowmobile. Proceed slowly with extra caution.

TUNE YOUR RIDE

Snowmobile handling and comfort depend upon suspension adjustments.

⚠ WARNING

Suspension adjustment could affect vehicle handling. Always take time to familiarize yourself with the vehicle's behavior after any suspension adjustment have been made. Always adjust LH and RH suspension components to the same setting.

Choice of suspension adjustments vary with carrying load, operator's weight, personal preference, riding speed and field condition.

NOTE: Some adjustments may not apply to your snowmobile.

⚠ WARNING

Before proceeding with any suspension adjustment, remember:

- Park in a safe place.
- Remove the tether cord cap and key.
- Use appropriate lifting device or have assistance to share lifting stress. If a lifting device is not used, use proper lifting techniques, notably using your legs force.
- Do not attempt to lift the front or rear of vehicle if it is above your limits.
- Support front of vehicle off the ground with a suitable device before adjusting suspension.
- Support rear of vehicle off the ground with a wide-base snowmobile stand with a rear deflector panel.
- Make sure support device is stable and secure.

The best way to set up the suspension is to customize each adjustment one at a time. Various adjustments

are interrelated. It may be necessary to readjust center spring after adjusting front springs for instance. Test run the snowmobile under the same conditions; trail, speed, snow, operator riding position, etc. Proceed methodically until you are satisfied.

Following are guidelines to fine-tune suspension. Use suspension adjustment tool provided in the tool kit.

Rear Suspension Adjustments

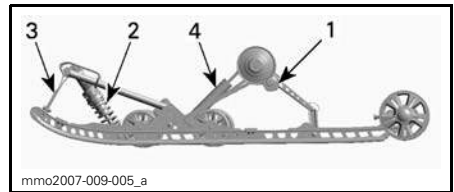

TYPICAL SC-5M™ REAR SUSPENSION

1. Rear spring cams
2. Center spring and shock absorber
3. Stopper strap
4. Rear shock absorber

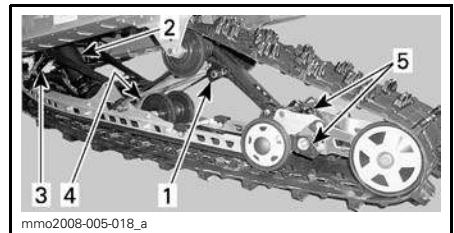

TYPICAL SC-5U REAR SUSPENSION

1. Rear spring cams
2. Center spring and shock absorber
3. Stopper strap
4. Rear shock absorber
5. Rear suspension extension adjustments

NOTICE Whenever adjusting rear suspension, check track tension and adjust if necessary.

Stopper Strap Length

Stopper strap length has an effect on the amount of weight the center spring has to carry especially during acceleration, therefore on the front end uplift.

Stopper strap length also has an effect on center spring travel.

ACTION	RESULT
Increasing stopper strap length	Lighter ski pressure under acceleration
	More center spring travel
	More bump absorption capability
Decreasing stopper strap length	Heavier ski pressure under acceleration
	Less center spring travel
	Less bump absorption capability

NOTE: Stopper strap could be set to position 1, 2, 3, 4 and 5. Below are illustrations for position 1, 2, 3. Smaller numbers correspond to a longer strap setting.

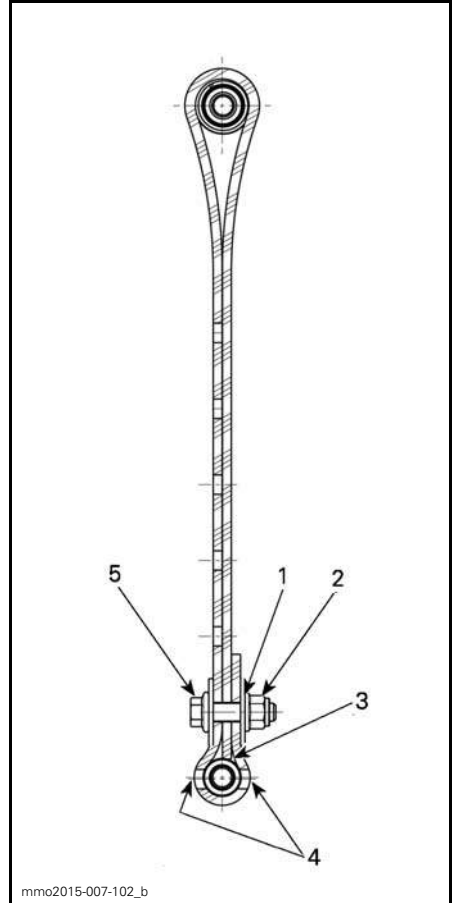

STOPPER STRAP POSITION 1 (1ST HOLE, LONGEST)

1. 1st hole from end
2. Towards rear
3. Tip of strap touching strap axis
4. Two holes left open between screw head and nut
5. Towards front

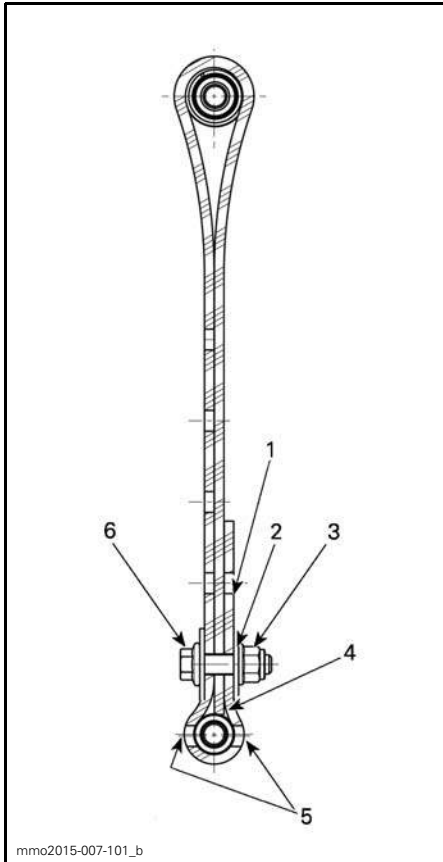

STOPPER STRAP POSITION 2 (2ND HOLE)

1. Free hole
2. 2nd hole from end
3. Towards rear
4. Tip of strap touching strap axis
5. Two holes left open between screw head and nut
6. Towards front

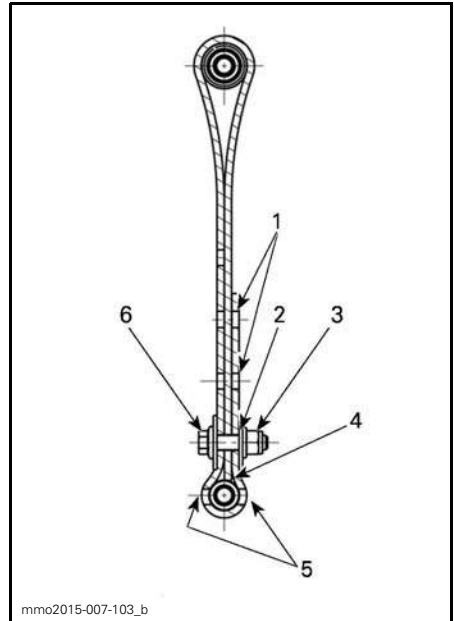

STOPPER STRAP POSITION 3 (3RD HOLE)

1. Free holes
2. 3rd hole from end
3. Towards rear
4. Tip of strap touching strap axis
5. Two holes left open between screw head and nut
6. Towards front

NOTE: Always install stopper strap bolt as close as possible to the lower shaft.

NOTE: Decreasing the stopper strap length may reduce comfort

When operating the snowmobile in deep snow, it may be necessary to vary stopper strap length and/or riding position, to change the angle at which the track rides on the snow. Operator's familiarity with the various adjustments as well as snow conditions will dictate the most efficient combination.

Generally, a longer stopper strap setting gives better performance in deep snow on a flat landscape.

Rear Spring Preload

Rear spring preload has an effect on comfort, ride height and load compensation.

Also, adjusting rear spring preload shifts more or less weight to the snowmobile front end. As a result, more or less weight is applied to the skis. This has an effect on performance in deep snow, steering effort and handling.

Slight suspension bottoming occurring under the worst riding conditions indicates a good choice of spring preload.

ACTION	RESULT
Increasing preload	Firmer rear suspension
	Higher rear end
	More bump absorption capability
	Heavier steering
Decreasing preload	Softer rear suspension
	Lower rear end
	Less bump absorption capability
	Lighter steering
	Better performance and handling in deep snow

Refer to the following to determine if preload is correct.

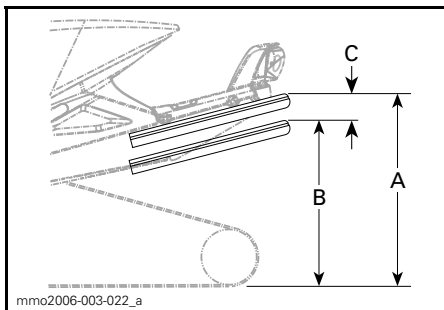

TYPICAL — PROPER ADJUSTMENT

- A. Suspension fully extended
- B. Suspension has collapsed with operator, passenger(s) and load added
- C. Distance between dimension "A" and "B", see table below

C	WHAT TO DO
50 to 75 mm (2 to 3 in)	No adjustment required
More than 75 mm (3 in)	Adjusted too soft, increase preload
Less than 50 mm (2 in)	Adjusted too firm, decrease preload

NOTE: If the specification is unattainable with the original springs, see an authorized Ski-Doo dealer for other available springs.

NOTICE To increase spring preload, always turn the left side adjustment cam in a clockwise direction, and the right side cam in a counterclockwise direction.

CAUTION Never set preload cams directly from position 5 to 1 or directly from position 1 to 5.

The adjustment cams have 5 different settings, 1 being the softest.

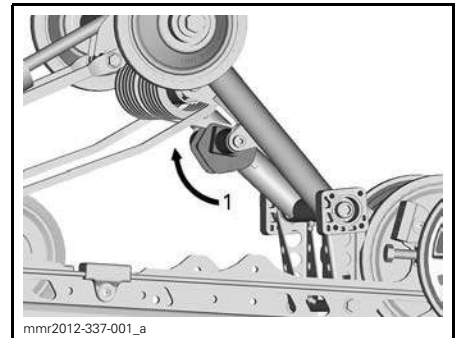

TYPICAL — LH SIDE

- 1. Adjust spring preload

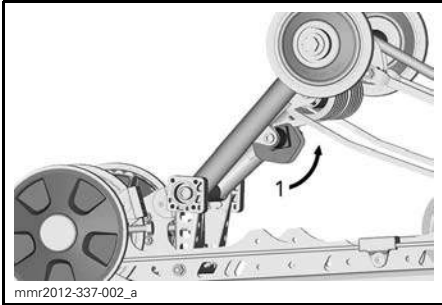

TYPICAL — RH SIDE
1. Adjust spring preload

Center Spring Preload

Center spring preload has an effect on steering effort, handling and bump absorption.

Also, since center spring preload adjustment puts more or less pressure on the front of the track, it has an effect on the performance in deep snow.

ACTION	RESULT
Increasing preload	Lighter steering
	More bump absorption capability
	Better deep snow starts
	Better deep snow performance and handling
Decreasing preload	Heavier steering
	Less bump absorption capability
	Better trail handling

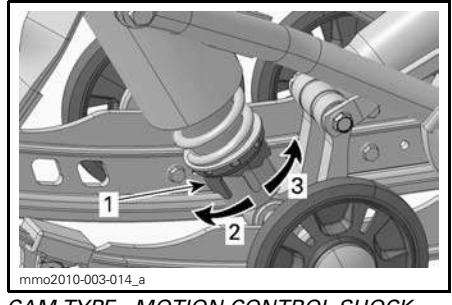

CAM TYPE - MOTION CONTROL SHOCK ABSORBER

1. Spring preload adjustment cam
2. Increase preload
3. Decrease preload

NOTE: For cam type preload adjuster, use the suspension adjustment tool provided in the tool kit.

Rear Suspension Extension Spring Preload (SC-5U)

Adjust by turning the preload cam.

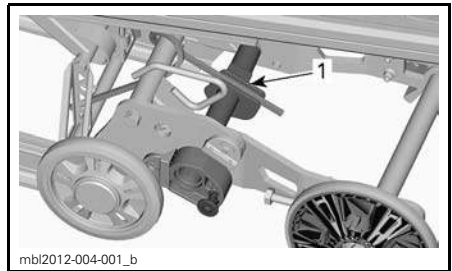

1. Preload cam

ACTION	RESULT
Increasing preload	More track surface on the ground
	Less extension lift
Decreasing preload	Better reverse capability especially in deep snow
	More extension lift

Rear Suspension Extension Stabilizer Cam

SC-5U Only

To change stabilizer cam setting, pull lock off, then turn cam.

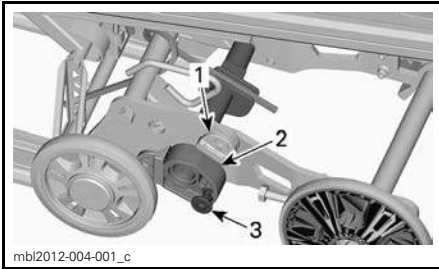

1. Stop block
2. Stabilizer cam
3. Lock

CAM SETTING	RESULT
Away from upper stop block	Allows free movement of the suspension extension on its entire stroke
	General use
Leaning on both stop blocks	Good reverse capability
	Locks the suspension extension in line with the suspension rails
	Better traction, full track contact surface
	Better towing capability

Adjustment Tips According to Vehicle Behavior

PROBLEM	CORRECTIVE MEASURES
Front suspension darting	Check ski alignment – Increase center spring preload. – Reduce rear spring preload.
Steering feels too heavy at steady speeds	– Increase center spring preload.
Steering feels too heavy during acceleration	– Reduce rear spring preload. – Lengthen limiter strap.
Too much ski lift during cornering or acceleration	– Shorten limiter strap. – Increase rear spring preload.
Rear of snowmobile seems too stiff	Reduce rear spring preload.
Rear of snowmobile seems too soft	Increase rear spring preload.
Rear suspension is frequently bottoming	– Increase rear spring preload. – Increase center spring preload. – Lengthen limiter strap.
Snowmobile seems to pivot around its center	– Reduce center spring preload. – Increase rear spring preload. – Shorten limiter strap.
Track spins too much at start	– Lengthen limiter strap.
Rear of track sinks when operating in reverse	– Decrease suspension extension spring preload. – Adjust suspension extension stabilizer cam in a position other than "locked".

VEHICLE TRANSPORTATION

Make sure that oil reservoir and fuel tank caps are properly installed.

Tilt bed trailers can easily be equipped with a winch mechanism to afford maximum safety in loading. Simple as it may seem, never drive your snowmobile onto a tilt bed trailer or any other kind of trailer or vehicle. Many serious accidents have resulted from driving up and over a trailer. Anchor your vehicle securely, front and rear, even on short hauls. Be certain all equipment is securely fastened. Cover your snowmobile when trailering to prevent road grime from causing damage.

Be certain your trailer meets state or provincial requirements. Ensure the hitch and safety chains are secure and the brake, turn indicators and clearance lights all function.

***This page is
intentionally blank***

MAINTENANCE

FIRST INSPECTION

This vehicle should be serviced by an authorized Ski-Doo dealer, repair shop, or person of your own choosing. The first inspection is very important and must not be neglected.

NOTE: The first inspection is at the expense of the vehicle owner.

Date of inspection

Signature of the Authorized Ski-Doo dealer,
repair shop, or person

Name of the Authorized Ski-Doo dealer,
repair shop, or person

FIRST INSPECTION (550F) AFTER THE FIRST 500 KM (300 MI) OR 10 HOURS OF OPERATION, WHICHEVER COMES FIRST
Inspect exhaust system and check for leaks
Inspect fuel lines and connections
Inspect throttle cable
Inspect drive belt
Visually inspect drive pulley
Tighten drive pulley retaining screw to specified torque
Inspect driven pulley
Adjust and align track
Change chaincase oil
Adjust drive chain
Check brake fluid level
Inspect brake hose, pads and disk
Inspect steering mechanism
Inspect skis and runners
Inspect front suspension
Inspect rear suspension (including stopper straps and slider shoes)
Adjust oil injection pump
Inspect spark plugs

**FIRST INSPECTION (600 ACE) AFTER THE FIRST 500 KM (300 MI) OR
10 HOURS OF OPERATION, WHICHEVER COMES FIRST**

Inspect engine seals and gaskets for leaks

Inspect exhaust system and check for leaks

Check coolant level

Inspect fuel lines and connections

Inspect drive belt

Visually inspect drive pulley

Tighten drive pulley retaining screw to specified torque

Inspect driven pulley

Check driven pulley preload

Adjust and align track

Change chaincase oil

Adjust drive chain

Check brake fluid level

Inspect brake hose, pads and disk

Inspect steering mechanism

Inspect skis and runners

Inspect front suspension

Inspect rear suspension (including stopper straps and slider shoes)

**FIRST INSPECTION (600 ACE) AFTER THE FIRST 3 000 KM (2,000 MI) OR
1 YEAR OF OPERATION, WHICHEVER COMES FIRST**

Change engine oil and filter

FIRST INSPECTION (600 HO E-TEC) AFTER THE FIRST 500 KM (300 MI) OR 10 HOURS OF OPERATION, WHICHEVER COMES FIRST
Inspect exhaust system and check for leaks
Check coolant level
Inspect fuel lines and connections
Inspect throttle cable
Inspect drive belt
Visually inspect drive pulley
Tighten drive pulley retaining screw to specified torque
Inspect driven pulley
Adjust and align track
Change chaincase oil
Adjust drive chain
Check brake fluid level
Inspect brake hose, pads and disk
Inspect steering mechanism
Inspect skis and runners
Inspect front suspension
Inspect rear suspension (including stopper straps and slider shoes)

MAINTENANCE SCHEDULE (550F)

Maintenance is very important for keeping your vehicle in safe operating condition. A repair shop or person of the owner's choosing may maintain, replace, or repair emission control devices and systems. These instructions do not require components or service by BRP or authorized Ski-Doo dealers. Although an authorized Ski-Doo dealer has an in-depth technical knowledge and tools to service the Ski-Doo snowmobile, the emission-related warranty is not conditioned on the use of an authorized Ski-Doo dealer or any other establishment with which BRP has a commercial relationship. For emission-related warranty claims, BRP is limiting the diagnosis and repair of emission-related parts to the authorized Ski-Doo dealers. For more information, please refer to the *US EPA EMISSION-RELATED WARRANTY* contained herein. Proper maintenance is the owner's responsibility. A warranty claim may be denied if, among other things, the owner or operator caused the problem through improper maintenance or use. You must follow the instructions for fuel requirements in the fuel section of this manual. Even if gasoline containing greater than ten volume percent ethanol is readily available, the US EPA issued a prohibition against the use of gasoline containing greater than 10 vol% ethanol that applies to this vehicle. The use of gasoline containing greater than 10 vol% ethanol with this engine may harm the emission control system. The vehicle should be serviced as per the maintenance schedule.

The maintenance schedule does not exempt the pre-ride inspection.

WARNING

Failure to properly maintain the vehicle according to the maintenance schedule can make it unsafe to operate.

EVERY 1 500 KM (1,000 MI)

Adjust drive chain

Check chaincase oil level

EVERY 3 000 KM (2,000 MI) OR 1 YEAR (WHICHEVER COMES FIRST)

Inspect engine rubber mounts

Inspect exhaust system and check for leaks

Visually inspect and clean drive pulley

Tighten drive pulley retaining screw to specified torque

Clean driven pulley

Adjust and align track

Inspect brake hose, pads and disk

Inspect steering mechanism

**EVERY 3 000 KM (2,000 MI) OR 1 YEAR
(WHICHEVER COMES FIRST)**

Inspect front suspension

Inspect rear suspension (including stopper straps and slider shoes)

Lubricate rear suspension (lubricate whenever the vehicle is used in wet conditions (rain, puddles))

**EVERY 6 000 KM (4,000 MI) OR 2 YEARS
(WHICHEVER COMES FIRST)**

Replace in-tank fuel strainer

Replace brake fluid

Inspect throttle cable

Clean and lubricate rewind starter

**EVERY 10 000 KM (6,000 MI) OR 3 YEARS
(WHICHEVER COMES FIRST)**

Replace injection oil filter

MAINTENANCE SCHEDULE (600 ACE)

Maintenance is very important for keeping your vehicle in safe operating condition. A repair shop or person of the owner's choosing may maintain, replace, or repair emission control devices and systems. These instructions do not require components or service by BRP or authorized Ski-Doo dealers. Although an authorized Ski-Doo dealer has an in-depth technical knowledge and tools to service the Ski-Doo snowmobile, the emission-related warranty is not conditioned on the use of an authorized Ski-Doo dealer or any other establishment with which BRP has a commercial relationship. For emission-related warranty claims, BRP is limiting the diagnosis and repair of emission-related parts to the authorized Ski-Doo dealers. For more information, please refer to the *US EPA EMISSION-RELATED WARRANTY* contained herein. Proper maintenance is the owner's responsibility. A warranty claim may be denied if, among other things, the owner or operator caused the problem through improper maintenance or use. You must follow the instructions for fuel requirements in the fuel section of this manual. Even if gasoline containing greater than ten volume percent ethanol is readily available, the US EPA issued a prohibition against the use of gasoline containing greater than 10 vol% ethanol that applies to this vehicle. The use of gasoline containing greater than 10 vol% ethanol with this engine may harm the emission control system. The vehicle should be serviced as per the maintenance schedule.

The maintenance schedule does not exempt the pre-ride inspection.

WARNING

Failure to properly maintain the vehicle according to the maintenance schedule can make it unsafe to operate.

EVERY 1 500 KM (1,000 MI)

Adjust drive chain

EVERY 3 000 KM (2,000 MI) OR 1 YEAR (WHICHEVER COMES FIRST)

Visually inspect and clean drive pulley

Tighten drive pulley retaining screw to specified torque

Clean driven pulley

Check driven pulley preload

Adjust and align track

Inspect brake hose, pads and disk

Inspect steering mechanism

Inspect front suspension

Inspect rear suspension (including stopper straps and slider shoes)

Lubricate rear suspension. Lubricate whenever the vehicle is used in wet conditions (rain, puddles)

EVERY 6 000 KM (4,000 MI) OR AT PRE-SEASON
(WHICHEVER COMES FIRST)

Change engine oil and filter

EVERY 6 000 KM (4,000 MI) OR 2 YEARS
(WHICHEVER COMES FIRST)

Replace fuel pump outlet filter

Replace brake fluid

EVERY 10 000 KM (6,000 MI) OR 3 YEARS
(WHICHEVER COMES FIRST)

Replace spark plugs

EVERY 5 YEARS

Replace engine coolant

MAINTENANCE SCHEDULE (600 HO E-TEC)

Maintenance is very important for keeping your vehicle in safe operating condition. A repair shop or person of the owner's choosing may maintain, replace, or repair emission control devices and systems. These instructions do not require components or service by BRP or authorized Ski-Doo dealers. Although an authorized Ski-Doo dealer has an in-depth technical knowledge and tools to service the Ski-Doo snowmobile, the emission-related warranty is not conditioned on the use of an authorized Ski-Doo dealer or any other establishment with which BRP has a commercial relationship. For emission-related warranty claims, BRP is limiting the diagnosis and repair of emission-related parts to the authorized Ski-Doo dealers. For more information, please refer to the *US EPA EMISSION-RELATED WARRANTY* contained herein. Proper maintenance is the owner's responsibility. A warranty claim may be denied if, among other things, the owner or operator caused the problem through improper maintenance or use. You must follow the instructions for fuel requirements in the fuel section of this manual. Even if gasoline containing greater than ten volume percent ethanol is readily available, the US EPA issued a prohibition against the use of gasoline containing greater than 10 vol% ethanol that applies to this vehicle. The use of gasoline containing greater than 10 vol% ethanol with this engine may harm the emission control system. The vehicle should be serviced as per the maintenance schedule.

The maintenance schedule does not exempt the pre-ride inspection.

WARNING

Failure to properly maintain the vehicle according to the maintenance schedule can make it unsafe to operate.

EVERY 1 500 KM (1,000 MI)

Adjust drive chain

EVERY 3 000 KM (2,000 MI) OR 1 YEAR (WHICHEVER COMES FIRST)

Inspect engine rubber mounts

Inspect exhaust system and check for leaks

Adjust engine stopper

Visually inspect and clean drive pulley

Tighten drive pulley retaining screw to specified torque

Clean driven pulley

Adjust and align track

Inspect brake hose, pads and disk

Inspect steering mechanism

**EVERY 3 000 KM (2,000 MI) OR 1 YEAR
(WHICHEVER COMES FIRST)**

Inspect front suspension

Inspect rear suspension (including stopper straps and slider shoes)

Lubricate rear suspension. Lubricate whenever the vehicle is used in wet conditions (rain, puddles)

**EVERY 6 000 KM (4,000 MI) OR 2 YEARS
(WHICHEVER COMES FIRST)**

Inspect fuel pump strainer and replace if necessary

Replace brake fluid

Inspect throttle cable

**EVERY 10 000 KM (6,000 MI) OR 3 YEARS
(WHICHEVER COMES FIRST)**

Replace spark plugs

Inspect oil injection pump strainer and clean if needed

EVERY 5 YEARS

Replace engine coolant

Replace in-line fuel filter

MAINTENANCE PROCEDURES

This section includes instructions for basic maintenance procedures.

⚠ WARNING

Turn off the engine, remove tether cord cap and follow these maintenance procedures when performing maintenance. If you do not follow proper maintenance procedures you can be injured by hot parts, moving parts, electricity, chemicals or other hazards.

⚠ WARNING

Should removal of a locking device (e.g. lock tabs, self-locking fasteners, etc.) be required when undergoing disassembly/assembly, always replace with a new one.

NOTICE LH and RH hand side carburetors are calibrated differently. Never switch carburetors around.

Air Filter

Air Filter Verification

Ensure the air filter is properly installed, clean and in good condition.

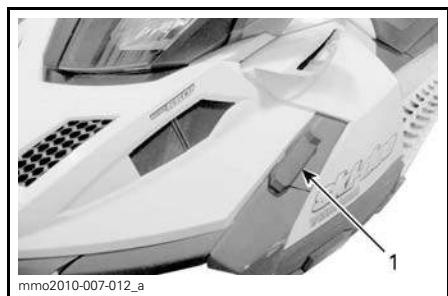

1. Air filter

NOTICE To prevent engine damage, never operate with a damaged or missing air filter.

Air Filter Removal

1. Refer to *CONTROLS, INSTRUMENTS AND EQUIPMENT* and remove hood and LH side panel.
2. Release all 5 air filter retaining clips.



1. Retaining clip
2. Air filter

Air Filter Cleaning

Rinse air filter with fresh water. Allow to dry completely before installation.

Air Filter Installation

1. Push air filter onto air intake silencer and secure using all 5 clips.

NOTE: If some clips do not engage properly, the filter may not be positioned correctly onto the air intake silencer.

Engine Coolant (600 ACE and 600 HO E-TEC)

⚠ WARNING

Never open coolant tank cap when engine is hot.

Engine Coolant Level Verification

Check coolant level at room temperature with the cap removed. Liquid should be at cold level line (engine cold) of coolant tank.

NOTE: When checking level at low temperature it may be slightly lower than the mark.

If additional coolant is necessary or if entire system has to be refilled, refer to an authorized Ski-Doo dealer, repair shop, or person of your own choosing.



mmo2011-003-002_a
TYPICAL
 1. Coolant tank
 2. COLD LEVEL line

Recommended Engine Coolant

Always use ethylene-glycol antifreeze containing corrosion inhibitors specifically for internal combustion aluminum engines.

Cooling system must be filled with LONG LIFE ANTIFREEZE (P/N 219 702 685) or with distilled water and antifreeze solution (50% distilled water, 50% antifreeze).

Engine Oil (600 ACE)

Recommended Engine Oil

ENGINE	RECOMMENDED ENGINE OIL
600 ACE	XPS 4-STROKE SYNTHETIC OIL (ALL CLIMATE) (P/N 293 600 112)

NOTICE The engine of this snowmobile has been developed and validated using the recommended BRP XPS™ oil. BRP recommends the use of its recommended XPS oil or equivalent. Damages caused by oil which is not suitable for this 4-stroke engine may not be covered by the BRP limited warranty.

If the recommended oil is not available, use SAE 0W40 synthetic-based oil that meets or exceeds the requirements for API service classification SM

Engine Oil Level Verification

NOTICE Check level before each ride and refill if necessary. Do not overfill. Operating the engine with an improper level may severely damage engine. Wipe off any spillage.

Make sure the engine is at normal operating temperature.

NOTE: The engine reaches its normal operating temperature when the rear radiator gets warm.

Place vehicle on a level surface and proceed as follows to check oil level:

1. Let engine run at idle for approximately 30 seconds.
2. Stop engine.
3. Remove the drive belt guard, refer to *CONTROLS, INSTRUMENTS AND EQUIPMENT*.
4. Remove dipstick from the filler tube, then wipe it clean.
5. Completely insert dipstick in the filler tube.
6. Remove dipstick and check the oil level. Oil level should be between the MIN. and MAX. marks as shown, add if necessary.

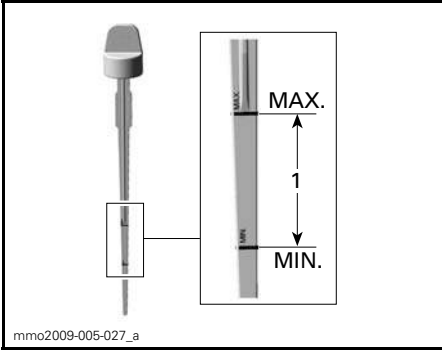

1. Oil level between MIN. and MAX.

WARNING
Wipe off any oil spills. Oil is highly flammable when heated.

Exhaust System

Exhaust System Verification

The muffler tail pipe should be centered with the exit hole in the bottom pan. Exhaust system must be free of rust or leaks. Make sure that all parts are securely in place.

Check retaining springs condition and replace if necessary.

The exhaust system is designed to reduce noise and to improve the total performance of the engine. Modification may be in violation of local laws.

NOTICE If any exhaust system component is removed, modified or damaged, severe engine damage may result.

Spark Plugs (550F)

Spare Spark Plug Storage

A space is provided in the tool kit to keep spare spark plugs dry and prevent shocks that might affect the adjustment or break them.

NOTE: Spare spark plugs are not supplied with snowmobile.

Spark Plug Removal

1. Remove drive belt guard, refer to *CONTROLS, INSTRUMENTS AND EQUIPMENT*.
2. Carefully remove spark plug wire cap with a twisting and pulling motion.
3. Using a proper socket or the spark plug socket and screwdriver pin from tool kit, unscrew spark plug a few turns without removing it.

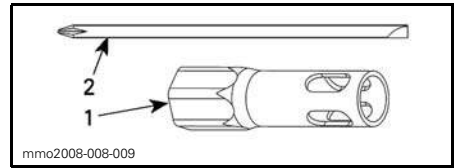

1. 19 mm socket
2. Screwdriver rod

4. Clean spark plugs and cylinder heads.

NOTICE Severe engine damage can occur if grime particles enter the combustion chamber.

5. Remove spark plug.

Spark Plug Installation

1. Measure spark plug gap.

NOTE: The gap is not adjustable. If gap is incorrect, replace spark plugs.

NOTICE Do not attempt to adjust gap on these spark plugs.

ENGINE	SPARK PLUG GAP (NOT ADJUSTABLE)
550F	0.45 mm (.018 in)

2. Apply LOCTITE 767 (ANTISEIZE LUBRICANT) (P/N 293 800 070) on spark plug threads.
3. Screw spark plugs into cylinder head by hand until it bottoms.

4. Perform the final tightening using the appropriate tools from the tool kit or with a torque wrench and a proper socket.
 - With a torque wrench (preferred): tighten to $27 \text{ N}\cdot\text{m} \pm 2 \text{ N}\cdot\text{m}$ ($20 \text{ lbf}\cdot\text{ft} \pm 1 \text{ lbf}\cdot\text{ft}$).
 - With the socket from the tool kit: tighten 1/2 turn for a new spark plug and 1/10 turn for a used spark plug.
5. Connect spark plug wires.

Spark Plugs (600 ACE and 600 HO E-TEC)

Spark plugs inspection or replacement may be performed by an authorized Ski-Doo dealer, repair shop, or person of your own choosing. Spark plugs inspection or replacement requires an in-depth technical knowledge. Though not required, it is recommended that an authorized Ski-Doo dealer performs spark plugs inspection or replacement.

Engine Stopper (600 HO E-TEC)

Engine Stopper Adjustment

The engine stopper is located on the LH front engine support, in front of the drive pulley.

1. Remove tether cord cap from engine cut-off switch.
2. Remove drive belt guard, refer to *CONTROLS, INSTRUMENTS AND EQUIPMENT* in this section.
3. Loosen the three screws retaining the engine stopper to the engine support just enough to allow a vertical play (1/2 to one turn).

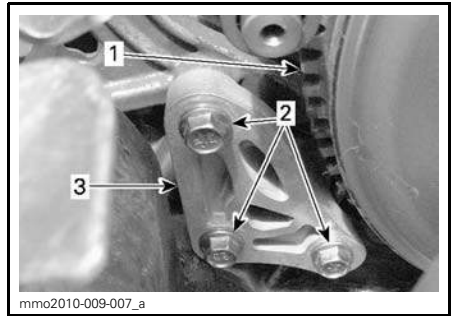

1. Drive pulley
2. Engine stopper screws
3. Engine stopper

4. Insert a 0.5 mm (.02 in) feeler gauge in the engine stopper opening (see illustration).

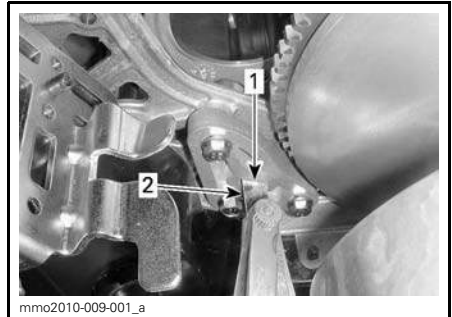

1. Opening
2. Feeler gauge

5. Place feeler gauge between engine stopper and rubber stop block (on engine).

NOTE: Do not insert the feeler gauge too deep, as it will pass over the bump at the surface of the rubber stop block and alter adjustment. See illustration.

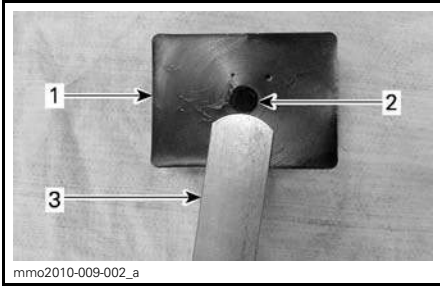

1. Rubber stop block
2. Bump
3. Feeler gauge

6. Tighten screws to $10\text{ N}\cdot\text{m} \pm 2\text{ N}\cdot\text{m}$ ($89\text{ lbf}\cdot\text{in} \pm 18\text{ lbf}\cdot\text{in}$) following the illustrated sequence, taking care not to pinch the feeler gauge.

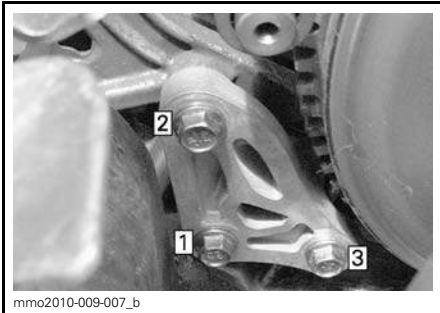

TIGHTENING SEQUENCE

NOTICE Serious pulley damage can occur if the engine stopper and its screws are not properly installed.

Brake Fluid

Recommended Fluid

Use only DOT 4 brake fluid from a sealed container. An opened container may be contaminated or may have absorbed moisture from the air.

⚠ WARNING

Use only DOT 4 brake fluid from a sealed container. To avoid serious damage to the braking system, do not use fluids other than the recommended one, nor mix different fluids for topping up.

NOTICE Brake fluid can damage painted and plastic parts. Handle with care. Rinse thoroughly in case of spillage.

Brake Fluid Level Verification

Place vehicle on a level surface.

Check brake fluid (DOT 4) in reservoir for proper level. Add fluid (DOT 4) as required.

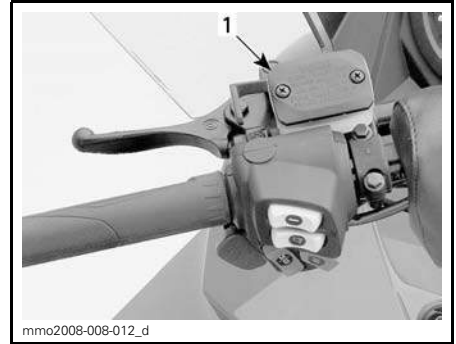

TYPICAL

1. Brake fluid reservoir

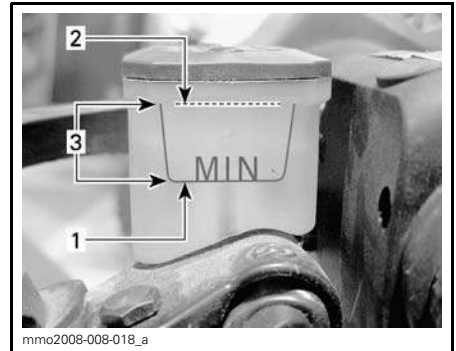

1. Minimum
2. Maximum
3. Operating range

⚠ CAUTION Avoid getting brake fluid on skin or eyes - it may cause severe burns. In case of contact skin, wash thoroughly. In case of contact with the eyes, immediately rinse with plenty of water for at least 10 minutes and then consult a doctor immediately.

Chaincase Oil

Recommended Chaincase Oil

RECOMMENDED CHAINCASE OIL
XPS SYNTHETIC CHAINCASE OIL (P/N 413 803 300)

NOTICE The chaincase of this snowmobile has been developed and validated using the XPS™ Synthetic chaincase oil. BRP strongly recommends the use of its XPS Synthetic chaincase oil at all times. Damages caused by oil which is not suitable for the chaincase will not be covered by the BRP limited warranty.

Access to Chaincase

Remove RH side panel, refer to *CONTROLS, INSTRUMENTS AND EQUIPMENT*.

Chaincase Oil Level Verification

With the vehicle on a level surface, check the oil level by removing the check plug.

Models with RER

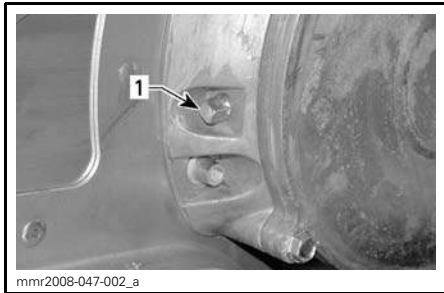

TYPICAL - WITH RER
1. Magnetic check plug

NOTE: It is normal to find metallic particles stuck to magnetic check plug. If bigger pieces of metal are found, remove the chaincase cover and inspect the chaincase parts.

Remove metal particles from magnetic check plug.

Models with Mechanical Reverse

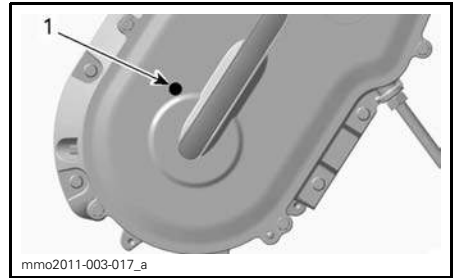

TYPICAL - WITH MECHANICAL REVERSE
1. Check plug

NOTE: On mechanical reverse models, make sure to use the check plug located on the chaincase cover.

All Models

Oil level must reach the threaded hole.

Chaincase Filling Procedure

Remove the check plug.

Remove the filler cap on the chaincase cover.



TYPICAL - TOP OF CHAINCASE
1. Filler cap

Pour recommended oil in chaincase by the filler hole until oil comes out by the check plug hole.

Reinstall check plug and torque to specification.

TORQUE	
Check plug	6 N•m ± 1 N•m (53 lbf•in ± 9 lbf•in)

Reinstall the filler cap.

Drive Chain

Drive Chain Adjustment

1. Refer to *CONTROLS, INSTRUMENTS AND EQUIPMENT* subsection and remove:
 - Hood
 - RH side panel.

600 HO E-TEC Model

2. Disconnect the EGTS (Exhaust Gas Temperature Sensor) connector.

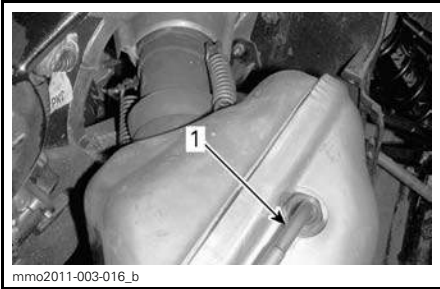

1. EGTS

All models

⚠ CAUTION Wear protective eye glasses when removing exhaust components. Beware of sudden spring tension release.

3. Remove the springs retaining the exhaust pipe to the muffler using the following tool.

SPRING INSTALLER/REMOVER
(P/N 529 035 983)



529035983

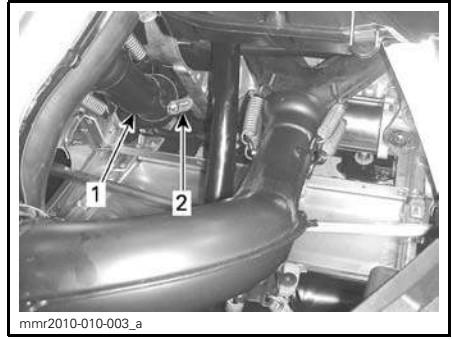

TYPICAL - 550F (FROM FRONT OF VEHICLE)

1. Exhaust elbow pipe
2. Elbow pipe to muffler retaining spring (2)

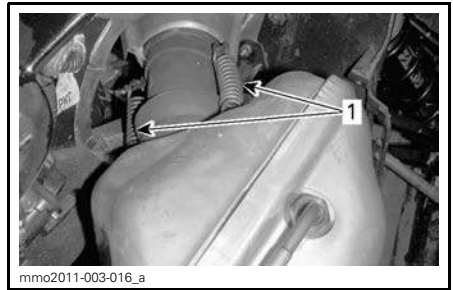

TYPICAL - 600 HO E-TEC (FROM RH SIDE OF VEHICLE)

1. Tuned pipe to muffler retaining springs

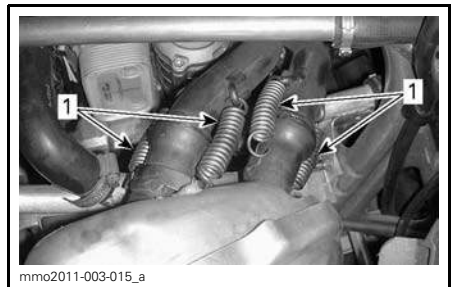

TYPICAL - 600 ACE (FROM RH SIDE OF VEHICLE)

1. Exhaust pipes to muffler retaining springs

4. Remove screws retaining the front of RH bottom pan.

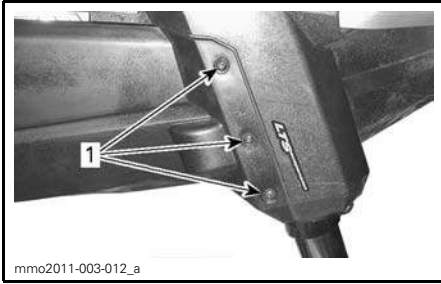

1. Bottom front retaining screws

5. Detach the tab retaining the front of RH bottom pan.

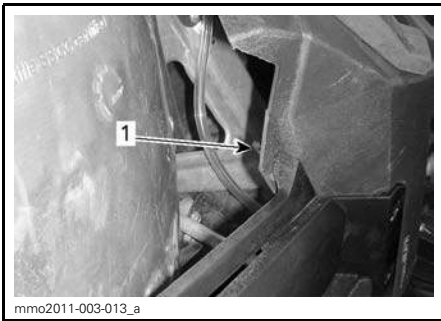

1. Bottom pan upper retaining tab

6. Remove the screw retaining the rear of RH bottom pan.



1. Bottom rear retaining screw

7. Remove the two muffler retaining springs.

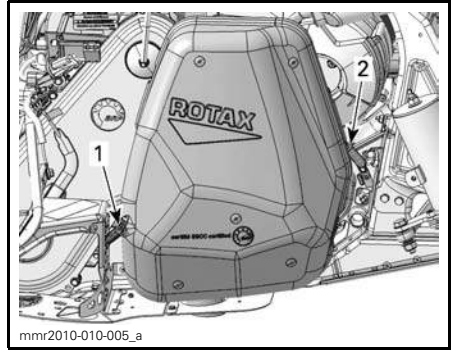

TYPICAL

- 1. Aft muffler retaining spring
- 2. Front muffler retaining spring

8. Remove the muffler.

9. Unscrew tensioner lock nut several turns.

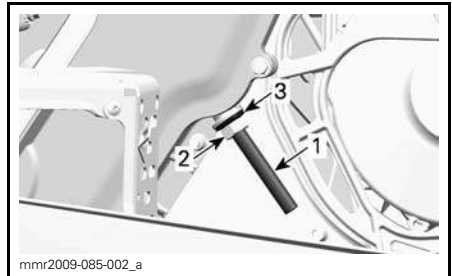

- 1. Tensioner adjustment screw
- 2. Lock nut
- 3. Seal washer

10. Unscrew tensioner adjustment screw a few turns.

11. Pull seal washer back.

12. Clean adjustment screw threads if necessary.

NOTICE Adjustment screw threads must be clean to obtain an accurate adjustment.

13. Tighten tensioner adjustment screw by hand.

NOTE: Turn adjustment screw until resistance is strong enough that it can not be turned by hand.

14. Hold tensioner adjustment screw and tighten lock nut to $36\text{ N}\cdot\text{m} \pm 3\text{ N}\cdot\text{m}$ ($27\text{ lbf}\cdot\text{ft} \pm 2\text{ lbf}\cdot\text{ft}$).
15. Install all removed parts. Make sure that exhaust hooks and springs are securely installed.

Drive Belt

Drive Belt Inspection

Inspect belt for cracks, fraying or abnormal wear (uneven wear, wear on one side, missing cogs, cracked fabric). If abnormal wear is noted, probable cause could be pulley misalignment, excessive RPM with frozen track, fast starts without warm-up period, burred or rusty sheave, oil on belt or distorted spare belt. Contact an authorized Ski-Doo dealer.

Drive Belt Replacement

Drive Belt Removal

1. Remove tether cord cap from engine cut-off switch.
2. Remove drive belt guard, refer to *CONTROLS, INSTRUMENTS AND EQUIPMENT*.
3. Insert the driven pulley expander provided in the tool kit in the threaded hole on the adjuster hub as shown.



mmo2012-005-980

PULLEY EXPANDER INSTALLED ON ADJUSTER HUB

4. Open the driven pulley by screwing the tool in.
5. Remove the belt by slipping it over the top of the driven pulley, then over the drive pulley.

Drive Belt Installation

1. If necessary, open the driven pulley, refer to *DRIVE BELT REMOVAL* above.
2. Slip the belt over the drive pulley, then over the driven pulley.

NOTICE Do not force or use tools to pry the belt into place, as this could cut or break the cords in the belt.

NOTE: The maximum drive belt life span is obtained when belt is installed with arrows in the direction of rotation.

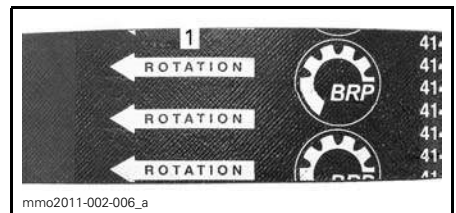

1. To be pointed in the direction of rotation
3. Unscrew and remove the driven pulley expander from the pulley.
4. Rotate the driven pulley several times to properly set the belt between the sheaves.
5. If a new belt was installed, adjust the belt height. Refer to *DRIVE BELT HEIGHT ADJUSTMENT* below.
6. Install belt guard, refer to *CONTROLS, INSTRUMENTS AND EQUIPMENT*.
7. Install side panel, refer to *CONTROLS, INSTRUMENTS AND EQUIPMENT*.

Drive Belt Height Adjustment

The drive belt height must be checked every time a new belt is installed.

To adjust the drive belt height, proceed as follows:

1. Remove tether cord cap from engine cut-off switch.
2. Remove drive belt guard, refer to *CONTROLS, INSTRUMENTS AND EQUIPMENT*.
3. Loosen the clamping bolt.

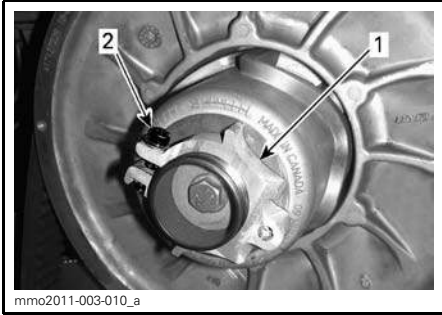

1. Adjuster hub
2. Clamping bolt

4. Using the suspension adjustment tool provided in the tool kit, turn the ring 1/4 turn at a time then rotate the driven pulley to properly set the belt between the pulley sheaves.

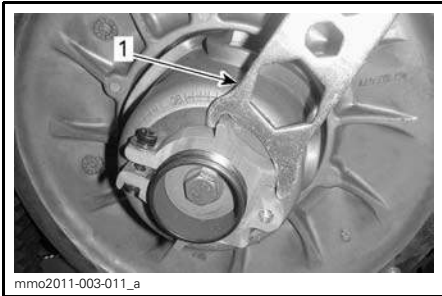

1. Suspension adjustment tool

NOTE: The adjustment ring has left hand treads.

Repeat step 4 until the lowest portion of the cogs on the external surface of drive belt is even with the driven pulley edge.



TYPICAL - PRELIMINARY SETTING

1. Lowest portion of cogs even with external surface of drive belt

NOTE: Turning the ring counterclockwise lowers the belt in the pulley. Turning the ring clockwise raises the belt in the pulley.

5. Firmly tighten the clamping bolt. If possible, tighten to specification.

TORQUE	
Clamping bolt	5.5 N•m ± 0.5 N•m (49 lbf•in ± 4 lbf•in)



- TYPICAL**
1. Clamping bolt

6. Install belt guard, refer to *CONTROLS, INSTRUMENTS AND EQUIPMENT*.

7. Install side panel, refer to *CONTROLS, INSTRUMENTS AND EQUIPMENT*.

NOTE: These settings are correct as a preliminary adjustment for most models. In some cases, when starting the engine, the vehicle could creep, indicating that the belt is too tight.

If the vehicle creeps, lower the drive belt height from the preliminary setting. Repeat procedure until creeping stops.

Reverse Activation

NOTE: The reverse may not activate if the belt is positioned too high in the driven pulley. If reverse activation does not work properly, ensure the drive belt is properly adjusted. Adjust the drive belt lower in the driven pulley if needed.

Drive Pulley

Drive Pulley Adjustment

600 HO E-TEC Models

⚠ WARNING
 Remove the tether cord cap and key before performing any adjustment. Vehicle must be parked in a safe place, away from the trail.

The drive pulley is factory calibrated to transmit maximum engine power at a predefined RPM. Factors such as ambient temperature, altitude or surface condition may vary this critical engine RPM thus affecting snowmobile efficiency.

This adjustable drive pulley allows setting maximum engine RPM to maintain maximum power.

Calibration screws should be adjusted so that actual maximum engine RPM matches the maximum horsepower RPM.

ENGINE	MAXIMUM HORSEPOWER RPM
600 HO E-TEC	8100 RPM (± 100)

NOTE: Use precision digital tachometer for engine RPM adjustment.

NOTE: The adjustment has an effect on high RPM only.

There are 6 positions numbered 1 to 6. The calibration screws have 6 different settings identified by numbers scribed on their head.

The actual setting is the screw head number aligned with the mark on the pulley.

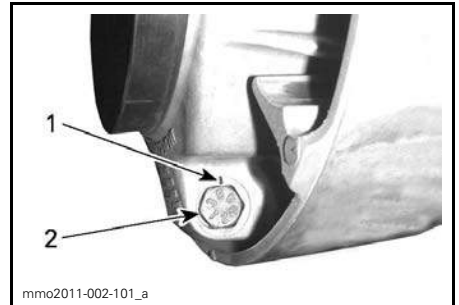

PULLEY SETTING

1. Mark
2. Number

Each position modifies maximum engine RPM by approximately 200 RPM.

Lower position numbers decrease engine RPM in steps of 200 RPM and higher position numbers increase it in steps of 200 RPM.

Example:

Calibration screws initially set at position 4 and changed to position 6 will increase maximum engine RPM by 400 RPM.

Procedure

Loosen the lock nut just enough to get the calibration screw head out of the pulley and rotate to the desired position.

NOTE: Do not completely remove the lock nut.

Set all 3 calibration screws to the same position.

Tighten lock nuts to $10\text{ N}\cdot\text{m} \pm 2\text{ N}\cdot\text{m}$ (89 lbf•in \pm 18 lbf•in).

NOTICE Do not completely remove calibration screw otherwise internal washers will fall off. Always adjust all 3 calibration screws and make sure they are all set to the same position.

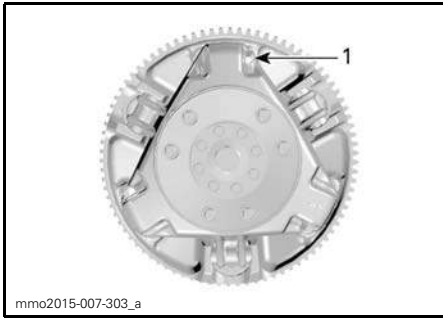

mmo2015-007-303_a

TYPICAL

1. Loosen just enough to permit rotating of calibrate screw

⚠ WARNING

NEVER disassemble or modify the drive pulley.

Improper assembly or modifications could cause the pulley to explode violently under the stress generated by the high rotational speed.

See your Ski-Doo dealer to maintain or service the drive pulley. Improper servicing or maintenance may affect performance and reduce belt life. Always respect maintenance schedules.

⚠ WARNING

NEVER operate engine:

- Without shields and belt guard securely installed.
- With hood and/or side panels opened or removed.

NEVER attempt to make adjustments to moving parts while engine is running.

Track

Track Condition

⚠ WARNING

Remove the tether cord cap and key before performing any maintenance or adjustment, unless otherwise specified. Vehicle must be parked in a safe place, away from the trail.

Remove the tether cord cap and key.

Lift the rear of the snowmobile and support it with a wide-base snowmobile mechanical stand with a rear deflector panel. With the engine off, rotate the track by hand, and inspect condition. If worn or cut, or if track fibers are exposed, or if missing or defective inserts or guides are noted; contact an authorized Ski-Doo dealer.

Snowmobiles Equipped with Traction Enhancing Products

If your snowmobile is equipped with a BRP approved studded track, refer to *INSPECTION* in the *TRACTION ENHANCING PRODUCTS* subsection.

⚠ WARNING

Riding with a damaged track or studs could lead to a loss of control.

Track Tension and Alignment

NOTE: Track tension and alignment are interrelated. Do not adjust one without the other.

⚠ WARNING

To prevent serious injury to individuals near the snowmobile:

- NEVER stand behind or near a moving track.
- Always use a wide-base snowmobile stand with a rear deflector panel if it is necessary to rotate track.
- When the track is raised off the ground, only run it at the lowest possible speed.

Centrifugal force could cause debris, damaged or loose studs, pieces of torn track, or an entire severed track to be violently thrown backwards out of the tunnel with tremendous force.

Track Tension Verification

NOTE: Ride the snowmobile in snow about 15 to 20 minutes prior to adjusting track tension.

1. Remove tether cord cap and key.
2. Lift rear of vehicle and support it off the ground.

⚠ CAUTION Use proper lifting techniques, notably using your legs for force. Do not attempt to lift the rear of vehicle if it is above your limits.

3. Allow rear suspension to fully extend.
4. Set tool O-ring to specification .

TRACK ADJUSTMENT SPECIFICATION		
Track deflection setting	Tundra Sport	30 mm - 35 mm (1-3/16 in - 1-3/8 in)
	Tundra LT Tundra Xtreme	45 mm - 50 mm (1-25/32 in - 1-31/32 in)
Track load reading	7.3 kg (16 lb)	



DEFLECTION SETTING

1. Bottom O-ring set to specification

5. Place upper O-ring to 0 kgf (0 lbf).
6. Position the tensiometer on track, halfway between front and rear idler wheels.
7. Push the tensiometer downwards until bottom O-ring (deflection set earlier) be aligned with the bottom of slider shoe.

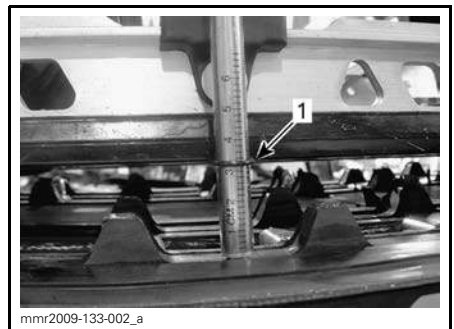
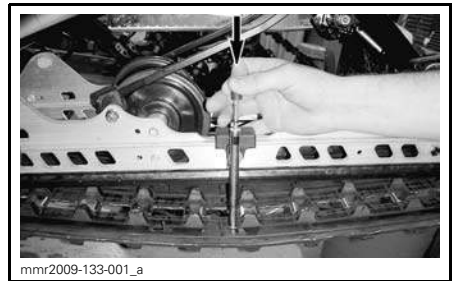

1. Deflection O-ring aligned with slider shoe

8. Read load recorded by the upper O-ring on the tensiometer.



LOAD READING
1. Upper O-ring

9. Load reading must be as per the following table.

TRACK ADJUSTMENT SPECIFICATION	
Track deflection setting (SC-5M)	30 mm - 35 mm (1-3/16 in - 1-3/8 in)
Track deflection setting (SC-5U)	45 mm - 50 mm (1-25/32 in - 1-31/32 in)
Track load reading	7.3 kg (16 lb)

10. If load reading is not in accordance with the specification, adjust track tension. Refer to *TRACK TENSION ADJUSTMENT*.

Track Tension Adjustment

1. Remove tether cord and key.
2. Remove rear wheel caps (if so equipped).

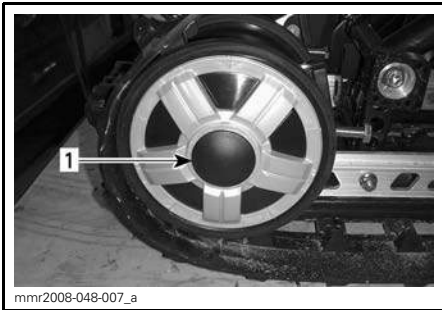

1. RH rear idler wheel cap

3. Loosen the rear idler wheel retaining screws.

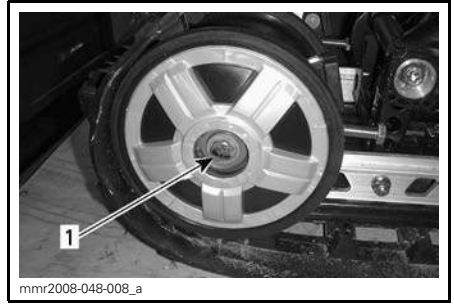

1. RH rear idler wheel bolt

4. Tighten or loosen both adjustment screws to increase or decrease track tension.



1. RH adjustment screw

5. If correct tension is unattainable, contact an authorized Ski-Doo dealer.
6. Retighten retaining bolts to specification.

TORQUE	
Retaining bolts	48 N•m ± 6 N•m (35 lbf•ft ± 4 lbf•ft)

7. Check track alignment as described below.

Track Alignment

⚠ WARNING

Before checking track alignment, ensure that the track is free of all particles which could be thrown out while track is rotating. Keep hands, tools, feet and clothing clear of track. Always lift the snowmobile on a wide-base stand with a rear deflector panel. Ensure no one is standing in close proximity to the snowmobile, especially at the rear of the track. Never rotate track at high speed. Centrifugal force could cause debris, damaged or loose studs, pieces of torn track, or an entire severed track to be violently thrown backwards out of the tunnel with tremendous force.

1. Lift rear of vehicle and support it off the ground.

⚠ CAUTION Use proper lifting techniques, notably using your legs for force. Do not attempt to lift the rear of vehicle if it is above your limits.

2. Start engine and accelerate slightly so that track slowly turns. This must be done in a short period of time (15 to 20 seconds).
3. Check that the track is well centered; equal distance on both sides between edges of track guides and slider shoes.

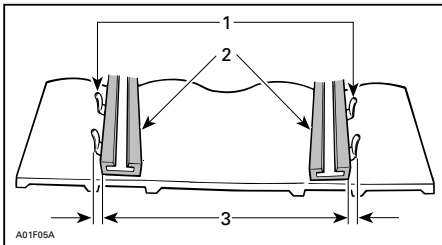

1. Guides
2. Slider shoes
3. Equal distance

4. To correct track alignment:

- 4.1 Stop engine.
- 4.2 Remove tether cord and key.

⚠ WARNING

Remove tether cord cap and key before performing any maintenance or adjustment, unless otherwise specified. Vehicle must be parked in a safe place, away from the trail.

- 4.3 Loosen rear wheel retaining screws.
- 4.4 Tighten adjustment screw on side where the slider shoe is the farthest from the track insert guides.

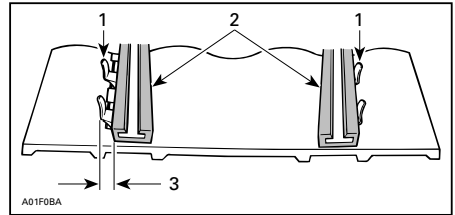

1. Guides
2. Slider shoes
3. Tighten on this side

5. Tighten retaining screws.

⚠ WARNING

Properly tighten wheel retaining bolts, otherwise wheel may come off and cause track to "lock".

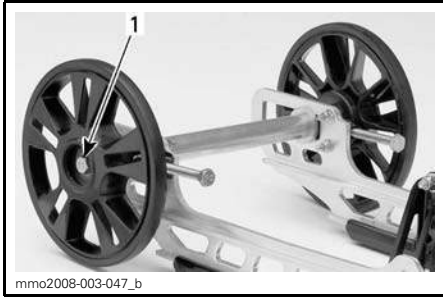

TYPICAL

1. Retighten to $48\text{N}\bullet\text{m} \pm 6\text{N}\bullet\text{m}$
($35\text{lb}\bullet\text{ft} \pm 4\text{lb}\bullet\text{ft}$)
6. Restart engine and rotate track slowly to recheck alignment.
7. Reposition snowmobile on the ground.
8. Install rear wheel caps if so equipped.

Suspension

Rear Suspension Condition

Visually inspect all suspension components including slider shoes, springs, wheels, etc.

NOTE: During normal driving, snow will act as a lubricant and coolant for the slider shoes. Extensive riding on ice or sanded snow, will create excessive heat build-up and cause premature slider shoe wear.

Suspension Stopper Strap Condition

Inspect stopper strap for wear and cracks, bolt and nut for tightness. If loose inspect holes for deformation. Replace as required. Torque nut to $10\text{N}\bullet\text{m} \pm 1\text{N}\bullet\text{m}$ ($89\text{lb}\bullet\text{in} \pm 9\text{lb}\bullet\text{in}$).

Rear Suspension Lubrication

Lubricate the following suspension pivots at grease fittings using SUSPENSION GREASE (P/N 293 550 033). Refer to *MAINTENANCE SCHEDULE* for maintenance frequency.

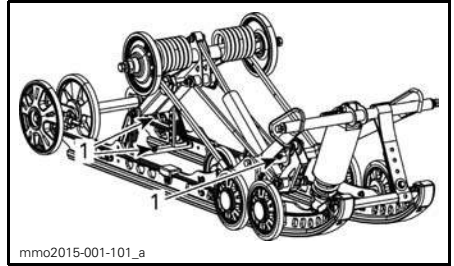

SC-5M

1. Grease fittings

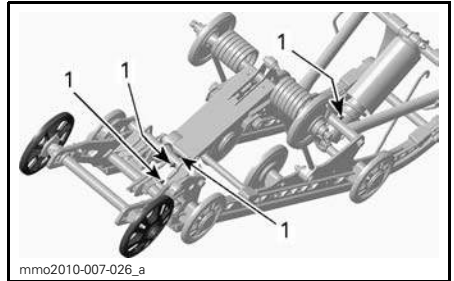

SC-5U

1. Grease fittings

Steering and Front Suspension Condition

Visually inspect steering and front suspension for tightness of components (steering arms, tie rods, ski bolts, ski legs, etc.). If necessary, contact an authorized Ski-Doo dealer.

Front Suspension Lubrication

Lubricate front suspension at grease fittings using suspension synthetic grease (P/N 293 550 033). Refer to *MAINTENANCE SCHEDULE* for maintenance frequency.

There is one grease fitting on each side. Each one is located on the front frame just below the steering arm.

Generally, 4 to 5 grease gun strokes is sufficient.

If too much grease is injected, the overflow will come out at steering levers and ski legs. Wipe off any excess of grease to avoid contact with other parts.

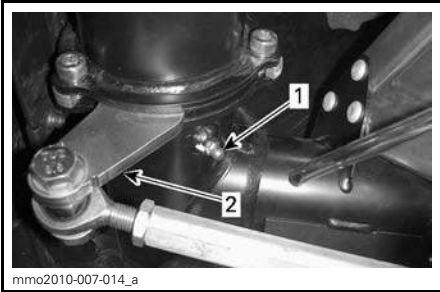

LH SIDE SHOWN

1. Grease fitting
2. Steering arm

Skis

Wear and Condition of Skis and Runners

Check the condition of the skis and ski runner carbides. If worn, contact an authorized Ski-Doo dealer.

⚠ WARNING

Excessively worn skis and/or ski runners will adversely affect snowmobile control.

Fuses

Fuse Inspection

The electrical system is protected with fuses.

Check fuse condition and replace it if necessary.

To remove fuse from holder, pull fuse out. Check if filament is melted.

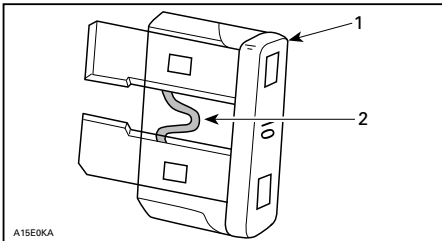

A15E0KA

1. Fuse
2. Check if melted

⚠ WARNING

Do not use a higher rated fuse.

⚠ WARNING

If fuse has burnt out, source of malfunction should be determined and corrected before restarting. See an authorized Ski-Doo dealer for servicing.

Fuse Location

550F

The main fuse is located on the oil reservoir.

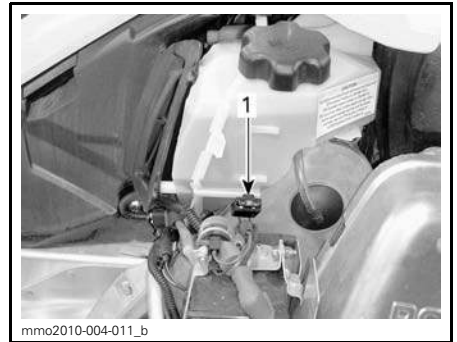

1. Main fuse

600 HO E-TEC

The fuses are located on the oil reservoir.



TYPICAL

1. 25 A charging system fuse
2. 5 A start/RER fuse

600 ACE

The fuse box is located on top of the chaincase.

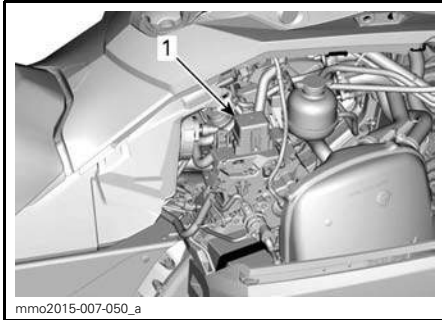

mmo2015-007-050_a

1. Fuse box

Refer to the cover decal or the *SPECIFICATIONS* subsection of this guide for fuses identification.

550F

The electric fuel level sender fuse is located behind the air intake silencer.

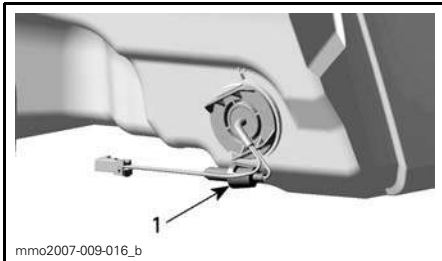

mmo2007-009-016_b

BEHIND AIR INTAKE SILENCER

1. Fuse location

Lights

Always check light operation after bulb replacement.

Headlights Bulb Replacement

NOTICE Never touch glass portion of an halogen bulb with bare fingers, it shortens its operating life. If glass is touched, clean it with isopropyl alcohol which will not leave a film on the bulb.

1. By using a small screwdriver, release gauge locking tabs.

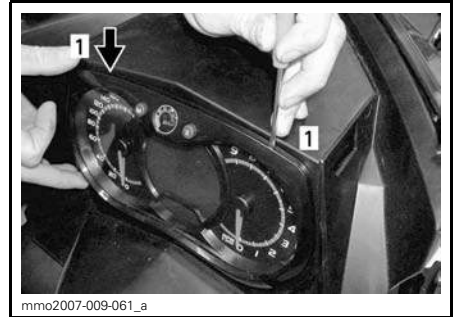

mmo2007-009-061_a

TYPICAL

1. Locking tab

2. Gently pull on gauge and set aside.



mmo2007-009-062_a

TYPICAL

3. Disconnect burnt bulb connector. Remove the rubber boot.

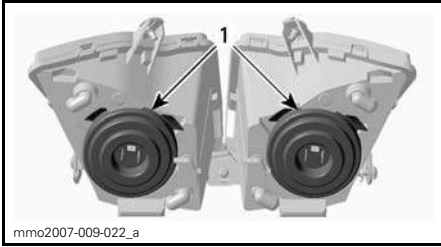

1. Rubber boots

4. Press and pull both sides of the retaining clip at the same time to release it from bulb support.

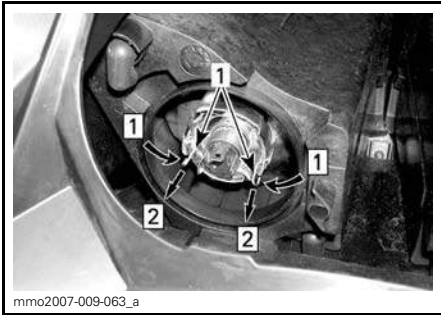

Step 1: Push both sides
Step 2: Pull to release

1. Retaining clip

5. Pull bulb and replace. Properly reinstall parts.

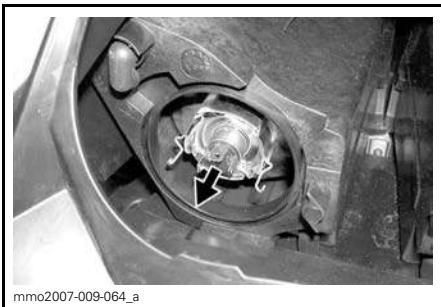

PULL BULB AND REPLACE

Headlights Beam Aiming

Remove gauge, refer to *HEADLIGHTS BULB REPLACEMENT*. Turn knob to adjust beam height.

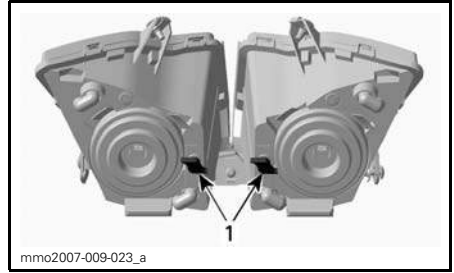

TYPICAL

1. Knobs

Taillight Bulb Replacement

All Models Except Tundra Xtreme

1. Remove taillight housing by carefully pulling on lens at both ends using an equal force.



TYPICAL - CAREFULLY PULL OUT AT CORNERS

NOTICE Taillight housing is held in place by two plastic pins inserted in rubber grommets. If taillight housing is not removed perpendicularly to the taillight holder, mounting pins may break and housing will have to be replaced. Do not pull taillight housing out too far to avoid damaging wiring.

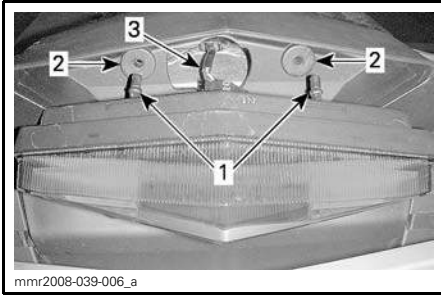

1. Taillight housing retaining pins
2. Retaining grommets
3. Light wire harness

2. Rotate bulb socket counterclockwise to remove it from taillight housing.
3. Push in and rotate bulb counterclockwise to remove it from its socket.
4. Install the new bulb by pushing it in the socket and turning it clockwise.

NOTE: Note position of bulb locking pins on its base, and socket alignment key.

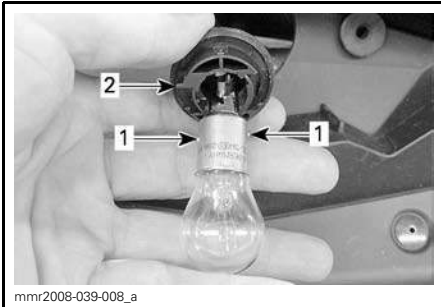

1. Bulb locking pins
2. Bulb holder alignment key

Tundra Xtreme

Remove both retaining bolts securing rear taillight to frame.



RETAINING BOLTS LOCATION - VIEWED FROM UNDER

Pull rear taillight support out of location and disconnect taillight connector.



TAILLIGHT CONNECTOR DISCONNECTION

Remove both retaining screws securing taillight to taillight support.



**RETAINING BOLTS SECURING TAILLIGHT
TO TAILLIGHT SUPPORT**

Replace taillight.

Installation is the reverse of removal. However pay attention to the following.

TIGHTENING TORQUE	
Taillight retaining screw	0.4 N•m (4 lbf•in)

VEHICLE CARE

Post-Operation Care

Remove snow and ice from rear suspension, track, front suspension, steering mechanism and skis.

WARNING

Make sure tether cord cap and key are removed before standing in front the vehicle, getting close to the track or rear suspension components.

Always cover your snowmobile when leaving it outside overnight or during extended periods of inactivity. This will protect it from frost and snow as well as help retain its appearance.

Vehicle Cleaning and Protection

Wash vehicle with water mixed with a mild detergent. Use only microfiber cloths or an equivalent.

NOTICE It is necessary to use microfiber cloths or equivalent on windshield and hood to avoid scratching the surfaces.

To remove grease, oil and grime, use BRP HEAVY DUTY CLEANER (P/N 293 110 001).

NOTICE Do not use Heavy duty cleaner on decals or vinyl.

To remove stubborn dirt from all plastic and vinyl surfaces, use XPS ALL PURPOSE CLEANER (P/N 219 701 709).

To remove scratches on windshield or hood use the SCRATCH REMOVER KIT (P/N 861 774 800).

NOTICE Never clean plastic parts or hood with strong detergent, degreasing agent, paint thinner, acetone, products containing chlorine, etc.

Wax painted portion of the vehicle for better protection.

NOTE: Apply wax on glossy finish only.

STORAGE

WARNING

Have an authorized Ski-Doo dealer, repair shop, or person of your own choosing inspect fuel and oil systems integrity as specified in *MAINTENANCE SCHEDULE*.

STORAGE

Clean the vehicle

Protect fuel system by adding fuel stabilizer to fuel following the product manufacturer recommendations
Run the engine after adding the product to the fuel

550F models: lubricate engine. See *ENGINE LUBRICATION PROCEDURE 500F* in this subsection

600 HO E-TEC models: lubricate engine. See *ENGINE STORAGE MODE (E-TEC)* in this subsection

Lubricate brake lever pivot

Lubricate rear suspension

Charge battery monthly to keep it fully charged during storage

Block muffler outlet with rags

Lift rear of vehicle until track is clear of the ground. Do not release track tension

Clean and lubricate rewind starter

During summer, or when a snowmobile is not in use for more than three months, proper storage is a necessity.

To prepare your snowmobile, refer to an authorized Ski-Doo dealer, repair shop, or person of your own choosing.

To facilitate the inspection and ensure adequate lubrication of components, it is recommended to clean the entire vehicle.

When storage procedure is completed, block muffler with clean rags.

Lift rear of vehicle until track is clear of the ground. Install on a wide-base snowmobile mechanical stand with a rear deflector panel.

 **CAUTION** Use appropriate lifting device or have assistance to share lifting stress. If a lifting device is not used, use proper lifting techniques, notably using your legs force. Do not attempt to lift the rear of vehicle if it is above your limits.

NOTE: Do not release track tension.

Protect the vehicle with an approved cover to prevent dust accumulation during storage.

NOTICE The snowmobile has to be stored in a cool and dry place and covered with an opaque but ventilated tarpaulin. This will prevent sun rays and grime from affecting plastic components and vehicle finish.

Engine Lubrication

Engine Lubrication Procedure (550F)

NOTICE Fuel stabilizer should be added prior to engine lubrication to ensure carburetor protection against varnish deposits.

Engine internal parts must be lubricated to protect them from possible corrosion during the storage period.

Proceed as follows:

1. Place the vehicle in a well ventilated area and start the engine.
2. Start the engine and let it run at idle speed until it reaches its operating temperature.
3. Stop the engine.

4. Remove the primary air intake silencer as follows:
 - 4.1 Remove LH side panel. Refer to *CONTROLS, INSTRUMENTS AND EQUIPMENT* section.
 - 4.2 Remove drive belt guard. Refer to *CONTROLS, INSTRUMENTS AND EQUIPMENT* section.
 - 4.3 Lift tab on rear section of connector tube.
 - 4.4 Twist tube adapter counter clockwise and pull it off the primary silencer slightly.

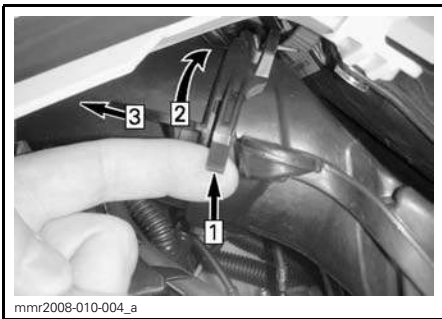
**TYPICAL**

Step 1: Lift tab

Step 2: Twist adapter

Step 3: Pull off

- 4.5 Press locking tab securing the primary air intake silencer and pull silencer out of adapter plate.

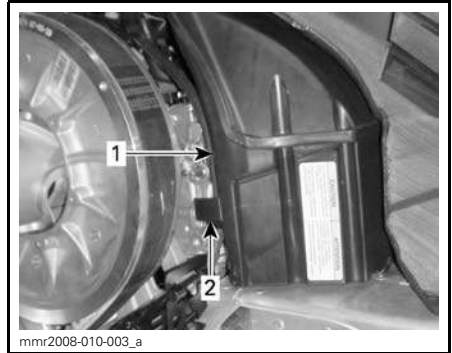

1. Primary air intake silencer

2. Primary intake silencer locking tab

5. Restart engine and run at idle speed.
6. Inject storage oil into each carburetor/throttle body until the engine stalls, or until a sufficient quantity of oil has entered the engine (approximately half a can).
7. With the engine stopped, remove the spark plugs and spray XPS STORAGE OIL (EXCEPT U.S. COUNTRY) (P/N 413 711 600) or XPS STORAGE OIL (U.S. COUNTRY ONLY) (P/N 413 711 900) into each cylinder.
8. Slowly crank engine 2 or 3 revolutions to lubricate cylinders.
9. Reinstall spark plugs and primary air intake silencer.

Engine Storage Mode (E-TEC)

Like other engines, the E-TEC has to be properly lubricated at storage for internal parts protection. The E-TEC system offers a built-in engine storage lubrication function (summerization) that can be initiated by the operator.

To engage procedure, do the following:

1. Place the vehicle in a well ventilated area.
2. Start the engine and let it run at idle speed until it reaches its operating temperature.

3. Push the SET (S) button repeatedly until odometer is displayed (total milieage).

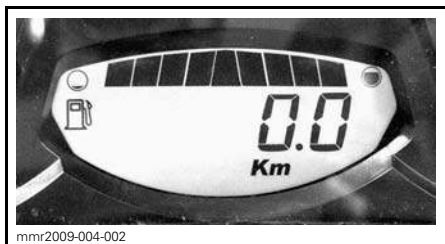

NOTE: The storage mode does not function in other modes (trip A, trip B and hr trip).

4. Repeatedly depress the HI/LOW beam switch rapidly, then, **while doing this**, press and hold the **SET button** until "PUSH S" appears on the display.

NOTE: It is critical for this procedure to depress the HI/LOW beam switch repeatedly **before** holding down the SET button.

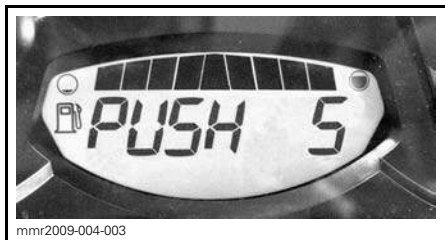

5. When the gauge displays "PUSH S", release all buttons.
6. Again, press and hold the SET button for 2 - 3 seconds.

The gauge will display "OIL" when the engine enters storage procedure (summarization feature).

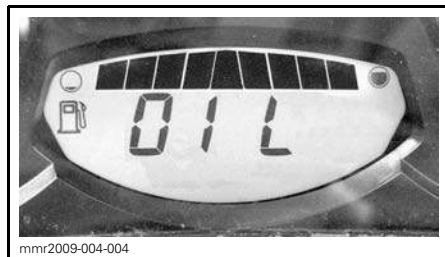

Do not touch anything during engine lubrication cycle.

The engine will increase its RPM to approximately 1600, then the oil pump will "fog with oil" the engine for 30-60 seconds.

When completed, the engine will stop by itself.

Remove D.E.S.S. key.

NOTICE Do not start the engine during storage period.

PRESEASON PREPARATION

PRESEASON PREPARATION (550F)
Inspect engine rubber mounts
Check exhaust system condition and check for leaks
Inspect crankshaft PTO seal
Inspect fuel lines and connections
Clean, inspect and adjust carburetors
Adjust oil injection pump
Inspect throttle cable
Replace spark plugs after starting the engine with the old spark plugs to burn the excess of storage oil
Inspect drive belt
Clean and visually inspect drive pulley
Clean and inspect driven pulley
Inspect, adjust and align track
Change chaincase oil
Check brake fluid level
Inspect brake hose, pads and disk
Inspect steering mechanism
Inspect skis and runners
Inspect front suspension
Inspect rear suspension (including stopper straps and slider shoes)
Charge battery (if so equipped)
Adjust headlight beam aiming
Inspect engine fan belt

PRESEASON PREPARATION (600 ACE AND 600 HO E-TEC)
Inspect engine rubber mounts (600 HO E-TEC)
Visually inspect engine seals and gaskets and check for leaks (600 ACE)
Change engine oil and filter (600 ACE)
Check exhaust system condition and check for leaks
Check coolant density
Inspect crankshaft PTO seal (600 HO E-TEC)
Inspect fuel lines and connections
Clean and inspect throttle body
Inspect throttle cable (600 HO E-TEC)
Inspect drive belt (adjust at every drive belt replacement)
Clean and visually inspect drive pulley
Clean and inspect driven pulley
Inspect, adjust and align track
Adjust drive chain
Change chaincase oil
Check brake fluid level
Inspect brake hose, pads and disc
Inspect steering mechanism
Inspect skis and runners
Inspect front suspension
Inspect rear suspension (including stopper straps and slider shoes)
Charge battery
Adjust headlight beam aiming

***This page is
intentionally blank***

TECHNICAL INFORMATION

VEHICLE IDENTIFICATION

Vehicle Description Decal

Vehicle description decal is located on right hand side of tunnel.



TYPICAL

1. Vehicle description decal

Vehicle Identification Number (VIN)

VIN is scribed on the vehicle description decal. See above. It is also engraved on the tunnel, near the vehicle description decal.

Model number and model year are part of the information found in the VIN. See illustration.

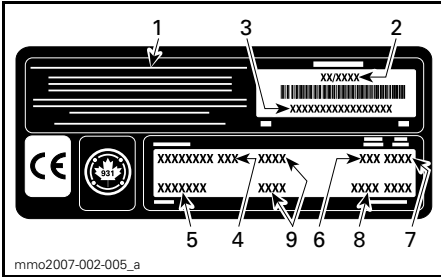
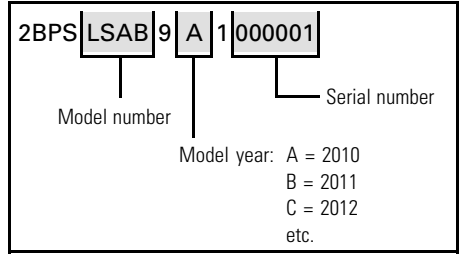

VEHICLE DESCRIPTION DECAL

1. Manufacturer name
2. Manufacturing date
3. Vehicle identification number (VIN)
4. Model name
5. Option package
6. Engine type
7. Model year
8. Color codes
9. Vehicle weight/engine power (European models)

Engine Identification Number

Refer to the following illustrations to locate the engine identification number on the applicable engine.

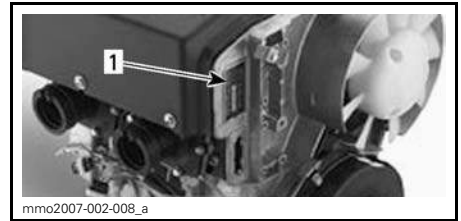

550F ENGINE

1. Engine identification number

Identification Numbers

The main components of your snowmobile (engine and frame) are identified by different identification numbers. It may sometimes become necessary to locate these numbers for warranty purposes or to trace your snowmobile in the event of loss. These numbers are required by the authorized Ski-Doo dealer to complete warranty claims properly. We strongly recommend that you take note of all the identification numbers on your snowmobile and supply them to your insurance company.



600 HO E-TEC ENGINE

1. Engine identification number

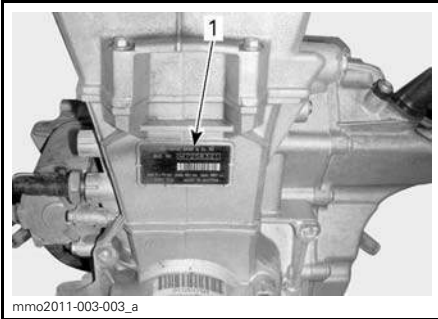

600 ACE ENGINE

1. Engine identification number

The EC-Declaration of Conformity does not appear in this version of the Operator's Guide.

Please refer to the printed version that was delivered with your vehicle.

EPA CERTIFIED ENGINES

Engine Emissions Information

Manufacturer's Responsibility

Beginning with **2007 model year engines**, snowmobile manufacturers of snowmobile engines need to determine the exhaust emission levels for each engine horsepower family and certify these engines with the United States of America Environmental Protection Agency (EPA). An emissions control information label, showing emission levels and engine specifications, must be placed on each vehicle at the time of manufacture.

Dealer's Responsibility

When performing service on a certified Ski-Doo snowmobiles that carry an emissions control information label, adjustments must be kept within published factory specifications.

Replacement or repair of any emission related component must be executed in a manner that maintains emission levels within the prescribed certification standards.

Dealers are not to modify the engine in any manner that would alter the horsepower or allow emission levels to exceed their predetermined factory specifications.

Exceptions include manufacturer's prescribed changes, such as altitude adjustments for example.

Owner Responsibility

The owner/operator is required to have engine maintenance performed to maintain emission levels within prescribed certification standards.

The owner/operator is not to, and should not allow anyone to modify the engine in any manner that would alter the horsepower or allow emissions levels to exceed their predetermined factory specifications.

EPA Emission Regulations

All Ski-Doo snowmobiles manufactured by BRP are certified to the EPA as conforming to the requirements of the regulations for the control of air pollution from new snowmobile engines. This certification is contingent on certain adjustments being set to factory standards. For this reason, the factory procedure for servicing the product must be strictly followed and, whenever practicable, returned to the original intent of the design.

The responsibilities listed above are general and in no way a complete listing of the rules and regulations pertaining to the EPA requirements on exhaust emissions for snowmobile products. For more detailed information on this subject, you may contact the following locations:

MAIL:

U.S. Environmental Protection Agency
Office of Transportation and Air Quality
1200 Pennsylvania Ave. NW
Mail Code 6403J
Washington D.C. 20460

INTERNET WEB SITE:

www.epa.gov/otaq/

SPECIFICATIONS

550F MODELS

MODEL		550F
ENGINE		
Engine type		Rotax® 550, fan-cooled (axial fan), cylinder reed porting
Cylinders		2
Displacement		553.4 cm ³ (33.8 in ³)
Bore		76 mm (3 in)
Stroke		61 mm (2.4 in)
Maximum horsepower RPM		6800 RPM
Carburetion		2 x VM-30
Exhaust system		Single tuned pipe, baffle muffler
Injection oil		Refer to <i>INJECTION OIL (550F AND 600 HO E-TEC)</i> section
Injection oil tank capacity		3.7 L (3.9 qt (U.S. liq.))
Recommended fuel		Regular unleaded (fuel containing MAXIMUM 10% ethanol)
Minimum octane rating. Refer to <i>FUEL REQUIREMENTS</i>		87 Pump Posted AKI (RON+MON)/2 (fuel with NO ethanol)
		92 RON (fuel with NO ethanol)
		91 Pump Posted AKI (RON+MON)/2 (fuel which may contain up to 10% MAX ethanol)
		95 RON (fuel which may contain up to 10% MAX ethanol)
Fuel tank capacity		40 L (10.6 U.S. gal.)
DRIVE SYSTEM		
Drive pulley type		eDrive II
Driven pulley type		QRS (short shaft)
Engagement		2600 RPM
Chaincase oil	Type	XPS SYNTHETIC CHAINCASE OIL (P/N 413 803 300)
	Capacity	350 ml (11.8 U.S. oz)
Small sprocket number of teeth		19
Large sprocket number of teeth		45
Drive sprocket number of teeth		8
Track nominal width		40.6 cm (16 in)
Track nominal length	Tundra Sport	345.6 cm (137 in)
	Tundra LT	392.3 cm (154 in)

MODEL		550F	
DRIVE SYSTEM (cont'd)			
Track profile height		Tundra Sport	31.8 mm (1.25 in)
		Tundra LT	38 mm (1.5 in)
Track tension	Deflection	Tundra Sport	30 mm to 35 mm (1-3/16 in to 1-3/8 in)
		Tundra LT	40 mm to 45 mm (1-1/2 in to 1-9/16 in)
	Force ⁽¹⁾		7.3 kg (16 lb)
Track alignment		Equal distance between edges of track guides and slider shoes	
BRAKE SYSTEM			
Brake system type		Hydraulic, REV-XP™ brake type	
Brake fluid		DOT 4	
SUSPENSION			
Front suspension		LTS	
Front shock		Motion control	
Front suspension max. travel		150 mm (6 in)	
Rear suspension	Tundra Sport	SC-5M	
	Tundra LT	SC-5U	
Center shock		Motion control	
Rear shock		HPG™	
Rear suspension max. travel	Tundra Sport	34 cm (13.4 in)	
	Tundra LT	35.6 cm (14 in)	
ELECTRICAL SYSTEM			
Lightning system output		340 watts @ 6000 RPM	
Headlights bulb HI/LOW beam		2 x 60/55 watts (H-4)	
Taillight bulb		5/21	
Spark plug	Type	NGK BR9ECS or equivalent	
	Gap	0.45 mm ± 0.05 mm (.018 in ± .002 in) (not adjustable)	
Fuse		25 A	

SPECIFICATIONS

MODEL		550F
WEIGHT AND DIMENSIONS		
Dry weight	Tundra Sport	210 kg (463 lb)
	Tundra LT	219 kg (483 lb)
Vehicle overall length	Tundra Sport	306.9 cm (120.8 in)
	Tundra LT	332.9 cm (131.1 in)
Vehicle overall width		100.2 cm (39.4 in)
Ski stance		81.3 cm (32 in)
Ski width		165 mm (6.5 in)

⁽¹⁾ Measure gap between slider shoe and bottom inside track when exerting a downward pull to the track.

600 ACE MODELS

MODEL		600 ACE
ENGINE		
Engine type		Rotax 600, liquid cooled, 4-stroke, D.O.H.C., dry sump.
Cylinders		2
Displacement		600 cm ³ (36.6 in ³)
Bore		74 mm (2.91 in)
Stroke		69.7 mm (2.74 in)
Maximum horsepower RPM		7250 RPM
Fuel injection system		Multi point EFI, 46 mm throttle body
Exhaust system		Double front pipe, baffle muffler
Engine oil		XPS 4-STROKE SYNTHETIC OIL (ALL CLIMATE) (P/N 293 600 112) or equivalent
Engine oil tank capacity		Oil change, 2.1 L (2.22 qt (U.S. liq.))
Coolant		Ethyl glycol/water mix (50% coolant, 50% distilled water). Use LONG LIFE ANTIFREEZE (P/N 219 702 685) or coolant specifically designed for aluminum engines
Recommended fuel		Regular unleaded (fuel containing MAXIMUM 10% ethanol)
Minimum octane rating. Refer to <i>FUEL REQUIREMENTS</i>		87 Pump Posted AKI (RON+MON)/2 (fuel with NO ethanol)
		92 RON (fuel with NO ethanol)
		91 Pump Posted AKI (RON+MON)/2 (fuel which may contain up to 10% MAX ethanol)
		95 RON (fuel which may contain up to 10% MAX ethanol)
Fuel tank capacity		40 L (10.6 U.S. gal.)
DRIVE SYSTEM		
Drive pulley type		eDrive II
Driven pulley type		QRS (short shaft)
Engagement		2200 RPM
Chaincase oil	Type	XPS SYNTHETIC CHAINCASE OIL (P/N 413 803 300)
	Capacity	500 ml (16.9 U.S. oz)
Small sprocket number of teeth		21
Large sprocket number of teeth		51
Drive sprocket number of teeth	Inside North America	8
	Europe	7
Track nominal width		40.6 cm (16 in)

SPECIFICATIONS

MODEL		600 ACE	
DRIVE SYSTEM (cont'd)			
Track nominal length		Tundra Sport	345.6 cm (137 in)
		Tundra LT	392.3 cm (154 in)
Track profile height		Tundra Sport	31.8 mm (1.25 in)
		Tundra LT	38 mm (1.5 in)
Track tension	Deflection	Tundra Sport	30 mm to 35 mm (1-3/16 in to 1-3/8 in)
		Tundra LT	40 mm to 45 mm (1-1/2 in to 1-9/16 in)
	Force ⁽¹⁾	7.3 kg (16 lb)	
Track alignment		Equal distance between edges of track guides and slider shoes	
BRAKE SYSTEM			
Brake system type		Hydraulic, REV-XP™ brake type	
Brake fluid		DOT 4	
SUSPENSION			
Front suspension		LTS	
Front shock		Motion control	
Front suspension max. travel		150 mm (6 in)	
Rear suspension		Tundra Sport	SC-5M
		Tundra LT	SC-5U
Center shock		Motion control	
Rear shock		HPG™	
Rear suspension max. travel		Tundra Sport	34 cm (13.4 in)
		Tundra LT	35.6 cm (14 in)
ELECTRICAL SYSTEM			
Lightning system output		650 watts @ 6000 RPM	
Headlights bulb HI/LOW beam		2 x 60/55 watts (H-4)	
Taillight bulb		5/21	
Spark plug	Type	NGK MR7BI or equivalent	
	Gap	0.8 mm (.031 in)	
Fuses and relays	FA: Main	40 A	
	F1: Ignition coils, Fuel injectors, Fuel pump, Starter solenoid	10 A	
	F2: Accessories, Heating elements	20 A	

MODEL		600 ACE
ELECTRICAL SYSTEM (cont'd)		
Fuses and relays	F3: Electromechanical reverse	Not Installed
	F4: Start button, Cooling fan, Clock	15 A
	F5: Headlights, Taillight, Brake light	20 A
	F6: ECM, gauge, CAPS	10 A
	R1: Main relay	Fuses F1, F3 and F6
	R2: Lighting relay	Fuse F5
	R3: Accessories relay	Fuse F2
WEIGHT AND DIMENSIONS		
Dry weight	Tundra Sport	219 kg (482 lb)
	Tundra LT	229 kg (505 lb)
Vehicle overall length	Tundra Sport	306.9 cm (120.8 in)
	Tundra LT	332.9 cm (131.1 in)
Vehicle overall width		100.2 cm (39.4 in)
Ski stance		81.3 cm (32 in)
Ski width		165 mm (6.5 in)

(1) Measure gap between slider shoe and bottom inside track when exerting a downward pull to the track.

600 HO E-TEC MODELS

MODEL		600 HO E-TEC
ENGINE		
Engine type	Rotax® 600, liquid cooled fw/reed valve, 3D-RAVE	
Cylinders	2	
Displacement	594.4 cm ³ (36.3 in ³)	
Bore	72 mm (2.8 in)	
Stroke	73 mm (2.9 in)	
Maximum horsepower RPM	8100 RPM	
Fuel injection system	E-TEC direct injection	
Exhaust system	Single tuned pipe, baffle muffler	
Injection oil	Refer to <i>INJECTION OIL (550F AND 600 HO E-TEC)</i> section	
Injection oil tank capacity	3.7 L (3.9 qt (U.S. liq.))	
Coolant	Ethyl glycol/water mix (50% coolant, 50% distilled water). Use LONG LIFE ANTIFREEZE (P/N 219 702 685) or coolant specifically designed for aluminum engines	
Recommended fuel	Premium unleaded (fuel with NO ethanol or fuel which may contain up to 10% MAX ethanol)	
Minimum octane rating. Refer to <i>FUEL REQUIREMENTS</i>	91 Pump Posted AKI (RON+MON)/2	
	95 RON	
Fuel tank capacity	40 L (10.6 U.S. gal.)	
DRIVE SYSTEM		
Drive pulley type	TRA™ III	
Driven pulley type	QRS	
Engagement	2800 RPM	
Chaincase oil	Type	XPS SYNTHETIC CHAINCASE OIL (P/N 413 803 300)
	Capacity	350 ml (11.8 U.S. oz)
Small sprocket number of teeth	19	
Large sprocket number of teeth	49	
Drive sprocket number of teeth	8	
Track nominal width	40.6 cm (16 in)	
Track nominal length	392.3 cm (154 in)	

MODEL		600 HO E-TEC
DRIVE SYSTEM (cont'd)		
Track profile height		63.5 mm (2.5 in)
Track tension	Deflection	40 mm to 45 mm (1-1/2 in to 1-9/16 in)
	Force ⁽¹⁾	7.3 kg (16 lb)
Track alignment		Equal distance between edges of track guides and slider shoes
BRAKE SYSTEM		
Brake system type		Hydraulic, REV-XP™ brake type
Brake fluid		DOT 4
SUSPENSION		
Front suspension		LTS
Front shock		Motion control
Front suspension max. travel		150 mm (6 in)
Rear suspension		SC-5U
Center shock		HPG™
Rear shock		HPG™
Rear suspension max. travel		35.6 cm (14 in)
ELECTRICAL SYSTEM		
Lightning system output		12 V/360 W 55 V/1100 W
Headlights bulb HI/LOW beam		2 x 60/55 watts (H-4)
Taillight bulb		2.6W/139mW LED
Spark plug	Type	NGK PZFR6F ⁽²⁾ or equivalent
	Gap	0.7 mm - 0.8 mm (.028 in - .031 in) (Not adjustable)
Fuse		Refer to <i>FUSES</i> section
WEIGHT AND DIMENSIONS		
Dry weight		225 kg (495 lb)
Vehicle overall length		332.9 cm (131.1 in)
Vehicle overall width		100.2 cm (39.4 in)
Ski stance		81.3 cm (32 in)
Ski width		165 mm (6.5 in)

⁽¹⁾ Measure gap between slider shoe and bottom inside track when exerting a downward pull to the track.

NOTICE ⁽²⁾ Do not attempt to adjust gap on this spark plug.

***This page is
intentionally blank***

TROUBLESHOOTING

TROUBLESHOOTING GUIDELINES (550F)

ENGINE IS CRANKED BUT FAILS TO START

1. **Engine stop switch or ignition switch (key) in OFF position or tether cord cap away from post.**
 - *Place engine stop switch and ignition switch in the ON position and install tether cord cap on post.*
2. **Mixture not rich enough to start cold engine.**
 - *Check fuel tank level.*
 - *Make sure to use choke properly, refer to CHOKE APPLICATION in BASIC PROCEDURES.*
3. **Flooded engine (spark plug wet when removed).**
 - *Do not choke. Remove wet spark plug, place engine stop switch in OFF position and crank engine several times. Install clean dry spark plugs.*
 - *Start engine following usual starting procedure. If engine continues to flood, seek service from an authorized Ski-Doo dealer, repair shop, or person of your own choosing for maintenance, repair, or replacement. Please refer to the US EPA EMISSIONS-RELATED WARRANTY contained herein for information about warranty claims.*
4. **No fuel to the engine (spark plug dry when removed).**
 - *Check fuel tank level; check condition of fuel and impulse lines and their connections. Possible fuel pump or carburetor failure, seek service from an authorized Ski-Doo dealer, repair shop, or person of your own choosing for maintenance, repair, or replacement. Please refer to the US EPA EMISSIONS-RELATED WARRANTY contained herein for information about warranty claims.*
5. **Spark plug/ignition (no spark).**
 - *Install new spark plugs crank engine. If engine fails to start, seek service from an authorized Ski-Doo dealer, repair shop, or person of your own choosing for maintenance, repair, or replacement. Please refer to the US EPA EMISSIONS-RELATED WARRANTY contained herein for information about warranty claims.*
6. **Engine compression.**
 - *As the engine is pulled over with the rewind starter, "cycles" of resistance should be felt as piston goes past top dead center (each piston on multi-cylinder engines).*
 - *If no pulsating resistance is felt, it suggests a major loss of compression. Seek service from an authorized Ski-Doo dealer, repair shop, or person of your own choosing for maintenance, repair, or replacement. Please refer to the US EPA EMISSIONS-RELATED WARRANTY contained herein for information about warranty claims.*

ENGINE LACKS POWER

1. **Fouled or defective spark plug.**
 - *See item 5 of ENGINE IS CRANKED BUT FAILS TO START.*
2. **Lack of fuel to engine.**
 - *See item 4 of ENGINE IS CRANKED BUT FAILS TO START.*

ENGINE LACKS POWER (cont'd)

3. Carburetor adjustments.

- *Seek service from an authorized Ski-Doo dealer, repair shop, or person of your own choosing for maintenance, repair, or replacement. Please refer to the US EPA EMISSIONS-RELATED WARRANTY contained herein for information about warranty claims.*

4. Drive belt worn too thin.

- *If the drive belt has lost more than 3 mm (1/8 in) of its original width, it will affect vehicle performance.*
- *Replace drive belt.*

5. Incorrect track adjustment.

- *See MAINTENANCE PROCEDURES and/or an authorized Ski-Doo dealer for proper alignment and tension adjustments.*

6. Drive and driven pulleys require servicing.

- *Contact an authorized Ski-Doo dealer.*

7. Engine overheats.

- *Check fan belt condition and tension.*
- *Check cooling fins. Clean if necessary.*
- *If engine overheating persists, seek service from an authorized Ski-Doo dealer, repair shop, or person of your own choosing for maintenance, repair, or replacement. Please refer to the US EPA EMISSIONS-RELATED WARRANTY contained herein for information about warranty claims.*

ENGINE BACKFIRES

1. Faulty spark plug (carbon accumulation).

- *See item 5 of ENGINE IS CRANKED BUT FAILS TO START.*

2. Engine is running too hot.

- *See item 7 of ENGINE LACKS ACCELERATION OR POWER.*

3. Incorrect ignition timing or ignition system failure.

- *Contact an authorized Ski-Doo dealer.*

ENGINE MISFIRES

1. Fouled/defective/worn spark plugs.

- *Clean/verify spark plug gap and identification number. Replace if required.*

2. Too much oil supplied to engine.

- *Improper oil pump adjustment, seek service from an authorized Ski-Doo dealer, repair shop, or person of your own choosing for maintenance, repair, or replacement. Please refer to the US EPA EMISSIONS-RELATED WARRANTY contained herein for information about warranty claims.*

3. Water in fuel.

- *Drain fuel system and refill with fresh fuel.*

TROUBLESHOOTING GUIDELINES (600 ACE)

STARTER DOES NOT WORK

1. One of the switch is not in the position to start the engine.
 - *Place emergency engine stop switch in the ON position and install tether cord cap (D.E.S.S. key) on post.*
2. Throttle applied while attempting an engine start.
 - *Release throttle while cranking.*

ENGINE RPM DOES NOT REACH CLUTCH ENGAGEMENT POINT

1. D.E.S.S. did not read tether cord cap (D.E.S.S. key) code. D.E.S.S. pilot lamp blinks (slow short beeps/repetitive).
 - *Properly install tether cord cap (D.E.S.S. key).*
2. D.E.S.S. has read a different code than the one programmed. D.E.S.S. pilot lamp blinks rapidly (fast short beeps/repetitive).
 - *Install a tether cord cap (D.E.S.S. key) for which this snowmobile was programmed.*
3. ECM does not recognize the D.E.S.S. key.
 - *Refer to an authorized Ski-Doo dealer.*

ENGINE OVERHEATS

1. Insufficient snow or hard packed snow.
 - *Drive in loose snow. If there is no loose snow near, pull over, stop engine and let it cool down. Once engine has cooled down, reach loose snow as soon as possible.*
2. Low coolant level.
 - *Check coolant level, see MAINTENANCE PROCEDURES.*
3. Clogged heat exchangers
 - *Clean heat exchangers.*

ENGINE LACKS ACCELERATION OR POWER

1. Learning key used.
 - *Use a Normal key.*
2. Sport mode not activated.
 - *Refer to ACTIVATING SPORT MODE in OPERATING MODES.*
3. Drive and driven pulleys require servicing.
 - *Contact an authorized Ski-Doo dealer.*
4. Drive belt worn too thin.
 - *If the drive belt has lost more than 3 mm (1/8 in) of its original width, it will affect vehicle performance.*
 - *Replace drive belt.*
5. Incorrect track adjustment.
 - *See MAINTENANCE INFORMATION and/or an authorized Ski-Doo dealer for proper alignment and tension adjustments.*

ENGINE SPEED IS LIMITED TO 3000 RPM

1. Defective brake switch or vehicle operated with brake lever activated for a prolonged period.
 - *See an authorized Ski-Doo dealer.*

ENGINE MISFIRES.

1. Water in fuel.
 - *Drain fuel system and refill with fresh fuel.*

NO RESPONSE FROM THE THROTTLE LEVER INPUTS. MESSAGE DISPLAYED: PRESS START TO GO

1. Engine management system has detected a sensor problem.
 - *Press and hold the start button in order to move vehicle. Seek service from an authorized Ski-Doo dealer, repair shop, or person of your own choosing for maintenance, repair, or replacement. Please refer to the US EPA EMISSIONS-RELATED WARRANTY contained herein for information about warranty claims.*

HEATED GRIPS/THUMB WARMERS ARE NOT WORKING

1. Engine RPM is too low.
 - *Make sure engine RPM is above 2000.*

ENGINE HAS SHUT DOWN WHILE IDLING

1. The engine shuts down after long periods of idling.
 - *Do not let engine idle too long. Refer to VEHICLE WARM-UP in OPERATING INSTRUCTION.*

TROUBLESHOOTING GUIDELINES (600 HO E-TEC)

ELECTRIC STARTER DOES NOT WORK

1. One of the switch is not in the position to start the engine.
 - *Place the emergency engine stop switch in the ON position and install tether cord cap (on engine cut-off switch).*
2. Throttle applied while attempting an engine start.
 - *Release throttle while cranking.*

ENGINE IS CRANKED BUT FAILS TO START

1. No fuel to the engine.
 - *Check fuel tank level, add fuel if necessary.*
2. System voltage too low.
 - *Contact an authorized Ski-Doo dealer.*

ENGINE RPM DOES NOT REACH CLUTCH ENGAGEMENT POINT

1. D.E.S.S. did not read D.E.S.S. key code in the tether cord cap. D.E.S.S. pilot lamp blinks (slow short beeps/repetitive).
 - *Properly install tether cord cap.*
2. D.E.S.S. has read a different code than the one programmed. D.E.S.S. pilot lamp blinks rapidly (fast short beeps/repetitive).
 - *Install a tether cord cap for which this snowmobile was programmed.*

ENGINE OVERHEATS

1. Insufficient snow or hard packed snow.
 - *Drive in loose snow. If there is no loose snow near, pull over, stop engine and let it cool down. Once engine has cooled down, reach loose snow as soon as possible.*
2. Low coolant level.
 - *Check coolant level, see MAINTENANCE PROCEDURES*
3. Clogged heat exchangers
 - *Clean heat exchangers.*

ENGINE LACKS POWER

1. Engine warm-up in progress.
 - *Drive vehicle at low speeds for a few minutes.*
2. Engine break-in period not completed.
 - *Complete break-in period.*
3. Incorrect drive pulley adjustment.
 - *Adjust drive pulley, refer to MAINTENANCE PROCEDURES.*
4. Drive and driven pulleys require servicing.
 - *Contact an authorized SKI-DOO dealer.*

ENGINE LACKS POWER (cont'd)

5. Drive belt worn too thin.

- *If the drive belt has lost more than 3 mm (1/8 in) of its original width, it will affect vehicle performance.*
- *Replace drive belt.*

6. Incorrect track adjustment.

- *See MAINTENANCE and/or an authorized SKI-DOO dealer for proper alignment and tension adjustments.*

7. R.A.V.E. valves problem.

- *Seek service from an authorized Ski-Doo dealer, repair shop, or person of your own choosing for maintenance, repair, or replacement. Please refer to the US EPA EMISSIONS-RELATED WARRANTY contained herein for information about warranty claims.*

8. Fuel pressure too low.

- *Seek service from an authorized Ski-Doo dealer, repair shop, or person of your own choosing for maintenance, repair, or replacement. Please refer to the US EPA EMISSIONS-RELATED WARRANTY contained herein for information about warranty claims.*

ENGINE BACKFIRES

1. Engine is running too hot.

- *See item 2 of ENGINE LACKS POWER/VEHICLE DOES NOT REACH FULL SPEED.*

2. Ignition timing is incorrect or there is an ignition system failure.

- *Seek service from an authorized Ski-Doo dealer, repair shop, or person of your own choosing for maintenance, repair, or replacement. Please refer to the US EPA EMISSIONS-RELATED WARRANTY contained herein for information about warranty claims.*

3. Exhaust system leak.

- *Seek service from an authorized Ski-Doo dealer, repair shop, or person of your own choosing for maintenance, repair, or replacement. Please refer to the US EPA EMISSIONS-RELATED WARRANTY contained herein for information about warranty claims.*

4. Fuel pressure too low.

- *Seek service from an authorized Ski-Doo dealer, repair shop, or person of your own choosing for maintenance, repair, or replacement. Please refer to the US EPA EMISSIONS-RELATED WARRANTY contained herein for information about warranty claims.*

ENGINE MISFIRES

1. Water in fuel.

- *Drain fuel system and refill with fresh fuel.*

ENGINE MISFIRES (cont'd)

2. RAVE valves malfunction.

- *Have RAVE valves system inspected. Seek service from an authorized Ski-Doo dealer, repair shop, or person of your own choosing for maintenance, repair, or replacement. Please refer to the US EPA EMISSIONS-RELATED WARRANTY contained herein for information about warranty claims*

HEATED GRIPS/THUMB WARMERS ARE NOT WORKING

1. Engine RPM is too low.

- *Make sure engine RPM is above 2000.*

ENGINE HAS SHUT DOWN WHILE IDLING

1. The engine shuts down after long periods of idling.

- *Do not let engine idle too long. Refer to VEHICLE WARM-UP in OPERATING INSTRUCTION.*

MONITORING SYSTEM (600 ACE AND 600 HO E-TEC)

Pilot Lamps, Messages and Beeper Codes

Gauge pilot lamp(s) will inform you if an anomaly occurs or to inform you of a particular condition.







TYPICAL — PILOT LAMPS

Pilot lamp can flash alone or in combination with another lamp.

Beeper codes will be emitted to catch your attention.

See table below for details.

NOTE: Some of the listed pilot lamps do not apply to all models.

PILOT LAMP(S) ON	BEEPER	DESCRIPTION
	4 short beeps every 30 seconds	Engine is overheating, reduce snowmobile speed and run in loose snow or stop engine immediately and let engine cool down. Check coolant level, refer to <i>MAINTENANCE</i> . If coolant level is correct and overheating persists, contact an authorized Ski-Doo dealer. Do not run the engine if condition persists.
		Reduce speed or stop engine. Let engine cool down and restart. If overheating persists, contact an authorized Ski-Doo dealer. Do not run the engine if condition persists.
	Short beeps repeating rapidly	Critical overheating. Stop engine immediately and let engine cool down. Check coolant level, refer to <i>MAINTENANCE</i> . If coolant level is correct and overheating persists, contact an authorized Ski-Doo dealer. Do not run the engine if condition persists.
		Critical overheating. Stop engine immediately and let engine cool down. If overheating persists, contact an authorized Ski-Doo dealer. Do not run the engine if condition persists. Do not run the engine if condition persists.
	4 short beeps every 5 minutes	Indicate a low or high battery voltage condition. See an authorized Ski-Doo dealer as soon as possible.
	4 short beeps	Engine fault, see an authorized Ski-Doo dealer, repair shop, or person of your own choosing as soon as possible.
—	4 short beeps every 5 minutes	Engine detonation (RPM is limited when this condition occurs). <ul style="list-style-type: none"> – Ensure recommended fuel is used. – Check fuel quality, replace if necessary. – If fault still occurs, contact an authorized Ski-Doo dealer, repair shop, or person of your own choosing.
—	4 short beeps every 5 minutes	Engine RPM limited for protection when certain faults occur.
—	Short beeps repeating rapidly	Shutdown procedure in force due to engine overheating or fuel pump problem, remove tether cord cap from engine cut-off switch and contact an authorized Ski-Doo dealer, repair shop, or person of your own choosing.

PILOT LAMP(S) ON	BEEPER	DESCRIPTION
DESS	2 short beeps	Good key, vehicle ready to operate.
	2 short beeps, repeating slowly	Unable to read key (bad connection). Make sure the key is clean and correctly snapped on post.
	Short beeps repeating rapidly	Invalid key or key not programmed. Use the proper key for the vehicle or have the programmed.
	(Blinking)	Fuel level sender problem.

***This page is
intentionally blank***

WARRANTY

BRP LIMITED WARRANTY USA AND CANADA: 2016 SKI-DOO® SNOWMOBILES

1) SCOPE OF THE LIMITED WARRANTY

Bombardier Recreational Products Inc. ("BRP")* warrants its 2016 Ski-Doo snowmobiles sold by authorized BRP dealers (as defined below) in the United States of America ("USA") and in Canada from defects in material or workmanship for the period and under the conditions described below. This limited warranty will become null and void if: (1) the snowmobile was used for racing or any other competitive activity, at any point, even by a previous owner; or (2) the snowmobile has been altered or modified in such a way so as to adversely affect its operation, performance or durability, or has been altered or modified to change its intended use.

Except if otherwise specified, all genuine Ski-Doo parts and accessories, installed by an authorized BRP dealer (as hereinafter defined) at the time of delivery of the 2016 Ski-Doo snowmobile, carry the same warranty as that of the snowmobile.

2) LIMITATIONS OF LIABILITY

THIS WARRANTY IS EXPRESSLY GIVEN AND ACCEPTED IN LIEU OF ANY AND ALL OTHER WARRANTIES, EXPRESSED OR IMPLIED, INCLUDING WITHOUT LIMITATION ANY WARRANTY OF MERCHANTABILITY OR FITNESS FOR A PARTICULAR PURPOSE. TO THE EXTENT THAT THEY CANNOT BE DISCLAIMED, THE IMPLIED WARRANTIES ARE LIMITED IN DURATION TO THE LIFE OF THE EXPRESS WARRANTY. INCIDENTAL AND CONSEQUENTIAL DAMAGES ARE EXCLUDED FROM COVERAGE UNDER THIS WARRANTY. SOME STATES/PROVINCES DO NOT ALLOW FOR THE DISCLAIMERS, LIMITATIONS AND EXCLUSIONS IDENTIFIED ABOVE, AS A RESULT, THEY MAY NOT APPLY TO YOU. THIS WARRANTY GIVES YOU SPECIFIC RIGHTS, AND YOU MAY ALSO HAVE OTHER LEGAL RIGHTS WHICH MAY VARY FROM STATE TO STATE, OR PROVINCE TO PROVINCE.

Neither the distributor, any BRP dealer nor any other person has been authorized to make any affirmation, representation or warranty regarding the product, other than those contained in this limited warranty, and if made, shall not be enforceable against BRP. BRP reserves the right to modify this warranty at any time, being understood that such modification will not alter the warranty conditions applicable to the products sold while this warranty is in effect.

3) EXCLUSIONS – ARE NOT WARRANTED

The following are not warranted under any circumstances:

- Normal wear and tear;
- Routine maintenance items, tune ups, adjustments;
- Damage caused by failure to provide proper maintenance and/or storage, as described in the Operator's Guide;
- Damage resulting from removal of parts, improper repairs, service, maintenance, modifications or use of parts or accessories not manufactured or approved by BRP or resulting from repairs done by a person that is not an authorized servicing BRP dealer;
- Damage caused by abuse, abnormal use, neglect, use of the product on surfaces other than snow, or operation of the product in a manner inconsistent with the recommended operation described in the Operator's Guide;

- Damage resulting from accident, submersion, fire, theft, vandalism or any act of God;
- Operation with fuels, oils or lubricants which are not suitable for use with the product (see the Operator’s Guide);
- Snow or water ingestion;
- Incidental or consequential damages, or damages of any kind including without limitation towing, storage, telephone, rental, taxi, inconvenience, insurance coverage, loan payments, loss of time, loss of income; and
- Damage resulting from studs installed on tracks if the installation does not conform to BRP’s instructions.

4) WARRANTY COVERAGE PERIOD

This warranty will be in effect from the date of delivery to the first retail consumer or the date the product is first put into use, whichever occurs first and for the following period:

TWELVE (12) CONSECUTIVE MONTHS, for private or commercial use owners. However, the warranty coverage period on a snowmobile delivered between June 1st and December 1st of a given year will expire November 30th of the following year.

For emission-related components; please also refer to the *US EPA EMISSION-RELATED WARRANTY* contained herein.

The repair or replacement of parts or the performance of service under this warranty does not extend the life of this warranty beyond its original expiration date.

5) CONDITIONS REQUIRED FOR WARRANTY COVERAGE

This warranty coverage is available **only** if each of the following conditions has been fulfilled:

- The 2016 Ski-Doo snowmobile must be purchased as new and unused by its first owner from a BRP dealer authorized to distribute Ski-Doo snowmobiles in the country in which the sale occurred (“**BRP dealer**”);
- The BRP specified pre-delivery inspection process must be completed and documented and signed by the purchaser;
- The 2016 Ski-Doo snowmobile must have undergone proper registration by an authorized BRP dealer;
- The 2016 Ski-Doo snowmobile must be purchased in the country in which the purchaser resides; and
- Routine maintenance outlined in the Operator’s Guide must be timely performed in order to maintain warranty coverage. BRP reserves the right to make warranty coverage contingent upon proof of proper maintenance.

BRP will not honor this limited warranty to any private use owner or commercial use owner if one of the preceding conditions has not been met. Such limitations are necessary in order to allow BRP to preserve both the safety of its products, and also that of its consumers and the general public.

6) WHAT TO DO TO OBTAIN WARRANTY COVERAGE

The customer must cease using the snowmobile upon the appearance of an anomaly. The customer must notify a servicing BRP dealer within three (3) days of the appearance of a defect, and provide it with reasonable access to the product and reasonable opportunity to repair it. The customer must also present to the authorized BRP dealer, proof of purchase of the product and must sign the repair/work order prior to starting the repair in order to validate the warranty repair. All parts replaced under this limited warranty become the property of BRP.

7) WHAT BRP WILL DO

BRP's obligations under this warranty are limited to, at its sole discretion, repairing parts found defective under normal use, maintenance and service, or replacing such parts with new genuine Ski-Doo parts without charge for parts and labor, at any authorized BRP dealer during the warranty coverage period under the conditions described herein. No claim of breach of warranty shall be cause for cancellation or rescission of the sale of the snowmobile to the owner.

In the event that service is required outside of the country of original sale, the owner will bear responsibility for any additional charges due to local practices and conditions, such as, but not limited to, freight, insurance, taxes, license fees, import duties, and any and all other financial charges, including those levied by governments, states, territories and their respective agencies.

BRP reserves the right to improve or modify products from time to time without assuming any obligation to modify products previously manufactured.

8) TRANSFER

If the ownership of a product is transferred during the warranty coverage period, this warranty shall also be transferred and be valid for the remaining coverage period provided that BRP is notified of such transfer of ownership in the following way:

1. The former owner contacts BRP (at the phone number provided below) or an authorized BRP dealer and gives the coordinates of the new owner; or
2. BRP or an authorized BRP dealer receives a proof that the former owner agreed to the transfer of ownership, in addition to the coordinates of the new owner.

9) CONSUMER ASSISTANCE

In the event of a controversy or a dispute in connection with this limited warranty, BRP suggests that you try to resolve the issue at the dealership level. We recommend discussing the issue with the authorized dealer's service manager or owner. If the issue has not yet been resolved, please submit your complaint in writing or call the appropriate number below:

In Canada

BOMBARDIER RECREATIONAL PRODUCTS INC.
Customer Assistance Center
75 J.-A. Bombardier Street
Sherbrooke QC J1L 1W3
Tel.: 1-888-272-9222

In USA

BRP US INC.
Customer Assistance Center
7575 Bombardier Court
Wausau WI 54401
Tel.: 1-888-272-9222

* In the USA, products are distributed and serviced by BRP US Inc.
© 2015 Bombardier Recreational Products Inc. All rights reserved.
® Registered trademark of Bombardier Recreational Products Inc.

US EPA EMISSION-RELATED WARRANTY

Bombardier Recreational Products Inc. ("BRP")* warrants to the ultimate purchaser and each subsequent purchaser that this new engine, including all parts of its exhaust emission-control system and its evaporative emission-control system, meets two conditions:

1. It is designed, built, and equipped so it conforms at the time of sale to the ultimate purchaser with the requirements of 40 CFR 1051 and 40 CFR 1060.
2. It is free from defects in materials and workmanship that may keep it from meeting the requirements of 40 CFR 1051 and 40 CFR 1060.

Where a warrantable condition exists, BRP will repair or replace, as it elects, any part or component with a defect in materials or workmanship that would increase the engine's emissions of any regulated pollutant within the stated warranty period at no cost to the owner, including expenses related to diagnosing and repairing or replacing emission-related parts. All defective parts replaced under this warranty become the property of BRP.

For all emission-related warranty claims, BRP is limiting the diagnosis and repair of emission-related parts to the authorized Ski-Doo dealers, unless for emergency repairs as required by item 2 of the following list.

As a certifying manufacturer, BRP will not deny emission-related warranty claims based on any of the following:

1. Maintenance or other service BRP or BRP's authorized facilities performed.
2. Engine/equipment repair work that an operator performed to correct an unsafe, emergency condition attributable to BRP as long as the operator tries to restore the engine/equipment to its proper configuration as soon as possible.
3. Any action or inaction by the operator unrelated to the warranty claim.
4. Maintenance that was performed more frequently than BRP specify.
5. Anything that is BRP fault or responsibility.
6. The use of any fuel that is commonly available where the equipment operates unless BRP written maintenance instructions state that this fuel would harm the equipment's emission control system and operators can readily find the proper fuel. See maintenance information section and fuel requirements of fueling section.

Emission-Related Warranty Period

The emission-related warranty is valid for the following period whichever comes first:

	HOURS	MONTHS	KILOMETERS
Exhaust emission-related components	200	30	4000
Evaporative emission-related components	N/A	24	N/A

Components Covered

The emission-related warranty covers all components whose failure would increase an engine's emissions of any regulated pollutant, including the following listed components:

1. For exhaust emissions, emission-related components include any engine parts related to the following systems:
 - Air-induction system
 - Fuel system
 - Ignition system
 - Exhaust gas recirculation systems
2. The following parts are also considered emission-related components for exhaust emissions:
 - Aftertreatment devices
 - Crankcase ventilation valves
 - Sensors
 - Electronic control units
3. The following parts are considered emission-related components for evaporative emissions:
 - Fuel tank
 - Fuel cap
 - Fuel line
 - Fuel line fittings
 - Clamps*
 - Pressure relief valves*
 - Control valves*
 - Control solenoids*
 - Electronic controls*
 - Vacuum control diaphragms*
 - Control cables*
 - Control linkages*
 - Purge valves
 - Vapor hoses
 - Liquid/vapor separator
 - Carbon canister
 - Canister mounting brackets
 - Carburetor purge port connector
4. Emission-related components also include any other part whose only purpose is to reduce emissions or whose failure will increase emissions without significantly degrading engine/equipment performance.

*As related to the evaporative emission control system

Limited Applicability

As a certifying manufacturer, BRP may deny emission-related warranty claims for failures that have been caused by the owner's or operator's improper maintenance or use, by accidents for which the manufacturer has no responsibility, or by acts of God. For example, an emission-related warranty claim need not be honored for failures that have been directly caused by the operator's abuse of the engine/equipment or the operator's use of the engine/equipment in a manner for which it was not designed and are not attributable to the manufacturer in any way.

* In the USA, products are distributed and serviced by BRP US Inc.

BRP INTERNATIONAL LIMITED WARRANTY: 2016 SKI-DOO® SNOWMOBILES

1) SCOPE OF THE LIMITED WARRANTY

Bombardier Recreational Products Inc. ("BRP")* warrants its 2016 Ski-Doo snowmobiles sold by distributors or dealers authorized by BRP to distribute SKI-Doo snowmobiles ("Ski-Doo Distributor/Dealer") outside of the fifty United States, Canada, members of the European Economic Area (which is comprised of the member states of the European Union plus Norway, Iceland and Liechtenstein) ("EEA"), members states of the Commonwealth of the Independent States (including Ukraine and Turkmenistan) ("CIS") and Turkey, from defects in material or workmanship for the period and under the conditions described below.

All genuine Ski-Doo parts and accessories, installed by an authorized Ski-Doo Distributor/Dealer at the time of delivery of the 2016 Ski-Doo snowmobile, carry the same warranty as that of the snowmobile.

This limited warranty will become null and void if: (1) the snowmobile was used for racing or any other competitive activity, at any point, even by a previous owner; or (2) the snowmobile has been altered or modified in such a way so as to adversely affect its operation, performance or durability, or has been altered or modified to change its intended use.

2) LIMITATIONS OF LIABILITY

TO THE EXTENT PERMITTED BY LAW, THIS WARRANTY IS EXPRESSLY GIVEN AND ACCEPTED IN LIEU OF ANY AND ALL OTHER WARRANTIES, EXPRESSED OR IMPLIED, INCLUDING WITHOUT LIMITATION ANY WARRANTY OF MERCHANTABILITY OR FITNESS FOR A PARTICULAR PURPOSE. TO THE EXTENT THAT THEY CANNOT BE DISCLAIMED, THE IMPLIED WARRANTIES ARE LIMITED IN DURATION TO THE LIFE OF THE EXPRESS WARRANTY. INCIDENTAL AND CONSEQUENTIAL DAMAGES ARE EXCLUDED FROM COVERAGE UNDER THIS WARRANTY. SOME JURISDICTIONS DO NOT ALLOW FOR THE DISCLAIMERS, LIMITATIONS AND EXCLUSIONS IDENTIFIED ABOVE, AS A RESULT, THEY MAY NOT APPLY TO YOU. THIS WARRANTY GIVES YOU SPECIFIC RIGHTS, AND YOU MAY ALSO HAVE OTHER LEGAL RIGHTS WHICH MAY VARY FROM COUNTRY TO COUNTRY. (FOR PRODUCTS PURCHASED IN AUSTRALIA SEE CLAUSE 4 BELOW).

Neither the Ski-Doo Distributor/Dealer nor any other person has been authorized to make any affirmation, representation or warranty regarding the product, other than those contained in this limited warranty, and if made, shall not be enforceable against BRP.

BRP reserves the right to modify this warranty at any time, being understood that such modification will not alter the warranty conditions applicable to the products sold while this warranty is in effect.

3) EXCLUSIONS – ARE NOT WARRANTED

The following are not warranted under this limited warranty under any circumstances:

- Normal wear and tear;
- Routine maintenance items, tune ups, adjustments;
- Damage caused by negligence or failure to provide proper maintenance and/or storage, as described in the Operator's Guide;

- Damage resulting from removal of parts, improper repairs, service, maintenance, modifications or use of parts or accessories not manufactured or approved by BRP which in its reasonable judgement are either incompatible with the product or adversely affect its operation, performance and durability, or resulting from repairs done by a person that is not an authorized servicing Ski-Doo Distributor/Dealer;
- Damage caused by abuse, abnormal use, neglect, racing or operation of the product on surfaces other than snow, or operation of the product in a manner inconsistent with the recommended operation described in the Operator's Guide;
- Damage resulting from accident, submersion, fire, snow or water ingestion, theft, vandalism or any act of God;
- Operation with fuels, oils or lubricants which are not suitable for use with the product (see the Operator's Guide);
- Damage resulting from rust, corrosion or exposure to the elements;
- Incidental or consequential damages, or damages of any kind including without limitation towing, storage, transportation expenses, telephone, rental, taxi, inconvenience, insurance coverage, loan payments, loss of time, loss of income; or time missed for downtime experience due to service work.
- And damage resulting from studs installed on tracks if the installation does not conform to BRP's instructions.

4) WARRANTY COVERAGE PERIOD

This warranty will be in effect from (1) the date of delivery to the first retail consumer or (2) the date the product is first put into use, whichever occurs first and for a period of:

TWELVE (12) CONSECUTIVE MONTHS, for private or commercial use owners. However, the warranty coverage period on a snowmobile delivered between June 1st and December 1st of a given year will expire November 30th of the following year.

The repair or replacement of parts or the performance of service under this warranty does not extend the life of this warranty beyond its original expiration date.

Note that the duration and any other modalities of the warranty coverage are subject to the applicable national or local legislation in the customer's country.

FOR PRODUCTS SOLD IN AUSTRALIA ONLY

Nothing in these Warranty terms and conditions should be taken to exclude, restrict or modify the application of any condition, warranty, guarantee, right or remedy conferred or implied under the Competition and Consumer Act 2010 (Cth), including the Australian Consumer Law or any other law, where to do so would contravene that law, or cause any part of these terms and conditions to be void. The benefits given to you under this limited warranty are in addition to other rights and remedies that you have under Australian law.

Our goods come with guarantees that cannot be excluded under the Australian Consumer Law. You are entitled to a replacement or refund for a major failure and for compensation for any other reasonably foreseeable loss or damage. You are also entitled to have the goods repaired or replaced if the goods fail to be of acceptable quality and the failure does not amount to a major failure.

5) CONDITIONS TO HAVE WARRANTY COVERAGE

This warranty coverage is available **only** if each of the following conditions has been fulfilled:

- The 2016 Ski-Doo snowmobile must be purchased as new and unused by its first owner from a Ski-Doo Distributor/Dealer authorized to distribute Ski-Doo snowmobiles in the country in which the sale occurred;
- The BRP specified pre-delivery inspection process must be completed and documented;
- The product must have undergone proper registration by an authorized Ski-Doo Distributor/Dealer;
- The 2016 Ski-Doo snowmobile must be purchased in the country or union of countries in which the purchaser resides.
- Routine maintenance outlined in the Operator's Guide must be timely performed in order to maintain warranty coverage. BRP reserves the right to make warranty coverage contingent upon proof of proper maintenance.

BRP will not honour this limited warranty to any private use owner or commercial use owner if one of the preceding conditions has not been met. Such limitations are necessary in order to allow BRP to preserve both the safety of its products, and also that of its consumers and the general public.

6) WHAT TO DO TO OBTAIN WARRANTY COVERAGE UNDER THIS WARRANTY

The customer must cease using the snowmobile upon the appearance of an anomaly. The customer must notify a servicing Ski-Doo Distributor/Dealer within two (2) days of the appearance of a defect, and provide it with reasonable access to the product and reasonable opportunity to repair it. The customer must also present to the authorized Ski-Doo Distributor/Dealer, proof of purchase of the product and must sign the repair/work order prior to starting the repair in order to validate the warranty repair. All parts replaced under this limited warranty become the property of BRP.

Note that the notification period is subject to the applicable national or local legislation in customer's country.

7) WHAT BRP WILL DO

To the extent permitted by law, BRP's obligations under this warranty are limited to, at its sole discretion, repairing parts found defective under normal use, maintenance and service, or replacing such parts with new genuine Ski-Doo parts without charge for parts and labour, at any authorized Ski-Doo Distributor/Dealer during the warranty coverage period under the conditions described herein. BRP's responsibility is limited to making the required repairs or replacements of parts. No claim of breach of warranty shall be cause for cancellation or rescission of the sale of the snowmobile to the owner. You may have other legal rights which may vary from country to country.

In the event that service is required outside of the country of original sale, the owner will bear responsibility for any additional charges due to local practices and conditions, such as, but not limited to, freight, insurance, taxes, license fees, import duties, and any and all other financial charges, including those levied by governments, states, territories and their respective agencies.

BRP reserves the right to improve or modify products from time to time without assuming any obligation to modify products previously manufactured.

8) TRANSFER

If the ownership of a product is transferred during the warranty coverage period, this warranty shall also be transferred and be valid for the remaining coverage period provided BRP or an authorized Ski-Doo Distributor/Dealer receives a proof that the former owner agreed to the transfer of ownership, in addition to the co-ordinates of the new owner.

9) CONSUMER ASSISTANCE

1. In the event of a controversy or a dispute in connection with this limited warranty, BRP suggests that you try to resolve the issue at the Ski-Doo Distributor/Dealer level. We recommend discussing the issue with the authorized Ski-Doo Distributor/Dealer's service manager or owner.
2. If further assistance is required, the Ski-Doo Distributor/Dealer service department should be contacted in order to resolve the matter.
3. If the matter still remains unresolved then contact BRP by writing at the address listed below.

For countries within Middle East and Africa please contact our European office:

BRP EUROPE N.V.

Customer Assistance Center
Skaldenstraat 125
9042 Gent
Belgium
Tel.: +32 9 218 26 00

For all other countries, please contact your local Ski-Doo Distributor/Dealer (visit our website at www.brp.com for contact information), or contact our North American office at:

BOMBARDIER RECREATIONAL PRODUCTS INC.

Customer Assistance Center
75, J.-A Bombardier Street
Sherbrooke QC J1L 1W3
Canada
Tel.: +1 819 566-3366

* For the territory covered by this limited warranty, products are distributed and serviced by Bombardier Recreational Products Inc. or its affiliates.

© 2015 Bombardier Recreational Products Inc. All rights reserved.

® Registered trademark of Bombardier Recreational Products Inc.

BRP LIMITED WARRANTY FOR THE EUROPEAN AND THE COMMONWEALTH OF THE INDEPENDENT STATES (CIS) AREAS AND TURKEY: 2016 SKI-DOO® SNOWMOBILES

1) SCOPE OF THE LIMITED WARRANTY

Bombardier Recreational Products Inc. ("BRP")* warrants its 2016 Ski-Doo snowmobiles sold by distributors or dealers authorized by BRP to distribute Ski-Doo snowmobiles ("Ski-Doo Distributor/Dealer") in member states of the European Economic Area (which is comprised of the member states of the European Union plus Norway, Iceland and Liechtenstein) ("EEA"), in member states of the Commonwealth of the Independent States (including Ukraine and Turkmenistan) ("CIS") and Turkey from defects in material or workmanship for the period and under the conditions described below.

All genuine Ski-Doo parts and accessories, installed by an authorized Ski-Doo Distributor/Dealer (at the time of delivery of the 2016 Ski-Doo snowmobile, carry the same warranty as that of the snowmobile.

This limited warranty will become null and void if: (1) the snowmobile was used for racing or any other competitive activity, at any point, even by a previous owner; or (2) the snowmobile has been altered or modified in such a way so as to adversely affect its operation, performance or durability, or has been altered or modified to change its intended use.

2) LIMITATIONS OF LIABILITY

TO THE EXTENT PERMITTED BY LAW, THIS WARRANTY IS EXPRESSLY GIVEN AND ACCEPTED IN LIEU OF ANY AND ALL OTHER WARRANTIES, EXPRESSED OR IMPLIED, INCLUDING WITHOUT LIMITATION ANY WARRANTY OF MERCHANTABILITY OR FITNESS FOR A PARTICULAR PURPOSE. TO THE EXTENT THAT THEY CANNOT BE DISCLAIMED, THE IMPLIED WARRANTIES ARE LIMITED IN DURATION TO THE LIFE OF THE EXPRESS WARRANTIES. INCIDENTAL AND CONSEQUENTIAL DAMAGES ARE EXCLUDED FROM COVERAGE UNDER THIS WARRANTY. SOME JURISDICTIONS DO NOT ALLOW FOR THE DISCLAIMERS, LIMITATIONS AND EXCLUSIONS IDENTIFIED ABOVE, AS A RESULT, THEY MAY NOT APPLY TO YOU. THIS WARRANTY GIVES YOU SPECIFIC RIGHTS, AND YOU MAY ALSO HAVE OTHER LEGAL RIGHTS WHICH MAY VARY FROM COUNTRY TO COUNTRY.

Neither the Ski-Doo Distributor/Dealer nor any other person has been authorized to make any affirmation, representation or warranty regarding the product, other than those contained in this limited warranty, and if made, shall not be enforceable against BRP.

BRP reserves the right to modify this warranty at any time, being understood that such modification will not alter the warranty conditions applicable to the products sold while this warranty is in effect.

3) EXCLUSIONS – ARE NOT WARRANTED

The following are not warranted under this limited warranty under any circumstances:

- Normal wear and tear;
- Routine maintenance items, tune ups, adjustments;

- Damage caused by negligence or failure to provide proper maintenance and/or storage, as described in the Operator's Guide;
- Damage resulting from removal of parts, improper repairs, service, maintenance, modifications or use of parts or accessories not manufactured or approved by BRP which in its reasonable judgement are either incompatible with the product or adversely affect its operation, performance and durability, or resulting from repairs done by a person that is not an authorized servicing Ski-Doo Distributor/Dealer;
- Damage caused by abuse, abnormal use, neglect, racing or operation of the product on surfaces other than snow, or operation of the product in a manner inconsistent with the recommended operation described in the Operator's Guide;
- Damage resulting from accident, submersion, fire, snow or water ingestion, theft, vandalism or any act of God;
- Operation with fuels, oils or lubricants which are not suitable for use with the product (see the Operator's Guide);
- Damage resulting from rust, corrosion or exposure to the elements;
- Incidental or consequential damages, or damages of any kind including without limitation towing, transportation expenses, storage, telephone, rental, taxi, inconvenience, insurance coverage, loan payments, loss of time, loss of income or time missed for downtime experience due to service work;
- and damage resulting from studs installed on tracks if the installation does not conform to BRP's instructions.

4) WARRANTY COVERAGE PERIOD

This warranty will be in effect from (1) the date of delivery to the first retail consumer or (2) the date the product is first put into use, whichever occurs first and for a period of:

TWENTY-FOUR (24) CONSECUTIVE MONTHS, for private use owners and TWELVE (12) CONSECUTIVE MONTHS for commercial use owners. However, the warranty coverage period on a snowmobile delivered between June 1st and December 1st of a given year will expire November 30th of the applicable year. A snowmobile is used commercially when it is used in connection with generating income or any work or employment during any part of the warranty period. A snowmobile is also used commercially when, at any point during the warranty period, it has commercial tags or is licensed for commercial use.

The repair or replacement of parts or the performance of service under this warranty does not extend the life of this warranty beyond its original expiration date.

Note that the duration and any other modalities of the warranty coverage are subject to the applicable national or local legislation in the customer's country.

5) CONDITIONS TO HAVE WARRANTY COVERAGE

This warranty coverage is available **only** if each of the following conditions has been fulfilled:

- The 2016 Ski-Doo snowmobile must be purchased as new and unused by its first owner from a Ski-Doo Distributor/Dealer authorized to distribute Ski-Doo products in the country in which the sale occurred;

- The BRP specified pre-delivery inspection process must be completed and documented;
- The product must have undergone proper registration by an authorized Ski-Doo Distributor/Dealer;
- The 2016 Ski-Doo snowmobile must be purchased within the EEA by an EEA resident, in the CIS for residents of the countries comprised in such area and in Turkey for residents of Turkey; and
- Routine maintenance outlined in the Operator's Guide must be timely performed in order to maintain warranty coverage. BRP reserves the right to make warranty coverage contingent upon proof of proper maintenance.

BRP will not honour this limited warranty to any private use owner or commercial use owner if one of the preceding conditions has not been met. Such limitations are necessary in order to allow BRP to preserve both the safety of its products, and also that of its consumers and the general public.

6) WHAT TO DO TO OBTAIN WARRANTY COVERAGE UNDER THIS WARRANTY

The customer must cease using the snowmobile upon the appearance of an anomaly. The customer must notify a servicing Ski-Doo Distributor/Dealer within two (2) months of the appearance of a defect, and provide it with reasonable access to the product and reasonable opportunity to repair it. The customer must also present to the authorized Ski-Doo Distributor/Dealer, proof of purchase of the product and must sign the repair/work order prior to starting the repair in order to validate the warranty repair. All parts replaced under this limited warranty become the property of BRP.

Note that the notification period is subject to the applicable national or local legislation in customer's country.

7) WHAT BRP WILL DO

To the extent permitted by law, BRP's obligations under this warranty are limited to, at its sole discretion, repairing parts found defective under normal use, maintenance and service, or replacing such parts with new genuine Ski-Doo parts without charge for parts and labour, at any authorized Ski-Doo Distributor/Dealer during the warranty coverage period under the conditions described herein. BRP's responsibility is limited to making the required repairs or replacements of parts. No claim of breach of warranty shall be cause for cancellation or rescission of the sale of the snowmobile to the owner. You may have other legal rights which may vary from country to country.

In the event that service is required outside of the EEA, CIS or Turkey, the owner will bear responsibility for any additional charges due to local practices and conditions, such as, but not limited to, freight, insurance, taxes, license fees, import duties, and any and all other financial charges, including those levied by governments, states, territories and their respective agencies.

BRP reserves the right to improve or modify products from time to time without assuming any obligation to modify products previously manufactured.

8) TRANSFER

If the ownership of a product is transferred during the warranty coverage period, this warranty shall also be transferred and be valid for the remaining coverage period provided BRP or an authorized Ski-Doo Distributor/Dealer receives a proof that the former owner agreed to the transfer of ownership, in addition to the co-ordinates of the new owner.

9) CONSUMER ASSISTANCE

1. In the event of a controversy or a dispute in connection with this limited warranty, BRP suggests that you try to resolve the issue at the Ski-Doo Distributor/Dealer level. We recommend discussing the issue with the authorized Ski-Doo Distributor/Dealer's service manager or owner.
2. If further assistance is required, the Ski-Doo Distributor/Dealer service department should be contacted in order to resolve the matter.
3. If the matter still remains unresolved then contact BRP at the address listed below:

For countries within EEA, CIS or Turkey, except Scandinavian countries please contact our European office:

BRP EUROPE N.V.

Customer Assistance Center
Skaldenstraat 125
9042 Gent
Belgium
Tel.: +32 9 218 26 00

For Scandinavian countries, please contact our Finland office:

BRP FINLAND OY

Service Department
Isoaavantie 7
FIN-96320 Rovaniemi
Finland
Tel.: +358 163 208 111

You can find your Ski-Doo Distributor/Dealer's coordinates on www.brp.com.

* In the EEA, products are distributed and serviced by BRP European Distribution S.A. and other affiliates or subsidiaries of BRP.

© 2015 Bombardier Recreational Products Inc. All rights reserved.

® Registered trademark of Bombardier Recreational Products Inc.

ADDITIONAL TERMS AND CONDITIONS FOR FRANCE ONLY

The following terms and conditions are applicable to products sold in France only:

The seller shall deliver goods that are complying with the contract and shall be responsible for defects existing upon delivery. The seller shall also be responsible for defects resulting from packaging, assembling instructions or the installation when it is its responsibility per the contract or if accomplished under its responsibility. To be compliant with the contract, the good shall:

1. Be fit for normal use for goods similar thereto and, if applicable:
 - Correspond to the description provided by the seller and have the qualities presented to the buyer through sample or model;
 - Have the qualities that a buyer may legitimately expect considering the public declarations of the seller, the manufacturer of its representative, including in advertising or labeling; or
2. Have the characteristics mutually agreed upon as between the parties or be fit for the specific use intended by the buyer and brought to the attention of the seller and which accepted

The action for failure to comply is prescribed after two years after delivery of the goods. The seller is responsible for the warranty for hidden defects of the good sold if such hidden defects are rendering the good unfit for the intended use, or if they diminish its use in such a way that the buyer would not have acquired the good or would have given a lesser price, had he known. The action for such hidden defects shall be taken by the buyer within 2 years of the discovery of the defect.

***This page is
intentionally blank***

CUSTOMER INFORMATION

PRIVACY INFORMATION

BRP wishes to inform you that your coordinates will be used for safety and warranty related purposes. Furthermore, BRP and its affiliates may use its customer list to distribute marketing and promotional information about BRP and related products.

To exercise your right to consult or correct your data, or to be removed from the addressee-list for direct marketing, please contact BRP.

By E-mail: privacyofficer@brp.com

By mail: BRP
Senior Legal Counsel-Privacy Officer
726 St-Joseph
Valcourt QC
Canada
J0E 2L0

CHANGE OF ADDRESS/OWNERSHIP

If your address has changed or if you are the new owner of the snowmobile, be sure to notify BRP by either:

- Mailing one of the change of address cards on the following pages
- North America only: Calling at 1-888-272-9222
- Notifying an authorized Ski-Doo dealer.

In case of change of ownership, please join a proof that the former owner agreed to the transfer.

Notifying BRP, even after the expiration of the limited warranty, is very important as it enables BRP to reach the snowmobile owner if necessary, like when safety recalls are initiated. It is the owner's responsibility to notify BRP.

STOLEN UNITS: If your personal snowmobile is stolen, you should notify BRP or an authorized Ski-Doo dealer. We will ask you to provide your name, address, phone number, the vehicle identification number and the date it was stolen.

North America

BOMBARDIER RECREATIONAL PRODUCTS INC.

Warranty Department
75 J.-A. Bombardier Street
Sherbrooke QC J1L 1W3
Canada

Scandinavian countries

BRP FINLAND OY

Service Department
Isoaavantie 7
FIN-96320 Rovaniemi

Other countries in the world

BRP EUROPEAN DISTRIBUTION

Warranty Department
Chemin de Messidor 5-7
1006 Lausanne
Switzerland

***This page is
intentionally blank***

CHANGE OF ADDRESS CHANGE OF OWNERSHIP 

VEHICLE IDENTIFICATION NUMBER

Model Number

Vehicle Identification Number (V.I.N.)

OLD ADDRESS
OR PREVIOUS OWNER:

NAME

NO.

STREET

APT

CITY

STATE/PROVINCE

ZIP/POSTAL CODE

COUNTRY

TELEPHONE

NEW ADDRESS
OR NEW OWNER:

NAME

NO.

STREET

APT

CITY

STATE/PROVINCE

ZIP/POSTAL CODE

COUNTRY

TELEPHONE

E-MAIL ADDRESS

V00A2F

CHANGE OF ADDRESS CHANGE OF OWNERSHIP 

VEHICLE IDENTIFICATION NUMBER

Model Number

Vehicle Identification Number (V.I.N.)

OLD ADDRESS
OR PREVIOUS OWNER:

NAME

NO.

STREET

APT

CITY

STATE/PROVINCE

ZIP/POSTAL CODE

COUNTRY

TELEPHONE

NEW ADDRESS
OR NEW OWNER:

NAME

NO.

STREET

APT

CITY

STATE/PROVINCE

ZIP/POSTAL CODE

COUNTRY

TELEPHONE

E-MAIL ADDRESS

V00A2F

***This page is
intentionally blank***

CHANGE OF ADDRESS CHANGE OF OWNERSHIP 

VEHICLE IDENTIFICATION NUMBER

Model Number

Vehicle Identification Number (V.I.N.)

OLD ADDRESS
OR PREVIOUS OWNER:

NAME

NO.

STREET

APT

CITY

STATE/PROVINCE

ZIP/POSTAL CODE

COUNTRY

TELEPHONE

NEW ADDRESS
OR NEW OWNER:

NAME

NO.

STREET

APT

CITY

STATE/PROVINCE

ZIP/POSTAL CODE

COUNTRY

TELEPHONE

E-MAIL ADDRESS

V00A2F

CHANGE OF ADDRESS CHANGE OF OWNERSHIP 

VEHICLE IDENTIFICATION NUMBER

Model Number

Vehicle Identification Number (V.I.N.)

OLD ADDRESS
OR PREVIOUS OWNER:

NAME

NO.

STREET

APT

CITY

STATE/PROVINCE

ZIP/POSTAL CODE

COUNTRY

TELEPHONE

NEW ADDRESS
OR NEW OWNER:

NAME

NO.

STREET

APT

CITY

STATE/PROVINCE

ZIP/POSTAL CODE

COUNTRY

TELEPHONE

E-MAIL ADDRESS

V00A2F

***This page is
intentionally blank***

NOTES



520 001 554

OPERATOR'S GUIDE, TUNDRA SERIES / ENGLISH
GUIDE DU CONDUCTEUR, SÉRIES TUNDRA / ANGLAIS

FAIT AU / MADE IN CANADA

U/M:P.C.