

***ski-doo***®



**2014**

**OPERATOR'S  
GUIDE**

Includes  
Safety, Vehicle  
and Maintenance Information

**REV-XR™**

**⚠ WARNING**

Read this guide thoroughly. It contains important safety information.

Minimum recommended operator's age: 16 years old.  
Keep this Operator's Guide in the vehicle.

5 2 0 0 0 1 3 6 9

## WARNING

Disregarding any of the safety precautions and instructions contained in this Operator's Guide, *SAFETY DVD* video and on-product safety labels could cause injury including the possibility of death!

## WARNING

This vehicle may exceed the performance of other vehicles you may have ridden. Take time to familiarize yourself with your new vehicle.



In USA, products are distributed by BRP US Inc.

In Canada, products are distributed by Bombardier Recreational Products Inc.

The following are trademarks of Bombardier Recreational Products Inc. or its subsidiaries.

4-TEC™	HPG™	RAVE™	ROTAX®	TNT™
ACE®	iTCT™	RENEGADE™ X™	SKI-DOO®	TRA™
D.E.S.S.™	Learning Key™	RER™	rMotion™	
E-TEC®	MX Z™	REV-XR™	SC™	

The KYB Pro series is a registered mark of KYB America LLC.

# FOREWORD

Deutsch	Dieses Handbuch ist möglicherweise in Ihrer Landessprache verfügbar. Bitte wenden Sie sich an Ihren Händler oder besuchen Sie: <a href="http://www.operatorsguide.brp.com">www.operatorsguide.brp.com</a> .
English	This guide may be available in your language. Check with your dealer or go to: <a href="http://www.operatorsguide.brp.com">www.operatorsguide.brp.com</a> .
Français	Ce guide peut être disponible dans votre langue. Vérifier avec votre concessionnaire ou aller à: <a href="http://www.operatorsguide.brp.com">www.operatorsguide.brp.com</a> .
Italiano	Questa guida potrebbe essere disponibile nella propria lingua. Contattare il concessionario o consultare: <a href="http://www.operatorsguide.brp.com">www.operatorsguide.brp.com</a> .
日本語	このガイドは、言語によって翻訳版が用意されています。ディーラーに問い合わせるか、次のアドレスでご確認ください： <a href="http://www.operatorsguide.brp.com">www.operatorsguide.brp.com</a> .
Norsk	Denne boken kan finnes tilgjengelig på ditt eget språk. Kontakt din forhandler eller gå til: <a href="http://www.operatorsguide.brp.com">www.operatorsguide.brp.com</a> .
Русский	Воспользуйтесь руководством на вашем языке. Узнайте о его наличии у дилера или на странице по адресу <a href="http://www.operatorsguide.brp.com">www.operatorsguide.brp.com</a> .
Suomi	Käyttöohjekirja voi olla saatavissa omalla kielelläsi. Tarkista jälleenmyyjältä tai käy osoitteessa: <a href="http://www.operatorsguide.brp.com">www.operatorsguide.brp.com</a>
Svenska	Denna bok kan finnas tillgänglig på ditt språk. Kontakta din återförsäljare eller gå till: <a href="http://www.operatorsguide.brp.com">www.operatorsguide.brp.com</a> .

Congratulations on your purchase of a new Ski-Doo® snowmobile. Whatever model you have chosen, it is backed by the Bombardier Recreational Products Inc. (BRP) warranty and a network of authorized Ski-Doo snowmobile dealers ready to provide the parts, service or accessories you may require.

Your dealer is committed to your satisfaction. He has taken training to perform the initial set-up and inspection of your snowmobile as well as completed the final adjustment required to suit your specific weight and riding environment before you took possession.

At delivery, you were informed of the warranty coverage and signed the *PREDELIVERY CHECK LIST* to ensure your new vehicle was prepared to your entire satisfaction.

## Know Before you Go

To learn how to reduce the risk for you, your passenger or bystanders being injured or killed, read the following sections before you operate the vehicle:

- *SAFETY INFORMATION*
- *VEHICLE INFORMATION*.

Also, read all safety labels on your snowmobile and watch attentively your *SAFETY DVD* video.

We highly recommend that you take a safety riding course. Please check with your dealer or local authorities for availability in your area.

Failure to follow the warnings contained in this Operator's Guide can result in **SERIOUS INJURY** or **DEATH**.

## Safety Messages

The types of safety messages, what they look like and how they are used in this guide are explained as follows:

The safety alert symbol  indicates a potential injury hazard.

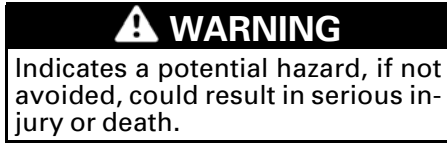

 **CAUTION** Indicates a hazard situation which, if not avoided, could result in minor or moderate injury.

**NOTICE** Indicates an instruction which, if not followed, could severely damage vehicle components or other property.

## About this Operator's Guide

This Operator's Guide has been prepared to acquaint the owner/operator and passenger with this snowmobile and its various controls, safe riding and maintenance instructions.

The following terminology in regards to operator, passenger and vehicle seat configuration is used as follows throughout this guide:

- **Operator:** refers to the person being behind the controls and driving the snowmobile.
- **Passenger:** refers to a person sitting behind the operator.
- **1-UP:** refers to a model designed for an operator only.
- **2-UP:** refers to a model designed to accommodate **one** passenger.

Keep this Operator's Guide in the vehicle as you can refer to it for things such as maintenance, troubleshooting and instructing others.

Note that this guide is available in several languages. In the event of any discrepancy, the English version shall prevail.

If you want to view and/or print an extra copy of your Operator's Guide, simply visit the following website [www.operatorsguide.brp.com](http://www.operatorsguide.brp.com).

The informations contained in this document are correct at the time of publication. BRP, however, maintains a policy of continuous improvement of its products without imposing upon itself any obligation to install them on products previously manufactured. Due to late changes, some differences between the manufactured product and the descriptions and/or specifications in this guide may occur. BRP reserves the right at any time to discontinue or change specifications, designs, features, models or equipment without incurring any obligation upon itself.

This Operator's Guide and the *SAFETY DVD* video should remain with the vehicle when it's sold.

---

# TABLE OF CONTENTS

<b>FOREWORD</b> .....	<b>1</b>
Know Before you Go .....	1
Safety Messages.....	2
About this Operator's Guide .....	2

## ***SAFETY INFORMATION***

<b>GENERAL PRECAUTIONS</b> .....	<b>8</b>
Avoid Carbon Monoxide Poisoning .....	8
Avoid Gasoline Fires and Other Hazards .....	8
Avoid Burns from Hot Parts .....	8
Accessories and Modifications .....	8
<b>SPECIAL SAFETY MESSAGES</b> .....	<b>9</b>
<b>ACTIVE TECHNOLOGIES (iTc) (900 ACE)</b> .....	<b>13</b>
Introduction.....	13
iTc (intelligent Throttle Control) .....	13
<b>RIDING THE VEHICLE</b> .....	<b>14</b>
Pre-Ride Inspection .....	14
How to Ride .....	16
Carrying Passenger .....	17
Terrain/Riding Variations .....	18
Environment.....	23
<b>TRACTION ENHANCING PRODUCTS</b> .....	<b>25</b>
Manoeuvrability .....	25
Acceleration .....	26
Braking .....	26
Important Safety Rules .....	26
Traction Enhancing Products Effect on the Snowmobile Durability.....	26
Installation of Studs on BRP Approved Tracks .....	27
Inspection of a Studded Track .....	28
<b>IMPORTANT ON-PRODUCT LABELS</b> .....	<b>29</b>
Hang Tag(s) .....	29
Vehicle Safety Labels .....	29
Compliance Labels.....	34
Technical Information Label .....	36

## ***VEHICLE INFORMATION***

<b>CONTROLS, INSTRUMENTS AND EQUIPMENT</b> .....	<b>40</b>
1) Handlebar .....	42
2) Throttle Lever.....	42
3) Brake Lever .....	42
4) Parking Brake Lever .....	42
5) Engine Cut-Off Switch .....	43
6) Emergency Engine Stop Switch .....	44

<b>CONTROLS, INSTRUMENTS AND EQUIPMENT (cont'd)</b>	
7) Multifunction Switch	44
8) Shift Lever (1200 4-TEC Models except GT and GSX)	48
9) Tilt Steering (1200 4-TEC Models except GT and GSX)	48
10) Mirrors	49
11) Tool Kit	49
12) Front Bumper	49
13) Analog/Digital Gauge (MX Z TNT and Renegade Adrenaline)	50
14) Multifunction Analog/Digital Gauge (All Models Except MX Z TNT and Renegade Adrenaline)	54
15) Operator's Guide	68
16) Seat Latch (1-UP Only)	68
17) Backrest	69
18) Passenger (1+1) Seat	69
19) Passengers Handholds	70
20) Storage Compartment	71
21) Rear Rack	72
22) Tunnel Bag (GSX LE)	72
23) Tunnel Bag (Grand Touring)	72
24) Saddlebags	73
25) Passenger Heated Grip Switch	73
26) Heated Seats Switches	74
27) Electric Visor Jack Connectors	74
28) 12-Volt Power Outlet	74
29) Hitch	74
30) Spare Drive Belt Stowage	76
31) Hood	76
32) Side Panels	76
33) Drive Belt Guard	77
34) ECO/Standard/Sport Mode Switch (900 ACE Only)	78
<b>FUEL</b>	<b>79</b>
Fuel Requirements	79
Vehicle Fueling Procedure	80
<b>INJECTION OIL (600 HO E-TEC AND 800R E-TEC)</b>	<b>81</b>
Recommended Injection Oil	81
Injection Oil Level Verification	81
<b>BREAK-IN PERIOD</b>	<b>82</b>
Operation During Break-In	82
<b>OPERATING MODES (900 ACE ONLY)</b>	<b>83</b>
ECO Mode (Fuel Economy Mode)	83
Standard Mode	83
Sport Mode	83
Navigating Operating Modes	83
Learning Key Modes	84
<b>BASIC PROCEDURES</b>	<b>86</b>
Engine Starting Procedure	86

**BASIC PROCEDURES (cont'd)**

Emergency Starting..... 86

Vehicle Warm-Up..... 87

Engaging Reverse (RER) (E-TEC) ..... 88

Shifting in Reverse or Forward (900 ACE and 1200 4-TEC) ..... 89

Shutting Off the Engine..... 89

**SPECIAL OPERATION..... 90**

Towing an Accessory ..... 90

Towing Another Snowmobile ..... 90

**TUNE YOUR RIDE ..... 91**

Rear Suspension Adjustments (rMotion) ..... 91

Front Suspension Adjustments ..... 97

Vehicle Behavior Related to Suspension Adjustment ..... 99

**VEHICLE TRANSPORTATION..... 100**

***MAINTENANCE***

**BREAK-IN INSPECTION ..... 102**

**MAINTENANCE SCHEDULE (600 HO E-TEC AND 800R E-TEC)..... 106**

**MAINTENANCE SCHEDULE (900 ACE AND 1200 4-TEC) ..... 108**

**MAINTENANCE PROCEDURES ..... 110**

Air Filter ..... 110

Engine Coolant ..... 110

Engine Oil (900 ACE)..... 111

Engine Oil (1200 4-TEC) ..... 113

Engine Oil Filter (900 ACE) ..... 115

Oil Filter (1200 4-TEC)..... 116

Exhaust System..... 117

Spark Plugs ..... 118

Engine Stopper (600 HO E-TEC and 800R E-TEC) ..... 118

Brake Fluid..... 119

Chaincase Oil..... 120

Drive Chain ..... 121

Drive Belt ..... 122

Drive Pulley (E-TEC)..... 124

Track..... 126

Suspension ..... 129

Skis ..... 130

Fuses..... 130

Lights..... 131

**VEHICLE CARE ..... 134**

Post-Operation Care ..... 134

Vehicle Cleaning and Protection ..... 134

**STORAGE..... 135**

Engine Storage Mode (E-TEC) ..... 135

**PRESEASON PREPARATION..... 137**

***TECHNICAL INFORMATION***

**VEHICLE IDENTIFICATION ..... 140**  
Vehicle Description Decal ..... 140  
Identification Numbers ..... 140  
**EC DECLARATION OF CONFORMITY..... 142**  
**EPA CERTIFIED ENGINES ..... 143**  
Engine Emissions Information ..... 143  
**SPECIFICATIONS ..... 144**

***TROUBLESHOOTING***

**TROUBLESHOOTING GUIDELINES (E-TEC)..... 160**  
**TROUBLESHOOTING GUIDELINES (900 ACE AND 1200 4-TEC) ..... 162**  
**MONITORING SYSTEM ..... 164**  
Pilot Lamps, Messages and Beeper Codes ..... 164  
Fault Codes ..... 167

***WARRANTY***

**BRP LIMITED WARRANTY USA AND CANADA: 2014 SKI-DOO®  
SNOWMOBILES ..... 170**  
**BRP INTERNATIONAL LIMITED WARRANTY: 2014 SKI-DOO®  
SNOWMOBILES ..... 174**  
**BRP LIMITED WARRANTY FOR THE EUROPEAN AND THE  
COMMONWEALTH OF THE INDEPENDENT STATES (CIS) AREAS  
AND TURKEY: 2014 SKI-DOO® SNOWMOBILES ..... 178**

***CUSTOMER INFORMATION***

**PRIVACY INFORMATION ..... 184**  
**CHANGE OF ADDRESS/OWNERSHIP..... 185**



# ***SAFETY INFORMATION***

---

# GENERAL PRECAUTIONS

## Avoid Carbon Monoxide Poisoning

All engine exhaust contains carbon monoxide, a deadly gas. Breathing carbon monoxide can cause headaches, dizziness, drowsiness, nausea, confusion and eventually death.

Carbon monoxide is a colorless, odorless, tasteless gas that may be present even if you do not see or smell any engine exhaust. Deadly levels of carbon monoxide can collect rapidly, and you can quickly be overcome and unable to save yourself. Also, deadly levels of carbon monoxide can linger for hours or days in enclosed or poorly ventilated areas. If you experience any symptoms of carbon monoxide poisoning, leave the area immediately, get fresh air and seek medical treatment.

To prevent serious injury or death from carbon monoxide:

- Never run the vehicle in poorly ventilated or partially enclosed areas such as garages, carports or barns. Even if you try to ventilate engine exhaust with fans or open windows and doors, carbon monoxide can rapidly reach dangerous levels.
- Never run the vehicle outdoors where engine exhaust can be drawn into a building through openings such as windows and doors.

## Avoid Gasoline Fires and Other Hazards

Gasoline is extremely flammable and highly explosive. Fuel vapors can spread and be ignited by a spark or flame many feet away from the engine. To reduce the risk of fire or explosion, follow these instructions:

- Use only an approved gasoline container to store fuel.
- Strictly adhere to instructions in *FUELING PROCEDURE*.
- Never start or operate the engine if the fuel cap is not properly installed.

Gasoline is poisonous and can cause injury or death.

- Never siphon gasoline by mouth.
- If you swallow gasoline, get any in your eye or inhale gasoline vapor, see your doctor immediately.

If gasoline spills on you, wash with soap and water and change your clothes.

## Avoid Burns from Hot Parts

The exhaust system and engine become hot during operation. Avoid contact during and shortly after operation to avoid burns.

## Accessories and Modifications

Do not make unauthorized modifications, or use attachments or accessories that are not approved by BRP. Since these changes have not been tested by BRP, they may increase the risk of crashes or injuries, and they can make the vehicle illegal.

Accessory passenger seats approved by BRP and conforming to SSCC standards may be available for certain models. If such a seat is used, you must follow the guidelines and recommendations in regards to a passenger in this guide.

### **WARNING**

Passenger seat must have a strap or handholds and must meet SSCC standards.

See your authorized Ski-Doo dealer for available accessories for your vehicle.

---

## SPECIAL SAFETY MESSAGES

**SEVERE INJURY OR DEATH** can result if you do not follow these instructions:

- Always make a pre-ride inspection BEFORE you start the engine.
- Throttle mechanism should be checked for free movement and return to idle position before starting engine.
- Always attach tether cord eyelet to clothing before starting the engine.
- Never operate the engine without drive belt guard and brake disk guard securely installed or, with hood or side panels opened or removed. Never run the engine without drive belt installed. Running an unloaded engine such as without drive belt or with track raised, can be dangerous.
- Always engage parking brake before starting the engine.
- Everyone is a beginner the first time he sits behind the controls of a snowmobile regardless of previous experience in driving any other type of vehicle. The safe use of your snowmobile depends on many conditions such as visibility, speed, weather, environment, traffic, vehicle condition and the condition of the operator.
- Basic training is required for the safe operation of any snowmobile. Study your Operator's Guide paying particular attention to cautions and warnings. Join your local snowmobile club: its social activities and trail systems are planned for both fun and safety. Obtain basic instructions from your snowmobile dealer, friend, fellow club member or enroll in your state or provincial safety training program.
- Any new operator must read and understand all safety labels on the snowmobile, the Operator's Guide and watch the *SAFETY DVD* video before operating the snowmobile. Only allow a new operator to operate the snowmobile in a restricted flat area, at least until he is completely familiar with its operation. If snowmobile operator's training course is offered in your area, have him enroll.
- The performance of some snowmobiles may significantly exceed that of other snowmobiles you have operated. Therefore, use by novice or inexperienced operators is not recommended.
- Snowmobiles are used in many areas and in many snow conditions. Not all models perform the same in similar conditions. Always consult your snowmobile dealer when selecting the snowmobile model for your particular needs and uses.
- Injury or death may to the snowmobile operator, passenger or bystander if the snowmobile is used in risky conditions which are beyond the operator's, passenger's or snowmobile's capabilities or intended use.
- BRP recommends the operator has at least 16 years old of age.
- It is very important to inform any operator, regardless of his experience, of the handling characteristics of this snowmobile. The snowmobile configuration, such as ski stance, ski type, suspension type, track length, width and type vary from a model to another. The snowmobile handling is greatly influenced by these characteristics.
- The novice operator should become familiar with the snowmobile through practice on a level area at slow speeds before venturing far afield.

- Know your local laws. Federal, state, provincial and local government agencies have enacted laws and regulations pertaining to the safe use and operation of snowmobiles. It is your responsibility as a snowmobiler to learn and obey these laws and regulations. Respect and observance will in safer snowmobiling for all. Be aware of the liability property damages and insurance laws regarding your equipment.
- Speeding can be fatal. In many cases, you cannot react or respond quickly enough to the unexpected. Always ride at a speed which is suitable to the trail, weather conditions and your own ability. Know your local rules. Speed limit may be in effect and meant to be observed.
- Always keep right hand side of the trail.
- Always keep a safe distance from other snowmobiles and bystanders.
- Remember, promotional material may show risky maneuvers performed by professional riders under ideal and/or controlled conditions. You should never attempt any such risky maneuvers if they are beyond your level of riding ability.
- Never use this vehicle drugs or alcohol. They slow reaction time and impair judgement.
- Your snowmobile is not designed to be operated on public streets, roads or highways.
- Avoid road traveling. If you must do so, and it is permitted, reduce speed. The snowmobile is not designed to operate or turn on paving. When crossing a road, make a full stop, then look carefully in both directions before crossing at a 90° angle. Be wary of parked vehicles.
- Snowmobiling at night can be a delightful experience but because of reduced visibility, be extra cautious. Avoid unfamiliar terrain and be sure your lights are working. Always carry a flashlight and spare light bulbs.
- Never remove any original equipment from your snowmobile. Each vehicle has many built in safety features. Such features include various guards and consoles, plus reflective materials and safety labels.
- Nature is wonderful but don't let it distract your attention from driving. If you want to truly appreciate winter's scenery, stop your snowmobile on the side of the trail so that you don't become a hazard to others.
- Fences represent a very serious threat for both you and your snowmobile. Give a wide berth to telephone poles or posts.
- Hidden wires unseen from a distance can cause serious accidents.
- Always wear an approved safety helmet, eye protection and a face shield. This also applies to your passenger.
- Be aware of inherent risks associated with riding off trails, such as avalanche and other natural or man made hazards or obstacles.
- Tailgating another snowmobile should be avoided. If the snowmobile in front of you slows for any reason, its operator and passenger could be harmed through your neglect. Maintain a safe stopping distance between you and the snowmobile in front of you. Depending on the terrain condition, stopping may require a little more space than you think. Play it safe. Be prepared to use evasive driving.

- Venturing out alone with your snowmobile could also be hazardous. You could run out of fuel, have an accident, or damage your snowmobile. Remember, your snowmobile is capable of traveling further in half an hour than you may be able to walk in a day. Use the “buddy system”. Always ride with a friend or member of your snowmobile club. Even then, tell someone where you are going and the approximate time you plan to return.
- Meadows sometimes have low areas where water accumulate and freezes over in winter. This ice is usually glare ice. Attempting to turn or brake on this surface could cause your vehicle to spin out of control. Never brake or attempt speeding or turning on glare ice. If you do happen to travel over such a condition, reduce speed by carefully releasing the throttle.
- Never “jump” with your snowmobile.
- When riding in a group, do not “gun” the throttle. Snow and ice can be thrown back into the path of a following snowmobile. In addition, when “gunning” the throttle, the vehicle digs into and leaves an irregular snow surface for others.
- Riding in a group is fun and enjoyable but don't show off or overtake others in the group. A less experienced operator might try to do the same as you and fail. When riding with others, limit your abilities to the experience of others.
- In case of an emergency, press down on the engine emergency stop switch, then apply brake.
- Always engage parking brake when vehicle is not in use.
- Never run the engine in a non-ventilated area and/or if vehicle is left unattended.
- **Electric start models only:** Never charge or boost a battery while installed on snowmobile.
- E-TEC engines: Never attempt any fuel system or electrical system maintenance or repair. Any maintenance or repair of these systems must be performed by an authorized Ski-Doo dealer.
- Ensure the path behind is clear of obstacles or bystanders before proceeding in reverse.
- Always remove the tether cord cap from engine cut-off switch when vehicle is not in operation in order to prevent accidental engine starting, to avoid unauthorized use by children or others or theft.
- NEVER stand behind or near a rotating track. Debris could be projected causing severe injuries. To remove packed snow or ice, stop engine, tilt and hold vehicle on its side and use screwdriver from tool kit.
- Do not stud the track unless it has been approved for studs. At speed, a studded track that has not been approved for studs could tear and separate from vehicle. See an authorized Ski-Doo dealer for current specific studding availability and applications.
- You may stud the track on this vehicle model. However, you MUST only use the BRP approved type stud for use on Ski-Doo snowmobiles. DO NOT EVER use conventional studs because the track thickness is thinner than our standard tracks. The stud could tear off of track and separate from vehicle.
- Always wear an approved helmet and follow the same dressing guidelines as those recommended for the operator and described in this guide.
- Make sure that you are able to achieve a stable stance, both feet resting positively on the footboards of footrests with good grip, and that you are able to hold on firmly to the handholds.

- Do not forget, with 2-UP models, the operator is responsible for the safety of the passenger. Always remember that the snowmobile handling, stability and braking distance may be affected when riding with a passenger.
- Before riding the vehicle, ask your passenger to inform you to slowdown or stop immediately if he feels uncomfortable or insecure during the ride. Keep a watchful eye on your passenger while riding.

---

# ACTIVE TECHNOLOGIES (iTC) (900 ACE)

## Introduction

**NOTE:** Some functions or features described in this section may not apply to every model, or may be available as an option.

The throttle is electronic and provides a command signal to an electronic module whose function is to assure proper operation of its system within set parameters.

This system provides improved snowmobile response to operator inputs and increased maneuverability and control.

It is extremely important for operators to read all information contained in this operator's guide so as to become familiar with this snowmobile, its systems, controls, capabilities and limitations.

## iTC (intelligent Throttle Control)

The system uses an electronic throttle control (ETC) that provides command signals to the ECM (Engine Control Module). With this system, there is no need for a traditional throttle cable.

The iTC allows the following operating modes:

- ECO mode
- Standard mode
- Sport mode.

## ECO Mode

When ECO mode is selected (fuel economy mode), vehicle torque and speed are limited whereby an optimal cruising speed is maintained in order to reduce fuel consumption.

Refer to *OPERATING MODES* subsection for detailed instructions.

## Standard Mode

In standard mode, acceleration is reduced when accelerating from a complete stop and when operating in the low vehicle speed range under certain conditions.

## Sport Mode

In sport mode, maximum engine power is available throughout the engine operational range.

Refer to *OPERATING MODES* subsection for detailed instructions.

## Learning Key Modes

The Ski-Doo™ learning key limits the torque and speed of the snowmobile therefore enabling first time users and less experienced operators to learn how to operate the snowmobile while gaining the necessary confidence and control.

## Limitations

The ability of a novice to operate the snowmobile can be exceeded even when a learning key is used.

Refer to *OPERATING MODES* subsection for details.

---

# RIDING THE VEHICLE

Each operator has a responsibility to ensure the safety of other recreationists or bystanders.

You are responsible for proper operation of your vehicle as well as training those whom you allow to ride or drive. There may be noticeable handling and performance differences from one snowmobile to the other.

A snowmobile is relatively simple to operate but like any other vehicle or mechanical equipment, it can be hazardous if you or a passenger are reckless, thoughtless or inattentive. We encourage you to have an Annual Safety Inspection of your snowmobile. Please contact an authorized Ski-Doo dealer for further details. Finally, we urge you to visit an authorized Ski-Doo dealer periodically for regular and safety maintenance, as well as snowmobile accessories you may require.

Before venturing on the trails, operate the snowmobile in a restricted flat area until you are completely familiar with its operation and feel comfortable that you can safely tackle a more demanding task. Have an enjoyable and safe ride.

## Pre-Ride Inspection

### **WARNING**

The pre-operation check is very important prior to operating the vehicle. Always check the proper operation of critical controls, safety features and mechanical components before starting.

## Before Starting the Engine

1. Remove snow and ice from body including lights, seat, footrests, controls and instruments.
2. Verify that air silencer prefilter is free of snow.
3. Verify that skis and steering operate freely. Check corresponding action of skis versus handlebar.
4. Check fuel and injection oil (if applicable) for levels and leaks. Replenish if necessary and see an authorized Ski-Doo dealer in case of any leaks.
5. Check coolant and brake fluid levels. In case of a low level, contact an authorized Ski-Doo dealer.
6. All storage compartments must be properly latched and they must not contain any heavy or breakable objects. Hood and side panels must be also properly latched.
7. Activate the throttle control lever several times to check that it operates easily and smoothly. It must return to idle position when released.
8. Check track condition. Remove snow or ice if necessary.
9. Check rear suspension slider shoes condition.
10. Activate the brake lever and make sure the brake fully applies before the brake control lever touches the handlebar grip. It must return to the rest position when released.
11. Apply parking brake and check if it operates properly. Leave parking brake applied.



## After Engine is Started

For proper engine starting procedure, refer to the appropriate *ENGINE STARTING PROCEDURE* section.

1. Check headlights high beam and low beam, taillight, stop light and pilot lamps operation.

**NOTE:** You may need to detach tether cord from your clothes to check lights. In such a case, attach cord as soon as you get back at the controls of the snowmobile.

2. Check the engine cut-off switch (by pulling tether cord cap) and emergency engine stop switch operation.

3. Release parking brake.

4. Refer to the *VEHICLE WARM UP* section and follow instructions.

## Pre-Ride Check List

ITEM	OPERATION
Body including seat, footrests, lights, air filter, controls and instruments	Check condition and remove snow or ice.
Skis and steering	Check for free movement and proper action.
Fuel and injection oil (if applicable)	Check for proper level and no leaks.
Coolant	Check for proper level and no leaks.
Storage compartment	Check for proper latching and no heavy or breakable objects.
Throttle lever	Check for proper action.
Track	Check condition and remove snow or ice.
Brake lever	Check for proper operation.
Parking brake	Check for proper operation.
Emergency engine stop switch and engine cut-off switch (tether cord cap)	Check for proper action. Tether cord must be attached to operator clothing eyelet.
Lights	Check for proper operation.

## How to Ride

### Riding Gear

Proper snowmobile clothing should be worn. It should be comfortable and not too tight. Always check the weather forecast before going on a ride. Dress for the coldest weather expected. Thermal underwear next to the skin also provides a good insulation.

Wear an approved helmet at all times for safety and comfort. A stocking type cap, balaclava and face mask should always be carried or worn. Goggles or a face shield that attaches to the helmet are indispensable. If your helmet does not have a built-in colored lens, carry colored lens goggles.

Hands should be protected by a pair of snowmobile gloves or mitts which have sufficient insulation and allow use of thumbs and fingers for operation of controls.

Rubber bottom boots with either a nylon or a leather top, with removable felt liners are best suited for snowmobiling.

You should keep yourself as dry as possible when snowmobiling. When you come indoors, take your snowmobile suit and boots off and make certain they dry properly.

Do not wear a long scarf or loose apparel that could get caught in moving parts.

### What to Bring

First aid kit	Provided tool kit
Mobile phone	Knife
Spare spark plugs	Flashlight
Friction tape	Trail map
Spare drive belt	Snack

### Rider Position (Forward Operation)

Your riding position and balance are the two basic principles of making your snowmobile go where you want it to. When turning on the side of a hill, you and your passenger must be ready to shift body weight to help it turn in the desired direction. Operator and passenger must never attempt this maneuvering by placing feet outside of the vehicle. Experience will teach you how much lean to put into turns at different speeds and how much you will have to lean into a slope to maintain proper balance.

Generally, the riding position for best balance and control is sitting. However, the posting, kneeling or standing positions are also used under certain conditions.

### WARNING

**Do not attempt any maneuvers if they are beyond your abilities.**

### Sitting

Feet on the running boards, body mid-way back on seat is an ideal position when operating the snowmobile over familiar, smooth terrain. Knees and hips should remain flexible to absorb shocks.



mme2008-003-001

## Posting

A semi-sitting position with the body off the seat and the feet under the body in a sort of squatting posture, thus allowing the legs to absorb the shocks when traveling over uneven terrain. Avoid abrupt stops.



## Rider Position (Reverse Operation)

We recommend sitting on your snowmobile when operating in reverse.

Avoid standing up. Your weight could shift forward against throttle lever while operating in reverse, causing an unexpected acceleration.

## Kneeling

This position is achieved by placing one foot firmly on the running board and the opposite knee on the seat. Avoid abrupt stops.



## Standing

Place both feet on the running boards. Knees should be flexed to absorb the shock from surface bumps. This is an effective position to see better and to shift weight as conditions dictate. Avoid abrupt stop.

## **⚠ WARNING**

Unexpected acceleration when snowmobile operates in reverse can cause a loss of control.

## Carrying Passenger

Certain snowmobiles are designed for an operator only, and others can allow one passenger only. Make sure to identify and respect the warnings according to your specific model.

Even when a passenger is allowed, this person must be physically fit for snowmobiling.

## **⚠ WARNING**

Any passenger must be able to firmly lay his feet on the footrests and keep his hands on the handholds or seat strap at all times when seated. Respecting those physical criteria is important to ensure that the passenger is stable and to reduce the risks of ejection.

The operator has a responsibility to ensure the safety of his passenger and should inform the passenger about snowmobiling basics.

### **⚠ WARNING**

- Passenger must only sit on designated passenger seat. Never allow anyone to sit between the handlebar and the operator.
- Passenger and operator must always wear an approved helmet and warm clothing appropriate for snowmobiling. Make sure that no skin is exposed.
- Once underway, if the passenger feels uncomfortable or insecure for any reason, he must right away inform the operator to slowdown or stop.

Riding with a passenger on board is different than riding alone. The operator has the benefit of knowing what will be the next maneuver and is able to prepare himself accordingly. The operator also benefits from the support of his grip on the handlebar. In contrast, the passenger has to rely on the operator's careful and safe operation of the vehicle. In addition, "body english" is limited with a passenger, and the operator can sometimes see more of the trail ahead than the passenger. Therefore, smooth starting and stopping are required with a passenger, and the operator must slow down. The operator must also warn the passenger about side hills, bumps, branches, etc. An unforeseen bump can leave you passenger-less. Remind your passenger to lean into the turn with you, without causing the vehicle to topple. Be extremely careful, go more slowly and check the passenger frequently.

### **⚠ WARNING**

When riding with a passenger:

- Braking ability and steering control are reduced. Decrease speed and allow extra space to maneuver.
- Adjust suspension according to weight.

For complete information on how to adjust the suspension, please refer to the *TUNE YOUR RIDE* subsection.

### **Riding with a child**

On snowmobiles allowing two passengers (with optional seat), if you have an adult and a child for passenger, BRP recommends that the child sits in the center location. This allows an adult sitting in the rear seat to keep a visual contact with the child and hold him if necessary. In addition, the child is best protected against the wind and cold temperature if seated in the center location.

Use extra caution and go even more slowly with a young passenger. Check frequently to make certain the child has a firm grip and is properly positioned with his feet on the running boards.

## **Terrain/Riding Variations**

### **Groomed Trail**

On a maintained trail, sitting is the most preferred riding position. Do not race and, above all, keep to the right hand side of the trail. Be prepared for the unexpected. Observe all trail signs. Do not zigzag from one side of the trail to the other.

## Ungroomed Trail

Unless there has been a fresh snowfall you can expect “washboard” and snowdrift conditions. Taken at excessive speeds, such conditions can be physically harmful. Slow down. Hold on the handlebar and assume a posting position. Feet should be under the body assuming a crouched position to absorb any jarring effect. On longer stretches of “washboard” trails, the kneeling position of one knee on the seat can be adopted. This provides a certain amount of comfort, while at the same time keeps the body loose and capable of vehicle control. Beware of hidden rocks or tree stumps partially hidden by a recent snowfall.

## Deep Snow

In deep “powder” snow, your vehicle could begin to “bog” down. If this occurs, turn in as wide an arc as possible and look for a firmer base. If you do get “bogged”, and it happens to everyone, do not spin your track as this makes the vehicle sink deeper. Instead, turn the engine off, get off and move the back of the vehicle onto new snow. Then tramp a clear path ahead of the vehicle. A few feet will generally suffice. Restart the engine. Assume the standing position and rock the vehicle gently as you steadily and slowly apply the throttle. Depending on whether the front or rear end of the vehicle is sinking, your feet should be placed on the opposing end of the running boards. Never place foreign material beneath the track for support. Do not allow anyone to stand in front of, or to the rear of, the snowmobile with the engine running. Stay away from the track. Personal injury will result if contact is made with the revolving track.

## Frozen Water

Traveling frozen lakes and rivers can be fatal. Avoid waterways. If you are in an unfamiliar area, ask the local authorities or residents about the ice condi-

tion, inlets, outlets, springs, fast moving currents or other hazards. Never attempt to operate your snowmobile on ice that may be too weak to support you and the vehicle. Operating a snowmobile on ice or icy surfaces can be very dangerous if you do not observe certain precautions. The very nature of ice is foreign to good control of a snowmobile or any vehicle. Traction for starting, turning or stopping is much less than that on snow. Thus, these distances can be multiplied manifold. Steering is minimal, and uncontrolled spins are an ever present danger. When operating on ice, drive slowly with caution. Allow yourself plenty of room for stopping and turning. This is especially true at night.

## Hard Packed Snow

Don't underestimate hard packed snow. It can be difficult to negotiate as both skis and track do not have as much traction. Best advice is to slow down and avoid rapid acceleration, turning or braking.

## Uphill

There are two types of hills you can encounter — the open hill on which there are few trees, cliffs or other obstacles, and a hill that can only be climbed directly. On an open hill, the approach is to climb it by side hilling or slaloming. Approach at an angle. Adopt a kneeling position. Keep your weight on the uphill side at all times. Maintain a steady, safe speed. Continue as far as you can in this direction, then switch to an opposite hill angle and riding position.

A direct climb could present problems. Choose the standing position, accelerate before you start the climb and then reduce throttle pressure to prevent track slippage.

In either case, vehicle speed should be as fast as the incline demands. Always slow down as you reach the crest. If you cannot proceed further, don't spin your track. Turn the engine off, free the skis by pulling them out and downhill, place the rear of the snowmobile uphill restart the engine and ease it out with slow even throttle pressure. Position yourself to avoid tipping over, then descend.

## Downhill

Downhill driving requires that you have full control of your vehicle at all times. On steeper hills, keep your center of gravity low and both hands on the handlebar. Maintain slight throttle pressure and allow the machine to run downhill with the engine operating. If a higher than safe speed is reached, slow down by braking but apply the brake with frequent light pressure. Never jam the brake and lock the track.

## Side Hill

When crossing a side hill or traversing up or downhill, certain procedures must be followed. All riders should lean towards the slope as required for stability. The preferred operating positions are the kneeling position, with

the knee of the down hill leg on the seat and the foot of the uphill leg on the running board, or the posting position. Be prepared to shift your weight quickly as needed. Side hills and steep slopes are not recommended for a beginner or a novice snowmobiler.

## Avalanche Hazard

When riding on mountainous terrain, you should be aware of the risk of avalanches. Avalanches vary in size and shapes and generally occur in steep terrain and on unstable snow.

New snow, animals, people, wind and snowmobiles can all trigger an avalanche. Avoid high marking or traversing steep terrain when avalanche conditions are possible. When in unstable snow conditions, travel should be restricted to lower angle slopes. Wind formed cornices should be avoided. Staying off unstable conditions is the key to safe mountain riding. Probably most important is to be aware of the conditions and dangers on a daily basis when in the mountains. Check local avalanche forecasts and threats each day before heading out to ride and heed forecasters advice.

You should always carry a snow shovel, probe and avalanche beacon while riding on mountains. We recommend that all mountain riders take a local avalanche safety training course to become more familiar with snow conditions and learn how to properly use their equipment.

Here are some web sites that can help you finding important information:

- US: [www.avalanche.org](http://www.avalanche.org)
- Europe: [www.avalanches.org](http://www.avalanches.org)
- Canada: [www.avalanche.ca](http://www.avalanche.ca)

## Slush

Slush should be avoided at all times. Always check for slush before starting across any lake or river. If dark spots appear in your tracks, get off the ice immediately. Ice and water can be thrown rearward into the path of a following snowmobile. Getting a vehicle out of a slush area is strenuous and in some cases, impossible.

## Fog or Whiteout Conditions

On land or water, fog or visibility-limiting snow can form. If you have to proceed into the fog or heavy snow, do so slowly with your lights on and watch intently for hazards. If you are not sure of your way, do not proceed. Keep a safe distance behind other snowmobilers to improve visibility and reaction time.

## Unfamiliar Territory

Whenever you enter an area that is new to you, drive with extreme caution. Go slow enough to recognize potential hazards such as fences or fence posts, brooks crossing your path, rocks, sudden dips, guy wires and countless other obstacles which could result in a termination of your snowmobile ride. Even when following existing tracks, be cautious. Travel at a speed so you can see what is around the next bend or over the top of the hill.

## Bright Sunshine

Bright sunny days can considerably reduce your vision. The glare from sun and snow may blind you to the extent that you cannot easily distinguish ravines, ditches or other obstacles. Goggles with colored lenses should always be worn under these conditions.

## Unseen Obstruction

There may be obstructions hidden beneath the snow. Driving off established trails and in the woods requires reduced speed and increased vigilance. Driving too fast in an area can make even minor obstacles very hazardous. Even hitting a small rock or stump could throw your snowmobile out of control and cause injury to its riders. Stay on established trails to reduce your exposure to hazards. Be safe, slow down and enjoy the scenery.

## Hidden Wires

Always be on the lookout for hidden wires, especially in areas that may have been farmed at one time or another. Too many accidents have been caused by running into wires in the fields, guy wires next to poles and roads, and into chains and wires used as road closures. Slow speeds are a must.

## Obstacles and Jumping

Unplanned jumps of snowdrifts, snowplow ridges, culverts or indistinguishable objects can be dangerous. You can avoid them by wearing the proper color lenses or face shields and by operating at a lower speed.

Jumping a snowmobile is an unsafe and dangerous practice. However, if the trail does suddenly drop away from you, crouch (stand) towards the rear of the vehicle and keep the skis up and straight ahead. Apply partial throttle and brace yourself for the impact. Knees must be flexed to act as shock absorbers.

## Turning

Depending on terrain conditions, there are two preferred ways to turn or corner a snowmobile. For most snow surfaces, “body english” is the key to turning. Leaning towards the inside of the turn and positioning body weight on the inside foot will create a “banking” condition beneath the track. By adopting this position and positioning yourself as far forward as possible, weight will be transferred to the inside ski.

On occasion, you will find that the only way to turn the vehicle about in deep snow is to pull the snowmobile around. Do not over-exert yourself. Get assistance. Remember to always lift using your legs as opposed to your back.



mmo2008-003-005

## Road Crossing

In some cases, you will be approaching the road from a ditch or snowbank. Choose a place where you know you can climb without difficulty. Use the standing position and proceed with only as much speed needed to crest the bank. Stop completely at the top of the bank and wait for all traffic to clear. Judge the drop to the roadway. Cross the road at a 90° angle. If you encounter another snowbank on the opposite side, position your feet near the rear of the vehicle. Remember, your snowmobile is not designed to operate on bare pavement and steering on this type of surface is more difficult.

## Railroad Crossing

Never ride on railroad tracks. It is illegal. Railroad tracks and railroad rights-of-way are private property. A snowmobile is no match for a train. Before crossing a railroad track, stop, look and listen.

## Night Rides

The amount of natural and artificial light at a given time can effect your ability to see or to be seen. Nighttime snowmobiling is delightful. It can be a unique experience if you acknowledge your reduced visibility. Before you start, make certain your lights are clean and work properly. Drive at speeds that will allow you to stop in time when you see an unknown or dangerous object ahead. Stay on established trails and never operate in unfamiliar territory. Avoid rivers and lakes. Guy wires, barbed wire fences, cabled road entrances and other objects such as tree limbs are difficult to see at night. Never drive alone. Always carry a flashlight. Keep away from residential areas and respect the right of others to sleep.

## Riding in a Group

Before starting out, designate a “trail boss” to lead the party and another person to follow-up at the end of the party. Ensure that all members of the party are aware of the proposed route and destination. Make certain that you are carrying all necessary tools and equipment and that you have sufficient fuel to complete the trip. Never overtake the trail boss or, for that matter, any other snowmobile. Use down-the-line hand signals to indicate hazards or intent of direction change. Assist others whenever necessary.

It is always IMPORTANT to keep a safe distance between each snowmobile. Always maintain a safe interval and allow sufficient stopping distance. Don't be a tailgater. Know the position of the machine ahead.



## Signals

If you intend to stop, raise either hand straight above your head. A left turn is indicated by extending your left hand straight out in the proper direction. For right turns, extend the left arm and raise the hand to a vertical position so it forms a right angle at the elbow. Every snowmobiler should relay any signal to the ones behind.

## Trail Stops

Whenever possible, pull off the trail when you stop. This will reduce the hazard to other snowmobilers using the trail.

## Trails and Signs

Trail signs are used to control, direct or regulate the use of snowmobiles on trails. Become familiar with all signs used in the area where you are snowmobiling.

## Environment

Wildlife compliments your snowmobiling day. Snowmobile tracks provide firm ground over which animals can travel from area to area. Do not violate this privilege by chasing or harassing wildlife. Fatigue and exhaustion can lead to animal's death. Avoid areas posted for the protection or feeding of wildlife.

If you happen to be fortunate enough to see an animal, stop your snowmobile and observe quietly.

The guidelines that we support are not designed to limit your snowmobiling fun, but to preserve the beautiful freedom that you can experience only on a snowmobile! These guidelines will keep snowmobilers healthy, happy and able to introduce others to what they know and enjoy about their favorite winter pastime. So, the next time you hit the trails on a cool, crisp and clear winter day, we ask you to remember that you are paving the way for the fu-

ture of our sport. Help us lead it down the right path! From all of us at BRP, thank you for doing your share.

There is nothing more exhilarating than snowmobiling. Venturing onto snowmobile trails that cross wild areas is an exciting and healthy winter sport. However, as the number of people using these recreational parks increases, so does the potential for damage to the environment. Abuse of land, facilities and resources inevitably leads to restrictions and closures of both private and public land.

In essence, the greatest threat to our sport, is all around us. Which leaves us with one logical choice. When we snowmobile, we must always ride responsibly.

The vast majority respect the law and the environment. Each of us must set an example for those who are new to the sport, young and old alike.

It is in every one's best interest to tread lightly into our recreational areas. Because, in the long run, to protect the sport we must preserve the environment.

Recognizing the importance of this issue and the need for snowmobilers to do their share in preserving areas that make it possible to enjoy our sport, BRP has developed the "Light Treading Is Smart Sledding" campaign for snowmobilers.

Light Treading refers to more than the thread of our tracks. It's a statement of concern, respect and willingness to take the lead and take action. It applies to the environment in general, its proper care and maintenance, its natural inhabitants and all enthusiasts and the public at large who enjoy the great outdoors. With this theme, we invite all snowmobilers to remember that respecting the environment is not only critical to the future of our industry but to future generations.

Light Treading in no way suggests you should curb your appetite for snowmobiling fun! It simply means tread with respect!

The fundamental objective of Light Treading is one of respect for where and how you ride a snowmobile. You're a light treader when you follow the principles below.

**Become informed.** Obtain maps, regulations and other information from the Forest Service or from other public land agencies. Learn the rules and follow them and that goes for speed limits, too!

**Avoid** running over young trees, shrubs, and grasses and don't cut wood. On flatlands or areas where trail riding is popular, it's important to ride only where authorized. Remember, there is a link between protecting your environment and your own safety.

**Respect wildlife** and be particularly sensitive of animals that are rearing young or suffering from food shortage. Stress can sap scarce energy reserves. Refrain from riding in areas where only animals are intended to tread!

**Obey** gate closures and regulatory signs and remember, light treaders don't litter!

**Stay out** of wilderness areas. They're closed to all vehicles. Know where the boundaries are.

**Obtain permission** to travel across private land. Respect the rights of landowners and other people's privacy. Remember, snowmobile technology has lowered the noise factor considerably, but you still shouldn't rev your engines where quiet "is the order of the day".

Snowmobilers know all too well the efforts that have been made throughout the sport's history to enjoy access to areas where people can snowmobile safely and responsibly. This effort continues today, as strong as ever.

Respecting the areas where we ride... wherever they may be... is the only way to ensure their future enjoyment. That's one major reason why we know you'll agree that Light Treading is smart sledding! And there are more.

Enjoying the opportunity to see winter and all its natural majestic wonders, is an experience cherished by snowmobilers. Light Treading will preserve this opportunity and will make it possible for us to expose others to the beauty of winter and the unique thrill of our sport! Light Treading will help our sport to grow!

Finally, Light Treading is the sign of a smart snowmobiler. You don't have to leave big tracks or careen through a virgin forest to show you can ride. So whether you're driving a high performance Ski-Doo, a sporty MX Z™ snowmobile or any other make or model, show you know what you're doing. Show you know how to send snow flying and make tracks with a light touch!

# TRACTION ENHANCING PRODUCTS

**NOTE:** This section is applicable to snowmobiles equipped with a factory installed track that has been approved by BRP for special studs installation.

Using traction enhancing products such as, more aggressive ski carbide runners and/or studs on your snowmobile will change its behavior, particularly in terms of manoeuvrability, acceleration, and braking.

Using traction enhancing products gives a better grip on packed snow and ice, but has no noticeable effect on soft snow. For this reason, driving a snowmobile equipped with traction enhancing products requires a certain adaptation period. If your snowmobile is equipped with traction enhancing products, be sure to take plenty of time to get used to the way it handles when turning, accelerating, and braking.

Also, always check local regulations concerning the use of traction enhancing products on snowmobiles. Always drive your snowmobile in a responsible manner, respecting the environment and other people's property.

## Manoeuvrability

Using traction enhancing products such as, more aggressive ski carbide runners and/or studs makes the snowmobile grip the ground better at both the front and at the rear. The use of carbide runners is therefore required to give the skis a better grip, so that the front and rear of the snowmobile are in balance. While off-the-shelf carbide ski runners are adequate, they don't necessarily give you optimal control, since that depends on your personal preferences, your riding style, and how your suspension is adjusted.

## ⚠ WARNING

If the front and rear of the snowmobile are out of balance due to an incorrect combination of traction enhancing products, the snowmobile may tend to oversteer or understeer, which could lead to a loss of control.

### Oversteering

In certain conditions, using more aggressive ski carbide runners without studs on the rear track could make the snowmobile prone to oversteering, see illustration.

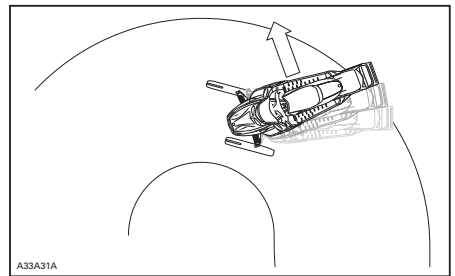

OVERSTEERING

### Understeering

In certain conditions, the use of studs on the track could make the snowmobile prone to understeering if the skis are not equipped with more aggressive ski carbide runners, see illustration.

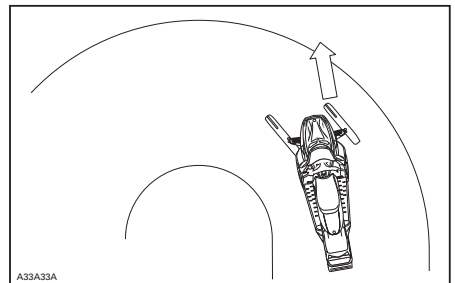

UNDERSTEERING

## Controlled Driving

A balanced combination of carbide ski runners and studs on the track ensures adequate control and better handling, see illustration.

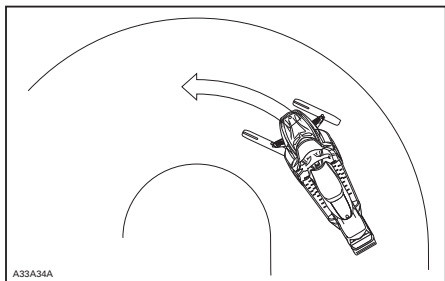

CONTROLLED DRIVING

## Acceleration

Using studs on the track will allow your sled to accelerate better on packed snow and ice but will have no noticeable effect on soft snow. This can cause sudden variations in traction under certain conditions.

### ⚠ WARNING

To prevent surprises that could lead to a loss of control of the snowmobile:

- Always go easy on the throttle.
- NEVER try to spin the track to make the rear of the snowmobile skid.

This could cause debris or ice to be thrown violently backwards, possibly injuring others nearby or on snowmobiles behind you.

## Braking

As in the case of acceleration, using studs on the track will give you better braking capacity on packed snow or ice but will have no noticeable effect on soft snow. Braking may thus vary suddenly under certain conditions. Be sure to use restraint in braking to

keep from blocking the track in order to avoid surprises that could lead to a loss of control.

## Important Safety Rules

### ⚠ WARNING

Centrifugal force could cause debris, damaged or loose studs, pieces of torn track, or an entire severed track to be violently thrown backwards out of the tunnel with tremendous force. To prevent serious injury to individuals near the snowmobile:

- NEVER stand behind or near a moving track.
- Always use a wide-base snowmobile stand with a rear deflector panel if it is necessary to rotate track.
- When the track is raised off the ground, only run it at the lowest possible speed.

## Traction Enhancing Products Effect on the Snowmobile Durability

The use of traction enhancing products can increase the load and the stress on certain snowmobile components, as well as the vibration level. This can cause premature wear on parts such as drive belts, brake linings, bearings, chain, chaincase sprocket, and on approved studded tracks, shorten track life. Always proceed with a visual inspection of your track before each use. For more information, refer to the *TRACK* section in *MAINTENANCE*.

Studs on the track can also cause serious damage to your snowmobile if it is not equipped with the tunnel protectors designed for your particular model. Damage to the electrical wiring or perforation of the heat exchangers are potential hazards, that could cause the engine to overheat and be severely damaged.

**⚠ WARNING**

If tunnel protectors are excessively worn or not installed, the gas tank could be punctured, causing a fire.

**NOTICE** Ask your dealer for the appropriate tunnel protectors model and kit number required for your snowmobile.

**NOTE:** Consult the BRP limited warranty to find out what warranty limitations are related to the use of studs.

**Installation of Studs on BRP Approved Tracks**

**⚠ WARNING**

Never stud a track that has not been approved for studs. Approved tracks can be identified by a stud symbol (see illustration below) molded into the track surface. Installing studs on an unapproved track could increase the risk of the track tearing or severing.

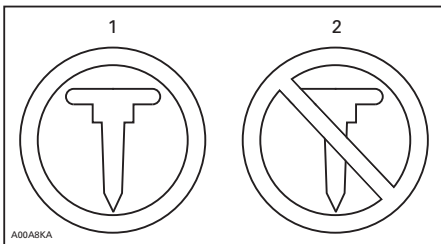

**TRACK SYMBOLS**

- 1. Approved
- 2. NOT Approved

To ensure safe and proper installation, BRP recommends to have the studs installed by your dealer.

- Use only the BRP approved special studs.
- Never use studs that exceed the height of your snowmobile's track profile by more than 9.5 mm (3/8 in).

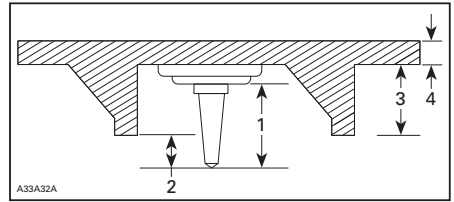

**INSTALLATION OF STUDS**

- 1. Stud size
- 2. Penetration range 6.4 mm to 9.5 mm (1/4 in to 3/8 in)
- 3. Track lug height
- 4. Track belt thickness

**⚠ WARNING**

- See an authorized Ski-Doo dealer for current specific studding availability and applications.
- Always consult the traction product manufacturer's installation instructions and recommendations before having your dealer install studs and runners.

**⚠ WARNING**

- You **MUST** only use the BRP approved stud type on these Ski-Doo snowmobiles. **DO NOT EVER** use conventional stud because, the track thickness is thinner than our standard tracks and the stud could tear off of track and separate from vehicle.
- Studs should only be installed in the locations indicated by molded bulges in the track surface. Some track models have two types of molded bulges; triangles and circles. See the warning molded into the track surface to know which one to use.
- Never stud a track with a profile of 35 mm (1.378 in) or more.
- The number of studs installed must always perfectly match the pattern of molded bulges in the track. Installing an incorrect number of studs can increase the risk of track tearing or severing.
- It is very important to follow the torque specifications for the stud bolts. Improper installation of studs can increase the risk of track tearing or severing.

- Bent studs (studded tracks)
- Missing studs
- Studs that are torn off the track
- Missing track guide(s)
- Loose studs.

On approved studded tracks, replace broken or damaged studs immediately. If your track shows signs of deterioration, it must be replaced immediately. When in doubt, ask your dealer. Always proceed with a visual inspection of your track before each use.

**⚠ WARNING**

**Riding with a damaged track or studs could lead to loss of control.**

**Inspection of a Studded Track**

PROCEED WITH A VISUAL INSPECTION OF YOUR TRACK BEFORE EACH RIDE.

Look for any defects, such as:

- Perforations in the track
- Tears in the track (particularly around traction holes on studded tracks)
- Lugs that are broken or torn off, exposing portions of rods
- Delamination of the rubber
- Broken rods
- Broken studs (studded tracks)

# IMPORTANT ON-PRODUCT LABELS

## Hang Tag(s)

**VEHICLE ENGINE DESCRIPTION:**  
XXXXXX

**EPA CERTIFIED**

NER (NORMALIZED EMISSION RATE) =  X  
ON A 0 TO 10 SCALE, 0 BEING THE CLEANEST

**\*NOT TO BE REMOVED PRIOR TO SALE**



704901107

vmo2006-005-009\_en

TYPICAL

Dear consumer,

Your new E-TEC engine technology has an automatic computer-controlled break-in period that ensures you get the most performance, efficiency and reliability for the life. During the break-in, it will consume more oil and fuel than normal. Also, you may feel the engine misfire. This is normal, the computer is protecting the engine components against premature wear and ensure optimal break-in. After this period, which lasts for about the first two tanks of fuel (22 gal./80 l), you'll be able to experience the unmatched performance, fuel and oil economy that only the E-TEC technology delivers.

Cher client,

Votre nouveau moteur à technologie E-TEC a une période de rodage contrôlée automatiquement qui assurera une performance, une efficacité et une fiabilité optimales à long terme. Durant la période de rodage, le moteur consommera plus d'huile et d'essence qu'à la normale. Ainsi, il se peut que le moteur ait des ratés. Cela est normal puisque le module de commande protège le moteur contre l'usure prématurée et assure un rodage optimal. Après cette période, qui dure environ 2 pleins d'essence (80 l), vous serez en mesure de profiter pleinement des performances, ainsi que de la faible consommation d'huile et d'essence, que seule la technologie E-TEC peut offrir.

516004621

516004621

800R E-TEC MODELS

## Vehicle Safety Labels

Read and understand all the safety labels on your vehicle.

These labels are affixed to the vehicle for the safety of the operator, passenger or bystanders.

The following labels are on your vehicle and they should be considered permanent parts of the vehicle. If missing or damaged, the decals can be replaced free of charge. See an authorized Ski-Doo dealer.

NOTE: In the event of any discrepancy between this guide and the vehicle, the safety labels on the vehicle have precedence over the labels in this guide.

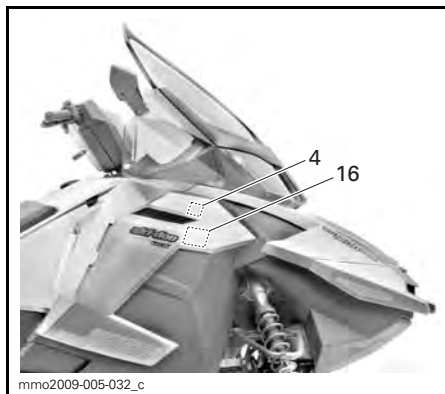
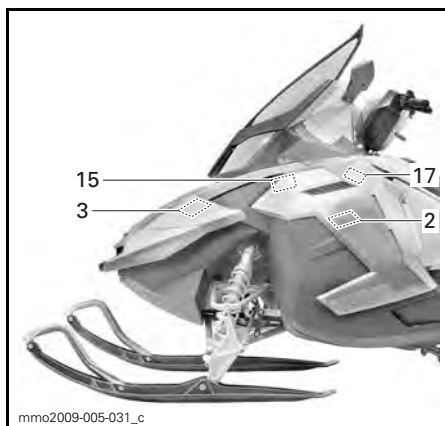

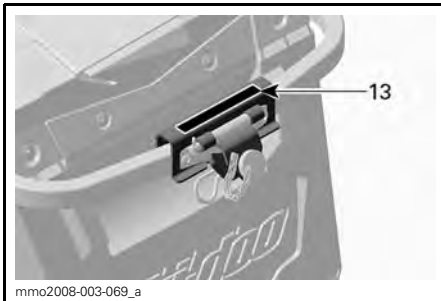
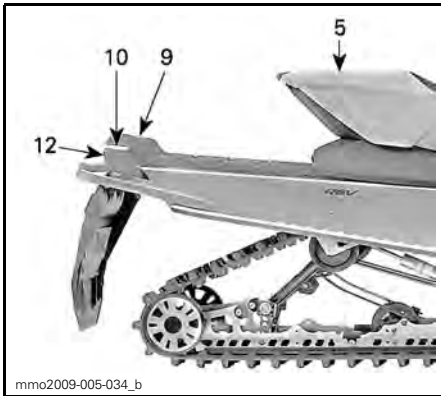
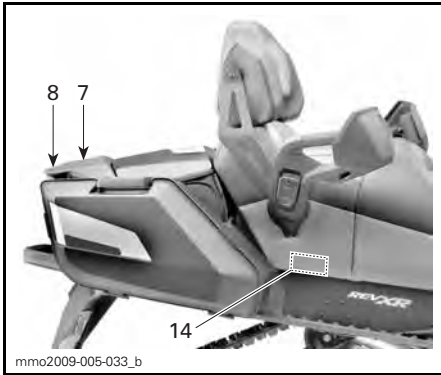

**⚠ WARNING**

- Read and understand all safety labels, operator's guide and watch your safety DVD before operation. Operator's guide is located either in the passenger seat or under the driver's seat. To access guide under driver's seat, pull front of seat cushion then pull tab to unlock seat (if applicable, passenger's seat needs to be removed first).
- Get familiar with your vehicle. Inexperienced riders may overlook risks and be surprised by vehicle's specific behavior and terrain conditions. Ride slowly.
- Excessive speed and reckless driving can kill!  
ALWAYS adjust your speed according to snow conditions and circumstances.
- Steering control and braking ability may be reduced on hard-pack snow, ice or roads. Reduce speed & allow more space to stop or turn.
- Respect laws on minimum operator age. Manufacturer recommends a minimum operating age of 16 years old.
- Never open side panels or hood while engine is running or if vehicle is in motion. Ensure to remove DESS key before opening those.

**BEFORE STARTING :**

1. Attach tether cord to your clothing.
2. Check proper operation of the throttle and brake levers each time before starting. They must return to their initial position when released.
3. Apply parking brake.
4. Turn handlebars all the way in both directions to check for interference and insure free operation.

**AFTER STARTING :**

1. Pull-out tether cord to check if engine shuts off.
2. Re-start and push in the emergency engine stop switch to check if engine shuts off.
3. Disengage parking brake before riding to avoid brake fading.

516005227

516005227

LABEL 1

**⚠ WARNING**

**This guard must ALWAYS be in place when engine is running**

Beware of rotating parts – they could cause injuries or catch your clothing.

516005509

516005509

LABEL 2





516005280

LABEL 3



mno2008-003-007

LABEL 4



mno2008-008-002\_a

LABEL 5 - 1-UP MODELS

## ⚠ WARNING

This vehicle is designed for one (1) operator and as many passengers as there are seats with straps or handgrips installed on the vehicle conforming to SSCC standards.

Ce véhicule a été conçu pour un (1) conducteur et autant de passagers qu'il y a de sièges avec courroies ou poignées installés sur le véhicule et rencontrant la norme SSCC.

**When riding with a passenger :**

- Braking ability and steering control are reduced. Decrease speed and allow extra space to maneuver.
- Adjust suspensions according to weight.

**REMEMBER : YOU ARE RESPONSIBLE FOR THE SAFETY OF YOUR PASSENGER!**

ALL DRIVERS AND PASSENGERS MUST READ THE FOLLOWING:

Avoid surprises!

BE ON THE LOOK-OUT for the unexpected.

Operate defensively.

- Scan constantly for people, objects, conditions and upcoming vehicles.
- Avoid thin ice / open water.
- Use extra caution whenever off-trail.

ALWAYS wear a DOT approved HELMET and clothing appropriate for snowmobiling.

NEVER ride under the influence of alcohol or drugs even as a passenger.





516005228

516005228

LABEL 6

**IMPORTANT ON-PRODUCT LABELS**

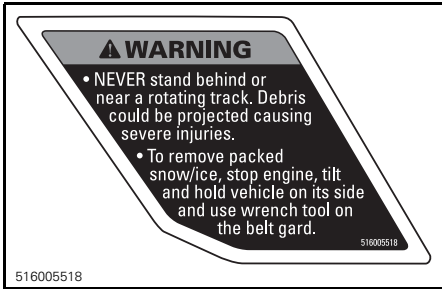

**LABEL 7 - GRAND TOURING**



**LABEL 10**



**LABEL 8 - GRAND TOURING**



**LABEL 11 - EUROPEAN MODELS**



**LABEL 9**



**LABEL 12 - APPLICABLE MODELS**

**⚠ WARNING**

Towing a load may affect handling of your snowmobile. • Reduce speed. • Use rigid tow bar.

- Ensure that the tow bar is securely fastened. Do not exceed the following loads:

**TOWING WEIGHT 250Kg / 562 lbs Max.    VERTICAL LOAD 10Kg / 23 lbs Max.**

516004568A

516004568A

LABEL 13 - APPLICABLE MODELS

**⚠ WARNING**

Before riding the snowmobile make sure to properly install and lock the seat(s) into place.

516005523

516005523

LABEL 14 - 2-UP MODELS

**⚠ CAUTION**

ENGINE OIL AND CERTAIN COMPONENTS IN THE ENGINE COMPARTMENT MAY BE HOT. DIRECT CONTACT MAY RESULT IN SKIN BURN.

**CHECKING ENGINE OIL LEVEL**

- Make sure engine is at operating temperature.
- Vehicle must be level to perform verification.
- Let engine running at idle for at least 30 seconds.
- Stop engine and wait at least 30 seconds.
- Check oil level using the dipstick.
- The engine of this snowmobile has been developed and validated using the BRP XPS™ Synthetic 4-stroke oil (253 600 112). BRP strongly recommends the use of its XPS™ Synthetic 4-stroke oil at all times. Damages caused by oil which is not suitable for the engine will not be covered by the BRP limited warranty.

516005521

516005521

LABEL 17 - 1200 4-TEC MODELS ONLY

**⚠ WARNING**

Always electrically disconnect both fuel injectors prior to testing for ignition spark. Otherwise, fuel vapors may ignite in presence of a spark creating a fire hazard.

5583A

516005583A

LABEL 15 - E-TEC ONLY

**⚠ WARNING**

- This shock absorber is pressurized.
- An explosion may occur if heated or punctured.
- Do not disassemble.

mmo2010-003-101\_en

LABEL 18 - ON GAS SHOCK ABSORBERS

**⚠ WARNING**

**Capacitor May Spark If Shorted.**

- Spark can ignite fuel vapors.
- Keep objects away from poles.
- When removing from vehicle, always discharge properly.

**CAPACITOR**



516 005 515

516005515

LABEL 16 - E-TEC ONLY

**⚠ AVERTISSEMENT**

Ce garde doit **TOUJOURS** être en place lorsque le moteur fonctionne.

**⚠ WARNING**

This guard must **ALWAYS** be in place when engine is running.

516005525

516005525

LABEL 19 - ON BRAKE DISC GUARD

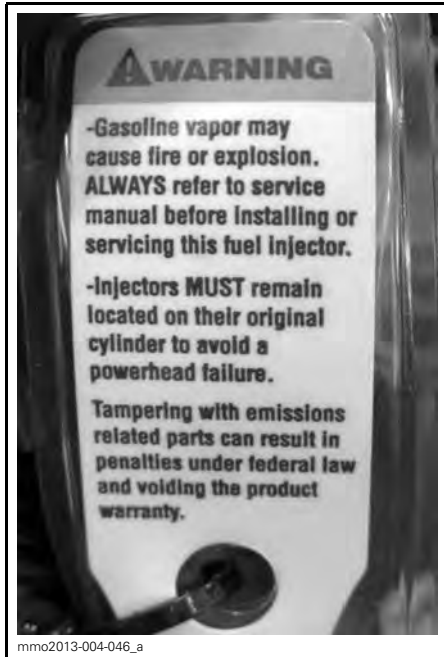

LABEL 20- E-TEC MODELS

## Compliance Labels

### EPA Compliance Label

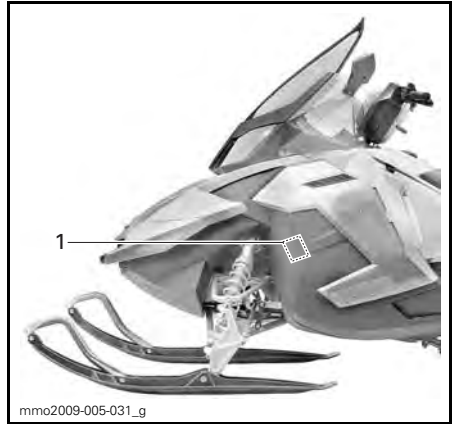

mmo2009-005-031\_g

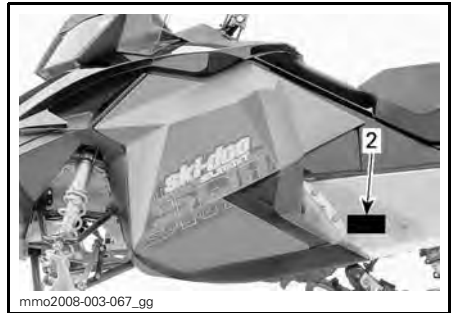

mmo2008-003-067\_gg

EMISSION CONTROL INFORMATION		EPA REGULATIONS FOR SNOWMOBILE SI ENGINES	EPA 121
ENGINE FAMILY	XXXX XXXXXXXX		
PERMEATION FAMILY	XXXXXXXXXXXXX	FAMILLE DE PERMÉATION	
FEL	XX g/kW-hr HC XXX g/kW-hr CO	LIMITE DES ÉMISSIONS DE LA FAMILLE	
ENGINE DISPLACEMENT	XXX.X cm <sup>3</sup>	CYLINDRÉE	
EXHAUST EMISSION CONTROL SYSTEM	XXX	SYSTÈME DE CONTRÔLE DES ÉMISSIONS	

**RENSEIGNEMENTS SUR LE DISPOSITIF ANTIPOLLUTION**  
 CE VÉHICULE EST CERTIFIÉ POUR FONCTIONNER À L'ESSENCE SANS PLOMB ET IL RÉPOND AUX NORMES [XXXX] DE L'EPA DES É.-U. POUR LES MOTONEIGES À MOTEUR SI.

SEE OPERATOR'S GUIDE FOR MAINTENANCE SPECIFICATIONS  
 VOIR GUIDE DU CONDUCTEUR POUR LES SPÉCIFICATIONS D'ENTRETIENS

**BOMBARDIER RECREATIONAL PRODUCTS INC.**  
 516 005 052

516005052

COMPLIANCE LABEL 1 - IN ENGINE COMPARTMENT



516005990

**LABEL 2 - 900 ACE AND 1200 4-TEC MODELS**

**SSCC Label**

Safety standards for snowmobiles have been adopted by the Snowmobile Safety and Certification Committee (SSCC) of which BRP is a proud participating member. Assurance that your snowmobile meets these standards is easily checked by locating the Certification Label on a right vertical portion of the vehicle.

The following label shows that an independent testing laboratory has verified compliance with the SSCC safety standards.



**ON TUNNEL**

## Technical Information Label

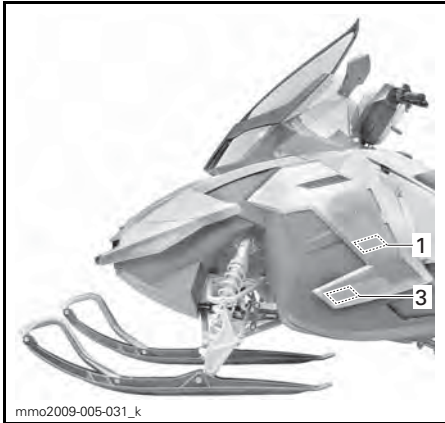

TYPICAL

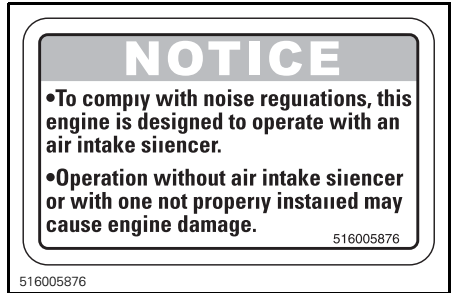

LABEL 1

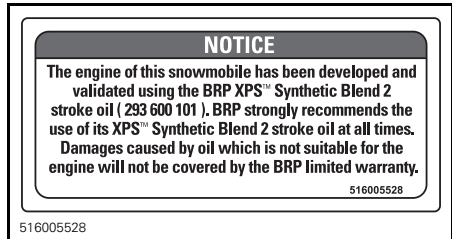

LABEL 2 - E-TEC MODELS

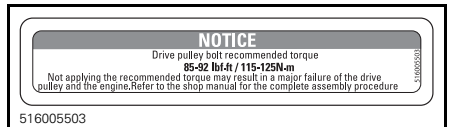

LABEL 3

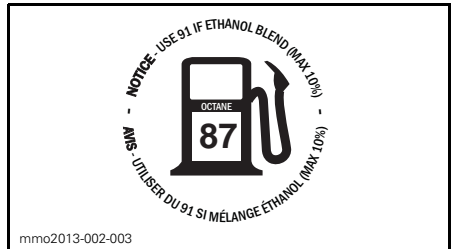

LOCATED ON FUEL CAP - ON 1200 4-TEC AND 900 ACE ENGINES (IN COUNTRIES USING PUMP POSTED AKI (RON+MON)/2 OCTANE RATINGS)

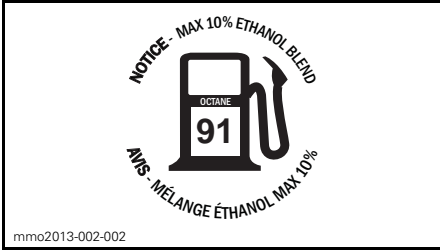

mmo2013-002-002

LOCATED ON FUEL CAP - ON E-TEC ENGINES (IN COUNTRIES USING PUMP POSTED AKI (RON+MON)/2 OCTANE RATINGS)

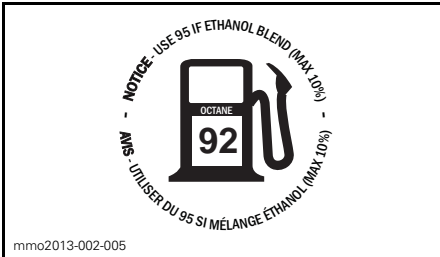

mmo2013-002-005

LOCATED ON FUEL CAP - ON 1200 4-TEC AND 900 ACE ENGINES (IN COUNTRIES USING RON OCTANE RATINGS)

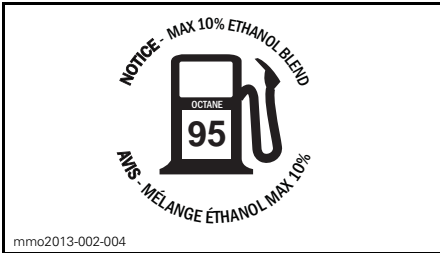

mmo2013-002-004

LOCATED ON FUEL CAP - ON E-TEC ENGINES (IN COUNTRIES USING RON OCTANE RATINGS)



516005507

LABEL 4- NEAR DRIVE PULLEY - 800R E-TEC

***This page is  
intentionally blank***



# ***VEHICLE INFORMATION***

# CONTROLS, INSTRUMENTS AND EQUIPMENT

NOTE: Controls, instruments or equipment may vary according to the model.

NOTE: Some vehicle safety labels are not shown on illustrations. For information on vehicle safety labels, refer to *VEHICLE SAFETY LABELS* subsection.

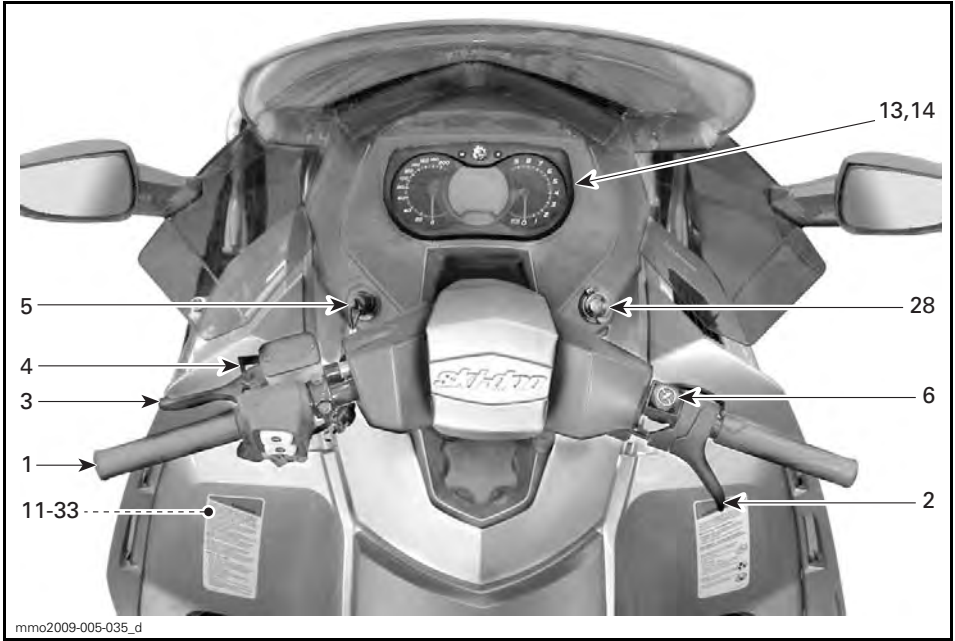

TYPICAL

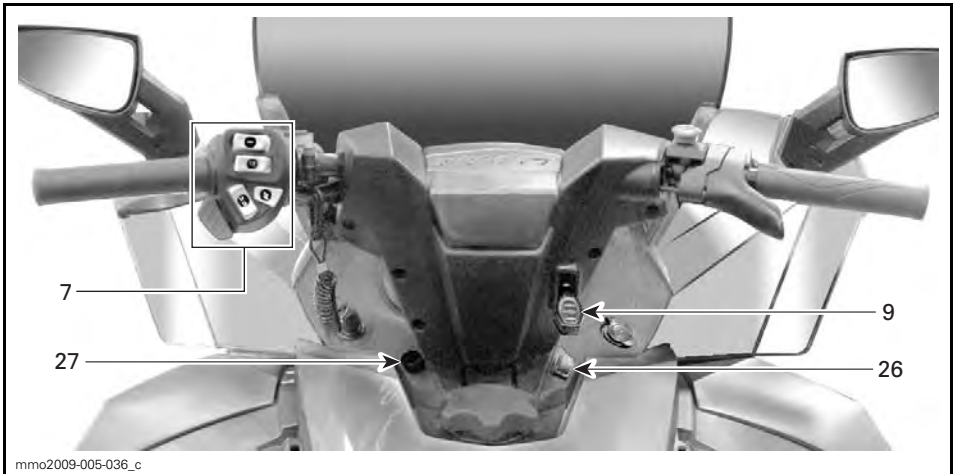

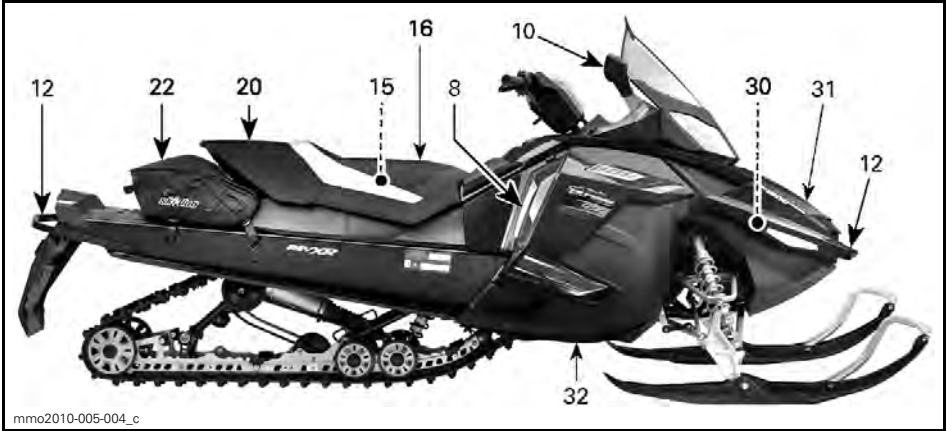

mmo2010-005-004\_c

TYPICAL - 1-UP

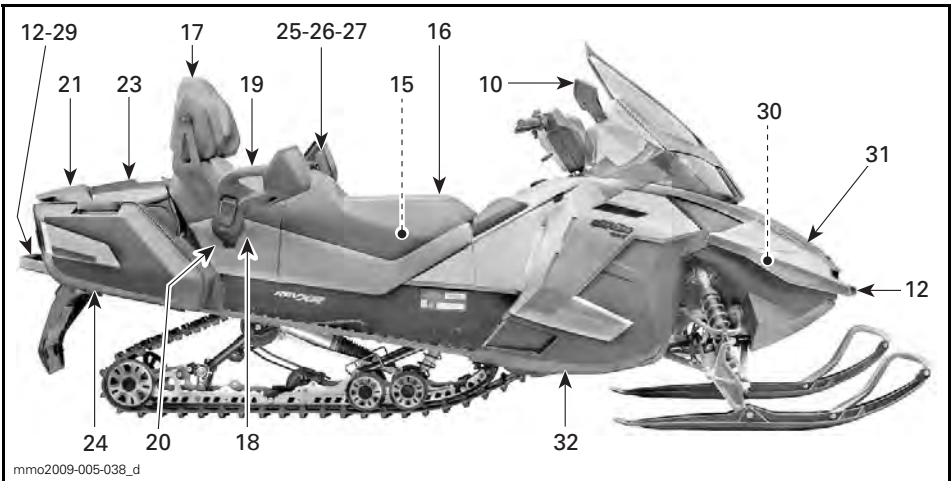

mmo2009-005-038\_d

TYPICAL - 2-UP



mmo2014-004-009\_e

TYPICAL - LH SIDE OF FUEL TANK - 900 ACE ONLY

## 1) Handlebar

The handlebar controls the steering of the snowmobile. As the handlebar is rotated to right or left, the skis are turned right or left to steer the snowmobile.

### **⚠️ WARNING**

Fast reverse while turning, could result in loss of stability and control.

## 2) Throttle Lever

Throttle lever is located on the RH side of handlebar.

Designed to be thumb activated. When squeezed, it increases the engine speed. When released, engine speed returns automatically to idle.



**TYPICAL**

1. Throttle lever
2. To accelerate
3. To decelerate

### **⚠️ WARNING**

Test the throttle lever operation each time before starting the engine. The lever must return to the rest position once released. Otherwise, do not start engine.

## 3) Brake Lever

Brake lever is located on the LH side of handlebar.

When squeezed, the brake is applied. When released, it automatically returns to the rest position. Braking effect is proportional to the pressure applied on the lever and to the type of terrain and its snow coverage.



**TYPICAL**

1. Brake lever
2. To apply brake

## 4) Parking Brake Lever

Parking brake lever is located on the LH side of handlebar.

Parking brake should be used whenever snowmobile is parked.

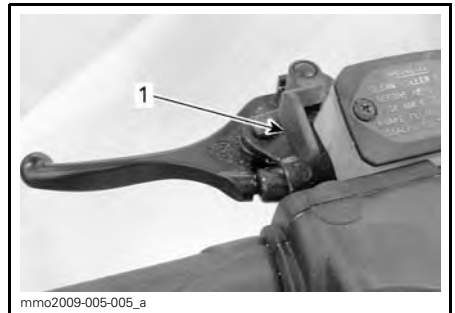

**TYPICAL**

1. Parking brake lever

**⚠ WARNING**

Make sure parking brake is fully disengaged before operating the snowmobile. When you ride the vehicle, brake pads that are caused to drag by a continuous pressure on the lever may cause damage to the brake system and cause loss of braking capacity and/or fire.

**To Engage Parking Brake**

Apply and hold brake, then lock brake lever using the parking brake lever as shown.

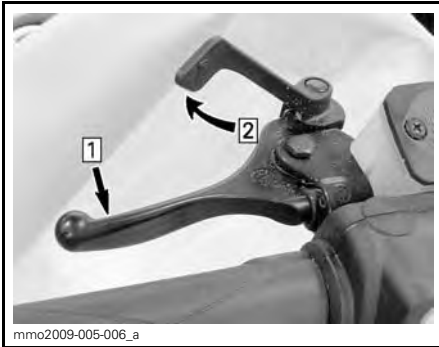
**TYPICAL — ENGAGE MECHANISM**

Step 1: Apply and hold brake  
Step 2: Lock brake lever using parking brake lever

**To Release Parking Brake**

Squeeze brake lever. Locking lever will automatically return to its original position.

Always release parking brake before riding.

**5) Engine Cut-Off Switch**

The engine cut-off switch (tether cord) is located to on the LH side of console.

The tether cord cap must be securely snapped on the engine cut-off switch to allow vehicle operation.

Pulling the tether cord cap from the switch shuts the engine off.

**⚠ WARNING**

Always attach the tether cord eye-let to clothing before starting the engine.

**D.E.S.S. (Digitally Encoded Security System)**

D.E.S.S. stands for Digitally Encoded Security System.

The tether cord cap contains an electronic chip which features a unique permanently memorized digital code (D.E.S.S. key).

Your authorized Ski-Doo dealer has programmed the D.E.S.S. of your snowmobile to recognize the D.E.S.S. key to allow vehicle operation.

**NOTE:** Two short beeps after engine is started means the D.E.S.S. key is recognized.

If another tether cord is used without programming the D.E.S.S., the engine will start but cannot be driven.

Make sure the tether cord cap is free of dirt or snow.

**TETHER CORD CAP**

1. Free of dirt or snow

## D.E.S.S. Flexibility

The D.E.S.S. of your snowmobile can be programmed by your authorized Ski-Doo dealer to accept up to 8 different keys.

We recommend the purchase of additional tether cords from your authorized Ski-Doo dealer. If you have more than one D.E.S.S.-equipped Ski-Doo snowmobile, each can be programmed by your authorized Ski-Doo dealer to accept the other vehicles D.E.S.S. keys.

## D.E.S.S. Key Types (900 ACE)

Two types of keys can be used:

- Normal key
- Learning key.

To ease key type recognition, the tether cord comes in different colors.

KEY TYPE	COLOR
Normal	Black
Learning	Green

The Ski-Doo learning key, limits the speed of the snowmobile and the engine torque, therefore enabling first time users and less experienced operators to learn how to operate the snowmobile while gaining the necessary confidence and control.

**NOTE:** The initial learning key programming can limit the speed to 40 km/h (25 MPH) or 70 km/h (43 MPH). Refer to your authorized Ski-Doo dealer to modify this setting.

Refer to *OPERATING MODES* subsection for details.

## 6) Emergency Engine Stop Switch

The emergency engine stop switch is located on the RH side of handlebar.

To stop the engine in an emergency, select OFF position (down) and simultaneously apply the brake.



OFF POSITION

To allow engine starting, the switch must be in the ON position (UP).



ON POSITION

All operators of the snowmobile should familiarize themselves with the function of the emergency engine stop switch by using it several times on first outing and whenever stopping the engine thereafter. This engine stopping procedure will become a reflex and will prepare operators for emergency situations requiring its use.

## **⚠ WARNING**

If the switch has been used in an emergency caused by a suspected malfunction, the source of the malfunction should be determined and corrected before restarting engine. See an authorized Ski-Doo dealer for servicing.

## 7) Multifunction Switch

Multifunction switch is located on the LH side of handlebar.

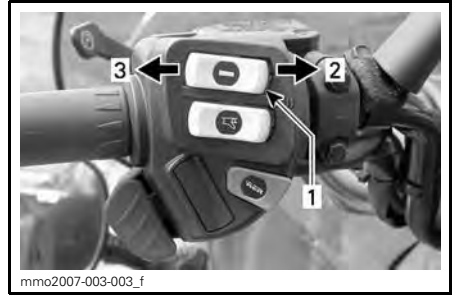

**TYPICAL**

1. Start/Electronic Reverse button
2. Headlights dimmer switch
3. Heated grips
4. Heated throttle lever
5. Mode/set button

**TYPICAL**

1. Heated grip switch
2. Increase heat
3. Decrease heat

**Start/Electronic Reverse Button**

Press to start engine. Refer to *ENGINE STARTING PROCEDURE* in the *BASIC PROCEDURES* section.

**Electronic Reverse Models**

Once engine is started, press to engage the electronic reverse. Refer to *OPERATING IN REVERSE* in *BASIC PROCEDURES* for details.

**Headlights Dimmer Switch**

Press to select HI or LOW beam. Lights are automatically ON when the engine is running.

**Heated Grips Switch**

Select the switch position according to the desired heating intensity to keep your hands at a comfortable temperature.

**Models with Analog/Digital Gauge**

**NOTE:** Under 2000 RPM, heated grips will be limited at 50%.

Depress switch as required to select heating intensity to keep your hands at a comfortable temperature.

**NOTE:** When released, display will return to fuel tank level.

The heating intensity is displayed via the digital display.

**NOTE:** There are nine intensity settings.



**HEATING INTENSITY DISPLAY**

1. Less heat
2. More heat

Heated grips will be in OFF position when there are no bars displayed on the gauge.

**Models with Multifunction Analog/Digital Gauge**

**E-TEC**

**NOTE:** Under 2000 RPM, heated grips will be limited at 50%.

**900 ACE**

**NOTE:** Heated grips are enabled above 2000 engine RPM.

**All Models**

Depress switch as required to select heating intensity to keep your hands at a comfortable temperature.

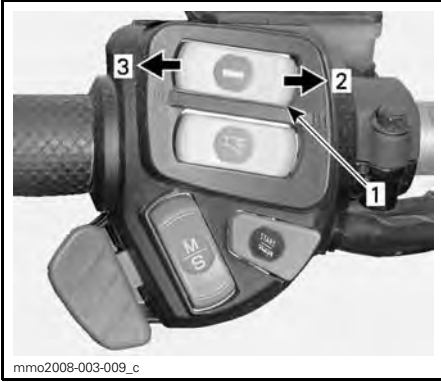

**VARIABLE INTENSITY**

1. Heated grips switch
2. Increase heat
3. Decrease heat

The heating intensity is displayed via the multifunction display.

**NOTE:** There are nine intensity settings. When released, display will return to engine coolant temperature (if equipped).

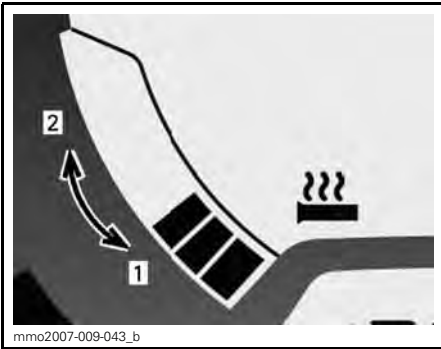

**HEATING INTENSITY DISPLAY**

1. Less heat
2. More heat

Heated grips will be in OFF position when there are no bars displayed on the gauge.

**Heated Throttle Lever Switch**

**Models with Analog/Digital Gauge**

**NOTE:** Under 2000 RPM, heated throttle lever will be limited at 50%.

Depress switch as required to select heating intensity to keep your thumb at a comfortable temperature.

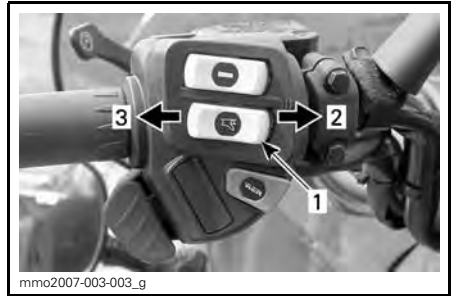

**TYPICAL**

1. Heated throttle lever switch
2. Increase heat
3. Decrease heat

**NOTE:** The heating intensity is displayed via the digital display with the activation of the throttle lever switch. There are nine intensity settings. When released, display will return to fuel tank level.



**HEATING INTENSITY DISPLAY**

1. Less heat
2. More heat

Heated throttle lever will be in OFF position when there are no bars displayed on the gauge.



## Models with Multifunction Analog/Digital Gauge

### E-TEC

**NOTE:** Under 2000 RPM, heated throttle lever will be limited at 50%.

### 900 ACE

**NOTE:** Heated throttle lever is enabled above 2000 engine RPM.

### All Models

Depress switch as required to select heating intensity to keep your thumb at a comfortable temperature.

**NOTICE** This switch is also used to adjust the ACS. Refer to *TUNE YOUR RIDE*.



#### VARIABLE INTENSITY

1. Heated throttle lever switch
2. Increase heat
3. Decrease heat

**NOTE:** The heating intensity is displayed via the multifunction display with the activation of the throttle lever switch. There are nine intensity settings. When released, display will return to fuel tank level.

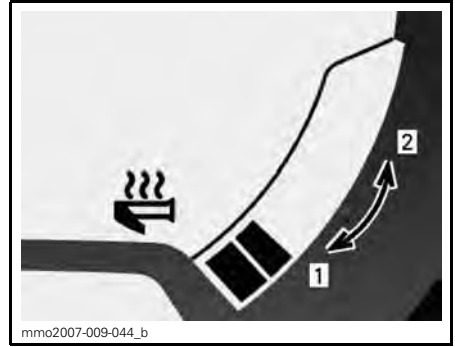

#### HEATING INTENSITY DISPLAY

1. Less heat
2. More heat

Heated throttle lever will be in OFF position when there are no bars displayed on the gauge.

**NOTE:** This switch is also used to adjust the ACS. Refer to *TUNE YOUR RIDE*.

### Mode/Set Button

#### Models with Multifunction Analog/Digital Gauge

This button can be used instead of the two buttons on top of the analog/digital gauge to facilitate gauge adjustments.

- When pressed upward, it has the same functions as the MODE (M) button.
- When pressed downward, it has the same functions as the SET (S) button.



**MULTIFUNCTION GAUGE**

1. MODE function
2. SET function

**8) Shift Lever (1200 4-TEC Models except GT and GSX)**

Use this lever to shift in forward or reverse.



1. Reverse shift lever



**PULL TO ENGAGE REVERSE GEAR**

Refer to *OPERATING IN REVERSE* in *BASIC PROCEDURES* for details.

**9) Tilt Steering (1200 4-TEC Models except GT and GSX)**

On the above mentioned models, the handlebar height is adjustable. To adjust, proceed as follows:

1. Pull up the lock lever.

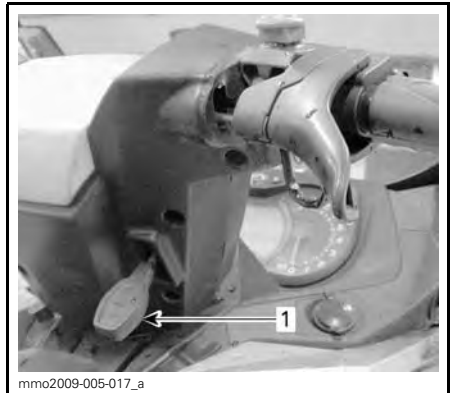

1. Tilt steering lock lever

2. Bring the handlebar to the desired position and release the lock lever.

**NOTE:** On other models, the steering can be set to a desired fixed position, see your Ski-Doo authorized dealer.

## 10) Mirrors

Each mirror can be adjusted to suit operator's preference by gently pressing in the corners of the mirror glass.

### **⚠ WARNING**

Adjust with vehicle at rest in a safe place.

## 11) Tool Kit

A tool kit containing tools for basic maintenance is supplied with the vehicle.

The tool kit support is located in engine compartment on pulley guard.

**NOTICE** Make sure tool kit is secured properly to avoid contact with continuously variable transmission (CVT) system.

To remove the tool kit support from the pulley guard, unlock the tab from underneath the pulley guard and pull the tool kit support towards front to release it.

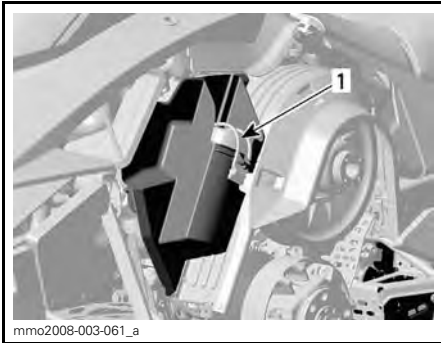

**TYPICAL**

1. Tool kit

## 12) Front Bumper

To be used whenever snowmobile requires manual lifting.

**⚠ CAUTION** Use proper lifting techniques, notably using your legs force. Do not attempt to lift either end of the vehicle if it is above your limits. Use appropriate lifting device or have assistance to share lifting stress if possible.

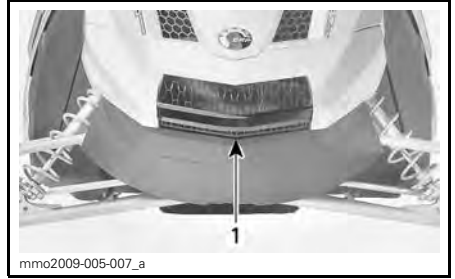

**FRONT**

1. Grab handle/bumper

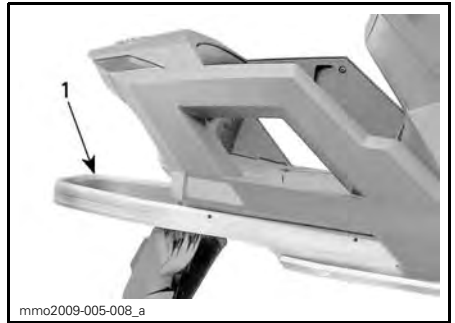

**REAR**

1. Rear bumper

**NOTICE** Do not use skis to pull or lift snowmobile.

### 13) Analog/Digital Gauge (MX Z TNT and Renegade Adrenaline)

#### **⚠ WARNING**

Reading the gauge digital display can distract from the operation of the vehicle, particularly from constantly scanning the environment.

#### Gauge Description



#### ANALOG/DIGITAL GAUGE

1. Speedometer
2. Tachometer (RPM)
3. Gauge Digital Display
4. Gauge Pilot Lamps
5. Gauge SET "S" button

**NOTE:** The gauge is factory preset in Imperial units but it is possible to change it to metric units, contact an authorized Ski-Doo dealer for unit settings.

#### 1) Speedometer

Measures vehicle speed (in miles or kilometers depending on the setting).



LH PORTION OF GAUGE

#### 2) Tachometer (RPM)

Measures engine revolution per minute (RPM). Multiply by 1000 to obtain the actual revolutions.



RH PORTION OF GAUGE

#### 3) Digital Display



1. Digital display

**WARNING**

Never adjust or set functions on the multifunction gauge while riding the vehicle.

- The multifunction display is used to:
- Display the WELCOME message on power up
  - Display the KEY recognition message
  - Provide various indications as selected by the operator

- Activating or changing various functions or modes of operation
- Display scrolling messages of function activation or system faults
- Display fault codes.

**4) Pilot Lamps and Messages**



TYPICAL — PILOT LAMPS

See table below for usual pilot lamps information.

Refer to *MONITORING SYSTEM* for details on malfunction pilot lamps.

**NOTE:** Some of the listed pilot lamps and messages do not apply to all models.

PILOT LAMP(S)		BEEPER	MESSAGE DISPLAY	DESCRIPTION
	ON	4 short beeps every 5 minutes	LOW OIL	E-TEC: Injection oil level is low. Stop vehicle in a safe place then, replenish injection oil reservoir.  Four stroke engines: See <i>MONITORING SYSTEMS</i>
	ON	—	—	Low fuel level. Replenish fuel tank as soon as possible.
	Blinking	Long beeps repeating slowly	REVERSE	Reverse is selected.
	ON	—	—	High beam headlights are selected.
—	—	—	WARM UP	E-TEC: Engine in warm-up mode. The engine's RPM is limited until a suitable temperature is reached.

**5) SET (S) Button**

Button use to navigate, adjust or reset gauge multifunction display.

**NOTE:** SET (S) button on the multifunction switch has the same functions and can also be used.

## Gauge Features

### Analog/Digital Gauge Only

Digital display that supplies several real time useful information to the operator.

AVAILABLE INDICATIONS IN NUMERICAL DISPLAY	
FUNCTIONS	
A) Odometer	X
B) Trip meter "A" or "B"	X
C) Trip hour meter	X
D) Engine Coolant Temperature <sup>(1)</sup>	Opt
E) Fuel level	X
F) Heated grips heating intensity	X
G) Heated throttle Lever heating intensity	X
X = An X indicates a standard feature Opt = Feature available as an option N.A. = Not available	
(1) Coolant temperature is an option package for. See a Ski-Doo dealer for more information	

**NOTE:** The display is factory preset in Imperial units but it is possible to change it to Metric units, contact an authorized Ski-Doo dealer for unit settings.

#### A) Odometer

Records the total distance travelled.

Press the SET (S) button to select odometer mode.

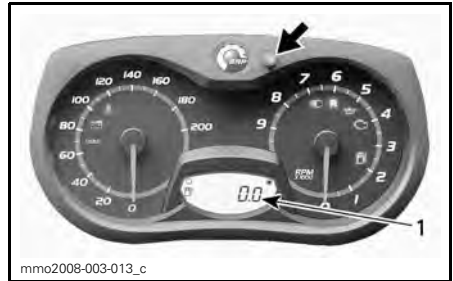

1. Odometer mode

#### B) Trip Meter "A" or "B"

Trip meters records distance travelled since it has been reset.

Press the SET (S) button to select trip meter (TRIP A/TRIP B) mode.



1. Trip meter (TRIP A/TRIP B) mode

Press and hold the SET (S) button to reset.



#### C) Trip Hour Meter

Records vehicle running time when the electrical system is activated since it has been reset.

Press the SET (S) button to select trip hour meter (HrTRIP) mode.

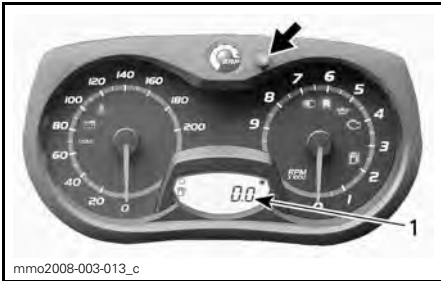

mmo2008-003-013\_c

1. Trip hour meter (HrTRIP) mode

Press and hold the SET (S) button to re-set.



mmo2008-003-013\_d

D) Engine Coolant Temperature  
*With Optional Module Installed*  
Overheating indicator.

**NOTICE** If engine overheats, stop vehicle in a safe place. Refer to **TROUBLESHOOTING** section.

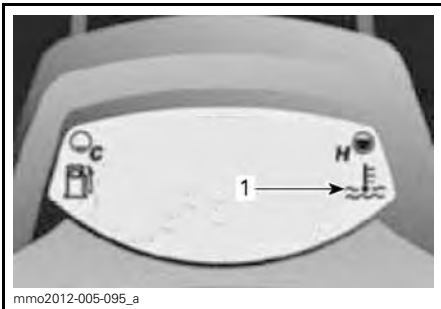

mmo2012-005-095\_a

**OPTIONAL MODULE INSTALLED**

1. Overheating indicator

E) Fuel Level

Bar gauge that continuously indicates the amount of fuel left in the fuel tank.

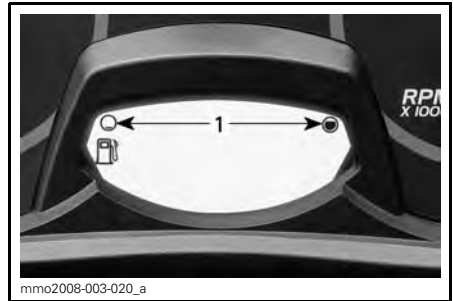

mmo2008-003-020\_a

**FUEL LEVEL**

1. Operating range

F) Heated Grips Heating Intensity

The heating intensity is displayed via the digital display.

**NOTE:** There are nine intensity settings. When released, display will return to fuel tank level.



mmo2013-004-039\_a

**HEATING INTENSITY DISPLAY**

1. Less heat  
2. More heat

H) Heated Throttle Lever Heating Intensity

**NOTE:** The heating intensity is displayed via the digital display with the activation of the throttle lever switch. When released, display will return to fuel tank level.

**NOTE:** There are nine intensity settings.



**HEATING INTENSITY DISPLAY**  
 1. Less heat  
 2. More heat

**14) Multifunction Analog/Digital Gauge (All Models Except MX Z TNT and Renegade Adrenaline)**

**⚠ WARNING**  
 Reading the gauge digital display can distract from the operation of the vehicle, particularly from constantly scanning the environment.

**Gauge Description**

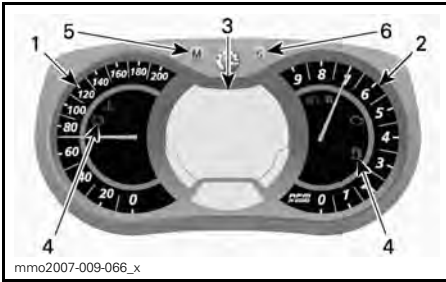

**MULTIFUNCTION ANALOG/DIGITAL GAUGE**  
 1. Speedometer  
 2. Tachometer  
 3. Multifunction digital display  
 4. Pilot lamps  
 5. Mode button  
 6. Set button

**NOTE:** The gauge is factory preset in Imperial units but it is possible to change it to metric units, contact an authorized Ski-Doo dealer for unit settings.

**1) Speedometer**  
 Measures vehicle speed.



**LH PORTION OF GAUGE**

**2) Tachometer (RPM)**  
 Measures engine revolution per minute (RPM). Multiply by 1000 to obtain the actual revolutions.



**RH PORTION OF GAUGE**



### 3) Multifunction Digital Display

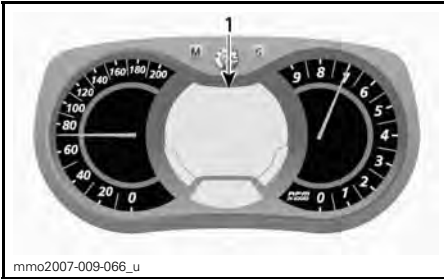

**MULTIFUNCTION ANALOG/DIGITAL GAUGE**  
1. Multifunction display

The multifunction display is used to:

- Display the WELCOME message on power up
- Display the KEY recognition message
- Provide various indications as selected by the operator

- Activating or changing various functions or modes of operation
- Display scrolling messages of function activation or system faults
- Display fault codes.



### 4) Pilot Lamps and Messages



**TYPICAL — PILOT LAMPS**

See table below for usual pilot lamps information. Refer to *MONITORING SYSTEM* for details on malfunction pilot lamps.

PILOT LAMP(S)	BEEPER	MESSAGE DISPLAY	DESCRIPTION
	4 short beeps every 5 minutes	LOW OIL	E-TEC: Injection oil level is low. Stop vehicle in a safe place then, replenish injection oil reservoir.
			Four stroke engines: Low engine oil pressure. Stop vehicle in a safe place then, check oil level. Fill to proper level. If oil level was correct, discontinue use and contact an authorized Ski-Doo dealer.
	—	—	Low fuel level. One (1) bar left in fuel level display. Replenish fuel tank as soon as possible.
	Long beeps repeating slowly	REVERSE	Reverse is selected.
	3 short beeps	REV. FAIL	Reverse did not engage, try again.
	—	—	High beam headlights are selected.

PILOT LAMP(S)	BEEPER	MESSAGE DISPLAY	DESCRIPTION
—	—	WARM UP	E-TEC: Engine and/or injection oil need to warm-up before normal operation. The engine's RPM is limited until desired temperature is reached (up to 10 minutes when driving). Warm-up period may occur after a restart in very cold weather.
900 ACE Only			
	—	—	Standard mode is selected.
	—	—	Sport mode is selected.
	—	—	ECO mode is selected.

### 5) MODE (M) Button

Button use to navigate in gauge multi-function display.

**NOTE:** MODE (M) button on the multi-switch housing has the same functions and can also be used.

### 6) SET (S) Button

Button used to navigate, adjust or re-set gauge multifunction display.

In order to memorize settings, engine must be running.

**NOTE:** SET (S) button on the multi-function switch has the same functions and can also be used.

### Gauge Features

#### *Multifunction Analog/Digital Gauge only*

Multifunction digital display that supplies several real time useful information to the operator either in English or French, contact an authorized Ski-Doo dealer for language settings.

** WARNING**

Never adjust or set functions on the multifunction gauge while riding the vehicle.

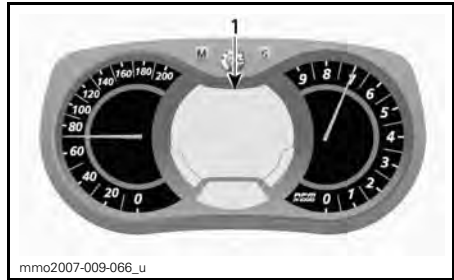

**MULTIFUNCTION ANALOG/DIGITAL GAUGE**  
1. Multifunction display

When the information center is first powered up, the numerical display defaults to the last selected indication.

<b>AVAILABLE INDICATIONS IN NUMERICAL DISPLAY</b>				
<b>FUNCTIONS</b>	<b>600 HO E-TEC</b>	<b>800R E-TEC</b>	<b>900 ACE</b>	<b>1200 4-TEC</b>
A) Speedometer	Indication by default			
B) Engine RPM	X	X	X	X
C) Odometer	X	X	X	X
D) Trip meter "A" or "B"	X	X	X	X
E) Trip hour meter	X	X	X	X
F) Clock	X	X	X	X
G) Fuel level	X	X	X	X
H) Altitude	X	X	X	N.A.
I) Top speed	X	X	X	X
J) Average speed	X	X	X	X
K) Heated grips heating intensity	X	X	X	X
L) Heated throttle lever heating intensity	X	X	X	X
M) Instant fuel consumption (4-stroke Models)			X	X
N) Total fuel consumption (4-stroke Models)			X	X
O) Message display	X	X	X	X
P) Engine coolant temperature	X	X	Opt	X <sup>(1)</sup>
Q) Lap record mode <sup>(1)</sup>	Opt	Opt	Opt	Opt
R) Air controlled suspension (ACS) <sup>(2)</sup>	Opt	Opt	Opt	Opt
S) E-TEC engine storage mode	X	X	N.A.	N.A.
<p>X = An X indicates a standard feature  Opt= Feature available as an option  N.A.= Not available</p> <p><sup>(1)</sup> Temperature, compass and lap record functions may be easily added to your vehicle through the purchase of a specific module. Contact your Ski-Doo dealer for additional information.  <sup>(2)</sup> Specific to SE models.</p>				

### A) Speedometer

In addition of the analog type speedometer, vehicle speed can also be displayed via the multifunction display.

Vehicle speed can be displayed on display 1 or display 2.



#### MULTIFUNCTION DISPLAY

1. Display 1
2. Display 2

Use MODE (M) button to select the desired display, then proceed as follows:



While display is flashing, press the SET (S) button to select speedometer mode.

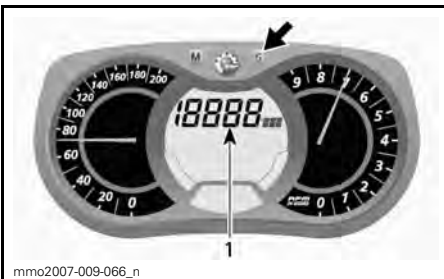

1. Speedometer mode

Press the MODE (M) button to confirm selection or wait 5 seconds.



### B) Tachometer (RPM)

In addition of the analog type tachometer, RPM can also be displayed via the multifunction display.

Engine RPM can be displayed on display 1 or display 2.



#### MULTIFUNCTION DISPLAY

1. Display 1
2. Display 2

Use MODE (M) button to select the desired display, then proceed as follows:



While display is flashing, press SET (S) button to select RPM mode.

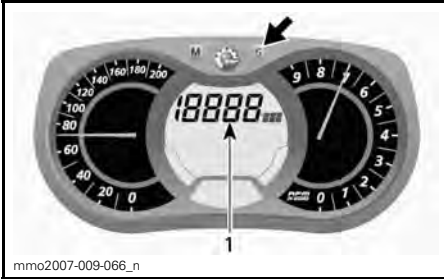

1. RPM mode

Press the MODE (M) button to confirm selection or wait 5 seconds.



### C) Odometer

Records the total distance travelled.

Press the SET (S) button to select odometer mode.

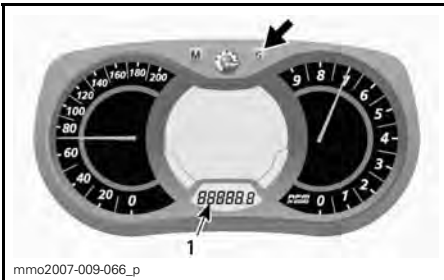

1. Odometer (km/mi) mode

### D) Trip Meter A or B

Trip meters records distance travelled since it has been reset.

Press the SET (S) button to select trip meter (TRIP A/TRIP B) mode.

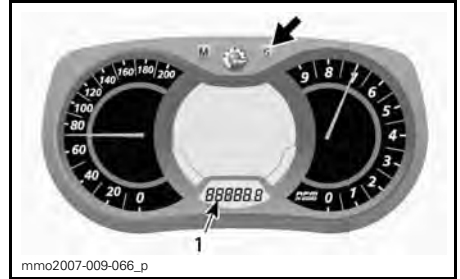

1. Trip meter (TRIP A/TRIP B) mode

Press and hold the SET (S) button to re-set.

**NOTE:** On 4-stroke models, resetting TRIP B mode will also reset TOTAL FUEL CONSUMPTION.

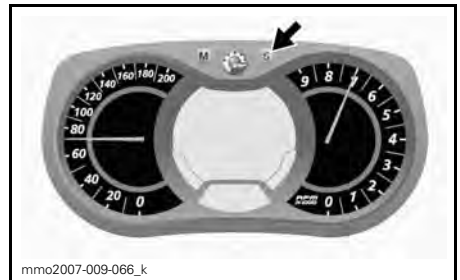

### E) Trip Hour Meter

Records vehicle running time when the electrical system is activated since it has been reset.

Press the SET (S) button to select trip hour meter (HrTRIP) mode.

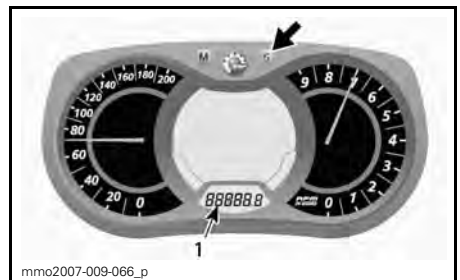

1. Trip hour meter (HrTRIP) mode

Press and hold the SET (S) button to re-set.

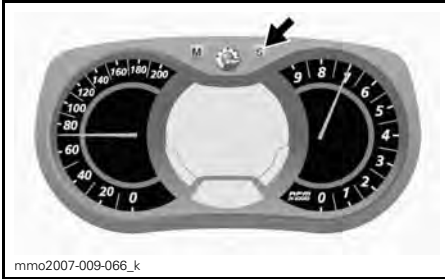

## F) Clock

### Electric Start Models

**NOTE:** This clock displays hour in the 24-hour format only.

Press the SET (S) button to select clock mode.

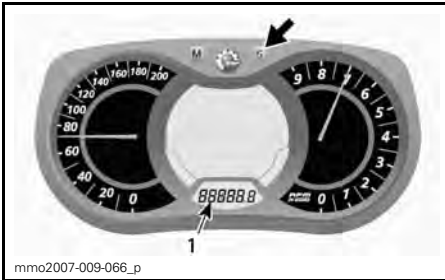

### 1. Clock mode

Press and hold the SET (S) button to activate clock set-up.

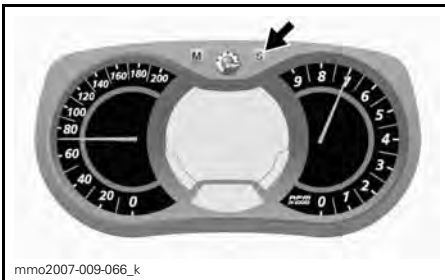

To change HOURS, while the value of HOURS is blinking, use the SET (S) button to change hours.

To change MINUTES, while the value of HOURS is blinking, press the MODE (M) button to switch to minutes. Use the SET (S) button to change minutes.

Press the MODE (M) button to save clock set-up and exit mode.

## G) Fuel Level

Bar gauge that continuously indicates the amount of fuel left in the fuel tank.

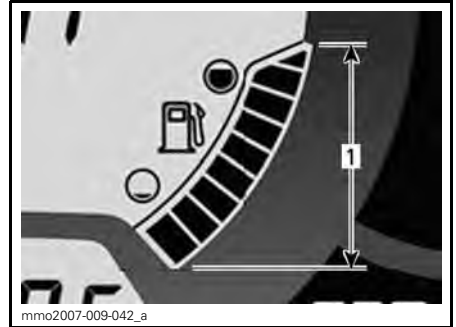

### FUEL LEVEL

1. Operating range

## H) Altitude

Displays vehicle **approximate** altitude above sea level calculated from the barometric pressure.

**NOTE:** Altitude displayed is rounded off every 100 meters when set in metric units or 200 feet when set in imperial units.

To display vehicle altitude, proceed as follows.

Press the MODE (M) button to select display 2.



While display is flashing, press the SET (S) button to select altitude mode.

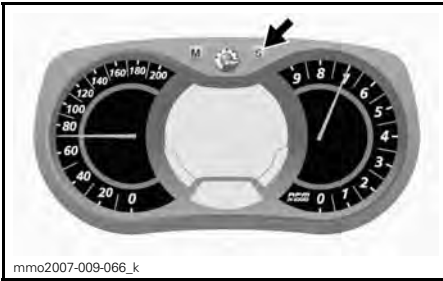

The following symbol appears when altitude mode is selected.



**ALTITUDE MODE**

Press the MODE (M) button to confirm selection or wait 5 seconds.



### 1) Top Speed

Records vehicle top speed since it has been reset.

To display vehicle top speed, proceed as follows.

Press the MODE (M) to select display 1.



While display flashes, press the SET (S) button to select top speed (TOP\_SPD) mode.

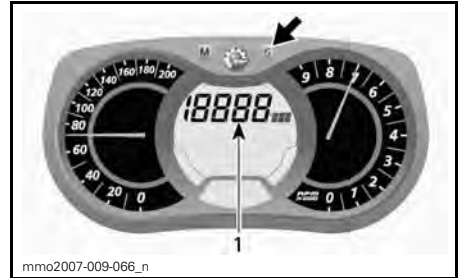

1. Top speed (TOP\_SPD) mode

Press the MODE (M) button to confirm selection or wait 5 seconds.



To reset, press the MODE (M) to select mode.



While display flashes, press and hold the SET (S) button within 5 seconds to reset.

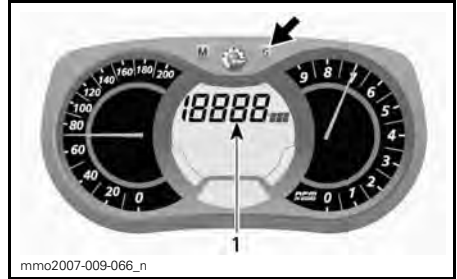

1. Vehicle average speed (AVR\_SPD) mode

Press the MODE (M) button to confirm selection or wait 5 seconds.



## J) Average Speed

Records vehicle average speed since it has been reset.

To display vehicle average speed, proceed as follows.

Press the MODE (M) to select display 1.



To reset, press the MODE (M) to select mode.



While display flashes, press SET (S) button to select vehicle average speed (AVR\_SPD) mode.



While display flashes, press and hold the SET (S) button within 5 seconds to reset.





### K) Heated Grips Heating Intensity

Bar gauge that indicates heating intensity.

Refer to *HEATED GRIPS SWITCH* for more details.

**NOTE:** There are nine intensity settings. When released, display will return to engine coolant temperature (if equipped).

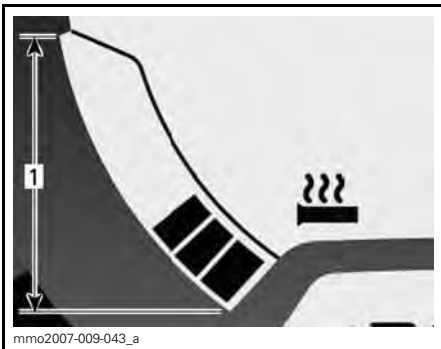

**HEATED GRIPS**  
1. Operating range

### L) Heated Throttle Lever Heating Intensity

Bar gauge that indicates heating intensity.

Bar gauge will be displayed instead of the fuel level with the activation of the heated throttle lever switch. There are nine intensity settings. When released, display will return to fuel level.

Refer to *HEATED THROTTLE LEVER SWITCH* for more details.

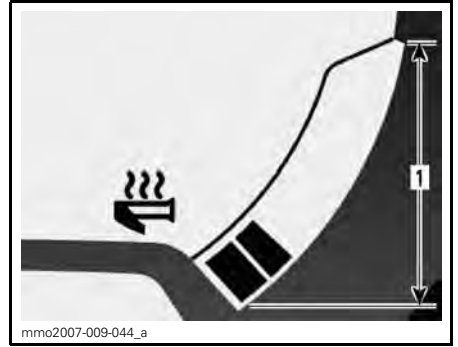

**HEATED THROTTLE LEVER**  
1. Operating range

### M) Instant Fuel Consumption (4-stroke Models)

Calculates vehicle average fuel consumption while riding.

To display vehicle average fuel consumption, proceed as follows.

Press the MODE (M) button to select display 1.



While display flashes, press SET (S) button to select instant fuel consumption mode.

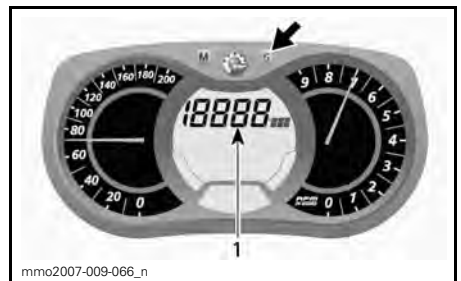

1. Instant fuel consumption mode

Press the MODE (M) button to confirm selection or wait 5 seconds.



### N) Total Fuel Consumption (4-stroke Models)

Records vehicle average fuel consumption since it has been reset.

To display vehicle total fuel consumption, proceed as follows.

Press the MODE (M) button to select display.



While display flashes, press the SET (S) button to select total fuel consumption (TC) mode.

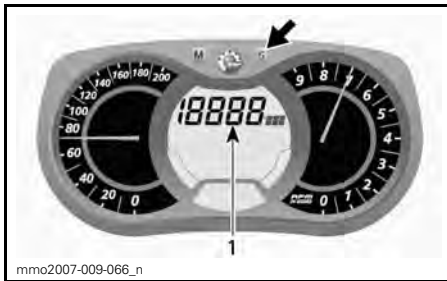

1. Total fuel consumption (TC) mode

TC appears when the mode is selected.

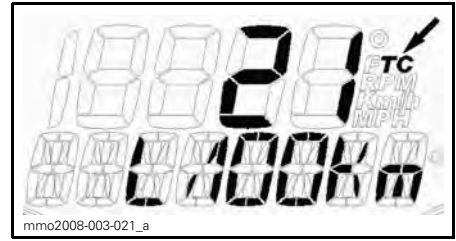

TYPICAL

Press the MODE (M) button to confirm selection or wait 5 seconds.



To reset, set the trip meter to TRIP B. Refer to *TRIP METER A OR B* for more details.

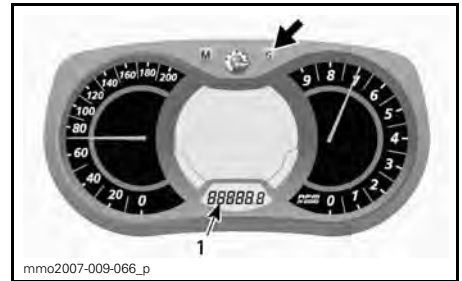

1. Trip meter (TRIP B) mode

Press and hold the SET (S) button to reset.



### O) Message Display

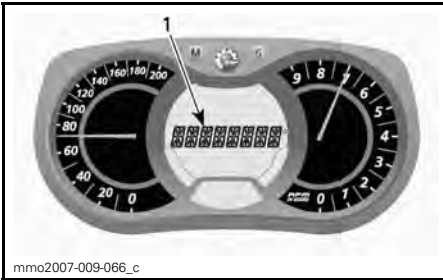

1. Message display

Refer to *PILOT LAMPS AND MESSAGES* in this section for details on usual messages.

Refer to *MONITORING SYSTEM* for details on malfunction and D.E.S.S. related messages.

### P) Engine Coolant Temperature

Bar gauge that indicates the engine coolant temperature.

During normal operation, the bars should not exceed approximately the middle of the gauge.

**NOTICE** If engine overheats, stop vehicle in a safe place. Refer to TROUBLESHOOTING section.

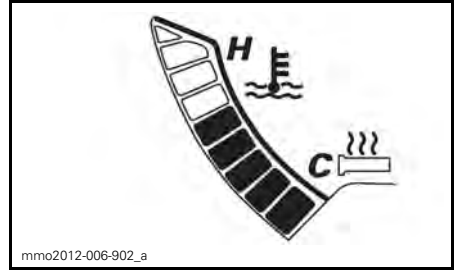

### Q) Lap Record Mode

With this mode, vehicle speed, engine revolutions per minute (RPM) and a preselected function in display 1 can be recorded at the same time during a period of time defined by the operator.

Also, a possibility of nine (9) different sessions (laps) can be recorded for a maximum total of 2.5 minutes.

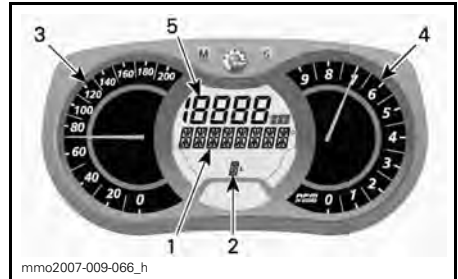

#### LAP RECORD MODE

1. Lap record mode display
2. Sessions (laps)
3. Vehicle speed
4. Engine revolution per minute (RPM)
5. Preselected function

To Activate Lap Record Mode:

1. Press the SET (S) button to select the odometer mode in display 3.
2. Press and hold SET (S) button for 2 seconds to activate mode, REC will be displayed to indicate that record mode has been selected.



1. Record mode
2. Odometer

3. Press the SET (S) button to scroll between modes.

Available modes are: STOP, REC (record) or PLAY.

To Record:

1. Select REC (record) mode.

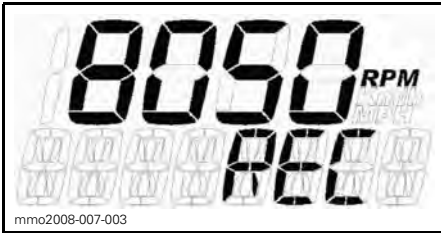

**RECORD MODE**

2. Press the MODE (M) button to start recording.
3. While recording, press the MODE (M) button again each time you want to record a new lap time (from 1 to 9 laps).

Press the SET (S) button to stop recording.

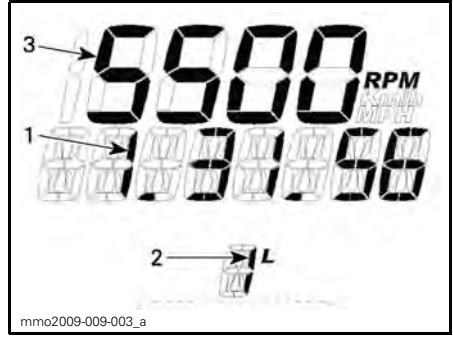

**RECORD MODE**

1. Recording time
2. Lap/session
3. Selected mode

To record another session, press the SET (S) button until REC (record) mode appears in display. Repeat same procedure previously described to record.

**To Review Recorded Data:**

Select PLAY mode.

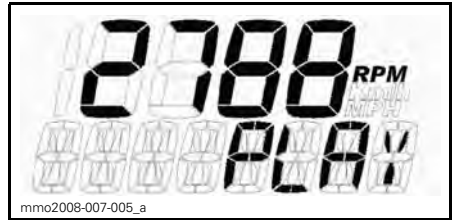

**PLAY MODE**

1. Press the MODE (M) button to play recorded data.

All recorded data (speedometer, tachometer and the preselected mode in display 1) will be displayed at the same time.

2. Press the SET (S) button to stop recorded lap OR press the MODE (M) button to switch to another recorded lap.

**NOTE:** Pressing the SET (S) button will stop time of the lap in progress, then the display will show the recorded time length of that lap and will switch automatically to the following recorded lap after 5 seconds.

At the end of all recorded laps, STOP will appear in display.

To review recorded data again, press the SET (S) button to return to PLAY mode. Repeat same procedure previously described to review.

To record other laps, press the SET (S) button to switch to REC (record) mode. Repeat same procedure previously described to record.

Press and hold SET (S) button for 5 seconds to exit the lap record mode, the previously selected mode will be displayed.

## R) Air Control Suspension

Displays rear suspension air shock absorber set point and actual setting.

## S) E-TEC Engine Storage Mode

Displays "OIL" when the storage mode procedure is initiated.

## T) E-TEC Engine Storage Mode

Displays "OIL" when the engine enters the storage procedure.

## Gauge Setup

### Clock Setting

**NOTE:** This clock displays in the 24-hour format only.

Press the SET (S) button to select clock mode.

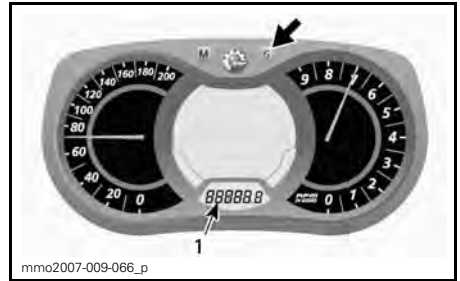

1. Clock mode

Press and hold the SET (S) button to activate clock set-up.

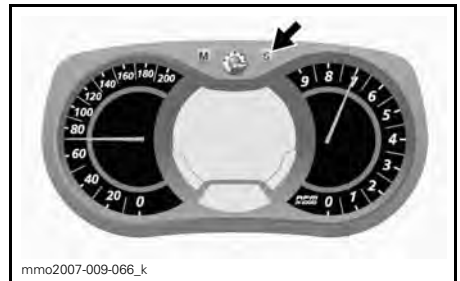

To change HOURS, while the value of HOURS is blinking, use the SET (S) button to change hours.

To change MINUTES, while the value of HOURS is blinking, press the MODE (M) button to switch to minutes. Use the SET (S) button to change minutes.

Press the MODE (M) button to save clock set-up and exit mode.

### Unit Selection (KM/H vs MPH)

The units can be set in metric or imperial. Refer to an authorized Ski-Doo dealer.

### Language Selection

The gauge display language can be changed. Refer to an authorized Ski-Doo dealer for language availability and setup the gauge to your preference.

## 15) Operator's Guide

The Operator's Guide is located in the operator's seat base.

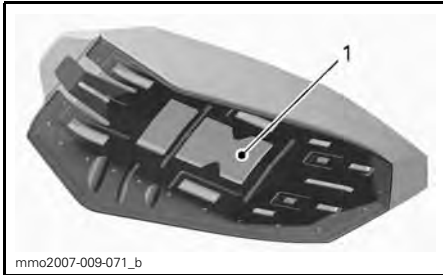

TYPICAL - SEAT

1. Operator's Guide location

### 2-UP Models

In the seat storage compartment.

## 16) Seat Latch (1-UP Only)

Operator's seat can be removed to access to the Operator's Guide (located in seat base) or for maintenance purposes.

The seat latch is located at the front of the seat.

### Seat Removal

To remove the operator's seat, proceed as follows:

**NOTE:** On the Grand Touring models, it is necessary to remove the passenger seat. Refer to *PASSENGER (1+1) SEAT*.

1. Pull the front portion of the seat cushion, firmly push seat forward to unload latch, then pull tab to unlock seat.
2. Holding the seat latch, slide seat towards rear.



TYPICAL

1. Seat latch



1. Seat latch

**NOTE:** On the models with a heated seat, disconnect the electrical connector located underneath the seat.

**NOTICE** Do not stretch the electrical connector and wiring.

3. Remove seat.

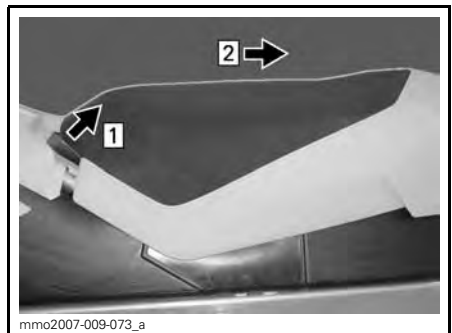

TYPICAL

Step 1: Pull and hold seat latch  
Step 2: Slide seat

## Seat Installation

**NOTICE** Riding the vehicle with any objects between the seat and the fuel tank could damage the fuel tank. NEVER place any objects between seat and fuel tank.

**NOTE:** On the Grand Touring SE model, connect the electrical connector located underneath the seat.

1. Position seat in place.
2. Push seat forward until it latches in its position.

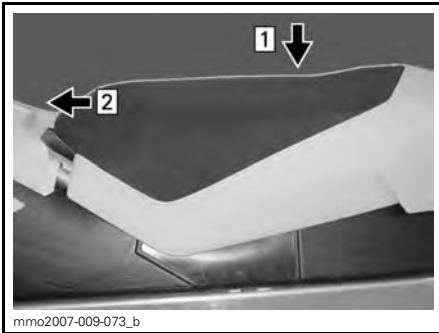

### TYPICAL

Step 1: Position seat in place

Step 2: Push seat forward until it latches

**NOTE:** A distinctive snap will be felt. Double check that the seat is secure by giving it a tug to confirm proper latching.



TYPICAL - SEAT INSTALLED

## **⚠️ WARNING**

Make sure seat is securely latched before riding.

## 17) Backrest

The back rest is adjustable and can be set for the passenger or the operator.

To adjust the backrest, proceed as follows:

1. Pull up and hold the lock lever.



1. Backrest lock lever

2. Set backrest to the desired position and release the lock lever.

**⚠️ CAUTION** The backrest is spring loaded and will quickly move forward if not held while pulling up the lock lever.

## 18) Passenger (1+1) Seat

On the Grand Touring models, a 1+1 passenger seat is provided as standard equipment.

## **⚠️ WARNING**

Any passenger must be able to firmly lay his feet on the footrests and keep his hands on the grab handles at all times when seated. Respecting those physical criteria is important to ensure that the passenger is stable and to reduce the risks of ejection.

## Passenger Seat Removal

To remove the rear seat, proceed as follows:

1. Remove the tunnel bag if equipped.
2. Pull the latch strap located at rear of the passenger seat as shown.



mmo2009-005-014\_a

3. Lift up the rear end of seat and gently pull back just enough to expose the accessories connector.

**NOTICE** Do not stretch the accessories connector and wiring.



mmo2009-005-012\_a

1. Rear seat
2. Accessories connector

4. Disconnect the accessories connector and remove seat.

## Passenger Seat Installation

To install the passenger seat, proceed as follows:

1. Put the passenger seat behind the operator's seat. Let enough space between the seats to connect the accessories connector.
2. Slightly incline the passenger seat towards front and engage seat hooks in the tunnel slots located behind the operator's seat.



mmo2009-005-013\_a

1. operator's seat
2. Tunnel slot

3. Push the front portion of the passenger seat towards the operator's seat and firmly push the rear portion down to lock the passenger seat in position.

**NOTE:** A distinctive snap will be felt. Double check that the seat is secure by giving it a tug to confirm proper latching.

## **⚠ WARNING**

**Make sure seat is securely latched before riding.**

## 19) Passengers Handholds

Adjustable and heated handholds mounted at rear on Grand Touring models.

To adjust the handhold height, proceed as follows:

1. Pull up the knob to release tension.



- Raise or lower the handhold to suit passenger's comfort.

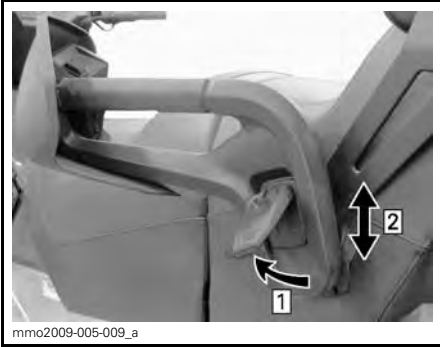

Step 1: Pull knob  
Step 2: Adjust height

- Press knob down to lock the handhold in position.

**NOTE:** The locking pressure applied on the handhold can be adjusted by screwing knob in or out when released.

## 20) Storage Compartment

### **⚠ WARNING**

All storage compartments must be securely closed and must not contain any sharp, heavy or breakable objects.

#### 1-UP Models

### **⚠ WARNING**

All storage compartments must be properly latched and they must not contain any sharp, heavy or breakable objects.

**NOTICE** MAXIMUM load is 1.8 kg (4 lb) evenly distributed.

Turn latch right then pull down right hand side of cover to unlock compartment.



- Storage compartment
- Latch

Push left hand side of cover back up first then push back right hand side of cover and turn latch right to lock.

#### 2-UP Models

To open storage compartment cover, unfasten buckles, then open cover.

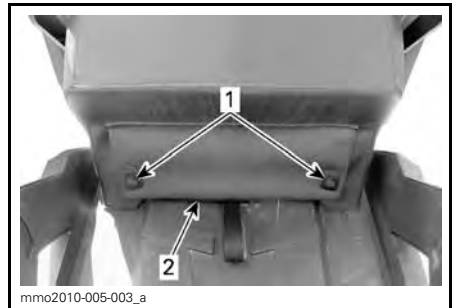

#### REAR OF PASSENGER SEAT

- Buckles
- Storage compartment cover

## 21) Rear Rack

*Grand Touring Only*

### **⚠ WARNING**

All objects in rear rack must be properly latched. Do not carry any breakable objects. Load in rack may reduce steering ability. The MAXIMUM cargo load is 15.8 kg (35 lb) including the storage compartment load. Reduce your speed when carrying a load. Always readjust suspension according to the load.

## 22) Tunnel Bag (GSX LE)

### **⚠ WARNING**

The tunnel bag must be properly secured and must not contain any sharp, heavy or breakable objects.

**⚠ CAUTION** MAXIMUM load for this bag is 1.4 kg (3 lb) evenly distributed.

The tunnel bag is secured to the tunnel by straps and anchors. To install, hook the straps plastic ends to the anchors and adjust the straps.

To remove the tunnel bag, push the straps plastic ends down to unhook from anchors.

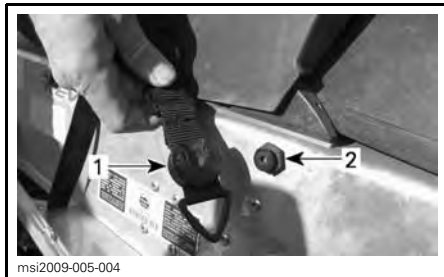

1. Strap
2. Anchor

## 23) Tunnel Bag (Grand Touring)

### **⚠ WARNING**

The tunnel bag must be properly secured and must not contain any sharp, heavy or breakable objects.

**⚠ CAUTION** MAXIMUM load for this bag is 2.27 kg (5 lb) evenly distributed.

The tunnel bag can be installed upright or flat on the tunnel and can also be converted into a back pack. The shoulder straps are stored in the pouch located at the bottom of the tunnel bag.

### Flat Installation

The tunnel bag should be installed flat on the on the tunnel when carried alone on the rear rack.

To install, secure to the rack using the Velcro straps as shown.



1. Velcro strap
2. Rear rack

The retaining Velcro straps can be hidden in side pouches. The side pouches flaps are hidden in the bottom lining of the tunnel bag.

### Upright Installation

The tunnel bag can be installed upright when carrying other luggage on the rear rack. The upright installation leaves room underneath the tunnel bag.

To install, take the shoulder straps out of the pouch located at the bottom of the tunnel bag. Install shoulder straps tight around the backrest as shown.



1. Backrest
2. Shoulder straps

## 24) Saddlebags

The Grand Touring SE is equipped with two hard lockable saddlebags installed at rear.

### Saddlebag Opening and Closing

To open the saddlebags, proceed as follows:

1. Unlock the handle with the provided key.
2. Pull handle approximately half the way up.
3. Open the slide locks then open lid.

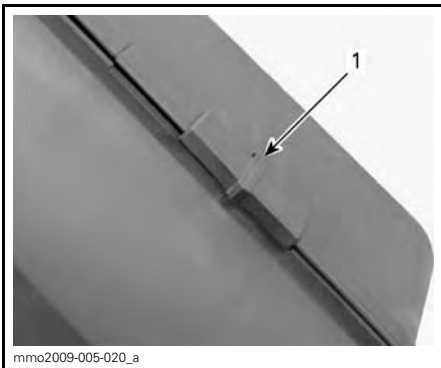

TYPICAL

1. Slide lock

**NOTE:** It is not necessary to remove saddlebags from the vehicle to open them.

### Saddlebag Removal

To remove a saddlebag, proceed as follows:

1. Unlock the handle with the provided key.
2. Pull handle all the way up and remove the saddlebag.

### Saddlebag Installation

To install the saddlebags on the rear rack, proceed as follows:

1. Insert the metal tabs, located on the rear bumper, in the saddlebag slots.
2. Firmly push the top of the saddlebag towards the vehicle. A "snap" will be felt when the saddlebag is properly secured. Make sure the saddle bags are properly secured before getting underway.

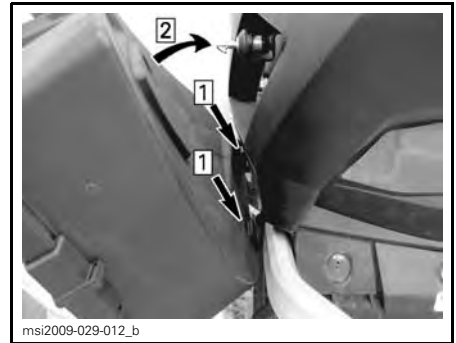

- Step 1: Insert tabs  
Step 2: Push towards vehicle

## 25) Passenger Heated Grip Switch

The switch is located on the LH passenger handhold.



1. Passenger heated grip switch

Adjust heating intensity as shown.



1. Off
2. Warm
3. Hot

## 26) Heated Seats Switches

The front seat switch is located on the console to the right of the steering column.

The Grand Touring SE model is equipped with heated operator and passenger seats.

The rear seat switch is located on the LH handhold.

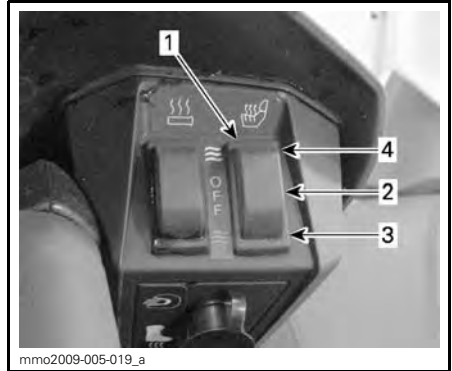

### REAR SEAT SWITCH SHOWN

1. Heated seat
2. OFF
3. Warm
4. Hot

## 27) Electric Visor Jack Connectors

An electric visor can be connected to the jack connector. Electric current is supplied whenever engine is running on the 1200 4-TEC models and from 2000 RPM on the E-TEC model. A stress relief extension is supplied with the vehicle.

### Grand Touring

A visor jack connector and a heating boots jack connector are installed at rear on the LH handhold.

## 28) 12-Volt Power Outlet

### All Models Except Renegade

A 12-volt electric appliance may be connected to that jack connector. Electric current is supplied whenever engine is running on the 1200 4-TEC models and from 2000 RPM on the E-TEC model.

**NOTICE** The 12-volt power outlet is not designed to supply current of more than 1 ampere.

## 29) Hitch

Use this hitch in conjunction with a tow bar to tow an accessory.

**NOTE:** Refer to decal on vehicle for towing weight capacities.

**⚠ WARNING**

Never tow an accessory with a rope. Always use a rigid tow bar. Using a rope would result in a collision between the object and the snowmobile and possibly in a tip over in case of a rapid deceleration or on a downward slope.

**How to Use the Hitch**

Detach hitch from its support by removing the hairpin.

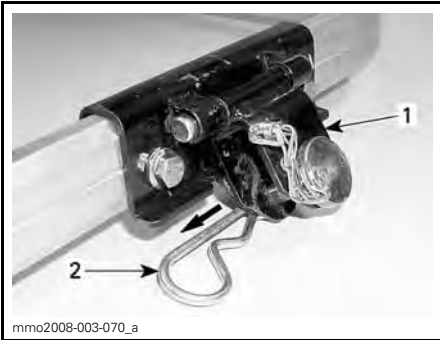

- 1. Hitch
- 2. Hairpin

Remove rod from hitch then attach rigid tow bar to hitch using the same rod.



- TYPICAL**
- 1. Rod

Secure rod to hitch using hairpin previously removed.

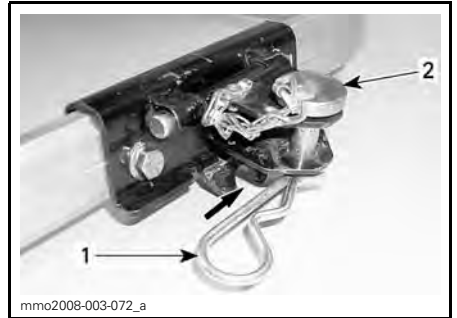

- TYPICAL**
- 1. Hairpin
- 2. Rod

**NOTICE** To avoid damages to the vehicle, always release hitch from its support. Ensure hitch moves freely when towing accessories.



**HITCH MOVES FREELY WHEN TOWING**

To avoid noise from hitch when not in use, secure hitch to its support by using the hairpin.

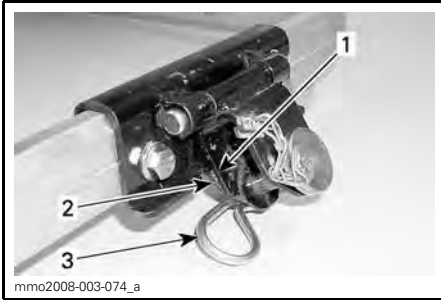

**HITCH NOT IN USE**

1. Hitch
2. Support
3. Hairpin

### 30) Spare Drive Belt Stowage

A spare drive belt can be stored on RH side of engine compartment.

**NOTE:** Spare drive belt is not supplied with the snowmobile.

Remove hood, see procedure in this subsection.

Position drive belt as shown.



1. Spare drive belt correctly stored

**NOTICE** Make sure that spare drive belt does not come in contact with the exhaust system.

### 31) Hood

**WARNING**  
Never operate engine with hood removed from vehicle.

### Hood Removal

1. Pull up the rear end of the hood on both sides.
2. Lift the rear end of the hood until it disengages from the bottom pan.



- Step 1: Pull up  
Step 2: Lift

### Hood Installation

1. Engage the tabs located at front of the hood into the slots on the bottom pan cover.
2. Lower the rear end of the hood and press down on both sides to lock it in place.

### 32) Side Panels

**WARNING**  
Never operate engine with side panels opened or removed from vehicle.

#### Side Panel Opening

1. Stretch and unhook the latches.
2. Pull the rear of side panel outwards.

**TYPICAL****1. Latches**

Reverse procedure to close the side panel.

**Side Panel Removal**

1. Open the side panel completely.
2. Lift up the side panel and free the lower hinge from its slot.
3. Free the upper hinge from its slot by lowering the side panel.
4. Remove side panel.

Reverse procedure to install the side panel.

**33) Drive Belt Guard****Drive Belt Guard Removal****⚠ WARNING**

**NEVER** operate engine:

- Without shields and drive belt guard securely installed.
- With hood and/or side panels opened or removed.

**NEVER** attempt to make adjustments to moving parts while engine is running.

Remove the tether cord cap from engine cut-off switch.

Open LH side panel, see procedure in this subsection.

Remove retaining pin.

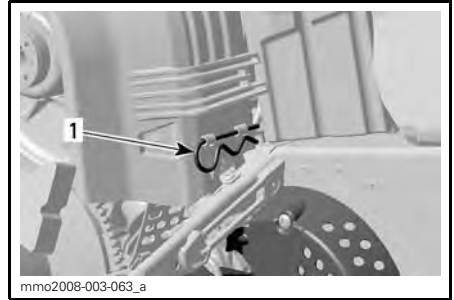
**1. Retaining pin**

Lift rear portion of guard then release from front tabs by pivoting the guard outwards.

**Drive Belt Guard Installation**

When reinstalling drive belt guard, position its cutaway toward front of snowmobile.

Place the front LH slot of the guard over the longest tab.

Pivot the guard inward to engage the shortest tab in the RH slot.

**1. Tabs**

Position the grommet over the retaining rod. It may be necessary to slightly lift the console to make room.



1. Retaining rod

Position rear portion of the drive belt guard over the retainer and secure it using the retaining pin.

**NOTE:** The drive belt guard is purposely made slightly oversize to maintain tension on its pins and retainers preventing undue noise and vibration. It is important that this tension be maintained when reinstalling.

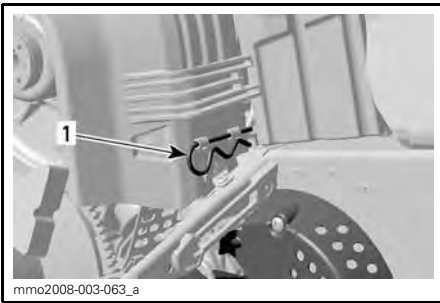

1. Retaining pin

### 34) ECO/Standard/Sport Mode Switch (900 ACE Only)

The Mode switch is located on the LH side of fuel tank.



TYPICAL - LH SIDE OF FUEL TANK

1. Mode switch

It is used to activate or deactivate Standard/Sport/Eco modes.

Refer to *OPERATING MODES* subsection for details.



# FUEL

## Fuel Requirements

**NOTICE** Always use fresh gasoline. Gasoline will oxidize; the result is loss of octane, volatile compounds, and the production of gum and varnish deposits which can damage the fuel system.

Alcohol fuel blending varies by country and region. Your vehicle has been designed to operate using the recommended fuels, however, be aware of the following:

- Use of fuel containing alcohol above the percentage specified by government regulations is not recommended and can result in the following problems in the fuel system components:
  - Starting and operating difficulties.
  - Deterioration of rubber or plastic parts.
  - Corrosion of metal parts.
  - Damage to internal engine parts.
- Inspect frequently for the presence of fuel leaks or other fuel system abnormalities if you suspect the presence of alcohol in gasoline exceeds the current government regulations.
- Alcohol blended fuels attract and hold moisture which may lead to fuel phase separation and can result in engine performance problems or engine damage.

### Recommended Fuel

Use unleaded gasoline containing MAXIMUM 10% ethanol. The gasoline must have the following minimum octane requirements.

FUEL TYPE	ENGINE	MIN. OCTANE RATING
Fuel with NO ethanol	900 ACE 1200 4-TEC	87 AKI (RON+MON)/2 92 RON
	600 HO E-TEC 800R E-TEC	91 AKI (RON+MON)/2 95 RON
Fuel which may contain up to 10% MAX ethanol	900 ACE 600 HO E-TEC 800R E-TEC 1200 4-TEC	91 AKI (RON+MON)/2 95 RON

**NOTICE** Never experiment with other fuels. Engine or fuel system damages may occur with the use of an inadequate fuel.

### Inside North-America

**NOTICE** Do NOT use fuel from fuel pumps labeled E85.

Use of fuel labeled E15 is prohibited by U.S. EPA Regulations.

### Fuel Antifreeze Additives

When using oxygenated fuel, additional gas line antifreeze or water absorbing additives are not required and should be not used.

When using non-oxygenated fuel, isopropyl base gas line antifreeze can be used in a proportion of 150ml (5 U.S. oz) of gas line antifreeze added to 40 L (10.6 U.S. gal.) of gas.

This precaution is in order to reduce the risk of frost buildup in fuel system components which may lead, in certain cases, to severe damage to engine.

**NOTE:** Use only methyl hydrate free gas line antifreeze.

## Vehicle Fueling Procedure

### **⚠ WARNING**

- Fuel is flammable and explosive under certain conditions.
- Never use an open flame to check fuel level.
- Never smoke or allow flame or spark in vicinity.
- Always work in a well-ventilated area.

1. Stop engine.

### **⚠ WARNING**

Always stop engine before refueling.

2. Have operator and passenger get off vehicle.

### **⚠ WARNING**

Do not allow anyone to remain in the vehicle while fueling. If there is a fire or explosion during fueling, a vehicle occupant could be unable to quickly leave the area.

3. Unscrew slowly the fuel reservoir cap counterclockwise to remove it.

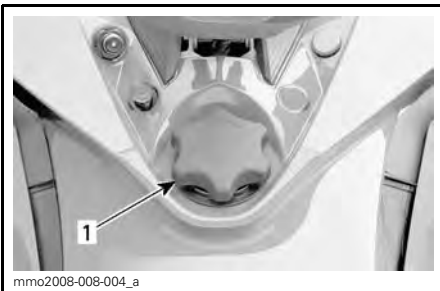

**TYPICAL**

1. Fuel tank cap

### **⚠ WARNING**

If a differential pressure condition is noticed (whistling sound heard when loosening fuel reservoir cap) have vehicle inspected and/or repaired before further operation.

4. Insert the spout into the filler neck.
5. Pour fuel slowly so that air can escape from the tank and prevent fuel flow back. Be careful not to spill fuel.
6. Stop filling when the fuel reaches the bottom of filler neck. Do not overfill.

### **⚠ WARNING**

Never top up the fuel tank before placing the vehicle in a warm area. As temperature increases, fuel expands and may overflow.

7. Fully tighten fuel reservoir cap clockwise.

### **⚠ WARNING**

Always wipe off any fuel spillage from the vehicle.

**NOTE:** Do not sit or lean on seat when fuel tank cap is not properly installed.

# INJECTION OIL (600 HO E-TEC AND 800R E-TEC)

## Recommended Injection Oil

RECOMMENDED INJECTION OIL			
ENGINE	(P/N 293 600 117)	(P/N 293 600 100)	(P/N 293 600 132)
600 HO E-TEC	-	✓	✓
800R E-TEC	-	✓	✓ (preferred)

**NOTICE** The engine of this snowmobile has been developed and validated using the recommended BRP XPS™ oil. BRP strongly recommends the use of its recommended XPS oil at all times. Damages caused by oil which is not suitable for the engine will not be covered by the BRP limited warranty.

## Injection Oil Level Verification

The injection oil reservoir is located behind the RH side panel. See *CONTROLS, INSTRUMENTS AND EQUIPMENT* for opening procedure.

Always maintain a sufficient amount of recommended injection oil in the injection oil reservoir.

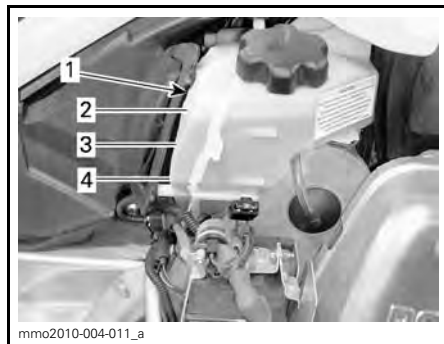

### TYPICAL

1. Oil reservoir
2. 3/4 level
3. 1/2 level
4. 1/4 level

**NOTICE** Check level and refill every time you refuel.

## To Add Injection Oil

Remove injection oil reservoir cap.

Add injection oil.

**NOTE:** Do not overfill. Do not pass the MAX range in the reservoir filler neck.

Reinstall cap and fully tighten.

**NOTICE** Do not mismatch oil reservoir cap with fuel tank cap.

## **⚠** WARNING

Wipe off any oil spills. Oil is highly flammable when heated.

---

# BREAK-IN PERIOD

## Operation During Break-In

A break-in period of 10 operating hours or 500 km (300 mi) is required for the vehicle.

After the break-in period, the vehicle should be inspected by an authorized Ski-Doo dealer. Refer to *MAINTENANCE* section.

### Engine

During the break-in period:

- Avoid prolonged full throttle operation.
- Avoid sustained accelerations.
- Avoid prolonged cruising speeds.
- Avoid engine overheating.

However, brief accelerations and speed variations contribute to a good break-in.

During the first few hours of break-in, the engine management system controls some engine parameters which will slightly reduce the engine performance.

### *E-TEC Models*

During a predetermined period, the engine management system controls some engine parameters.

The duration is based on fuel volume. It will take approximately two fuel tanks to complete the break-in.

During this period:

- The engine performance and behavior will not be optimal.
- The fuel and oil consumption will be higher.

### Drive Belt

A new drive belt requires a break in period of 50 km (30 mi).

During the break-in period:

- Avoid strong acceleration and deceleration.
- Avoid pulling a load.
- Avoid high speed cruising.

# OPERATING MODES (900 ACE ONLY)

## **⚠ WARNING**

Whenever changing operating mode, make sure to maintain situational awareness while riding.

### **ECO Mode (Fuel Economy Mode)**

When ECO mode is selected (fuel economy mode), vehicle torque and speed are limited whereby an optimal cruising speed is maintained in order to reduce fuel consumption.

Once activated, ECO mode will remain active until it is deactivated by the operator.

### **Standard Mode**

A Standard mode indicator is ON in the multifunction gauge to confirm the active mode of operation.

### **Sport Mode**

## **⚠ WARNING**

Ensure passenger is advised to hold on tightly before activating Sport mode. Sport mode provides increased acceleration.

When selected, Sport mode provides for instant throttle response and more rapid accelerations than Standard or ECO mode.

Once activated, Sport mode will remain active until it is deactivated by the operator.

### **Navigating Operating Modes**

Use ECO/Standard/Sport Mode switch to navigate between power levels, from ECO (reduced power) to Standard (full power) to Sport (increased power).

To increase power, press the switch upwards. To decrease power, press the switch downwards.



*TYPICAL - LH SIDE OF FUEL TANK  
1. Mode switch*

To activate Standard mode when in Sport mode, press bottom end of switch once.

To activate ECO mode when in Sport mode, press bottom end of switch twice.

To activate ECO mode when in Standard mode, press bottom end of switch once.



*TYPICAL  
Step 1: Press bottom end of switch*

## **⚠ WARNING**

Ensure passenger is advised to hold on tightly before activating Sport mode. Sport mode provides increased acceleration.

To activate Sport mode when in Standard mode, press top end of switch once.

To activate Sport mode when in ECO mode, press top end of switch twice.

To activate Standard mode when in ECO mode, press top end of switch once.

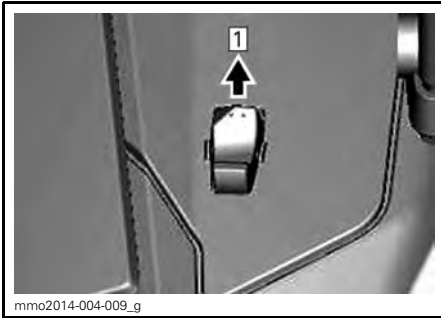

TYPICAL  
Step 1: Press top end of switch

### **⚠ WARNING**

When adjusting modes, be sure to maintain situational awareness of other snowmobiles, obstacles, or persons .

## Learning Key Modes

The learning key provides a mode of operation whereby engine torque and speed are limited.

**NOTE:** The initial learning key programming can limit the speed to 40 km/h (25 MPH) or 70 km/h (43 MPH). Refer to your authorized Ski-Doo dealer to modify this setting.

There are 3 levels available for the learning key mode.

### Changing Learning Key Settings

To change learning key setting, carry out the following:

1. Press the START/electronic reverse button to wake up the electrical system and install the NORMAL key on the engine cut-off switch.

2. Wait for the information center to complete its self-test and display the key recognition message.

### Analog/Digital Gauge

3. Press the SET button until LEARN is visible in the digital screen of the information center.

### Multifunction Analog/Digital Gauge

4. Press the MODE button once, then press the SET button until LEARN is visible in the digital center of the gauge.



MULTIFUNCTION GAUGE

1. MODE function
2. SET function

### All Models

5. Use the heated grip switch to toggle the key setting between 1 and 3.

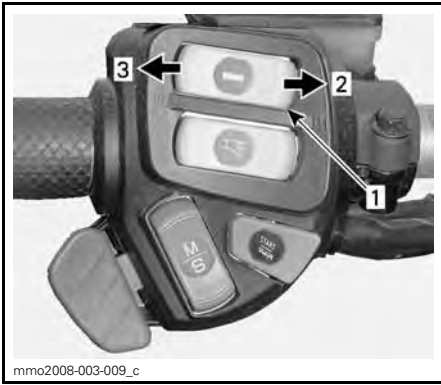

1. Heated grips switch
2. Increase
3. Decrease

**NOTE:** Setting 1 is the lowest available torque, while setting 3 is the highest available torque for learning key.

6. After a few seconds, the setting is automatically confirmed and saved.

**NOTE:** The key speed setting is applicable to any key of the same type used on a specific snowmobile. The same key type used on a different snowmobile may therefore have a different key speed setting.

**NOTE:** Vehicle performance may vary depending on riding conditions.

# BASIC PROCEDURES

## Engine Starting Procedure

### Procedure

1. Apply parking brake.
2. Recheck throttle control lever operation.
3. Put your helmet on.
4. Ensure that the tether cord cap is installed on the engine cut-off switch and that the cord is attached to your clothing eyelet.
5. Ensure that the emergency engine stop switch is in the ON position.
6. Depress the START/electronic reverse button to engage the electric starter and start the engine. Release button immediately when engine has started.

### **⚠ WARNING**

Never depress throttle while starting engine.

7. Release parking brake.

**NOTE:** For an initial cold start, do not release parking brake. Perform the *VEHICLE WARM-UP* procedure as explained below.

**NOTICE** Do not engage electric starter for more than 10 seconds at a time. A rest period of at least 30 seconds should be observed between the cranking cycles to allow electric starter to cool down.

### Manual Start Models

Grab rewind starter handle, pull handle slowly until a resistance is felt, then hold handle firmly and pull vigorously to start engine.

### Electric Start Models

Depress the START/RER button to engage the electric starter and start the engine. Release button immediately when engine has started.

**NOTICE** Do not engage electric starter for more than 10 seconds at a time. A rest period should be observed between the cranking cycles to allow electric starter to cool down.

## Emergency Starting

### *1200 4-TEC and 900 ACE*

Do not attempt an emergency starting procedure. Have the battery charged or replaced.

### *E-TEC*

The engine can be started with the emergency starter rope supplied with the tool kit.

Remove drive belt guard.

### **⚠ WARNING**

Do not wind starting rope around your hand. Hold rope by the handle only. Do not start the snowmobile by the drive pulley unless it is a true emergency situation. Have the snowmobile repaired as soon as possible.



Attach one end of emergency rope to rewind handle.

**NOTE:** The spark plug socket can be used as an emergency handle.





Attach the other end of emergency rope to the starter clip supplied in the tool kit.



Hook up clip on drive pulley.

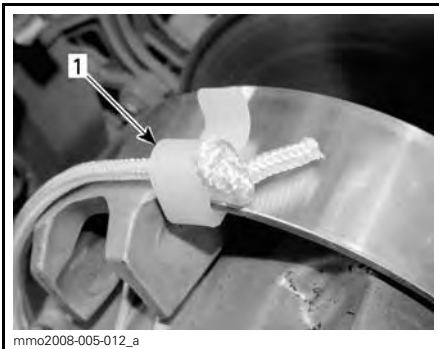

1. *Clip installation location*

Wind the rope tightly around drive pulley. When pulled, pulley must rotate counterclockwise.

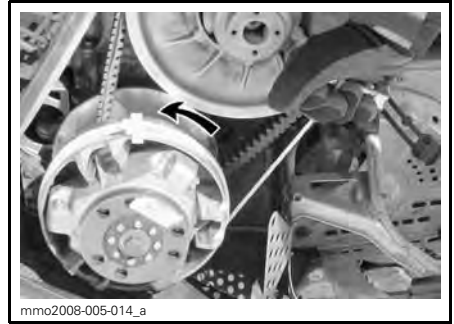

Pull the rope using a sharp, crisp pull so the rope comes free of the drive pulley. Start engine as per usual manual starting.

### **⚠ WARNING**

When starting the snowmobile in an emergency situation, using drive pulley, do not reinstall the drive belt guard and return slowly to have snowmobile repaired.

## **Vehicle Warm-Up**

Before every ride, vehicle has to be warmed up as follows.

1. Start engine as explained in *ENGINE STARTING PROCEDURE* above.
2. Allow engine to warm up one or two minutes at idle speed.

**NOTE:** The engine will shut down after approximately 12 minutes of idling.

3. Disengage parking brake.
4. Apply throttle until drive pulley engages. Drive at low speed the first two or three minutes.

**NOTICE** If vehicle does not move when throttle is applied, stop engine, remove tether cord cap from the engine cut-off switch, then do the following.

- Check if skis are stuck on the ground. Lift one ski at a time by the handle, then put it down.
- Check if track is stuck on the ground. Lift rear of snowmobile enough to clear track from the ground, then drop.
- Check rear suspension for hard snow or ice accumulation that could interfere with track rotation. Clean the area.

**CAUTION** Use proper lifting techniques, notably using your legs force. Do not attempt to lift the either end of the vehicle if it is above your limits.

**WARNING**  
Make sure tether cord cap is removed before standing in front the vehicle, getting close to the track or rear suspension components.

**NOTE:** On E-TEC models, warm-up is controlled by the engine management system. During this period (up to 10 minutes depending on ambient temperature), engine RPM is limited.

### Engaging Reverse (RER) (E-TEC)

When the engine is running, depressing the RER button will slow down engine RPM to almost a stop and advance the ignition timing to invert crankshaft rotation.

- Engine will automatically shift into forward when restarting after stopping or stalling.
- Shifting procedure will take place only when the engine is running.

- If engine is running at a speed above 4300 RPM, the function of the RER button is disabled.
- It is recommended to warm up the engine to its normal operating temperature before shifting.

### Shifting in Reverse

1. Bring vehicle to a complete stop.
2. Apply and hold brake. Remain seated, refer to *RIDER POSITION (REVERSE OPERATION)* for posture information.
3. With engine at idle speed, press and release the RER button.
4. Wait until reverse beeper sounds, then gently depress throttle lever.

**WARNING**  
Engaging the reverse mode is done by depressing the RER button when the engine is running. Wait until the reverse alarm sounds and the RER pilot lamp comes on in the analog/digital gauge before operating throttle to proceed in reverse. The reverse speed is not limited. Always proceed with caution as fast reverse could result in loss of vehicle stability. Come to complete stop before depressing RER button. Always remain seated and apply the brake before shifting. Ensure the path behind is clear of obstacles or bystanders before proceeding.

### Shifting in Forward

1. Bring vehicle to a complete stop.
2. Apply and hold brake.
3. Press and release the RER button.
4. RER pilot lamp will stop.
5. Apply throttle slowly and evenly. Allow drive pulley to engage then accelerate carefully.

## Shifting in Reverse or Forward (900 ACE and 1200 4-TEC)

### WARNING

When shifting in reverse, wait until the reverse alarm sounds and the pilot lamp comes on in the analog/digital gauge before operating throttle. The reverse speed is not limited. Always proceed with caution as fast reverse could result in loss of vehicle stability. Come to complete stop before depressing engaging the reverse. Always remain seated and apply the brake before shifting. Ensure the path behind is clear of obstacles or bystanders before proceeding.

### Reverse (Manual Shift Models)

#### Shifting in Reverse

To engage reverse gear, proceed as follows:

1. Bring vehicle to a complete stop.
2. Apply and hold brake. Remain seated, refer to *RIDER POSITION (REVERSE OPERATION)* for posture information.
3. With engine at idle speed, pull the reverse shift lever all the way out.
4. Gently depress throttle lever.

#### Shifting in Forward

To engage forward gear, proceed as follows:

1. Bring vehicle to a complete stop.
2. Apply and hold brake.
3. With engine at idle speed, push the reverse shift lever all the way in.
4. Gently depress throttle lever.

### Reverse (Electronic Shift Models)

#### Shifting in Reverse/Shifting in Forward

To engage reverse or forward, proceed as follows:

1. Bring vehicle to a complete stop.
2. Apply and hold brake.
3. With engine at idle speed, press the START/REAR button and release.
4. Gently depress throttle lever.

### Shutting Off the Engine

Release throttle lever and wait until engine has returned to idle speed.

Shut off the engine using either the emergency engine stop switch or by pulling off the tether cord cap from the engine cut-off switch.

### WARNING

Always remove the tether cord cap from engine cut-off switch when vehicle is not in operation in order to prevent accidental engine starting, theft or use by unauthorized persons.

---

# SPECIAL OPERATION

## Towing an Accessory

Always use a rigid tow bar to tow an accessory. Any towed accessory should have reflectors on both sides and at the rear. Check local laws for brake light(s) requirements.

### WARNING

Never tow an accessory with a rope. Always use a rigid tow bar. Using a rope would result in a collision between the object and the snowmobile and possibly in a tip over in case of a rapid deceleration or on a downward slope.

## Towing Another Snowmobile

If a snowmobile is disabled and must be towed use a rigid tow bar. Remove the drive belt from disabled snowmobile, refer to *DRIVE BELT* in the *MAINTENANCE PROCEDURES* subsection and tow at moderate speed.

**NOTICE** Always remove the drive belt of the snowmobile that is to be towed to prevent damage to its drive belt and drive system.

In an emergency situation only, if a rigid tow bar is not available, use a rope. Proceed with extra caution. In some areas, it may be illegal to do so. Check with state or local authorities.

Remove the drive belt, attach the rope to the ski legs (spindles), have someone sit on the towed snowmobile to activate the brake, and tow at low speed.

**NOTICE** In order to prevent damage to the steering system, never attach the tow rope to the ski loops (handles).

### WARNING

Never ride at high speed when towing a disabled snowmobile. Proceed slowly with extra caution.

# TUNE YOUR RIDE

Snowmobile handling and comfort depend upon suspension adjustments.

## **⚠ WARNING**

Suspension adjustment could affect vehicle handling. Always take time to familiarize yourself with the vehicle's behavior after any suspension adjustment have been made. Always adjust LH and RH suspension components to the same setting.

Choice of suspension adjustments vary with carrying load, operator's weight, personal preference, riding speed and field condition.

**NOTE:** Some adjustments may not apply to your snowmobile.

## **⚠ WARNING**

Before proceeding with any suspension adjustment, remember:

- Park in a safe place.
- Remove the tether cord cap from the engine cut-off switch.
- Use appropriate lifting device or have assistance to share lifting stress. If a lifting device is not used, use proper lifting techniques, notably using your legs force.
- Do not attempt to lift the front or rear of vehicle if it is above your limits.
- Support front of vehicle off the ground with a suitable device before adjusting suspension.
- Support rear of vehicle off the ground with a wide-base snowmobile stand with a rear deflector panel.
- Make sure support device is stable and secure.

are interrelated. It may be necessary to readjust center spring after adjusting front springs for instance. Test run the snowmobile under the same conditions; trail, speed, snow, operator riding position, etc. Proceed methodically until you are satisfied.

Following are guidelines to fine-tune suspension. Use suspension adjustment tool provided in the tool kit.

## **Rear Suspension Adjustments (rMotion)**

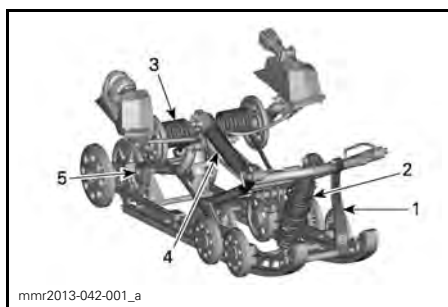

*rMOTION - ADJUSTABLE COMPONENTS*

1. Stopper strap
2. Center spring
3. Rear springs
4. Rear shock absorber
5. Coupling blocks (RH side shown)

**NOTICE** Whenever adjusting rear suspension, check track tension and adjust if necessary.

### **Stopper Strap**

Stopper strap length has an effect on the amount of weight the center spring has to carry especially during acceleration, therefore on the front end uplift.

Stopper strap length also has an effect on center spring travel.

**NOTICE** Whenever stopper strap length is changed, track tension must be checked.

The best way to set up the suspension is to customize each adjustment one at a time. Various adjustments

ACTION	RESULT
Increasing stopper strap length	Lighter ski pressure under acceleration
	More center spring travel
	More bump absorption capability
Decreasing stopper strap length	Heavier ski pressure under acceleration
	Less center spring travel
	Less bump absorption capability

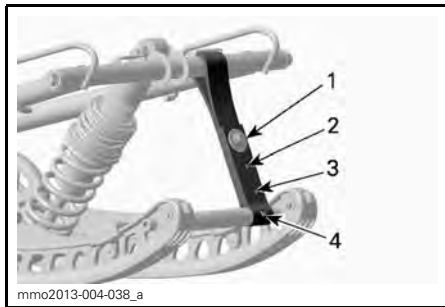

**TYPICAL**

1. Position 1 (longest, factory setting)
2. Position 2
3. Position 3
4. Position 4

**NOTE:** Decreasing the stopper strap length may reduce comfort. If too much weight transfer is felt, try to correct it by adjusting the coupling blocks first. Always install stopper strap bolt as close as possible to the lower shaft.

When operating the snowmobile in deep snow, it may be necessary to vary stopper strap length and/or riding position, to change the angle at which the track rides on the snow. Operator's familiarity with the various adjustments as well as snow conditions will dictate the most efficient combination.

Generally, a longer stopper strap setting gives better performance in deep snow on a flat landscape.

**Center Spring**

Center spring preload has an effect on steering effort, handling and bump absorption.

Also, since center spring preload adjustment puts more or less pressure on the front of the track, it has an effect on the performance in deep snow.

**⚠ CAUTION** For ring type, do not excessively decrease preload. The length of the two springs combined, when suspension is fully extended, should not exceed 234 mm (9 in).

ACTION	RESULT
Increasing preload	Lighter steering
	More bump absorption capability
	Better deep snow starts
	Better deep snow performance and handling
Decreasing preload	Heavier steering
	Less bump absorption capability
	Better trail handling

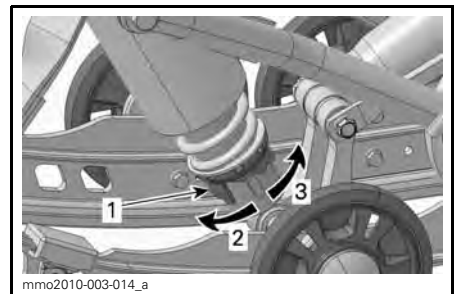

**CAM TYPE - MOTION CONTROL SHOCK ABSORBER**

1. Spring preload adjustment cam
2. Increase preload
3. Decrease preload

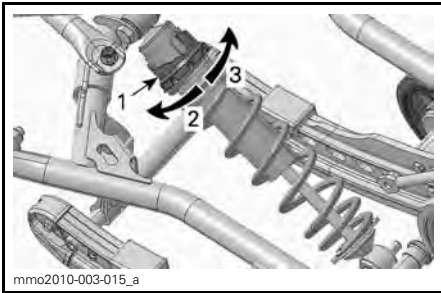

mmo2010-003-015\_a

**CAM TYPE - HPG™ SHOCK ABSORBER**

1. Spring preload adjustment cam
2. Decrease preload
3. Increase preload

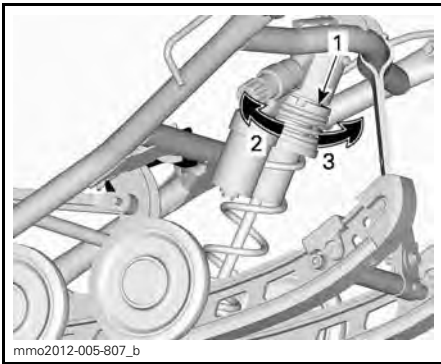

mmo2012-005-807\_b

**TYPICAL - RING TYPE**

1. Spring preload adjustment ring
2. Increase preload
3. Decrease preload

**NOTE:** Use the suspension adjustment tool provided in the tool kit.

**Rear Springs**

Rear spring preload has an effect on comfort, ride height and load compensation.

Also, adjusting rear spring preload shifts more or less weight to the snowmobile front end. As a result, more or less weight is applied to the skis. This has an effect on performance in deep snow, steering effort and handling.

Slight suspension bottoming occurring under the worst riding conditions indicates a good choice of spring preload.

ACTION	RESULT
Increasing preload	Firmer rear suspension
	Higher rear end
	More bump absorption capability
	Heavier steering
Decreasing preload	Softer rear suspension
	Lower rear end
	Less bump absorption capability
	Lighter steering
	Better deep snow performance and handling

Refer to the following to determine if preload is correct.

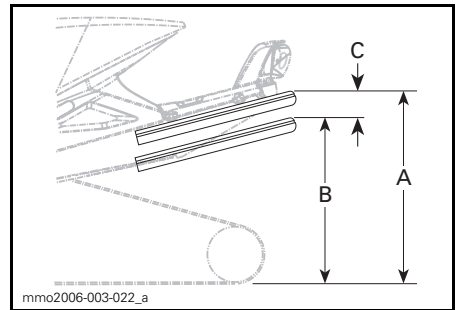

mmo2006-003-022\_a

**TYPICAL — PROPER ADJUSTMENT**

- Suspension fully extended
- Suspension has collapsed with operator, passenger and load added
- Distance between dimension "A" and "B", see table below

"C"	WHAT TO DO
50 to 75 mm (2 to 3 in)	No adjustment required
More than 75 mm (3 in)	Adjusted too soft, increase preload
Less than 50 mm (2 in)	Adjusted too firm, decrease preload

**NOTE:** If the specification is unattainable with the original springs, see an authorized Ski-Doo dealer for other available springs.

***rMotion Without Quick Adjust Knob System***

To increase spring preload using tool, always turn the left side adjustment cam in a clockwise direction, and the right side cam in a counterclockwise direction.

**⚠ CAUTION** Never set preload cams directly from position 5 to 1 or directly from position 1 to 5.

**⚠ WARNING**

Both rear spring preload must be set at the same position. Otherwise vehicle behavior may be unpredictable and suspension may become warped.

The adjustment cams have 5 different settings, 1 being the softest.

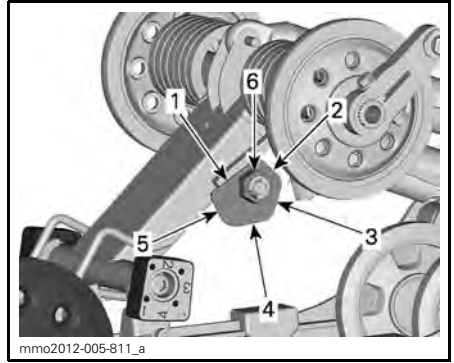

***rMOTION WITHOUT QUICK ADJUST SYSTEM— RH SIDE***

1. Position 1
2. Position 2
3. Position 3
4. Position 4
5. Position 5
6. Adjustment nut

***rMotion with Quick Adjust Knob System***

Turn the left side knob to adjust the spring preload.

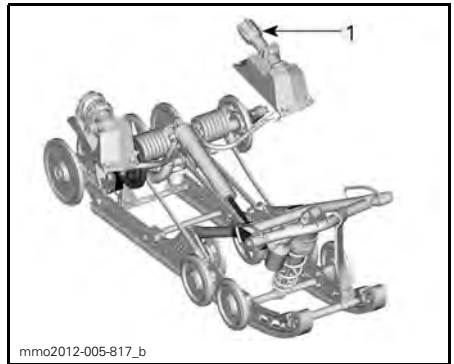

***rMOTION WITH QUICK ADJUST SYSTEM***  
1. LH side knob to adjust spring preload

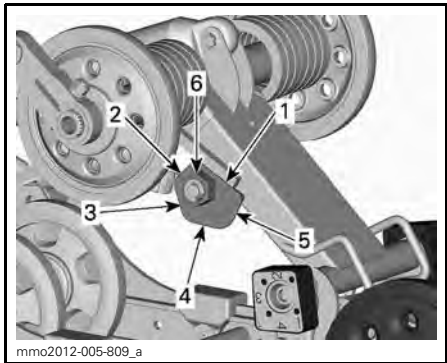

***rMOTION WITHOUT QUICK ADJUST SYSTEM— LH SIDE***

1. Position 1
2. Position 2
3. Position 3
4. Position 4
5. Position 5
6. Adjustment nut



ACTION	RESULT
Increasing preload	Firmer rear suspension
	Higher rear end
	More bump absorption capability
	Heavier steering
Decreasing preload	Softer rear suspension
	Lower rear end
	Less bump absorption capability
	Lighter steering
	Better performance and handling in deep snow

**Rear Shock Absorber**

**Rear Shock Compression Damping**

**NOTE:** Both low and high speed compression damping are adjusted simultaneously.

Low speed compression damping controls how the shock absorber reacts to a low suspension velocity (slow compression strokes, in most cases when riding at lower speeds).

High speed compression damping controls how the shock absorber reacts to a high suspension velocity (quick compression strokes, in most cases when riding at higher speeds).

ACTION	RESULT ON BIG AND SMALL BUMPS
Increasing compression damping force	Firmer compression damping
Decreasing compression damping force	Softer compression damping

**rMotion Without Quick Adjust Knob System**

To adjust, turn the adjuster button located on the oil reservoir on shock clockwise to increase compression damping force and counterclockwise to decrease compression damping force.

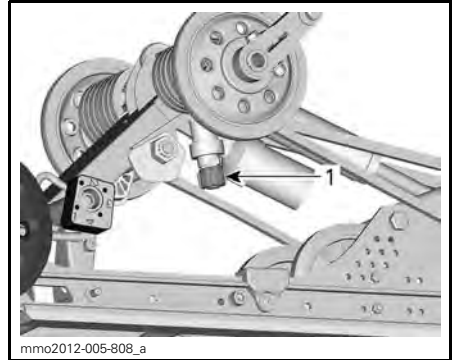

1. Compression damping adjustment button

**rMotion wth Quick Adjust Knob System**

Turn the right side knob to adjust the shock compression speed.

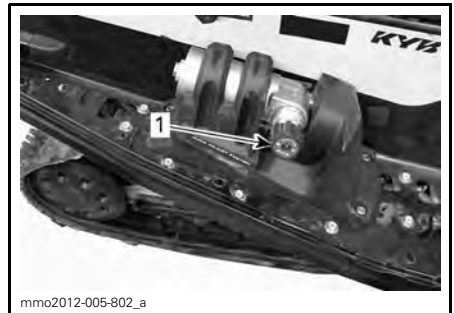

**rMOTION — RH SIDE**  
1. Knob to adjust low/high speed compression damping

**Rear Shock Mounting Position**

Two rear shock mounting position of fer two ride mounting position: high performance and sport.

Factory setting is set to lowest mounting position (high performance) which will suit most operators riding preferences. The sport mounting hole adjustment allows for another range of softer settings, but all other rear suspension adjustments should be performed before changing the rear shock mounting position.

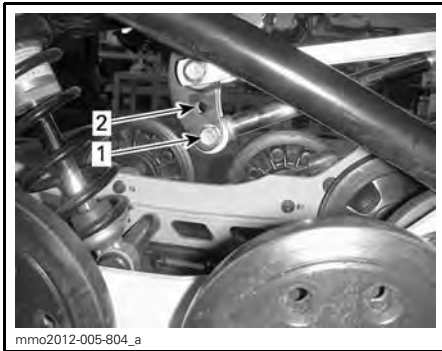

**REAR SHOCK MOUNTING POSITION**

1. High performance position
2. Sport position

### Coupling Blocks

Coupling blocks adjustment has an effect on vehicle handling during acceleration only.

**NOTE:** A high coupling block setting will reduce both comfort and transfer under acceleration.

To adjust, push on release button under cam and turn coupling block to the desired setting.

Place the desired setting number towards rubber stopper. No tools required.

### **⚠ WARNING**

Both blocks must be set at the same position. Otherwise vehicle behavior may be unpredictable and suspension may become warped.

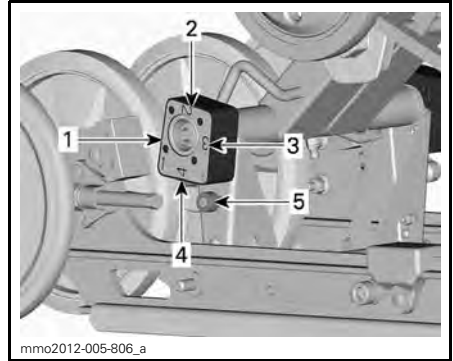

**COUPLING BLOCK — RIGHT SIDE VIEW**  
("R" — RIGHT EMBOSSED ON BLOCK)

1. Position 1 (minimum)
2. Position 2
3. Position 3
4. Position 4 (maximum)
5. Release button

### Coupling Blocks Setting

POSITION	USE
1	More ski lift during acceleration - and best comfort
2	Intermediate setting
3	Intermediate setting
4	Less ski lift during acceleration - and some comfort loss

### ACS Rear Shock Air Pressure

#### *rMotion with ACS*

The operator can adjust the comfort and ride height by adjusting the air pressure inside the air shock absorber.

To adjust, proceed as follows:

1. Start engine.
2. Press the MODE (M) button to select suspension mode.

When the air suspension mode is selected, AIR\_SUSP is displayed. The display also shows the actual suspension setting (a number from 1 to 5, 1 being the softest setting).

- Depress the heated throttle lever switch as shown to increase or decrease air pressure.

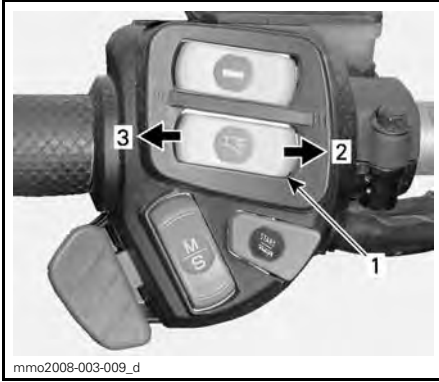

#### VARIABLE INTENSITY

- Heated throttle lever switch
- Increase pressure
- Decrease pressure

- The desired set point appears on the display. To confirm, press the MODE (M) button or wait 5 seconds.



- Set point
- Actual setting

## Front Suspension Adjustments

### Front Springs

#### Spring Preload

Front spring preload has an effect on front suspension firmness.

Front spring preload also has an effect on the steering behavior.

ACTION	RESULT
Increasing preload	Firmer front suspension
	Higher front end
	More precise steering
Decreasing preload	More bump absorption capability
	Softer front suspension
	Lower front end
	Lighter steering
	Less bump absorption capability

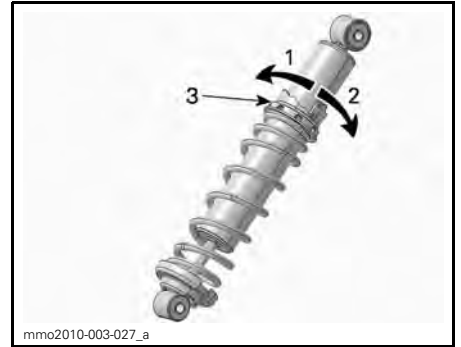

#### CAM TYPE - HPG SHOCK ABSORBER

- Decrease preload
- Increase preload
- Spring preload adjustment cam

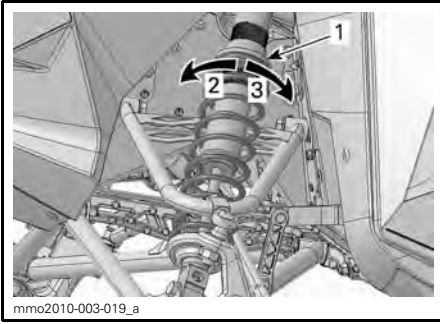

mmo2010-003-019\_a

**TYPICAL- RING TYPE**

1. Spring preload adjustment ring
2. Increase preload
3. Decrease preload

**NOTICE** On KYB PRO Series shock absorbers, in order to have a sufficient preload, the spring free length (with skis off the ground) must not exceed 270 mm (10.63 in). An insufficient preload can cause the spring stopper to fall off the shock absorber.

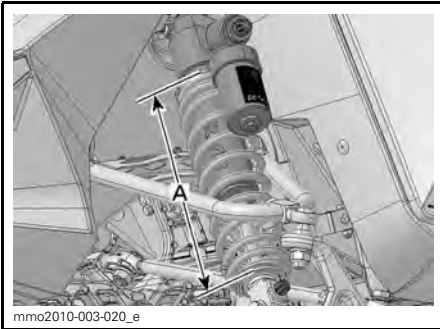

mmo2010-003-020\_e

1. Maximum 270 mm (10.63 in) with skis off the ground

ACTION	RESULT
Increasing rebound damping force	Firmer rebound damping (extension stroke)
Decreasing rebound damping force	Softer rebound damping (extension stroke)

**NOTE:** In repetitive short small bumps (ripple), it is recommended to use a lower rebound damping setting.

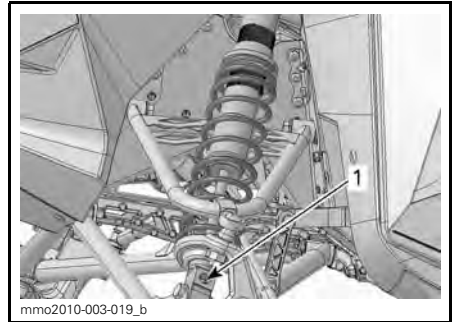

mmo2010-003-019\_b

1. Rebound adjuster (knob or slot)

**Front Shock Absorbers**

**Shock Rebound Damping**

*HPG Plus R Only*

Rebound damping controls how the shock absorber restrains the extension stroke.

## Vehicle Behavior Related to Suspension Adjustment

PROBLEM	CORRECTIVE MEASURES
Front suspension darting	Check ski alignment: <ul style="list-style-type: none"> <li>– Reduce front suspension spring preload.</li> <li>– Increase center spring preload.</li> <li>– Reduce rear spring preload.</li> </ul>
Steering feels too heavy at steady speeds	<ul style="list-style-type: none"> <li>– Reduce front suspension spring preload.</li> <li>– Increase center spring preload.</li> </ul>
Steering feels too heavy during acceleration	<ul style="list-style-type: none"> <li>– Set coupling blocks to a lower position.</li> <li>– Reduce rear spring preload.</li> <li>– Lengthen limiter strap.</li> </ul>
Too much ski lift during cornering or acceleration	<ul style="list-style-type: none"> <li>– Set coupling blocks to a higher position.</li> <li>– Shorten limiter strap.</li> <li>– Increase rear spring preload.</li> </ul>
Rear of snowmobile seems too stiff	<ul style="list-style-type: none"> <li>– Reduce rear spring preload.</li> <li>– Reduce compression damping adjustment if equipped.</li> </ul>
Rear of snowmobile seems too soft	<ul style="list-style-type: none"> <li>– Increase rear spring preload.</li> </ul>
Rear suspension is frequently bottoming	<ul style="list-style-type: none"> <li>– Increase rear spring preload.</li> <li>– Increase center spring preload.</li> <li>– Lengthen limiter strap.</li> <li>– Increase compression damping adjustment if equipped.</li> </ul>
Snowmobile seems to pivot around its center	<ul style="list-style-type: none"> <li>– Reduce center spring preload.</li> <li>– Increase rear spring preload.</li> <li>– Increase front suspension spring preload.</li> <li>– Shorten limiter strap.</li> </ul>
Track spins too much at start	<ul style="list-style-type: none"> <li>– Set coupling blocks to a lower position.</li> <li>– Lengthen limiter strap.</li> </ul>

---

# VEHICLE TRANSPORTATION

Make sure the fuel tank cap is properly installed.

Tilt bed trailers can easily be equipped with a winch mechanism to afford maximum safety in loading. Simple as it may seem, never drive your snowmobile onto a tilt bed trailer or any other kind of trailer or vehicle. Many serious accidents have resulted from driving up and over a trailer. Anchor your vehicle securely, front and rear, even on short hauls. Be certain all equipment is securely fastened. Cover your snowmobile when trailering to prevent road grime from causing damage.

Be certain your trailer meets state or provincial requirements. Ensure the hitch and safety chains are secure and the brake, turn indicators and clearance lights all function.

## **WARNING**

Do not tow the vehicle facing backwards. If the vehicle is towed facing backwards, the wind may cause damage to the windshield or even loss of the windshield.

# ***MAINTENANCE***

---

## **BREAK-IN INSPECTION**

We suggest that after the first 10 hours or 500 km (300 mi) of operation, whichever comes first, your vehicle be inspected by an authorized Ski-Doo dealer. The break-in inspection is very important and must not be neglected.

**NOTE:** The break-in inspection is at the expense of the vehicle owner.

We recommend that this inspection be signed by an authorized Ski-Doo dealer.

---

Date of inspection

---

Authorized dealer signature

---

Dealer name



**BREAK-IN INSPECTION 600 HO E-TEC AND 800R E-TEC**

Inspect exhaust system and check for leaks

Check coolant level

Inspect fuel lines and connections

Inspect throttle cable

Inspect drive belt

Visually inspect drive pulley

Tighten drive pulley retaining screw to specified torque

Inspect driven pulley

Adjust and align track

Change chaincase oil

Adjust drive chain

Check brake fluid level

Inspect brake hose, pads and disk

Inspect steering mechanism

Inspect skis and runners

Inspect front suspension

Inspect rear suspension (including stopper strap and slider shoes)

<b>BREAK-IN INSPECTION (900 ACE)</b>
Inspect engine seals and gaskets for leaks
Inspect exhaust system and check for leaks
Check coolant level
Change engine oil and filter
Inspect fuel lines and connections
Inspect drive belt
Visually inspect drive pulley
Tighten drive pulley retaining screw to specified torque
Inspect driven pulley
Check driven pulley preload
Adjust and align track
Change chaincase oil
Adjust drive chain
Check brake fluid level
Inspect brake hose, pads and disk
Inspect steering mechanism
Inspect skis and runners
Inspect front suspension
Inspect rear suspension (including stopper straps and slider shoes)

BREAK-IN INSPECTION (1200 4-TEC)
Inspect engine seals and gaskets for leaks
Inspect exhaust system and check for leaks
Check coolant level
Change engine oil and filter
Inspect fuel lines and connections
Inspect throttle cable
Inspect drive belt
Visually inspect drive pulley
Tighten drive pulley retaining screw to specified torque
Inspect driven pulley
Adjust and align track
Change chaincase oil
Adjust drive chain
Check brake fluid level
Inspect brake hose, pads and disk
Inspect steering mechanism
Inspect skis and runners
Inspect front suspension
Inspect rear suspension (including stopper strap and slider shoes)

# MAINTENANCE SCHEDULE (600 HO E-TEC AND 800R E-TEC)

## EVERY 1 500 KM (1,000 MI)

Adjust drive chain

Check chaincase oil level

## EVERY 3 000 KM (2,000 MI) OR 1 YEAR (WHICHEVER COMES FIRST)

Inspect engine rubber mounts

Inspect exhaust system and check for leaks

Adjust engine stopper

Visually inspect and clean drive pulley

Tighten drive pulley retaining screw to specified torque

Clean driven pulley

Adjust and align track

Inspect brake hose, pads and disk

Inspect steering mechanism

Inspect front suspension

Inspect rear suspension (including stopper strap and slider shoes)

Lubricate rear suspension (lubricate whenever the vehicle is used in wet conditions (rain, puddles))

## EVERY 6 000 KM (4,000 MI) OR 2 YEARS (WHICHEVER COMES FIRST)

Inspect fuel pump strainer and replace if necessary

Replace brake fluid

Inspect throttle cable

Clean and lubricate rewind starter

Replace the following drive pulley wear parts: slider shoes, O-rings and sliding sheave bushing (800R E-TEC)

**EVERY 10 000 KM (6,000 MI) OR 3 YEARS  
(WHICHEVER COMES FIRST)**

Replace spark plugs

Inspect oil injection pump strainer and clean if needed

Replace the following drive pulley wear parts: spring cover bushing and ramps  
(800R E-TEC)

**EVERY 5 YEARS**

Replace engine coolant

Replace in-line fuel filter

# MAINTENANCE SCHEDULE (900 ACE AND 1200 4-TEC)

NOTE: The maintenance schedule does not exempt the pre-ride inspection.

## EVERY 1 500 KM (1,000 MI)

Adjust drive chain

Check chaincase oil level

## EVERY 3 000 KM (2,000 MI) OR 1 YEAR (WHICHEVER COMES FIRST)

Replace drive pulley O-rings

Inspect exhaust system and check for leaks

Visually inspect and clean drive pulley

Tighten drive pulley retaining screw to specified torque

Adjust and align track

Inspect brake hose, pads and disk

Inspect steering mechanism

Inspect front suspension

Inspect rear suspension (including stopper strap and slider shoes)

Lubricate rear suspension (lubricate whenever the vehicle is used in wet conditions (rain, puddles))

## EVERY 6 000 KM (4,000 MI) OR AT PRE-SEASON (WHICHEVER COMES FIRST)

Change engine oil and filter

## EVERY 6 000 KM (4,000 MI) OR 2 YEARS (WHICHEVER COMES FIRST)

Replace fuel filter (1200 4-TEC)

Replace fuel pump outlet filter (900 ACE)

Inspect drive pulley sliders and replace if necessary (1200 4-TEC)

Replace brake fluid

Inspect throttle cable (1200 4-TEC)

Clean and lubricate rewind starter

**EVERY 10 000 KM (6,000 MI) OR 3 YEARS  
(WHICHEVER COMES FIRST)**

Replace spark plugs

**EVERY 20 000 KM (12,500 MI)**

Check valve clearance and adjust if necessary

**EVERY 5 YEARS**

Replace engine coolant

# MAINTENANCE PROCEDURES

Maintenance is very important for keeping your vehicle in safe operating condition. Proper maintenance is the owner's responsibility. The vehicle should be serviced as per the maintenance schedule.

## **⚠ WARNING**

Failure to properly maintain the vehicle according to the maintenance schedule and procedures can make it unsafe to operate.

This section includes instructions for basic maintenance procedures. If you have the necessary mechanical skills and the required tools, you can perform these procedures. If not, see your authorized Ski-Doo dealer.

Other important items in the maintenance schedule that are more difficult and require special tools are best performed by your authorized Ski-Doo dealer.

## **⚠ WARNING**

Turn off the engine, remove tether cord cap and follow these maintenance procedures when performing maintenance. If you do not follow proper maintenance procedures you can be injured by hot parts, moving parts, electricity, chemicals or other hazards.

## **⚠ WARNING**

Should removal of a locking device be required (e.g. lock tabs, self-locking fasteners, etc.) when undergoing disassembly/assembly, always replace with a new one.

## **Air Filter**

### **Air Filter Verification**

Ensure that air filter is properly installed, clean and in good condition.



1. Air filter

If the air filter has to be cleaned or replaced, see an authorized Ski-Doo dealer.

## **Engine Coolant**

### **⚠ WARNING**

Never open coolant tank cap when engine is hot.

### **Engine Coolant Level Verification**

#### ***600 HO E-TEC and 800R E-TEC***

The engine coolant tank is located under the hood. See *CONTROLS, INSTRUMENTS AND EQUIPMENT* for hood removal procedure.

#### ***1200 4-TEC***

The engine coolant tank is located behind the RH side panel. See *CONTROLS, INSTRUMENTS AND EQUIPMENT* for side panel opening procedure.

#### ***All Models***

Check coolant level at room temperature with the cap removed. Liquid should be at cold level line (engine cold) of coolant tank.

**NOTE:** When checking level at low temperature it may be slightly lower than the mark.

If additional coolant is necessary or if entire system has to be refilled, refer to an authorized Ski-Doo dealer.





1200 4-TEC MODEL SHOWN

1. Coolant tank
2. COLD LEVEL line

### Recommended Engine Coolant

Always use ethylene-glycol antifreeze containing corrosion inhibitors specifically for internal combustion aluminum engines.

Cooling system must be filled with (P/N 219 702 685) or with distilled water and antifreeze solution (50% distilled water, 50% antifreeze).

### Engine Oil (900 ACE)

#### Recommended Engine Oil

RECOMMENDED ENGINE OIL
(P/N 293 600 112)

**NOTICE** The engine of this snowmobile has been developed and validated using the recommended BRP XPS™ oil. BRP strongly recommends the use of its recommended XPS oil at all times. Damages caused by oil which is not suitable for the engine will not be covered by the BRP limited warranty.

If the recommended oil is not available, use SAE 0W-40 synthetic-based oil that meets or exceeds the requirements for API service classification SM.

### Engine Oil Level Verification

**NOTICE** Check level every 10 hours of use and refill if necessary. Do not overfill. Operating the engine with an improper level may severely damage engine. Wipe off any spillage.

Make sure the engine is at normal operating temperature.

**NOTE:** The engine reaches normal temperature when the rear radiator gets warm indicating the thermostat has opened.

Place vehicle on a level surface and proceed as follows to check oil level:

1. Let engine run at idle for approximately 30 seconds.
2. Stop engine.
3. Open the LH side panel, refer to *CONTROLS, INSTRUMENTS AND EQUIPMENT*.
4. Remove the drive belt guard, refer to *CONTROLS, INSTRUMENTS AND EQUIPMENT*.
5. Remove dipstick from the filler tube, then wipe it clean.
6. Completely insert dipstick in the filler tube.
7. Remove dipstick and check the oil level. Oil level should be between the MIN. and MAX. marks as shown, add if necessary.

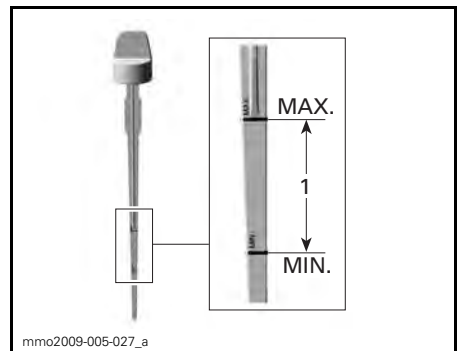

1. Oil level between MIN. and MAX.

**⚠ WARNING**

Wipe off any oil spills. Oil is highly flammable when heated.

**Engine Oil Replacement**

**⚠ WARNING**

The engine oil can be very hot. Wait until engine oil is warm.

**NOTICE** Engine oil and oil filter must be replaced at the same time.

1. Place vehicle on a level surface.
2. Remove the LH side panel.
3. Remove dipstick.

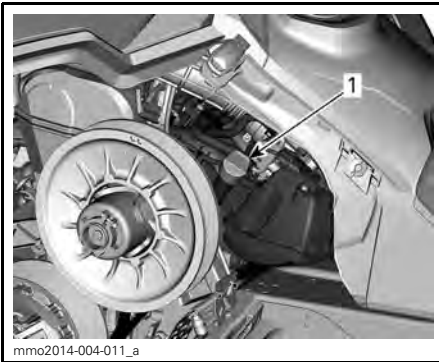

mmo2014-004-011\_a

**LH SIDE OF VEHICLE**

1. Oil tank dipstick
4. From underneath the vehicle, access the drain plug:
    - 4.1 Remove one access cover retaining screw and loosen the other.
    - 4.2 Pivot the access cover to clear the bottom pan opening.



mmo2014-004-012\_a

1. Drain plugs access cover

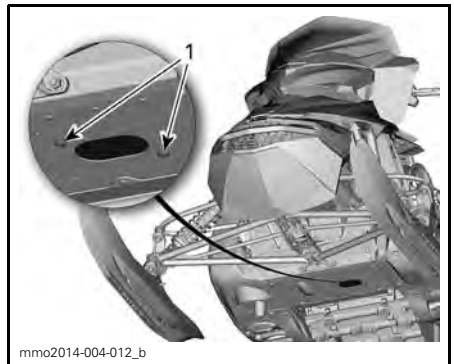

mmo2014-004-012\_b

**PIVOT THE ACCESS COVER**

1. Retaining screws
5. Clean drain plug area.
  6. Place a drain pan under the bottom pan opening.
  7. Remove engine drain plugs in the following order.
    - 7.1 Main drain plug.
    - 7.2 Secondary drain plug.

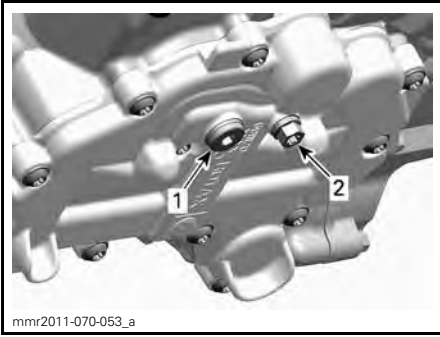

**UNDERNEATH THE ENGINE**

1. Main drain plug
2. Secondary drain plug

8. Allow oil to drain completely.
9. Install **NEW** sealing washers on oil drain plugs.

**NOTICE** Never use a sealing washer a second time. Always replace with a new one.

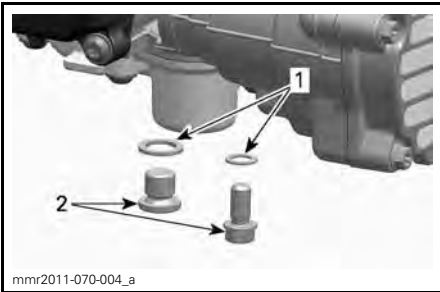

1. Sealing washer
2. Oil drain plug

10. Install drain plugs and tighten to the specified torque.

**DRAIN PLUGS TIGHTENING TORQUE**

20 N•m ± 2 N•m (15 lbf•ft ± 1.5 lbf•ft)

11. Replace *OIL FILTER*, see procedure in this subsection.
12. Refill oil tank at the proper level with the recommended oil.

**APPROXIMATE ENGINE OIL CAPACITY (WITH FILTER)**

3.3 L (3.5 qt (U.S. liq.))

13. Reinstall dipstick in oil tank and properly tighten it.
14. Start engine and let it idle for a few minutes.
15. Ensure there are no leaks.
16. Stop engine and check oil level as explained in this subsection. Refill if necessary.
17. Dispose oil and filter as per your local environmental regulations.

**Engine Oil (1200 4-TEC)**

**Recommended Engine Oil**

RECOMMENDED ENGINE OIL

(P/N 293 600 112)

**NOTICE** The engine of this snowmobile has been developed and validated using the recommended BRP XPS™ oil. BRP strongly recommends the use of its recommended XPS oil at all times. Damages caused by oil which is not suitable for the engine will not be covered by the BRP limited warranty.

If the recommended oil is not available, use SAE 0W40 synthetic-based oil that meets or exceeds the requirements for API service classification SM.

**Engine Oil Level Verification**

Check engine oil level every 10 hours or 500 km (300 mi) whichever comes first.

**NOTICE** Operating the engine with an improper oil level may severely damage engine. Wipe off any spillage.

Make sure the engine is at normal operating temperature.

**NOTE:** The engine reaches its normal operating temperature when the rear radiator gets warm.

Place vehicle on a level surface and proceed as follows to check oil level:

1. Let engine run at idle for approximately 30 seconds.
2. Stop engine.
3. Remove the drive belt guard, refer to *CONTROLS, INSTRUMENTS AND EQUIPMENT*.
4. Remove dipstick from the filler tube, then wipe it clean.
5. Completely insert dipstick in the filler tube.
6. Remove dipstick and check the oil level. Oil level should be between the MIN and MAX marks as shown, add if necessary.

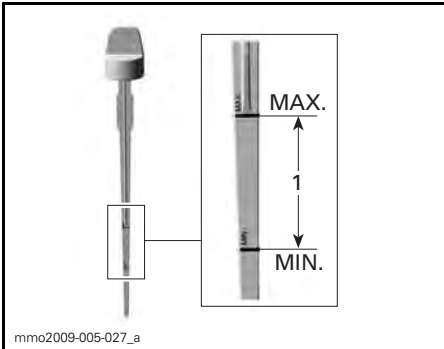

1. Oil level between MIN. and MAX.

**⚠ WARNING**  
Wipe off any oil spills. Oil is highly flammable when heated.

### Engine Oil Replacement

**⚠ WARNING**  
The engine oil can be very hot. Wait until engine oil is warm.

**NOTICE** Engine oil and oil filter must be replaced at the same time.

1. Place vehicle on a level surface.
2. Remove the LH side panel.
3. Remove the drive belt guard. Refer to *CONTROLS, INSTRUMENTS AND EQUIPMENT* section.
4. Remove dipstick.



LH SIDE OF VEHICLE

1. Oil tank dipstick

5. From underneath vehicle, clean drain plug area.

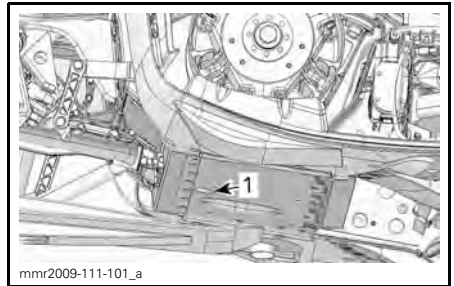

1. Frame opening to reach drain plug

6. Place a drain pan under frame opening.
7. Remove engine oil drain plug and discard sealing washer.
8. Allow oil to drain completely.
9. Install **NEW** sealing washer and O-ring on oil drain plug.

**NOTICE** Never use a sealing washer a second time. Always replace with a new one.

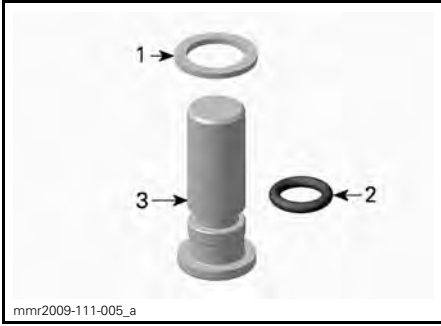

1. Sealing washer
2. O-ring
3. Oil drain plug

10. Install drain plug and tighten to the specified torque.

**DRAIN PLUG TIGHTENING TORQUE**

30 N•m (22 lbf•ft)

11. Replace *OIL FILTER*, see procedure in this subsection.
12. Refill oil tank at the proper level with the recommended oil.

**APPROXIMATE ENGINE OIL CAPACITY (WITH FILTER)**

3.5 L (3.7 qt (U.S. liq.))

13. Reinstall dipstick in oil tank.
14. Start engine and let it idle for a few minutes.
15. Ensure there are no leaks.
16. Stop engine and check oil level as explained in this subsection. Refill as necessary.
17. Dispose oil and filter as per your local environmental regulations.

**Engine Oil Filter (900 ACE)**

**Engine Oil Filter Replacement**

**Oil Filter Removal**

1. Remove the RH side panel.
2. Clean oil filter area.

3. Remove:
  - Oil filter cover screws
  - Oil filter cover with O-ring
  - Oil filter.

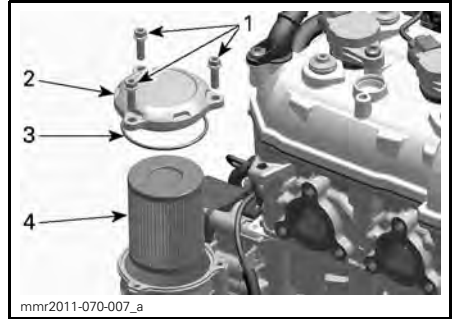

1. Oil filter cover screws
2. Oil filter cover
3. O-ring
4. Oil filter

4. Dispose filter as per your local environmental regulations.

**Oil Filter Installation**

1. Check the oil filter inlet and outlet orifices inside oil filter receptacle (integrated part of magneto cover) for dirt and contaminations.

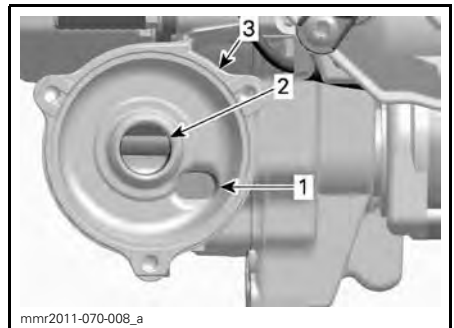

1. Oil inlet orifice from the oil pressure pump
2. Oil outlet orifice to the engine lubrication system
3. Oil filter receptacle

2. Install a O-ring on oil filter cover.
3. Lubricate filter seal and cover O-ring with engine oil.

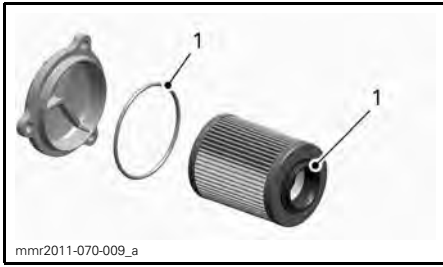

1. Lubricate with engine oil

4. Install the oil filter cover.
5. Tighten oil filter cover screws to the specified torque.

**OIL FILTER COVER TIGHTENING TORQUE**

10 N•m ± 1 N•m (89 lbf•in ± 9 lbf•in)

**Oil Filter (1200 4-TEC)**

**Oil Filter Removal**

1. Remove the RH side panel.
2. Remove muffler, refer to *EXHAUST SYSTEM* in this subsection.
3. Clean oil filter area.
4. Remove:
  - Oil filter cover screws
  - Oil filter cover with O-ring
  - Oil filter.

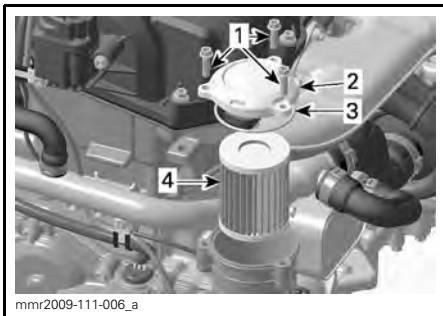

1. Oil filter cover screws
2. Oil filter cover
3. O-ring
4. Oil filter

5. Dispose filter as per your local environmental regulations.

**Oil Filter Installation**

1. Check the oil filter inlet and outlet orifices inside oil filter receptacle (integrated part of magneto cover) for dirt and contaminations.

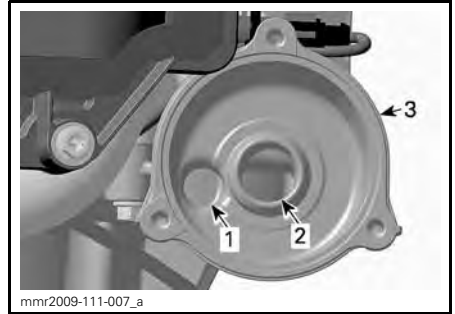

1. Oil inlet orifice from the oil pressure pump
2. Oil outlet orifice to the engine lubrication system
3. Oil filter receptacle

2. Install a **NEW** O-ring on oil filter cover.
3. Lubricate filter seal and cover O-ring with engine oil.

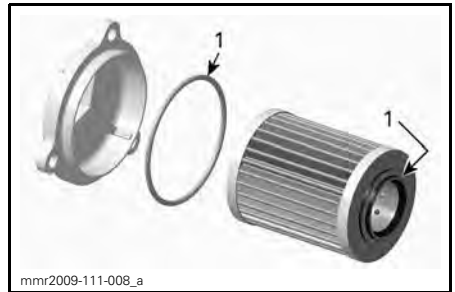

1. Lubricate with engine oil

4. Install the oil filter cover.
5. Tighten oil filter cover screws to the specified torque.

**OIL FILTER COVER TIGHTENING TORQUE**

10 N•m ± 1 N•m (89 lbf•in ± 9 lbf•in)

(P/N 529 035 983)

6. Install muffler.

**Exhaust System**

**Exhaust System Verification**

The muffler tail pipe should be centered with the exit hole in the bottom pan. Exhaust system must be free of rust or leaks. Make sure that all parts are securely in place.

Check retaining springs condition and replace if necessary.

The exhaust system is designed to reduce noise and to improve the total performance of the engine. Modification may be in violation of local laws.

**NOTICE** If any exhaust system component is removed, modified or damaged, severe engine damage may result.

**Muffler Removal and Installation**

1. Refer to *CONTROLS, INSTRUMENTS AND EQUIPMENT* and remove:
  - RH side panel
  - Drive belt guard.

**600 HO E-TEC and 800R E-TEC**

2. Disconnect the EGTS (Exhaust Gas Temperature Sensor).

**900 ACE and 1200 4-TEC**

3. Remove exhaust pipe:
  - 3.1 Remove LH side panel and hood. Refer to *CONTROLS, INSTRUMENTS AND EQUIPMENT*.
  - 3.2 Remove the springs retaining the exhaust pipe to the muffler and exhaust manifold using the following tool.



**CAUTION** Wear protective eye glasses when removing exhaust components. Beware of sudden spring tension release.

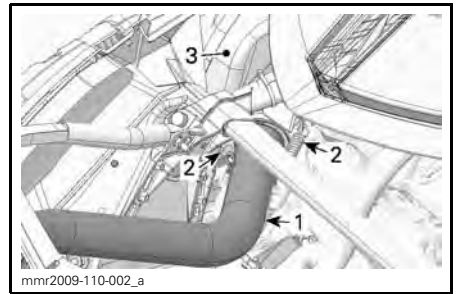

1. Exhaust pipe
2. Exhaust springs
3. Muffler

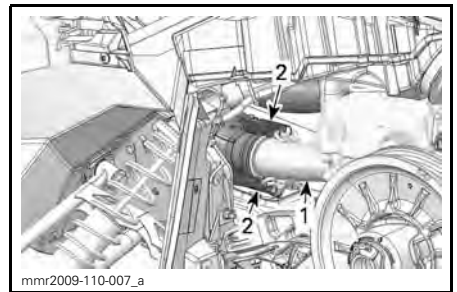

**AIR INTAKE SILENCER REMOVED FOR CLARITY**

1. Exhaust manifold
2. Exhaust springs (4)

- 3.3 Move the exhaust pipe forward to free its retaining rod from the rubber damper.

**NOTICE** Do not drop the exhaust gaskets.

*All Models*

4. Remove muffler:

- 4.1 Remove springs retaining the muffler to the chassis.

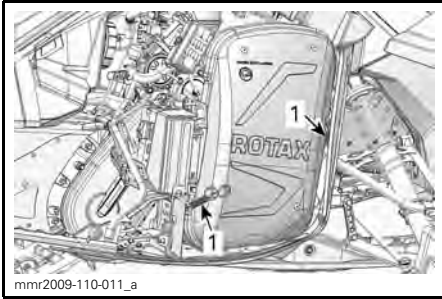

**TYPICAL**

1. Exhaust springs

- 4.2 Lift up muffler to free the retaining hook.

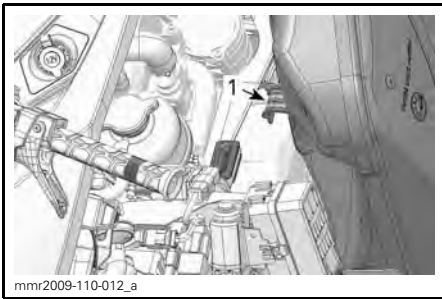

1. Retaining hook

- 4.3 Remove muffler.

Inspect doughnut shaped muffler gasket and replace if necessary.

To install muffler, reverse removal procedure.

**Spark Plugs**

Spark plugs inspection or replacement must be done by an authorized Ski-Doo dealer.

**⚠ WARNING**

Always electrically disconnect both fuel injectors prior to testing for ignition spark. Otherwise, fuel vapors may ignite in presence of a spark creating a fire hazard.

**Engine Stopper (600 HO E-TEC and 800R E-TEC)**

**Engine Stopper Adjustment**

The engine stopper is located on the LH front engine support, in front of the drive pulley.

1. Remove tether cord cap from engine cut-off switch.
2. Remove drive belt guard, refer to *CONTROLS, INSTRUMENTS AND EQUIPMENT* in this section.
3. Loosen the three screws retaining the engine stopper to the engine support just enough to allow a vertical play (1/2 to one turn).

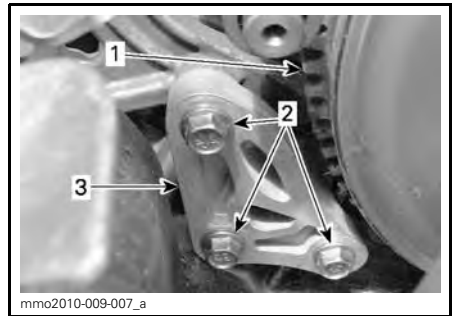

1. Drive pulley
2. Engine stopper screws
3. Engine stopper

4. Insert a 0.5 mm (.02 in) feeler gauge in the engine stopper opening (see illustration).



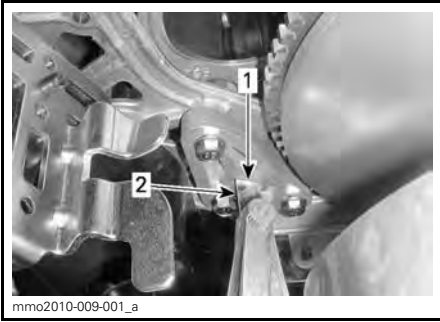

1. Opening
2. Feeler gauge

5. Place feeler gauge between engine stopper and rubber stop block (on engine).

**NOTE:** Do not insert the feeler gauge too deep, as it will pass over the bump at the surface of the rubber stop block and alter adjustment. See illustration.

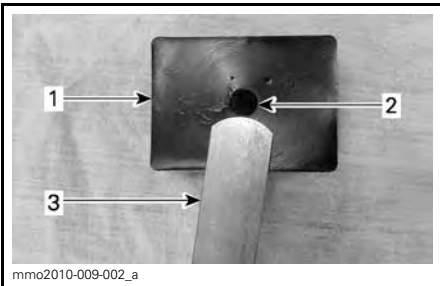

1. Rubber stop block
2. Bump
3. Feeler gauge

6. Tighten screws to the specified torque, following the illustrated sequence. Take care not to pinch the feeler gauge.



**TIGHTENING SEQUENCE**

**STOPPER SCREW TIGHTENING TORQUE**

10 N•m ± 2 N•m (89 lbf•in ± 18 lbf•in)

**NOTICE** Serious pulley damage can occur if the engine stopper and its screws are not properly installed.

**Brake Fluid**

**Recommended Brake Fluid**

Use only DOT 4 brake fluid from a sealed container. An opened container may be contaminated or may have absorbed moisture from the air.

**⚠ WARNING**

Use only DOT 4 brake fluid from a sealed container. To avoid serious damage to the braking system, do not use fluids other than the recommended one, nor mix different fluids for topping up.

**NOTICE** Brake fluid can damage painted and plastic parts. Handle with care. Rinse thoroughly in case of spillage.

**Brake Fluid Level Verification**

**NOTICE** Vehicle must be on a level surface before checking any fluid levels.

Check brake fluid in reservoir for proper level. Add recommended brake fluid as required.

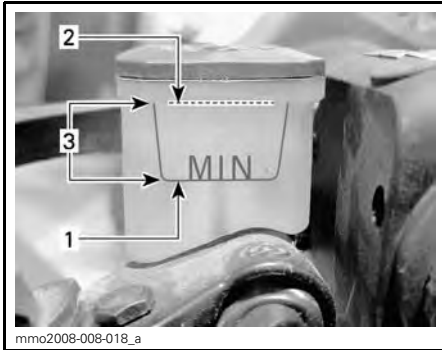

1. Minimum
2. Maximum
3. Operating range

**CAUTION** Avoid getting brake fluid on skin or eyes - it may cause severe burns. In case of contact with the eyes, immediately rinse with plenty of water for at least 10 minutes and then consult a doctor immediately.

## Chaincase Oil

### Recommended Chaincase Oil

RECOMMENDED CHAINCASE OIL
(P/N 413 803 300)

**NOTICE** The chaincase of this snowmobile has been developed and validated using the XPS™ synthetic chaincase oil. BRP strongly recommends the use of its XPS Synthetic chaincase oil at all times. Damages caused by oil which is not suitable for the chaincase will not be covered by the BRP limited warranty.

### Access to Chaincase

Open RH side panel, refer to *CONTROLS, INSTRUMENTS AND EQUIPMENT*.

### Chaincase Oil Level Verification

With the vehicle on a level surface, check the oil level by removing the check plug.

#### 600 HO E-TEC and 800R E-TEC

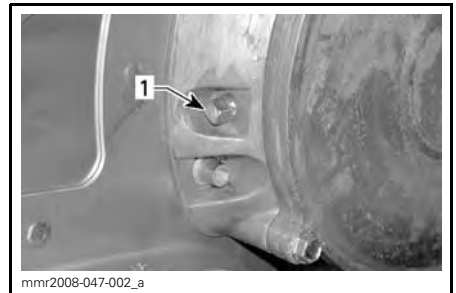

#### TYPICAL - 600 HO E-TEC AND 800R E-TEC

1. Magnetic check plug

**NOTE:** It is normal to find metallic particles stuck to magnetic check plug. If bigger pieces of metal are found, remove the chaincase cover and inspect the chaincase parts.

Remove metal particles from magnetic check plug.

#### 900 ACE and 1200 4-TEC

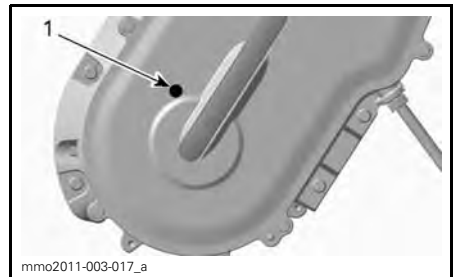

#### TYPICAL - 900 ACE AND 1200 4-TEC MODELS

1. Check plug

### All Models

Oil level must reach the threaded hole.

## Chaincase Filling Procedure

Remove the check plug.

Remove the filler cap on the chaincase cover.

### 600 HO E-TEC and 800R E-TEC



mmo2009-003-009\_a

#### TYPICAL - TOP OF CHAINCASE

1. Filler cap

### 900 ACE and 1200 4-TEC

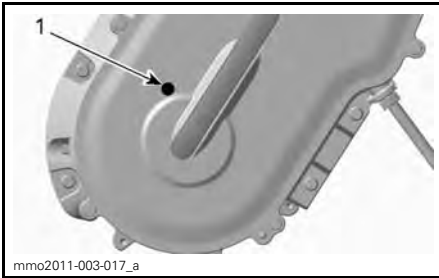

mms2011-003-017\_a

#### TYPICAL

1. Check plug

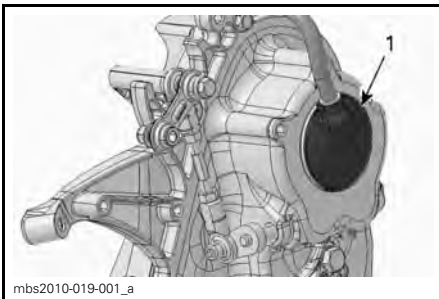

mbs2010-019-001\_a

1. Filler cap

## All Models

Pour recommended oil in chaincase by the filler hole until oil comes out by the check plug hole.

Reinstall check plug and torque to specification.

CHECK PLUG TORQUE
6 N•m ± 1 N•m (53 lbf•in ± 9 lbf•in)

Reinstall the filler cap.

## Drive Chain

### Access to Chaincase

Open RH side panel, refer to *CONTROLS, INSTRUMENTS AND EQUIPMENT*.

### Drive Chain Adjustment

1. Remove muffler, refer to *EXHAUST SYSTEM* in this subsection.
2. Unscrew tensioner lock nut several turns.

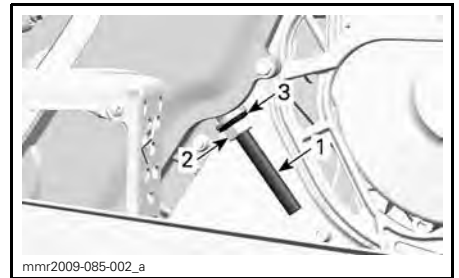

mnr2009-085-002\_a

1. Tensioner adjustment screw
2. Lock nut
3. Seal washer

3. Unscrew tensioner adjustment screw a few turns.
4. Pull seal washer back.
5. Clean adjustment screw threads if necessary.

**NOTICE** Adjustment screw threads must be clean to obtain an accurate adjustment.

6. Tighten tensioner adjustment screw by hand.

**NOTE:** Turn adjustment screw until resistance is strong enough that it can not be turned by hand.

7. Hold tensioner adjustment screw and tighten lock nut to specification.

SPECIFICATION
36 N•m ± 3 N•m (27 lbf•ft ± 2 lbf•ft)

8. Install muffler.

## Drive Belt

### Drive Belt Inspection

Inspect drive belt for cracks, fraying or abnormal wear (uneven wear, wear on one side, missing cogs, cracked fabric). If abnormal wear is noted, probable cause could be pulley misalignment, excessive RPM with frozen track, fast starts without warm-up period, burred or rusty sheave, oil on drive belt or distorted spare drive belt. Contact an authorized Ski-Doo dealer.

### Drive Belt Removal

1. Remove tether cord cap from engine cut-off switch.
2. Remove drive belt guard, refer to *CONTROLS, INSTRUMENTS AND EQUIPMENT*.
3. Insert the driven pulley expander in the threaded hole on the adjuster hub as shown.



**PULLEY EXPANDER INSTALLED ON ADJUSTER HUB**

4. Open the driven pulley by screwing the tool in.
5. Remove the drive belt by slipping it over the top of the driven pulley, then over the drive pulley.

### Drive Belt Installation

1. If necessary, open the driven pulley, refer to *DRIVE BELT REMOVAL* above.
2. Slip the drive belt over the drive pulley, then over the driven pulley.

**NOTICE** Do not force or use tools to pry the drive belt into place, as this could cut or break the cords in the drive belt.

**NOTE:** The maximum drive belt life span is obtained when drive belt is installed with arrows in the direction of rotation.

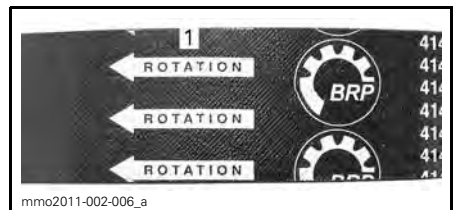

1. To be pointed in the direction of rotation
3. Unscrew and remove the driven pulley expander from the pulley.

4. Rotate the driven pulley several times to properly set the drive belt between the sheaves.
5. If a new drive belt was installed, adjust the drive belt height. Refer to *DRIVE BELT HEIGHT ADJUSTMENT* below.
6. Install drive belt guard and close side panel, refer to *CONTROLS, INSTRUMENTS AND EQUIPMENT*.

### Drive Belt Height Adjustment

The drive belt height must be checked every time a new drive belt is installed.

To adjust the drive belt height, proceed as follows:

1. Remove tether cord cap from engine cut-off switch.
2. Remove drive belt guard, refer to *CONTROLS, INSTRUMENTS AND EQUIPMENT*.
3. Loosen the clamping bolt.

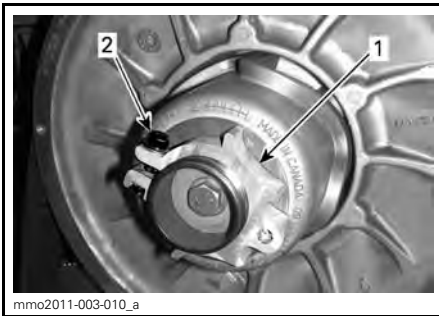

1. Adjuster hub
2. Clamping bolt

4. Using the suspension adjustment tool provided in the tool kit, turn the ring 1/4 turn at a time then rotate the driven pulley to properly set the drive belt between the pulley sheaves.



1. Suspension adjustment tool

**NOTE:** The adjustment ring has left hand treads.

### *1200 4-TEC with Electromechanical Reverse*

Repeat step 4 until the external surface of drive belt is even with the driven pulley edge.

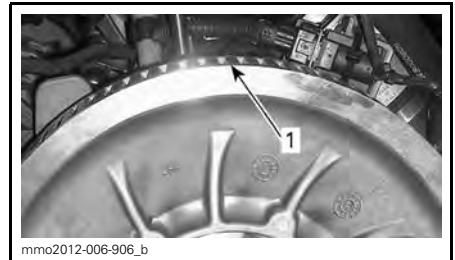

- TYPICAL - PRELIMINARY SETTING**
1. Cogs are even with pulley

### *E-TEC and 1200 4-TEC with Mechanical Reverse*

Repeat step 4 until the lowest portion of the cogs on the external surface of drive belt is even with the driven pulley edge.



**TYPICAL - PRELIMINARY SETTING**

1. Lowest portion of cogs even with external surface of drive belt

**All Models**

**NOTE:** Turning the ring counterclockwise lowers the drive belt in the pulley. Turning the ring clockwise raises the drive belt in the pulley.

5. Firmly tighten the clamping bolt. If possible, tighten to specification.

SPECIFICATION	
Clamping bolt	5.5 N•m ± 0.5 N•m (49 lbf•in ± 4 lbf•in)



**TYPICAL**

1. Clamping bolt
6. Install drive belt guard, refer to *CONTROLS, INSTRUMENTS AND EQUIPMENT*.
7. Install side panel, refer to *CONTROLS, INSTRUMENTS AND EQUIPMENT*.

**NOTE:** These settings are correct as a preliminary adjustment for most models. In some cases, when starting the engine, the vehicle could creep, indicating that the drive belt is too tight.

If the vehicle creeps, lower the drive belt height from the preliminary setting. Repeat procedure until creeping stops.

**Reverse Activation**

**NOTE:** The reverse may not activate or may be harder to activate if the drive belt is positioned too high in the driven pulley. If reverse activation does not work properly, ensure the drive belt is properly adjusted. Adjust the drive belt lower in the driven pulley if needed.

**Drive Pulley (E-TEC)**

**Drive Pulley Adjustment**

**⚠ WARNING**

Remove the tether cord cap from engine cut-off switch before performing any adjustment. Vehicle must be parked in a safe place, away from the trail.

The drive pulley is factory calibrated to transmit maximum engine power at a predefined RPM. Factors such as ambient temperature, altitude or surface condition may vary this critical engine RPM thus affecting snowmobile efficiency.

This adjustable drive pulley allows setting maximum engine RPM to maintain maximum power.

Calibration screws should be adjusted so that actual maximum engine RPM matches the maximum horsepower RPM.

ENGINE	MAXIMUM HORSEPOWER RPM
600 HO E-TEC	8100 RPM (± 100)
800R E-TEC	7900 RPM (± 100)
1200 4-TEC	7800 RPM (± 100)

**NOTE:** Use precision digital tachometer for engine RPM adjustment.

**NOTE:** The adjustment has an effect on high RPM only.

The calibration screws have 6 different settings identified by numbers scribed on their head.

The actual setting is the screw head number aligned with the mark on the pulley.

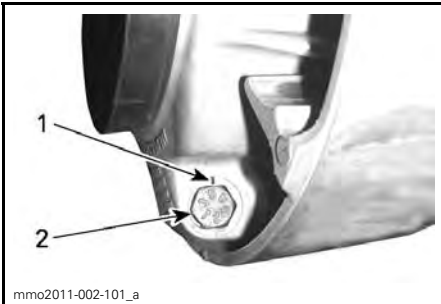

**PULLEY SETTING**

1. Mark
2. Number

Each position modifies maximum engine RPM by about 200 RPM.

Lower position numbers decrease engine RPM in steps of 200 RPM and higher position numbers increase it in steps of 200 RPM.

Example:

Calibration screws initially set at position 4 and changed to position 6 will increase maximum engine RPM by 400 RPM.

**Procedure**

Loosen the lock nut just enough to get the calibration screw head out of the pulley and rotate to the desired position.

**NOTE:** Do not completely remove the lock nut.

Set all 3 calibration screws to the same position.

Tighten lock nuts to 10 N•m ± 2 N•m (89 lbf•in ± 18 lbf•in).

**NOTICE** Do not completely remove calibration screw otherwise internal washers will fall off. Always adjust all 3 calibration screws and make sure they are all set to the same position.

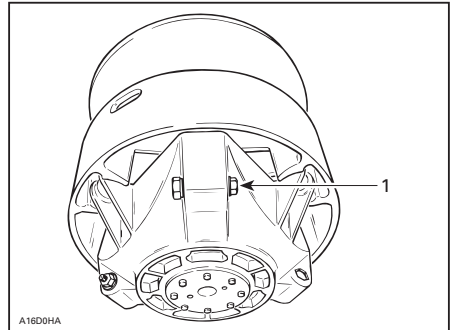

**TYPICAL**

1. Loosen just enough to permit rotating of calibrate screw

**⚠ WARNING**

**NEVER** disassemble or modify the drive pulley. Improper assembly or modifications could cause the pulley to explode violently under the stress generated by the high rotational speed. See your Ski-Doo dealer to maintain or service the drive pulley. Improper servicing or maintenance may affect performance and reduce drive belt life. Always respect maintenance schedules.

**⚠ WARNING**

NEVER operate engine:

- Without shields and drive belt guard securely installed.
- With hood and/or side panels opened or removed.

NEVER attempt to make adjustments to moving parts while engine is running.

**Track**

**Track Condition**

**⚠ WARNING**

Remove tether cord cap from engine cut-off switch before performing any maintenance or adjustment, unless otherwise specified. Vehicle must be parked in a safe place, away from the trail.

Remove tether cord cap from engine cut-off switch.

Lift the rear of the snowmobile and support it with a wide-base snowmobile mechanical stand with a rear deflector panel. With the engine off, rotate the track by hand, and inspect condition. If worn or cut, or if track fibers are exposed, or if missing or defective inserts or guides are noted; contact an authorized Ski-Doo dealer.

***Snowmobiles Equipped with Traction Enhancing Products***

If your snowmobile is equipped with a BRP approved studded track, refer to *INSPECTION OF A STUDDED TRACK* in the *TRACTION ENHANCING PRODUCTS* subsection.

**⚠ WARNING**

Riding with a damaged track or studs could lead to a loss of control.

**Track Tension and Alignment**

**NOTE:** Track tension and alignment are interrelated. Do not adjust one without the other.

**⚠ WARNING**

To prevent serious injury to individuals near the snowmobile:

- NEVER stand behind or near a moving track.
- Always use a wide-base snowmobile stand with a rear deflector panel if it is necessary to rotate track.
- When the track is raised off the ground, only run it at the lowest possible speed.

Centrifugal force could cause debris, damaged or loose studs, pieces of torn track, or an entire severed track to be violently thrown backwards out of the tunnel with tremendous force.

**Track Tension Verification**

**NOTE:** Ride the snowmobile in snow about 15 to 20 minutes prior to adjusting track tension.

1. Remove tether cord cap from engine cut-off switch.
2. Lift rear of vehicle and support it off the ground.

**⚠ CAUTION** Beware of injuries by using proper lifting techniques, notably using your legs force. Do not attempt to lift the rear of vehicle if it is above your limits.

3. Allow rear suspension to fully extend.
4. Use the (P/N 414 348 200).





- Set deflection between 30 mm and 35 mm (1-3/16 in and 1-3/8 in) using bottom O-ring.



**DEFLECTION SETTING**

- Bottom O-ring set to specification

- Place upper O-ring to 0 kgf (0 lbf).
- Position the tensiometer on track, halfway between front and rear idler wheels.
- Push the tensiometer downwards until bottom O-ring (deflection set earlier) be aligned with the bottom of slider shoe.

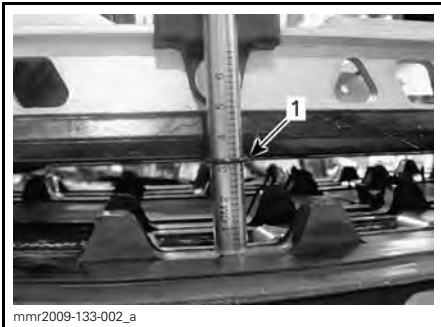
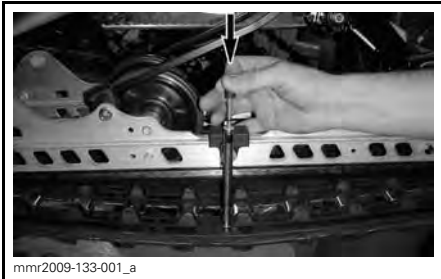

- Deflection O-ring aligned with slider shoe

- Read load recorded by the upper O-ring on the tensiometer.



**LOAD READING**

- Upper O-ring

- Load reading must be as per the following table.

TRACK ADJUSTMENT SPECIFICATION	
Track deflection setting	30 mm - 35 mm (1-3/16 in - 1-3/8 in)
Track load reading	7.3 kg (16 lb)

- If load reading is not in accordance with the specification, adjust track tension. Refer to *TRACK TENSION ADJUSTMENT*.

**Track Tension Adjustment**

- Remove tether cord cap from engine cut-off switch.
- Remove rear wheel caps (if so equipped).



- RH rear idler wheel cap

- Loosen the rear idler wheel retaining screws.

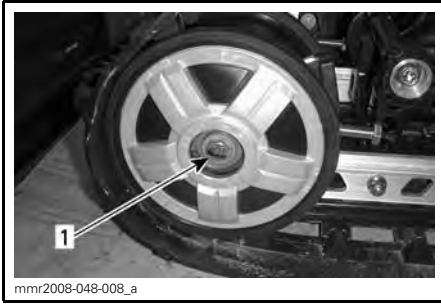

1. RH rear idler wheel bolt

4. Tighten or loosen both adjustment screws to increase or decrease track tension.



1. RH adjustment screw

5. If correct tension is unattainable, contact an authorized Ski-Doo dealer.
6. Retighten retaining screws to specifications.

TORQUE	
Rear idler wheel retaining screw	48 N•m ± 6 N•m (35 lbf•ft ± 4 lbf•ft)

7. Check track alignment as described below.

## Track Alignment

### **⚠ WARNING**

Before checking track alignment, ensure that the track is free of all particles which could be thrown out while track is rotating. Keep hands, tools, feet and clothing clear of track. Always lift the snowmobile on a wide-base stand with a rear deflector panel. Ensure no one is standing in close proximity to the snowmobile, especially at the rear of the track. Never rotate track at high speed. Centrifugal force could cause debris, damaged or loose studs, pieces of torn track, or an entire severed track to be violently thrown backwards out of the tunnel with tremendous force.

Start the engine and accelerate slightly so that track barely turns. This must be done in a short period of time (about 5 seconds).

Check that the track is well centered; equal distance on both sides between edges of track guides and slider shoes.

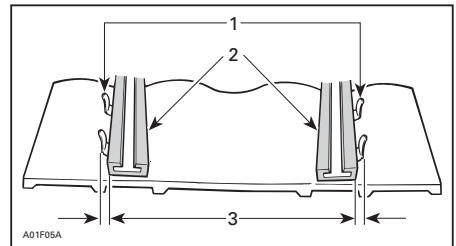

1. Guides
2. Slider shoes
3. Equal distance

If off center, perform alignment as follows:

**⚠ WARNING**

Remove the D.E.S.S. key (tether cord cap) before performing any maintenance or adjustment, unless otherwise specified. Vehicle must be parked in a safe place, away from the trail.

1. Remove the from engine cut-off switch tether cord cap.
2. Loosen rear idler wheel retaining bolts.
3. Tighten the adjustment bolt on side where the slider shoe is the farthest from the track insert guides.

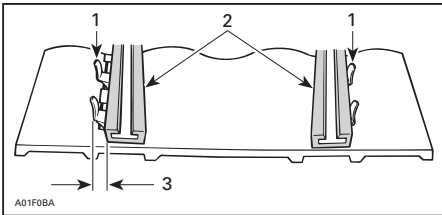

1. Guides
2. Slider shoes
3. Tighten on this side

4. Tighten retaining bolts.

**⚠ WARNING**

Properly tighten wheel retaining bolts, otherwise wheel may come off and cause track to "lock".

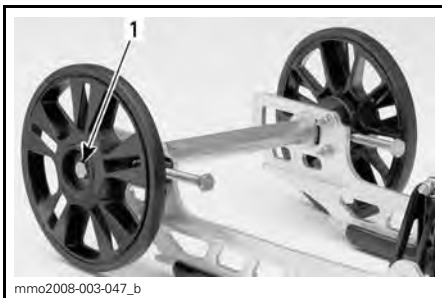

**TYPICAL**

1. Retighten to  $48\text{N}\cdot\text{m} \pm 6\text{N}\cdot\text{m}$  ( $35\text{lb}\cdot\text{ft} \pm 4\text{lb}\cdot\text{ft}$ )

5. Restart engine and rotate track slowly to recheck alignment.
6. Reposition snowmobile on ground.
7. Install rear wheel caps if so equipped.

**Suspension**

**Rear Suspension Condition**

Visually inspect all suspension components including slider shoes, springs, wheels, etc.

**NOTE:** During normal driving, snow will act as a lubricant and coolant for the slider shoes. Extensive riding on ice or sanded snow, will create excessive heat build-up and cause premature slider shoe wear.

**Suspension Stopper Strap Condition**

Inspect stopper strap for wear and cracks, bolt and nut for tightness. If loose inspect holes for deformation. Replace as required. Torque nut to  $10\text{N}\cdot\text{m} \pm 1\text{N}\cdot\text{m}$  ( $89\text{lb}\cdot\text{in} \pm 9\text{lb}\cdot\text{in}$ ).

**Suspension Lubrication**

Lubricate the following suspension pivots at grease fittings using suspension (P/N 293 550 033). Refer to *MAINTENANCE SCHEDULE* for maintenance frequency.

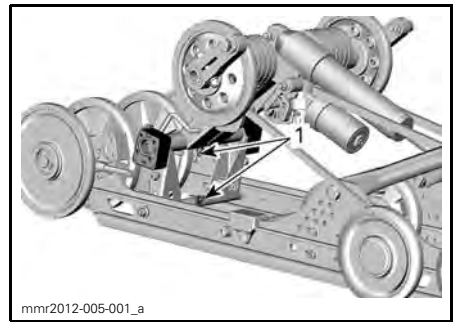

**rMOTION**

1. Grease fittings

## Steering and Front Suspension Condition

Visually inspect steering and front suspension for tightness of components (steering arms, control arms and links, tie rods, ball joints, ski bolts, ski legs, etc.). If necessary, contact an authorized Ski-Doo dealer.

## Skis

### Wear and Condition of Skis and Runners

Check the condition of the skis and ski runner carbides. If worn, contact an authorized Ski-Doo dealer.

## ⚠ WARNING

Excessively worn skis and/or ski runners will adversely affect snowmobile control.

## Fuses

### Fuse Inspection

The electrical system is protected with fuses.

Check fuse condition and replace it if necessary.

To remove fuse from holder, pull fuse out. Check if filament is melted.

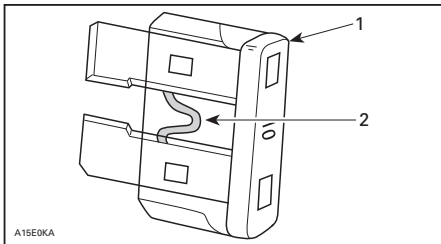

1. Fuse
2. Check if melted

**NOTICE** Do not use a higher rated fuse as this can cause severe damage to electrical components and/or be a potential fire.

## ⚠ WARNING

If fuse has burnt out, source of malfunction should be determined and corrected before restarting. See an authorized Ski-Doo dealer for servicing.

### Fuse Location

Remove RH side panel, refer to *CONTROLS, INSTRUMENTS AND EQUIPMENT*.

*All models except 1200 4-TEC*



TYPICAL - RH SIDE OF ENGINE COMPARTMENT

1. 30 A charging system fuse
2. 5 A START/REAR fuse

*1200 4-TEC*



RH SIDE OF ENGINE COMPARTMENT

1. Fuse box
2. 30 A charging system fuse

Refer to the cover decal or the *SPECIFICATIONS* section of this guide for fuses identification.

**All Models**

The electric fuel level sender fuse is located behind the air intake silencer.

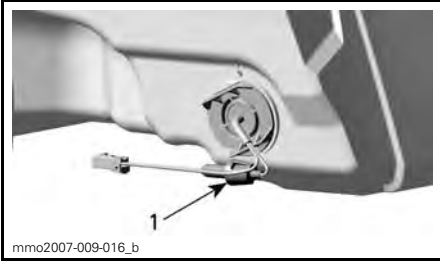

**BEHIND AIR INTAKE SILENCER**  
1. Fuse location

**Lights**

Always check light operation after bulb replacement.

**Headlights Bulb Replacement**

**NOTICE** Never touch glass portion of an halogen bulb with bare fingers, it shortens its operating life. If glass is touched, clean it with isopropyl alcohol which will not leave a film on the bulb.

1. By using a small screwdriver, release multifunction gauge locking tabs.



1. Locking tab
2. Gently pull on multifunction gauge and set aside.



3. Disconnect burnt bulb connector. Remove the rubber boot.

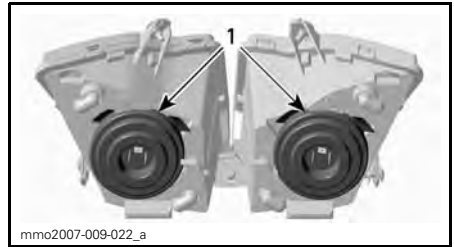

1. Rubber boots
4. Press and pull both sides of the retaining clip at the same time to release it from bulb support.



- Step 1: Push both sides  
Step 2: Pull to release
1. Retaining clip

5. Pull bulb and replace. Properly reinstall parts.

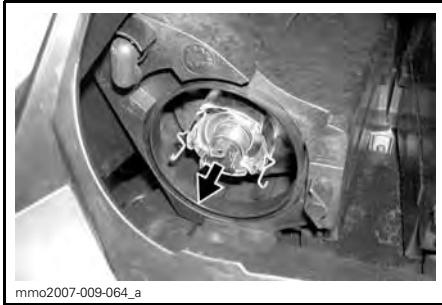

PULL BULB AND REPLACE

### Headlights Beam Aiming

Remove multifunction gauge, refer to *HEADLIGHTS BULB REPLACEMENT*. Turn knob to adjust beam height.

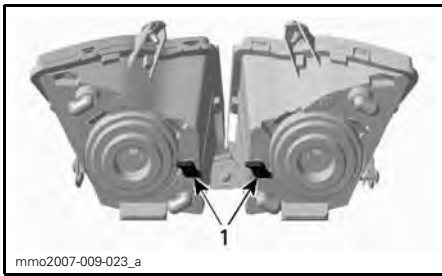

TYPICAL  
1. Knobs

### Taillight Bulb Replacement

#### 1-UP Models

1. Remove taillight housing by carefully pulling on lens at both ends using an equal force.



TYPICAL - CAREFULLY PULL OUT AT CORNERS

**NOTICE** If taillight housing is not removed perpendicularly to the taillight holder, mounting pins may break and taillight housing will have to be replaced.

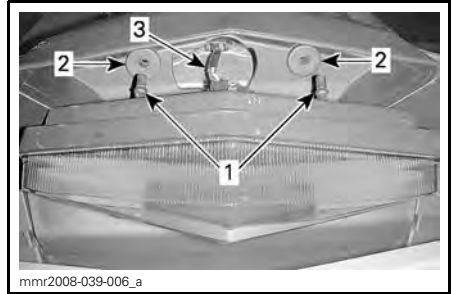

1. Taillight housing retaining pins
2. Retaining grommets
3. Light wire harness

**NOTICE** Do not pull taillight housing out too far to avoid damaging wiring.

2. Rotate bulb socket counterclockwise to remove it from taillight housing.
3. Push in and rotate bulb counterclockwise to remove it from its socket.
4. Install the new bulb by pushing it in the socket and turning it clockwise.

**NOTE:** Note position of bulb locking pins on its base, and socket alignment key.

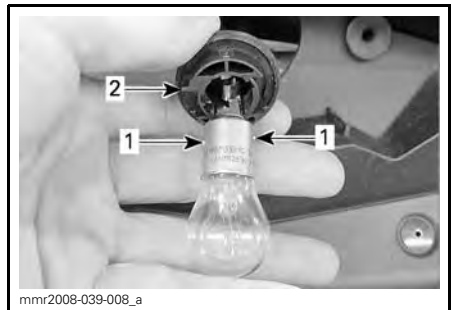

1. Bulb locking pins
2. Bulb holder alignment key

## 2-UP Models

To expose bulbs, proceed as follows:

1. Remove the taillight cover by pulling up the rear end of cover.



1. *Taillight cover*

2. Remove the screws retaining the taillight housing.



1. *Taillight housing retaining screws*

3. To remove the socket from the taillight housing, turn the socket counterclockwise then pull it out.

---

# VEHICLE CARE

## Post-Operation Care

Remove snow and ice from rear suspension, track, front suspension, steering mechanism and skis.

NOTE: Apply wax on glossy finish only.

### WARNING

Make sure tether cord cap is away from engine cut-off switch before standing in front the vehicle, getting close to the track or rear suspension components.

Always cover your snowmobile when leaving it outside overnight or during extended periods of inactivity. This will protect it from frost and snow as well as help retain its appearance.

## Vehicle Cleaning and Protection

Remove any dirt or rust.

To clean the entire vehicle, use only flannel cloths or equivalent.

**NOTICE** It is necessary to use flannel cloths or equivalent on windshield and hood to avoid scratching the surfaces.

To remove grease, oil and grime, use (P/N 293 110 001).

**NOTICE** Do not use Heavy duty cleaner on decals or vinyl.

To remove stubborn dirt from all plastic and vinyl surfaces, use (P/N 219 701 709).

To remove scratches on windshield or hood use the (P/N 861 774 800).

**NOTICE** Never clean plastic parts or hood with strong detergent, degreasing agent, paint thinner, acetone, products containing chlorine, etc.

Wax painted portion of the vehicle for better protection.



# STORAGE

During summer, or when a snowmobile is not in use for more than three months, proper storage is a necessity.

STORAGE
Clean the vehicle
Add fuel stabilizer to fuel following the product manufacturer recommendations. Run the engine after adding the product to the fuel
E-TEC models: lubricate engine. See <i>ENGINE STORAGE MODE (E-TEC)</i> in this subsection
Lubricate brake lever pivot
Lubricate rear suspension
Charge battery monthly to keep it fully charged during storage
Block muffler outlet with rags
Lift rear of vehicle until track is clear of the ground. Do not release track tension

**CAUTION** Use appropriate lifting device or have assistance to share lifting stress. If a lifting device is not used, use proper lifting techniques, notably using your legs force. Do not attempt to lift the rear of vehicle if it is above your limits.

**NOTICE** The snowmobile has to be stored in a cool and dry place and covered with an opaque but ventilated tarpaulin. This will prevent sun rays and grime from affecting plastic components and vehicle finish.

## Engine Storage Mode (E-TEC)

Like other engines, the E-TEC has to be properly lubricated at storage for internal parts protection. The E-TEC system offers a built-in engine lubrication function can be initiated by the operator.

To engage procedure, do the following:

1. Place the vehicle in a well ventilated area.
2. Start the engine and let it run at idle speed until it reaches its operating temperature.
3. Push the SET (S) button repeatedly until odometer is displayed (total milieage).



**NOTE:** The storage mode does not function in other modes (trip A, trip B and hr trip).

4. Repeatedly depress the HI/LOW beam switch rapidly, then, **while doing this**, press and hold the SET button until "PUSH S" appears on the display.

**NOTE:** It is critical for this procedure to depress the HI/LOW beam switch repeatedly **before** holding down the SET button.



5. When the gauge displays "PUSH S", release all buttons.
6. Again, press and hold the SET button for 2 - 3 seconds.

The gauge will display "OIL" when the engine enters storage procedure (summerization feature).



Do not touch anything during engine lubrication cycle.

The engine will increase its RPM to approximately 1600, then the oil pump will "fog with oil" the engine for 30 - 60 seconds.

When completed, the engine will stop by itself.

Remove D.E.S.S. key.

**NOTICE** Do not start the engine during storage period.

# PRESEASON PREPARATION

PRESEASON PREPARATION (600 HO E-TEC AND 800R E-TEC)
Inspect engine motor mounts
Check exhaust system condition and check for leaks
Tighten exhaust manifold screws or nuts to specified torque
Inspect cooling system cap, hoses and clamps
Check coolant density
Inspect crankshaft PTO seal
Inspect fuel lines and connections
Inspect throttle cable
Inspect drive belt (adjust at every drive belt replacement)
Clean and visually inspect drive pulley
Clean and inspect driven pulley
Inspect, adjust and align track
Adjust drive chain
Change chaincase oil
Check brake fluid level
Inspect brake hose, pads and disk
Inspect steering mechanism
Inspect skis and runners
Inspect front suspension
Inspect rear suspension (including stopper strap and slider shoes)
Charge battery (on models equipped with electric starter)
Adjust headlight beam aiming

PRESEASON PREPARATION (900 ACE AND 1200 4-TEC)
Visually inspect engine seals and gaskets and check for leaks
Check exhaust system condition and check for leaks
Change engine oil and filter
Check coolant density
Inspect fuel lines and connections
Clean and inspect throttle body
Inspect throttle cable (1200 4-TEC)
Inspect drive belt (adjust at every drive belt replacement)
Clean and visually inspect drive pulley
Clean and inspect driven pulley
Inspect, adjust and align track
Adjust drive chain
Change chaincase oil
Check brake fluid level
Inspect brake hose, pads and disk
Inspect steering mechanism
Inspect skis and runners
Inspect front suspension
Inspect rear suspension (including stopper strap and slider shoes)
Charge battery (on models equipped with electric starter)
Adjust headlight beam aiming

# ***TECHNICAL INFORMATION***

# VEHICLE IDENTIFICATION

## Vehicle Description Decal

Vehicle description decal is located on right hand side of tunnel.

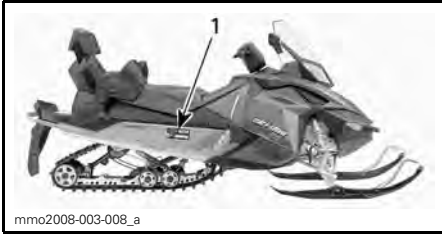

mmo2008-003-008\_a

### TYPICAL

1. Vehicle description decal

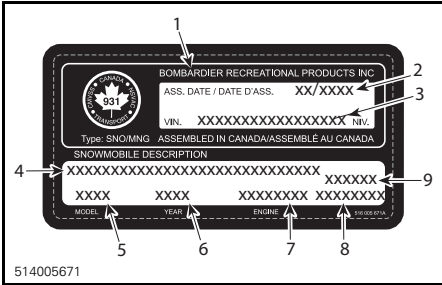

### VEHICLE DESCRIPTION DECAL

1. Manufacturer name
2. Manufacturing date
3. Vehicle identification number (VIN)
4. Model and package name
5. Model number
6. Model year
7. Engine type
8. Vehicle weight (European models)
9. Vehicle engine power (European models)

## Identification Numbers

The main components of your snowmobile (engine and frame) are identified by different identification numbers. It may sometimes become necessary to locate these numbers for warranty purposes or to trace your snowmobile in the event of loss. These numbers are required by the authorized Ski-Doo dealer to complete warranty claims properly. No warranty will be allowed by BRP if the engine identification number or vehicle identification number (VIN) is removed or mutilated in any way. We strongly rec-

ommend that you take note of all the identification numbers on your snowmobile and supply them to your insurance company.

## Vehicle Identification Number (VIN)

VIN is scribed on vehicle description decal. See above. It is also engraved on tunnel near vehicle description decal.

## Model Number Location

Model number and model year are part of the information found in the VIN See illustration.

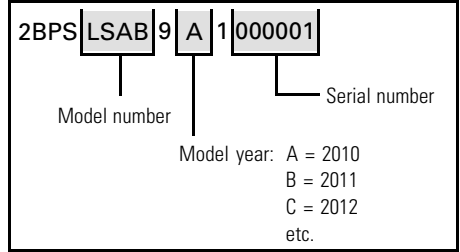

## Engine Identification Number



mmo2007-002-007\_a

### TYPICAL - 600 HO E-TEC ENGINE

1. Engine identification number



mmo2007-002-006\_a

### 800R E-TEC ENGINE

1. Engine identification number

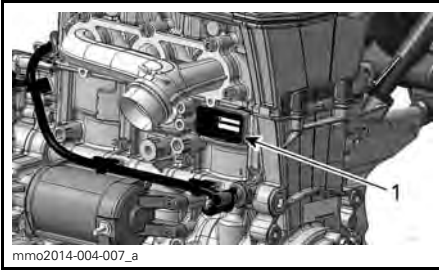

**900 ACE ENGINE**

1. Engine identification number

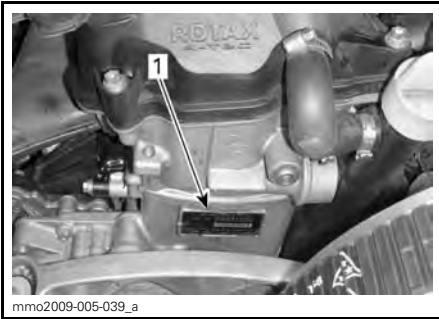

**1200 4-TEC ENGINE**

1. Engine identification number

The EC-Declaration of Conformity does not appear in this version of the Operator's Guide.

Please refer to the printed version that was delivered with your vehicle.



---

# EPA CERTIFIED ENGINES

Maintenance, replacement, or repair of the emission control devices and systems may be performed by any snowmobile SI (spark ignition) engine repair establishments or individual.

## Engine Emissions Information

### Manufacturer's Responsibility

Beginning with 2007 model year engines, snowmobile manufacturers of snowmobile engines need to determine the exhaust emission levels for each engine horsepower family and certify these engines with the United States of America Environmental Protection Agency (EPA). An emissions control information label, showing emission levels and engine specifications, must be placed on each vehicle at the time of manufacture.

### Dealer's Responsibility

When performing service on a certified Ski-Doo snowmobiles that carry an emissions control information label, adjustments must be kept within published factory specifications.

Replacement or repair of any emission related component must be executed in a manner that maintains emission levels within the prescribed certification standards.

Dealers are not to modify the engine in any manner that would alter the horsepower or allow emission levels to exceed their predetermined factory specifications.

Exceptions include manufacturer's prescribed changes, such as altitude adjustments for example.

### Owner Responsibility

The owner/operator is required to have engine maintenance performed to maintain emission levels within prescribed certification standards.

The owner/operator is not to, and should not allow anyone to modify the engine in any manner that would alter the horsepower or allow emissions levels to exceed their predetermined factory specifications.

## EPA Emission Regulations

All Ski-Doo snowmobiles manufactured by BRP are certified to the EPA as conforming to the requirements of the regulations for the control of air pollution from new snowmobile engines. This certification is contingent on certain adjustments being set to factory standards. For this reason, the factory procedure for servicing the product must be strictly followed and, whenever practicable, returned to the original intent of the design.

The responsibilities listed above are general and in no way a complete listing of the rules and regulations pertaining to the EPA requirements on exhaust emissions for snowmobile products. For more detailed information on this subject, you may contact the following locations:

### MAIL:

U.S. Environmental Protection Agency  
Office of Transportation and Air Quality  
1200 Pennsylvania Ave. NW  
Mail Code 6403J  
Washington D.C. 20460

### INTERNET WEB SITE:

[www.epa.gov/otaq/](http://www.epa.gov/otaq/)

# SPECIFICATIONS

## 600 HO E-TEC

MODEL	600 HO E-TEC
<b>ENGINE</b>	
Engine type	Rotax® 593, liquid cooled w/Reed valve, 3D-RAVE
Cylinders	2
Displacement	594.4 cm <sup>3</sup> (36.3 in <sup>3</sup> )
Bore	72 mm (2.83 in)
Stroke	73 mm (2.87 in)
Maximum horsepower engine RPM	8100 ± 100 RPM
Exhaust system	Single tuned pipe, baffle muffler
Engine oil	(P/N 293 600 100) <sup>(1)</sup>
Engine oil tank capacity	3.7 L (3.9 qt (U.S. liq.))
Engine coolant	Ethyl glycol/water mix (50% coolant, 50% distilled water). Use BRP premix coolant or coolant specifically designed for aluminum engines
<b>FUEL SYSTEM</b>	
Fuel injection system	E-TEC Direct injection
Recommended fuel type	Super unleaded (fuel which may contain up to 10% MAX ethanol)
Minimum octane Refer to <i>FUEL REQUIREMENTS</i>	91 Pump Posted AKI (RON+MON)/2
	95 RON
Fuel tank capacity	40 L (10.6 U.S. gal.)
<b>DRIVE SYSTEM</b>	
Drive pulley type	TRA™ III
Driven pulley type	QRS
Engagement	3400 ± 100 RPM
Small sprocket number of teeth	23
Large sprocket number of teeth	45
Drive sprocket number of teeth	8
Chaincase oil	(P/N 413 803 300)
Chaincase oil capacity	250 ml (8.5 U.S. oz)
Track nominal width	381 mm (15 in)
Track nominal length	3 487 mm (137 in)

MODEL		600 HO E-TEC
<b>DRIVE SYSTEM (cont'd)</b>		
Track profile height	Grand Touring LE	25.4 mm (1 in)
	GSX SE	31.8 mm (1.25 in)
Track tension	Deflection	30 mm - 35 mm (1-3/16 in - 1-3/8 in)
	Force <sup>(2)</sup>	7.3 kg (16 lb)
Track alignment		Equal distance between edges of track guides and slider shoes
<b>BRAKE SYSTEM</b>		
Brake system		Hydraulic, REV-XP brake type
Brake fluid		DOT 4
<b>SUSPENSION</b>		
Front suspension		REV-XP
Front shock		HPG
Front suspension max. travel		229 mm (9 in)
Rear suspension		rMotion
Center shock	Grand Touring LE	Motion Control
	GSX SE	HPG
Rear shock	Grand Touring LE	HPG
	GSX SE	ACS
Rear suspension max. travel	Grand Touring LE	330 mm (13 in)
	GSX SE	406 mm (16 in)
<b>ELECTRICAL SYSTEM</b>		
Lightning system output		12 V/360 W 55 V/1100 W
Headlights bulb HI/LOW beam		2 x 60/55 Watts (H-4)
Taillight bulb		21/5 W
Spark plug	Type	NGK PZFR6F <sup>(3)</sup>
	Gap	0.7 mm - 0.8 mm (.028 in - .031 in) (Not adjustable)
Fuses		Refer to <i>FUSES</i> section

**SPECIFICATIONS**

<b>MODEL</b>		<b>600 HO E-TEC</b>
<b>WEIGHT AND DIMENSIONS</b>		
Dry weight	Grand Touring LE	244 kg (538 lb)
	GSX SE	215 kg (474 lb)
Vehicle overall length	Grand Touring LE	322.6 cm (127 in)
	GSX SE	311 cm (122.4 in)
Vehicle overall width		121.7 cm (47.9 in)
Vehicle overall height	GT LE	137 cm (53.9 in)
	GSX SE	133.8 cm (52.7 in)
Ski stance		107.7 cm (42.4 in)
Ski overall length		106.6 cm (42 in)
Ski width		145 mm (5.7 in)

- (1) Refer to *INJECTION OIL (600 HO E-TEC AND 800R E-TEC)* subsection for detailed information.
- (2) Measure gap between slider shoe and bottom inside track when exerting a downward pull to the track.
- (3) **NOTICE** Do not attempt to adjust gap on this spark plug.

**800R E-TEC**

<b>MODEL</b>	<b>800R E-TEC</b>
<b>ENGINE</b>	
Engine type	Rotax 797, liquid cooled w/Reed valve, 3D-RAVE
Cylinders	2
Displacement	799.5 cm <sup>3</sup> (48.8 in <sup>3</sup> )
Bore	82 mm (3.2 in)
Stroke	75.7 mm (3 in)
Maximum engine speed	7900 ± 100 RPM
Fuel injection system	E-TEC Direct injection
Exhaust system	Single tuned pipe, baffle muffler
Engine oil	(P/N 293 600 100) <sup>(1)</sup>
Engine oil tank capacity	3.7 L (3.9 qt. (U.S. liq.))
Coolant	Ethyl glycol/water mix (50% coolant, 50% distilled water). Use (P/N 219 700 362) or coolant specifically designed for aluminum engines
Recommended fuel	Premium unleaded (fuel containing MAXIMUM 10% ethanol)
Minimum octane rating. Refer to <i>FUEL REQUIREMENTS</i>	91 Pump Posted AKI (RON+MON)/2
	95 RON
Fuel tank capacity	40 L (10.6 U.S. gal.)
<b>DRIVE SYSTEM</b>	
Drive pulley type	TRA VII
Driven pulley type	QRS
Engagement	3800 ± 100 RPM
Chaincase oil	(P/N 413 803 300)
Small sprocket number of teeth	27
Large sprocket number of teeth	45
Drive sprocket number of teeth	8

**SPECIFICATIONS**

<b>MODEL</b>		<b>800R E-TEC</b>
<b>DRIVE SYSTEM (cont'd)</b>		
Track nominal width		38.1 cm (15 in)
Track nominal length		348.7 cm (137 in)
Track profile height		31.8 mm (1.25 in)
Track tension	Deflection	30 mm to 35 mm (1-3/16 in to 1-3/8 in)
	Force <sup>(2)</sup>	7.3 kg (16 lb)
Track alignment		Equal distance between edges of track guides and slider shoes
<b>BRAKE SYSTEM</b>		
Brake system type		Hydraulic, REV-XP brake type
Brake fluid		DOT 4
<b>SUSPENSION</b>		
Front suspension		REV-XP
Front shock		HPG
Front suspension max. travel		229 mm (9 in)
Rear suspension		rMotion
Center shock		HPG
Rear shock		ACS
Rear suspension max. travel		40.6 cm (16 in)
<b>ELECTRICAL SYSTEM</b>		
Lightning system output		12V/360 W 60 V/1100 W
Headlights bulb HI/LOW beam		2 x 60/55 Watts (H-4)
Taillight bulb		21/5 W
Spark plug	Type	NGK PFR7AB <sup>(3)</sup>
	Gap	0.75 mm ± 0.05 mm (.03 in ± .002 in) (Not adjustable)
Fuse		Refer to <i>FUSES</i> section

MODEL	800R E-TEC
<b>DIMENSIONS AND WEIGHT</b>	
Vehicle overall length	311 cm (122.4 in)
Vehicle overall width	121.7 cm (47.9 in)
Dry weight	221 kg (488 lb)
Ski stance	107.7 cm (42.4 in)
Ski overall length	106.6 cm (42 in)
Ski width	145 mm (5.7 in)

- (1) Refer to *INJECTION OIL (600 HO E-TEC AND 800R E-TEC)* subsection for detailed information.
- (2) Measure gap between slider shoe and bottom inside track when exerting a downward pull to the track.
- (3) **NOTICE** Do not attempt to adjust gap on this spark plug.

**900 ACE Models**

MODEL		900 ACE
<b>ENGINE</b>		
Engine type		Rotax 903, liquid cooled, 4-stroke, D.O.H.C., dry sump
Cylinders		3
Displacement		899 cm <sup>3</sup> (54.9 in <sup>3</sup> )
Bore		74 mm (2.9 in)
Stroke		69.7 mm (2.74 in)
Maximum horsepower RPM		7250 RPM
Exhaust system		Single tuned pipe, baffle muffler
Engine oil		(P/N 293 600 112) or SAE 0W 40 API SM synthetic oil
Engine oil capacity		Oil change, 3.3 L (3.5 qt (U.S. liq.))
Engine coolant		Ethyl glycol/water mix (50% coolant, 50% distilled water). Use BRP premix coolant or coolant specifically designed for aluminum engines
<b>FUEL SYSTEM</b>		
Fuel injection system		Multi point EFI, 46 mm throttle body
Recommended fuel		Regular unleaded (fuel containing MAXIMUM 10% ethanol)
Minimum octane rating Refer to <i>FUEL REQUIREMENTS</i>		87 Pump Posted AKI (RON+MON)/2 (fuel with NO ethanol)
		92 RON (fuel with NO ethanol)
		91 Pump Posted AKI (RON+MON)/2 (fuel containing MAXIMUM 10% ethanol)
		95 RON (fuel containing MAXIMUM 10% ethanol)
Fuel tank capacity		40 L (10.6 U.S. gal.)
<b>ELECTRICAL SYSTEM</b>		
Lightning system output		420 Watts @ 6000 RPM
Headlights bulb HI/LOW beam	Spark plug	2 x 60/55 Watts (H-4)
Taillight bulb		2 x P 21/5 W
Spark Plug	Type	MR7B1
	Gap	.8 mm (.031 in)



MODEL		900 ACE
<b>ELECTRICAL SYSTEM (cont'd)</b>		
Fuses and relays	FA: Main	40 A
	F1: Ignition coils, fuel injectors, fuel pump, starter solenoid	10 A
	F2: Accessories	20 A
	F3: Electro mechanical reverse	20 A
	F4: Start clock, cooling fan	20 A
	F5: Headlights, taillight, brake light	10 A
	F6: ECM, gauge, CAPS	10 A
	R1: Main relay	Fuses F1, F3 and F6
	R2: Lighting relay	Fuse F5
	R3: Accessory relay	Fuse F2
<b>DRIVE SYSTEM</b>		
Drive pulley type		eDrive 2
Driven pulley type		QRS (short shaft)
Engagement		2200 RPM
Chaincase oil	Type	(P/N 413 803 300)
	Capacity	500 ml (16.9 U.S. oz)
Small sprocket number of teeth		24
Large sprocket number of teeth		49
Drive sprocket number of teeth		16
Track nominal width		38.1 cm (15 in)
Track nominal length		348.6 cm (137 in)
Track profile height		2.54 cm (1 in) Ripsaw
Track tension	Deflection	30 mm to 35 mm (1-3/16 in to 1-3/8 in)
	Force <sup>(1)</sup>	7.3 kg (16 lb)
Track alignment		Equal distance between edges of track guides and slider shoes
<b>BRAKE SYSTEM</b>		
Brake system type		Brembo with braided stainless-steel brake line
Brake fluid		DOT 4

**SPECIFICATIONS**

<b>MODEL</b>	<b>900 ACE</b>
<b>SUSPENSION</b>	
Front suspension	Dual A-arms
Front shock	HPG
Front suspension max. travel	229 mm (9 in)
Rear suspension	rMotion
Center shock	Motion control
Rear shock	HPG™
Rear suspension max. travel	33 cm (13 in)
<b>WEIGHT AND DIMENSIONS</b>	
Dry weight	259 kg (570 lb)
Vehicle overall length	322.6 cm (127 in)
Vehicle overall width	121.7 cm (47.9 in)
Vehicle overall height	137 cm (53.9 in)
Ski stance	107.7 cm (42.4 in)
Ski overall length	106.6 cm (42 in)
Ski width	145 mm (5.7 in)

## 1200 4-TEC

MODEL	1200 4-TEC
<b>ENGINE</b>	
Engine type	Rotax 1203, liquid cooled, 4-Stroke, D.O.H.C. with balancer shaft, dry sump
Cylinders	3
Displacement	1 170.7 cm <sup>3</sup> (71.4 in <sup>3</sup> )
Bore	91 mm (3.58 in)
Stroke	60 mm (2.36 in)
Maximum horsepower engine RPM	7800 RPM
Exhaust system	Exhaust pipe, muffler
Engine oil	(P/N 293 600 112) <sup>(1)</sup>
Engine oil tank capacity	Oil change with filter: 3.5 L (3.7 qt (U.S. liq.))
Engine coolant	Ethyl glycol/water mix (50% coolant, 50% distilled water). Use BRP premix coolant or coolant specifically designed for aluminum engines
<b>FUEL SYSTEM</b>	
Fuel injection system	Multi point EFI, 52 mm heated throttle body
Recommended fuel type	Regular unleaded (fuel containing MAXIMUM 10% ethanol)
Minimum octane Refer to <i>FUEL REQUIREMENTS</i>	87 Pump Posted AKI (RON + MON)/2 (fuel with NO ethanol)
	92 RON (fuel with NO ethanol)
	91 Pump Posted AKI (RON+MON)/2 (fuel containing MAXIMUM 10% ethanol)
	95 RON (fuel containing MAXIMUM 10% ethanol)
Fuel tank capacity	40 L (10.6 U.S. gal.)
<b>DRIVE SYSTEM</b>	
Drive pulley type	eDrive II
Driven pulley type	QRS
Engagement	2500 RPM
Small sprocket number of teeth	24

**SPECIFICATIONS**

<b>MODEL</b>		<b>1200 4-TEC</b>
<b>DRIVE SYSTEM (cont'd)</b>		
Large sprocket number of teeth	MX Z GSX LE	43
	GSX SE Grand Touring LE Grand Touring SE (Can/US) Renegade	45
	Grand Touring SE (Eur)	49
Drive sprocket number of teeth		8
Chaincase oil		XPS synthetic chaincase oil
Chaincase oil capacity		500 ml (16.9 U.S. oz)
Track nominal width	MX Z GSX Grand Touring LE Grand Touring SE (Can/US)	381 mm (15 in)
	Grand Touring SE (Eur) Renegade	406 mm (16 in)
Track nominal length	MX Z GSX LE	3 051 mm (120 in)
	Grand Touring LE	3 489 mm (137 in)
	Renegade GSX SE Grand Touring SE	3 487 mm (137 in)
Track profile height	Grand Touring	25.4 mm (1 in)
	MX Z GSX Renegade Grand Touring SE (Eur)	31.8 mm (1.25 in)
Track tension	Deflection	30 mm - 35 mm (1-3/16 in - 1-3/8 in)
	Force <sup>(2)</sup>	7.3 kg (16 lb)
Track alignment		Equal distance between edges of track guides and slider shoes
<b>BRAKE SYSTEM</b>		
Brake system		Hydraulic, REV-XP brake type
Brake fluid		DOT 4

MODEL		1200 4-TEC
<b>SUSPENSION</b>		
Front suspension		REV-XP
Front shock	GSX Grand Touring	HPG
	MX Z X Renegade X	HPG Plus R
	Renegade Adrenaline MX Z TNT	HPG Plus
Front suspension max. travel		229 mm (9 in)
Rear suspension		rMotion
Center shock	GSX LE Grand Touring LE	Motion Control
	GSX SE Grand Touring SE Renegade Adrenaline	HPG
	MX Z Renegade X	HPG Plus
Rear shock	Renegade Adrenaline	HPG
	MX Z TNT	HPG Plus
	GSX LE Grand Touring LE	HPG
	MX Z X Renegade X	KYB PRO 36
	GSX SE Grand Touring SE	ACS
Rear suspension maximum travel	Grand Touring LE Grand Touring SE	330 mm (13 in)
	GSX LE MX Z TNT	381 mm (15 in)
	MX Z X	394 mm (15.5 in)
	GSX SE Renegade	406 mm (16 in)

**SPECIFICATIONS**

<b>MODEL</b>		<b>1200 4-TEC</b>
<b>ELECTRICAL SYSTEM</b>		
Lightning system output		12 V/490 W
Headlights bulb HI/LOW beam		2 x 60/55 Watts (H-4)
Taillight bulb		2 x P 21/5 W
Spark plug	Type	NGK CR8EKB <sup>(3)</sup>
	Gap	Not adjustable
Fuses	FA: Battery charging (main)	30 A
	F1: Gauge	15 A
	F2: Fuel pump/starter solenoid/CAPS	10 A
	F3: Cylinder 3/injection/ignition	5 A
	F4: Cylinder 2/injection/ignition	5 A
	F5: Cylinder 1/injection/ignition	5 A
	F6: Taillight/heating element/air suspension/12-volt accessory outlet	20 A
	F7: Headlights	15 A
	F8: E-Reverse	20 A
	F9: Start button/clock/relays	5 A
	F10: Rear accessories	15 A
F11: Fan	15 A	
<b>WEIGHT AND DIMENSIONS</b>		
Dry weight	MX Z X	232 kg (512 lb)
	MXZ TNT	230 kg (507 lb)
	GSX LE	240 kg (529 lb)
	GSX SE	249 kg (549 lb)
	Renegade Adrenaline	241 kg (532 lb)
	Renegade X	237 kg (522 lb)
	Grand Touring LE	267 kg (589 lb)
	Grand Touring SE	274 kg (604 lb)

MODEL		1200 4-TEC
WEIGHT AND DIMENSIONS (cont'd)		
Vehicle overall length	MX Z GSX LE	290.5 cm (114.4 in)
	Renegade GSX SE	311 cm (122.4 in)
	Grand Touring LE Grand Touring SE	322.6 cm (127 in)
Vehicle overall width		121.7 cm (47.9 in)
Vehicle overall height	GSX LE	127 cm (49.3 in)
	GSX SE	133.8 cm (52.7 in)
	Grand Touring	137 cm (53.9 in)
	MX Z TNT Renegade Adrenaline	121 cm (47.6 in)
	MX Z X Renegade X	113 cm (44.5 in)
Ski stance		1 077 mm (42.4 in)
Ski overall length		106.6 cm (42 in)
Ski width	MX Z GSX Renegade Grand Touring	145 mm (5.7 in)
	Renegade X (Eur) Grand Touring SE (Eur)	175 mm (6.9 in)

- (1) The engine of this snowmobile has been developed and validated using the recommended BRP XPS™ oil. BRP strongly recommends the use of its recommended XPS oil at all times. Damages caused by oil which is not suitable for the engine will not be covered by the BRP limited warranty.
- (2) Measure gap between slider shoe and bottom inside track when exerting a downward pull to the track.
- (3) **NOTICE** Do not attempt to adjust gap on this spark plug.

***This page is  
intentionally blank***



# ***TROUBLESHOOTING***

---

# TROUBLESHOOTING GUIDELINES (E-TEC)

---

## ELECTRIC STARTER DOES NOT WORK

---

1. One of the switch is not in the position to start the engine.
  - *Place the emergency engine stop switch in the ON position and install tether cord cap on engine cut-off switch.*
2. Throttle applied while attempting an engine start.
  - *Release throttle while cranking.*

---

## ENGINE IS CRANKED BUT FAILS TO START

---

1. No fuel to the engine.
  - *Check fuel tank level, add fuel if necessary.*
2. System voltage too low.
  - *Contact an authorized Ski-Doo dealer.*

---

## ENGINE RPM DOES NOT REACH CLUTCH ENGAGEMENT POINT

---

1. D.E.S.S. key not recognized. D.E.S.S. pilot lamp blinks (slow short beeps/repetitive).
  - *Properly install tether cord cap (D.E.S.S. key).*
  - *Install a tether cord cap with the D.E.S.S. key for which this snowmobile was programmed.*

---

## ENGINE OVERHEATS

---

1. Insufficient snow or hard packed snow.
  - *Drive in loose snow. If there is no loose snow near, pull over, stop engine and let it cool down. Once engine has cooled down, reach loose snow as soon as possible.*
2. Low coolant level.
  - *Check coolant level, see MAINTENANCE PROCEDURES.*
3. Clogged heat exchangers.
  - *Clean heat exchangers.*
4. Rear suspension adjusted too high (too much distance between the snow guard and the ground)

---

## ENGINE LACKS POWER

---

1. Engine warm-up in progress.
  - *Drive vehicle at low speeds for a few minutes.*
2. Engine break-in period not completed.
  - *Complete break-in period.*
3. Incorrect drive pulley adjustment.
  - *Adjust drive pulley, refer to MAINTENANCE PROCEDURES.*
4. Drive and driven pulleys require servicing.
  - *Contact an authorized Ski-Doo dealer.*

---

**ENGINE LACKS POWER (cont'd)**

---

**5. Drive belt worn too thin.**

- *If the drive belt has lost more than 3 mm (1/8 in) of its original width, it will affect vehicle performance.*
- *Replace drive belt.*

**6. Incorrect track adjustment.**

- *See MAINTENANCE INFORMATION and/or an authorized Ski-Doo dealer for proper alignment and tension adjustments.*

**7. RAVE valves problem.**

- *Contact an authorized Ski-Doo dealer.*

**8. Fuel pressure too low.**

- *Contact an authorized Ski-Doo dealer.*

---

**ENGINE BACKFIRES**

---

**1. Engine is running too hot.**

- *See ENGINE OVERHEATS.*

**2. Ignition timing is incorrect or there is an ignition system failure.**

- *Contact an authorized Ski-Doo dealer.*

**3. Exhaust system leak.**

- *Contact an authorized Ski-Doo dealer.*

**4. Fuel pressure too low.**

- *Contact an authorized Ski-Doo dealer.*

---

**ENGINE MISFIRES**

---

**1. Water in fuel.**

- *Drain fuel system and refill with fresh fuel.*

**2. RAVE valves malfunction.**

- *Have RAVE valves system inspected by an authorized SKI-DOO dealer.*

---

**REVERSE DOES NOT ENGAGE**

---

**1. Incorrect shifting procedure.**

- *Make sure to follow correct shifting procedure, refer to OPERATING IN REVERSE in BASIC PROCEDURES.*

**2. Incorrect drive belt height.**

- *Adjust drive belt properly, refer to DRIVE BELT in MAINTENANCE PROCEDURES.*

---

**ENGINE HAS SHUT DOWN WHILE IDLING.**

---

**1. The engine shuts down after long periods of idling.**

- *Do not let engine idle too long. Refer to VEHICLE WARM-UP in OPERATING INSTRUCTION.*

---

# TROUBLESHOOTING GUIDELINES (900 ACE AND 1200 4-TEC)

---

## STARTER DOES NOT WORK

1. Engine stop switch in OFF position or tether cord cap (D.E.S.S. key) away from post.
  - *Place engine stop switch in the ON position and install tether cord cap (D.E.S.S. key) on post.*
2. Throttle applied while attempting an engine start.
  - *Release throttle while cranking.*

---

## ENGINE RPM DOES NOT REACH CLUTCH ENGAGEMENT POINT

1. D.E.S.S. did not read tether cord cap (D.E.S.S. key) code. D.E.S.S. pilot lamp blinks (slow short beeps/repetitive).
  - *Properly install tether cord cap (D.E.S.S. key).*
2. D.E.S.S. has read a different code than the one programmed. D.E.S.S. pilot lamp blinks rapidly (fast short beeps/repetitive).
  - *Install a tether cord cap (D.E.S.S. key) for which this snowmobile was programmed.*
3. ECM does not recognize the D.E.S.S. key (900 ACE).
  - *Refer to an authorized Ski-Doo dealer.*

---

## ENGINE OVERHEATS

1. Insufficient snow or hard packed snow.
  - *Drive in loose snow. If there is no loose snow near, pull over, stop engine and let it cool down. Once engine has cooled down, reach loose snow as soon as possible.*
2. Low coolant level.
  - *Check coolant level, see MAINTENANCE PROCEDURES.*
3. Clogged heat exchangers.
  - *Clean heat exchangers.*
4. Rear suspension adjusted too high (too much distance between the snow guard and the ground)

---

## ENGINE LACKS ACCELERATION OR POWER

1. Learning key used (900 ACE).
  - *Use a Normal key.*
2. Sport mode not activated (900 ACE).
  - *Refer to ACTIVATING SPORT MODE in OPERATING MODES.*
3. Drive and driven pulleys require servicing.
  - *Contact an authorized Ski-Doo dealer.*

---

## ENGINE LACKS ACCELERATION OR POWER (cont'd)

---

### 4. Drive belt worn too thin.

- *If the drive belt has lost more than 3 mm (1/8 in) of its original width, it will affect vehicle performance.*
- *Replace drive belt.*

### 5. Incorrect track adjustment.

- *See MAINTENANCE INFORMATION and/or an authorized Ski-Doo dealer for proper alignment and tension adjustments.*

---

## ENGINE MISFIRES

---

### 1. Water in fuel.

- *Drain fuel system and refill with fresh fuel.*

---

## NO RESPONSE FROM THE THROTTLE LEVER INPUTS. MESSAGE DISPLAYED: PRESS START TO GO

---

### 1. Engine management system has detected a sensor problem.

- *Press and hold the start button in order to move vehicle. Contact an authorized Ski-Doo dealer.*

---

## REVERSE DOES NOT ENGAGE

---

### 1. Incorrect shifting procedure.

- *Make sure to follow correct shifting procedure, refer to OPERATING IN REVERSE in BASIC PROCEDURES.*

### 2. Incorrect drive belt height.

- *Adjust drive belt properly, refer to DRIVE BELT in MAINTENANCE PROCEDURES.*

---

## HEATED GRIPS ARE NOT WORKING

---

### 1. Engine RPM is too low.

- *Make sure engine RPM is running above 2000 (900 ACE).*

---

## ENGINE HAS SHUT DOWN WHILE IDLING.

---

### 1. The engine shuts down after long periods of idling.

- *Do not let engine idle too long. Refer to VEHICLE WARM-UP in OPERATING INSTRUCTION.*

---

# MONITORING SYSTEM

## Pilot Lamps, Messages and Beeper Codes

Gauge pilot lamp(s) will inform you if an anomaly occurs or to inform you of a particular condition.



*TYPICAL — PILOT LAMPS*

Pilot lamp can flash alone or in combination with another lamp.

On the multifunction analog/digital gauge, the display is used as a complement of the pilot lamps to give you a brief description if an anomaly occurs or to inform you of a particular condition.

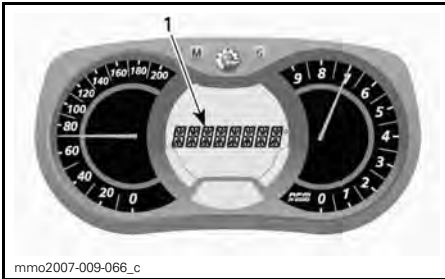







*1. Message display*

Messages will be displayed with a beep code and pilot lamp(s).

Beeper codes will be emitted and messages (depending on gauge model) will be displayed to catch your attention.

See table below for details.

**NOTE:** Some of the listed pilot lamps and messages do not apply to all models. Message display only available on the multifunction analog/digital gauge.

PILOT LAMP(S)		BEEPER	MESSAGE DISPLAY	DESCRIPTION
	Blinking	3 short beeps	REV. FAIL	Reverse did not engage, try again. If reverse still fails to engage, see <i>TROUBLESHOOTING</i> .
	Blinking, then ON	4 short beeps every 30 seconds	ENGINE OVERHEAT	Engine is overheating, run in loose snow or stop engine immediately and let engine cool down. Check coolant level, refer to <i>MAINTENANCE</i> . If coolant level is correct and overheating persists, contact an authorized Ski-Doo dealer. Do not run the engine if condition persists.
	Blinking, then ON	Short beeps repeating rapidly	ENGINE OVERHEAT	Critical overheat. Stop engine immediately and let engine cool down. Check coolant level, refer to <i>MAINTENANCE</i> . If coolant level is correct and overheating persists, contact an authorized Ski-Doo dealer. Do not run the engine if condition persists.
	ON	4 short beeps every 5 minutes	LOW OIL	Four stroke engines: Low engine oil pressure. Stop vehicle in a safe place then, check oil level. Fill to proper level. If oil level was correct, discontinue use and contact an authorized Ski-Doo dealer.
				Two stroke engine: Injection oil level is low. Stop vehicle in a safe place then, replenish injection oil reservoir.
	ON	4 short beeps every 5 minutes	LOW BAT	Indicate a low or high battery voltage condition. See an authorized Ski-Doo dealer as soon as possible.
			HIGH BAT	
	Blinking, then ON	4 short beeps	CHECK ENGINE	Engine fault, see an authorized Ski-Doo dealer as soon as possible.

PILOT LAMP(S)		BEEPER	MESSAGE DISPLAY	DESCRIPTION
	—	—	—	Displayed when brake is applied for more than 15 seconds while throttle lever is squeezed and vehicle is moving at more than 5 km/h (3 MPH)
—	—	4 short beeps every 5 minutes	REV LIMIT	Engine RPM limited for protection when certain faults occur.
—	—	—	OVER REV	On E-TEC engines, indicates that maximum engine RPM is reached. Check clutch calibration.
—	—	Short beeps repeating rapidly	SHUTDOWN	Shutdown procedure in force due to engine overheating or fuel pump problem, remove tether cord cap from engine cut-off switch and contact an authorized Ski-Doo dealer.
—	—	—	COMMUNICATION	Communication problem between ECM and gauge. Stop engine, remove D.E.S.S. key (tether cord cap). Wait a few minutes, then start engine. If problem persists, contact an authorized Ski-Doo dealer.
<b>DESS</b>	Blinking	2 short beeps	—	Good key, vehicle ready to operate.
		2 short beeps, repeating slowly	CHECK KEY	Unable to read key (bad connection). Make sure the key is clean and correctly snapped on post.
		Short beeps repeating rapidly	BAD KEY	Invalid key or key not programmed. Use the proper key for the vehicle or have the programmed.



PILOT LAMP(S)	BEEPER	MESSAGE DISPLAY	DESCRIPTION
—	—	 (Blinking)	Fuel level sensor problem.
—	—	THROTTLE OPEN	1200 4-TEC and 900 ACE: Throttle lever applied while attempting an engine start (engine cranks but won't run). Release throttle while starting.
—	—	DROWN MODE	Throttle wide open while attempting an engine start (engine cranks but won't run). Release throttle while starting.

## Fault Codes

### *Multifunction Analog/Digital Display Only*

To read any active fault code, press and hold MODE (M) Button and simultaneously depress the HI/LOW beam switch repeatedly several times.

If two or more codes are registered, use SET (S) or MODE (M) to scroll.

To exit the fault codes mode, press and hold MODE (M) Button.

Contact an authorized Ski-Doo dealer for code signification.

***This page is  
intentionally blank***

# ***WARRANTY***

---

# **BRP LIMITED WARRANTY USA AND CANADA: 2014 SKI-DOO® SNOWMOBILES**

## **1) SCOPE OF THE LIMITED WARRANTY**

Bombardier Recreational Products Inc. ("BRP")\* warrants its 2014 Ski-Doo snowmobiles sold by authorized BRP dealers (as defined below) in the United States of America ("USA") and in Canada from defects in material or workmanship for the period and under the conditions described below. This limited warranty will become null and void if: (1) the snowmobile was used for racing or any other competitive activity, at any point, even by a previous owner; or (2) the snowmobile has been altered or modified in such a way so as to adversely affect its operation, performance or durability, or has been altered or modified to change its intended use.

Except if otherwise specified, all genuine Ski-Doo parts and accessories, installed by an authorized BRP dealer (as hereinafter defined) at the time of delivery of the 2014 Ski-Doo snowmobile, carry the same warranty as that of the snowmobile.

## **2) LIMITATIONS OF LIABILITY**

THIS WARRANTY IS EXPRESSLY GIVEN AND ACCEPTED IN LIEU OF ANY AND ALL OTHER WARRANTIES, EXPRESSED OR IMPLIED, INCLUDING WITHOUT LIMITATION ANY WARRANTY OF MERCHANTABILITY OR FITNESS FOR A PARTICULAR PURPOSE. TO THE EXTENT THAT THEY CANNOT BE DISCLAIMED, THE IMPLIED WARRANTIES ARE LIMITED IN DURATION TO THE LIFE OF THE EXPRESS WARRANTY. INCIDENTAL AND CONSEQUENTIAL DAMAGES ARE EXCLUDED FROM COVERAGE UNDER THIS WARRANTY. SOME STATES/PROVINCES DO NOT ALLOW FOR THE DISCLAIMERS, LIMITATIONS AND EXCLUSIONS IDENTIFIED ABOVE, AS A RESULT, THEY MAY NOT APPLY TO YOU. THIS WARRANTY GIVES YOU SPECIFIC RIGHTS, AND YOU MAY ALSO HAVE OTHER LEGAL RIGHTS WHICH MAY VARY FROM STATE TO STATE, OR PROVINCE TO PROVINCE.

Neither the distributor, any BRP dealer nor any other person has been authorized to make any affirmation, representation or warranty regarding the product, other than those contained in this limited warranty, and if made, shall not be enforceable against BRP. BRP reserves the right to modify this warranty at any time, being understood that such modification will not alter the warranty conditions applicable to the products sold while this warranty is in effect.

## **3) EXCLUSIONS – ARE NOT WARRANTED**

The following are not warranted under any circumstances:

- Normal wear and tear;
- Routine maintenance items, tune ups, adjustments;
- Damage caused by failure to provide proper maintenance and/or storage, as described in the Operator's Guide;
- Damage resulting from removal of parts, improper repairs, service, maintenance, modifications or use of parts or accessories not manufactured or approved by BRP or resulting from repairs done by a person that is not an authorized servicing BRP dealer;
- Damage caused by abuse, abnormal use, neglect, use of the product on surfaces other than snow, or operation of the product in a manner inconsistent with the recommended operation described in the Operator's Guide;

- Damage resulting from accident, submersion, fire, theft, vandalism or any act of God;
- Operation with fuels, oils or lubricants which are not suitable for use with the product (see the Operator’s Guide);
- Snow or water ingestion;
- Incidental or consequential damages, or damages of any kind including without limitation towing, storage, telephone, rental, taxi, inconvenience, insurance coverage, loan payments, loss of time, loss of income; and
- Damage resulting from studs installed on tracks if the installation does not conform to BRP’s instructions.

#### **4) WARRANTY COVERAGE PERIOD**

This warranty will be in effect from the date of delivery to the first retail consumer or the date the product is first put into use, whichever occurs first and for the following period:

TWELVE (12) CONSECUTIVE MONTHS, for private or commercial use owners. However, the warranty coverage period on a snowmobile delivered between June 1<sup>st</sup> and December 1<sup>st</sup> of a given year will expire November 30<sup>th</sup> of the following year.

Exhaust emission-related components that are installed on EPA certified snowmobiles registered in the USA are covered for thirty (30) consecutive months or 200 hours or 2500 miles (4000 km) of engine use whichever occurs first. If the 2500 miles (4000 km) are reached during the regular warranty coverage period, the emission-related components are still covered by BRP’s standard warranty until the end of regular coverage period. Evaporative emission related components that are installed on EPA certified snowmobiles registered in the USA are warranted for twenty-four (24) consecutive months.

To obtain a list of the current warranted emission-related components, please see an authorized Ski-Doo dealer.

The repair or replacement of parts or the performance of service under this warranty does not extend the life of this warranty beyond its original expiration date.

#### **5) CONDITIONS REQUIRED FOR WARRANTY COVERAGE**

This warranty coverage is available **only** if each of the following conditions has been fulfilled:

- The 2014 Ski-Doo snowmobile must be purchased as new and unused by its first owner from a BRP dealer authorized to distribute Ski-Doo snowmobiles in the country in which the sale occurred (“BRP dealer”);
- The BRP specified pre-delivery inspection process must be completed and documented and signed by the purchaser;
- The 2014 Ski-Doo snowmobile must have undergone proper registration by an authorized BRP dealer;

- The 2014 Ski-Doo snowmobile must be purchased in the country in which the purchaser resides; and
- Routine maintenance outlined in the Operator's Guide must be timely performed in order to maintain warranty coverage. BRP reserves the right to make warranty coverage contingent upon proof of proper maintenance.

BRP will not honor this limited warranty to any private use owner or commercial use owner if one of the preceding conditions has not been met. Such limitations are necessary in order to allow BRP to preserve both the safety of its products, and also that of its consumers and the general public.

## **6) WHAT TO DO TO OBTAIN WARRANTY COVERAGE**

The customer must cease using the snowmobile upon the appearance of an anomaly. The customer must notify a servicing BRP dealer within three (3) days of the appearance of a defect, and provide it with reasonable access to the product and reasonable opportunity to repair it. The customer must also present to the authorized BRP dealer, proof of purchase of the product and must sign the repair/work order prior to starting the repair in order to validate the warranty repair. All parts replaced under this limited warranty become the property of BRP.

## **7) WHAT BRP WILL DO**

BRP's obligations under this warranty are limited to, at its sole discretion, repairing parts found defective under normal use, maintenance and service, or replacing such parts with new genuine Ski-Doo parts without charge for parts and labor, at any authorized BRP dealer during the warranty coverage period under the conditions described herein. No claim of breach of warranty shall be cause for cancellation or rescission of the sale of the snowmobile to the owner.

In the event that service is required outside of the country of original sale, the owner will bear responsibility for any additional charges due to local practices and conditions, such as, but not limited to, freight, insurance, taxes, license fees, import duties, and any and all other financial charges, including those levied by governments, states, territories and their respective agencies.

BRP reserves the right to improve or modify products from time to time without assuming any obligation to modify products previously manufactured.

## **8) TRANSFER**

If the ownership of a product is transferred during the warranty coverage period, this warranty shall also be transferred and be valid for the remaining coverage period provided that BRP is notified of such transfer of ownership in the following way:

1. The former owner contacts BRP (at the phone number provided below) or an authorized BRP dealer and gives the coordinates of the new owner; or
2. BRP or an authorized BRP dealer receives a proof that the former owner agreed to the transfer of ownership, in addition to the coordinates of the new owner.

## **9) CONSUMER ASSISTANCE**

In the event of a controversy or a dispute in connection with this limited warranty, BRP suggests that you try to resolve the issue at the dealership level. We recommend discussing the issue with the authorized dealer's service manager or owner. If the issue has not yet been resolved, please submit your complaint in writing or call the appropriate number below:

### **In Canada**

**BOMBARDIER RECREATIONAL PRODUCTS INC.**  
Customer Assistance Center  
75 J.-A. Bombardier Street  
Sherbrooke QC J1L 1W3  
Tel.: 819 566-3366

### **In USA**

**BRP US INC.**  
Customer Assistance Center  
7575 Bombardier Court  
Wausau WI 54401  
Tel.: 715 848-4957

\* In the USA, products are distributed and serviced by BRP US Inc.  
© 2013 Bombardier Recreational Products Inc. All rights reserved.  
® Registered trademark of Bombardier Recreational Products Inc.

---

# **BRP INTERNATIONAL LIMITED WARRANTY: 2014 SKI-DOO® SNOWMOBILES**

## **1) SCOPE OF THE LIMITED WARRANTY**

Bombardier Recreational Products Inc. ("BRP")\* warrants its 2014 Ski-Doo snowmobiles sold by distributors or dealers authorized by BRP to distribute SKI-Doo snowmobiles ("Ski-Doo Distributor/Dealer") outside of the fifty United States, Canada, members of the European Economic Area (which is comprised of the member states of the European Union plus Norway, Iceland and Liechtenstein) ("EEA"), members states of the Commonwealth of the Independent States (including Ukraine and Turkmenistan) ("CIS") and Turkey, from defects in material or workmanship for the period and under the conditions described below.

All genuine Ski-Doo parts and accessories, installed by an authorized Ski-Doo Distributor/Dealer at the time of delivery of the 2014 Ski-Doo snowmobile, carry the same warranty as that of the snowmobile.

This limited warranty will become null and void if: (1) the snowmobile was used for racing or any other competitive activity, at any point, even by a previous owner; or (2) the snowmobile has been altered or modified in such a way so as to adversely affect its operation, performance or durability, or has been altered or modified to change its intended use.

## **2) LIMITATIONS OF LIABILITY**

TO THE EXTENT PERMITTED BY LAW, THIS WARRANTY IS EXPRESSLY GIVEN AND ACCEPTED IN LIEU OF ANY AND ALL OTHER WARRANTIES, EXPRESSED OR IMPLIED, INCLUDING WITHOUT LIMITATION ANY WARRANTY OF MERCHANTABILITY OR FITNESS FOR A PARTICULAR PURPOSE. TO THE EXTENT THAT THEY CANNOT BE DISCLAIMED, THE IMPLIED WARRANTIES ARE LIMITED IN DURATION TO THE LIFE OF THE EXPRESS WARRANTY. INCIDENTAL AND CONSEQUENTIAL DAMAGES ARE EXCLUDED FROM COVERAGE UNDER THIS WARRANTY. SOME JURISDICTIONS DO NOT ALLOW FOR THE DISCLAIMERS, LIMITATIONS AND EXCLUSIONS IDENTIFIED ABOVE, AS A RESULT, THEY MAY NOT APPLY TO YOU. THIS WARRANTY GIVES YOU SPECIFIC RIGHTS, AND YOU MAY ALSO HAVE OTHER LEGAL RIGHTS WHICH MAY VARY FROM COUNTRY TO COUNTRY. (FOR PRODUCTS PURCHASED IN AUSTRALIA SEE CLAUSE 4 BELOW).

Neither the Ski-Doo Distributor/Dealer nor any other person has been authorized to make any affirmation, representation or warranty regarding the product, other than those contained in this limited warranty, and if made, shall not be enforceable against BRP.

BRP reserves the right to modify this warranty at any time, being understood that such modification will not alter the warranty conditions applicable to the products sold while this warranty is in effect.

## **3) EXCLUSIONS – ARE NOT WARRANTED**

The following are not warranted under this limited warranty under any circumstances:

- Normal wear and tear;
- Routine maintenance items, tune ups, adjustments;
- Damage caused by negligence or failure to provide proper maintenance and/or storage, as described in the Operator's Guide;



- Damage resulting from removal of parts, improper repairs, service, maintenance, modifications or use of parts or accessories not manufactured or approved by BRP which in its reasonable judgement are either incompatible with the product or adversely affect its operation, performance and durability, or resulting from repairs done by a person that is not an authorized servicing Ski-Doo Distributor/Dealer;
- Damage caused by abuse, abnormal use, neglect, racing or operation of the product on surfaces other than snow, or operation of the product in a manner inconsistent with the recommended operation described in the Operator's Guide;
- Damage resulting from accident, submersion, fire, snow or water ingestion, theft, vandalism or any act of God;
- Operation with fuels, oils or lubricants which are not suitable for use with the product (see the Operator's Guide);
- Damage resulting from rust, corrosion or exposure to the elements;
- Incidental or consequential damages, or damages of any kind including without limitation towing, storage, transportation expenses, telephone, rental, taxi, inconvenience, insurance coverage, loan payments, loss of time, loss of income; or time missed for downtime experience due to service work.
- And damage resulting from studs installed on tracks if the installation does not conform to BRP's instructions.

#### **4) WARRANTY COVERAGE PERIOD**

This warranty will be in effect from (1) the date of delivery to the first retail consumer or (2) the date the product is first put into use, whichever occurs first and for a period of:

TWELVE (12) CONSECUTIVE MONTHS, for private or commercial use owners. However, the warranty coverage period on a snowmobile delivered between June 1<sup>st</sup> and December 1<sup>st</sup> of a given year will expire November 30<sup>th</sup> of the following year.

The repair or replacement of parts or the performance of service under this warranty does not extend the life of this warranty beyond its original expiration date.

Note that the duration and any other modalities of the warranty coverage are subject to the applicable national or local legislation in the customer's country.

#### **FOR PRODUCTS SOLD IN AUSTRALIA ONLY**

Nothing in these Warranty terms and conditions should be taken to exclude, restrict or modify the application of any condition, warranty, guarantee, right or remedy conferred or implied under the Competition and Consumer Act 2010 (Cth), including the Australian Consumer Law or any other law, where to do so would contravene that law, or cause any part of these terms and conditions to be void. The benefits given to you under this limited warranty are in addition to other rights and remedies that you have under Australian law.

Our goods come with guarantees that cannot be excluded under the Australian Consumer Law. You are entitled to a replacement or refund for a major failure and for compensation for any other reasonably foreseeable loss or damage. You are also entitled to have the goods repaired or replaced if the goods fail to be of acceptable quality and the failure does not amount to a major failure.

## **5) CONDITIONS TO HAVE WARRANTY COVERAGE**

This warranty coverage is available **only** if each of the following conditions has been fulfilled:

- The 2014 Ski-Doo snowmobile must be purchased as new and unused by its first owner from a Ski-Doo Distributor/Dealer authorized to distribute Ski-Doo snowmobiles in the country in which the sale occurred;
- The BRP specified pre-delivery inspection process must be completed and documented;
- The product must have undergone proper registration by an authorized Ski-Doo Distributor/Dealer;
- The 2014 Ski-Doo snowmobile must be purchased in the country or union of countries in which the purchaser resides.
- Routine maintenance outlined in the Operator's Guide must be timely performed in order to maintain warranty coverage. BRP reserves the right to make warranty coverage contingent upon proof of proper maintenance.

BRP will not honour this limited warranty to any private use owner or commercial use owner if one of the preceding conditions has not been met. Such limitations are necessary in order to allow BRP to preserve both the safety of its products, and also that of its consumers and the general public.

## **6) WHAT TO DO TO OBTAIN WARRANTY COVERAGE UNDER THIS WARRANTY**

The customer must cease using the snowmobile upon the appearance of an anomaly. The customer must notify a servicing Ski-Doo Distributor/Dealer within two (2) days of the appearance of a defect, and provide it with reasonable access to the product and reasonable opportunity to repair it. The customer must also present to the authorized Ski-Doo Distributor/Dealer, proof of purchase of the product and must sign the repair/work order prior to starting the repair in order to validate the warranty repair. All parts replaced under this limited warranty become the property of BRP.

Note that the notification period is subject to the applicable national or local legislation in customer's country.

## **7) WHAT BRP WILL DO**

To the extent permitted by law, BRP's obligations under this warranty are limited to, at its sole discretion, repairing parts found defective under normal use, maintenance and service, or replacing such parts with new genuine Ski-Doo parts without charge for parts and labour, at any authorized Ski-Doo Distributor/Dealer during the warranty coverage period under the conditions described herein. BRP's responsibility is limited to making the required repairs or replacements of parts. No claim of breach of warranty shall be cause for cancellation or rescission of the sale of the snowmobile to the owner. You may have other legal rights which may vary from country to country.

In the event that service is required outside of the country of original sale, the owner will bear responsibility for any additional charges due to local practices and conditions, such as, but not limited to, freight, insurance, taxes, license fees, import duties, and any and all other financial charges, including those levied by governments, states, territories and their respective agencies.

BRP reserves the right to improve or modify products from time to time without assuming any obligation to modify products previously manufactured.

## **8) TRANSFER**

If the ownership of a product is transferred during the warranty coverage period, this warranty shall also be transferred and be valid for the remaining coverage period provided BRP or an authorized Ski-Doo Distributor/Dealer receives a proof that the former owner agreed to the transfer of ownership, in addition to the co-ordinates of the new owner.

## **9) CONSUMER ASSISTANCE**

1. In the event of a controversy or a dispute in connection with this limited warranty, BRP suggests that you try to resolve the issue at the Ski-Doo Distributor/Dealer level. We recommend discussing the issue with the authorized Ski-Doo Distributor/Dealer's service manager or owner.
2. If further assistance is required, the Ski-Doo Distributor/Dealer service department should be contacted in order to resolve the matter.
3. If the matter still remains unresolved then contact BRP by writing at the address listed below.

**For countries within Middle East and Africa please contact our European office:**

**BRP EUROPE N.V.**

Customer Assistance Center  
Skaldenstraat 125  
9042 Gent  
Belgium  
Tel.: +32 9 218 26 00

**For all other countries, please contact your local Ski-Doo Distributor/Dealer (visit our website at [www.brp.com](http://www.brp.com) for contact information), or contact our North American office at:**

**BOMBARDIER RECREATIONAL PRODUCTS INC.**

Customer Assistance Center  
75, J.-A Bombardier Street  
Sherbrooke QC J1L 1W3  
Canada  
Tel.: +1 819 566-3366

\* For the territory covered by this limited warranty, products are distributed and serviced by Bombardier Recreational Products Inc. or its affiliates.

© 2013 Bombardier Recreational Products Inc. All rights reserved.

® Registered trademark of Bombardier Recreational Products Inc.

---

# **BRP LIMITED WARRANTY FOR THE EUROPEAN AND THE COMMONWEALTH OF THE INDEPENDENT STATES (CIS) AREAS AND TURKEY: 2014 SKI-DOO® SNOWMOBILES**

## **1) SCOPE OF THE LIMITED WARRANTY**

Bombardier Recreational Products Inc. ("BRP")\* warrants its 2014 Ski-Doo snowmobiles sold by distributors or dealers authorized by BRP to distribute Ski-Doo snowmobiles ("Ski-Doo Distributor/Dealer") in member states of the European Economic Area (which is comprised of the member states of the European Union plus Norway, Iceland and Liechtenstein) ("EEA"), in member states of the Commonwealth of the Independent States (including Ukraine and Turkmenistan) ("CIS") and Turkey from defects in material or workmanship for the period and under the conditions described below.

All genuine Ski-Doo parts and accessories, installed by an authorized Ski-Doo Distributor/Dealer (at the time of delivery of the 2014 Ski-Doo snowmobile, carry the same warranty as that of the snowmobile.

This limited warranty will become null and void if: (1) the snowmobile was used for racing or any other competitive activity, at any point, even by a previous owner; or (2) the snowmobile has been altered or modified in such a way so as to adversely affect its operation, performance or durability, or has been altered or modified to change its intended use.

## **2) LIMITATIONS OF LIABILITY**

TO THE EXTENT PERMITTED BY LAW, THIS WARRANTY IS EXPRESSLY GIVEN AND ACCEPTED IN LIEU OF ANY AND ALL OTHER WARRANTIES, EXPRESSED OR IMPLIED, INCLUDING WITHOUT LIMITATION ANY WARRANTY OF MERCHANTABILITY OR FITNESS FOR A PARTICULAR PURPOSE. TO THE EXTENT THAT THEY CANNOT BE DISCLAIMED, THE IMPLIED WARRANTIES ARE LIMITED IN DURATION TO THE LIFE OF THE EXPRESS WARRANTIES. INCIDENTAL AND CONSEQUENTIAL DAMAGES ARE EXCLUDED FROM COVERAGE UNDER THIS WARRANTY. SOME JURISDICTIONS DO NOT ALLOW FOR THE DISCLAIMERS, LIMITATIONS AND EXCLUSIONS IDENTIFIED ABOVE, AS A RESULT, THEY MAY NOT APPLY TO YOU. THIS WARRANTY GIVES YOU SPECIFIC RIGHTS, AND YOU MAY ALSO HAVE OTHER LEGAL RIGHTS WHICH MAY VARY FROM COUNTRY TO COUNTRY.

Neither the Ski-Doo Distributor/Dealer nor any other person has been authorized to make any affirmation, representation or warranty regarding the product, other than those contained in this limited warranty, and if made, shall not be enforceable against BRP.

BRP reserves the right to modify this warranty at any time, being understood that such modification will not alter the warranty conditions applicable to the products sold while this warranty is in effect.

## **3) EXCLUSIONS – ARE NOT WARRANTED**

The following are not warranted under this limited warranty under any circumstances:

- Normal wear and tear;
- Routine maintenance items, tune ups, adjustments;

- Damage caused by negligence or failure to provide proper maintenance and/or storage, as described in the Operator's Guide;
- Damage resulting from removal of parts, improper repairs, service, maintenance, modifications or use of parts or accessories not manufactured or approved by BRP which in its reasonable judgement are either incompatible with the product or adversely affect its operation, performance and durability, or resulting from repairs done by a person that is not an authorized servicing Ski-Doo Distributor/Dealer;
- Damage caused by abuse, abnormal use, neglect, racing or operation of the product on surfaces other than snow, or operation of the product in a manner inconsistent with the recommended operation described in the Operator's Guide;
- Damage resulting from accident, submersion, fire, snow or water ingestion, theft, vandalism or any act of God;
- Operation with fuels, oils or lubricants which are not suitable for use with the product (see the Operator's Guide);
- Damage resulting from rust, corrosion or exposure to the elements;
- Incidental or consequential damages, or damages of any kind including without limitation towing, transportation expenses, storage, telephone, rental, taxi, inconvenience, insurance coverage, loan payments, loss of time, loss of income or time missed for downtime experience due to service work;
- and damage resulting from studs installed on tracks if the installation does not conform to BRP's instructions.

#### **4) WARRANTY COVERAGE PERIOD**

This warranty will be in effect from (1) the date of delivery to the first retail consumer or (2) the date the product is first put into use, whichever occurs first and for a period of:

TWENTY-FOUR (24) CONSECUTIVE MONTHS, for private use owners and TWELVE (12) CONSECUTIVE MONTHS for commercial use owners. However, the warranty coverage period on a snowmobile delivered between June 1<sup>st</sup> and December 1<sup>st</sup> of a given year will expire November 30<sup>th</sup> of the applicable year. A snowmobile is used commercially when it is used in connection with generating income or any work or employment during any part of the warranty period. A snowmobile is also used commercially when, at any point during the warranty period, it has commercial tags or is licensed for commercial use.

The repair or replacement of parts or the performance of service under this warranty does not extend the life of this warranty beyond its original expiration date.

Note that the duration and any other modalities of the warranty coverage are subject to the applicable national or local legislation in the customer's country.

#### **5) CONDITIONS TO HAVE WARRANTY COVERAGE**

This warranty coverage is available **only** if each of the following conditions has been fulfilled:

- The 2014 Ski-Doo snowmobile must be purchased as new and unused by its first owner from a Ski-Doo Distributor/Dealer authorized to distribute Ski-Doo products in the country in which the sale occurred;

- The BRP specified pre-delivery inspection process must be completed and documented;
- The product must have undergone proper registration by an authorized Ski-Doo Distributor/Dealer;
- The 2014 Ski-Doo snowmobile must be purchased within the EEA by an EEA resident, in the CIS for residents of the countries comprised in such area and in Turkey for residents of Turkey; and
- Routine maintenance outlined in the Operator's Guide must be timely performed in order to maintain warranty coverage. BRP reserves the right to make warranty coverage contingent upon proof of proper maintenance.

BRP will not honour this limited warranty to any private use owner or commercial use owner if one of the preceding conditions has not been met. Such limitations are necessary in order to allow BRP to preserve both the safety of its products, and also that of its consumers and the general public.

## **6) WHAT TO DO TO OBTAIN WARRANTY COVERAGE UNDER THIS WARRANTY**

The customer must cease using the snowmobile upon the appearance of an anomaly. The customer must notify a servicing Ski-Doo Distributor/Dealer within two (2) months of the appearance of a defect, and provide it with reasonable access to the product and reasonable opportunity to repair it. The customer must also present to the authorized Ski-Doo Distributor/Dealer, proof of purchase of the product and must sign the repair/work order prior to starting the repair in order to validate the warranty repair. All parts replaced under this limited warranty become the property of BRP.

Note that the notification period is subject to the applicable national or local legislation in customer's country.

## **7) WHAT BRP WILL DO**

To the extent permitted by law, BRP's obligations under this warranty are limited to, at its sole discretion, repairing parts found defective under normal use, maintenance and service, or replacing such parts with new genuine Ski-Doo parts without charge for parts and labour, at any authorized Ski-Doo Distributor/Dealer during the warranty coverage period under the conditions described herein. BRP's responsibility is limited to making the required repairs or replacements of parts. No claim of breach of warranty shall be cause for cancellation or rescission of the sale of the snowmobile to the owner. You may have other legal rights which may vary from country to country.

In the event that service is required outside of the EEA, CIS or Turkey, the owner will bear responsibility for any additional charges due to local practices and conditions, such as, but not limited to, freight, insurance, taxes, license fees, import duties, and any and all other financial charges, including those levied by governments, states, territories and their respective agencies.

BRP reserves the right to improve or modify products from time to time without assuming any obligation to modify products previously manufactured.

## 8) TRANSFER

If the ownership of a product is transferred during the warranty coverage period, this warranty shall also be transferred and be valid for the remaining coverage period provided BRP or an authorized Ski-Doo Distributor/Dealer receives a proof that the former owner agreed to the transfer of ownership, in addition to the co-ordinates of the new owner.

## 9) CONSUMER ASSISTANCE

1. In the event of a controversy or a dispute in connection with this limited warranty, BRP suggests that you try to resolve the issue at the Ski-Doo Distributor/Dealer level. We recommend discussing the issue with the authorized Ski-Doo Distributor/Dealer's service manager or owner.
2. If further assistance is required, the Ski-Doo Distributor/Dealer service department should be contacted in order to resolve the matter.
3. If the matter still remains unresolved then contact BRP at the address listed below:

**For countries within EEA, CIS or Turkey, except Scandinavian countries please contact our European office:**

**BRP EUROPE N.V.**

Customer Assistance Center  
Skaldenstraat 125  
9042 Gent  
Belgium  
Tel.: +32 9 218 26 00

**For Scandinavian countries, please contact our Finland office:**

**BRP FINLAND OY**

Service Department  
Isoaavantie 7  
FIN-96320 Rovaniemi  
Finland  
Tel.: +358 163 208 111

You can find your Ski-Doo Distributor/Dealer's coordinates on [www.brp.com](http://www.brp.com).

\* In the EEA, products are distributed and serviced by BRP European Distribution S.A. and other affiliates or subsidiaries of BRP.

© 2013 Bombardier Recreational Products Inc. All rights reserved.

® Registered trademark of Bombardier Recreational Products Inc.

## ADDITIONAL TERMS AND CONDITIONS FOR FRANCE ONLY

The following terms and conditions are applicable to products sold in France only:

The seller shall deliver goods that are complying with the contract and shall be responsible for defects existing upon delivery. The seller shall also be responsible for defects resulting from packaging, assembling instructions or the installation when it is its responsibility per the contract or if accomplished under its responsibility. To be compliant with the contract, the good shall:

1. Be fit for normal use for goods similar thereto and, if applicable:
  - Correspond to the description provided by the seller and have the qualities presented to the buyer though sample or model;
  - Have the qualities that a buyer may legitimately expect considering the public declarations of the seller, the manufacturer of its representative, including in advertising or labeling; or
2. Have the characteristics mutually agreed upon as between the parties or be fit for the specific use intended by the buyer and brought to the attention of the seller and which accepted

The action for failure to comply is prescribed after two years after delivery of the goods. The seller is responsible for the warranty for hidden defects of the good sold if such hidden defects are rendering the good unfit for the intended use, or if they diminish its use in such a way that the buyer would not have acquired the good or would have given a lesser price, had he known. The action for such hidden defects shall be taken by the buyer within 2 years of the discovery of the defect.



# ***CUSTOMER INFORMATION***

---

## PRIVACY INFORMATION

BRP wishes to inform you that your coordinates will be used for safety and warranty related purposes. Furthermore, BRP and its affiliates may use its customer list to distribute marketing and promotional information about BRP and related products.

To exercise your right to consult or correct your data, or to be removed from the addressee-list for direct marketing, please contact BRP.

By E-mail: [privacyofficer@brp.com](mailto:privacyofficer@brp.com)

By mail: BRP  
Senior Legal Counsel-Privacy Officer  
726 St-Joseph  
Valcourt QC  
Canada  
J0E 2L0

---

## CHANGE OF ADDRESS/OWNERSHIP

If your address has changed or if you are the new owner of the snowmobile, be sure to notify BRP by either:

- Mailing one of the change of address cards on the following pages
- North America only: Calling at 715 848-4957 (USA) or 819 566-3366 (Canada)
- Notifying an authorized Ski-Doo dealer.

In case of change of ownership, please join a proof that the former owner agreed to the transfer.

Notifying BRP, even after the expiration of the limited warranty, is very important as it enables BRP to reach the snowmobile owner if necessary, like when safety recalls are initiated. It is the owner's responsibility to notify BRP.

**STOLEN UNITS:** If your personal snowmobile is stolen, you should notify BRP or an authorized Ski-Doo dealer. We will ask you to provide your name, address, phone number, the vehicle identification number and the date it was stolen.

### North America

#### BOMBARDIER RECREATIONAL PRODUCTS INC.

Warranty Department  
75 J.-A. Bombardier Street  
Sherbrooke QC J1L 1W3  
Canada

### Scandinavian countries

#### BRP FINLAND OY

Service Department  
Isoaavantie 7  
FIN-96320 Rovaniemi

### Other countries in the world

#### BRP EUROPEAN DISTRIBUTION

Warranty Department  
Chemin de Messidor 5-7  
1006 Lausanne  
Switzerland

***This page is  
intentionally blank***

CHANGE OF ADDRESS

CHANGE OF OWNERSHIP



VEHICLE IDENTIFICATION NUMBER

Model Number

Vehicle Identification Number (V.I.N.)

Model Number

Vehicle Identification Number (V.I.N.)

OLD ADDRESS  
OR PREVIOUS OWNER:

NAME

NO.

STREET

APT

CITY

STATE/PROVINCE

ZIP/POSTAL CODE

COUNTRY

TELEPHONE

NEW ADDRESS  
OR NEW OWNER:

NAME

NO.

STREET

APT

CITY

STATE/PROVINCE

ZIP/POSTAL CODE

COUNTRY

TELEPHONE

E-MAIL ADDRESS

V00A2F

CHANGE OF ADDRESS

CHANGE OF OWNERSHIP



VEHICLE IDENTIFICATION NUMBER

Model Number

Vehicle Identification Number (V.I.N.)

Model Number

Vehicle Identification Number (V.I.N.)

OLD ADDRESS  
OR PREVIOUS OWNER:

NAME

NO.

STREET

APT

CITY

STATE/PROVINCE

ZIP/POSTAL CODE

COUNTRY

TELEPHONE

NEW ADDRESS  
OR NEW OWNER:

NAME

NO.

STREET

APT

CITY

STATE/PROVINCE

ZIP/POSTAL CODE

COUNTRY

TELEPHONE

E-MAIL ADDRESS

V00A2F



CHANGE OF ADDRESS CHANGE OF OWNERSHIP 

VEHICLE IDENTIFICATION NUMBER

Model Number

Vehicle Identification Number (V.I.N.)

OLD ADDRESS  
OR PREVIOUS OWNER:

NAME

NO.

STREET

APT

CITY

STATE/PROVINCE

ZIP/POSTAL CODE

COUNTRY

TELEPHONE

NEW ADDRESS  
OR NEW OWNER:

NAME

NO.

STREET

APT

CITY

STATE/PROVINCE

ZIP/POSTAL CODE

COUNTRY

TELEPHONE

E-MAIL ADDRESS

V00A2F

CHANGE OF ADDRESS CHANGE OF OWNERSHIP 

VEHICLE IDENTIFICATION NUMBER

Model Number

Vehicle Identification Number (V.I.N.)

OLD ADDRESS  
OR PREVIOUS OWNER:

NAME

NO.

STREET

APT

CITY

STATE/PROVINCE

ZIP/POSTAL CODE

COUNTRY

TELEPHONE

NEW ADDRESS  
OR NEW OWNER:

NAME

NO.

STREET

APT

CITY

STATE/PROVINCE

ZIP/POSTAL CODE

COUNTRY

TELEPHONE

E-MAIL ADDRESS

V00A2F









520 001 369

CA

OPERATOR'S GUIDE REV-XR / ENGLISH  
GUIDE DU CONDUCTEUR REV-XR / ANGLAIS

FAIT AU / MADE IN CANADA

U/M:P.C.