

***ski-doo***®



**2010**

**OPERATOR'S  
GUIDE** Includes  
Safety, Vehicle  
and Maintenance Information

**REV-XP™ (F/C)**

**⚠ WARNING**

Read this guide thoroughly.  
It contains important safety information.  
Minimum recommended operator's age: 16 years old.  
Keep this Operator's Guide in the vehicle.

**5 2 0 0 0 0 8 9 5**

**! WARNING**

Disregarding any of the safety precautions and instructions contained in this Operator's Guide, *SAFETY DVD* and on-product labels could cause injury including the possibility of death!

**! WARNING**

This vehicle may exceed the performance of other vehicles you may have ridden in the past. Take time to familiarize yourself with your new vehicle.

**CALIFORNIA PROPOSITION 65 WARNING**

**! WARNING**

This product contains or emits chemicals known to the state of California to cause cancer and birth defects or other reproductive harm.



In USA, products are distributed by BRP US Inc.

In Canada, products are distributed by Bombardier Recreational Products Inc.

The following are trademarks of Bombardier Recreational Products Inc. or its subsidiaries.

SKI-DOO®

XPST™

ROTAX®

TRA™ III

RERT™

SC™

HPG™

REV-XP™

---

# FOREWORD

Congratulations on your purchase of a new Ski-Doo® snowmobile. Whatever model you have chosen, it is backed by the Bombardier Recreational Products Inc. (BRP) warranty and a network of authorized Ski-Doo snowmobile dealers ready to provide the parts, service or accessories you may require.

Your dealer is committed to your satisfaction. He has taken training to perform the initial set-up and inspection of your snowmobile as well as completed the final adjustment required to suit your specific weight and riding environment before you took possession.

At delivery, you were informed of the warranty coverage and signed the *PREDELIVERY CHECK LIST* to ensure your new vehicle was prepared to your entire satisfaction.

## Know Before you Go

To learn how to reduce the risk for you, your passenger or bystanders being injured or killed, read the following sections before you operate the vehicle:

- *SAFETY INFORMATION*
- *VEHICLE INFORMATION*.

Also read all safety labels on your snowmobile and watch your *SAFETY DVD*.

We highly recommend that you take a safety riding course. Please check with your dealer or local authorities for availability in your area.

Failure to follow the warnings contained in this Operator's Guide can result in **SERIOUS INJURY** or **DEATH**.

## Safety Messages

The types of safety messages, what they look like and how they are used in this guide are explained as follows:

### **WARNING**

Indicates a potential hazard, if not avoided, could result in serious injury or death.

 **CAUTION** Indicates a hazard situation which, if not avoided, could result in minor or moderate injury.

**NOTICE** Indicates an instruction which, if not followed, could severely damage vehicle components or other property.

## About this Operator's Guide

This Operator's Guide has been prepared to acquaint the owner/operator and passenger with this snowmobile and its various controls, safe riding and maintenance instructions.

Keep this Operator's Guide in the vehicle as you can refer to it for things such as maintenance, troubleshooting and instructing others.

Note that this guide is available in several languages. In the event of any discrepancy, the English version shall prevail.

If you want to view and/or print an extra copy of your Operator's Guide, simply visit the following website [www.operatorsguide.brp.com](http://www.operatorsguide.brp.com).

The informations contained in this document are correct at the time of publication. BRP, however, maintains a policy of continuous improvement of its products without imposing upon itself any obligation to install them on products previously manufactured. Due to late changes, some differences between the manufactured product and the descriptions and/or specifications in this guide may occur. BRP reserves the right at any time to discontinue or change specifications, designs, features, models or equipment without incurring any obligation upon itself.

This Operator's Guide and the *SAFETY DVD* should remain with the vehicle when it's sold.

---

# TABLE OF CONTENTS

<b>FOREWORD</b> .....	<b>1</b>
Know Before you Go .....	1
Safety Messages .....	1
About this Operator's Guide .....	1

## ***SAFETY INFORMATION***

<b>GENERAL PRECAUTIONS</b> .....	<b>6</b>
Avoid Carbon Monoxide Poisoning .....	6
Avoid Gasoline Fires and Other Hazards .....	6
Avoid Burns from Hot Parts .....	6
Accessories and Modifications .....	6
<b>SPECIAL SAFETY MESSAGES</b> .....	<b>7</b>
<b>RIDING THE VEHICLE</b> .....	<b>10</b>
Pre-Ride Inspection .....	10
How to Ride .....	11
Carrying a Passenger .....	13
Terrain/Riding Variations .....	14
Environment .....	17
<b>TRACTION ENHANCING PRODUCTS</b> .....	<b>20</b>
Manoeuvrability .....	20
Acceleration .....	21
Braking .....	21
Important Safety Rules .....	21
Effects of Having a Studded Track on the Life of the Snowmobile .....	22
Installation of Studs on BRP Approved Tracks .....	22
Maintenance/Replacement .....	23
<b>IMPORTANT ON-PRODUCT LABELS</b> .....	<b>24</b>
Hang Tag .....	24
Vehicle Safety Labels .....	24
Compliance Labels .....	28
Technical Information Labels .....	28

## ***VEHICLE INFORMATION***

<b>CONTROLS, INSTRUMENTS AND EQUIPMENT</b> .....	<b>30</b>
1) Handlebar .....	31
2) Throttle Lever .....	31
3) Brake Lever .....	32
4) Parking Brake Lever .....	32
5) Tether Stop Switch .....	33
6) Engine Stop Switch .....	33
7) Ignition Switch .....	34
8) Choke Lever .....	34
9) Multifunction Switch .....	34

**CONTROLS, INSTRUMENTS AND EQUIPMENT (cont'd)**

10) Rewind Starter Handle ..... 35

11) Adjustable Mirrors ..... 35

12) Driver's Seat ..... 35

13) Tool Kit ..... 36

14) Grab Handle/Bumper ..... 37

15) Gauge ..... 37

16) Storage Compartment ..... 39

17) Rear Rack ..... 40

18) Passenger Seat ..... 40

19) Passenger Handholds ..... 40

20) Electric Visor Jack Connector ..... 40

21) Hitch ..... 40

**FUEL AND OIL ..... 42**

Recommended Fuel ..... 42

Fueling Procedure ..... 42

Recommended Oil ..... 42

Injection Oil Level ..... 43

**OPERATING INSTRUCTIONS ..... 44**

Operating During Break-In ..... 44

Engine Starting Procedure ..... 44

Emergency Starting ..... 45

Riding Conditions and your Snowmobile ..... 46

Vehicle Warm-Up ..... 46

Reverse (RER) ..... 47

Shutting Off the Engine ..... 48

Towing an Accessory ..... 48

Towing Another Snowmobile ..... 48

Post-Operation Care ..... 48

**TUNE YOUR RIDE ..... 49**

Rear Suspension Adjustments ..... 49

Front Suspension Adjustments ..... 53

Adjustment Tips According to Vehicle Behavior ..... 55

**VEHICLE TRANSPORTATION ..... 56**

***MAINTENANCE INFORMATION***

**MAINTENANCE SCHEDULE ..... 58**

**10-HOUR INSPECTION ..... 61**

**MAINTENANCE PROCEDURES ..... 62**

Air Filter ..... 62

Exhaust System ..... 62

Spark Plugs ..... 62

Brake Fluid ..... 63

Chaincase Oil ..... 64

Drive Belt Guard ..... 65

<b>MAINTENANCE PROCEDURES (cont'd)</b>	
Spare Drive Belt Storage .....	66
Drive Belt .....	66
Drive Pulley .....	68
Track .....	70
Suspension .....	72
Skis .....	73
Fuses .....	73
Lights .....	74
Body .....	76
<b>STORAGE AND PRESEASON PREPARATION .....</b>	<b>78</b>
Storage .....	78
Preseason Preparation .....	78

### ***TECHNICAL INFORMATION***

<b>VEHICLE IDENTIFICATION .....</b>	<b>80</b>
Vehicle Description Decal .....	80
Identification Numbers .....	80
<b>EC DECLARATION OF CONFORMITY .....</b>	<b>81</b>
<b>EPA CERTIFIED ENGINES .....</b>	<b>82</b>
Engine Emissions Information .....	82
<b>SPECIFICATIONS .....</b>	<b>83</b>

### ***TROUBLESHOOTING***

<b>TROUBLESHOOTING GUIDELINES .....</b>	<b>88</b>
---	-----------

### ***WARRANTY***

<b>BRP LIMITED WARRANTY USA AND CANADA: 2010 SKI-DOO® SNOWMOBILES .....</b>	<b>92</b>
<b>BRP INTERNATIONAL LIMITED WARRANTY: 2010 SKI-DOO® SNOWMOBILES .....</b>	<b>96</b>
<b>BRP LIMITED WARRANTY FOR THE EUROPEAN ECONOMIC AREA: 2010 SKI-DOO® SNOWMOBILES .....</b>	<b>100</b>

### ***CUSTOMER INFORMATION***

<b>PRIVACY OBLIGATION/DISCLAIMER .....</b>	<b>106</b>
<b>CHANGE OF ADDRESS/OWNERSHIP .....</b>	<b>107</b>

# ***SAFETY INFORMATION***

---

# GENERAL PRECAUTIONS

## **Avoid Carbon Monoxide Poisoning**

All engine exhaust contains carbon monoxide, a deadly gas. Breathing carbon monoxide can cause headaches, dizziness, drowsiness, nausea, confusion and eventually death.

Carbon monoxide is a colorless, odorless, tasteless gas that may be present even if you do not see or smell any engine exhaust. Deadly levels of carbon monoxide can collect rapidly, and you can quickly be overcome and unable to save yourself. Also, deadly levels of carbon monoxide can linger for hours or days in enclosed or poorly ventilated areas. If you experience any symptoms of carbon monoxide poisoning, leave the area immediately, get fresh air and seek medical treatment.

To prevent serious injury or death from carbon monoxide:

- Never run the vehicle in poorly ventilated or partially enclosed areas such as garages, carports or barns. Even if you try to ventilate engine exhaust with fans or open windows and doors, carbon monoxide can rapidly reach dangerous levels.
- Never run the vehicle outdoors where engine exhaust can be drawn into a building through openings such as windows and doors.

## **Avoid Gasoline Fires and Other Hazards**

Gasoline is extremely flammable and highly explosive. Fuel vapors can spread and be ignited by a spark or flame many feet away from the engine. To reduce the risk of fire or explosion, follow these instructions:

- Refuel outdoors in a well ventilated area away from flames, sparks, anyone smoking and other sources of ignition.
- Never add fuel with engine running.

- Never top off the fuel tank. Leave some room for the fuel to expand with temperature changes.
- Wipe up any spilled fuel.
- Never start or operate the engine with the fuel cap removed.
- Use only an approved red gasoline container to store fuel.

Gasoline is poisonous and can cause injury or death.

- Never siphon gasoline by mouth.
- If you swallow gasoline, get any in your eye or inhale gasoline vapor, see your doctor immediately.

If gasoline spills on you, wash with soap and water and change your clothes.

## **Avoid Burns from Hot Parts**

The exhaust system and engine become hot during operation. Avoid contact during and shortly after operation to avoid burns.

## **Accessories and Modifications**

Do not make unauthorized modifications, or use attachments or accessories that are not approved by BRP. Since these changes have not been tested by BRP, they may increase the risk of crashes or injuries, and they can make the vehicle illegal.

See your authorized Ski-Doo dealer for available accessories for your vehicle.



---

## SPECIAL SAFETY MESSAGES

**SEVERE INJURY OR DEATH** can result if you do not follow these instructions:

- Always make a pre-ride inspection **BEFORE** you start the engine.
- Throttle mechanism should be checked for free movement and return to idle position before starting engine.
- Never operate the engine without belt guard and brake disk guard securely installed or, with hood or side panels opened or removed. Never run the engine without drive belt installed. Running an unloaded engine such as without drive belt or with track raised, can be dangerous.
- Always engage parking brake before starting the engine.
- Everyone is a beginner the first time he sits behind the controls of a snowmobile regardless of previous experience in driving any other type of vehicle. The safe use of your snowmobile depends on many conditions such as visibility, speed, weather, environment, traffic, vehicle condition and the condition of the driver.
- Basic training is required for the safe operation of any snowmobile. Study your Operator's Guide paying particular attention to cautions and warnings. Join your local snowmobile club: its social activities and trail systems are planned for both fun and safety. Obtain basic instructions from your snowmobile dealer, friend, fellow club member or enroll in your state or provincial safety training program.
- Any new operator must read and understand all safety labels on the snowmobile, the Operator's Guide and watch the *SAFETY DVD* before operating the snowmobile. Only allow a new operator to operate the snowmobile in a restricted flat area, at least until he is completely familiar with its operation. If snowmobile operator's training course is offered in your area, have him enroll.
- The performance of some snowmobiles may significantly exceed that of other snowmobiles you have operated. Therefore, use by novice or inexperienced operators is not recommended.
- Snowmobiles are used in many areas and in many snow conditions. Not all models perform the same in similar conditions. Always consult your snowmobile dealer when selecting the snowmobile model for your particular needs and uses.
- Injury or death may result to the snowmobile operator, passenger or bystander if the snowmobile is used in risky conditions which are beyond the driver's, passenger's or snowmobile's capabilities or intended use.
- BRP recommends the operator has at least 16 years old of age.
- Know your local laws. Federal, state, provincial and local government agencies have enacted laws and regulations pertaining to the safe use and operation of snowmobiles. It is your responsibility as a snowmobiler to learn and obey these laws and regulations. Respect and observance will result in safer snowmobiling for all. Be aware of the liability property damages and insurance laws regarding your equipment.
- Speeding can be fatal. In many cases, you cannot react or respond quickly enough to the unexpected. Always ride at a speed which is suitable to the trail, weather conditions and your own ability. Know your local rules. Speed limit may be in effect and meant to be observed.
- Always keep right hand side of the trail.
- Always keep a safe distance from other snowmobiles and bystanders.

- Remember, promotional material may show risky maneuvers performed by professional riders under ideal and/or controlled conditions. You should never attempt any such risky maneuvers if they are beyond your level of riding ability.
- Never ride this vehicle under influence of alcohol or drugs. They slow reaction time and impair judgement.
- Your snowmobile is not designed to be operated on public streets, roads or high-ways.
- Avoid road traveling. If you must do so, and it is permitted, reduce speed. The snowmobile is not designed to operate or turn on paving. When crossing a road, make a full stop, then look carefully in both directions before crossing at a 90° angle. Be wary of parked vehicles.
- Snowmobiling at night can be a delightful experience but because of reduced visibility, be extra cautious. Avoid unfamiliar terrain and be sure your lights are working. Always carry a flashlight and spare light bulbs.
- Never remove any original equipment from your snowmobile. Each vehicle has many built in safety features. Such features include various guards and consoles, plus reflective materials and safety labels.
- Nature is wonderful but don't let it distract your attention from driving. If you want to truly appreciate winter's scenery, stop your snowmobile on the side of the trail so that **you** don't become a hazard to others.
- Fences represent a very serious threat for both you and your snowmobile. Give a wide berth to telephone poles or posts.
- Hidden wires unseen from a distance can cause serious accidents.
- Always wear an approved safety helmet, eye protection and a face shield. This also applies to your passenger.
- Be aware of inherent risks associated with riding off trails, such as avalanche and other natural or man made hazards or obstacles.
- Tailgating another snowmobile should be avoided. If the snowmobile in front of you slows for any reason, its driver and passenger could be harmed through your neglect. Maintain a safe stopping distance between you and the snowmobile in front of you. Depending on the terrain condition, stopping may require a little more space than you think. Play it safe. Be prepared to use evasive driving.
- Venturing out alone with your snowmobile could also be hazardous. You could run out of fuel, have an accident, or damage your snowmobile. Remember, your snowmobile is capable of traveling further in half an hour than you may be able to walk in a day. Use the "buddy system". Always ride with a friend or member of your snowmobile club. Even then, tell someone where you are going and the approximate time you plan to return.
- Meadows sometimes have low areas where water accumulate and freezes over in winter. This ice is usually glare ice. Attempting to turn or brake on this surface could cause your vehicle to spin out of control. Never brake or attempt speeding or turning on glare ice. If you do happen to travel over such a condition, reduce speed by carefully releasing the throttle.
- Never "jump" with your snowmobile.
- While on safari, do not "gun" the throttle. Snow and ice can be thrown back into the path of a following snowmobile. In addition, when "gunning" the throttle, the vehicle digs into and leaves an irregular snow surface for others.

- Safaris are both fun and enjoyable but don't show off or overtake others in the group. A less experienced operator might try to do the same as you and fail. When riding with others, limit your abilities to the experience of others.
- In an emergency, the snowmobile engine can be stopped by pressing down on the engine stop switch or by pulling the tether cord cap.
- Always engage parking brake when vehicle is not in use.
- Never run the engine in a non-ventilated area and/or if vehicle is left unattended.
- **Electric start models only:** Never charge or boost a battery while installed on snowmobile.
- Ensure the path behind is clear of obstacles or bystanders before proceeding in reverse.
- Always remove the tether cord cap and key when vehicle is not in operation in order to prevent accidental engine starting, to avoid unauthorized use by children or others or theft.
- Raising the rear of your snowmobile while the engine is running could cause snow, ice or debris to be thrown back at an observer. To clear or inspect the track, stop the engine, tilt the vehicle on its side and remove blockage with a piece of wood or branch. Never allow anyone near a rotating snowmobile track.
- Do not stud the track unless it has been approved for studs. At speed, a studded track that has not been approved for studs could tear and separate from vehicle posing a risk of severe injury or death. See an authorized Ski-Doo dealer for current specific studding availability and applications.
- You may stud the track on this vehicle model. However, you **MUST** only use the BRP approved type stud for use on Ski-Doo snowmobiles. **DO NOT EVER** use conventional studs because the track thickness is thinner than our standard tracks. The stud could tear off of track and separate from vehicle.
- Never ride as a passenger unless the snowmobile is equipped with a passenger seat and passenger handholds or holding strap. Sit only on the designated passenger seat.
- Always wear an approved helmet and follow the same dressing guidelines as those recommended for the operator and described in this guide.
- Make sure that you are able to achieve a stable stance, both feet resting positively on the footboards of footrests with good grip, and that you are able to hold on firmly to the handholds.
- Once underway, if you feel uncomfortable or insecure for any reason, don't wait, tell the driver to slow down or stop.

---

# RIDING THE VEHICLE

Each operator has a responsibility to ensure the safety of other recreationists or bystanders.

You are responsible for proper operation of your vehicle as well as training those whom you allow to ride or drive. There may be noticeable handling and performance differences from one snowmobile to the other.

A snowmobile is relatively simple to operate but like any other vehicle or mechanical equipment, it can be hazardous if you or a passenger are reckless, thoughtless or inattentive. We encourage you to have an Annual Safety Inspection of your snowmobile. Please contact an authorized Ski-Doo dealer for further details. Finally, we urge you to visit an authorized Ski-Doo dealer periodically for regular and safety maintenance, as well as snowmobile accessories you may require.

Before venturing on the trails, operate the snowmobile in a restricted flat area until you are completely familiar with its operation and feel comfortable that you can safely tackle a more demanding task. Have an enjoyable and safe ride.

## Pre-Ride Inspection

### **WARNING**

The pre-operation check is very important prior to operating the vehicle. Always check the proper operation of critical controls, safety features and mechanical components before starting.

## Before Starting the Engine

1. Remove snow and ice from body including lights, seat, footrests, controls and instruments.
2. Verify that air filter is free of snow.

3. Verify that skis and steering operate freely. Check corresponding action of skis versus handlebar.
4. Check fuel and oil for levels and leaks. Replenish if necessary and see an authorized Ski-Doo dealer in case of any leaks.
5. All storage compartments must be properly latched and they must not contain any heavy or breakable objects. Hood and side panels must be also properly latched.
6. Activate the throttle control lever several times to check that it operates easily and smoothly. It must return to idle position when released.
7. Activate the brake lever and make sure the brake fully applies before the brake control lever touches the handlebar grip. It must fully return when released.
8. Apply parking brake and check if it operates properly. Leave parking brake applied.

## After Engine is Started

For proper engine starting procedure, refer to the appropriate *ENGINE STARTING PROCEDURE* section.

1. Check headlights high beam and low beam, taillight, stop light and pilot lamps operation.
2. Check tether cord cap and engine stop switch operation.
3. Release parking brake.
4. Refer to the *WARM UP* section and follow instructions.

## Pre-Ride Check List

ITEM	OPERATION	✓
Body including seat, footrests, lights, air filter, controls and instruments	Check condition and remove snow or ice.	
Skis and steering	Check for free movement and proper action.	
Fuel and oil	Check for proper level and leaks.	
Storage compartment	Check for proper latching and no heavy or breakable objects.	
Throttle lever	Check for proper action.	
Brake lever	Check for proper action.	
Parking device	Check for proper action.	
Engine stop switch, tether cord cap and lights	Check for proper action. Tether cord must be attached to driver clothing eyelet.	

## How to Ride

### Riding Gear

Proper snowmobile clothing should be worn. It should be comfortable and not too tight. Always check the weather forecast before going on a ride. Dress for the coldest weather expected. Thermal underwear next to the skin also provides a good insulation.

Wear an approved helmet at all times for safety and comfort. They provide both warmth and reduce injury. A stocking type cap, balaclava and face mask should always be carried or worn. Goggles or a face shield that attach to the helmet are indispensable.

Hands should be protected by a pair of snowmobile gloves or mitts which have sufficient insulation and allow use of thumbs and fingers for operation of controls.

Rubber bottom boots with either a nylon or a leather top, with removable felt liners are best suited for snowmobiling.

You should keep yourself as dry as possible when snowmobiling. When you come indoors, take your snowmobile suit and boots off and make certain they dry properly.

Do not wear long scarfs and loose apparels that could get caught in moving parts.

### What to Bring

Every snowmobiler should carry at least the following basic parts and tools that can help him and others in an emergency:

- This Operator's Guide
- Spare spark plugs and wrench
- Friction tape
- Spare drive belt
- Spare starter rope
- Spare light bulbs
- Tool kit (including at least pliers, screwdriver, adjustable wrench)
- Knife
- Flashlight
- Colored lens goggles
- Trail map.

Include other items depending on the length and time of your ride.

### Riding Position

Your riding position and balance are the two basic principles of making your snowmobile go where you want it to. When turning on the side of a hill, you and your passenger must be ready to shift body weight to help it turn in the desired direction. Driver and passenger(s) must never attempt this maneuvering by placing feet outside of the vehicle. Experience will teach you how much lean to put into turns at different speeds and how much you will have to lean into a slope to maintain proper balance.

Generally, the riding position for best balance and control is sitting. However, the posting, kneeling or standing positions are also used under certain conditions.

The novice driver should become familiar with the snowmobile through practice on a level area at slow speeds before venturing afield.

### WARNING

Do not attempt any maneuvers if they are beyond your abilities.

### Sitting

Feet on the running boards, body mid-way back on seat is an ideal position when operating the snowmobile over familiar, smooth terrain. Knees and hips should remain flexible to absorb shocks.



### Posting

A semi-sitting position with the body off the seat and the feet under the body in a sort of squatting posture, thus allowing the legs to absorb the shocks when traveling over uneven terrain. Avoid abrupt stops.



### Kneeling

This position is achieved by placing one foot firmly on the running board and the opposite knee on the seat. Avoid abrupt stops.



### Standing

Place both feet on the running boards. Knees should be flexed to absorb the shock from surface bumps. This is an effective position to see better and to shift weight as conditions dictate. Avoid abrupt stop.



mmo2008-003-004

## Carrying a Passenger

Certain snowmobiles are designed for an operator only, others can allow one passenger only, and others can allow up to two passengers. Refer to the indications on the vehicles to know if any particular snowmobile can accommodate passengers or not, and if so, how many. Always respect those indications. Overloading is dangerous because snowmobiles are not designed for it.

Even when passengers are allowed, you must make sure that the persons who would like to become passengers are physically fit for snowmobiling.

### **⚠ WARNING**

**Any passenger must be able to firmly lay his feet on the footrests and keep his hands on the handholds or seat strap at all times when seated. Respecting those physical criteria is important to ensure that the passenger is stable and to reduce the risks of ejection.**

On snowmobiles allowing two passengers, if you have an adult and a child for passenger, BRP recommends that the child sits in the center location. This allows an adult sitting in the rear seat to keep a visual contact with the child and hold him if necessary. In addition, the child is best protected against the wind and cold temperature if seated in the center location.

Each operator has a responsibility to ensure the safety of his passengers and should inform them of snowmobiling basics.

### **⚠ WARNING**

- Passengers must only sit on designated passenger seats. Never allow anyone to sit between the handlebar and the operator.
- Each passenger seat must have a strap or handholds and meet SSCC standards.
- Passengers and operators must always wear an approved helmets and warm clothing appropriate for snowmobiling. Make sure that no skin is exposed.
- Once underway, if a passenger feels uncomfortable or insecure for any reason, he must not wait, and tell the driver to slowdown or stop.

Riding with passengers on board is different than riding alone. The operator has the benefit of knowing what will be the next maneuver and is able to prepare himself accordingly. The operator also benefits from the support of his grip on the handlebar. In contrast, the passengers have to rely on the operator's careful and safe operation of the vehicle. In addition, "body english" is limited with passengers, and the operator can sometimes see more of the trail ahead than the passengers. Therefore, smooth starting and stopping are required with passengers, and the operator must slow down. The operator must also warn passengers of side hills, bumps, branches, etc. An unforeseen bump can leave you passenger-less. Remind your passengers to lean into the turn with you, without causing the vehicle to topple. Be extremely careful, go more slowly and check the passengers frequently.

**⚠ WARNING**

When riding with a passenger:

- Braking ability and steering control are reduced. Decrease speed and allow extra space to maneuver.
- Adjust suspension according to weight.

For complete information on how to adjust the suspension, please refer to the *TUNE YOUR RIDE* section.

Use extra caution and go even more slowly with young passengers. Check frequently to make certain the child has a firm grip and is properly positioned with his feet on the running boards.

## Terrain/Riding Variations

### Groomed Trail

On a maintained trail, sitting is the most preferred riding position. Do not race and, above all, keep to the right hand side of the trail. Be prepared for the unexpected. Observe all trail signs. Do not zigzag from one side of the trail to the other.

### Ungroomed Trail

Unless there has been a fresh snowfall you can expect “washboard” and snowdrift conditions. Taken at excessive speeds, such conditions can be physically harmful. Slow down. Hold on the handlebar and assume a posting position. Feet should be under the body assuming a crouched position to absorb any jarring effect. On longer stretches of “washboard” trails, the kneeling position of one knee on the seat can be adopted. This provides a certain amount of comfort, while at the same time keeps the body loose and capable of vehicle control. Beware of hidden rocks or tree stumps partially hidden by a recent snowfall.

### Deep Snow

In deep “powder” snow, your vehicle could begin to “bog” down. If this occurs, turn in as wide an arc as possible and look for a firmer base. If you do get “bogged”, and it happens to everyone, do not spin your track as this makes the vehicle sink deeper. Instead, turn the engine off, get off and move the back of the vehicle onto new snow. Then tramp a clear path ahead of the vehicle. A few feet will generally suffice. Restart the engine. Assume the standing position and rock the vehicle gently as you steadily and slowly apply the throttle. Depending on whether the front or rear end of the vehicle is sinking, your feet should be placed on the opposing end of the running boards. Never place foreign material beneath the track for support. Do not allow anyone to stand in front of, or to the rear of, the snowmobile with the engine running. Stay away from the track. Personal injury will result if contact is made with the revolving track.

### Frozen Water

Traveling frozen lakes and rivers can be fatal. Avoid waterways. If you are in an unfamiliar area, ask the local authorities or residents about the ice condition, inlets, outlets, springs, fast moving currents or other hazards. Never attempt to operate your snowmobile on ice that may be too weak to support you and the vehicle. Operating a snowmobile on ice or icy surfaces can be very dangerous if you do not observe certain precautions. The very nature of ice is foreign to good control of a snowmobile or any vehicle. Traction for starting, turning or stopping is much less than that on snow. Thus, these distances can be multiplied manyfold. Steering is minimal, and uncontrolled spins are an ever present danger. When operating on ice, drive slowly with caution. Allow



yourself plenty of room for stopping and turning. This is especially true at night.

### **Hard Packed Snow**

Don't underestimate hard packed snow. It can be difficult to negotiate as both skis and track do not have as much traction. Best advice is to slow down and avoid rapid acceleration, turning or braking.

### **Uphill**

There are two types of hills you can encounter — the open hill on which there are few trees, cliffs or other obstacles, and a hill that can only be climbed directly. On an open hill, the approach is to climb it by side hilling or slaloming. Approach at an angle. Adopt a kneeling position. Keep your weight on the uphill side at all times. Maintain a steady, safe speed. Continue as far as you can in this direction, then switch to an opposite hill angle and riding position.

A direct climb could present problems. Choose the standing position, accelerate before you start the climb and then reduce throttle pressure to prevent track slippage.

In either case, vehicle speed should be as fast as the incline demands. Always slow down as you reach the crest. If you cannot proceed further, don't spin your track. Turn the engine off, free the skis by pulling them out and downhill, place the rear of the snowmobile uphill restart the engine and ease it out with slow even throttle pressure. Position yourself to avoid tipping over, then descend.

### **Downhill**

Downhill driving requires that you have full control of your vehicle at all times. On steeper hills, keep your center of gravity low and both hands on the handlebar. Maintain slight throttle pressure and allow the machine to run downhill with the engine operating.

If a higher than safe speed is reached, slow down by braking but apply the brake with frequent light pressure. Never jam the brake and lock the track.

### **Side Hill**

When crossing a side hill or traversing up or downhill, certain procedures must be followed. All riders should lean towards the slope as required for stability. The preferred operating positions are the kneeling position, with the knee of the down hill leg on the seat and the foot of the uphill leg on the running board, or the posting position. Be prepared to shift your weight quickly as needed. Side hills and steep slopes are not recommended for a beginner or a novice snowmobiler.

### **Slush**

Slush should be avoided at all times. Always check for slush before starting across any lake or river. If dark spots appear in your tracks, get off the ice immediately. Ice and water can be thrown rearward into the path of a following snowmobile. Getting a vehicle out of a slush area is strenuous and in some cases, impossible.

### **Fog or Whiteouts**

On land or water, fog or visibility-limiting snow can form. If you have to proceed into the fog or heavy snow, do so slowly with your lights on and watch intently for hazards. If you are not sure of your way, do not proceed. Keep a safe distance behind other snowmobilers to improve visibility and reaction time.

### **Unfamiliar Territory**

Whenever you enter an area that is new to you, drive with extreme caution. Go slow enough to recognize potential hazards such as fences or fence posts, brooks crossing your path, rocks, sudden dips, guy wires and countless other obstacles which could result in a termination of your

snowmobile ride. Even when following existing tracks, be cautious. Travel at a speed so you can see what is around the next bend or over the top of the hill.

### **Bright Sunshine**

Bright sunny days can considerably reduce your vision. The glare from sun and snow may blind you to the extent that you cannot easily distinguish ravines, ditches or other obstacles. Goggles with colored lenses should always be worn under these conditions.

### **Unseen Obstruction**

There may be obstructions hidden beneath the snow. Driving off established trails and in the woods requires reduced speed and increased vigilance. Driving too fast in an area can make even minor obstacles very hazardous. Even hitting a small rock or stump could throw your snowmobile out of control and cause injury to its riders. Stay on established trails to reduce your exposure to hazards. Be safe, slow down and enjoy the scenery.

### **Hidden Wires**

Always be on the lookout for hidden wires, especially in areas that may have been farmed at one time or another. Too many accidents have been caused by running into wires in the fields, guy wires next to poles and roads, and into chains and wires used as road closures. Slow speeds are a must.

### **Obstacles and Jumping**

Unplanned jumps of snowdrifts, snowplow ridges, culverts or indistinguishable objects can be dangerous. You can avoid them by wearing the proper color lenses or face shields and by operating at a lower speed.

Jumping a snowmobile is an unsafe and dangerous practice. However, if the trail does suddenly drop away from you, crouch (stand) towards the rear of the vehicle and keep the skis up and straight ahead. Apply partial throttle and brace yourself for the impact. Knees must be flexed to act as shock absorbers.

### **Turning**

Depending on terrain conditions, there are two preferred ways to turn or corner a snowmobile. For most snow surfaces, "body english" is the key to turning. Leaning towards the inside of the turn and positioning body weight on the inside foot will create a "banking" condition beneath the track. By adopting this position and positioning yourself as far forward as possible, weight will be transferred to the inside ski.

On occasion, you will find that the only way to turn the vehicle about in deep snow is to pull the snowmobile around. Do not over-exert yourself. Get assistance. Remember to always lift using your legs as opposed to your back.



### **Road Crossing**

In some cases, you will be approaching the road from a ditch or snowbank. Choose a place where you know you can climb without difficulty. Use the standing position and proceed with only as much speed needed to crest

the bank. Stop completely at the top of the bank and wait for all traffic to clear. Judge the drop to the roadway. Cross the road at a 90° angle. If you encounter another snowbank on the opposite side, position your feet near the rear of the vehicle. Remember, your snowmobile is not designed to operate on bare pavement and steering on this type of surface is more difficult.

## Railroad Crossing

Never ride on railroad tracks. It is illegal. Railroad tracks and railroad rights-of-way are private property. A snowmobile is no match for a train. Before crossing a railroad track, stop, look and listen.

## Night Rides

The amount of natural and artificial light at a given time can effect your ability to see or to be seen. Nighttime snowmobiling is delightful. It can be a unique experience if you acknowledge your reduced visibility. Before you start, make certain your lights are clean and work properly. Drive at speeds that will allow you to stop in time when you see an unknown or dangerous object ahead. Stay on established trails and never operate in unfamiliar territory. Avoid rivers and lakes. Guy wires, barbed wire fences, cabled road entrances and other objects such as tree limbs are difficult to see at night. Never drive alone. Always carry a flashlight. Keep away from residential areas and respect the right of others to sleep.

## Safari Riding

Before starting out, designate a "trail boss" to lead the party and another person to follow-up at the end of the party. Ensure that all members of the party are aware of the proposed route and destination. Make certain that you are carrying all necessary tools and equipment and that you have sufficient fuel to complete the trip. Never overtake

the trail boss or, for that matter, any other snowmobile. Use down-the-line hand signals to indicate hazards or intent of direction change. Assist others whenever necessary.

It is always IMPORTANT to keep a safe distance between each snowmobile. Always maintain a safe interval and allow sufficient stopping distance. Don't be a tailgater. Know the position of the machine ahead.

## Signals

If you intend to stop, raise either hand straight above your head. A left turn is indicated by extending your left hand straight out in the proper direction. For right turns, extend the left arm and raise the hand to a vertical position so it forms a right angle at the elbow. Every snowmobiler should relay any signal to the ones behind.

## Trail Stops

Whenever possible, pull off the trail when you stop. This will reduce the hazard to other snowmobilers using the trail.

## Trails and Signs

Trail signs are used to control, direct or regulate the use of snowmobiles on trails. Become familiar with all signs used in the area where you are snowmobiling.

## Environment

Wildlife compliments your snowmobiling day. Snowmobile tracks provide firm ground over which animals can travel from area to area. Do not violate this privilege by chasing or harassing wildlife. Fatigue and exhaustion can lead to animal's death. Avoid areas posted for the protection or feeding of wildlife.

If you happen to be fortunate enough to see an animal, stop your snowmobile and observe quietly.

The guidelines that we support are not designed to limit your snowmobiling fun, but to preserve the beautiful freedom that you can experience only on a snowmobile! These guidelines will keep snowmobilers healthy, happy and able to introduce others to what they know and enjoy about their favorite winter pastime. So, the next time you hit the trails on a cool, crisp and clear winter day, we ask you to remember that you are paving the way for the future of our sport. Help us lead it down the right path! From all of us at BRP, thank you for doing your share.

There is nothing more exhilarating than snowmobiling. Venturing onto snowmobile trails that cross wild areas is an exciting and healthy winter sport. However, as the number of people using these recreational parks increases, so does the potential for damage to the environment. Abuse of land, facilities and resources inevitably leads to restrictions and closures of both private and public land.

In essence, the greatest threat to our sport, is all around us. Which leaves us with one logical choice. When we snowmobile, we must always ride responsibly.

The vast majority respect the law and the environment. Each of us must set an example for those who are new to the sport, young and old alike.

It is in every one's best interest to tread lightly into our recreational areas. Because, in the long run, to protect the sport we must preserve the environment.

Recognizing the importance of this issue and the need for snowmobilers to do their share in preserving areas that make it possible to enjoy our sport, BRP has developed the "Light Treading Is Smart Sledding" campaign for snowmobilers.

Light Treading refers to more than the thread of our tracks. It's a statement of concern, respect and willingness

to take the lead and take action. It applies to the environment in general, its proper care and maintenance, its natural inhabitants and all enthusiasts and the public at large who enjoy the great outdoors. With this theme, we invite all snowmobilers to remember that respecting the environment is not only critical to the future of our industry but to future generations.

Light Treading in no way suggests you should curb your appetite for snowmobiling fun! It simply means tread with respect!

The fundamental objective of Light Treading is one of respect for where and how you ride a snowmobile. You're a light treader when you follow the principles below.

**Become informed.** Obtain maps, regulations and other information from the Forest Service or from other public land agencies. Learn the rules and follow them and that goes for speed limits, too!

**Avoid** running over young trees, shrubs, and grasses and don't cut wood. On flatlands or areas where trail riding is popular, it's important to ride only where authorized. Remember, there is a link between protecting your environment and your own safety.

**Respect wildlife** and be particularly sensitive of animals that are rearing young or suffering from food shortage. Stress can sap scarce energy reserves. Refrain from riding in areas where only animals are intended to tread!

**Obey** gate closures and regulatory signs and remember, light treaders don't litter!

**Stay out** of wilderness areas. They're closed to all vehicles. Know where the boundaries are.

**Obtain permission** to travel across private land. Respect the rights of landowners and other people's privacy. Remember, snowmobile technology has lowered the noise factor

considerably, but you still shouldn't rev your engines where quiet "is the order of the day".

Snowmobilers know all too well the efforts that have been made throughout the sport's history to enjoy access to areas where people can snowmobile safely and responsibly. This effort continues today, as strong as ever.

Respecting the areas where we ride... wherever they may be... is the only way to ensure their future enjoyment. That's one major reason why we know you'll agree that Light Treading is smart sledding! And there are more.

Enjoying the opportunity to see winter and all its natural majestic wonders, is an experience cherished by snowmobilers. Light Treading will preserve this opportunity and will make it possible for us to expose others to the beauty of winter and the unique thrill of our sport! Light Treading will help our sport to grow!

Finally, Light Treading is the sign of a smart snowmobiler. You don't have to leave big tracks or careen through a virgin forest to show you can ride. So whether you're driving a high performance Ski-Doo, a sporty MX Z™ snowmobile or any other make or model, show you know what you're doing. Show you know how to send snow flying and make tracks with a light touch!

# TRACTION ENHANCING PRODUCTS

**NOTE:** This section is applicable to snowmobiles equipped with a factory installed track that has been approved by BRP for special studs installation.

## **⚠ WARNING**

Never stud a track that has not been approved for studs. Installing studs on an unapproved track could increase the risk of the track tearing or severing.

## **⚠ WARNING**

You may stud the track on this vehicle model. However, you **MUST** only use the BRP approved type stud for use on these Ski-Doo snowmobiles. **DO NOT EVER** use conventional studs as the track thickness is thinner than other standard tracks. The stud could tear off of track and separate from vehicle. See an authorized Ski-Doo dealer for current specific studding availability and applications.

Using traction enhancing products such as, more aggressive ski carbide runners and/or studs on your snowmobile will change its behavior, particularly in terms of manoeuvrability, acceleration, and braking.

Using traction enhancing products gives a better grip on packed snow and ice, but has no noticeable effect on soft snow. For this reason, driving a snowmobile equipped with traction enhancing products requires a certain adaptation period. If your snowmobile is equipped with traction enhancing products, be sure to take plenty of time to get used to the way it handles when turning, accelerating, and braking.

Also, always check local regulations concerning the use of traction enhancing products on snowmobiles. Always

drive your snowmobile in a responsible manner, respecting the environment and other people's property.

## **Manoeuvrability**

Using traction enhancing products such as, more aggressive ski carbide runners and/or studs makes the snowmobile grip the ground better at both the front and at the rear. The use of carbide runners is therefore required to give the skis a better grip, so that the front and rear of the snowmobile are in balance. While off-the-shelf carbide ski runners are adequate, they don't necessarily give you optimal control, since that depends on your personal preferences, your riding style, and how your suspension is adjusted.

## **⚠ WARNING**

If the front and rear of the snowmobile are out of balance due to an incorrect combination of traction enhancing products, the snowmobile may tend to oversteer or understeer, which could lead to a loss of control.

## **Oversteering**

In certain conditions, using more aggressive ski carbide runners without studs on the rear track could make the snowmobile prone to oversteering, see illustration.

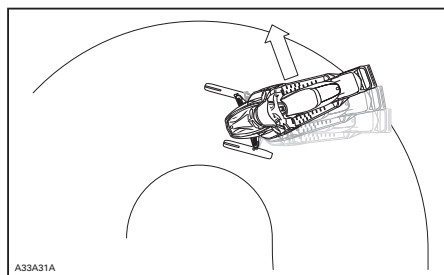

**OVERSTEERING**

## Understeering

In certain conditions, the use of studs on the track could make the snowmobile prone to understeering if the skis are not equipped with more aggressive ski carbide runners, see illustration.

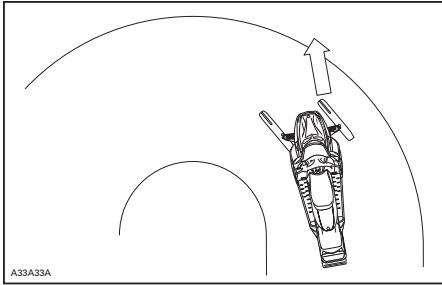

A33A33A

UNDERSTEERING

## Controlled Driving

A balanced combination of carbide ski runners and studs on the track ensures adequate control and better handling, see illustration.

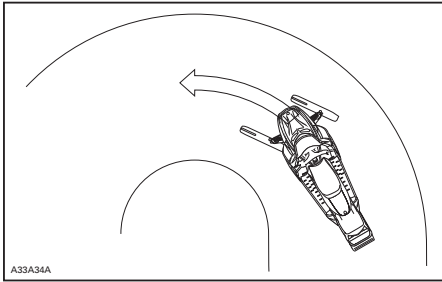

A33A34A

CONTROLLED DRIVING

## Acceleration

Using studs on the track will allow your sled to accelerate better on packed snow and ice but will have no noticeable effect on soft snow. This can cause sudden variations in traction under certain conditions.

## ⚠ WARNING

To prevent surprises that could lead to a loss of control of the snowmobile:

- Always go easy on the throttle.
- NEVER try to spin the track to make the rear of the snowmobile skid.

This could cause debris or ice to be thrown violently backwards, possibly injuring others nearby or on snowmobiles behind you.

## Braking

As in the case of acceleration, using studs on the track will give you better braking capacity on packed snow or ice but will have no noticeable effect on soft snow. Braking may thus vary suddenly under certain conditions. Be sure to use restraint in braking to keep from blocking the track in order to avoid surprises that could lead to a loss of control.

## Important Safety Rules

### ⚠ WARNING

To prevent serious injury to individuals near the snowmobile:

- NEVER stand behind or near a moving track.
- Always use a wide-base snowmobile stand with a rear deflector panel if it is necessary to rotate track.
- When the track is raised off the ground, only run it at the lowest possible speed.

Centrifugal force could cause debris, damaged or loose studs, pieces of torn track, or an entire severed track to be violently thrown backwards out of the tunnel with tremendous force.

## Effects of Having a Studded Track on the Life of the Snowmobile

The use of traction enhancing products can increase the load and the stress on certain snowmobile components, as well as the vibration level. This can cause premature wear on parts such as belts, brake linings, bearings, chain, chaincase sprocket, and on approved studded tracks, shorten track life. Always proceed with a visual inspection of your track before each use. For more information, refer to the *TRACK* section in *MAINTENANCE INFORMATION*.

Studs on the track can also cause serious damage to your snowmobile if it is not equipped with the tunnel protectors designed for your particular model. Damage to the electrical wiring or perforation of the heat exchangers are potential hazards, that could cause the engine to overheat and be severely damaged.

### **WARNING**

If tunnel protectors are excessively worn or not installed, the gas tank could be punctured, causing a fire.

**NOTICE** Ask your dealer for the appropriate tunnel protectors model and kit number required for your snowmobile.

**NOTE:** Consult the BRP limited warranty to find out what warranty limitations are related to the use of studs.

## Installation of Studs on BRP Approved Tracks

### **WARNING**

Never stud a track that has not been approved for studs. Approved tracks can be identified by a stud symbol (see illustration below) molded into the track surface. Installing studs on an unapproved track could increase the risk of the track tearing or severing.

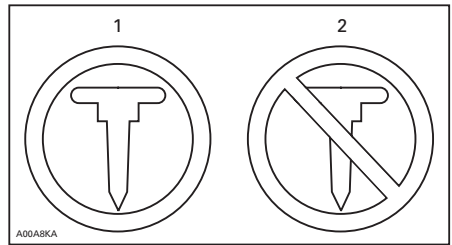

#### TRACK SYMBOLS

1. Approved
2. NOT Approved

To ensure safe and proper installation, BRP recommends to have the studs installed by your dealer.

- Use only the BRP approved special studs.
- Never use studs that exceed the height of your snowmobile's track profile by more than 9.5 mm (3/8 in).

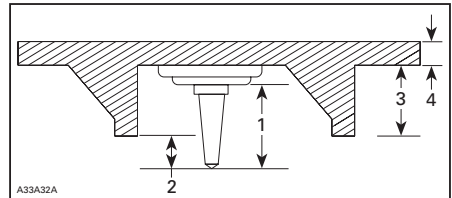

#### INSTALLATION OF STUDS

1. Stud size
2. Penetration range 6.4 to 9.5 mm (1/4 to 3/8 in)
3. Track lug height
4. Track belt thickness



**⚠ WARNING**

- See an authorized Ski-Doo dealer for current specific stud-  
ding availability and applica-  
tions.
- **DO NOT EVER** use conventional  
stud because, the track thick-  
ness is thinner than our stan-  
dard tracks and the stud could  
tear off of track and separate  
from vehicle.
- Studs should only be installed  
in the locations indicated by  
molded bulges in the track sur-  
face.
- Never stud a track with a profile  
of 35 mm (1.375 in) or more.
- The number of studs installed  
must always perfectly match  
the pattern of molded bulges in  
the track.
- Always consult the traction  
product manufacturer's instal-  
lation instructions and recom-  
mendations before having your  
dealer install studs and runners.  
It is very important to follow  
the torque specifications for the  
stud bolts.

**INSTALLING AN INCORRECT  
NUMBER OF STUDS OR AN IM-  
PROPER INSTALLATION CAN IN-  
CREASE THE RISK OF THE TRACK  
TEARING OR SEVERING.**

- Broken studs (studded tracks)
- Bent studs (studded tracks)
- Missing studs
- Studs that are torn off the track
- Missing track guide(s)
- Also, ensure that studs nut are  
tighten to the recommended  
torque.

On approved studded tracks, replace broken or damaged studs immediately. If your track shows signs of deterioration, it must be replaced immediately. When in doubt, ask your dealer. Always proceed with a visual inspection of your track before each use.

**⚠ WARNING**

**Riding with a damaged track or  
studs could lead to loss of control.**

**Maintenance/Replacement**

PROCEED WITH A VISUAL INSPEC-  
TION OF YOUR TRACK BEFORE  
EACH USE.

Look for any defects, such as:

- Perforations in the track
- Tears in the track (particularly  
around traction holes on studded  
tracks)
- Lugs that are broken or torn off, ex-  
posing portions of rods
- Delamination of the rubber
- Broken rods

# IMPORTANT ON-PRODUCT LABELS

## Hang Tag

**VEHICLE ENGINE DESCRIPTION:**  
XXXXX

**EPA CERTIFIED**

NER (NORMALIZED EMISSION RATE) =  X  
ON A 0 TO 1.0 SCALE, 0 BEING THE CLEANEST  
**\*NOT TO BE REMOVED PRIOR TO SALE**



704901107

vmo2006-005-009\_en

## Vehicle Safety Labels

The following labels are on your vehicle and they should be considered permanent parts of the vehicle. If missing or damaged, the decals can be replaced free of charge. See an authorized Ski-Doo dealer.

**NOTE:** The following illustrations used in this Operator's Guide are a general representation only. Your model may differ.

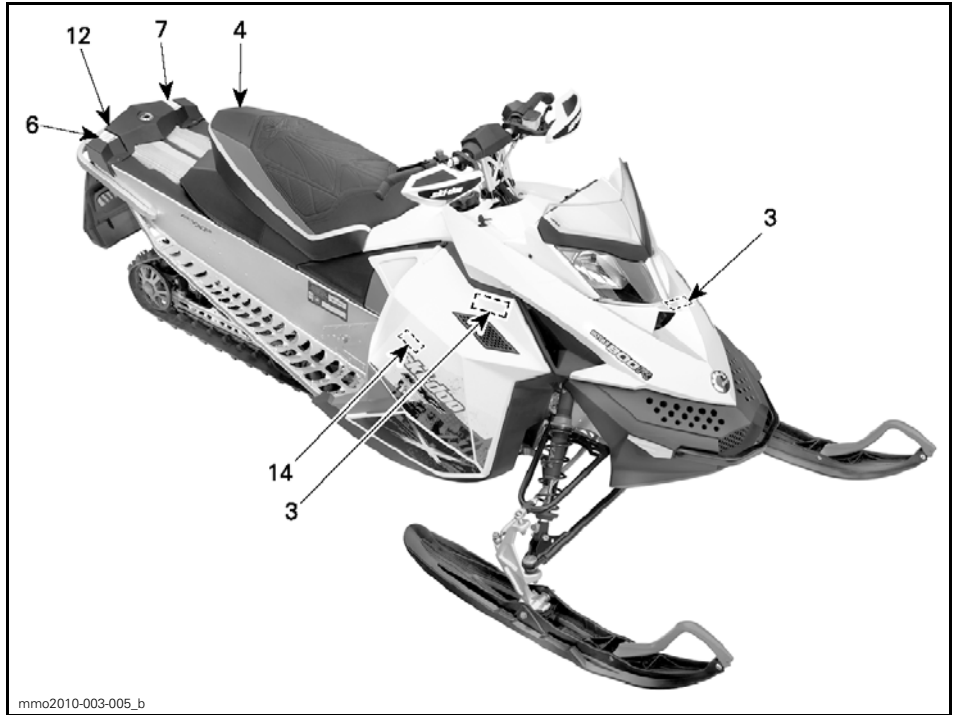

TYPICAL

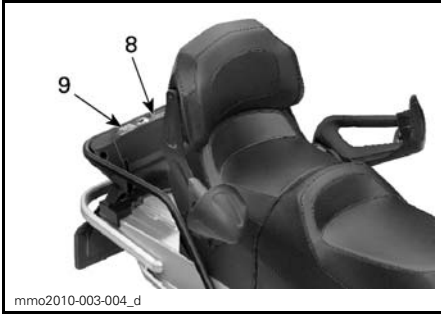

TYPICAL

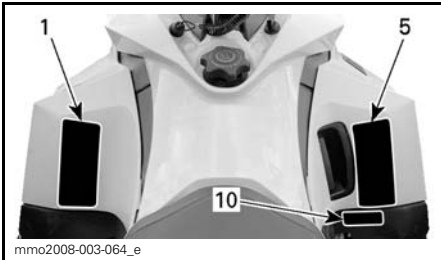

TYPICAL

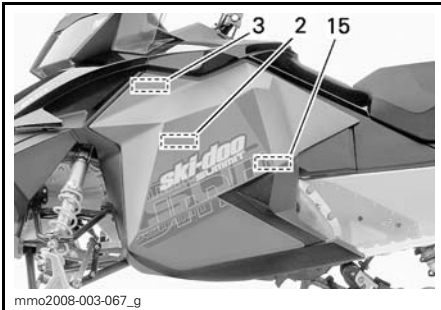

TYPICAL

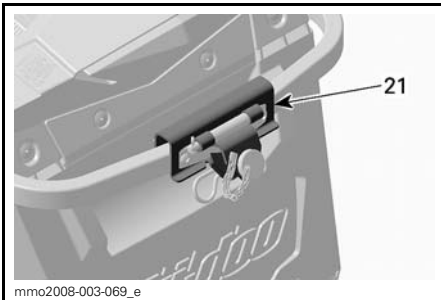

TYPICAL

**WARNING**

- Read and understand all warning labels and operator's guide before operation. Operator's guide is located in the under seat base. Pull latch located under front lip of seat and slide it to the rear to have access. If guide is missing, ask your dealer for a new one.
- Get familiar with your vehicle. Inexperienced riders may overlook risks and be surprised by vehicle's specific behavior and terrain conditions. Ride slowly.
- Excessive speed and reckless driving can kill! ALWAYS adjust your speed according to snow conditions and circumstances.
- Steering control and braking ability may be reduced on hard-pack snow, ice or roads. Reduce speed & allow more space to stop or turn.
- Respect laws on minimum operator age. Manufacturer recommends a minimum operating age of 16 years old.
- Never open side panels or hood while engine is running or if vehicle is in motion. Ensure to remove DESS key before opening those.

**BEFORE STARTING :**

1. Attach tether cord to your clothing.
2. Check proper operation of the throttle and brake levers each time before starting. They must return to their initial position when released.
3. Apply parking brake.
4. Turn handlebars all the way in both directions to check for interference and insure free operation.

**AFTER STARTING :**

1. Pull-out tether cord to check if engine shuts off.
2. Re-start and push in engine cut-off switch to check if engine shuts off.
3. Disengage parking brake before riding to avoid fading.

mmo2009-003-001\_en

**INSTRUCTION 1 - ALL MODELS EXCEPT GRAND TOURING**

**WARNING**

- Read and understand all warning labels and operator's guide before operation. Operator's guide is located either in the passenger seat or under the seat. To access guide under seat, pull front of seat cushion then pull tab to unlock seat.
- Get familiar with your vehicle. Inexperienced riders may overlook risks and be surprised by vehicle's specific behavior and terrain conditions. Ride slowly.
- Excessive speed and reckless driving can kill! ALWAYS adjust your speed according to snow conditions and circumstances.
- Steering control and braking ability may be reduced on hard-pack snow, ice or roads. Reduce speed & allow more space to stop or turn.
- Respect laws on minimum operator age. Manufacturer recommends a minimum operating age of 16 years old.
- Never open side panels or hood while engine is running or if vehicle is in motion. Ensure to remove DESS key before opening those.

**BEFORE STARTING :**

1. Attach tether cord to your clothing.
2. Check proper operation of the throttle and brake levers each time before starting. They must return to their initial position when released.
3. Apply parking brake.
4. Turn handlebars all the way in both directions to check for interference and insure free operation.

**AFTER STARTING :**

1. Pull-out tether cord to check if engine shuts off.
2. Re-start and push in engine cut-off switch to check if engine shuts off.
3. Disengage parking brake before riding to avoid fading.

s1600209

mmo2010-003-026\_en

**INSTRUCTION 1 - GRAND TOURING**

**⚠ WARNING**  
 This guard must ALWAYS be in place when engine is running. Beware of rotating parts – they could cause injuries or catch your clothing.

**⚠ AVERTISSEMENT**  
 Ce garde-courroie doit TOUJOURS être en place lorsque le moteur fonctionne. Attention aux pièces en rotation – elles peuvent vous blesser ou capter vos vêtements.

A33A2FA 516 002 670

INSTRUCTION 2

**⚠ WARNING**  
 Beware of HOT parts!

**⚠ AVERTISSEMENT**  
 Attention aux pièces CHAUDES!

A33A2GA 516002664

INSTRUCTION 3



**DO NOT SIT HERE/  
 NE PAS S'ASSEOIR ICI**

mmo2008-003-006\_a

INSTRUCTION 4

**⚠ WARNING**

This vehicle is designed for one (1) operator and as many passengers as there are seats with straps or handgrips installed on the vehicle conforming to SSSC standards.

**When riding with a passenger :**

- Braking ability and steering control are reduced. Decrease speed and allow extra space to maneuver.
- Adjust suspensions according to weight.

**REMEMBER : YOU ARE RESPONSIBLE FOR THE SAFETY OF YOUR PASSENGER!**

ALL DRIVERS AND PASSENGERS MUST READ THE FOLLOWING:  
 Avoid surprises!  
 BE ON THE LOOK-OUT for the unexpected.

- Operate defensively.
- Scan constantly for people, objects, conditions and upcoming vehicles.
- Avoid thin ice / open water.
- Use extra caution whenever off-trail.

ALWAYS wear a DOT approved HELMET and clothing appropriate for snowmobiling.

NEVER ride after consuming alcohol or drugs even as a passenger.



mmo2009-003-002\_en

INSTRUCTION 5

**⚠ WARNING**

- NEVER STAND BEHIND or near a rotating track.
- Only spin track at lowest possible speed whenever off the ground. Broken track or debris could be projected with great force which could sever legs or cause other serious injuries.



mmo2007-009-053\_en

INSTRUCTION 6 - ALL EXCEPT GRAND TOURING

**▲ WARNING**

NEVER SIT IN CARGO AREA.

---

Exceeding maximum cargo load may affect steering control and braking ability.

MAXIMUM cargo load :  
15,8 Kg / 35 Lbs.

mmo2007-009-058\_en

**INSTRUCTION 7 - ALL EXCEPT GRAND TOURING**

**▲ WARNING**

- NEVER STAND BEHIND or near a rotating track.
- Only spin track at lowest possible speed whenever off the ground. Broken track or debris could be projected with great force which could sever legs or cause other serious injuries.



516003934A

mmo2010-003-003\_en

**INSTRUCTION 9 - GRAND TOURING**

**▲ WARNING**

NEVER SIT IN CARGO AREA.

---

Exceeding maximum cargo load may affect steering control and braking ability.

MAXIMUM cargo load : 15,8 Kg / 35 Lbs.

516004298

mmo2010-003-021\_en

**INSTRUCTION 8 - GRAND TOURING (EXCEPT EUROPE)**

**▲ WARNING | ▲ AVERTISSEMENT**







mmo2006-003-007\_a

**INSTRUCTION 10 - EUROPEAN MODELS**

Towing a load may affect handling of your snowmobile.

- Reduce speed.
- Use rigid tow bar.
- Ensure that the tow bar is securely fastened. Do not exceed the following loads:

DRAWBAR xxx Kg / xxxlbs Max.  
VERTICAL LOAD xx Kg / xxlbs Max.

**▲ WARNING**

mmo2007-002-001\_en

**INSTRUCTION 11 - RENEGADE™ EUROPEAN MODELS**

**▲ WARNING**

NEVER SIT IN CARGO AREA.

Exceeding maximum cargo load may affect steering control and braking ability.

MAXIMUM cargo load : 15,8 Kg / 35 Lbs.

---

Towing a load may affect handling of your snowmobile.

- Reduce speed.
- Use rigid tow bar.
- Ensure that the tow bar is securely fastened.

Do not exceed the following loads :

DRAWBAR 2500N / 255 kg / 562 lbf Max.  
VERTICAL LOAD 100N / 10,2 kg / 22,5 lbs Max.

516004293A

mmo2010-003-022\_en

**INSTRUCTION 8 - GRAND TOURING (EUROPE)**

**▲ WARNING**

If you stud the track on this vehicle use special BRP approved studs ONLY.

Studding this track with conventional studs may cause studs to tear off of track and separate from vehicle posing a potential risk of severe injury or death

See the Operator's Guide that came with this vehicle for all details pertaining to track studding

mmo2008-003-052\_en

**INSTRUCTION 12 - MODELS WITH TRACK APPROVED FOR STUDS**



INSTRUCTION 13 - ON BRAKE DISC GUARD



ON SHOCK GAS CHARGED ABSORBERS

## Compliance Labels

### EPA Compliance Label

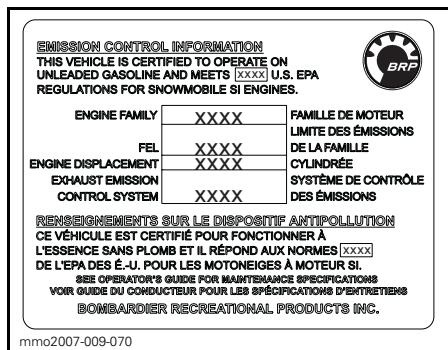

IN ENGINE COMPARTMENT

### SSCC Label

Safety standards for snowmobiles have been adopted by the Snowmobile Safety and Certification Committee (SSCC) of which BRP is a proud participating member. Assurance that your snowmobile meets these stan-

dards is easily checked by locating the Certification Label on a right vertical portion of the vehicle.

The following label shows that an independent testing laboratory has verified compliance with the SSCC safety standards.



ON TUNNEL

## Technical Information Labels

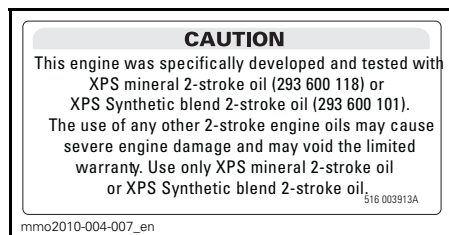

INSTRUCTION 14

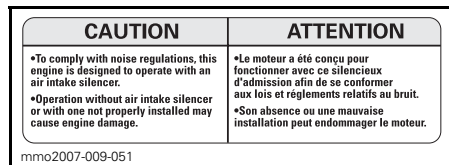

INSTRUCTION 15

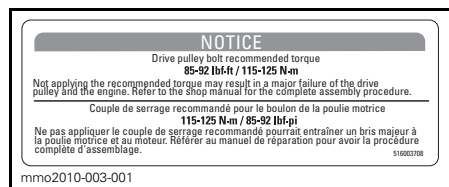

ON DRIVE BELT GUARD

# ***VEHICLE INFORMATION***

# CONTROLS, INSTRUMENTS AND EQUIPMENT

NOTE: Some controls, instruments or equipment do not apply or are optional on some models.



TYPICAL

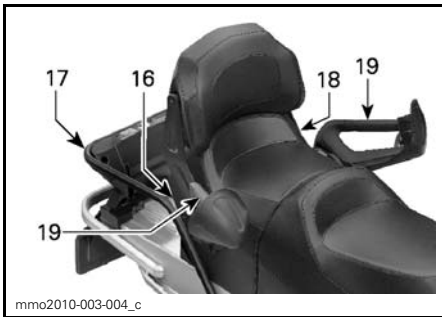

TYPICAL



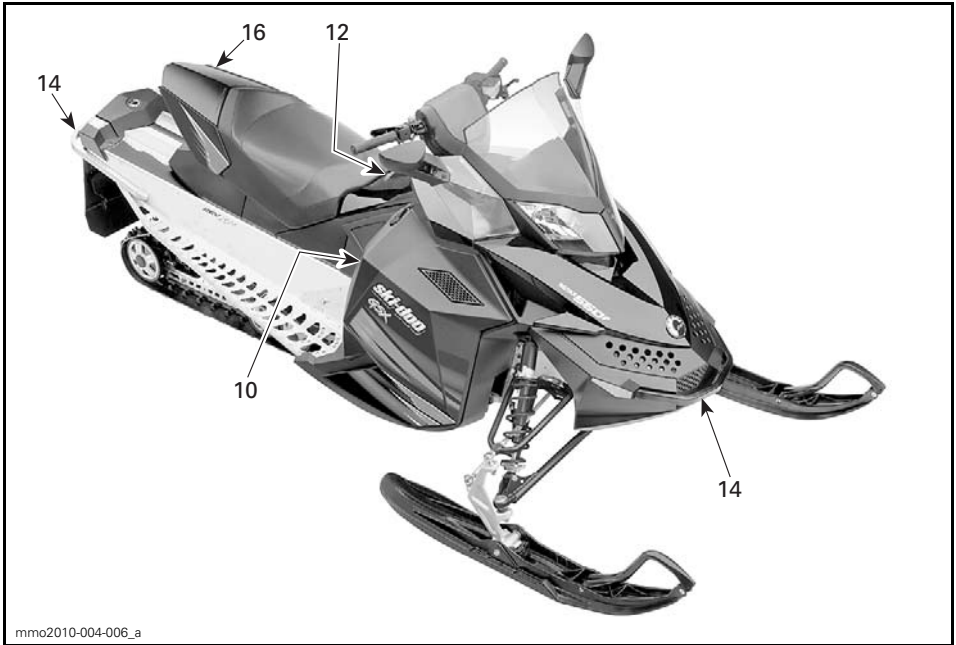

mmo2010-004-006\_a

TYPICAL

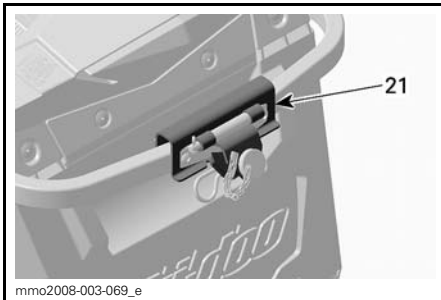

mmo2008-003-069\_e

ALL EUROPEAN MODELS EXCEPT MX Z

## 1) Handlebar

The handlebar controls the steering of the snowmobile. As the handlebar is rotated right or left, the skis are turned right or left to steer the snowmobile.

### **⚠ WARNING**

Fast reverse while turning, could result in loss of stability and control.

## 2) Throttle Lever

Throttle lever is located on the RH side of handlebar.

Designed to be thumb activated. When squeezed, it increases the engine speed and engages the transmission. When released, engine speed returns automatically to idle.

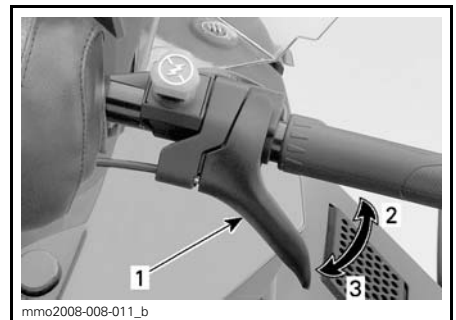

mmo2008-008-011\_b

TYPICAL

1. Throttle lever
2. To accelerate
3. To decelerate

**⚠ WARNING**

Test the throttle lever operation each time before starting the engine. The lever must return to its original position once released. Otherwise, do not start engine.

**3) Brake Lever**

Brake lever is located on the LH side of handlebar.

When squeezed, brake is applied. When released, it automatically returns to its original position. Braking effect is proportional to the pressure applied on the lever and to the type of terrain and its snow coverage.

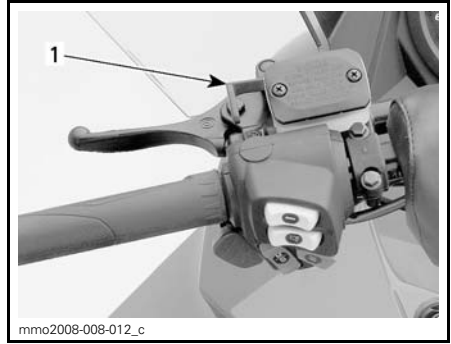

**TYPICAL**  
1. Parking brake lever

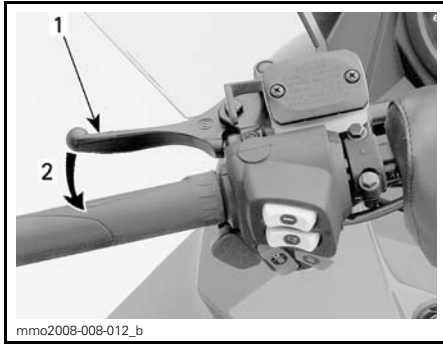

**TYPICAL**  
1. Brake lever  
2. To apply brake

**4) Parking Brake Lever**

Parking brake is located on the LH side of handlebar.

Parking brake should be used whenever snowmobile is parked.

**⚠ WARNING**

Make sure parking brake is fully disengaged before operating the snowmobile. When you ride the vehicle, brake pads that are caused to drag by a continuous pressure on the lever may cause damage to the brake system and cause loss of braking capacity and/or fire.

**To Engage Parking Brake**

Squeeze brake lever and maintain while pulling locking lever with a finger. When brake lever is held at halfway the parking brake should be fully applied.

**NOTICE** Parking brake position can vary depending on brake pads wear. Ensure when the parking brake is applied that the vehicle stays securely in place.

**NOTE:** Locking lever can be adjusted in two different positions.

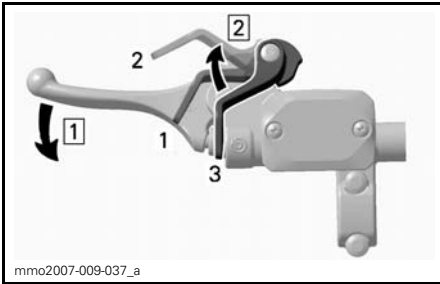
**TYPICAL — ENGAGE MECHANISM**

Step 1: Squeeze and maintain brake lever  
Step 2: Adjust locking lever

1. Position 1
2. Position 2
3. OFF

**To Release Parking Brake**

Squeeze brake lever. Locking lever will automatically return to its original position. Always release parking brake before riding.

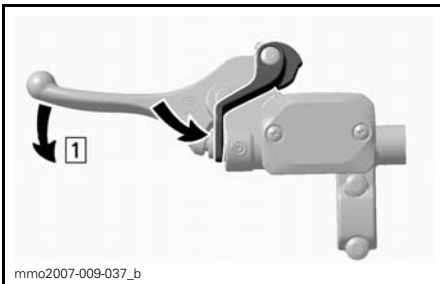
**TYPICAL — RELEASE MECHANISM**

Step 1: Squeeze brake lever

**5) Tether Stop Switch**

Tether stop switch (post), is located on the LH side of console.

Pulling the tether cord cap off its post shuts the engine off.

**⚠ WARNING**

Always attach tether cord eyelet to clothing before starting the engine.

If emergency engine shut off is required, pull tether cord cap off its post.

**6) Engine Stop Switch**

Engine stop switch is located on the RH side of handlebar.

Push-pull type switch. To stop the engine in an emergency, select OFF position (down) and simultaneously apply the brake. To restart, button must be at the ON position (up).

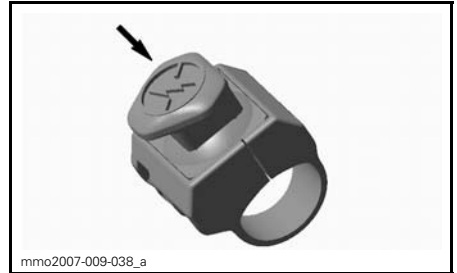

OFF POSITION

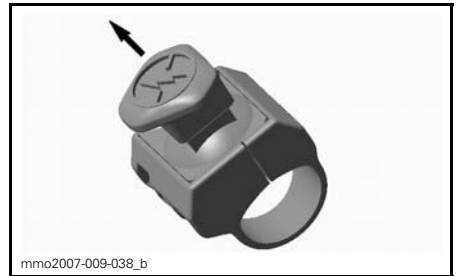

ON POSITION

All operators of the snowmobile should familiarize themselves with the function of the engine stop switch by using it several times on first outing and whenever stopping the engine thereafter. This engine stopping procedure will become a reflex and will prepare operators for emergency situations requiring its use.

**⚠ WARNING**

If the switch has been used in an emergency caused by a suspected malfunction, the source of the malfunction should be determined and corrected before restarting engine. See an authorized Ski-Doo dealer for servicing.

**7) Ignition Switch**

Ignition switch is located on the RH side of gauge support.

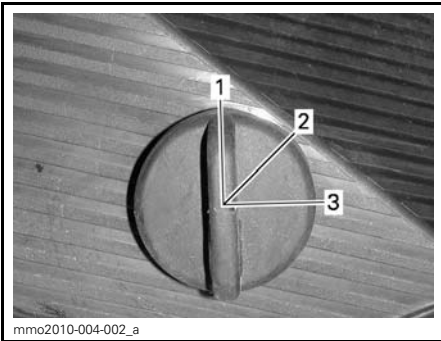

- 1. OFF
- 2. ON
- 3. START

Turn key to ON position to allow manual engine starting.

On electric start models, turn key to START position to engage starter.

Refer to *ENGINE STARTING PROCEDURE* in the *OPERATING INSTRUCTIONS* section for detailed starting procedure.

**8) Choke Lever**

The choke lever has 3-positions.

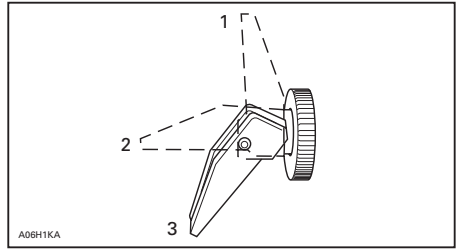

- 1. OFF
- 2. Position 2
- 3. Position 3

Refer to *CHOKE APPLICATION* in the *OPERATING INSTRUCTIONS* section for instructions on choke use.

**9) Multifunction Switch**

Multifunction switch is located on the LH side of handlebar.

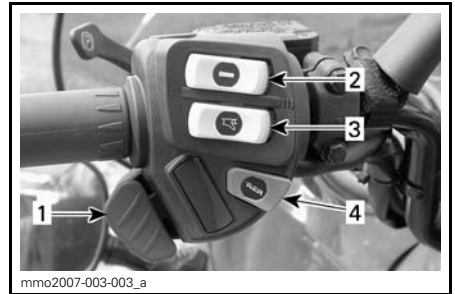

- 1. Headlights dimmer switch
- 2. Heated grips switch
- 3. Heated throttle lever switch
- 4. Electronic reverse button

**Electronic Reverse Button**

Press to engage the electronic reverse. Refer to *REVERSE (RER™)* in *OPERATING INSTRUCTIONS* section for procedure.

**Headlights Dimmer Switch**

Press to select HI or LOW beam. Lights are automatically ON when the engine is running.

## Heated Grips Switch

Select the switch position according to the desired heating intensity to keep your hands at a comfortable temperature.

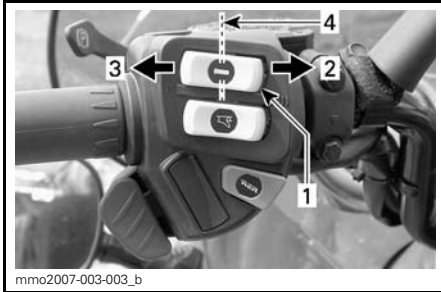

### TYPICAL

1. Heated grip switch
2. Hot
3. Warm
4. Off

## Heated Throttle Lever Switch

Select the switch position according to the desired heating intensity to keep your thumb at a comfortable temperature.

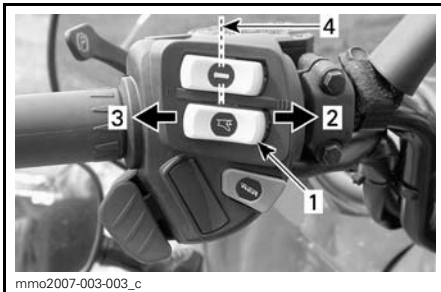

### TYPICAL

1. Heated throttle lever switch
2. Hot
3. Warm
4. Off

## 10) Rewind Starter Handle

Auto-rewind type located on right hand side of snowmobile. To engage mechanism, pull handle slowly until a resistance is felt then pull vigorously. Slowly release handle.

## 11) Adjustable Mirrors

Each mirror can be adjusted to suit driver's preference.

### **⚠ WARNING**

Adjust with vehicle at rest in a safe place.

## 12) Driver's Seat

### Operator's Guide Location

#### *All Models Except Grand Touring*

The Operator's Guide is located in the seat base.

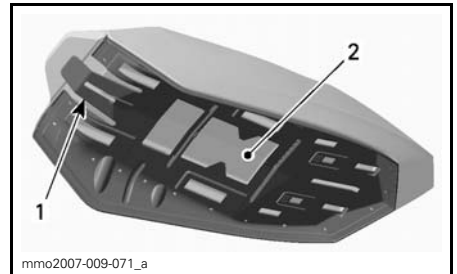

### SEAT BASE

1. Seat latch
2. Operator's Guide location

#### *Grand Touring*

See *STORAGE COMPARTMENT* below.

### Seat Removal

To remove seat, pull front of seat cushion then pull tab to unlock seat.

**NOTE:** If front seat needs to be removed on a Grand Touring model, the passenger seat must be removed first. See *PASSENGER SEAT* below.

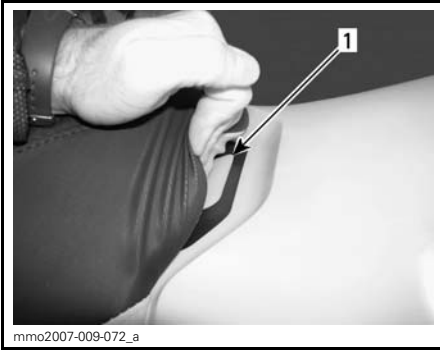

1. Seat latch

Pull and hold seat latch, then, pull seat with a rearward movement.

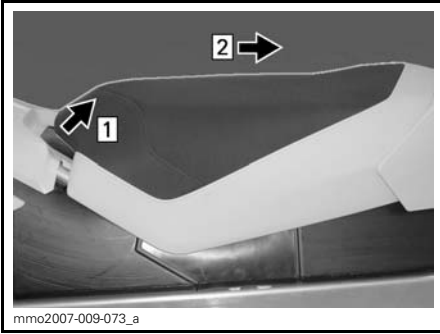

Step 1: Pull and hold seat latch  
Step 2: Pull seat with a rearward movement

### Seat Installation

**NOTICE** Riding the vehicle with any objects between the seat and the fuel tank could damage the fuel tank. NEVER place any objects between seat and fuel tank.

Position seat in place.

Push seat forward until it latch in its position.

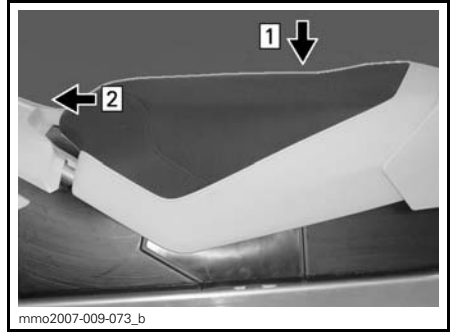

Step 1: Position seat in place  
Step 2: Push seat forward until it latch

**NOTE:** A distinctive snap will be felt. Double check that the seat is secure by giving it a tug to confirm proper latching.



SEAT INSTALLED

**WARNING**  
Make sure seat is securely latched before riding.

### 13) Tool Kit

A tool kit containing tools for basic maintenance is supplied with the vehicle.

The tool box is located in engine compartment on pulley guard.

To remove the tool box from the pulley guard, unlock the tab from underneath the pulley guard and pull the tool box towards front to release it.

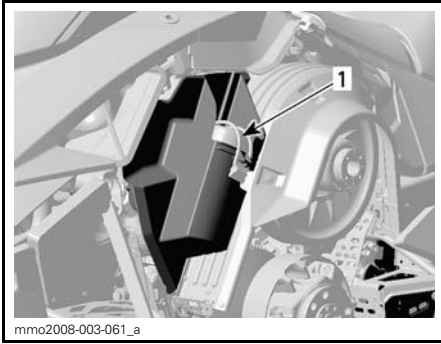

**TYPICAL**  
1. Tool kit

## 14) Grab Handle/Bumper

To be used whenever snowmobile requires manual lifting.

### **⚠ WARNING**

Do not attempt to lift the vehicle by hand alone. Use appropriate lifting device or have assistance to share lifting stress in order to avoid risk of strain injuries.

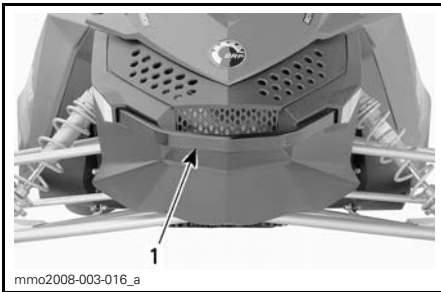

**FRONT**  
1. Grab handle/bumper

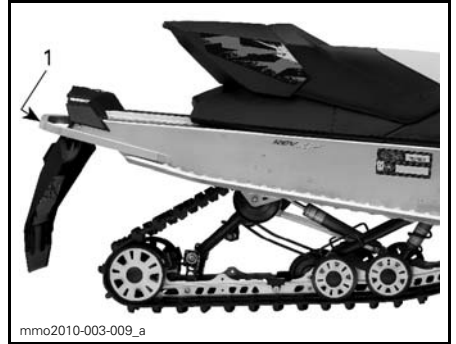

**REAR**  
1. Grab handle/bumper

**NOTICE** Do not use skis to pull or lift snowmobile.

## 15) Gauge

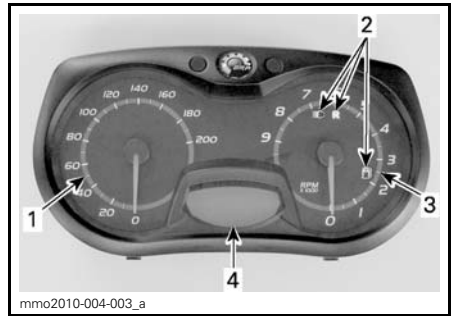

1. Speedometer
2. Pilot lamps
3. Tachometer
4. Digital display

**NOTE:** The gauge is factory preset in Imperial units but it is possible to change it to metric units, contact an authorized Ski-Doo dealer for unit settings.

### Speedometer

Measures vehicle speed (in miles per hour or kilometers per hour depending on the setting).



LH PORTION OF GAUGE

### Tachometer (RPM)

Measures engine revolution per minute (RPM). Multiply by 1000 to obtain the actual revolutions.



RH PORTION OF GAUGE

### Pilot Lamps and Messages



1. Pilot lamps

See table below for pilot lamps information.

PILOT LAMP(S) ON	BEEPER	DESCRIPTION
	—	Low fuel level. Replenish fuel tank as soon as possible.
	Long beeps repeating slowly	Reverse is selected.
	—	High beam headlights are selected.

### Digital Display

Displays odometer and fuel level.

## ⚠ WARNING

Reading the gauge digital display can distract from the operation of the vehicle, particularly from constantly scanning the environment which could lead to a collision or loss of control. Before reading the gauge digital display, ensure your environment is clear and free from obstacle, and bring the vehicle to a low speed.



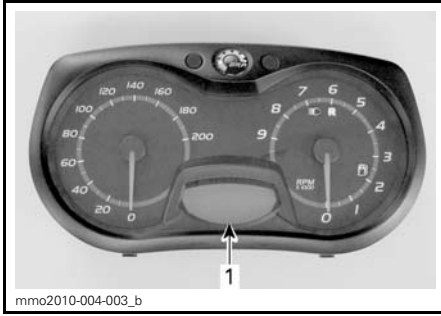

1. Digital display

### DISPLAY FEATURES

FUNCTIONS	REFER TO TOPICS
Odometer	A
Fuel level	B

#### A) Odometer

Records the total distance travelled (in miles or kilometers depending on the setting).

The odometer is displayed on the digital display.

#### B) Fuel Level

Bar gauge that continuously indicates the amount of fuel left in the fuel tank. Displayed on the digital display.

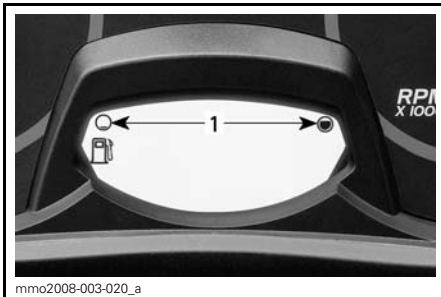

#### FUEL LEVEL

1. Operating range

## 16) Storage Compartment

### ⚠ WARNING

All storage compartments must be securely closed and must not contain any sharp, heavy or breakable objects.

#### *MXZ, Renegade and GSX™ Models*

**NOTICE** MAXIMUM load is 1.8 kg (4 lb) evenly distributed.

Pull latch slightly upward then, backward to unlock cover.

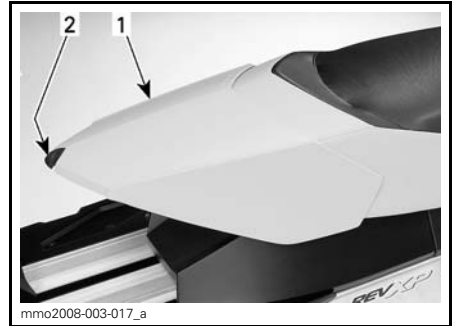

1. Storage compartment  
2. Latch

#### *Grand Touring Model*

The storage compartment is located at rear of the rear seat.

The Operator's Guide is in the storage compartment.

Simply open and close using the zipper.



1. Storage compartment zipper

## 17) Rear Rack

*Grand Touring Model*

### **⚠ WARNING**

All objects in rear rack must be properly latched. Do not carry any breakable objects. Excessive weight in rack may reduce steering ability. Always readjust suspension according to the load. The capacity of this rack is limited, the **MAXIMUM** cargo load is 15.8 Kg (35 lb). Ride at very low speed when loaded. Avoid speed over bumps.

## 18) Passenger Seat

*Grand Touring Only*

To remove passenger seat, remove all 4 retaining screws from underneath tunnel.

### **⚠ WARNING**

Any passenger must be able to firmly lay his feet on the footrests and keep his hands on the handholds at all times when seated. Respecting those physical criteria is important to ensure that the passenger is stable and to reduce the risks of ejection.

## 19) Passenger Handholds

*Grand Touring Model*

Rear handholds provides a grip for the passenger.

## 20) Electric Visor Jack Connector

*Grand Touring and GSX Models*

An electric visor can be connected to the jack connector. Electric current is supplied whenever engine is running. A stress relief extension is supplied with the vehicle.

## 21) Hitch

*European Models Except MX Z*

Use this hitch in conjunction with a tow bar to tow an accessory.

**NOTE:** Refer to decal on vehicle for towing weight capacities.

### **⚠ WARNING**

Never tow an accessory with a rope. Always use a rigid tow bar. Using a rope would result in a collision between the object and the snowmobile and possibly in a tip over in case of a rapid deceleration or on a downward slope.

### **How to Use the Hitch**

Detach hitch from its support by removing the hairpin.

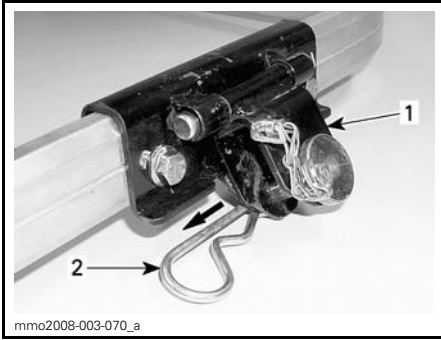

1. Hitch
2. Hairpin

Remove rod from hitch then attach rigid tow bar to hitch using the same rod.

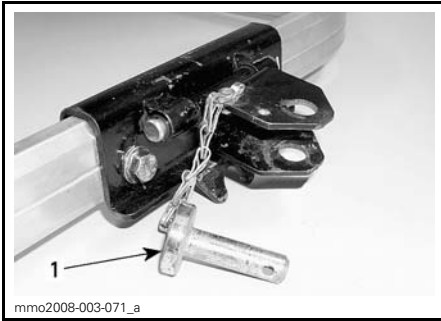

- TYPICAL
1. Rod

Secure rod to hitch using hairpin previously removed.

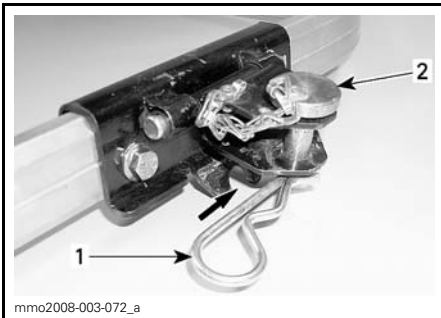

- TYPICAL
1. Hairpin
  2. Rod

**NOTICE** To avoid damages to the vehicle, always release hitch from its support. Ensure hitch moves freely when towing accessories.

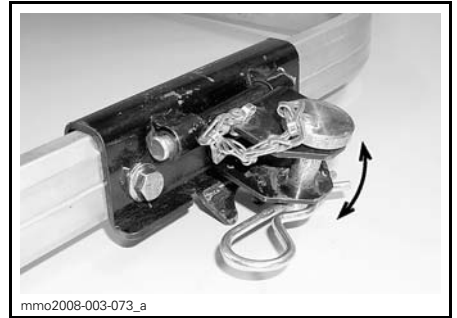

HITCH MOVES FREELY WHEN TOWING

To avoid noise from hitch when not in use, secure hitch to its support by using the hairpin.

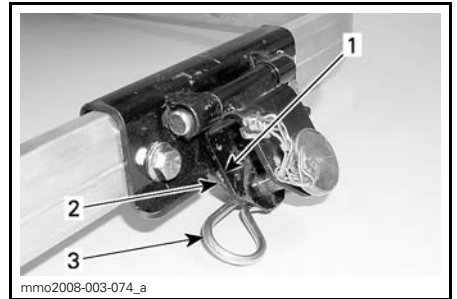

HITCH NOT IN USE

1. Hitch
2. Support
3. Hairpin

# FUEL AND OIL

## Recommended Fuel

Use unleaded gasoline available from most service stations or oxygenated fuel containing a maximum total of 10% of ethanol or methanol. The gasoline used must have the following recommended minimum octane rating.

MINIMUM OCTANE RATING (550 F)	
INSIDE NORTH AMERICA	87 (RON + MON)/2
OUTSIDE NORTH AMERICA	92 RON

**NOTICE** Never experiment with other fuels. The use of not recommended fuel can result in snowmobile performance deterioration and damage to critical parts in the fuel system and engine components. Do not mistake oil reservoir cap for fuel tank cap. Oil reservoir cap is identified OIL.

## Fuel Antifreeze Additives

When using oxygenated fuel, additional gas line antifreeze or water absorbing additives are not required and should be not used.

When using non-oxygenated fuel, we highly recommend the use of isopropyl base gas line antifreeze in a proportion of 150 ml (5 U.S. oz) of gas line antifreeze added to 40 L (10.6 U.S. gal.) of gas.

This precaution is in order to reduce the risk of frost buildup in carburetors or other fuel system components which may lead, in certain cases, to severe damage to engine.

**NOTE:** Use only methyl hydrate free gas line antifreeze.

## Fueling Procedure

Unscrew to fill up tank then fully tighten.

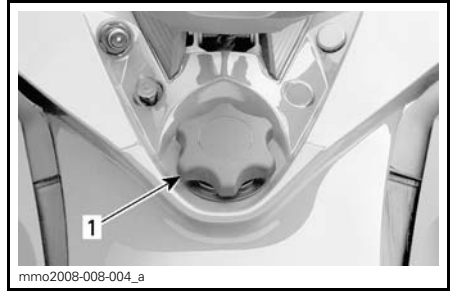

TYPICAL

1. Fuel tank cap

## WARNING

Always stop the engine before refueling. Fuel is flammable and explosive under certain conditions. Always work in a well ventilated area. Do not smoke or allow open flames or sparks in the vicinity. Open cap slowly. If a differential pressure condition is noticed (whistling sound heard when loosening fuel tank cap) have vehicle inspected and/or repaired before further operation. Do not overfill or top off the fuel tank before placing the vehicle in a warm area. As temperature increases, fuel expands and might overflow. Always wipe off any fuel spillage from the vehicle. Periodically verify fuel system.

**NOTE:** Do not sit or lean on seat when fuel tank cap is not properly installed.

## Recommended Oil

Use one of the following XPS™ injection oils.

ENGINE	RECOMMENDED INJECTION OIL
550F	XPS mineral injection oil
	XP-S synthetic blend
	XP-S synthetic oil

If XPS Mineral Injection Oil is not available, API TC high-quality low ash two-stroke injection oil may be used.

**NOTE:** All XPS injection oils are compatible, they can be mixed together.

XPS mineral injection oil is a special blend of basic oil and additives especially selected to ensure unequalled lubrication, engine cleanliness and minimum spark plug fouling.

The XPS synthetic blend and synthetic injection oils **provide superior lubrication**, reduced engine component wear and oil deposit, thus maintaining maximum-level performance and antifriction properties. The synthetic blend injection and synthetic oils meet the latest ASTM and JASO standards by ensuring high biodegradability and low exhaust smoke.

**NOTICE** Use only injection oil that flows at - 40°C (- 40°F). Do not mismatch oil reservoir cap with fuel tank cap. Oil reservoir cap is identified OIL.

**NOTICE** Never use four-stroke petroleum or synthetic motor oil and never mix these with outboard motor oil. Do not use NMMA TC-W, TC-W2 or TC-W3 outboard two-stroke engine oils or ashless two-stroke engine oils. Avoid mixing different brands of API TC oil as resulting chemical reactions may cause severe engine damage.

## Injection Oil Level

Always maintain a sufficient amount of recommended injection oil in the injection oil reservoir.

Unscrew injection oil reservoir cap to fill up reservoir then fully tighten.

**NOTICE** Check level and refill every time you refuel.

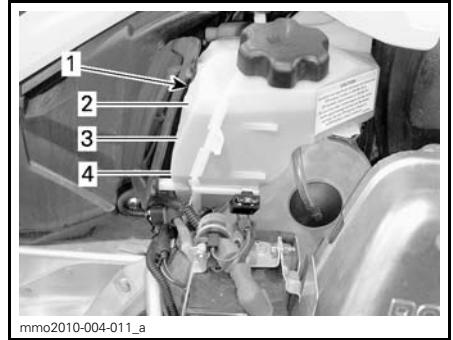

1. Oil reservoir
2. 3/4 level
3. 1/2 level
4. 1/4 level

## **⚠ WARNING**

Do not overfill. Reinstall cap and fully tighten. Wipe off any oil spills. Oil is highly flammable when heated.

# OPERATING INSTRUCTIONS

## Operating During Break-In

### Engine

**NOTICE** A break-in period of 10 operating hours (500 km (300 mi)) is required before running the snowmobile at full throttle.

During break-in period, brief full accelerations and speed variations contribute to a good break-in. Do not maintain a constant speed for an extended period of time.

**NOTICE** Engine overheating, continued wide open throttle runs and prolonged cruising without speed variations should be avoided, this can cause engine damage during the break-in period.

To assure additional protection during the initial engine break-in, 500 ml (17 U.S. oz) of recommended injection oil should be added to fuel for the first full filling of fuel tank. Have spark plugs cleaned after engine break-in.

### Belt

A new drive belt requires a break-in period of 50 km (30 mi). Avoid strong acceleration/deceleration, pulling a load or high speed cruising.

### 10-Hour Inspection

We suggest that after the first 10 hours or 500 km (300 mi), of operation whichever comes first, your snowmobile be checked by an authorized Ski-Doo dealer. Refer to *MAINTENANCE INFORMATION* section.

## Engine Starting Procedure

### Procedure

1. Apply parking brake.
2. Recheck throttle control lever operation.
3. Put your helmet on.

4. Ensure that the tether cord cap is in position and that the cord attached to your clothing eyelet.
5. Ensure that the engine stop switch is in the ON position.
6. Activate the choke according to the temperature. Refer to *CHOKE APPLICATION* further.
7. Start engine as explained below.

### WARNING

Never depress throttle while starting engine.

### Manual Start

Turn ignition key to ON position.

Grab rewind starter handle, pull handle slowly until a resistance is felt, then hold handle firmly and pull vigorously to start engine.

### Electric Start Models

Turn key clockwise until starter engages.

**NOTE:** If for any reason, the engine cannot be started electrically, start engine manually using the rewind starter.

**NOTICE** Do not engage electric starter for more than 10 seconds at a time. A rest period should be observed between the cranking cycles to allow electric starter to cool down.

8. Release parking brake.

**NOTE:** For an initial cold start, do not release parking brake. Perform the *VEHICLE WARM-UP* procedure as explained below.

### Choke Application

Initial Cold Starting When Temperature is Below -10°C (14°F)

**NOTE:** Do not operate the throttle lever with the choke lever on.

Set the choke lever to position 3.

**NOTE:** After the engine is started, let engine warm up at fast idle until engine speed drops. Then, close off choke to ensure proper air-fuel mixture.

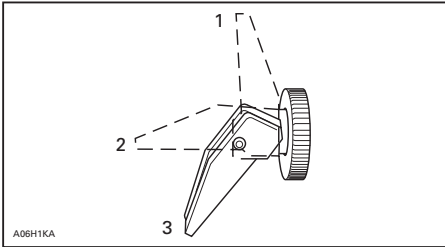

1. OFF
2. Position 2
3. Position 3

### Initial Cold Starting When Temperature is Above - 10°C (above + 15°F)

Set the choke lever to position 2.

**NOTE:** After the engine is started, close off choke to ensure proper air-fuel mixture.

### Warm Engine Starting

Start the engine without any choke. If the engine will not start after two pulls of the rope or two 5 second attempts with the electric starter move choke lever to position 2. Start the engine without activating the throttle lever. As soon as the engine starts move the choke lever to OFF.

### Emergency Starting

The engine can be started with the emergency starter rope supplied with the tool kit.

Remove belt guard.

## **⚠ WARNING**

Do not wind starting rope around your hand. Hold rope by the handle only. Do not start the snowmobile by the drive pulley unless it is a true emergency situation. Have the snowmobile repaired as soon as possible.

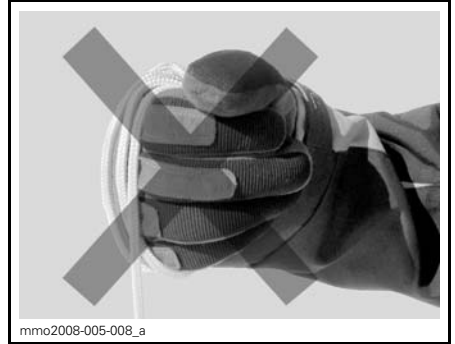

Attach one end of emergency rope to rewind handle.

**NOTE:** The spark plug socket can be used as an emergency handle.

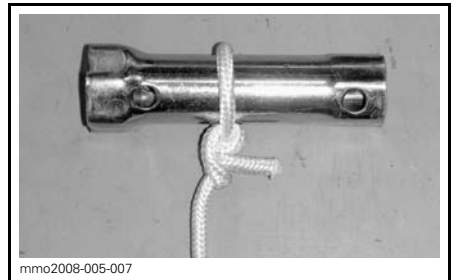

Attach the other end of emergency rope to the starter clip supplied in the tool kit.

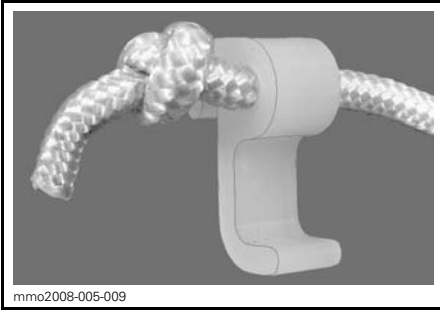

**⚠ WARNING**

When starting the snowmobile in an emergency situation, using drive pulley, do not reinstall the belt guard and return slowly to have snowmobile repaired.

**Riding Conditions and your Snowmobile**

Hook up clip on drive pulley.

**Altitude**

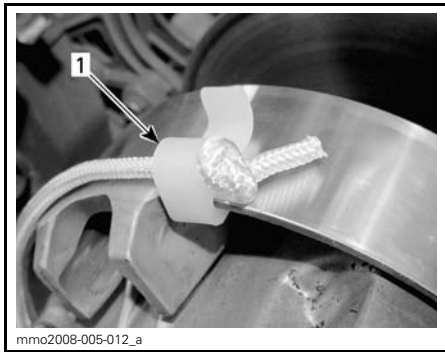

All models covered in this Operator's Guide are calibrated for SEA LEVEL operation.

Operating those vehicles above 600 m (2,000 ft) requires parts and adjustments.

**NOTICE** Failure to re-calibrate may cause serious engine damage.

Refer to an authorized Ski-Doo dealer for proper calibration modifications if required.

1. Clip installation location

**Temperature**

Wind the rope tightly around drive pulley. When pulled, pulley must rotate counterclockwise.

This engine has been calibrated for - 20°C (- 4°F). It can be operated at warmer winter temperatures without risk of problems.

**NOTICE** For temperatures colder than - 20°C (- 4°F), carburetor(s) must be re-calibrated to avoid engine damage. Refer to an authorized Ski-Doo dealer.

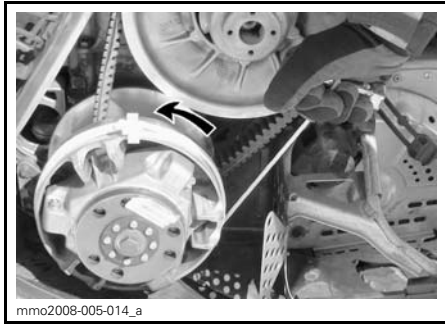

**Vehicle Warm-Up**

Pull the rope using a sharp, crisp pull so the rope comes free of the drive pulley. Start engine as per usual manual starting.

Before every ride, vehicle has to be warmed up as follows.

1. Start engine as explained in *ENGINE STARTING PROCEDURE* above.
2. Allow engine to warm up one or two minutes at idle speed.

**NOTE:** It is not recommended to let engine running at idle speed for more than 10 minutes.

3. Disengage parking brake.



4. Apply throttle until drive pulley engages. Drive at low speed the first two or three minutes.

**NOTICE** If vehicle does not move when throttle is applied, stop engine, remove tether cord cap, then do the following.

- Check if skis are stuck on the ground. Lift one ski at a time by the handle, then put it down.
- Check if track is stuck on the ground. Lift rear of snowmobile enough to clear track from the ground, then drop.
- Check rear suspension for hard snow or ice accumulation that could interfere with track rotation. Clean the area.

**CAUTION** Beware of injuries by using proper lifting techniques, notably using your legs force. Do not attempt to lift the rear of vehicle if it is above your limits.

### **WARNING**

Make sure tether cord cap and key are removed before standing in front the vehicle, getting close to the track or rear suspension components.

## **Reverse (RER)**

When the engine is running, depressing the RER button will slow down engine RPM to almost a stop and advance the ignition timing to invert crankshaft rotation.

- Engine will automatically shift into forward when restarting after stopping or stalling.
- Shifting procedure will take place only when the engine is running.

- If engine is running at a speed above 4300 RPM, the function of the RER button is disabled.
- It is recommended to warm up the engine to its normal operating temperature before shifting.

## **Shifting in Reverse**

### **WARNING**

Engaging the reverse mode is done by depressing the RER button when the engine is running. Wait until the reverse alarm sounds and the RER pilot lamp comes on in the analog/digital gauge before operating throttle to proceed in reverse. The reverse speed is not limited. Always proceed with caution as fast reverse could result in loss of vehicle stability. Come to complete stop before depressing RER button. Always remain seated and apply the brake before shifting. Ensure the path behind is clear of obstacles or bystanders before proceeding.

With the snowmobile completely stopped and engine running at idle, press and release the RER button.

The RER pilot lamp will blink when the snowmobile is engaged in reverse.

Apply throttle slowly and evenly. Allow drive pulley to engage then accelerate carefully.

## **Shifting in Forward**

With the snowmobile completely stopped and engine running at idle, press and release the RER button.

RER pilot lamp will stop.

Apply throttle slowly and evenly. Allow drive pulley to engage then accelerate carefully.

## Shutting Off the Engine

Release throttle lever and wait until engine has returned to idle speed.

Shut off the engine using either ignition switch (key), engine stop switch or pulling off the tether cord cap.

### WARNING

Always remove the tether cord cap and key when vehicle is not in operation in order to prevent accidental engine starting or to avoid unauthorized use by children or others or theft.

## Towing an Accessory

Always use a rigid tow bar to tow an accessory. Any towed accessory should have reflectors on both sides and at the rear. Check local laws for brake light(s) requirements.

### WARNING

Never tow an accessory with a rope. Always use a rigid tow bar. Using a rope would result in a collision between the object and the snowmobile and possibly in a tip over in case of a rapid deceleration or on a downward slope.

## Towing Another Snowmobile

If a snowmobile is disabled and must be towed use a rigid tow bar. Remove the drive belt from disabled snowmobile, refer to *DRIVE BELT* in the *MAINTENANCE PROCEDURE* section and tow at moderate speed.

**NOTICE** Always remove the drive belt of the snowmobile that is to be towed to prevent damage to its belt and drive system.

In an emergency situation only, if a rigid tow bar is not available, a rope can be used provided you proceed with extra

caution. In some areas, it may be illegal to do so. Check with state or local authorities.

Remove the drive belt, attach the rope to the ski legs (spindles), have someone sit on the towed snowmobile to activate the brake, and tow at low speed.

**NOTICE** In order to prevent damage to the steering system, never attach the tow rope to the ski loops (handles).

### WARNING

Never ride at high speed when towing a disabled snowmobile. Proceed slowly with extra caution.

## Post-Operation Care

Remove snow and ice from rear suspension, track, front suspension, steering mechanism and skis.

### WARNING

Make sure tether cord cap and key are removed before standing in front the vehicle, getting close to the track or rear suspension components.

Always cover your snowmobile when leaving it outside overnight or during extended periods of inactivity. This will protect it from frost and snow as well as help retain its appearance.

# TUNE YOUR RIDE

Snowmobile handling and comfort depend upon suspension adjustments.

## **⚠ WARNING**

Suspension adjustment could affect vehicle handling. Always take time to familiarize yourself with the vehicle's behavior after any suspension adjustment have been made. Always adjust LH and RH suspension components to the same setting.

Choice of suspension adjustments vary with carrying load, driver's weight, personal preference, riding speed and field condition.

**NOTE:** Some adjustments may not apply to your snowmobile.

## **⚠ WARNING**

Before proceeding with any suspension adjustment, remember:

- Park in a safe place.
- Remove the tether cord cap and key.
- Use appropriate lifting device or have assistance to share lifting stress. If a lifting device is not used, use proper lifting techniques, notably using your legs force.
- Do not attempt to lift the front or rear of vehicle if it is above your limits.
- Support front of vehicle off the ground with a suitable device before adjusting suspension.
- Support rear of vehicle off the ground with a wide-base snowmobile stand with a rear deflector panel.
- Make sure support device is stable and secure.

The best way to set up the suspension is to customize each adjustment one at a time. Various adjustments are

interrelated. It may be necessary to readjust center spring after adjusting front springs for instance. Test run the snowmobile under the same conditions; trail, speed, snow, driver riding position, etc. Proceed methodically until you are satisfied.

Following are guidelines to fine-tune suspension. Use suspension adjustment tool provided in the tool kit.

## Rear Suspension Adjustments

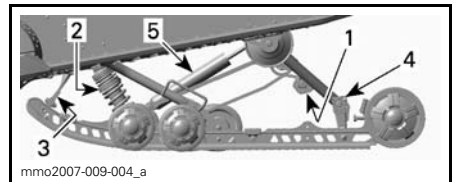

### SC-5™ REAR SUSPENSION (MX Z, GSX AND RENEGADE)

1. Rear springs preload
2. Center spring preload and shock absorber damping
3. Stopper strap
4. Coupling blocks
5. Rear shock absorber damping

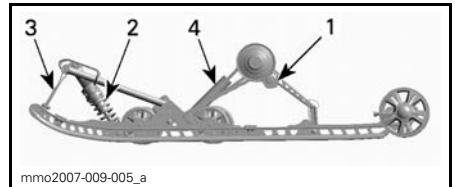

### SC-5M REAR SUSPENSION (GRAND TOURING)

1. Rear springs preload
2. Center spring preload
3. Stopper strap
4. Rear shock absorber

**NOTICE** Whenever adjusting rear suspension, check track tension and adjust if necessary.

## Stopper Strap Length

Stopper strap length has an effect on the amount of weight the center spring has to carry especially during acceleration, therefore on the front end uplift.

Stopper strap length also has an effect on center spring travel.

**NOTICE** Whenever stopper strap length is changed, track tension must be checked.

ACTION	RESULT
Increasing stopper strap length	Lighter ski pressure under acceleration
	More center spring travel
	More bump absorption capability
Decreasing stopper strap length	Heavier ski pressure under acceleration
	Less center spring travel
	Less bump absorption capability

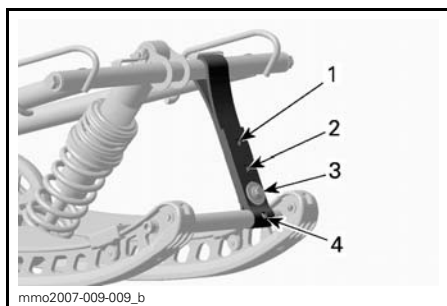

**TYPICAL**

1. Position 1 (longest)
2. Position 2
3. Position 3
4. Position 4

**NOTE:** Decreasing the stopper strap length may reduce comfort. If too much weight transfer is felt, try to correct it by adjusting the coupling blocks first. Always install stopper strap bolt as close as possible to the lower shaft.

When operating the snowmobile in deep snow, it may be necessary to vary stopper strap length and/or riding position, to change the angle at which the track rides on the snow. Operator's fa-

miliarity with the various adjustments as well as snow conditions will dictate the most efficient combination.

Generally, a longer stopper strap setting gives better performance in deep snow on a flat landscape.

**Rear Spring Preload**

Rear spring preload has an effect on comfort, ride height and load compensation.

Also, adjusting rear spring preload shifts more or less weight to the snowmobile front end. As a result, more or less weight is applied to the skis. This has an effect on performance in deep snow, steering effort and handling.

Slight suspension bottoming occurring under the worst riding conditions indicates a good choice of spring preload.

ACTION	RESULT
Increasing preload	Firmer rear suspension
	Higher rear end
	More bump absorption capability
	Heavier steering
Decreasing preload	Softer rear suspension
	Lower rear end
	Less bump absorption capability
	Lighter steering
	Better performance and handling in deep snow

Refer to the following to determine if preload is correct.

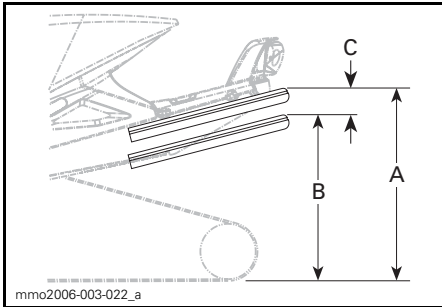
**TYPICAL — PROPER ADJUSTMENT**

- A. Suspension fully extended  
 B. Suspension has collapsed with driver, passenger(s) and load added  
 C. Distance between dimension "A" and "B", see table below

"C"	WHAT TO DO
50 to 75 mm (2 to 3 in)	No adjustment required
More than 75 mm (3 in)	Adjusted too soft, increase preload
Less than 50 mm (2 in)	Adjusted too firm, decrease preload

**NOTE:** If the specification is unattainable with the original springs, see an authorized Ski-Doo dealer for other available springs.

**NOTICE** To increase spring preload, always turn the left side adjustment cam in a clockwise direction, and the right side cam in a counterclockwise direction.

**CAUTION** Never set preload cams directly from position 5 to 1 or directly from position 1 to 5.

The adjustment cams have 5 different settings, 1 being the softest.

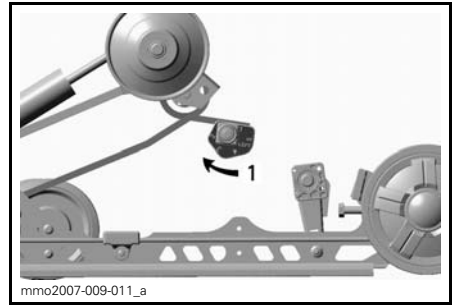
**TYPICAL — SC-5 — LH SIDE**

1. Adjust spring preload

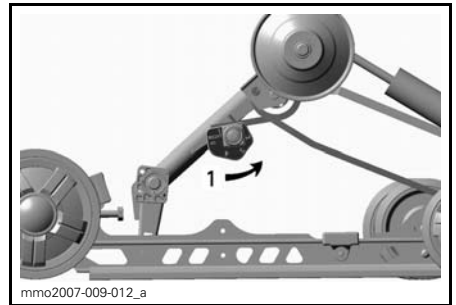
**TYPICAL — SC-5 — RH SIDE**

1. Adjust spring preload

**Center Spring Preload**

Center spring preload has an effect on steering effort, handling and bump absorption.

Also, since center spring preload adjustment puts more or less pressure on the front of the track, it has an effect on the performance in deep snow.

ACTION	RESULT
Increasing preload	Lighter steering
	More bump absorption capability
	Better deep snow starts
	Better deep snow performance and handling
Decreasing preload	Heavier steering
	Less bump absorption capability
	Better trail handling

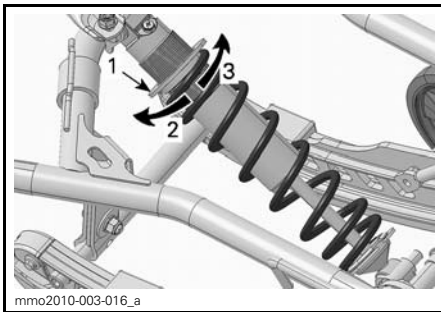

**TYPICAL- RING TYPE**

1. Spring preload adjustment ring
2. Increase preload
3. Decrease preload

**NOTE:** For cam type preload adjuster, use the suspension adjustment tool provided in the tool kit.

**Coupling Blocks**

**SC-5 Suspension Only**

Coupling blocks adjustment has an effect on vehicle handling during acceleration only.

To adjust, turn coupling blocks using the suspension adjustment tool provided in the tool kit.

Place the desired setting number towards rubber stopper.

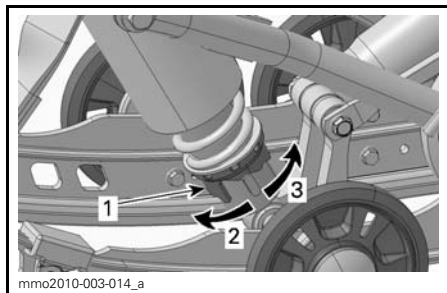

**CAM TYPE - MOTION CONTROL SHOCK ABSORBER**

1. Spring preload adjustment cam
2. Increase preload
3. Decrease preload

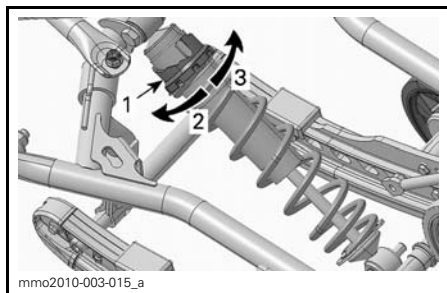

**CAM TYPE - HPG™ SHOCK ABSORBER**

1. Spring preload adjustment cam
2. Decrease preload
3. Increase preload

**⚠ WARNING**

Both blocks must be set at the same position. Otherwise vehicle behavior may be unpredictable and suspension may become warped.

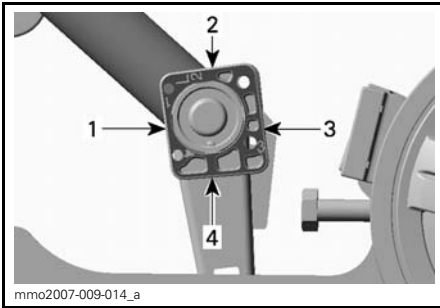

**COUPLING BLOCK — LEFT SIDE VIEW**  
(L — LEFT EMBOSSED ON BLOCK)

1. Position 1 (minimum)
2. Position 2
3. Position 3
4. Position 4 (maximum)

### Coupling Blocks Setting

POSITION	USE
1	More ski lift during acceleration
2	Intermediate setting
3	Intermediate setting
4	Less ski lift during acceleration

## Front Suspension Adjustments

### Spring Preload

Front spring preload has an effect on front suspension firmness.

Front spring preload also has an effect on the steering behavior.

ACTION	RESULT
Increasing preload	Firmer front suspension
	Higher front end
	More precise steering
	More bump absorption capability
Decreasing preload	Softer front suspension
	Lower front end
	Lighter steering
	Less bump absorption capability

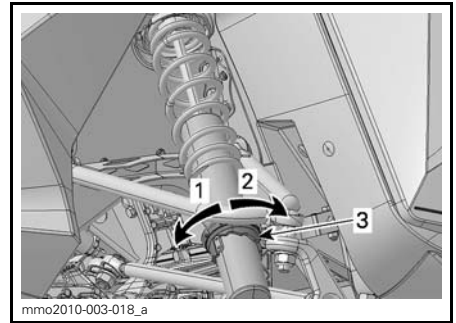

**CAM TYPE - MOTION CONTROL SHOCK ABSORBER**

1. Increase preload
2. Decrease preload
3. Spring preload adjustment cam

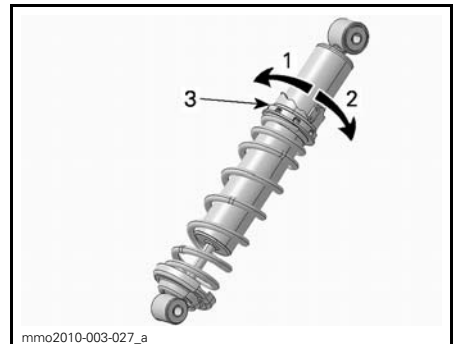

**CAM TYPE - HPG SHOCK ABSORBER**

1. Decrease preload
2. Increase preload
3. Spring preload adjustment cam

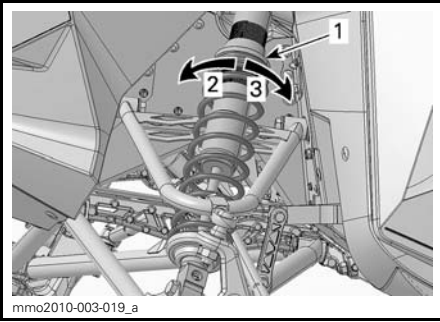

**TYPICAL - RING TYPE**

1. Spring preload adjustment ring
2. Increase preload
3. Decrease preload

**NOTICE** Make sure that both front springs are still pre-loaded when front of vehicle is off the ground.



## Adjustment Tips According to Vehicle Behavior

PROBLEM	CORRECTIVE MEASURES
Front suspension darting	Check ski alignment – Reduce front suspension spring preload. – Increase center spring preload. – Reduce rear spring preload.
Steering feels too heavy at steady speeds	– Reduce front suspension spring preload. – Increase center spring preload.
Steering feels too heavy during acceleration	– Set coupling blocks to a lower position. – Reduce rear spring preload. – Lengthen limiter strap.
Too much ski lift during cornering or acceleration	– Set coupling blocks to a higher position. – Shorten limiter strap. – Increase rear spring preload.
Rear of snowmobile seems too stiff	Reduce rear spring preload.
Rear of snowmobile seems too soft	Increase rear spring preload.
Rear suspension is frequently bottoming	– Increase rear spring preload. – Increase center spring preload. – Lengthen limiter strap.
Snowmobile seems to pivot around its center	– Reduce center spring preload. – Increase rear spring preload. – Increase front suspension spring preload. – Shorten limiter strap.
Track spins too much at start	– Set coupling blocks to a lower position. – Lengthen limiter strap.

---

## VEHICLE TRANSPORTATION

Make sure that oil reservoir and fuel tank caps are properly installed.

Tilt bed trailers can easily be equipped with a winch mechanism to afford maximum safety in loading. Simple as it may seem, never drive your snowmobile onto a tilt bed trailer or any other kind of trailer or vehicle. Many serious accidents have resulted from driving up and over a trailer. Anchor your vehicle securely, front and rear, even on short hauls. Be certain all equipment is securely fastened. Cover your snowmobile when trailering to prevent road grime from causing damage.

Be certain your trailer meets state or provincial requirements. Ensure the hitch and safety chains are secure and the brake, turn indicators and clearance lights all function.

# ***MAINTENANCE INFORMATION***

# MAINTENANCE SCHEDULE

Maintenance is very important for keeping your vehicle in safe operating condition. Proper maintenance is the owner's responsibility. Perform periodic checks and follow the maintenance schedule.

## WARNING

Failure to properly maintain the vehicle according to the maintenance schedule and procedures can make it unsafe to operate.

PART/TASK	*10-hour or 500 km (300 mi)										LEGEND	
	Weekly or every 250 km (150 mi)											
PART/TASK	Monthly or every 800 km (500 mi)										LEGEND	
	EVERY year or 3200 km (2000 mi)											
PART/TASK	EVERY 2 years or 6000 km (3700 mi)										LEGEND	
	*Storage											
PART/TASK	*Preseason										LEGEND	
	LEGEND											
<b>ENGINE</b>												
Rewind starter										L, C	I	(1) Retighten to specified torque.
Engine motor mounts	I				I					I		
Exhaust system	I				I					I		
Exhaust manifold screws <sup>(1)</sup>	I										I	
Engine lubrication										L		
Crankshaft PTO seal											I	
Injection oil filter									R			
Oil injection pump	A				A						A	
<b>FUEL SYSTEM</b>												
Fuel stabilizer										(2)		(2) Add to fuel prior to engine lubrication. (3) Fuel filter must be replaced by an authorized Ski-Doo dealer.
Fuel filter <sup>(3)</sup>									R			
Fuel lines and connections	I										I	
Carburetor venturi											C	
Throttle cable	I				I						I	
Air filter				I							I	

A: ADJUST C: CLEAN I: INSPECT L: LUBRICATE R: REPLACE  * TO BE PERFORMED BY AN AUTHORIZED SKI-DOO DEALER	*10-hour or 500 km (300 mi)										LEGEND
	Weekly or every 250 km (150 mi)										
	Monthly or every 800 km (500 mi)										
	EVERY year or 3200 km (2000 mi)										
	EVERY 2 years or 6000 km (3700 mi)										
	*Storage										
	*Preseason										
PART/TASK											
<b>DRIVE SYSTEM</b>											
Drive belt <sup>(4)</sup>	I	I								I	(4) Adjust drive belt height and have the tension checked by an authorized Ski-Doo dealer at every belt replacement. (5) Tightening torque of drive pulley must be checked at the 10-hour inspection and every year or 3200 km (2000 mi) thereafter. (6) Driven pulley preload should be checked at the 10-hour inspection and every year or 3200 km (2000 mi) thereafter. (7) Check track condition before each ride. (8) Adjust track tension and alignment as required.
Drive pulley <sup>(5)</sup>	I		I	C					I	C	
Driven pulley <sup>(6)</sup>	I		I	C					I	C	
Drive chain	A		A						A		
Chaincase oil									R		
Track <sup>(7)</sup>	A	(8)									
<b>BRAKE SYSTEM</b>											
Brake fluid	I	I					R			I	—
Brake hose, pads and disk	I	I								I	
Brake lever								L			
<b>STEERING</b>											
Steering mechanism <sup>(9)</sup>	I, L		I	L					I, L		(9) Lubricate whenever the vehicle is used in wet conditions (wet snow, rain, puddles).
<b>FRONT SUSPENSION</b>											
Front suspension <sup>(9)</sup>	I, L		I	L					I, L		(9) Lubricate whenever the vehicle is used in wet conditions (wet snow, rain, puddles).
Skis and runners	I	I							I		
<b>REAR SUSPENSION</b>											
Rear suspension <sup>(9)</sup>	I		I, L						I, L		(9) Lubricate whenever the vehicle is used in wet conditions (wet snow, rain, puddles).
Suspension stopper strap				I					I		

A: ADJUST C: CLEAN I: INSPECT L: LUBRICATE R: REPLACE  * TO BE PERFORMED BY AN AUTHORIZED SKI-DOO DEALER	<b>*10-hour or 500 km (300 mi)</b>										<b>LEGEND</b>
	<b>Weekly or every 250 km (150 mi)</b>										
	<b>Monthly or every 800 km (500 mi)</b>										
	<b>EVERY year or 3200 km (2000 mi)</b>										
	<b>EVERY 2 years or 6000 km (3700 mi)</b>										
	<b>*Storage</b>										
<b>*Preseason</b>											
<b>PART/TASK</b>											
<b>ELECTRICAL SYSTEM</b>											
Spark plugs <sup>(10)</sup>	I		I							R	(10) Before installing new spark plugs at preseason preparation, it is suggested to burn excess storage oil by starting the engine with the old spark plugs. Only perform this operation in a well ventilated area.
Battery (if so equipped)	I		I					I	I		
Wiring harnesses, cables and lines	I		I					I			
Lighting system (HI/LO beam, brake light, etc.). Engine stop switch and tether cord cap	I	I						I			
<b>CHASSIS/BODY</b>											
Headlights beam aiming				A						A	—
Engine compartment	C		C					C			
Vehicle cleaning and protection	C		C					C			

---

## 10-HOUR INSPECTION

We suggest that after the first 10 hours or 500 km (300 mi) of operation, whichever comes first, your vehicle be inspected by an authorized Ski-Doo dealer. The initial maintenance is very important and must not be neglected.

**NOTE:** The 10-hour inspection is at the expense of the vehicle owner.

We recommend that this inspection be signed by an authorized Ski-Doo dealer.

---

Date of 10-hour inspection

---

Authorized dealer signature

---

Dealer name

# MAINTENANCE PROCEDURES

This section includes instructions for basic maintenance procedures. If you have the necessary mechanical skills and the required tools, you can perform these procedures. If not, see your authorized Ski-Doo dealer.

Other important items in the maintenance schedule that are more difficult and require special tools are best performed by your authorized Ski-Doo dealer.

## **⚠ WARNING**

Turn off the engine, remove tether cord cap and follow these maintenance procedures when performing maintenance. If you do not follow proper maintenance procedures you can be injured by hot parts, moving parts, electricity, chemicals or other hazards.

## **⚠ WARNING**

Should removal of a locking device (e.g. lock tabs, self-locking fasteners, etc.) be required when undergoing disassembly/assembly, always replace with a new one.

**NOTICE** LH and RH hand side carburetors are calibrated differently. Never switch carburetors around.

## **Air Filter**

### **Air Filter Verification**

Ensure the air filter is properly installed, clean and in good condition.

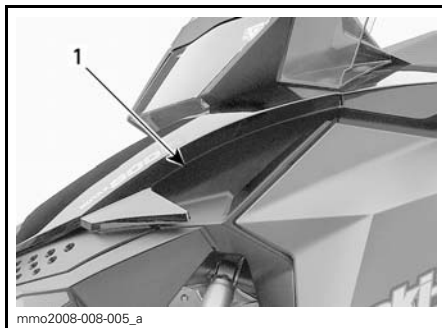

1. Air filter

If the air filter has to be cleaned or replaced, see an authorized Ski-Doo dealer.

## **Exhaust System**

### **Exhaust System Verification**

The muffler tail pipe should be centered with the exit hole in the bottom pan. Exhaust system must be free of rust or leaks. Make sure that all parts are securely in place.

Check retaining springs condition and replace if necessary.

The exhaust system is designed to reduce noise and to improve the total performance of the engine. Modification may be in violation of local laws.

**NOTICE** If any exhaust system component is removed, modified or damaged, severe engine damage may result.

## **Spark Plugs**

### **Spare Spark Plug Storage**

A space is provided in the tool kit to keep spare spark plugs dry and prevent shocks that might affect the adjustment or break them.

**NOTE:** Spare spark plugs are not supplied with snowmobile.

### **Spark Plug Removal**

1. Open LH side panel, refer to *BODY*.



2. Remove belt guard, refer to *DRIVE BELT GUARD REMOVAL*.
3. Carefully remove spark plug wire cap with a twisting and pulling motion.
4. Using a proper socket or the spark plug socket and screwdriver pin from toolbox, unscrew spark plug a few turns without removing it.

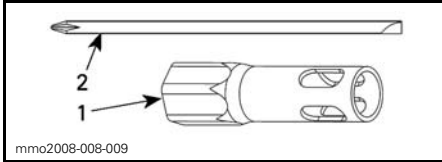

1. 19 mm socket
2. Screwdriver rod

5. Clean spark plugs and cylinder heads.

**NOTICE** Severe engine damage can occur if grime particles enter the combustion chamber.

6. Remove spark plug.

### Spark Plug Installation

1. Measure spark plug gap.

**NOTE:** The gap is not adjustable. If gap is incorrect, replace spark plugs.

**NOTICE** Do not attempt to adjust gap on these spark plugs.

ENGINE	SPARK PLUG GAP (NOT ADJUSTABLE)
550F	0.45 mm (.018 in)

2. Apply LOCTITE 767 (ANTISEIZE LUBRICANT) (P/N 293 800 070) on spark plug threads.
3. Screw spark plugs into cylinder head by hand until it bottoms.

4. Perform the final tightening using the appropriate tools from the tool kit or with a torque wrench and a proper socket.
  - With a torque wrench (preferred): tighten to  $27 \text{ N}\cdot\text{m} \pm 2 \text{ N}\cdot\text{m}$  ( $20 \text{ lbf}\cdot\text{ft} \pm 1 \text{ lbf}\cdot\text{ft}$ ).
  - With the socket from the tool kit: tighten 1/2 turn for a new spark plug and 1/10 turn for a used spark plug.
5. Connect spark plug wires.

## Brake Fluid

### Recommended Fluid

Use only DOT 4 brake fluid from a sealed container. An opened container may be contaminated or may have absorbed moisture from the air.

**⚠ WARNING**

Use only DOT 4 brake fluid from a sealed container. To avoid serious damage to the braking system, do not use fluids other than the recommended one, nor mix different fluids for topping up.

**NOTICE** Brake fluid can damage painted and plastic parts. Handle with care. Rinse thoroughly in case of spillage.

### Brake Fluid Level

**NOTICE** Vehicle must be on a level surface before checking any fluid levels.

Check brake fluid (DOT 4) in reservoir for proper level. Add fluid (DOT 4) as required.

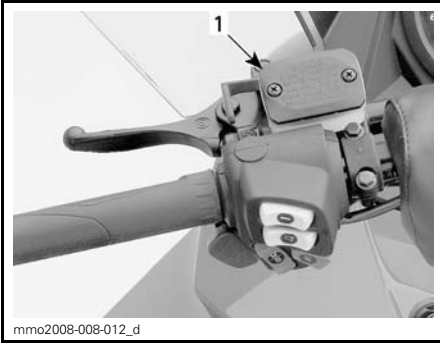

**TYPICAL**

1. Brake fluid reservoir

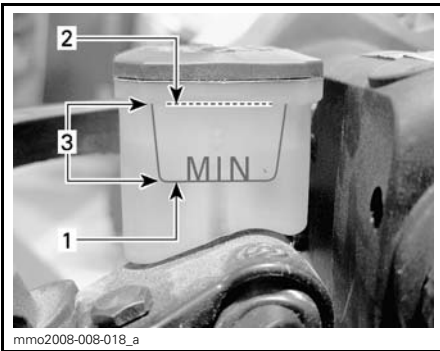

1. Minimum
2. Maximum
3. Operating range

**⚠ WARNING**

Avoid getting brake fluid on skin or eyes - it may cause severe burns. In case of contact skin, wash thoroughly. In case of contact with the eyes, immediately rinse with plenty of water for at least 10 minutes and then consult a doctor immediately.

**Chaincase Oil**

**Recommended Chaincase Oil**

Use XPS synthetic chaincase oil (P/N 413 803 300).

**NOTICE** Use only the recommended type of oil when servicing. Do not mix synthetic oil with other types of oil.

**Chaincase Oil Level**

With the vehicle on a level surface, check the oil level by removing the magnetic check plug on the left side of chaincase.

Oil level must reach the threaded hole's lower edge.

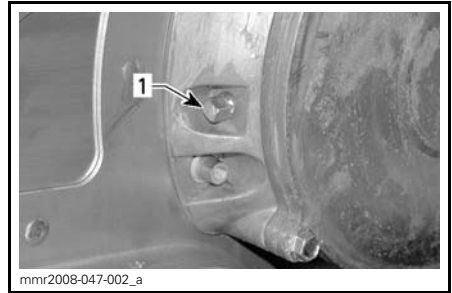

1. Magnetic check plug

**NOTE:** It is normal to find metallic particles stuck to magnetic check plug. If bigger pieces of metal are found, remove the chaincase cover and inspect the chaincase parts.

Remove metal particles from magnetic check plug.

To add oil, remove the filler cap on the chaincase cover.



1. Filler cap

Pour recommended oil in chaincase by the filler hole until oil comes out by the magnetic check plug hole. Reinstall magnetic check plug and torque to  $6\text{ N}\cdot\text{m} \pm 1\text{ N}\cdot\text{m}$  ( $53\text{ lbf}\cdot\text{in} \pm 9\text{ lbf}\cdot\text{in}$ ).

## Drive Belt Guard

### Drive Belt Guard Removal

#### **⚠ WARNING**

**NEVER** operate engine:

- Without shields and belt guard securely installed.
- With hood and/or side panels opened or removed.

**NEVER** attempt to make adjustments to moving parts while engine is running.

**NOTE:** Belt guard is purposely made slightly oversize to maintain tension on its pins and retainers preventing undue noise and vibration. It is important that this tension be maintained when reinstalling.

Remove the tether cord cap and key.

Open engine compartment LH side panel.

Remove retaining pin.

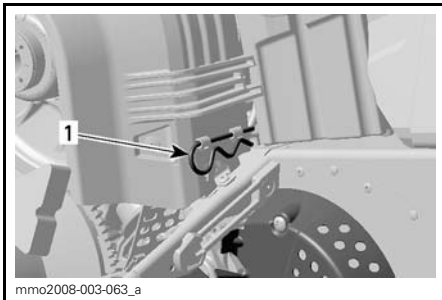

1. Retaining pin

Lift rear portion of guard then release from front tabs by pivoting the guard outwards.

### Drive Belt Guard Installation

When reinstalling belt guard, position its cutaway toward front of snowmobile.

Place the front LH slot of the guard over the longest tab.

Pivot the guard inward to engage the shortest tab in the RH slot.



1. Tabs

Position the grommet over the retaining rod. It may be necessary to slightly lift the console to make room.

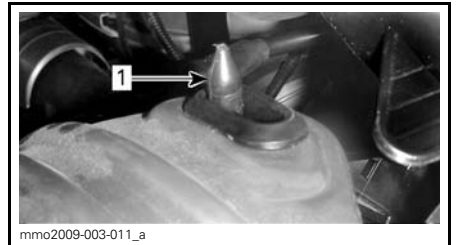

1. Retaining rod

Position rear portion of the belt guard over the retainer and secure it using the retaining pin.

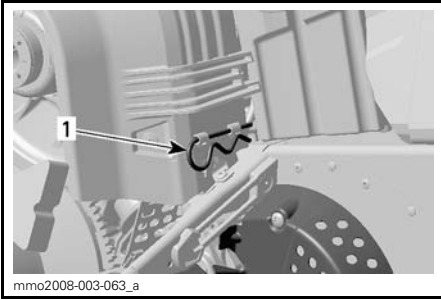

1. Retaining pin

## Spare Drive Belt Storage

A spare drive belt (not provided with the vehicle) can be stored in the storage compartment.

*MX Z, Renegade and GSX*

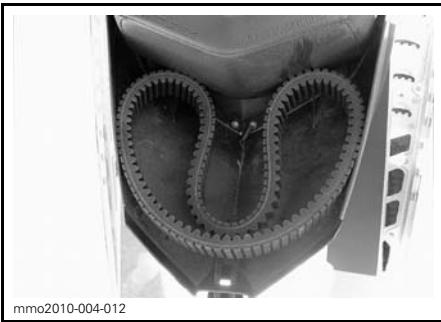

### *Grand Touring*

On Grand Touring models, store spare belt in the passenger seat storage compartment. Shape belt as shown above.

## Drive Belt

### Drive Belt Inspection

Inspect belt for cracks, fraying or abnormal wear (uneven wear, wear on one side, missing cogs, cracked fabric). If abnormal wear is noted, probable cause could be pulley misalignment, excessive RPM with frozen track, fast starts without warm-up period, burred or rusty sheave, oil on belt or distorted spare belt. Contact an authorized Ski-Doo dealer.

## Drive Belt Replacement

### Drive Belt Removal

1. Remove tether cord cap and key.
2. Open LH side panel, refer to *BODY*.
3. Remove belt guard, refer to *BELT GUARD REMOVAL*.
4. Insert the driven pulley expander provided in the tool kit in the threaded hole on the adjuster hub as shown.

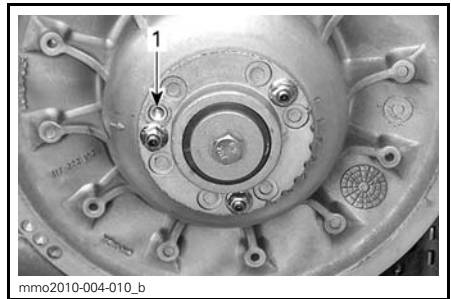

1. Threaded hole



5. Open the driven pulley by screwing the tool in.
6. Remove the belt by slipping it over the top of the driven pulley, then over the drive pulley.

### Drive Belt Installation

1. If necessary, open the driven pulley, refer to *DRIVE BELT REMOVAL* above.
2. Slip the belt over the drive pulley, then over the driven pulley.

**NOTICE** Do not force or use tools to pry the belt into place, as this could cut or break the cords in the belt.

**NOTE:** The maximum drive belt life span is obtained when belt is installed with arrows in the direction of rotation.

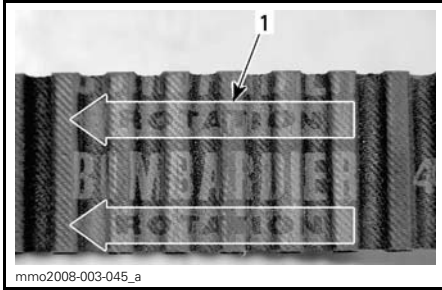

1. To be pointed in the direction of rotation

3. Unscrew and remove the driven pulley expander from the pulley.
4. Rotate the driven pulley several times to properly set the belt between the sheaves.
5. If a new belt was installed, adjust the belt height. Refer to *DRIVE BELT HEIGHT ADJUSTMENT* below.
6. Install belt guard, refer to *DRIVE BELT GUARD INSTALLATION*.
7. Close side panel, refer to *BODY*.

**Drive Belt Height Adjustment (Screw Type Pulley Adjuster)**

The drive belt height must be checked every time a new belt is installed.

To adjust the drive belt height, proceed as follows:

1. Remove tether cord cap and key.
2. Open LH side panel, refer to *BODY*.
3. Remove belt guard, refer to *DRIVE BELT GUARD REMOVAL*.
4. Keep the set screws from turning using a 3 mm Allen key and loosen the three lock nuts using a 10 mm open wrench.

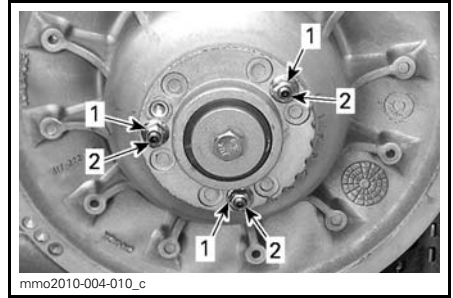

1. Lock nuts
2. Adjustment screws

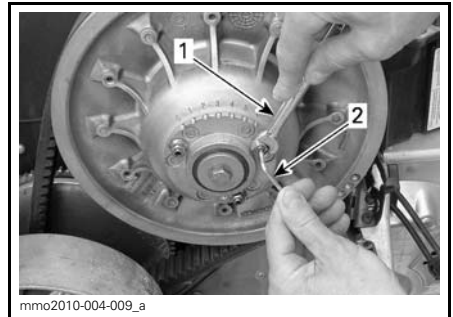

**LOOSEN THE LOCK NUTS**

1. 3 mm Allen key
  2. 10 mm open wrench
5. Turn one set screw 1/4 turn at a time then rotate the driven pulley to properly set the belt between the pulley sheaves.

**Belt without External Cogs**

Repeat step 5 until the external surface of drive belt exceeds driven pulley edge by 2 mm (.079 in).

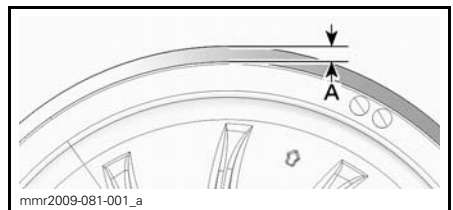

**PRELIMINARY SETTING**

- A. 2 mm (.079 in)

### Belt with External Cogs

Repeat step 5 until the bottom of grooves on the external side of drive belt are flush with the driven pulley edges.

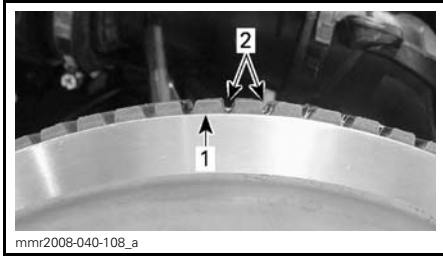

#### PRELIMINARY SETTING

1. Driven pulley edge
2. External drive belt grooves

### All Drive Belt Types

**NOTE:** Turning the set screws clockwise lowers the belt in the pulley. Turning the set screws counterclockwise raises the belt in the pulley.

6. Turn the other set screws clockwise so that they just contact the bottom. Do not screw any further
7. Keep the set screws from turning and tighten the lock nuts to  $8 \text{ N}\cdot\text{m} \pm 2 \text{ N}\cdot\text{m}$  ( $71 \text{ lbf}\cdot\text{in} \pm 18 \text{ lbf}\cdot\text{in}$ )
8. Install belt guard, refer to *DRIVE BELT GUARD INSTALLATION*.
9. Close side panel, refer to *BODY*.

**NOTE:** This setting is correct as a preliminary adjustment for most models and belt types. In some cases, when starting the engine, the vehicle could creep, indicating that the belt is too tight.

If the vehicle creeps, lower the drive belt height from the preliminary setting. Repeat procedure until creeping stops.

### Reverse Activation

**NOTE:** The reverse may not activate or may be harder to activate if the belt is positioned too high in the driven pulley. If reverse activation does not work properly, ensure the drive belt is properly adjusted. Adjust the drive belt lower in the driven pulley if needed.

## Drive Pulley

### Drive Pulley Adjustment

#### **⚠ WARNING**

Remove the tether cord cap and key before performing any adjustment. Vehicle must be parked in a safe place, away from the trail.

The drive pulley is factory calibrated to transmit maximum engine power at a predefined RPM. Factors such as ambient temperature, altitude or surface condition may vary this critical engine RPM thus affecting snowmobile efficiency.

This adjustable drive pulley allows setting maximum engine RPM to maintain maximum power.

Calibration screws should be adjusted so that actual maximum engine RPM matches the maximum horsepower RPM.

ENGINE	MAXIMUM HORSEPOWER RPM
550F	6800 RPM ( $\pm 100$ )

**NOTE:** Use precision digital tachometer for engine RPM adjustment.

**NOTE:** The adjustment has an effect on high RPM only.

Calibration screw has a notch on top of its head.

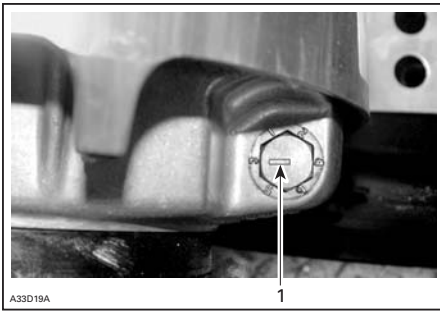

**TYPICAL**  
1. Notch

There are 6 positions numbered 1 to 6.

Each position modifies maximum engine RPM by about 200 RPM.

Lower position numbers decrease engine RPM in steps of 200 RPM and higher position numbers increase it in steps of 200 RPM.

Example:

Calibration screw is set at position 4 and is changed to position 6. So maximum engine RPM is increased by 400 RPM.

**Procedure**

Just loosen locking nut enough to pull calibration screw partially out and adjust to desired position. Do not completely remove the locking nut. Torque locking nuts to  $10\text{ N}\cdot\text{m} \pm 2\text{ N}\cdot\text{m}$  ( $89\text{ lbf}\cdot\text{in} \pm 18\text{ lbf}\cdot\text{in}$ ).

**NOTICE** Do not completely remove calibration screw otherwise internal washers will fall off. Always adjust all 3 calibration screws and make sure they are all set to the same position.

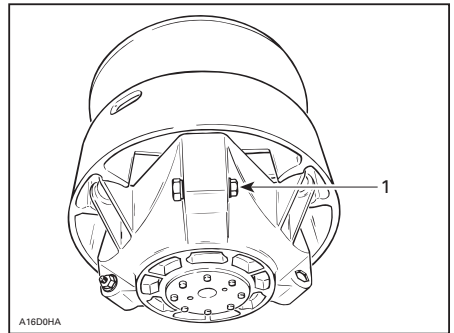

**TYPICAL**  
1. Loosen just enough to permit rotating of calibrate screw

**⚠ WARNING**

**NEVER** disassemble or modify the drive pulley. Improper assembly or modifications could cause the pulley to explode violently under the stress generated by the high rotational speed. See your Ski-Doo dealer to maintain or service the drive pulley. Improper servicing or maintenance may affect performance and reduce belt life. Always respect maintenance schedules.

**⚠ WARNING**

**NEVER** operate engine:

- Without shields and belt guard securely installed.
- With hood and/or side panels opened or removed.

**NEVER** attempt to make adjustments to moving parts while engine is running.

## Track

### Track Condition

#### WARNING

Remove the tether cord cap and key before performing any maintenance or adjustment, unless otherwise specified. Vehicle must be parked in a safe place, away from the trail.

Remove the tether cord cap and key.

Lift the rear of the snowmobile and support it with a wide-base snowmobile mechanical stand with a rear deflector panel. With the engine off, rotate the track by hand, and inspect condition. If worn or cut, or if track fibers are exposed, or if missing or defective inserts or guides are noted; contact an authorized Ski-Doo dealer.

### *Snowmobiles Equipped with Traction Enhancing Products*

If your snowmobile is equipped with a BRP approved studded track, PROCEED WITH A VISUAL INSPECTION OF YOUR TRACK BEFORE EACH USE.

Look for any defects, such as:

- Perforations in the track
- Tears in the track (particularly around traction holes on studded tracks)
- Lugs that are broken or torn off, exposing portions of rods
- Delamination of the rubber
- Broken rods
- Broken studs (studded tracks)
- Bent studs (studded tracks)
- Missing studs
- Studs that are torn off the track
- Missing track guide(s)
- Also, ensure that studs nut are tighten to the recommended torque.

On approved studded tracks, replace broken or damaged studs immediately. If your track shows signs of deterioration, it must be replaced immediately. When in doubt, ask your dealer.

#### WARNING

Riding with a damaged track or studs could lead to a loss of control.

For complete information on traction enhancing products, refer to the section entitled *TRACTION ENHANCING PRODUCTS* in the *SAFETY INFORMATION* section at the beginning of this Operator's Guide.

### Track Tension and Alignment

**NOTE:** Track tension and alignment are interrelated. Do not adjust one without the other.

#### WARNING

To prevent serious injury to individuals near the snowmobile:

- NEVER stand behind or near a moving track.
- Always use a wide-base snowmobile stand with a rear deflector panel if it is necessary to rotate track.
- When the track is raised off the ground, only run it at the lowest possible speed.

Centrifugal force could cause debris, damaged or loose studs, pieces of torn track, or an entire severed track to be violently thrown backwards out of the tunnel with tremendous force.

### Tension

**NOTE:** Ride the snowmobile in snow about 15 to 20 minutes prior to adjusting track tension.

Remove the tether cord cap and key.



Lift rear of snowmobile and support it with a wide-base snowmobile mechanical stand.

Allow the suspension to extend normally and check gap halfway between front and rear idler wheels. Measure between slider shoe bottom and inside of track. The gap should be as given in *SPECIFICATIONS* at the end of this guide. If the track tension is too loose, track will have a tendency to thump.

**NOTE:** A belt tension tester (P/N 414 348 200) may be used to measure deflection as well as force applied.

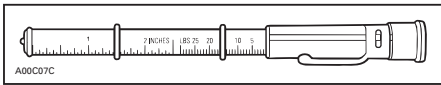

**BELT TENSION TESTER**

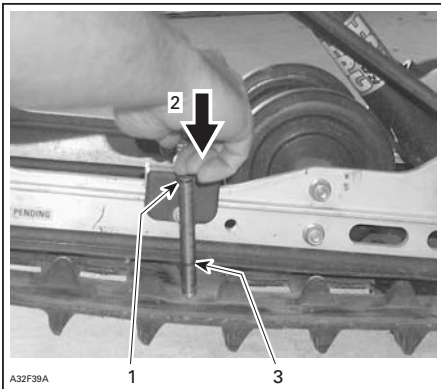

**TYPICAL**

1. Top tool O-ring positioned at 7.3 kg (16 lb)
2. Push on top portion of tool until it contacts the top O-ring
3. Measured track deflection

**NOTICE** Too much tension will result in power loss and excessive stresses on suspension components.

To adjust track tension:

- Remove the tether cord cap and key.
- Remove rear wheel caps (if so equipped).

- Loosen the rear idler wheel retaining bolts.
- Turn adjustment bolts to adjust.

If correct tension is unattainable, contact an authorized Ski-Doo dealer.

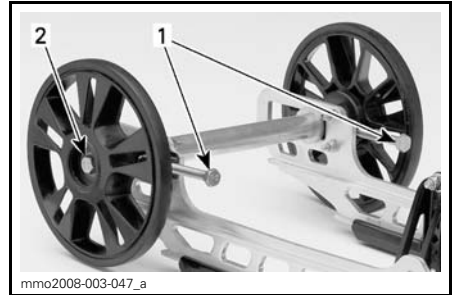

**TYPICAL**

1. Adjustment bolts
2. Loosen bolt

1. Retighten retaining bolts.
2. Check track alignment as described below.

**Alignment**

**⚠ WARNING**

Before checking track alignment, ensure that the track is free of all particles which could be thrown out while track is rotating. Keep hands, tools, feet and clothing clear of track. Always lift the snowmobile on a wide-base stand with a rear deflector panel. Ensure no one is standing in close proximity to the snowmobile, especially at the rear of the track. Never rotate track at high speed.

Centrifugal force could cause debris, damaged or loose studs, pieces of torn track, or an entire severed track to be violently thrown backwards out of the tunnel with tremendous force.

Start the engine and accelerate slightly so that track barely turns. This must be done in a short period of time (about 5 seconds).

Check that the track is well centered; equal distance on both sides between edges of track guides and slider shoes.

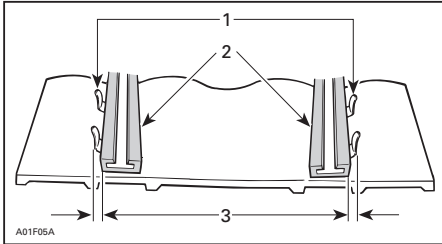

1. Guides
2. Slider shoes
3. Equal distance

If off center, perform alignment as follows:

### **⚠ WARNING**

Remove the tether cord cap and key before performing any maintenance or adjustment, unless otherwise specified. Vehicle must be parked in a safe place, away from the trail.

1. Remove the tether cord cap and key.
2. Loosen rear idler wheel retaining bolts.
3. Tighten the adjustment bolt on side where the slider shoe is the farthest from the track insert guides.

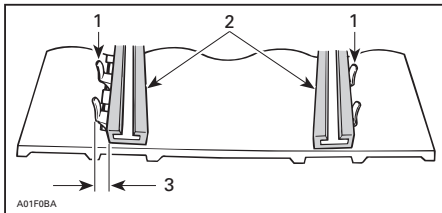

1. Guides
2. Slider shoes
3. Tighten on this side

4. Tighten retaining bolts.

### **⚠ WARNING**

Properly tighten wheel retaining bolts, otherwise wheel may come off and cause track to "lock".

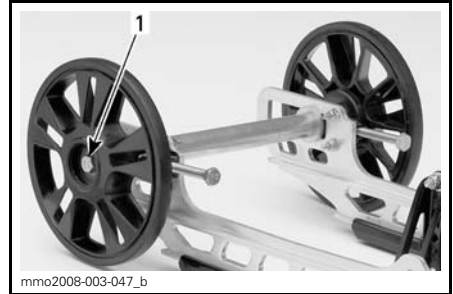

#### TYPICAL

1. Retighten to  $48\text{ N}\cdot\text{m} \pm 6\text{ N}\cdot\text{m}$   
( $35\text{ lbf}\cdot\text{ft} \pm 4\text{ lbf}\cdot\text{ft}$ )

5. Restart engine and rotate track slowly to recheck alignment.
6. Reposition snowmobile on ground.
7. Install rear wheel caps if so equipped.

## Suspension

### Rear Suspension Condition

Visually inspect all suspension components including slider shoes, springs, wheels, etc.

**NOTE:** During normal driving, snow will act as a lubricant and coolant for the slider shoes. Extensive riding on ice or sanded snow, will create excessive heat build-up and cause premature slider shoe wear.

### Suspension Stopper Strap Condition

Inspect stopper strap for wear and cracks, bolt and nut for tightness. If loose inspect holes for deformation. Replace as required. Torque nut to  $10\text{ N}\cdot\text{m} \pm 1\text{ N}\cdot\text{m}$  ( $89\text{ lbf}\cdot\text{in} \pm 9\text{ lbf}\cdot\text{in}$ ).

## Rear Arm Lubrication

Lubricate rear arm at grease fittings using suspension synthetic grease (P/N 293 550 033). Refer to *MAINTENANCE SCHEDULE* for maintenance frequency.

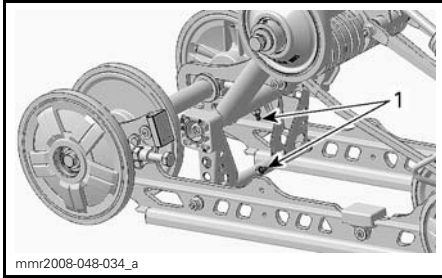

mmr2008-048-034\_a  
MX Z™ AND GSX SERIES  
1. Grease fittings

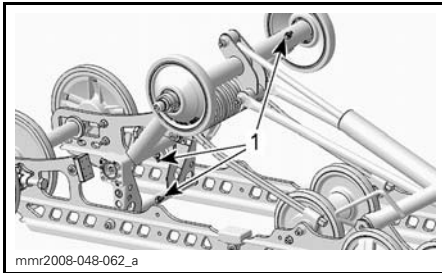

mmr2008-048-062\_a  
RENEAGE AND GRAND TOURING SERIES  
1. Grease fittings

## Steering and Front Suspension Condition

Visually inspect steering and front suspension for tightness of components (steering arms, control arms and links, tie rods, ball joints, ski bolts, ski legs, etc.). If necessary, contact an authorized Ski-Doo dealer.

## Skis

### Wear and Condition of Skis and Runners

Check the condition of the skis and ski runner carbides. If worn, contact an authorized Ski-Doo dealer.

## WARNING

Excessively worn skis and/or ski runners will adversely affect snowmobile control.

## Fuses

### Fuse Inspection

The electrical system is protected with fuses, refer to *MAINTENANCE INFORMATION* for details.

Check fuse condition and replace it if necessary.

To remove fuse from holder, pull fuse out. Check if filament is melted.

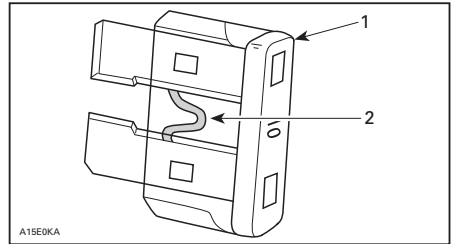

1. Fuse
2. Check if melted

**NOTICE** Do not use a higher rated fuse as this can cause severe damage to electrical components and/or be a potential fire.

## WARNING

If fuse has burnt out, source of malfunction should be determined and corrected before restarting. See an authorized Ski-Doo dealer for servicing.

### Fuse Location

The main fuse is located on the oil reservoir.



mmo2010-004-011\_b

1. Main fuse

The electric fuel level sender fuse is located behind the air intake silencer.

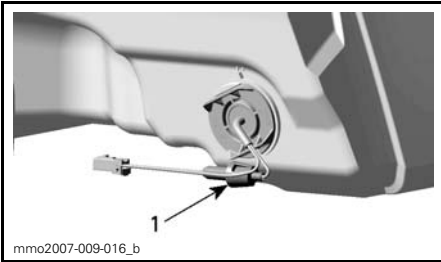

mmo2007-009-016\_b

**BEHIND AIR INTAKE SILENCER**

1. Fuse location

**Lights**

Always check light operation after bulb replacement.

**Headlights Bulb Replacement**

**NOTICE** Never touch glass portion of an halogen bulb with bare fingers, it shortens its operating life. If glass is touched, clean it with isopropyl alcohol which will not leave a film on the bulb.

1. By using a small screwdriver, release gauge locking tabs.

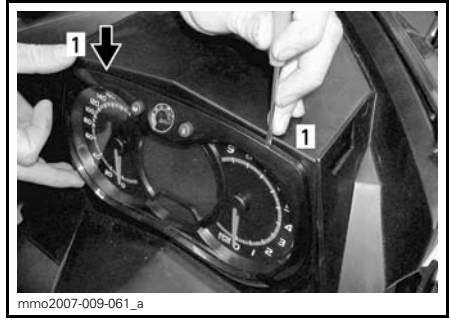

mmo2007-009-061\_a

**TYPICAL**

1. Locking tab

2. Gently pull on gauge and set aside.



mmo2007-009-062\_a

**TYPICAL**

3. Disconnect burnt bulb connector. Remove the rubber boot.

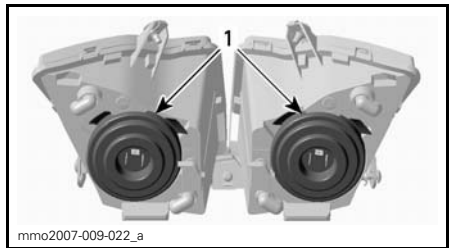

mmo2007-009-022\_a

1. Rubber boots

4. Press and pull both sides of the retaining clip at the same time to release it from bulb support.

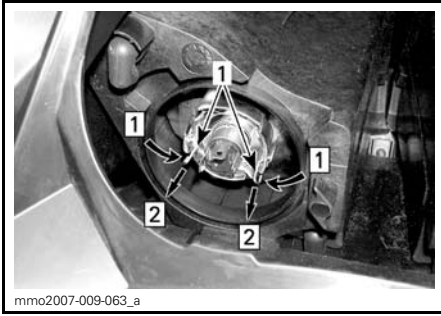

1. Retaining clip

Step 1: Push both sides

Step 2: Pull to release

5. Pull bulb and replace. Properly re-install parts.

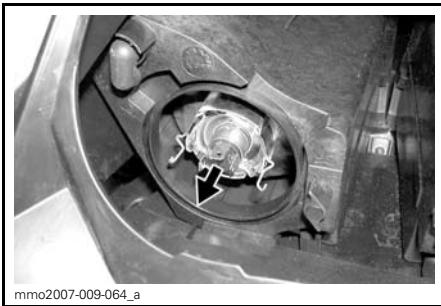

PULL BULB AND REPLACE

### Headlights Beam Aiming

Remove gauge, refer to *HEADLIGHTS BULB REPLACEMENT*. Turn knob to adjust beam height.

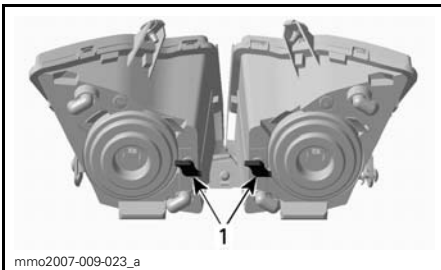

TYPICAL

1. Knobs

### Taillight Bulb Replacement

1. Remove taillight housing by carefully pulling on lens at both ends.

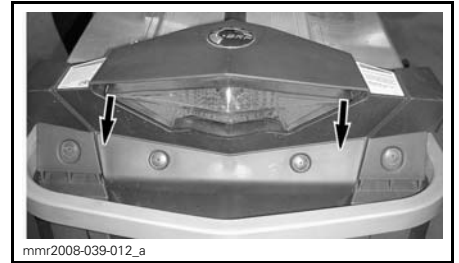

TYPICAL - CAREFULLY PULL OUT AT CORNERS

**NOTICE** Taillight housing is held in place by two plastic pins inserted in rubber grommets. If taillight housing is forced too far sideways when removing, mounting pins may break and housing will have to be replaced. Do not pull taillight housing out too far to avoid damaging wiring.

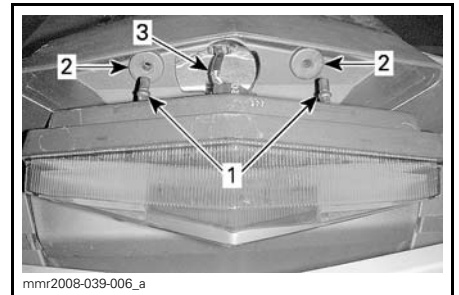

1. Taillight housing retaining pins  
2. Retaining grommets  
3. Light wire harness

2. Rotate bulb socket counterclockwise to remove it from taillight housing.  
3. Push in and rotate bulb counterclockwise to remove it from its socket.  
4. Install the new bulb by pushing it in the socket and turning it clockwise.

**NOTE:** Note position of bulb locking pins on its base, and socket alignment key.

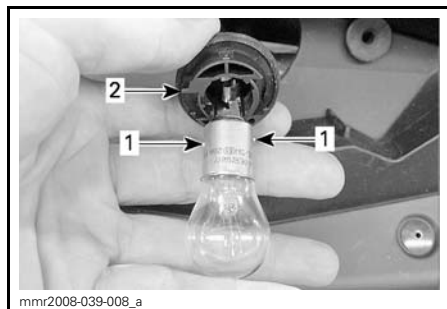

1. Bulb locking pins  
2. Bulb holder alignment key

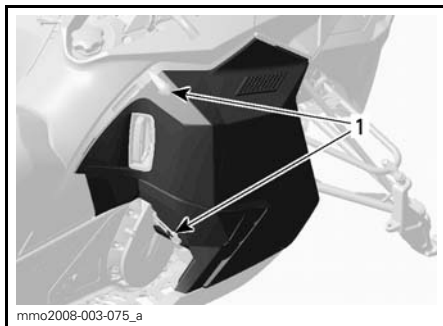

TYPICAL  
1. Latches

To remove a side panel, open it then lift it up. Free the lower hinge from its slot, then free the upper hinge by lowering the panel.

## Body

### Hood

To open hood, release hood retaining pins then slide hood towards the front of the vehicle.

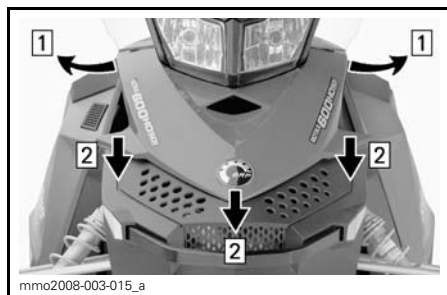

- Step 1: Release retaining pins  
Step 2: Slide hood towards the front

**⚠ WARNING**  
Never operate engine with hood removed from vehicle.

### Side Panels

To open a side panel, stretch and unhook the latches.

**⚠ WARNING**

Never operate engine with side panels opened or removed from vehicle.

### Vehicle Cleaning and Protection

Remove any dirt or rust.

**NOTICE** Always make sure the cooling fan flow is not obstructed. Check the inlet and outlet ducts for cleanliness.

To clean the entire vehicle, use only flannel cloths or equivalent.

**NOTICE** It is necessary to use flannel cloths or equivalent on windshield and hood to avoid damaging further surfaces to clean.

To remove grease, oil and grime, use Heavy duty cleaner (P/N 293 110 001) (spray can 400 g) and (P/N 293 110 002) (4 L).

**NOTICE** Do not use Heavy duty cleaner on decals or vinyl.

To remove stubborn dirt from all plastic and vinyl surfaces, use Vinyl & Plastic Cleaner ((P/N 413 711 200) (6 x 1 L)).

To remove scratches on windshield or hood use the Scratch Remover Kit (P/N 861 774 800).

**NOTICE** Never clean plastic parts or hood with strong detergent, degreasing agent, paint thinner, acetone, products containing chlorine, etc.

Wax painted portion of the vehicle for better protection.

**NOTE:** Apply wax on glossy finish only.

---

# STORAGE AND PRESEASON PREPARATION

## **WARNING**

Have an authorized Ski-Doo dealer inspect fuel and oil systems integrity as specified in *MAINTENANCE SCHEDULE*.

**NOTICE** Have carburetors cleaned-up before restarting engine.

## **Storage**

During summer, or when a snowmobile is not in use for more than three months, proper storage is a necessity.

To prepare your snowmobile, refer to an authorized Ski-Doo dealer.

To facilitate the inspection and ensure adequate lubrication of components, it is recommended to clean the entire vehicle.

When storage procedure is completed, block muffler with clean rags.

Lift rear of vehicle until track is clear of the ground. Install on a wide-base snowmobile mechanical stand with a rear deflector panel.

** CAUTION** Use appropriate lifting device or have assistance to share lifting stress. If a lifting device is not used, use proper lifting techniques, notably using your legs force. Do not attempt to lift the rear of vehicle if it is above your limits.

**NOTE:** Do not release track tension.

Protect the vehicle with an approved cover to prevent dust accumulation during storage.

**NOTICE** The snowmobile has to be stored in a cool and dry place and covered with an opaque but ventilated tarpaulin. This will prevent sun rays and grime from affecting plastic components and vehicle finish.

## **Preseason Preparation**

To prepare your snowmobile, refer to an authorized Ski-Doo dealer.



# ***TECHNICAL INFORMATION***

# VEHICLE IDENTIFICATION

## Vehicle Description Decal

Vehicle description decal is located on right hand side of tunnel.

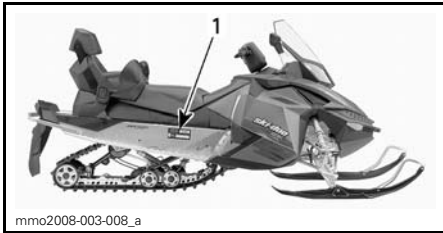

TYPICAL

1. Vehicle description decal

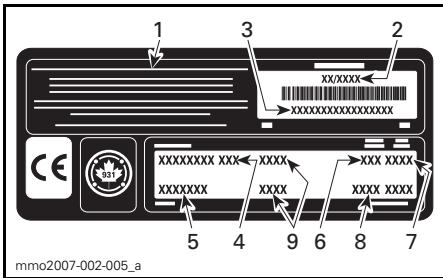

### VEHICLE DESCRIPTION DECAL

1. Manufacturer name
2. Manufacturing date
3. Vehicle identification number (V.I.N.)
4. Model name
5. Option package
6. Engine type
7. Model year
8. Color codes
9. Vehicle weight/engine power (European models)

## Identification Numbers

The main components of your snowmobile (engine and frame) are identified by different identification numbers. It may sometimes become necessary to locate these numbers for warranty purposes or to trace your snowmobile in the event of loss. These numbers are required by the authorized Ski-Doo dealer to complete warranty claims properly. No warranty will be allowed by BRP if the engine identification number or vehicle identification number (V.I.N.) is removed or mutilated in any way. We strongly rec-

ommend that you take note of all the identification numbers on your snowmobile and supply them to your insurance company.

## Vehicle Identification Number (V.I.N.)

V.I.N. is scribed on vehicle description decal. See above. It is also engraved on tunnel near vehicle description decal.

Model number and model year are part of the information found in the V.I.N. See illustration.

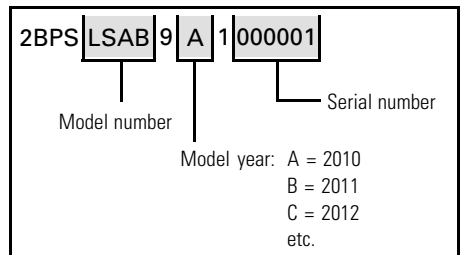

## Engine Identification Number

Refer to the following illustrations to locate the engine identification number on the applicable engine.

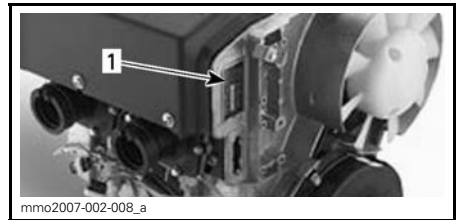

550F ENGINE

1. Engine identification number

The EC-Declaration of Conformity does not appear in this version of the Operator's Guide.

Please refer to the printed version that was delivered with your vehicle.

---

# EPA CERTIFIED ENGINES

Maintenance, replacement, or repair of the emission control devices and systems may be performed by any snowmobile SI (spark ignition) engine repair establishments or individual.

## Engine Emissions Information

### Manufacturer's Responsibility

Beginning with 2007 model year engines, snowmobile manufacturers of snowmobile engines need to determine the exhaust emission levels for each engine horsepower family and certify these engines with the United States of America Environmental Protection Agency (EPA). An emissions control information label, showing emission levels and engine specifications, must be placed on each vehicle at the time of manufacture.

### Dealer's Responsibility

When performing service on a certified Ski-Doo snowmobiles that carry an emissions control information label, adjustments must be kept within published factory specifications.

Replacement or repair of any emission related component must be executed in a manner that maintains emission levels within the prescribed certification standards.

Dealers are not to modify the engine in any manner that would alter the horsepower or allow emission levels to exceed their predetermined factory specifications.

Exceptions include manufacturer's prescribed changes, such as altitude adjustments for example.

### Owner Responsibility

The owner/operator is required to have engine maintenance performed to maintain emission levels within prescribed certification standards.

The owner/operator is not to, and should not allow anyone to modify the engine in any manner that would alter the horsepower or allow emissions levels to exceed their predetermined factory specifications.

### EPA Emission Regulations

All Ski-Doo snowmobiles manufactured by BRP are certified to the EPA as conforming to the requirements of the regulations for the control of air pollution from new snowmobile engines. This certification is contingent on certain adjustments being set to factory standards. For this reason, the factory procedure for servicing the product must be strictly followed and, whenever practicable, returned to the original intent of the design.

The responsibilities listed above are general and in no way a complete listing of the rules and regulations pertaining to the EPA requirements on exhaust emissions for snowmobile products. For more detailed information on this subject, you may contact the following locations:

#### MAIL:

U.S. Environmental Protection Agency  
Office of Transportation and Air Quality  
1200 Pennsylvania Ave. NW  
Mail Code 6403J  
Washington D.C. 20460

#### INTERNET WEB SITE:

[www.epa.gov/otaq/](http://www.epa.gov/otaq/)

# SPECIFICATIONS

MODEL		550F
<b>ENGINE</b>		
Engine type		Rotax® 552, axial fan-cooled w/cylinder reed porting
Cylinders		2
Displacement		553.4 cm <sup>3</sup> (33.8 in <sup>3</sup> )
Bore		76 mm (3 in)
Stroke		61 mm (2.4 in)
Maximum horsepower RPM		6800 RPM
Carburetion		2 x VM-30
Exhaust system		Single tuned pipe, baffle muffler
Engine oil		Refer to <i>RECOMMENDED OIL</i> section
Engine oil tank capacity		3.7 L (3.9 qt (U.S. liq.))
Recommended fuel		Regular unleaded
Minimum octane rating	Inside North America	(87 (RON + MON)/2)
	Outside North America	92 RON
Fuel tank capacity		40 L (10.6 U.S. gal.)
<b>DRIVE SYSTEM</b>		
Drive pulley type		TRA™ III
Driven pulley type		LPV-VSA
Engagement	MX Z	3900 RPM
	Others	3000 RPM
Chaincase oil		XPS synthetic chaincase oil
Small sprocket number of teeth	Grand Touring (Europe)	19
	Others	21
Large sprocket number of teeth	Others	45
Drive sprocket number of teeth		8
Track nominal width	Grand Touring (Europe)	40.6 cm (16 in)
	Others	38 cm (15 in)
Track nominal length	MX Z/GSX	305 cm (120 in)
	Grand Touring	348 cm (137 in)

**SPECIFICATIONS**

<b>MODEL</b>		<b>550F</b>
<b>DRIVE SYSTEM (cont'd)</b>		
Track profile height	GSX/Grand Touring (North America)	25.4 mm (1 in)
	Others	31.8 mm (1.25 in)
Track tension	Deflection	30 mm to 35 mm (1-3/16 in to 1-3/8 in)
	Force <sup>(1)</sup>	7.3 kg (16 lb)
Track alignment		Equal distance between edges of track guides and slider shoes
<b>BRAKE SYSTEM</b>		
Brake system type		Hydraulic, REV-XP™ brake type
Brake fluid		DOT 4
<b>SUSPENSION</b>		
Front suspension		REV-XP
Front shock	MX Z	HPG Plus
	Renegade (Europe)	HPG
	Others	Motion control
Front suspension max. travel		229 mm (9 in)
Rear suspension	Grand Touring	SC-5 M
	Others	SC-5
Center shock	MX Z	HPG Plus
	Renegade (Europe)	HPG
	Others	Motion control
Rear shock	MX Z	HPG Plus
	GSX	MC
	Others	HPG
Rear suspension max. travel		38 cm (15 in)
<b>ELECTRICAL SYSTEM</b>		
Lightning system output		340 Watts @ 6000 RPM
Headlights bulb HI/LOW beam		2 x 60/55 Watts (H-4)
Taillight bulb		5/21
Spark plug	Type	NGK BR9ECS
	Gap	0.45 mm ± 0.05 mm (.018 in ± .002 in)
Fuse		Refer to <i>FUSES</i> section

MODEL		550F
<b>DIMENSIONS AND WEIGHT</b>		
Vehicle overall length	MX Z/GSX	289 cm (113.8 in)
	Renegade/Grand Touring	311 cm (122.4 in)
Vehicle overall width		121.7 cm (47.9 in)
Dry weight	MX Z	187 kg (412 lb)
	GSX/Renegade	199 kg (439 lb)
	Grand Touring	219 kg (483 lb)
Ski stance	Others	107.7 cm (42.4 in)
Ski width	Renegade (Europe)/Grand Touring (Europe)	175 mm (6.9 in)
	Others	145 mm (5.7 in)

<sup>(1)</sup> Measure gap between slider shoe and bottom inside track when exerting a downward pull to the track.





# ***TROUBLESHOOTING***

---

# TROUBLESHOOTING GUIDELINES

---

## ENGINE IS CRANKED BUT FAILS TO START

---

1. Engine stop switch or ignition switch (key) in OFF position or tether cord cap away from post.
  - Place engine stop switch and ignition switch in the ON position and install tether cord cap on post.
2. Mixture not rich enough to start cold engine.
  - Check fuel tank level.
  - Make sure to use choke properly, refer to *CHOKE APPLICATION* in *OPERATING INSTRUCTIONS*.
3. Flooded engine (spark plug wet when removed).
  - Do not choke. Remove wet spark plug, place engine stop switch in OFF position and crank engine several times. Install clean dry spark plugs.
  - Start engine following usual starting procedure. If engine continues to flood, see an authorized Ski-Doo dealer.
4. No fuel to the engine (spark plug dry when removed).
  - Check fuel tank level; check condition of fuel and impulse lines and their connections. Possible fuel pump or carburetor failure, contact an authorized Ski-Doo dealer.
5. Spark plug/ignition (no spark).
  - Install new spark plugs crank engine. If engine fails to start, contact an authorized Ski-Doo dealer.
6. Engine compression.
  - As the engine is pulled over with the rewind starter, “cycles” of resistance should be felt as piston goes past top dead center (each piston on multi-cylinder engines).
  - If no pulsating resistance is felt, it suggests a major loss of compression. Contact an authorized Ski-Doo dealer.

---

## ENGINE LACKS OF POWER/VEHICLE DOES NOT REACH FULL SPEED

---

1. Fouled or defective spark plug.
  - See item 5 of *ENGINE IS CRANKED BUT FAILS TO START*.
2. Lack of fuel to engine.
  - See item 4 of *ENGINE IS CRANKED BUT FAILS TO START*.
3. Carburetor adjustments.
  - Contact an authorized Ski-Doo dealer.
4. Drive belt worn too thin.
  - If the drive belt has lost more than 3 mm (1/8 in) of its original width, it will affect vehicle performance.
  - Replace drive belt.
5. Incorrect track adjustment.
  - See *MAINTENANCE PROCEDURES* and/or an authorized Ski-Doo dealer for proper alignment and tension adjustments.

---

**ENGINE LACKS OF POWER/VEHICLE DOES NOT REACH FULL SPEED (cont'd)**

---

- 6. Drive and driven pulleys require servicing.**
  - *Contact an authorized Ski-Doo dealer.*
- 7. Engine overheats.**
  - *Check fan belt condition and tension.*
  - *Check cooling fins. Clean if necessary.*
  - *If engine overheating persists, contact an authorized Ski-Doo dealer.*

---

**ENGINE BACKFIRES**

---

- 1. Faulty spark plug (carbon accumulation).**
  - *See item 5 of ENGINE IS CRANKED BUT FAILS TO START.*
- 2. Engine is running too hot.**
  - *See item 6 of ENGINE LACKS ACCELERATION OR POWER.*
- 3. Incorrect ignition timing or ignition system failure.**
  - *Contact an authorized Ski-Doo dealer.*

---

**ENGINE MISFIRES**

---

- 1. Fouled/defective/worn spark plugs.**
  - *Clean/verify spark plug gap and identification number. Replace if required.*
- 2. Too much oil supplied to engine.**
  - *Improper oil pump adjustment, refer to an authorized Ski-Doo dealer.*
- 3. Water in fuel.**
  - *Drain fuel system and refill with fresh fuel.*



# ***WARRANTY***

---

# **BRP LIMITED WARRANTY USA AND CANADA: 2010 SKI-DOO® SNOWMOBILES**

## **1) SCOPE OF THE LIMITED WARRANTY**

Bombardier Recreational Products Inc. ("BRP")\* warrants its 2010 Ski-Doo snowmobiles sold by authorized BRP dealers (as hereinafter defined) in the fifty United States and Canada from defects in material or workmanship for the period and under the conditions described below. This limited warranty will become null and void if: (1) the snowmobile was used for racing or any other competitive activity, at any point, even by a previous owner; or (2) the snowmobile has been altered or modified in such a way so as to adversely affect its operation, performance or durability, or has been altered or modified to change its intended use.

All genuine Ski-Doo parts and accessories, installed by an authorized BRP dealer at the time of delivery of the 2010 Ski-Doo snowmobile, carry the same warranty as that of the snowmobile.

## **2) LIMITATIONS OF LIABILITY**

THIS WARRANTY IS EXPRESSLY GIVEN AND ACCEPTED IN LIEU OF ANY AND ALL OTHER WARRANTIES, EXPRESSED OR IMPLIED, INCLUDING WITHOUT LIMITATION ANY WARRANTY OF MERCHANTABILITY OR FITNESS FOR A PARTICULAR PURPOSE. TO THE EXTENT THAT THEY CANNOT BE DISCLAIMED, THE IMPLIED WARRANTIES ARE LIMITED IN DURATION TO THE LIFE OF THE EXPRESS WARRANTY. INCIDENTAL AND CONSEQUENTIAL DAMAGES ARE EXCLUDED FROM COVERAGE UNDER THIS WARRANTY. SOME STATES/PROVINCES DO NOT ALLOW FOR THE DISCLAIMERS, LIMITATIONS AND EXCLUSIONS IDENTIFIED ABOVE, AS A RESULT, THEY MAY NOT APPLY TO YOU. THIS WARRANTY GIVES YOU SPECIFIC RIGHTS, AND YOU MAY ALSO HAVE OTHER LEGAL RIGHTS WHICH MAY VARY FROM STATE TO STATE, OR PROVINCE TO PROVINCE.

Neither the distributor any BRP dealer nor any other person has been authorized to make any affirmation, representation or warranty regarding the product, other than those contained in this limited warranty, and if made, shall not be enforceable against BRP.

BRP reserves the right to modify this warranty at any time, being understood that such modification will not alter the warranty conditions applicable to the products sold while this warranty is in effect.

## **3) EXCLUSIONS – ARE NOT WARRANTED**

The following are not warranted under any circumstances:

- Normal wear and tear;
- Routine maintenance items, tune ups, adjustments;
- Damage caused by failure to provide proper maintenance and/or storage, as described in the Operator's Guide;
- Damage resulting from removal of parts, improper repairs, service, maintenance, modifications or use of parts not manufactured or approved by BRP or resulting from repairs done by a person that is not an authorized servicing BRP dealer;
- Damage caused by abuse, abnormal use, neglect, use of the product on surfaces other than snow, or operation of the product in a manner inconsistent with the recommended operation described in the Operator's Guide;

- Damage resulting from accident, submersion, fire, theft, vandalism or any act of God;
- Operation with fuels, oils or lubricants which are not suitable for use with the product (see the Operator’s Guide);
- Snow or water ingestion;
- Incidental or consequential damages, or damages of any kind including without limitation towing, storage, telephone, rental, taxi, inconvenience, insurance coverage, loan payments, loss of time, loss of income; and
- Damage resulting from studs installed on tracks if the installation does not conform to BRP’s instructions.

#### **4) WARRANTY COVERAGE PERIOD**

This warranty will be in effect from (1) the date of delivery to the first retail consumer or (2) the date the product is first put into use, whichever occurs first and for a period of:

TWELVE (12) CONSECUTIVE MONTHS, for private or commercial use owners. However, the warranty coverage period on a snowmobile delivered between June 1<sup>st</sup> and December 1<sup>st</sup> of a given year will expire November 30<sup>th</sup> of the following year.

Exhaust emission-related components that are installed on EPA certified snowmobiles registered in the USA are covered for thirty (30) consecutive months or 200 hours or 2500 miles (4000 km) of engine use whichever occurs first. If the 2500 miles (4000 km) are reached during the regular warranty coverage period, the emission-related components are still covered by BRP’s standard warranty until the end of regular coverage period. Evaporative emission related components that are installed on EPA certified snowmobiles registered in the USA are warranted for twenty-four (24) consecutive months.

To obtain a list of the current warranted emission-related components, please see an authorized Can-Am dealer.

The repair or replacement of parts or the performance of service under this warranty does not extend the life of this warranty beyond its original expiration date.

#### **5) CONDITIONS TO HAVE WARRANTY COVERAGE**

This warranty coverage is available **only** if each of the following conditions has been fulfilled:

- The 2010 Ski-Doo snowmobile must be purchased as new and unused by its first owner from a BRP dealer authorized to distribute Ski-Doo snowmobiles in the country in which the sale occurred (“BRP dealer”);
- The BRP specified pre-delivery inspection process must be completed and documented;
- The product must have undergone proper registration by an authorized BRP dealer;
- The 2010 Ski-Doo snowmobile must be purchased in the country in which the purchaser resides; and
- Routine maintenance outlined in the Operator’s Guide must be timely performed in order to maintain warranty coverage. BRP reserves the right to make warranty coverage contingent upon proof of proper maintenance.

BRP will not honor this limited warranty to any private use owner or commercial use owner if the preceding conditions have not been met. Such limitations are necessary in order to allow BRP to preserve both the safety of its products, and also that of its consumers and the general public.

## **6) WHAT TO DO TO OBTAIN WARRANTY COVERAGE**

The customer must cease using the snowmobile upon the appearance of an anomaly. The customer must notify a servicing BRP dealer within two (2) days of the appearance of a defect, and provide it with reasonable access to the product and reasonable opportunity to repair it. The customer must also present to the authorized BRP dealer, proof of purchase of the product and must sign the repair/work order prior to starting the repair in order to validate the warranty repair. All parts replaced under this limited warranty become the property of BRP.

## **7) WHAT BRP WILL DO**

BRP's obligations under this warranty are limited to, at its sole discretion, repairing parts found defective under normal use, maintenance and service, or replacing such parts with new genuine Ski-Doo parts without charge for parts and, at any authorized BRP dealer during the warranty coverage period under the conditions described herein. BRP's responsibility is limited to making the required repairs or replacements of parts. No claim of breach of warranty shall be cause for cancellation or rescission of the sale of the snowmobile to the owner.

In the event that service is required outside of the country of original sale, the owner will bear responsibility for any additional charges due to local practices and conditions, such as, but not limited to, freight, insurance, taxes, license fees, import duties, and any and all other financial charges, including those levied by governments, states, territories and their respective agencies.

BRP reserves the right to improve or modify products from time to time without assuming any obligation to modify products previously manufactured.

## **8) TRANSFER**

If the ownership of a product is transferred during the warranty coverage period, this warranty shall also be transferred and be valid for the remaining coverage period provided that BRP is notified of such transfer of ownership in the following way:

1. The former owner contacts BRP (at the phone number provided below) or an authorized BRP dealer and gives the coordinates of the new owner; or
2. BRP or an authorized BRP dealer receives a proof that the former owner agreed to the transfer of ownership, in addition to the coordinates of the new owner.



## **9) CONSUMER ASSISTANCE**

In the event of a controversy or a dispute in connection with this limited warranty, BRP suggests that you try to resolve the issue at the dealership level. We recommend discussing the issue with the authorized dealer's service manager or owner.

If the issue has not yet been resolved, please submit your complaint in writing or call the appropriate number below:

### **In Canada**

**BOMBARDIER  
RECREATIONAL PRODUCTS INC.**

Warranty Department  
75 J.-A. Bombardier Street  
Sherbrooke QC J1L 1W3  
Canada  
Fax: 819 566-3590

### **In USA**

**BRP US INC.**

Warranty Department  
7575 Bombardier Court  
Wausau WI 54401  
Tel.: 715 848-4957

\* In the USA, products are distributed and serviced by BRP US Inc.  
© 2009 Bombardier Recreational Products Inc. All rights reserved.  
® Registered trademark of Bombardier Recreational Products Inc.

---

# **BRP INTERNATIONAL LIMITED WARRANTY: 2010 SKI-DOO® SNOWMOBILES**

## **1) SCOPE OF THE LIMITED WARRANTY**

Bombardier Recreational Products Inc. ("BRP")\* warrants its 2010 Ski-Doo snowmobiles sold by authorized BRP distributor/dealer (as hereinafter defined) outside of the fifty United States, Canada and states members of the European Economic Area ("EEA") (which is comprised of the states member of the European Union plus Norway, Iceland and Liechtenstein) from defects in material or workmanship for the period and under the conditions described below. This limited warranty will become null and void if: (1) the snowmobile was used for racing or any other competitive activity, at any point, even by a previous owner; or (2) the snowmobile has been altered or modified in such a way so as to adversely affect its operation, performance or durability, or has been altered or modified to change its intended use.

All genuine Ski-Doo parts and accessories, installed by an authorized BRP distributor/dealer at the time of delivery of the 2010 Ski-Doo snowmobile, carry the same warranty as that of the snowmobile.

## **2) LIMITATIONS OF LIABILITY**

THIS WARRANTY IS EXPRESSLY GIVEN AND ACCEPTED IN LIEU OF ANY AND ALL OTHER WARRANTIES, EXPRESSED OR IMPLIED, INCLUDING WITHOUT LIMITATION ANY WARRANTY OF MERCHANTABILITY OR FITNESS FOR A PARTICULAR PURPOSE. TO THE EXTENT THAT THEY CANNOT BE DISCLAIMED, THE IMPLIED WARRANTIES ARE LIMITED IN DURATION TO THE LIFE OF THE EXPRESS WARRANTY. INCIDENTAL AND CONSEQUENTIAL DAMAGES ARE EXCLUDED FROM COVERAGE UNDER THIS WARRANTY. SOME STATES/PROVINCES DO NOT ALLOW FOR THE DISCLAIMERS, LIMITATIONS AND EXCLUSIONS IDENTIFIED ABOVE, AS A RESULT, THEY MAY NOT APPLY TO YOU. THIS WARRANTY GIVES YOU SPECIFIC RIGHTS, AND YOU MAY ALSO HAVE OTHER LEGAL RIGHTS WHICH MAY VARY FROM STATE TO STATE, OR PROVINCE TO PROVINCE.

Neither the distributor any BRP distributor/dealer nor any other person has been authorized to make any affirmation, representation or warranty regarding the product, other than those contained in this limited warranty, and if made, shall not be enforceable against BRP.

BRP reserves the right to modify this warranty at any time, being understood that such modification will not alter the warranty conditions applicable to the products sold while this warranty is in effect.

## **3) EXCLUSIONS – ARE NOT WARRANTED**

The following are not warranted under any circumstances:

- Normal wear and tear;
- Routine maintenance items, tune ups, adjustments;
- Damage caused by failure to provide proper maintenance and/or storage, as described in the Operator's Guide;
- Damage resulting from removal of parts, improper repairs, service, maintenance, modifications or use of parts not manufactured or approved by BRP or resulting from repairs done by a person that is not an authorized servicing BRP distributor/dealer;

- Damage caused by abuse, abnormal use, neglect, use of the product on surfaces other than snow, or operation of the product in a manner inconsistent with the recommended operation described in the Operator’s Guide;
- Damage resulting from accident, submersion, fire, theft, vandalism or any act of God;
- Operation with fuels, oils or lubricants which are not suitable for use with the product (see the Operator’s Guide);
- Snow or water ingestion;
- Incidental or consequential damages, or damages of any kind including without limitation towing, storage, telephone, rental, taxi, inconvenience, insurance coverage, loan payments, loss of time, loss of income; and
- Damage resulting from studs installed on tracks if the installation does not conform to BRP’s instructions.

#### **4) WARRANTY COVERAGE PERIOD**

This warranty will be in effect from (1) the date of delivery to the first retail consumer or (2) the date the product is first put into use, whichever occurs first and for a period of:

TWELVE (12) CONSECUTIVE MONTHS, for private or commercial use owners. However, the warranty coverage period on a snowmobile delivered between June 1<sup>st</sup> and December 1<sup>st</sup> of a given year will expire November 30<sup>th</sup> of the following year.

The repair or replacement of parts or the performance of service under this warranty does not extend the life of this warranty beyond its original expiration date.

Note that the duration and any other modalities of the warranty coverage are subject to the applicable national or local legislation in the customer's country.

#### **5) CONDITIONS TO HAVE WARRANTY COVERAGE**

This warranty coverage is available **only** if each of the following conditions has been fulfilled:

- The 2010 Ski-Doo snowmobile must be purchased as new and unused by its first owner from a BRP distributor/dealer authorized to distribute Ski-Doo snowmobiles in the country in which the sale occurred (“BRP distributor/dealer”);
- The BRP specified pre-delivery inspection process must be completed and documented;
- The product must have undergone proper registration by an authorized BRP distributor/dealer;
- The 2010 Ski-Doo snowmobile must be purchased in the country in which the purchaser resides;
- Routine maintenance outlined in the Operator’s Guide must be timely performed in order to maintain warranty coverage. BRP reserves the right to make warranty coverage contingent upon proof of proper maintenance.

BRP will not honour this limited warranty to any private use owner or commercial use owner if the preceding conditions have not been met. Such limitations are necessary in order to allow BRP to preserve both the safety of its products, and also that of its consumers and the general public.

## **6) WHAT TO DO TO OBTAIN WARRANTY COVERAGE**

The customer must cease using the snowmobile upon the appearance of an anomaly. The customer must notify a servicing BRP distributor/dealer within two (2) days of the appearance of a defect, and provide it with reasonable access to the product and reasonable opportunity to repair it. The customer must also present to the authorized BRP distributor/dealer, proof of purchase of the product and must sign the repair/work order prior to starting the repair in order to validate the warranty repair. All parts replaced under this limited warranty become the property of BRP.

Note that the notification period is subject to the applicable national or local legislation in customer's country.

## **7) WHAT BRP WILL DO**

BRP's obligations under this warranty are limited to, at its sole discretion, repairing parts found defective under normal use, maintenance and service, or replacing such parts with new genuine Ski-Doo parts without charge for parts and labour, at any authorized BRP distributor/dealer during the warranty coverage period under the conditions described herein. BRP's responsibility is limited to making the required repairs or replacements of parts. No claim of breach of warranty shall be cause for cancellation or rescission of the sale of the snowmobile to the owner.

In the event that service is required outside of the country of original sale, the owner will bear responsibility for any additional charges due to local practices and conditions, such as, but not limited to, freight, insurance, taxes, license fees, import duties, and any and all other financial charges, including those levied by governments, states, territories and their respective agencies.

BRP reserves the right to improve or modify products from time to time without assuming any obligation to modify products previously manufactured.

## **8) TRANSFER**

If the ownership of a product is transferred during the warranty coverage period, this warranty shall also be transferred and be valid for the remaining coverage period provided BRP or an authorized BRP distributor/dealer receives a proof that the former owner agreed to the transfer of ownership, in addition to the co-ordinates of the new owner.

## **9) CONSUMER ASSISTANCE**

In the event of a controversy or a dispute in connection with this limited warranty, BRP suggests that you try to resolve the issue at the dealership level. We recommend discussing the issue with the authorized distributor/dealer's service manager or owner. If further assistance is required, the distributor's service department should be contacted in order to resolve the matter. If the matter still remains unresolved then contact BRP at the address listed below.

**For European countries please contact our Finland office:**

**BRP FINLAND OY**

Service Department  
Isoaavantie 7  
FIN-96320 Rovaniemi  
Finland  
Tel.: +358 163 208 111

**For countries within Middle East, Africa, CIS & Russia please contact our European office:**

**BRP EUROPE N.V.**

Customer Assistance Center  
Skaldenstraat 125  
9042 Gent  
Belgium  
Tel.: +32 9 218 26 00

**For all other countries, please contact your local distributor or, our North American office:**

**BOMBARDIER RECREATIONAL PRODUCTS INC.**

Customer Assistance Center  
75 J.-A. Bombardier Street  
Sherbrooke QC J1L 1W3  
Canada  
Tel.: +1 819 566 3366

You will find your distributor's coordinates on [www.brp.com](http://www.brp.com).

\* In certain countries, products are distributed and serviced by affiliates or subsidiaries of BRP.

© 2009 Bombardier Recreational Products Inc. All rights reserved.

® Registered trademark of Bombardier Recreational Products Inc.

---

# **BRP LIMITED WARRANTY FOR THE EUROPEAN ECONOMIC AREA: 2010 SKI-DOO® SNOWMOBILES**

## **1) SCOPE OF THE LIMITED WARRANTY**

Bombardier Recreational Products Inc. ("BRP")\* warrants its 2010 Ski-Doo snowmobiles sold by authorized BRP distributor/dealer (as hereinafter defined) in states members of the European Economic Area ("EEA") (which is comprised of the states member of the European Union plus Norway, Iceland and Liechtenstein) from defects in material or workmanship for the period and under the conditions described below. This limited warranty will become null and void if: (1) the snowmobile was used for racing or any other competitive activity, at any point, even by a previous owner; or (2) the snowmobile has been altered or modified in such a way so as to adversely affect its operation, performance or durability, or has been altered or modified to change its intended use.

All genuine Ski-Doo parts and accessories, installed by an authorized BRP distributor/dealer (at the time of delivery of the 2010 Ski-Doo snowmobile, carry the same warranty as that of the snowmobile.

## **2) LIMITATIONS OF LIABILITY**

THIS WARRANTY IS EXPRESSLY GIVEN AND ACCEPTED IN LIEU OF ANY AND ALL OTHER WARRANTIES, EXPRESSED OR IMPLIED, INCLUDING WITHOUT LIMITATION ANY WARRANTY OF MERCHANTABILITY OR FITNESS FOR A PARTICULAR PURPOSE. TO THE EXTENT THAT THEY CANNOT BE DISCLAIMED, THE IMPLIED WARRANTIES ARE LIMITED IN DURATION TO THE LIFE OF THE EXPRESS WARRANTIES. INCIDENTAL AND CONSEQUENTIAL DAMAGES ARE EXCLUDED FROM COVERAGE UNDER THIS WARRANTY. SOME JURISDICTIONS DO NOT ALLOW FOR THE DISCLAIMERS, LIMITATIONS AND EXCLUSIONS IDENTIFIED ABOVE, AS A RESULT, THEY MAY NOT APPLY TO YOU. THIS WARRANTY GIVES YOU SPECIFIC RIGHTS, AND YOU MAY ALSO HAVE OTHER LEGAL RIGHTS WHICH MAY VARY FROM COUNTRY TO COUNTRY, OR PROVINCE TO PROVINCE.

Neither the distributor any BRP distributor/dealer nor any other person has been authorized to make any affirmation, representation or warranty regarding the product, other than those contained in this limited warranty, and if made, shall not be enforceable against BRP.

BRP reserves the right to modify this warranty at any time, being understood that such modification will not alter the warranty conditions applicable to the products sold while this warranty is in effect.

## **3) EXCLUSIONS – ARE NOT WARRANTED**

The following are not warranted under any circumstances:

- Normal wear and tear;
- Routine maintenance items, tune ups, adjustments;
- Damage caused by failure to provide proper maintenance and/or storage, as described in the Operator's Guide;
- Damage resulting from removal of parts, improper repairs, service, maintenance, modifications or use of parts not manufactured or approved by BRP or resulting from repairs done by a person that is not an authorized servicing BRP distributor/dealer;

- Damage caused by abuse, abnormal use, neglect, use of the product on surfaces other than snow, or operation of the product in a manner inconsistent with the recommended operation described in the Operator’s Guide;
- Damage resulting from accident, submersion, fire, theft, vandalism or any act of God;
- Operation with fuels, oils or lubricants which are not suitable for use with the product (see the Operator’s Guide);
- Snow or water ingestion;
- Incidental or consequential damages, or damages of any kind including without limitation towing, storage, telephone, rental, taxi, inconvenience, insurance coverage, loan payments, loss of time, loss of income; and
- Damage resulting from studs installed on tracks if the installation does not conform to BRP’s instructions.

#### **4) WARRANTY COVERAGE PERIOD**

This warranty will be in effect from (1) the date of delivery to the first retail consumer or (2) the date the product is first put into use, whichever occurs first and for a period of:

TWENTY-FOUR (24) CONSECUTIVE MONTHS, for private use owners and TWELVE (12) CONSECUTIVE MONTHS for commercial use owners. However, the warranty coverage period on a snowmobile delivered between June 1<sup>st</sup> and December 1<sup>st</sup> of a given year will expire November 30<sup>th</sup> of the applicable year. A snowmobile is used commercially when it is used in connection with generating income or any work or employment during any part of the warranty period. A snowmobile is also used commercially when, at any point during the warranty period, it has commercial tags or is licensed for commercial use.

The repair or replacement of parts or the performance of service under this warranty does not extend the life of this warranty beyond its original expiration date.

Note that the duration and any other modalities of the warranty coverage are subject to the applicable national or local legislation in the customer's country.

#### **5) CONDITIONS TO HAVE WARRANTY COVERAGE**

This warranty coverage is available **only** if each of the following conditions has been fulfilled:

- The 2010 Ski-Doo snowmobile must be purchased as new and unused by its first owner from a BRP distributor/dealer authorized to distribute Ski-Doo products in the country in which the sale occurred (“BRP distributor/dealer”);
- The BRP specified pre-delivery inspection process must be completed and documented;
- The product must have undergone proper registration by an authorized BRP distributor/dealer;
- The 2010 Ski-Doo snowmobile must be purchased within the EEA;
- Routine maintenance outlined in the Operator’s Guide must be timely performed in order to maintain warranty coverage. BRP reserves the right to make warranty coverage contingent upon proof of proper maintenance.

BRP will not honour this limited warranty to any private use owner or commercial use owner if the preceding conditions have not been met. Such limitations are necessary in order to allow BRP to preserve both the safety of its products, and also that of its consumers and the general public.

## **6) WHAT TO DO TO OBTAIN WARRANTY COVERAGE**

The customer must cease using the snowmobile upon the appearance of an anomaly. The customer must notify a servicing BRP distributor/dealer within two (2) months of the appearance of a defect, and provide it with reasonable access to the product and reasonable opportunity to repair it. The customer must also present to the authorized BRP distributor/dealer, proof of purchase of the product and must sign the repair/work order prior to starting the repair in order to validate the warranty repair. All parts replaced under this limited warranty become the property of BRP.

Note that the notification period is subject to the applicable national or local legislation in customer's country.

## **7) WHAT BRP WILL DO**

BRP's obligations under this warranty are limited to, at its sole discretion, repairing parts found defective under normal use, maintenance and service, or replacing such parts with new genuine Ski-Doo parts without charge for parts and labour, at any authorized BRP distributor/dealer during the warranty coverage period under the conditions described herein. BRP's responsibility is limited to making the required repairs or replacements of parts. No claim of breach of warranty shall be cause for cancellation or rescission of the sale of the snowmobile to the owner.

In the event that service is required outside of the EEA, the owner will bear responsibility for any additional charges due to local practices and conditions, such as, but not limited to, freight, insurance, taxes, license fees, import duties, and any and all other financial charges, including those levied by governments, states, territories and their respective agencies.

BRP reserves the right to improve or modify products from time to time without assuming any obligation to modify products previously manufactured.

## **8) TRANSFER**

If the ownership of a product is transferred during the warranty coverage period, this warranty shall also be transferred and be valid for the remaining coverage period provided BRP or an authorized BRP distributor/dealer receives a proof that the former owner agreed to the transfer of ownership, in addition to the co-ordinates of the new owner.



## **9) CONSUMER ASSISTANCE**

In the event of a controversy or a dispute in connection with this limited warranty, BRP suggests that you try to resolve the issue at the dealership level. We recommend discussing the issue with the authorized distributor/dealer's service manager or owner. If further assistance is required, the distributor's service department should be contacted in order to resolve the matter. If the matter still remains unresolved then contact BRP at the address listed below:

### **BRP FINLAND OY**

Service Department  
Isoaavantie 7  
FIN-96320 Rovaniemi  
Finland  
Tel.: +358 163 208 111

You can find your distributor's coordinates on [www.brp.com](http://www.brp.com).

\* In the EEA, products are distributed and serviced by BRP European Distribution S.A. and other affiliates or subsidiaries of BRP.

© 2009 Bombardier Recreational Products Inc. All rights reserved.

® Registered trademark of Bombardier Recreational Products Inc.



# ***CUSTOMER INFORMATION***

---

## PRIVACY OBLIGATION/DISCLAIMER

We wish to inform you that your coordinates will be used for safety and warranty purposes. Sometimes, we also use the coordinates of our clients to inform them about our products and to present them offers. Should you prefer not to receive information on our products, services and offers, please let us know by writing to the address below.

Also note that, from time to time, carefully selected and trustworthy organizations may be permitted to use the coordinates of our clients to promote quality products and services. If you prefer not to have your name and address released, please let us know by writing to the address below:

### **In Canada**

#### **BOMBARDIER RECREATIONAL PRODUCTS INC.**

Warranty Department  
75 J.-A. Bombardier Street  
Sherbrooke QC J1L 1W3  
Canada  
Fax Number: 819 566-3590

### **In USA**

#### **BRP US INC.**

Warranty Department  
7575 Bombardier Court  
Wausau WI 54401  
Tel.: 715 848-4957

### **For Russia, CIS and the Middle East**

#### **BRP EUROPEAN DISTRIBUTION**

After Sales Service Department  
Chemin de Messidor 5-7  
1006 Lausanne  
Switzerland  
Fax Number: +41213187801

### **For Scandinavian and European countries**

#### **BRP FINLAND OY**

Service Department  
Isoaavantie 7  
FIN-96320 Rovaniemi  
Finland  
Tel.: +358 16 3208 111

### **For all other countries, please contact A) or B)**

**A) Your respective distributor (you will find his coordinates on [www.brp.com](http://www.brp.com)).**

**B) Our North American office:**

#### **BOMBARDIER RECREATIONAL PRODUCTS INC.**

Warranty Department  
75 J.-A. Bombardier Street  
Sherbrooke QC J1L 1W3  
Canada  
Fax Number: 819 566-3590

---

# CHANGE OF ADDRESS/OWNERSHIP

If your address has changed or if you are the new owner of the vehicle, be sure to notify BRP by either:

- Mailing one of the following card below;
- **North America Only:** calling at 715 848-4957 (USA) or 819 566-3366 (Canada);
- Notifying an authorized Ski-Doo dealer.

## **In Canada**

**BOMBARDIER  
RECREATIONAL PRODUCTS INC.**

Warranty Department  
75 J.-A. Bombardier Street  
Sherbrooke QC J1L 1W3  
Canada  
Fax Number: 819 566-3590

## **In USA**

**BRP US INC.**

Warranty Department  
7575 Bombardier Court  
Wausau WI 54401  
Tel.: 715 848-4957

## **For Russia, CIS and the Middle East**

**BRP EUROPEAN DISTRIBUTION**

After Sales Service Department  
Chemin de Messidor 5-7  
1006 Lausanne  
Switzerland  
Fax Number: +41213187801

## **For Scandinavian and European countries**

**BRP FINLAND OY**

Service Department  
Isoaavantie 7  
FIN-96320 Rovaniemi  
Finland  
Tel.: +358 16 3208 111

## **For all other countries, please contact A) or B)**

**A) Your respective distributor** (you will find his coordinates on [www.brp.com](http://www.brp.com)).

**B) Our North American office:**

**BOMBARDIER RECREATIONAL PRODUCTS INC.**

Warranty Department  
75 J.-A. Bombardier Street  
Sherbrooke QC J1L 1W3  
Canada  
Fax Number: 819 566-3590

In case of change of ownership, please join a proof that the former owner agreed to the transfer.

Notifying BRP, even after the expiration of the limited warranty, is very important as it enables BRP to reach the vehicle owner if necessary, like when safety recalls are initiated. It is the owner's responsibility to notify BRP.

**STOLEN UNITS:** If your personal vehicle is stolen, you should notify BRP or an authorized Ski-Doo dealer. We will ask you to provide your name, address, phone number, the vehicle identification number and the date it was stolen.



CHANGE OF ADDRESS

CHANGE OF OWNERSHIP



VEHICLE IDENTIFICATION NUMBER

Model Number

Vehicle Identification Number (V.I.N.)

OLD ADDRESS  
OR PREVIOUS OWNER:

NAME

NO.

STREET

APT

CITY

STATE/PROVINCE

ZIP/POSTAL CODE

COUNTRY

TELEPHONE

NEW ADDRESS  
OR NEW OWNER:

NAME

NO.

STREET

APT

CITY

STATE/PROVINCE

ZIP/POSTAL CODE

COUNTRY

TELEPHONE

E-MAIL ADDRESS

V00A2F

CHANGE OF ADDRESS

CHANGE OF OWNERSHIP



VEHICLE IDENTIFICATION NUMBER

Model Number

Vehicle Identification Number (V.I.N.)

OLD ADDRESS  
OR PREVIOUS OWNER:

NAME

NO.

STREET

APT

CITY

STATE/PROVINCE

ZIP/POSTAL CODE

COUNTRY

TELEPHONE

NEW ADDRESS  
OR NEW OWNER:

NAME

NO.

STREET

APT

CITY

STATE/PROVINCE

ZIP/POSTAL CODE

COUNTRY

TELEPHONE

E-MAIL ADDRESS

V00A2F











520 000 895

CA

OPERATOR'S GUIDE REV-XP (F/C) / ENGLISH  
GUIDE DU CONDUCTEUR REV-XP (F/C) / ANGLAIS

FAIT EN / MADE IN CANADA

U/M:P.C.