

ski-doo®



2008

**Operator's
Guide**

REV XP™ SERIES

**Includes
Safety, Vehicle
and Maintenance Information**

 **WARNING**

Read this guide thoroughly. It contains important safety information. Minimum recommended operator's age: 16 years old. Do not remove this Operator's Guide from the vehicle.

5 2 0 0 0 0 6 8 9

SAFETY WARNING

Disregarding any of the safety precautions and instructions contained in this Operator's Guide, *SAFETY VIDEO* or on-product warnings may result in injury, including the possibility of death.

This Operator's Guide and *SAFETY VIDEO* should remain with the snowmobile at time of resale.



In USA, products are distributed by BRP US Inc.

In Canada, products are distributed by Bombardier Recreational Products Inc.

The following are trademarks of Bombardier Recreational Products Inc. or its subsidiaries.

DESS™

RAVE™

ROTAX™

SUMMIT®

HPG™

RERT™

SC™

TRA™

MX Z®

Renegade™

SKI-DOO®

X™

GSX®

FOREWORD

Congratulations on your purchase of a new SKI-DOO® snowmobile. Whatever model you have chosen, it is backed by the Bombardier Recreational Products Inc. (BRP) warranty and a network of authorized SKI-DOO snowmobile dealers ready to provide the parts, service or accessories you may require.

The Operator's Guide has been prepared to acquaint the owner/operator and passenger with this new snowmobile and its various controls, maintenance and safe riding instructions. This guide is indispensable for the proper use of the product and should be kept with this snowmobile at all times.

Make sure you read and understand the content of this Operator's Guide.

After reading, please keep this Operator's Guide with the snowmobile. If the snowmobile is resold, please give the guide to the new owner for his awareness.

If you want to view and/or print an extra copy of your Operator's Guide, simply visit the following website www.operatorsguide.brp.com. Also note that the guide is available in several languages.

If you have any question regarding any topic whether or not it is covered in this Operator's Guide, please call BRP at the number below and we will be happy to assist you:

In USA:
715 848-4957

In Canada:
819 566-3366

For Russia, CIS and the middle east:
+ 32 9 218 26 00

For Scandinavian and European countries:
+ 358 16 3208 111

**For all other countries, please contact your respective distributor (his coordinates are on www.brp.com) or our North American office:
+ 1 819 566-3366**

This guide uses the following safety alert symbol in conjunction with signal words to indicate a potential personal injury hazard.

WARNING

Indicates a potentially hazardous situation which, if not avoided, could result in death or serious injury.

CAUTION

Indicates a potentially hazardous situation which, if not avoided, may result in minor or moderate injury. When used without the safety alert symbol , potential hazard exists for property damage only.

NOTE: Indicates supplementary information needed to fully complete an instruction.

Although the mere reading of such information does not eliminate the hazard, the understanding and application of the information will promote the correct use of the vehicle.

Your dealer is committed to your satisfaction. He has taken training to perform the initial set-up and inspection of your snowmobile as well as completed the final adjustment required to suit your specific weight and riding environment before you took possession. At delivery, your dealer would have explained the snowmobile controls and provided you with a brief explanation of the various suspension adjustments. We trust you have taken full advantage of this!

At delivery, you were also informed of the warranty coverage and have completed the Warranty Registration process.

The information and components/system descriptions contained in this guide are correct at time of publication. BRP, however maintains a policy of continuous improvement of its products without imposing upon itself any obligation to install them on products previously manufactured.

Because of its ongoing commitment to product quality and innovation, BRP reserves the right at any time to discontinue or change specifications, designs, features, models or equipment without incurring obligation.

The illustrations in this document show the typical construction of the different assemblies and, in all cases, may not reproduce the full detail or exact shape of the parts shown, however, they represent parts which have the same or a similar function.

It is understood that this guide may be translated into another language. In the event of any discrepancy, the English version shall prevail.

Specifications are given in the SI metric system with the SAE U.S. equivalent in parentheses. Where precise accuracy is not required, some conversions are rounded off for easier use.

Most components of this snowmobile are built with parts dimensioned in the metric system. Most fasteners are metric and must not be replaced by customary fasteners or vice versa.

We recommend genuine BRP products for replacement parts and accessories. They've been specially designed for your vehicle and manufactured to meet BRP's demanding standards.

A *SHOP MANUAL* can be obtained for complete service, maintenance and more repair information.

For any questions pertaining to the warranty and its application, consult the *WARRANTY* section in this guide, and/or an authorized SKI-DOO dealer.

TABLE OF CONTENTS

SAFETY INFORMATION

INTRODUCTION	8
IMPORTANT BASIC SAFETY MEASURES	9
LAWS AND REGULATIONS	13
RIDING THE VEHICLE	14
TRACTION ENHANCING PRODUCTS	23
LOCATION OF THE IMPORTANT LABELS	27

ENVIRONMENT INFORMATION

GENERAL	34
JUST WHAT IS LIGHT TREADING?	35
WHY IS LIGHT TREADING SMART	36

VEHICLE INFORMATION

HOW TO IDENTIFY YOUR SNOWMOBILE	38
CONTROLS/INSTRUMENTS/EQUIPMENT	40
1) Speedometer	44
2) Tachometer (RPM)	44
3) Gauge Digital Display	44
4) Gauge Multifunction Digital Display	45
5) Gauge Pilot Lamps	56
6) Gauge MODE (M) Button	58
7) Gauge SET (S) Button	58
8) Throttle Lever	58
9) Brake Lever	58
10) Parking Brake Lever	58
11) Multi-Switch Housing	59
12) Handlebar	61
13) Holding Strap	61
14) Tether Cut-Out Switch	61
15) Engine Cut-Out Switch	63
16) Rewind Starter Handle	63
17) Choke Lever	63
18) Fuel Tank Cap	64
19) Heated Carburetor Valve	64
20) Hood and Side Panels	65
21) Fuses	65
22) Grab Handle/Bumper	67
23) Storage Compartment	67

24) Tool Kit.....	67
25) Spark Plug Storage.....	67
26) Spare Drive Belt Holder.....	68
27) Shields and Guards.....	68
28) Track.....	68
29) Seat Latch.....	69
30) 1+1 Seat.....	71
31) Rear Passenger Heating Grip Switch.....	72
32) Rear Grab Handles.....	72
33) Electric Visor Jack Connector.....	72
34) Adjustable Mirrors.....	72
35) Integrated Bag.....	72
36) Rear Rack.....	73
37) 12-Volt Power Outlet.....	73
38) C-Type Hitch.....	73
RECOMMENDED FUEL AND OIL.....	75
BREAK-IN PERIOD.....	77
OPERATING INSTRUCTIONS.....	78
Pre-Operation Check.....	78
SDI Engine Starting Procedure.....	79
Carburetor Engine Starting Procedure.....	80
Vehicle Warm-Up.....	81
Shifting in Reverse.....	81
Shutting Off the Engine.....	82
Post-Operation Care.....	82
SPECIAL OPERATING INSTRUCTIONS.....	83
Riding at High Altitudes or Sea Level.....	83
Riding in Cold Weather.....	83
Emergency Starting.....	83
Towing an Accessory.....	84
Towing Another Snowmobile.....	84
Transporting the Vehicle.....	85
SUSPENSION ADJUSTMENTS.....	86
Rear Springs — Comfort.....	87
Center Spring — Steering Behavior.....	88
Stopper Strap — Weight Transfer.....	89
Coupling Blocks — Handling.....	90
Rear Shock Motion Ratio — Damping Strength.....	90
Front Springs — Handling.....	91
Front Suspension Shock Damping.....	92
Suspension Troubleshooting Chart.....	93
Deep Snow Riding.....	93
TROUBLESHOOTING.....	94
Beeper Codes.....	94
General.....	94

SPECIFICATIONS	97
-----------------------------	-----------

MAINTENANCE INFORMATION

PERIODIC MAINTENANCE CHART	108
ENGINE SYSTEM.....	112
Air Intake Silencer Prefilter Verification.....	112
Cooling System	112
Exhaust System.....	112
EPA Certified Engines	112
DRIVE SYSTEM.....	114
Belt Guard Removal and Installation.....	114
Brake Fluid Level.....	114
Brake Condition	115
Brake Adjustment.....	115
Chaincase Oil.....	115
Drive Chain Tension	115
Drive Belt Inspection	116
Drive Belt Removal	116
Drive Belt Installation/Adjustment	117
Drive Pulley Adjustment	120
Track Condition.....	121
Track Tension and Alignment	122
REAR SUSPENSION	125
STEERING AND FRONT SUSPENSION.....	126
ELECTRICAL SYSTEM	127
Fuse Removal/Inspection	127
BODY/FRAME.....	130
Vehicle Cleaning and Protection.....	130
Bulb Replacement	130
Headlamp Beam Aiming	131
STORAGE AND PRESEASON PREPARATION	132

WARRANTY

BRP LIMITED WARRANTY NORTH AMERICA: 2008 SKI-DOO® SNOWMOBILES	134
BRP INTERNATIONAL LIMITED WARRANTY: 2008 SKI-DOO® SNOWMOBILES	139
BRP EUROPEAN UNION MEMBER STATES LIMITED WARRANTY: 2008 SKI-DOO® SNOWMOBILES.....	143
PRIVACY OBLIGATIONS/DISCLAIMER.....	147
CHANGE OF ADDRESS/OWNERSHIP	148

SAFETY INFORMATION

INTRODUCTION

Everyone is a beginner the first time he sits behind the controls of a snowmobile regardless of previous experience in driving an automobile, a motorcycle or a motorboat. The safe use of your snowmobile is dependent on many conditions such as visibility, speed, weather, environment, traffic, vehicle condition and the condition of the driver.

Each operator has a responsibility to ensure the safety of his/her passenger, if any, and of other recreationists or bystanders.

You are responsible for proper operation of your vehicle as well as training those whom you allow to ride or drive. There may be noticeable handling and performance differences from one snowmobile to the other.

A snowmobile is relatively simple to operate but like any other vehicle or mechanical equipment, it can be hazardous if you or a passenger are reckless, thoughtless or inattentive. We encourage you to have an Annual Safety Inspection of your snowmobile. Please contact an authorized SKI-DOO dealer for further details. Finally, we urge you to visit an authorized SKI-DOO dealer periodically for regular and safety maintenance, as well as snowmobile accessories you may require.

IMPORTANT BASIC SAFETY MEASURES

Training

- △ Basic training is required for the safe operation of any snowmobile. Study your Operator's Guide paying particular attention to cautions and warnings. Join your local snowmobile club: its social activities and trail systems are planned for both fun and safety. Obtain basic instructions from your snowmobile dealer, friend, fellow club member or enroll in your state or provincial safety training program.
- △ Always show a new operator how to start and stop the vehicle. Indicate the correct riding positions and, above all else, only allow him to operate the snowmobile in a restricted flat area — at least until he is completely familiar with its operation. If there is a local snowmobile operator's training course existing, have him enroll.

Performance

- △ The performance of some snowmobiles may significantly exceed that of other snowmobiles you have operated. Therefore, use by novice or inexperienced operators is not recommended.
- △ Snowmobiles are used in many areas and in many snow conditions. Not all models perform the same in similar conditions. Always consult your snowmobile dealer when selecting the snowmobile model for your particular needs and uses.
- △ Injury or death may result to the snowmobile operator, passenger or bystander if the snowmobile is used in risky conditions which are beyond the driver's, passenger's or snowmobile's capabilities or intended use.

Age

- △ BRP recommends the operator has at least 16 years old of age.

Speed

- △ Speeding can be fatal. In many cases, you cannot react or respond quickly enough to the unexpected. Always ride at a speed which is suitable to the trail, weather conditions and your own ability. Know your local rules. Speed limit may be in effect and meant to be observed.

Riding

- △ Always keep right hand side of the trail.
- △ Always keep a safe distance from other snowmobiles and bystanders.
- △ Remember, promotional material may show risky maneuvers performed by professional riders under ideal and/or controlled conditions. You should never attempt any such risky maneuvers if they are beyond your level of riding ability.
- △ Never ride after consuming drugs or alcohol or if you feel tired or ill. Operate your snowmobile prudently.
- △ Your snowmobile is not designed to be operated on public streets, roads or highways.
- △ Snowmobiling at night can be a delightful experience but because of reduced visibility, be extra cautious. Avoid unfamiliar terrain and be sure your lights are working. Always carry a flashlight and spare light bulbs.

- ⚠ Nature is wonderful but don't let it distract your attention from driving. If you want to truly appreciate winter's scenery, stop your snowmobile on the side of the trail so that you don't become a hazard to others.
- ⚠ Fences represent a very serious threat for both you and your snowmobile. Give a wide berth to telephone poles or posts.
- ⚠ Hidden wires unseen from a distance can cause serious accidents.
- ⚠ Always wear an approved safety helmet, eye protection and a face shield. This also applies to your passenger.
- ⚠ Be aware of inherent risks associated with riding off trails, such as avalanche and other natural or man made hazards or obstacles.
- ⚠ Avoid road traveling. If you must do so, and it is permitted, reduce speed. The snowmobile is not designed to operate or turn on paving. When crossing a road, make a full stop, then look carefully in both directions before crossing at a 90° angle. Be wary of parked vehicles.
- ⚠ Tailgating another snowmobile should be avoided. If the snowmobile in front of you slows for any reason, its driver and passenger could be harmed through your neglect. Maintain a safe stopping distance between you and the snowmobile in front of you. Depending on the terrain condition, stopping may require a little more space than you think. Play it safe. Be prepared to use evasive driving.
- ⚠ Venturing out alone with your snowmobile could also be hazardous. You could run out of fuel, have an accident, or damage your snowmobile. Remember, your snowmobile is capable of traveling further in half an hour than you may be able to walk in a day. Use the "buddy system". Always ride with a friend or member of your snowmobile club. Even then, tell someone where you are going and the approximate time you plan to return.
- ⚠ Meadows sometimes have low areas where water accumulate and freezes over in winter. This ice is usually glare ice. Attempting to turn or brake on this surface could cause your vehicle to spin out of control. Never brake or attempt speeding or turning on glare ice. If you do happen to travel over such a condition, reduce speed by carefully releasing the throttle.
- ⚠ Never "jump" with your snowmobile. This should be left to professional stunt men. Don't show off. Be responsible.
- ⚠ While on safari, do not "gun" the throttle. Snow and ice can be thrown back into the path of a following snowmobile. In addition, when "gunning" the throttle, the vehicle digs into and leaves an irregular snow surface for others.
- ⚠ Safaris are both fun and enjoyable but don't show off or overtake others in the group. A less experienced operator might try to do the same as you and fail. When riding with others, limit your abilities to the experience of others.

Operation

- ⚠ Always make a pre-start inspection BEFORE you start the engine.
- ⚠ In an emergency, the snowmobile engine can be stopped by pressing down on the engine cut-out switch or by pulling the tether cord cap (DESS™ key).
- ⚠ Throttle mechanism should be checked for free movement and return to idle position before starting engine.
- ⚠ Always engage parking brake when vehicle is not in use.
- ⚠ Never run the engine in a non-ventilated area and/or if vehicle is left unattended.
- ⚠ Never operate the engine without belt guard securely installed or, with hood or side panels opened or removed. Never run the engine without drive belt installed. Running an unloaded engine such as without drive belt or with track raised, can be dangerous.
- ⚠ **Electric start models only:** Never charge or boost a battery while installed on snowmobile.
- ⚠ Ensure the path behind is clear of obstacles or bystanders before proceeding in reverse.
- ⚠ Always remove the tether cord cap (DESS key) when vehicle is not in operation in order to prevent accidental engine starting, to avoid unauthorized use by children or others or theft.
- ⚠ Raising the rear of your snowmobile while the engine is running could cause snow, ice or debris to be thrown back at an observer. Never raise the rear of the vehicle while the engine is running. To clear or inspect the track, stop the engine, tilt the vehicle on its side and remove blockage with a piece of wood or branch. Never allow anyone near a rotating snowmobile track.

Maintenance

- ⚠ Know your snowmobile and treat it with the respect and care due of any power driven machine. Common sense, proper handling and routine maintenance will result in safer and enjoyable use.
- ⚠ Only perform procedures as detailed in this guide. Unless otherwise specified, engine should be turned OFF and cold for all lubrication, adjustment and maintenance procedures.
- ⚠ Never have the engine running while the hood or side panels are opened. Even at idle, a snowmobile engine is turning around 1800 revolutions per minute. Always turn off the engine before opening the hood and/or side panels for any reason.
- ⚠ Never remove any original equipment from your snowmobile. Each vehicle has many built in safety features. Such features include various guards and consoles, plus reflective materials and warning labels.
- ⚠ A poorly maintained snowmobile itself can be a potential hazard. Excessively worn components could render the vehicle completely inoperative. Keep the snowmobile in good working condition at all times. Follow your pre-operation check, weekly, monthly and annually routine maintenance and lubrication procedures as detailed in this guide. Consult a snowmobile dealer or acquire a shop manual and proper tools and equipment if other repairs or service is required.

⚠ Do not stud the track unless it has been approved for studs. At speed, a studded track that has not been approved for studs could tear and separate from vehicle posing a risk of severe injury or death. See an authorized SKI-DOO dealer for current specific studding availability and applications.

⚠ You may stud the track on this vehicle model. However, you MUST only use the BRP approved type stud for use on Ski-Doo snowmobiles. DO NOT EVER use conventional studs because the track thickness is thinner than our standard tracks. The stud could tear off of track and separate from vehicle posing a potential risk of severe injury or death.

Fuel

⚠ Always stop the engine before refueling. Fuel is flammable and explosive under certain conditions. Always work in a well-ventilated area. Do not smoke or allow open flames or sparks in the vicinity. Open cap slowly. If a differential pressure condition is noticed (whistling sound heard when loosening fuel tank cap) have vehicle inspected and/or repaired before further operation. Do not overfill or top off the fuel tank before placing the vehicle in a warm area. As temperature increases, fuel expands and might overflow. Always wipe off any fuel spillage from the vehicle. Periodically verify fuel system.

Basics for Passenger

⚠ Never ride as a passenger unless the snowmobile is equipped with a passenger seat, and sit only on the designated passenger seat.

⚠ Always wear a DOT approved helmet and follow the same dressing guidelines as those recommended for the operator and described in this guide.

⚠ Make sure that you are able to achieve a stable stance, both feet resting positively on the footboards of footrests with good grip, and that you are able to hold on firmly to the handholds.

⚠ Once underway, if you feel uncomfortable or insecure for any reason, don't wait, tell the driver to slow down or stop.

LAWS AND REGULATIONS

⚠ Know your local laws.

Federal, state, provincial and local government agencies have enacted laws and regulations pertaining to the safe use and operation of snowmobiles. It is your responsibility as a snowmobiler to learn and obey these laws and regulations. Respect and observance will result in safer snowmobiling for all.

Be aware of the liability property damages and insurance laws regarding your equipment.

RIDING THE VEHICLE

Before venturing on the trails, operate the snowmobile in a restricted flat area until you are completely familiar with its operation and feel comfortable that you can safely tackle a more demanding task. Have an enjoyable and safe ride.

Principle of Operation

Propulsion

Depressing throttle lever increases engine RPM causing the drive pulley to engage. Depending on models, engine RPM must be between 2500 and 4200 before drive pulley engagement will occur.

Outer sheave of drive pulley moves toward inner sheave, forcing the drive belt to move upward on the drive pulley and simultaneously forcing the sheaves apart on the driven pulley.

The driven pulley senses the load on the track and limits the belt movement. The result is an optimized speed ratio between engine RPM and the speed of the vehicle at any time.

WARNING

Never operate engine without belt guard securely installed or, with hood or side panels opened or removed.

Power is transferred to the track through the chaincase and drive axle.

WARNING

Always use a wide-base snowmobile mechanical stand to properly support vehicle during any track verification. Slowly accelerate engine in order to rotate track at very low speed when it is not on ground.

Turning

Handlebar allows the steering of the vehicle. As the handlebar is rotated to right or left, the skis are turned right or left to steer the snowmobile.

Stopping

Before riding your snowmobile, you should understand how to stop it. This is done by releasing the throttle and gradually depressing the brake lever on the left side of the handlebar. In an emergency, you may stop your vehicle by pressing the engine cut-out switch located near the throttle control and applying the brake. Remember, a snowmobile cannot "stop on a dime". Braking characteristics vary with deep snow, packed snow or ice. If the track is locked during hard braking, skidding may result.

How to Ride

How to Dress

Proper snowmobile clothing should be worn. It should be comfortable and not too tight. Always check the weather forecast before going on a ride. Dress for the coldest weather expected. Thermal underwear next to the skin also provides a good insulation.

DOT approved helmets are recommended at all times. They provide both warmth and reduce injury. A stocking type cap, balaclava and face mask should always be carried or worn. Goggles or a face shield that attach to the helmet are indispensable.

Hands should be protected by a pair of snowmobile gloves or mitts which have sufficient insulation and allow use of thumbs and fingers for operation of controls.

Rubber bottom boots with either a nylon or a leather top, with removable felt liners are best suited for snowmobiling.

You should keep yourself as dry as possible when snowmobiling. When you come indoors, take your snowmobile suit and boots off and make certain they dry properly.

Do not wear long scarfs and loose apparel that could get caught in moving parts.

What to Bring

Every snowmobiler should carry at least the following basic parts and tools that can help him and others in an emergency:

- this Operator's Guide
- spare spark plugs and wrench
- friction tape
- spare drive belt
- spare starter rope
- spare light bulbs
- tool kit (including at least pliers, screwdriver, adjustable wrench)
- knife
- flashlight.

Include other items depending on the length and time of your ride.

Riding Position

Your riding position and balance are the two basic principles of making your snowmobile go where you want it to. When turning on the side of a hill, you and your passenger must be ready to shift body weight to help it turn in the desired direction. Driver and passenger(s) must never attempt this maneuvering by placing feet outside of the vehicle. Experience will teach you how much lean to put into turns at different speeds and how much you will have to lean into a slope to maintain proper balance.

Generally, the riding position for best balance and control is sitting. However, the posting, kneeling or standing positions are also used under certain conditions.

The novice driver should become familiar with the snowmobile through practice on a level area at slow speeds before venturing afield.

⚠ WARNING

Do not attempt any maneuvers if they are beyond your abilities.

Sitting

Feet on the running boards, body mid-way back on seat is an ideal position when operating the snowmobile over familiar, smooth terrain. Knees and hips should remain flexible to absorb shocks.



Posting

A semi-sitting position with the body off the seat and the feet under the body in a sort of squatting posture, thus allowing the legs to absorb the shocks when traveling over uneven terrain. Avoid abrupt stops.



Standing

Place both feet on the running boards. Knees should be flexed to absorb the shock from surface bumps. This is an effective position to see better and to shift weight as conditions dictate. Avoid abrupt stop.



Kneeling

This position is achieved by placing one foot firmly on the running board and the opposite knee on the seat. Avoid abrupt stops.



Carrying a Passenger

Certain snowmobiles are designed for an operator only, others can allow one passenger only, and others can allow up to two passengers. Refer to the indications on the vehicles to know if any particular snowmobile can accommodate passengers or not, and if so, how many. Always respect those indications. Overloading is dangerous because snowmobiles are not designed for it.

Even when passengers are allowed, you must make sure that the persons who would like to become passengers are physically fit for snowmobiling.

WARNING

Any passenger must be able to firmly lay his feet on the footrests and keep his hands on the grab handles or seat strap at all times when seated. Respecting those physical criteria is important to ensure that the passenger is stable and to reduce the risks of ejection.

On snowmobiles allowing two passengers, if you have an adult and a child for passenger, BRP recommends that the child sits in the center location. This allows an adult sitting in the rear seat to keep a visual contact with the child and hold him if necessary. In addition, the child is best protected against the wind and cold temperature if seated in the center location.

Each operator has a responsibility to ensure the safety of his passengers and should inform them of snowmobiling basics.

 **WARNING**

- Passengers must only sit on designated passenger seats. Never allow anyone to sit between the handlebar and the operator.
- Each passenger seat must have a strap or grab handles and meet SSCC standards.
- Passengers and operators must always wear DOT approved helmets and warm clothing appropriate for snowmobiling. Make sure that no skin is exposed.
- Once underway, if a passenger feels uncomfortable or insecure for any reason, he must not wait, and tell the driver to slow-down or stop.

Riding with passengers on board is different than riding alone. The operator has the benefit of knowing what will be the next maneuver and is able to prepare himself accordingly. The operator also benefits from the support of his grip on the handlebar. In contrast, the passengers have to rely on the operator's careful and safe operation of the vehicle. In addition, "body english" is limited with passengers, and the operator can sometimes see more of the trail ahead than the passengers. Therefore, smooth starting and stopping are required with passengers, and the operator must slow down. The operator must also warn passengers of side hills, bumps, branches, etc. An unforeseen bump can leave you passenger-less. Remind your passengers to lean into the turn with you, without causing the vehicle to topple. Be extremely careful, go more slowly and check the passengers frequently.

 **WARNING**

- When riding with a passenger:
- Braking ability and steering control are reduced. Decrease speed and allow extra space to maneuver.
 - Adjust suspension according to weight.

For complete information on how to adjust the suspension, please refer to the section of this Operator's Guide entitled *SUSPENSION ADJUSTMENTS*.

Use extra caution and go even more slowly with young passengers. Check frequently to make certain the child has a firm grip and is properly positioned with his feet on the running boards.

Terrain/Riding Variations

Groomed Trail

On a maintained trail, sitting is the most preferred riding position. Do not race and, above all, keep to the right hand side of the trail. Be prepared for the unexpected. Observe all trail signs. Do not zigzag from one side of the trail to the other.

Ungroomed Trail

Unless there has been a fresh snowfall you can expect "washboard" and snowdrift conditions. Taken at excessive speeds, such conditions can be physically harmful. Slow down. Hold on the handlebar and assume a posting position. Feet should be under the body assuming a crouched position to absorb any jarring effect. On longer stretches of "washboard" trails, the kneeling position of one knee on the seat can be adopted. This provides a certain amount of comfort, while at the same time keeps the body loose and capable of vehicle control. Beware of hidden rocks or tree stumps partially hidden by a recent snowfall.

Deep Snow

In deep "powder" snow, your vehicle could begin to "bog" down. If this occurs, turn in as wide an arc as possible and look for a firmer base. If you do get "bogged", and it happens to everyone, do not spin your track as this makes the vehicle sink deeper. Instead, turn the engine off, get off and move the back of the vehicle onto new snow. Then tramp a clear path ahead of the vehicle. A few feet will generally suffice. Restart the engine. Assume the standing position and rock the vehicle gently as you steadily and slowly apply the throttle. Depending on whether the front or rear end of the vehicle is sinking, your feet should be placed on the opposing end of the running boards. Never place foreign material beneath the track for support. Do not allow anyone to stand in front of, or to the rear of, the snowmobile with the engine running. Stay away from the track. Personal injury will result if contact is made with the revolving track.

Frozen Water

Traveling frozen lakes and rivers can be fatal. Avoid waterways. If you are in an unfamiliar area, ask the local authorities or residents about the ice condition, inlets, outlets, springs, fast moving currents or other hazards. Never attempt to operate your snowmobile on ice that may be too weak to support you and the vehicle. Operating a snowmobile on ice or icy surfaces can be very dangerous if you do not observe certain precautions. The very nature of ice is foreign to good control of a snowmobile or any vehicle. Traction for starting, turning or stopping is much less than that on snow. Thus, these distances can be multiplied manyfold. Steering is minimal, and uncontrolled spins are an ever present danger. When operating on ice, drive slowly with caution. Allow yourself plenty of room for stopping and turning. This is especially true at night.

Hard Packed Snow

Don't underestimate hard packed snow. It can be difficult to negotiate as both skis and track do not have as much traction. Best advice is to slow down and avoid rapid acceleration, turning or braking.

Uphill

There are two types of hills you can encounter — the open hill on which there are few trees, cliffs or other obstacles, and a hill that can only be climbed directly. On an open hill, the approach is to climb it by side hilling or slalomming. Approach at an angle. Adopt a kneeling position. Keep your weight on the uphill side at all times. Maintain a steady, safe speed. Continue as far as you can in this direction, then switch to an opposite hill angle and riding position.

A direct climb could present problems. Choose the standing position, accelerate before you start the climb and then reduce throttle pressure to prevent track slippage.

In either case, vehicle speed should be as fast as the incline demands. Always slow down as you reach the crest. If you cannot proceed further, don't spin your track. Turn the engine off, free the skis by pulling them out and downhill, place the rear of the snowmobile uphill restart the engine and ease it out with slow even throttle pressure. Position yourself to avoid tipping over, then descend.

Downhill

Downhill driving requires that you have full control of your vehicle at all times. On steeper hills, keep your center of gravity low and both hands on the handlebar. Maintain slight throttle pressure and allow the machine to run downhill with the engine operating. If a higher than safe speed is reached, slow down by braking but apply the brake with frequent light pressure. Never jam the brake and lock the track.

Side Hill

When crossing a side hill or traversing up or downhill, certain procedures must be followed. All riders should lean towards the slope as required for stability. The preferred operating positions are the kneeling position, with the knee of the down hill leg on the seat and the foot of the uphill leg on the running board, or the posting position. Be prepared to shift your weight quickly as needed. Side hills and steep slopes are not recommended for a beginner or a novice snowmobiler.

Slush

Slush should be avoided at all times. Always check for slush before starting across any lake or river. If dark spots appear in your tracks, get off the ice immediately. Ice and water can be thrown rearward into the path of a following snowmobile. Getting a vehicle out of a slush area is strenuous and in some cases, impossible.

Fog or Whiteouts

On land or water, fog or visibility-limiting snow can form. If you have to proceed into the fog or heavy snow, do so slowly with your lights on and watch intently for hazards. If you are not sure of your way, do not proceed. Keep a safe distance behind other snowmobilers to improve visibility and reaction time.

Unfamiliar Territory

Whenever you enter an area that is new to you, drive with extreme caution. Go slow enough to recognize potential hazards such as fences or fence posts, brooks crossing your path, rocks, sudden dips, guy wires and countless other obstacles which could result in a termination of your snowmobile ride. Even when following existing tracks, be cautious. Travel at a speed so you can see what is around the next bend or over the top of the hill.

Bright Sunshine

Bright sunny days can considerably reduce your vision. The glare from sun and snow may blind you to the extent that you cannot easily distinguish ravines, ditches or other obstacles. Goggles with colored lenses should always be worn under these conditions.

Unseen Obstruction

There may be obstructions hidden beneath the snow. Driving off established trails and in the woods requires reduced speed and increased vigilance. Driving too fast in an area can make even minor obstacles very hazardous. Even hitting a small rock or stump could throw your snowmobile out of control and cause injury to its riders. Stay on established trails to reduce your exposure to hazards. Be safe, slow down and enjoy the scenery.

Hidden Wires

Always be on the lookout for hidden wires, especially in areas that may have been farmed at one time or another. Too many accidents have been caused by running into wires in the fields, guy wires next to poles and roads, and into chains and wires used as road closures. Slow speeds are a must.

Obstacles and Jumping

Unplanned jumps of snowdrifts, snowplow ridges, culverts or indistinguishable objects can be dangerous. You can avoid them by wearing the proper color lenses or face shields and by operating at a lower speed.

Jumping a snowmobile is an unsafe and dangerous practice. However, if the trail does suddenly drop away from you, crouch (stand) towards the rear of the vehicle and keep the skis up and straight ahead. Apply partial throttle and brace yourself for the impact. Knees must be flexed to act as shock absorbers.

Turning

Depending on terrain conditions, there are two preferred ways to turn or corner a snowmobile. For most snow surfaces, “body english” is the key to turning. Leaning towards the inside of the turn and positioning body weight on the inside foot will create a “banking” condition beneath the track. By adopting this position and positioning yourself as far forward as possible, weight will be transferred to the inside ski.

On occasion, you will find that the only way to turn the vehicle about in deep snow is to pull the snowmobile around. Do not over-exert yourself. Get assistance. Remember to always lift using your legs as opposed to your back.



Road Crossing

In some cases, you will be approaching the road from a ditch or snowbank. Choose a place where you know you can climb without difficulty. Use the standing position and proceed with only as much speed needed to crest the bank. Stop completely at the top of the bank and wait for all traffic to clear. Judge the drop to the roadway. Cross the road at a 90° angle. If you encounter another snowbank on the opposite side, position your feet near the rear of the vehicle. Remember, your snowmobile is not designed to operate on bare pavement and steering on this type of surface is more difficult.

Railroad Crossing

Never ride on railroad tracks. It is illegal. Railroad tracks and railroad rights-of-way are private property. A snowmobile is no match for a train. When crossing a railroad track, stop, look and listen.

Night Rides

The amount of natural and artificial light at a given time can effect your ability to see or to be seen. Nighttime snowmobiling is delightful. It can be a unique experience if you acknowledge your reduced visibility. Before you start, make certain your lights are clean and work properly. Drive at speeds that will allow you to stop in time when you see an unknown or dangerous object ahead. Stay on established trails and never operate in unfamiliar territory. Avoid rivers and lakes. Guy wires, barbed wire fences, cabled road entrances and other objects such as tree limbs are difficult to see at night. Never drive alone. Always carry a flashlight. Keep away from residential areas and respect the right of others to sleep.

Safari Riding

Before starting out, designate a “trail boss” to lead the party and another person to follow-up at the end of the party. Ensure that all members of the party are aware of the proposed route and destination. Make certain that you are carrying all necessary tools and equipment and that you have sufficient fuel to complete the trip. Never overtake the trail boss or, for that matter, any other snowmobile. Use down-the-line hand signals to indicate hazards or intent of direction change. Assist others whenever necessary.

It is always IMPORTANT to keep a safe distance between each snowmobile. Always maintain a safe interval and allow sufficient stopping distance. Don't be a tailgater. Know the position of the machine ahead.

Signals

If you intend to stop, raise either hand straight above your head. A left turn is indicated by extending your left hand straight out in the proper direction. For right turns, extend the left arm and raise the hand to a vertical position so it forms a right angle at the elbow. Every snowmobiler should relay any signal to the ones behind.

Trail Stops

Whenever possible, pull off the trail when you stop. This will reduce the hazard to other snowmobilers using the trail.

Trails and Signs

Trail signs are used to control, direct or regulate the use of snowmobiles on trails. Become familiar with all signs used in the area where you are snowmobiling.

Transporting and Towing

Follow transporting and towing instructions explained further in this guide.

TRACTION ENHANCING PRODUCTS

NOTE: This section is applicable to snowmobiles equipped with a factory installed track that has been approved by BRP for special studs installation.

WARNING

Never stud a track that has not been approved for studs. Installing studs on an unapproved track could increase the risk of the track tearing or severing, possibly resulting in serious injury or death.

WARNING

You may stud the track on this vehicle model. However, you **MUST** only use the BRP approved type stud for use on these Ski-Doo snowmobiles. **DO NOT EVER** use conventional studs as the track thickness is thinner than other standard tracks. The stud could tear off of track and separate from vehicle posing a potential risk of severe injury or death. See an authorized SKI-DOO dealer for current specific studding availability and applications.

Using traction enhancing products such as, more aggressive ski carbide runners and/or studs on your snowmobile will change its behavior, particularly in terms of manoeuvrability, acceleration, and braking.

Using traction enhancing products gives a better grip on packed snow and ice, but has no noticeable effect on soft snow. For this reason, driving a snowmobile equipped with traction enhancing products requires a certain adaptation period. If your snowmobile is equipped with traction enhancing products, be sure to take plenty of time to get used to the way it handles when turning, accelerating, and braking.

Also, always check local regulations concerning the use of traction enhancing products on snowmobiles. Always drive your snowmobile in a responsible manner, respecting the environment and other people's property.

Manoeuvrability

Using traction enhancing products such as, more aggressive ski carbide runners and/or studs makes the snowmobile grip the ground better at both the front and at the rear. The use of carbide runners is therefore required to give the skis a better grip, so that the front and rear of the snowmobile are in balance. While off-the-shelf carbide ski runners are adequate, they don't necessarily give you optimal control, since that depends on your personal preferences, your riding style, and how your suspension is adjusted.

WARNING

If the front and rear of the snowmobile are out of balance due to an incorrect combination of traction enhancing products, the snowmobile may tend to oversteer or understeer, which could lead to a loss of control.

Oversteering

In certain conditions, using more aggressive ski carbide runners without studs on the rear track could make the snowmobile prone to oversteering, see illustration.

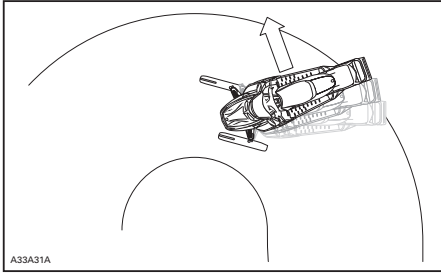

OVERSTEERING

Understeering

In certain conditions, the use of studs on the track could make the snowmobile prone to understeering if the skis are not equipped with more aggressive ski carbide runners, see illustration.

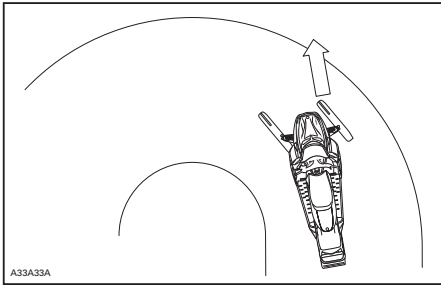

UNDERSTEERING

Controlled Driving

A balanced combination of carbide ski runners and studs on the track ensures adequate control and better handling, see illustration.

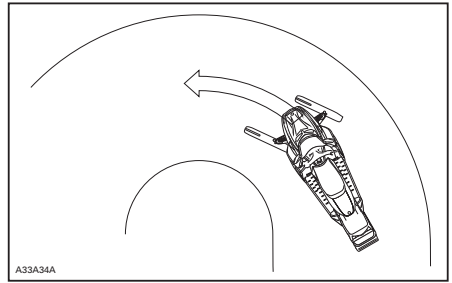

CONTROLLED DRIVING

Acceleration

Using studs on the track will allow your sled to accelerate better on packed snow and ice but will have no noticeable effect on soft snow. This can cause sudden variations in traction under certain conditions.

WARNING

To prevent surprises that could lead to a loss of control of the snowmobile, possibly resulting in serious injury or death:

- Always go easy on the throttle.
- NEVER try to spin the track to make the rear of the snowmobile skid.

This could cause debris or ice to be thrown violently backwards, possibly injuring others nearby or on snowmobiles behind you.

Braking

As in the case of acceleration, using studs on the track will give you better braking capacity on packed snow or ice but will have no noticeable effect on soft snow. Braking may thus vary suddenly under certain conditions. Be sure to use restraint in braking to keep from blocking the track in order to avoid surprises that could lead to a loss of control.

Important Safety Rules

WARNING

To prevent serious injury to individuals near the snowmobile:

- NEVER stand behind or near a moving track.
- Always use a wide-base snowmobile stand with a rear deflector panel.
- When the track is raised off the ground, only run it at the lowest possible speed.

Centrifugal force could cause debris, damaged or loose studs, pieces of torn track, or an entire severed track to be violently thrown backwards out of the tunnel with tremendous force, possibly resulting in the loss of a leg or other serious injury.

Effects of Having a Studded Track on the Life of the Snowmobile

The use of traction enhancing products can increase the load and the stress on certain snowmobile components, as well as the vibration level. This can cause premature wear on parts such as belts, brake linings, bearings, chain, chaincase sprocket, and on approved studded tracks, shorten track life. Always proceed with a visual inspection of your track before each use. For more information, refer to *TRACK CONDITION* section further in this guide.

Studs on the track can also cause serious damage to your snowmobile if it is not equipped with the tunnel protectors designed for your particular model. Damage to the electrical wiring or perforation of the heat exchangers are potential hazards, that could cause the engine to overheat and be severely damaged.

WARNING

If tunnel protectors are excessively worn or not installed, the gas tank could be punctured, causing a fire.

CAUTION: Ask your dealer for the appropriate tunnel protectors model and kit number required for your snowmobile.

NOTE: Consult the BRP limited warranty to find out what warranty limitations are related to the use of studs.

Installation of Studs on BRP Approved Tracks

WARNING

Never stud a track that has not been approved for studs. Approved tracks can be identified by a stud symbol (see illustration below) molded into the track surface. Installing studs on an unapproved track could increase the risk of the track tearing or severing, possibly resulting in serious injury or death.

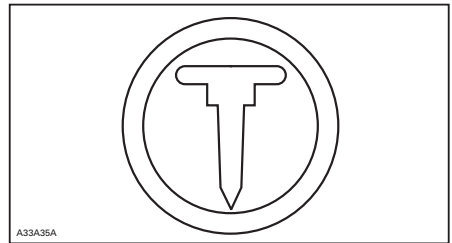

APPROVED TRACKS CAN BE IDENTIFIED BY THIS SYMBOL

To ensure safe and proper installation, BRP recommends to have the studs installed by your dealer.

- Use only the BRP approved special studs.
- Never use studs that exceed the height of your snowmobile's track profile by more than 9.5 mm (3/8 in).

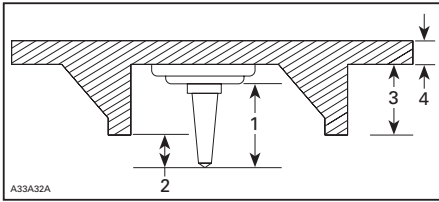

INSTALLATION OF STUDS

1. Stud size
2. Penetration range 6.4 to 9.5 mm (1/4 to 3/8 in)
3. Track lug height
4. Track belt thickness

⚠ WARNING

- See an authorized SKI-DOO dealer for current specific studding availability and applications.
- DO NOT EVER use conventional stud because, the track thickness is thinner than our standard tracks and the stud could tear off of track and separate from vehicle posing a potential risk of severe injury or death.
- Studs should only be installed in the locations indicated by molded bulges in the track surface.
- Never stud a track with a profile of 35 mm (1.375 in) or more.
- The number of studs installed must always perfectly match the pattern of molded bulges in the track.
- Always consult the traction product manufacturer's installation instructions and recommendations before having your dealer install studs and runners. It is very important to follow the torque specifications for the stud bolts.

INSTALLING AN INCORRECT NUMBER OF STUDS OR AN IMPROPER INSTALLATION CAN INCREASE THE RISK OF THE TRACK TEARING OR SEVERING, POSSIBLY RESULTING IN SERIOUS INJURY OR DEATH.

Maintenance/Replacement

PROCEED WITH A VISUAL INSPECTION OF YOUR TRACK BEFORE EACH USE.

Look for any defects, such as:

- perforations in the track
- tears in the track (particularly around traction holes on studded tracks)
- lugs that are broken or torn off, exposing portions of rods
- delamination of the rubber
- broken rods
- broken studs (studded tracks)
- bent studs (studded tracks)
- missing studs
- studs that are torn off the track
- missing track guide(s)
- also, ensure that studs nut are tight-en to the recommended torque.

On approved studded tracks, replace broken or damaged studs immediately. If your track shows signs of deterioration, it must be replaced immediately. When in doubt, ask your dealer. Always proceed with a visual inspection of your track before each use.

⚠ WARNING

Riding with a damaged track or studs could lead to loss of control, resulting in a risk of serious injury or death.

LOCATION OF THE IMPORTANT LABELS

Safety standards for snowmobiles have been adopted by the Snowmobile Safety and Certification Committee (SSCC) of which BRP is a proud participating member. Assurance that your snowmobile meets these standards is easily checked by locating the Certification Label on a right vertical portion of the vehicle.

This label shows that an independent testing laboratory has verified compliance with the SSCC safety standards.



Other important labels on the vehicle are WARNING or CAUTION labels relating to safety, maintenance and/or snowmobile operation. Ensure all such labeling is retained on the vehicle and its content is followed by vehicle operator and passenger.

If missing or damaged, the decals can be replaced free of charge. See an authorized SKI-DOO dealer.

Please read the following instructions carefully before operating this snowmobile.

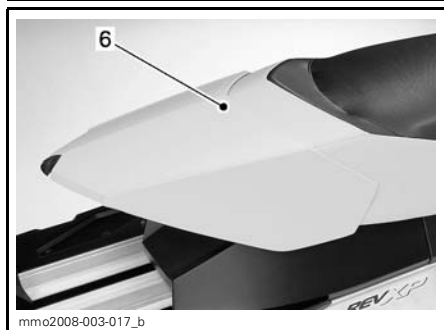
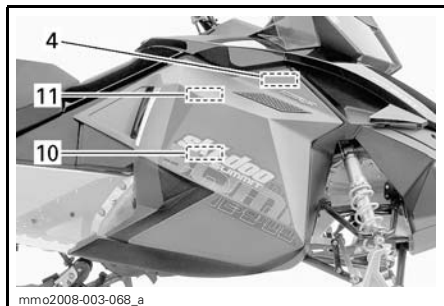
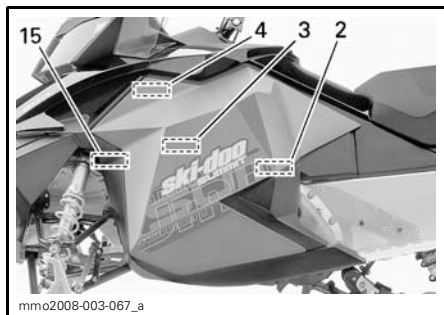
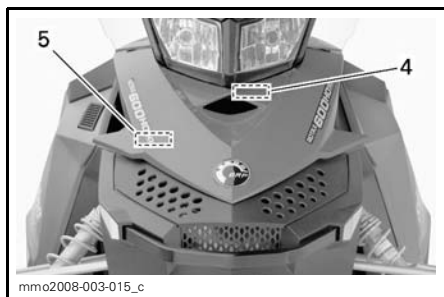

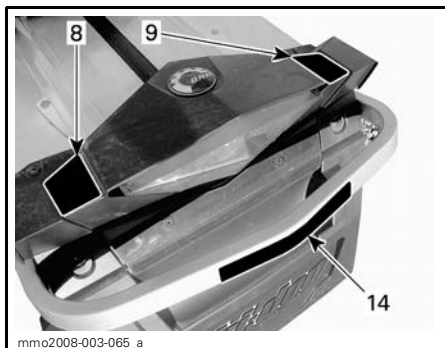

mmo2008-003-065_a

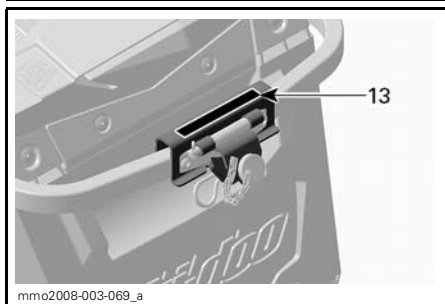

mmo2008-003-069_a

Instruction 1

⚠ WARNING

- Read and understand all warning labels and operator's guide before operation. Operator's guide is located in the under seat base. Pull latch located under front lip of seat and slide it to the rear to have access. If guide is missing, ask your dealer for a new one.
- Get familiar with your vehicle. Inexperienced riders may overlook risks and be surprised by vehicle's specific behavior and terrain conditions. Ride slowly.
- Excessive speed and reckless driving can kill ! ALWAYS adjust your speed according to snow conditions and circumstances.
- Steering control and braking ability may be reduced on hard-pack snow, ice or roads. Reduce speed & allow more space to stop or turn.
- Respect laws on minimum operator age. Manufacturer recommends a minimum operating age of 16 years old.
- Never open side panels or hood while engine is running or if vehicle is in motion. Ensure to remove DESS key before opening those.

BEFORE STARTING :

1. Attach tether cord to your clothing.
2. Check proper operation of the throttle and brake levers each time before starting. They must return to their initial position when released.
3. Apply parking brake.
4. Turn handlebars all the way in both directions to check for interference and insure free operation.

AFTER STARTING :

1. Pull-out tether cord to check if engine shuts off.
2. Re-start and push in engine cut-off switch to check if engine shuts off.
3. Disengage parking brake before riding to avoid fading.

mmo2007-009-050_en

Instruction 2

CAUTION	ATTENTION
<ul style="list-style-type: none"> •To comply with noise regulations, this engine is designed to operate with an air intake silencer. •Operation without air intake silencer or with one not properly installed may cause engine damage. 	<ul style="list-style-type: none"> •Le moteur a été conçu pour fonctionner avec ce silencieux, d'admission afin de se conformer aux lois et règlements relatifs au bruit. •Son absence ou une mauvaise installation peut endommager le moteur.

mmo2007-009-051

Instruction 3

⚠ WARNING

This guard must ALWAYS be in place when engine is running. Beware of rotating parts – they could cause injuries or catch your clothing.

⚠ AVERTISSEMENT

Ce garde-courroie doit TOUJOURS être en place lorsque le moteur fonctionne. Attention aux pièces en rotation – elles peuvent vous blesser ou capter vos vêtements.

516 002 670

A33A2FA

Instruction 4

⚠ WARNING

Beware of HOT parts!

⚠ AVERTISSEMENT

Attention aux pièces CHAUDES!

516002664

A33A2GA

Instruction 5



mmo2008-003-007

Instruction 6



Instruction 7

⚠ WARNING

This vehicle is designed for one (1) operator and as many passengers as there are seats with straps or handgrips installed on the vehicle conforming to SSCC standards.

When riding with a passenger :

- Braking ability and steering control are reduced. Decrease speed and allow extra space to maneuver.
- Adjust suspensions according to weight.

REMEMBER : YOU ARE RESPONSIBLE FOR THE SAFETY OF YOUR PASSENGER!

ALL DRIVERS AND PASSENGERS MUST READ THE FOLLOWING:
Avoid surprises!
BE ON THE LOOK-OUT for the unexpected. 

Operate defensively.

- Scan constantly for people, objects, conditions and upcoming vehicles.
- Avoid thin ice / open water.
- Use extra caution whenever off-trail.

ALWAYS wear a DOT approved HELMET and clothing appropriate for snowmobiling. 

NEVER ride after consuming alcohol or drugs even as a passenger. 

mmo2007-009-052_en

Instruction 8

⚠ WARNING

- NEVER STAND BEHIND or near a rotating track.
- Only spin track at lowest possible speed whenever off the ground. Broken track or debris could be projected with great force which could sever legs or cause other serious injuries.



mmo2007-009-053_en

Instruction 9

⚠ WARNING

NEVER SIT IN CARGO AREA.

Exceeding maximum cargo load may affect steering control and braking ability.

MAXIMUM cargo load :
15,8 Kg / 35 Lbs.

mmo2007-009-058_en

Instruction 10

<div style="background-color: #cccccc; padding: 2px; text-align: center;">⚠ AVERTISSEMENT</div> <p>Le condensateur peut produire une étincelle si court-circuité.</p> <ul style="list-style-type: none"> - Une étincelle peut enflammer les vapeurs d'essence. - Garder tout objet éloigné des bornes. - Si démonté du véhicule, toujours décharger adéquatement. 	<div style="background-color: #cccccc; padding: 2px; text-align: center;">⚠ WARNING</div> <p>Capacitor May Spark If Shorted.</p> <ul style="list-style-type: none"> - Spark can ignite fuel vapors. - Keep objects away from poles. - When removing from vehicle, always discharge properly. 	<div style="background-color: #cccccc; padding: 2px;">CAPACITOR CONDENSATEUR</div>  <p style="font-size: 8px;">516.002.001</p>
---	--	--

A33A20A

SDI MODELS MANUAL START

Instruction 11

<div style="background-color: #cccccc; padding: 2px; text-align: center;">CAUTION</div> <p>Use XP-S= 2-Stroke Synthetic blend or XP-S= Synthetic 2-Stroke oil.</p>	<div style="background-color: #cccccc; padding: 2px; text-align: center;">ATTENTION</div> <p>Utilisez de l'huile semi-synthétique 2-temps XP-S... ou synthétique 2-temps XP-S...</p> <p style="font-size: 8px;">516.002.055A</p>
---	---

A33A2HA

600 HO SDI AND 800R POWER TEK ENGINES

Instruction 12



mmo2006-003-007_a

EUROPEAN MODELS

Instruction 13

Towing a load may affect handling of your snowmobile.
 • Reduce speed, • Use rigid tow bar, • Ensure that the tow bar is securely fastened, Do not exceed the following loads:

DRAWBAR xxx Kg / xxxlbs Max.
 VERTICAL LOAD xx Kg / xxlbs Max.

▲ WARNING

mmo2007-002-001_en

RENEGADE™ EUROPEAN MODELS

Instruction 14

▲ WARNING

If you stud the track on this vehicle use special BRP approved studs ONLY.
 Studding this track with conventional studs may cause studs to tear off of track and separate from vehicle posing a potential risk of severe injury or death.
 See the Operator's Guide that came with this vehicle for all details pertaining to track studding.

mmo2008-003-052_en

MODELS WITH TRACK APPROVED FOR STUDS

Instruction 15

EMISSION CONTROL INFORMATION

THIS VEHICLE IS CERTIFIED TO OPERATE ON UNLEADED GASOLINE AND MEETS [xxxx] U.S. EPA REGULATIONS FOR SNOWMOBILE SI ENGINES.



ENGINE FAMILY	XXXX	FAMILLE DE MOTEUR LIMITE DES ÉMISSIONS DE LA FAMILLE
FEL	XXXX	CYLINDRÉE
ENGINE DISPLACEMENT	XXXX	SYSTÈME DE CONTRÔLE DES ÉMISSIONS
EXHAUST EMISSION CONTROL SYSTEM	XXXX	

RENSEIGNEMENTS SUR LE DISPOSITIF ANTIPOLLUTION

CE VÉHICULE EST CERTIFIÉ POUR FONCTIONNER À L'ESSENCE SANS PLOMB ET IL RÉPOND AUX NORMES [xxxx] DE L'EPA DES É.-U. POUR LES MOTONEIGES À MOTEUR SI.

SEE OPERATOR'S GUIDE FOR MAINTENANCE SPECIFICATIONS
 VOIR GUIDE DU CONDUCTEUR POUR LES SPÉCIFICATIONS D'ENTRETIEN
 BOMBARDIER RECREATIONAL PRODUCTS INC.

mmo2007-009-070

HANGTAG (not shown)

VEHICLE ENGINE DESCRIPTION:
XXXXX

EPA CERTIFIED

NER (NORMALIZED EMISSION RATE) = X
ON A 0 TO 10 SCALE, 0 BEING THE CLEANEST

***NOT TO BE REMOVED PRIOR TO SALE**



704901107

vmo2006-005-009_en

CAUTION

This snowmobile is calibrated for operating at altitudes between 2000 ft and 8000 ft. Operating above or below these altitudes requires calibration parts and adjustment. For more details, REFER to your Operator's Guide that came with your snowmobile or see your authorized Ski-Doo dealer. FAILURE TO RECALIBRATE MAY CAUSE SERIOUS ENGINE DAMAGE

mmo2008-003-053_en

SUMMIT® — NORTH AMERICA

CAUTION

This snowmobile is calibrated for operating at SEA-LEVEL. Operating above 2000 ft requires calibration parts and adjustment. For more details, REFER to your Operator's Guide that came with your snowmobile or see your authorized Ski-Doo dealer. INCORRECT ADJUSTMENTS MAY CAUSE PARTS DAMAGE

mmo2008-003-054_en

SUMMIT — EUROPE

ENVIRONMENT INFORMATION

GENERAL

Wildlife compliments your snowmobiling day. Snowmobile tracks provide firm ground over which animals can travel from area to area. Do not violate this privilege by chasing or harassing wildlife. Fatigue and exhaustion can lead to animal's death. Avoid areas posted for the protection or feeding of wildlife.

If you happen to be fortunate enough to see an animal, stop your snowmobile and observe quietly.

The guidelines that we support are not designed to limit your snowmobiling fun, but to preserve the beautiful freedom that you can experience only on a snowmobile! These guidelines will keep snowmobilers healthy, happy and able to introduce others to what they know and enjoy about their favorite winter pastime. So, the next time you hit the trails on a cool, crisp and clear winter day, we ask you to remember that you are paving the way for the future of our sport. Help us lead it down the right path! From all of us at BRP, thank you for doing your share.

There is nothing more exhilarating than snowmobiling. Venturing onto snowmobile trails that criss-cross the wild areas of the U.S. and Canada is an exciting and healthy winter sport. However, as the number of people using these recreational parks increases, so does the potential for damage to the environment. Abuse of land, facilities and resources inevitably leads to restrictions and closures of both private and public land.

In essence, the greatest threat to our sport, is all around us. Which leaves us with one logical choice. When we snowmobile, we must always ride responsibly.

The vast majority respect the law and the environment. Each of us must set an example for those who are new to the sport, young and old alike.

It is in every one's best interest to tread lightly into our recreational areas. Because, in the long run, to protect the sport we must preserve the environment.

Recognizing the importance of this issue and the need for snowmobilers to do their share in preserving areas that make it possible to enjoy our sport, BRP has developed the "Light Treading Is Smart Sledding" campaign for snowmobilers.

Light Treading refers to more than the thread of our tracks. It's a statement of concern, respect and willingness to take the lead and take action. It applies to the environment in general, its proper care and maintenance, its natural inhabitants and all enthusiasts and the public at large who enjoy the great outdoors. With this theme, we invite all snowmobilers to remember that respecting the environment is not only critical to the future of our industry but to future generations.

Light Treading in no way suggests you should curb your appetite for snowmobiling fun! It simply means tread with respect!

JUST WHAT IS LIGHT TREADING?

The fundamental objective of Light Treading is one of respect for where and how you ride a snowmobile. You're a light treader when you follow the principles below.

Become informed. Obtain maps, regulations and other information from the Forest Service or from other public land agencies. Learn the rules and follow them and that goes for speed limits, too!

Avoid running over young trees, shrubs, and grasses and don't cut wood. On flatlands or areas where trail riding is popular, it's important to ride only where authorized. Remember, there is a link between protecting your environment and your own safety.

Respect wildlife and be particularly sensitive of animals that are rearing young or suffering from food shortage. Stress can sap scarce energy reserves. Refrain from riding in areas where only animals are intended to tread!

Obey gate closures and regulatory signs and remember, light treaders don't litter!

Stay out of wilderness areas. They're closed to all vehicles. Know where the boundaries are.

Obtain permission to travel across private land. Respect the rights of landowners and other people's privacy. Remember, snowmobile technology has lowered the noise factor considerably, but you still shouldn't rev your engines where quiet "is the order of the day".

WHY IS LIGHT TREADING SMART

Snowmobilers know all too well the efforts that have been made throughout the sport's history to enjoy access to areas where people can snowmobile safely and responsibly. This effort continues today, as strong as ever.

Respecting the areas where we ride... wherever they may be... is the only way to ensure their future enjoyment. That's one major reason why we know you'll agree that Light Treading is smart sledding! And there are more.

Enjoying the opportunity to see winter and all its natural majestic wonders, is an experience cherished by snowmobilers. Light Treading will preserve this opportunity and will make it possible for us to expose others to the beauty of winter and the unique thrill of our sport! Light Treading will help our sport to grow!

Finally, Light Treading is the sign of a smart snowmobiler. You don't have to leave big tracks or careen through a virgin forest to show you can ride. So whether you're driving a high performance Ski-Doo, a sporty MX Z snowmobile or any other make or model, show you know what you're doing. Show you know how to send snow flying and make tracks with a light touch!

VEHICLE INFORMATION

HOW TO IDENTIFY YOUR SNOWMOBILE

Vehicle Description Decal

Vehicle description decal is located on right hand side of tunnel.

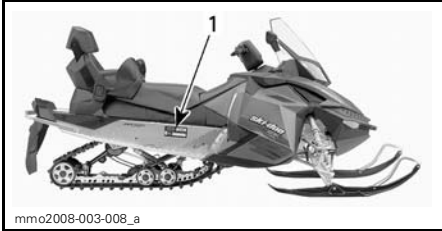

TYPICAL

1. Vehicle description decal

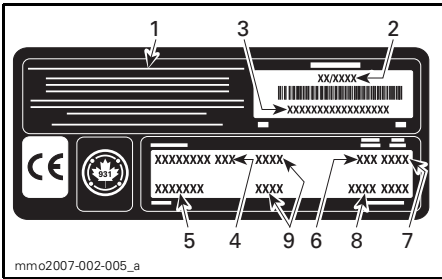

VEHICLE DESCRIPTION DECAL

1. Manufacturer name
2. Manufacturing date
3. Vehicle identification number (VIN)
4. Model name
5. Option package
6. Engine type
7. Model year
8. Color codes
9. Vehicle weight/engine power (European models)

Serial Numbers

The main components of your snowmobile (engine and frame) are identified by different serial numbers. It may sometimes become necessary to locate these numbers for warranty purposes or to trace your snowmobile in the event of loss. These numbers are required by the authorized SKI-DOO dealer to complete warranty claims properly. No warranty will be allowed by BRP if the engine serial number or vehicle identification number (VIN) is removed or mutilated in any way. We strongly recommend that you take note of all the serial numbers on your snowmobile and supply them to your insurance company.

Vehicle Identification Number (VIN) Location

VIN is scribed on vehicle description decal. See above. It is also engraved on tunnel near vehicle description decal.

Model Number Location

Model number is part of vehicle identification number (VIN).

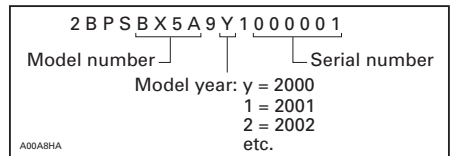

VIN DESCRIPTION

Engine Serial Number Location



500SS/600 HO SDI ENGINES

1. Engine serial number

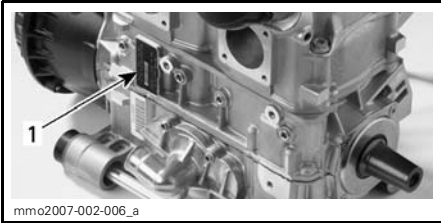

800R POWER TEK ENGINE

1. Engine serial number

CONTROLS/INSTRUMENTS/EQUIPMENT

NOTE: Some controls/instruments/equipment do not apply or are optional on some models. In these cases their reference numbers are deliberately missing in the illustrations.

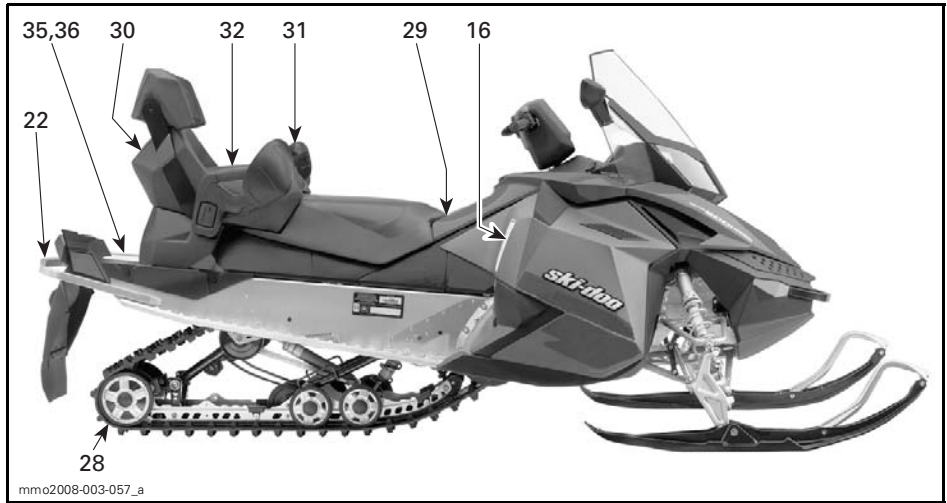

TYPICAL

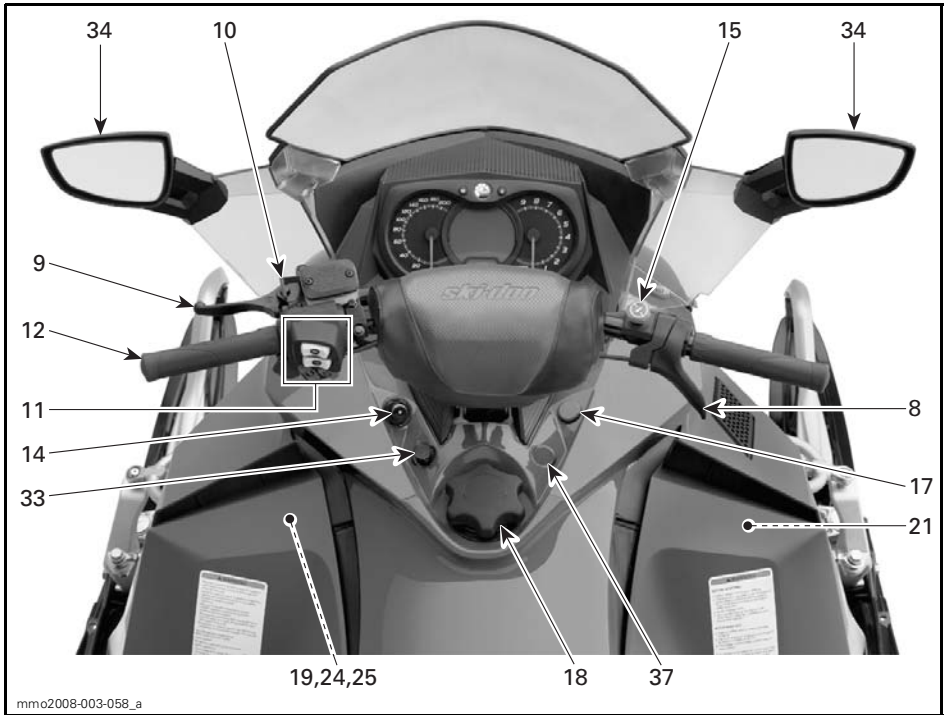

TYPICAL

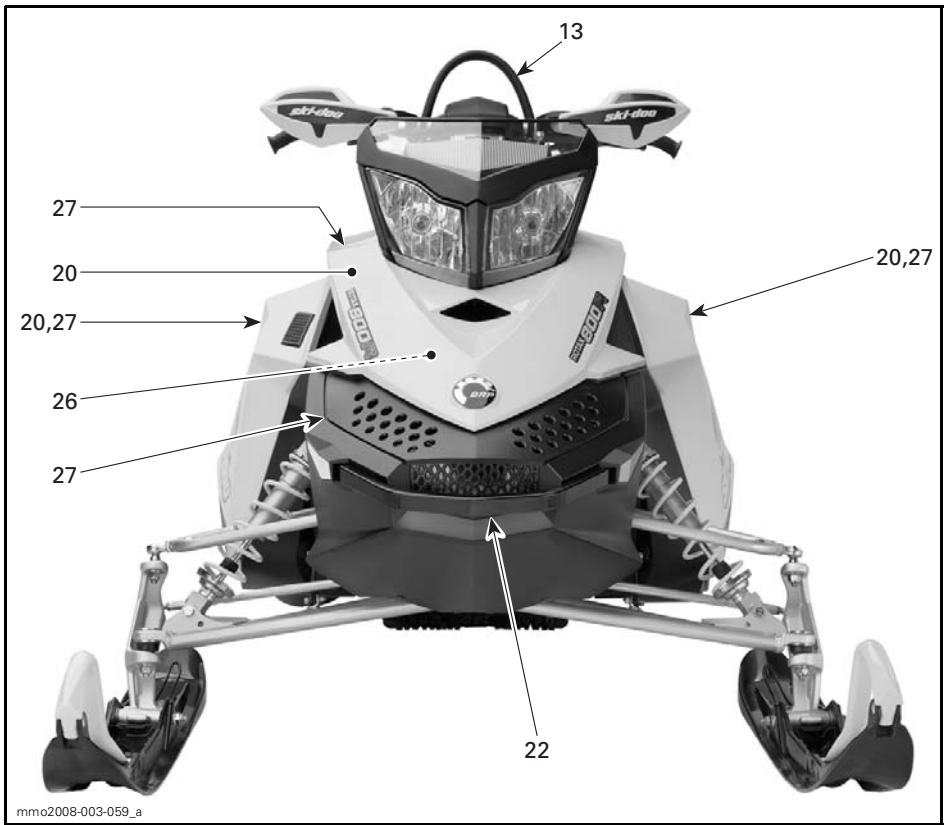

mms2008-003-059_a

TYPICAL

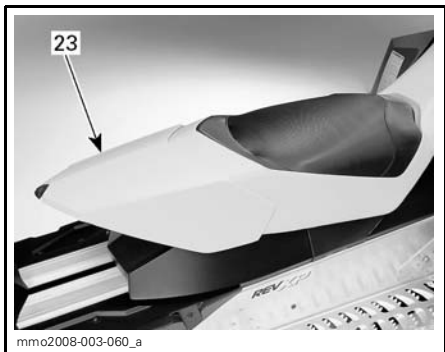

TYPICAL

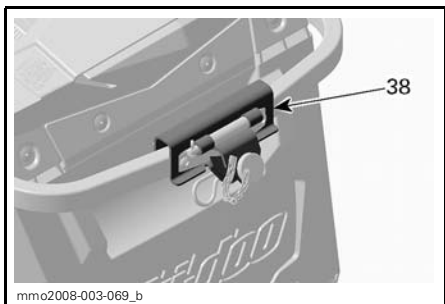

RENEGADE EUROPEAN MODELS ONLY

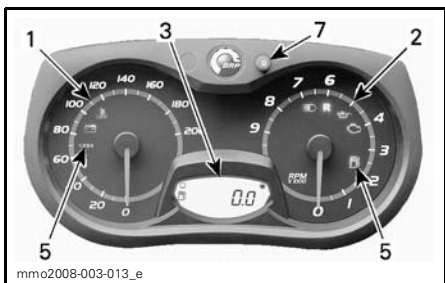

ANALOG/DIGITAL GAUGE

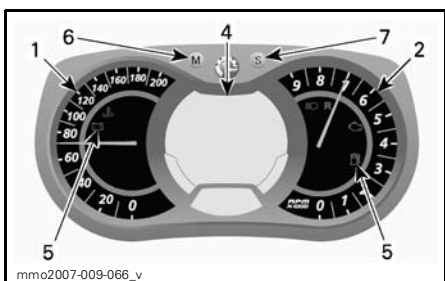

MULTIFUNCTION ANALOG/DIGITAL GAUGE

1. Speedometer
2. Tachometer (RPM)
3. Gauge Digital Display
4. Gauge Multifunction Digital Display
5. Gauge Pilot Lamps
6. Gauge MODE (M) Button
7. Gauge SET (S) Button
8. Throttle Lever
9. Brake Lever
10. Parking Brake Lever
11. Multi-Switch Housing
12. Handlebar
13. Holding Strap
14. Tether Cut-Out Switch
15. Engine Cut-Out Switch
16. Rewind Starter Handle
17. Choke Lever
18. Fuel Tank Cap
19. Heated Carburetor Valve
20. Hood and Side Panels
21. Fuses
22. Grab Handle/Bumper
23. Storage Compartment
24. Tool Kit
25. Spark Plug Storage
26. Spare Drive Belt Holder
27. Shields and Guards
28. Track
29. Seat Latch
30. 1+1 Seat
31. Rear Passenger Heating Grip Switch
32. Rear Grab Handles
33. Electric Visor Jack Connector
34. Adjustable Mirrors
35. Integrated Bag
36. Rear Rack
37. 12-Volt Power Outlet
38. C-Type Hitch

1) Speedometer

Measures vehicle speed in miles or kilometers.

The speedometer is factory preset in Imperial units but it is possible to change it to Metric units, contact an authorized SKI-DOO dealer for unit settings.



LH PORTION OF GAUGE

2) Tachometer (RPM)

Measures engine revolution per minute (RPM). Multiply by 1000 to obtain the actual revolutions.



RH PORTION OF GAUGE

3) Gauge Digital Display

Digital display that supplies several real time useful information to the driver.

⚠ WARNING

Reading the gauge digital display can distract from the operation of the vehicle, particularly from constantly scanning the environment. This could lead to a collision resulting in severe injuries or death. Before reading the gauge digital display, ensure your environment is clear and free from obstacle, and bring the vehicle to a low speed. Before proceeding with any adjustments, park vehicle in a safe place and away from the trail.

The digital display is factory preset in Imperial units but it is possible to change it to Metric units, contact an authorized SKI-DOO dealer for unit settings.

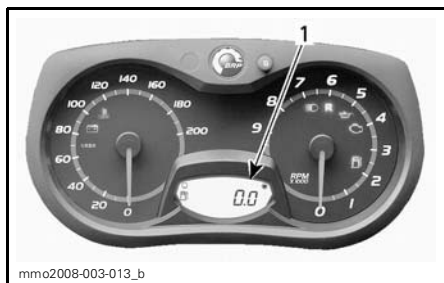

ANALOG/DIGITAL GAUGE

1. Digital display

DISPLAY FEATURES

FUNCTIONS	REFER TO TOPICS
Odometer	A)
Trip meter "A" or "B"	B)
Trip hour meter	C)
Fuel level	D)

A) Odometer

Records the total distance travelled.

Push the SET (S) button to select odometer (Km/Mi) mode.

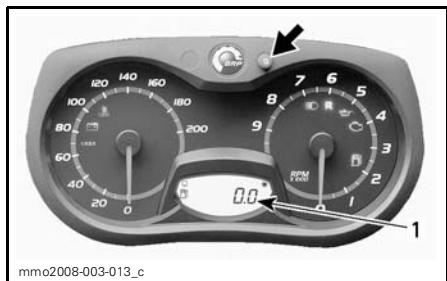

1. Odometer (Km/Mi) mode

B) Trip Meter "A" or "B"

Trip meters records distance travelled since it has been reset.

Push the SET (S) button to select trip meter (TRIP A/TRIP B) mode.

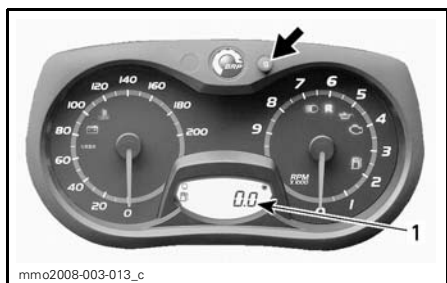

1. Trip meter (TRIP A/TRIP B) mode

Push and hold the SET (S) button to reset.

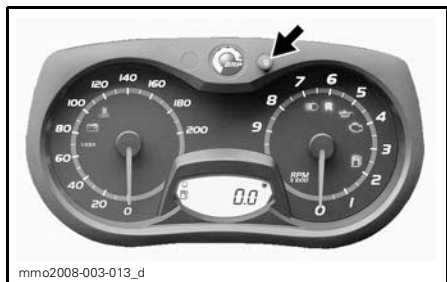

C) Trip Hour Meter

Records vehicle running time when the electrical system is activated since it has been reset.

Push the SET (S) button to select trip hour meter (HrTRIP) mode.

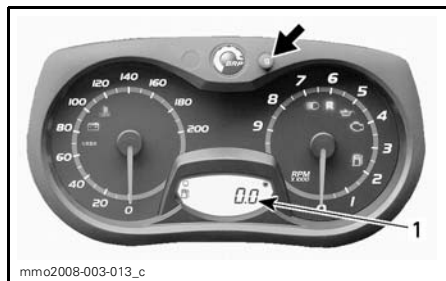

1. Trip hour meter (HrTRIP) mode

Push and hold the SET (S) button to reset.

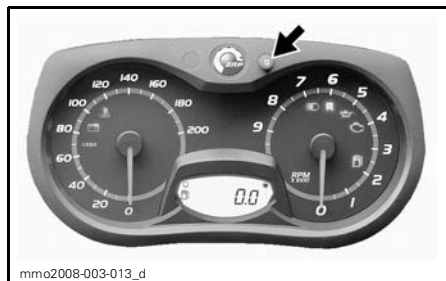

D) Fuel Level

Bar gauge that continuously indicates the amount of fuel left in the fuel tank.

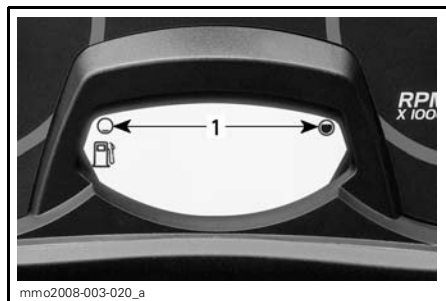

FUEL LEVEL

1. Operating range

4) Gauge Multifunction Digital Display

Multifunction digital display that supplies several real time useful information to the driver either in English or French, contact an authorized SKI-DOO dealer for language settings.

WARNING

Reading the gauge digital display can distract from the operation of the vehicle, particularly from constantly scanning the environment. This could lead to a collision resulting in severe injuries or death. Before reading the gauge digital display, ensure your environment is clear and free from obstacle, and bring the vehicle to a low speed. Before proceeding with any adjustments, park vehicle in a safe place and away from the trail.

Also, the multifunction digital display is factory preset in Imperial units but it is possible to change it to Metric units, contact an authorized SKI-DOO dealer for unit settings.

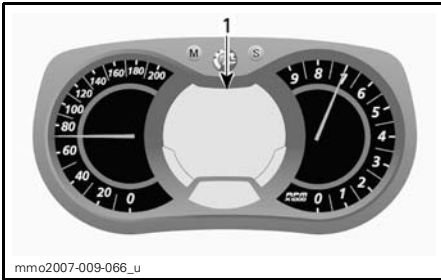

mmo2007-009-066_u

MULTIFUNCTION ANALOG/DIGITAL GAUGE

1. Multifunction display

DISPLAY FEATURES	
FUNCTIONS	REFER TO TOPICS
Speedometer	A)
Tachometer (RPM)	B)
Odometer	C)
Trip meter "A" or "B"	D)
Trip hour meter	E)
Clock	F)
Fuel level	G)
Altitude	H)
Top speed	I)
Top RPM	J)
Average speed	K)
Heated grips heating intensity	L)
Heated throttle lever heating intensity	M)
Instant fuel consumption	N)
Total fuel consumption	O)
Message Display	P)

A) Speedometer

In addition of the analog type speedometer, vehicle speed can also be displayed via the multifunction display.

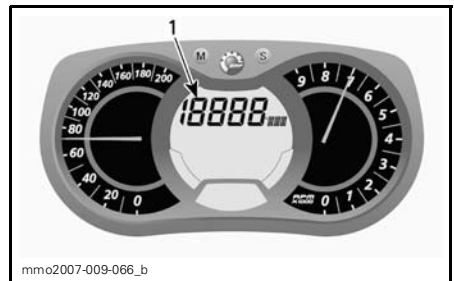

mmo2007-009-066_b

1. Vehicle speed display

To display vehicle speed, proceed as follow.

Push the MODE (M) button to select display.



NOTE: Display will flash for approximately 5 seconds, then will return to the previously selected mode if display is not changed.

Push the SET (S) button to select speedometer (MPH/Km/h) mode.

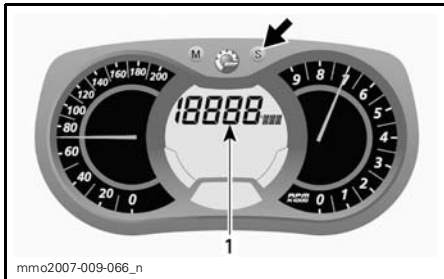

1. Speedometer (MPH/Km/h) mode

Push the MODE (M) button to confirm selection or wait 5 seconds.

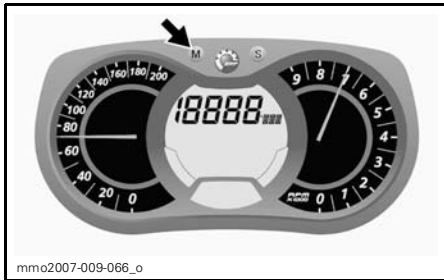

B) Tachometer (RPM)

In addition of the analog type tachometer, RPM can also be displayed via the multifunction display.

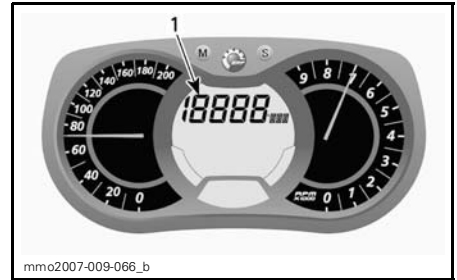

1. RPM display

To display RPM, proceed as follow.

Push the MODE (M) button to select display.



NOTE: Display will flash for approximately 5 seconds, then will return to the previously selected mode if display is not changed.

Push SET (S) button to select RPM mode.

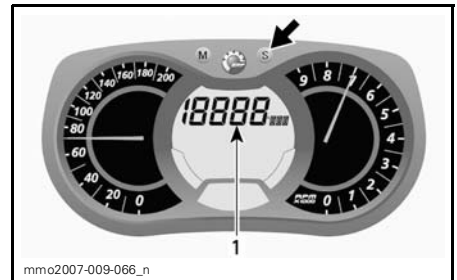

1. RPM mode

Push the MODE (M) button to confirm selection or wait 5 seconds.

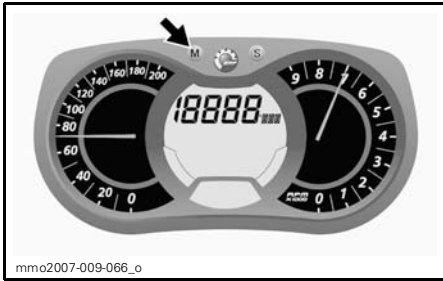

NOTE: On SDI models, resetting TRIP B mode will also reset TOTAL FUEL CONSUMPTION.

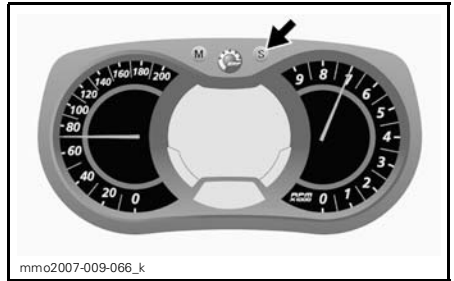

C) Odometer

Records the total distance travelled.
Push the SET (S) button to select odometer (Km/Mi) mode.

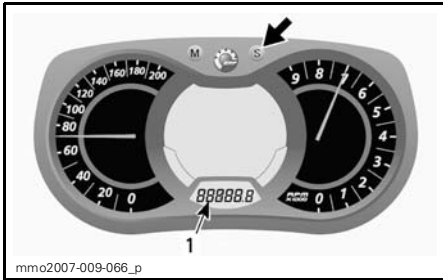

1. Odometer (Km/Mi) mode

D) Trip Meter "A" or "B"

Trip meters records distance travelled since it has been reset.
Push the SET (S) button to select trip meter (TRIP A/TRIP B) mode.

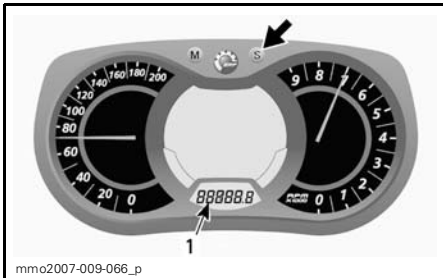

1. Trip meter (TRIP A/TRIP B) mode

Push and hold the SET (S) button to reset.

E) Trip Hour Meter

Records vehicle running time when the electrical system is activated since it has been reset.

Push the SET (S) button to select trip hour meter (HrTRIP) mode.

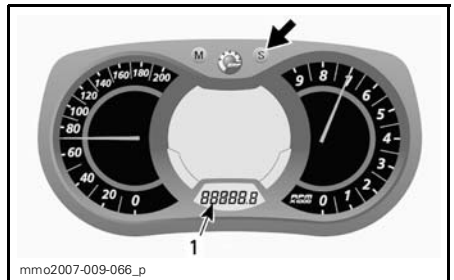

1. Trip hour meter (HrTRIP) mode

Push and hold the SET (S) button to reset.

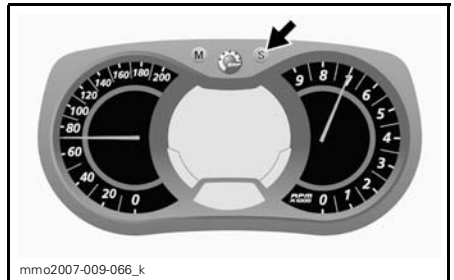

F) Clock

Electric Start Models

Push the SET (S) button to select clock mode.

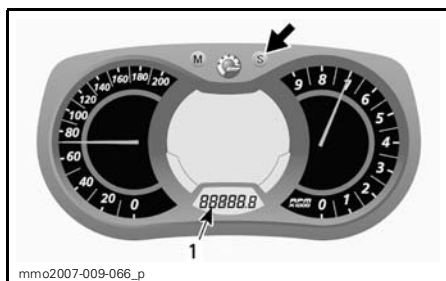

1. Clock mode

Push and hold the SET (S) button to activate clock set-up.

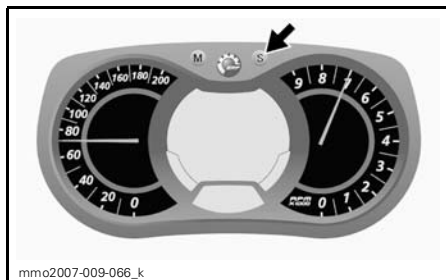

To change HOURS, while the value of HOURS is blinking, use the SET (S) button to change hours.

To change MINUTES, while the value of HOURS is blinking, press the MODE (M) button to switch to minutes. Use the SET (S) button to change minutes.

Push the MODE (M) button to save clock set-up and exit mode.

G) Fuel Level

Bar gauge that continuously indicates the amount of fuel left in the fuel tank.

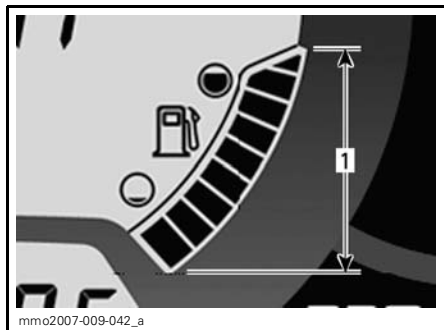

FUEL LEVEL

1. Operating range

H) Altitude

Displays vehicle altitude above sea level in meters or feet.

Vehicle altitude can be displayed via **display 1** or **display 2** of the multi-function display.

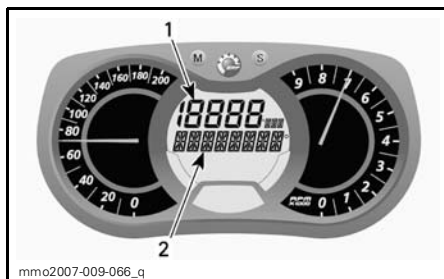

MULTIFUNCTION DISPLAY

1. Display 1
2. Display 2

Via Display 1

To display vehicle altitude via **display 1**, proceed as follow.

Push the MODE (M) button to select display.



NOTE: Display will flash for approximately 5 seconds, then will return to the previously selected mode if display is not changed.

Push the SET (S) button to select altitude (M/FT) mode.

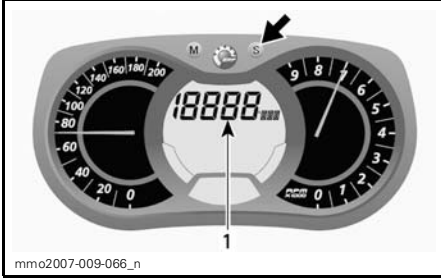

1. Altitude (M/FT) mode

Look for the following symbol to ensure proper mode.



ALTITUDE MODE

Push the MODE (M) button to confirm selection or wait 5 seconds.

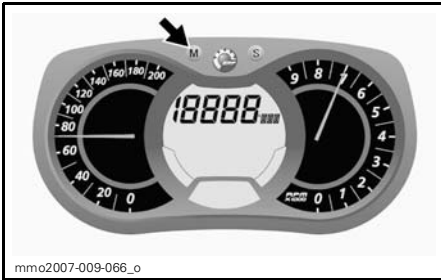

Via Display 2

To display vehicle altitude via display 2, proceed as follow.

Push the MODE (M) button 2 times within a second to select display.

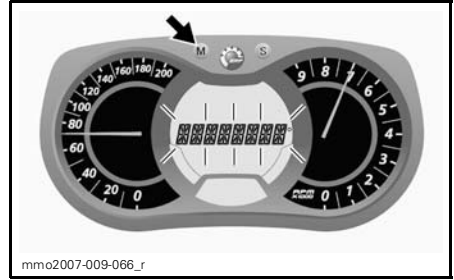

NOTE: Display will flash for approximately 5 seconds, then will return to the previously selected mode if display is not changed.

Push the SET (S) button to select altitude (M/FT) mode.

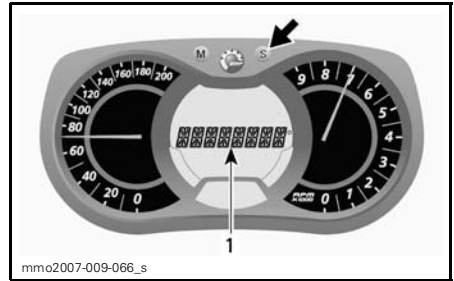

1. Altitude (M/FT) mode

Look for the following symbol to ensure proper mode.



ALTITUDE MODE

Push MODE (M) button to confirm selection or wait 5 seconds.

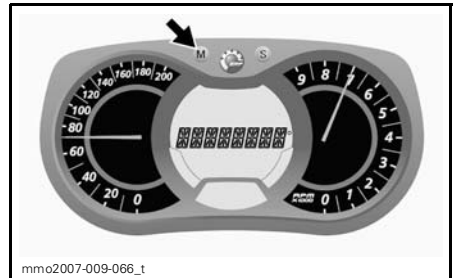

I) Top Speed

Records vehicle top speed since it has been reset.

To display vehicle top speed, proceed as follow.

Push the MODE (M) button to select display.



To reset, push the MODE (M) to select mode.



Push and hold the SET (S) button with- in 5 seconds to reset.

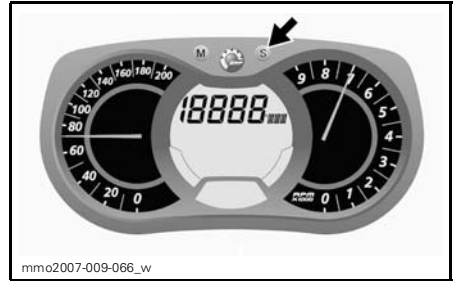

NOTE: Display will flash for approxi- mately 5 seconds, then will return to the previously selected mode if dis- play is not changed.

Push the SET (S) button to select top speed (TOP_SPD) mode.

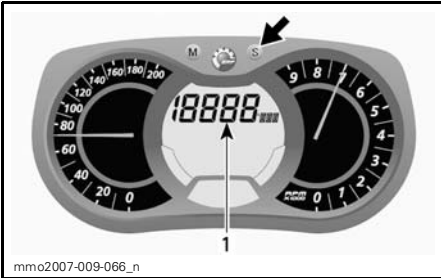

1. Top speed (TOP_SPD) mode

Push the MODE (M) button to confirm selection or wait 5 seconds.

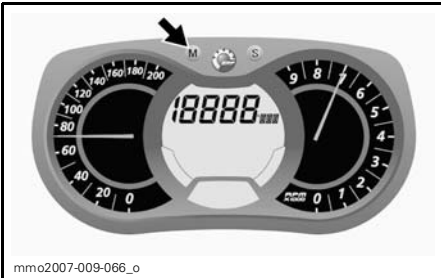

J) Top RPM

Records engine top revolution per minute (RPM) since it has been reset.

To display engine top revolution per minute, proceed as follow.

Push the MODE (M) button to select display.



NOTE: Display will flash for approxi- mately 5 seconds, then will return to the previously selected mode if dis- play is not changed.

Push the SET (S) button to select top RPM (TOP_RPM) mode.

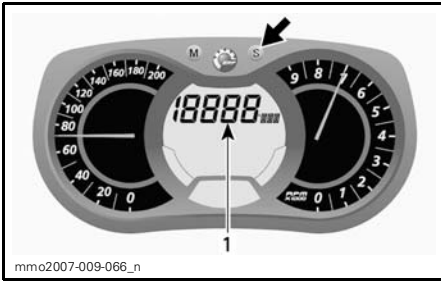

1. Top RPM (TOP_RPM) mode

Push the MODE (M) button to confirm selection or wait 5 seconds.

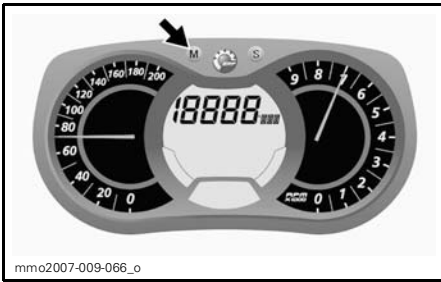

To reset, push the MODE (M) to select mode.



Push and hold the SET (S) button within 5 seconds to reset.

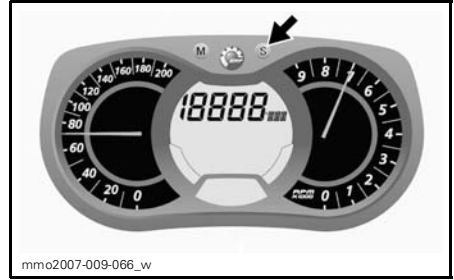

K) Average Speed

Records vehicle average speed since it has been reset.

To display vehicle average speed, proceed as follow.

Push the MODE (M) button to select display.

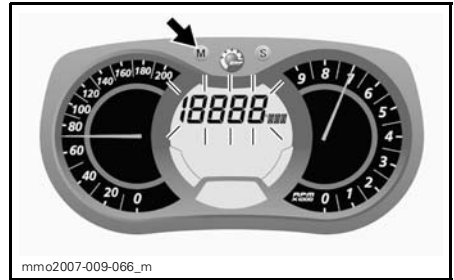

NOTE: Display will flash for approximately 5 seconds, then will return to the previously selected mode if display is not changed.

Push SET (S) button to select vehicle average speed (AVR_SPD) mode.

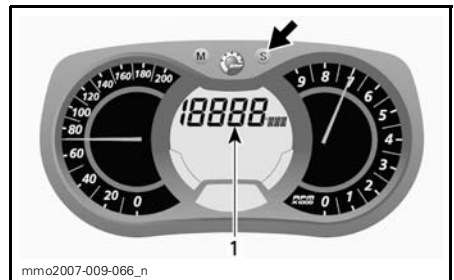

1. Vehicle average speed (AVR_SPD) mode

Push the MODE (M) button to confirm selection or wait 5 seconds.

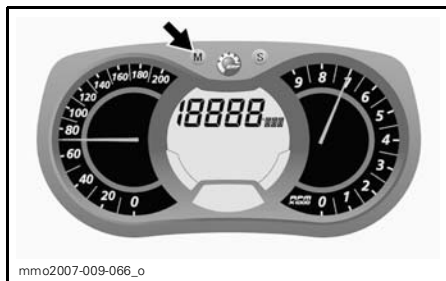

To reset, push the MODE (M) to select mode.



Push and hold the SET (S) button within 5 seconds to reset.

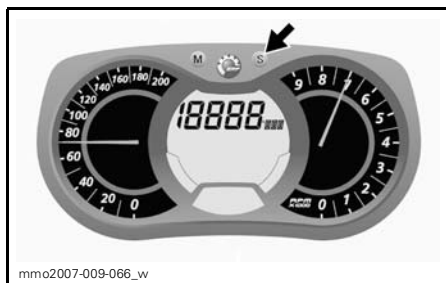

L) Heated Grips Heating Intensity

Bar gauge that indicates heating intensity.

Refer to *HEATING GRIPS SWITCH* for more details.

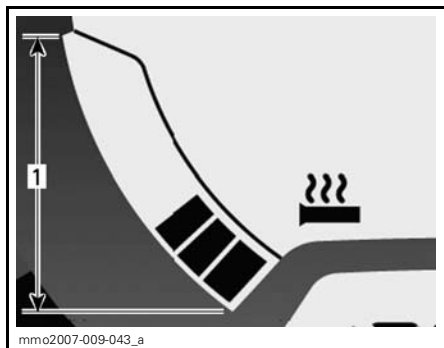

HEATING GRIPS

1. Operating range

M) Heated Throttle Lever Heating Intensity

Bar gauge that indicates heating intensity.

Bar gauge will be displayed instead of the fuel level with the activation of the heating throttle lever switch. When released, display will return to fuel level.

Refer to *HEATING THROTTLE LEVER SWITCH* for more details.

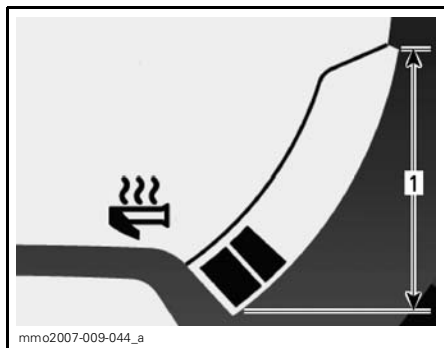

HEATING THROTTLE LEVEL

1. Operating range

N) Instant Fuel Consumption

600 HO SDI Models Only

Calculates vehicle average fuel consumption while riding.

To display vehicle average fuel consumption, proceed as follow.

Push the MODE (M) button to select display.

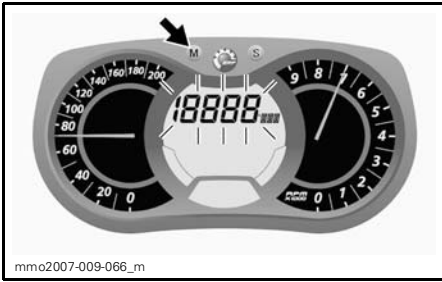

NOTE: Display will flash for approximately 5 seconds, then will return to the previously selected mode if display is not changed.

Push SET (S) button to select instant fuel consumption (L/100 km/MPG) mode.

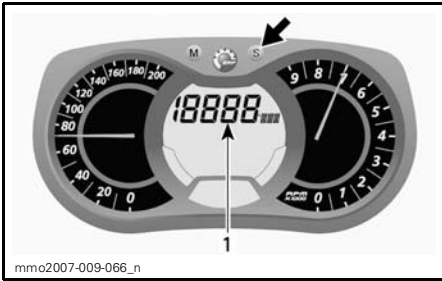

1. Instant fuel consumption (L/100 km/MPG) mode

Push the MODE (M) button to confirm selection or wait 5 seconds.

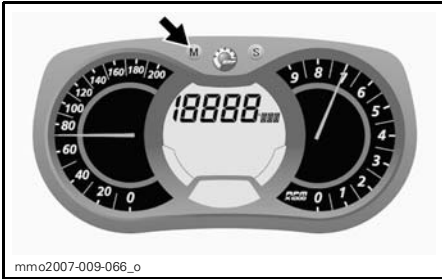

O) Total Fuel Consumption

600 HO SDI Models Only

Records vehicle average fuel consumption since it has been reset.

To display vehicle total fuel consumption, proceed as follow.

Push the MODE (M) button to select display.



NOTE: Display will flash for approximately 5 seconds, then will return to the previously selected mode if display is not changed.

Push the SET (S) button to select total fuel consumption (TC) mode.

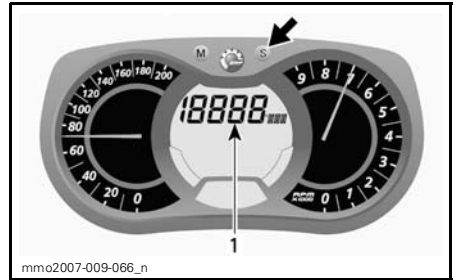

1. Total fuel consumption (TC) mode

Look for the abbreviation (TC) to ensure proper mode.

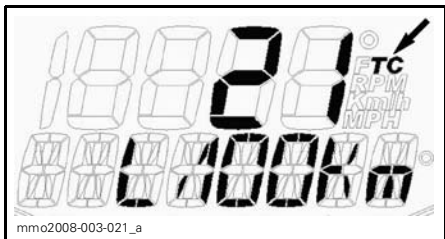

TYPICAL

Push the MODE (M) button to confirm selection or wait 5 seconds.

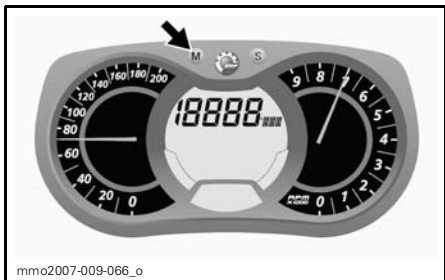

To reset, set the trip meter to TRIP B. Refer to *TRIP METER "A" OR "B"* for more details.

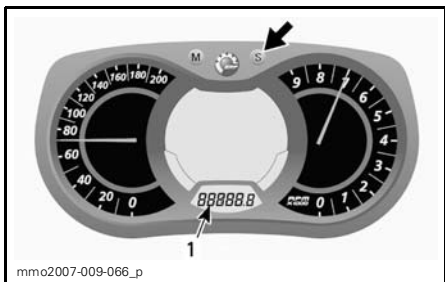

1. Trip meter (TRIP B) mode

Push and hold the SET (S) button to reset.



P) Message Display

This display is used as a complement of the pilot lamps to catch your attention and to give you a brief description if an anomaly occurs or to inform you of a particular condition.

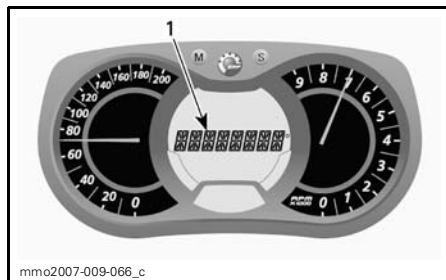

1. Message display

Message will be displayed with a beep code and pilot lamp(s).

Refer to *GAUGE PILOT LAMPS* for more details on beeper codes and what to do depending on the message.

MESSAGE	DESCRIPTION
ENGINE	Engine is overheating
CHECK ENGINE	Engine fault
LOW BAT/ HIGH BAT	Low/high battery voltage (if so equipped)
REVERSE	Reverse is selected
REV. FAIL	Reverse fail, try again
LOW OIL	Injection oil level is low
KNOCK	Ensure recommended fuel is used
SHUTDOWN	Engine overheating problem

5) Gauge Pilot Lamps

Gauge pilot lamp(s) will inform you if an anomaly occurs or to inform you of a particular condition.











TYPICAL — PILOT LAMPS

Pilot lamp can flash alone or in combination with another lamp.

Beeper codes will be heard and messages (depending on gauge model) will be displayed to catch your attention.

Refer to the following table for more details.

NOTE: Message display is not available on all gauges.

PILOT LAMP(S) ON	BEEPER	MESSAGE DISPLAY	DESCRIPTION
	Fast short beeps	ENGINE	Engine is overheating, reduce snowmobile speed and run in loose snow or stop engine immediately and allow engine to cool. Check cooling system.
	4 short beeps every 2 minutes	LOW BAT	Indicate a low or high battery voltage condition. See an authorized SKI-DOO dealer as soon as possible.
		HIGH BAT	
	Fast short beeps	LOW OIL	Critical low injection oil level. Stop vehicle in a safe place then, replenish injection oil reservoir as soon as possible.
	4 short beeps	CHECK ENGINE	Engine fault, see an authorized SKI-DOO dealer as soon as possible.
	4 short beeps every 2 minutes	KNOCK	<ul style="list-style-type: none"> - Ensure recommended fuel is used. - Check fuel quality, replace if necessary. - If fault still occurs, contact an authorized SKI-DOO dealer.
	Continuously beeps	SHUTDOWN	Shutdown procedure in force due to engine overheating problem, remove tether cord cap (DESS key) and contact an authorized SKI-DOO dealer.
	4 short beeps every 2 minutes	LOW OIL	Injection oil level is low. Stop vehicle in a safe place then, replenish injection oil reservoir.
	—	—	Low fuel level. One (1) bar left in fuel level display. Replenish fuel tank as soon as possible.
	Slow long beeps	REVERSE	Electronic reverse is selected.
	3 short beeps	REV. FAIL	Engine rotation did not change after reverse try, try again.
	—	—	Headlamp is in HI beam position
DESS	Refer to <i>DESS PILOT LAMP CODES</i> in <i>TETHER CUT-OUT SWITCH</i>		

6) Gauge MODE (M) Button

Multifunction Analog/Digital Gauge Only

Button use to navigate in gauge multi-function display.

NOTE: MODE (M) button on the multi-switch housing has the same functions and can also be used.

7) Gauge SET (S) Button

Button use to navigate, adjust or reset gauge multifunction display.

NOTE: SET (S) button on the multi-switch housing has the same functions and can also be used.

8) Throttle Lever

Designed to be thumb activated. When squeezed, it increases the engine speed and engages the transmission. When released, engine speed returns automatically to idle.

⚠ WARNING

Test the throttle lever operation each time before starting the engine. The lever must return to its original position once released. Otherwise, do not start engine.

9) Brake Lever

When squeezed, the brake is applied. When released, it automatically returns to its original position. Braking effect is proportional to the pressure applied on the lever and to the type of terrain and its snow coverage.

10) Parking Brake Lever

Parking brake should be used whenever snowmobile is parked.

⚠ WARNING

Make sure parking brake is fully disengaged before operating the snowmobile. When you ride the vehicle, brake pads that are caused to drag by a continuous pressure on the lever may cause damage to the brake system and cause loss of braking capacity and/or fire.

To Engage Mechanism

Squeeze brake lever and maintain while pulling locking lever with a finger. When brake lever is held at halfway the parking brake should be fully applied.

CAUTION: Parking brake position can vary depending on brake pads wear. Ensure when the parking brake is applied that the vehicle stays securely in place.

NOTE: Locking lever can be adjusted in two different positions.

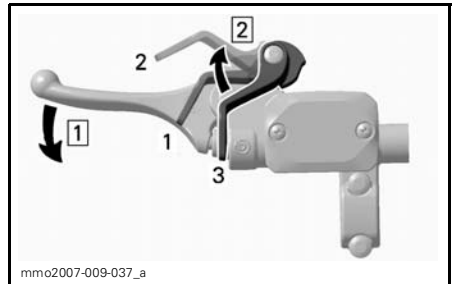

TYPICAL — ENGAGE MECHANISM

Step 1: Squeeze and maintain brake lever
Step 2: Adjust locking lever

1. Position 1
2. Position 2
3. OFF

To Release Mechanism

Squeeze brake lever. Locking lever will automatically return to its original position. Always release parking brake before riding.

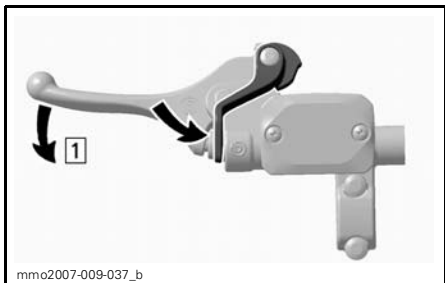

mmo2007-009-037_b

TYPICAL — RELEASE MECHANISM

Step 1: Squeeze brake lever

11) Multi-Switch Housing

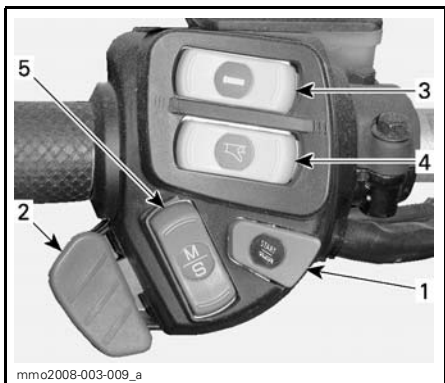

mmo2008-003-009_a

TYPICAL

1. Electronic Reverse (RER) button
2. Headlamp dimmer switch
3. Heating grips
4. Heating throttle lever
5. Mode/set button

Electronic Reverse (RER™) Button

When pressed, it allows selection the electronic reverse, refer to *SHIFTING IN REVERSE* in *OPERATING INSTRUCTIONS* section for procedure.

Headlamp Dimmer Switch

When pressed, it allows selection of headlamp HI or LOW beam. Lights are automatically ON whenever the engine is running.

Heating Grips Switch

Select the desired position to keep your hands at a comfortable temperature.

All Models except X™ and Limited Package

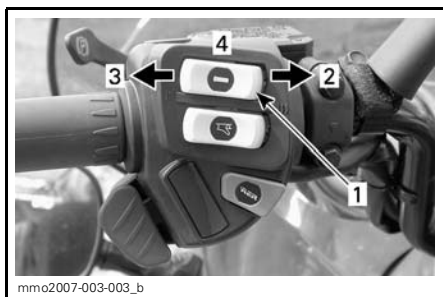

mmo2007-003-003_b

TYPICAL

1. Heating grip switch
2. Hot
3. Warm
4. Off

X and Limited Package Only

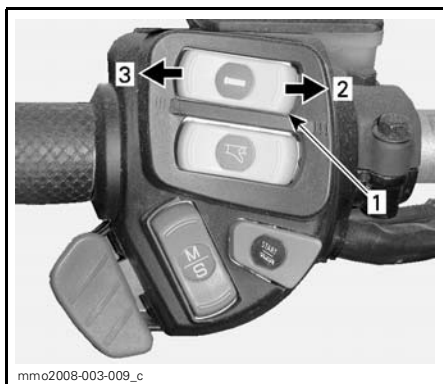

mmo2008-003-009_c

1. Heating grip switch
2. Warmer
3. Colder

On the above mentioned models, grips heating intensity will be displayed via the multifunction display

Heating grips will be in OFF position when there are no bars left in the display.

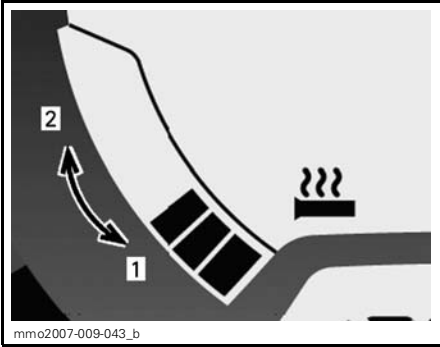

mmo2007-009-043_b

MULTIFUNCTION GAUGE — HEATING INTENSITY

1. Colder
2. Warmer

Heating Throttle Lever Switch

Select the desired position to keep your thumb at a comfortable temperature.

All Models except X and Limited Package

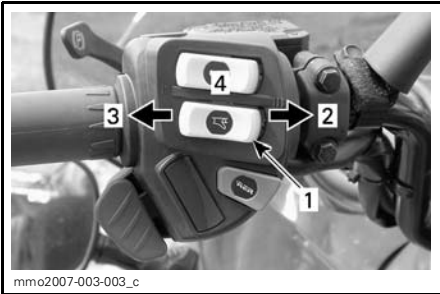

mmo2007-003-003_c

TYPICAL

1. Heated throttle lever switch
2. Hot
3. Warm
4. Off

X and Limited Package Only

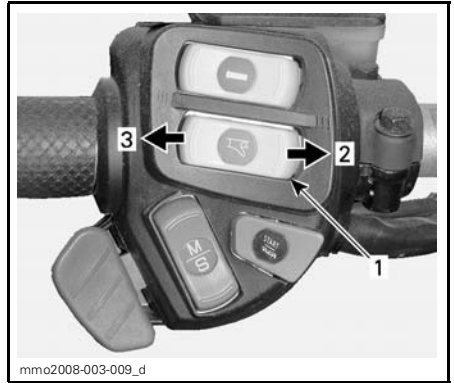

mmo2008-003-009_d

1. Heated throttle lever switch
2. Warmer
3. Colder

Heating throttle lever will be in OFF position when there are no bars left in the display.

NOTE: Bar gauge will be displayed with the activation of the throttle lever switch. When released, display will return to fuel tank level.

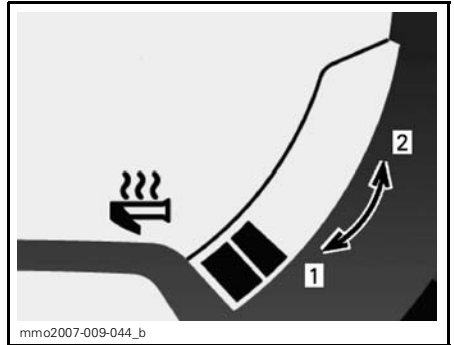

mmo2007-009-044_b

MULTIFUNCTION GAUGE — HEATING INTENSITY

1. Colder
2. Warmer

Mode/Set Button

X and Limited Package Only

This button can be used instead of the two buttons on top of the analog/digital gauge to facilitate gauge adjustments.

- When pushed upward, it has the same functions as the MODE (M) button.
- When pushed downward, it has the same functions as the SET (S) button.

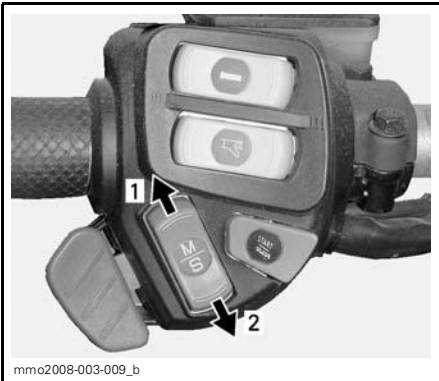

MULTIFUNCTION GAUGE

1. MODE function
2. SET function

12) Handlebar

The handlebar controls the steering of the snowmobile. As the handlebar is rotated to right or left, the skis are turned right or left to steer the snowmobile.

⚠ WARNING

Fast reverse while turning, could result in loss of stability and control.

13) Holding Strap

Summit and Renegade X Models

Holding strap provides a grip for driver when side-hilling.

⚠ WARNING

This strap is not for towing, lifting or other purpose than temporary use as a grab handle during side-hilling. Always keep at least one hand on handlebar.

14) Tether Cut-Out Switch

General

When the tether cord cap (DESS key) is removed, it shuts the engine off preventing snowmobile to runaway if the operator falls off the vehicle accidentally.

⚠ WARNING

Always remove the tether cord cap (DESS key) when vehicle is not in operation in order to prevent accidental engine starting, to avoid unauthorized use by children or others or theft.

Operation

Attach tether cord eyelet to clothing, then snap cap (DESS key) over post before starting engine.

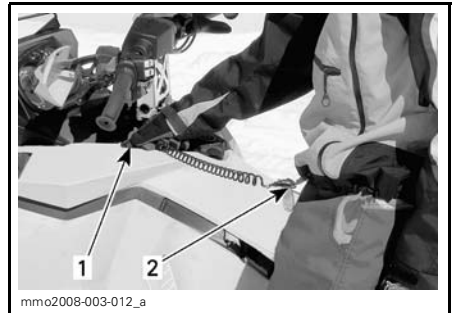

TYPICAL

1. Snap over post
2. Attach to clothing

If emergency engine shut off is required, pull tether cord cap (DESS key) from post completely.

DESS (Digitally Encoded Security System) Key/Cut-Out Switch

On these models, the tether cord cap (DESS key) is digitally encoded to provide you and your snowmobile with the equivalent security of a conventional lock key and it shuts off the engine preventing snowmobile to run-away if the operator falls off the vehicle accidentally.

The DESS key provided with your snowmobile contains an electronic chip which features a unique permanently memorized digital code. Your authorized SKI-DOO dealer programs this key in the ECM (Engine Control Module) of your snowmobile to allow engine operation above 3000 RPM if and only if this unique code has been read after engine starting.

If another DESS key is installed, the engine will start but will not reach drive pulley engagement speed to move vehicle.

Make sure the DESS key is free of dirt or snow.

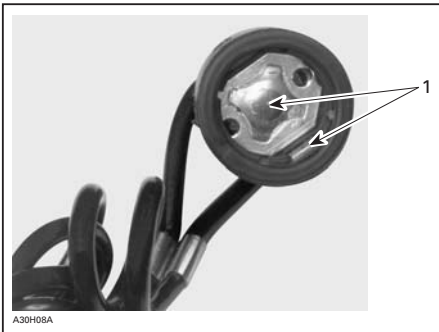

DESS KEY

1. Free of dirt or snow

Additional DESS Keys

The ECM of your snowmobile can be programmed by your authorized SKI-DOO dealer to accept 8 different keys.

We recommend the purchase of additional keys from your authorized SKI-DOO dealer. If you have more than one DESS-equipped SKI-DOO snowmobile, each can be programmed by your authorized SKI-DOO dealer to accept the other vehicles keys.

DESS Pilot Lamp Codes

NOTE: If any code still occurs, contact an authorized SKI-DOO dealer.

WARNING SIGNALS		DESCRIPTION	
BEEPER	DISPLAY MESSAGE		
2 shorts	WELCOME...	Personalized welcome message, good key	
Slow short beeps/ repetitive	CHECK KEY	Unable to read key (bad connection)	Make sure the key is free of dirt or snow. Reinstall key and restart engine. Vehicle can not be driven.
Fast short beeps/ repetitive	BAD KEY	Invalid key or key not programmed	Use the proper key for this vehicle or have the key programmed. Vehicle can not be driven.

15) Engine Cut-Out Switch

Push-pull type switch. To stop the engine in an emergency, select OFF position (down) and simultaneously apply the brake. To restart, button must be at the ON position (up).

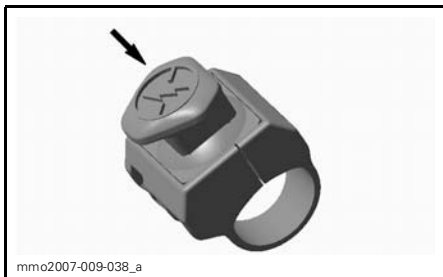

OFF POSITION

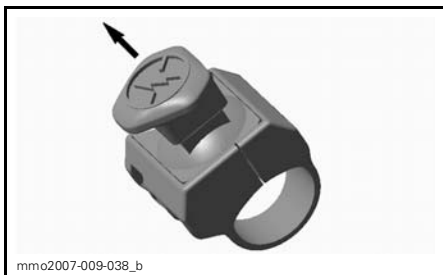

ON POSITION

All operators of the snowmobile should familiarize themselves with the function of this device by using it several times on first outing and whenever stopping the engine thereafter. This engine cut-out procedure will become a reflex and will prepare operators for emergency situations requiring its use.

WARNING

If the switch has been used in an emergency caused by a suspected malfunction, the source of the malfunction should be determined and corrected before restarting engine. See an authorized SKI-DOO dealer for servicing.

16) Rewind Starter Handle

Auto-rewind type located on right hand side of snowmobile. To engage mechanism, pull handle slowly until a resistance is felt then pull vigorously. Slowly release handle.

17) Choke Lever

See proper usage instructions in *OPERATING INSTRUCTIONS* section.

This device features a 3-position lever to facilitate cold start.

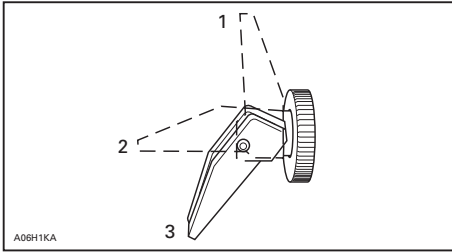

1. OFF
2. Position 2
3. Position 3

Initial Cold Starting

NOTE: Do not operate the throttle lever with the choke lever on.

Move the choke lever to position 3 and start the engine. As soon as the engine starts, move the lever to position 2. After a few seconds (10 seconds maximum) move the choke lever to OFF.

NOTE: In severe cold weather, colder than -20°C (-4°F) you may need to flip choke lever from OFF to position 1 a couple of times once engine is started.

Warm Engine Starting

Start the engine without any choke. If the engine will not start after two pulls of the rope or two 5 second attempts with the electric starter move choke lever to position 2. Start the engine without activating the throttle lever. As soon as the engine starts move the choke lever to OFF.

18) Fuel Tank Cap

Unscrew to fill up tank then fully tighten.

⚠ WARNING

Always stop the engine before refueling. Fuel is flammable and explosive under certain conditions. Always work in a well ventilated area. Do not smoke or allow open flames or sparks in the vicinity. Open cap slowly. If a differential pressure condition is noticed (whistling sound heard when loosening fuel tank cap) have vehicle inspected and/or repaired before further operation. Do not overfill or top off the fuel tank before placing the vehicle in a warm area. As temperature increases, fuel expands and might overflow. Always wipe off any fuel spillage from the vehicle. Periodically verify fuel system.

NOTE: Do not sit or lean on seat when fuel tank cap is not properly installed.

19) Heated Carburetor Valve

The heated carburetor valve should be closed except:

- When riding between -5°C and 5°C (23°F and 41°F) in a high relative humidity.
- When riding in deep powder snow.
- When following another snowmobile in high snow conditions.

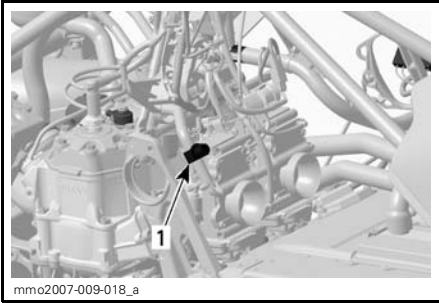

TYPICAL — REMOVE BELT GUARD
 1. Carburetor valve

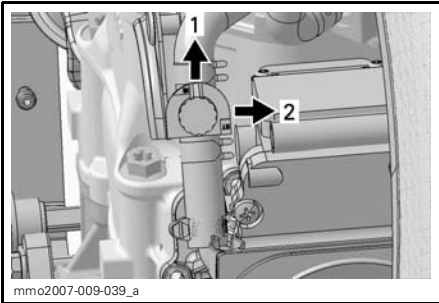

1. ON position
 2. OFF position

CAUTION: When operating the snowmobile above 5°C (41°F), move the carburetor heating valve to the OFF position.

20) Hood and Side Panels

Hood

To open hood, release hood retaining pins then slide hood towards the front of the vehicle.

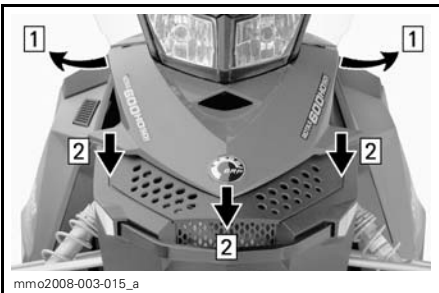

Step 1: Release retaining pins
 Step 2: Slide hood towards the front

Side Panels

To open a side panel, stretch and unhook the latches.

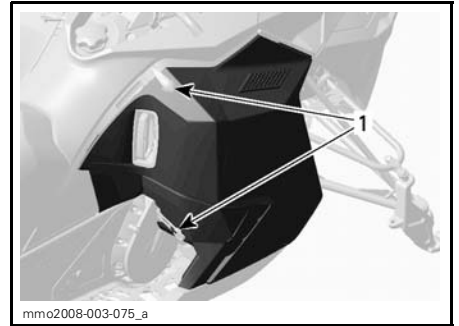

TYPICAL
 1. Latches

21) Fuses

The electrical system is protected with fuses, refer to *MAINTENANCE* for details.

The fuse holders are located in the engine compartment.

CAUTION: Do not use a higher rated fuse as this can cause severe damage to electrical components and/or be a potential fire.

⚠️ WARNING

If fuse has burnt out, source of malfunction should be determined and corrected before restarting. See an authorized SKI-DOO dealer for servicing.

500SS and 800R Engines

Manual Start



RH SIDE OF ENGINE COMPARTMENT

1. Fuse location

600 HO SDI Engine

Manual Start

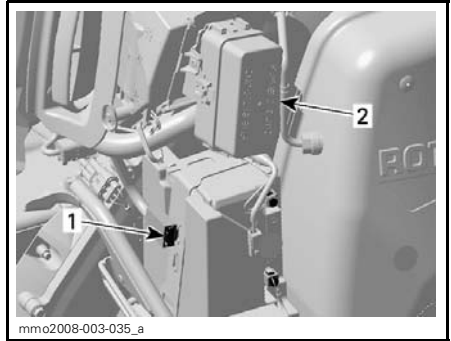

RH SIDE OF ENGINE COMPARTMENT

1. Fuse location
2. Fuse box

Electric Start

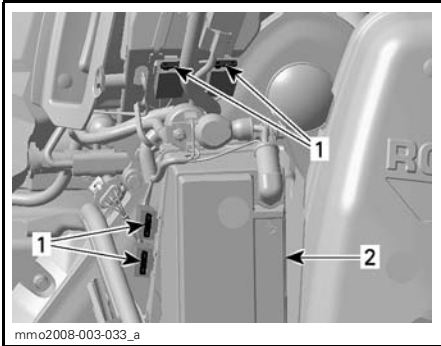

RH SIDE OF ENGINE COMPARTMENT

1. Fuse location
2. Battery

Electric Start

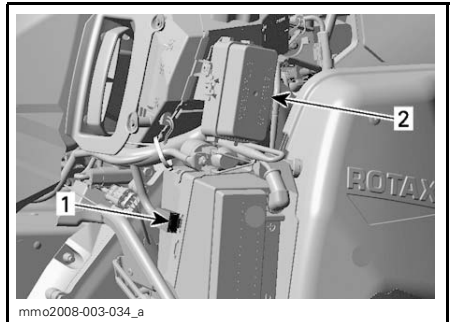

RH SIDE OF ENGINE COMPARTMENT

1. Fuse location
2. Fuse box

Electric Fuel Level Sender

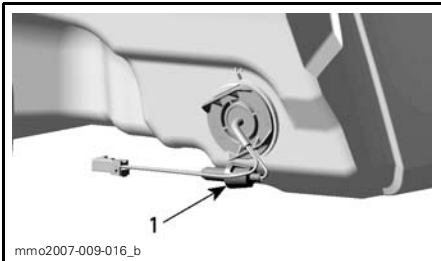

BEHIND AIR INTAKE SILENCER

1. Fuse location

Electric Fuel Level Sender

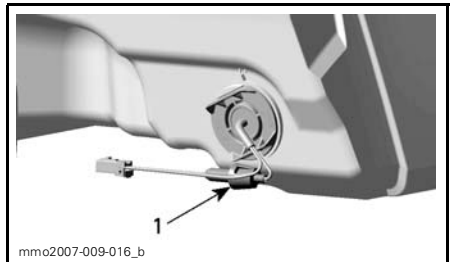

BEHIND AIR INTAKE SILENCER

1. Fuse location

22) Grab Handle/Bumper

To be used whenever snowmobile requires manual lifting.

WARNING

Do not attempt to lift the vehicle by hand alone. Use appropriate lifting device or have assistance to share lifting stress in order to avoid risk of strain injuries.

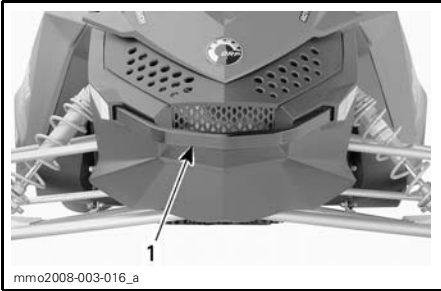

FRONT

1. Grab handle/bumper



REAR

1. Grab handle/bumper

CAUTION: Do not use skis to pull or lift snowmobile.

23) Storage Compartment

WARNING

All storage compartments must be properly latched and they must not contain any sharp, heavy or breakable objects.

CAUTION: MAXIMUM load is 1.8 kg (4 lb) evenly distributed.

Pull latch slightly upward then, backward to unlock cover.

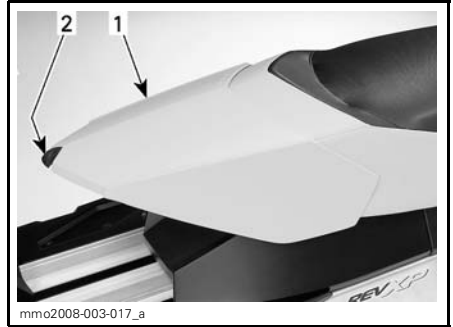

1. Storage compartment
2. Latch

24) Tool Kit

A tool kit containing tools for basic maintenance is supplied with the vehicle.

Tool bag is located in engine compartment on pulley guard.

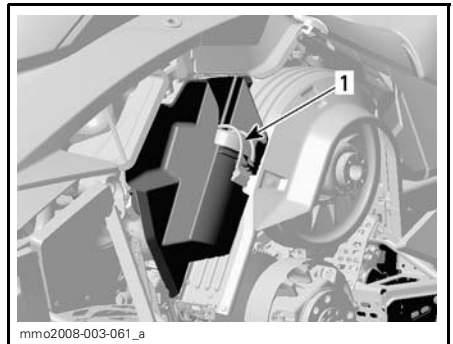

1. Tool kit

25) Spark Plug Storage

A space is provided in the tool kit to keep spare spark plugs dry and prevent shocks that might affect the adjustment or break them.

NOTE: Spare spark plugs are not supplied with snowmobile.

NOTE: Check spare spark plug gap according to *SPECIFICATIONS* before installation.

CAUTION: Do not attempt to adjust spark plug gap.

26) Spare Drive Belt Holder

A spare drive belt can be stored in holder.

NOTE: Spare drive belt is not supplied with the snowmobile.

CAUTION: To avoid damages to the drive belt, ensure that belt does not come in contact with tuned pipe when installed in its support.

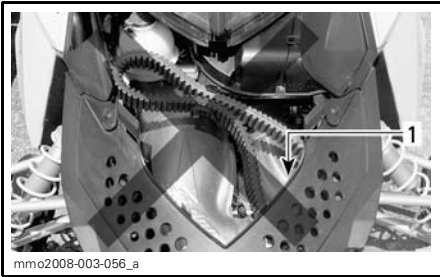

WRONG INSTALLATION

1. Drive belt in contact with tuned pipe

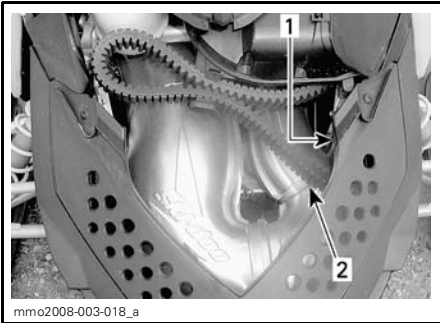

INSTALLED CORRECTLY

1. Drive belt over bumper
2. Ensure there is no contact with tuned pipe

27) Shields and Guards

WARNING

Never operate engine without belt guard securely installed or, with hood, brake disk guard or side panels opened or removed.

Your snowmobile is provided with a number of shields and guards. Leave these in place on your vehicle as they are designed to keep clothing and hands out of moving parts and away from hot components. Never attempt to make adjustments to any moving part while the engine is running.



TYPICAL

1. Side panels
2. Upper front hood
3. Lower front hood

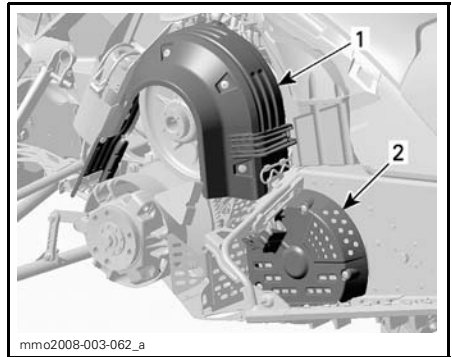

1. Belt guard
2. Brake disk guard

28) Track

WARNING

Never stud a track that has not been approved for studs. Installing studs on an unapproved track could increase the risk of the track tearing or severing, possibly resulting in serious injury or death.

WARNING

You may stud the track on this vehicle model. However, you **MUST** only use the BRP approved type stud. **DO NOT EVER** use conventional studs as the track thickness is thinner than other standard tracks. The stud could tear off of track and separate from vehicle posing a potential risk of severe injury or death. See an authorized SKI-DOO dealer for current specific studding availability and applications.

Depending on the model of snowmobile that you own, your vehicle may come with a track that has been approved by BRP for special studs installation, a track for which the manufacturer permits the installation of special studs or a track for which the manufacturer forbids it.

Tracks approved for the installation of special studs have a stud symbol (see illustration) molded into the track surface, and tracks not approved bear a forbidden stud symbol (see illustration).

Before proceeding with the installation of special studs on tracks you must contact your authorized SKI-DOO snowmobile dealer for current specific studding availability and applications. You must first acquaint yourself with the safety instructions related to the studding of tracks, found in the section entitled *TRACTION ENHANCING PRODUCTS* in the *SAFETY INFORMATION* section at the beginning of this guide. This section also provides other important information that you must consider before having studs installed on a track.

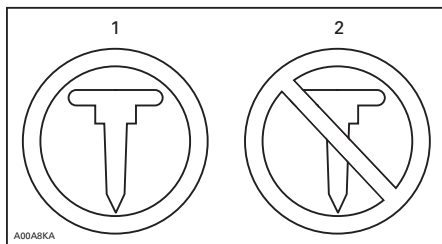

TRACK SYMBOLS

1. *Approved*
2. *NOT Approved*

Models Equipped with Track Profile Height of 44.5 mm (1.75 in) and Higher

Generally, snowmobiles adapted for mountain riding comes with tracks equipped with high lug profiles. These tracks are optimized for operation on loose snow.

BRP does **not recommend** to ride a snowmobile equipped with high lug profile track at **high speed** in a trail, on hard packed surfaces or ice for an extended period of time.

In the event that you have to, **reduce your speed**, then minimize the distance you ride on those surfaces.

CAUTION: Running those tracks at **high speed** in a trail, on hard packed surfaces or ice put more stress on the lugs, which tend to heat up as a result. To avoid potential degradation or damage to the track, **reduce your speed**, then minimize the distance you ride on those surfaces.

For general instructions on maintenance of tracks, refer to the sections *TRACK CONDITION* and *TRACK TENSION AND ALIGNMENT* in the *MAINTENANCE* section of this guide.

29) Seat Latch

Seat can be removed to have access to the Operator's Guide (located in seat base) or for maintenance purposes.

Seat latch is located at the front of the seat.

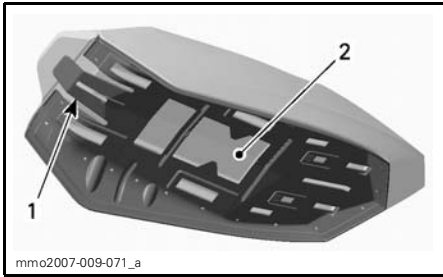

SEAT BASE

1. Seat latch
2. Operator's Guide location

Seat Removal

To have access to seat latch, gently pull the front of seat.

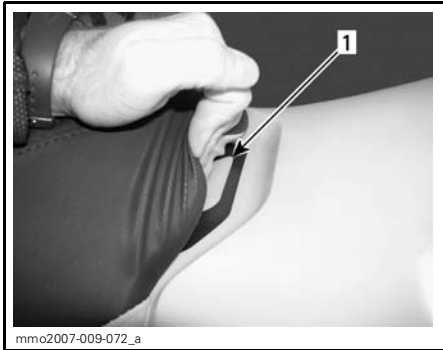

1. Seat latch

Pull and hold seat latch, then, pull seat with a rearward movement to remove.

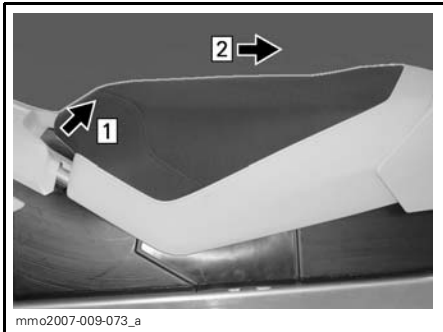

- Step 1: Pull and hold seat latch
- Step 2: Pull seat with a rearward movement

Seat Installation

CAUTION: Riding the vehicle with any objects between the seat and the fuel tank could damage the fuel tank. NEVER place any objects between seat and fuel tank.

Position seat in place.

Push seat forward until it latch in its position.

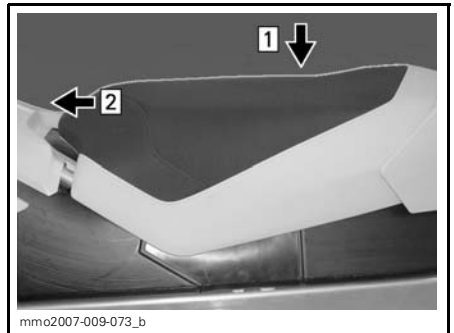

- Step 1: Position seat in place
- Step 2: Push seat forward until it latch

NOTE: A distinctive snap will be felt. Double check that the seat is secure by giving it a tug to confirm proper latching.



SEAT INSTALLED

WARNING

Make sure seat is securely latched before riding.

30) 1+1 Seat

GSX® Limited Touring Only

On the above mentioned models, a 1+1 passenger seat is provided as standard equipment.

WARNING

Any passenger must be able to firmly lay his feet on the footrests and keep his hands on the grab handles at all times when seated. Respecting those physical criteria is important to ensure that the passenger is stable and to reduce the risks of ejection.

1+1 Seat Removal

Unplug 1+1 seat connector.

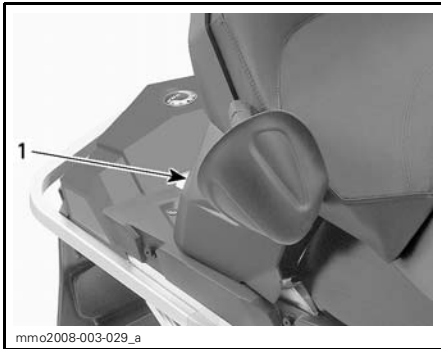

1. Connector location

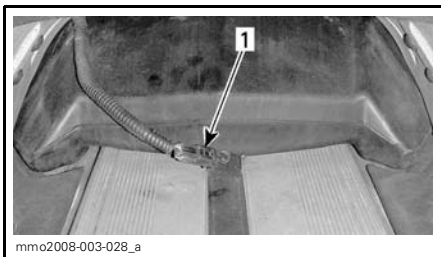

1. Connector

Push and hold seat latch while gently lifting rear of seat.

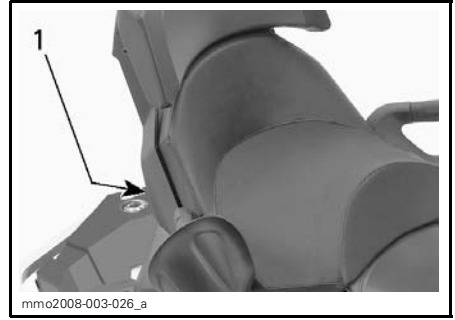

1. Seat latch location

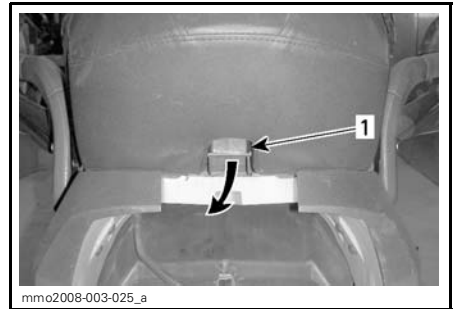

1. Seat latch

Continue lifting movement until you can release the front retaining device then completely remove seat.



1. Retaining device

CAUTION: Make sure to unplug seat harness before removing seat.

1+1 Seat Installation

Insert seat retaining device into set base.

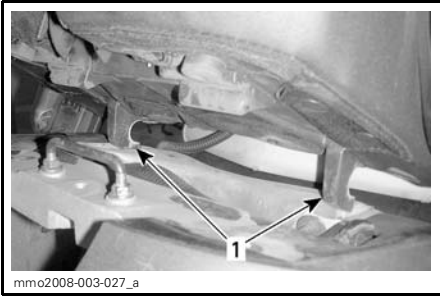

1. Retaining device

When seat rests in its position, firmly push seat down to latch.

NOTE: A distinctive snap will be felt. Double check that the seat is secure by giving it a tug to confirm proper latching.

⚠ WARNING

Make sure seat is securely latched before riding.

Connect 1+1 seat connector.

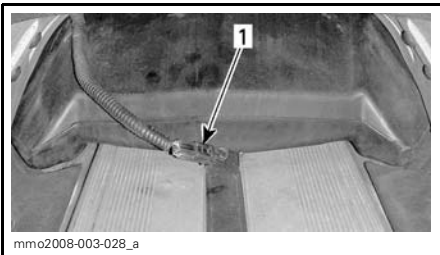

1. Connector

31) Rear Passenger Heating Grip Switch

GSX Limited Touring Only

Three-position switch. Select the desired position to keep rear passenger's hands at a comfortable temperature.

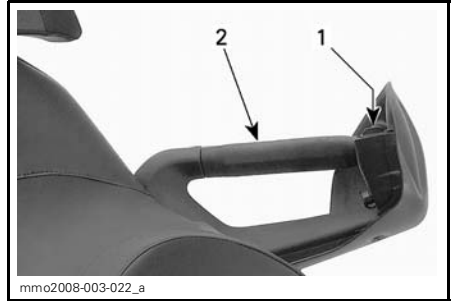

PASSENGER LH GRAB HANDLE

1. Switch
2. LH grab handle

32) Rear Grab Handles

GSX Limited Touring Only

Rear grab handles provides a grip for the passenger.

33) Electric Visor Jack Connector

An electric visor can be connected to the jack connector. Electric current is supplied whenever engine is running. A stress relief extension is supplied with the vehicle.

34) Adjustable Mirrors

Each mirror can be adjusted to suit driver's preference.

⚠ WARNING

Adjust with vehicle at rest in a safe place.

35) Integrated Bag

GSX Sport and Limited Only

On the above mentioned models, a sport tunnel bag is provided as standard equipment.

⚠ WARNING

Integrated bag must be properly latched and must not contain any sharp, heavy or breakable objects.

CAUTION: MAXIMUM load for this bag is 1.4 kg (3 lb) evenly distributed.



mmo2008-003-030

36) Rear Rack

⚠ WARNING

All objects in rear rack must be properly latched. Do not carry any breakable objects. Excessive weight in rack may reduce steering ability.

CAUTION: Always readjust suspension according to the load. The capacity of this rack is limited, the MAXIMUM cargo load is 15.8 Kg (35 lb). Ride at very low speed when loaded. Avoid speed over bumps.

37) 12-Volt Power Outlet

GSX Limited and Limited Touring Only

A 12-volt electric appliance may be connected to that jack connector. Electric current is supplied whenever engine is running.

38) C-Type Hitch

Use this hitch in conjunction with a tow bar to tow an accessory.

CAUTION: Refer to decal on vehicle for towing weight capacities.

⚠ WARNING

Never tow an accessory with a rope. Always use a rigid tow bar. Using a rope would result in a collision between the object and the snowmobile and possibly in a tip over in case of a rapid deceleration or on a downward slope.

How to use the C-Type Hitch

Detach hitch from its support by removing the hairpin.

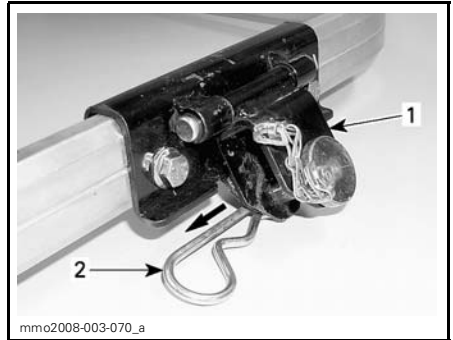

mmo2008-003-070_a

1. Hitch
2. Hairpin

Remove rod from hitch then attach rigid tow bar to hitch using the same rod.

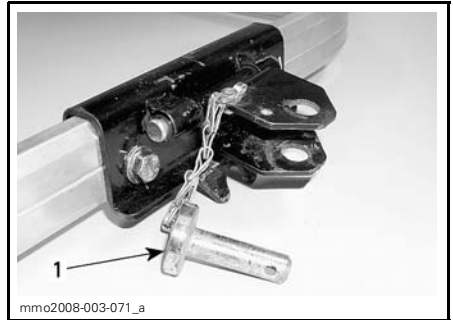

mmo2008-003-071_a

TYPICAL

1. Rod

Secure rod to hitch using hairpin previously removed.

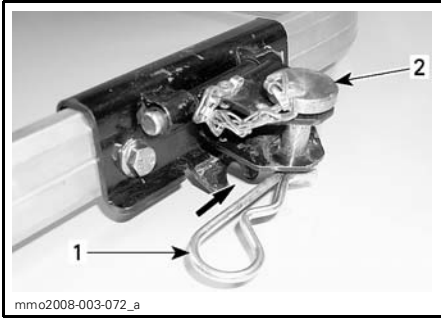

TYPICAL
 1. Hairpin
 2. Rod

CAUTION: To avoid damages to the vehicle, always release hitch from its support. Ensure hitch moves freely when towing accessories.

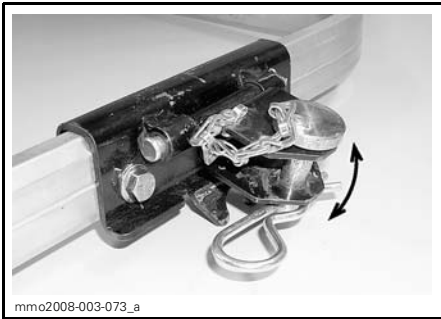

HITCH MOVES FREELY WHEN TOWING

To avoid noise from hitch when not in use, secure hitch to its support by using the hairpin.

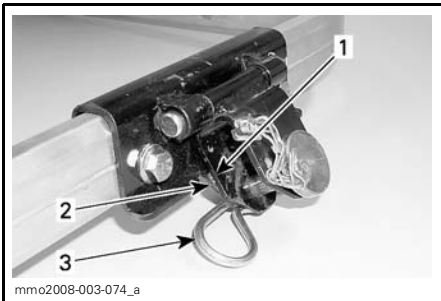

HITCH NOT IN USE
 1. Hitch
 2. Support
 3. Hairpin

RECOMMENDED FUEL AND OIL

Recommended Fuel

Use unleaded gasoline available from most service stations or oxygenated fuel containing a maximum total of 10% of ethanol or methanol or both. The gasoline used must have the following recommended minimum octane number.

OCTANE NUMBER				
Inside North America				
(87 (RON + MON)/2)				
(91 (RON + MON)/2)				
Outside North America				
92 RON				
95 RON				
	▼	▼	▼	▼
ENGINES	95	92	91	87
500SS	X	X	X	X
600 HO SDI	X	X	X	X
800R Power TEK	X	—	X	—

CAUTION: Never experiment with other fuels or fuel ratios. The use of unrecommended fuel can result in snowmobile performance deterioration and damage to critical parts in the fuel system and engine components. Do not mistake oil reservoir cap for fuel tank cap. Oil reservoir cap is identified OIL.

WARNING

Always stop the engine before refueling. Fuel is flammable and explosive under certain conditions. Always work in a well ventilated area. Do not smoke or allow open flames or sparks in the vicinity. Open cap slowly. If a differential pressure condition is noticed (whistling sound heard when loosening fuel tank cap) have vehicle inspected and/or repaired before further operation. Do not overfill or top off the fuel tank before placing the vehicle in a warm area. As temperature increases, fuel expands and might overflow. Always wipe off any fuel spillage from the vehicle. Periodically verify fuel system.

Fuel System Antifreeze

When using oxygenated fuel, additional gas line antifreeze or water absorbing additives are not required and should be not used.

When using non-oxygenated fuel, we highly recommend the use of isopropyl base gas line antifreeze in a proportion of 150 mL (5 U.S. oz) of gas line antifreeze added to 40 liters (10-1/2 U.S. gal) of gas.

This precaution is in order to reduce the risk of frost buildup in carburetors which may lead, in certain cases, to high fuel consumption or severe damage to engine.

NOTE: Use only methyl hydrate free gas line antifreeze.

Recommended Oil

CAUTION: Use only injection oil that flows at - 40°C (- 40°F). Do not mismatch oil reservoir cap with fuel tank cap. Oil reservoir cap is identified OIL.

Always maintain a sufficient amount of recommended injection oil in the injection oil reservoir.

Use only two-stroke engine injection oil sold by authorized SKI-DOO dealers.

CAUTION: Check level and refill every time you refuel.

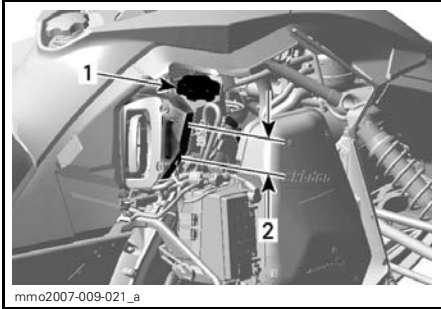

TYPICAL

1. Injection oil reservoir
2. Level marks (1/4, 1/2, 3/4)

⚠ WARNING

Do not overfill. Reinstall cap and fully tighten. Wipe off any oil spills. Oil is highly flammable when heated.

RECOMMENDED INJECTION OIL

XP-S synthetic oil ⁽²⁾ ⁽³⁾			
XP-S synthetic blend ⁽²⁾ ⁽³⁾			
XP-S mineral injection oil ⁽⁴⁾			
ENGINES	▼	▼	▼
500SS	X	X	X
600 HO SDI	—	X ⁽¹⁾	X
800R Power TEK	—	X ⁽¹⁾	X

(1) Preferred.

CAUTION: ⁽²⁾ XP-S synthetic oil and XP-S synthetic blend oil are specially formulated and tested for the severe requirements of these engines. Use of any other brand two-stroke oil may void the limited warranty. Use only XP-S synthetic oil or XP-S synthetic blend. There is no known equivalent on the market for the moment. If a high quality equivalent were available, it could be used.

⁽³⁾ XP-S synthetic oil and XP-S synthetic blend injection oil are compatible, they can be mixed together.

⁽⁴⁾ If not available, API TC high-quality low ash two-stroke injection oil may be used.

CAUTION: Never use four-stroke petroleum or synthetic motor oil and never mix these with outboard motor oil. Do not use NMMA TC-W, TC-W2 or TC-W3 outboard two-stroke engine oils or ashless two-stroke engine oils. Avoid mixing different brands of API TC oil as resulting chemical reactions may cause severe engine damage.

XP-S Mineral Injection

This is a special blend of basic oil and additives specially selected to ensure unequalled lubrication, engine cleanliness and minimum spark plug fouling.

XP-S Synthetic and XP-S Synthetic Blend Oil

The XP-S synthetic blend and XP-S synthetic oil provides superior lubrication, reduced engine component wear and oil deposit, thus maintaining maximum-level performance and anti-friction properties. These synthetic and synthetic blend injection oil meets the latest ASTM and JASO standards by ensuring high biodegradability and low exhaust smoke.

BREAK-IN PERIOD

Engine

CAUTION: A break-in period of 10 operating hours — 500 km (300 miles) — is required before running the snowmobile at full throttle.

During break-in period, maximum throttle should not exceed 3/4 opening. However, brief full acceleration and speed variations contribute to a good break-in.

CAUTION: Engine overheating, continued wide open throttle runs and prolonged cruising without speed variations should be avoided, this can cause engine damage during the break-in period.

500SS and 800R Engine Only

To assure additional protection during the initial engine break-in, 500 mL (18 imp. oz) of recommended injection oil should be added to fuel for the first full filling of fuel tank. Have spark plugs cleaned after engine break-in.

Belt

A new drive belt requires a break-in period of 50 km (30 miles). Avoid strong acceleration/deceleration, pulling a load or high speed cruising.

10-Hour Inspection

NOTE: The 10-hour inspection is at the expense of the snowmobile owner.

As with any precision piece of mechanical equipment, we suggest that after the first 10 hours of operation or 500 km (300 miles), whichever comes first, your snowmobile be checked by an authorized SKI-DOO dealer. This inspection will also give you the opportunity to discuss the unanswered questions you may have encountered during the first hours of operation.

OPERATING INSTRUCTIONS

Pre-Operation Check

WARNING

The pre-operation check is very important prior to operating the vehicle. Always check the proper operation of critical controls, safety features and mechanical components before starting. If not done as specified here, severe injury or death might occur.

- Remove snow and ice from body including seat, footrests, controls and instruments.
- Lights — The headlamp, the tail-light and the brake light are standard equipment. Be sure lights are clear of dirt, slush or snow and are in good working order or condition.
- Verify that track and idler wheels are free to turn and not frozen.

WARNING

Always use a wide base snowmobile mechanical stand to properly support vehicle during any track verification. Slowly accelerate engine in order to rotate track at very low speed when it is not on ground.

- Activate the brake control lever and make sure the brake fully applies before the brake control lever touches the handlebar grip. It must fully return when released.
- Check the parking device. Apply parking brake and check if it operates properly.
- Activate the throttle control lever several times to check that it operates easily and smoothly.

WARNING

Throttle lever must operate easily and smoothly. It must return to idle position when released.

- Check operation of tether cord cap (DESS key), engine cut-out switches, headlamp switch (HI-LO), tail-light, brake light and pilot lamps.
- Verify that skis and steering operate freely. Check corresponding action of skis versus handlebar.
- Check fuel and oil for levels and leaks. Replenish as necessary and see an authorized SKI-DOO dealer in case of any leaks.
- Verify that air silencer prefilter is free of snow.
- All storage compartments must be properly latched and they must not contain any heavy or breakable objects. Hood and side panels must be also properly latched.

WARNING

All adjustable features should be positioned at optimal setting. Securely tighten all adjustment locks.

- Make certain your snowmobile is pointed away from people or objects before you start it. No one is to be standing in front of or in back of the snowmobile.
- Be warmly dressed with clothing designed for snowmobiling.

PRE-OPERATION CHECK LIST		
ITEM	OPERATION	✓
Body including seat, footrests, lights, controls and instruments	Check that there is no snow or ice.	
Track and idler wheels	Check for free movement.	
Brake lever	Check proper action.	
Parking device	Check proper action.	
Throttle lever	Check proper action.	
Switches and lights	Check proper action. Tether cord must be attached to driver clothing eyelet.	
Skis and steering	Check for free movement and proper action.	
Fuel and oil	Check for proper level and leaks.	
Air silencer prefilter	Check that there is no snow or ice.	
Adjustable features	Check for optimal adjustment and securely tightened adjustment locks.	
Storage compartment	Check for proper latching and no heavy or breakable objects.	
Vehicle vicinity	Snowmobile must be pointed away from people or objects. No one is to be standing in front of or in back of the snowmobile.	
Clothing	Be warmly dressed with clothing designed for snowmobiling.	

SDI Engine Starting Procedure

General

IMPORTANT:

- if the low battery voltage pilot lamp is on, battery would not have enough power to start the engine. In this case, use the manual rewind starter
- if the battery is dead, engine cannot be started. Have the battery recharged or replaced.

Procedure

- Recheck throttle control lever operation.

- Ensure that the tether cord cap (DESS key) is in position and that the cord is attached to your clothing eyelet.
- Ensure that the engine cutout switch is in the ON position.

Manual Starting

- Grab manual starter handle, pull handle slowly until a resistance is felt, then hold handle firmly and pull vigorously to start engine.

WARNING

Do not apply throttle while starting.

Electric Starting (if so equipped)

- Depressing the START/RER button will engage the electric starter and start the engine.
- Release button immediately when engine has started.

WARNING

Do not apply throttle while starting.

CAUTION: Do not use electric starter for more than 10 seconds. A rest period should be observed between the cranking cycles to let electric starter cool down. Using electric starter when engine has started could damage electric starter mechanism.

NOTE: If for any reason, the engine cannot be cranked electrically, start engine manually using the rewind starter.

Carburetor Engine Starting Procedure

Procedure

- Recheck throttle control lever operation.
- Ensure that the tether cord cap (DESS key) is in position and that the cord attached to your clothing eyelet.
- Ensure that the engine cutout switch is in the ON position.
- Activate the choke according to the temperature as explained below.

Choke Application

Initial Cold Starting When Temperature is Below - 10°C (+ 15°F)

NOTE: Do not operate the throttle lever with the choke lever on.

Set the choke lever to position 3.

NOTE: After the engine is started, let engine warm up at fast idle until engine speed drops. Then, close off choke to ensure proper air-fuel mixture.

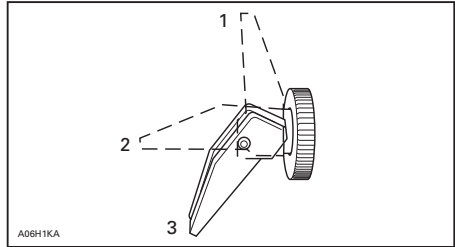

1. OFF
2. Position 2
3. Position 3

Initial Cold Starting When Temperature is Above - 10°C (above + 15°F)

Set the choke lever to position 2.

NOTE: After the engine is started, close off choke to ensure proper air-fuel mixture.

Warm Engine Starting

Start the engine without any choke. If the engine will not start after two pulls of the rope or two 5 second attempts with the electric starter move choke lever to position 2. Start the engine without activating the throttle lever. As soon as the engine starts move the choke lever to OFF.

Procedure (cont'd)

Manual Starting

- Grab rewind starter handle, pull handle slowly until a resistance is felt, then hold handle firmly and pull vigorously to start engine.

Electric Starting (if so equipped)

WARNING

Never depress throttle while starting engine.

CAUTION: Do not engage electric starter for more than 10 seconds at a time. A rest period should be observed between the cranking cycles to allow electric starter to cool down. Using electric starter when engine has started could damage electric starter mechanism.

- Depressing the START/RER button will engage the electric starter and start the engine.
- Release button immediately when engine has started.

NOTE: If for any reason, the engine cannot be started electrically, start engine manually using the rewind starter.

Vehicle Warm-Up

Before every ride, vehicle has to be warmed up as follows.

Engage parking brake.

Snowmobile must be securely supported by the rear bumper using a wide-base snowmobile mechanical stand. Track must be 100 mm (4 in) off the ground.

Attach tether cord to operator's clothing eyelet.

Start engine and allow it to warm up two or three minutes at idle speed.

Disengage parking brake.

WARNING

Make sure wide-base snowmobile mechanical stand is stable. Stay clear of the front of vehicle and the track. Do not use too much throttle during warm-up or when track is free-hanging.

Apply throttle until drive pulley engages. Let track rotate at low speed for several turns. The lower the vehicle temperature, the longer vehicle warm-up should be.

Shut-off the engine and remove the wide-base snowmobile mechanical stand.

Skis may be frozen on the ground. Grab both skis one at a time by their loops and lift their front end slightly off the ground.

After restarting engine, the vehicle can be driven at low speed for the first 2 or 3 minutes of riding. After that, it may be driven up to the legal speed limit as per normal safety practices.

Shifting in Reverse

When the engine is running, depressing the RER button will slow down engine RPM to almost a stop and advance the ignition timing to cause direction change in crankshaft rotation.

- Engine will automatically shift into forward when re-starting after stopping or stalling.
- Shifting procedure will take place only when the engine is running.
- If engine is running at a speed above 4300 RPM, the reverse function of the RER button is cancelled.
- It is recommended to warm up the engine to its normal operating temperature before shifting.

Shifting in Reverse

WARNING

Shifting to reverse mode on these snowmobiles is done by depressing the RER button when the engine is running. Wait until the reverse alarm sounds and the RER pilot lamp comes on in the dash before operating throttle to proceed in reverse. The reverse speed of these snowmobiles is not limited. Always proceed with caution as fast reverse could result in loss of vehicle stability. Come to complete stop before depressing RER button. Always remain seated and apply the brake before shifting. Ensure the path behind is clear of obstacles or bystanders before proceeding.

With the snowmobile completely stopped and engine running at idle, press and release the RER button.

The RER pilot lamp will blink when the snowmobile is engaged in reverse.

Apply throttle slowly and evenly. Allow drive pulley to engage then accelerate carefully.

Shifting in Forward

With the snowmobile completely stopped and engine running at idle, press and release the RER button.

RER pilot lamp will stop.

Apply throttle slowly and evenly. Allow drive pulley to engage then accelerate carefully.

Shutting Off the Engine

Release throttle lever and wait until engine has returned to idle speed.

Shut off the engine using either engine cut-out switch or tether cord cap (DESS key) engine cut-out switch.



WARNING

Always remove the tether cord cap (DESS key) when vehicle is not in operation in order to prevent accidental engine starting or to avoid unauthorized use by children or others or theft.

Post-Operation Care

Shut off the engine. Install rear of vehicle on a wide-base snowmobile mechanical stand.

Remove snow and ice from rear suspension, track, front suspension, steering mechanism and skis.

Always cover your snowmobile when leaving it outside overnight or during extended periods of inactivity. This will protect it from frost and snow as well as help retain its appearance.

SPECIAL OPERATING INSTRUCTIONS

Riding at High Altitudes or Sea Level

CAUTION: Failure to re-calibrate may cause serious engine damage.

Refer to an authorized SKI-DOO dealer for proper calibration modifications.

MODEL(S)	FACTORY CALIBRATED FOR	PARTS REPLACEMENT/ADJUSTMENTS REQUIRED WHEN ALTITUDE IS
GSX and MX Z®	Sea level	Above 600 m (2000 ft)
SUMMIT (North America)	Within 600 – 2400 m (2000 – 8000 ft)	Below 600 m (2000 ft) OR above 2400 m (8000 ft)
SUMMIT (Europe)	Sea level	Above 600 m (2000 ft)

Riding in Cold Weather

Carburetor Equipped Models

All vehicles have been calibrated for - 20°C (- 4°F). They can be operated at warmer winter temperatures without risk of problems.

CAUTION: For colder temperatures than - 20°C (- 4°F), carburetor(s) must be recalibrated to avoid engine damage. Refer to an authorized SKI-DOO dealer.

Refer also to *RIDING AT HIGH ALTITUDES OR SEA LEVEL*.

Emergency Starting

The engine can be started with the emergency starter rope supplied with the tool kit.

Remove belt guard.

WARNING

Do not wind starting rope around your hand. Hold rope by the handle only. Do not start the snowmobile by the drive pulley unless it is a true emergency situation. Have the snowmobile repaired as soon as possible.

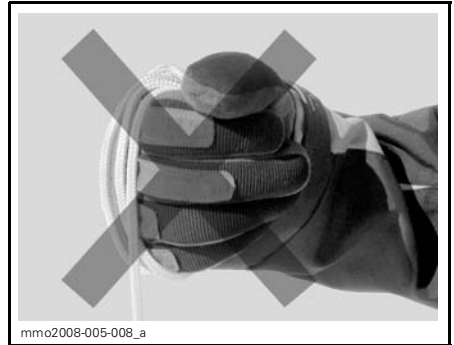

Attach one end of emergency rope to rewind handle.

NOTE: The spark plug socket can be used as an emergency handle.

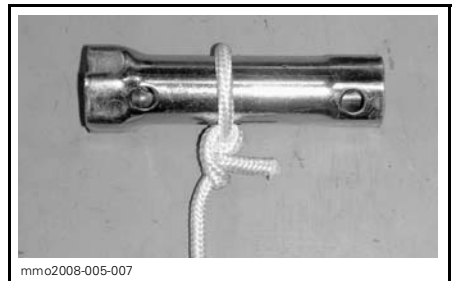

Attach the other end of emergency rope to the starter clip supplied in the tool kit.



⚠ WARNING

When starting the snowmobile in an emergency situation, using drive pulley, do not reinstall the belt guard and return slowly to have snowmobile repaired.

Towing an Accessory

Always use a rigid tow bar to tow an accessory. Any towed accessory should have reflectors on both sides and at the rear. Check local laws for brake light(s) requirements.

Hook up clip on drive pulley.

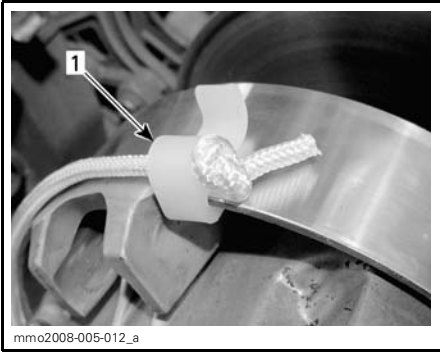

⚠ WARNING

Never tow an accessory with a rope. Always use a rigid tow bar. Using a rope would result in a collision between the object and the snowmobile and possibly in a tip over in case of a rapid deceleration or on a downward slope.

Towing Another Snowmobile

If a snowmobile is disabled and must be towed use a rigid tow bar, remove the drive belt from disabled snowmobile and tow at moderate speed.

1. Clip installation location

Wind the rope tightly around drive pulley. When pulled, pulley must rotate counterclockwise.

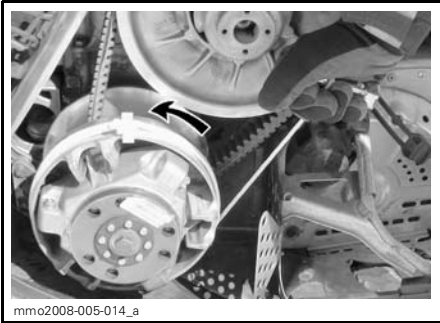

CAUTION: Always remove the drive belt of the snowmobile that is to be towed to prevent damage to its belt and drive system.

In an emergency situation only, if a rigid tow bar is not available, a rope can be used provided you proceed with extra caution. In some areas, it may be illegal to do so. Check with state or local authorities.

Pull the rope using a sharp, crisp pull so the rope comes free of the drive pulley.

Remove the drive belt, attach the rope to the ski legs (spindles), have someone sit on the towed snowmobile to activate the brake, and tow at low speed.

Start engine as per usual manual starting.

CAUTION: In order to prevent damage to the steering system, never attach the tow rope to the ski loops (handles).

 **WARNING**

Never ride at high speed when towing a disabled snowmobile. Proceed slowly with extra caution.

Transporting the Vehicle

Make sure that oil reservoir and fuel tank caps are properly installed.

Tilt bed trailers can easily be equipped with a winch mechanism to afford maximum safety in loading. Simple as it may seem, never drive your snowmobile onto a tilt bed trailer or any other kind of trailer or vehicle. Many serious accidents have resulted from driving up and over a trailer. Anchor your vehicle securely, front and rear, even on short hauls. Be certain all equipment is securely fastened. Cover your snowmobile when trailering to prevent road grime from causing damage.

Be certain your trailer meets state or provincial requirements. Ensure the hitch and safety chains are secure and the brake, turn indicators and clearance lights all function.

SUSPENSION ADJUSTMENTS

Snowmobile handling and comfort depend upon suspension adjustments.

Choice of suspension adjustments vary with carrying load, driver's weight, personal preference, riding speed and field condition.

NOTE: Some adjustments may not apply to your snowmobile. Use special keys in tool kit.

REAR SUSPENSION TYPE		
MODELS	TYPE	
	SC™-5M	SC-5
Summit	X	—
Others	—	X

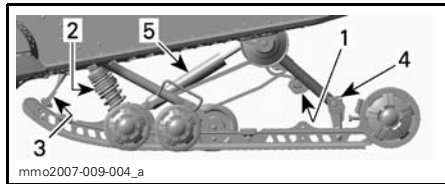

SC-5 REAR SUSPENSION

1. Rear springs adjustable cams for comfort and ride height
2. Center spring for steering behavior
3. Stopper strap for snowmobile weight transfer
4. Coupling blocks — Handling
5. Rear shock motion ratio — Damping strength (not adjustable on all models)

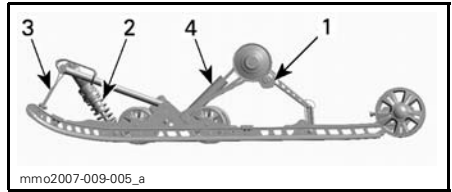

SC-5M REAR SUSPENSION

1. Rear springs adjustable cams for comfort and ride height
2. Center spring for steering behavior
3. Stopper strap for snowmobile weight transfer
4. Rear shock motion ratio — Damping strength (not adjustable)

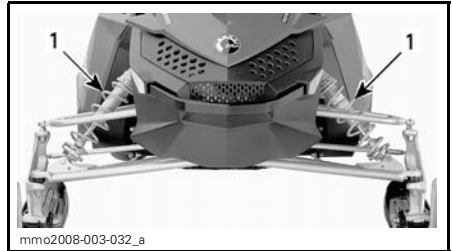

FRONT SUSPENSION

1. Front springs for handling

Following are guidelines to fine-tune suspension.

The best way to set up the suspension, is to start from factory settings, then customize each adjustment one at a time. Adjustments 2 through 6 are interrelated. It may be necessary to readjust center spring after adjusting front springs for instance. Test run the snowmobile under the same conditions; trail, speed, snow, driver riding position, etc. Change one adjustment and retest. Proceed methodically until you are satisfied.

WARNING

Always remove the tether cord cap (DESS key) before performing any maintenance or adjustment, unless otherwise specified. Vehicle must be parked in a safe place, away from the trail. Always lift the front of vehicle off the ground with a suitable lifting device before adjusting ski suspension. Lift the rear of vehicle off the ground with a wide-base snowmobile stand with a rear deflector panel before rear suspension adjustment.

WARNING

Do not attempt to lift the vehicle by hand alone. Use appropriate lifting device to avoid risk of strain injuries. Always make sure the lifting device is stable and secure before proceeding to adjust the suspension components.

CAUTION: Whenever adjusting rear suspension, check track tension and adjust as necessary.

Slight suspension bottoming occurring under the worst riding conditions indicates a good choice of spring preload.

NOTE: Some models may come from factory equipped with Take/Apart (T/A) shocks. These can be rebuilt or recalibrated. See an authorized SKI-DOO dealer.

Rear Springs — Comfort

IMPORTANT: Make sure that all objects to be transported are in place in storage compartment and rear rack.

- Grab rear bumper and lift until suspension is fully extended.
- From this point, rear of snowmobile should collapse by 50 to 75 mm (2 to 3 in) when driver and passenger (if so applicable) take place. Measure at rear bumper as shown in next illustration.

WARNING

Do not attempt to lift the vehicle by hand alone. Use appropriate lifting device or have assistance to share lifting stress in order to avoid risk of strain injuries.

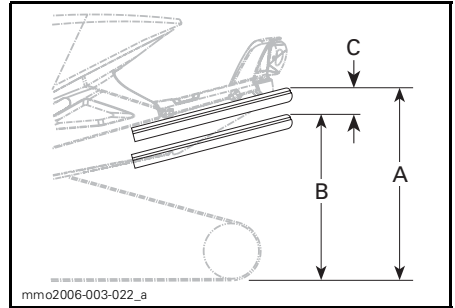

TYPICAL — PROPER ADJUSTMENT

- Suspension fully extended
- Suspension has collapse with driver, passenger(s) and load added
- Distance between dimension "A" and "B", must not exceed 50 to 75 mm (2 to 3 in), see table

Springs Adjustment

"C"	CAUSE	SOLUTION
50 to 75 mm (2 to 3 in)	No adjustment required	
More than 75 mm (3 in)	Adjusted too soft	Increase preload (see preload adjustment)
Less than 50 mm (2 in)	Adjusted too hard	Decrease preload (see preload adjustment)

Preload Adjustment

NOTE: Left and right adjustment cams may be at different settings.

CAM POSITIONS	SPRING PRELOAD
1	Minimum
2	Minimum/Intermediate
3	Intermediate
4	Intermediate/Maximum
5	Maximum

CAUTION: To adjust spring preload, always turn the left side adjustment cam in a clockwise direction, and the right side cam in a counterclockwise direction.

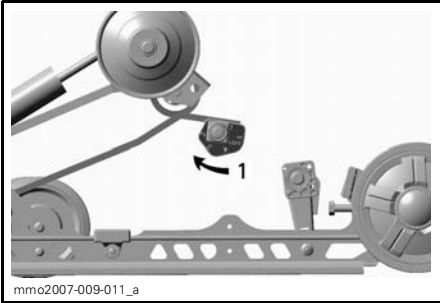

TYPICAL — SC-5 — LH SIDE
1. Adjust spring preload

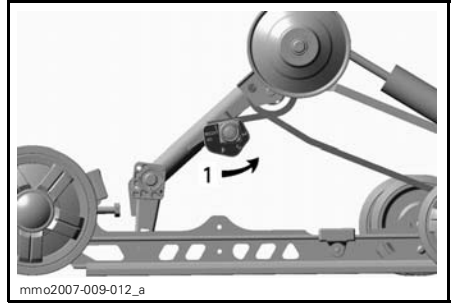

TYPICAL — SC-5 — LH SIDE
1. Adjust spring preload

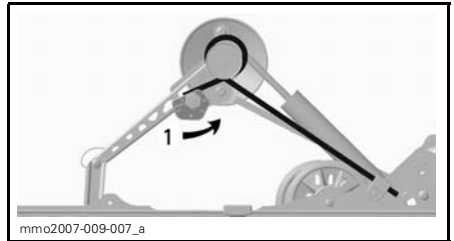

TYPICAL — SC-5M — RH SIDE
1. Adjust spring preload

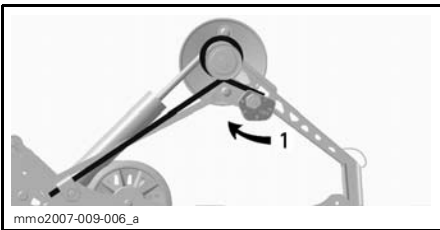

TYPICAL — SC-5M — LH SIDE
1. Adjust spring preload

Center Spring — Steering Behavior

- Ride at moderate speed on a trail.
- If handlebar seems too easy or too hard to turn, adjust center spring accordingly.

⚠ WARNING

Before proceeding with any suspension adjustment, remember:

- park in a safe place
- remove the tether cord cap (DESS key)
- lift rear of vehicle off the ground with a wide-base snowmobile stand with a rear deflector panel
- make sure lifting device is stable and secure.

CENTER SPRING ADJUSTMENT		
HANDLEBAR (steering attitude)	PROBLEM	SOLUTION
Easy to turn (neutral)	No adjustment required	
Harder to turn (oversteering)	Adjusted too soft	Increase preload
Very easy to turn (understeering)	Adjusted too hard	Decrease preload

Preload Adjustment

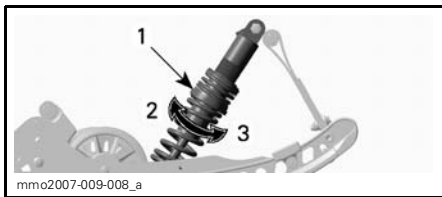

TYPICAL

1. Turn spring preload adjuster to increase or decrease preload
2. Turn clockwise to increase spring preload
3. Turn counterclockwise to decrease spring preload

Stopper Strap — Weight Transfer

- Ride at low speed then fully accelerate.
- Note steering behavior.
- Adjust stopper strap length accordingly.

WARNING

Before proceeding with any suspension adjustment, remember:

- park in a safe place
- remove the tether cord cap (DESS key)
- lift rear of vehicle off the ground with suitable lifting device
- make sure lifting device is stable and secure.

CAUTION: Whenever stopper strap length is changed, track tension must be readjusted.

STOPPER STRAP — WEIGHT TRANSFER			
WEIGHT TRANSFER		ADJUSTMENTS	
Steering	Track (skis)	Problem	Solution
Comfortable	Good weight transfer (light pressure)	No adjustment required	
Light	Too much weight transfer (lift off the ground)	Strap too long	Reduce strap length
Heavy	Not enough weight transfer (heavy pressure)	Strap too short	Increase strap length

Strap Adjustment

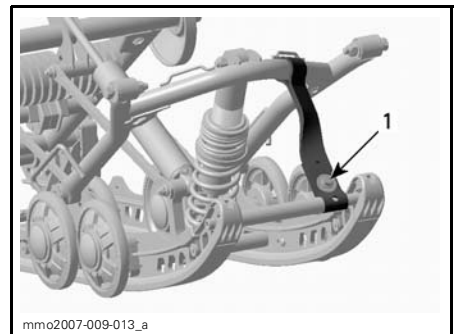

TYPICAL — SC-5

1. Increase or decrease strap length by bolting to a different hole

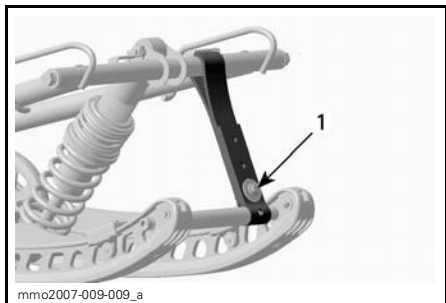

TYPICAL — SC-5M

1. Increase or decrease strap length by bolting to a different hole

Coupling Blocks — Handling

SC-5 Suspension Only

Coupling blocks will have an effect on vehicle handling while accelerating.

A minimum coupling adjustment while accelerating will generate less pressure on the skis.

At the opposite, a maximum coupling adjustment will generate more pressure on the skis.

Perform moderate acceleration from a stand point or while riding and check for desired handling.

If handling requires adjustment, turn both left and right blocks by 90° to the desired position.

NOTE: There are four possible adjustment positions. Side of block with the desired adjustment number must be facing the rubber stopper.

⚠ WARNING

Both blocks must be set at the same position. Otherwise vehicle behavior may be unpredictable and suspension may become warped.

Use tool provided in tool bag to adjust coupling blocks.

NOTE: When in driving position, the coupling blocks should not touch the rubber stoppers.

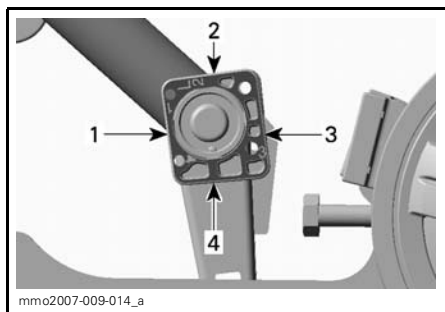

COUPLING BLOCK — LEFT SIDE VIEW ("L" — LEFT EMBOSSED ON BLOCK)

1. Position 1 (minimum)
2. Position 2 (minimum/intermediate)
3. Position 3 (intermediate/maximum)
4. Position 4 (maximum)

Rear Shock Motion Ratio — Damping Strength

MX Z X and Renegade X Only

Rear shock on the above mentioned models feature 2 adjustments.

Low Speed Compression Adjuster

The low speed adjuster modifies the compression damping force for small suspension velocities. This adjuster has 5 turns of adjustment. Use a flat screwdriver to adjust it. Turning it clockwise increases shock damping action (stiffer) for these low compression speeds.

High Speed Compression Adjuster

The high speed adjuster modifies the compression damping force for high suspension velocities. Use a 17 mm wrench to adjust it. Turning it clockwise increases shock damping action (stiffer) for these high compression speeds.

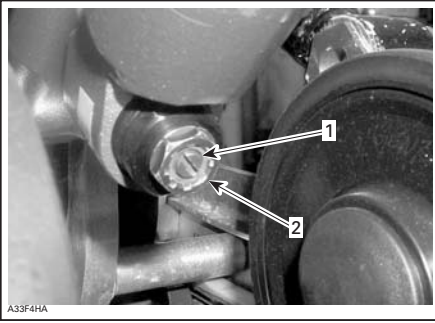

A33F4HA

TYPICAL

1. Low speed compression adjuster (flat screwdriver)
2. High speed compression adjuster (17 mm wrench)

Front Springs — Handling

- Ride at moderate speed and check for proper handling.
- Adjust front springs accordingly.

⚠ WARNING

Before proceeding with any suspension adjustment, remember:

- park in a safe place
- remove the tether cord cap (DESS key).

⚠ WARNING

Always adjust both front springs to same position.

FRONT SPRINGS ADJUSTMENT

HANDLING	STEERING	PROBLEM	SOLUTION
Good	Comfortable	No adjustment required	
Bad	Too easy to turn	Adjusted too soft	Increase spring preload
Bad	Hard to turn	Adjusted too hard	Decrease spring preload

Preload Adjustment

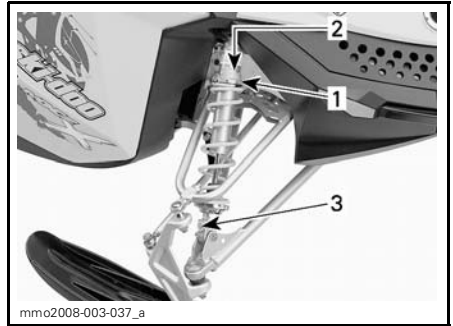

mmo2008-003-037_a

MX Z X AND RENEGADE X — CAN/US ONLY

1. Adjustment cam
2. Cam positions
3. Compression/rebound adjustment

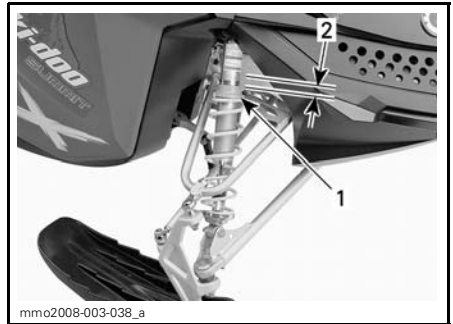

mmo2008-003-038_a

SUMMIT X/TNT/X PACKAGE EUROPE ONLY

1. Adjustment ring
2. Ring positions

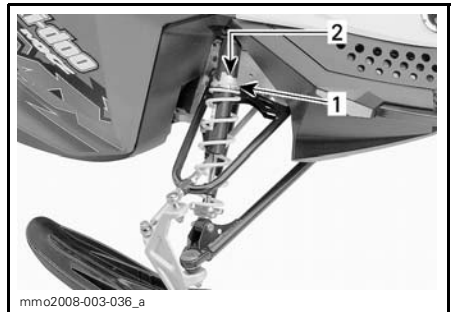

mmo2008-003-036_a

OTHERS

1. Adjustment cam
2. Cam positions

CAUTION: Make sure that both front springs are still pre loaded when front of vehicle is off the ground.

Front Suspension Shock Damping

X Package — Can/US Only

Compression/Rebound Adjustment

Front shock on the above mentioned models feature a compression/rebound adjustment.

Turn the damping adjuster accordingly. Turning it clockwise increases shock damping action (stiffer).

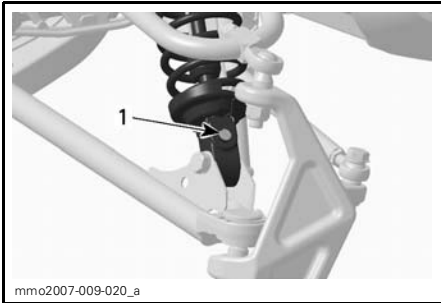

TYPICAL

1. *Damping adjuster*

Suspension Troubleshooting Chart

PROBLEM	CORRECTIVE MEASURES
Front suspension wandering	Check ski alignment and camber angle adjustment. See an authorized SKI-DOO dealer. Reduce ski ground pressure. <ul style="list-style-type: none"> – Reduce front suspension spring preload. – Increase center spring preload. – Reduce rear spring preload.
Snowmobile seems unstable and seems to pivot around its center	Reduce rear suspension front arm pressure. <ul style="list-style-type: none"> – Reduce center spring preload. – Increase rear spring preload. – Increase front suspension spring preload.
Steering feels too heavy	Reduce ski ground pressure. <ul style="list-style-type: none"> – Reduce front suspension spring preload. – Increase center spring preload.
Rear of snowmobile seems too stiff	Reduce rear spring preload.
Rear of snowmobile seems too soft	Increase rear spring preload.
Rear suspension front shock absorber is frequently bottoming	Lengthen stopper strap. Increase center spring preload.
Track spins too much at start	Lengthen stopper strap. Move thicker part of coupling block downward.

Deep Snow Riding

When operating the snowmobile in deep snow, it may be necessary to vary stopper strap length and/or riding position, to change the angle at which the track rides on the snow. Operator's familiarity with the various adjustments as well as snow conditions will dictate the most efficient combination.

TROUBLESHOOTING

Beeper Codes

Beeper codes are used to inform you on the DESS system operation and/or as a complement of the pilot lamps to catch your attention if an anomaly occurs or to inform you of a particular condition.

For more details on DESS system beeper codes, refer to *DESS PILOT LAMP CODES* in *TETHER CUT-OUT SWITCH*.

For more details on gauge pilot lamps, refer to *GAUGE PILOT LAMPS*.

For any beep code not listed in this Operator's Guide, refer to an authorized SKI-DOO dealer.

General

ENGINE IS CRANKED BUT FAILS TO START.

1. Engine cut-out switch is in OFF position or tether cord cap (DESS key) away from post.

- Place engine cut-out switch in the ON position and install tether cord cap (DESS key) on post.

2. Mixture not rich enough to start cold engine.

- Check fuel tank level and check starting procedure, particularly use of the choke.

3. Flooded engine (spark plug wet when removed).

- Do not choke. Remove wet spark plug, place engine cut-out switch in OFF position and crank engine several times. Install clean dry spark plug.
- Start engine following usual starting procedure. If engine continues to flood, see an authorized SKI-DOO dealer.

4. No fuel to the engine (spark plug dry when removed).

- Check fuel tank level; check condition of fuel and impulse lines and their connections. A failure of the fuel pump or carburetor has occurred. Contact an authorized SKI-DOO dealer.

5. Spark plug/ignition (no spark).

- Remove spark plug(s) then reconnect to spark cap. Check that engine cut-out switch is at the ON position and the tether cord cap (DESS key) snapped over the receptacle.
- Start engine with spark plug(s) grounded to engine away from spark plug hole. If no spark appears, replace spark plug. If trouble persists, contact an authorized SKI-DOO dealer.

6. Engine compression.

- As the engine is pulled over with the rewind starter, "cycles" of resistance should be felt as piston goes past top dead center (each piston on multi-cylinder engines).
- If no pulsating resistance is felt, it suggests a major loss of compression. Contact an authorized SKI-DOO dealer.

ENGINE LACKS ACCELERATION OR POWER.

- 1. DESS did not read tether cord cap (DESS KEY) code. DESS pilot lamp blinks once every 1.5 seconds. Engine can not exceed 3000 RPM.**
 - *Properly install tether cord cap (DESS key).*
- 2. DESS has read a different code than the one programmed. DESS pilot lamp blinks rapidly (3 times per second). Engine can not exceed 3000 RPM.**
 - *Install a tether cord cap (DESS key) for which this snowmobile was programmed.*
- 3. Fouled or defective spark plug.**
 - *Check item 5 of ENGINE TURNS OVER BUT FAILS TO START.*
- 4. Lack of fuel to engine.**
 - *Check item 4 of ENGINE TURNS OVER BUT FAILS TO START.*
- 5. Carburetor adjustments.**
 - *Contact an authorized SKI-DOO dealer.*
- 6. Drive belt worn too thin.**
 - *If the drive belt has lost more than 3 mm (1/8 in) of its original width, it will affect vehicle performance.*
 - *Replace drive belt.*
- 7. Drive and driven pulleys require servicing.**
 - *Contact an authorized SKI-DOO dealer.*

ENGINE BACKFIRES.

- 1. DESS did not read tether cord cap (DESS key) code. DESS pilot lamp blinks once every 1.5 seconds. Engine can not exceed 3000 RPM.**
 - *Properly install tether cord cap (DESS key).*
- 2. DESS has read a different tether cord cap (DESS key) code than the one programmed. DESS pilot lamp blinks rapidly (3 times per second). Engine can not exceed 3000 RPM.**
 - *Install a tether cord cap (DESS key) for which this snowmobile was programmed.*
- 3. Faulty spark plug (carbon accumulation).**
 - *See item 5 of ENGINE TURNS OVER BUT FAILS TO START.*
- 4. Engine is running too hot.**
 - *See item 6 of ENGINE LACKS ACCELERATION OR POWER.*
- 5. Ignition timing is incorrect or there is an ignition system failure.**
 - *Contact an authorized SKI-DOO dealer.*

ENGINE MISFIRES.

- 1. DESS did not read tether cord cap (DESS key) code. DESS pilot lamp blinks once every 1.5 seconds. Engine can not exceed 3000 RPM.**
 - *Properly install tether cord cap (DESS key).*

ENGINE MISFIRES. (cont'd)

2. DESS has read a different code than the one programmed. DESS pilot lamp blinks rapidly (3 times per second). Engine can not exceed 3000 RPM.

- *Install a tether cord cap (DESS key) for which this snowmobile was programmed.*

3. Fouled/defective/worn spark plugs.

- *Clean/verify spark plug gap and identification number. Replace as required.*

4. Too much oil supplied to engine.

- *Improper oil pump adjustment, refer to an authorized SKI-DOO dealer.*

5. Water in fuel.

- *Drain fuel system and refill with fresh fuel.*

SNOWMOBILE CANNOT REACH FULL SPEED.

1. Drive belt.

- *Check item 6 of ENGINE LACKS ACCELERATION OR POWER.*

2. Incorrect track adjustment.

- *See MAINTENANCE and/or an authorized SKI-DOO dealer for proper alignment and tension adjustments.*

3. Pulleys misaligned.

- *Contact an authorized SKI-DOO dealer.*

4. Engine.

- *See items 1, 2, 6 and 7 of ENGINE LACKS ACCELERATION OR POWER.*

SPECIFICATIONS

NOTE: Because of its ongoing commitment to product quality and innovation, BRP reserves the right, at any time, to make changes in design and specifications and/or to make additions to, or improvements in its products without imposing any obligation upon itself to install them on its products previously manufactured.

MODEL		500SS
ENGINE SYSTEM		
Engine type	Rotax™ 500 SS, liquid cooled w/Reed valve, RAVE™	
Cylinders	2	
Displacement	cc (in ³)	597 (36.4)
Bore	mm (in)	76 (3)
Stroke	mm (in)	65.8 (2.6)
Maximum horsepower RPM	8000 RPM	
Carburetion	2 x TM-40	
Exhaust system	Single tuned pipe, baffle muffler	
DRIVE SYSTEM		
Drive pulley type	TRA™ III	
Driven pulley type	QRS	
Engagement	GSX	3400 RPM
	MX Z	3800 RPM
Drive belt part number	417 300 197 ⁽³⁾	
Small sprocket number of teeth	GSX	24
	MX Z	25
Large sprocket number of teeth	45	
Drive sprocket number of teeth	8	
Brake system	Hydraulic, REV-XP brake type	
Track nominal width	381 mm (15 in)	
Track nominal length	3051 mm (120 in)	
Track profile height	25.4 mm (1 in)	
Track tension	Deflection	30-35 mm (1-3/16 - 1-3/8 in)
	Force ⁽¹⁾	7.3 kg (16 lb)
Track alignment	Equal distance between edges of track guides and slider shoes	

MODEL		500SS
SUSPENSION		
Front suspension		REV-XP
Front shock	GSX/MX Z Trail	Motion control
	MX Z TNT	HPG™ T/A aluminum
Front suspension max. travel		229 mm (9 in)
Rear suspension		SC-5
Front arm shock	GSX/MX Z Trail	Motion control
	MX Z TNT	HPG T/A aluminum
Rear arm shock	GSX/MX Z Trail	Motion control
	MX Z TNT	HPG T/A aluminum
Rear suspension max. travel		381 mm (15 in)
ELECTRICAL		
Lightning system output		360 Watts @ 6000 RPM
Headlamp bulb HI/LOW beam		2 x 60/55 Watts (H-4)
Taillight bulb		5/21
Spark plug	Type	NGK BR10ECS ⁽²⁾
	Gap	Not adjustable (0.75 ± 0.05 mm (.030 ± .002 in))
Fuse		Refer to <i>FUSE</i> section
DIMENSIONS		
Vehicle overall length		2890 mm (113.8 in)
Vehicle overall width		1217 mm (47.9 in)
Vehicle overall height	GSX Sport	1211 mm (47.7 in)
	MX Z TNT	1000 mm (39.4 in)
	MX Z Trail	1168 mm (46 in)
Official dry weight	GSX Sport	198 kg (437 lb)
	MX Z TNT	181 kg (399 lb)
	MX Z Trail	188 kg (415 lb)
Ski stance		1195 mm (47 in)
Ski overall length		1066 mm (42 in)
Ski width		145 mm (5.7 in)

MODEL		500SS
LIQUIDS		
Recommended fuel type		Regular unleaded
Minimum octane	Inside North America	(87 (RON + MON)/2)
	Outside North America	92 RON
Recommended oil (engine)		Refer to <i>RECOMMENDED OIL</i> section
Brake system fluid		SRF (DOT 4) or GTLMA (DOT 4)
Oil type (chaincase/transmission)		XP-S synthetic chaincase oil
Coolant	Mixture	Ethyl glycol/water mix (50% coolant, 50% distilled water). Use coolant specifically designed for aluminum engines
	Premix	(P/N 219 700 362) 12 x 1 L
CAPACITIES		
Fuel tank	L (U.S. gal)	40 (10.6)
Oil tank	L (U.S. quarts)	3.7 (3.9)
⁽¹⁾ Measure gap between slider shoe and bottom inside track when exerting a downward pull to the track. ⁽²⁾ CAUTION: Do not attempt to adjust gap on this plug. ⁽³⁾ Drive belt height must be adjusted every time a new drive belt is installed. Confirm drive belt part number application with an authorized SKI-DOO dealer.		

MODEL		600 HO SDI
ENGINE SYSTEM		
Engine type	Rotax 600 HO SDI, liquid cooled w/Reed valve, e-RAVE	
Cylinders	2	
Displacement	cc (in ³)	594.4 (36.3)
Bore	mm (in)	72 (2.8)
Stroke	mm (in)	73 (2.9)
Maximum engine speed	8100 RPM	
Carburetion	Electronic SDI	
Exhaust system	Single tuned pipe, baffle muffler	
DRIVE SYSTEM		
Drive pulley type	TRA III	
Driven pulley type	QRS	
Engagement	3800 RPM	
Drive belt part number	417 300 197 ⁽³⁾	
Small sprocket number of teeth	All Renegade	24
	Others	25
Large sprocket number of teeth	45	
Drive sprocket number of teeth	8	
Brake system	Hydraulic, REV-XP brake type	
Track nominal width	All Renegade	406 mm (16 in)
	Others	381 mm (15 in)
Track nominal length	All Renegade	3487 mm (137 in)
	Others	3051 mm (120 in)
Track profile height	All Renegade	31.8 mm (1.25 in)
	MX Z X	31.8 mm (1.25 in)
	Others	25.4 mm (1 in)
Track tension	Deflection	30-35 mm (1-3/16 - 1-3/8 in)
	Force ⁽¹⁾	7.3 kg (16 lb)
Track alignment	Equal distance between edges of track guides and slider shoes	

MODEL		600 HO SDI
SUSPENSION		
Front suspension		REV-XP
Front shock	All X Package	HPG clicker T/A
	Others	HPG
Front suspension max. travel		229 mm (9 in)
Rear suspension		SC-5
Front arm shock	MX Z Renegade X	HPG clicker T/A
	MX Z X	HPG T/A aluminum
	Others	HPG
Rear arm shock	GSX	HPG-VR
	MX Z	HPG
	All X Package	C-36 racing clicker
Rear suspension max. travel	All Renegade	406 mm (16 in)
	Others	381 mm (15 in)
ELECTICAL		
Lightning system output		480 Watts @ 6000 RPM
Headlamp bulb HI/LOW beam		2 x 60/55 Watts (H-4)
Taillight bulb		8/27
Spark plug	Type	NGK BR8ECS ⁽²⁾
	Gap	Not adjustable (0.75 ± 0.05 mm (.030 ± .002 in))
Fuse		Refer to <i>FUSE</i> section
DIMENSIONS		
Vehicle overall length	All Renegade	3110 mm (122.4 in)
	Others	2890 mm (113.8 in)
Vehicle overall width		1217 mm (47.9 in)
Vehicle overall height	GSX	1211 mm (47.7 in)
	MX Z	1168 mm (46 in)
	All X Package	1000 mm (39.4 in)

MODEL		600 HO SDI
DIMENSIONS (cont'd)		
Official dry weight	GSX Limited	203 kg (448 lb)
	GSX Limited Touring	215 kg (475 lb)
	MX Z Adrenaline	194 kg (428 lb)
	MX Z Renegade	199 kg (438 lb)
	MX Z Renegade X	195 kg (430 lb)
	MX Z X	190 kg (418 lb)
Ski stance		1195 mm (47 in)
Ski overall length		1066 mm (42 in)
Ski width		145 mm (5.7 in)
LIQUIDS		
Recommended fuel type		Regular unleaded
Minimum octane	Inside North America	(87 (RON + MON)/2)
	Outside North America	92 RON
Recommended oil (engine)		Refer to <i>RECOMMENDED OIL</i> section
Brake system fluid		SRF (DOT 4) or GTLMA (DOT 4)
Oil type (chaincase)		XP-S synthetic chaincase oil
Coolant	Mixture	Ethyl glycol/water mix (50% coolant, 50% distilled water). Use coolant specifically designed for aluminum engines
	Premix	(P/N 219 700 362) 12 x 1 L
CAPACITIES		
Fuel tank	L (U.S. gal)	40 (10.6)
Oil tank	L (U.S. quarts)	3.7 (3.9)
<p>(1) Measure gap between slider shoe and bottom inside track when exerting a downward pull to the track.</p> <p>(2) CAUTION: Do not attempt to adjust gap on this plug.</p> <p>(3) Drive belt height must be adjusted every time a new drive belt is installed. Confirm drive belt part number application with an authorized SKI-DOO dealer.</p>		

MODEL		800R
ENGINE SYSTEM		
Engine type		Rotax 800R, Power TEK, liquid cooled, 3-D RAVE
Cylinders		2
Displacement	cc (in ³)	799.5 (48.8)
Bore		82 mm (3.2 in)
Stroke		75.7 mm (3.0 in)
Maximum engine speed		8150 RPM
Carburetion		2 x TM-40
Exhaust system		Single tuned pipe, baffle muffler
DRIVE SYSTEM		
Drive pulley type		TRA VII
Driven pulley type		QRS
Engagement		3800 RPM
Drive belt part number		417 300 166 ⁽³⁾
Small sprocket number of teeth	GSX	26
	MX Z	27
	All Renegade	25
	Summit	21 (146 in)
		20 (154 in)
		19 (163 in)
Large sprocket number of teeth		45
Drive sprocket number of teeth		8
Brake system		Hydraulic, REV-XP brake type
Track nominal width	All Renegade	406 mm (16 in)
	Summit	406 mm (16 in)
	Others	381 mm (15 in)
Track nominal length	All Renegade	3487 mm (137 in)
	Summit	3705 mm (146 in)
		3923 mm (154 in)
		4141 mm (163 in)
Others	3051 mm (120 in)	

MODEL		800R
DRIVE SYSTEM (cont'd)		
Track profile height	All Renegade	31.8 mm (1.25 in)
	MX Z X	31.8 mm (1.25 in)
	Summit	57.2 mm (2.25 in)
	Others	25.4 mm (1 in)
Track tension	Deflection	30-35 mm (1-3/16 - 1-3/8 in)
	Force ⁽¹⁾	7.3 kg (16 lb)
Track alignment		Equal distance between edges of track guides and slider shoes
SUSPENSION		
Front suspension		REV-XP
Front shock	MX Z Renegade X	HPG clicker T/A
	MX Z X	HPG clicker T/A
	Summit X	HPG T/A aluminum
	Others	HPG
Front suspension max. travel		229 mm (9 in)
Rear suspension	Summit	SC-5M
	Others	SC-5
Front arm shock	X package	HPG T/A aluminum
	Others	HPG
Rear arm shock	GSX	HPG-VR
	MX Z Renegade X	C-36 racing clicker
	MX Z X	C-36 racing clicker
	Summit X	HPG T/A aluminum
	Others	HPG
Rear suspension max. travel	All Renegade	406 mm (16 in)
	Summit	356 mm (14 in)/(146 in)
		381 mm (15 in)/(154 in)
		406 mm (16 in)/(163 in)
Others	381 mm (15 in)	

MODEL		800R
ELECTRICAL		
Lightning system output		360 Watts @ 6000 RPM
Headlamp bulb HI/LOW beam		2 x 60/55 Watts (H-4)
Taillight bulb		5/21
Spark plug	Type	NGK BR9ECS ⁽²⁾
	Gap	Not adjustable (0.75 ± 0.05 mm (.030 ± .002 in))
Fuse		Refer to <i>FUSE</i> section
DIMENSIONS		
Vehicle overall length	All Renegade	3110 mm (122.4 in)
	Summit	3200 mm (126 in)/(146 in)
		3310 mm (130.3 in)/(154 in)
		3420 mm (134.6 in)/(163 in)
Others	2890 mm (113.8 in)	
Vehicle overall width	Summit	1163 to 1204 mm (45.8 to 47.4 in)
	Others	1217 mm (47.9 in)
Vehicle overall height	GSX	1211 mm (47.7 in)
	MX Z Renegade X	1000 mm (39.4 in)
	MX Z X	1000 mm (39.4 in)
	Summit X	1000 mm (39.4 in)
	Others	1168 mm (46 in)
Official dry weight	GSX	206 kg (455 lb)
	MX Z Adrenaline	197 kg (435 lb)
	MX Z X	193 kg (425 lb)
	MX Z Renegade	202 kg (445 lb)
	MX Z Renegade X	198 kg (437 lb)
	Summit	197 kg (435 lb)/(146 in)
		199 kg (439 lb)/(154 in)
	Summit X	193 kg (425 lb)/(146 in)
		195 kg (429 lb)/(154 in)
197 kg (434 lb)/(163 in)		

MODEL		800R
DIMENSIONS (cont'd)		
Ski stance	Summit	1138 to 1179 mm (44.8 to 46.4 in)
	Others	1195 mm (47 in)
Ski overall length		1066 mm (42 in)
Ski width	Summit	175 mm (6.9 in)
	Others	145 mm (5.7 in)
LIQUIDS		
Recommended fuel type		Premium unleaded
Minimum octane	Inside North America	(91 (RON + MON)/2)
	Outside North America	95 RON
Recommended oil (engine)		Refer to <i>RECOMMENDED OIL</i> section
Brake system fluid		SRF (DOT 4) or GTLMA (DOT 4)
Oil type (chaincase/transmission)		XP-S synthetic chaincase oil
Coolant	Mixture	Ethyl glycol/water mix (50% coolant, 50% distilled water). Use coolant specifically designed for aluminum engines
	Premix	(P/N 219 700 362) 12 x 1 L
CAPACITIES		
Fuel tank	L (U.S. gal)	40 (10.6)
Oil tank	L (U.S. quarts)	3.7 (3.9)
⁽¹⁾ Measure gap between slider shoe and bottom inside track when exerting a downward pull to the track. ⁽²⁾ CAUTION: Do not attempt to adjust gap on this plug. ⁽³⁾ Drive belt height must be adjusted every time a new drive belt is installed. Confirm drive belt part number application with an authorized SKI-DOO dealer.		

MAINTENANCE INFORMATION

PERIODIC MAINTENANCE CHART

WARNING

It is recommended that the assistance of an authorized SKI-DOO dealer be periodically obtained on other components/systems not covered in this guide. Unless otherwise specified, engine must be cold and not running. Remove the tether cord cap (DESS key) before performing any maintenance or adjustment, unless otherwise specified. Vehicle must be parked in a safe place, away from the trail.

WARNING

Observe WARNINGS and CAUTIONS mentioned throughout this guide which are relevant to the item being checked. When component conditions seem less than satisfactory, replace with genuine BRP parts or approved equivalents.

Some items may not apply to your particular model. Refer to *MAINTENANCE* in *SHOP MANUAL* for more details.

A: ADJUST C: CLEAN I: INSPECT L: LUBRICATE R: REPLACE T: PROCEED WITH TASK *: TO BE PERFORMED BY AN AUTHORIZED SKI-DOO DEALER	*10-HOUR OR 500 KM (300 mi)					
	WEEKLY OR EVERY 240 KM (150 mi)					
	MONTHLY OR EVERY 800 KM (500 mi)					
	EVERY YEAR OR 3200 KM (2000 mi)					
	EVERY 2 YEARS OR 6000 KM (3700 mi)					
	*STORAGE					
*PRESEASON						
PART/TASK	LEGEND					
ENGINE						
Rewind starter					L,C	I
Engine motor mounts	I			I		I
Exhaust system	I			I		I
Exhaust manifold screws	I					I
Engine lubrication					L	
Cooling system	I			I		I
Coolant	I				R	
Crankshaft PTO seal						I
RAVE valves				C		
RAVE valves solenoid (SDI and Power TEK)				I		
Injection oil filter					R	
Oil injection pump	A			A		A
FUEL SYSTEM						
Add fuel stabilizer					T	
Fuel filter					R	
Fuel lines, fuel rail and connections	I					I
Carburetor venturi						C
Throttle body (SDI)						C
Throttle cable	I			I		I
Air silencer prefilter			I			I
Fuel injection system (visual inspection)				I		I

A: ADJUST C: CLEAN I: INSPECT L: LUBRICATE R: REPLACE T: PROCEED WITH TASK *: TO BE PERFORMED BY AN AUTHORIZED SKI-DOO DEALER	*10-HOUR OR 500 KM (300 mi)									
	WEEKLY OR EVERY 240 KM (150 mi)									
	MONTHLY OR EVERY 800 KM (500 mi)									
	EVERY YEAR OR 3200 KM (2000 mi)									
	EVERY 2 YEARS OR 6000 KM (3700 mi)									
	*STORAGE									
*PRESEASON										
PART/TASK					LEGEND					
DRIVE SYSTEM										
Drive belt	I	I								I
Drive belt height adjustment	EVERY BELT REPLACEMENT									
Drive and driven pulleys	I		I	C			I			C
Tightening torque of drive pulley screw	I			I						
Driven pulley preload	I			I						I
Brake fluid	I	I					R			I
Brake hose, pads and disk	I	I								I
Drive chain tension	A		A						A	
Chaincase oil									R	
Track condition	BEFORE EACH RIDE									
Track tension and alignment	A	AS REQUIRED								
STEERING/FRONT SUSPENSION										
Steering and front suspension mechanism ⁽²⁾	I,L		I	L			I,L			
Wear and condition of skis and runners	I	I					I			
SUSPENSION										
Suspension adjustments	A	AS REQUIRED								
Rear suspension ⁽²⁾	I		I,L				I,L			
Suspension stopper strap				I			I			

A: ADJUST C: CLEAN I: INSPECT L: LUBRICATE R: REPLACE T: PROCEED WITH TASK *: TO BE PERFORMED BY AN AUTHORIZED SKI-DOO DEALER	*10-HOUR OR 500 KM (300 mi)						
	WEEKLY OR EVERY 240 KM (150 mi)						
	MONTHLY OR EVERY 800 KM (500 mi)						
	EVERY YEAR OR 3200 KM (2000 mi)						
	EVERY 2 YEARS OR 6000 KM (3700 mi)						
	*STORAGE						
*PRESEASON						LEGEND	
ELECTRICAL SYSTEM							
EMS fault codes	I					I	(1) Before installing new spark plugs at pre-season preparation, it is suggested to burn excess storage oil by starting the engine with the old spark plugs. Only perform this operation in a well ventilated area.
Spark plugs ⁽¹⁾	I		I			R	
Battery (if so equipped)	I		I			I	
Wiring harnesses, cables and lines	I		I			I	
Operation of lighting system (HI/LO beam, brake light, etc.), test operation of engine cut-out switch and tether engine cut-out switch	I	I				I	
VEHICLE							
Headlamp beam aiming				A		A	—
Engine compartment	C		C			C	
Vehicle cleaning and protection	C		C			C	

ENGINE SYSTEM

Air Intake Silencer Prefilter Verification

Ensure that air intake silencer prefilter is properly installed and in good condition, replace if damaged.

Cooling System

Check coolant level at room temperature. Liquid should be at cold level line (engine cold) of coolant tank.

NOTE: When checking level at low temperature it may be slightly lower than the mark.

If additional coolant is necessary or if entire system has to be refilled, refer to an authorized SKI-DOO dealer.

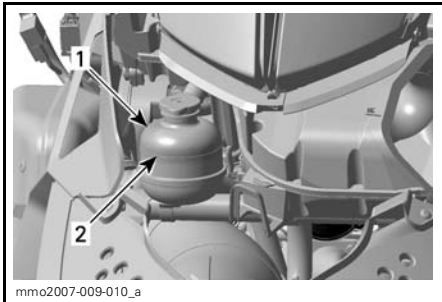

TYPICAL

1. Coolant tank
2. COLD LEVEL line

Exhaust System

The tail pipe of the muffler should be centered with the exit hole in the bottom pan. Exhaust system must be free of rust or leaks. Make sure that gear clamps are properly tightened.

The exhaust system is designed to reduce noise and to improve the total performance of the engine. Modification may be in violation of local laws.

CAUTION: If any exhaust system component is removed, modified or damaged, severe engine damage may result.

EPA Certified Engines

Maintenance, replacement, or repair of the emission control devices and systems may be performed by any snowmobile SI (spark ignition) engine repair establishments or individual.

Engine Emissions Information

Manufacturer's Responsibility

Beginning with 2007 model year engines, snowmobile manufacturers of snowmobile engines need to determine the exhaust emission levels for each engine horsepower family and certify these engines with the United States of America Environmental Protection Agency (EPA). An emissions control information label, showing emission levels and engine specifications, must be placed on each vehicle at the time of manufacture.

Dealer's Responsibility

When performing service on a certified SKI-DOO snowmobiles that carry an emissions control information label, adjustments must be kept within published factory specifications.

Replacement or repair of any emission related component must be executed in a manner that maintains emission levels within the prescribed certification standards.

Dealers are not to modify the engine in any manner that would alter the horsepower or allow emission levels to exceed their predetermined factory specifications.

Exceptions include manufacturer's prescribed changes, such as altitude adjustments for example.

Owner Responsibility

The owner/operator is required to have engine maintenance performed to maintain emission levels within prescribed certification standards.

The owner/operator is not to, and should not allow anyone to modify the engine in any manner that would alter the horsepower or allow emissions levels to exceed their predetermined factory specifications.

EPA Emission Regulations

All 2007 SKI-DOO snowmobiles manufactured by BRP are certified to the EPA as conforming to the requirements of the regulations for the control of air pollution from new snowmobile engines. This certification is contingent on certain adjustments being set to factory standards. For this reason, the factory procedure for servicing the product must be strictly followed and, whenever practicable, returned to the original intent of the design.

The responsibilities listed above are general and in no way a complete listing of the rules and regulations pertaining to the EPA requirements on exhaust emissions for snowmobile products. For more detailed information on this subject, you may contact the following locations:

REGULAR U.S. POSTAL MAIL:

1200 Pennsylvania Ave. NW
Mail Code 6403J
Washington D.C. 20460

FOR ALL COURIER SERVICES:

U.S. Environmental Protection Agency
Office of Transportation and Air Quality
1310 L Street NW
Washington D.C. 20005

INTERNET WEB SITE:

www.epa.gov/otaq/

E-MAIL:

otaqpublicweb@epa.gov

DRIVE SYSTEM

Belt Guard Removal and Installation

WARNING

NEVER operate engine:

- without shields and belt guard securely installed
- with hood and/or side panels opened or removed.

NEVER attempt to make adjustments to moving parts while engine is running.

NOTE: Belt guard is purposely made slightly oversize to maintain tension on its pins and retainers preventing undue noise and vibration. It is important that this tension be maintained when reinstalling.

Remove the tether cord cap (DESS key).

Open engine compartment LH side panel.

Remove retaining pin.

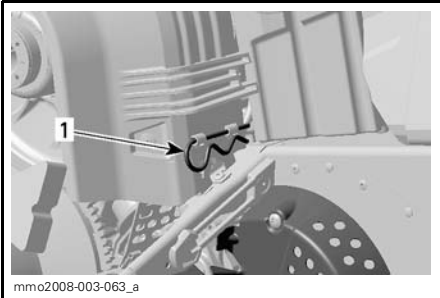

1. Retaining pin

Lift rear portion of guard then release from front tabs.

When reinstalling belt guard, position its cutaway toward front of snowmobile.

Place belt guard slots over tabs first, then snap the other end in rear retainer.

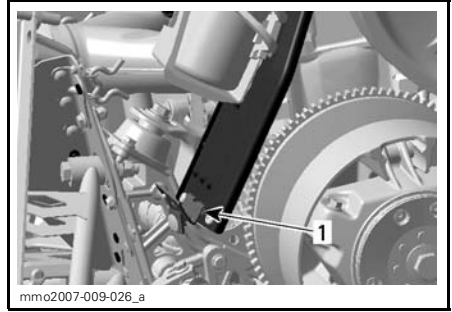

TYPICAL

1. Slots

Secure belt guard using retaining pin.

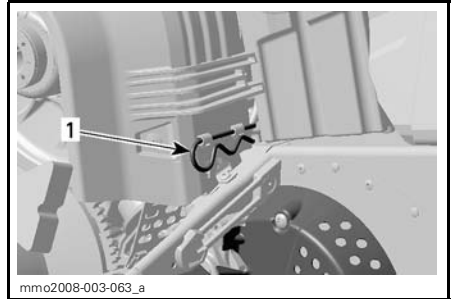

1. Retaining pin

Brake Fluid Level

CAUTION: Vehicle must be on a level surface before checking any fluid levels.

Check brake fluid (DOT 4) in reservoir for proper level. Add fluid (DOT 4) as required.

CAUTION: Use only DOT 4 brake fluid from a sealed container. Never use any other types of fluid.

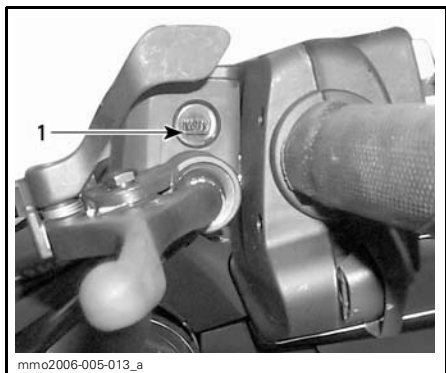

TYPICAL — BRAKE FLUID RESERVOIR
1. Minimum

Brake Condition

WARNING

The brake mechanism on your snowmobile is an essential safety device. Keep this mechanism in proper working condition. Above all, do not operate the snowmobile without an effective brake system. Periodically verify the condition/wear of the brake pads.

Brake Adjustment

No adjustment is provided for hydraulic brake. See an authorized SKI-DOO dealer if any problems.

Chaincase Oil

Recommended Oil

Use XP-S synthetic chaincase oil (P/N 413 803 300).

CAUTION: Use only the recommended type oil when servicing. Do not mix synthetic oil with other types of oil.

Oil Level Verification

With the vehicle on a level surface, check the oil level by removing the magnetic check plug on the left side of chaincase. Oil level must be equal with the lower edge.

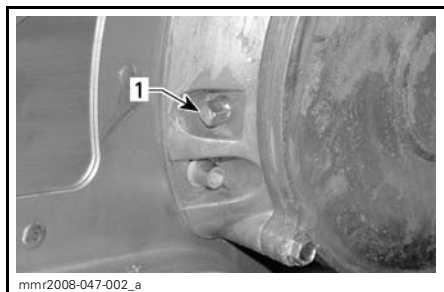

1. Magnetic check plug

NOTE: It is normal to find metallic particles stuck to magnetic check plug. If bigger pieces of metal are found, remove the chaincase cover and inspect the chaincase parts.

Remove metal particles from magnetic check plug.

To add oil, remove the filler cap on chaincase cover.

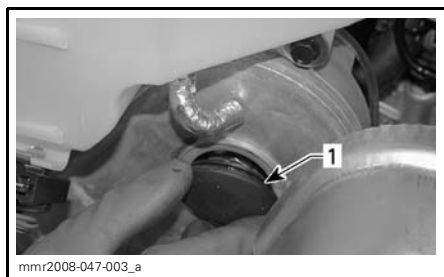

1. Filler cap

Pour recommended oil in chaincase by the filler hole until oil comes out by the magnetic check plug hole. Reinstall magnetic check plug and torque to 6 N•m (53 lbf•in).

Drive Chain Tension

See an authorized SKI-DOO dealer.

Drive Belt Inspection

Inspect belt for cracks, fraying or abnormal wear (uneven wear, wear on one side, missing cogs, cracked fabric). If abnormal wear is noted, probable cause could be pulley misalignment, excessive RPM with frozen track, fast starts without warm-up period, burred or rusty sheave, oil on belt or distorted spare belt. Contact an authorized SKI-DOO dealer.

Drive Belt Removal

Open LH side panel.

Remove belt guard, refer to *BELT GUARD REMOVAL/INSTALLATION*.

To open the driven pulley and remove the drive belt, first, loosen the locking nut inside the driven pulley adjustment ring.



DRIVEN PULLEY

1. Locking nut
2. Adjustment ring

To loosen the locking nut, use the following tools from tool kit.

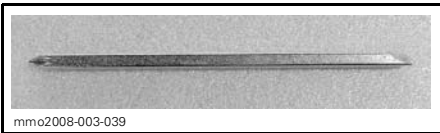

SCREWDRIVER PIN

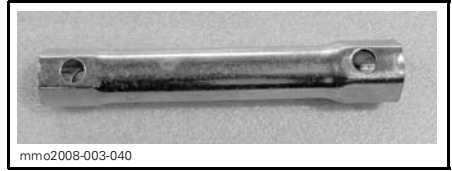

WRENCH SOCKET 16/18 MM

Insert the screwdriver pin into the 16 mm wrench socket.

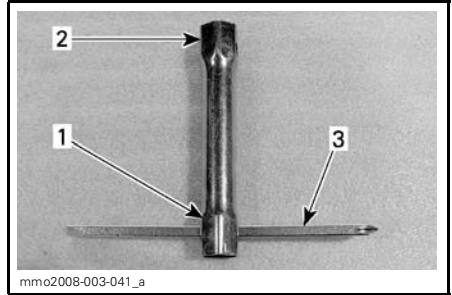

1. 16 mm end
2. 18 mm end
3. Screwdriver pin

Insert and set the 18 mm socket end on the locking nut inside the adjustment ring.

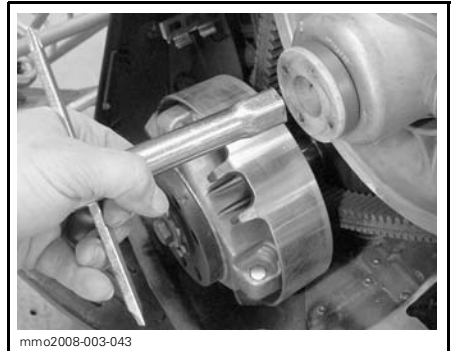

INSERT TOOL

Loosen locking nut by turning the tool counterclockwise (± 4 turns).

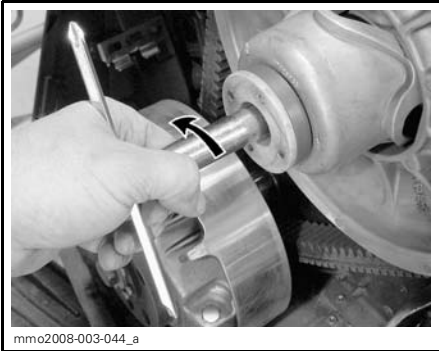

mms2008-003-044_a

TURN TOOL COUNTERCLOCKWISE

Then, to open the driven pulley use the following tool from tool kit.

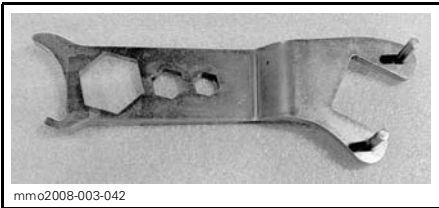

mms2008-003-042

SUSPENSION ADJUSTMENT TOOL

Completely open the driven pulley by turning the suspension adjustment tool clockwise.

Turn tool clockwise until it bottoms.

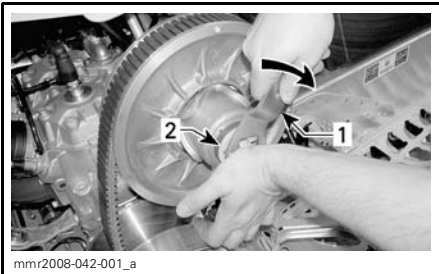

mms2008-042-001_a

1. Suspension adjustment tool
2. Adjustment ring

To remove the drive belt, slip the belt over the top of driven pulley.



mms2008-042-002

Remove drive belt from drive pulley.

Install and adjust drive belt, refer to **DRIVE BELT INSTALLATION/ADJUSTMENT**.

Drive Belt Installation/Adjustment

NOTE: The drive belt height must be checked each time a drive belt is installed and should be rechecked after 50 km (30 miles).

The maximum drive belt life span is obtained when the arrow on the drive belt is directed toward the front of the vehicle. This will ensure that correct direction of rotation is respected.

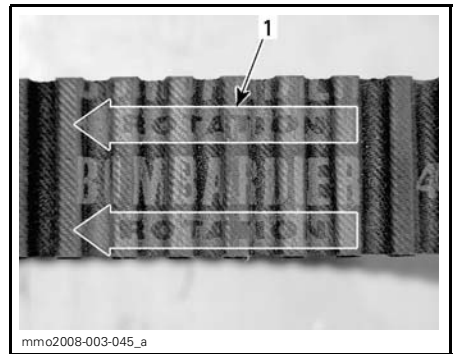

mms2008-003-045_a

1. Arrow pointing the front of vehicle

NOTE: If your drive belt was broken while riding, you will need to open the driven pulley sheaves first before trying to install a new belt. Refer to **DRIVE BELT REMOVAL** for procedure. Install drive belt.

Set drive belt in drive pulley then in driven pulley starting at the bottom.



MANUALLY ROTATE DRIVE BELT

When drive belt is in position, driven pulley sheaves needs to be adjusted to obtain proper drive belt adjustment.

To adjust driven pulley sheaves, use the following tool from tool kit.

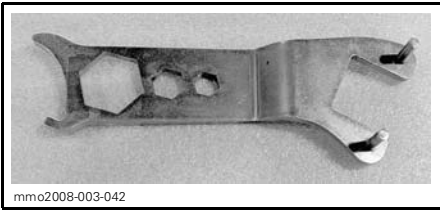

SUSPENSION ADJUSTMENT TOOL

Turn adjustment ring counterclockwise (± 1 turn) then, manually rotate drive belt to position it properly inside pulley sheaves. Repeat this procedure until proper belt adjustment is obtained.

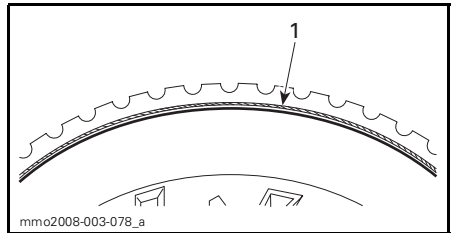

PROPER ADJUSTMENT

1. Drive belt cord flush with pulley edge

NOTE: If correct adjustment is unattainable, contact an authorized SKI-DOO dealer.

When the drive belt is properly adjusted, ensure that the swivel ring rest against the driven pulley cam.

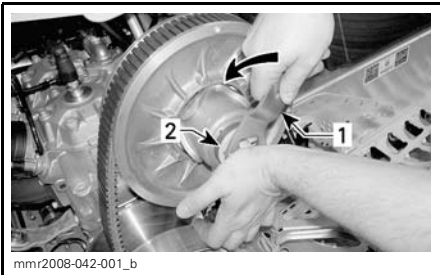

1. Suspension adjustment tool
2. Adjustment ring

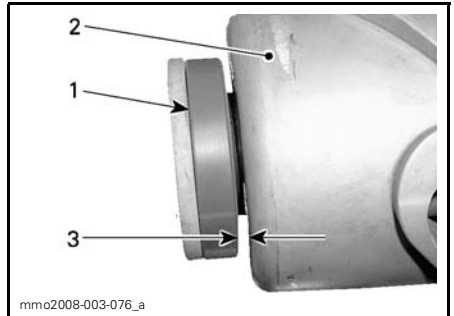

INCORRECT POSITION

1. Swivel ring
2. Driven pulley cam
3. Not in contact with driven pulley

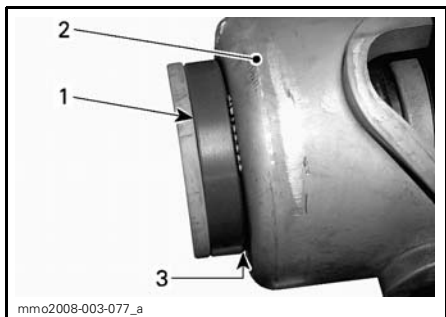

mmo2008-003-077_a

PROPER POSITION

1. Swivel ring
2. Driven pulley cam
3. In contact with driven pulley

If not, turn adjustment ring clockwise to lean the swivel ring against the driven pulley cam.

CAUTION: Overtightening swivel ring will modify drive belt adjustment and reduce drive belt life span.

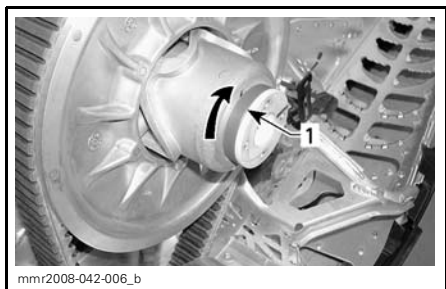

mml2008-042-006_b

1. Swivel ring

Then, snug up the locking nut.



mml2008-042-003_a

DRIVEN PULLEY

1. Locking nut
2. Adjustment ring

To snug up the locking nut, use the following tools from tool kit.



mmo2008-003-039

SCREWDRIVER PIN



mmo2008-003-040

WRENCH SOCKET 16/18 MM

Insert the screwdriver pin into the 16 mm wrench socket.

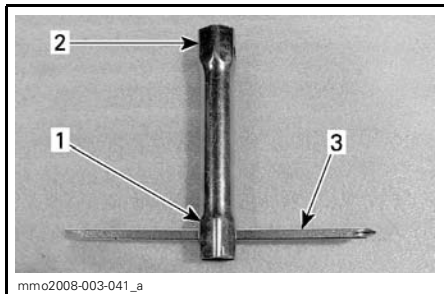

mmo2008-003-041_a

1. 16 mm end
2. 18 mm end
3. Screwdriver pin

Insert and set the 18 mm socket end on the locking nut inside the adjustment ring.

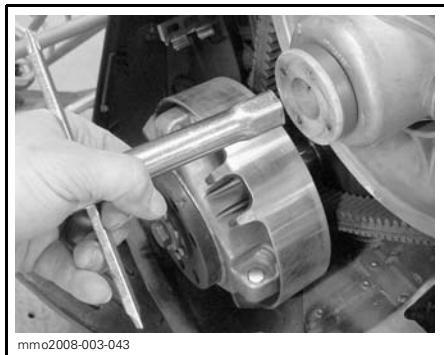

mmo2008-003-043

INSERT TOOL

Snug up locking nut by turning tool clockwise (± 4 turns).



TURN TOOL CLOCKWISE

Reinstall belt guard.
Close LH side panel.

Drive Pulley Adjustment

WARNING

Remove the tether cord cap (DESS key) before performing any maintenance or adjustment, unless otherwise specified. Vehicle must be parked in a safe place, away from the trail.

General

The drive pulley is factory calibrated to transmit maximum engine power at a predefined RPM. Factors such as ambient temperature, altitude or surface condition may vary this critical engine RPM thus affecting snowmobile efficiency.

This adjustable drive pulley allows setting maximum engine RPM to maintain maximum power.

Calibration screws should be adjusted so that actual maximum engine RPM matches the maximum horsepower RPM.

ENGINE	MAXIMUM HORSEPOWER RPM
500SS	8000 RPM (± 100)
600 HO SDI	8100 RPM (± 100)
800R	8150 RPM (± 100)

NOTE: Use precision digital tachometer for engine RPM adjustment.

NOTE: The adjustment has an effect on high RPM only.

Calibration screw has a notch on top of its head.

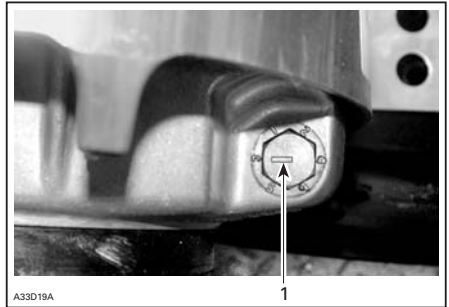

TYPICAL

1. Notch

There are 6 positions numbered 1 to 6. Each position modifies maximum engine RPM by about 200 RPM.

Lower position numbers decrease engine RPM in steps of 200 RPM and higher position numbers increase it in steps of 200 RPM.

Example:

Calibration screw is set at position 4 and is changed to position 6. So maximum engine RPM is increased by 400 RPM.

Adjustment

Just loosen locking nut enough to pull calibration screw partially out and adjust to desired position. Do not completely remove the locking nut. Torque locking nuts to 10 N•m (89 lbf•in).

CAUTION: Do not completely remove calibration screw otherwise internal washers will fall off. Always adjust all 3 calibration screws and make sure they are all set to the same position.

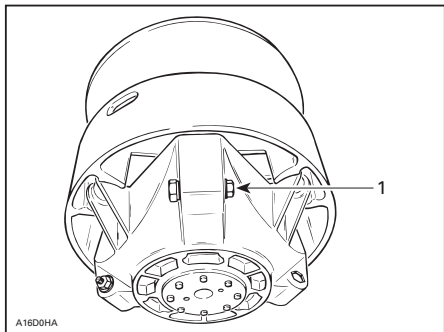

TYPICAL

1. Loosen just enough to permit rotating of calibrate screw

⚠ WARNING

NEVER disassemble or modify the drive pulley.

Improper assembly or modifications could cause the pulley to explode violently under the stress generated by the high rotational speed. This could lead to serious injury including the possibility of death.

See your SKI-DOO dealer to maintain or service the drive pulley. Improper servicing or maintenance may affect performance and reduce belt life. Always respect maintenance schedules.

⚠ WARNING

NEVER operate engine:

- without shields and belt guard securely installed
- with hood and/or side panels opened or removed.

NEVER attempt to make adjustments to moving parts while engine is running.

Track Condition

⚠ WARNING

Remove the tether cord cap (DESS key) before performing any maintenance or adjustment, unless otherwise specified. Vehicle must be parked in a safe place, away from the trail.

Remove the tether cord cap (DESS key).

Lift the rear of the snowmobile and support it with a wide-base snowmobile mechanical stand with a rear deflector panel. With the engine off, rotate the track by hand, and inspect condition. If worn or cut, or if track fibers are exposed, or if missing or defective inserts or guides are noted; contact an authorized SKI-DOO dealer.

Snowmobiles Equipped with Traction Enhancing Products

If your snowmobile is equipped with a BRP approved studded track, PROCEED WITH A VISUAL INSPECTION OF YOUR TRACK BEFORE EACH USE.

Look for any defects, such as:

- perforations in the track
- tears in the track (particularly around traction holes on studded tracks)
- lugs that are broken or torn off, exposing portions of rods
- delamination of the rubber
- broken rods
- broken studs (studded tracks)
- bent studs (studded tracks)
- missing studs
- studs that are torn off the track
- missing track guide(s)
- also, ensure that studs nut are tighten to the recommended torque.

On approved studded tracks, replace broken or damaged studs immediately. If your track shows signs of deterioration, it must be replaced immediately. When in doubt, ask your dealer.

WARNING

Riding with a damaged track or studs could lead to a loss of control, resulting in a risk of serious injury or death.

For complete information on traction enhancing products, refer to the section entitled *TRACTION ENHANCING PRODUCTS* in the *SAFETY INFORMATION* section at the beginning of this Operator's Guide.

Track Tension and Alignment

NOTE: Track tension and alignment are interrelated. Do not adjust one without the other.

WARNING

To prevent serious injury to individuals near the snowmobile:

- NEVER stand behind or near a moving track
- always use a wide-base snowmobile stand with a rear deflector panel
- when the track is raised off the ground, only run it at the lowest possible speed.

Centrifugal force could cause debris, damaged or loose studs, pieces of torn track, or an entire severed track to be violently thrown backwards out of the tunnel with tremendous force, possibly resulting in the loss of a leg or other serious injury.

Tension

NOTE: Ride the snowmobile in snow about 15 to 20 minutes prior to adjusting track tension.

Remove the tether cord cap (DESS key).

Lift rear of snowmobile and support it with a wide-base snowmobile mechanical stand.

Allow the suspension to extend normally and check gap halfway between front and rear idler wheels. Measure between slider shoe bottom and inside of track. The gap should be as given in *SPECIFICATIONS* at the end of this guide. If the track tension is too loose, track will have a tendency to thump.

NOTE: A belt tension tester (P/N 414 348 200) may be used to measure deflection as well as force applied.

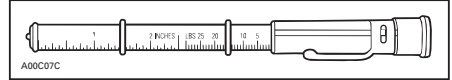

BELT TENSION TESTER

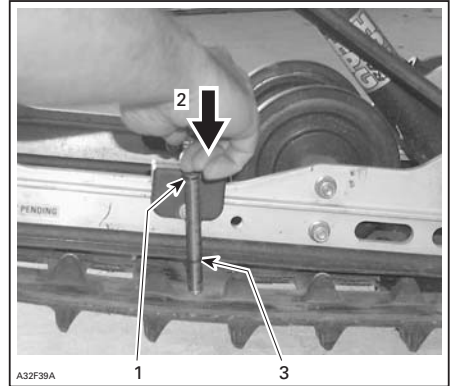

TYPICAL

1. Top tool O-ring positioned at 7.3 kg (16 lb)
2. Push on top portion of tool until it contacts the top O-ring
3. Measured track deflection

CAUTION: Too much tension will result in power loss and excessive stresses on suspension components.

To adjust track tension:

- Remove the tether cord cap (DESS key).

- Remove rear wheel caps (if so equipped).
- Loosen the rear idler wheel retaining bolts.
- Turn adjustment bolts to adjust.

If correct tension is unattainable, contact an authorized SKI-DOO dealer.

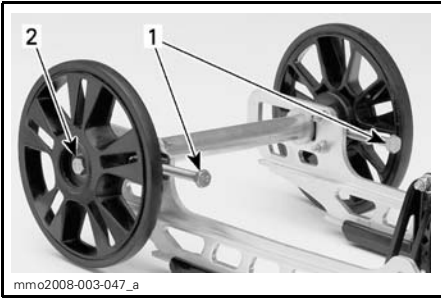

TYPICAL

1. Adjustment bolts
2. Loosen bolt

- Retighten retaining bolts.
- Check track alignment as described below.

Alignment

⚠ WARNING

Before checking track alignment, ensure that the track is free of all particles which could be thrown out while track is rotating. Keep hands, tools, feet and clothing clear of track. Always lift the snowmobile on a wide-base stand with a rear deflector panel. Ensure no one is standing in close proximity to the snowmobile, especially at the rear of the track. Never rotate track at high speed. Centrifugal force could cause debris, damaged or loose studs, pieces of torn track, or an entire severed track to be violently thrown backwards out of the tunnel with tremendous force, possibly resulting in the loss of a leg or other serious injury.

Start the engine and accelerate slightly so that track barely turns. This must be done in a short period of time (15 to 20 seconds).

Check that the track is well centered; equal distance on both sides between edges of track guides and slider shoes.

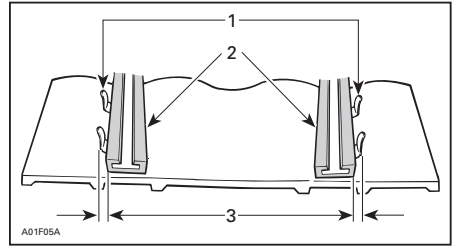

1. Guides
2. Slider shoes
3. Equal distance

To Adjust Track Alignment:

⚠ WARNING

Remove the tether cord cap (DESS key) before performing any maintenance or adjustment, unless otherwise specified. Vehicle must be parked in a safe place, away from the trail.

- Remove the tether cord cap (DESS key).
- Loosen rear idler wheel retaining bolts.
- Tighten the adjustment bolt on side where the slider shoe is the farthest from the track insert guides.

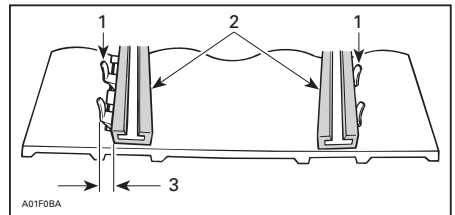

1. Guides
2. Slider shoes
3. Tighten on this side

Tighten retaining bolts.

⚠ WARNING

Properly tighten wheel retaining bolts, otherwise wheel may come off and cause track to “lock”.

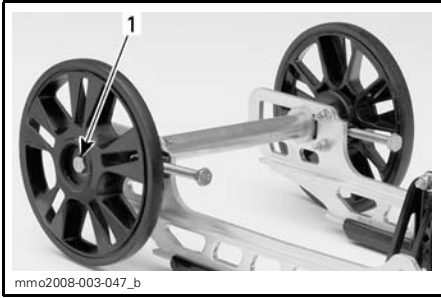

TYPICAL

1. Retighten to 48 N•m (35 lbf•ft)

Restart engine and rotate track slowly to recheck alignment.

Reposition snowmobile on ground.

Install rear wheel caps if so equipped.

REAR SUSPENSION

Rear Suspension Condition

Visually inspect all suspension components including slider shoes, springs, wheels, etc.

NOTE: During normal driving, snow will act as a lubricant and coolant for the slider shoes. Extensive riding on ice or sanded snow, will create excessive heat build-up and cause premature slider shoe wear.

Suspension Stopper Strap Condition

Inspect stopper strap for wear and cracks, bolt and nut for tightness. If loose inspect holes for deformation. Replace as required. Torque nut to 11 N•m (97 lbf•in).

STEERING AND FRONT SUSPENSION

Visually inspect steering and front suspension for tightness of components (steering arms, control arms and links, tie rods, ball joints, ski bolts, ski legs, etc.). If necessary, contact an authorized SKI-DOO dealer.

Wear and Condition of Skis and Runners

Check the condition of the skis and ski runner carbides. If worn, contact an authorized SKI-DOO dealer.



WARNING

Excessively worn skis and/or ski runners will adversely affect snowmobile control.

ELECTRICAL SYSTEM

Fuse Removal/Inspection

Check fuse condition and replace it if necessary.

To remove fuse from holder, pull fuse out. Check if filament is melted.

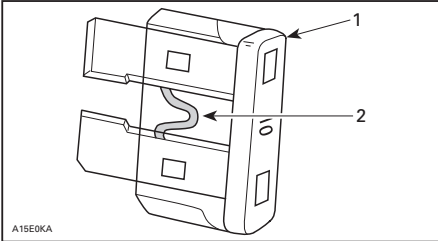

1. Fuse
2. Check if melted

CAUTION: Do not use a higher rated fuse as this can cause severe damage to electrical components and/or be a potential fire.

WARNING

If fuse has burnt out, source of malfunction should be determined and corrected before restarting. See an authorized SKI-DOO dealer for servicing.

500SS and 800R Engines

Manual Start

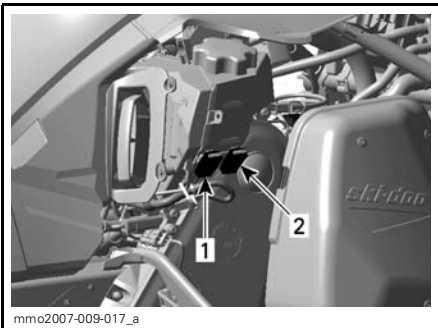

RH SIDE OF ENGINE COMPARTMENT

1. 15 A headlight fuse (RED/ORANGE wire)
2. 15 A accessories fuse (RED/YELLOW wire)

Electric Start

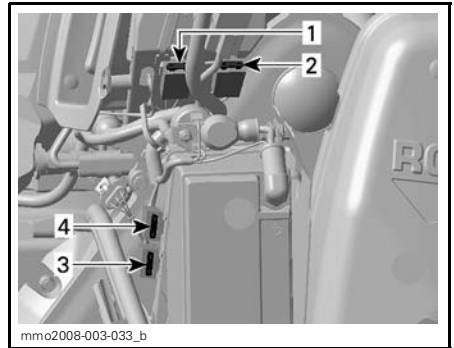

RH SIDE OF ENGINE COMPARTMENT

1. 15 A headlight fuse (RED/ORANGE wire)
2. 15 A accessories fuse (RED/YELLOW wire)
3. 30 A charging system
4. 5 A ECM (Engine Control Module)

Electric Fuel Level Sender

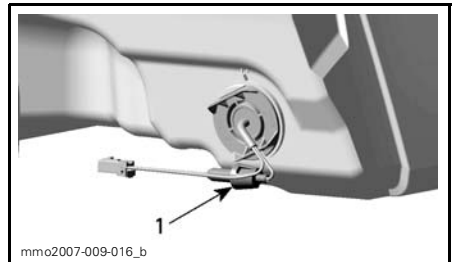

BEHIND AIR INTAKE SILENCER

1. Fuse location

600 HO SDI Engine

Fuse Box

Open RH side panel.

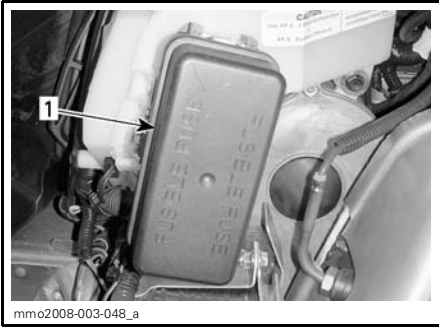

1. Fuse box

To open fuse box, push both tabs at the same time then pull on cover.

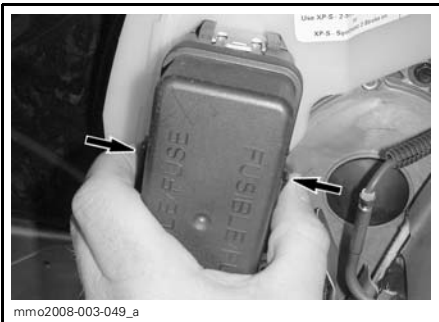

mimo2008-003-049_a

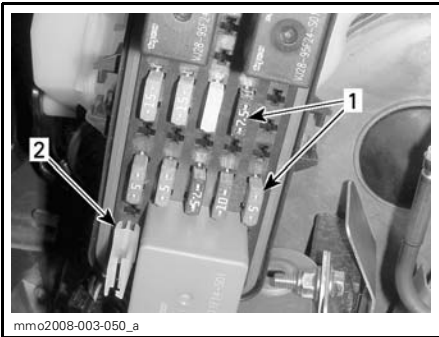

1. Fuses
2. Fuse remover/installer

FUSE		DESCRIPTION
F1	5 A	Outer injectors
F2	5 A	Inner injectors
F3	5 A	ECM
F4	7.5 A	Gauge multifunction display
F5	10 A	Fuel pump/ignition coils
F6	15 A	Accessories/tail lamp
F7	15 A	Headlamp
F8	20 A	Capacitor
F9	5 A	Relays/start button

To remove a fuse, use fuse remover/installer.

Pull on fuse to remove.



mimo2008-003-051

Charging System

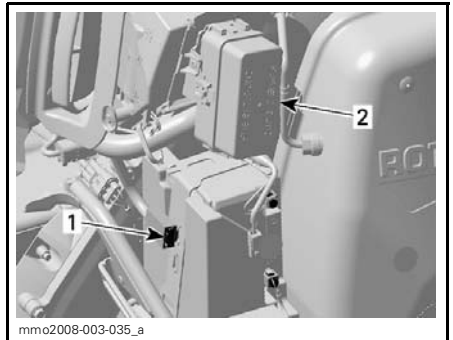

RH SIDE OF ENGINE COMPARTMENT

1. 30 A fuse
2. Fuse box

Electric Fuel Level Sender

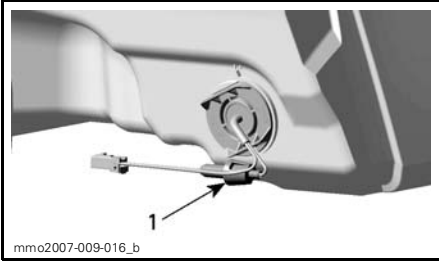

BEHIND AIR INTAKE SILENCER

1. 0.25 A fuse

BODY/FRAME

Vehicle Cleaning and Protection

Remove any dirt or rust.

To clean the entire vehicle, use only flannel cloths or equivalent.

CAUTION: It is necessary to use flannel cloths or equivalent on windshield and hood to avoid damaging further surfaces to clean.

To remove grease, oil and grime, use Heavy duty cleaner (P/N 293 110 001) (spray can 400 g) and (P/N 293 110 002) (4 L).

CAUTION: Do not use Heavy duty cleaner on decals or vinyl.

To remove stubborn dirt from all plastic and vinyl surfaces, use Vinyl & Plastic Cleaner ((P/N 413 711 200) (6 x 1 L)).

To remove scratches on windshield or hood use the Scratch Remover Kit (P/N 861 774 800).

CAUTION: Never clean plastic parts or hood with strong detergent, degreasing agent, paint thinner, acetone, products containing chlorine, etc.

Clean sheaves of both pulleys using Pulley flange cleaner (P/N 413 711 809).

Inspect the hood and repair any damage.

Touch up all metal spots where paint has been scratched off. Spray all metal parts including shock chromed rods with XP-S Lube (P/N 293 600 016).

Wax painted portion of the vehicle for better protection.

NOTE: Apply wax on glossy finish only. Protect the vehicle with a cover to prevent dust accumulation during storage.

CAUTION: The snowmobile has to be stored in a cool and dry place and covered with an opaque tarpaulin. This will prevent sun rays and grime from affecting plastic components and vehicle finish.

Lift rear of vehicle until track is clear of the ground. Install on a wide-base snowmobile mechanical stand with a rear deflector panel.

WARNING

Do not attempt to lift the vehicle by hand alone. Use appropriate lifting device or have assistance to share lifting stress in order to avoid risk of strain injuries.

NOTE: Do not release track tension.

Bulb Replacement

Always check light operation after bulb replacement.

Headlamp

CAUTION: Never touch glass portion of a halogen bulb with bare fingers, it shortens its operating life. If glass is touched, clean it with isopropyl alcohol which will not leave a film on the bulb.

By using a small screwdriver, release multifunction gauge locking tabs.



1. Locking tab

Gently pull on multifunction gauge and set aside.



Unplug burnt bulb connector. Remove the rubber boot.

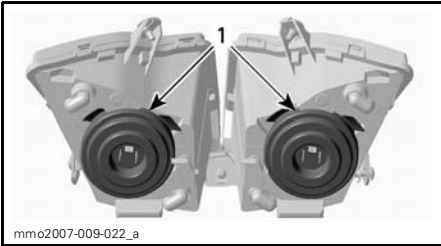

1. Rubber boot

Press and pull both sides of the spindle at the same time to release it from bulb support.

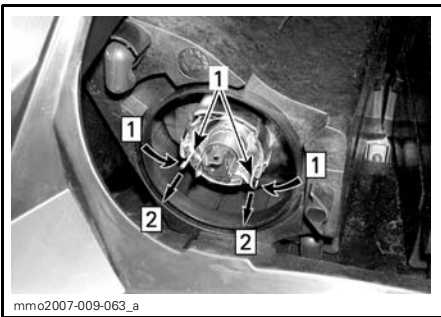

Step 1: Push both sides

Step 2: Pull to release

1. Spindle

Pull bulb and replace. Properly reinstall parts.

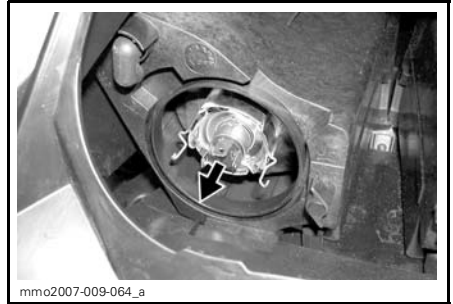

PULL BULB AND REPLACE

Taillight

If taillight bulb is burnt, expose the bulb by removing the red plastic lens. To remove, unscrew the 2 lens screws.

Headlamp Beam Aiming

Remove multifunction gauge, refer to BULB REPLACEMENT. Turn knob to adjust beam height.

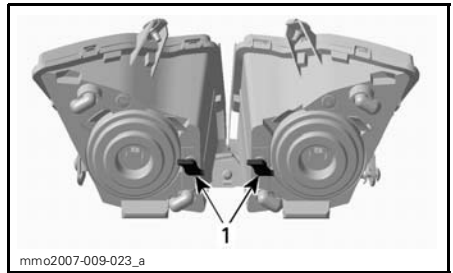

TYPICAL

1. Knob

STORAGE AND PRESEASON PREPARATION

WARNING

Have an authorized SKI-DOO dealer inspect fuel and oil systems integrity as specified in *PERIODIC MAINTENANCE CHART*.

Storage

It is during summer, or when a snowmobile is not in use for more than one month that proper storage is a necessity.

To prepare your snowmobile, refer to an authorized SKI-DOO dealer.

Engine Cooling System

Antifreeze should be replaced every 2 years or 6000 km (3700 mi) to prevent antifreeze deterioration.

The antifreeze replacement and a density test should be performed by an authorized SKI-DOO dealer.

CAUTION: Improper antifreeze mixture might allow freezing of the liquid in the cooling system if vehicle is stored in area where freezing point is reached. This would seriously damage the engine. Failure to replace the antifreeze for storage may allow its degradation that could result in poor cooling when engine will be used.

CAUTION: Do not run engine during storage period.

Preseason Preparation

Refer to an authorized SKI-DOO dealer.

CAUTION: Have carburetors cleaned-up before restarting engine.

WARRANTY

BRP LIMITED WARRANTY NORTH AMERICA: 2008 SKI-DOO® SNOWMOBILES

1) SCOPE OF THE LIMITED WARRANTY

Bombardier Recreational Products Inc. ("BRP")* warrants its 2008 Ski-Doo snowmobiles sold by authorized BRP dealers (as hereinafter defined) in the fifty United States and Canada from defects in material or workmanship for the period and under the conditions described below.

All genuine Ski-Doo parts and accessories, installed by an authorized BRP dealer at the time of delivery of the 2008 Ski-Doo snowmobile, carry the same warranty as that of the snowmobile.

A GPS receiver may be supplied by BRP as standard equipment on certain 2008 Ski-Doo snowmobiles. The GPS receiver is covered by the limited warranty issued by the GPS receiver's manufacturer and is not covered by this BRP limited warranty.

Use of the product for racing or any other competitive activity, at any point, even by a previous owner, will render this warranty null and void.

2) EXCLUSIONS – ARE NOT WARRANTED

The following are not warranted under any circumstances:

- Normal wear and tear;
- Routine maintenance items, tune ups, adjustments;
- Damage caused by failure to provide proper maintenance and/or storage, as described in the Operator's Guide;
- Damage resulting from removal of parts, improper repairs, service, maintenance, modifications or use of parts not manufactured or approved by BRP or resulting from repairs done by a person that is not an authorized servicing BRP dealer;
- Damage caused by abuse, abnormal use, neglect, use of the product on surfaces other than snow, or operation of the product in a manner inconsistent with the recommended operation described in the Operator's Guide;
- Damage resulting from accident, submersion, fire, theft, vandalism or any act of God;
- Operation with fuels, oils or lubricants which are not suitable for use with the product (see the Operator's Guide);
- Snow or water ingestion;
- Incidental or consequential damages, or damages of any kind including without limitation towing, storage, telephone, rental, taxi, inconvenience, insurance coverage, loan payments, loss of time, loss of income; and
- Damage resulting from studs installed on tracks if the installation does not conform to BRP's instructions.

3) LIMITATIONS OF LIABILITY

THIS WARRANTY IS EXPRESSLY GIVEN AND ACCEPTED IN LIEU OF ANY AND ALL OTHER WARRANTIES, EXPRESSED OR IMPLIED, INCLUDING WITHOUT LIMITATION ANY WARRANTY OF MERCHANTABILITY OR FITNESS FOR A PARTICULAR PURPOSE. TO THE EXTENT THAT THEY CANNOT BE DISCLAIMED, THE IMPLIED WARRANTIES ARE LIMITED IN DURATION TO THE LIFE OF THE EXPRESS WARRANTY. INCIDENTAL AND CONSEQUENTIAL DAMAGES ARE EXCLUDED FROM COVERAGE UNDER THIS WARRANTY. SOME STATES/PROVINCES DO NOT ALLOW FOR THE DISCLAIMERS, LIMITATIONS AND EXCLUSIONS IDENTIFIED ABOVE, AS A RESULT, THEY MAY NOT APPLY TO YOU. THIS WARRANTY GIVES YOU SPECIFIC RIGHTS, AND YOU MAY ALSO HAVE OTHER LEGAL RIGHTS WHICH MAY VARY FROM STATE TO STATE, OR PROVINCE TO PROVINCE.

Neither the distributor, any BRP dealer nor any other person has been authorized to make any affirmation, representation or warranty regarding the product, other than those contained in this limited warranty, and if made, shall not be enforceable against BRP.

BRP reserves the right to modify this warranty at any time, being understood that such modification will not alter the warranty conditions applicable to the products sold while this warranty is in effect.

4) WARRANTY COVERAGE PERIOD

This warranty will be in effect from the date of delivery to the first retail consumer or the date the product is first put into use, whichever occurs first and for a period of:

TWELVE (12) CONSECUTIVE MONTHS, for private or commercial use owners. However, the warranty coverage period on a snowmobile delivered between June 1st and December 1st of a given year will expire December 1st of the following year.

The emission-related components included in the chart below, that are installed on EPA certified snowmobiles (see list below) registered in the USA are covered for thirty (30) consecutive months or 2500 miles (4000 km) of engine use whichever occurs first. If the 2500 miles (4000 km) are reached during the regular warranty coverage period, the emission-related components are still covered by BRP's standard warranty until the end of regular coverage period.

The EPA certified snowmobiles are those equipped with: 550 (fan cooled), 600, 600 HO SDI, 4-TEC V800 engines:

EMISSION-RELATED COMPONENTS	500SS	600 HO SDI	800R
Carburetor	X		X
Carburetor Air Intake Adapter	X	X	X
Reed Valve	X	X	X
Rave Hose System		X	X
Throttle Position Sensor (TPS)		X	X
Air Temperature Sensor (ATS)		X	X
Air Pressure Sensor (APS)		X	X
Knock Sensor		X	X
Engine Management System (EMS)		X	X
Fuel Pressure Regulator		X	
Fuel Injectors		X	
Muffler Temperature Sensor		X	
Coolant Temperature Sensor (CTS)			X
DPM solenoid			X

The repair or replacement of parts or the performance of service under this warranty does not extend the life of this warranty beyond its original expiration date.

5) CONDITIONS TO HAVE WARRANTY COVERAGE

This warranty coverage is available only if each of the following conditions has been fulfilled:

- The 2008 Ski-Doo snowmobile must be purchased as new and unused by its first owner from a BRP dealer authorized to distribute Ski-Doo snowmobiles in the country in which the sale occurred ("BRP dealer");
- The BRP specified pre-delivery inspection process must be completed and documented;
- The product must have undergone proper registration by an authorized BRP dealer;
- The 2008 Ski-Doo snowmobile must be purchased in the country in which the purchaser resides;
- Routine maintenance outlined in the Operator's Guide must be timely performed in order to maintain warranty coverage. BRP reserves the right to make warranty coverage contingent upon proof of proper maintenance.

BRP will not honour this limited warranty to any private use owner or commercial use owner if the preceding conditions have not been met. Such limitations are necessary in order to allow BRP to preserve both the safety of its products, and also that of its consumers and the general public.

6) WHAT TO DO TO OBTAIN WARRANTY COVERAGE

The customer must notify a servicing BRP dealer within two (2) days of the appearance of a defect, and provide it with reasonable access to the product and reasonable opportunity to repair it. The customer must also present to the authorized BRP dealer, proof of purchase of the product and must sign the repair/work order prior to starting the repair in order to validate the warranty repair. All parts replaced under this limited warranty become the property of BRP.

7) WHAT BRP WILL DO

BRP's obligations under this warranty are limited to, at its sole discretion, repairing parts found defective under normal use, maintenance and service, or replacing such parts with new genuine Ski-Doo parts without charge for parts and labor, at any authorized BRP dealer during the warranty coverage period.

BRP reserves the right to improve or modify products from time to time without assuming any obligation to modify products previously manufactured.

8) TRANSFER

If the ownership of a product is transferred during the warranty coverage period, this warranty shall also be transferred and be valid for the remaining coverage period provided that BRP is notified of such transfer of ownership in the following way:

- a) The former owner contacts BRP (at the phone number provided below) or an authorized BRP dealer and gives the coordinates of the new owner; or
- b) BRP or an authorized BRP dealer receives a proof that the former owner agreed to the transfer of ownership, in addition to the coordinates of the new owner.

9) CONSUMER ASSISTANCE

- a) In the event of a controversy or a dispute in connection with this limited warranty, BRP suggests that you try to resolve the issue at the dealership level. We recommend discussing the issue with the authorized dealer's service manager or owner.
- b) If the issue has not yet been resolved, please submit your complaint in writing or call the appropriate number below:

In Canada

BOMBARDIER RECREATIONAL PRODUCTS INC.

Consumer Services Group
75, J.-A. Bombardier Street
Sherbrooke, Québec J1L 1W3
Tel.: 819 566-3366

In USA

BRP US INC.

Consumer Services Group
7575 Bombardier Court
Wausau WI 54401
Tel.: 715 848-4957

* In the USA, products are distributed and serviced by BRP US Inc.

© 2007 Bombardier Recreational Products Inc. All rights reserved.

® Registered trademark of Bombardier Recreational Products Inc.

BRP INTERNATIONAL LIMITED WARRANTY: 2008 SKI-DOO® SNOWMOBILES

1) SCOPE OF THE LIMITED WARRANTY

Bombardier Recreational Products Inc. ("BRP") warrants its 2008 Ski-Doo snowmobiles sold by authorized BRP distributor/dealer (as hereinafter defined) outside of the fifty United States, Canada and states members of the European Union from defects in material or workmanship for the period and under the conditions described below.

All genuine Ski-Doo parts and accessories, installed by an authorized BRP distributor/dealer at the time of delivery of the 2008 Ski-Doo snowmobile, carry the same warranty as that of the snowmobile.

A GPS receiver may be supplied by BRP as standard equipment on certain 2008 Ski-Doo snowmobiles. The GPS receiver is covered by the limited warranty issued by the GPS receiver's manufacturer and is not covered by this BRP limited warranty.

Use of the product for racing or any other competitive activity, at any point, even by a previous owner, will render this warranty null and void.

2) EXCLUSIONS – ARE NOT WARRANTED

The following are not warranted under any circumstances:

- Normal wear and tear;
- Routine maintenance items, tune ups, adjustments;
- Damage caused by failure to provide proper maintenance and/or storage, as described in the Operator's Guide;
- Damage resulting from removal of parts, improper repairs, service, maintenance, modifications or use of parts not manufactured or approved by BRP or resulting from repairs done by a person that is not an authorized servicing BRP distributor/dealer;
- Damage caused by abuse, abnormal use, neglect, use of the product on surfaces other than snow, or operation of the product in a manner inconsistent with the recommended operation described in the Operator's Guide;
- Damage resulting from accident, submersion, fire, theft, vandalism or any act of God;
- Operation with fuels, oils or lubricants which are not suitable for use with the product (see the Operator's Guide);
- Snow or water ingestion;
- Incidental or consequential damages, or damages of any kind including without limitation towing, storage, telephone, rental, taxi, inconvenience, insurance coverage, loan payments, loss of time, loss of income; and
- Damage resulting from studs installed on tracks if the installation does not conform to BRP's instructions.

3) LIMITATIONS OF LIABILITY

THIS WARRANTY IS EXPRESSLY GIVEN AND ACCEPTED IN LIEU OF ANY AND ALL OTHER WARRANTIES, EXPRESSED OR IMPLIED, INCLUDING WITHOUT LIMITATION ANY WARRANTY OF MERCHANTABILITY OR FITNESS FOR A PARTICULAR PURPOSE. TO THE EXTENT THAT THEY CANNOT BE DISCLAIMED, THE IMPLIED WARRANTIES ARE LIMITED IN DURATION TO THE LIFE OF THE EXPRESS WARRANTY. INCIDENTAL AND CONSEQUENTIAL DAMAGES ARE EXCLUDED FROM COVERAGE UNDER THIS WARRANTY. SOME STATES/PROVINCES DO NOT ALLOW FOR THE DISCLAIMERS, LIMITATIONS AND EXCLUSIONS IDENTIFIED ABOVE, AS A RESULT, THEY MAY NOT APPLY TO YOU. THIS WARRANTY GIVES YOU SPECIFIC RIGHTS, AND YOU MAY ALSO HAVE OTHER LEGAL RIGHTS WHICH MAY VARY FROM STATE TO STATE, OR PROVINCE TO PROVINCE.

Neither the distributor, any BRP distributor/dealer nor any other person has been authorized to make any affirmation, representation or warranty regarding the product, other than those contained in this limited warranty, and if made, shall not be enforceable against BRP.

BRP reserves the right to modify this warranty at any time, being understood that such modification will not alter the warranty conditions applicable to the products sold while this warranty is in effect.

4) WARRANTY COVERAGE PERIOD

This warranty will be in effect from the date of delivery to the first retail consumer or the date the product is first put into use, whichever occurs first and for a period of:

TWELVE (12) CONSECUTIVE MONTHS, for private or commercial use owners. However, the warranty coverage period on a snowmobile delivered between June 1st and December 1st of a given year will expire December 1st of the following year.

The repair or replacement of parts or the performance of service under this warranty does not extend the life of this warranty beyond its original expiration date.

Note that the duration and any other modalities of the warranty coverage are subject to the applicable national or local legislation in your country.

5) CONDITIONS TO HAVE WARRANTY COVERAGE

This warranty coverage is available only if each of the following conditions has been fulfilled:

- The 2008 Ski-Doo snowmobile must be purchased as new and unused by its first owner from a BRP distributor/dealer authorized to distribute Ski-Doo snowmobiles in the country in which the sale occurred (“BRP distributor/dealer”);
- The BRP specified pre-delivery inspection process must be completed and documented;
- The product must have undergone proper registration by an authorized BRP distributor/dealer;
- The 2008 Ski-Doo snowmobile must be purchased in the country or union of countries in which the purchaser resides.

- Routine maintenance outlined in the Operator's Guide must be timely performed in order to maintain warranty coverage. BRP reserves the right to make warranty coverage contingent upon proof of proper maintenance.

BRP will not honour this limited warranty to any private use owner or commercial use owner if the preceding conditions have not been met. Such limitations are necessary in order to allow BRP to preserve both the safety of its products, and also that of its consumers and the general public.

6) WHAT TO DO TO OBTAIN WARRANTY COVERAGE

The customer must notify a servicing BRP distributor/dealer within two (2) days of the appearance of a defect, and provide it with reasonable access to the product and reasonable opportunity to repair it. The customer must also present to the authorized BRP distributor/dealer, proof of purchase of the product and must sign the repair/work order prior to starting the repair in order to validate the warranty repair. All parts replaced under this limited warranty become the property of BRP.

Note that the notification period is subject to the applicable national or local legislation in your country.

7) WHAT BRP WILL DO

BRP's obligations under this warranty are limited to, at its sole discretion, repairing parts found defective under normal use, maintenance and service, or replacing such parts with new genuine Ski-Doo parts without charge for parts and labor, at any authorized BRP distributor/dealer during the warranty coverage period.

BRP reserves the right to improve or modify products from time to time without assuming any obligation to modify products previously manufactured.

8) TRANSFER

If the ownership of a product is transferred during the warranty coverage period, this warranty shall also be transferred and be valid for the remaining coverage period provided BRP or an authorized BRP distributor/dealer receives a proof that the former owner agreed to the transfer of ownership, in addition to the coordinates of the new owner.

9) CONSUMER ASSISTANCE

- a) In the event of a controversy or a dispute in connection with this limited warranty, BRP suggests that you try to resolve the issue at the dealership level. We recommend discussing the issue with the authorized distributor/dealer's service manager or owner.
- b) If further assistance is required, the distributor's service department should be contacted in order to resolve the matter. You can find your distributor's coordinates on www.brp.com.
- c) If the matter still remains unresolved then contact BRP at the address listed below.

For Russia, CIS and the Middle East, please contact our European office:

BRP EUROPE N.V.

Consumer Services Group
Skaldenstraat 125
9042 Gent
Belgique
Tel.: + 32-9-218-26-00

For Scandinavia and European countries, please contact our Finland office:

BRP FINLAND OY

Service Department
Ahjotie 30
FIN-96320 Rovaniemi
Finland
Tel.: + 358 16 3208 111

For all other countries, please contact our North American office:

BOMBARDIER RECREATIONAL PRODUCTS INC.

Consumer Services Group
75, J.-A. Bombardier Street
Sherbrooke, Québec J1L 1W3
Tel.: 819 566-3366

BRP EUROPEAN UNION MEMBER STATES LIMITED WARRANTY: 2008 SKI-DOO® SNOWMOBILES

1) SCOPE OF THE LIMITED WARRANTY

Bombardier Recreational Products Inc. ("BRP")* warrants its 2008 Ski-Doo snowmobiles sold by authorized BRP distributor/dealer (as hereinafter defined) in states members of the European Union from defects in material or workmanship for the period and under the conditions described below.

All genuine Ski-Doo parts and accessories, installed by an authorized BRP distributor/dealer (at the time of delivery of the 2008 Ski-Doo snowmobile, carry the same warranty as that of the snowmobile.

A GPS receiver may be supplied by BRP as standard equipment on certain 2008 Ski-Doo snowmobiles. The GPS receiver is covered by the limited warranty issued by the GPS receiver's manufacturer and is not covered by this BRP limited warranty.

Use of the product for racing or any other competitive activity, at any point, even by a previous owner, will render this warranty null and void.

2) EXCLUSIONS – ARE NOT WARRANTED

The following are not warranted under any circumstances:

- Normal wear and tear;
- Routine maintenance items, tune ups, adjustments;
- Damage caused by failure to provide proper maintenance and/or storage, as described in the Operator's Guide;
- Damage resulting from removal of parts, improper repairs, service, maintenance, modifications or use of parts not manufactured or approved by BRP or resulting from repairs done by a person that is not an authorized servicing BRP distributor/dealer;
- Damage caused by abuse, abnormal use, neglect, use of the product on surfaces other than snow, or operation of the product in a manner inconsistent with the recommended operation described in the Operator's Guide;
- Damage resulting from accident, submersion, fire, theft, vandalism or any act of God;
- Operation with fuels, oils or lubricants which are not suitable for use with the product (see the Operator's Guide);
- Snow or water ingestion;
- Incidental or consequential damages, or damages of any kind including without limitation towing, storage, telephone, rental, taxi, inconvenience, insurance coverage, loan payments, loss of time, loss of income; and
- Damage resulting from studs installed on tracks if the installation does not conform to BRP's instructions.

3) LIMITATIONS OF LIABILITY

THIS WARRANTY IS EXPRESSLY GIVEN AND ACCEPTED IN LIEU OF ANY AND ALL OTHER WARRANTIES, EXPRESSED OR IMPLIED, INCLUDING WITHOUT LIMITATION ANY WARRANTY OF MERCHANTABILITY OR FITNESS FOR A PARTICULAR PURPOSE. TO THE EXTENT THAT THEY CANNOT BE DISCLAIMED, THE IMPLIED WARRANTIES ARE LIMITED IN DURATION TO THE LIFE OF THE EXPRESS WARRANTY. INCIDENTAL AND CONSEQUENTIAL DAMAGES ARE EXCLUDED FROM COVERAGE UNDER THIS WARRANTY. SOME JURISDICTIONS DO NOT ALLOW FOR THE DISCLAIMERS, LIMITATIONS AND EXCLUSIONS IDENTIFIED ABOVE, AS A RESULT, THEY MAY NOT APPLY TO YOU. THIS WARRANTY GIVES YOU SPECIFIC RIGHTS, AND YOU MAY ALSO HAVE OTHER LEGAL RIGHTS WHICH MAY VARY FROM COUNTRY TO COUNTRY, OR PROVINCE TO PROVINCE.

Neither the distributor, any BRP distributor/dealer nor any other person has been authorized to make any affirmation, representation or warranty regarding the product, other than those contained in this limited warranty, and if made, shall not be enforceable against BRP.

BRP reserves the right to modify this warranty at any time, being understood that such modification will not alter the warranty conditions applicable to the products sold while this warranty is in effect.

4) WARRANTY COVERAGE PERIOD

This warranty will be in effect from the date of delivery to the first retail consumer or the date the product is first put into use, whichever occurs first and for a period of:

TWENTY-FOUR (24) CONSECUTIVE MONTHS for private use owners, and TWELVE (12) CONSECUTIVE MONTHS for commercial use owners. However, the warranty coverage period on a snowmobile delivered between June 1st and December 1st of a given year will expire December 1st of the applicable year. A snowmobile is used commercially when it is used in connection with generating income or any work or employment during any part of the warranty period. A snowmobile is also used commercially when, at any point during the warranty period, it has commercial tags or is licensed for commercial use.

The repair or replacement of parts or the performance of service under this warranty does not extend the life of this warranty beyond its original expiration date.

Note that the duration and any other modalities of the warranty coverage are subject to the applicable national or local legislation in your country.

5) CONDITIONS TO HAVE WARRANTY COVERAGE

This warranty coverage is available only if each of the following conditions has been fulfilled:

- The 2008 Ski-Doo snowmobile must be purchased as new and unused by its first owner from a BRP distributor/dealer authorized to distribute Ski-Doo products in the country in which the sale occurred (“BRP distributor/dealer”);
- The BRP specified pre-delivery inspection process must be completed and documented;

- The product must have undergone proper registration by an authorized BRP distributor/dealer;
- The 2008 Ski-Doo snowmobile must be purchased in the country or union of countries in which the purchaser resides;
- Routine maintenance outlined in the Operator's Guide must be timely performed in order to maintain warranty coverage. BRP reserves the right to make warranty coverage contingent upon proof of proper maintenance.

BRP will not honour this limited warranty to any private use owner or commercial use owner if the preceding conditions have not been met. Such limitations are necessary in order to allow BRP to preserve both the safety of its products, and also that of its consumers and the general public.

6) WHAT TO DO TO OBTAIN WARRANTY COVERAGE

The customer must notify a servicing BRP distributor/dealer within two (2) months of the appearance of a defect, and provide it with reasonable access to the product and reasonable opportunity to repair it. The customer must also present to the authorized BRP distributor/dealer, proof of purchase of the product and must sign the repair/work order prior to starting the repair in order to validate the warranty repair. All parts replaced under this limited warranty become the property of BRP.

Note that the notification period is subject to the applicable national or local legislation in your country.

7) WHAT BRP WILL DO

BRP's obligations under this warranty are limited to, at its sole discretion, repairing parts found defective under normal use, maintenance and service, or replacing such parts with new genuine Ski-Doo parts without charge for parts and labor, at any authorized BRP distributor/dealer during the warranty coverage period.

BRP reserves the right to improve or modify products from time to time without assuming any obligation to modify products previously manufactured.

8) TRANSFER

If the ownership of a product is transferred during the warranty coverage period, this warranty shall also be transferred and be valid for the remaining coverage period provided BRP or an authorised BRP distributor/dealer receives a proof that the former owner agreed to the transfer of ownership, in addition to the coordinates of the new owner.

9) CONSUMER ASSISTANCE

- a) In the event of a controversy or a dispute in connection with this limited warranty, BRP suggests that you try to resolve the issue at the dealership level. We recommend discussing the issue with the authorized distributor/dealer's service manager or owner.
- b) If further assistance is required, the distributor's service department should be contacted in order to resolve the matter. You can find your distributor's coordinates on www.brp.com.
- c) If the matter still remains unresolved then contact BRP at the address listed below.

For Russia, CIS and the Middle East, please contact our European office:

BRP EUROPE N.V.

Consumer Services Group
Skaldenstraat 125
9042 Gent
Belgique
Tel.: + 32-9-218-26-00

For Scandinavia and European countries, please contact our Finland office:

BRP FINLAND OY

Service Department
Ahjotie 30
FIN-96320 Rovaniemi
Finland
Tel.: + 358 16 3208 111

For all other countries, please contact our North American office:

BOMBARDIER RECREATIONAL PRODUCTS INC.

Consumer Services Group
75, J.-A. Bombardier Street
Sherbrooke, Québec J1L 1W3
Tel.: 819 566-3366

PRIVACY OBLIGATIONS/DISCLAIMER

We wish to inform you that your coordinates will be used for safety and warranty purposes. Sometimes, we also use the coordinates of our clients to inform them about our products and to present them offers. Should you prefer not to receive information on our products, services and offers, please let us know by writing to the address below.

Also note that, from time to time, carefully selected and trustworthy organizations may be permitted to use the coordinates of our clients to promote quality products and services. If you prefer not to have your name and address released, please let us know by writing to the address below:

In Canada

BOMBARDIER RECREATIONAL PRODUCTS INC.

Warranty Department
75, J.-A. Bombardier Street
Sherbrooke, Québec J1L 1W3
Fax Number: 819 566-3590

In USA

BRP US INC.

Warranty Department
7575 Bombardier Court
Wausau WI 54401
Tel.: 715 848-4957

For Russia, CIS and the Middle East

BRP EUROPEAN DISTRIBUTION

After Sales Service Department
Chemin de Messidor 5-7
1006 Lausanne
Switzerland
Fax Number: + 41213187801

For Scandinavian and European countries

BRP FINLAND OY

Service Department
Ahjotie 30
FIN-96320 Rovaniemi
Finland
Tel.: + 358 16 3208 111

For all other countries, please contact A) or B)

A) Your respective distributor (you will find its coordinates on www.brp.com).

B) Our North American office:

BOMBARDIER RECREATIONAL PRODUCTS INC.

Warranty Department
75, J.-A. Bombardier Street
Sherbrooke, Québec J1L 1W3
Canada
Fax Number: 819 566-3590

CHANGE OF ADDRESS/OWNERSHIP

If your address has changed or if you are the new owner of the vehicle, be sure to notify BRP by either:

- mailing one of the following card below;
- **North America Only:** calling at 715 848-4957 (USA) or 819 566-3366 (Canada);
- notifying an authorized SKI-DOO dealer.

In North America

BOMBARDIER RECREATIONAL PRODUCTS INC.

Warranty Department
75, J.-A. Bombardier Street
Sherbrooke, Québec J1L 1W3
Fax Number: 819 566-3590

For Russia, CIS and the Middle East

BRP EUROPEAN DISTRIBUTION

After Sales Service Department
Chemin de Messidor 5-7
1006 Lausanne
Switzerland
Fax Number: + 41213187801

For Scandinavian and European countries

BRP FINLAND OY

Service Department
Ahjotie 30
FIN-96320 Rovaniemi
Finland
Tel.: + 358 16 3208 111

For all other countries, please contact A) or B)

A) Your respective distributor (you will find its coordinates on www.brp.com).

B) Our North American office:

BOMBARDIER RECREATIONAL PRODUCTS INC.

Warranty Department
75, J.-A. Bombardier Street
Sherbrooke, Québec J1L 1W3
Canada
Fax Number: 819 566-3590

In case of change of ownership, please join a proof that the former owner agreed to the transfer.

Notifying BRP, even after the expiration of the limited warranty, is very important as it enables BRP to reach the vehicle owner if necessary, like when safety recalls are initiated. It is the owner's responsibility to notify BRP.

STOLEN UNITS: If your personal vehicle is stolen, you should notify BRP or an authorized SKI-DOO dealer. We will ask you to provide your name, address, phone number, the vehicle identification number and the date it was stolen.



CHANGE OF ADDRESS <input type="checkbox"/>			CHANGE OF OWNERSHIP <input type="checkbox"/>		
VEHICLE IDENTIFICATION NUMBER					
<input type="text"/>		<input type="text"/>			
Model Number		Vehicle Identification Number (V.I.N.)			
OLD ADDRESS OR PREVIOUS OWNER:			NAME		
NO.		STREET		APT	
CITY		STATE/PROVINCE		ZIP/POSTAL CODE	
COUNTRY			TELEPHONE		
NEW ADDRESS OR NEW OWNER:			NAME		
NO.		STREET		APT	
CITY		STATE/PROVINCE		ZIP/POSTAL CODE	
COUNTRY			TELEPHONE		

V00A2F

In case of change of ownership, please join a proof that the former owner agreed to the transfer.

Notifying BRP, even after the expiration of the limited warranty, is very important as it enables BRP to reach the vehicle owner if necessary, like when safety recalls are initiated. It is the owner's responsibility to notify BRP.

STOLEN UNITS: If your personal vehicle is stolen, you should notify BRP or an authorized SKI-DOO dealer. We will ask you to provide your name, address, phone number, the vehicle identification number and the date it was stolen.



CHANGE OF ADDRESS <input type="checkbox"/>	CHANGE OF OWNERSHIP <input type="checkbox"/>																
VEHICLE IDENTIFICATION NUMBER																	
Model Number	Vehicle Identification Number (V.I.N.)																
<table border="0" style="width: 100%;"> <tr> <td style="width: 40%; vertical-align: top;"> <p>OLD ADDRESS OR PREVIOUS OWNER:</p> </td> <td style="width: 60%; border-bottom: 1px solid black;">NAME</td> </tr> <tr> <td></td> <td style="border-bottom: 1px solid black;">NO. STREET APT</td> </tr> <tr> <td></td> <td style="border-bottom: 1px solid black;">CITY STATE/PROVINCE ZIP/POSTAL CODE</td> </tr> <tr> <td></td> <td style="border-bottom: 1px solid black;">COUNTRY TELEPHONE</td> </tr> <tr> <td style="vertical-align: top; padding-top: 20px;"> <p>NEW ADDRESS OR NEW OWNER:</p> </td> <td style="border-bottom: 1px solid black;">NAME</td> </tr> <tr> <td></td> <td style="border-bottom: 1px solid black;">NO. STREET APT</td> </tr> <tr> <td></td> <td style="border-bottom: 1px solid black;">CITY STATE/PROVINCE ZIP/POSTAL CODE</td> </tr> <tr> <td></td> <td style="border-bottom: 1px solid black;">COUNTRY TELEPHONE</td> </tr> </table>		<p>OLD ADDRESS OR PREVIOUS OWNER:</p>	NAME		NO. STREET APT		CITY STATE/PROVINCE ZIP/POSTAL CODE		COUNTRY TELEPHONE	<p>NEW ADDRESS OR NEW OWNER:</p>	NAME		NO. STREET APT		CITY STATE/PROVINCE ZIP/POSTAL CODE		COUNTRY TELEPHONE
<p>OLD ADDRESS OR PREVIOUS OWNER:</p>	NAME																
	NO. STREET APT																
	CITY STATE/PROVINCE ZIP/POSTAL CODE																
	COUNTRY TELEPHONE																
<p>NEW ADDRESS OR NEW OWNER:</p>	NAME																
	NO. STREET APT																
	CITY STATE/PROVINCE ZIP/POSTAL CODE																
	COUNTRY TELEPHONE																

V00A2F



520 000 689

CA

OPERATOR'S GUIDE, REV XP SERIES / ENGLISH
GUIDE DU CONDUCTEUR, SÉRIE REV XP / ANGLAIS

FAIT AU / MADE IN CANADA

U/M:P.C.