

ski-doo®



2007
Operator's
Guide

Mini Z™

Includes
Safety, Vehicle
and Maintenance Information

WARNING

Read this guide thoroughly. It contains important safety information.
Minimum recommended operator's age: 6 years old.
Maximum operator's weight: 45 kg (100 lb). Do not remove this Operator's Guide from the vehicle.

5 2 0 0 0 0 6 3 9

SAFETY WARNING

Disregarding any of the safety precautions and instructions contained in this Operator's Guide, *SAFETY VIDEO* or on-product warnings may result in injury, including the possibility of death. This Operator's Guide and *SAFETY VIDEO* should remain with the vehicle at time of resale.



In USA, products are distributed by BRP US Inc. (BRP).

In Canada, products are distributed by Bombardier Recreational Products Inc.

The following are trademarks of Bombardier Recreational Products Inc. or its subsidiaries.

SKI-DOO®

MINI Z™

XP-S

FOREWORD

Congratulations on your purchase of a new SKI-DOO snowmobile. Whatever model you have chosen, it is backed by the Bombardier Recreational Products Inc. (BRP) warranty and a network of authorized SKI-DOO snowmobile dealers ready to provide the parts, service or accessories you may require.

The Operator's Guide has been prepared to acquaint the owner/operator with this new snowmobile and its various controls, maintenance and safe riding instructions. This guide is indispensable for the proper use of the product and should be kept with this snowmobile at all times.

Make sure you read and understand the content of this Operator's Guide.

After reading, please keep this Operator's Guide with the snowmobile. If the snowmobile is resold, please give the guide to the new owner for his awareness.

If you want to view and/or print an extra copy of your Operator's Guide, simply visit the following website **www.operators.guide.brp.com**. Also note that the guide is available in several languages.

If you have any question regarding any topic whether or not it is covered in this Operator's Guide, please call BRP at the number below and we will be happy to assist you:

In USA:	In Canada:	Other countries in the world:
(715) 848-4957	(819) 566-3366	+32 (0) 9 272 63 30

This guide uses the following safety alert symbol in conjunction with signal words to indicate a potential personal injury hazard.

WARNING

Indicates a potentially hazardous situation which, if not avoided, could result in death or serious injury.

CAUTION

Indicates a potentially hazardous situation which, if not avoided, may result in minor or moderate injury. When used without the safety alert symbol , potential hazard exists for property damage only.

CAUTION: Denotes an instruction which, if not followed, could severely damage vehicle components.

NOTE: Indicates supplementary information needed to fully complete an instruction.

Although the mere reading of such information does not eliminate the hazard, the understanding and application of the information will promote the correct use of the vehicle.

Your dealer is committed to your satisfaction. He has taken training to perform the initial set-up and inspection of your snowmobile as well as completed the final adjustment required to suit your specific weight and riding environment before you took possession. At delivery, your dealer would have explained the snowmobile controls and provided you with a brief explanation of the various suspension adjustments. We trust you have taken full advantage of this!

At delivery, you were also informed of the warranty coverage and have completed the Warranty Registration process.

The information and components/system descriptions contained in this guide are correct at time of publication. BRP, however maintains a policy of continuous improvement of its products without imposing upon itself any obligation to install them on products previously manufactured.

Because of its ongoing commitment to product quality and innovation, BRP reserves the right at any time to discontinue or change specifications, designs, features, models or equipment without incurring obligation.

The illustrations in this document show the typical construction of the different assemblies and, in all cases, may not reproduce the full detail or exact shape of the parts shown, however, they represent parts which have the same or a similar function.

It is understood that this guide may be translated into another language. In the event of any discrepancy, the English version shall prevail.

Specifications are given in the SI metric system with the SAE U.S. equivalent in parentheses. Where precise accuracy is not required, some conversions are rounded off for easier use.

Most components of this snowmobile are built with parts dimensioned in the metric system. Most fasteners are metric and must not be replaced by customary fasteners or vice versa.

We recommend genuine BRP products for replacement parts and accessories. They've been specially designed for your vehicle and manufactured to meet BRP's demanding standards.

A *SHOP MANUAL* can be obtained for complete service, maintenance and more repair information.

For any questions pertaining to the warranty and its application, consult the *WARRANTY* section in this guide, and/or an authorized SKI-DOO dealer.

TABLE OF CONTENTS

SAFETY INFORMATION

INTRODUCTION	8
NOTICE TO PARENTS	9
IMPORTANT BASIC SAFETY MEASURES.....	10
LAWS AND REGULATIONS.....	14
RIDING THE VEHICLE	15
Principle of Operation	15
How to Ride	16
Carrying a Passenger	20
People at Front	21
Signals	22
SAFETY LABELING	25

ENVIRONMENT INFORMATION

GENERAL.....	30
JUST WHAT IS LIGHT TREADING?	32
WHY IS LIGHT TREADING SMART	33

CHILD'S SECTION

SNOWMOBILE DESCRIPTION.....	36
CLOTHING.....	37
SNOWMOBILE CONTROLS.....	38
1) Throttle Lever.....	39
2) Brake Lever.....	39
3) Handlebar	39
4) Ignition Switch.....	39
5) Tether Cut-Out Switch	41
6) Engine Cut-Out Switch	42
7) Rewind Starter Handle	42
8) Choke Button.....	42
9) Hood Latches.....	43
OPERATING INSTRUCTIONS.....	44
Before you Start.....	44
How to Start.....	47
How to Stop.....	51
Emergency Stop	52

First Ride	53
After Use	54

PARENT'S SECTION

VEHICLE INFORMATION.....	56
How to Identify the Snowmobile.....	56
Recommended Fuel and Oil.....	58
Break-In Period.....	60
Pre-Operation Check.....	61
Starting the Engine.....	63
Troubleshooting.....	64
Specifications.....	66
MAINTENANCE INFORMATION.....	69
Periodic Maintenance Chart.....	69
General.....	72
Engine System.....	72
Drive System.....	74
Rear Suspension.....	84
Steering and Front Suspension.....	85
Body/Frame.....	85
Storage and Preseason Preparation.....	87

WARRANTY

BRP LIMITED WARRANTY NORTH AMERICA: 2007 SKI-DOO® SNOWMOBILES	90
BRP INTERNATIONAL LIMITED WARRANTY: 2007 SKI-DOO® SNOWMOBILES	95
BRP EUROPEAN UNION MEMBER STATES LIMITED WARRANTY: 2007 SKI-DOO® SNOWMOBILES	99
PRIVACY OBLIGATIONS/DISCLAIMER	103
CHANGE OF ADDRESS/OWNERSHIP.....	104

SAFETY INFORMATION

INTRODUCTION

Everyone is a beginner the first time he sits behind the controls of a snowmobile regardless of previous experience in driving any other type of recreational products. The safe use of your snowmobile is dependent on many conditions such as visibility, speed, weather, environment, traffic, vehicle condition and the condition of the driver.

Each operator has a responsibility to ensure the safety of other recreationists or bystanders.

You are responsible for proper operation of your vehicle as well as training those whom you allow to ride or drive. There may be noticeable handling and performance differences from one snowmobile to the other.

A snowmobile is relatively simple to operate but like any other vehicle or mechanical equipment, it can be hazardous if you are reckless, thoughtless or inattentive. We encourage you to have an Annual Safety Inspection of your snowmobile. Please contact an authorized SKI-DOO dealer for further details. Finally, we urge you to visit an authorized SKI-DOO dealer periodically for regular and safety maintenance, as well as snowmobile accessories you may require.

NOTICE TO PARENTS

Carefully read this Operator's Guide and understand the controls and operation of the snowmobile.

Please take time with your child to review the entire content including the instructions on its safe proper use, while paying attention to the on-product safety labeling before allowing him to ride snowmobile.

It is important that you supervise the children at all times in order to prevent serious injuries. It is your discretion to allow unsupervised use only if you should determine that all children have the ability, strength and judgment to operate the snowmobile safely.

Do not allow children to ride snowmobile if they are younger than the recommended age of 6 years or weighing over 45 kg (100 lb) or if they do not have the strength, skills or judgment required to operate the snowmobile. Always remember that your approach to safety influences the child. If available locally, enroll your children in a snowmobile safety training program.

WARNING

This snowmobile is classified as a children snowmobile. It is not designed to exceed speeds of 13 km/h (8 MPH), nor to carry passenger(s), cargo, pull a sleigh, toboggan or any object of similar nature.

Use of snowmobile should be limited to daylight operation only, in areas clear of obstacles and on adequate snow covered terrain. Ensure children do not operate the snowmobile on frozen bodies of water, or on snowmobile or ATV recreational trails or near streets, roadways, driveways or sidewalks. In most States or Provinces, it is considered an illegal operation.

WARNING

This snowmobile is not intended for use on snowmobile or ATV recreational trails. Regular size snowmobiles circulate at much higher speed which would create significant risks of collision with the children snowmobile.

Make sure area is free of wire fencing, tree stumps or other hazards. THIS GUIDE SHOULD REMAIN WITH THE SNOWMOBILE AT ITS RESALE.

IMPORTANT BASIC SAFETY MEASURES

Training

- △ Basic training is required for the safe operation of any snowmobile. Study your Operator's Guide paying particular attention to cautions and warnings. Obtain basic instructions from your snowmobile dealer, friend, fellow club member or enroll in your state or provincial safety training program.
- △ Always show a new operator how to start and stop the vehicle. Indicate the correct riding positions and, above all else, only allow him to operate the snowmobile in a restricted flat area — at least until he is completely familiar with its operation. If there is a local snowmobile operator's training course existing, have him enroll.

Performance

- △ Injury or death may result to the snowmobile operator or bystander if the snowmobile is used in risky conditions which are beyond the driver's or snowmobile's capabilities or intended use.

Speed

- △ Speeding can be fatal. In many cases, you cannot react or respond quickly enough to the unexpected. Always ride at a speed which is suitable to the trail, weather conditions and your own ability. Know your local rules. Speed limit may be in effect and meant to be observed.

Riding

- △ If you are a parent, you must be the judge of your child's capability to understand, to operate and to control a snowmobile. Warn against speeding, over confidence and carelessness. Never let children snowmobile unsupervised.
- △ Always keep a safe distance from other snowmobiles and bystanders.
- △ Remember, promotional material may show risky maneuvers performed by professional riders under ideal and/or controlled conditions. You should never attempt any such risky maneuvers if they are beyond your level of riding ability.
- △ Never ride after consuming drugs or alcohol or if you feel tired or ill. Operate your snowmobile prudently.
- △ Your snowmobile is not designed to be operated on public streets, roads or highways.

- △ Snowmobiling at night can be a delightful experience but because of reduced visibility, be extra cautious. Avoid unfamiliar terrain and be sure your lights are working. Always carry a flashlight and spare light bulbs.
- △ Fences represent a very serious threat for both you and your snowmobile. Give a wide berth to telephone poles or posts.
- △ Hidden wires unseen from a distance can cause serious accidents.
- △ Always wear an approved safety helmet, eye protection and a face shield.
- △ Be aware of inherent risks associated with riding off trails, such as avalanche and other natural or man made hazards or obstacles.
- △ Meadows sometimes have low areas where water accumulate and freezes over in winter. This ice is usually glare ice. Attempting to turn or brake on this surface could cause your vehicle to spin out of control. Never brake or attempt speeding or turning on glare ice. If you do happen to travel over such a condition, reduce speed by carefully releasing the throttle.
- △ Never “jump” with your snowmobile. This should be left to professional stunt men. Don't show off. Be responsible.
- △ While on safari, do not “gun” the throttle. Snow and ice can be thrown back into the path of a following snowmobile. In addition, when “gunning” the throttle, the vehicle digs into and leaves an irregular snow surface for others.
- △ Safaris are both fun and enjoyable but don't show off or overtake others in the group. A less experienced operator might try to do the same as you and fail. When riding with others, limit your abilities to the experience of others.

Operation

- △ Always make a pre-start inspection BEFORE you turn on the ignition.
- △ Securely attach the tether cord to the child's clothing eyelet prior to starting the engine.
- △ In an emergency, the snowmobile engine can be stopped by activating the engine cut-out switch, pulling the tether cord cap or turning off the key.
- △ Throttle mechanism should be checked for free movement and return to idle position before starting engine.
- △ Always engage parking brake when vehicle is not in use.

- ⚠ Never run the engine in a non-ventilated area and/or if vehicle is left unattended.
- ⚠ Never operate the engine without chain guard securely installed or, with hood or access/side panels open or removed. Never run the engine without drive chain installed. Running an unloaded engine such as without drive chain or with track raised, can be dangerous.
- ⚠ Do not leave your keys in the ignition switch, it is an invitation to thieves and a danger to young children.
- ⚠ Raising the rear of your snowmobile while the engine is running could cause snow, ice or debris to be thrown back at an observer. Never raise the rear of the vehicle while the engine is running. To clear or inspect the track, stop the engine, tilt the vehicle on its side and remove blockage with a piece of wood or branch. Never allow anyone near a rotating snowmobile track.

Maintenance

- ⚠ Do not allow children to attempt any repairs or servicing.
- ⚠ Know your snowmobile and treat it with the respect and care due of any power driven machine. Common sense, proper handling and routine maintenance will result in safer and enjoyable use.
- ⚠ Only perform procedures as detailed in this guide. Unless otherwise specified, engine should be turned OFF and cold for all lubrication, adjustment and maintenance procedures.
- ⚠ Never have the engine running while the hood is open. Always turn off the ignition before opening the hood for any reason.
- ⚠ Never remove any original equipment from your snowmobile. Each vehicle has many built in safety features. Such features include various guards and consoles, plus reflective materials and warning labels.
- ⚠ A poorly maintained snowmobile itself can be a potential hazard. Excessively worn components could render the vehicle completely inoperative. Keep the snowmobile in good working condition at all times. Follow your pre-operation check, weekly, monthly and annually routine maintenance and lubrication procedures as detailed in this guide. Consult a snowmobile dealer or acquire a *SHOP MANUAL* and proper tools and equipment if other repairs or service is required.
- ⚠ Do not stud the track unless it as been approved for studs. At speed, a studded track that as not been approved for studs could tear and separate from vehicle posing a risk of severe injury or death.

Fuel

- ⚠ Do not allow children to refuel the snowmobile.
- ⚠ Always stop the engine before refueling. Fuel is flammable and explosive under certain conditions. Always work in a well ventilated area. Do not smoke or allow open flames or sparks in the vicinity. Open cap slowly. If a differential pressure condition is noticed (whistling sound heard when loosening fuel tank cap) have vehicle inspected and/or repaired before further operation. Do not overfill or top off the fuel tank before placing the vehicle in a warm area. As temperature increases, fuel expands and might overflow. Always wipe off any fuel spillage from the vehicle. Periodically verify fuel system.

LAWS AND REGULATIONS

⚠ Know your local laws.

Federal, state, provincial and local government agencies have enacted laws and regulations pertaining to the safe use and operation of snowmobiles. It is your responsibility as a snowmobiler to learn and obey these laws and regulations. Respect and observance will result in safer snowmobiling for all.

Be aware of the liability property damages and insurance laws regarding your equipment.

RIDING THE VEHICLE

Operate the snowmobile in a restricted flat area until you are completely familiar with its operation and feel comfortable that you can safely tackle a more demanding task. Have an enjoyable and safe ride.

Principle of Operation

Propulsion

Depressing throttle lever increases engine RPM causing the drive pulley to engage.

WARNING

Never operate engine without chain guard securely installed or, with hood or access/side panels open or removed.

Power is transferred to the track through the drive chain and drive axle.

WARNING

Always use a wide-base snowmobile mechanical stand to properly support vehicle during any track verification. Slowly accelerate engine in order to rotate track at very low speed when it is not on ground.

Turning

Handlebar controls the steering of the vehicle. As the handlebar is rotated to right or left, the skis are turned right or left to steer the snowmobile.

Stopping

Before riding your snowmobile, you should understand how to stop it. This is done by releasing the throttle and gradually depressing the brake lever on the left side of the handlebar. In an emergency, you may stop your vehicle by pressing the engine cut-out switch located near the throttle control and applying the brake. Remember, a snowmobile cannot "stop on a dime". Braking characteristics vary with deep snow, packed snow or ice. If the track is locked during hard braking, skidding may result.

How to Ride

How to Dress

Proper snowmobile clothing should be worn. It should be comfortable and not too tight. Always check the weather forecast before going on a ride. Dress for the coldest weather expected. Thermal underwear next to the skin also provides a good insulation.

DOT approved helmets are recommended at all times. They provide both warmth and reduce injury. A stocking type cap, balaclava and face mask should always be carried or worn. Goggles or a face shield that attach to the helmet are indispensable.

Hands should be protected by a pair of snowmobile gloves or mitts which have sufficient insulation and allow use of thumbs and fingers for operation of controls.

Rubber bottom boots with either a nylon or a leather top, with removable felt liners are best suited for snowmobiling.

You should keep yourself as dry as possible when snowmobiling. When you come indoors, take your snowmobile suit and boots off and make certain they dry properly.

Do not wear long scarfs and loose apparels that could get caught in moving parts.

Riding Position

Your riding position and balance are the two basic principles of making your snowmobile go where you want it to.

These are 3 ways to position your body while riding the snowmobile; sitting, kneeling or standing.

WARNING

Do not attempt any maneuvers if they are beyond your abilities.

Sitting

Feet on the running boards, body midway back on seat is an ideal position when operating the snowmobile over familiar, smooth terrain. Knees and hips should remain flexible to absorb shocks.



A31H14A

FEET ON THE RUNNING BOARDS, KNEES AND HIPS FLEXIBLE



A31H15A

WRONG

Kneeling

This position is achieved by placing one foot firmly on the running board and the opposite knee on the seat. Avoid abrupt stops.



ONE FOOT ON THE RUNNING BOARD AND THE OPPOSITE KNEE ON THE SEAT

Standing

Place both feet on the running boards. Knees should be flexed to absorb the shock from surface bumps. This is an effective position to see better and to shift weight as conditions dictate. Avoid abrupt stop.



A31H16A

BOTH FEET ON THE RUNNING BOARD WITH KNEES FLEXED

WARNING

Be watchful of any overhead branches or other hazards.

Carrying a Passenger

This vehicle is intended for one operator only no passenger.



A31H17A

WRONG

People at Front

Make certain your snowmobile is pointed away from people or objects before you start it. No one is to be standing in front of or on back of the snowmobile.



A31A0LA

WRONG

Signals

WARNING

Always be careful of other snowmobiles ahead or near you. Stop or steer away from others.

If you intend to stop, raise either hand straight above your head. A left turn is indicated by extending your left hand straight out in the proper direction. For right turns, extend the left arm and raise the hand to a vertical position so it forms a right angle at the elbow.

Stop



A31H05A

TYPICAL — TO INDICATE STOP

Left Turn



A31H06A

TYPICAL — TO INDICATE LEFT TURN

Right Turn



A31H07A

TYPICAL — TO INDICATE RIGHT TURN

SAFETY LABELING

Safety standards for snowmobiles have been adopted by the Snowmobile Safety and Certification Committee (SSCC) of which BRP is a proud participating member. Assurance that your snowmobile meets these standards is easily checked by locating the Certification Label on a right vertical portion of the vehicle.

This label shows that an independent testing laboratory has verified compliance with the SSCC safety standards.



Other important labels on the vehicle are WARNING or CAUTION labels relating to safety, maintenance and/or snowmobile operation. Ensure all such labeling is retained on the vehicle and its content is followed by vehicle operator and passenger.

If missing or damaged, the decals can be replaced free of charge. See an authorized SKI-DOO dealer.

Please read the following instructions carefully before operating this snowmobile.

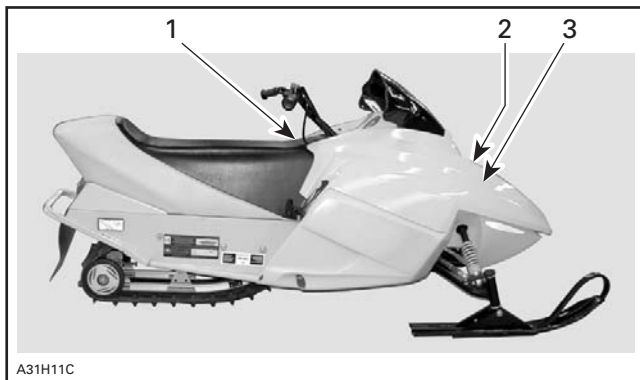

LOCATION OF IMPORTANT INSTRUCTIONS

Instruction 1

WARNING

- This snowmobile is classified as a children's snowmobile, group 1. It is not designed to exceed speeds of eight 8 mph (12.9 Km/h), nor to carry passenger(s), cargo, pull a sleigh, toboggan or any object of similar nature.
- Children should only be allowed to use the snowmobile in the presence or under the supervision of an adult. It is recommended that children using this snowmobile be not less than six (6) years of age.
- Use of snowmobile should be limited to daylight operation, in areas clear of obstacles, on adequate snow covered terrain, and not on frozen bodies of water, snowmobile or ATV trails or near streets or roadways.
- Test the throttle lever operation each time before starting the engine. -Securely attach the safety lanyard to the child's body prior to the start of the engine.
- Always make sure children wear all appropriate protective clothing, including an approved safety helmet, with goggles.
- Always comply with these instructions on proper use, carefully read the operator's guide and safety handbook and observe safe and responsible riding.

516 001 665

A31A0MA

Instruction 2

<p>◆WARNING! Do not run engine without this guard in place.</p> <p>◆AVERTISSEMENT! Ne pas mettre le moteur en marche sans ce protecteur.</p>
A31A00A

Instruction 3

<p>▲ WARNING</p> <p>Certain components in the engine compartment may be very hot. Direct contact may result in skin burn.</p>	<p>▲ AVERTISSEMENT</p> <p>Certaines composantes dans l'habitacle du moteur peuvent être très chaudes. Le contact direct sur la peau peut causer des brûlures.</p>
A33A0HA	516 001 297

ENVIRONMENT INFORMATION

GENERAL

Wildlife compliments your snowmobiling day. Snowmobile tracks provide firm ground over which animals can travel from area to area. Do not violate this privilege by chasing or harassing wildlife. Fatigue and exhaustion can lead to animal's death. Avoid areas posted for the protection or feeding of wildlife.

If you happen to be fortunate enough to see an animal, stop your snowmobile and observe quietly.

The guidelines that we support are not designed to limit your snowmobiling fun, but to preserve the beautiful freedom that you can experience only on a snowmobile! These guidelines will keep snowmobilers healthy, happy and able to introduce others to what they know and enjoy about their favorite winter pastime. So, the next time you hit the trails on a cool, crisp and clear winter day, we ask you to remember that you are paving the way for the future of our sport. Help us lead it down the right path! From all of us at BRP, thank you for doing your share.

There is nothing more exhilarating than snowmobiling. Venturing onto snowmobile trails that criss-cross the wild areas of the U.S. and Canada is an exciting and healthy winter sport. However, as the number of people using these recreational parks increases, so does the potential for damage to the environment. Abuse of land, facilities and resources inevitably leads to restrictions and closures of both private and public land.

In essence, the greatest threat to our sport, is all around us. Which leaves us with one logical choice. When we snowmobile, we must always ride responsibly.

The vast majority respect the law and the environment. Each of us must set an example for those who are new to the sport, young and old alike.

It is in every one's best interest to tread lightly into our recreational areas. Because, in the long run, to protect the sport we must preserve the environment.

Recognizing the importance of this issue and the need for snowmobilers to do their share in preserving areas that make it possible to enjoy our sport, BRP has developed the "Light Treading Is Smart Sledding" campaign for snowmobilers.

Light Treading refers to more than the thread of our tracks. It's a statement of concern, respect and willingness to take the lead and take action. It applies to the environment in general, its proper care and maintenance, its natural inhabitants and all enthusiasts and the public at large who enjoy the great outdoors. With this theme, we invite all snowmobilers to remember that respecting the environment is not only critical to the future of our industry but to future generations.

Light Treading in no way suggests you should curb your appetite for snowmobiling fun! It simply means tread with respect!

JUST WHAT IS LIGHT TREADING?

The fundamental objective of Light Treading is one of respect for where and how you ride a snowmobile. You're a light treader when you follow the principles below.

Become informed. Obtain maps, regulations and other information from the Forest Service or from other public land agencies. Learn the rules and follow them and that goes for speed limits, too!

Avoid running over young trees, shrubs, and grasses and don't cut wood. On flatlands or areas where trail riding is popular, it's important to ride only where authorized. Remember, there is a link between protecting your environment and your own safety.

Respect wildlife and be particularly sensitive of animals that are rearing young or suffering from food shortage. Stress can sap scarce energy reserves. Refrain from riding in areas where only animals are intended to tread!

Obey gate closures and regulatory signs and remember, light treaders don't litter!

Stay out of wilderness areas. They're closed to all vehicles. Know where the boundaries are.

Obtain permission to travel across private land. Respect the rights of landowners and other people's privacy. Remember, snowmobile technology has lowered the noise factor considerably, but you still shouldn't rev your engines where quiet "is the order of the day".

WHY IS LIGHT TREADING SMART

Snowmobilers know all too well the efforts that have been made throughout the sport's history to enjoy access to areas where people can snowmobile safely and responsibly. This effort continues today, as strong as ever.

Respecting the areas where we ride... wherever they may be... is the only way to ensure their future enjoyment. That's one major reason why we know you'll agree that Light Treading Is Smart Sledding! And there are more.

Enjoying the opportunity to see winter and all its natural majestic wonders, is an experience cherished by snowmobilers. Light Treading will preserve this opportunity and will make it possible for us to expose others to the beauty of winter and the unique thrill of our sport! Light Treading will help our sport to grow!

Finally, Light Treading is the sign of a smart snowmobiler. You don't have to leave big tracks or careen through a virgin forest to show you can ride. So whether you're driving a high performance Ski-Doo, a sporty MX Z snowmobile or any other make or model, show you know what you're doing. Show you know how to send snow flying and make tracks with a light touch!

CHILD'S SECTION

SNOWMOBILE DESCRIPTION

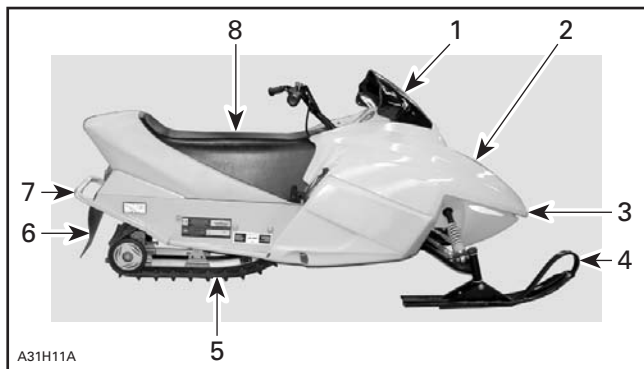

TYPICAL

1. Windshield
2. Hood
3. Front bumper
4. Skis
5. Track
6. Snow guard
7. Rear bumper
8. Seat

CLOTHING

Always wear all appropriate protective clothing including an approved safety helmet.

User(s) should be adequately clothed. Do not permit loose clothing which could be entangled in moving parts or get snagged on tree branches.

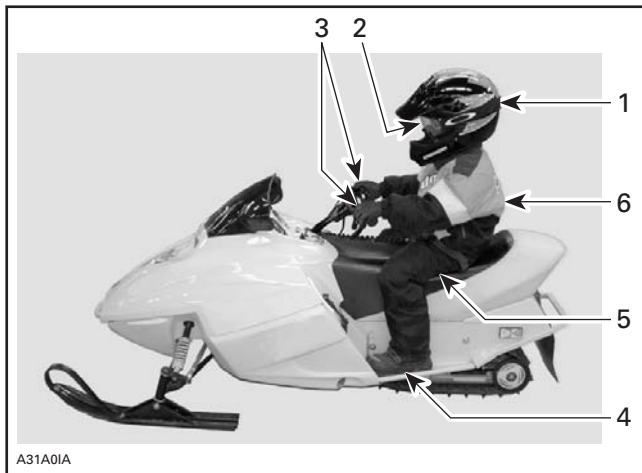

1. Safety helmet
2. Eyes protection (goggles or shield)
3. Mittens or gloves
4. Warm-up boots
5. Warm-up pants
6. Jacket

SNOWMOBILE CONTROLS

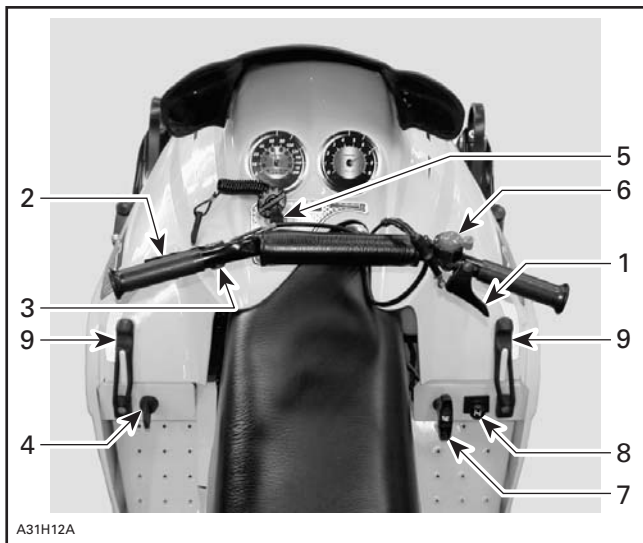

1. *Throttle lever*
2. *Brake lever*
3. *Handlebar*
4. *Ignition switch*
5. *Tether cut-out switch*
6. *Engine cut-out switch*
7. *Rewind starter handle*
8. *Choke button*
9. *Hood latches*

1) Throttle Lever

Squeezing the lever with your thumb will make the snowmobile go faster. Releasing the lever slows the snowmobile.

WARNING

Test the throttle lever operation each time before starting the engine. The lever must return to its original position once release. Otherwise, do not start engine.

2) Brake Lever

Squeezing the brake lever toward the handlebar slows and stops the snowmobile. The throttle lever should also be released to bring the snowmobile to a complete half.

CAUTION: Do not apply throttle and brake at the same time.

3) Handlebar

The handlebar controls the steering of the snowmobile. As the handlebar is rotated to right or left, the skis are turned right or left to steer the snowmobile.

4) Ignition Switch

The lights come ON automatically whenever the engine is running.

Manual Starting

Key operated, 2-position switch. To start the engine, first turn the key to ON position, then follow *STARTING PROCEDURE*. To stop the engine, turn the key to OFF position.

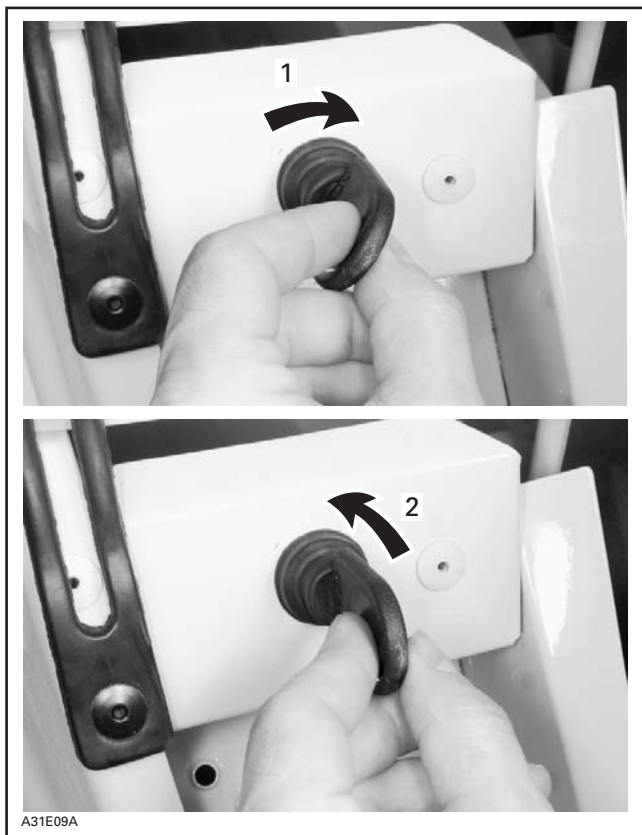

1. ON
2. OFF

5) Tether Cut-Out Switch

When the tether cord cap is pulled off its switch post, the engine stops and prevents the snowmobile from running away if a throttle problem occurs or you fall off while riding. Always attach the tether cord to your clothing eyelet and install the tether cord cap on its post before starting the engine. Leave it attached during your ride.

WARNING

Do not remove disk from tether cord. This safety device will unplug tether cord cap if hood is lifted. Engine will automatically stop.

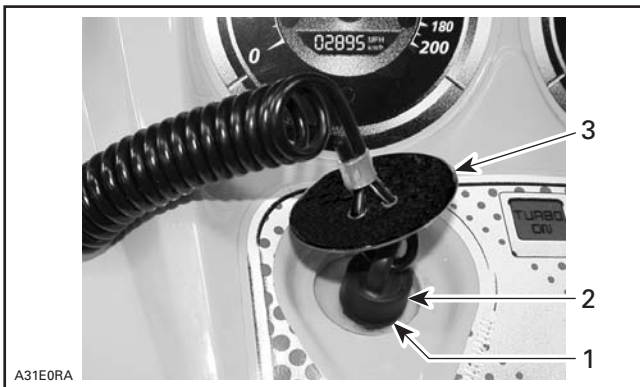

1. Tether cut-out switch post
2. Tether cord cap
3. Do not remove this disk

6) Engine Cut-Out Switch

All drivers of the snowmobile should familiarize themselves with the function of this device by using it several times on first outing and every time to stop the engine there after. Thereby this engine cut-out procedure will become reflex preparing operators to emergency situations requiring its use.

WARNING

If the switch has been used in an emergency caused by a mechanical malfunction, the source of the malfunction should be determined and corrected before restarting engine.

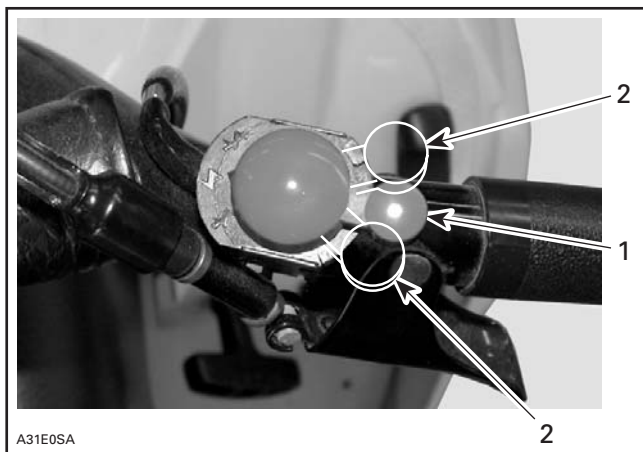

1. ON
2. OFF

7) Rewind Starter Handle

Auto-rewind type located on right hand side of snowmobile. To engage mechanism, pull handle slowly until a resistance is felt then pull vigorously. Slowly release handle.

8) Choke Button

This device features a multi-position button to facilitate cold start.

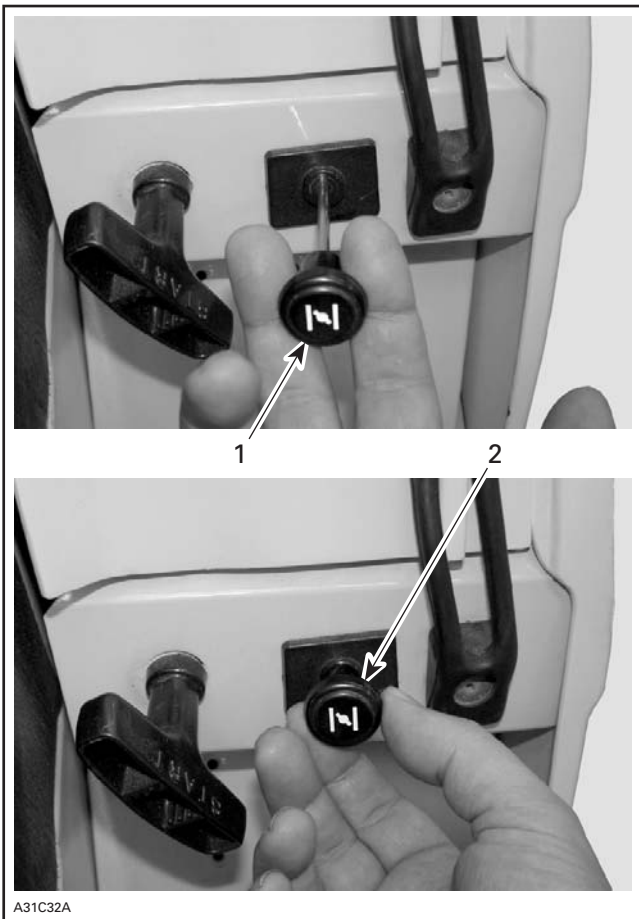

A31C32A

1. *Cold start*
2. *Warm start*

9) Hood Latches

Hood latches are used to lock hood to its anchors.

OPERATING INSTRUCTIONS

Before you Start

Always do a pre-start inspection with your parents or an adult before you turn on the ignition. Refer to *PRE-OPERATION CHECK*.

Throttle

Operate the throttle 2 or 3 times before you turn on the ignition. It must return freely to the idle or closed position, as shown.

WARNING

Test the throttle lever operation each time before starting the engine. The lever must return to its original position once released. Otherwise, do not start engine.



A31C09A

CORRECT THROTTLE POSITION BEFORE STARTING

Brake

Test your brake lever as you did the throttle.



A31D05A

CORRECT BRAKE LEVER POSITION BEFORE STARTING

Visual Inspection

Make certain hood is fastened with hood latches and remove any snow and ice buildup from lights, windshield and running boards.



A31H13A

LEFT SIDE SHOWN — HOOD LATCH IN FASTENING POSITION

Track

Make sure the track is not frozen to the ground. To verify, lift rear of snowmobile or ask an adult to help.

WARNING

Do not attempt to lift the vehicle by hand alone. Use appropriate lifting device or have assistance to share lifting stress in order to avoid risk of strain injuries.



A31A0JA

LIFTING REAR OF SNOWMOBILE

WARNING

Never lift snowmobile if engine is running.

How to Start

Never attempt to start the engine unless the throttle returns to its normal or idle position. Verify this **before** starting. Keep hands off of throttle when actually starting.

Put on your safety helmet and attach tether cord to your clothing eyelet.



A31A0KA

TETHER CORD ATTACHED TO CLOTHING EYELET

Install tether cord cap on post.

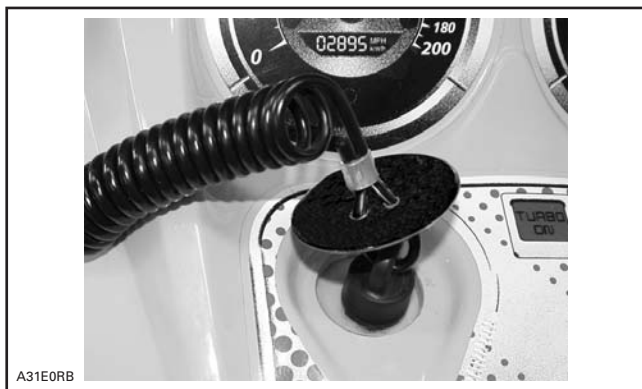

TETHER CORD CAP INSTALLED ON POST

Turn the ignition key to the ON position.

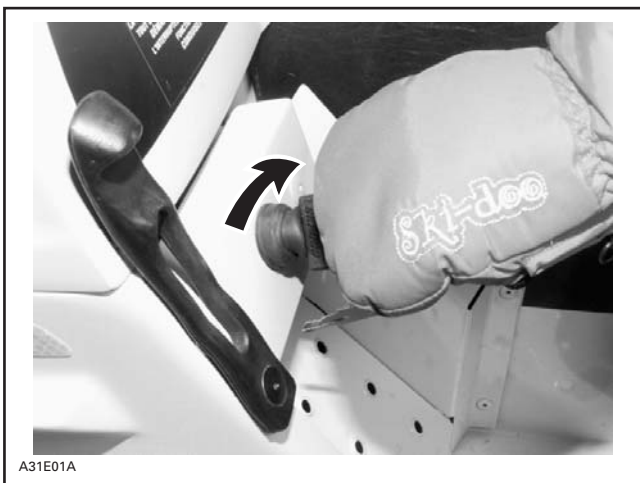

TYPICAL — IGNITION KEY TO THE ON POSITION

Set engine cut-out switch to middle position.



A31E05B

ENGINE CUT-OUT SWITCH TO MIDDLE POSITION

Engage choke only if the engine is cold.

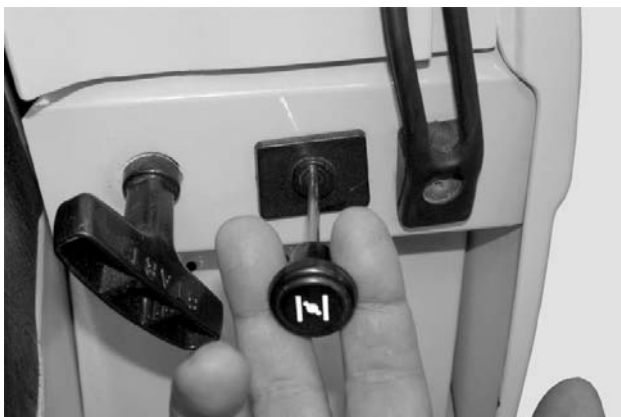

A31C30A

CHOKE IS ENGAGED FOR COLD ENGINE STARTING

Pull starter handle to start engine.



STARTER HANDLE IS PULLED

Allow engine to warm then disengage choke before operating at full throttle.

While the engine is warming, check the headlamp and the taillight, then set the engine cut-out switch to both extreme positions to be certain it will stop the engine. Before restarting your snowmobile, recheck the throttle control and be sure the vehicle is headed away from people or objects. Now restart your engine again.

How to Stop

Before riding your snowmobile, you should understand how to stop it.

Release the throttle and gradually depress the brake lever on the left side of the handlebar and then turn the ignition key to the OFF position.

WARNING

Always disconnect tether cord cap when leaving vehicle unattended and keep in a secured location.



A31E01B

TYPICAL — TURNING IGNITION KEY TO STOP ENGINE

Emergency Stop

In an emergency, you may stop your vehicle by turning the engine cut-out switch located near the throttle control and applying the brake.

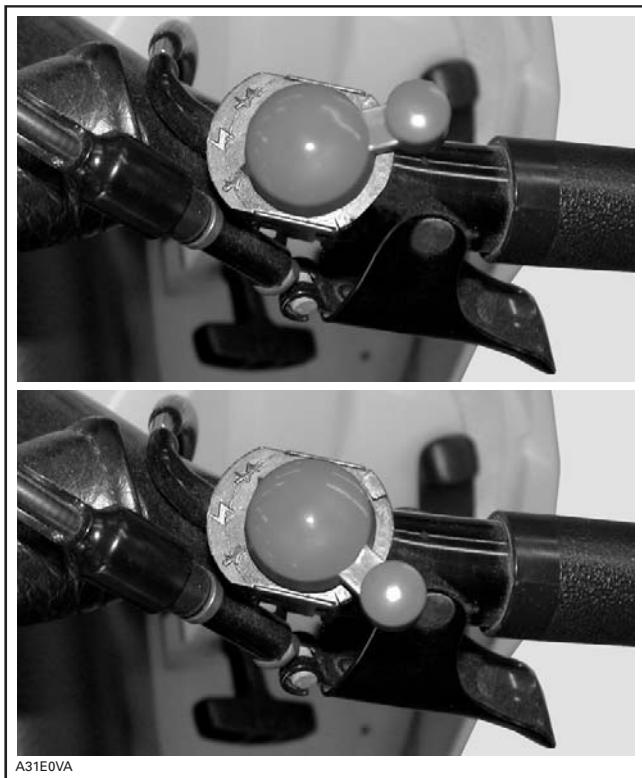

BOTH OFF POSITION FOR EMERGENCY STOP

Remember, a snowmobile cannot “stop on a dime”. Braking characteristics vary with deep snow, packed snow or ice. If the track is locked during hard braking, skidding may result.

First Ride

Under adult supervision, select an open snow covered area which is free of hazards.

Push on throttle lever holding on to handlebar.



A31C34A

TO ACCELERATE

Practice riding by using throttle lever to accelerate then brake lever to brake.

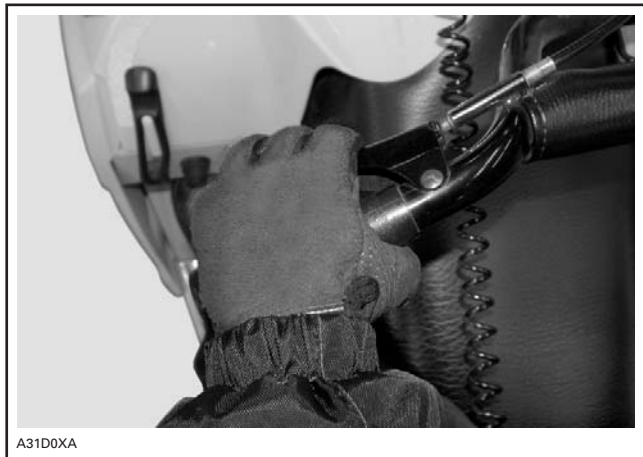

TO BRAKE

Go slowly and avoid all obstacles.

After Use

When you return from your ride, stop the engine and remove the tether cord cap from its post. Talk to your parents or the owner of the snowmobile about your ride.

Remember, always drive carefully with your snowmobile.

PARENT'S SECTION

VEHICLE INFORMATION

How to Identify the Snowmobile

The main components of the snowmobile (engine and frame) are identified by different serial numbers. It may sometimes become necessary to locate these numbers for warranty purposes or to trace the snowmobile in the event of loss. These numbers are required by the authorized SKI-DOO dealer to complete warranty claims properly. No warranty will be allowed by BRP if the engine serial number or the vehicle identification number (VIN) is removed or mutilated in any way. We strongly recommend that you take note of the serial numbers on the snowmobile and supply them to your insurance company.

Vehicle Identification Number Location

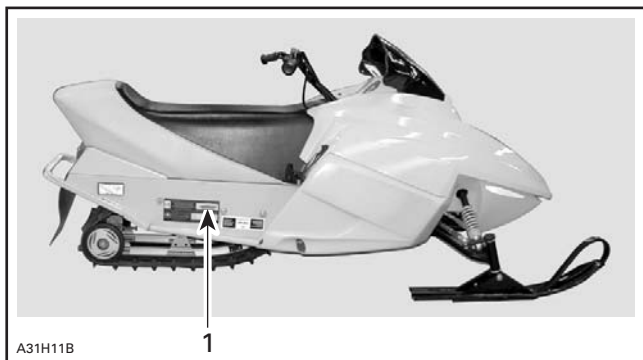

TYPICAL

1. *Vehicle identification number*

Engine Serial Number Location

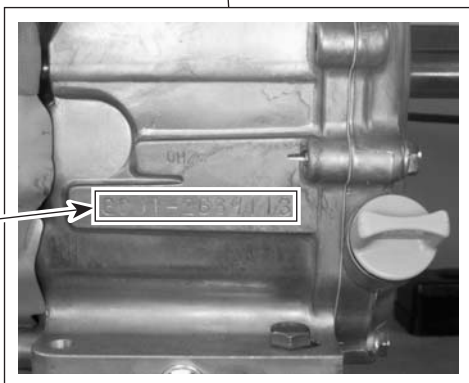
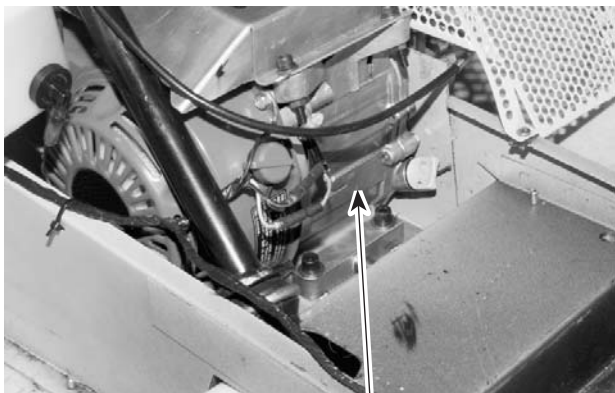

A31H0RA

1. Engine serial number

Recommended Fuel and Oil

Recommended Fuel

Use regular unleaded gasoline, available from most service stations or oxygenated fuel containing a maximum total of 10% of ethanol or methanol or both. The gasoline used must have the following recommended minimum octane number.

OCTANE NUMBER	
Inside North America	(87 (R + M)/2) or higher
Outside North America	92 RON or higher

CAUTION: Never experiment with other fuels. The use of unrecommended fuel can result on snowmobile performance deterioration and damage to critical parts in fuel system and engine components.

WARNING

Always stop engine before refueling. Open cap slowly. If a differential pressure condition is noticed (whistling sound heard when loosening fuel tank cap) have vehicle inspected and/or repaired before further operation. Fuel is flammable and explosive under certain conditions. Never use an open flame or spark in vicinity. Always work in a well-ventilated area. Never top up the fuel tank before placing the vehicle in a warm area. As temperature increases, fuel expands and may overflow. Always wipe any fuel spillage from the vehicle.

Fuel System Antifreeze

When using oxygenated fuel, additional gas line antifreeze or water absorbing additives are not required and should be used.

When using non-oxygenated fuel, we highly recommend the use of isopropyl base gas line antifreeze in a proportion of 150 mL (5 U.S oz) of gas line antifreeze added to 40 liters (10.5 U.S. gal.) of gas.

This precaution is in order to reduce the risk of frost build-up in carburetor which may lead, in certain cases, to high fuel consumption or severe damage to engine.

NOTE: Use only methyl hydrate free gas line antifreeze.

CAUTION: Never mix oil with fuel. This snowmobile has a 4-stroke engine. Oil must be added to engine base only.

WARNING

Do not allow children to refuel the snowmobile.



WRONG

Recommended Oil

Always maintain engine oil level with 4-stroke engine oil that meets or exceeds the requirements for API service classification SM, SL or SJ. Always check the API service label certification on the oil container, it must contain at least one of the above standards.

SAE 5W30 engine oil is recommended for general, all temperature use.

Other viscosities shown on the chart may be used when the average temperature in your area within the indicated range.

NOTE: For improved overall performance and wear protection use XP-S 0W 40 synthetic oil (P/N 293 600 054).

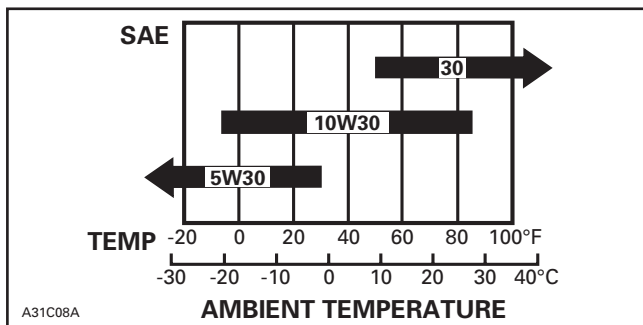

Break-In Period

Engine

A break-in period of 10 operating hours is required before running the snowmobile at full throttle.

CAUTION: Never mix fuel and oil. This snowmobile is equipped with a 4-Stroke engine.

During this period, maximum throttle should not exceed 3/4. However, brief full acceleration and speed variations contribute to a good break-in.

CAUTION: Engine overheating, continued wide open throttle runs and prolonged cruising speeds without speed variations should be avoided, this can cause engine damage during the break-in period.

Always remove and clean spark plug after engine break-in.

10-Hour Inspection

NOTE: The 10-hour inspection is at the expense of the snowmobile owner.

As with any precision piece of mechanical equipment, we suggest that after the first 10 hours of operation or 30 days after the purchase, whichever comes first, your snowmobile be checked by an authorized SKI-DOO dealer. This inspection will give you the opportunity to discuss the unanswered questions you may have encountered during the first hours of operation.

Pre-Operation Check

WARNING

The pre-operation check is very important prior to operating the vehicle. Always check the proper operation of critical controls, safety features and mechanical components before starting. If not done as specified here, severe injury or death might occur.

- Remove snow and ice from body including seat, footrests, lights, controls and instruments.
- Verify that skis, track and idler wheels are unfrozen and free to turn.

WARNING

Never lift snowmobile if engine is running.

- Activate the brake control lever and make sure the brake fully applies before the brake control lever touches the handlebar grip. It must fully return when released. Refer to *BRAKE ADJUSTMENT*.
- Activate the throttle control lever several times to check that it operates easily and smoothly.

WARNING

Test the throttle lever operation each time before starting the engine. The lever must return to its original position once released. Otherwise, do not start engine.

- Clean then check operation of tether cut-out and engine cut-out switches, headlamp and taillight.
- Verify that skis and steering operate freely. Check corresponding action skis versus handlebar. There should be no excessive play in the steering linkage or connections to the skis. Remove accumulated ice and snow from underneath the hood.
- Check fuel and engine oil for levels and leaks. Replenish as necessary (**to be done by an adult only**). See an authorized SKI-DOO dealer in case of any leaks.
- Check for drive chain excessive wear. Have vehicle repaired if necessary.
- Make certain hood is fastened with hood latches and remove any snow and ice buildup from lights, windshield and running boards.

- Check weather forecast: Will you be warm enough?
- Make certain your snowmobile is pointed away from people or objects before you start it. No one is to be standing in front of or in back of the snowmobile.
- Ensure fuel shut-off valve is in fully open position. Fuel shut-off valve is located on carburetor in engine compartment.

PRE-OPERATION CHECK LIST		
ITEM	OPERATION	✓
Body including seat, footrests, lights, controls and instruments	Check that there is no snow or ice.	
Track and idler wheels	Check for free movement.	
Brake lever	Check proper action.	
Throttle lever	Check proper action.	
Switches	Check proper action. Tether cord must be attached to driver clothing eyelet.	
Skis and steering	Check for free movement and proper action.	
Fuel and oil	Check for proper level and leaks.	
Fuel shut-off valve	Check for fully open position.	
Drive chain	Check for proper condition.	
Vehicle vicinity	Snowmobile must be pointed away from people or objects. No one is to be standing in front of or on back of the snowmobile.	
Hood fastening	Check for proper latching.	
Clothing	Be warmly dressed according to weather forecast.	

Starting the Engine

General

- Re-check throttle operation.
- Ensure that the engine cut-out switch is in the ON position.
- Ensure the tether cord cap is installed on its post and that the tether cord is attached to child's clothing.
- Check that tether cord disk is in place and in good condition. This disk will unplug tether cord cap and stop engine if children try to open hood while engine is running. Refer to *TETHER CUT-OUT SWITCH*.
- Set choke button to ON or OFF position, depending on the weather. Refer to *CHOKE BUTTON*.

Manual Starting

Insert the key in the ignition switch and turn to ON position.

Grab starter handle, pull handle slowly until a resistance is felt, then hold handle firmly and pull vigorously to start engine.

WARNING

Do not apply throttle while starting.

WARNING

Do not allow children to refuel the snowmobile.

Troubleshooting

NOTE: All troubleshooting should be done by an adult or an authorized SKI-DOO dealer.

ENGINE TURNS OVER BUT FAILS TO START

1. Ignition switch, engine cut-out switch or tether cut-out switch is in the OFF position.

- Place all switches in the RUN or ON position.

2. Mixture not rich enough to start cold engine.

- Check fuel tank level and check starting procedure, particularly use of the choke.

3. Flooded engine (spark plug wet when removed).

- Do not choke.
- Remove wet spark plug, turn ignition switch to OFF and crank engine several times.
- Install clean dry properly gapped spark plug.
- Start engine following usual starting procedure.
- If engine continues to flood, see an authorized SKI-DOO dealer.

4. No fuel to the engine (spark plug dry when removed).

- Check fuel tank level; turn fuel valve on, check condition of fuel and impulse lines and their connections.
- Check carburetor cleanness and adjustments.
- Contact an authorized SKI-DOO dealer.

5. Spark plug/ignition (no spark).

- Remove spark plug then reconnect to spark cap. Check that engine cut-out switch is at the ON position and the tether cord cap is snapped over the post. Start engine with spark plug grounded to engine away from spark plug hole.
- If no spark appears, replace spark plug with a new one properly gapped.
- If trouble persists, contact an authorized SKI-DOO dealer.

ENGINE LACKS ACCELERATION OR POWER

1. Fouled or defective spark plug.

- Check item 5 of ENGINE TURNS OVER BUT FAILS TO START.

2. Lack of fuel to engine.

- Check item 4 of ENGINE TURNS OVER BUT FAILS TO START.

3. Carburetor adjustments.

- Contact an authorized SKI-DOO dealer.

4. Clutch requires servicing.

- Contact an authorized SKI-DOO dealer.

ENGINE LACKS ACCELERATION OR POWER (cont'd)

5. Engine is overheating.

- *Clean cooling fins of engine; if overheating persists, contact an authorized SKI-DOO dealer.*

ENGINE BACKFIRES

1. Faulty spark plug (carbon accumulation) or wrong gap.

- *See item 5 of ENGINE TURNS OVER BUT FAILS TO START.*

2. Engine is running too hot.

- *See item 5 of ENGINE TURNS OVER BUT FAILS TO START.*

3. Ignition timing is incorrect or there is an ignition system failure.

- *Contact an authorized SKI-DOO dealer.*

ENGINE MISFIRES

1. Fouled/defective/worn spark plug or wrong gap.

- *Clean/verify spark plug gap and heat range. Replace as required.*

2. Water in fuel.

- *Drain fuel system and refill with fresh fuel.*

SNOWMOBILE CANNOT REACH FULL SPEED

1. Incorrect track adjustment.

- *See REPAIR AND MAINTENANCE and/or dealer for proper alignment and tension adjustments.*

2. Engine.

- *See items 1, 2 and 5 of ENGINE LACKS ACCELERATION OR POWER.*

Specifications

MODEL		MINI Z
ENGINE		
Type		120 4-stroke
Details		Axial air cooled
Cylinders		1
Displacement	cm ³ (in ³)	118 (7.2)
Bore	mm (in)	60 (2.4)
Stroke	mm (in)	42 (1.7)
Maximum power engine speed	± 100 RPM	3850
Carburetion		Horizontal type, butterfly valve
Exhaust system		Mini Z
DRIVE SYSTEM		
Drive pulley type		Comet
Driven pulley type		48 teeth sprocket
Drive sprocket diameter	mm (in)	81 (3.2)
Drive chain	Number of links	78
	Pitch	12.7 mm (.50 in)
Brake system		Mechanical
Track nominal width	mm (in)	254 (10)
Track nominal length	mm (in)	1749 (68.9)
Track profile height	mm (in)	16 (.63)
Track	Tension	35 mm (1-3/8 in) ⁽¹⁾
	Alignment	⁽²⁾

MODEL		MINI Z
ELECTRICAL		
Spark plug	Type	NGK BPR 6 ES
	Gap	0.75 ± 0.05 mm (.030 ± .002 in)
SUSPENSION		
Front suspension		A-arm Mini Z
Front shock		Mini Z
Front suspension maximum travel	mm (in)	75 (3)
Rear suspension		Mini Z
Rear suspension maximum travel	mm (in)	152.4 (6)
DIMENSIONS		
Vehicle overall length	mm (in)	1860 (73.2)
Vehicle overall width	mm (in)	788 (31)
Vehicle overall height	mm (in)	750 (29.5)
Dry weight	kg (lb)	70 (154)
Ski stance	mm (in)	685 (27)
Ski overall length	mm (in)	645 (25)
Ski width	mm (in)	103 (4.1)
LIQUIDS		
Recommended fuel type		Regular unleaded
Minimum octane	Inside North America	(87 (RON + MON)/2)
	Outside North America	92 RON
Engine oil		SAE 5W30 ⁽³⁾

MODEL		MINI Z
CAPACITIES		
Fuel tank	L (U.S. gal)	1.8 (.5)
Oil tank	L (U.S. oz)	0.6 (20.3)
<p>(1) to (3): See at end of specifications. Because of its ongoing commitment to product quality and innovation, BRP reserves the right, at any time, to make changes in design and specifications and/or to make additions to, or improvements in its products without imposing any obligation upon itself to install them on its products previously manufactured.</p>		

- (1) Measure gap between slider shoe and bottom inside of track when exerting a downward pull of 7.3 kg (16 lb) to the track.
- (2) Equal distance between edges of track guides and slider shoes.
- (3) Engine oil that meets or exceeds the requirements for API service classification SM, SL or SJ. Refer to *OIL VISCOSITY CHART* for other grade.

MAINTENANCE INFORMATION

Periodic Maintenance Chart

Refer to *MAINTENANCE* in *SHOP MANUAL* for more details.

PERIODIC MAINTENANCE CHART						
A: ADJUST C: CLEAN I: INSPECT L: LUBRICATE R: REPLACE (1) TO BE PERFORMED BY AN AUTHORIZED SKI-DOO DEALER	INITIAL INSPECTION 10 H (1)					
	WEEKLY					
	MONTHLY					
	ONCE A YEAR					
	STORAGE (1)					
	PRESEASON (1)					
PART/TASK						LEGEND
ENGINE						
Engine oil level	EVERY RIDE					—
Engine oil change	R		Every 6 months/ 100 h			
Rewind starter and rope					I,L	
Engine head nuts	I			I		
Engine mount nuts	I			I		
Exhaust system	I		I			
Engine lubrication					L	
Condition of engine seals					I	
Valves clearance				I		
FUEL SYSTEM						
Fuel filter					R	—
Fuel lines and connections	I				I	
Carburetor	A			A	A, C	
Throttle cable	I			I	I	

PERIODIC MAINTENANCE CHART

A: ADJUST C: CLEAN I: INSPECT L: LUBRICATE R: REPLACE (1) TO BE PERFORMED BY AN AUTHORIZED SKI-DOO DEALER	INITIAL INSPECTION 10 H (1)						
	WEEKLY						
	MONTHLY						
	ONCE A YEAR						
	STORAGE (1)						
	PRESEASON (1)						
PART/TASK							LEGEND
DRIVE							
Drive and driven sprockets	I		I		I	I	—
Clutch and chain	L		L		L	L	
Clutch retaining screw	I		I		I	I	
BRAKE							
Brake	I	I	A			I, A	—
TRANSMISSION							
Drive chain tension	I		I				—
STEERING/SUSPENSION							
Steering and front suspension mechanism	I		I		I	I	—
Wear and condition of skis and runners	I	I					
Suspension lubrication	I		L	I	L	I	
Suspension stopper strap				I		I	
Track	I		I			I	
Track tension and alignment	I	AS REQUIRED					

PERIODIC MAINTENANCE CHART

A: ADJUST
C: CLEAN
I: INSPECT
L: LUBRICATE
R: REPLACE

(1) TO BE PERFORMED BY AN
AUTHORIZED SKI-DOO
DEALER

INITIAL INSPECTION 10 H (1)

WEEKLY

MONTHLY

ONCE A YEAR

STORAGE (1)

PRESEASON (1)

PART/TASK

LEGEND

ELECTRICAL

Spark plug (2)

I I I I R

Ignition timing

I I I I I

Headlamp beam aiming

I I I I I

Wiring harnesses, cables and lines

I I I I I

Operation of lighting system (headlamp, taillight, etc.), test operation of engine cut-out switch and tether cut-out switch

I I I I I

(2) Before installing a new spark plug at preseason preparation, it is suggested to burn excess storage oil by starting the engine with the old spark plug. Only perform this operation in a well ventilated area.

BODY/FRAME

Rags in air intake and exhaust system

I I I I R R

Engine compartment

C C I C

Vehicle cleaning and protection

C C I C

—

General

NOTE: All maintenance should be done by an adult or an authorized SKI-DOO dealer and according to these directions as well as the *MAINTENANCE CHART*.

Do not allow children to lift hood to attempt repairs or maintenance.



WRONG

WARNING

Engine and its components may be hot.

WARNING

It is recommended that the assistance of an authorized SKI-DOO dealer be periodically obtained on other components/systems not covered in this guide. Unless otherwise specified, engine must be cold and not running. The tether cord cap must be removed for all maintenance procedures.

Engine System

Engine Oil Level

NOTE: This should only be done by an adult.

With snowmobile on a level surface, check the oil level by removing dipstick at engine base. Oil level must reach the top of the oil filler neck. If not, refill up to oil filler neck with recommended oil, refer to *RECOMMENDED OIL*.

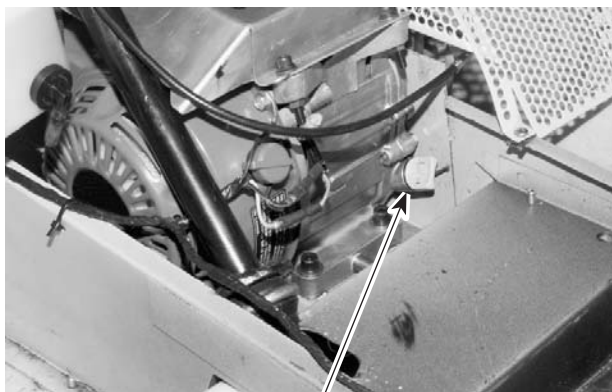

A31C2ZA

CHECKING OIL LEVEL

1. Top of the oil filler neck

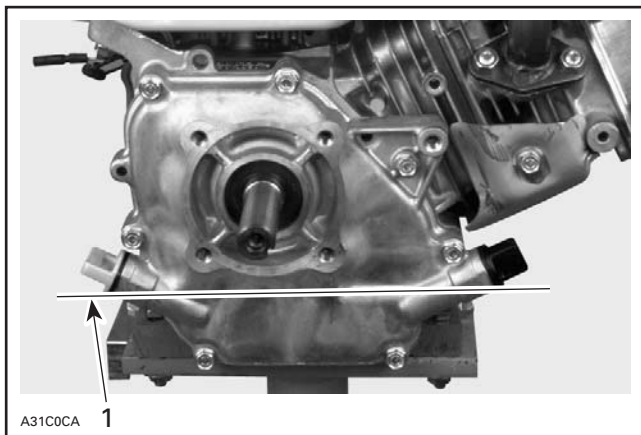

1. *Proper oil level*

WARNING

Whenever checking oil level or refilling, be careful not to overfill. Wipe off any spillage.

Exhaust System

The tail pipe of the muffler should be centered with the exit hole in the bottom pan. It must be free of rust or leaks.

The exhaust system is designed to reduce noise and to improve the total performance of the engine. If any exhaust system component is removed from the engine, severe engine damage will result.

Drive System

Chain Guard Removal and Installation

Remove tether cord cap.

Open hood. Remove chain guard retaining screws and lift off the guard.

WARNING

Engine should be running only when chain guard is secured in place.

WARNING

When removing chain guard, ensure that engine is not running.

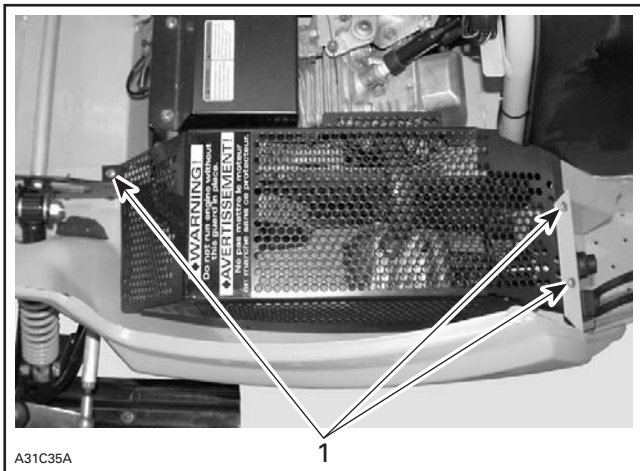

CHAIN GUARD

1. Retaining screws

Clutch Axle and Drive Chain Lubrication

Clutch Axle Lubrication

Remove chain guard.

Find connecting link (inner side of chain), then separate chain. Remove chain from clutch sprocket.

NOTE: Do not remove chain from driven sprocket. Chain may be difficult to install.

Remove clutch retaining screw and slide out the clutch.

Put clutch on a bench and drip a few drops of oil into clutch sleeve, as shown in the next illustration.

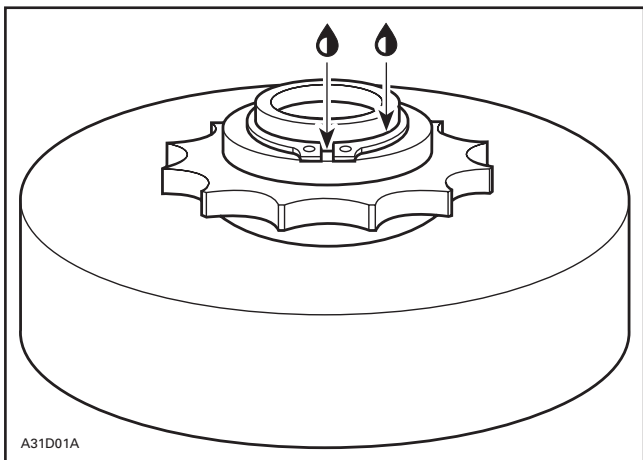

A31D01A

CLUTCH LUBRICATION

Reinstall clutch. Torque retaining screw to 23 N•m (17 lbf•ft).

Joint both drive chain ends using connecting link.

Secure connecting link using outer link and circlip installed on inner side of chain.

Install circlip so that open end is positioned opposite side of drive chain rotation. See the following illustration.

WARNING

Always ensure that connecting link, outer link and circlip are in good condition. Ensure that circlip is properly secured.

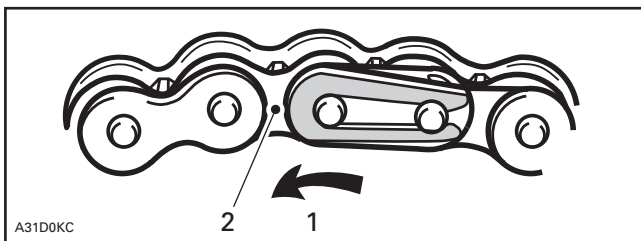

A31D0KC

TYPICAL

1. Rotation
2. Inner side of chain

Drive Chain Lubrication

With chain properly installed on both sprockets, spray aerosol chain oil over the chain.

CAUTION: Always lubricate drive chain slightly. Oil must not contact brake pads.

Drive Chain Tension

Snowmobile is equipped with an automatic tensioner. Ensure that tensioner spring is not damaged.

Brake Condition

The brake mechanism on the snowmobile is an essential safety device. Keep this mechanism in proper working condition. Above all, do not operate the snowmobile without an effective brake system. Periodically, verify the condition/wear of the brake pads.

Brake Adjustment

Fully apply brake with brake lever. If brake lever is not within 15 to 20 mm (19/32 to 25/32 in) of the handlebar, readjust brake.

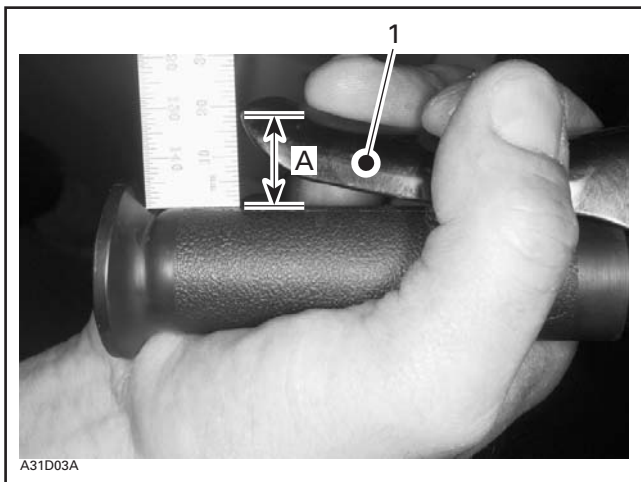

1. Brake lever

A. 15 to 20 mm (19/32 to 25/32 in)

To adjust brake, loosen Allen screw then pull on brake cable.

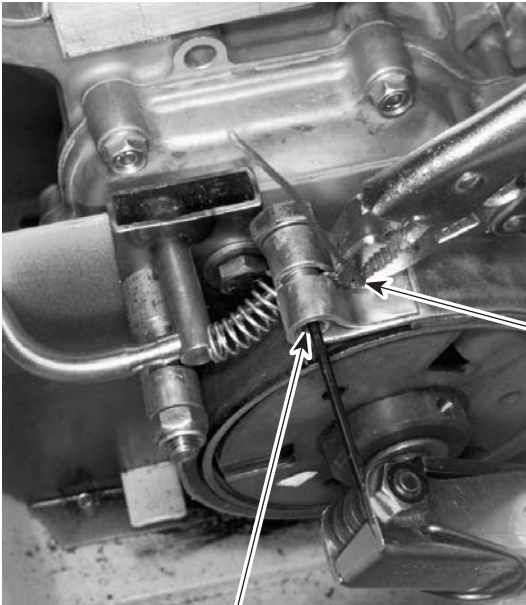

A31D04A

1

2

1. Loosen Allen screw
2. Pull brake cable with pliers

Retighten Allen screw.

WARNING

Always reinstall chain guard. Do not operate engine with hood opened or chain guard removed. Improper servicing, modification or poor adjustment may affect sprockets performance and life. Always obtain authorized SKI-DOO dealer advice before servicing or modifying the drive or driven sprockets. Always respect maintenance schedules.

Track Condition

Lift the rear of the snowmobile and support it off the ground. With the engine **off**, rotate the track by hand, and inspect condition. If worn or cut, or if track fibers are exposed, or if missing or defective inserts or guides are noted; contact an authorized SKI-DOO dealer.

WARNING

Do not modify track, including the installation of traction enhancing products. At speed it may cause the track to tear and separate from vehicle posing a risk of severe injury or death. Do not operate or rotate a track if torn, damaged or excessively worn (exposed fibers).

Track Tension and Alignment

Tension

NOTE: The snowmobile should be ridden in snow about 15 to 20 minutes prior to adjusting track tension.

Lift rear of snowmobile and support it with a wide-base snowmobile mechanical stand.

Allow the suspension to extend normally and check gap 60 mm (2-3/8 in) from rear idler wheel bracket. The gap should be as given in *SPECIFICATIONS*. If the track tension is too loose, track will have a tendency to thump.

NOTE: A belt tension tester (P/N 414 348 200) may be used to measure deflection as well as force applied.

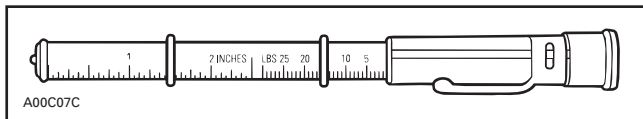

BELT TENSION TESTER

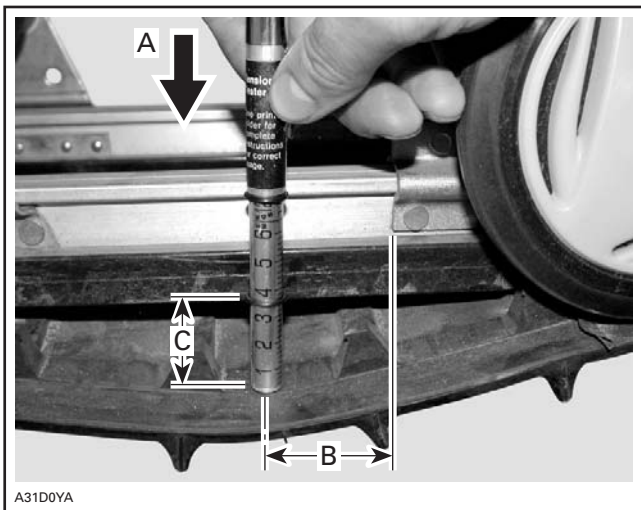

A31D0YA

- A. 7.3 kg (16 lb)
- B. 60 mm (2-3/8 in)
- C. 35 mm (1-3/8 in)

CAUTION: Too much tension will result in power loss and excessive stresses on suspension components.

To adjust tension:

- Loosen the rear idler wheel retaining screws.
- Loosen the lock nuts then turn adjustment screws to adjust.

If correct tension is unattainable, contact an authorized SKI-DOO dealer.

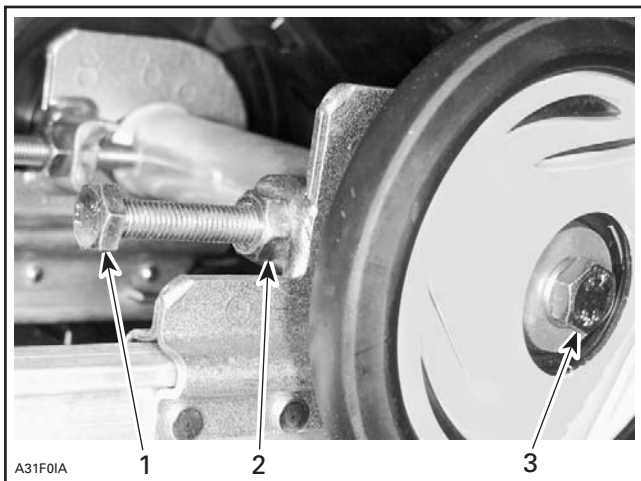

1. Adjustment screw
2. Loosen lock nut
3. Loosen screw

Alignment

NOTE: Track tension and alignment are interrelated. Do not adjust one without the other.

WARNING

Before checking track alignment, ensure that the track is free of all particles which could be thrown out while track is rotating. Keep hands, tools, feet and clothing clear of track. Ensure no one is standing in close proximity to the snowmobile. Never rotate track at high speed.

Start the engine and accelerate slightly so that track barely rotates. The track should be rotated less than 20 seconds to prevent track's shrink, due to the heat during working. Check that the track is well centered; equal distance on both sides between edges of track guides and slider shoes.

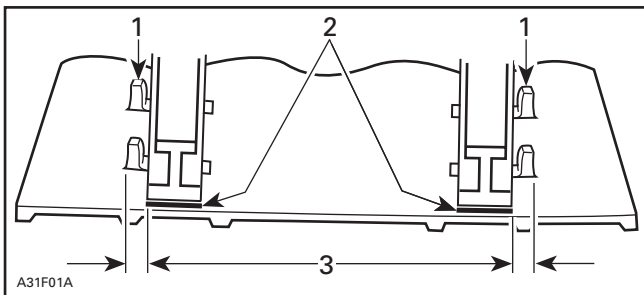

TYPICAL

1. Guides
2. Slider shoes
3. Equal distance

To correct, **stop the engine**: Loosen the lock nuts and tighten the adjustment screw on side where the slider shoe is the farthest from the track guides.

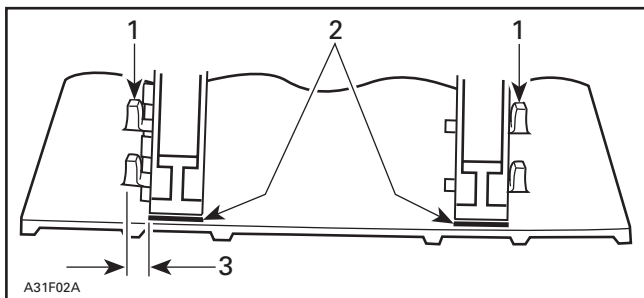

TYPICAL

1. Guides
2. Slides shoes
3. Tighten on this side

Tighten lock nuts and rear idler wheel retaining screws.

⚠ WARNING

If lock nuts or retaining screws are not tightened properly, the adjusting screws could loosen causing the track to become extremely loose and, under some operating conditions, allow the idler wheels to climb over the track lugs forcing the track against the tunnel causing the track to "lock".

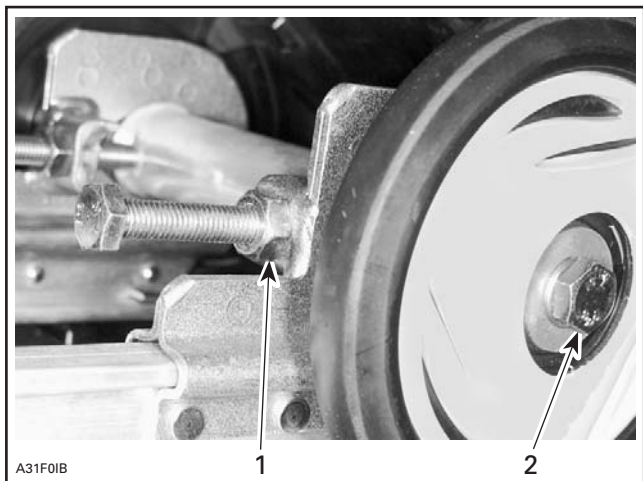

1. *Retighten lock nuts*
2. *Retighten rear idler wheel retaining screws*

Restart engine and rotate track slowly to recheck alignment.

Reposition snowmobile on the ground.

Rear Suspension

Condition

Visually inspect all suspension components including slider shoes, springs, wheels, etc.

NOTE: During normal driving, snow will act as a lubricant and coolant for the slider shoes. Extensive riding on ice or sanded snow, will create excessive heat buildup and cause premature wear of slider shoes.

Stopper Straps Condition

Inspect stopper straps for wear and cracks, bolts and nuts for tightness. If loose inspect holes for deformation. Replace as required. Torque nut to 9 N•m (80 lbf•in).

Steering and Front Suspension

Mechanism

Visually inspect steering and front suspension mechanism for tightness of components (steering arms, control arms and links, tie rods, ball joints, ski coupler bolts, etc.). If necessary, contact an authorized SKI-DOO dealer.

Wear and Condition of Skis and Runners

Check the condition of the skis and runners. If worn, contact an authorized SKI-DOO dealer.

WARNING

Excessively worn skis and/or ski runners will affect adversely snowmobile control.

Body/Frame

Vehicle Cleaning and Protection

Remove any dirt or rust.

To clean the entire vehicle, use only flannel cloths or an equivalent.

CAUTION: It is necessary to use flannel cloths or an equivalent on windshield and hood to avoid damaging further surfaces to clean.

To clean entire vehicle, including bottom pan and metallic parts, use Heavy Duty Cleaner (P/N 293 110 001) (spray can 400 g) or (P/N 293 110 002) (4 L) or with an equivalent.

CAUTION: Do not use Heavy Duty Cleaner on decals or vinyl.

For vinyl and plastic parts use Vinyl & Plastic Cleaner (P/N 413 711 200) (6 x 1 L) or an equivalent.

To remove scratches on windshield or hood use BRP Scratch Remover Kit (P/N 861 774 800) or an equivalent.

CAUTION: Never clean plastic parts or hood with strong detergent, degreasing agent, paint thinner, acetone, products containing chlorine, etc.

Inspect the hood and repair any damage.

Touch up all metal spots where paint has been scratched off. Spray all metal parts with XP-S Lube (P/N 293 600 016) or an equivalent.

Wax the hood and the painted portion of the frame for better protection.

NOTE: Apply wax on glossy finish only. Protect the vehicle with a cover to prevent dust accumulation during storage.

CAUTION: The snowmobile has to be stored on a cool and dry place and covered with an opaque tarpaulin. This will prevent sun rays and grime from affecting plastic components and vehicle finish.

Lift rear of vehicle until track is clear of the ground, Install on a wide-base snowmobile mechanical stand.

NOTE: Do not release track tension.

Bulb Replacement

Always check light operation after bulb replacement.

Headlamp

Find which bulb is burnt, then replace it with a new one (P/N 415 128 619).

Unplug electrical connector then, turn bulb counterclockwise to remove it.

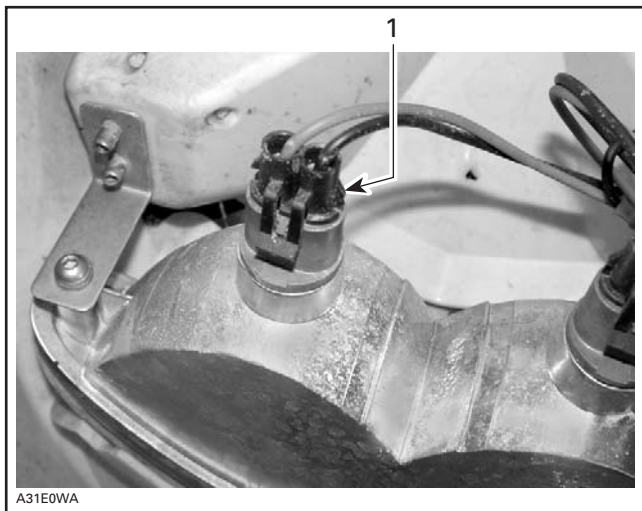

1. Electrical connector

If damaged, the headlamp harness can be replaced with a new one (P/N 415 128 618).

Taillight

Taillight is sealed. If it is burnt, replace taillight ass'y with new one.

To remove, unscrew the 2 taillight screws.

Pull out taillight.

Unplug connector.

Install a new taillight.

Storage and Preseason Preparation

Storage

It is during summer, or when a snowmobile is not in use for more than one month, that proper storage is a necessary.

To prepare your snowmobile, refer to an authorized SKI-DOO dealer.

CAUTION: Do not run engine during storage period.

Preseason Preparation

Refer to an authorized SKI-DOO dealer.

CAUTION: Have carburetor cleaned-up before restarting engine.

WARRANTY

BRP LIMITED WARRANTY NORTH AMERICA: 2007 SKI-DOO® SNOWMOBILES

1) SCOPE OF THE LIMITED WARRANTY

Bombardier Recreational Products Inc. ("BRP")* warrants its 2007 Ski-Doo snowmobiles from defects in material or workmanship for the period and under the conditions described below.

All genuine Ski-Doo parts and accessories, installed by an authorized BRP dealer (as hereinafter defined) at the time of delivery of the 2007 Ski-Doo snowmobile, carry the same warranty as that of the snowmobile.

Use of the product for racing or any other competitive activity, at any point, even by a previous owner, will render this warranty null and void.

2) EXCLUSIONS - ARE NOT WARRANTED

The following are not warranted under any circumstances:

- Normal wear and tear;
- Routine maintenance items, tune ups, adjustments;
- Damage caused by failure to provide proper maintenance and/or storage, as described in the Operator's Guide;
- Damage resulting from removal of parts, improper repairs, service, maintenance, modifications or use of parts not manufactured or approved by BRP or resulting from repairs done by a person that is not an authorized servicing BRP dealer;
- Damage caused by abuse, abnormal use, neglect, use of the product on surfaces other than snow, or operation of the product in a manner inconsistent with the recommended operation described in the Operator's Guide;
- Damage resulting from accident, submersion, fire, theft, vandalism or any act of God;
- Operation with fuels, oils or lubricants which are not suitable for use with the product (see the Operator's Guide);
- Snow or water ingestion;
- Incidental or consequential damages, or damages of any kind including without limitation towing, storage, telephone, rental, taxi, inconvenience, insurance coverage, loan payments, loss of time, loss of income; and
- Damage resulting from studs installed on tracks if the installation does not conform to BRP's instructions.

3) LIMITATIONS OF LIABILITY

THIS WARRANTY IS EXPRESSLY GIVEN AND ACCEPTED IN LIEU OF ANY AND ALL OTHER WARRANTIES, EXPRESSED OR IMPLIED, INCLUDING WITHOUT LIMITATION ANY WARRANTY OF MERCHANTABILITY OR FITNESS FOR A PARTICULAR PURPOSE. TO THE EXTENT THAT THEY CANNOT BE DISCLAIMED, THE IMPLIED WARRANTIES ARE LIMITED IN DURATION TO THE LIFE OF THE EXPRESS WARRANTY. INCIDENTAL AND CONSEQUENTIAL DAMAGES ARE EXCLUDED FROM COVERAGE UNDER THIS WARRANTY. SOME STATES/PROVINCES DO NOT ALLOW FOR THE DISCLAIMERS, LIMITATIONS AND EXCLUSIONS IDENTIFIED ABOVE, AS A RESULT, THEY MAY NOT APPLY TO YOU. THIS WARRANTY GIVES YOU SPECIFIC RIGHTS, AND YOU MAY ALSO HAVE OTHER LEGAL RIGHTS WHICH MAY VARY FROM STATE TO STATE, OR PROVINCE TO PROVINCE.

Neither the distributor, any BRP dealer nor any other person has been authorized to make any affirmation, representation or warranty regarding the product, other than those contained in this limited warranty, and if made, shall not be enforceable against BRP.

BRP reserves the right to modify this warranty at any time, being understood that such modification will not alter the warranty conditions applicable to the products sold while this warranty is in effect.

4) WARRANTY COVERAGE PERIOD

This warranty will be in effect from the date of delivery to the first retail consumer or the date the product is first put into use, whichever occurs first and for a period of:

TWELVE (12) CONSECUTIVE MONTHS, for private or commercial use owners. However, the warranty coverage period on a snowmobile delivered between June 1st and December 1st of a given year will expire December 1st of the following year.

The emission-related components included in the chart below, that are installed on EPA certified snowmobiles (see list below) registered in the USA are covered for thirty (30) consecutive months or 2500 miles (4000 km) of engine use whichever occurs first. If the 2500 miles (4000 km) are reached during the regular warranty coverage period, the emission-related components are still covered by BRP's standard warranty until the end of regular coverage period.

The EPA certified snowmobiles are those equipped with: 120 engines (Mini Z)

EMISSION-RELATED COMPONENTS	120 ENGINE
Carburetor	X

The repair or replacement of parts or the performance of service under this warranty does not extend the life of this warranty beyond its original expiration date.

5) **CONDITIONS TO HAVE WARRANTY COVERAGE**

This warranty coverage is available only if each of the following conditions has been fulfilled:

- The 2007 Ski-Doo snowmobile must be purchased as new and unused by its first owner from a BRP dealer authorized to distribute Ski-Doo snowmobiles in the country in which the sale occurred ("BRP dealer");
- The BRP specified pre-delivery inspection process must be completed and documented;
- The product must have undergone proper registration by an authorized BRP dealer;
- The 2007 Ski-Doo snowmobile must be purchased in the country or union of countries in which the purchaser resides;
- Routine maintenance outlined in the Operator's Guide must be timely performed in order to maintain warranty coverage. BRP reserves the right to make warranty coverage contingent upon proof of proper maintenance.

BRP will not honour this limited warranty to any private use owner or commercial use owner if the preceding conditions have not been met. Such limitations are necessary in order to allow BRP to preserve both the safety of its products, and also that of its consumers and the general public.

6) WHAT TO DO TO OBTAIN WARRANTY COVERAGE

The customer must notify a servicing BRP dealer within two (2) days of the appearance of a defect, and provide it with reasonable access to the product and reasonable opportunity to repair it. The customer must also present to the authorized BRP dealer, proof of purchase of the product and must sign the repair/work order prior to starting the repair in order to validate the warranty repair. All parts replaced under this limited warranty become the property of BRP.

7) WHAT BRP WILL DO

BRP's obligations under this warranty are limited to, at its sole discretion, repairing parts found defective under normal use, maintenance and service, or replacing such parts with new genuine Ski-Doo parts without charge for parts and labor, at any authorized BRP dealer during the warranty coverage period.

BRP reserves the right to improve or modify products from time to time without assuming any obligation to modify products previously manufactured.

8) TRANSFER

If the ownership of a product is transferred during the warranty coverage period, this warranty shall also be transferred and be valid for the remaining coverage period provided that BRP is notified of such transfer of ownership in the following way:

- a) The former owner contacts BRP (at the phone number provided below) or an authorized BRP dealer and gives the coordinates of the new owner; or
- b) BRP or an authorized BRP dealer receives a proof that the former owner agreed to the transfer of ownership, in addition to the coordinates of the new owner.

9) CONSUMER ASSISTANCE

- a) In the event of a controversy or a dispute in connection with this limited warranty, BRP suggests that you try to resolve the issue at the dealership level. We recommend discussing the issue with the authorized dealer's service manager or owner.
- b) If the issue has not yet been resolved, please submit your complaint in writing or call the appropriate number below:

IN CANADA:

**BOMBARDIER
RECREATIONAL PRODUCTS INC.
SKI-DOO
CONSUMER SERVICES GROUP
VALCOURT QC J0E 2L0
Tel.: (819) 566-3366**

IN USA:

**BRP US Inc.
SKI-DOO
CONSUMER SERVICES GROUP
7575 BOMBARDIER COURT
WAUSAU WI 54401
Tel.: (715) 848-4957**

* In the USA, products are distributed and serviced by BRP US Inc.
© 2006 Bombardier Recreational Products Inc. All rights reserved.
® Registered trademark of Bombardier Recreational Products Inc.

BRP INTERNATIONAL LIMITED WARRANTY: 2007 SKI-DOO® SNOWMOBILES

1) SCOPE OF THE LIMITED WARRANTY

Bombardier Recreational Products Inc. ("BRP") warrants its 2007 Ski-Doo snowmobiles from defects in material or workmanship for the period and under the conditions described below.

All genuine Ski-Doo parts and accessories, installed by an authorized BRP distributor/dealer (as hereinafter defined) at the time of delivery of the 2007 Ski-Doo snowmobile, carry the same warranty as that of the snowmobile.

Use of the product for racing or any other competitive activity, at any point, even by a previous owner, will render this warranty null and void.

2) WARRANTY COVERAGE PERIOD

This warranty will be in effect from the date of delivery to the first retail consumer or the date the product is first put into use, whichever occurs first and for a period of:

TWELVE (12) CONSECUTIVE MONTHS, for private or commercial use owners. However, the warranty coverage period on a snowmobile delivered between June 1st and December 1st of a given year will expire December 1st of the following year. Note that the warranty coverage period may vary from country to country, state to state, region to region and province to province for private use or commercial use owners. Please contact your dealer or distributor to know the specifics of your warranty coverage period.

The repair or replacement of parts or the performance of service under this warranty does not extend the life of this warranty beyond its original expiration date.

Note that the duration and any other modalities of the warranty coverage are subject to the applicable national or local legislation in your country.

3) CONDITIONS TO HAVE WARRANTY COVERAGE

This warranty coverage is available only if each of the following conditions has been fulfilled:

- The 2007 Ski-Doo snowmobile must be purchased as new and unused by its first owner from a BRP distributor/dealer authorized to distribute Ski-Doo snowmobiles in the country in which the sale occurred ("BRP distributor/dealer");

- The BRP specified pre-delivery inspection process must be completed and documented;
- The product must have undergone proper registration by an authorized BRP distributor/dealer;
- The 2007 Ski-Doo snowmobile must be purchased in the country or union of countries in which the purchaser resides;
- Routine maintenance outlined in the Operator's Guide must be timely performed in order to maintain warranty coverage. BRP reserves the right to make warranty coverage contingent upon proof of proper maintenance.

BRP will not honour this limited warranty to any private use owner or commercial use owner if the preceding conditions have not been met. Such limitations are necessary in order to allow BRP to preserve both the safety of its products, and also that of its consumers and the general public.

4) WHAT TO DO TO OBTAIN WARRANTY COVERAGE

The customer must notify a servicing BRP distributor/dealer within two (2) days of the appearance of a defect, and provide it with reasonable access to the product and reasonable opportunity to repair it. The customer must also present to the authorized BRP distributor/dealer, proof of purchase of the product and must sign the repair/work order prior to starting the repair in order to validate the warranty repair. All parts replaced under this limited warranty become the property of BRP.

Note that the notification period is subject to the applicable national or local legislation in your country.

5) WHAT BRP WILL DO

BRP's obligations under this warranty are limited to, at its sole discretion, repairing parts found defective under normal use, maintenance and service, or replacing such parts with new genuine Ski-Doo parts without charge for parts and labor, at any authorized BRP distributor/dealer during the warranty coverage period.

BRP reserves the right to improve or modify products from time to time without assuming any obligation to modify products previously manufactured.

6) EXCLUSIONS - ARE NOT WARRANTED

The following are not warranted under any circumstances:

- Normal wear and tear;

- Routine maintenance items, tune ups, adjustments;
- Damage caused by failure to provide proper maintenance and/or storage, as described in the Operator's Guide;
- Damage resulting from removal of parts, improper repairs, service, maintenance, modifications or use of parts not manufactured or approved by BRP or resulting from repairs done by a person that is not an authorized servicing BRP distributor/dealer;
- Damage caused by abuse, abnormal use, neglect, use of the product on surfaces other than snow, or operation of the product in a manner inconsistent with the recommended operation described in the Operator's Guide;
- Damage resulting from accident, submersion, fire, theft, vandalism or any act of God;
- Operation with fuels, oils or lubricants which are not suitable for use with the product (see the Operator's Guide);
- Snow or water ingestion;
- Incidental or consequential damages, or damages of any kind including without limitation towing, storage, telephone, rental, taxi, inconvenience, insurance coverage, loan payments, loss of time, loss of income; and
- Damage resulting from studs installed on tracks if the installation does not conform to BRP's instructions.

7) LIMITATIONS OF LIABILITY

THIS WARRANTY IS EXPRESSLY GIVEN AND ACCEPTED IN LIEU OF ANY AND ALL OTHER WARRANTIES, EXPRESSED OR IMPLIED, INCLUDING WITHOUT LIMITATION ANY WARRANTY OF MERCHANTABILITY OR FITNESS FOR A PARTICULAR PURPOSE. TO THE EXTENT THAT THEY CANNOT BE DISCLAIMED, THE IMPLIED WARRANTIES ARE LIMITED IN DURATION TO THE LIFE OF THE EXPRESS WARRANTY. INCIDENTAL AND CONSEQUENTIAL DAMAGES ARE EXCLUDED FROM COVERAGE UNDER THIS WARRANTY. SOME STATES/PROVINCES DO NOT ALLOW FOR THE DISCLAIMERS, LIMITATIONS AND EXCLUSIONS IDENTIFIED ABOVE, AS A RESULT, THEY MAY NOT APPLY TO YOU. THIS WARRANTY GIVES YOU SPECIFIC RIGHTS, AND YOU MAY ALSO HAVE OTHER LEGAL RIGHTS WHICH MAY VARY FROM STATE TO STATE, OR PROVINCE TO PROVINCE.

Neither the distributor, any BRP distributor/dealer nor any other person has been authorized to make any affirmation, representation or warranty regarding the product, other than those contained in this limited warranty, and if made, shall not be enforceable against BRP.

BRP reserves the right to modify this warranty at any time, being understood that such modification will not alter the warranty conditions applicable to the products sold while this warranty is in effect.

8) TRANSFER

If the ownership of a product is transferred during the warranty coverage period, this warranty shall also be transferred and be valid for the remaining coverage period provided BRP or an authorised BRP distributor/dealer receives a proof that the former owner agreed to the transfer of ownership, in addition to the co-ordinates of the new owner.

9) CONSUMER ASSISTANCE

- a) In the event of a controversy or a dispute in connection with this limited warranty, BRP suggests that you try to resolve the issue at the dealership level. We recommend discussing the issue with the authorized distributor/dealer's service manager or owner.
- b) If further assistance is required, the distributor's service department should be contacted in order to resolve the matter.
- c) If the matter still remains unresolved then contact BRP at the address listed below.

For countries within Europe, Middle East, Africa, Russia & CIS, please contact our European office:

BOMBARDIER RECREATIONAL PRODUCTS EUROPE N.V.

CONSUMER SERVICES GROUP
SKALDENSTRAAT 125
9042 GENT
BELGIQUE
Tel.: +32 (0) 9 272 63 30

For all other countries, please contact our North American office:

BOMBARDIER RECREATIONAL PRODUCTS INC.

SKI-DOO
CONSUMER SERVICES GROUP
VALCOURT QC J0E 2L0
Tel.: +1 (819) 566-3366

© 2006 Bombardier Recreational Products Inc. All rights reserved.
® Registered trademark of Bombardier Recreational Products Inc.

BRP EUROPEAN UNION MEMBER STATES LIMITED WARRANTY: 2007 SKI-DOO® SNOWMOBILES

1) SCOPE OF THE LIMITED WARRANTY

Bombardier Recreational Products Inc. ("BRP") warrants its 2007 Ski-Doo snowmobiles from defects in material or workmanship for the period and under the conditions described below.

All genuine Ski-Doo parts and accessories, installed by an authorized BRP distributor/dealer (as hereinafter defined) at the time of delivery of the 2007 Ski-Doo snowmobile, carry the same warranty as that of the snowmobile.

Use of the product for racing or any other competitive activity, at any point, even by a previous owner, will render this warranty null and void.

2) WARRANTY COVERAGE PERIOD

This warranty will be in effect from the date of delivery to the first retail consumer or the date the product is first put into use, whichever occurs first and for a period of:

TWENTY-FOUR (24) CONSECUTIVE MONTHS for private use owners, and TWELVE (12) CONSECUTIVE MONTHS for commercial use owners. However, the warranty coverage period on a snowmobile delivered between June 1st and December 1st of a given year will expire December 1st of the following year.

The repair or replacement of parts or the performance of service under this warranty does not extend the life of this warranty beyond its original expiration date.

Note that the duration and any other modalities of the warranty coverage are subject to the applicable national or local legislation in your country.

3) CONDITIONS TO HAVE WARRANTY COVERAGE

This warranty coverage is available only if each of the following conditions has been fulfilled:

- The 2007 Ski-Doo snowmobile must be purchased as new and unused by its first owner from a BRP distributor/dealer authorized to distribute Ski-Doo products in the country in which the sale occurred ("BRP distributor/dealer");

- The BRP specified pre-delivery inspection process must be completed and documented;
- The product must have undergone proper registration by an authorized BRP distributor/dealer;
- The 2007 Ski-Doo snowmobile must be purchased in the country or union of countries in which the purchaser resides;
- Routine maintenance outlined in the Operator's Guide must be timely performed in order to maintain warranty coverage. BRP reserves the right to make warranty coverage contingent upon proof of proper maintenance.

BRP will not honour this limited warranty to any private use owner or commercial use owner if the preceding conditions have not been met. Such limitations are necessary in order to allow BRP to preserve both the safety of its products, and also that of its consumers and the general public.

4) WHAT TO DO TO OBTAIN WARRANTY COVERAGE

The customer must notify a servicing BRP distributor/dealer within two (2) months of the appearance of a defect, and provide it with reasonable access to the product and reasonable opportunity to repair it. The customer must also present to the authorized BRP distributor/dealer, proof of purchase of the product and must sign the repair/work order prior to starting the repair in order to validate the warranty repair. All parts replaced under this limited warranty become the property of BRP.

Note that the notification period is subject to the applicable national or local legislation in your country.

5) WHAT BRP WILL DO

BRP's obligations under this warranty are limited to, at its sole discretion, repairing parts found defective under normal use, maintenance and service, or replacing such parts with new genuine Ski-Doo parts without charge for parts and labor, at any authorized BRP distributor/dealer during the warranty coverage period.

BRP reserves the right to improve or modify products from time to time without assuming any obligation to modify products previously manufactured.

6) EXCLUSIONS - ARE NOT WARRANTED

The following are not warranted under any circumstances:

- Normal wear and tear;

- Routine maintenance items, tune ups, adjustments;
- Damage caused by failure to provide proper maintenance and/or storage, as described in the Operator's Guide;
- Damage resulting from removal of parts, improper repairs, service, maintenance, modifications or use of parts not manufactured or approved by BRP or resulting from repairs done by a person that is not an authorized servicing BRP distributor/dealer;
- Damage caused by abuse, abnormal use, neglect, use of the product on surfaces other than snow, or operation of the product in a manner inconsistent with the recommended operation described in the Operator's Guide;
- Damage resulting from accident, submersion, fire, theft, vandalism or any act of God;
- Operation with fuels, oils or lubricants which are not suitable for use with the product (see the Operator's Guide);
- Snow or water ingestion;
- Incidental or consequential damages, or damages of any kind including without limitation towing, storage, telephone, rental, taxi, inconvenience, insurance coverage, loan payments, loss of time, loss of income; and
- Damage resulting from studs installed on tracks if the installation does not conform to BRP's instructions.

7) LIMITATIONS OF LIABILITY

THIS WARRANTY IS EXPRESSLY GIVEN AND ACCEPTED IN LIEU OF ANY AND ALL OTHER WARRANTIES, EXPRESSED OR IMPLIED, INCLUDING WITHOUT LIMITATION ANY WARRANTY OF MERCHANTABILITY OR FITNESS FOR A PARTICULAR PURPOSE. TO THE EXTENT THAT THEY CANNOT BE DISCLAIMED, THE IMPLIED WARRANTIES ARE LIMITED IN DURATION TO THE LIFE OF THE EXPRESS WARRANTY. INCIDENTAL AND CONSEQUENTIAL DAMAGES ARE EXCLUDED FROM COVERAGE UNDER THIS WARRANTY. SOME JURISDICTIONS DO NOT ALLOW FOR THE DISCLAIMERS, LIMITATIONS AND EXCLUSIONS IDENTIFIED ABOVE, AS A RESULT, THEY MAY NOT APPLY TO YOU. THIS WARRANTY GIVES YOU SPECIFIC RIGHTS, AND YOU MAY ALSO HAVE OTHER LEGAL RIGHTS WHICH MAY VARY FROM COUNTRY TO COUNTRY, OR PROVINCE TO PROVINCE.

Neither the distributor, any BRP distributor/dealer nor any other person has been authorized to make any affirmation, representation or warranty regarding the product, other than those contained in this limited warranty, and if made, shall not be enforceable against BRP.

BRP reserves the right to modify this warranty at any time, being understood that such modification will not alter the warranty conditions applicable to the products sold while this warranty is in effect.

8) TRANSFER

If the ownership of a product is transferred during the warranty coverage period, this warranty shall also be transferred and be valid for the remaining coverage period provided BRP or an authorised BRP distributor/dealer receives a proof that the former owner agreed to the transfer of ownership, in addition to the co-ordinates of the new owner.

9) CONSUMER ASSISTANCE

- a) In the event of a controversy or a dispute in connection with this limited warranty, BRP suggests that you try to resolve the issue at the dealership level. We recommend discussing the issue with the authorized distributor/dealer's service manager or owner.
- b) If further assistance is required, the distributor's service department should be contacted in order to resolve the matter.
- c) If the matter still remains unresolved then contact BRP at the address listed below.

For countries within Europe, Middle East, Africa, Russia & CIS, please contact our European office:

BOMBARDIER RECREATIONAL PRODUCTS EUROPE N.V.

CONSUMER SERVICES GROUP
SKALDENSTRAAT 125
9042 GENT
BELGIQUE
Tel.: +32 (0) 9 272 63 30

For all other countries, please contact our North American office:

BOMBARDIER RECREATIONAL PRODUCTS INC.

SKI-DOO
CONSUMER SERVICES GROUP
VALCOURT QC J0E 2L0
Tel.: +1 (819) 566-3366

© 2006 Bombardier Recreational Products Inc. All rights reserved.

® Registered trademark of Bombardier Recreational Products Inc.

PRIVACY OBLIGATIONS/DISCLAIMER

We wish to inform you that your coordinates will be used for safety and warranty purposes. Sometimes, we also use the coordinates of our clients to inform them about our products and to present them offers. Should you prefer not to receive information on our products, services and offers, please let us know by writing to the address below.

Also note that, from time to time, carefully selected and trustworthy organizations may be permitted to use the coordinates of our clients to promote quality products and services. If you prefer not to have your name and address released, please let us know by writing to the address below:

IN CANADA

Bombardier Recreational
Products Inc.
Warranty Department
75 J.A. Bombardier Street
Sherbrooke, Québec J1L 1W3
Fax Number: (819) 566-3590

IN USA

BRP US Inc.
Warranty Department
7575 Bombardier Court
Wausau WI 54401
Tel.: (715) 848-4957

FOR COUNTRIES WITHIN EUROPE, MIDDLE EAST, AFRICA, RUSSIA & CIS

Bombardier Recreational Products Europe N.V.
Warranty Department
SKALDENSTRAAT 125
9042 GENT
BELGIQUE
Tel.: +32 (0) 9 272 63 30

FOR ALL OTHER COUNTRIES, PLEASE CONTACT OUR NORTH AMERICAN OFFICE

Bombardier Recreational Products Inc.
Warranty Department
75 J.A. Bombardier Street
Sherbrooke, Québec J1L 1W3
Fax Number: (819) 566-3590

CHANGE OF ADDRESS/OWNERSHIP

If your address has changed or if you are the new owner of the vehicle, be sure to notify BRP by either:

- mailing one of the following card below;
- **North America Only:** calling at (715) 848-4957 (USA) or (819) 566-3366 (Canada);
- notifying an authorized SKI-DOO dealer.

In case of change of ownership, please join a proof that the former owner agreed to the transfer.

Notifying BRP, even after the expiration of the limited warranty, is very important as it enables BRP to reach the vehicle owner if necessary, like when safety recalls are initiated. It is the owner's responsibility to notify BRP.

STOLEN UNITS: If your personal vehicle is stolen, you should notify BRP or an authorized SKI-DOO dealer. We will ask you to provide your name, address, phone number, the vehicle identification number and the date it was stolen.

IN NORTH AMERICA

Bombardier Recreational Products Inc.

Warranty Department

75 J.A. Bombardier Street

Sherbrooke, Québec J1L 1W3

Canada

FOR COUNTRIES WITHIN EUROPE, MIDDLE EAST, AFRICA, RUSSIA & CIS

Bombardier Recreational Products Europe N.V.

Warranty Department

SKALDENSTRAAT 125

9042 GENT

BELGIQUE

FOR ALL OTHER COUNTRIES, PLEASE CONTACT OUR NORTH AMERICAN OFFICE

Bombardier Recreational Products Inc.

Warranty Department

75 J.A. Bombardier Street

Sherbrooke, Québec J1L 1W3

Canada



CHANGE OF ADDRESS

CHANGE OF OWNERSHIP

VEHICLE IDENTIFICATION NUMBER

--	--	--	--	--	--	--	--	--	--	--	--	--	--	--	--	--	--	--

**OLD ADDRESS
OR PREVIOUS OWNER**

NAME

TELEPHONE

NO.

STREET

APT.

CITY

STATE/PROVINCE

ZIP/POSTAL CODE

**NEW ADDRESS
OR NEW OWNER**

NAME

TELEPHONE

NO.

STREET

APT.

CITY

STATE/PROVINCE

ZIP/POSTAL CODE

A00A8I



CHANGE OF ADDRESS

CHANGE OF OWNERSHIP

VEHICLE IDENTIFICATION NUMBER

--	--	--	--	--	--	--	--	--	--	--	--	--	--	--	--	--	--	--	--	--	--	--	--	--

**OLD ADDRESS
OR PREVIOUS OWNER**

NAME

TELEPHONE

NO.

STREET

APT.

CITY

STATE/PROVINCE

ZIP/POSTAL CODE

**NEW ADDRESS
OR NEW OWNER**

NAME

TELEPHONE

NO.

STREET

APT.

CITY

STATE/PROVINCE

ZIP/POSTAL CODE

A00A8I



520 000 639

CA

OPERATOR'S GUIDE, MINI Z / ENGLISH
GUIDE DU CONDUCTEUR, MINI Z / ANGLAIS

FAIT AU / MADE IN CANADA

U/M:P.C.