

ski-doo®



Operator's Guide

*Includes
Safety, Vehicle
and Maintenance
Information*



2 0 0 6

RF Series

WARNING

Read this guide thoroughly. It contains important safety information. Minimum recommended operator's age: 16 years old. Do not remove this Operator's Guide from the vehicle.

5 2 0 0 0 0 5 3 9

SAFETY WARNING

Disregarding any of the safety precautions and instructions contained in this *Operator's Guide*, *Safety Videocassette* or on-product warnings may result in injury, including the possibility of death.

This *Operator's Guide* and *Safety Videocassette* should remain with the unit at time of resale.



In USA, products are distributed by BRP US Inc.

In Canada, products are distributed by Bombardier Recreational Products Inc.

The following are trademarks of Bombardier Recreational Products Inc. or its subsidiaries.

SKI-DOO

RER™

ROTAX™

Freestyle™

FOREWORD

Congratulations on your purchase of a new SKI-DOO snowmobile. Whatever model you have chosen, it is backed by the Bombardier Recreational Products Inc. (BRP) warranty and a network of authorized SKI-DOO snowmobile dealers ready to provide the parts, service or accessories you may require.

The Operator's Guide has been prepared to acquaint the owner/operator and passenger with this new snowmobile and its various controls, maintenance and safe riding instructions. This guide is indispensable for the proper use of the product and should be kept with this snowmobile at all times.

Make sure you read and understand the content of this Operator's Guide.

After reading, please keep this Operator's Guide with the snowmobile. If the snowmobile is resold, please give the guide to the new owner for his awareness. An extra copy of the Operator's Guide is available from your SKI-DOO snowmobile dealer at no charge.

If you have any question regarding any topic whether or not it is covered in this Operator's Guide, please call BRP at the number below and we will be happy to assist you:

In USA:

(715) 848-4957

In Canada:

(819) 566-3366

This guide uses the following safety alert symbol in conjunction with signal words to indicate a potential personal injury hazard.

 **WARNING**

Indicates a potentially hazardous situation which, if not avoided, could result in death or serious injury.

 **CAUTION**

Indicates a potentially hazardous situation which, if not avoided, may result in minor or moderate injury. When used without the safety alert symbol , potential hazard exists for property damage only.

NOTE: Indicates supplementary information needed to fully complete an instruction.

Although the mere reading of such information does not eliminate the hazard, the understanding and application of the information will promote the correct use of the vehicle.

Your dealer is committed to your satisfaction. He has taken training to perform the initial set-up and inspection of your snowmobile as well as completed the final adjustment required to suit your specific weight and riding environment before you took possession. At delivery, your dealer would have explained the snowmobile controls and provided you with a brief explanation of the various suspension adjustments. We trust you have taken full advantage of this!

At delivery, you were also informed of the warranty coverage and have completed the Warranty Registration process.

The information and components/system descriptions contained in this guide are correct at time of publication. BRP, however maintains a policy of continuous improvement of its products without imposing upon itself any obligation to install them on products previously manufactured.

Because of its ongoing commitment to product quality and innovation, BRP reserves the right at any time to discontinue or change specifications, designs, features, models or equipment without incurring obligation.

The illustrations in this document show the typical construction of the different assemblies and, in all cases, may not reproduce the full detail or exact shape of the parts shown, however, they represent parts which have the same or a similar function.

It is understood that this guide may be translated into another language. In the event of any discrepancy, the English version shall prevail.

Specifications are given in the SI metric system with the SAE U.S. equivalent in parentheses. Where precise accuracy is not required, some conversions are rounded off for easier use.

Most components of this snowmobile are built with parts dimensioned in the metric system. Most fasteners are metric and must not be replaced by customary fasteners or vice versa.

We recommend genuine BRP products for replacement parts and accessories. They've been specially designed for your vehicle and manufactured to meet BRP's demanding standards.

A Shop Manual can be obtained for complete service, maintenance and more repair information.

For any questions pertaining to the warranty and its application, consult the WARRANTY section in this guide, and/or an authorized SKI-DOO dealer.

TABLE OF CONTENTS

SAFETY INFORMATION

INTRODUCTION	8
IMPORTANT BASIC SAFETY MEASURES	9
LAWS AND REGULATIONS	13
RIDING THE VEHICLE	14
Principle of Operation	14
How to Ride	14
Carrying a Passenger	16
Terrain/Riding Variations	18
Transporting and Towing	22
TRACTION ENHANCING PRODUCTS	23
SAFETY LABELING	27

ENVIRONMENT INFORMATION

GENERAL	34
JUST WHAT IS LIGHT TREADING?	35
WHY IS LIGHT TREADING SMART	36

VEHICLE INFORMATION

HOW TO IDENTIFY YOUR SNOWMOBILE	38
CONTROLS/INSTRUMENTS/EQUIPMENT	40
1) Speedometer	40
2) Reverse Pilot Lamp (Red)	41
3) High Beam Pilot Lamp (Blue)	41
4) Throttle Lever	41
5) Brake Lever	42
6) Parking Brake Lever	42
7) RER Button	42
8) Handlebar	43
9) Ignition Switch	43
10) Tether Cut-Out Switch	44
11) Engine Cut-Out Switch	44
12) Headlamp Dimmer Switch	45
13) Rewind Starter Handle	45
14) Choke Lever	45
15) Fuel Tank Cap/Gauge	45
16) Heating Grip/Throttle Lever Switch	46
17) Windshield	46
18) Hood and Side Panel Latches	46

19) Fuses	47
20) Front Grab Handle/Front Bumper	48
21) Seat Latch	48
22) Storage Compartment	49
23) Rear Rack	49
24) Tool Kit	49
25) Spark Plug Holder	50
26) Spare Drive Belt Compartment	50
27) Hitch	50
28) Shields and Guards	50
29) Track	50
RECOMMENDED FUEL AND OIL	52
BREAK-IN PERIOD.....	54
OPERATING INSTRUCTIONS.....	55
Pre-Operation Check	55
Engine Starting Procedure	56
Vehicle Warm-Up	57
Shutting Off the Engine	57
Post-Operation Care	58
Suspension Adjustments	58
SPECIAL OPERATING INSTRUCTIONS.....	63
Riding at High Altitudes or Sea Level.....	63
Riding in Cold Weather.....	63
Emergency Starting.....	63
Towing an Accessory	64
Towing Another Snowmobile.....	64
Transporting the Vehicle.....	64
TROUBLESHOOTING.....	66
SPECIFICATIONS	68

MAINTENANCE INFORMATION

PERIODIC MAINTENANCE CHART	72
ENGINE SYSTEM.....	75
Air Filter Cleaning	75
Exhaust System.....	75
Oil Injection System	75
DRIVE SYSTEM.....	76
Belt Guard Removal and Installation.....	76
Brake Fluid Level.....	76
Brake Condition	77
Brake Adjustment.....	77
Chaincase Oil Level.....	77
Drive Chain Tension	77
Drive Belt Condition	78
Drive Belt Removal/Installation.....	78

Track Condition.....	79
Track Tension and Alignment.....	79
ELECTRICAL SYSTEM.....	83
Battery Electrolyte.....	83
REAR SUSPENSION.....	84
STEERING AND FRONT SUSPENSION.....	85
BODY/FRAME.....	86
Vehicle Cleaning and Protection.....	86
Bulb Replacement.....	86
Headlamp Beam Aiming.....	87
STORAGE AND PRESEASON PREPARATION.....	88

WARRANTY

BRP LIMITED WARRANTY NORTH AMERICA: 2006 SKI-DOO® SNOWMOBILES.....	90
BRP INTERNATIONAL LIMITED WARRANTY: 2006 SKI-DOO® SNOWMOBILES.....	93
PRIVACY OBLIGATIONS/DISCLAIMER.....	96
CHANGE OF ADDRESS OR OWNERSHIP.....	97
CHANGE OF ADDRESS OR OWNERSHIP.....	99

SAFETY INFORMATION

INTRODUCTION

Everyone is a beginner the first time he sits behind the controls of a snowmobile regardless of previous experience in driving an automobile, a motorcycle or a motorboat. The safe use of your snowmobile is dependent on many conditions such as visibility, speed, weather, environment, traffic, vehicle condition and the condition of the driver.

Each operator has a responsibility to ensure the safety of his/her passenger, if any, and of other recreationists or bystanders.

You are responsible for proper operation of your vehicle as well as training those whom you allow to ride or drive. There may be noticeable handling and performance differences from one snowmobile to the other.

A snowmobile is relatively simple to operate but like any other vehicle or mechanical equipment, it can be hazardous if you or a passenger are reckless, thoughtless or inattentive. We encourage you to have an Annual Safety Inspection of your snowmobile. Please contact an authorized SKI-DOO dealer for further details. Finally, we urge you to visit an authorized SKI-DOO dealer periodically for regular and safety maintenance, as well as snowmobile accessories you may require.

IMPORTANT BASIC SAFETY MEASURES

Training

- △ Basic training is required for the safe operation of any snowmobile. Study your Operator's Guide paying particular attention to cautions and warnings. Join your local snowmobile club: its social activities and trail systems are planned for both fun and safety. Obtain basic instructions from your snowmobile dealer, friend, fellow club member or enroll in your state or provincial safety training program.
- △ Always show a new operator how to start and stop the vehicle. Indicate the correct riding positions and, above all else, only allow him to operate the snowmobile in a restricted flat area — at least until he is completely familiar with its operation. If there is a local snowmobile operator's training course existing, have him enroll.

Performance

- △ The performance of some snowmobiles may significantly exceed that of other snowmobiles you have operated. Therefore, use by novice or inexperienced operators is not recommended.
- △ Snowmobiles are used in many areas and in many snow conditions. Not all models perform the same in similar conditions. Always consult your snowmobile dealer when selecting the snowmobile model for your particular needs and uses.
- △ Injury or death may result to the snowmobile operator, passenger or bystander if the snowmobile is used in risky conditions which are beyond the driver's, passenger's or snowmobile's capabilities or intended use.

Age

- △ BRP recommends the operator has at least 16 years old of age.

Speed

- △ Speeding can be fatal. In many cases, you cannot react or respond quickly enough to the unexpected. Always ride at a speed which is suitable to the trail, weather conditions and your own ability. Know your local rules. Speed limit may be in effect and meant to be observed.

Riding

- △ Always keep right hand side of the trail.
- △ Always keep a safe distance from other snowmobiles and bystanders.
- △ Remember, promotional material may show risky maneuvers performed by professional riders under ideal and/or controlled conditions. You should never attempt any such risky maneuvers if they are beyond your level of riding ability.
- △ Never ride after consuming drugs or alcohol or if you feel tired or ill. Operate your snowmobile prudently.
- △ Your snowmobile is not designed to be operated on public streets, roads or highways.
- △ Snowmobiling at night can be a delightful experience but because of reduced visibility, be extra cautious. Avoid unfamiliar terrain and be sure your lights are working. Always carry a flashlight and spare light bulbs.
- △ Nature is wonderful but don't let it distract your attention from driving. If you want to truly appreciate winter's scenery, stop your snowmobile on the side of the trail so that you don't become a hazard to others.

- ⚠ Fences represent a very serious threat for both you and your snowmobile. Give a wide berth to telephone poles or posts.
- ⚠ Hidden wires unseen from a distance can cause serious accidents.
- ⚠ Always wear an approved safety helmet, eye protection and a face shield. This also applies to your passenger.
- ⚠ Be aware of inherent risks associated with riding off trails, such as avalanche and other natural or man made hazards or obstacles.
- ⚠ Avoid road traveling. If you must do so, and it is permitted, reduce speed. The snowmobile is not designed to operate or turn on paving. When crossing a road, make a full stop, then look carefully in both directions before crossing at a 90° angle. Be wary of parked vehicles.
- ⚠ Tailgating another snowmobile should be avoided. If the snowmobile in front of you slows for any reason, its driver and passenger could be harmed through your neglect. Maintain a safe stopping distance between you and the snowmobile in front of you. Depending on the terrain condition, stopping may require a little more space than you think. Play it safe. Be prepared to use evasive driving.
- ⚠ Venturing out alone with your snowmobile could also be hazardous. You could run out of fuel, have an accident, or damage your snowmobile. Remember, your snowmobile is capable of traveling further in half an hour than you may be able to walk in a day. Use the "buddy system". Always ride with a friend or member of your snowmobile club. Even then, tell someone where you are going and the approximate time you plan to return.
- ⚠ Meadows sometimes have low areas where water accumulate and freezes over in winter. This ice is usually glare ice. Attempting to turn or brake on this surface could cause your vehicle to spin out of control. Never brake or attempt speeding or turning on glare ice. If you do happen to travel over such a condition, reduce speed by carefully releasing the throttle.
- ⚠ Never "jump" with your snowmobile. This should be left to professional stunt men. Don't show off. Be responsible.
- ⚠ While on safari, do not "gun" the throttle. Snow and ice can be thrown back into the path of a following snowmobile. In addition, when "gunning" the throttle, the vehicle digs into and leaves an irregular snow surface for others.
- ⚠ Safaris are both fun and enjoyable but don't show off or overtake others in the group. A less experienced operator might try to do the same as you and fail. When riding with others, limit your abilities to the experience of others.

Operation

- ⚠ Always make a pre-start inspection BEFORE you turn on the ignition.
- ⚠ In an emergency, the snowmobile engine can be stopped by activating the engine cut-out switch, pulling the tether cord cap or turning off the key.
- ⚠ Throttle mechanism should be checked for free movement and return to idle position before starting engine.
- ⚠ Always engage parking brake when vehicle is not in use.
- ⚠ Never run the engine in a non-ventilated area and/or if vehicle is left unattended.
- ⚠ Never operate the engine without belt guard securely installed or, with hood or access/side panels open or removed. Never run the engine without drive belt installed. Running an unloaded engine such as without drive belt or with track raised, can be dangerous.
- ⚠ **Electric start models only:** Never charge or boost a battery while installed on snowmobile.
- ⚠ Ensure the path behind is clear of obstacles or bystanders before proceeding in reverse.
- ⚠ Do not leave your keys in the ignition switch, it is an invitation to thieves and a danger to young children.
- ⚠ Raising the rear of your snowmobile while the engine is running could cause snow, ice or debris to be thrown back at an observer. Never raise the rear of the vehicle while the engine is running. To clear or inspect the track, stop the engine, tilt the vehicle on its side and remove blockage with a piece of wood or branch. Never allow anyone near a rotating snowmobile track.

Maintenance

- ⚠ Know your snowmobile and treat it with the respect and care due of any power driven machine. Common sense, proper handling and routine maintenance will result in safer and enjoyable use.
- ⚠ Only perform procedures as detailed in this guide. Unless otherwise specified, engine should be turned OFF and cold for all lubrication, adjustment and maintenance procedures.
- ⚠ Never have the engine running while the hood is open. Even at idle, a snowmobile engine is turning around 1,800 revolutions per minute. Always turn off the ignition before opening the hood for any reason.
- ⚠ Never remove any original equipment from your snowmobile. Each vehicle has many built in safety features. Such features include various guards and consoles, plus reflective materials and warning labels.
- ⚠ A poorly maintained snowmobile itself can be a potential hazard. Excessively worn components could render the vehicle completely inoperative. Keep the snowmobile in good working condition at all times. Follow your pre-operation check, weekly, monthly and annually routine maintenance and lubrication procedures as detailed in this guide. Consult a snowmobile dealer or acquire a shop manual and proper tools and equipment if other repairs or service is required.
- ⚠ Do not stud the track unless it as been approved for studs. At speed, a studded track that as not been approved for studs could tear and separate from vehicle posing a risk of severe injury or death.

Fuel

- ⚠ Always stop the engine before refueling. Fuel is flammable and explosive under certain conditions. Always work in a well-ventilated area. Do not smoke or allow open flames or sparks in the vicinity. Open cap slowly. If a differential pressure condition is noticed (whistling sound heard when loosening fuel tank cap) have vehicle inspected and/or repaired before further operation. Do not overfill or top off the fuel tank before placing the vehicle in a warm area. As temperature increases, fuel expands and might overflow. Always wipe off any fuel spillage from the vehicle. Periodically verify fuel system.

Basics for Passenger

- ⚠ Never ride as a passenger unless the snowmobile is equipped with a passenger seat, and sit only on the designated passenger seat.
- ⚠ Always wear a DOT approved helmet and follow the same dressing guidelines as those recommended for the operator and described in this guide.
- ⚠ Make sure that you are able to achieve a stable stance, both feet resting positively on the footboards of footrests with good grip, and that you are able to hold on firmly to the handholds.
- ⚠ Once underway, if you feel uncomfortable or insecure for any reason, don't wait, tell the driver to slow down or stop.

LAWS AND REGULATIONS

⚠ Know your local laws.

Federal, state, provincial and local government agencies have enacted laws and regulations pertaining to the safe use and operation of snowmobiles. It is your responsibility as a snowmobiler to learn and obey these laws and regulations. Respect and observance will result in safer snowmobiling for all.

Be aware of the liability property damages and insurance laws regarding your equipment.

RIDING THE VEHICLE

Before venturing on the trails, operate the snowmobile in a restricted flat area until you are completely familiar with its operation and feel comfortable that you can safely tackle a more demanding task. Have an enjoyable and safe ride.

Principle of Operation

Propulsion

Depressing throttle lever increases engine RPM causing the drive pulley to engage. Depending on models engine RPM must be between 2500 and 4200 before drive pulley engagement will occur.

Outer sheave of drive pulley moves toward inner sheave, forcing the drive belt to move upward on the drive pulley and simultaneously forcing the sheaves apart on the driven pulley.

The driven pulley senses the load on the track and limits the belt movement. The result is an optimized speed ratio between engine RPM and the speed of the vehicle at any time.

WARNING

Never operate engine without belt guard securely installed or, with hood or access/side panels open or removed.

Power is transferred to the track through the chaincase or gearbox and drive axle.

WARNING

Always use a wide-base snowmobile mechanical stand to properly support vehicle during any track verification. Slowly accelerate engine in order to rotate track at very low speed when it is not on ground.

Turning

Handlebar controls the steering of the vehicle. As the handlebar is rotated to right or left, the skis are turned right or left to steer the snowmobile.

Stopping

Before riding your snowmobile, you should understand how to stop it. This is done by releasing the throttle and gradually depressing the brake lever on the left side of the handlebar. In an emergency, you may stop your vehicle by pressing the engine cut-out switch located near the throttle control and applying the brake. Remember, a snowmobile cannot "stop on a dime". Braking characteristics vary with deep snow, packed snow or ice. If the track is locked during hard braking, skidding may result.

How to Ride

How to Dress

Proper snowmobile clothing should be worn. It should be comfortable and not too tight. Always check the weather forecast before going on a ride. Dress for the coldest weather expected. Thermal underwear next to the skin also provides a good insulation.

DOT approved helmets are recommended at all times. They provide both warmth and reduce injury. A stocking type cap, balaclava and face mask should always be carried or worn. Goggles or a face shield that attach to the helmet are indispensable.

Hands should be protected by a pair of snowmobile gloves or mitts which have sufficient insulation and allow use of thumbs and fingers for operation of controls.

Rubber bottom boots with either a nylon or a leather top, with removable felt liners are best suited for snowmobiling.

You should keep yourself as dry as possible when snowmobiling. When you come indoors, take your snowmobile suit and boots off and make certain they dry properly.

Do not wear long scarfs and loose apparel that could get caught in moving parts.

What to Bring

Every snowmobiler should carry at least the following basic parts and tools that can help him and others in an emergency:

- this Operator's Guide
- spare spark plugs and wrench
- friction tape
- spare drive belt
- spare starter rope
- spare Light bulbs
- tool kit (including at least pliers, screwdriver, adjustable wrench)
- knife
- flashlight.

Include other items depending on the length and time of your ride.

Riding Position

Your riding position and balance are the two basic principles of making your snowmobile go where you want it to. When turning on the side of a hill, you and your passenger must be ready to shift body weight to help it turn in the desired direction. Driver and passenger(s) must never attempt this maneuvering by placing feet outside of the vehicle. Experience will teach you how much lean to put into turns at different speeds and how much you will have to lean into a slope to maintain proper balance.

Generally, the riding position for best balance and control is sitting. However, the posting, kneeling or standing positions are also used under certain conditions.

The novice driver should become familiar with the snowmobile through practice on a level area at slow speeds before venturing afield.

⚠ WARNING
Do not attempt any maneuvers if they are beyond your abilities.

Sitting

Feet on the running boards, body mid-way back on seat is an ideal position when operating the snowmobile over familiar, smooth terrain. Knees and hips should remain flexible to absorb shocks.



Posting

A semi-sitting position with the body off the seat and the feet under the body in a sort of squatting posture, thus allowing the legs to absorb the shocks when traveling over uneven terrain. Avoid abrupt stops.



Standing

Place both feet on the running boards. Knees should be flexed to absorb the shock from surface bumps. This is an effective position to see better and to shift weight as conditions dictate. Avoid abrupt stop.



Kneeling

This position is achieved by placing one foot firmly on the running board and the opposite knee on the seat. Avoid abrupt stops.



Carrying a Passenger

Certain snowmobiles are designed for an operator only, others can allow one passenger only, and others can allow up to two passengers. Refer to the indications on the vehicles to know if any particular snowmobile can accommodate passengers or not, and if so, how many. Always respect those indications. Overloading is dangerous because snowmobiles are not designed for it.

Even when passengers are allowed, you must make sure that the persons who would like to become passengers are physically fit for snowmobiling.

WARNING

Any passenger must be able to firmly lay his feet on the footrests and keep his hands on the grab handles or seat strap at all times when seated. Respecting those physical criteria is important to ensure that the passenger is stable and to reduce the risks of ejection.

On snowmobiles allowing two passengers, if you have an adult and a child for passenger, BRP recommends that the child sits in the center location. This allows an adult sitting in the rear seat to keep a visual contact with the child and hold him if necessary. In addition, the child is best protected against the wind and cold temperature if seated in the center location.

Each operator has a responsibility to ensure the safety of his passengers and should inform them of snowmobiling basics.

WARNING

- Passengers must only sit on designated passenger seats. Never allow anyone to sit between the handlebar and the operator.
- Each passenger seat must have a strap or grab handles and meet SSCC standards.
- Passengers and operators must always wear DOT approved helmets and warm clothing appropriate for snowmobiling. Make sure that no skin is exposed.
- Once underway, if a passenger feels uncomfortable or unsecure for any reason, he must not wait, and tell the driver to slowdown or stop.

Riding with passengers on board is different than riding alone. The operator has the benefit of knowing what will be the next maneuver and is able to prepare himself accordingly. The operator also benefits from the support of his grip on the handlebar. In contrast, the passengers have to rely on the operator's careful and safe operation of the vehicle. In addition, "body english" is limited with passengers, and the operator can sometimes see more of the trail ahead than the passengers. Therefore, smooth starting and stopping are required with passengers, and the operator must slow down. The operator must also warn passengers of side hills, bumps, branches, etc. An unforeseen bump can leave you passenger-less. Remind your passengers to lean into the turn with you, without causing the vehicle to topple. Be extremely careful, go more slowly and check the passengers frequently.

WARNING

When riding with a passenger:

- Braking ability and steering control are reduced. Decrease speed and allow extra space to maneuver.
- Adjust suspension according to weight.

For complete information on how to adjust the suspension, please refer to the section of this Operator's Guide entitled SUSPENSION ADJUSTMENTS under OPERATING INSTRUCTIONS and to the relevant label on the belt guard.

Use extra caution and go even more slowly with young passengers. Check frequently to make certain the child has a firm grip and is properly positioned with his feet on the running boards.

Terrain/Riding Variations

Groomed Trail

On a maintained trail, sitting is the most preferred riding position. Do not race and, above all, keep to the right hand side of the trail. Be prepared for the unexpected. Observe all trail signs. Do not zigzag from one side of the trail to the other.

Ungroomed Trail

Unless there has been a fresh snowfall you can expect "washboard" and snowdrift conditions. Taken at excessive speeds, such conditions can be physically harmful. Slow down. Hold on the handlebar and assume a posting position. Feet should be under the body assuming a crouched position to absorb any jarring effect. On longer stretches of "washboard" trails, the kneeling position of one knee on the seat can be adopted. This provides a certain amount of comfort, while at the same time keeps the body loose and capable of vehicle control. Beware of hidden rocks or tree stumps partially hidden by a recent snowfall.

Deep Snow

In deep "powder" snow, your vehicle could begin to "bog" down. If this occurs, turn in as wide an arc as possible and look for a firmer base. If you do get "bogged", and it happens to everyone, do not spin your track as this makes the vehicle sink deeper. Instead, turn the engine off, get off and move the back of the vehicle onto new snow. Then tramp a clear path ahead of the vehicle. A few feet will generally suffice. Restart the engine. Assume the standing position and rock the vehicle gently as you steadily and slowly apply the throttle. Depending on whether the front or rear end of the vehicle is sinking, your feet should be placed on the opposing end of the running boards. Never place foreign material beneath the track for support. Do not allow anyone to stand in front of, or to the rear of, the snowmobile with the engine running. Stay away from the track. Personal injury will result if contact is made with the revolving track.

Frozen Water

Traveling frozen lakes and rivers can be fatal. Avoid waterways. If you are in an unfamiliar area, ask the local authorities or residents about the ice condition, inlets, outlets, springs, fast moving currents or other hazards. Never attempt to operate your snowmobile on ice that may be too weak to support you and the vehicle. Operating a snowmobile on ice or icy surfaces can be very dangerous if you do not observe certain precautions. The very nature of ice is foreign to good control of a snowmobile or any vehicle. Traction for starting, turning or stopping is much less than that on snow. Thus, these distances can be multiplied manyfold. Steering is minimal, and uncontrolled spins are an ever present danger. When operating on ice, drive slowly with caution. Allow yourself plenty of room for stopping and turning. This is especially true at night.

Hard Packed Snow

Don't underestimate hard packed snow. It can be difficult to negotiate as both skis and track do not have as much traction. Best advice is to slow down and avoid rapid acceleration, turning or braking.

Uphill

There are two types of hills you can encounter — the open hill on which there are few trees, cliffs or other obstacles, and a hill that can only be climbed directly. On an open hill, the approach is to climb it by side hilling or slalom-ing. Approach at an angle. Adopt a kneeling position. Keep your weight on the uphill side at all times. Maintain a steady, safe speed. Continue as far as you can in this direction, then switch to an opposite hill angle and riding position.

A direct climb could present problems. Choose the standing position, accelerate before you start the climb and then reduce throttle pressure to prevent track slippage.

In either case, vehicle speed should be as fast as the incline demands. Always slow down as you reach the crest. If you cannot proceed further, don't spin your track. Turn the engine off, free the skis by pulling them out and downhill, place the rear of the snowmobile uphill restart the engine and ease it out with slow even throttle pressure. Position yourself to avoid tipping over, then descend.

Downhill

Downhill driving requires that you have full control of your vehicle at all times. On steeper hills, keep your center of gravity low and both hands on the handlebar. Maintain slight throttle pressure and allow the machine to run downhill with the engine operating. If a higher than safe speed is reached, slow down by braking but apply the brake with frequent light pressure. Never jam the brake and lock the track.

Side Hill

When crossing a side hill or traversing up or downhill, certain procedures must be followed. All riders should lean towards the slope as required for stability. The preferred operating positions are the kneeling position, with the knee of the down hill leg on the seat and the foot of the uphill leg on the running board, or the posting position. Be prepared to shift your weight quickly as needed. Side hills and steep slopes are not recommended for a beginner or a novice snowmobiler.

Slush

Slush should be avoided at all times. Always check for slush before starting across any lake or river. If dark spots appear in your tracks, get off the ice immediately. Ice and water can be thrown rearward into the path of a following snowmobile. Getting a vehicle out of a slush area is strenuous and in some cases, impossible.

Fog or Whiteouts

On land or water, fog or visibility-limiting snow can form. If you have to proceed into the fog or heavy snow, do so slowly with your lights on and watch intently for hazards. If you are not sure of your way, do not proceed. Keep a safe distance behind other snowmobilers to improve visibility and reaction time.

Unfamiliar Territory

Whenever you enter an area that is new to you, drive with extreme caution. Go slow enough to recognize potential hazards such as fences or fence posts, brooks crossing your path, rocks, sudden dips, guy wires and countless other obstacles which could result in a termination of your snowmobile ride. Even when following existing tracks, be cautious. Travel at a speed so you can see what is around the next bend or over the top of the hill.

Bright Sunshine

Bright sunny days can considerably reduce your vision. The glare from sun and snow may blind you to the extent that you cannot easily distinguish ravines, ditches or other obstacles. Goggles with colored lenses should always be worn under these conditions.

Unseen Obstruction

There may be obstructions hidden beneath the snow. Driving off established trails and in the woods requires reduced speed and increased vigilance. Driving too fast in an area can make even minor obstacles very hazardous. Even hitting a small rock or stump could throw your snowmobile out of control and cause injury to its riders. Stay on established trails to reduce your exposure to hazards. Be safe, slow down and enjoy the scenery.

Hidden Wires

Always be on the lookout for hidden wires, especially in areas that may have been farmed at one time or another. Too many accidents have been caused by running into wires in the fields, guy wires next to poles and roads, and into chains and wires used as road closures. Slow speeds are a must.

Obstacles and Jumping

Unplanned jumps of snowdrifts, snowplow ridges, culverts or indistinguishable objects can be dangerous. You can avoid them by wearing the proper color lenses or face shields and by operating at a lower speed.

Jumping a snowmobile is an unsafe and dangerous practice. However, if the trail does suddenly drop away from you, crouch (stand) towards the rear of the vehicle and keep the skis up and straight ahead. Apply partial throttle and brace yourself for the impact. Knees must be flexed to act as shock absorbers.

Turning

Depending on terrain conditions, there are two preferred ways to turn or corner a snowmobile. For most snow surfaces, “body english” is the key to turning. Leaning towards the inside of the turn and positioning body weight on the inside foot will create a “banking” condition beneath the track. By adopting this position and positioning yourself as far forward as possible, weight will be transferred to the inside ski.

On occasion, you will find that the only way to turn the vehicle about in deep snow is to pull the snowmobile around. Do not over-exert yourself. Get assistance. Remember to always lift using your legs as opposed to your back.



mmo2006-003-005

Road Crossing

In some cases, you will be approaching the road from a ditch or snowbank. Choose a place where you know you can climb without difficulty. Use the standing position and proceed with only as much speed needed to crest the bank. Stop completely at the top of the bank and wait for all traffic to clear. Judge the drop to the roadway. Cross the road at a 90° angle. If you encounter another snowbank on the opposite side, position your feet near the rear of the vehicle. Remember, your snowmobile is not designed to operate on bare pavement and steering on this type of surface is more difficult.

Railroad Crossing

Never ride on railroad tracks. It is illegal. Railroad tracks and railroad rights-of-way are private property. A snowmobile is no match for a train. When crossing a railroad track, stop, look and listen.

Night Rides

The amount of natural and artificial light at a given time can effect your ability to see or to be seen. Nighttime snowmobiling is delightful. It can be a unique experience if you acknowledge your reduced visibility. Before you start, make certain your lights are clean and work properly. Drive at speeds that will allow you to stop in time when you see an unknown or dangerous object ahead. Stay on established trails and never operate in unfamiliar territory. Avoid rivers and lakes. Guy wires, barbed wire fences, cabled road entrances and other objects such as tree limbs are difficult to see at night. Never drive alone. Always carry a flashlight. Keep away from residential areas and respect the right of others to sleep.

Safari Riding

Before starting out, designate a “trail boss” to lead the party and another person to follow-up at the end of the party. Ensure that all members of the party are aware of the proposed route and destination. Make certain that you are carrying all necessary tools and equipment and that you have sufficient fuel to complete the trip. Never overtake the trail boss or, for that matter, any other snowmobile. Use down-the-line hand signals to indicate hazards or intent of direction change. Assist others whenever necessary.

It is always IMPORTANT to keep a safe distance between each snowmobile. Always maintain a safe interval and allow sufficient stopping distance. Don't be a tailgater. Know the position of the machine ahead.

Signals

If you intend to stop, raise either hand straight above your head. A left turn is indicated by extending your left hand straight out in the proper direction. For right turns, extend the left arm and raise the hand to a vertical position so it forms a right angle at the elbow. Every snowmobiler should relay any signal to the ones behind.

Trail Stops

Whenever possible, pull off the trail when you stop. This will reduce the hazard to other snowmobilers using the trail.

Trails and Signs

Trail signs are used to control, direct or regulate the use of snowmobiles on trails. Become familiar with all signs used in the area where you are snowmobiling.

Transporting and Towing

Follow transporting and towing instructions explained further in this guide.

TRACTION ENHANCING PRODUCTS

NOTE: This section is applicable only to snowmobile equipped with a track that as been approved for studs.

Using more positive carbide ski runners and traction enhancing products on your snowmobile will change its behavior, particularly in terms of manoeuvrability, acceleration, and braking.

Studding the track gives a better grip on packed snow and ice, but has no noticeable effect on soft snow. For this reason, driving a snowmobile equipped with traction enhancing products (studs, carbide ski runners) requires a certain adaptation period. If your snowmobile is equipped with traction products, be sure to take plenty of time to get used to the way it handles when turning, accelerating, and braking.

Also, always check local regulations concerning the use of studs on snowmobiles. Always drive your snowmobile in a responsible manner, respecting the environment and other people's property.

Manoeuvrability

Studding the track makes the snowmobile grip the ground better at the rear. The use of carbide runners is therefore required to give the skis a better grip, so that the front and rear of the snowmobile are in balance. While off-the-shelf carbide ski runners are adequate, they don't necessarily give you optimal control, since that depends on your personal preferences, your riding style, and how your suspension is set.

WARNING

If the front and rear of the snowmobile are out of balance due to an incorrect combination of studs and runners, the snowmobile may tend to oversteer or understeer, which could lead to a loss of control.

1) Oversteering

In certain conditions, using more positive carbide ski runners without studding the track could make the snowmobile prone to oversteering, see illustration.

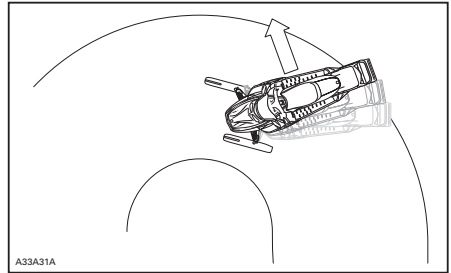

OVERSTEERING

2) Understeering

In certain conditions, the use of studs could make the snowmobile prone to understeering if the skis are not equipped with more positive carbide runners, see illustration.

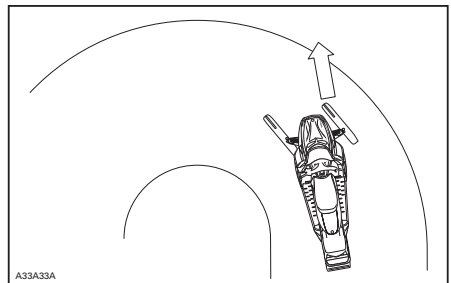

UNDERSTEERING

3) Controlled Driving

A balanced combination of carbide ski runners and studs ensures adequate control and better handling, see illustration.

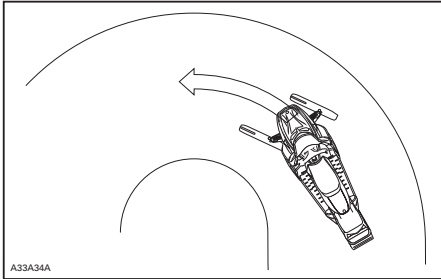

CONTROLLED DRIVING

Acceleration

Studding the track will allow your sled to accelerate better on packed snow and ice but will have no noticeable effect on soft snow. This can cause sudden variations in traction under certain conditions.

WARNING

To prevent surprises that could lead to a loss of control of the snowmobile, possibly resulting in serious injury or death:

- Always go easy on the throttle.
- NEVER try to spin the track to make the rear of the snowmobile skid.

This could cause debris or ice to be thrown violently backwards, possibly injuring others nearby or on snowmobiles behind you.

Braking

As is the case for acceleration, studding the track will give you better braking capacity on packed snow or ice but will have no noticeable effect on soft snow. Braking may thus vary suddenly under certain conditions. Be sure to use restraint in braking to keep from blocking the track in order to avoid surprises that could lead to a loss of control.

Important Safety Rules

WARNING

To prevent serious injury to individuals near the snowmobile:

- NEVER stand behind or near a moving track.
- Always use a wide-base snowmobile stand with a rear deflector panel.
- When the track is raised off the ground, only run it at the lowest possible speed.

Centrifugal force could cause debris, damaged or loose studs, pieces of torn track, or an entire severed track to be violently thrown backwards out of the tunnel with tremendous force, possibly resulting in the loss of a leg or other serious injury.

Effects of Studding on the Life of the Snowmobile

The use of traction enhancing products can increase the load and the stress on certain snowmobile components, as well as the vibration level. This can cause premature wear on parts such as belts, brake linings, bearings, chain, and chaincase sprocket, and shorten track life. For this reason, it is even more important to follow the detailed maintenance program given in the PERIODIC MAINTENANCE CHART.

Studs can also cause serious damage to your snowmobile if it is not equipped with the tunnel protectors designed for your particular model. Damage to the electrical wiring or perforation of the heat exchangers are potential hazards, that could cause the engine to overheat and be severely damaged.

⚠ WARNING

If tunnel protectors are excessively worn or not installed, the gas tank could be punctured, causing a fire.

CAUTION: Ask your dealer for the appropriate tunnel protectors model and kit number required for your snowmobile.

NOTE: Consult the BRP limited warranty to find out what warranty limitations are related to the use of studs.

Installation of Studs

To ensure safe and proper installation, BRP recommends to have the studs installed by your dealer.

- Use only studs, mounting plates, and nuts sold by BRP.
- Never use studs that exceed the height of your snowmobile's track profile by more than 9.5 mm (3/8 in).

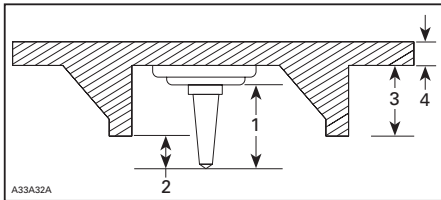

INSTALLATION OF STUDS

1. Stud size
2. Penetration range 6.4 to 9.5 mm (1/4 to 3/8 in)
3. Track lug height
4. Track belt thickness

⚠ WARNING

- Never stud a track that has not been approved for studs. Approved tracks can be identified by a stud symbol (see illustration) molded into the track surface.
- Studs should only be installed in the locations indicated by molded bulges in the track surface.
- Never stud a track with a profile of 35 mm (1.375 in) or more.
- The number of studs installed must always perfectly match the pattern of molded bulges in the track.
- Always consult the traction product manufacturer's installation instructions and recommendations before having your dealer install studs and runners. It is very important to follow the torque specifications for the stud bolts.

INSTALLING AN INCORRECT NUMBER OF STUDS OR AN IMPROPER INSTALLATION CAN INCREASE THE RISK OF THE TRACK TEARING OR SEVERING, POSSIBLY RESULTING IN SERIOUS INJURY OR DEATH.

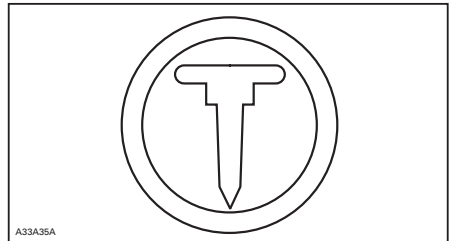

APPROVED TRACKS CAN BE IDENTIFIED BY THIS SYMBOL

Maintenance/Replacement

PROCEED WITH A VISUAL INSPECTION OF YOUR TRACK BEFORE EACH USE.

Look for any defects, such as:

- perforations in the track
- tears in the track (particularly around traction holes)
- lugs that are broken or torn off, exposing portions of rods
- delamination of the rubber
- broken rods
- broken studs
- bent studs
- studs that are torn off the track
- missing track guide(s).

Replace broken or damaged studs immediately. If your track shows signs of deterioration, it must be replaced immediately. When in doubt, ask your dealer. Always follow the inspections schedule given in the PERIODIC MAINTENANCE CHART.

WARNING

Riding with a damaged track or studs could lead to loss of control, resulting in a risk of serious injury or death.

SAFETY LABELING

Safety standards for snowmobiles have been adopted by the Snowmobile Safety and Certification Committee (SSCC) of which BRP is a proud participating member. Assurance that your snowmobile meets these standards is easily checked by locating the Certification Label on a right vertical portion of the vehicle.

This label shows that an independent testing laboratory has verified compliance with the SSCC safety standards.



Other important labels on the vehicle are WARNING or CAUTION labels relating to safety, maintenance and/or snowmobile operation. Ensure all such labeling is retained on the vehicle and its content is followed by vehicle operator and passenger.

If missing or damaged, the decals can be replaced free of charge. See an authorized SKI-DOO dealer.

Please read the following instructions carefully before operating this snowmobile.



LH SIDE PANEL



RH SIDE PANEL

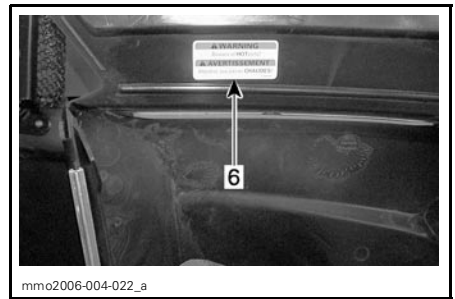

INSIDE RH SIDE PANEL

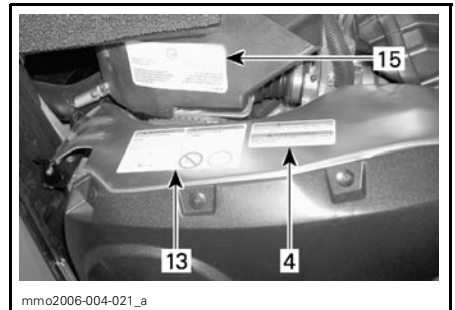

PULLEY GUARD



AIR INTAKE SILENCER (BODY SIDE)

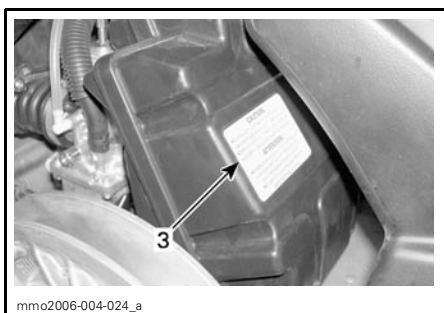

AIR INTAKE SILENCER (ENGINE SIDE)



DRIVE PULLEY

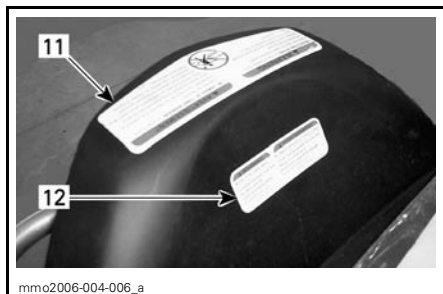

REAR CARGO AREA — FREESTYLE™



REAR CARGO AREA — TUNDRA

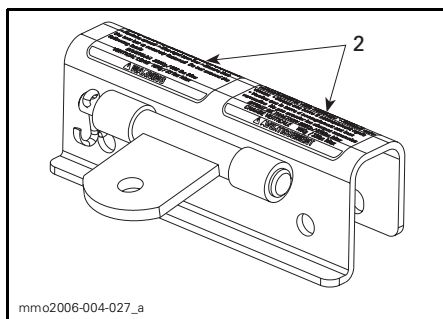

TUNDRA — CANADA/U.S. MODELS

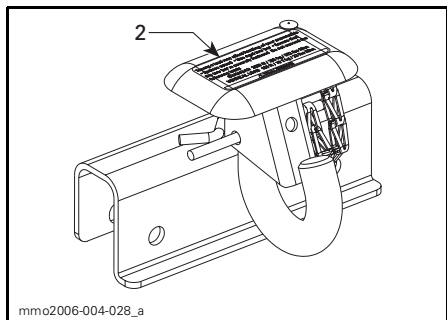

TUNDRA — EUROPEAN MODELS

Instruction 1

⚠ WARNING	⚠ AVERTISSEMENT
<p>BEFORE STARTING :</p> <ol style="list-style-type: none"> 1. Attach tether cord to your clothing. 2. Check proper operation of the throttle and brake levers each time before starting. They must return to their initial position when released. 3. Apply parking brake. 4. Turn handlebars all the way in both directions to check for interference and insure free operation. <p>AFTER STARTING :</p> <ol style="list-style-type: none"> 1. Pull-out tether cord to check if engine shuts off. 2. Restart and push in engine cut-off switch to check if engine shuts off. 3. Disengage parking brake before riding to avoid fading. 	<p>AVANT DE DÉMARRER :</p> <ol style="list-style-type: none"> 1. Attachez le cordon coupe-circuit à votre vêtement. 2. Vérifiez le bon fonctionnement des manettes d'accélérateur et de frein avant chaque démarrage. Elles doivent revenir à leur position initiale lorsque relâchées. 3. Engagez le frein de stationnement. 4. Tournez le guidon au maximum de chaque côté pour vérifier les interférences et le libre fonctionnement. <p>APRÈS LE DÉMARRAGE :</p> <ol style="list-style-type: none"> 1. Déconnectez le cordon coupe-circuit pour vérifier qu'il arrête le moteur. 2. Redémarrez et enfoncez le bouton d'arrêt d'urgence pour vérifier qu'il arrête le moteur. 3. Désengagez le frein de stationnement avant le départ pour éviter la surchauffe et la perte du frein.

A33A2CA

Instruction 2

Towing a load may affect handling of your snowmobile.

- Reduce speed.
- Use rigid tow bar.
- Ensure that the tow bar is securely fastened. Do not exceed the following loads:

DRAWBAR 250Kg / 562 lbs Max.
VERTICAL LOAD 10Kg / 23 lbs Max.

⚠ WARNING

A33A2DA

ENGLISH LABEL

⚠ WARNING	⚠ AVERTISSEMENT
<p>Towing a load may affect handling of your snowmobile.</p> <ul style="list-style-type: none"> • Reduce speed. • Use rigid tow bar. • Ensure that the tow bar is securely fastened. <p>Do not exceed the following loads:</p> <p>DRAWBAR 250kg / 562lbs Max. VERTICAL LOAD 10kg / 23lbs Max.</p> <p>516 002 667</p>	<p>Le remorquage d'une charge peut affecter le comportement de votre motoneige.</p> <ul style="list-style-type: none"> • Réduisez votre vitesse. • Utilisez une barre d'accouplement rigide. • Vérifiez que la barre d'accouplement soit bien verrouillée. <p>Ne pas excéder les charges maximales:</p> <p>EFFORT DE TRACTION 250kg / 562lbs Max. CHARGE VERTICALE 10kg / 23lbs Max.</p>

mmo2006-004-026

FRENCH LABEL

Instruction 3

CAUTION

- To comply with noise regulations, this engine is designed to operate with an air intake silencer.
- Operation without air intake silencer or with one not properly installed may cause engine damage.

ATTENTION

- Le moteur a été conçu pour fonctionner avec ce silencieux d'admission afin de se conformer aux lois et règlements relatifs au bruit.
- Son absence ou une mauvaise installation peut endommager le moteur.

A01A2EA 516 001 191

Instruction 4

⚠ WARNING

This guard must ALWAYS be in place when engine is running. Beware of rotating parts – they could cause injuries or catch your clothing.

⚠ AVERTISSEMENT

Ce garde-courroie doit TOUJOURS être en place lorsque le moteur fonctionne. Attention aux pièces en rotation – elles peuvent vous blesser ou capter vos vêtements.

A33A2FA 516 002 670

Instruction 5

⚠ WARNING

Do not disassemble or modify this pulley.

⚠ AVERTISSEMENT

Ne pas démonter ni modifier cette poulie.

516 001 726

Instruction 6

⚠ WARNING

Beware of HOT parts!

⚠ AVERTISSEMENT

Attention aux pièces CHAUDES!

A33A2GA 516002664

Instruction 7

DO NOT SIT HERE / NE PAS S'ASSEOIR ICI



mmo2006-004-001_a

Instruction 8

⚠ WARNING

ALL DRIVERS AND PASSENGERS MUST READ THE FOLLOWING:

Avoid surprises! **BE ON THE LOOK-OUT** for the unexpected. Operate defensively.

- Scan constantly for people, objects, conditions and upcoming vehicles.
- Avoid thin ice / open water.
- Use extra caution whenever off-trail.



ALWAYS wear a DOT approved HELMET and clothing appropriate for snowmobiling.



NEVER ride after consuming alcohol or drugs even as a passenger.



⚠ AVERTISSEMENT

TOUS LES CONDUCTEURS ET PASSENGERS DOIVENT LIRE CE QUI SUIT:

Évitez les surprises! **SOYEZ AUX AGUETS** pour les imprévus. Conduisez défensivement.

- Scutez constamment pour repérer personnes, objets, conditions et autres véhicules.
- Évitez la glace mince / étendue d'eau non gelée.
- Redoublez de vigilance hors sentier.

TOUJOURS porter un CASQUE approuvé DOT et des vêtements appropriés à la motoneige.

Ne **JAMAIS** utiliser ce véhicule sous l'influence de drogues ou alcool même en tant que passager.

510 002 008

mmo2006-004-002

Instruction 9

⚠ WARNING

This vehicle is designed for one (1) operator and as many passengers as there are seats with straps or handgrips installed on the vehicle conforming to SSCC standards.

When riding with a passenger:

- Braking ability and steering control are reduced. **Decrease speed** and allow extra space to maneuver.
- **Adjust suspensions** according to weight.

REMEMBER: YOU ARE RESPONSIBLE FOR THE SAFETY OF YOUR PASSENGER!

A33A2KA

⚠ AVERTISSEMENT

Ce véhicule a été conçu pour un (1) conducteur et autant de passagers qu'il y a de sièges avec courroies ou poignées installés sur le véhicule et rencontrant la norme SSCC.

Lors de la conduite avec passager:

- La capacité de freinage et la direction sont réduites. **Réduisez votre vitesse** et prévoyez plus d'espace pour manœuvrer.
- **Ajustez les suspensions** selon le poids.

N'OUBLIEZ PAS: VOUS ÊTES RESPONSABLE DE LA SÉCURITÉ DE VOTRE PASSAGER!

510 002 012

Instruction 10

⚠ WARNING

• **Read and understand all warning labels and operator's guide before operation.** If guide is missing, ask your dealer for a new one.

• **Get familiar with your vehicle.** Inexperienced riders may overlook risks and be surprised by vehicle's specific behavior and terrain conditions. Ride slowly.

• **Excessive speed and reckless driving can kill!** ALWAYS adjust your speed according to snow conditions and circumstances.

• **Steering control and braking ability may be reduced** on hard-packed snow, ice or roads. Reduce speed & allow more space to stop or turn.

• **Respect laws** on minimum operator age. Manufacturer recommends a minimum operating age of **16 years old**.

⚠ AVERTISSEMENT

• **Lire et comprendre toutes les étiquettes d'avertissements et le guide du conducteur avant utilisation.** Si le guide est introuvable, demandez-en un nouveau à votre concessionnaire.

• **Familiarisez-vous avec votre véhicule.** Les personnes inexpérimentées peuvent sous-estimer les risques et être surpris par le comportement spécifique du véhicule et des conditions du terrain. Conduisez lentement.

• **La vitesse excessive et la conduite irresponsable peuvent causer la mort!** TOUJOURS adapter votre vitesse selon les conditions de neige et les circonstances environnantes.

• **Le contrôle de la direction et la freinage peuvent être réduits** sur la neige compactée, la glace ou les routes. Réduisez votre vitesse et laissez plus d'espace pour tourner ou freiner.

• **Respectez les lois** sur l'âge minimal du conducteur. Le fabricant recommande que le conducteur soit âgé d'au moins **16 ans**.

510 002 017

mmo2006-004-003

Instruction 11

⚠ WARNING

• **NEVER STAND BEHIND** or near a rotating track. Only spin track at lowest possible speed whenever off the ground. Broken track or debris could be projected with great force which could sever legs or cause other serious injuries.



⚠ AVERTISSEMENT

• **NE JAMAIS SE TENIR DERRIÈRE** ou près d'une chenille qui tourne. • Seulement faire tourner la chenille à la vitesse la plus basse possible lorsque soulevée de terre. Une chenille brisée ou des débris pourraient être projetés avec grande puissance pouvant sectionner une jambe ou causer d'autres blessures sérieuses.

A33A2NA

Instruction 12

⚠ WARNING

NEVER SIT IN CARGO AREA.

Exceeding maximum cargo load may affect steering control and braking ability. **MAXIMUM cargo load:** 15,8 Kg / 35 Lbs.

⚠ AVERTISSEMENT

NE JAMAIS S'ASSEOIR À LA PLACE DU CARGO.

Excéder le poids maximal du cargo peut affecter le contrôle de la direction et la capacité de freinage. **Charge MAXIMALE cargo:** 15,8 Kg / 35 Lbs.

510 002 006

A33A2OA

Instruction 13

⚠ WARNING

EMERGENCY STARTING

- **NEVER** wind rope around your hand.
- If starter clip remained stuck, your hand could be pulled in by the clutch.
- See operator's guide for proper procedure.



⚠ AVERTISSEMENT

DÉMARRAGE D'URGENCE

- **NE JAMAIS** enrouler la corde autour de votre main.
- Si l'agraffe restait attachée sur la poulie motrice, votre main pourrait être entraînée dans la poulie.
- Voir votre guide de l'opérateur pour connaître la méthode d'utilisation adéquate.



A33A2PA

Instruction 14



EUROPEAN MODELS

Instruction 15

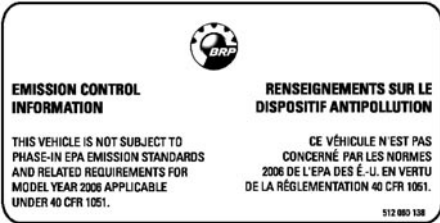

ENVIRONMENT INFORMATION

GENERAL

Wildlife compliments your snowmobiling day. Snowmobile tracks provide firm ground over which animals can travel from area to area. Do not violate this privilege by chasing or harassing wildlife. Fatigue and exhaustion can lead to animal's death. Avoid areas posted for the protection or feeding of wildlife.

If you happen to be fortunate enough to see an animal, stop your snowmobile and observe quietly.

The guidelines that we support are not designed to limit your snowmobiling fun, but to preserve the beautiful freedom that you can experience only on a snowmobile! These guidelines will keep snowmobilers healthy, happy and able to introduce others to what they know and enjoy about their favorite winter pastime. So, the next time you hit the trails on a cool, crisp and clear winter day, we ask you to remember that you are paving the way for the future of our sport. Help us lead it down the right path! From all of us at BRP, thank you for doing your share.

There is nothing more exhilarating than snowmobiling. Venturing onto snowmobile trails that criss-cross the wild areas of the U.S. and Canada is an exciting and healthy winter sport. However, as the number of people using these recreational parks increases, so does the potential for damage to the environment. Abuse of land, facilities and resources inevitably leads to restrictions and closures of both private and public land.

In essence, the greatest threat to our sport, is all around us. Which leaves us with one logical choice. When we snowmobile, we must always ride responsibly.

The vast majority respect the law and the environment. Each of us must set an example for those who are new to the sport, young and old alike.

It is in every one's best interest to tread lightly into our recreational areas. Because, in the long run, to protect the sport we must preserve the environment.

Recognizing the importance of this issue and the need for snowmobilers to do their share in preserving areas that make it possible to enjoy our sport, BRP has developed the "Light Treading Is Smart Sledding" campaign for snowmobilers.

Light Treading refers to more than the tread of our tracks. It's a statement of concern, respect and willingness to take the lead and take action. It applies to the environment in general, its proper care and maintenance, its natural inhabitants and all enthusiasts and the public at large who enjoy the great outdoors. With this theme, we invite all snowmobilers to remember that respecting the environment is not only critical to the future of our industry but to future generations.

Light Treading in no way suggests you should curb your appetite for snowmobiling fun! It simply means tread with respect!

JUST WHAT IS LIGHT TREADING?

The fundamental objective of Light Treading is one of respect for where and how you ride a snowmobile. You're a light treader when you follow the principles below.

Become informed. Obtain maps, regulations and other information from the Forest Service or from other public land agencies. Learn the rules and follow them and that goes for speed limits, too!

Avoid running over young trees, shrubs, and grasses and don't cut wood. On flatlands or areas where trail riding is popular, it's important to ride only where authorized. Remember, there is a link between protecting your environment and your own safety.

Respect wildlife and be particularly sensitive of animals that are rearing young or suffering from food shortage. Stress can sap scarce energy reserves. Refrain from riding in areas where only animals are intended to tread!

Obey gate closures and regulatory signs and remember, light treaders don't litter!

Stay out of wilderness areas. They're closed to all vehicles. Know where the boundaries are.

Obtain permission to travel across private land. Respect the rights of landowners and other people's privacy. Remember, snowmobile technology has lowered the noise factor considerably, but you still shouldn't rev your engines where quiet "is the order of the day".

WHY IS LIGHT TREADING SMART

Snowmobilers know all too well the efforts that have been made throughout the sport's history to enjoy access to areas where people can snowmobile safely and responsibly. This effort continues today, as strong as ever.

Respecting the areas where we ride... wherever they may be... is the only way to ensure their future enjoyment. That's one major reason why we know you'll agree that Light Treading Is Smart Sledding! And there are more.

Enjoying the opportunity to see winter and all its natural majestic wonders, is an experience cherished by snowmobilers. Light Treading will preserve this opportunity and will make it possible for us to expose others to the beauty of winter and the unique thrill of our sport! Light Treading will help our sport to grow!

Finally, Light Treading is the sign of a smart snowmobiler. You don't have to leave big tracks or careen through a virgin forest to show you can ride. So whether you're driving a high performance Ski-Doo, a sporty MX-Z snowmobile or any other make or model, show you know what you're doing. Show you know how to send snow flying and make tracks with a light touch!

VEHICLE INFORMATION

HOW TO IDENTIFY YOUR SNOWMOBILE

Vehicle Description Decal

Vehicle description decal is located on right hand side of tunnel.



TYPICAL

1. Vehicle description decal

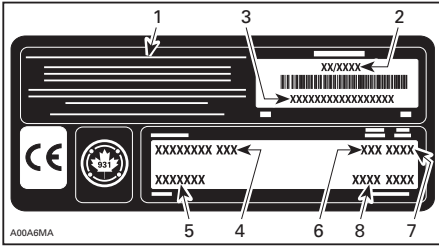

VEHICLE DESCRIPTION DECAL

1. Manufacturer name
2. Manufacturing date
3. Vehicle identification number (VIN)
4. Model name
5. Option package
6. Engine type
7. Model year
8. Color codes

Serial Numbers

The main components of your snowmobile (engine and frame) are identified by different serial numbers. It may sometimes become necessary to locate these numbers for warranty purposes or to trace your snowmobile in the event of loss. These numbers are required by the authorized SKI-DOO dealer to complete warranty claims properly. No warranty will be allowed by BRP if the engine serial number or vehicle identification number (VIN) is removed or mutilated in any way. We strongly recommend that you take note of all the serial numbers on your snowmobile and supply them to your insurance company.

Vehicle Identification Number (VIN) Location

VIN is scribed on vehicle description decal. See above. It is also engraved on tunnel near vehicle description decal.

Model Number Location

Model number is part of vehicle identification number (VIN).

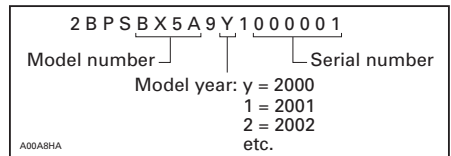

VIN DESCRIPTION

Engine Serial Number Location

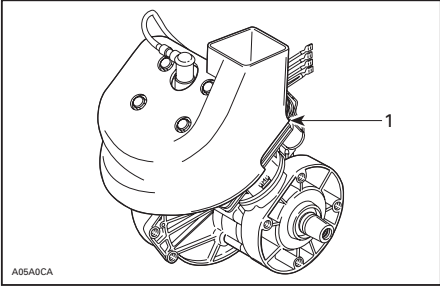

A05A0CA

TYPICAL

1. *Engine serial number*

CONTROLS/INSTRUMENTS/EQUIPMENT

NOTE: Some controls/instruments/equipment do not apply or are optional on some models. In these cases their reference numbers are deliberately missing in the illustrations.

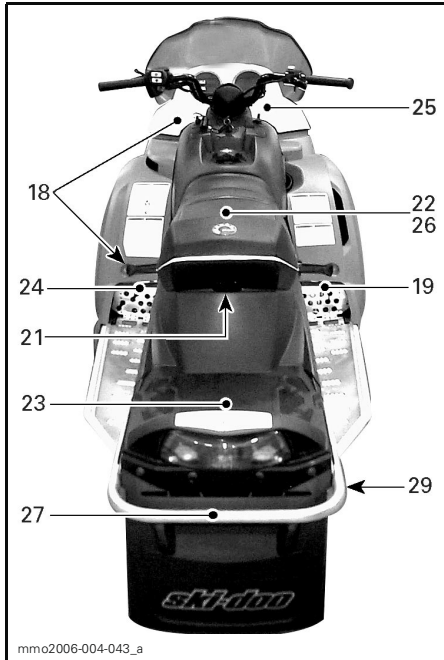

TYPICAL

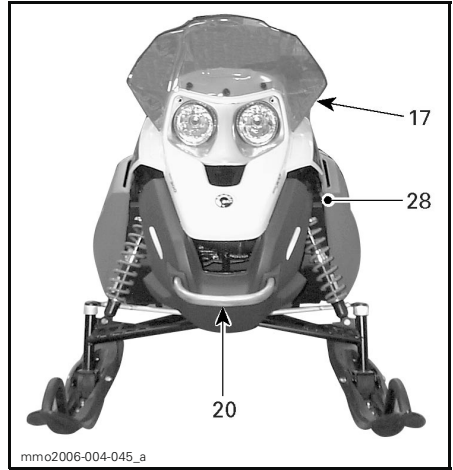

TYPICAL

1) Speedometer

European Models Only

These models are equipped with an electronic speedometer. It may show speed in km/h or MPH.

NOTE: At vehicle speed of 90 km/h (55 MPH) and more, the multifunction display will show speed only instead of the selected mode.

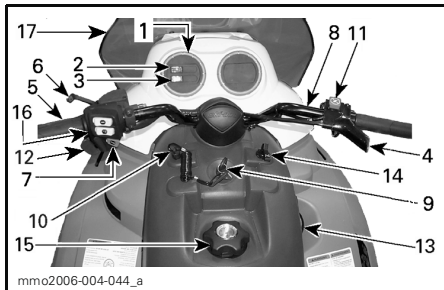

TYPICAL

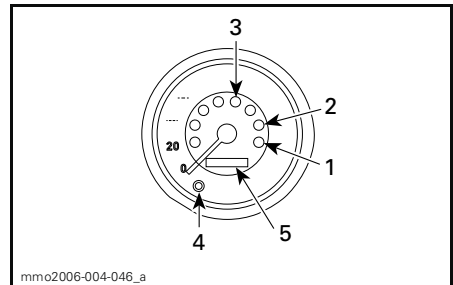

1. Brake/parking brake pilot lamp (red)
2. Reverse pilot lamp
3. High beam pilot lamp (blue)
4. Mode Button
5. Multifunction display

Brake/Parking Brake Pilot Lamp (Red)

Lights when brake or parking brake is applied (with engine running).

Reverse Pilot Lamp (Red)

This pilot lamp will light up when reverse is selected.

High Beam Pilot Lamp (Blue)

Lights when headlamp is on HIGH beam.

Mode Button

Depress mode button to change multifunction display. Each time engine is started, display shows odometer. From that point depressing mode button will change display for the trip meter.

Depressing mode button again will change display for the resettable hourmeter. Push mode button again to return to odometer.

Push and hold mode button for 2 seconds to reset the tripmeter or the resettable hourmeter depending on the one displayed.

Multifunction Display

Odometer

Odometer records the total distance travelled and displays it either in miles or kilometers. Refer to UNIT MODIFICATION (KM/H VS MPH) for changing units.

Trip Meter

Records distance travelled since it has been reset. Distance travelled is displayed either in miles or kilometers. Refer to UNIT MODIFICATION (KM/H VS MPH) for changing units.

Resettable Hourmeter

Records engine running time in hours and minutes since it has been reset.

Push and hold mode button for 2 seconds to reset the hourmeter.

Multifunction Display Code

If your speedometer shows **SCALE** in the multi-function display, it means that the display selector button is stuck in the down position or depressed when the electrical system was activated.

Unit Modification (KM/H vs MPH)

NOTE: Speedometer, odometer and trip meter will have their units (kilometer or miles) changed all together.

Stop engine.

Open LH and RH side panels.

Unplug hood harness.

Open hood.

Underneath hood, look for:

- 1 circuit male connector housing with BLACK/GREY wire
- 1 circuit female connector housing with YELLOW/BLACK wire.

Plug connectors together to change units from miles to kilometers.

Unplug to return to miles reading.

2) Reverse Pilot Lamp (Red)

Canada/U.S. Models

This pilot lamp will light up when reverse is selected.

3) High Beam Pilot Lamp (Blue)

Canada/U.S. Models

Lights when headlamp is on HIGH beam.

4) Throttle Lever

Located on the right hand side of handlebar and designed to be thumb activated. When squeezed, it increases the engine speed and engages the transmission. When released, engine speed returns automatically to idle.

WARNING

Test the throttle lever operation each time before starting the engine. The lever must return to its original position once released. Otherwise, do not start engine.

5) Brake Lever

Located on the left hand side of handlebar. When squeezed, the brake is applied. When released, it automatically returns to its original position. Braking effect is proportional to the pressure applied on the lever and to the type of terrain and its snow coverage.

6) Parking Brake Lever

Located on left hand side of handlebar. Parking brake should be used whenever snowmobile is parked.

Whenever parking brake is applied and engine is running, injection oil level/parking brake pilot lamp lights up to remind you that it is engaged.

WARNING

Make sure parking brake is fully disengaged before operating the snowmobile. When you ride the vehicle, brake pads that are caused to drag by a continuous pressure on the lever may cause damage to the brake system and cause loss of braking capacity and/or fire.

To Engage Mechanism

Squeeze brake lever and maintain while pulling locking lever with a finger. When brake lever is held at halfway the parking brake should be fully applied.

NOTE: Locking lever can be adjusted in two different positions.

To Release Mechanism

Squeeze brake lever. Locking lever will automatically return to its original position. Always release parking brake before riding.

7) RER Button

General

When the engine is running, depressing the RER button will command the engine to reverse crankshaft rotation as driving the snowmobile in reverse is achieved by changing the direction of rotation of the engine, not by shifting the chaincase in reverse gear.

When depressing the RER button, the electronic module will practically slow down the engine RPM to a stop and advance the ignition timing to cause crankshaft rotation reversing.

Engine will automatically shift into forward when starting after stopping or stalling.

Shifting procedure will take place only when the engine is running.

If engine is running at a speed above 4300 RPM, the reverse function of the RER button is cancelled.

It is recommended to warm up the engine to its normal operating temperature before shifting.

Shifting in Reverse

WARNING

Shifting to reverse mode on these snowmobiles is done by depressing the RER button when the engine is running. Wait until the reverse alarm sounds and the RER pilot lamp comes on in the dash before operating throttle to proceed in reverse. The reverse speed of these snowmobiles is not limited. Always proceed with caution as fast reverse could result in loss of vehicle stability. Come to complete stop before depressing RER button. Always remain seated and apply the brake before shifting. Ensure the path behind is clear of obstacles or bystanders before proceeding.

With the snowmobile completely stopped and engine running at idle, press and release the RER button.

The RER™ pilot lamp will blink and a warning buzzer will sound once every second with a half a second duration when the snowmobile is engaged in reverse.

Apply throttle slowly and evenly. Allow drive pulley to engage then accelerate carefully.

Shifting in Forward

With the snowmobile completely stopped and engine running at idle, press and release the RER button.

RER pilot lamp and warning buzzer will stop.

Apply throttle slowly and evenly. Allow drive pulley to engage then accelerate carefully.

8) Handlebar

The handlebar controls the steering of the snowmobile. As the handlebar is rotated to right or left, the skis are turned right or left to steer the snowmobile.

WARNING

Fast reverse while turning, could result in loss of stability and control.

9) Ignition Switch

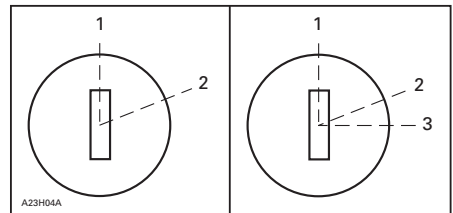

MANUAL START/ELECTRIC START MODELS

1. OFF
2. ON
3. START

Manual Starting

To start the engine, first turn the key to ON position then, pull rewind starter grip. To stop the engine, turn the key to OFF position.

Electric Starting

To start engine, turn key to START position and hold until engine has started. See illustration above.

CAUTION: Do not use electric starter for more than 10 seconds. A rest period should be observed between the cranking cycles to let electric starter cool down. Using electric starter when engine has started could damage electric starter mechanism.

Release key as soon as the engine starts. Key returns to ON position as soon as it is released.

If engine does not start on first try, turn key back to OFF position and wait a few seconds before restarting. To stop engine, turn key to OFF position.

NOTE: Engine may be manually started with rewind starter if necessary.

If starter does not operate, check starting system fuse condition. Refer to FUSES.

10) Tether Cut-Out Switch

General

When the tether cord cap is removed, it shuts the engine off preventing snowmobile to runaway if the operator falls off the vehicle accidentally.

WARNING

Always remove tether cord cap and key when vehicle is not in operation in order to prevent accidental engine starting, to avoid unauthorized use by children or others or theft.

Operation

Attach tether cord eyelet to clothing, then snap tether cord cap over post before starting engine.

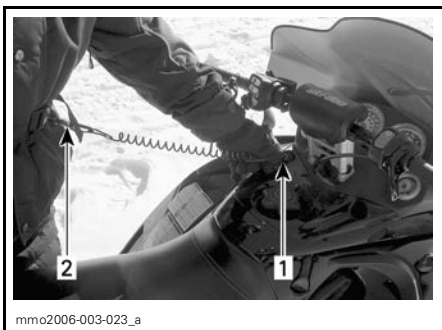

TYPICAL

1. Snap over post
2. Attach to eyelet

If emergency engine shut off is required, completely pull tether cord cap from post.

11) Engine Cut-Out Switch

This push-pull type switch is located on the right hand side of the handlebar. To stop the engine in an emergency, select OFF position and simultaneously apply the brake. To restart, button must be at the ON position.

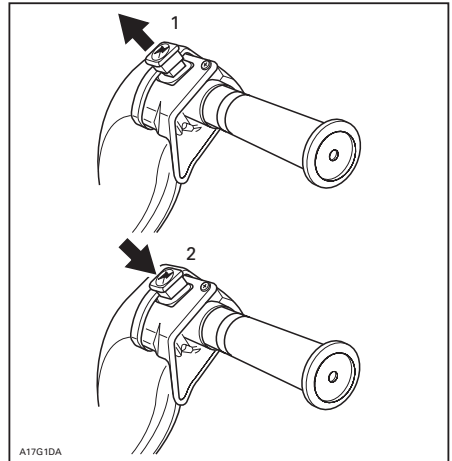

TYPICAL

1. ON
2. OFF

All operators of the snowmobile should familiarize themselves with the function of this device by using it several times on first outing and whenever stopping the engine thereafter. This engine cut-out procedure will become a reflex and will prepare operators for emergency situations requiring its use.

WARNING

If the switch has been used in an emergency caused by a suspected malfunction, the source of the malfunction should be determined and corrected before restarting engine. See an authorized SKI-DOO dealer for servicing.

12) Headlamp Dimmer Switch

Located on left hand side of handlebar, allows selection of headlamp beam. Note that lights are automatically ON whenever the engine is running.

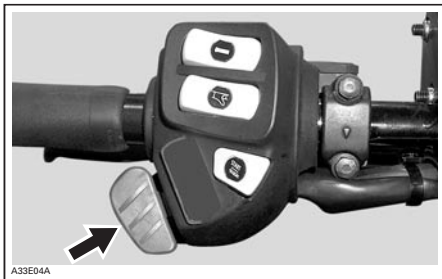

TYPICAL

13) Rewind Starter Handle

Auto-rewind type located on right hand side of snowmobile. To engage mechanism, pull handle slowly until a resistance is felt then pull vigorously. Slowly release handle.

14) Choke Lever

This device features a 3-position lever to facilitate cold start.

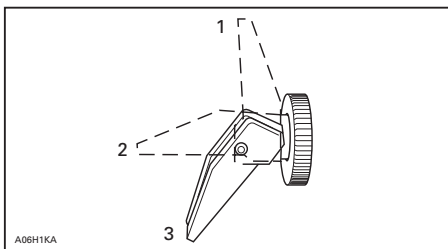

1. OFF
2. Position 2
3. Position 3

Initial Cold Starting

NOTE: Do not operate the throttle lever with the choke lever on.

Move the choke lever to position 3 and start the engine. As soon as the engine starts move the lever to position 2. After a few seconds (10 seconds maximum) move the choke lever to OFF.

NOTE: In severe cold weather, colder than -20°C (-4°F) you may need to flip choke lever from OFF to position 1 a couple of times once engine is started.

Warm Engine Starting

Start the engine without any choke. If the engine will not start after two pulls of the rope or two 5 second attempts with the electric starter move choke lever to position 2. Start the engine without activating the throttle lever. As soon as the engine starts move the choke lever to OFF.

15) Fuel Tank Cap/Gauge

Unscrew to fill up tank then fully tighten.

Fuel tank cap features a mechanical gauge.

WARNING

Always stop the engine before refueling. Fuel is flammable and explosive under certain conditions. Always work in a well ventilated area. Do not smoke or allow open flames or sparks in the vicinity. Open cap slowly. If a differential pressure condition is noticed (whistling sound heard when loosening fuel tank cap) have vehicle inspected and/or repaired before further operation. Do not overfill or top off the fuel tank before placing the vehicle in a warm area. As temperature increases, fuel expands and might overflow. Always wipe off any fuel spillage from the vehicle. Periodically verify fuel system.

NOTE: Do not sit or lean on seat when fuel tank cap is not properly installed.

16) Heating Grip/Throttle Lever Switch

It is a three-position switch. Select the desired position to keep your hands at a comfortable temperature.

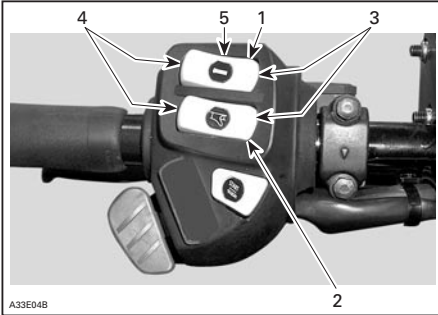

TYPICAL

1. Heating grip switch
2. Heating throttle lever switch
3. Hot
4. Warm
5. Off

17) Windshield

Windshield provides operator comfort, as well as protection by deflecting wind and snow away from the operator.

18) Hood and Side Panel Latches

Side Panels Latch

To open a side panel, stretch and unhook the latch.



TYPICAL

1. Latch

To remove a side panel remove by pulling up both locking devices from hinge.

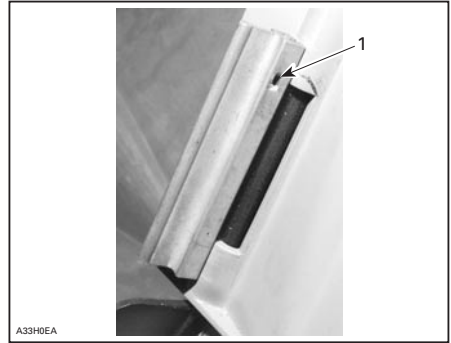

1. Locking device

Hood Latches

To open hood, open side panels first to have access to hood latches, refer to procedure above.

Unplug hood harness.

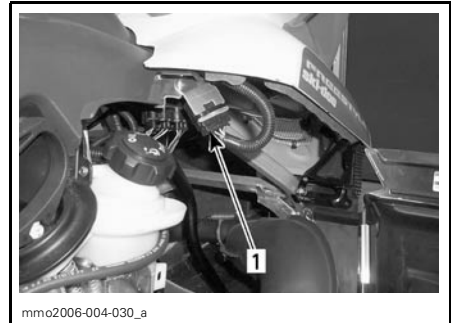

RH SIDE OF VEHICLE

1. Hood harness

Stretch and unhook the hood latches.

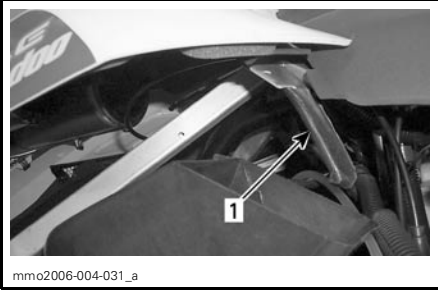

TYPICAL ON BOTH SIDES
1. Latch

To remove hood, lift hood in a vertical position then pull to remove.



HOOD REMOVAL

19) Fuses

To remove fuse from holder, pull fuse out. Check if filament is melted.

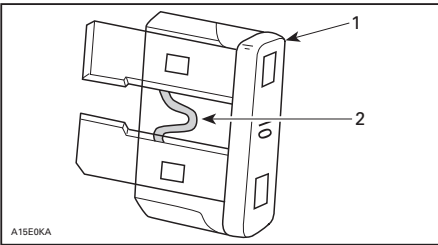

1. Fuse
2. Check if melted

CAUTION: Do not use a higher rated fuse as this can cause severe damage to electric components and/or fire.

WARNING

If fuse has burnt out, source of malfunction should be determined and corrected before restarting. See an authorized SKI-DOO dealer for servicing.

Ground Protection Fuse

Electric Start Models

Ground wire is protected with a 30 ampere rated fuse. See following illustration for fuse holder location. Check fuse condition and replace it if necessary.

CAUTION: This fuse should always be disconnected before doing any maintenance under the hood. This is to prevent any unexpected electrical activation.



1. Ground wire protection fuse

Accessories Fuse

Accessories are protected with 30 ampere rated fuse. See following illustration for fuse holder location. If any of the accessories stops functioning, check fuse condition and replace it if necessary.

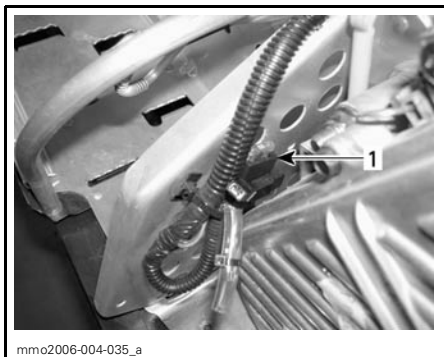

MANUAL START MODELS

1. Accessories fuse



ELECTRICAL START MODELS

1. Accessories fuse

20) Front Grab Handle/Front Bumper

To be used whenever front of snowmobile requires manual lifting.

WARNING

Do not attempt to lift the vehicle by hand alone. Use appropriate lifting device or have assistance to share lifting stress in order to avoid risk of strain injuries.



1. Front grab handle

CAUTION: Do not use skis to pull or lift snowmobile.

21) Seat Latch

Located underneath the rear end of seat. It allows the removal of seat to give access to storage compartment.



1. Seat latch

Seat Removal

Push latch while gently lifting rear of seat. Pull seat rearward. Continue lifting movement until you can release the front retaining device then completely remove seat.

Seat Installation

Insert front tabs of seat into frame hook. When seat rests in its position, firmly push seat down to latch.

NOTE: A distinctive snap will be felt. Double check that the seat is secure by giving it a tug to confirm proper latching.

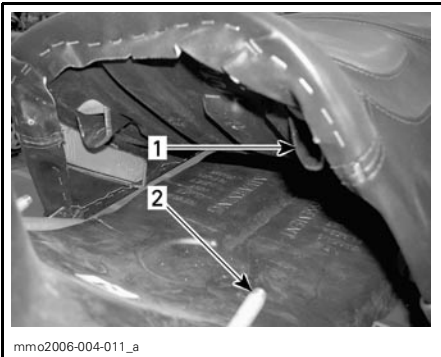

1. Insert these tabs in hooks
2. Hooks

⚠ WARNING

Make sure seat is securely latched before riding.

22) Storage Compartment

⚠ WARNING

Storage compartment must be properly latched and must not contain any heavy or breakable objects.

Storage compartment is located underneath the seat.

For seat removal refer to procedure above.



STORAGE COMPARTMENT

23) Rear Rack

⚠ WARNING

All objects in rear rack must be properly latched. Do not carry any breakable objects. Excessive weight in rack may reduce steering ability.

CAUTION: Always readjust suspension according to the load. The capacity of this rack is limited. Ride at very low speed when loaded. Avoid speed over bumps.

24) Tool Kit

A tool kit containing tools for basic maintenance is supplied with the vehicle.

Tool bag is located in engine compartment above left hand side toehold.

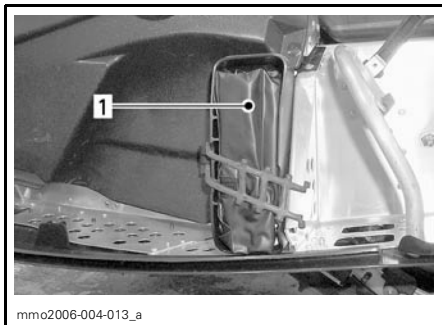

1. Tool kit

25) Spark Plug Holder

To keep spare spark plugs dry and prevent shocks that might affect the adjustment or break them, a holder is provided in engine compartment.

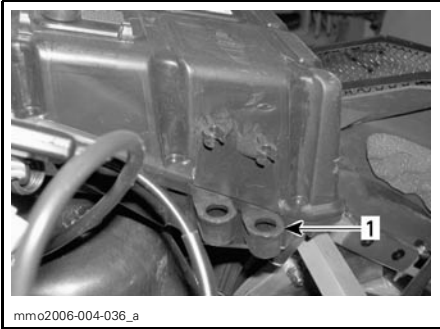

SPARK PLUG HOLDER ON AIR INTAKE SILENCER (BODY SIDE)

1. Spare spark plugs holder

NOTE: Spare spark plugs are not supplied with snowmobile.

NOTE: Check spare spark plug gap according to SPECIFICATIONS before installation.

26) Spare Drive Belt Compartment

A spare drive belt can be stored in storage compartment under seat.

NOTE: Spare drive belt is not supplied with the snowmobile.

27) Hitch

The hitch can be used to pull most equipment. Use a rigid tow bar.

28) Shields and Guards

WARNING

Never operate engine without belt guard securely installed or, with hood or access/side panels open or removed.

Your snowmobile is provided with a number of shields and guards. Leave these in place on your vehicle as they are designed to keep clothing and hands out of moving parts and away from hot components. Never attempt to make adjustments to any moving part while the engine is running.

29) Track

Depending on the model of snowmobile that you own, your vehicle may come with a track for which the manufacturer permits the installation of studs, or a track for which the manufacturer forbids it. Tracks approved for the installation of studs have a stud symbol (see illustration) molded into the track surface, and tracks not approved bear a forbidden stud symbol (see illustration). Before proceeding to the installation of studs on tracks for which it is allowed, you must first acquaint yourself with the safety instructions related to the studding of tracks, found in the section entitled TRACTION ENHANCING PRODUCTS in the SAFETY INFORMATION section at the beginning of this guide. This section also provides other important information that you must consider before having studs installed on a track.

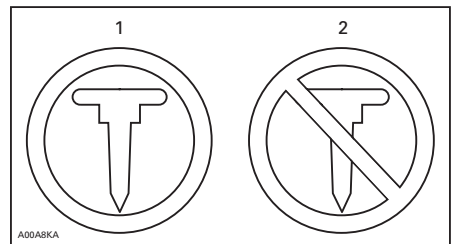

TRACK SYMBOLS

1. Approved
2. NOT approved

Generally, snowmobiles adapted for mountain riding comes with tracks equipped with high lug profiles. These tracks are optimized for operation on loose snow. Running those tracks on hard packed surfaces put more stress on the lugs, which tend to heat up as a result. Avoid riding a snowmobile equipped with a high lug profiles track in a trail or on hard surfaces for an extended period of time to avoid potential degradation or damage to the track.

For general instructions on maintenance of tracks, refer to the sections TRACK CONDITION and TRACK TENSION AND ALIGNMENT in the MAINTENANCE section of this guide.

RECOMMENDED FUEL AND OIL

Recommended Fuel

Use regular unleaded gasoline, available from most service stations or oxygenated fuel containing a maximum total of 10% of ethanol or methanol or both. The gasoline used must have the following recommended minimum octane number.

LOCATION	OCTANE NUMBER
Inside North America	87 octane (RON + MON)/2
Outside North America	91 RON

CAUTION: Never experiment with other fuels or fuel ratios. The use of unrecommended fuel can result in snowmobile performance deterioration and damage to critical parts in the fuel system and engine components. Do not mistake oil reservoir cap for fuel tank cap. Oil reservoir cap is identified OIL.

WARNING

Always stop the engine before refueling. Fuel is flammable and explosive under certain conditions. Always work in a well ventilated area. Do not smoke or allow open flames or sparks in the vicinity. Open cap slowly. If a differential pressure condition is noticed (whistling sound heard when loosening fuel tank cap) have vehicle inspected and/or repaired before further operation. Do not overfill or top off the fuel tank before placing the vehicle in a warm area. As temperature increases, fuel expands and might overflow. Always wipe off any fuel spillage from the vehicle. Periodically verify fuel system.

Fuel System Antifreeze

When using oxygenated fuel, additional gas line antifreeze or water absorbing additives are not required and should be not used.

When using non-oxygenated fuel, we highly recommend the use of isopropyl base gas line antifreeze in a proportion of 150 mL (5 U.S. oz) of gas line antifreeze added to 40 liters (10-1/2 U.S. gal) of gas.

This precaution is in order to reduce the risk of frost buildup in carburetor(s) which may lead, in certain cases, to high fuel consumption or severe damage to engine.

NOTE: Use only methyl hydrate free gas line antifreeze.

Recommended Oil

CAUTION: Use only injection oil that flows at - 40°C (- 40°F). Do not mismatch oil reservoir cap with fuel tank cap. Oil reservoir cap is identified OIL.

Oil is contained in the injection oil reservoir.

Use only two-stroke engine injection oil sold by authorized SKI-DOO dealers.

OIL TYPE
XP-S™ mineral injection oil (1)

(1) If XP-S™ Mineral Injection Oil is not available, API TC high-quality low ash two-stroke injection oil may be used.

XP-S™ mineral injection oil is a special blend of basic oil and additives especially selected to ensure unequalled lubrication, engine cleanliness and minimum spark plug fouling.

CAUTION: Never use four-stroke petroleum or synthetic motor oil and never mix these with outboard motor oil. Do not use NMMA TC-W, TC-W2 or TC-W3 outboard two-stroke engine oils or ashless two-stroke engine oils. Avoid mixing different brands of API TC oil as resulting chemical reactions may cause severe engine damage.

Always maintain a sufficient amount of recommended oil in the injection oil reservoir.

CAUTION: Check level and refill every time you refuel. Do not mismatch oil reservoir cap with fuel tank cap. Install cap that is identified OIL.

 **WARNING**

Do not overfill. Reinstall cap and fully tighten. Wipe off any oil spills. Oil is highly flammable.

BREAK-IN PERIOD

Engine

CAUTION: A break-in period of 10 operating hours — 500 km (300 miles) — is required before running the snowmobile at full throttle.

During break-in period, maximum throttle should not exceed 3/4. However, brief full acceleration and speed variations contribute to a good break-in.

CAUTION: Engine overheating, continued wide open throttle runs and prolonged cruising without speed variations should be avoided, this can cause engine damage during the break-in period.

To assure additional protection during the initial engine break-in, 500 mL (18 imp. oz) of recommended injection oil should be added to fuel for the first full filling of fuel tank. Have spark plugs cleaned after engine break-in.

Belt

A new drive belt requires a break-in period of 50 km (30 miles). Avoid strong acceleration/deceleration, pulling a load or high speed cruising.

10-Hour Inspection

NOTE: The 10-hour inspection is at the expense of the snowmobile owner.

As with any precision piece of mechanical equipment, we suggest that after the first 10 hours of operation — 500 km (300 miles) — or 30 days after the purchase, whichever comes first, your snowmobile be checked by an authorized SKI-DOO dealer. This inspection will also give you the opportunity to discuss the unanswered questions you may have encountered during the first hours of operation.

OPERATING INSTRUCTIONS

Pre-Operation Check

WARNING

The pre-operation check is very important prior to operating the vehicle. Always check the proper operation of critical controls, safety features and mechanical components before starting. If not done as specified here, severe injury or death might occur.

- Remove snow and ice from body including seat, footrests, controls and instruments.
- Lights — The headlamp, the taillight and the brake light are standard equipment. Be sure lights are clear of dirt, slush or snow and are in good working order or condition.
- Verify that track and idler wheels are free to turn and not frozen.

WARNING

Always use a wide base snowmobile mechanical stand to properly support vehicle during any track verification. Slowly accelerate engine in order to rotate track at very low speed when it is not on ground.

- Activate the brake control lever and make sure the brake fully applies before the brake control lever touches the handlebar grip. It must fully return when released.
- Check the parking device. Apply parking brake and check if it operates properly.
- Activate the throttle control lever several times to check that it operates easily and smoothly.

WARNING

Throttle lever must operate easily and smoothly. It must return to idle position when released.

- Check operation of tether and engine cutout switches, ignition switch, headlamp switch (HI-LO), taillight, brake light and pilot lamps.
- Verify that skis and steering operate freely. Check corresponding action of skis versus handlebar.
- Check fuel and oil for levels and leaks. Replenish as necessary and see an authorized SKI-DOO dealer in case of any leaks.
- Verify that air filter(s) is free of snow, if so equipped.
- All storage compartments must be properly latched and they must not contain any heavy or breakable objects. Hood must be also properly latched.

WARNING

All adjustable features should be positioned at optimal setting. Securely tighten all adjustment locks.

- Make certain your snowmobile is pointed away from people or objects before you start it. No one is to be standing in front of or in back of the snowmobile.
- Be warmly dressed with clothing designed for snowmobiling.

PRE-OPERATION CHECK LIST

ITEM	OPERATION	✓
Body including seat, footrests, lights, controls and instruments	Check that there is no snow or ice.	
Track and idler wheels	Check for free movement.	
Brake lever	Check proper action.	
Parking device	Check proper action.	
Throttle lever	Check proper action.	
Switches and lights	Check proper action. Tether cord must be attached to driver clothing eyelet.	
Skis and steering	Check for free movement and proper action.	
Fuel and oil	Check for proper level and leaks.	
Air filter	Check that there is no snow or ice.	
Adjustable features	Check for optimal adjustment and securely tightened adjustment locks.	
Storage compartment	Check for proper latching and no heavy or breakable objects.	
Vehicle vicinity	Snowmobile must be pointed away from people or objects. No one is to be standing in front of or in back of the snowmobile.	
Clothing	Be warmly dressed with clothing designed for snowmobiling.	

Engine Starting Procedure

Procedure

- Recheck throttle control lever operation.
- Ensure that the tether cord cap is in position and that the cord is attached to your clothing eyelet.
- Ensure that the engine cutout switch is in the ON position.
- Turn ignition key to ON position.
- Activate the choke according to the temperature as explained below.

Choke Application

Initial Cold Starting When Temperature is Below - 10°C (+ 15°F)

NOTE: Do not operate the throttle lever with the choke lever on.

Set the choke lever to position 3.

NOTE: After the engine is started, let engine warm up at fast idle until engine speed drops. Then, close off choke to ensure proper air-fuel mixture.

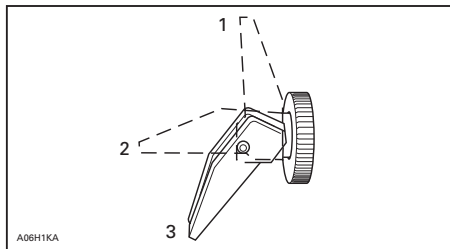

1. OFF
2. Position 2
3. Position 3

Initial Cold Starting When Temperature is Above - 10°C (above + 15°F)

Set the choke lever to position 2.

NOTE: After the engine is started, close off choke to ensure proper air-fuel mixture.

Warm Engine Starting

Start the engine without any choke. If the engine will not start after two pulls of the rope or two 5 second attempts with the electric starter move choke lever to position 2. Start the engine without activating the throttle lever. As soon as the engine starts move the choke lever to OFF.

Procedure (cont'd)

Manual Starting

- Grab manual starter handle, pull handle slowly until a resistance is felt, then hold handle firmly and pull vigorously to start engine.

Electric Starting (if so equipped)

 **WARNING**
Never depress throttle while starting engine.

CAUTION: Do not use electric starter for more than 10 seconds. A rest period should be observed between the cranking cycles to let electric starter cool down. Using electric starter when engine has started could damage electric starter mechanism.

- Turn key clockwise until starter engages.
- Release key immediately when engine has started.

NOTE: If for any reason, the engine cannot be cranked electrically, leave ignition key to ON position and start engine manually using the rewind starter.

Vehicle Warm-Up

Before every ride, vehicle has to be warmed up as follows.

Snowmobile must be securely supported by the rear bumper using a wide-base snowmobile mechanical stand. Track must be 100 mm (4 in) off the ground.

Attach tether cord to operator's clothing eyelet.

Start engine and allow it to warm up two or three minutes at idle speed.

Release parking brake.

 **WARNING**
Make sure wide-base snowmobile mechanical stand is stable. Stay clear of the front of vehicle and the track. Do not use too much throttle during warm-up or when track is free-hanging.

Apply throttle until drive pulley engages. Let track rotate at low speed for several turns. The lower the vehicle temperature is the longer vehicle warm-up should be.

Shut-off the engine and remove the wide-base snowmobile mechanical stand.

Skis may be frozen on the ground. Grab both skis one at a time by their loops and lift their front end slightly off the ground.

After restarting engine, the vehicle can be driven at low speed for the first 2 or 3 minutes of riding. After that, it may be driven up to the legal speed limit as per normal safety practices.

Shutting Off the Engine

Release throttle lever and wait until engine has returned to idle speed.

Shut off the engine using either ignition switch, engine cut-out switch or tether cut-out switch.

WARNING

Always remove tether cord cap and key when vehicle is not in operation in order to prevent accidental engine starting or to avoid unauthorized use by children or others or theft.

Post-Operation Care

Shut off the engine. Install rear of vehicle on a wide-base snowmobile mechanical stand.

Remove snow and ice from rear suspension, track, front suspension, steering mechanism and skis.

Always cover your snowmobile when leaving it overnight or during extended periods of inactivity. This will protect it from freezing as well as retain its appearance.

Suspension Adjustments

Snowmobile handling and comfort depend upon suspension adjustments.

For factory recommended adjustments refer to decal inside LH side panel. It describes settings for optimum comfort according to load for your SKI-DOO model.

Choice of suspension adjustments vary with carrying load, driver's weight, personal preference, riding speed and field condition.

NOTE: Some adjustments may not apply to your snowmobile. Use special keys in tool kit.

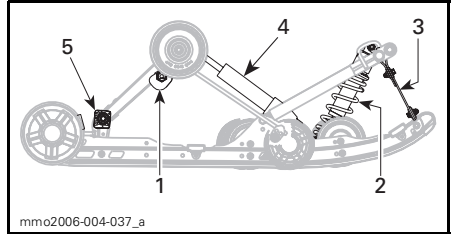

TYPICAL — FREESTYLE

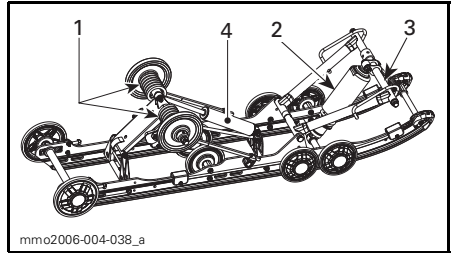

TYPICAL — TUNDRA

1. Rear springs adjustable cams for comfort and ride height
2. Center spring for steering behavior
3. Stopper strap for snowmobile weight transfer
4. Rear shock motion ratio — Damping strength (not adjustable)
5. Coupling blocks — Handling (Freestyle only)
6. Front springs for handling (not adjustable on all models) (not shown)

Following are guidelines to fine-tune suspension.

The best way to set up the suspension, is to start from factory settings, then customize each adjustment one at a time. Adjustments 2 through 6 are interrelated. It may be necessary to readjust center spring after adjusting front springs for instance. Test run the snowmobile under the same conditions; trail, speed, snow, driver riding position, etc. Change one adjustment and retest. Proceed methodically until you are satisfied.

⚠ WARNING

Always remove tether cord cap before performing any maintenance or adjustment, unless otherwise specified. Vehicle must be parked in a safe place, away from the trail. Always lift the front of vehicle off the ground with a suitable lifting device before adjusting ski suspension. Lift the rear of vehicle off the ground with a wide-base snowmobile stand with a rear deflector panel before rear suspension adjustment.

⚠ WARNING

Do not attempt to lift the vehicle by hand alone. Use appropriate lifting device to avoid risk of strain injuries. Always make sure the lifting device is stable and secure before proceeding to adjust the suspension components.

CAUTION: Whenever adjusting rear suspension, check track tension and adjust as necessary.

Slight suspension bottoming occurring under the worst riding conditions indicates a good choice of spring preload.

NOTE: Some models may come from factory equipped with Take/Apart (T/A) shocks. These can be rebuilt or recalibrated. See an authorized SKI-DOO dealer.

Rear Springs — Comfort

IMPORTANT: Make sure that all objects to be transported are in place in storage compartment and rear rack.

- Grab rear bumper and lift until suspension is fully extended.
- From this point, rear of snowmobile should collapse by 50 to 75 mm (2 to 3 in) when driver and passenger (if so applicable) take place. Measure at rear bumper as shown in next photo.

⚠ WARNING

Do not attempt to lift the vehicle by hand alone. Use appropriate lifting device or have assistance to share lifting stress in order to avoid risk of strain injuries.

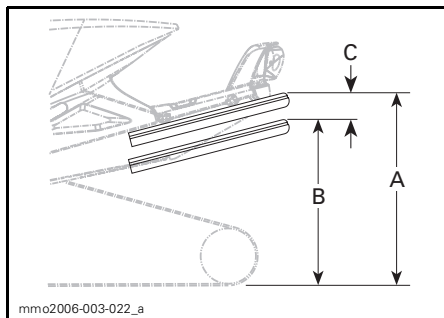

TYPICAL — PROPER ADJUSTMENT

- A. Suspension fully extended
- B. Suspension has collapsed with driver, passenger(s) and load added
- C. Distance between dimension A and B, must not exceed 50 to 75 mm (2 to 3 in), see table

REAR SPRINGS ADJUSTMENT

"C"	CAUSE	SOLUTION
50 to 75 mm (2 to 3 in)	No adjustment required	
More than 75 mm (3 in)	Too soft of adjustment	Increase preload
Less than 50 mm (2 in)	Too hard of adjustment	Decrease preload

Preload Adjustment

NOTE: Left and right adjustment cams may be at different settings.

CAM POSITIONS	SPRING PRELOAD
1	Minimum
2	Minimum/Intermediate
3	Intermediate/Maximum
4	Maximum

CAUTION: To increase preload, always turn the left side adjustment cam in a clockwise direction, and the right side cam in a counterclockwise direction.

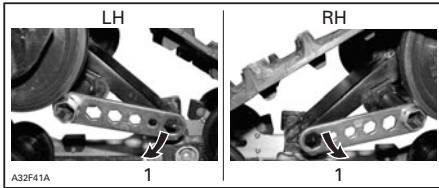

TYPICAL

1. Increase spring preload

CAUTION: To decrease preload, always turn the left side adjustment cam in a counterclockwise direction, the right side cam in a clockwise direction.

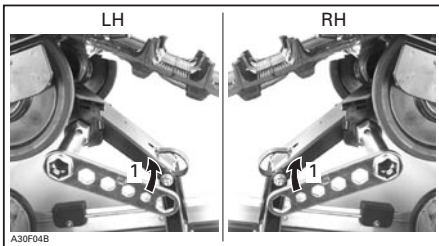

TYPICAL

1. Decrease spring preload

Center Spring — Steering Behavior

- Ride at moderate speed on a trail.
- If handlebar is felt too easy or too hard to turn, adjust center spring accordingly.

⚠ WARNING

Before proceeding with any suspension adjustment, remember:

- park in a safe place
- remove tether cord cap
- lift rear of vehicle off the ground with a wide-base snowmobile stand with a rear deflector panel
- make sure lifting device is stable and secure.

CENTER SPRING ADJUSTMENT		
HANDLEBAR (steering attitude)	PROBLEM	SOLUTION
Easy to turn (neutral)	No adjustment required	
Harder to turn (oversteering)	Too soft of adjustment	Increase preload
Very easy to turn (understeering)	Too hard of adjustment	Decrease preload

Preload Adjustment

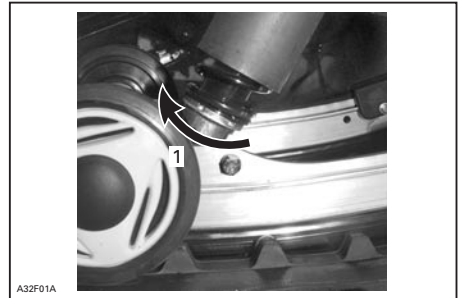

TYPICAL

1. Use adjuster wrench provided in tool kit to increase or decrease preload

Stopper Strap — Weight Transfer

- Ride at low speed then fully accelerate.
- Note steering behavior.
- Adjust stopper strap length accordingly.

⚠ WARNING

Before proceeding with any suspension adjustment, remember:

- park in a safe place
- remove tether cord cap
- lift rear of vehicle off the ground with suitable lifting device
- make sure lifting device is stable and secure.

CAUTION: Whenever stopper strap length is changed, track tension must be readjusted.

STOPPER STRAP			
WEIGHT TRANSFER		ADJUSTMENTS	
Steering	Track (skis)	Problem	Solution
Comfortable	Good weight transfer (light pressure)	No adjustment required	
Light	Too much weight transfer (lift off the ground)	Too long strap	Reduce strap length
Heavy	Not enough weight transfer (heavy pressure)	Too short strap	Increase strap length

Strap Adjustment

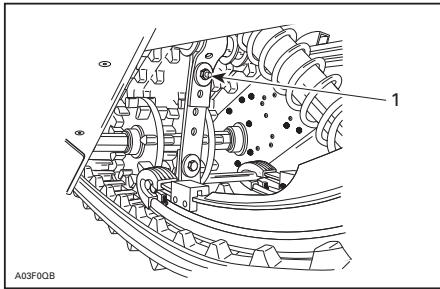

TYPICAL

1. Increase or decrease strap length by bolting to a different hole

Coupling Blocks — Handling

Freestyle Models Only

- Ride at moderate speed and check for desired handling.
- If handling requires adjustment, turn both left and right blocks by 90° to the desired position.

NOTE: There are four possible adjustment positions. Side of block with the desired adjustment number must be facing the rubber stopper.

WARNING

Both blocks must be set at the same position. Otherwise vehicle behavior may be unpredictable and suspension may become warped.

Use tool provided in tool bag to adjust coupling blocks.

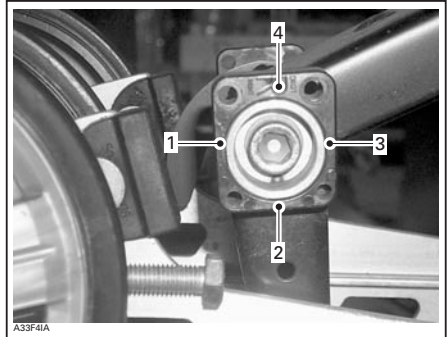

COUPLING BLOCK — RIGHT SIDE VIEW
("R" — RIGHT EMBOSSED ON BLOCK)

1. Position 1 (minimum)
2. Position 2 (minimum/intermediate)
3. Position 3 (intermediate/maximum)
4. Position 4 (maximum)

Front Springs — Handling

Front shock springs are not adjustable on those models.

SUSPENSION TROUBLESHOOTING CHART	
Problem	Corrective measures
Front suspension wandering	<ul style="list-style-type: none">– Check ski alignment and camber angle adjustment. See an authorized SKI-DOO dealer.– Reduce ski ground pressure.• Increase center spring preload.• Reduce rear spring preload.
Snowmobile seems unstable and seems to pivot around its center	<ul style="list-style-type: none">– Reduce rear suspension front arm pressure.• Reduce center spring preload.• Increase rear spring preload.
Steering feels too heavy	<ul style="list-style-type: none">– Reduce ski ground pressure.• Increase center spring preload.
Rear of snowmobile seems too stiff	<ul style="list-style-type: none">– Reduce rear spring preload.
Rear of snowmobile seems too soft	<ul style="list-style-type: none">– Increase rear spring preload.
Rear suspension front shock absorber is frequently bottoming	<ul style="list-style-type: none">– Lengthen stopper strap.– Increase center spring preload.
Track spins too much at start	<ul style="list-style-type: none">– Lengthen stopper strap.– Move thicker part of coupling block downward.

In Deep Snow

When operating the snowmobile in deep snow, it may be necessary to vary stopper strap length and/or riding position, to change the angle at which the track rides on the snow. Operator's familiarity with the various adjustments as well as snow conditions will dictate the most efficient combination.

SPECIAL OPERATING INSTRUCTIONS

Riding at High Altitudes or Sea Level

CAUTION: Failure to re-calibrate may cause serious engine damage.

Those models are calibrated for SEA LEVEL operation.

Operating above 600 m (2000 ft) requires parts and adjustments.

Refer to an authorized SKI-DOO dealer for proper calibration modifications.

Riding in Cold Weather

All vehicles have been calibrated for - 20°C (- 4°F). They can be operated at warmer winter temperatures without problems.

CAUTION: For colder temperatures than - 20°C (- 4°F), carburetor(s) must be recalibrated to avoid engine damage. Refer to an authorized SKI-DOO dealer.

Refer also to RIDING AT HIGH ALTITUDES OR SEA LEVEL in previous pages.

Emergency Starting

The engine can be started with the emergency starter rope supplied with the tool kit.

Remove belt guard.

⚠ WARNING

Do not wind starting rope around your hand. Hold rope by the handle only. Do not start the snowmobile by the drive pulley unless it is a true emergency situation. Have the snowmobile repaired as soon as possible.

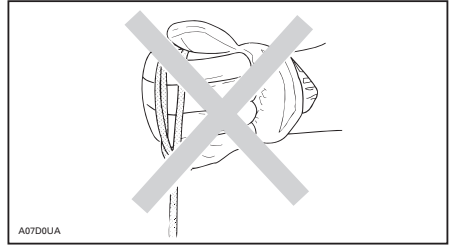

Attach one end of emergency rope to rewind handle.

NOTE: The spark plug socket can be used as an emergency handle.

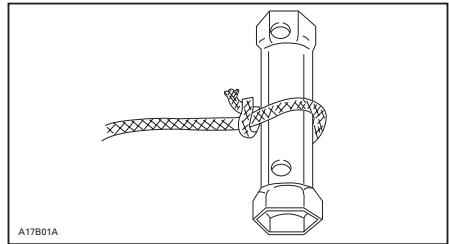

TYPICAL

Attach the other end of emergency rope to the starter clip supplied in the tool kit.

Hook up clip on drive pulley.

Wind the rope tightly around drive pulley. When pulled, pulley must rotate counterclockwise.

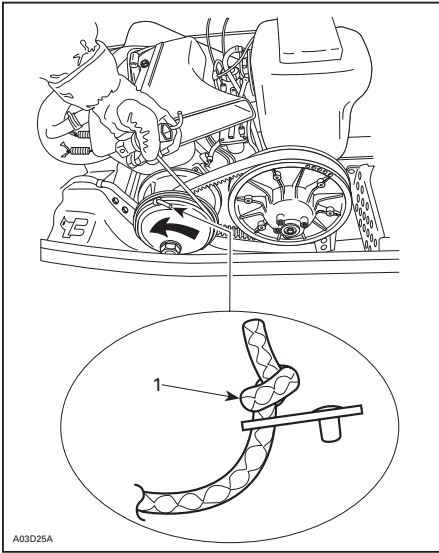

TYPICAL
1. Knot on this side

Pull the rope using a sharp, crisp pull so the rope comes free of the drive pulley.

Start engine as per usual manual starting.

⚠ WARNING

When starting the snowmobile in an emergency situation, using drive pulley, do not reinstall the belt guard and return slowly to have snowmobile repaired.

Towing an Accessory

Always use a rigid towbar to tow an accessory. Any towed accessory should have reflectors on both sides and at the rear. Check local laws for brake lights requirements.

⚠ WARNING

Never tow an accessory with a rope. Always use a rigid towbar. Using a rope would result in a collision between the object and the snowmobile and possibly in a tip over in case of a rapid deceleration or on a downward slope.

Towing Another Snowmobile

If a snowmobile is disabled and must be towed use a rigid towbar, remove the drive belt and tow at moderate speed.

CAUTION: Always remove the drive belt of the snowmobile that is to be towed to prevent damage to its belt and drive system.

In an emergency situation only, if a rigid towbar is not available, a rope can be used provided you proceed with extra caution.

Remove the drive belt, attach the rope to the ski legs (spindles), have someone sit on the towed snowmobile to activate the brake, and tow at low speed.

CAUTION: In order to prevent damage to the steering system, never attach the tow rope to the ski loops (handles).

⚠ WARNING

Never ride at high speed when towing a disabled snowmobile. Proceed slowly with extra caution.

Transporting the Vehicle

Make sure that oil reservoir and fuel tank caps are properly installed.

Tilt bed trailers can easily be equipped with a winch mechanism to afford maximum safety in loading. Simple as it may seem, never drive your snowmobile onto a tilt bed trailer or any other kind of trailer or vehicle. Many serious accidents have resulted from driving up and over a trailer. Anchor your vehicle securely, front and rear, even on short hauls. Be certain all equipment is securely fastened. Cover your snowmobile when trailering to prevent road grime from causing damage.

Be certain your trailer meets state or provincial requirement. Ensure the hitch and safety chains are secure and the brake, turn indicators and clearance lights all function.

TROUBLESHOOTING

1 LONG BEEP PER SECOND.

1. Reverse is selected.

- *Vehicle can be driven in reverse.*

BATTERY PILOT LAMP LIGHTS UP.

1. No charging.

- *Check battery and charging system.*

ENGINE IS CRANKED BUT FAILS TO START.

1. Ignition switch or engine cut-out switch in OFF position or tether cord cap away from post.

- *Place engine cut-out switch in the ON position and install tether cord cap on post.*

2. Mixture not rich enough to start cold engine.

- *Check fuel tank level and check starting procedure, particularly use of the choke.*

3. Flooded engine (spark plug wet when removed).

- *Do not choke. Remove wet spark plug, turn ignition switch to OFF and crank engine several times. Install clean dry spark plug.*
- *Start engine following usual starting procedure. If engine continues to flood, see an authorized SKI-DOO dealer.*

4. No fuel to the engine (spark plug dry when removed).

- *Check fuel tank level; turn fuel valve on if applicable; check fuel filter; replace if clogged; check condition of fuel and impulse lines and their connections. A failure of the fuel pump or carburetor has occurred. Contact an authorized SKI-DOO dealer.*

5. Spark plug/ignition (no spark).

- *Remove spark plug(s) then reconnect to spark cap. Check that engine cut-out switch is at the ON position and the tether cut-out cord cap is snapped over the receptacle.*
- *Start engine with spark plug(s) grounded to engine away from spark plug hole. If no spark appears, replace spark plug. If trouble persists, contact an authorized SKI-DOO dealer.*

6. Engine compression.

- *As the engine is pulled over with the rewind starter, "cycles" of resistance should be felt as piston goes past top dead center (each piston on multi-cylinder engines).*
- *If no pulsating resistance is felt, it suggests a major loss of compression. Contact an authorized SKI-DOO dealer.*

ENGINE LACKS ACCELERATION OR POWER.

1. Fouled or defective spark plug.

- *Check item 5 of ENGINE TURNS OVER BUT FAILS TO START.*

ENGINE LACKS ACCELERATION OR POWER. (cont'd)

2. Lack of fuel to engine.

- *Check item 4 of ENGINE TURNS OVER BUT FAILS TO START.*

3. Carburetor adjustments.

- *Contact an authorized SKI-DOO dealer.*

4. Drive belt worn too thin.

- *If the drive belt has lost more than 3 mm (1/8 in) of its original width, it will affect vehicle performance.*
- *Replace drive belt.*

5. Drive and driven pulleys require servicing.

- *Contact an authorized SKI-DOO dealer.*

ENGINE BACKFIRES.

1. Faulty spark plug (carbon accumulation).

- *See item 5 of ENGINE TURNS OVER BUT FAILS TO START.*

2. Engine is running too hot.

- *See item 6 of ENGINE LACKS ACCELERATION OR POWER.*

3. Ignition timing is incorrect or there is an ignition system failure.

- *Contact an authorized SKI-DOO dealer.*

ENGINE MISFIRES.

1. Fouled/defective/worn spark plugs.

- *Clean/verify spark plug gap and identification number. Replace as required.*

2. Too much oil supplied to engine.

- *Improper oil pump adjustment, refer to an authorized SKI-DOO dealer.*
- *On premixed models only, improper fuel/oil mixture. Drain fuel tank and refill with appropriate mixture ratio.*

3. Water in fuel.

- *Drain fuel system and refill with fresh fuel.*

SNOWMOBILE CANNOT REACH FULL SPEED.

1. Drive belt.

- *Check item 6 of ENGINE LACKS ACCELERATION OR POWER.*

2. Incorrect track adjustment.

- *See MAINTENANCE and/or an authorized SKI-DOO dealer for proper alignment and tension adjustments.*

3. Pulleys misaligned.

- *Contact an authorized SKI-DOO dealer.*

4. Engine.

- *See items 1 to 5 of ENGINE LACKS ACCELERATION OR POWER.*

SPECIFICATIONS

NOTE: Because of its ongoing commitment to product quality and innovation, BRP reserves the right, at any time, to make changes in design and specifications and/or to make additions to, or improvements in its products without imposing any obligation upon itself to install them on its products previously manufactured.

		TUNDRA	FREESTYLE
Engine System			
Engine type	Rotax 380, fan-cooled w/piston porting		
Cylinders	1		
Displacement	cc (in ³)	268.7 (16.4)	
Bore	mm (in)	72 (2.8)	
Stroke	mm (in)	66 (2.6)	
Maximum engine speed	7000 RPM		
Carburetion	1 x VM-34		
Exhaust system	Tuned muffler		
Drive System			
Drive pulley type	Bombardier Lite		
Driven pulley type	RF		
Engagement	3000 RPM		
Small sprocket number of teeth	15		
Large sprocket number of teeth	45		
Drive sprocket number of teeth	9		
Brake system	Hydraulic caliper, self adjusting		
Track nominal width	381 mm (15 in)		
Track nominal length	Freestyle	3074 mm (121 in)	
	Tundra	3456 mm (136 in)	
Track profile height	18.4 mm (0.72 in)		
Track adjustment	Deflection	35-40 mm (1-3/8 - 1-9/16 in)	
	Force ⁽¹⁾	7.3 kg (16 lb)	
Track alignment	Equal distance between edges of track guides and slider shoes		

		TUNDRA	FREESTYLE
Suspension			
Front suspension		Single A-Arm	
Front suspension max. travel		160 mm (6.3 in)	
Rear suspension		SC-136	SC-4
Rear suspension max. travel		381 mm (15 in)	
Electrical			
Lightning system output		340 Watts	
Headlamp bulb HI/LOW beam		2 x 60/55 Watts (H-4)	
Spark plug	Type	NGK BR9ES	
	Gap	0.45 ± 0.05 mm (.018 ± .002 in)	
Dimensions			
Vehicle overall length		3025 mm (119.1 in)	2845 mm (112 in)
Vehicle overall width		1000 mm (39.4 in)	970 mm (38.2 in)
Vehicle overall height		1300 mm (51.2 in)	1170 mm (46.1 in)
Official dry weight		169 kg (375 lb)	167 kg (370 lb)
Ski stance		817 mm (32.2 in)	
Ski overall length		1033 mm (40.7 in)	1000 mm (39.4 in)
Ski width		172 mm (6.8 in)	140 mm (5.5 in)
Liquids			
Recommended fuel type		Regular unleaded	
Minimum octane	Inside North America	87 (RON + MON)/2	
	Outside North America	91 RON	
Recommended oil (engine)		XP-S mineral injection oil	
Brake system fluid		SRF (DOT 4) or GTLMA (DOT 4)	
Oil type (chaincase/transmission)		XP-S synthetic chaincase oil	
Capacities			
Fuel tank	L (U.S. gal)	34 (9)	
Oil tank	L (U.S. oz)	3.5 (118)	
(1) Measure gap between slider shoe and bottom inside track when exerting a downward pull to the track.			

MAINTENANCE INFORMATION

PERIODIC MAINTENANCE CHART

WARNING

It is recommended that the assistance of an authorized SKI-DOO dealer be periodically obtained on other components/systems not covered in this guide. Unless otherwise specified, engine must be cold and not running. Remove tether cord cap before performing any maintenance or adjustment, unless otherwise specified. Vehicle must be parked in a safe place, away from the trail.

WARNING

Observe WARNINGS and CAUTIONS mentioned throughout this guide which are relevant to the item being checked. When component conditions seem less than satisfactory, replace with genuine BRP parts or approved equivalents.

Some items may not apply to your particular model. Refer to MAINTENANCE in Shop Manual for more details.

A: ADJUST C: CLEAN I: INSPECT L: LUBRICATE R: REPLACE T: PROCEED WITH TASK *: TO BE PERFORMED BY AN AUTHORIZED SKI-DOO DEALER	*10-HOUR OR 500 KM (300 mi)						
	WEEKLY OR EVERY 240 KM (150 mi)						
	MONTHLY OR EVERY 800 KM (500 mi)						
	ONCE A YEAR OR EVERY 3200 KM (2000 mi)						
	ONCE A YEAR OR EVERY 6000 KM (3700 mi)						
	*STORAGE						
	*PRESEASON						
PART/TASK							LEGEND
ENGINE							
Rewind starter and rope					I,L,C	I	
Engine motor mounts	I			I		I	
Exhaust system	I		I			I	
Engine lubrication						L	
Injection oil filter			I			R	
Oil injection pump	A			A			A

A: ADJUST C: CLEAN I: INSPECT L: LUBRICATE R: REPLACE T: PROCEED WITH TASK *: TO BE PERFORMED BY AN AUTHORIZED SKI-DOO DEALER	*10-HOUR OR 500 KM (300 mi)												
	WEEKLY OR EVERY 240 KM (150 mi)												
	MONTHLY OR EVERY 800 KM (500 mi)												
	ONCE A YEAR OR EVERY 3200 KM (2000 mi)												
	ONCE A YEAR OR EVERY 6000 KM (3700 mi)												
	*STORAGE												
*PRESEASON													
PART/TASK							LEGEND						

FUEL SYSTEM

Add fuel stabilizer							T	
Fuel filter								R
Fuel lines	I							I
Carburetor	A			A				A,C
Throttle cable	I			I				I
Air filter			C					C
Fuel injection system (visual inspection)							T	

DRIVE SYSTEM

Drive belt	I	I						I	
Drive and driven pulleys	I		I	C			I	C	
Tightening torque of drive pulley screw	I			I				I	
Driven pulley preload	I			I				I	
Brake fluid	I	I					R	I	
Brake hose, pads and disk	I	I						I	
Drive chain tension	A		A				A		
Countershaft lubrication ⁽²⁾	T		T				T		
Chaincase oil	I		I				R	I	
Drive axle end bearing ⁽²⁾	L		L				L		
Track	I		I				I		
Track tension and alignment	A		AS REQUIRED						

(2) Lubricate whenever the vehicle is used in wet conditions (wet snow, rain, puddles)

A: ADJUST C: CLEAN I: INSPECT L: LUBRICATE R: REPLACE T: PROCEED WITH TASK *: TO BE PERFORMED BY AN AUTHORIZED SKI-DOO DEALER	*10-HOUR OR 500 KM (300 mi)													
	WEEKLY OR EVERY 240 KM (150 mi)													
	MONTHLY OR EVERY 800 KM (500 mi)													
	ONCE A YEAR OR EVERY 3200 KM (2000 mi)													
	ONCE A YEAR OR EVERY 6000 KM (3700 mi)													
	*STORAGE													
*PRESEASON														
PART/TASK						LEGEND								
STEERING/FRONT SUSPENSION														
Steering and front suspension mechanism ⁽²⁾			I,L		I	L		I,L					(2) Lubricate whenever the vehicle is used in wet conditions (wet snow, rain, puddles)	
Wear and condition of skis and runners			I	I				I						
SUSPENSION														
Suspension adjustments			A		AS REQUIRED									
Suspension ⁽²⁾			I		I,L			I,L						
Suspension stopper strap						I		I						
ELECTRICAL SYSTEM														
Spark plugs ⁽¹⁾			I		I							R	(1) Before installing new spark plugs at preseason preparation, it is suggested to burn excess storage oil by starting the engine with the old spark plugs. Only perform this operation in a well ventilated area.	
Battery (if so equipped)			I		I			I				I		
Wiring harnesses, cables and lines			I		I			I						
Operation of lighting system (hi/lo beam, brake light, etc.), test operation of engine cut-out switch and tether cut-out switch			I	I				I						
VEHICLE														
Headlamp beam aiming						A						A		
Rags in air intake and exhaust system								T				T		
Engine compartment			C		C			C						
Vehicle cleaning and protection			C		C			C						

ENGINE SYSTEM

Air Filter Cleaning



LH SIDE — AIR FILTER LOCATION
1. Air filter



1. Removal of filter from its grill

Check that the air silencer is clean and dry and properly reinstall the filter.

CAUTION: Snowmobile engines have been calibrated with the filters installed. Operating the snowmobile without them may cause engine damage.

Exhaust System

The tail pipe of the muffler should be centered with the exit hole in the bottom pan. Exhaust system must be free of rust or leaks. Make sure that gear clamps are properly tightened.

The exhaust system is designed to reduce noise and to improve the total performance of the engine. Modification may be in violation of local laws.

CAUTION: If any exhaust system component is removed, modified or damaged, severe engine damage may result.

Oil Injection System

Always maintain a sufficient amount of recommended injection oil in the injection oil reservoir.

CAUTION: Never allow oil reservoir to be almost empty. Do not mismatch oil reservoir cap with fuel tank cap. Install cap that is identified OIL.

WARNING

Check level and refill every time you refuel. Be careful not to overfill. Wipe off any spillage. Oil is highly flammable when heated.

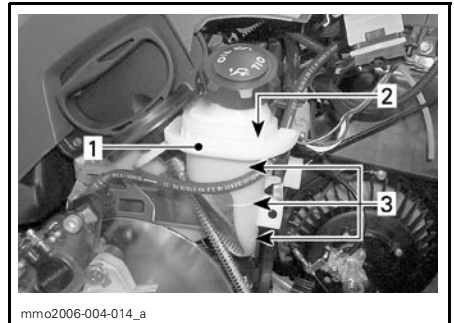

TYPICAL

1. Injection oil reservoir
2. Maximum level indicator: 13 mm (1/2 in) from top
3. Level marks (1/4, 1/2, 3/4)

DRIVE SYSTEM

Belt Guard Removal and Installation

WARNING

NEVER operate engine:

- without shields and belt guard securely installed
 - with hood opened or removed.
- NEVER attempt to make adjustments to moving parts while engine is running.

NOTE: Belt guard is purposely made slightly oversize to maintain tension on its pins and retainers preventing undue noise and vibration. It is important that this tension be maintained when reinstalling.

- Remove tether cord cap.
- Open engine compartment.
- Open retainer to release pin then pull belt guard out of vehicle.

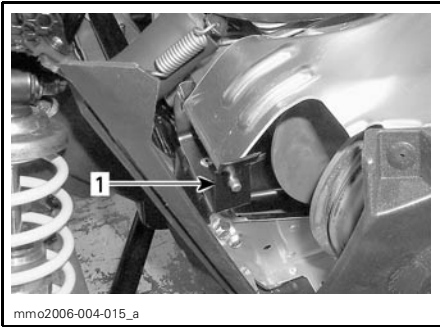

TYPICAL
1. Pin retainer

When reinstalling belt guard, position its cutaway toward front of snowmobile. Refer to decal in belt guard.

Place belt guard slots over tabs first, then snap the other end in retainer.



TYPICAL
1. Slots

Brake Fluid Level

CAUTION: Vehicle must be on a level surface before checking any fluid levels.

Check brake fluid (DOT 4) in reservoir for proper level. Add fluid (DOT 4) as required.

CAUTION: Use only DOT 4 brake fluid from a sealed container. Never use any other types of fluid.



1. Brake fluid reservoir

Brake Condition

WARNING

The brake mechanism on your snowmobile is an essential safety device. Keep this mechanism in proper working condition. Above all, do not operate the snowmobile without an effective brake system. Periodically verify the condition/wear of the brake pads.

Brake Adjustment

No adjustment is provided for hydraulic brake. See an authorized SKI-DOO dealer if any problems.

Chaincase Oil Level

CAUTION: Vehicle must be on a level surface before checking any fluid levels.

With snowmobile on a level surface, check the oil level by removing dipstick. Oil level must be between lower and upper marks.

NOTE: It is normal to find metallic particles stuck to dipstick magnet. If bigger pieces of metal are found, see an authorized SKI-DOO dealer.

Remove metal particles from magnet.

Refill up to upper mark using recommended oil, refer to SPECIFICATIONS.

CAUTION: Do not use other un-recommended types of oil when servicing. Do not mix synthetic oil with other types of oil.

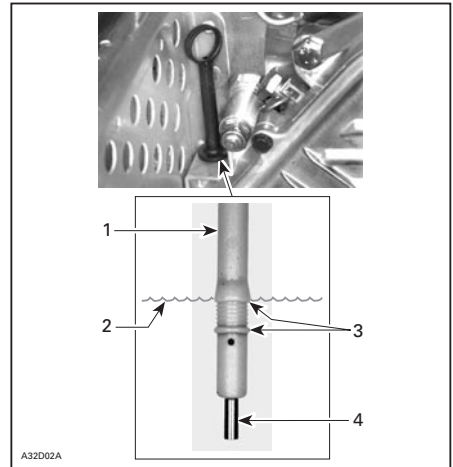

TYPICAL

1. Dipstick
2. Oil level
3. Level between marks
4. Magnet

Drive Chain Tension

Remove hair pin.

Fully tighten tensioner adjustment screw by hand, then back off only far enough for hair pin to engage in locking hole.

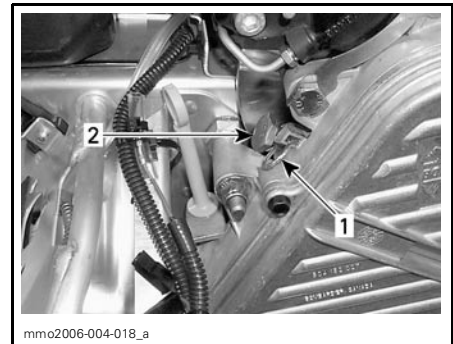

TYPICAL

1. Hair pin
2. Adjustment screw

Drive Belt Condition

Inspect belt for cracks, fraying or abnormal wear (uneven wear, wear on one side, missing cogs, cracked fabric). If abnormal wear is noted, probable cause could be pulley misalignment, excessive RPM with frozen track, fast starts without warm-up period, burred or rusty sheave, oil on belt or distorted spare belt. Contact an authorized SKI-DOO dealer.

Check the drive belt width. Replace the drive belt if width is less than the minimum width recommended in SPECIFICATIONS.

Drive Belt Removal/Installation

WARNING

Remove tether cord cap before performing any maintenance or adjustment, unless otherwise specified. Vehicle must be parked in a safe place, away from the trail.

Removal

NOTE: Removal and installation of drive belt is easier when driven pulley is held with brake so that it can not rotate. Apply parking brake, for this purpose.

Remove tether cord cap. Open engine compartment and remove belt guard.

Open the driven pulley with the drive belt installer/remover provided in tool bag.

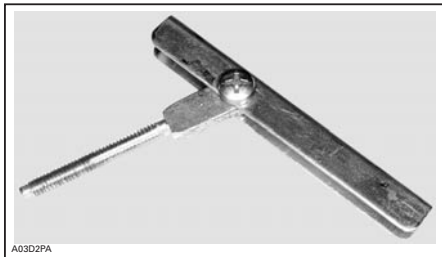

DRIVE BELT INSTALLER/REMOVER

Screw drive belt installer/remover in the free threaded hole and tighten to open the pulley. Remove belt.

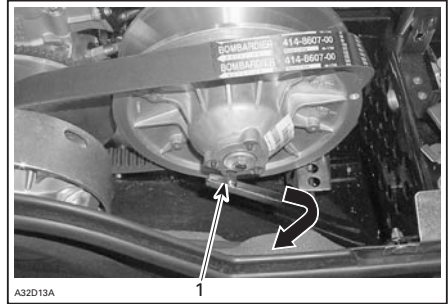

TYPICAL

1. Tighten to open pulley

Slip the belt over the top edge of the sliding half of driven pulley, as shown in previous photo.

Slip belt under drive pulley then, remove it from vehicle.

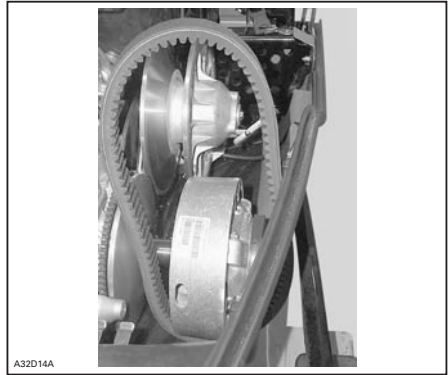

TYPICAL

Clean sheaves of both pulleys using Pulley flange cleaner (P/N 413 711 809).

Installation

To install the drive belt, reverse the removal procedure, however pay attention to the following:

The maximum drive belt life span is obtained when the belt has the proper rotation direction. See arrow on belt.

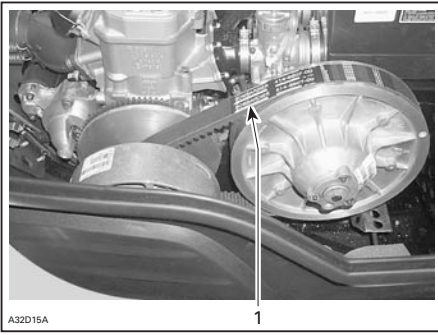

TYPICAL

1. Arrow pointing front of vehicle

CAUTION: Do not force or use tools to pry the belt into place, as this could cut or break the cords in the belt.

To install the drive belt, first place belt between drive pulley sheaves. Then, between driven pulley sheaves, finishing with bottom.

Remove drive belt installer/remover. Reinstall belt guard.

Close engine compartment.

Track Condition

⚠ WARNING

Remove tether cord cap before performing any maintenance or adjustment, unless otherwise specified. Vehicle must be parked in a safe place, away from the trail.

Remove tether cord cap.

Lift the rear of the snowmobile and support it with a wide-base snowmobile mechanical stand with a rear deflector panel. With the engine off, rotate the track by hand, and inspect condition. If worn or cut, or if track fibers are exposed, or if missing or defective inserts or guides are noted; contact an authorized SKI-DOO dealer.

Studded Tracks

If the track of your snowmobile is studded, **PROCEED WITH A VISUAL INSPECTION OF YOUR TRACK BEFORE EACH USE.**

Look for any defects, such as:

- perforations in the track
- tears in the track (particularly around traction holes)
- lugs that are broken or torn off, exposing portions of rods
- delamination of the rubber
- broken rods
- broken studs
- bent studs
- studs that are torn off the track
- missing track guide(s).

Replace broken or damaged studs immediately. If your track shows signs of deterioration, it must be replaced immediately. When in doubt, ask your dealer. Always follow the inspections schedule given in the PERIODIC MAINTENANCE CHART.

⚠ WARNING

Riding with a damaged track or studs could lead to a loss of control, resulting in a risk of serious injury or death.

For a complete information on studs, please refer to the section entitled TRACTION ENHANCING PRODUCTS in the SAFETY INFORMATION section at the beginning of this Operator's Guide.

Track Tension and Alignment

NOTE: Track tension and alignment are interrelated. Do not adjust one without the other.

WARNING

To prevent serious injury to individuals near the snowmobile:

- NEVER stand behind or near a moving track
- always use a wide-base snowmobile stand with a rear deflector panel
- when the track is raised off the ground, only run it at the lowest possible speed.

Centrifugal force could cause debris, damaged or loose studs, pieces of torn track, or an entire severed track to be violently thrown backwards out of the tunnel with tremendous force, possibly resulting in the loss of a leg or other serious injury.

Tension

NOTE: Ride the snowmobile in snow about 15 to 20 minutes prior to adjusting track tension.

Remove the tether cord cap.

Lift rear of snowmobile and support it with a wide-base snowmobile mechanical stand.

Allow the suspension to extend normally and check gap halfway between front and rear idler wheels. Measure between slider shoe bottom and inside of track. The gap should be as given in SPECIFICATIONS in this guide. If the track tension is too loose, track will have a tendency to thump.

NOTE: A belt tension tester (P/N 414 348 200) may be used to measure deflection as well as force applied.

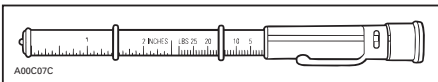

BELT TENSION TESTER

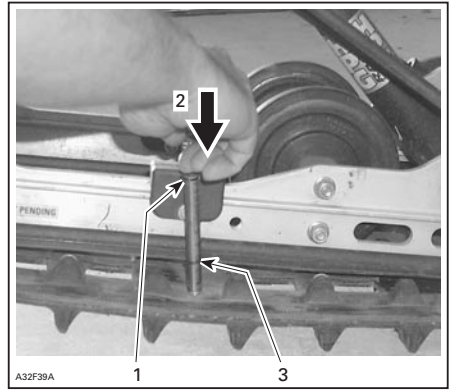

TYPICAL

1. Top tool O-ring positioned at 7.3 kg (16 lb)
2. Push on top portion of tool until it contacts the top O-ring
3. Measured track deflection

CAUTION: Too much tension will result in power loss and excessive stresses on suspension components.

To adjust track tension:

- Remove the tether cord cap.
- On some models, remove rear wheel caps.
- Loosen the rear idler wheel retaining screws.
- Turn adjustment screws to adjust.

If correct tension is unattainable, contact an authorized SKI-DOO dealer.

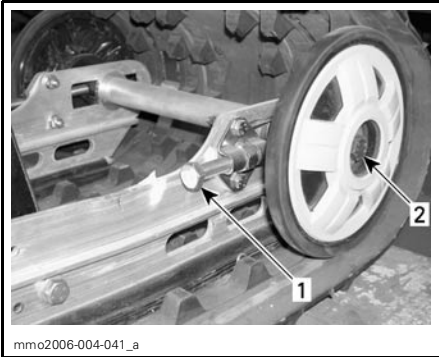

TYPICAL — SC-136

1. Adjustment screw
2. Loosen screw

- Retighten retaining screws and lock nuts (on so equipped models).
- Check track alignment as described below.

Alignment

⚠ WARNING

Before checking track alignment, ensure that the track is free of all particles which could be thrown out while track is rotating. Keep hands, tools, feet and clothing clear of track. Always lift the snowmobile on a wide-base stand with a rear deflector panel. Ensure no one is standing in close proximity to the snowmobile, especially at the rear of the track. Never rotate track at high speed. Centrifugal force could cause debris, damaged or loose studs, pieces of torn track, or an entire severed track to be violently thrown backwards out of the tunnel with tremendous force, possibly resulting in the loss of a leg or other serious injury.

Start the engine and accelerate slightly so that track barely turns. This must be done in a short period of time (15 to 20 seconds).

Check that the track is well centered; equal distance on both sides between edges of track guides and slider shoes.

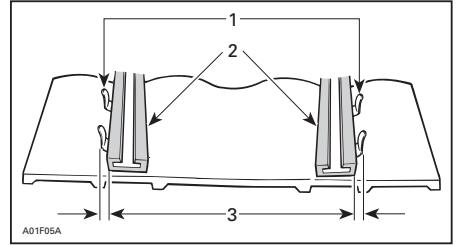

1. Guides
2. Slider shoes
3. Equal distance

To Adjust Track Alignment:

⚠ WARNING

Remove tether cord cap before performing any maintenance or adjustment, unless otherwise specified. Vehicle must be parked in a safe place, away from the trail.

- Remove the tether cord cap.
- Loosen rear idler wheel retaining screws.
- Loosen the lock nuts (on so equipped models).
- Tighten the adjustment screw on side where the slider shoe is the farthest from the track insert guides.

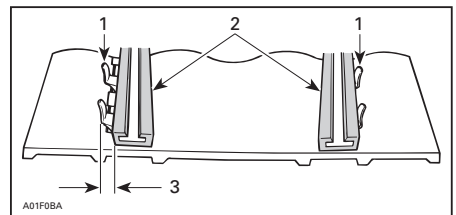

1. Guides
2. Slider shoes
3. Tighten on this side

Tighten lock nuts (some models only) and retaining screws.

⚠ WARNING

If lock nuts are not tightened properly, the adjusting screws could loosen causing the track to become extremely loose and, under some operating conditions, allow the idler wheels to climb over the track lugs forcing the track against the tunnel causing the track to "lock". Properly tighten wheel retaining screws, otherwise wheel may come off and cause track to "lock".

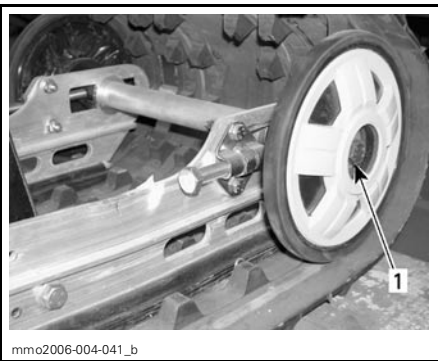

TYPICAL — SC-136

1. Retighten to 48 N•m (35 lbf•ft)

Restart engine and rotate track slowly to recheck alignment.

Reposition snowmobile on ground.

Install rear wheel caps if so equipped.

ELECTRICAL SYSTEM

Battery Electrolyte

Electric Start Models Only

These vehicles are equipped with a maintenance-free battery. Electrolyte level can not be checked.

 **WARNING**

BLACK negative battery cable must always be disconnected first and connected last.

 **WARNING**

Never charge or boost battery while installed. Battery electrolyte contains sulfuric acid which is corrosive and poisonous. In case of contact with skin, flush with water and call a physician immediately.

 **WARNING**

Should the battery casing be damaged, wear a suitable pair of non-absorbent gloves when removing the battery by hand.

CAUTION: Should any electrolyte spillage occur, immediately wash off with a solution of baking soda and water to prevent damage to vehicle components.

REAR SUSPENSION

Rear Suspension Condition

Visually inspect all suspension components including slider shoes, springs, wheels, etc.

NOTE: During normal driving, snow will act as a lubricant and coolant for the slider shoes. Extensive riding on ice or sanded snow, will create excessive heat build-up and cause premature slider shoe wear.

Suspension Stopper Strap Condition

Inspect stopper strap for wear and cracks, bolt and nut for tightness. If loose inspect holes for deformation. Replace as required. Torque nut to 11 N•m (97 lbf•in).

STEERING AND FRONT SUSPENSION

Visually inspect steering and front suspension for tightness of components (steering arms, control arms and links, tie rods, ball joints, ski bolts, ski legs, etc.). If necessary, contact an authorized SKI-DOO dealer.

Wear and Condition of Skis and Runners

Check the condition of the skis, ski runners and ski runner carbides (if so equipped). If worn, contact an authorized SKI-DOO dealer.

WARNING

Excessively worn skis and/or ski runners will adversely affect snowmobile control.

BODY/FRAME

Vehicle Cleaning and Protection

Remove any dirt or rust.

To clean the entire vehicle, use only flannel cloths or equivalent.

CAUTION: It is necessary to use flannel cloths or equivalent on windshield and hood to avoid damaging further surfaces to clean.

To clean the entire vehicle, including bottom pan and metallic parts use Heavy duty cleaner (P/N 293 110 001) (spray can 400 g) and (P/N 293 110 002) (4 L).

CAUTION: Do not use Heavy duty cleaner on decals or vinyl.

For vinyl and plastic parts use Vinyl & Plastic Cleaner (P/N 413 711 200) (6 x 1 L).

To remove scratches on windshield or hood use BOMBARDIER* Scratch Remover Kit (P/N 861 774 800).

CAUTION: Never clean plastic parts or hood with strong detergent, degreasing agent, paint thinner, acetone, products containing chlorine, etc.

Clean sheaves of both pulleys using Pulley flange cleaner (P/N 413 711 809).

Inspect the hood and repair any damage.

Touch up all metal spots where paint has been scratched off. Spray all metal parts including shock chromed rods with BOMBARDIER LUBE (P/N 293 600 016).

Wax the hood and the painted portion of the frame for better protection.

NOTE: Apply wax on glossy finish only. Protect the vehicle with a cover to prevent dust accumulation during storage.

CAUTION: The snowmobile has to be stored in a cool and dry place and covered with an opaque tarpaulin. This will prevent sun rays and grime from affecting plastic components and vehicle finish.

Lift rear of vehicle until track is clear of the ground. Install on a wide-base snowmobile mechanical stand with a rear deflector panel.

WARNING

Do not attempt to lift the vehicle by hand alone. Use appropriate lifting device or have assistance to share lifting stress in order to avoid risk of strain injuries.

NOTE: Do not release track tension.

Bulb Replacement

Always check light operation after bulb replacement.

Headlamp

CAUTION: Never touch glass portion of an halogen bulb with bare fingers, it shortens its operating life. If glass is touched, clean it with isopropyl alcohol which will not leave a film on the bulb.

Unplug burnt bulb connector.

Turn bulb locking ring counterclockwise to remove it. Detach the bulb and replace. Properly reinstall parts.



1. Locking ring

Taillight

If taillight bulb is burnt, expose the bulb by removing the red plastic lens. To remove, unscrew the 2 lens screws.

Headlamp Beam Aiming

Open left side panel. Turn screw to adjust beam height.

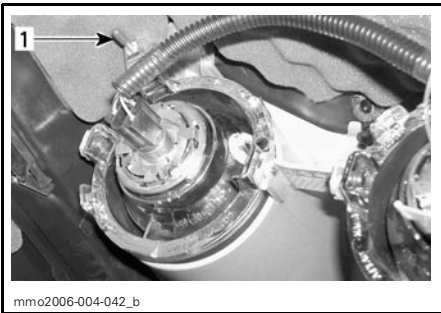

1. Screw

STORAGE AND PRESEASON PREPARATION

WARNING

Have an authorized SKI-DOO dealer inspect fuel and oil systems integrity as specified in PERIODIC MAINTENANCE CHART.

Storage

It is during summer, or when a snowmobile is not in use for more than one month that proper storage is a necessity.

To prepare your snowmobile, refer to an authorized SKI-DOO dealer.

Preseason Preparation

Refer to an authorized SKI-DOO dealer.

CAUTION: Have carburetor(s) cleaned-up before restarting engine.

WARRANTY

BRP LIMITED WARRANTY NORTH AMERICA: 2006 SKI-DOO® SNOWMOBILES

1) SCOPE OF THE LIMITED WARRANTY

Bombardier Recreational Products Inc. ("BRP")* warrants its 2006 Ski-Doo snowmobiles from defects in material or workmanship for the period and under the conditions described below.

All genuine Ski-Doo parts and accessories, installed by an authorized BRP dealer (as hereinafter defined) at the time of delivery of the 2006 Ski-Doo snowmobile, carry the same warranty as that of the snowmobile.

Use of the product for racing or any other competitive activity, at any point, even by a previous owner, will render this warranty null and void.

2) WARRANTY COVERAGE PERIOD

This warranty will be in effect from the date of delivery to the first retail consumer or the date the product is first put into use, whichever occurs first and for a period of:

TWELVE (12) CONSECUTIVE MONTHS, for private or commercial use owners. However, the warranty coverage period on a snowmobile delivered between June 1st and December 1st of a given year will expire December 1st of the following year.

The repair or replacement of parts or the performance of service under this warranty does not extend the life of this warranty beyond its original expiration date.

3) CONDITIONS TO HAVE WARRANTY COVERAGE

This warranty coverage is available only on 2006 Ski-Doo snowmobile purchased as new and unused by its first owner from a BRP dealer authorized to distribute Ski-Doo products in the country in which the sale occurred ("BRP dealer"), and then only after the BRP specified predelivery inspection process is completed and documented. Warranty coverage only becomes available upon proper registration of the product by an authorized BRP dealer. Moreover, this warranty coverage is only available if the Ski-Doo snowmobile is purchased in the country in which the purchaser resides. BRP will not honor this limited warranty to any private use owner or commercial use owner if the preceding conditions have not been met. Such limitations are necessary in order to allow BRP to preserve both the safety of its products, and also that of its consumers and the general public.

Routine maintenance outlined in the Operator's Guide must be timely performed in order to maintain warranty coverage. BRP reserves the right to make warranty coverage contingent upon proof of proper maintenance.

4) WHAT TO DO TO OBTAIN WARRANTY COVERAGE

The customer must notify a servicing BRP dealer within two (2) days of the appearance of a defect, and provide it with reasonable access to the product and reasonable opportunity to repair it. The customer must also present to the authorized BRP dealer, proof of purchase of the product and must sign the repair/work order prior to starting the repair in order to validate the warranty repair. All parts replaced under this limited warranty become the property of BRP.

5) WHAT BRP WILL DO

BRP's obligations under this warranty are limited to, at its sole discretion, repairing parts found defective under normal use, maintenance and service, or replacing such parts with new genuine Ski-Doo parts without charge for parts and labor, at any authorized BRP dealer during the warranty coverage period.

BRP reserves the right to improve or modify products from time to time without assuming any obligation to modify products previously manufactured.

6) EXCLUSIONS

The following are not warranted under any circumstances:

- Normal wear and tear;
- Routine maintenance items, tune ups, adjustments;
- Damage caused by failure to provide proper maintenance and/or storage, as described in the Operator's Guide;
- Damage resulting from removal of parts, improper repairs, service, maintenance, modifications or use of parts not manufactured or approved by BRP or resulting from repairs done by a person that is not an authorized servicing BRP dealer;
- Damage caused by abuse, abnormal use, neglect, use of the product on surfaces other than snow, or operation of the product in a manner inconsistent with the recommended operation described in the Operator's Guide;
- Damage resulting from accident, submersion, fire, theft, vandalism or any act of God;
- Operation with fuels, oils or lubricants which are not suitable for use with the product (see the Operator's Guide);
- Snow or water ingestion;
- Incidental or consequential damages, or damages of any kind including without limitation towing, storage, telephone, rental, taxi, inconvenience, insurance coverage, loan payments, loss of time, loss of income; and
- Damage resulting from studs installed on tracks if the installation does not conform to BRP's instructions.

7) LIMITATIONS OF LIABILITY

THIS WARRANTY IS EXPRESSLY GIVEN AND ACCEPTED IN LIEU OF ANY AND ALL OTHER WARRANTIES, EXPRESSED OR IMPLIED, INCLUDING WITHOUT LIMITATION ANY WARRANTY OF MERCHANTABILITY OR FITNESS FOR A PARTICULAR PURPOSE. TO THE EXTENT THAT THEY CANNOT BE DISCLAIMED, THE IMPLIED WARRANTIES ARE LIMITED IN DURATION TO THE LIFE OF THE EXPRESS WARRANTY. INCIDENTAL AND CONSEQUENTIAL DAMAGES ARE EXCLUDED FROM COVERAGE UNDER THIS WARRANTY. SOME STATES/PROVINCES DO NOT ALLOW FOR THE DISCLAIMERS, LIMITATIONS AND EXCLUSIONS IDENTIFIED ABOVE, AS A RESULT, THEY MAY NOT APPLY TO YOU. THIS WARRANTY GIVES YOU SPECIFIC RIGHTS, AND YOU MAY ALSO HAVE OTHER LEGAL RIGHTS WHICH MAY VARY FROM STATE TO STATE, OR PROVINCE TO PROVINCE.

Neither the distributor, any BRP dealer nor any other person has been authorized to make any affirmation, representation or warranty regarding the product, other than those contained in this limited warranty, and if made, shall not be enforceable against BRP.

BRP reserves the right to modify this warranty at any time, being understood that such modification will not alter the warranty conditions applicable to the products sold while this warranty is in effect.

8) TRANSFER

If the ownership of a product is transferred during the warranty coverage period, this warranty shall also be transferred and be valid for the remaining coverage period provided that BRP is notified of such transfer of ownership in the following way:

- a) The former owner contacts BRP (at the phone number provided below) or an authorized BRP dealer and gives the coordinates of the new owner; or
- b) BRP or an authorized BRP dealer receives a proof that the former owner agreed to the transfer of ownership, in addition to the coordinates of the new owner.

9) CONSUMER ASSISTANCE

- a) In the event of a controversy or a dispute in connection with this limited warranty, BRP suggests that you try to resolve the issue at the dealership level. We recommend discussing the issue with the authorized dealer's service manager or owner.
- b) If the issue has not yet been resolved, please submit your complaint in writing or call the appropriate number below:

IN CANADA:

**BOMBARDIER
RECREATIONAL PRODUCTS INC.**

SKI-DOO
CONSUMER SERVICES GROUP
VALCOURT QC J0E 2L0
Tel: (819) 566-3366

IN USA:

BRP US Inc.

SKI-DOO
CONSUMER SERVICES GROUP
7575 BOMBARDIER COURT
WAUSAU WI 54401
Tel : (715) 848-4957

* In the USA, products are distributed and serviced by BRP US Inc.
© 2005 Bombardier Recreational Products Inc. All rights reserved.
® Registered trademark of Bombardier Recreational Products Inc.

BRP INTERNATIONAL LIMITED WARRANTY: 2006 SKI-DOO® SNOWMOBILES

1) SCOPE OF THE LIMITED WARRANTY

Bombardier Recreational Products Inc. ("BRP") warrants its 2006 Ski-Doo snowmobiles from defects in material or workmanship for the period and under the conditions described below.

All genuine Ski-Doo parts and accessories, installed by an authorized BRP distributor/dealer (as hereinafter defined) at the time of delivery of the 2006 Ski-Doo snowmobile, carry the same warranty as that of the snowmobile.

Use of the product for racing or any other competitive activity, at any point, even by a previous owner, will render this warranty null and void.

2) WARRANTY COVERAGE PERIOD

This warranty will be in effect from the date of delivery to the first retail consumer or the date the product is first put into use, whichever occurs first and for a period of:

TWELVE (12) CONSECUTIVE MONTHS, for private or commercial use owners. However, the warranty coverage period on a snowmobile delivered between June 1st and December 1st of a given year will expire December 1st of the following year.

The repair or replacement of parts or the performance of service under this warranty does not extend the life of this warranty beyond its original expiration date.

3) CONDITIONS TO HAVE WARRANTY COVERAGE

This warranty coverage is available only on 2006 Ski-Doo snowmobile purchased as new and unused by its first owner from a BRP distributor/dealer authorized to distribute Ski-Doo products in the country in which the sale occurred ("BRP distributor/dealer"), and then only after the BRP specified predelivery inspection process is completed and documented. Warranty coverage only becomes available upon proper registration of the product by an authorized BRP distributor/dealer. Moreover, this warranty coverage is only available if the Ski-Doo snowmobile is purchased in the country or union of countries in which the purchaser resides. BRP will not honor this limited warranty to any private use owner or commercial use owner if the preceding conditions have not been met. Such limitations are necessary in order to allow BRP to preserve both the safety of its products, and also that of its consumers and the general public.

Routine maintenance outlined in the Operator's Guide must be timely performed in order to maintain warranty coverage. BRP reserves the right to make warranty coverage contingent upon proof of proper maintenance.

4) WHAT TO DO TO OBTAIN WARRANTY COVERAGE

The customer must notify a servicing BRP distributor/dealer within two (2) days of the appearance of a defect, and provide it with reasonable access to the product and reasonable opportunity to repair it. The customer must also present to the authorized BRP distributor/dealer, proof of purchase of the product and must sign the repair/work order prior to starting the repair in order to validate the warranty repair. All parts replaced under this limited warranty become the property of BRP.

5) WHAT BRP WILL DO

BRP's obligations under this warranty are limited to, at its sole discretion, repairing parts found defective under normal use, maintenance and service, or replacing such parts with new genuine Ski-Doo parts without charge for parts and labor, at any authorized BRP distributor/dealer during the warranty coverage period.

BRP reserves the right to improve or modify products from time to time without assuming any obligation to modify products previously manufactured.

6) EXCLUSIONS

The following are not warranted under any circumstances:

- Normal wear and tear;
- Routine maintenance items, tune ups, adjustments;
- Damage caused by failure to provide proper maintenance and/or storage, as described in the Operator's Guide;
- Damage resulting from removal of parts, improper repairs, service, maintenance, modifications or use of parts not manufactured or approved by BRP or resulting from repairs done by a person that is not an authorized servicing BRP distributor/dealer;
- Damage caused by abuse, abnormal use, neglect, use of the product on surfaces other than snow, or operation of the product in a manner inconsistent with the recommended operation described in the Operator's Guide;
- Damage resulting from accident, submersion, fire, theft, vandalism or any act of God;
- Operation with fuels, oils or lubricants which are not suitable for use with the product (see the Operator's Guide);
- Snow or water ingestion;
- Incidental or consequential damages, or damages of any kind including without limitation towing, storage, telephone, rental, taxi, inconvenience, insurance coverage, loan payments, loss of time, loss of income; and
- Damage resulting from studs installed on tracks if the installation does not conform to BRP's instructions.

7) LIMITATIONS OF LIABILITY

THIS WARRANTY IS EXPRESSLY GIVEN AND ACCEPTED IN LIEU OF ANY AND ALL OTHER WARRANTIES, EXPRESSED OR IMPLIED, INCLUDING WITHOUT LIMITATION ANY WARRANTY OF MERCHANTABILITY OR FITNESS FOR A PARTICULAR PURPOSE. TO THE EXTENT THAT THEY CANNOT BE DISCLAIMED, THE IMPLIED WARRANTIES ARE LIMITED IN DURATION TO THE LIFE OF THE EXPRESS WARRANTY. INCIDENTAL AND CONSEQUENTIAL DAMAGES ARE EXCLUDED FROM COVERAGE UNDER THIS WARRANTY. SOME STATES/PROVINCES DO NOT ALLOW FOR THE DISCLAIMERS, LIMITATIONS AND EXCLUSIONS IDENTIFIED ABOVE, AS A RESULT, THEY MAY NOT APPLY TO YOU. THIS WARRANTY GIVES YOU SPECIFIC RIGHTS, AND YOU MAY ALSO HAVE OTHER LEGAL RIGHTS WHICH MAY VARY FROM STATE TO STATE, OR PROVINCE TO PROVINCE.

Neither the distributor, any BRP distributor/dealer nor any other person has been authorized to make any affirmation, representation or warranty regarding the product, other than those contained in this limited warranty, and if made, shall not be enforceable against BRP.

BRP reserves the right to modify this warranty at any time, being understood that such modification will not alter the warranty conditions applicable to the products sold while this warranty is in effect.

8) TRANSFER

If the ownership of a product is transferred during the warranty coverage period, this warranty shall also be transferred and be valid for the remaining coverage period provided BRP or an authorized BRP distributor/dealer receives a proof that the former owner agreed to the transfer of ownership, in addition to the coordinates of the new owner.

9) CONSUMER ASSISTANCE

- a) In the event of a controversy or a dispute in connection with this limited warranty, BRP suggests that you try to resolve the issue at the dealership level. We recommend discussing the issue with the authorized distributor/dealer's service manager or owner.
- b) If further assistance is required, the distributor's service department should be contacted in order to resolve the matter.
- c) If the matter still remains unresolved then contact BRP at the address listed below.

BOMBARDIER RECREATIONAL PRODUCTS INC.

SKI-DOO
CONSUMER SERVICES GROUP
VALCOURT QC J0E 2L0
Tel : +1-819-566-3366

© 2005 Bombardier Recreational Products Inc. All rights reserved.

® Registered trademark of Bombardier Recreational Products Inc.

PRIVACY OBLIGATIONS/DISCLAIMER

We wish to inform you that your coordinates will be used for safety and warranty purposes. Sometimes, we also use the coordinates of our clients to inform them about our products and to present them offers. Should you prefer not to receive information on our products, services and offers, please let us know by writing to the address below.

Also note that, from time to time, carefully selected and trustworthy organizations may be permitted to use the coordinates of our clients to promote quality products and services. If you prefer not to have your name and address released, please let us know by writing to the address below:

Bombardier Recreational Products Inc.

Warranty Department
75, J.A. Bombardier Street
Sherbrooke, Québec J1L 1W3
Canada
Fax Number (819) 566-3590

AFFIX
PROPER
POSTAGE



Bombardier Recreational Products Inc.

WARRANTY DEPARTMENT
75, J.-A. Bombardier Street
Sherbrooke, Québec
Canada J1L 1W3

V00A2G

AFFIX
PROPER
POSTAGE



Bombardier Recreational Products Inc.

WARRANTY DEPARTMENT
75, J.-A. Bombardier Street
Sherbrooke, Québec
Canada J1L 1W3

V00A2G



520 000 539

CA

OPERATOR'S GUIDE, RF SERIES / ENGLISH
GUIDE DU CONDUCTEUR, SÉRIE RF / ANGLAIS

FAIT AU / MADE IN CANADA

U/M:P.C.