

2004 *ski-doo*®

Operator's Guide

Includes **Safety,**
Vehicle and **Maintenance**
Information



Elite™



WARNING

Read this guide thoroughly. It contains important safety information.

Minimum recommended operator's age: 16 years old.

Minimum recommended passenger's age (if applicable): 16 years old.

Do not remove this Operator's Guide from the vehicle.



5 2 0 0 0 0 4 4 1

SAFETY WARNING

Disregarding any of the safety precautions and instructions contained in this *Operator's Guide*, *Safety Videocassette* or on-product warnings may result in injury, including the possibility of death.

This *Operator's Guide* and *Safety Videocassette* should remain with the unit at time of resale.

BOMBARDIER
RECREATIONAL PRODUCTS



In USA, products are distributed by Bombardier Motor Corporation of America. In Canada, products are distributed by Bombardier Inc.

The following are trademarks of Bombardier Inc or its subsidiaries.

BOMBARDIER®
SKI-DOO®

DESS™
ROTAX™

4-TEC™
ELITE™

Printed in Canada (mmo2004-004a.fm GM)

™ ®* are trademarks and ® are registered trademarks of Bombardier Inc or its subsidiaries.

© 2003 Bombardier Inc. All rights reserved.

2004 SKI-DOO OPERATOR'S GUIDE

This guide is applicable to:

Elite™ Model

FOREWORD

Congratulations on your purchase of a new SKI-DOO snowmobile. Whatever model you have chosen, it is backed by the Bombardier warranty and a network of authorized SKI-DOO snowmobile dealers ready to provide the parts, service or accessories you may require.

The *Operator's Guide* has been prepared to acquaint the owner/operator and passenger with this new snowmobile and its various controls, maintenance and safe riding instructions. This guide is essential for the proper use of the product and should be kept with this snowmobile at all times.

Make sure you read and understand the content of this *Operator's Guide*.

For any questions pertaining to the warranty and its application, consult the WARRANTY section in this guide, and/or an authorized SKI-DOO dealer.

This guide uses the following safety alert symbol in conjunction with signal words to indicate a potential personal injury hazard.

WARNING

Indicates a potentially hazardous situation which, if not avoided, could result in death or serious injury.

CAUTION

Indicates a potentially hazardous situation which, if not avoided, may result in minor or moderate injury. When used without the safety alert symbol , potential hazard exists for property damage only.

NOTE: Indicates supplementary information needed to fully complete an instruction.

Although the mere reading of such information does not eliminate the hazard, the understanding and application of the information will promote the correct use of the vehicle.

Your dealer is committed to your satisfaction. He has taken training to perform the initial set-up and inspection of your snowmobile as well as completed the final adjustment required to suit your specific weight and riding environment before you took possession. At delivery, your dealer would have explained the snowmobile controls and provided you with a brief explanation of the various suspension adjustments. We trust you have taken full advantage of this!

At delivery, you were also informed of the warranty coverage and completed the Warranty Registration Form which is to be sent to us for processing.

The information and components/system descriptions contained in this guide are correct at time of publication. Bombardier Inc., however maintains a policy of continuous improvement of its products without imposing upon itself any obligation to install them on products previously manufactured.

Because of its ongoing commitment to product quality and innovation, Bombardier reserves the right at any time to discontinue or change specifications, designs, features, models or equipment without incurring obligation.

The illustrations in this document show the typical construction of the different assemblies and, in all cases, may not reproduce the full detail or exact shape of the parts shown, however, they represent parts which have the same or a similar function.

It is understood that this guide may be translated into another language. In the event of any discrepancy, the English version shall prevail.

Specifications are given in the SI metric system with the SAE U.S. equivalent in parentheses. Where precise accuracy is not required, some conversions are rounded off for easier use.

Most components of this snowmobile are built with parts dimensioned in the metric system. Most fasteners are metric and must not be replaced by customary fasteners or vice versa.

We recommend genuine Bombardier products for replacement parts and accessories. They've been specially designed for your vehicle and manufactured to meet Bombardier's demanding standards.

A *Shop Manual* can be obtained for complete service, maintenance and more repair information.

TABLE OF CONTENTS

2004 SKI-DOO OPERATOR'S GUIDE	1
FOREWORD	2
TABLE OF CONTENTS	4
SAFETY MEASURES	7

SAFETY INFORMATION

INTRODUCTION	12
SAFETY LABELING	13
A WORD TO ALL SNOWMOBILERS	15
LAWS AND REGULATIONS	16
SUMMARY OF ACCIDENT PREVENTION PRACTICES	16
ENVIRONMENT	20

VEHICLE INFORMATION

LIST OF HOT PARTS	24
LIST OF MOVING PARTS	24
BOMBARDIER LIMITED WARRANTY NORTH AMERICA	25
INTERNATIONAL BOMBARDIER LIMITED WARRANTY	28
FREQUENTLY ASKED QUESTIONS	31
AUTHORIZED SKI-DOO DEALERS	33
HOW TO IDENTIFY YOUR SNOWMOBILE	34
Vehicle Description Decal	34
Serial Numbers	35
ON-VEHICLE IMPORTANT INSTRUCTIONS	37
CONTROLS/INSTRUMENTS/EQUIPMENT	42
1) Throttle Lever	44
2) Brake Lever	44
3) Parking Brake Lever	44
4) Brake/Parking Brake Pilot Lamp (Red)	45
5) Gear Shift Lever	45
6) Reverse Pilot Lamp	46
7) Steering Wheel	46
8) Adjustable Seats	48
9) Seat Belts	48
10) Adjustable Rear View Mirror	49
11) Windshield	49
12) Ignition Switch	49
13) DESS Switch	50
14) DESS Pilot Lamp	51
15) Engine Cut-Out Switch	52
16) Headlamp Dimmer Switch	52
17) High Beam Pilot Lamp (Blue)	53

18) Low Oil Pressure Pilot Lamp	53
19) Alternator Pilot Lamp	53
20) Engine Management System (EMS) Pilot Lamp.....	53
21) Speedometer	53
22) Mode Button.....	55
23) Odometer.....	55
24) Trip Meter	55
25) Resetable Hourmeter.....	55
26) Tachometer.....	56
27) Fuel Tank Cap	56
28) Electric Fuel Level Gauge	57
29) Temperature Gauge	58
30) Engine Overheat Warning Lamp (Red)	58
31) Driver's Grip Heating Switch.....	59
32) Heating Throttle Lever Switch	59
33) Passenger's Heating Grab Handle Switch	60
34) Passenger's Heating Grab Handle	60
35) Additional Handles	61
36) Electric Visor Jack Connector	62
37) Electric Power Outlet.....	62
38) Fog Lights Switch	62
39) Door Handle	63
40) Engine Hood Latch.....	63
41) Fuses	64
42) Front Bumper.....	68
43) Storage Compartment Catch Release	68
44) Tool Kit.....	70
45) Spare Drive Belt Holder	70
46) Shields and Guards	70
47) Adjustable Suspensions.....	70
Guidelines to Adjust Suspension	71
FUEL AND OIL	85
Recommended Fuel.....	85
Recommended Oil	86
BREAK-IN PERIOD	86
Engine	86
Belt.....	86
10-Hour Inspection.....	86
PRE-OPERATION CHECK	87
PRE-OPERATION CHECK LIST	89
OPERATING INSTRUCTIONS.....	90
Principle of Operation	90
Starting the Engine	91
Shutting Off the Engine	92
VEHICLE WARM-UP.....	92

RIDING THE VEHICLE	93
HOW TO RIDE	94
TERRAIN/RIDING VARIATIONS	96
POST-OPERATION CARE	99
SPECIAL OPERATIONS	100
Riding at High Altitudes	100
Engine Overheating	100
Rear Suspension Slider Shoe Sticking.....	100
MAINTENANCE INFORMATION	
PERIODIC MAINTENANCE CHART	102
FLUID LEVELS	104
Brake System	104
Engine Oil Level	105
Gearbox Oil Level	107
Cooling System	109
Battery Electrolyte	110
MAINTENANCE	111
Vehicle Cleaning and Protection	111
Belt Guard Removal and Installation	112
Drive Belt Removal/Installation	117
TRA Drive Pulley Adjustment	119
Drive Belt Condition	122
Brake Condition	122
Brake Adjustment	122
Rear Suspension Condition	122
Suspension Stopper Strap Condition.....	122
Track Condition.....	123
Track Tension and Alignment	123
Steering and Front Suspension	128
Wear and Condition of Skis and Runners	128
Exhaust System	128
Air Filter Cleaning	128
Bulb Replacement	129
TOWING THE VEHICLE	130
TRANSPORTING THE VEHICLE	131
STORAGE AND PRESEASON PREPARATION.....	131
Storage	131
Preseason Preparation	131
TROUBLESHOOTING	132
Monitoring Beeper Coded Signals.....	132
SPECIFICATIONS	135
PRIVACY OBLIGATIONS/DISCLAIMER	136
CHANGE OF ADDRESS OR OWNERSHIP	137

⚠ SAFETY MEASURES

Observe the Following Warnings:

- ⚠ Both driver and passenger must have their seat belts securely fastened and positioned properly at all times while riding.
- ⚠ All occupants should be tall enough to sit properly and achieve proper seat belt fit.
- ⚠ Keep limbs inside vehicle at all times.
- ⚠ Always wear an approved helmet and proper snowmobile clothing.
- ⚠ The performance of this snowmobile is very different and may significantly exceed that of other snowmobiles you have operated.
- ⚠ Basic training is required for the safe operation of any snowmobile. Study your *Operator's Guide* paying particular attention to cautions and warnings. Join your local snowmobile club: its social activities and trail systems are planned for both fun and safety. Obtain basic instructions from your snowmobile dealer, friend, fellow club member or enroll in your state or provincial safety training program.
- ⚠ Know the local laws regarding snowmobiles and be aware of the liability, property damage and insurance laws relating to your equipment.
- ⚠ Always keep right hand side of the trail.
- ⚠ Always keep a safe distance from other snowmobiles and bystanders.
- ⚠ Jumping a snowmobile is an unsafe and dangerous practice.
- ⚠ Know your snowmobile and exercise prudence and care suitable for any power driven machines. Common sense, proper handling and routine maintenance will result in a safer and enjoyable use. Check your machine before each ride.
- ⚠ Always make a pre-start inspection BEFORE you turn on the ignition.
- ⚠ Bombardier recommends not to operate this snowmobile under the age of 16. Warn against speeding, over confidence and carelessness.
- ⚠ Snowmobiles are used in many areas and in many snow conditions. Not all models perform the same in similar conditions. Always consult your snowmobile dealer when selecting the snowmobile model for your particular needs and uses.

- ⚠ Injury or death may result to the snowmobile operator, passenger or bystander if the snowmobile is used in risky conditions which are beyond the driver's, passenger's or snowmobile's capabilities or intended use.
- ⚠ Remember, promotional material may show risky maneuvers performed by professional riders under ideal and/or controlled conditions. You should never attempt any such risky maneuvers or any other that are beyond your level of riding ability.
- ⚠ Never ride after consuming drugs or alcohol or if you feel tired or ill. Operate your snowmobile prudently.
- ⚠ Speeding can be fatal. In many cases, you cannot react or respond quickly enough to the unexpected. Always ride at a speed which is suitable to the trail, weather conditions and your own ability. Know your local rules. Speed limit may be in effect and meant to be observed.
- ⚠ This snowmobile can carry only one passenger.
- ⚠ In an emergency, the snowmobile engine can be stopped by activating the engine cut-out switch, removing the DESS cap from its post or turning off the key.
- ⚠ Your snowmobile is not designed to be operated on public streets, roads or highways. In most States and Provinces, it is considered an illegal operation.
- ⚠ Throttle mechanism should be checked for free movement and return to idle position before starting engine.
- ⚠ For vehicles with a parking brake, always engage brake when vehicle is not in use.
- ⚠ Always stop the engine before refueling. Fuel is inflammable and explosive under certain conditions. Always work in a well-ventilated area. Do not smoke or allow open flames or sparks in the vicinity. Open cap slowly. If a differential pressure condition is noticed (whistling sound heard when loosening fuel tank cap) have vehicle inspected and/or repaired before further operation. Do not overfill or top off the fuel tank before placing the vehicle in a warm area. As temperature increases, fuel expands and might overflow. Always wipe off any fuel spillage from the vehicle. Periodically verify fuel system.
- ⚠ Never run the engine in a non-ventilated area and/or if vehicle is left unattended.
- ⚠ Never operate the engine without belt guard securely installed or, with hood or access/side panels open or removed. Never run the engine without drive belt installed. Running an unloaded engine such as without drive belt or with track raised, can be dangerous.

- ⚠ Unless otherwise specified, never run the engine when the tracks are raised off the ground or with the hood opened or removed.
- ⚠ Do not stud the tracks. At speed it may cause the tracks to tear and separate from vehicle posing a risk of severe injury or death.
- ⚠ Maintain your snowmobile in top mechanical condition at all times.
- ⚠ Do not lubricate throttle and/or brake cables and housings.
- ⚠ Only perform procedures as detailed in this guide. Unless otherwise specified, engine should be turned OFF and cold for all lubrication, adjustment and maintenance procedures.
- ⚠ Never charge or boost a battery while installed on snowmobile.
- ⚠ The engine and components used in a particular model should not be used on other models. Use of Rotax™ snowmobile engines in other than SKI-DOO snowmobiles is not recommended or authorized by Bombardier Inc. or its subsidiaries.
- ⚠ The reverse speed of this snowmobile is not limited. Always proceed with caution as fast reverse could result in loss of vehicle stability and control. Come to complete stop before selecting reverse gear. Wait until the reverse alarm sounds before operating throttle to proceed in reverse. Always remain seated and apply the brake before shifting. Ensure the path behind is clear of obstacles or bystanders before proceeding.

SAFETY INFORMATION

INTRODUCTION

This safety information section includes safety WARNINGS which if not followed may result in serious personal injury including the possibility of death.

After reading, please keep this *Operator's Guide* with the snowmobile. If the snowmobile is resold, please give the guide to the new owner for his awareness. An extra copy of the *Operator's Guide* is available from your SKI-DOO snowmobile dealer at no charge.

This safety information section is dedicated to safer snowmobiling.

SAFETY LABELING

Safety standards for snowmobiles have been adopted by the Snowmobile Safety and Certification Committee (SSCC) of which Bombardier is a proud participating member. Assurance that your snowmobile meets these standards is easily checked by looking at the Certification Label located above shifting lever.

This label shows that an independent testing laboratory has verified compliance with the SSCC safety standards. Other important labels on the vehicle are WARNING or CAUTION labels relating to safety, maintenance and/or snowmobile operation. Ensure all such labeling is retained on the vehicle and its content is followed by vehicle operator and passenger.



OTHER SAFETY FEATURES

Read this *Operator's Guide* for other features that may be on your particular snowmobile model. Do not operate your snowmobile unless all its safety features are in place and in good working order.

Lights — The headlamp, the taillight and the brake light are standard equipment. Be sure lights are clear of dirt, slush or snow and are in good working order or condition.

HOW TO DRESS

Proper snowmobile clothing should be worn. It should be comfortable and not too tight. Always check the weather forecast before going on a ride. Dress for the coldest weather expected. Thermal underwear next to the skin also provides a good insulation.

Approved helmets are recommended at all times despite the enclosed nature of this snowmobile. They provide warmth and reduce the risk of injury. A stocking type cap, balaclava and face mask should always be carried or worn. Goggles or a face shield that attach to the helmet are indispensable.

Hands should be protected by a pair of snowmobile gloves or mitts which have sufficient insulation and allow use of thumbs and fingers for operation of controls.

Rubber bottom boots with either a nylon or a leather top, with removable felt liners are best suited for snowmobiling.

You should keep yourself as dry as possible when snowmobiling. When you come indoors, take your snowmobile suit and boots off and make sure they dry before putting them back on.

Do not wear long scarfs and loose apparels that could get caught in moving parts.

WHAT TO BRING

Every snowmobiler should carry at least the following basic parts and tools that can help him and others in an emergency:

- this *Operator's Guide*
- spare spark plugs and wrench
- friction tape
- spare drive belt
- shovel
- spare light bulbs
- tool kit (including at least pliers, screwdriver, adjustable wrench)
- knife
- flashlight.

Include other items depending on the length and time of your ride.

A WORD TO ALL SNOWMOBILERS

Everyone is a beginner when one first sits behind the steering wheel of this snowmobile regardless of previous experience in driving an automobile, a motorcycle or a motorboat. The safe use of your snowmobile depends on many conditions such as visibility, speed, weather, environment, traffic, vehicle condition and the condition of the driver.



Each operator has a responsibility to ensure the safety of his/her passenger, if any, and of other recreationists or bystanders.

You are responsible for proper operation of your vehicle as well as training those whom you allow to ride or drive. There may be noticeable handling and performance differences from one snowmobile to another.

A snowmobile is relatively simple to operate but like any other vehicle or mechanical equipment, it can be hazardous if you or a passenger are the least bit reckless, thoughtless or inattentive. We encourage you to have an Annual Safety Inspection of your snowmobile. Please contact an authorized SKI-DOO dealer for further details. Finally, we urge you to visit an authorized SKI-DOO dealer periodically for regular and safety maintenance, as well as snowmobile accessories you may require.

TRANSPORTING AND TOWING

Follow transporting and towing instructions explained further in this guide.

LAWS AND REGULATIONS

Federal, state, provincial and local government agencies have enacted laws and regulations pertaining to the safe use and operation of snowmobiles. It is your responsibility as a snowmobiler to learn and obey these laws and regulations. Respect and observance will result in safer snowmobiling for all.

SUMMARY OF ACCIDENT PREVENTION PRACTICES

- △ Both driver and passenger must have their seat belts securely fastened and positioned properly at all times.
- △ Snowmobiling at night can be a delightful experience but because of reduced visibility, be extra cautious. Avoid unfamiliar terrain and be sure your lights are working. Always carry a flashlight and spare light bulbs.
- △ Do not leave your keys in the ignition switch, it is an invitation to thieves and a danger to young children.
- △ Nature is wonderful but don't let it distract your attention from driving. If you want to truly appreciate winter's scenery, stop your snowmobile on the side of the trail so that **you** don't become a hazard to others.
- △ Fences represent a very serious threat for both you and your snowmobile. Give a wide berth to telephone poles or posts.
- △ Hidden wires unseen from a distance can cause serious accidents. Obtain reflective tape or markings and identify hazardous wires near your trail.
- △ Overhead branches can distract the driver, cut faces and even cause eye injury. Always wear an approved safety helmet, eye protection and a face shield. This also applies to the passenger.
- △ Smoking while refueling or while checking the fuel level can be dangerous. All fuel gives off fumes. If you do smoke, do so away from the snowmobile.
- △ Although the snow on the ground is several inches/feet deep, dry grasses — in certain areas — may extend above snow level. Remove any such accumulation from tracks, engine and gas tank areas.
- △ Be aware of inherent risks associated with riding off trails, such as avalanche and other natural or man made hazards or obstacles.

- ⚠ Avoid road traveling. If you must do so, and if it is allowed, reduce speed. The snowmobile is not designed to operate or turn on paving. When crossing a road, make a full stop, then look carefully in both directions before crossing at a 90° angle. Be wary of parked vehicles.
- ⚠ Do not tailgate another snowmobile. If the snowmobile in front of you slows down for any reason, this negligence could harm the driver and the passenger. Maintain a safe stopping distance between you and the snowmobile in front of you. Depending on the terrain condition, stopping may require a little more space than you think. Play it safe. Be prepared to use evasive driving.



- ⚠ Make sure to check the throttle movement prior to starting the snowmobile to ascertain that the throttle cable is operational. If not, correct the problem before using the snowmobile. When starting the engine, be prepared to immediately respond and shut off the engine should a malfunction occur, by either turning off the ignition switch, pressing the engine cut-out switch, or pulling out the DESS cap.

- △ Always show a new operator how to start and stop the vehicle. Indicate the correct riding positions and, above all else, only allow him to operate the snowmobile in a restricted flat area — at least until he is completely familiar with its operation. If there is a local snowmobile operator's training course existing, have him enroll. Make sure he is dressed properly for the weather with no long scarves or loose fitting apparel that could get caught in moving parts. Make sure his limbs are inside of vehicle at all times. Make sure that both driver and passenger have their seat belt securely fastened and positioned properly at all times firmly holds.
- △ Never have the engine running while the hood is open. Even at idle, a snowmobile engine is turning around 1,800 revolutions per minute. Always turn off the ignition before opening the hood for any reason.
- △ Never remove any original equipment from your snowmobile. Each vehicle has many built-in safety features. Such features include various guards and consoles, plus reflective materials and warning labels.
- △ Venturing out alone with your snowmobile could also be hazardous. You could run out of fuel, have an accident, or damage your snowmobile. Remember, your snowmobile can cover more distance in half an hour than you may be able to walk in a day. Use the "buddy system". Always ride with a friend or member of your snowmobile club. Even so, tell someone where you are going and when you plan to return.
- △ Meadows sometimes have low areas where water accumulates and freezes over in winter. This ice is usually glare ice. Attempting to turn or brake on this surface could cause your vehicle to spin out of control. Never brake or attempt speeding or turning on glare ice. If you do happen to travel over such a condition, reduce speed by slowly releasing the throttle.
- △ Never "jump" with your snowmobile. This should be left to professional stunt men. Don't show off. Be responsible.
- △ **Stay sober.** Safe riders don't ride under the influence of alcohol or drugs. Drinking and driving demonstrates a most irresponsible attitude not only to others but to yourself. Legislators and the population in general do not tolerate it and BOMBARDIER Recreational Products doesn't either!
- △ Wildlife compliments your snowmobiling day. Snowmobile tracks provide firm ground over which animals can travel from area to area. Do not violate this privilege by chasing or harassing wildlife. Fatigue and exhaustion can lead to animal's death. Avoid areas posted for the protection or feeding of wildlife.
- △ If you happen to be fortunate enough to see an animal, stop your snowmobile and observe quietly.

- ⚠ Excessive speeding can be fatal. In many cases, you cannot react or respond quickly enough to the unexpected. Ride at a speed which is suitable to the trail and weather conditions. If a maximum speed is posted, observe it.
- ⚠ A poorly maintained snowmobile itself can be a potential hazard. Excessively worn components could render the vehicle completely inoperative. Keep the snowmobile in good working condition at all times. Follow your pre-operation check, weekly, monthly and annually routine maintenance and lubrication procedures as detailed in this guide. Consult a snowmobile dealer or acquire a shop manual and proper tools and equipment if other repairs or service is required.
- ⚠ Raising the rear of your snowmobile while the engine is running could cause snow, ice or debris to be thrown back at an observer. Never raise the rear of the vehicle while the engine is running. To clear or inspect the tracks, stop the engine, lift the rear of vehicle with a wide-base mechanical stand. Never allow anyone near a rotating snowmobile track.
- ⚠ Do not stud the tracks. At speed it may cause the tracks to tear and separate from vehicle posing a risk of severe injury or death.
- ⚠ While on safari, do not “gun” the throttle. Snow and ice can be thrown back into the path of a following snowmobile. In addition, when “gunning” the throttle, the vehicle digs into and leaves an irregular snow surface for others.
- ⚠ Safaris are both fun and enjoyable but don’t show off or overtake others in the group. A less experienced operator might try to do the same as you and fail. When riding with others, limit your abilities to the experience of others.
- ⚠ Always cover your snowmobile with the supplied tarpaulin when leaving it overnight or during extended periods of inactivity. This will protect it from freezing as well as retain its appearance. Never leave the snowmobile stored in direct sunlight. Never store snowmobile in a plastic bag.
- ⚠ The guidelines that we support are not designed to limit your snowmobiling fun, but to preserve the beautiful freedom that you can experience only on a snowmobile! These guidelines will keep snowmobilers healthy, happy and able to introduce others to what they know and enjoy about their favorite winter pastime. So, the next time you hit the trails on a cool, crisp and clear winter day, we ask you to remember that you are paving the way for the future of our sport. Help us lead it down the right path! From all of us at BOMBARDIER Recreational Products, thank you for doing your share.

ENVIRONMENT

There is nothing more exhilarating than snowmobiling. Venturing onto snowmobile trails that criss-cross the wild areas of the U.S. and Canada is an exciting and healthy winter sport. However, as the number of people using these recreational parks increases, so does the potential for damage to the environment. Abuse of land, facilities and resources inevitably leads to restrictions and closures of both private and public land.

In essence, the greatest threat to our sport, is all around us. Which leaves us with one logical choice. When we snowmobile, we must always ride responsibly.

The vast majority respect the law and the environment. Each of us must set an example for those who are new to the sport, young and old alike.

It is in every one's best interest to tread lightly into our recreational areas. Because, in the long run, to protect the sport we must preserve the environment.

Recognizing the importance of this issue and the need for snowmobilers to do their share in preserving areas that make it possible to enjoy our sport, BOMBARDIER Recreational Products has developed the "Light Treading Is Smart Sledding" campaign for snowmobilers.

Light Treading refers to more than the tread of our tracks. It's a statement of concern, respect and willingness to take the lead and take action. It applies to the environment in general, its proper care and maintenance, its natural inhabitants and all enthusiasts and the public at large who enjoy the great outdoors. With this theme, we invite all snowmobilers to remember that respecting the environment is not only critical to the future of our industry but to future generations.

Light Treading in no way suggests you should curb your appetite for snowmobiling fun! It simply means tread with respect!

JUST WHAT IS LIGHT TREADING?

The fundamental objective of Light Treading is one of respect for where and how you ride a snowmobile. You're a light treader when you follow the principles below.

Become informed. Obtain maps, regulations and other information from the Forest Service or from other public land agencies. Learn the rules and follow them and that goes for speed limits, too!

Avoid running over young trees, shrubs, and grasses and don't cut wood. On flatlands or areas where trail riding is popular, it's important to ride only where authorized. Remember, there is a link between protecting your environment and your own safety.

Respect wildlife and be particularly sensitive of animals that are rearing young or suffering from food shortage. Stress can sap scarce energy reserves. Refrain from riding in areas where only animals are intended to tread!

Obey gate closures and regulatory signs and remember, light treaders don't litter!

Stay out of wilderness areas. They're closed to all vehicles. Know where the boundaries are.

Obtain permission to travel across private land. Respect the rights of landowners and other people's privacy. Remember, snowmobile technology has lowered the noise factor considerably, but you still shouldn't rev your engines where quiet "is the order of the day".

WHY IS LIGHT TREADING SMART

Snowmobilers know all too well the efforts that have been made throughout the sport's history to enjoy access to areas where people can snowmobile safely and responsibly. This effort continues today, as strong as ever.

Respecting the areas where we ride... wherever they may be... is the only way to ensure their future enjoyment. That's one major reason why we know you'll agree that Light Treading Is Smart Sledding! And there are more.

Enjoying the opportunity to see winter and all its natural majestic wonders, is an experience cherished by snowmobilers. Light Treading will preserve this opportunity and will make it possible for us to expose others to the beauty of winter and the unique thrill of our sport! Light Treading will help our sport to grow!

Finally, Light Treading is the sign of a smart snowmobiler. You don't have to leave big tracks or careen through a virgin forest to show you can ride. So whether you're driving a high performance Ski-Doo, a sporty MX-Z snowmobile or any other make or model, show you know what you're doing. Show you know how to send snow flying and make tracks with a light touch!

VEHICLE INFORMATION

LIST OF HOT PARTS

All power train components.

LIST OF MOVING PARTS

All transmission, suspension and steering parts.

BOMBARDIER LIMITED WARRANTY NORTH AMERICA: 2004 SKI-DOO® SNOWMOBILES

1. SCOPE OF THE LIMITED WARRANTY

In Canada, BOMBARDIER INC. (hereinafter "BOMBARDIER"), and in the USA, Bombardier on behalf of BOMBARDIER MOTOR CORPORATION OF AMERICA (BMCA) warrants its 2004 SKI-DOO snowmobiles from defects in material or workmanship for the period described below.

All genuine BOMBARDIER parts and accessories, installed by an authorized BOMBARDIER dealer (as hereinafter defined) at the time of delivery of the 2004 SKI-DOO snowmobile, carry the same warranty as that of the snowmobile.

Use of the product for racing or any other competitive activity, at any point, even by a prior owner will render this warranty null and void.

2. WARRANTY COVERAGE PERIOD

This warranty will be in effect FROM THE DATE OF DELIVERY TO THE FIRST RETAIL CONSUMER or the date the product is first put into use, whichever occurs first and for a period of:

TWELVE (12) CONSECUTIVE MONTHS, for private or commercial use owners. The warranty coverage period on a snowmobile delivered between June 1st and December 1st of a given year will expire December 1st of the following year

The repair or replacement of parts or the performance of service under this warranty does not extend the life of this warranty beyond its original expiration date.

3. CONDITIONS TO HAVE WARRANTY COVERAGE

This warranty coverage is available only on 2004 SKI-DOO snowmobile purchased as new and unused by its first owner from a BOMBARDIER dealer authorized to distribute SKI-DOO products in the country in which the sale occurred (hereinafter "BOMBARDIER dealer"), and then only after the BOMBARDIER specified pre-delivery inspection process is completed and documented. Moreover, this warranty coverage is only available if the SKI-DOO snowmobile is purchased in the country in which the purchaser resides. Bombardier will not honor this limited warranty to any personal use owner or commercial use owner where the preceding conditions have not been met. Warranty coverage only becomes available upon proper registration of the product by a BOMBARDIER dealer. Such limitations are necessary in order to allow BOMBARDIER to preserve both the safety of its products, and also that of its consumers and the public. Routine maintenance outlined in the *Operator's Guide* must be timely performed in order to maintain warranty coverage. BOMBARDIER reserves the right to make warranty coverage contingent upon proof of proper maintenance.

4. WHAT TO DO TO OBTAIN WARRANTY COVERAGE

The customer must notify a servicing BOMBARDIER dealer within two (2) days of the appearance of a defect, and provide it with reasonable access to the product and reasonable opportunity to repair it. The customer must also present to the BOMBARDIER dealer, proof of purchase of the product and must sign the repair/work order prior to the start of the repair in order to validate the warranty repair. All parts replaced under this limited warranty become the property of BOMBARDIER.

5. WHAT BOMBARDIER WILL DO

BOMBARDIER's obligations under this warranty are limited to, at its sole discretion, repairing parts found defective under normal use, maintenance and service, or replacing such parts with new genuine BOMBARDIER parts without charge for parts and labor, at any authorized BOMBARDIER dealer.

BOMBARDIER reserves the right to improve or modify products from time to time without assuming any obligation to modify products previously manufactured.

6. EXCLUSIONS - ARE NOT WARRANTED

- Normal wear and tear;
- Routine maintenance items, tune ups, adjustments;
- Damage caused by failure to provide proper maintenance and/or storage, as described in the *Operator's Guide*;
- Damage resulting from removal of parts, improper repairs, service, maintenance, modifications or use of parts not manufactured or approved by BOMBARDIER or resulting from repairs done by a person that is not an authorized servicing BOMBARDIER dealer;
- Damage caused by abuse, abnormal use, neglect, use of the product on surfaces other than snow, or operation of the product in a manner inconsistent with the recommended operation described in the *Operator's Guide*;
- Damage resulting from accident, submersion, fire, theft, vandalism or any act of God;
- Operation with fuels, oils or lubricants which are not suitable for use with the product (see the *Operator's Guide*);
- Snow or water ingestion;
- Incidental or consequential damages, or damages of any kind including without limitation towing, storage, telephone, rental, taxi, inconvenience, insurance coverage, loan payments, loss of time, loss of income; and
- Damage resulting from tracks which have been studded.

7. LIMITATIONS OF LIABILITY

THIS WARRANTY IS EXPRESSLY GIVEN AND ACCEPTED IN LIEU OF ANY AND ALL OTHER WARRANTIES, EXPRESSED OR IMPLIED, INCLUDING WITHOUT LIMITATION ANY WARRANTY OF MERCHANTABILITY OR FITNESS FOR A PARTICULAR PURPOSE. TO THE EXTENT THAT THEY CANNOT BE DISCLAIMED, THE IMPLIED WARRANTIES ARE LIMITED IN DURATION TO THE LIFE OF THE EXPRESS WARRANTY. INCIDENTAL AND CONSEQUENTIAL DAMAGES ARE EXCLUDED FROM COVERAGE UNDER THIS WARRANTY. SOME STATES/PROVINCES DO NOT ALLOW FOR THE DISCLAIMERS, LIMITATIONS AND EXCLUSIONS IDENTIFIED ABOVE, AS A RESULT, THEY MAY NOT APPLY TO YOU. THIS WARRANTY GIVES YOU SPECIFIC RIGHTS, AND YOU MAY ALSO HAVE OTHER LEGAL RIGHTS WHICH MAY VARY FROM STATE TO STATE, OR PROVINCE TO PROVINCE.

Neither the distributor, any BOMBARDIER dealer nor any other person has been authorized to make any affirmation, representation or warranty regarding the product, other than those contained in this limited warranty, and if made, shall not be enforceable against BOMBARDIER.

BOMBARDIER reserves the right to modify this warranty at any time, being understood that such modification will not alter the warranty conditions applicable to the products sold while this warranty is in effect.

8. TRANSFER

If the ownership of a product is transferred during the warranty coverage period, this warranty shall also be transferred and be valid for the remaining coverage period provided that BOMBARDIER is notified of such transfer of ownership in the following way:

- a. The former owner contacts BOMBARDIER (at the phone number provided below) or an authorized BOMBARDIER dealer and gives the coordinates of the new owner; or
- b. BOMBARDIER or an authorized BOMBARDIER dealer receives a proof that the former owner agreed to the transfer of ownership, in addition to the coordinates of the new owner.

9. CONSUMER ASSISTANCE

- a. In the event of a controversy or a dispute in connection with this BOMBARDIER LIMITED WARRANTY, BOMBARDIER suggests that you try to resolve the issue at the dealership level. We recommend discussing the issue with the authorized dealer's service manager or owner.
- b. If the issue has not yet been resolved, please submit your complaint in writing or call the appropriate number below:

In Canada:

BOMBARDIER INC.
RECREATIONAL PRODUCTS
SKI-DOO®
CUSTOMER ASSISTANCE CENTER
VALCOURT QC J0E 2L0
Tel: (819) 566-3366

In USA:

BOMBARDIER MOTOR
CORPORATION OF AMERICA
RECREATIONAL PRODUCTS
SKI-DOO®
CUSTOMER ASSISTANCE CENTER
7575 BOMBARDIER COURT
WAUSAU WI 54401
Tel: (715) 848-4957

INTERNATIONAL BOMBARDIER LIMITED WARRANTY 2004 SKI-DOO® SNOWMOBILES

1. SCOPE OF THE LIMITED WARRANTY

BOMBARDIER INC. (hereinafter "BOMBARDIER") warrants its 2004 SKI-DOO snowmobiles from defects in material or workmanship for the period described below.

All genuine BOMBARDIER parts and accessories, installed by an authorized BOMBARDIER distributor/dealer (as hereinafter defined) at the time of delivery of the 2004 SKI-DOO snowmobile, carry the same warranty as that of the snowmobile.

Use of the product for racing or any other competitive activity, at any point, even by a prior owner will render this warranty null and void.

2. WARRANTY COVERAGE PERIOD

This warranty will be in effect FROM THE DATE OF DELIVERY TO THE FIRST RETAIL CONSUMER or the date the product is first put into use, whichever occurs first and for a period of:

TWELVE (12) CONSECUTIVE MONTHS, for private or commercial use owners. The warranty coverage period on a snowmobile delivered between June 1st and December 1st of a given year will expire December 1st of the following year.

The repair or replacement of parts or the performance of service under this warranty does not extend the life of this warranty beyond its original expiration date.

3. CONDITIONS TO HAVE WARRANTY COVERAGE

This warranty coverage is available only on 2004 SKI-DOO snowmobile purchased as new and unused by its first owner from a BOMBARDIER distributor/dealer authorized to distribute SKI-DOO products in the country in which the sale occurred (hereinafter "BOMBARDIER distributor/dealer"), and then only after the BOMBARDIER specified pre-delivery inspection process is completed and documented. Moreover, this warranty coverage is only available if the SKI-DOO snowmobile is purchased in the country in which the purchaser resides. Bombardier will not honor this limited warranty to any personal use owner or commercial use owner where the preceding conditions have not been met. Warranty coverage only becomes available upon proper registration of the product by a BOMBARDIER dealer. Such limitations are necessary in order to allow BOMBARDIER to preserve both the safety of its products, and also that of its consumers and the public. Routine maintenance outlined in the *Operator's Guide* must be timely performed in order to maintain warranty coverage. BOMBARDIER reserves the right to make warranty coverage contingent upon proof of proper maintenance.

4. WHAT TO DO TO OBTAIN WARRANTY COVERAGE

The customer must notify a servicing BOMBARDIER distributor/dealer within two (2) months of the appearance of a defect, and provide it with reasonable access to the product and reasonable opportunity to repair it. The customer must also present to the BOMBARDIER dealer, proof of purchase of the product and must sign the repair/work order prior to the start of the repair in order to validate the warranty repair. All parts replaced under this limited warranty become the property of BOMBARDIER.

5. WHAT BOMBARDIER WILL DO

BOMBARDIER's obligations under this warranty are limited to, at its sole discretion, repairing parts found defective under normal use, maintenance and service, or replacing such parts with new genuine BOMBARDIER parts without charge for parts and labor, at any authorized BOMBARDIER distributor/dealer.

BOMBARDIER reserves the right to improve or modify products from time to time without assuming any obligation to modify products previously manufactured.

6. EXCLUSIONS - ARE NOT WARRANTED

- Normal wear and tear;
- Routine maintenance items, tune ups, adjustments;
- Damage caused by failure to provide proper maintenance and/or storage, as described in the *Operator's Guide*;
- Damage resulting from removal of parts, improper repairs, service, maintenance, modifications or use of parts not manufactured or approved by BOMBARDIER or resulting from repairs done by a person that is not an authorized servicing BOMBARDIER dealer;
- Damage caused by abuse, abnormal use, neglect, use of the product on surfaces other than snow, or operation of the product in a manner inconsistent with the recommended operation described in the *Operator's Guide*;
- Damage resulting from accident, submersion, fire, theft, vandalism or any act of God;
- Operation with fuels, oils or lubricants which are not suitable for use with the product (see the *Operator's Guide*);
- Snow or water ingestion;
- Incidental or consequential damages, or damages of any kind including without limitation towing, storage, telephone, rental, taxi, inconvenience, insurance coverage, loan payments, loss of time, loss of income; and
- Damage resulting from tracks which have been studded.

7. LIMITATIONS OF LIABILITY

THIS WARRANTY IS EXPRESSLY GIVEN AND ACCEPTED IN LIEU OF ANY AND ALL OTHER WARRANTIES, EXPRESSED OR IMPLIED, INCLUDING WITHOUT LIMITATION ANY WARRANTY OF MERCHANTABILITY OR FITNESS FOR A PARTICULAR PURPOSE. TO THE EXTENT THAT THEY CANNOT BE DISCLAIMED, THE IMPLIED WARRANTIES ARE LIMITED IN DURATION TO THE LIFE OF THE EXPRESS WARRANTY. INCIDENTAL AND CONSEQUENTIAL DAMAGES ARE EXCLUDED FROM COVERAGE UNDER THIS WARRANTY. SOME JURISDICTIONS DO NOT ALLOW FOR THE DISCLAIMERS, LIMITATIONS AND EXCLUSIONS IDENTIFIED ABOVE, AS A RESULT, THEY MAY NOT APPLY TO YOU. THIS WARRANTY GIVES YOU SPECIFIC RIGHTS, AND YOU MAY ALSO HAVE OTHER LEGAL RIGHTS WHICH MAY VARY FROM COUNTRY TO COUNTRY.

Neither the distributor, any BOMBARDIER dealer nor any other person has been authorized to make any affirmation, representation or warranty regarding the product, other than those contained in this limited warranty, and if made, shall not be enforceable against BOMBARDIER.

BOMBARDIER reserves the right to modify this warranty at any time, being understood that such modification will not alter the warranty conditions applicable to the products sold while this warranty is in effect.

8. TRANSFER

If the ownership of a product is transferred during the warranty coverage period, this warranty shall also be transferred and be valid for the remaining coverage period provided that BOMBARDIER is notified of such transfer of ownership in the following way:

BOMBARDIER or an authorized BOMBARDIER SKI-DOO distributor/dealer receives a proof that the former owner agreed to the transfer of ownership, in addition to the co-ordinates of the new owner. The distributor will then forward this information directly to Bombardier.

9. CONSUMER ASSISTANCE

- a. In the event of a controversy or a dispute in connection with this BOMBARDIER LIMITED WARRANTY, BOMBARDIER suggests that you try to resolve the issue at the dealership level. We recommend discussing the issue with the authorized dealer's service manager or owner.
- b. If further assistance is required, the distributor's service department should be contacted in order to resolve the matter.
- c. If the matter still remains unresolved then contact Bombardier by writing to us at the address listed below.

In Canada:

BOMBARDIER INC.
RECREATIONAL PRODUCTS
SKI-DOO®
CUSTOMER ASSISTANCE CENTER
VALCOURT QC J0E 2L0
Tel: (819) 566-3366



BOMBARDIER
RECREATIONAL PRODUCTS

© 2003 Bombardier Inc. All rights reserved
® Registered trademark of Bombardier Inc. or its subsidiaries.

FREQUENTLY ASKED QUESTIONS

Q: Why must my snowmobile be registered at the factory? After all I do have my original invoice as proof of when I purchased my snowmobile.

A: *Registration is very important and your SKI-DOO dealer must register your snowmobile with Bombardier. Make sure the registration form has been sent. All of this will allow you to:*

a) have warranty work performed at any authorized SKI-DOO dealer in North America. Your registration form will provide the authorized SKI-DOO dealer with all the necessary data to complete warranty claim forms.

b) be advised by Bombardier should there be a safety recall or particular warranty campaign.

c) be contacted much faster by the police, the minute they find your stolen snowmobile (if such a case occurs).

Q: Why must my snowmobile be registered with the governing body having jurisdiction over snowmobile use?

A: *Snowmobile registration has two purposes: In many provinces or states it is mandatory to register a snowmobile in the same way as for a car. It allows the state or province to maintain records of existing snowmobiles and governmental agencies use part of the registration fees for establishing and maintaining trails.*

Q: Where can I find information on the lubrication and maintenance of my snowmobile?

A: *In the Operator's Guide provided with the snowmobile at the time of delivery.*

Q: Will the entire warranty be voided or cancelled, if I do not operate or maintain my new snowmobile exactly as specified in the *Operator's Guide*?

A: *The warranty of the new snowmobile cannot be "Voided" or "Cancelled" if predelivered by an authorized SKI-DOO dealer. However, if a particular failure is caused by inappropriate operation or maintenance instructions in the Operator's Guide are not followed and, THAT failure may not be covered under warranty. This includes service work performed by the customer, especially the critical adjustments such as pulley alignment and calibration.*

Q: Would you give some examples of abnormal use or strain, neglect or abuse which may affect warranty?

A: *These terms are general and overlap each other in areas. Some specific examples may include: running the snowmobile out of oil, chain failure caused by a lack of lubrication, operating the snowmobile with a broken or damaged part which causes another part to fail, and so on. If you have any specific questions on operation or maintenance, please contact an authorized SKI-DOO dealer for advice.*

Q: What costs are my responsibility during the warranty period?

A: *The customer's responsibility includes all costs of normal maintenance services, non-warranty repairs, accidents and collision damage, as well as oils, and spark plugs, and incidental or consequential damages costs as explained in the warranty.*

Q: Are "Genuine" Bombardier replacement parts used in warranty repairs covered by warranty?

A: *Yes. When installed by an authorized SKI-DOO dealer, any "Genuine" Bombardier part used in warranty repairs assumes the remaining warranty that exists on the snowmobile.*

Q: If I sell my snowmobile within the warranty period, will the new owner qualify for the balance of the warranty?

A: *Yes, provided the resale has been registered with the manufacturer.*

Q: How can I receive the best owner assistance?

A: *The satisfaction and goodwill of the owners of Bombardier products are of primary concern to your authorized SKI-DOO dealer and Bombardier. Normally, any problems that arise in connection with the sales transaction or the operation of your snowmobile will be handled by your authorized SKI-DOO Dealers Sales or Service Departments. It is recognized, however, that despite the best intentions of everyone concerned, misunderstandings will sometimes occur. Frequently, complaints are the result of a breakdown in communications and can quickly be resolved by a member of the authorized SKI-DOO dealership management. If the problem already has been reviewed with the Sales Manager or Service Manager, contact the General Manager or the owner of this authorized SKI-DOO dealership.*

We are always pleased to receive your comments on the Ski-Doo snowmobile.

AUTHORIZED SKI-DOO DEALERS

For Canada and USA Only

To find the nearest authorized SKI-DOO dealer, dial: 1 800 375-4366
or visit our web site at WWW.SKIDOO.COM.

HOW TO IDENTIFY YOUR SNOWMOBILE

Vehicle Description Decal

Vehicle description decal is located below the seats.



TYPICAL

1. *Vehicle description decal*

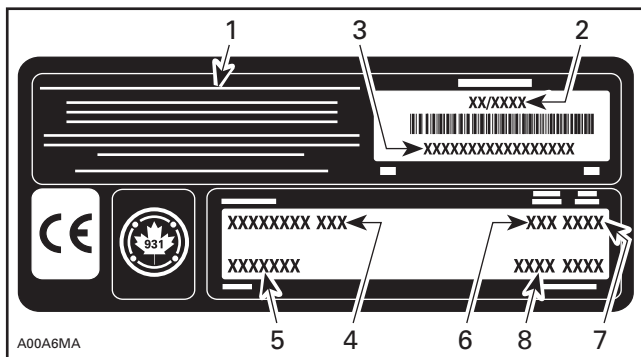

VEHICLE DESCRIPTION DECAL

1. Manufacturer name
2. Manufacturing date
3. Vehicle identification number (VIN)
4. Model name
5. Option package
6. Engine type
7. Model year
8. Color codes

Serial Numbers

The main components of your snowmobile (engine and frame) are identified by different serial numbers. It may sometimes become necessary to locate these numbers for warranty purposes or to trace your snowmobile in the event of loss. These numbers are required by the authorized SKI-DOO dealer to complete warranty claims properly. No warranty will be allowed by Bombardier if the engine serial number or vehicle identification number (VIN) is removed or mutilated in any way. We strongly recommend that you take note of all the serial numbers on your snowmobile and supply them to your insurance company.

Vehicle Identification Number (VIN) Location

VIN is scribed on vehicle description decal. See above. It is also embossed on tunnel near vehicle description decal.

Model Number Location

Model number is part of vehicle identification number (VIN).

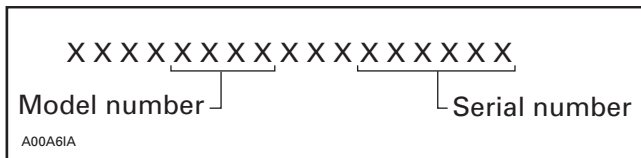

VIN DESCRIPTION

Engine Serial Number Location

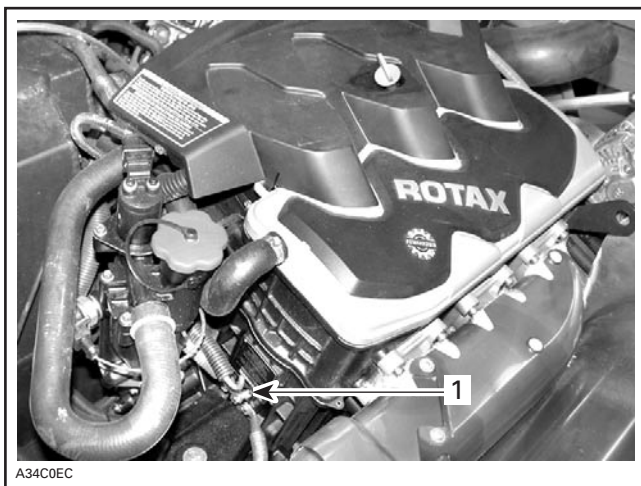

1. Engine serial number

ON-VEHICLE IMPORTANT INSTRUCTIONS

The following instructions are on your snowmobile. If missing or damaged, the decals can be replaced free of charge. See an authorized SKI-DOO dealer.

Please read the following instructions carefully before operating this snowmobile.

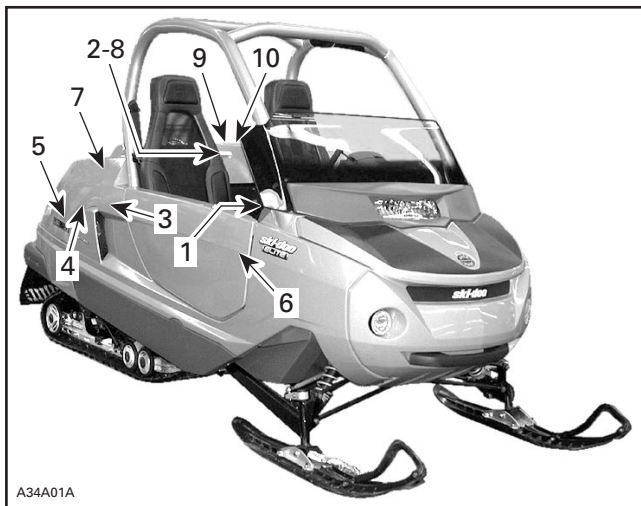

TYPICAL — LOCATION OF IMPORTANT INSTRUCTIONS

Instruction 1

⚠ WARNING

- Read and follow all warning labels & Operator's Guide before operation.

- Severe injury or death can result from ignoring warnings or improper use of snowmobile.

Before starting engine, check:

- If throttle lever returns to its initial position when released.

- All guards are in place.

- Front and rear hoods are closed and properly latched.

- Parking brake is applied.

After starting, check proper operation of:

- Engine emergency cut-off switch and all controls.

Before operating the vehicle:

- Make sure parking brake is fully disengaged.

- Both driver and passenger must have seat belt fastened at all times and wear approved helmets.

- Drive carefully.

- Keep limbs inside snowmobile at all times.

A01A2HA

Instruction 2

⚠ WARNING

When opening the coolant reservoir, make sure nobody is seated in the snowmobile.

⚠ AVERTISSEMENT

Quand on ouvre le reservoir de liquide de refroidissement, s'assurer que personne n'est assis dans la motoneige.

516 002 133

A01A2IA

Instruction 3

CAUTION

- To comply with noise regulations, this engine is designed to operate with an air intake silencer.
- Operation without air intake silencer or with one not properly installed may cause engine damage.

ATTENTION

- Le moteur a été conçu pour fonctionner avec ce silencieux d'admission afin de se conformer aux lois et règlements relatifs au bruit.
- Son absence ou une mauvaise installation peut endommager le moteur.

516 001 191

A01A2EA

Instruction 4

WARNING

This guard must always
be in place when engine is running.

AVERTISSEMENT

Ce garde-courroie doit toujours être
en place lorsque le moteur fonctionne.

516 001 190

A01A2FA

Instruction 5



TYPICAL

Instruction 6

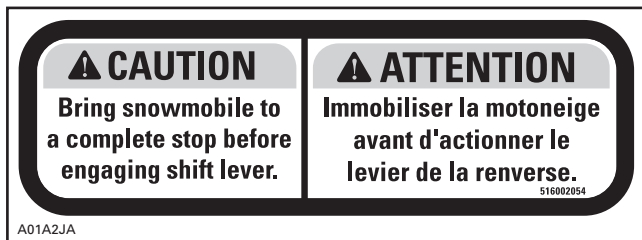

Instruction 7

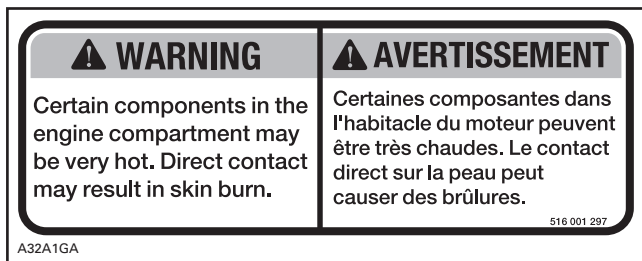

Instruction 8



A32A1HA

Instruction 9

 **WARNING**

NEVER sit here.

A01A2KA

Instruction 10

CAUTION

CHECKING ENGINE OIL LEVEL

- Make sure engine is at operating temperature.
- Snowmobile must be on a level surface.
- Let engine running at idle for at least 30 seconds.
- Stop engine and wipe the dipstick.
- Dipstick must be pushed in completely before checking oil level.
- Use BOMBARDIER synthetic oil 0W40.

ATTENTION

VÉRIFICATION DU NIVEAU D'HUILE DU MOTEUR

- S'assurer que le moteur est à température normale d'opération.
- La motoneige doit être au niveau.
- Laisser tourner le moteur au ralenti 30 secondes minimum.
- Arrêter le moteur et nettoyer la jauge de niveau d'huile.
- Insérer la jauge complètement avant de mesurer le niveau d'huile.
- Utiliser de l'huile synthétique BOMBARDIER 0W40.

A01A2LA

CONTROLS/INSTRUMENTS/EQUIPMENT

NOTE: Some controls/instruments/equipment do not apply or are optional on some models. In these cases their reference numbers are deliberately missing in the illustrations.

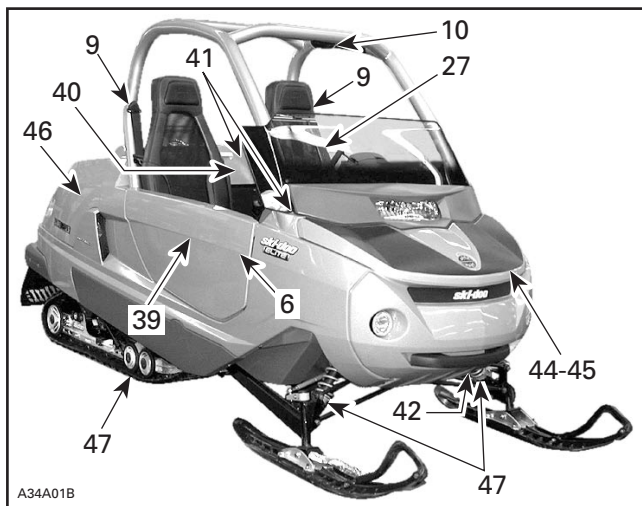

TYPICAL

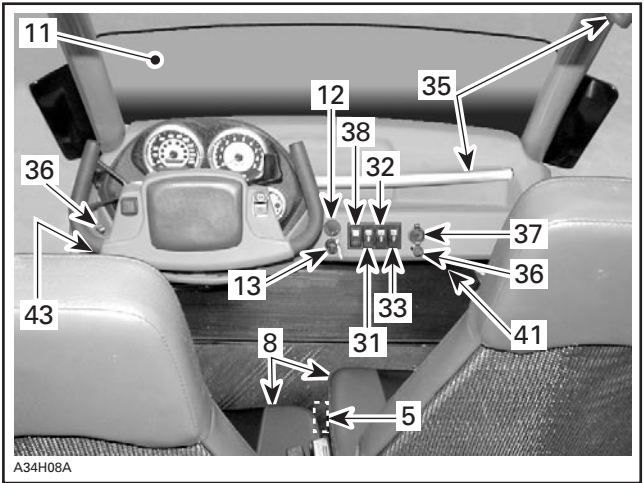

TYPICAL

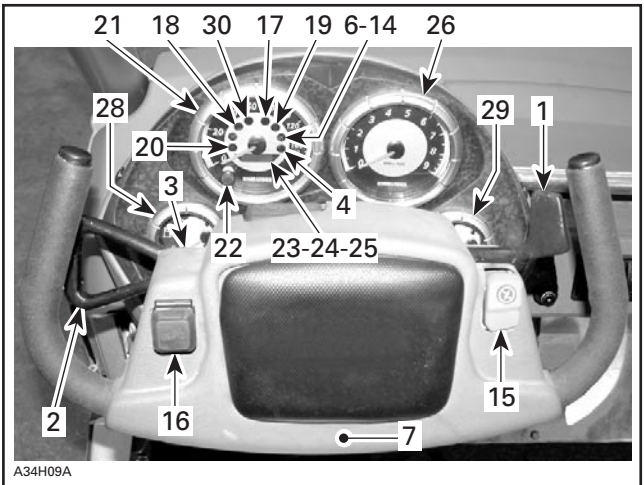

TYPICAL

1) Throttle Lever

Located on the right hand side of steering wheel and designed to be thumb activated. When squeezed, it increases the engine speed and engages the transmission. When released, engine speed returns automatically to idle.

2) Brake Lever

Located on the left hand side of steering wheel. When squeezed, the brake is applied. When released, it automatically returns to its original position. Braking effect is proportional to the pressure applied on the lever and to the type of terrain and its snow coverage.

3) Parking Brake Lever

Located on left hand side of steering wheel. Parking brake should be used whenever snowmobile is parked.

Whenever parking brake is applied and engine is running, parking brake pilot lamp lights up to remind you that it is engaged.

WARNING

Make sure parking brake is fully disengaged before operating the snowmobile.

When you ride the vehicle, brake that are caused to drag by a continuous pressure on the lever may cause damage to the brake system and cause loss of braking capacity and/or fire.

To engage mechanism, squeeze brake lever and maintain while pushing locking lever with a finger. When brake lever is held at half-way the parking brake should be fully applied.

To release mechanism, squeeze brake lever. Locking lever will automatically return to its original position. Always release parking brake before riding.

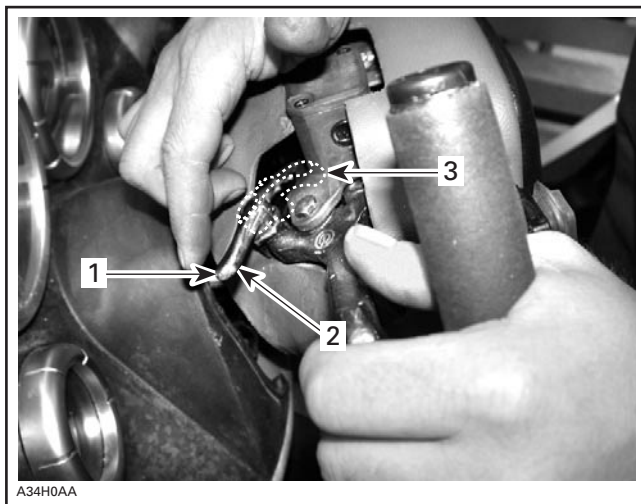

A34H0AA

TYPICAL

1. Locking lever

2. OFF

3. ON

4) Brake/Parking Brake Pilot Lamp (Red)

Lights up when brake or parking brake is applied (with engine running).

5) Gear Shift Lever

⚠ WARNING

The reverse speed of this snowmobile is not limited. Always proceed with caution as fast reverse could result in loss of vehicle stability and control. Come to complete stop before using gear lever. Wait until the reverse alarm sounds before operating throttle to proceed in reverse. Always remain seated and apply the brake before shifting. Ensure the path behind is clear of obstacles or bystanders before proceeding.

This model is equipped with a mechanical reverse controlled by a 2-position gear shift lever.

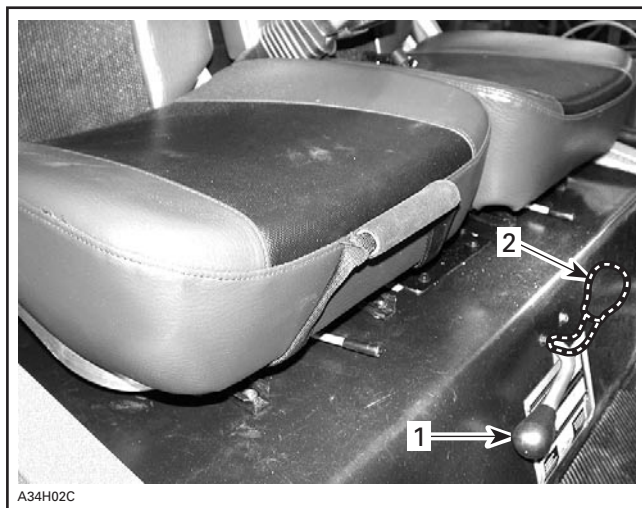

TYPICAL

1. Forward
2. Reverse

Shifting Procedure

Stop the vehicle completely before using gear shift lever.

Do not force lever. If unable to shift, apply throttle to move snowmobile, stop vehicle then, try again.

6) Reverse Pilot Lamp

This pilot lamp will light up when reverse is selected.

NOTE: The reverse pilot lamp is combined with the DESS pilot lamp.

7) Steering Wheel

As the steering wheel is rotated to right or left, the skis are turned right or left to steer the snowmobile.

WARNING

Fast reverse while turning, could result in loss of stability and control.



A34G01A

STEERING WHEEL FULLY TURNED TO THE LEFT



A34G02A

STEERING WHEEL FULLY TURNED TO THE RIGHT

8) Adjustable Seats

Move the locking lever to the left, slide the seat to the desired position. Release the locking lever to lock the seat in position.



1. Locking lever

9) Seat Belts

WARNING

Both driver and passenger must have their seat belt securely fastened and positioned properly at all times.



10) Adjustable Rear View Mirror

The rear view mirror can be adjusted to suit driver's preference.

WARNING

Adjust with vehicle at rest in a safe place.

11) Windshield

Windshield provides operator and passenger comfort, as well as protection by deflecting wind and snow away from the operator and passenger.

12) Ignition Switch

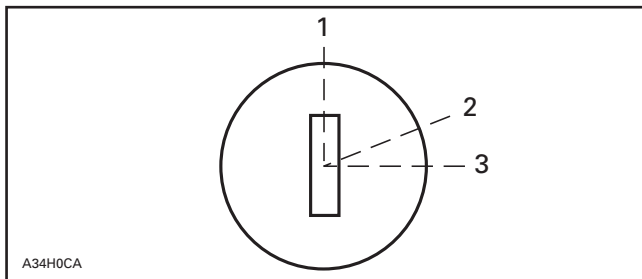

1. OFF
2. ON
3. START

Install DESS tether cord cap on its post. Make sure the engine cut-out switch is ON.

First, turn key to ON position and wait for a double beep to be heard. This indicates that both the EMS (engine management system) and the VMS (vehicle management system) have recognized the code in the DESS tether cord cap.

To start engine, turn key to START position and hold until engine has started. See illustration above.

CAUTION: Do not use electric starter for more than 10 seconds. A rest period should be observed between the cranking cycles to let electric starter cool down. Using electric starter when engine has started could damage electric starter mechanism.

Release the key as soon as the engine starts. Key returns to ON position as soon as it is released.

If the engine does not start on the first try, turn the key back to OFF and wait a few seconds before restarting. To stop engine, turn the key to OFF.

NOTE: With the engine running, turning the key from ON position to START position will shut-off the engine.

If the starter does not operate, check the starting system fuse condition. Refer to FUSES.

13) DESS Switch

WARNING

Always remove DESS tether cord cap and key when vehicle is not in operation in order to prevent accidental engine starting, to avoid unauthorized use by children or others, or theft.

DESS (Digitally Encoded Security System) Description

This system is digitally encoded to provide you and your snowmobile with the equivalent security as a conventional lock key.

The DESS tether cord cap provided with your snowmobile contains an electronic chip in which a unique digital code is permanently memorized. Your authorized SKI-DOO dealer programs this key code in both the EMS (engine management system) and the VMS (vehicle management system) of your snowmobile to allow engine starting if and only if this unique code has been read when installing DESS tether cord cap on DESS post.

If a DESS tether cord cap with different code is installed, the engine will not start.

Operation

Attach to clothing eyelet then snap the DESS tether cord cap over DESS post before starting engine.

Additional DESS Tether Cord Caps

Both the EMS (engine management system) and the VMS (vehicle management system) of your snowmobile can be programmed by your authorized SKI-DOO dealer to accept 8 different DESS tether cord cap codes.

We recommend the purchase of additional caps from your authorized SKI-DOO dealer as additional keys. If you have more than one SKI-DOO snowmobile, each can be programmed by your authorized SKI-DOO dealer to accept the other vehicles' keys.

DESS Pilot Lamp Codes

DESS pilot lamp lights up for one second and a long beep is heard means that a bad connection has been detected. Engine cannot be started.

To check for bad connection, remove. Make sure the DESS tether cord cap is free of dirt or snow. Reinstall cap and restart engine. If the DESS pilot lamp still lights up for one second and a long beep is still heard contact an authorized dealer.

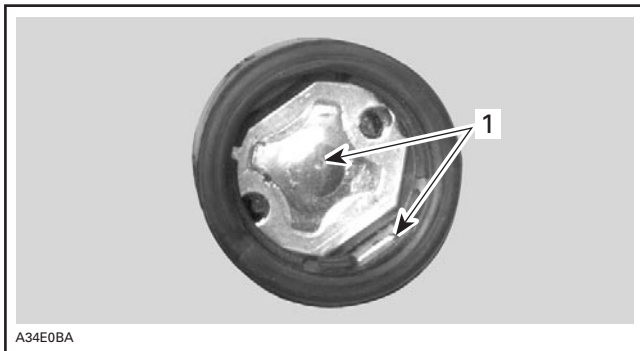

1. Free of dirt or snow

A DESS pilot lamp blinking 3 times per second means that you have installed a cap with a code which the EMS and VMS of this snowmobile are not programmed to recognize (wrong key). Engine cannot be started.

14) DESS Pilot Lamp

This lamp will light up to confirm DESS status. Refer to previous paragraphs for description.

NOTE: DESS pilot lamp is combined with reverse pilot lamp.

15) Engine Cut-Out Switch

This toggle type switch is located on the right side of the steering wheel. To stop the engine in an emergency, select the OFF position and simultaneously apply the brake. To restart, button must be at the ON position.

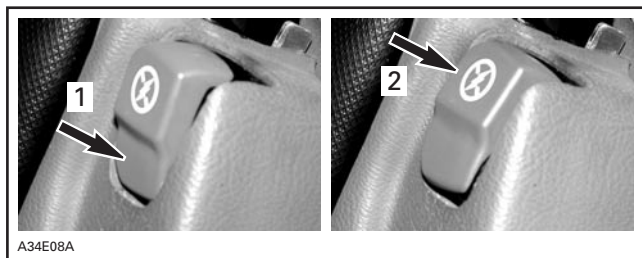

TYPICAL

1. ON
2. OFF

All operators of the snowmobile should familiarize themselves with the function of this device by using it several times on first outing and whenever stopping the engine there-after. This engine cut-out procedure will become a reflex and will prepare operators for emergency situations requiring its use.

WARNING

If the switch has been used in an emergency caused by a suspected malfunction, the source of the malfunction should be determined and corrected before restarting engine. See an authorized SKI-DOO dealer for servicing.

16) Headlamp Dimmer Switch

Located on left hand side of steering wheel, allows selection of headlamp beam. Note that lights are automatically ON whenever the engine is running.

17) High Beam Pilot Lamp (Blue)

Lights up when headlamp is on HIGH beam.

18) Low Oil Pressure Pilot Lamp

This pilot lamp will light up when engine oil pressure is too low. Stop vehicle without delay in a safe place and turn engine off, then check oil level and replenish as described in FLUID LEVEL.

Restart engine, oil pilot lamp must turn off after few seconds. If oil pilot lamp still lights up, stop engine immediately and have lubrication system inspected by an authorized SKI-DOO dealer.

CAUTION: Running the engine with low oil pressure can lead to severe engine damage.

19) Alternator Pilot Lamp

This lamp will light up when the alternator fails to charge the battery. See an authorized SKI-DOO dealer as soon as possible.

20) Engine Management System (EMS) Pilot Lamp

This lamp will light up to indicate a trouble. Refer to TROUBLESHOOTING for trouble code meaning and remedy.

21) Speedometer

This model is equipped with an electronic speedometer. It may show speed in km/h or MPH.

NOTE: At 90 km/h (55 MPH) and above, the LCD screen will automatically display speed instead of the data from the selected mode.

Change from One Unit to the Other

Stop vehicle in a safe place. From under the dash, plug connectors together to change units from miles to kilometers.

Unplug to return to miles reading.

NOTE: Speedometer, odometer and trip meter will have their units (kilometer or miles) changed all together.

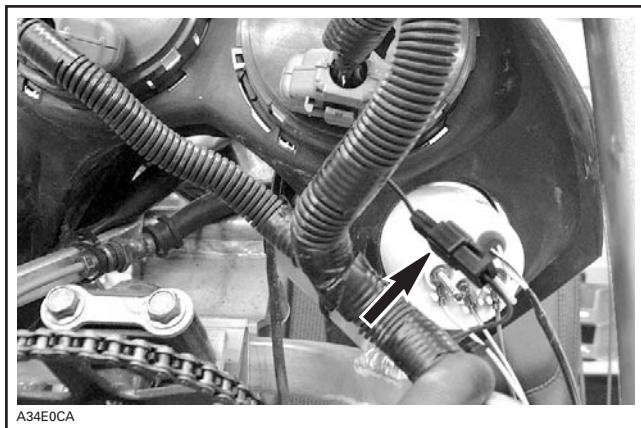

A34E0CA

KILOMETERS READING — CONNECTORS PLUGGED

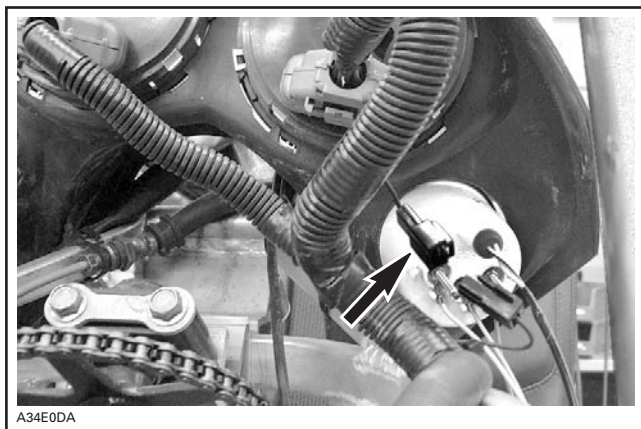

A34E0DA

MILES READING — CONNECTORS UNPLUGGED

22) Mode Button

Depress mode button to change display. Each time engine is started, display shows odometer. From that point depressing mode button will change display for the trip meter.

Depressing mode button again will change display for the resettable hourmeter. Push mode button again to return to odometer.

Push and hold mode button for 2 seconds to reset the tripmeter or the resettable hourmeter depending on the one displayed.

23) Odometer

Odometer records the total distance travelled and displays it either in miles or kilometers. Refer to SPEEDOMETER for changing units.

NOTE: At 90 km/h (55 MPH) and above, the LCD screen will automatically display speed instead of the data from the selected mode.

24) Trip Meter

Records distance travelled since it has been reset. Distance travelled is displayed either in miles or kilometers. Refer to SPEEDOMETER for changing units.

NOTE: At 90 km/h (55 MPH) and above, the LCD screen will automatically display speed instead of the data from the selected mode.

25) Resettable Hourmeter

Records engine running time in hours and minutes since it has been reset.

NOTE: At 90 km/h (55 MPH) and above, the LCD screen will automatically display speed instead of the data from the selected mode.

Push and hold mode button for 2 seconds to reset the resettable hourmeter.

26) Tachometer

Direct-reading dial indicates the number of thousand of revolutions per minute (RPM) of the engine.

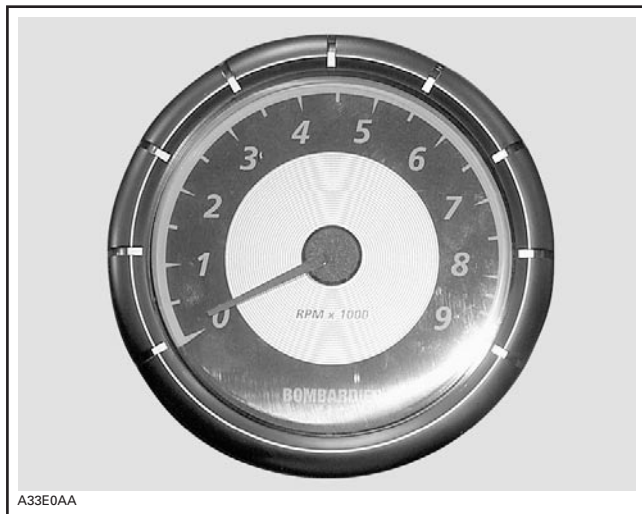

MULTIPLY THE READING BY 1000

27) Fuel Tank Cap

Unscrew to fill up tank then fully tighten.

WARNING

Always stop the engine before refueling. Fuel is flammable and explosive under certain conditions. Always work in a well ventilated area. Do not smoke or allow open flames or sparks in the vicinity. Open cap slowly. If a differential pressure condition is noticed (whistling sound heard when loosening fuel tank cap) have vehicle inspected and/or repaired before further operation. Do not overfill or top off the fuel tank before placing the vehicle in a warm area. As temperature increases, fuel expands and might overflow. Always wipe off any fuel spillage from the vehicle. Periodically verify fuel system.

28) Electric Fuel Level Gauge

Dash-mounted gauge to facilitate fuel level reading. This gauge functions when engine is running.

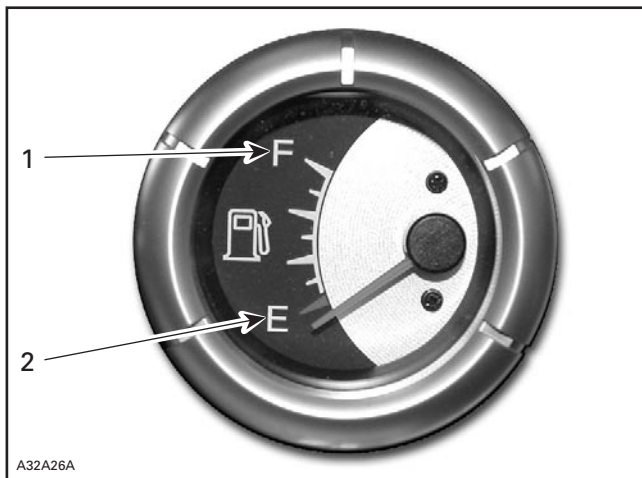

TYPICAL

- 1. Full*
- 2. Empty*

29) Temperature Gauge

The gauge indicates engine coolant temperature. The needle moves to the normal range as engine warms. Under all riding conditions, the needle should stay within this range. If needle moves into the overheat range, reduce snowmobile speed and run snowmobile in loose snow or stop engine immediately.

CAUTION: Operating the snowmobile with the coolant temperature in the overheat range can lead to severe engine damage.

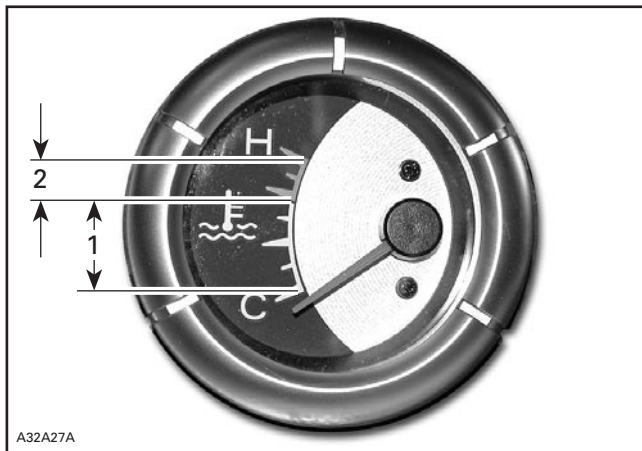

TYPICAL

1. Normal
2. Overheat

30) Engine Overheat Warning Lamp (Red)

If this lamp lights up, reduce snowmobile speed and run snowmobile in loose snow or stop engine immediately.

31) Driver's Grip Heating Switch

Three-position toggle switch. Select the desired position to keep driver's hands at a comfortable temperature.

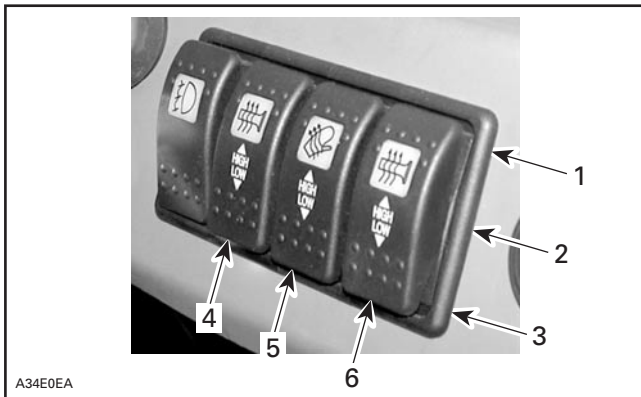

TYPICAL

1. HOT
2. OFF
3. WARM
4. Heating grip switch
5. Heating throttle lever switch
6. Passenger heating grab handle switch

32) Heating Throttle Lever Switch

Three-position toggle switch. Select the desired position to keep your right thumb at a comfortable temperature. See illustration above.

33) Passenger's Heating Grab Handle Switch

Three-position toggle switch. Select the desired position to keep passenger's hands at a comfortable temperature. See illustration above.

34) Passenger's Heating Grab Handle

Attached to the passenger's seat, this grab handle features an heating element controlled by the passenger's heating grab handle switch.



1. Passenger's heating grab handle

35) Additional Handles

Located in front of passenger's seat, there is a dash-mounted handle to help getting in vehicle.

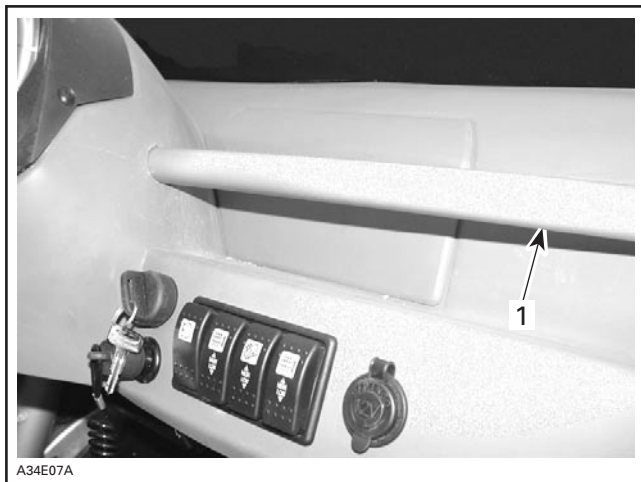

1. Dash-mounted handle

Located on right-hand side of structural upper chassis, there is another additional handle.

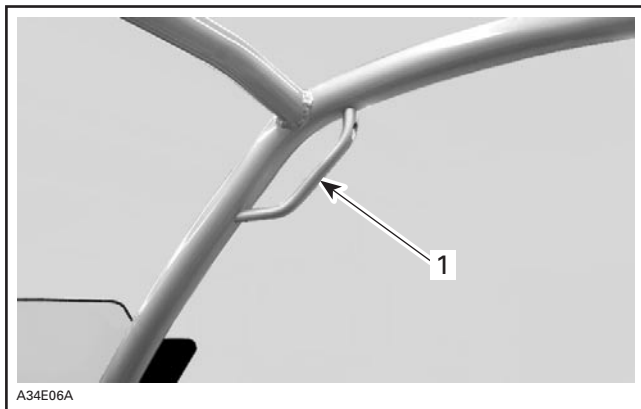

1. Handle

36) Electric Visor Jack Connector

There are two electric visor jack connectors, one for the driver and one for the passenger.

Electric visors can be connected to these jack connectors. Electric current is supplied whenever engine is running. Two stress relief extensions are supplied with the vehicle. They are included in the pre-delivery kit. Ask your authorized SKI-DOO dealer for the extensions.

37) Electric Power Outlet

A 12-volt electric appliance may be connected to that jack connector. Electric current is supplied when ever engine is running. See FUSES below for electric power outlet fuse location.



A29I04A

TYPICAL

38) Fog Lights Switch

Push the top portion of switch to turn on the fog lights.

39) Door Handle

To open the doors, either from outside of inside the vehicle, use door handle.



1. Door handle

Once a door is open, it can be removed from the vehicle. To do so, lift the door to unhook it from its hinges.

WARNING

- Always remain seated with your seat belt securely fastened and positioned properly at all times when riding.
- Never attempt to assist maneuvering by moving arms or legs outside vehicle. Keep limbs inside at all times.
- Always wear an approved helmet.

40) Engine Hood Latch

Stretch and unhook the latch to unlock the engine hood from its anchor.

WARNING

Engine hood must be properly latched whenever the vehicle is operated.

Always lift engine hood gently until stopped by retaining device.

Close engine hood slowly then hook up latch.

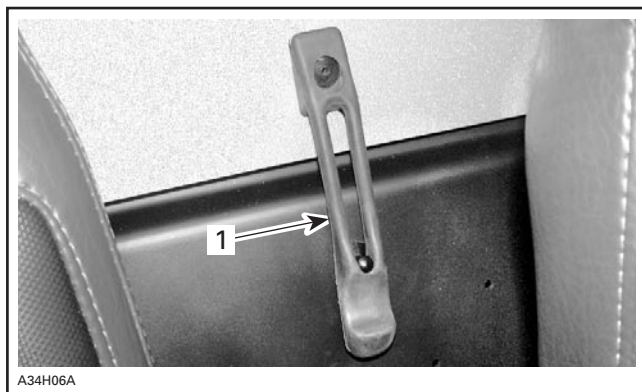

A34H06A

1. Engine hood latch

41) Fuses

Main Fuse and Alternator Fuse

These fuses are located on the battery rack.

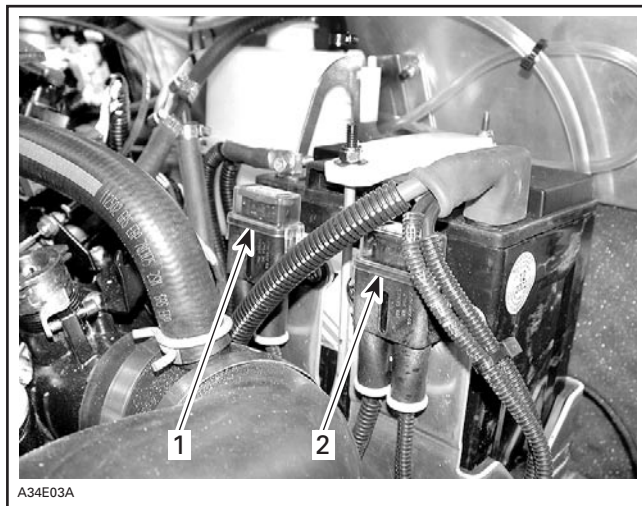

A34E03A

1. Main fuse 50 A
2. Alternator fuse 60 A

Engine Fuse Box

This fuse box is located in engine compartment, near coolant tank on engine compartment wall. Fuse description is printed above the fuse box cover. There are some spare fuses stored inside the cover.



1. Engine fuse box

Vehicle Fuse Box

This fuse box is located above passenger's feet. Fuse description is printed inside the fuse box cover. There are some spare fuses clipped inside the cover.

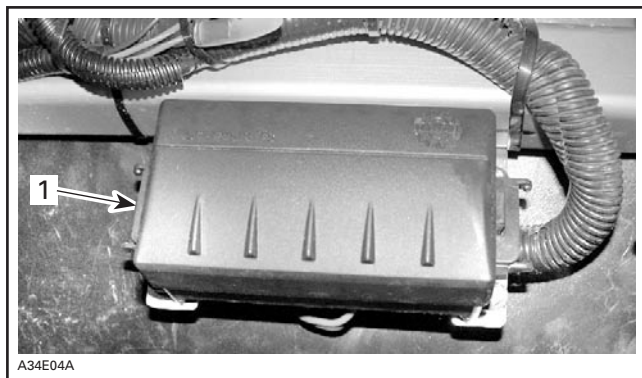

1. Vehicle fuse box

To remove fuse from fuse box, use fuse remover/installer found in fuse box above passenger's feet. Cover of engine fuse box can also be used as a fuse remover/installer.

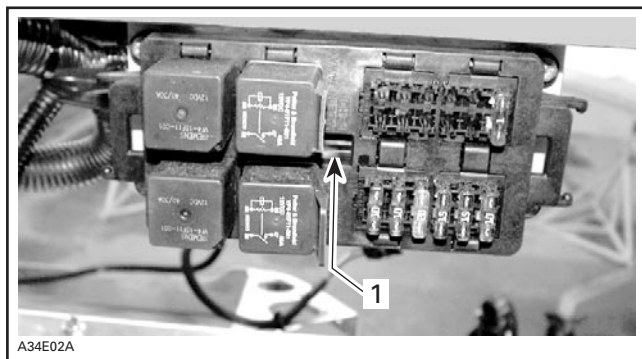

1. Fuse remover/installer location

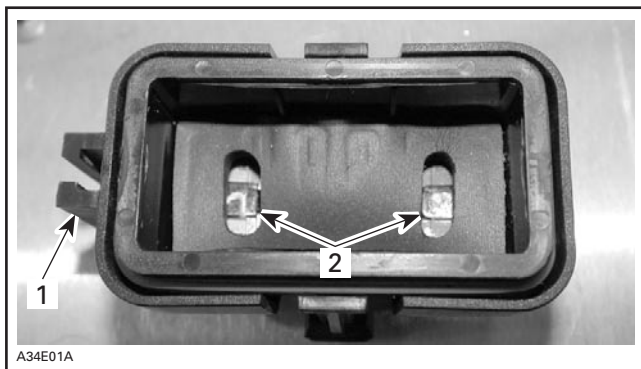

A34E01A

1. Portion of engine fuse box cover for removing a fuse
2. Spare fuse

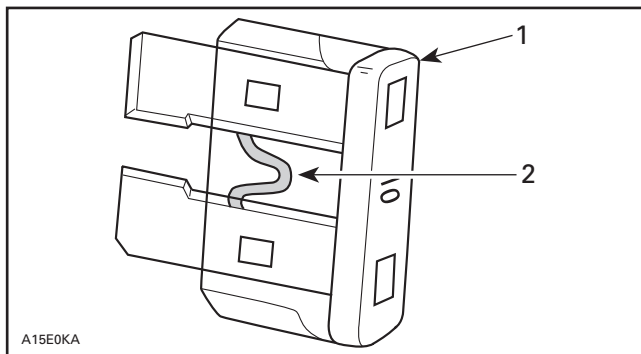

A15E0KA

1. Fuse
2. Check if melted

WARNING

If a fuse has burnt out, the source of malfunction should be determined and corrected before restarting. Never install fuses of higher rating than specified. This can cause severe damage including the possibility of fire. See an authorized SKI-DOO dealer for servicing.

42) Front Bumper

To be used whenever front of snowmobile requires manual pulling.

WARNING

Do not attempt to pull the vehicle by hand alone. Have assistance to share pulling stress in order to avoid risk of strain injuries. Do not attempt to lift the vehicle by hand. Use appropriate lifting device.

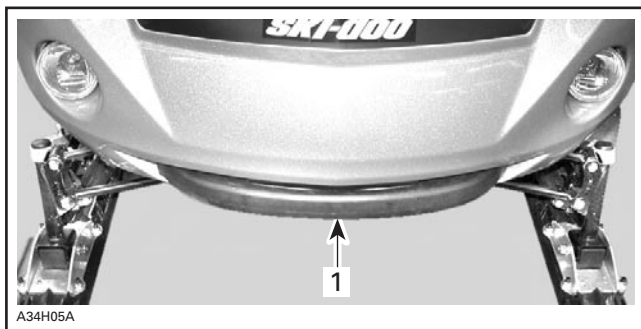

1. Front bumper

CAUTION: Do not use skis to pull or lift snowmobile.

43) Storage Compartment Catch Release

WARNING

Storage compartment must be properly latched whenever the vehicle is operated. Never put heavy or breakable objects in storage compartment.

To unlock storage compartment cover, pull down the catch release.

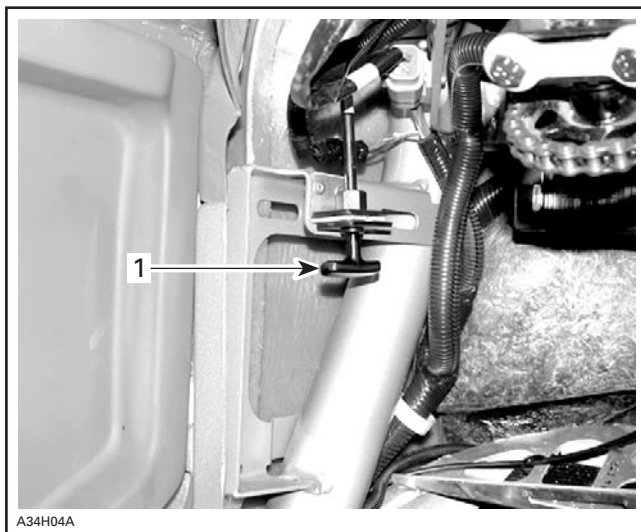

A34H04A

UNDERNEATH LEFT CORNER OF DASH

1. Catch release



A34H03A

STORAGE COMPARTMENT OPENING

44) Tool Kit

A tool kit containing tools for basic maintenance is supplied with the vehicle. Tool kit is located in storage compartment.

45) Spare Drive Belt Holder

A spare drive belt can be stored in holder found in storage compartment.

NOTE: Spare drive belt is not supplied with the snowmobile.

46) Shields and Guards

Your snowmobile is provided with a number of shields and guards. Leave these in place on your vehicle as they are designed to keep clothing and hands away from moving parts and hot components.

WARNING

Never operate engine:

- without shields and belt guard securely installed
- with hood opened or removed.

Never attempt to make adjustments to moving parts while engine is running.

47) Adjustable Suspensions

General

Snowmobile handling and comfort depend upon suspension adjustments.

For factory recommended adjustments refer to decal on engine compartment wall. It describes settings for optimum comfort according to the load for your SKI-DOO model.

Choice of suspension adjustments vary with carrying load, driver's and passenger's weight, personal preference, riding speed and field condition.

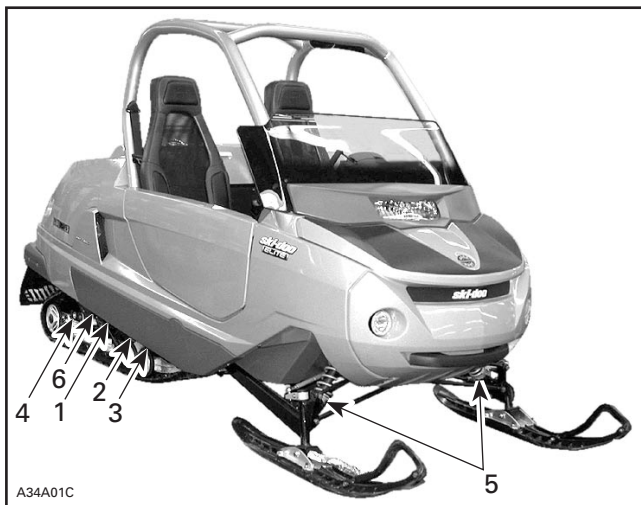

TYPICAL

1. *Rear springs for comfort*
2. *Center spring for comfort*
3. *Stopper strap for snowmobile weight transfer*
4. *Coupling blocks — Handling*
5. *Front springs for handling*
6. *Rear shock motion ratio — Damping strength*

Guidelines to Adjust Suspension

Following are guidelines to fine-tune suspension.

The best way to set up suspension, is to start from factory settings then customize each adjustment one at a time. Adjustments 2 through 6 are interrelated. It may be necessary to readjust center spring after adjusting front springs for instance. Test run the snowmobile under the same conditions; trail, speed, snow, etc. Change one adjustment and retest. Proceed methodically until you are satisfied.

WARNING

Always remove DESS tether cord cap before performing any maintenance or adjustment, unless otherwise specified. Vehicle must be parked in a safe place, away from the trail. Always lift the front of vehicle off the ground with a suitable lifting device before adjusting ski suspension. Lift the rear of vehicle off the ground with a suitable lifting device before rear suspension adjustment.

WARNING

Do not attempt to lift the vehicle by hand alone. Use appropriate lifting device to avoid risk of strain injuries. Always make sure the lifting device is stable and secure before proceeding to adjust the suspension components.

CAUTION: Whenever adjusting rear suspension, check track tension and adjust as necessary. Have both suspensions adjusted the same.

Slight suspension bottoming occurring under the worst riding conditions indicates a good choice of spring preload.

1. Rear Springs — Comfort

WARNING

Before proceeding with any suspension adjustment, remember:

- Park in a safe place.
- Remove DESS tether cord cap.
- Lift rear of vehicle off the ground with suitable lifting device.
- Make sure lifting device is stable and secure.

**TOO SOFT OF ADJUSTMENT
(REAR SUSPENSIONS ARE TOO SMOOTH)**



CAUTION: To increase preload, always turn the left side adjustment cam in a clockwise direction, and the right side cam in a counterclockwise direction. Left and right adjustment cams may be at different settings.

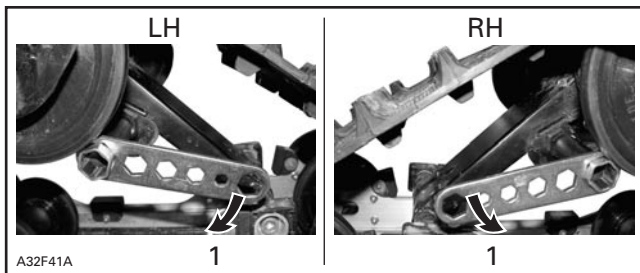

1. Increase spring preload

**TOO HARD OF ADJUSTMENT
(REAR SUSPENSIONS ARE TOO STIFF)**



CAUTION: To decrease preload, always turn the left side adjustment cam in a counterclockwise direction, the right side cam in a clockwise direction. Left and right adjustment cams may be at different settings.

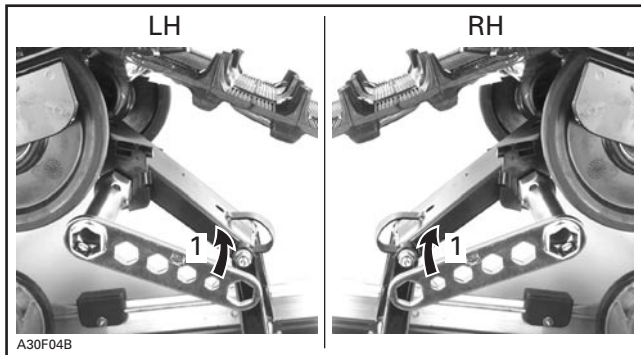

1. *Decrease spring preload*

2. Center Spring — Comfort

Ride at moderate speed on a trail.

If the rear suspensions are too stiff but don't bottom out or too smooth and bottom out, adjust center spring accordingly.

WARNING

Before proceeding with any suspension adjustment, remember:

- Park in a safe place.
- Remove DESS tether cord cap.
- Lift rear of vehicle off the ground with suitable lifting device.
- Make sure lifting device is stable and secure.

**TOO SOFT OF ADJUSTMENT —
SUSPENSIONS ARE TOO SMOOTH AND BOTTOM OUT**

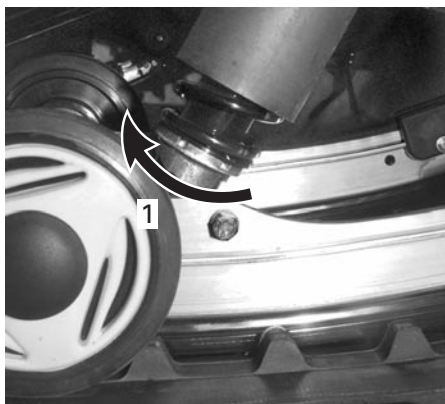

A32F01A

TYPICAL

1. Use adjuster wrench provided in tool kit to increase preload

**TOO HARD OF ADJUSTMENT —
SUSPENSIONS ARE TOO STIFF**

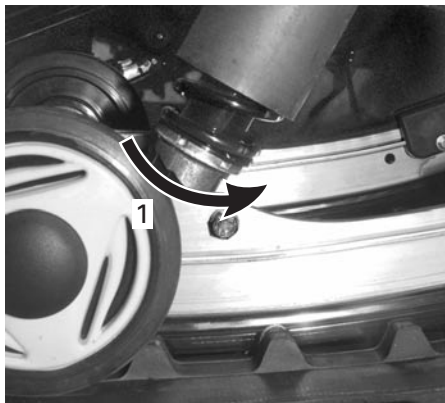

A32F01B

TYPICAL

1. Use adjuster wrench provided in tool kit to decrease preload

3. Stopper Strap — Weight Transfer

Ride at low speed then fully accelerate. Note steering behavior. Adjust length of stopper straps accordingly.

WARNING

Before proceeding with any suspension adjustment, remember:

- Park in a safe place.
- Remove DESS tether cord cap.
- Lift front of vehicle off the ground with suitable lifting device.
- Make sure lifting device is stable and secure.

CAUTION: Whenever length of stopper straps is changed, track tension must be readjusted.

TOO LONG STRAPS — SKIS LIFT OFF THE GROUND

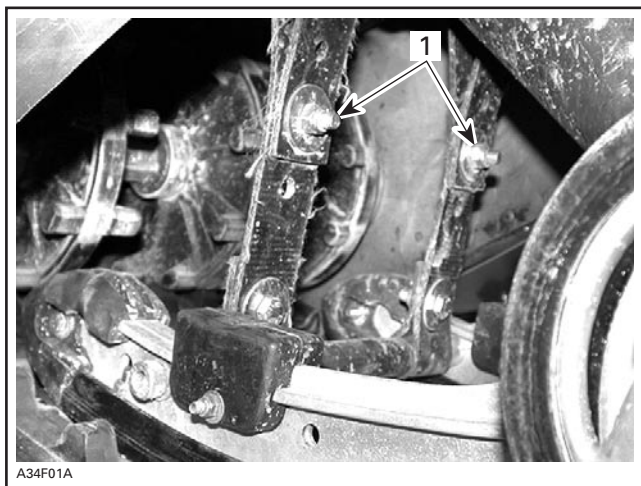

TYPICAL

1. Reduce length of straps by bolting to a different hole

TOO SHORT STRAPS — HEAVY STEERING

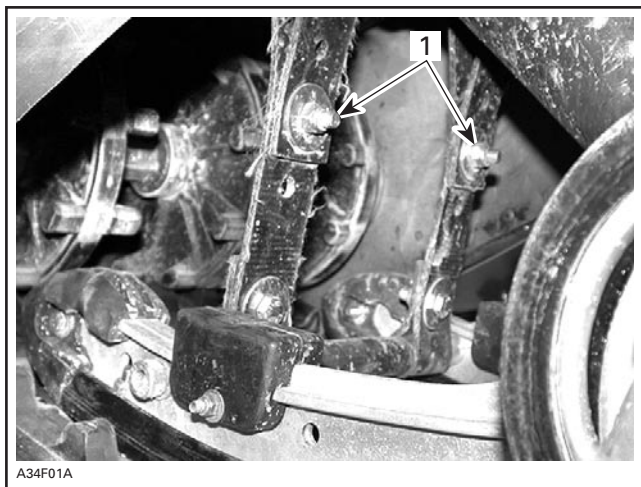

TYPICAL

1. Increase length of straps by bolting to a different hole

4. Coupling Blocks — Handling

Ride at moderate speed and check for desired handling.

When driver and passenger (if applicable) are seated in vehicle, the coupling blocks should be centered between rubber stoppers. This condition is achieved when a proper rear spring preload is done. See above REAR SPRING adjustment.

If handling requires adjustment, turn all 4 blocks by 90°.

There are only two adjustment positions. Thicker part of block must be facing rearward or downward.

As a general rule, thicker part of block should be facing rearward for more ski steering.

WARNING

All 4 blocks must be set at the same position. Otherwise vehicle behavior may be unpredictable and suspension may become warped.

Use tool provided in tool bag to adjust coupling blocks.

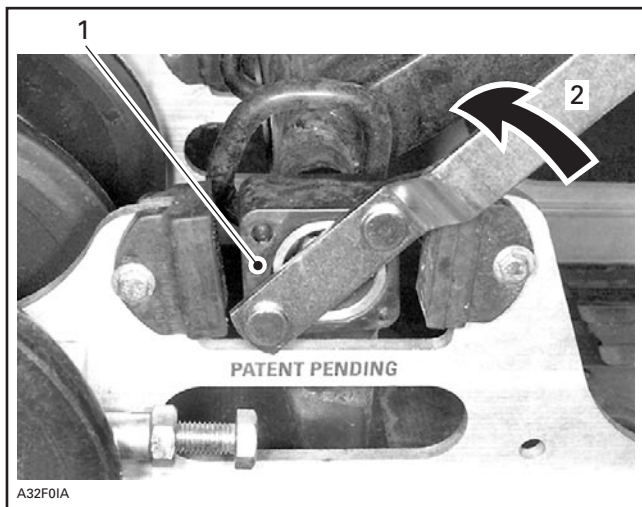

COUPLING BLOCK — RIGHT SIDE VIEW (“R” — RIGHT EMBOSSED ON BLOCK)

1. Thicker part of block facing rearward (fully coupled suspension) — less track grip and more skis steering
2. Turn block in this direction to adjust to the other position

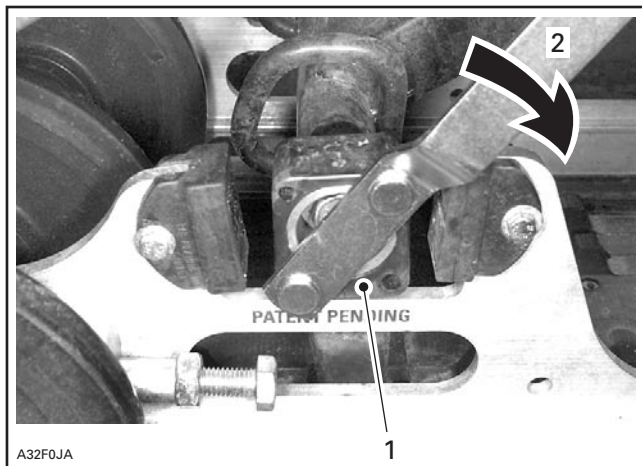

COUPLING BLOCK — RIGHT SIDE VIEW (“R” — RIGHT EMBOSSED ON BLOCK)

1. Thicker part of block facing downward (partly coupled suspension) — more track grip and less skis steering
2. Turn block in this direction to adjust to the other position

5. Front Springs — Handling

Ride at moderate speed and check for proper handling.

Adjust front springs accordingly.

⚠ WARNING

Before proceeding with any suspension adjustment, remember:

- Park in a safe place.
- Remove DESS tether cord cap.
- Lift front of vehicle off the ground with suitable lifting device.
- Make sure lifting device is stable and secure.

⚠ WARNING

Always adjust both front springs to same position.

**TOO SOFT OF ADJUSTMENT —
BAD HANDLING AND FRONT SUSPENSION BOTTOMS OUT**

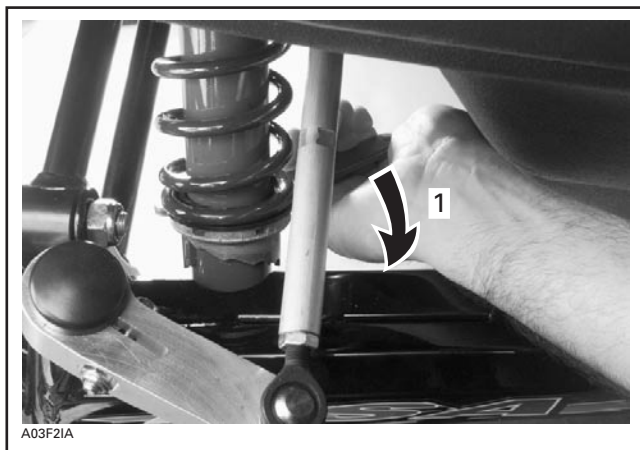

1. Increase spring preload

**TOO HARD OF ADJUSTMENT —
STEERING HARD TO TURN AND
FRONT SUSPENSION IS TOO STIFF**

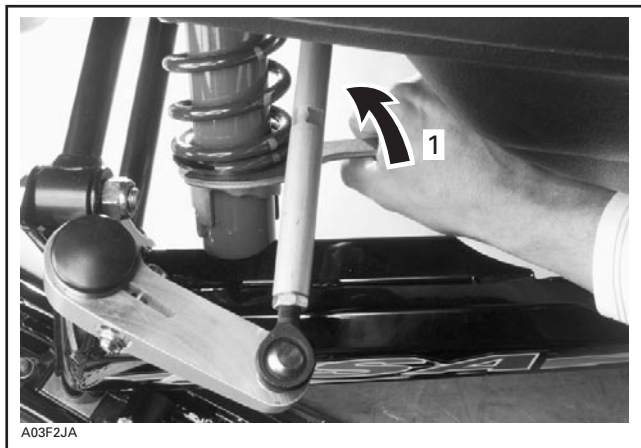

1. Decrease spring preload

6. Rear Shock Motion Ratio — Damping Strength

Rear shock motion ratio can be adjusted according to driver and passenger weight and/or trail condition.

There are two adjustment positions.

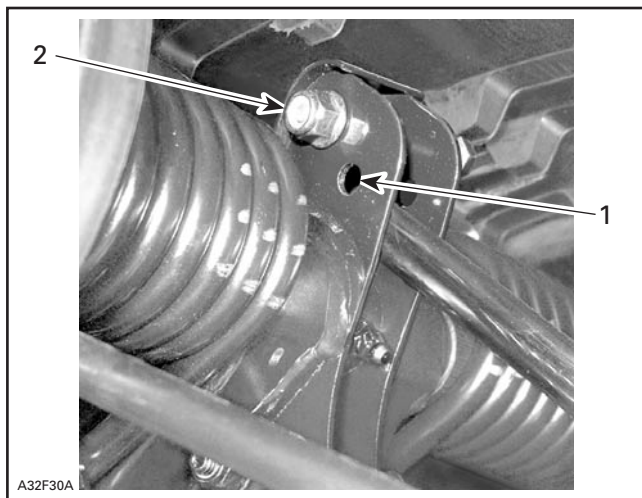

1. Soft position
2. Firm position

WARNING

Before proceeding with any suspension adjustment, remember:

- Park in a safe place.
- Remove tether cord DESS tether cord cap.
- Lift rear of vehicle off the ground with suitable lifting device.
- Make sure lifting device is stable and secure.

To adjust, remove nut, move bolt to desired position. Install a new nut and torque it to 24 N•m (18 lbf•ft).

WARNING

Never reuse elastic stop nut. Always install a new one.

Suspension Troubleshooting Chart

PROBLEM	CORRECTIVE MEASURES
Front suspension wandering	<ul style="list-style-type: none"> – Check ski alignment and camber angle adjustment. See an authorized SKI-DOO dealer. – Reduce ski ground pressure. <ul style="list-style-type: none"> • Reduce front suspension spring preload. • Increase center spring preload. • Reduce rear spring preload.
Snowmobile seems unstable and seems to pivot around its center	<ul style="list-style-type: none"> – Reduce rear suspension front arm pressure. <ul style="list-style-type: none"> • Reduce center spring preload. • Increase rear spring preload. • Increase front suspension spring preload.
Steering feels too heavy	<ul style="list-style-type: none"> – Reduce ski ground pressure. <ul style="list-style-type: none"> • Reduce front suspension spring preload. • Increase center spring preload.
Rear of snowmobile seems too stiff	<ul style="list-style-type: none"> – Reduce rear spring preload.
Rear of snowmobile seems too soft	<ul style="list-style-type: none"> – Increase rear spring preload.
Rear suspension front shock absorber is frequently bottoming	<ul style="list-style-type: none"> – Lengthen stopper strap. – Increase center spring preload.
Tracks spin too much at start	<ul style="list-style-type: none"> – Lengthen stopper strap. – Move thicker part of coupling block downward.

FUEL AND OIL

Recommended Fuel

Use regular unleaded gasoline, available from most service stations or oxygenated fuel containing less than 10% of ethanol or 5% of methanol. The gasoline used must have an octane number $(R + M)/2$ of 87 or higher.

NOTE: In most service station pump octane number corresponds to $(R + M)/2$ octane number.

CAUTION: Never experiment with other fuels or fuel ratios. The use of unrecommended fuel can result in snowmobile performance deterioration and damage to critical parts in the fuel system and engine components.

WARNING

Always stop the engine before refueling. Fuel is flammable and explosive under certain conditions. Always work in a well ventilated area. Do not smoke or allow open flames or sparks in the vicinity. Open cap slowly. If a differential pressure condition is noticed (whistling sound heard when loosening fuel tank cap) have vehicle inspected and/or repaired before further operation. Do not overfill or top off the fuel tank before placing the vehicle in a warm area. As temperature increases, fuel expands and might overflow. Always wipe off any fuel spillage from the vehicle. Periodically verify fuel system.

Fuel System Antifreeze

When using oxygenated fuel, additional gas line antifreeze or water absorbing additives are not required and should be not used.

When using non-oxygenated fuel, we highly recommend the use of isopropyl base gas line antifreeze in a proportion of 150 mL (5 U.S. oz) of gas line antifreeze added to 40 liters (10-1/2 U.S. gal) of gas.

This precaution is necessary in order to reduce the risk of frost build-up in carburetor(s) which may lead, in certain cases, to high fuel consumption or severe damage to engine.

NOTE: Use only **methyl hydrate free** gas line antifreeze.

Recommended Oil

This model is equipped with a 4-stroke engine.

Use BOMBARDIER 4-stroke synthetic oil 0W40 (P/N 293 600 054 — 12 x 1L).

NOTE: There is no known equivalent for this oil on the market for the moment. If a high quality equivalent were available, it could be used.

CAUTION: Check level and refill every time you refuel.

WARNING

Do not overfill. Reinstall cap and fully tighten. Wipe off any oil spills. Oil is highly flammable.

BREAK-IN PERIOD

Engine

CAUTION: A break-in period of 10 operating hours — 500 km (300 miles) — is required before running the snowmobile at full throttle.

During break-in period, maximum throttle should not exceed 3/4. However, brief full acceleration and speed variations contribute to a good break-in.

CAUTION: Engine overheating, continued wide open throttle runs and prolonged cruising without speed variations should be avoided, this can cause engine damage during the break-in period.

Belt

A new drive belt requires a break-in period of 50 km (30 miles). Avoid strong acceleration/deceleration, pulling a load or high speed cruising.

10-Hour Inspection

As with any precision piece of mechanical equipment, we suggest that after the first 10 hours of operation — 500 km (300 miles) — or 30 days after the purchase, whichever comes first, your snowmobile be checked by an authorized SKI-DOO dealer. This inspection will also give you the opportunity to discuss any unanswered questions you may have encountered during the first hours of operation.

The 10-hour inspection is at the expense of the snowmobile owner.

PRE-OPERATION CHECK

WARNING

The pre-operation check is very important prior to operating the vehicle. Always check the proper operation of critical controls, safety features and mechanical components before starting. If not done as specified here, severe injury or death might occur.

- Remove snow and ice from body including seats, interior, lights, controls and instruments.
- Verify that tracks and idler wheels are free to turn.

WARNING

Always use a wide base snowmobile mechanical stand to properly support vehicle during any track verification. Slowly accelerate engine in order to rotate tracks at very low speed when they are not on ground.

- Activate the brake control lever and make sure the brake fully applies before the brake control lever touches the handlebar grip. It must fully return when released.
- Check the parking device. Apply parking brake and check if it operates properly.
- Activate the throttle control lever several times to check that it operates easily and smoothly.

WARNING

Throttle lever must operate easily and smoothly. It must return to idle position when released, otherwise, do not start engine.

- Check operation of DESS and engine cut-out switches, ignition switch, headlamp switch (HI-LO), taillight, brake light and pilot lamps.
- Check gear shift lever position.
- Verify that skis and steering operate freely. Check corresponding action of skis versus steering wheel.
- Check fuel and oil for levels and leaks. Replenish as necessary and see an authorized SKI-DOO dealer in case of any leaks.
- Verify that air filter(s) is free of snow, if so equipped.
- Storage compartment must be properly latched and it must not contain any heavy or breakable objects. Hood must be also properly latched.

WARNING

All adjustable features should be positioned at optimal setting. Securely tighten all adjustment locks.

- Make sure both driver and passenger have an approved helmet on and securely fastened.
- Make sure both driver and passenger have their seat belt securely fastened and positioned properly.
- Make sure your snowmobile is pointed away from people or objects before you start it. No one is to be standing in front of or in back of the snowmobile.
- Be warmly dressed with clothing designed for snowmobiling.

PRE-OPERATION CHECK LIST

ITEM	OPERATION	✓
Body including seats, interior, lights, controls and instruments	Check that there is no snow or ice.	
Tracks and idler wheels	Check for free movement.	
Brake lever	Check proper action.	
Parking device	Check proper action.	
Throttle lever	Check proper action.	
Switches and lights	Check proper action.	
Skis and steering	Check for free movement and proper action.	
Fuel and oil	Check for proper level and leaks.	
Air filter	Check that there is no snow or ice.	
Adjustable features	Check for optimal adjustment and securely tightened adjustment locks.	
Storage compartment and engine hood	Check for proper latching and no heavy or breakable objects.	
Vehicle vicinity	Snowmobile must be pointed away from people or objects. No one is to be standing in front of or in back of the snowmobile.	
Clothing	Be warmly dressed according to weather forecast.	
Helmet	Make sure both driver and passenger put on an approved helmet and fasten it securely.	
Seat belts	Make sure that both driver and passenger have their seat belts securely fastened and positioned properly.	

OPERATING INSTRUCTIONS

WARNING

Proceed with pre-operation check list before riding.

Principle of Operation

Propulsion

Depressing throttle lever increases engine RPM causing the drive pulley to engage. Engine RPM must be around 2200 before drive pulley engages.

The outer sheave of the drive pulley moves toward the inner sheave, forcing drive belt to move upward on the drive pulley and simultaneously forcing the sheaves apart on the driven pulley.

The driven pulley senses the load on the tracks and limits the belt movement. The result is an optimized speed ratio between engine RPM and the speed of the vehicle at any time.

WARNING

Never operate engine without belt guard securely installed or, with hood or access/side panels open or removed.

Power is transferred to the tracks through the gearbox, final drive belt and drive axle.

WARNING

Always use a wide-base snowmobile mechanical stand to properly support vehicle during any track verification. Slowly accelerate engine in order to rotate tracks at very low speed when it is not on ground.

Turning

As the steering wheel is rotated to right or left, the skis are turned right or left to steer the snowmobile.

Stopping

Before riding your snowmobile, you should understand how to stop it. This is done by releasing the throttle and gradually depressing the brake lever on the left side of the steering wheel. In an emergency, you may stop your vehicle by pressing the engine cut-out switch located near the throttle control and applying the brake. Remember, a snowmobile cannot “stop on a dime”. Braking characteristics vary with deep snow, packed snow or ice. If the tracks are locked during hard braking, skidding may result.

Starting the Engine

- Driver and passenger must buckle up their safety belt.
- Re-check throttle control lever operation.
- Ensure that the engine cut-out switch is in the ON position.
- Ensure that the DESS tether cord cap is in position.

WARNING

Do not depress throttle lever (even only partially) when starting engine to avoid sudden acceleration.

Insert key in ignition switch.

First, turn key to ON position and wait for a double beep to be heard. This indicates that both the EMS (engine management system) and the VMS (vehicle management system) have recognized the code in the DESS tether cord cap.

Turn key clockwise until starter engages.

CAUTION: Do not use electric starter for more than 10 seconds. A rest period should be observed between the cranking cycles to let electric starter cool down. Using electric starter when engine has started could damage electric starter mechanism.

Release the key as soon as the engine starts. Key returns to ON position as soon as it is released.

If the engine does not start on the first try, turn the key back to OFF and wait a few seconds before restarting. To stop engine, turn the key to OFF.

NOTE: With the engine running, turning the key from ON position to START position will shut-off the engine.

If the starter does not operate, check the starting system fuse condition. Refer to FUSES.

Shutting Off the Engine

Release throttle lever and wait until engine has returned to idle speed.

Shut off the engine using either ignition switch, engine cut-out switch or DESS switch.

WARNING

Always remove DESS tether cord cap and key when vehicle is not in operation in order to prevent accidental engine starting or to avoid unauthorized use by children or others or theft.

VEHICLE WARM-UP

Before every ride, vehicle has to be warmed up as follows.

Snowmobile must be securely supported by the rear bumper using a wide-base snowmobile mechanical stand. Tracks must be 100 mm (4 in) off the ground.

Start engine and allow it to warm up two or three minutes at idle speed.

Release parking brake.

WARNING

Make sure wide-base snowmobile mechanical stand is stable. Stay clear of the front of vehicle and the tracks. Do not use too much throttle during warm-up or when tracks are free-hanging.

Apply throttle until drive pulley engages. Let tracks rotate at low speed for several turns. The lower the vehicle temperature is the longer vehicle warm-up should be.

Shut-off the engine and remove the wide-base snowmobile mechanical stand.

Skis may be frozen on the ground. Grab both skis one at a time by their loops and lift their front end slightly off the ground.

After restarting engine, the vehicle can be driven at low speed for the first 2 or 3 minutes of riding. After that, it may be driven up to the legal speed limit as per normal safety practices.

RIDING THE VEHICLE

At this point you are acquainted to the specifics of these models of snowmobile and you are instructed about the control locations and operation.

Before starting out on your first ride with this vehicle, read the following safety information in order to know what are the safe operating practices.

Although the mere reading of such information does not eliminate the hazard, understanding and heeding of all the warnings and cautions will promote the safe use of the vehicle.

Before venturing on the trails, operate the snowmobile in a restricted flat area until you are completely familiar with its operation and feel comfortable that you can safely tackle a more demanding task. Have an enjoyable and safe ride.

HOW TO RIDE

The performance of this snowmobile is very different and may significantly exceed that of other snowmobiles you have operated.

Every driver should become familiar with the snowmobile through practice on a level area at slow speeds before venturing afield.

Bombardier recommends not to operate this snowmobile under the age of 16.

WARNING

Do not attempt any maneuvers if they are beyond your level of ability.

Sitting

WARNING

- Always remain seated with your seat belt securely fastened and positioned properly at all times when riding.
- Never attempt to assist maneuvering by moving arms or legs outside vehicle. Keep limbs inside at all times.
- Always wear an approved helmet.

Seat Belt

Proper fit of the seat belt is essential to ensure protection in case of an impact. A seat belt that does not fit or is not positioned properly is dangerous, and therefore, no driver nor passenger should be allowed to ride in this snowmobile if a proper fit of the seat belt cannot be achieved. To fit properly, the lap portion of the belt should lie securely across the occupant's upper thigh, and the shoulder portion of the belt should fit snugly across the chest and rest between the neck and the shoulder. In addition, you must make sure that the occupant is tall enough to sit with his back against the seat back rest, with his knees bent over the edge of the seat without slouching. For a child, according to the National Highway Traffic Safety Administration (NHTSA), this occurs at approximately eight years of age and 145 cm (4 feet 9 inches). The positioning of the seat belt is also essential. Never allow an occupant to ride with the shoulder portion of the belt resting behind his back, under the arm, across the neck or the abdomen. Remember, a seat belt that is not positioned properly or does not fit properly is dangerous and could result in severe injuries in case of an impact. And it goes without saying that a seat belt that is not buckled up offers no degree of protection whatsoever in case of an impact!

WARNING

All occupants must be tall enough to sit properly and allow the seat belt to fit properly. A seat belt that does not fit or is not positioned properly is dangerous and could lead to severe injuries or death in case or an impact.

TERRAIN/RIDING VARIATIONS

Groomed Trail

Do not race and, above all, keep to the right hand side of the trail. Be prepared for the unexpected. Observe all trail signs. Do not zigzag from one side of the trail to the other.

Uneven Terrains

Due to the nature of this snowmobile configuration, it is advisable to remain in groomed trails at all times. However, situations will be encountered when you will have to negotiate uneven terrains or obstacles such as when crossing an embankment for example. Always remember that this snowmobile differs from other ones you may have ridden due to the fact that, being seated and restrained by the seat belt, you cannot change your riding position to shift your center of gravity and consequently alter the balance and behavior of the vehicle. Therefore, extra caution should be used whenever negotiating sloped surfaces, and steep inclines should be avoided to prevent the risk of loss of control that could potentially result in severe injuries. Whenever faced with uneven terrains or obstacles, especially those involving significant inclines, use your common sense. If you judge that it is safe to proceed, do so with extreme caution. Remember, if the snowmobile reaches the point of loss of control, you won't be able to compensate by shifting your weight around.

WARNING

- Always remain seated with your seat belt securely fastened and positioned properly at all times when riding.
- Never attempt to assist maneuvering by moving arms or legs outside vehicle. Keep limbs inside at all times.
- Always wear an approved helmet.

Slush

Slush should be avoided at all times. Always check for slush before starting across any lake or river. If dark spots appear in your tracks, get off the ice immediately. Ice and water can be thrown rearward into the path of a following snowmobile. Getting a vehicle out of a slush area is strenuous and in some cases, impossible.

Fog or Whiteouts

On land or water, fog or visibility-limiting snow can form. If you have to proceed into the fog or heavy snow, do so slowly with your lights on and watch intently for hazards. If you are not sure of your way, do not proceed. Keep a safe distance behind other snowmobilers to improve visibility and reaction time.

Unfamiliar Territory

Whenever you enter an area that is new to you, drive with extreme caution. Go slow enough to recognize potential hazards such as fences or fence posts, brooks crossing your path, rocks, sudden dips, guy wires and countless other obstacles which could result in a termination of your snowmobile ride. Even when following existing tracks, be cautious. Travel at a speed that will allow you to see what is around the next curve or over the top of the hill.

Bright Sunshine

Bright sunny days can considerably reduce your vision. The glare from sun and snow may blind you to the extent that you cannot easily distinguish ravines, ditches or other obstacles. Goggles with colored lenses should always be worn under these conditions.

Unseen Obstruction

There may be obstructions hidden beneath the snow. Driving off established trails and in the woods requires reduced speed and increased vigilance. Driving too fast in an area can make even minor obstacles very hazardous. Even hitting a small rock or stump could throw your snowmobile out of control and cause injury to its riders. Stay on established trails to reduce your exposure to hazards. Be safe, slow down and enjoy the scenery.

Hidden Wires

Always be on the lookout for hidden wires, especially in areas that may have been farmed at one time or another. Too many accidents have been caused by running into wires in the fields, guy wires next to poles and roads, and into chains and wires used as road closures. Slow speeds are a must.

Obstacles and Jumping

Unplanned jumps of snowdrifts, snowplow ridges, culverts or indistinguishable objects can be dangerous. You can avoid them by wearing the proper color lenses or face shields and by operating at a lower speed.

Jumping a snowmobile is an unsafe and dangerous practice. However, if the trail does suddenly drop away from you, keep steering in straight ahead position and keep limbs inside vehicle.

Road Crossing

In some cases, you will be approaching the road from a ditch or snowbank. Choose a place where you know you can climb without difficulty. Proceed with only as much speed needed to crest the bank. Stop completely at the top of the bank and wait for all traffic to clear. Judge the drop to the roadway. Cross the road at a 90° angle. Remember, your snowmobile is not designed to operate on bare pavement and steering on this type of surface is more difficult.

Railroad Crossing

Never ride on railroad tracks. It is illegal. Railroad tracks and railroad rights-of-way are private property. A snowmobile is no match for a train. When crossing a railroad track, stop, look and listen.

Night Rides

The amount of natural and artificial light at a given time can effect your ability to see or to be seen. Nighttime snowmobiling is delightful. It can be a unique experience if you acknowledge your reduced visibility. Before you start, make certain your lights are clean and work properly. Drive at speeds that will allow you to stop in time when you see an unknown or dangerous object ahead. Stay on established trails and **never** operate in unfamiliar territory. Avoid rivers and lakes. Guy wires, barbed wire fences, cabled road entrances and other objects such as tree limbs are difficult to see at night. Never drive alone. Always carry a flashlight. Keep away from residential areas and respect the right of others to sleep.

Safari Riding

Before starting out, designate a “trail boss” to lead the party and another person to follow-up at the end of the party. Ensure that all members of the party are aware of the proposed route and destination. Make certain that you are carrying all necessary tools and equipment and that you have sufficient fuel to complete the trip. Never overtake the trail boss or, for that matter, any other snowmobile. Use down-the-line hand signals to indicate hazards or intent of direction change. Assist others whenever necessary.

It is always IMPORTANT to keep a safe distance between each snowmobile. Always maintain a safe interval and allow sufficient stopping distance. Don't be a tailgater. Know the position of the machine ahead.

Signals

If you intend to stop, raise either hand straight above your head. A left turn is indicated by extending your left hand straight out in the proper direction. For right turns, extend the left arm and raise the hand to a vertical position so it forms a right angle at the elbow. Every snowmobiler should relay any signal to the ones behind.

Carrying a Passenger

Each operator has a responsibility to ensure the safety of his passenger. You should inform him of snowmobiling basics. Make sure that you instruct your passenger to buckle up his seat belt and wear an approved helmet. In addition, make sure that your passenger is tall enough to achieve a proper seating position and seat belt fit. Make sure his seat belt is positioned properly with the shoulder portion resting snugly across the chest between the neck and the shoulder. Never allow a passenger to ride with the shoulder portion of the belt behind his back, under the arm, or across his neck or abdomen. Never carry more than one passenger. Overloading is dangerous and the machine is not designed for it. Be extremely careful, go more slowly and check the passenger frequently.

Never allow anyone to sit between the steering wheel and the operator.

Use extra caution and reduce speed with young passengers. Smooth starting and stopping are required. You have the benefit of anticipating the maneuvers as well as the additional support of your grip on the steering wheel.

Your passenger has to rely on your careful and safe operation of the vehicle. Use moderate speeds. Warn passengers of side hills, bumps, branches, etc. Also, be certain that you and your passenger are warm enough and that no skin is exposed.

Trail Stops

Whenever possible, pull off the trail when you stop. This will reduce the hazard to other snowmobilers using the trail.

Trails and Signs

Trail signs are used to control, direct or regulate the use of snowmobiles on trails. Become familiar with all signs used in the area where you are snowmobiling.

POST-OPERATION CARE

Shut off the engine. Install rear of vehicle on a wide-base snowmobile mechanical stand.

Remove snow and ice from rear suspensions, tracks, front suspension, steering mechanism and skis.

Protect vehicle with a snowmobile cover.

SPECIAL OPERATIONS

Riding at High Altitudes

If you ride at altitudes above 600 m (2000 ft), your snowmobile should be modified. Refer to an authorized SKI-DOO dealer.

CAUTION: Do not change original factory calibration if snowmobile is used below 600 m (2000 ft).

Engine Overheating

Engine overheating pilot lamp will light up if engine is too hot.

Reduce snowmobile speed and run snowmobile in loose snow or stop engine immediately.

Check for adequate coolant level. See an authorized SKI-DOO dealer.

Rear Suspension Slider Shoe Sticking

Slider shoes are cooled and lubricated by snow. When riding at moderate or high speed on a thin-snow-covered surface, slider shoes may stick on metallic track guides.

Run snowmobile on a surface covered by snow or drive snowmobile at very slow speed.

Have slider shoes inspected by an authorized SKI-DOO dealer.

MAINTENANCE INFORMATION





PERIODIC MAINTENANCE CHART





WARNING

Observe WARNINGS and CAUTIONS mentioned throughout this guide which are pertinent to the item being checked. When component conditions seem less than satisfactory, replace with genuine BOMBARDIER parts or approved equivalents.

Refer to MAINTENANCE in *Shop Manual* for more details.

- ① 10-HOUR OR 500 km (300 miles) INSPECTION
(to be performed by an authorized SKI-DOO dealer)
- ② WEEKLY OR EVERY 240 km (150 miles)
- ③ MONTHLY OR EVERY 800 km (500 miles)
- ④ ONCE A YEAR OR EVERY 5000 km (3100 miles)
- ⑤ EVERY 10 000 km (6200 miles)
- ⑥ STORAGE (to be performed by an authorized SKI-DOO dealer)
- ⑦ PRESEASON PREPARATION
(to be performed by an authorized SKI-DOO dealer)

PERIODIC MAINTENANCE CHART		①	②	③	④	⑤	⑥	⑦
	Engine Nuts and Screws	I			I		I	
	Exhaust System	I		I			I	
	Engine Lubrication						L	
	Cooling System	I			I			I
	Coolant	I					R	
	Condition of Seals						I	I
	Engine Oil and Filter Replacement	R			R		R	
	Fuel Stabilizer						R	
	Fuel Injection System (visual inspection)					I		I
	Fuel Lines and Connections	I					I	I
	Throttle Cable	I			I		I	I
	Air Filter			C				C
	Drive Belt	I	I					I
	Final Drive Belt	I			I	R	I	I
	Drive and Driven Pulleys	I		I	C		I	C
	Tightening Torque of Drive Pulley Screw	I			I			I
	Driven Pulley Preload	I			I		I	

PERIODIC MAINTENANCE CHART		①	②	③	④	⑤	⑥	⑦
	Brake Fluid	I	I				R	I
	Brake	I	I	A			I,A	I
	Gearbox Oil	R		I			R	I
	Drive Axle**	L		L			L	
	Steering and Front Suspension Mechanism**	A,I,L		A,I	L		A,I,L	
	Wear and Condition of Skis and Runners	I	I				I	
	Suspension Adjustments	AS REQUIRED						
	Suspension**	I		I,L			I,L	
	Suspension Stopper Strap				I		I	
	Tracks	I		I			I	
	Track Tension and Alignment	A	AS REQUIRED					
	EMS Fault Codes	I			I			
	ECU Connectors				I			
	Spark Plugs*	I						R
	Battery	I		I			I	I
	Alternator Belt	I			I		I	
	Headlamp Beam Aiming				A			A
	Wiring Harnesses, Cables and Lines	I		I			I	
	Operation of Lighting System (HI/LO beam, brake light, etc.), Test Operation of Engine Cut-Out Switch and DESS Switch	I	I				I	
	Rags in Air Intake and Exhaust System						R	C
	Engine Compartment	C		C			C	
	Vehicle Cleaning and Protection	C		C			C	

A = ADJUST

I = INSPECT (clean, inspect, repair, adjust and lubricate)

L = LUBRICATE

R = REPLACE

C = CLEAN

*Before installing new spark plugs at pre-season preparation, it is suggested to burn excess storage oil by starting the engine with the old spark plugs. Only perform this operation in a well ventilated area.

**Lubricate whenever the vehicle is used in wet conditions (wet snow, rain, puddles).

FLUID LEVELS

WARNING

It is recommended that the assistance of an authorized SKI-DOO dealer be periodically obtained on other components/systems not covered in this guide. Unless otherwise specified, engine must be cold and not running. Always Remove DESS tether cord cap before performing any maintenance or adjustment, unless otherwise specified. Vehicle must be parked in a safe place, away from the trail.

CAUTION: Vehicle must be on a level surface before checking any fluid levels.

Brake System

Check brake fluid (DOT 4) in reservoir for proper level. Add fluid (DOT 4) as required.

CAUTION: Use only DOT 4 brake fluid from a sealed container. Never use any other types of fluid. Immediately wipe off any spillage, as brake fluid can damage painted surfaces.



TYPICAL — BRAKE FLUID RESERVOIR

1. *Minimum*

Engine Oil Level

CAUTION: Check level frequently and refill if necessary. Do not overfill it would make the engine smoke and reduce its power. Operating the engine with an improper level may severely damage engine. Wipe off any spillage.

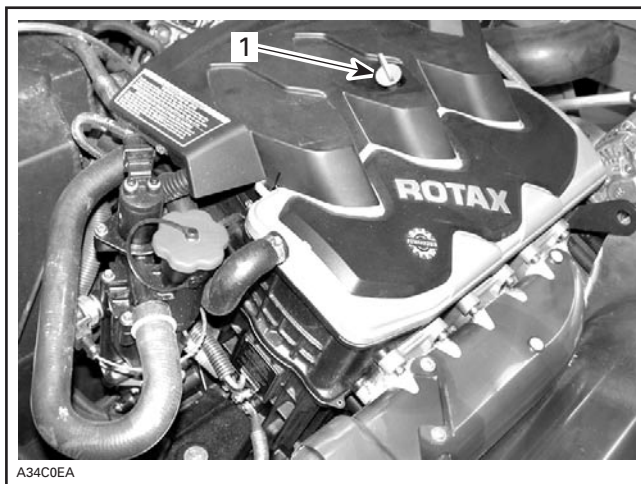

TYPICAL

1. Dipstick

Check the oil level as follows:

NOTE: Before checking the oil level on this engine, it is necessary to let it idle for 30 seconds **before** shutting it off. Thereafter it is necessary to wait 30 seconds. Then, the oil can be checked. This is required to allow the oil to properly level in the different oil chambers. Otherwise, the oil level reading will be wrong.

1. Vehicle must be level. Engine must be warm.
2. Warm-up engine then let **idle for 30 seconds** before stopping.
3. Stop engine.
4. **Wait at least 30 seconds** then pull dipstick out and wipe clean.

WARNING

Engine oil may be hot. Certain components in the engine compartment may be very hot. Direct contact may result in skin burn.

5. Reinstall dipstick, push in completely.
6. Remove dipstick and read oil level. It should be between marks.

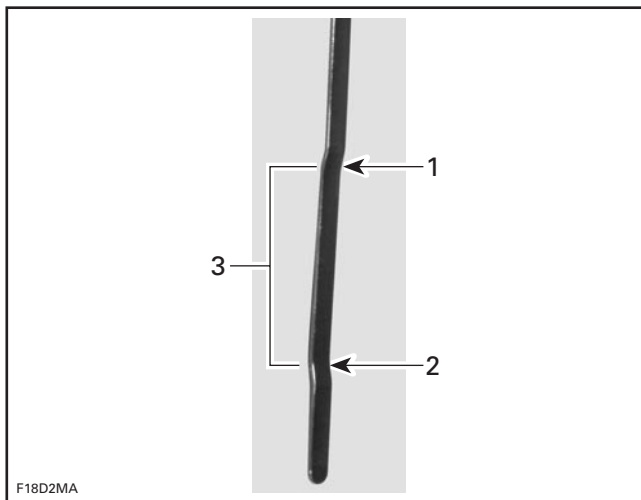

1. Full
2. Add
3. Operating range

NOTE: There is a capacity of 1 L (34 U.S. oz) between the two marks.

7. Otherwise, add oil up to have the level between marks as required.
8. To add oil, unscrew oil cap. Place a funnel into the opening and add the recommended oil to the proper level. **Do not overfill.**

NOTE: Every time oil is added in engine, the complete procedure explained above must be done (engine restarted, idling for 30 seconds, 30 seconds waiting time and then, rechecking the oil level). This is required to allow the oil to properly transfer in the different oil chambers and to then level. Otherwise, the oil level reading will be wrong.

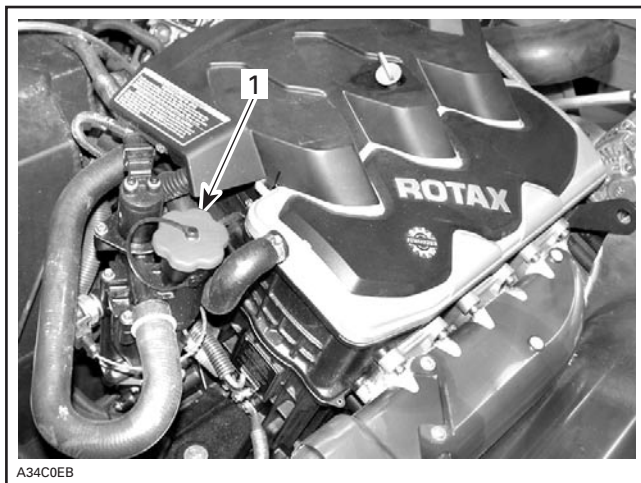

A34C0EB

TYPICAL

1. Oil cap

9. Properly reinstall oil cap and dipstick.

Gearbox Oil Level

With snowmobile on a level surface, check the oil level by removing dipstick. Oil level must be between lower and upper marks.

NOTE: It is normal to find metallic particles stuck to dipstick magnet. If bigger pieces of metal are found, see an authorized SKI-DOO dealer.

Remove metal particles from magnet.

Refill up to upper mark using BOMBARDIER synthetic chaincase oil (P/N 413 803 300 — 12 x 355 mL).

CAUTION: Do not use other unrecommended types of oil when servicing. Do not mix synthetic oil with other types of oil.

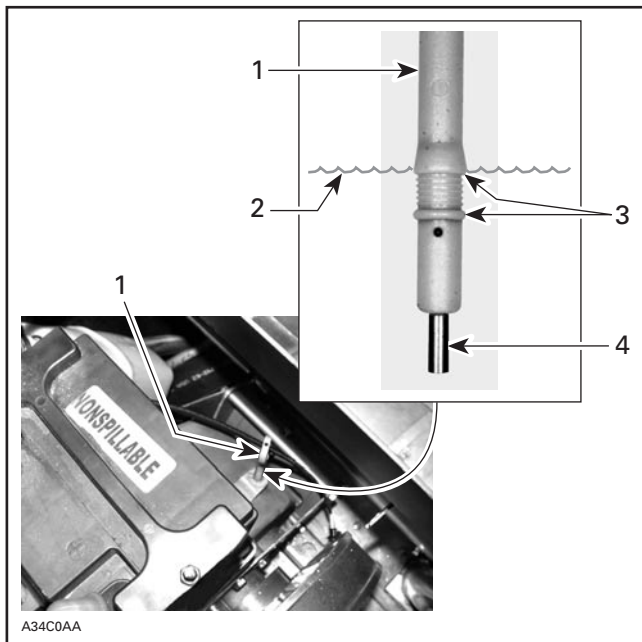

TYPICAL — IN ENGINE COMPARTMENT, BETWEEN BATTERY AND ENGINE COMPARTMENT WALL

1. Dipstick
2. Oil level
3. Level between marks
4. Magnet

Cooling System

Check coolant level at room temperature with engine cold. Liquid should be between MINIMUM and MAXIMUM level lines of coolant reservoir.

NOTE: When checking level at low temperature it may be slightly lower than MINIMUM level line.

If additional coolant is necessary or if entire system has to be refilled, refer to an authorized SKI-DOO dealer.

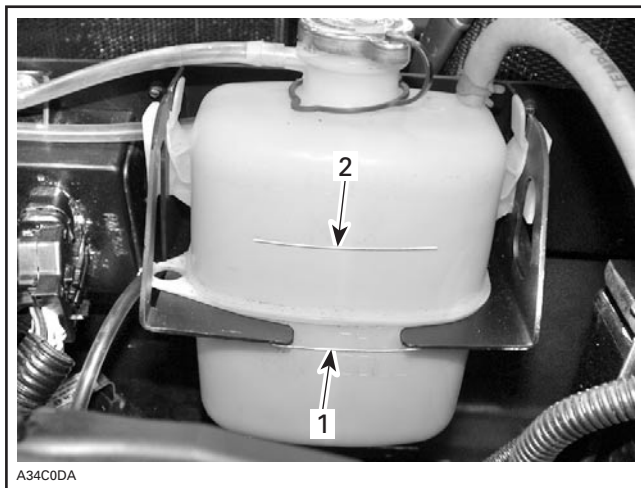

1. MINIMUM line
2. MAXIMUM line

WARNING

To prevent risk of burn injuries,

- Never open coolant reservoir cap when engine is hot.
- Never open coolant reservoir cap while someone is seated in the vehicle.

Battery Electrolyte

This model is equipped with a maintenance-free battery. Electrolyte level can not be checked.

WARNING

Battery BLACK negative cable must always be disconnected first and connected last.

WARNING

Never charge or boost battery while installed. Battery electrolyte contains sulfuric acid which is corrosive and poisonous. In case of contact with skin, flush with water and call a physician immediately.

WARNING

Should the battery casing be damaged, wear a suitable pair of non-absorbent gloves when removing the battery by hand.

CAUTION: Should any electrolyte spillage occur, immediately wash off with a solution of baking soda and water to prevent damage to vehicle components.

MAINTENANCE

WARNING

It is recommended that the assistance of an authorized SKI-DOO dealer be periodically obtained on other components/systems not covered in this guide. Unless otherwise specified, engine must not be running and cold. Always remove DESS tether cord cap before performing any maintenance or adjustment, unless otherwise specified. Vehicle must be parked in a safe place, away from the trail.

Vehicle Cleaning and Protection

Remove any dirt or rust.

To clean the entire vehicle, use only flannel cloths or equivalent. Use water and mild detergent.

CAUTION: It is necessary to use flannel cloths or equivalent on windshield and hood to avoid further damaging the surfaces to clean.

To clean metallic parts use Heavy duty cleaner (P/N 293 110 001 (spray can 400 g) and P/N 293 110 002 (4 L)).

CAUTION: Do not use Heavy duty cleaner on decals or vinyl.

For vinyl and plastic parts use Vinyl & Plastic Cleaner (P/N 413 711 200 (6 x 1 L)).

To remove scratches on windshield or hood use BOMBARDIER Scratch Remover Kit (P/N 861 774 800).

CAUTION: Never clean plastic parts or hood with strong detergent, degreasing agent, paint thinner, acetone, products containing chlorine, etc.

Clean sheaves of both pulleys using Pulley flange cleaner (P/N 413 711 809).

Inspect the body and repair any damage.

Touch up all metal spots where paint has been scratched off. Spray all metal parts including shock absorbers chromed rods with BOMBARDIER LUBE (P/N 293 600 016).

Wax the body for better protection. Use a non-abrasive wax such as silicone wax.

NOTE: Apply wax on glossy finish only. Protect the vehicle with the supplied tarpaulin to prevent dust accumulation during storage.

CAUTION: The snowmobile has to be stored in a cool and dry place and covered with the supplied tarpaulin. This will prevent sun rays and grime from affecting plastic components and vehicle finish. Never store snowmobile in a plastic bag.

Lift rear of vehicle until tracks are clear of the ground. Install on a wide-base snowmobile mechanical stand.

NOTE: Do not release track tension.

Belt Guard Removal and Installation

WARNING

Never operate engine:

- without shields and belt guard securely installed
- with hood opened or removed.

Never attempt to make adjustments to moving parts while engine is running.

Removal

1. Remove DESS tether cord cap.
2. Open hood.
3. Remove air silencer access panel.

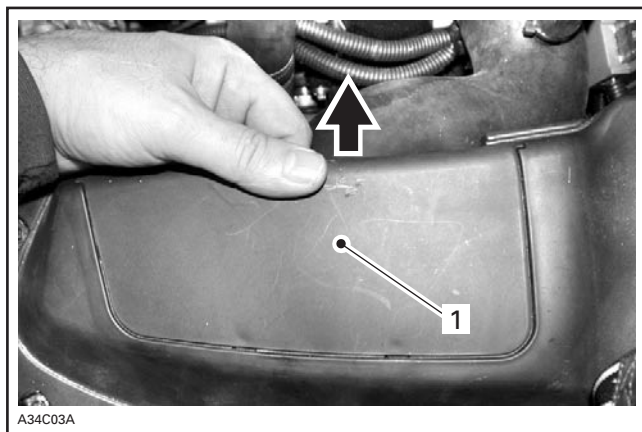

TYPICAL

1. Access panel

4. Loosen collar.

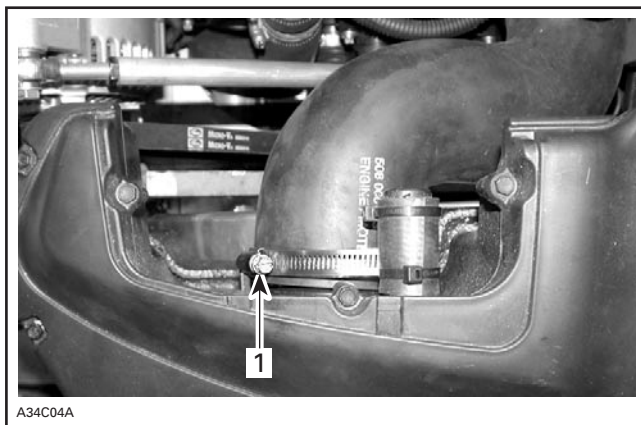

A34C04A

TYPICAL

1. Collar

5. Disconnect air temperature sensor from air silencer.



A34C05A

TYPICAL

1. Air temperature sensor

6. Remove air silencer, then formed foam.

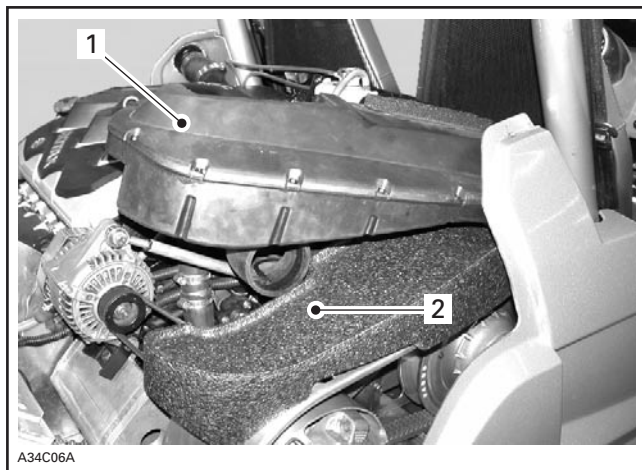

TYPICAL

1. Air silencer
2. Formed foam

7. Open belt guard retaining clip.

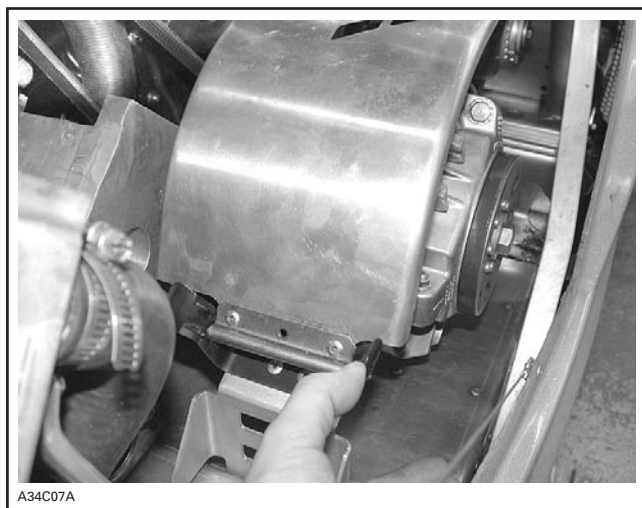

8. Unhook belt guard from front bracket.

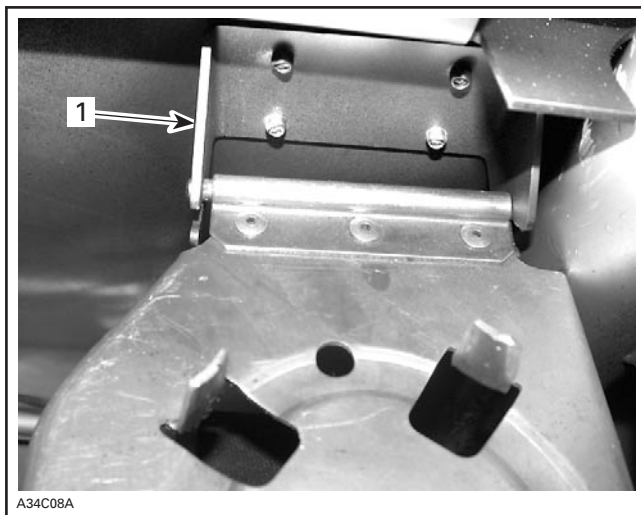

TYPICAL

1. *Front bracket*

Installation

Reinstall all parts by reversing the removal procedure and paying attention to the following.

Refer to belt guard decal for proper installation. Shown arrow on decal must point toward front of vehicle.

NOTE: Belt guard is purposely made slightly oversize to maintain tension on its pins and retainers preventing undue noise and vibration. It is important that this tension be maintained when reinstalling.

Align formed foam holes with rubber stopper of belt guard.

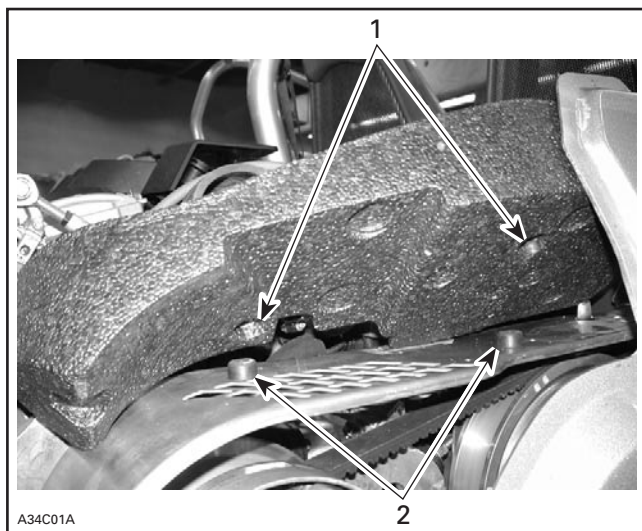

1. Formed foam holes
2. Rubber stoppers

Connect air temperature sensor to air silencer. Otherwise, a trouble code will appear.



TYPICAL

1. Air temperature sensor

Drive Belt Removal/Installation

WARNING

Always remove DESS tether cord cap before performing any maintenance or adjustment, unless otherwise specified. Vehicle must be parked in a safe place, away from the trail.

Removal

NOTE: Removal and installation of drive belt is easier when driven pulley is held with brake so that it can not rotate. Apply parking brake, for this purpose.

Remove DESS tether cord cap. Open hood and remove belt guard.

Open the driven pulley with the drive belt installer/remover provided in tool box.

Screw tool in the threaded hole (in line with embossed arrow) and tighten to open the pulley. Remove belt.

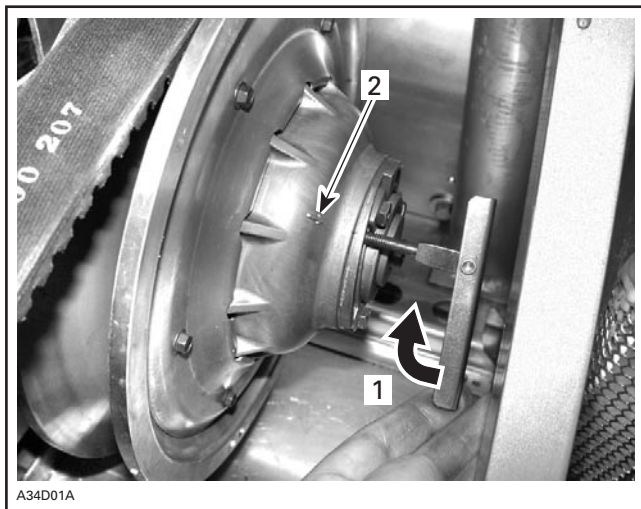

TYPICAL

1. Tighten to open pulley
2. Embossed arrow

Slip the belt over the top edge of the sliding half, as shown.

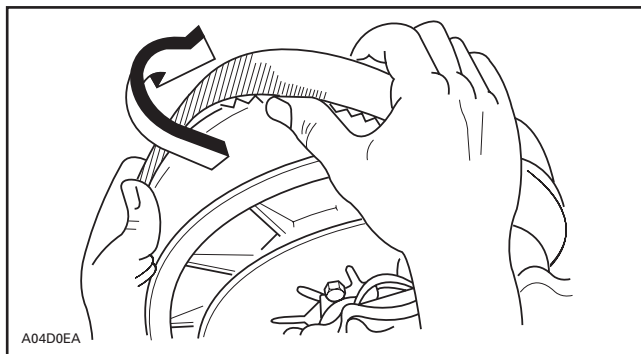

TYPICAL

Installation

The maximum drive belt life span is obtained when the belt has the proper rotation direction. Install it so the arrow printed on belt is pointing at rear of vehicle.

CAUTION: Do not force or use tools to pry the belt into place, as this could cut or break the cords in the belt.

Clean sheaves of both pulleys using Pulley flange cleaner (P/N 413 711 809).

Remove installer/remover.

Reinstall belt guard.

TRA Drive Pulley Adjustment

WARNING

Always remove DESS tether cord cap before performing any maintenance or adjustment, unless otherwise specified. Vehicle must be parked in a safe place, away from the trail.

General

From factory TRA drive pulley adjustment screws are set to position 3. This position allows the best compromise between acceleration, top speed and fuel economy.

Position 1 or 2 would provide the best fuel economy. Top speed would be reduced.

Position 4 would give the best acceleration. Fuel economy would be reduced.

Adjustment

Calibration screw has a notch on top of its head. There are 6 positions numbered 1 to 6.

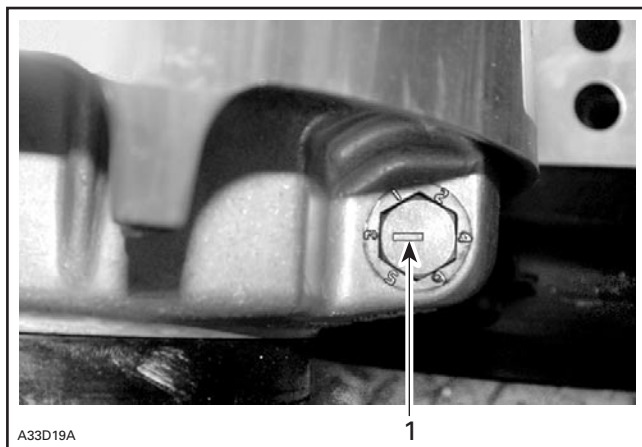

1. Notch

To adjust:

Just loosen locking nut enough to pull calibration screw **partially** out and adjust to desired position. Do not completely remove the locking nut. Torque locking nuts to 10 N•m (89 lbf•in).

CAUTION: Do not completely remove calibration screw otherwise the internal washers will fall off. Always adjust all 3 calibration screws and make sure they are all set to the same position.

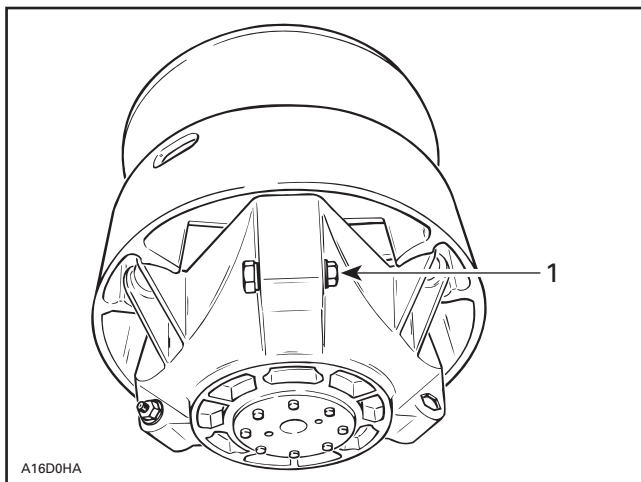

TYPICAL

1. Loosen just enough to permit rotating of calibrate screw

⚠ WARNING

Always reinstall belt guard. Do not operate engine with hood open or belt guard removed. Improper servicing, modification or poor adjustment may affect drive pulley performance and belt life. Always refer to the *Shop Manual* or obtain SKI-DOO dealer advice before servicing or modifying the drive or driven pulleys. Always respect maintenance schedules.

Drive Belt Condition

Inspect belt for cracks, fraying or abnormal wear (uneven wear, wear on one side, missing cogs, cracked fabric). If abnormal wear is noted, possible cause could be pulley misalignment, excessive RPM with frozen tracks, fast starts without warm-up period, burred or rusty sheave, oil on belt or distorted spare belt. Contact an authorized SKI-DOO dealer.

Check the drive belt width. Replace the drive belt if width is less than the minimum width recommended in SPECIFICATIONS.

Brake Condition

WARNING

The brake mechanism on your snowmobile is an essential safety device. Keep this mechanism in proper working condition. Above all, do not operate the snowmobile without an effective brake system. Periodically verify the condition/wear of the brake pads.

Brake Adjustment

No adjustment is provided for hydraulic brake. See an authorized SKI-DOO dealer if any problems.

Rear Suspension Condition

Visually inspect all suspension components including slider shoes, springs, wheels, etc.

NOTE: During normal driving, snow will act as a lubricant and coolant for the slider shoes. Extensive riding on ice or sanded snow, will create excessive heat build-up and cause premature slider shoe wear.

Suspension Stopper Strap Condition

Inspect stopper strap for wear and cracks, bolt and nut for tightness. If loose inspect holes for deformation. Replace as required. Torque nut to 9 N•m (80 lbf•in).

Track Condition

WARNING

Always remove DESS tether cord cap before performing any maintenance or adjustment, unless otherwise specified. Vehicle must be parked in a safe place, away from the trail.

Remove DESS tether cord cap.

Lift the rear of the snowmobile and support it with a wide-base snowmobile mechanical stand. With the engine off, rotate the tracks by hand, and inspect condition. If worn or cut, or if track fibers are exposed, or if missing or defective inserts or guides are noted; contact an authorized SKI-DOO dealer.

WARNING

Do not modify tracks, nor install traction enhancing products. At speed it may cause the tracks to tear and separate from vehicle posing a risk of severe injury or death. Do not operate or rotate a track if torn, damaged or excessively worn (fibers showing).

Track Tension and Alignment

NOTE: Track tension and alignment are inter-related. Do not adjust one without the other. Always adjust both tracks.

Tension

NOTE: Ride the snowmobile in snow about 15 to 20 minutes prior to adjusting track tension.

Remove the DESS tether cord cap.

Lift rear of snowmobile and support it with a wide-base **snowmobile mechanical stand**.

Allow the suspensions to extend normally and check gap half-way between front and rear idler wheels. Measure between slider shoe bottom and inside of track. The gap should be as given in SPECIFICATIONS at the end of this guide. If the track tension is too loose, track will have a tendency to thump.

NOTE: A belt tension tester (P/N 414 348 200) may be used to measure deflection as well as force applied.

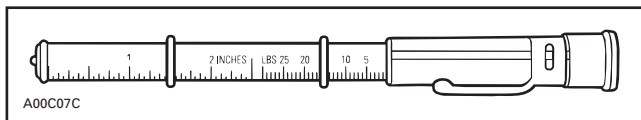

BELT TENSION TESTER

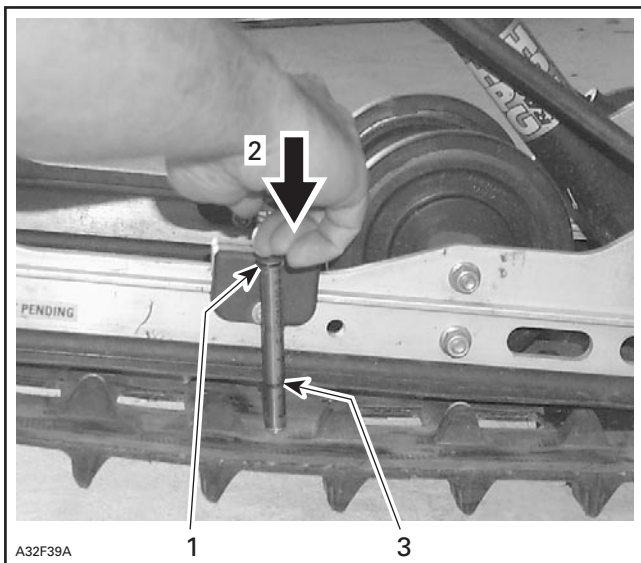

TYPICAL

1. Top tool O-ring positioned at 7.3 kg (16 lb)
2. Push on top portion of tool until it contacts the top O-ring
3. Measured track deflection

CAUTION: Too much tension will result in power loss and excessive stresses on suspension components.

To adjust track tension:

- Remove the DESS tether cord cap.
- Remove the cap then, loosen the rear idler wheel retaining screws.
- Turn adjustment screws to adjust.

If correct tension is unattainable, contact an authorized SKI-DOO dealer.

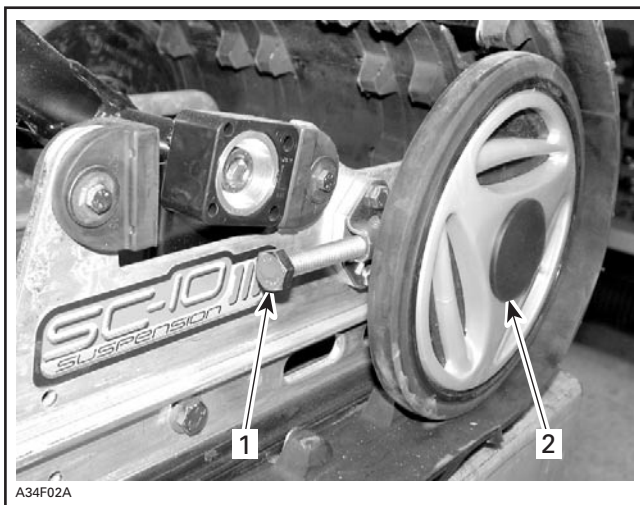

TYPICAL

1. Adjustment screw
2. Loosen screw

- Retighten retaining screws, then reinstall the cap.
- Check track alignment as described below.

Alignment

⚠ WARNING

Before checking track alignment, ensure that the tracks are free of all particles which could be thrown out while tracks are rotating. Keep hands, tools, feet and clothing clear of tracks. Ensure no one is standing in close proximity to the snowmobile. Never rotate tracks at high speed.

Start the engine and accelerate slightly so that tracks barely turn. This must be done in a short period of time (15 to 20 seconds).

Check that each track is well centered; equal distance on both sides between edges of track guides and slider shoes.

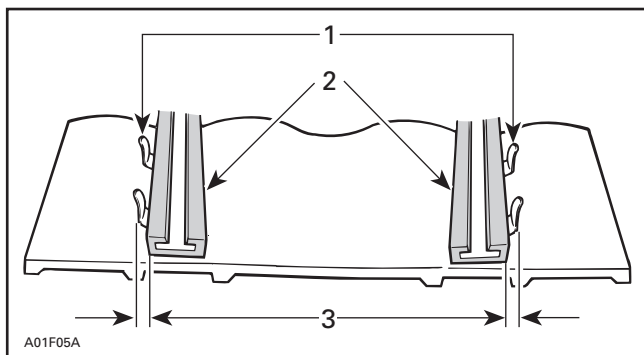

1. Guides
2. Slider shoes
3. Equal distance

To adjust track alignment:

WARNING

Always remove DESS tether cord cap before performing any maintenance or adjustment, unless otherwise specified. Vehicle must be parked in a safe place, away from the trail.

- Remove the DESS tether cord cap.
- Remove the cap then, loosen rear idler wheel retaining screws.
- Tighten the adjustment screw on side where the slider shoe is the farthest from the track insert guides.

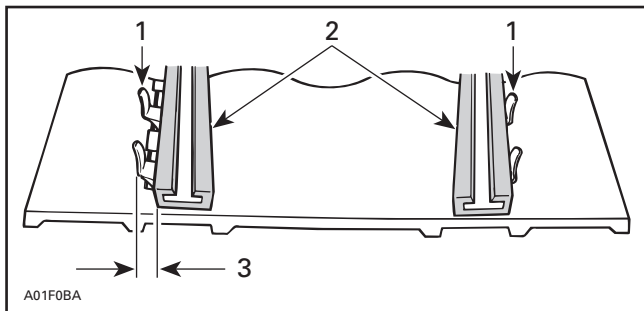

1. Guides
2. Slider shoes
3. Tighten on this side

Tighten retaining screws then, reinstall the cap.

⚠ WARNING

Properly tighten wheel retaining screws, otherwise wheel may come off and cause track to "lock".

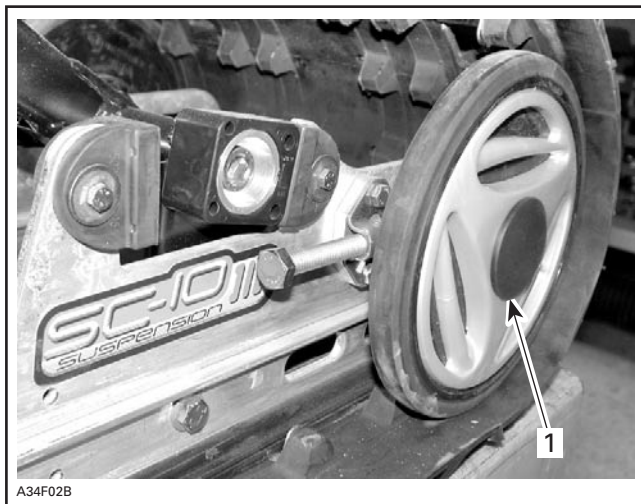

TYPICAL

1. Retighten to 48 N•m (35 lbf•ft)

Restart engine and rotate tracks slowly to recheck alignment.

Reposition snowmobile on ground.

Steering and Front Suspension

Visually inspect steering and front suspension for tightness of components (steering arms, control arms and links, tie rods, ball joints, ski bolts, ski legs, etc.). If necessary, contact an authorized SKI-DOO dealer.

Wear and Condition of Skis and Runners

Check the condition of the skis, ski runners and ski runner carbides. If worn, contact an authorized SKI-DOO dealer.

WARNING

Excessively worn skis and/or ski runners will adversely affect snowmobile control.

Exhaust System

WARNING

Certain components in the engine compartment may be very hot. Direct contact may result in skin burn.

The tail pipe of the muffler should be centered with the exit hole in the chassis. It must be free of rust or leaks.

The exhaust system is designed to reduce noise and to improve the total performance of the engine. Modification may be in violation of local laws.

CAUTION: If any exhaust system component is removed, modified or damaged, severe engine damage may result.

Air Filter Cleaning

Leaving the snowmobile uncovered during a snowfall or riding in deep powder snow may block air filter and choke the engine.

Remove snow from filter on air intake silencer.

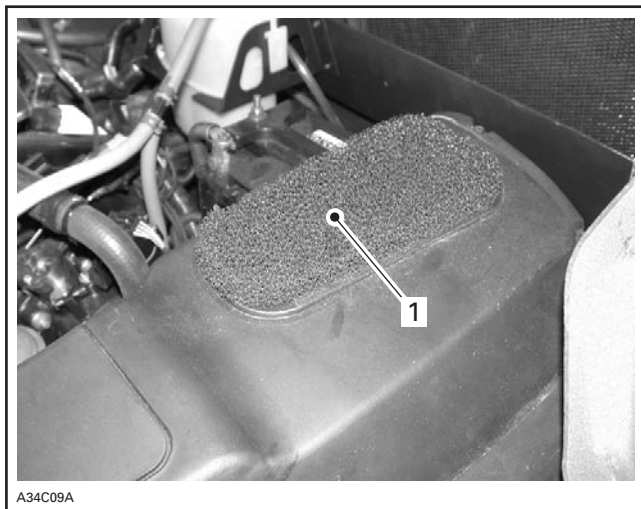

A34C09A

TYPICAL

1. Snow filter on air silencer

Shake the snow out of filter then, dry it out.

Check that the air silencer is clean and dry and properly reinstall the filter.

CAUTION: Snowmobile engines have been calibrated with the filter installed. Operating the snowmobile without it may cause engine damage.

Bulb Replacement

Always check light operation after bulb replacement.

Headlamp

CAUTION: Never touch glass portion of an halogen bulb with bare fingers, it shortens its operating life. If glass is touched, clean it with isopropyl alcohol which will not leave a film on the bulb.

Open access door in dashboard.

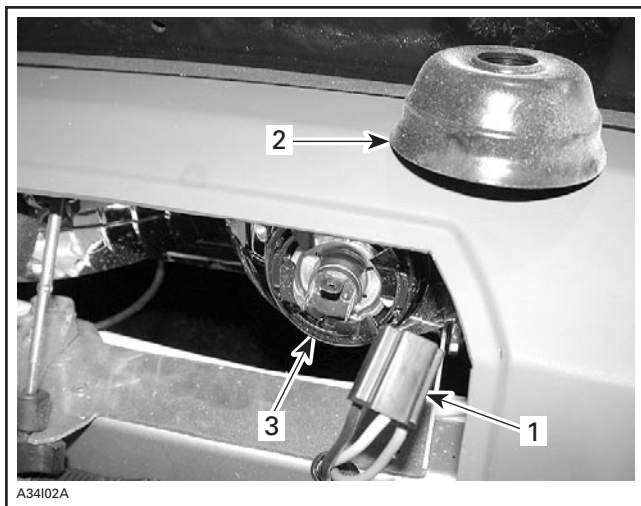

TYPICAL — ACCESS DOOR REMOVED

1. Connector
2. Rubber boot
3. Retainer ring

Unplug the connector from the burnt bulb. Remove the rubber boot then, unscrew bulb retainer ring. Detach the bulb and replace it with a new one. Properly reinstall parts.

Taillight

If taillight bulb is burnt, expose the bulb by removing the red plastic lens. To remove, unscrew the 2 lens screws.

TOWING THE VEHICLE

First remove drive belt from vehicle to be towed.

A rope is not suitable to tow. Use a rigid bar and tow at very low speed.

Do not carry passengers on a towed snowmobile. Each towed vehicle should have reflectors on each side and on the rear.

TRANSPORTING THE VEHICLE

Make sure that engine oil cap and fuel tank cap are properly installed.

Tilt bed trailers can easily be equipped with a winch mechanism to afford maximum safety in loading. Simple as it may seem, never drive your snowmobile onto a tilt bed trailer or any other kind of trailer or vehicle. Many serious accidents have resulted from driving up and over a trailer. Anchor your vehicle securely, front and rear, even on short hauls. Be certain all equipment is securely fastened. Cover your snowmobile when trailering to prevent road grime from causing damage.

Be certain your trailer meets state or provincial requirement. Ensure the hitch and safety chains are secure and the brake, turn indicators and clearance lights all function.

STORAGE AND PRESEASON PREPARATION

WARNING

Have an authorized SKI-DOO dealer inspect fuel and oil systems integrity as specified in PERIODIC MAINTENANCE CHART.

Storage

It is during summer, or when a snowmobile is not in use for more than one month that proper storage is a necessity.

To prepare your snowmobile, refer to an authorized SKI-DOO dealer.

CAUTION: Do not run engine during storage period.

Preseason Preparation

Refer to an authorized SKI-DOO dealer.

TROUBLESHOOTING

Monitoring Beeper Coded Signals

CODED SIGNALS	POSSIBLE CAUSE	REMEDY
2 short beeps (while installing DESS tether cord cap on DESS post). DESS/RER pilot lamp also blinks.	Confirms that proper DESS tether cord cap is installed. Engine can be started.	(Normal condition).
1 long beep (while installing DESS tether cord cap on DESS post). DESS/RER pilot lamp also lights up for one second. Engine cannot be started.	Bad DESS system connection. Defective DESS tether cord cap. Dirt or snow in DESS tether cord cap. Defective DESS post.	Reinstall DESS tether cord cap correctly over post. Use another programmed DESS tether cord cap. Clean DESS tether cord cap. Replace DESS post.
1 long beep per second and DESS/RER pilot lamp lights up at same rate.	Reverse is selected.	Vehicle can be driven in reverse.
3 short beeps per second. Engine can be started.	DESS tether cord cap left on post while engine is not running.	Remove the DESS tether cord cap from its post when leaving the vehicle.
One continuous beep and overheating or oil pressure pilot lamp lights up.	Engine is overheating or oil pressure is too low.	Stop engine immediately and allow to cool. Check cooling system or oil level.
3 short beeps per second. Oil pilot lamp also lights up.	Low oil pressure.	Stop engine immediately and check oil level as explained in this guide.
Battery pilot lamp lights up.	No charging or over charging.	Check battery and charging system.

SYMPTOM: Engine cranks but fails to start.

POSSIBLE CAUSES	WHAT TO DO
1. Flooded engine (spark plug wet when removed).	See an authorized SKI-DOO dealer.
2. No fuel to the engine (spark plug dry when removed).	Check fuel tank level; check condition of fuel lines and their connections. If a failure of the fuel pump or fuel injection system has occurred, contact an authorized SKI-DOO dealer.

SYMPTOM: Engine lacks acceleration or power.

POSSIBLE CAUSES	WHAT TO DO
1. Fouled or defective spark plug.	Replace spark plugs.
2. Lack of fuel to engine.	Check item 2 of ENGINE CRANKS BUT FAILS TO START.
3. Drive belt worn too thin.	If the drive belt has lost more than 3 mm (1/8 in) of its original width, it will affect vehicle performance. Replace drive belt.
4. Drive and driven pulleys require servicing.	Contact an authorized SKI-DOO dealer.
5. Engine is overheating.	Check coolant level. If overheating persists, contact an authorized SKI-DOO dealer.

SYMPTOM: Engine backfires.

POSSIBLE CAUSES	WHAT TO DO
1. Exhaust system is leaking.	Contact an authorized SKI-DOO dealer.

SYMPTOM: *Engine misfires.***POSSIBLE CAUSES****WHAT TO DO**

1. Engine, carburetion and ignition.

Contact an authorized SKI-DOO dealer.

SYMPTOM: *Snowmobile cannot reach full speed.***POSSIBLE CAUSES****WHAT TO DO**

2. Drive belt.

See item 3 of ENGINE LACKS ACCELERATION OR POWER.

3. Incorrect track adjustment.

See MAINTENANCE and/or an authorized SKI-DOO dealer for proper alignment and tension adjustments.

4. Pulleys misaligned.

Contact an authorized SKI-DOO dealer.

5. Engine.

See an authorized SKI-DOO dealer.

SPECIFICATIONS

MODEL	ELITE	
Engine		
– Maximum power engine speed	± 100 RPM	7300
Drive Belt		
– Part number		417 300 207
– Wear limit width	mm (in)	34.2 (1-11/32)
Spark Plug		
– Type		NGK DCPR8E
– Gap	± 0.05 mm (± .002 in)	0.75 (.030)
Track		
– Tension	mm (in)	30 - 35 (1-3/16 - 1-3/8) ①
– Alignment		②
Fuel		
– Type		③
– Tank capacity	L (U.S. gal)	52.0 (13.7)
Oil (engine)		
– Type		④
– Capacity (oil change W/filter)	L (U.S. quart)	3.0 (2.7)
Chaincase/Transmission Oil		
– Type		⑤
– Capacity	L (quart oz)	1.0 (1.06)
Coolant		
– Type		⑥
– Capacity	L (U.S. quart)	6.6 (7.0)
Brake System Fluid		
– Type		⑦

① to ⑦ and N.A.: See at end of specifications.

Because of its ongoing commitment to product quality and innovation, Bombardier reserves the right, at any time, to make changes in design and specifications and/or to make additions to, or improvements in its products without imposing any obligation upon itself to install them on its products previously manufactured.

- ① Measure gap between slider shoe and bottom inside of track when exerting a downward pull of 7.3 kg (16 lb) to the track.
 - ② Equal distance between edges of track guides and slider shoes.
 - ③ Regular unleaded gasoline with a minimum octane number of 87 (R + M)/2.
 - ④ BOMBARDIER 4-stroke synthetic oil 0W40 (P/N 293 600 054 — 12 x 1L).
 - ⑤ Bombardier synthetic chaincase oil (P/N 413 803 300 — 12 x 355 mL).
 - ⑥ Bombardier premixed coolant (P/N 413 711 802 — 16 x 1 L).
 - ⑦ SRF (DOT 4) (P/N 293 600 063) or GTLMA (DOT 4) (P/N 293 600 062).
- N.A.: Not applicable

PRIVACY OBLIGATIONS/DISCLAIMER

We wish to inform you that your coordinates will be used for safety and warranty purposes. Sometimes, we also use the coordinates of our clients to inform them about our products and to present them offers. Should you prefer not to receive information on our products, services and offers, please let us know by writing to the address below.

Also note that, from time to time, carefully selected and trustworthy organizations may be permitted to use the coordinates of our clients to promote quality products and services. If you prefer not to have your name and address released, please let us know by writing to the address below:

Bombardier Inc.

Recreational Products

Warranty Department
75 J.A. Bombardier Street
Sherbrooke, Québec J1L 1W3
Canada
Fax Number (819) 566-3590

CHANGE OF ADDRESS OR OWNERSHIP

If your address has changed or if you have sold or given your vehicle to anyone, be sure to fill out and mail the card provided on next page.

Such notification is necessary for your safety or the safety of any subsequent owner, even after expiration of the original warranty, since Bombardier will be in a position to contact you if correction to your snowmobile becomes necessary.

NOTICE TO ALL NEW OWNERS:

Make sure to mail the *Change of Ownership Card* as you are entitled to the unexpired portion of the warranty.

STOLEN UNITS

If the event that your snowmobile is stolen, you should notify your area distributor's warranty department of such.

Please provide your name, address, phone number, vehicle serial number and date of theft.

Bombardier will provide a list of stolen units to all authorized SKI-DOO dealers on a monthly basis to aid in recovery of such units to their owners.



CHANGE OF ADDRESS

CHANGE OF OWNERSHIP

VEHICLE IDENTIFICATION NUMBER

--	--	--	--	--	--	--	--	--	--	--	--	--	--	--	--	--	--	--	--

OLD ADDRESS
OR PREVIOUS OWNER:

NAME

NO STREET APT.

CITY STATE/PROVINCE ZIP/POSTAL CODE

NEW ADDRESS
OR NEW OWNER:

NAME

NO STREET APT.

CITY STATE/PROVINCE ZIP/POSTAL CODE

AFFIX
PROPER
POSTAGE

BOMBARDIER
RECREATIONAL PRODUCTS

WARRANTY DEPARTMENT
75 J.A. BOMBARDIER ST.
SHERBROOKE (QUEBEC)
CANADA J1L 1W3

AFFIX
PROPER
POSTAGE

BOMBARDIER
RECREATIONAL PRODUCTS

WARRANTY DEPARTMENT
75 J.A. BOMBARDIER ST.
SHERBROOKE (QUEBEC)
CANADA J1L 1W3

AFFIX
PROPER
POSTAGE

BOMBARDIER
RECREATIONAL PRODUCTS

WARRANTY DEPARTMENT
75 J.A. BOMBARDIER ST.
SHERBROOKE (QUEBEC)
CANADA J1L 1W3



®™ TRADEMARKS OF BOMBARDIER INC. OR ITS SUBSIDIARIES.
©2003 BOMBARDIER INC. ALL RIGHTS RESERVED. PRINTED IN CANADA