



ski-doo®

2002

Operator's Guide



WARNING

Read this guide thoroughly.
It contains important safety information.

ZX Series

484 100 044

SAFETY WARNING

Disregarding any of the safety precautions and instructions contained in this *Operator's Guide*, *Safety Handbook*, *Safety Video* or on-product warnings may result in injury, including the possibility of death.

This *Operator's Guide*, *Safety Handbook* and *Safety Video* should remain with the unit at time of resale.

BOMBARDIER
RECREATIONAL PRODUCTS



In USA, products are distributed by Bombardier Motor Corporation of America. In Canada, products are distributed by Bombardier Inc.

The following are trademarks of Bombardier Inc or its subsidiaries.

BOMBARDIER®	GRAND TOURING™	SUMMIT®
ROTAX®	MX-Z®	SKI-DOO®
RER™	LEGEND™	DESS™
DPM™		

Kleen-Flo* is a trademark of Kleen-Flo Tumbler Industries Ltd.

2002 SKI-DOO OPERATOR'S GUIDE

This guide is applicable to the following ZX series models:

Legend™

Grand Touring™

MX-Z®

Summit®

FOREWORD

Congratulations on your purchase of a new SKI-DOO snowmobile. Whatever model you have chosen, it is backed by the Bombardier warranty and a network of authorized SKI-DOO snowmobile dealers ready to provide the parts, service or accessories you may require.

The *Operator's Guide* and the *Safety Handbook* have been prepared to acquaint the owner/operator and passenger of a new snowmobile with the various snowmobile controls, maintenance and safe operating instructions. Each is indispensable for the proper use of the product.

WARNING

Identifies an instruction which if not followed, may cause injuries including the possibility of death.

CAUTION: Denotes an instruction which if not followed, may damage the and/or components.

Although the mere reading of such information does not eliminate the hazard, the understanding and application of the information will promote the correct use of the vehicle.

Your dealer is committed to your satisfaction. He has taken training to perform the initial set-up and inspection of your snowmobile as well as completed the final adjustment required to suit your specific weight and riding environment before you took possession. At delivery, your dealer would have explained the snowmobile controls and provided you with a brief explanation of the various suspension adjustments. We trust you have taken full advantage of this! If you need more complete servicing information, please ask your dealer about the proper model-year *SKI-DOO Shop Manual*.

At delivery, you were also informed of the warranty coverage and completed the Warranty Registration Form which is to be sent to us for processing.

The information and components/system descriptions contained in this guide are correct at time of publication.

We also reserve the right at any time to discontinue or change specifications, designs, features, models or equipment without incurring obligation.

The illustrations show the typical construction of the different assemblies and, in all cases, may not reproduce the full detail or exact shape of the parts shown, however, they represent parts which have the same or a similar function.

It is understood that this guide may be translated into another language. In the event of any discrepancy, the English version shall prevail.

Most components of this snowmobile are built with parts dimensioned in the metric system. Most fasteners are metric and must not be replaced by customary fasteners or vice versa.

We recommend genuine Bombardier products for replacement parts and accessories. They've been specially designed for your vehicle and manufactured to meet of Bombardier demanding standards.

A *Shop Manual* can be obtained for complete service, maintenance and more repair information.

TABLE OF CONTENTS

△ SAFETY MEASURES	7
BOMBARDIER LIMITED WARRANTY NORTH AMERICA: 2002 SKI-DOO® SNOWMOBILES	8
BOMBARDIER LIMITED WARRANTY INTERNATIONAL: 2002 SKI-DOO® SNOWMOBILES	11
FREQUENTLY ASKED QUESTIONS	14
AUTHORIZED SKI-DOO DEALERS	16
HOW TO IDENTIFY YOUR SNOWMOBILE	16
Vehicle Description Decal.....	16
Serial Numbers	17
ON-VEHICLE IMPORTANT INSTRUCTIONS	19
CONTROLS/INSTRUMENTS/EQUIPMENT	26
1) Throttle Lever	29
2) Brake Lever	29
3) Parking Brake Button.....	29
4) Injection Oil Level/Parking Brake Pilot Lamp (Red).....	31
5) Handlebar	32
6) Adjustable Handlebar	32
7) Holding Strap.....	33
8) Reverse Button	33
9) Reverse/Start Button	35
10) Ignition Switch.....	36
11) Tether Cut-Out Switch	37
12) DESS Pilot Lamp (Red).....	39
13) DESS/RER Pilot Lamp (Red).....	39
14) Engine Cut-Out Switch.....	40
15) Headlamp Dimmer Switch	41
16) High Beam Pilot Lamp (Blue)	41
17) Rewind Starter Handle	41
18) Choke Lever	42
19) Speedometer.....	42
20) Odometer	42
21) Trip Meter.....	42
22) Trip Meter Reset Button	43
23) Tachometer	44
24) Temperature Gauge	45
25) Engine Overheat Warning Lamp (Red).....	45
26) Fuel Tank Cap/Gauge	46
27) Electric Fuel Level Gauge.....	47
28) Heated Grip Switch	47

29) Heated Throttle Lever Switch	48
30) Electric Visor Jack Connector	49
31) 12-Volt Power Outlet	50
32) Electric Valving Shock Switch	50
33) Electric Valving Shock Pilot Lamp (Amber)	50
34) Air Suspension Switch	51
35) Air Suspension Gauge.....	52
36) Hood Latches.....	53
37) Adjustable Mirrors.....	53
38) Adjustable Toeholds.....	54
39) Heated Carburetor Valve.....	55
40) Adjustable Backrest	56
41) Seat Strap	58
42) Rear Passenger Heated Grip Switch.....	59
43) Adjustable Rear Grab Handles	60
44) Hood Grills	60
45) Storage Compartment	62
46) Tool Bag	62
47) Fuses	63
48) Spare Spark Plug Holder	65
49) Spare Drive Belt Holder	66
50) Front Grab Handles/Front Bumper	66
51) Convertible Ski Stance	67
52) Adjustable Suspensions.....	67
General.....	68
Guidelines to Adjust Suspension	69
TROUBLESHOOTING CHART.....	89
In Deep Snow	89
FUEL AND OIL	90
Recommended Fuel.....	90
Recommended Oil.....	91
COLD WEATHER CARBURETION MODIFICATIONS	92
BREAK-IN PERIOD	92
Engine	92
Belt.....	92
10-Hour Inspection.....	92
PRE-OPERATION CHECK	93
PRE-OPERATION CHECK LIST	94
OPERATING INSTRUCTIONS.....	95
Principle of Operation	95
Starting the Engine	96
Emergency Starting	98
Shutting Off the Engine	101

VEHICLE WARM-UP	101
POST-OPERATION CARE	102
SPECIAL OPERATIONS	102
Riding at High Altitudes	102
Engine Overheating	102
Fuel Flooded Engine	102
Rear Suspension Slider Shoe Sticking.....	103
PERIODIC MAINTENANCE CHART	104
FLUID LEVELS.....	106
Brake System	106
Chaincase Oil Level	106
Oil Injection System	108
Cooling System	109
MAINTENANCE	110
Vehicle Cleaning and Protection	110
Belt Guard Removal and Installation	111
Drive Belt Removal/Installation	113
Drive Chain Tension	117
TRA Drive Pulley Adjustment	117
Drive Belt Condition	120
Brake Condition	120
Brake Adjustment.....	120
Rear Suspension Condition	121
Suspension Stopper Strap Condition.....	121
Track Condition.....	121
Track Tension and Alignment	121
Steering and Front Suspension Mechanism	125
Wear and Condition of Skis and Runners	125
Exhaust System	126
Air Filter Cleaning	126
Headlight Beam Aiming.....	129
Bulb Replacement	129
TOWING THE VEHICLE	132
TRANSPORTING THE VEHICLE.....	132
STORAGE AND PRESEASON PREPARATION.....	133
Storage	133
Preseason Preparation	133
TROUBLESHOOTING	134
SPECIFICATIONS	137
CHANGE OF ADDRESS OR OWNERSHIP.....	142

⚠ SAFETY MEASURES

Observe the Following Warnings:

- ⚠ For vehicles with a parking brake, always engage brake when vehicle is not in use.
- ⚠ Throttle mechanism should be checked for free movement before starting engine.
- ⚠ In an emergency, the snowmobile engine can be stopped by activating the engine cut-out button, pulling the tether cord or turning off the key. Note that only the fan cooled models have an ignition key.
- ⚠ Engine should be running only when belt guard is secured in place. Never run the engine without drive belt installed. Running an unloaded engine such as without drive belt or with track raised, can prove to be dangerous.
- ⚠ Never run the engine with the hood opened or removed.
- ⚠ Maintain your snowmobile in top mechanical condition at all times.
- ⚠ Your snowmobile is not designed to be operated on public streets, roads or highways. In most States and Provinces, it is considered an illegal operation.
- ⚠ Electric start models only: Never charge or boost a battery while installed on snowmobile.
- ⚠ Do not lubricate throttle and/or brake cables and housings.
- ⚠ Only perform procedures as detailed in this guide. Unless otherwise specified, engine should be turned OFF and cold for all lubrication, adjustment and maintenance procedures.
- ⚠ Some snowmobiles are designed for the driver only and no provisions have been made for a passenger.
- ⚠ The performance of this snowmobile may significantly exceed that of other snowmobiles you have operated. Therefore, use by novice or inexperienced operators is not recommended.
- ⚠ The engine and components used in a particular model should not be used on other models. Use of Rotax® snowmobile engines in other than SKI-DOO snowmobiles is not recommended or authorized by Bombardier Inc.
- ⚠ Do not stud the track.
- ⚠ Reverse models only: These snowmobiles are capable of a fast reverse. Always remain seated and apply the brake before shifting. Come to a complete stop before selecting reverse gear. Ensure the path behind is clear of obstacles or bystanders. Fast reverse could result in loss of stability.

BOMBARDIER LIMITED WARRANTY NORTH AMERICA: 2002 SKI-DOO® SNOWMOBILES

1. SCOPE OF THE LIMITED WARRANTY

BOMBARDIER INC. (hereinafter "BOMBARDIER") warrants its 2002 SKI-DOO snowmobiles from defects in material or workmanship for the period described below.

All genuine BOMBARDIER parts and accessories, installed by an authorized BOMBARDIER dealer (as hereinafter defined) at the time of delivery of the 2002 SKI-DOO snowmobile, carry the same warranty as that of the snowmobile.

Use of the product for racing or any other competitive activity, at any point, even by a prior owner will render this warranty null and void.

2. WARRANTY COVERAGE PERIOD

This warranty will be in effect FROM THE DATE OF DELIVERY TO THE FIRST RETAIL CONSUMER or the date the product is first put into use, whichever occurs first and for a period of:

- a. TWELVE (12) CONSECUTIVE MONTHS, for private use owners. The warranty coverage period on a snowmobile delivered between June 1st and December 1st of a given year will expire December 1st of the following year; or
- b. TWELVE (12) CONSECUTIVE MONTHS, for commercial use owners. The warranty coverage period on a snowmobile delivered between June 1st and December 1st of a given year will expire December 1st of the following year.

The repair or replacement of parts or the performance of service under this warranty does not extend the life of this warranty beyond its original expiration date.

3. CONDITIONS TO HAVE WARRANTY COVERAGE

This warranty coverage is available only on 2002 SKI-DOO snowmobile purchased as new and unused by its first owner from a BOMBARDIER dealer authorized to distribute SKI-DOO products in the country in which the sale occurred (hereinafter "BOMBARDIER dealer"), and then only after the BOMBARDIER specified pre-delivery inspection process is completed and documented. Warranty coverage only becomes available upon proper registration of the product by a BOMBARDIER dealer. Such limitations are necessary in order to allow BOMBARDIER to preserve both the safety of its products, and also that of its consumers and the public.

Routine maintenance outlined in the *Operator's Guide* must be timely performed in order to maintain warranty coverage. BOMBARDIER reserves the right to make warranty coverage contingent upon proof of proper maintenance.

4. WHAT TO DO TO OBTAIN WARRANTY COVERAGE

The customer must notify a servicing BOMBARDIER dealer within two (2) days of the appearance of a defect, and provide it with reasonable access to the product and reasonable opportunity to repair it. The customer must also present to the BOMBARDIER dealer, proof of purchase of the product and must sign the repair/work order prior to the start of the repair in order to validate the warranty repair. All parts replaced under this limited warranty become the property of BOMBARDIER.

5. WHAT BOMBARDIER WILL DO

BOMBARDIER's obligations under this warranty are limited to, at its sole discretion, repairing parts found defective under normal use, maintenance and service, or replacing such parts with new genuine BOMBARDIER parts without charge for parts and labor, at any authorized BOMBARDIER dealer.

BOMBARDIER reserves the right to improve or modify products from time to time without assuming any obligation to modify products previously manufactured.

6. EXCLUSIONS - ARE NOT WARRANTED

- Normal wear and tear;
- Routine maintenance items, tune ups, adjustments;
- Damage caused by failure to provide proper maintenance and/or storage, as described in the *Operator's Guide*;
- Damage resulting from removal of parts, improper repairs, service, maintenance, modifications or use of parts not manufactured or approved by BOMBARDIER or resulting from repairs done by a person that is not an authorized servicing BOMBARDIER dealer;
- Damage caused by abuse, abnormal use, neglect, use of the product on surfaces other than snow, or operation of the product in a manner inconsistent with the recommended operation described in the *Operator's Guide*;
- Damage resulting from accident, submersion, fire, theft, vandalism or any act of God;
- Operation with fuels, oils or lubricants which are not suitable for use with the product (see the *Operator's Guide*);
- Snow or water ingestion;
- Incidental or consequential damages, or damages of any kind including without limitation towing, storage, telephone, rental, taxi, inconvenience, insurance coverage, loan payments, loss of time, loss of income; and
- Damage resulting from tracks which have been studded.

7. LIMITATIONS OF LIABILITY

THIS WARRANTY IS EXPRESSLY GIVEN AND ACCEPTED IN LIEU OF ANY AND ALL OTHER WARRANTIES, EXPRESSED OR IMPLIED, INCLUDING WITHOUT LIMITATION ANY WARRANTY OF MERCHANTABILITY OR FITNESS FOR A PARTICULAR PURPOSE. TO THE EXTENT THAT THEY CANNOT BE DISCLAIMED, THE IMPLIED WARRANTIES ARE LIMITED IN DURATION TO THE LIFE OF THE EXPRESS WARRANTY. INCIDENTAL AND CONSEQUENTIAL DAMAGES ARE EXCLUDED FROM COVERAGE UNDER THIS WARRANTY. SOME STATES/PROVINCES DO NOT ALLOW FOR THE DISCLAIMERS, LIMITATIONS AND EXCLUSIONS IDENTIFIED ABOVE, AS A RESULT, THEY MAY NOT APPLY TO YOU. THIS WARRANTY GIVES YOU SPECIFIC RIGHTS, AND YOU MAY ALSO HAVE OTHER LEGAL RIGHTS WHICH MAY VARY FROM STATE TO STATE, OR PROVINCE TO PROVINCE.

Neither the distributor, any BOMBARDIER dealer nor any other person has been authorized to make any affirmation, representation or warranty regarding the product, other than those contained in this limited warranty, and if made, shall not be enforceable against BOMBARDIER.

BOMBARDIER reserves the right to modify this warranty at any time, being understood that such modification will not alter the warranty conditions applicable to the products sold while this warranty is in effect.

8. TRANSFER

If the ownership of a product is transferred during the warranty coverage period, this warranty shall also be transferred and be valid for the remaining coverage period provided that BOMBARDIER is notified of such transfer of ownership in the following way:

- a. The former owner contacts BOMBARDIER (at the phone number provided below) or an authorized BOMBARDIER dealer and gives the coordinates of the new owner; or
- b. BOMBARDIER or an authorized BOMBARDIER dealer receives a proof that the former owner agreed to the transfer of ownership, in addition to the coordinates of the new owner.

9. CONSUMER ASSISTANCE

- a. In the event of a controversy or a dispute in connection with this BOMBARDIER LIMITED WARRANTY, BOMBARDIER suggests that you try to resolve the issue at the dealership level. We recommend discussing the issue with the authorized dealer's service manager or owner.
- b. If the issue has not yet been resolved, please submit your complaint in writing or call the appropriate number below:

In Canada:

BOMBARDIER INC.
RECREATIONAL PRODUCTS
SKI-DOO®
CUSTOMER ASSISTANCE CENTER
VALCOURT QC J0E 2L0
Tel: (819) 566-3366

In USA:

BOMBARDIER MOTOR
CORPORATION OF AMERICA
RECREATIONAL PRODUCTS
SKI-DOO®
CUSTOMER ASSISTANCE CENTER
P.O. BOX 8035
7575 BOMBARDIER COURT
WAUSAU WI 54402-8035
Tel: (715) 848-4957



BOMBARDIER
RECREATIONAL PRODUCTS

© 2000 Bombardier Inc. All rights reserved

® Registered trademark of Bombardier Inc.

BOMBARDIER LIMITED WARRANTY INTERNATIONAL: 2002 SKI-DOO® SNOWMOBILES

1. SCOPE OF THE LIMITED WARRANTY

BOMBARDIER INC. (hereinafter "BOMBARDIER") warrants its 2002 SKI-DOO snowmobiles from defects in material or workmanship for the period described below.

All genuine BOMBARDIER parts and accessories, installed by an authorized BOMBARDIER distributor/dealer (as hereinafter defined) at the time of delivery of the 2002 SKI-DOO snowmobile, carry the same warranty as that of the snowmobile.

Use of the product for racing or any other competitive activity, at any point, even by a prior owner will render this warranty null and void.

2. WARRANTY COVERAGE PERIOD

This warranty will be in effect FROM THE DATE OF DELIVERY TO THE FIRST RETAIL CONSUMER or the date the product is first put into use, whichever occurs first and for a period of:

- a. TWELVE (12) CONSECUTIVE MONTHS, for private use owners. The warranty coverage period on a snowmobile delivered between June 1st and December 1st of a given year will expire December 1st of the following year; or
- b. TWELVE (12) CONSECUTIVE MONTHS, for commercial use owners. The warranty coverage period on a snowmobile delivered between June 1st and December 1st of a given year will expire December 1st of the following year.

The repair or replacement of parts or the performance of service under this warranty does not extend the life of this warranty beyond its original expiration date.

3. CONDITIONS TO HAVE WARRANTY COVERAGE

This warranty coverage is available only on 2002 SKI-DOO snowmobile purchased as new and unused by its first owner from a BOMBARDIER distributor/dealer authorized to distribute SKI-DOO products in the country in which the sale occurred (hereinafter "BOMBARDIER distributor/dealer"), and then only after the BOMBARDIER specified pre-delivery inspection process is completed and documented. Warranty coverage only becomes available upon proper registration of the product by a BOMBARDIER dealer. Such limitations are necessary in order to allow BOMBARDIER to preserve both the safety of its products, and also that of its consumers and the public.

Routine maintenance outlined in the *Operator's Guide* must be timely performed in order to maintain warranty coverage. BOMBARDIER reserves the right to make warranty coverage contingent upon proof of proper maintenance.

4. WHAT TO DO TO OBTAIN WARRANTY COVERAGE

The customer must notify a servicing BOMBARDIER distributor/dealer within two (2) days of the appearance of a defect, and provide it with reasonable access to the product and reasonable opportunity to repair it. The customer must also present to the BOMBARDIER dealer, proof of purchase of the product and must sign the repair/work order prior to the start of the repair in order to validate the warranty repair. All parts replaced under this limited warranty become the property of BOMBARDIER.

5. WHAT BOMBARDIER WILL DO

BOMBARDIER's obligations under this warranty are limited to, at its sole discretion, repairing parts found defective under normal use, maintenance and service, or replacing such parts with new genuine BOMBARDIER parts without charge for parts and labor, at any authorized BOMBARDIER distributor/dealer.

BOMBARDIER reserves the right to improve or modify products from time to time without assuming any obligation to modify products previously manufactured.

6. EXCLUSIONS - ARE NOT WARRANTED

- Normal wear and tear;
- Routine maintenance items, tune ups, adjustments;
- Damage caused by failure to provide proper maintenance and/or storage, as described in the *Operator's Guide*;
- Damage resulting from removal of parts, improper repairs, service, maintenance, modifications or use of parts not manufactured or approved by BOMBARDIER or resulting from repairs done by a person that is not an authorized servicing BOMBARDIER dealer;
- Damage caused by abuse, abnormal use, neglect, use of the product on surfaces other than snow, or operation of the product in a manner inconsistent with the recommended operation described in the *Operator's Guide*;
- Damage resulting from accident, submersion, fire, theft, vandalism or any act of God;
- Operation with fuels, oils or lubricants which are not suitable for use with the product (see the *Operator's Guide*);
- Snow or water ingestion;
- Incidental or consequential damages, or damages of any kind including without limitation towing, storage, telephone, rental, taxi, inconvenience, insurance coverage, loan payments, loss of time, loss of income; and
- Damage resulting from tracks which have been studded.

7. LIMITATIONS OF LIABILITY

THIS WARRANTY IS EXPRESSLY GIVEN AND ACCEPTED IN LIEU OF ANY AND ALL OTHER WARRANTIES, EXPRESSED OR IMPLIED, INCLUDING WITHOUT LIMITATION ANY WARRANTY OF MERCHANTABILITY OR FITNESS FOR A PARTICULAR PURPOSE. TO THE EXTENT THAT THEY CANNOT BE DISCLAIMED, THE IMPLIED WARRANTIES ARE LIMITED IN DURATION TO THE LIFE OF THE EXPRESS WARRANTY. INCIDENTAL AND CONSEQUENTIAL DAMAGES ARE EXCLUDED FROM COVERAGE UNDER THIS WARRANTY. SOME STATES/PROVINCES DO NOT ALLOW FOR THE DISCLAIMERS, LIMITATIONS AND EXCLUSIONS IDENTIFIED ABOVE, AS A RESULT, THEY MAY NOT APPLY TO YOU. THIS WARRANTY GIVES YOU SPECIFIC RIGHTS, AND YOU MAY ALSO HAVE OTHER LEGAL RIGHTS WHICH MAY VARY FROM STATE TO STATE, OR PROVINCE TO PROVINCE.

Neither the distributor, any BOMBARDIER dealer nor any other person has been authorized to make any affirmation, representation or warranty regarding the product, other than those contained in this limited warranty, and if made, shall not be enforceable against BOMBARDIER.

BOMBARDIER reserves the right to modify this warranty at any time, being understood that such modification will not alter the warranty conditions applicable to the products sold while this warranty is in effect.

8. TRANSFER

If the ownership of a product is transferred during the warranty coverage period, this warranty shall also be transferred and be valid for the remaining coverage period provided that BOMBARDIER is notified of such transfer of ownership in the following way:

- a. The former owner contacts BOMBARDIER or an authorized BOMBARDIER distributor/dealer and gives the coordinates of the new owner; or
- b. BOMBARDIER or an authorized BOMBARDIER distributor/dealer receives a proof that the former owner agreed to the transfer of ownership, in addition to the coordinates of the new owner.

9. CONSUMER ASSISTANCE

- a. In the event of a controversy or a dispute in connection with this BOMBARDIER LIMITED WARRANTY, BOMBARDIER suggests that you try to resolve the issue at the distributorship/dealership level. We recommend discussing the issue with the authorized dealer's service manager or owner.
- b. If further assistance is required, the distributor's service department should be contacted in order to resolve the matter.



BOMBARDIER *RECREATIONAL PRODUCTS*

© 2000 Bombardier Inc. All rights reserved

® Registered trademark of Bombardier Inc.

FREQUENTLY ASKED QUESTIONS

Q: Why must my snowmobile be registered at the factory? After all I do have my original invoice as proof of when I purchased my snowmobile.

A: *Registration is very important and your SKI-DOO dealer must register your snowmobile with Bombardier. Make sure the registration form has been sent. All of this will allow you to:*

- a) *have warranty work performed at any authorized SKI-DOO dealer in North America. Your registration form will provide the SKI-DOO dealer with all the necessary data to complete warranty claim forms.*
- b) *be advised by Bombardier should there be a safety recall or particular warranty campaign.*
- c) *be contacted much faster by the police, the minute they find your stolen snowmobile (if such a case occurs).*

Q: Why must my snowmobile be registered with the governing body having jurisdiction over snowmobile use?

A: *Snowmobile registration has two purposes: In many provinces or states it is mandatory to register a snowmobile in the same way as for a car. It allows the state or province to maintain records of existing snowmobiles and governmental agencies use part of the registration fees for establishing and maintaining trails.*

Q: Where can I find information on the lubrication and maintenance of my snowmobile?

A: *In the Operator's Guide provided with the snowmobile at the time of delivery.*

Q: Will the entire warranty be voided or cancelled, if I do not operate or maintain my new snowmobile exactly as specified in the *Operator's Guide*?

A: *The warranty of the new snowmobile cannot be "Voided" or "Cancelled" if predelivered by an authorized SKI-DOO dealer. However, if a particular failure is caused by operation or maintenance other than is shown in the Operator's Guide, THAT failure may not be covered under warranty. This includes service work performed by the customer, especially the critical adjustments: ignition timing, carburetion and oil injection/or oil mixture.*

Q: Would you give some examples of abnormal use or strain, neglect or abuse which may affect warranty?

A: *These terms are general and overlap each other in areas. Some specific examples may include: running the snowmobile out of oil, chain failure caused by a lack of lubrication, operating the snowmobile with a broken or damaged part which causes another part to fail, and so on. If you have any specific questions on operation or maintenance, please contact your SKI-DOO dealer for advice.*

Q: What costs are my responsibility during the warranty period?

A: *The customer's responsibility includes all costs of normal maintenance services, non-warranty repairs, accidents and collision damage, as well as oils, and spark plugs, and incidental or consequential damage costs as explained in the warranty.*

Q: Are "Genuine" Bombardier replacement parts used in warranty repairs covered by warranty?

A: *Yes. When installed by an authorized SKI-DOO dealer, any "Genuine" Bombardier part used in warranty repairs assumes the remaining warranty that exists on the snowmobile.*

Q: If I sell my snowmobile within the warranty period, will the new owner qualify for the balance of the warranty?

A: *Yes, provided the re-sale has been registered with the manufacturer.*

Q: How can I receive the best owner assistance?

A: *The satisfaction and goodwill of the owners of Bombardier products are of primary concern to your SKI-DOO dealer and Bombardier. Normally, any problems that arise in connection with the sales transaction or the operation of your snowmobile will be handled by your SKI-DOO Dealers Sales or Service Departments. It is recognized, however, that despite the best intentions of everyone concerned, misunderstandings will sometimes occur. Frequently, complaints are the result of a breakdown in communications and can quickly be resolved by a member of the SKI-DOO dealership management. If the problem already has been reviewed with the Sales Manager or Service Manager, contact the SKI-DOO Dealer himself or the General Manager.*

We are always pleased to receive your comments on the SKI-DOO snowmobile.

AUTHORIZED SKI-DOO DEALERS

For Canada and USA Only

To find the nearest authorized SKI-DOO dealer, dial: 1-800-375-4366.

HOW TO IDENTIFY YOUR SNOWMOBILE

Vehicle Description Decal

Vehicle description decal is located on right hand side of tunnel.

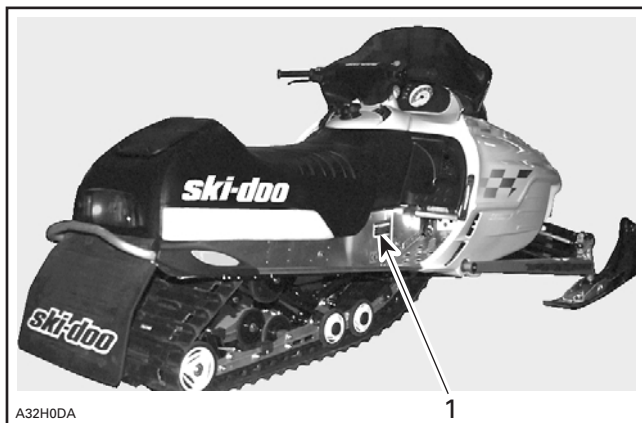

TYPICAL

1. *Vehicle description decal*

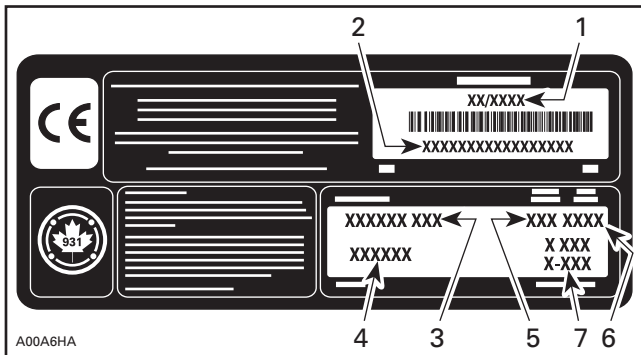

VEHICLE DESCRIPTION DECAL

1. Manufacturing date
2. Vehicle identification number (VIN)
3. Model name
4. Option package
5. Engine type
6. Model year
7. Color codes

Serial Numbers

The main components of your snowmobile (engine and frame) are identified by different serial numbers. It may sometimes become necessary to locate these numbers for warranty purposes or to trace your snowmobile in the event of loss. These numbers are required by the SKI-DOO dealer to complete warranty claims properly. No warranty will be allowed by Bombardier Inc. if the engine serial number or Vehicle Identification Number (VIN) is removed or mutilated in any way. We strongly recommend that you take note of all the serial numbers on your snowmobile and supply them to your insurance company.

Vehicle Identification Number (VIN) Location

VIN is scribed on vehicle description decal. See above. It is also embossed on tunnel near vehicle description decal.

ON-VEHICLE IMPORTANT INSTRUCTIONS

Please read the following instructions carefully before operating snowmobile.

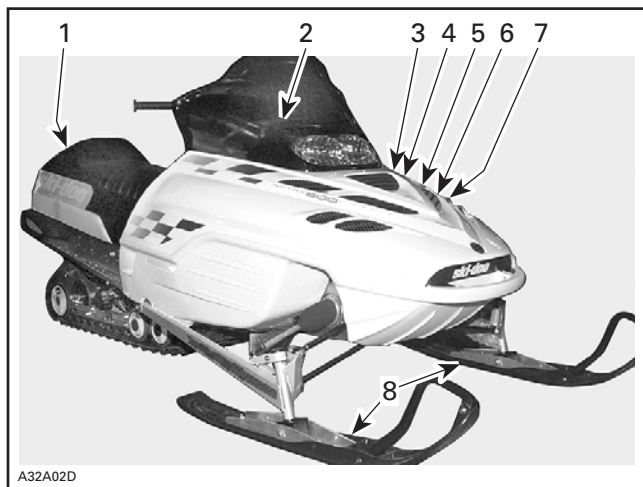

LOCATION OF IMPORTANT INSTRUCTIONS

Instruction 1



ALL MODELS

SINGLE SEAT MODELS

⚠ WARNING

•Read and follow all warning labels & operator's guide/safety handbook before operation.
 •Severe injury or death can result from ignoring warnings or through improper use of snowmobile.
 Before starting engine, check: •If throttle lever returns to its initial position when released. •All guards are in place.
 After starting engine, check: •If clutch lever returns to its initial position when released. •If parking brake is applied.
 After starting check: •Engine emergency cut-off switch and all controls.
 Before operating the vehicle: •Make sure parking is fully disengaged.
 •Drive carefully.

This vehicle is designed for operator only, "NO PASSENGER".

⚠ AVERTISSEMENT

•Lisez et respectez tous les avertissements contenus dans le guide du conducteur/guide de sécurité, avant toute mise en marche.
 •Le fait de passer outre aux avertissements ou d'utiliser le moteur de façon inadéquate peut entraîner de graves blessures ou la mort.
 Avant de démarrer le moteur, s'assurer que: •La manette d'accélérateur revient à sa position initiale lorsque véhicule.
 •Le frein à main est serré. •Le frein de stationnement est appliqué.
 Après avoir démarré le moteur, vérifier: •Le retour du levier de commande de la pédale de frein de stationnement soit appliqué.
 •Le fonctionnement correct de tous les contrôles.
 Avant d'utiliser le véhicule: •S'assurer que le frein de stationnement soit complètement relâché.
 •Conduisez prudemment.

Ce véhicule est conçu pour un conducteur seulement, "AUCUN PASSAGER".

511 901 721

A02A0HA

DOUBLE SEAT MODELS

⚠ WARNING

•Read and follow all warning labels & operator's guide/safety handbook before operation.
 •Severe injury or death can result from ignoring warnings or through improper use of snowmobile.
 Before starting engine, check: •If clutch lever returns to its initial position when released. •All guards are in place.
 After starting engine, check: •If parking brake is applied.
 After starting check: •Engine emergency cut-off switch and all controls.
 Before operating the vehicle: •Make sure parking is fully disengaged.
 •Drive carefully.

⚠ AVERTISSEMENT

•Lisez et respectez tous les avertissements contenus dans le guide du conducteur/guide de sécurité, avant toute mise en marche.
 •Le fait de passer outre aux avertissements ou d'utiliser le moteur de façon inadéquate peut entraîner de graves blessures ou la mort.
 Avant de démarrer le moteur, s'assurer que: •Le frein à main est serré. •Le frein de stationnement est appliqué.
 •Les gardes soient en place. •Le capot soit fermé et le panneau d'accès de la pédale soit installé. •Le frein de stationnement soit appliqué.
 Après démarrage, s'assurer que: •L'interrupteur d'arrêt d'urgence du moteur et tous les contrôles fonctionnent normalement.
 Avant d'utiliser le véhicule: •S'assurer que le frein de stationnement soit complètement relâché.
 •Conduisez prudemment.

511 901 725

Instruction 3

CAUTION

- To comply with noise regulations, this engine is designed to operate with an air intake silencer.
- Operation without air intake silencer or with one not properly installed may cause engine damage.

ATTENTION

- Le moteur a été conçu pour fonctionner avec ce silencieux d'admission afin de se conformer aux lois et règlements relatifs au bruit.
- Son absence ou une mauvaise installation peut endommager le moteur.

516 001 191

A01A2EA

ALL MODELS

Instruction 4

WARNING

This guard must always
be in place when engine is running.

AVERTISSEMENT

Ce garde-courroie doit toujours être
en place lorsque le moteur fonctionne.

516 001 190

A01A2FA

ALL MODELS

Instruction 5



A01A24D

TYPICAL — ALL MODELS

Instruction 6

SUSPENSION ADJUSTMENT CHART/TABLEAU DES RÉGLAGES DE LA SUSPENSION

FRONT SUSPENSION (SKI)/SUSPENSION AVANT (SKI)

NOT APPLICABLE

SANS OBJET

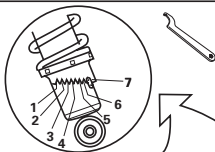

REAR SUSPENSION/SUSPENSION ARRIÈRE

ADJUST ACCORDING TO LOAD/RÉGLER SELON LA CHARGE

(LB)	LOAD CHARGE	(kg)	REAR SPRING RESSORT ARRIÈRE		
up to 125		jusqu'à 57	1		NOT APPLICABLE
125 to 150		57 à 68	2		SANS OBJET
150 to 175		68 à 79	3		
175 to 200		79 à 91	4		

FOR LOADS EXCEEDING RANGE SHOWN ABOVE, CONSULT YOUR DEALER.

SI LES CHARGES EXCÈDENT LES PLAGES MONTREES CI-HAUT, CONSULTEZ VOTRE CONCESSIONNAIRE.

418 0017 01

A01A25D

TYPICAL — ALL MODELS

CAUTION

This snowmobile is calibrated for **HIGH-ALTITUDE** operation. Operating this snowmobile below 8000 ft. or above 10000 ft. requires calibration parts and adjustments. Refer to following chart for correct maximum horsepower RPM. For more details, refer to Operator's Guide or see your authorized Ski-Doo dealer. Failure to re-calibrate may cause serious engine damage.

MAXIMUM HORSEPOWER/RPM CHART TABLEAU RÉGIME DE PUISSANCE MAXIMALE

Engine Type•Moteur	RPM•TR/MN (+/-100)
593	8000
693	8000
793	7850

ATTENTION

Cette motoneige est calibrée en fonction d'une utilisation en **HAUTE ALTITUDE**. Si on utilise cette motoneige à moins de 2400 mètres ou au delà de 3000 mètres, il est nécessaire de la recalibrer et d'installer certaines pièces. Se référer au tableau suivant pour connaître le régime de puissance maximale TR/MN. Pour plus de détails, se référer au Guide du conducteur ou consulter un concessionnaire autorisé de motoneiges Ski-Doo. Sans cette recalibration, le moteur peut-être gravement endommagé.

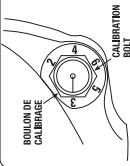

Adjust all three drive pulley bolts to same position.
Increase number = Increase RPM.
Decrease Number = Decrease RPM.
Régler tous les boulons de la poulie motrice à la même position.
Augmenter le numéro = Augmenter le régime TR/MN
Diminuer le numéro = Diminuer le régime TR/MN

516.001.232

A32A0MA

SUMMIT WITHOUT RENAGADE PACKAGE

CAUTION

This snowmobile is calibrated for SEA-LEVEL operation. Operating this snowmobile above 2000 ft. requires calibration parts and adjustments. Refer to following chart for correct maximum horsepower RPM. For more details, refer to Operator's Guide or see your authorized Ski-Doo dealer. Incorrect adjustments may cause parts damage.

MAXIMUM HORSEPOWER/RPM CHART

TABLEAU REGIME DE PUISSANCE MAXIMALE

Engine Type • Moteur	RPM • TR/MIN (+/-100)
593	8000
693	8000
793	7850

ATTENTION

Cette motoneige est calibrée en fonction d'une utilisation en NIVEAU DE LA MER.

Si on utilise cette motoneige au delà de 600 mètres il est nécessaire de la recalibrer et d'installer certaines pièces. Se référer au tableau suivant pour connaître le régime de puissance maximale TR/MIN.

Pour plus de détails, se référer au Guide du conducteur ou consulter un concessionnaire autorisé de motoneiges Ski-Doo. Sans cette recalibration, le moteur peut-être gravement endommagé.

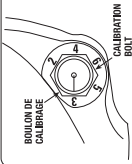

Adjust all three drive pulley bolts to same position.
Increase number = Increase RPM.
Decrease Number = Decrease RPM.

Régler tous les boulons de la poulie motrice à la même position.

Augmenter le numéro = Augmenter le régime TR/MIN
Diminuer le numéro = Diminuer le régime TR/MIN

516.001.235

Instruction 8

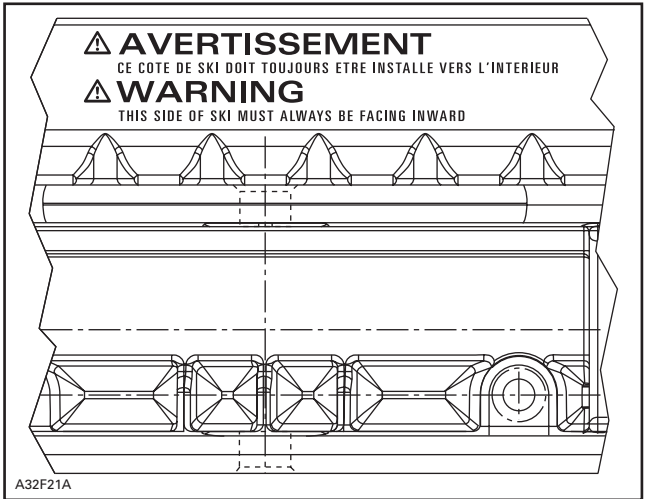

SUMMIT

CONTROLS/INSTRUMENTS/EQUIPMENT

NOTE: Some controls/instruments/equipment are optional on some models.

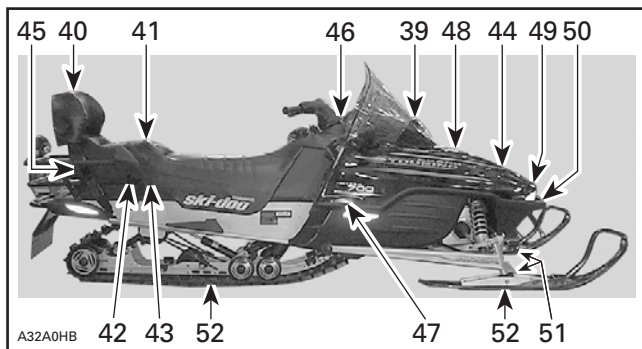

TYPICAL

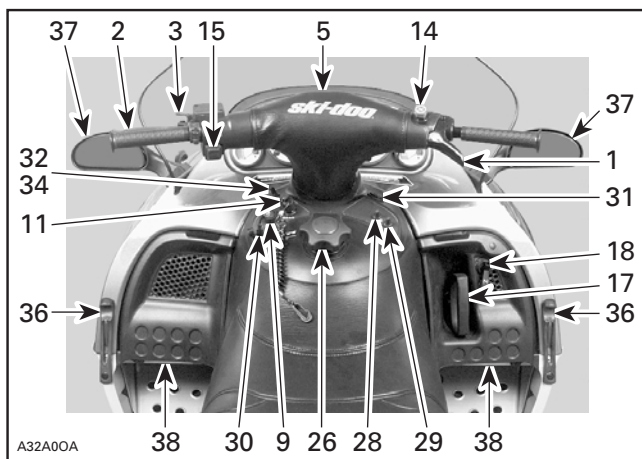

TYPICAL — LIQUID COOLED ELECTRIC START MODELS

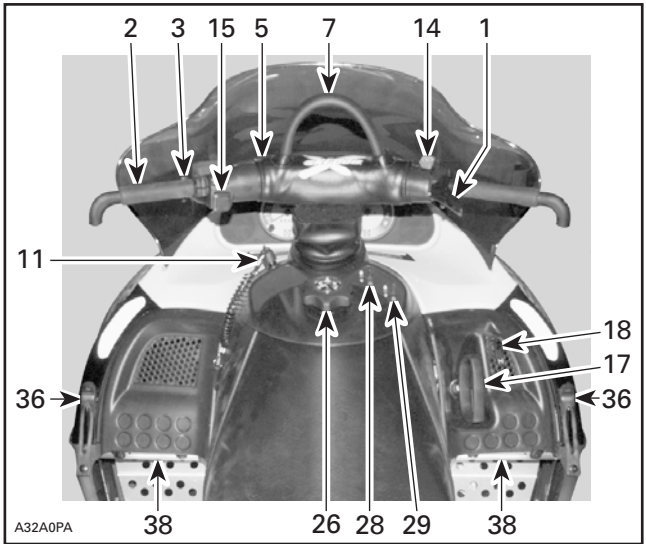

TYPICAL — LIQUID COOLED MANUAL START MODELS

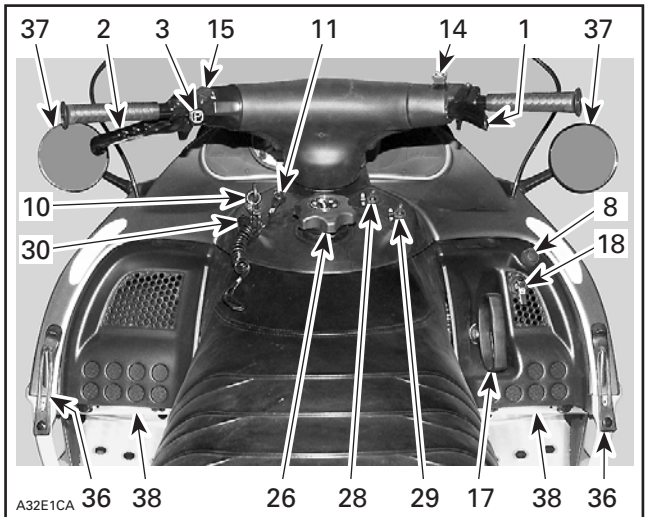

TYPICAL — FAN COOLED MODELS

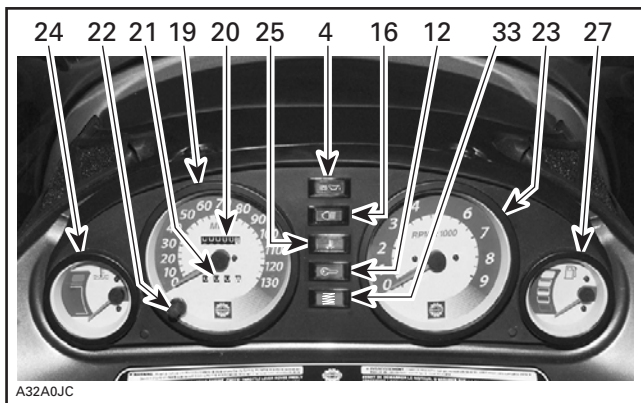

A32A0JC

TYPICAL — EXCEPT GRAND TOURING 800 SE

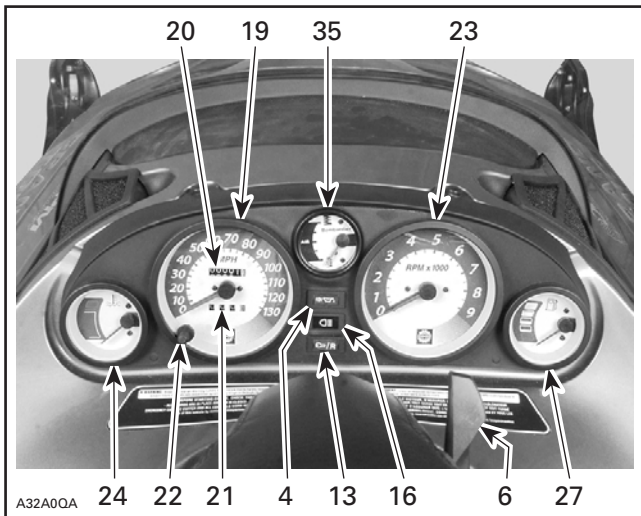

A32A0QA

GRAND TOURING 800 SE

1) Throttle Lever

Located on the right side of handlebar. When compressed, it controls the engine speed and the engagement of the transmission. When released, engine speed returns automatically to idle.

WARNING

Throttle lever must operate easily and smoothly. It must return to idle position when released.

2) Brake Lever

Located on the left side of handlebar. When compressed, the brake is applied. When released, it automatically returns to its original position. Braking effect is proportional to the pressure applied on the lever and to the type of terrain and its snow coverage.

CAUTION: Excessive or repetitive use of brakes for high speed stops will cause an overheated brake system. This overheated condition could cause sudden loss of braking power and/or fire.

3) Parking Brake Button

Located on left side of handlebar. Parking brake should be used whenever snowmobile is parked.

Whenever parking brake is applied and engine is running, injection oil level/parking brake pilot lamp lights up to remind you that it is engaged.

CAUTION: Make sure parking brake is fully disengaged before operating the snowmobile. Otherwise, brake system may overheat leading to sudden loss of brakes and/or fire.

MECHANICAL BRAKE

To **engage** mechanism, squeeze brake lever and maintain while pulling button with the other hand. There are 2 retaining notches on button lever; pull button until it locks on a notch then release brake lever.

To **release** mechanism, squeeze brake lever then fully push parking brake button. Always release parking brake before riding.

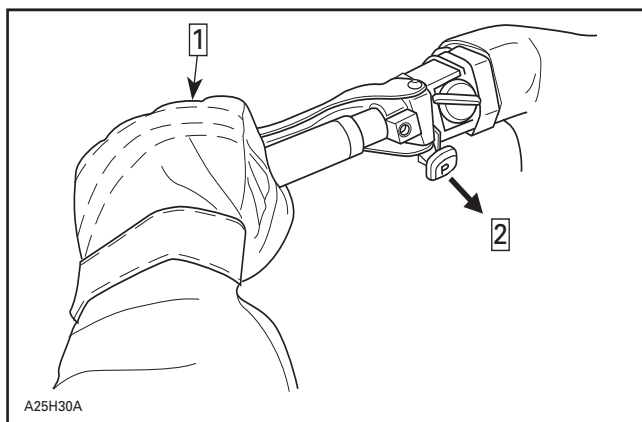

TYPICAL

Step **1**: Squeeze and hold

Step **2**: Fully pull

HYDRAULIC BRAKE

To **engage** mechanism, squeeze brake lever and maintain while pulling locking lever with a finger. When brake lever is compressed half-way the brake should be fully applied.

To **release** mechanism, squeeze brake lever. Locking lever will automatically return to its original position. Brake lever now returns to rest position. Always release parking brake before riding.

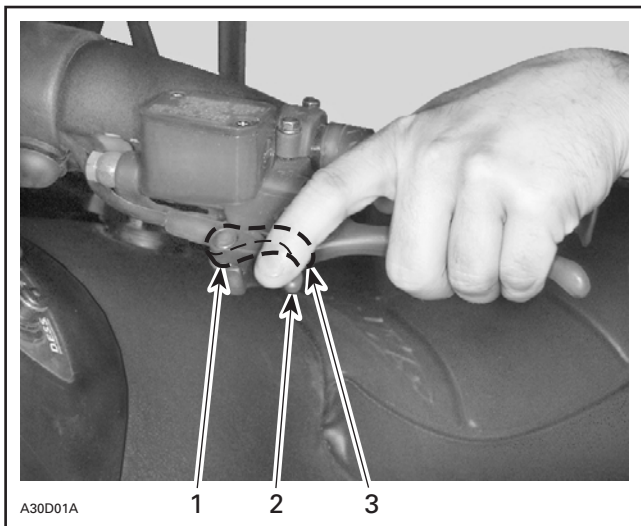

TYPICAL

1. Locking lever
2. OFF
3. ON

4) Injection Oil Level/Parking Brake Pilot Lamp (Red)

Lights when injection oil level is low or when brake or parking brake is applied (with engine running). Check oil level and replenish as soon as possible.

5) Handlebar

The handlebar controls the direction of travel of the snowmobile. As the handlebar is rotated to right or left, the skis are turned in the direction of intended travel.

Handlebar height is adjustable. See an authorized SKI-DOO dealer.

6) Adjustable Handlebar

Handlebar angle can be adjusted to suit driver's preference. Lift lever, tilt handlebar to desired position then release lever.

WARNING

Adjust with vehicle at rest in a safe place. Securely tighten all adjustments.

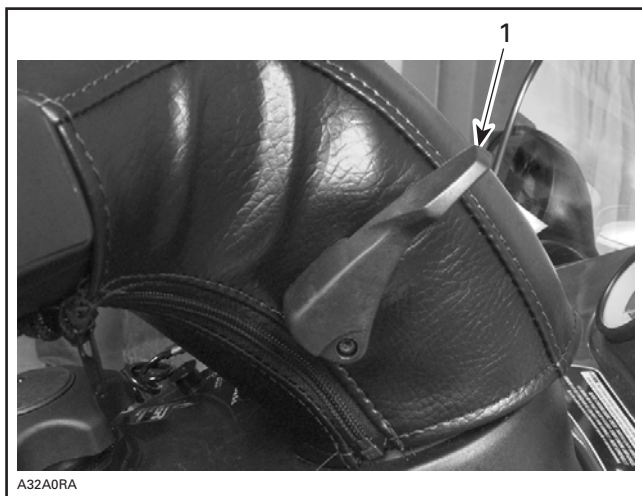

1. Lever

7) Holding Strap

Holding strap provides a grip for driver when side-hilling.

WARNING

This strap is not for towing, lifting or other purpose than temporary use as a grab bar during side-hilling. Always keep at least one hand on handlebar.

8) Reverse Button

WARNING

These snowmobiles are capable of a fast reverse. Always remain seated and apply the brake before shifting. Come to a complete stop then push reverse button. Ensure the path behind is clear of obstacles or bystanders. Fast reverse, could result in loss of stability.

Some models are equipped with a Rotax Electronic Reverse (RER™) controlled by a reverse button.

General

Driving in reverse is achieved by changing the direction of engine rotation.

Shifting in reverse is an electronic operation consisting of a control module that modifies the ignition timing of the engine.

When depressing the reverse button, a signal will slow down the engine RPM enough to modify the ignition timing advance. This reverses crankshaft rotation.

Engine will automatically shift into forward when starting after stopping or stalling.

Shifting procedure will take place only when the engine is running.

It is recommended to warm up the engine to its normal operating temperature before shifting.

Shifting in Reverse

With the snowmobile completely stopped and engine running at idle, press and release the reverse button.

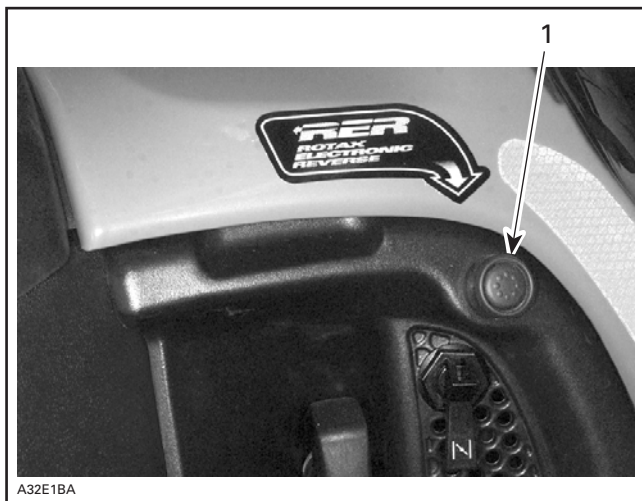

1. Reverse button

The DESS™ (Digitally Encoded Security System) indicator lamp will blink and a warning buzzer will sound when the snowmobile is engaged in reverse.

Apply throttle slowly and evenly. Allow drive pulley to engage then accelerate carefully.

Shifting in Forward

With the snowmobile completely stopped and engine running at idle, press and release the reverse button.

DESS indicator lamp and warning buzzer will stop.

Apply throttle slowly and evenly. Allow drive pulley to engage then accelerate carefully.

RER Modification at High Altitude

General

At high altitude, the RER system needs a different engine timing curve to work properly.

Operation

Fan Cooled Models

Before using vehicle at high altitude see an authorized SKI-DOO dealer for installation of a high altitude cap. Fan cooled Summit models are already equipped with high altitude cap.

Non-DPM™ Liquid Cooled Models

Before using the reverse system, first select the altitude mode that changes engine timing curve.

To do so, push and hold reverse button with engine running. After 2 seconds, one beep is heard meaning that the low altitude mode can be selected. Releasing button just after hearing that one beep will select the low altitude mode. The reverse system is now ready to operate in low altitude regions. Shifting in reverse is achieved as described above in **Shifting in Reverse**.

To select high altitude mode, push and hold reverse button until 2 beeps are heard. Release button within one second. The reverse system is now ready to operate in high altitude regions. Shifting in reverse is achieved as described above in **Shifting in Reverse**.

As long as the reverse button is pushed and held the RER system switches from one mode to the other. One beep then 2 beeps then one beep then 2 beeps and so on are heard with one second interval. The mode to be selected corresponds to the last beep code heard.

The selected altitude mode is kept in memory until a new one is chosen — whether the engine is stopped or not.

DPM Liquid Cooled Models

These vehicles are equipped with a Digital Performance Management (DPM) system. This system takes care of the altitude mode required by the RER.

No reverse button operation is needed to select a mode. Just follow **Shifting in Reverse** above.

9) Reverse/Start Button

Liquid Cooled Electric Start Models Only

Start Mode

To start engine, push reverse/start button and hold until engine has started.

CAUTION: Do not hold reverse/start button more than 15 seconds. A rest period should be observed between the cranking cycles to let starter cool down. Holding reverse/start button when engine has started could damage starter mechanism.

Release reverse/start button immediately when engine has started.

If engine does not start on first try, wait a few seconds then repeat procedure. To stop engine, turn off engine cut-out switch or pull off tether cord cap.

NOTE: If necessary engine may be manually started with rewind starter.

Reverse Mode

Once engine is started, push reverse/start button to activate the Rotax Electronic Reverse (RER).

Refer to **Reverse Button** above for operating instructions.

10) Ignition Switch

Fan Cooled Models Only

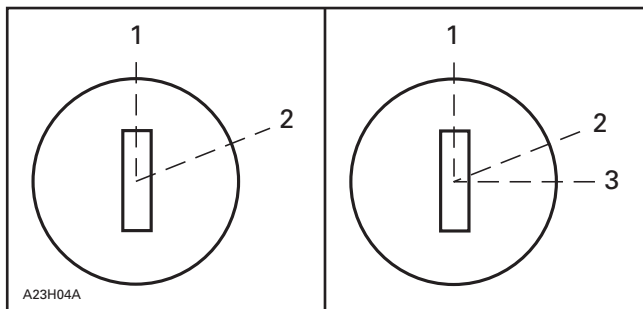

MANUAL START

1. OFF
2. ON

ELECTRIC START MODELS

1. OFF
2. ON
3. START

Manual Starting

Key operated, 2-position switch. To start the engine, first turn the key to ON position then, pull rewind starter grip. To stop the engine, turn the key to OFF position.

Electric Starting

Key operated, 3-position switch. To start engine, turn key to START position and hold until engine has started. See illustration above.

CAUTION: Do not hold key at START position more than 15 seconds. A rest period should be observed between the cranking cycles to let starter cool down. Holding key in START position when engine has started could damage starter mechanism.

Release key immediately when engine has started. Key returns to ON position as soon as it is released.

If engine does not start on first try, turn key back to OFF position before restarting. To stop engine, turn key to OFF position.

NOTE: Engine may be manually started with rewind starter if necessary.

If starter does not operate, check starting system fuse condition. Refer to **Starting System Fuse** below.

11) Tether Cut-Out Switch

General

All Models

The tether cut-out system shuts-off engine if the driver accidentally falls off the vehicle.

Liquid Cooled Models Only

The tether cut-out system also features the DESS™ which performs the same function as a key.

Operation

All Models

Attach tether cord to clothing then snap tether cord cap over receptacle before starting engine.

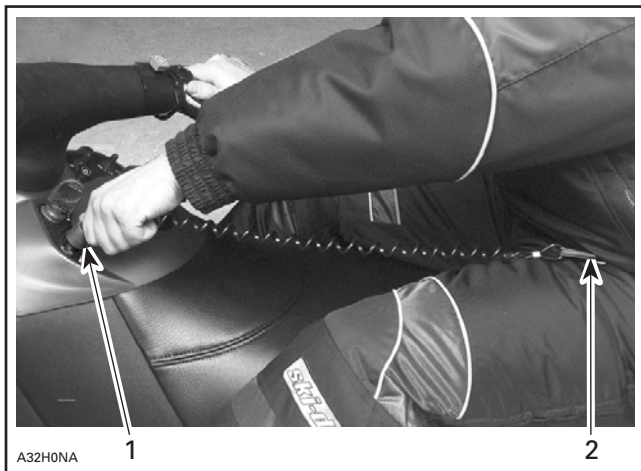

TYPICAL

1. Snap over receptacle
2. Attach to eyelet

To stop engine, completely pull cap from safety switch.

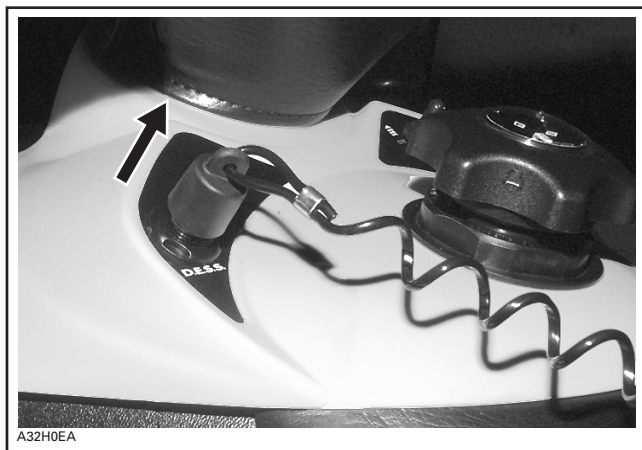

A32H0EA

TYPICAL

DESS Description

Liquid Cooled Models Only

This system is a deterrent against theft. The tether cord cap provided with your snowmobile is SKI-DOO dealer programmed and is the only one that allows engine to turn more than 3000 RPM. If an incorrectly programmed tether cord cap is installed the engine can not reach engagement speed required to move vehicle.

Additional Tether Cord Caps

Liquid Cooled Models Only

We recommend the purchase of additional tether cord caps from your authorized SKI-DOO dealer.

DESS Pilot Lamp and Buzzer Codes

NOTE: Only models with RER have a buzzer. Every time DESS pilot lamp will blink, buzzer will sound.

DESS pilot lamp blinking one time per three seconds means that a bad connection has been detected. Vehicle can not be driven.

To check for bad connection, remove tether cord. Make sure it is free of dirt or snow. Reinstall tether cord and restart engine. If a blink per 3 seconds still occurs contact an authorized SKI-DOO dealer.

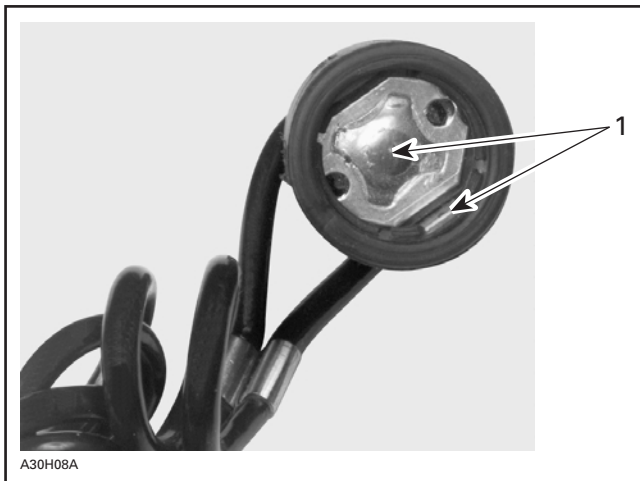

1. Free of dirt or snow

A rapid DESS pilot lamp blinking means that an incorrectly programmed tether cord is being used. Vehicle can not be driven.

12) DESS Pilot Lamp (Red)

This lamp will light up to confirm DESS status. Refer to previous paragraphs for description.

13) DESS/RER Pilot Lamp (Red)

This lamp will light up to confirm DESS and RER status. Refer to previous paragraphs for description.

14) Engine Cut-Out Switch

A push-pull type switch located on the right side of the handlebar. To stop the engine, push the button to the lower OFF position and simultaneously apply the brake. To restart, button must be at the upper ON position.

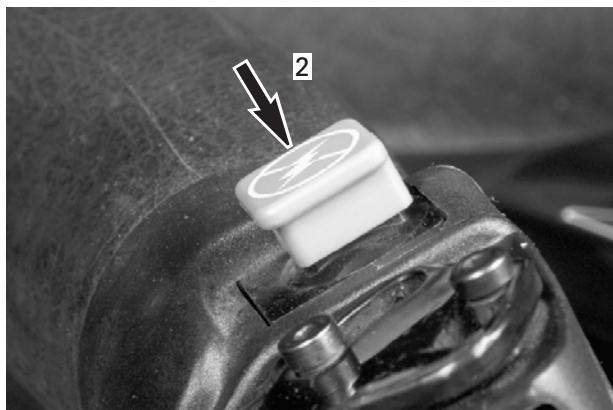
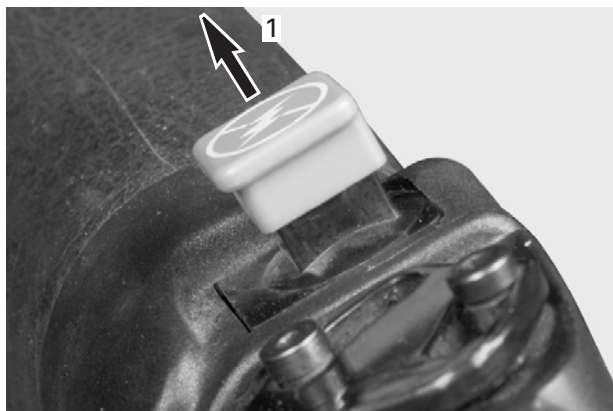

A30E03A

TYPICAL

1. ON
2. OFF

All drivers of the snowmobile should familiarize themselves with the function of this device by using it several times on first outing and to stop the engine there after. Thereby being mentally prepared for emergency situations requiring its use.

WARNING

If the switch has been used in a mechanical malfunction, the source of malfunction should be determined and corrected before restarting engine.

15) Headlamp Dimmer Switch

Located on left side of handlebar, allows selection of headlamp beam. Note that lights are automatically ON whenever the engine is running.

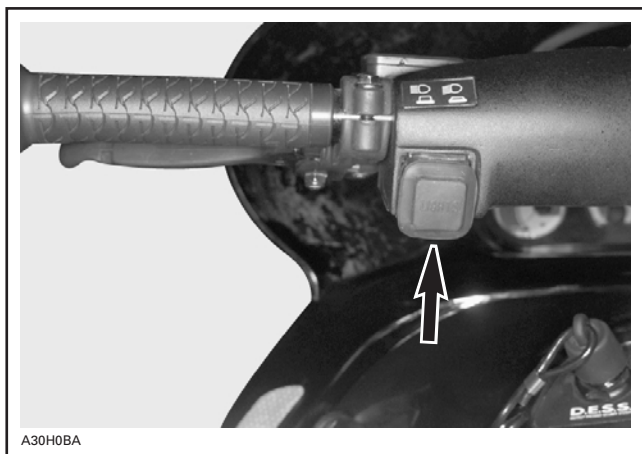

TYPICAL — ALL MODELS

16) High Beam Pilot Lamp (Blue)

Lights when headlamp is on HIGH beam.

17) Rewind Starter Handle

Auto-rewind type located on right hand side of snowmobile. To engage mechanism, pull handle slowly until a resistance is felt then pull vigorously. Slowly release handle.

18) Choke Lever

This device features a 3-position lever to facilitate cold start.

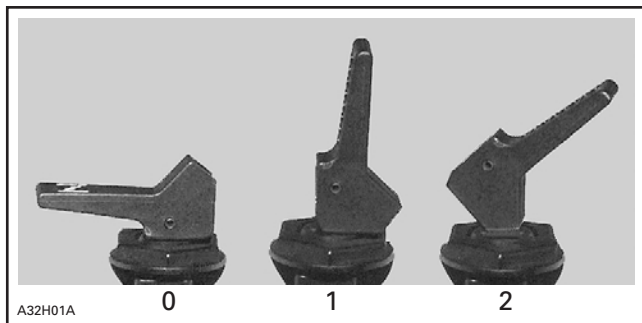

- 0. OFF
- 1. Position 1
- 2. Position 2

See OPERATING INSTRUCTIONS for more details.

19) Speedometer

Direct-reading dial indicates the speed of the snowmobile in kilometers per hour (miles per hour for the USA).

20) Odometer

Odometer records the total distance travelled in kilometers (miles for the USA).

21) Trip Meter

Records distance travelled in kilometers (miles for the USA) until it is reset. It can be used to establish a fuel tank range or distance between 2 relays for instance.

22) Trip Meter Reset Button

To reset, push on button until all numbers read zero.

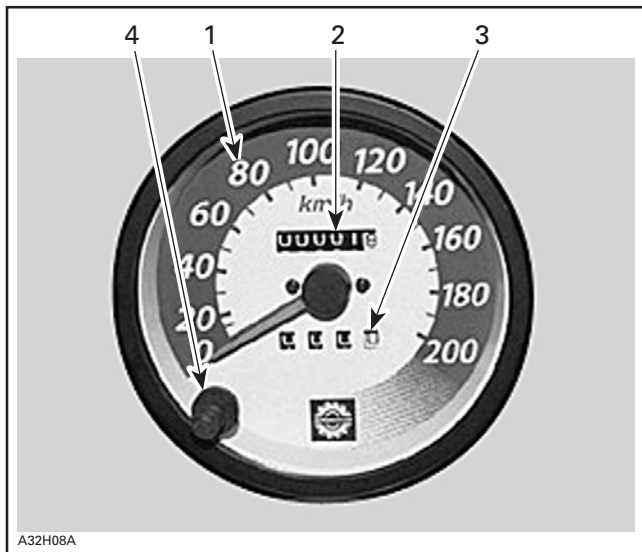

ALL MODELS

1. Speedometer
2. Odometer
3. Trip meter
4. Reset button

23) Tachometer

Direct-reading dial indicates the number of thousand of revolutions per minute (RPM) of the engine.

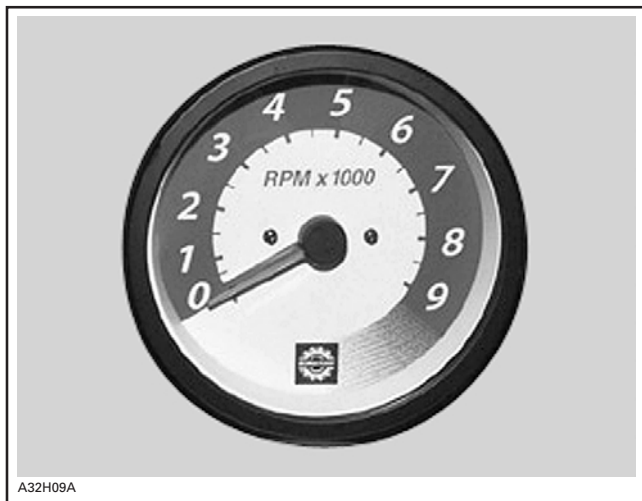

MULTIPLY THE READING BY 1000

24) Temperature Gauge

The gauge indicates engine coolant temperature. The needle moves to the normal range as engine warms. Under all riding conditions, the needle should stay within this range. If needle moves into the over-heat range, reduce snowmobile speed and run snowmobile in loose snow or stop engine immediately.

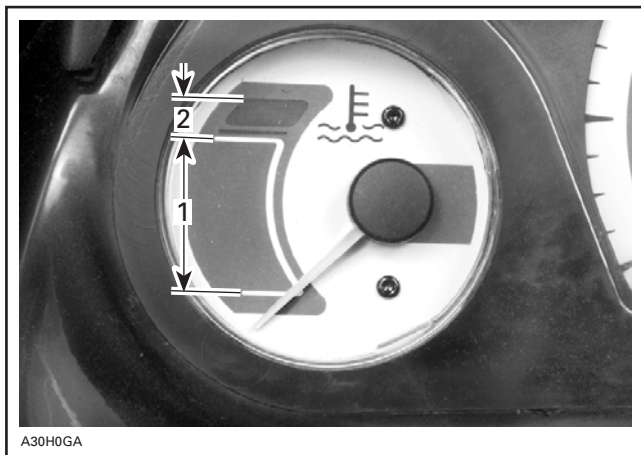

TYPICAL

1. Normal
2. Overheat

25) Engine Overheat Warning Lamp (Red)

If this lamp glows, stop engine immediately and allow to cool. If problem repeats, see your authorized SKI-DOO dealer.

26) Fuel Tank Cap/Gauge

On some models fuel level gauge is part of fuel tank cap. Unscrew to fill up tank then fully tighten.

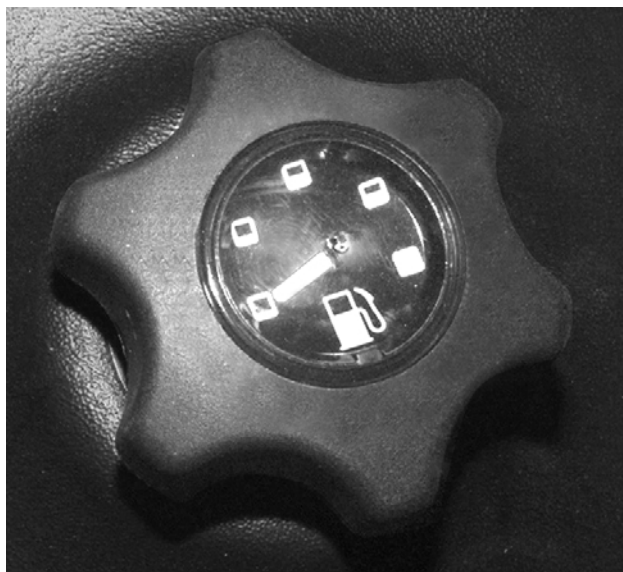

A32101A

WARNING

Fuel may be pressurized, open cap slowly. Fuel is flammable and explosive. Never use an open flame to check fuel level. Never smoke or allow flame or spark in vicinity. Never top up the fuel tank before placing the vehicle in a warm area. As temperature increases, fuel expands and may overflow. Always wipe off any fuel spillage from the vehicle.

CAUTION: Do not mismatch oil reservoir cap with fuel tank cap. Oil reservoir cap is identified OIL.

27) Electric Fuel Level Gauge

Dash-mounted gauge to facilitate fuel level reading. This gauge functions when engine is running.

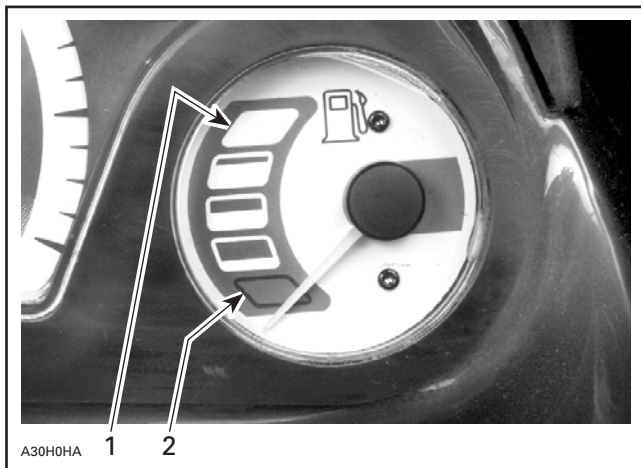

TYPICAL

1. Full
2. Empty

28) Heated Grip Switch

Three-position toggle switch. Select the desired position to keep your hands at a comfortable temperature.

29) Heated Throttle Lever Switch

Three-position toggle switch. Select the desired position to keep your right thumb at a comfortable temperature.

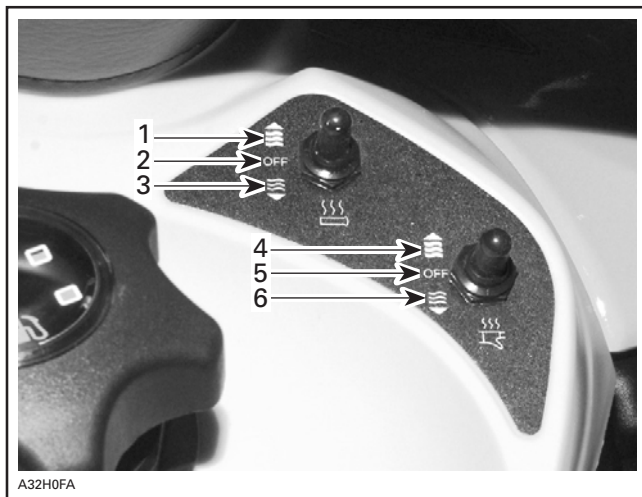

HEATED GRIP SWITCH

1. HOT
2. OFF
3. WARM

HEATED THROTTLE LEVER SWITCH

4. HOT
5. OFF
6. WARM

30) Electric Visor Jack Connector

An electric visor can be connected to the jack connector. Electric current is supplied whenever engine is running. An extension is supplied with the vehicle. It is included in the predelivery kit. Ask your SKI-DOO dealer for the extension.

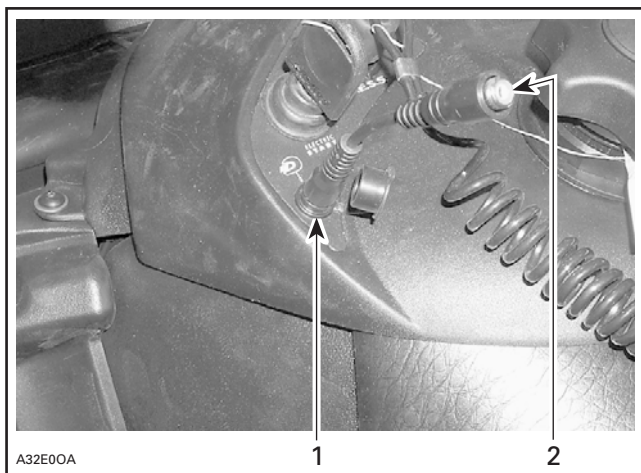

1. Electric visor jack connector
2. Extension

31) 12-Volt Power Outlet

A 12-volt electric appliance may be connected to that jack connector. Electric current is supplied when ever engine is running. See **Fuses** below for 12-volt power outlet fuse location.

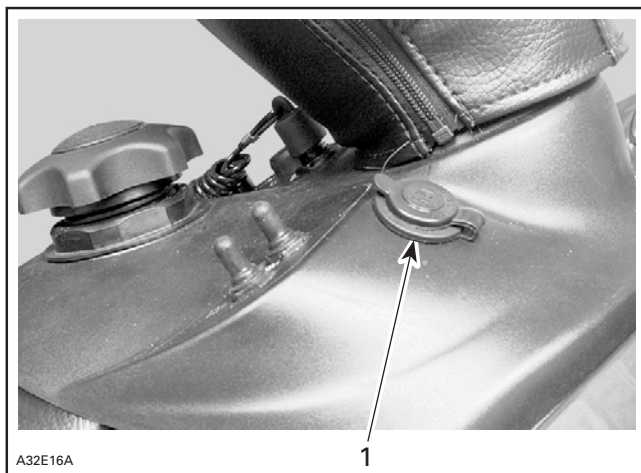

1. 12-volt power outlet

32) Electric Valving Shock Switch

This toggle type switch allows two different rear suspension rear shock valving: SPORT or COMFORT.

The selected valving will remain even after engine has been stopped. Run vehicle at least 2 minutes to warm up shock before changing valving.

33) Electric Valving Shock Pilot Lamp (Amber)

This pilot lamp will light up when SPORT valving is selected.

34) Air Suspension Switch

This switch controls pressure inside rear air shock absorber.

NOTE: Compressor can be activated only with the engine running.

Holding switch upward (SPORT) increases air pressure.

Holding switch downward (COMFORT) decreases air pressure.



WARNING

Always completely stop vehicle in a safe place before attempting any suspension adjustments.

NOTE: Compressor will keep the minimum required pressure when engine is running. If the minimum required pressure can not be maintained, see an authorized SKI-DOO dealer.

35) Air Suspension Gauge

Grand Touring SE Only

This gauge indicates comfort level (pressure inside rear air shock absorber).

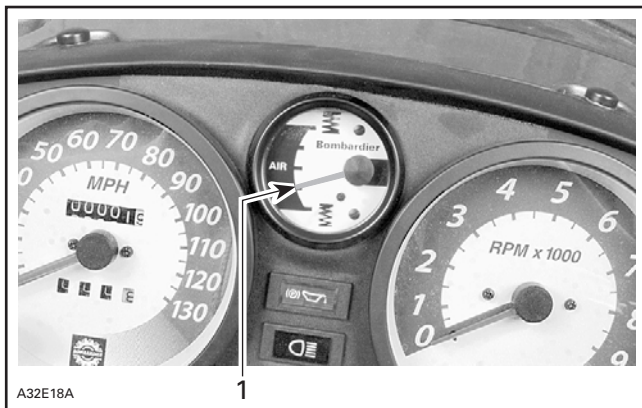

TYPICAL — AIR SUSPENSION GAUGE

1. Minimum required pressure before riding

36) Hood Latches

Stretch and unhook the latches to unlock the hood from its anchors.

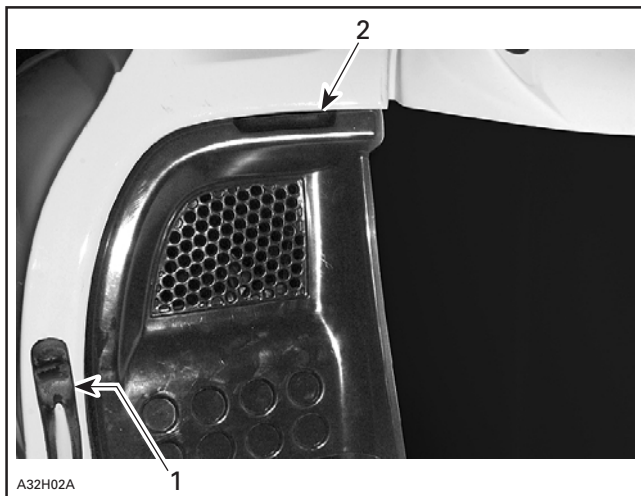

1. Latch
2. Recess provided to open hood

Always lift hood gently until stopped by retaining device.
Close hood slowly then hook up latches.

37) Adjustable Mirrors

Each mirror can be adjusted to suit driver's preference.

WARNING

Adjust with vehicle at rest in a safe place.

38) Adjustable Toeholds

Each toehold can be adjusted to suit driver's preference. Loosen bolts, adjust then, retighten bolts to 10 N•m (89 lbf•in).

WARNING

Adjust with vehicle at rest in a safe place. Do not adjust too snugly. Securely tighten all adjustments.

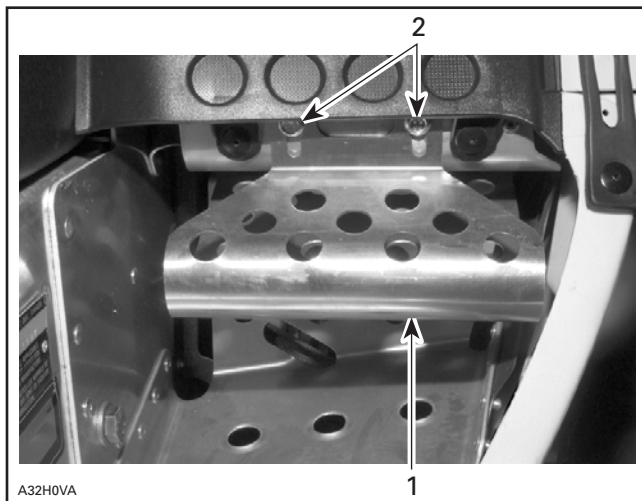

RIGHT SIDE SHOWN

1. Toehold
2. After adjustment retighten bolts to 10 N•m (89 lbf•in)

39) Heated Carburetor Valve

Turn valve on when riding at 5°C (41°F) or colder temperatures.

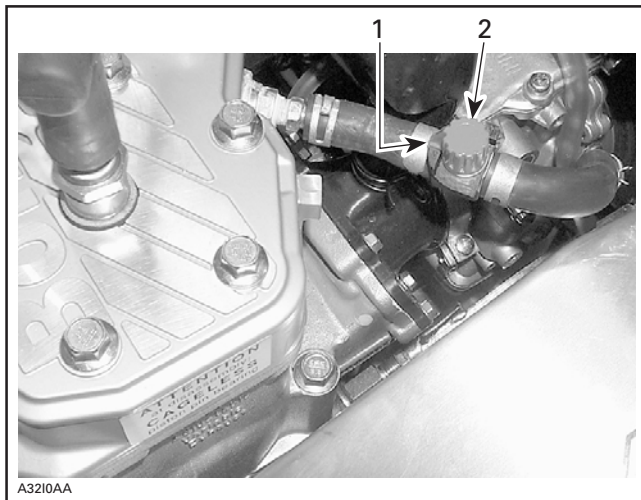

1. ON
2. OFF

CAUTION: When operating the snowmobile above 5°C (41°F), move the carburetor heating valve to the OFF position.

40) Adjustable Backrest

The backrest position and support angle may be adjusted to suit driver or passenger convenience.

WARNING

Adjust with vehicle at rest in a safe place. Securely tighten all adjustments.

Grand Touring 500 F



TYPICAL — BACKREST POSITION

1. Loosen bottom knobs on both sides, position backrest as desired then tighten knobs



A03A0KC

TYPICAL — BACKREST SUPPORT ANGLE

1. Loosen top knob to adjust then retighten



A03A0KB

TYPICAL — BACKREST HEIGHT

1. Loosen center knobs (both sides) to adjust then retighten

Liquid Cooled Grand Touring

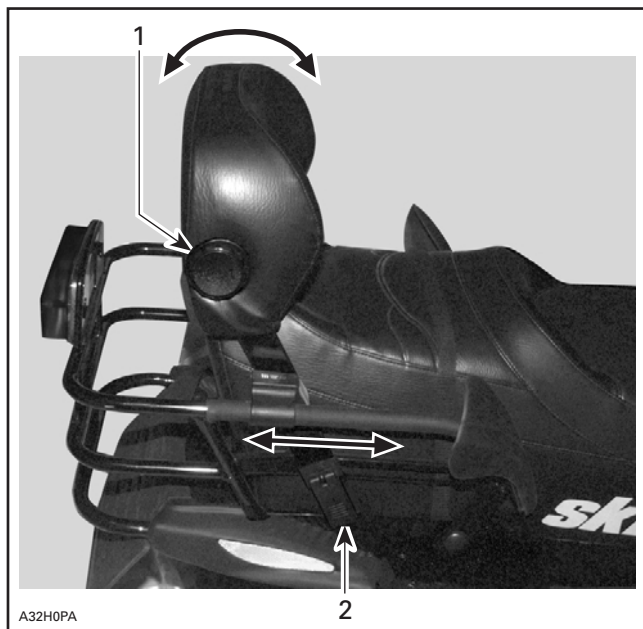

1. Turn adjustment knob
2. Lift adjustment lock (both sides)

Secure adjustment locks after desired position is obtained.

41) Seat Strap

Seat strap provides a grip for the passenger.

42) Rear Passenger Heated Grip Switch

Three-position switch. Select the desired position to keep rear passenger's hands at a comfortable temperature.

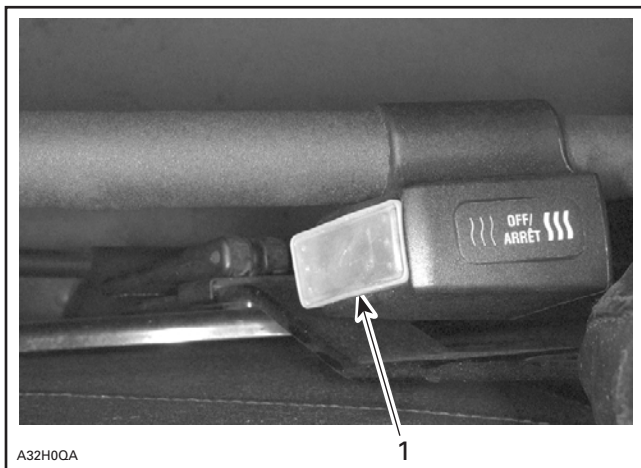

TYPICAL — RIGHT SIDE OF PASSENGER GRAB HANDLE

1. Rear passenger heated grab handles switch

43) Adjustable Rear Grab Handles

Height of rear grab handles can be adjusted.

Lift adjustment lock, move grab handle to desired position. Secure adjustment lock. Proceed the same with the other side.

WARNING

Adjust with vehicle at rest in a safe place. Securely tighten all adjustments.

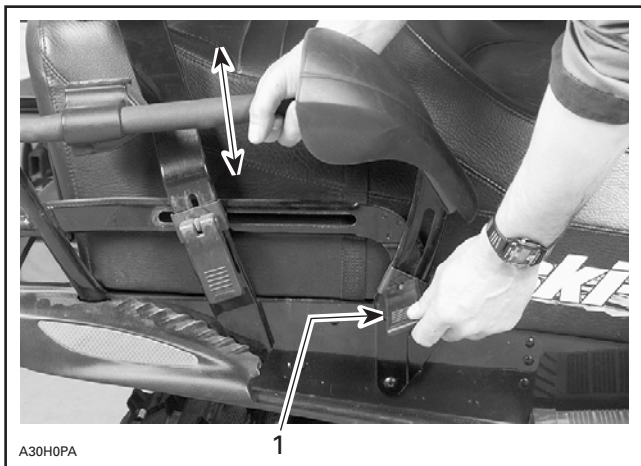

TYPICAL

1. Lift adjustment lock

44) Hood Grills

When riding on powdered snow, close plastic sliding hood grills from underneath hood. Otherwise always keep grills open. Squeeze tabs to close grills.

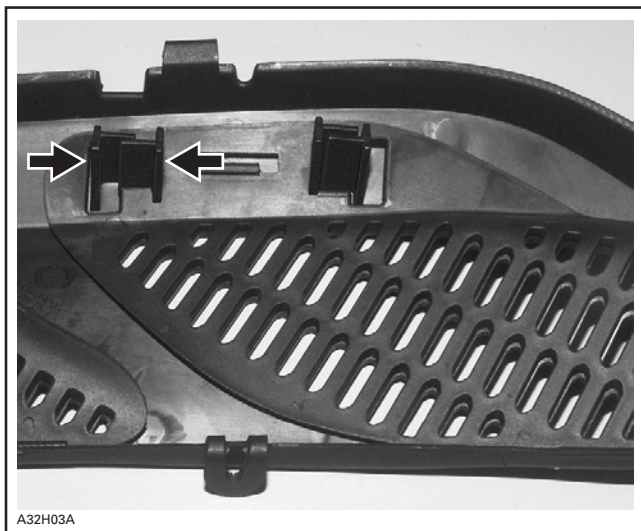

A32H03A

TO CLOSE, SQUEEZE CLOSING TABS BETWEEN THUMB AND INDEX

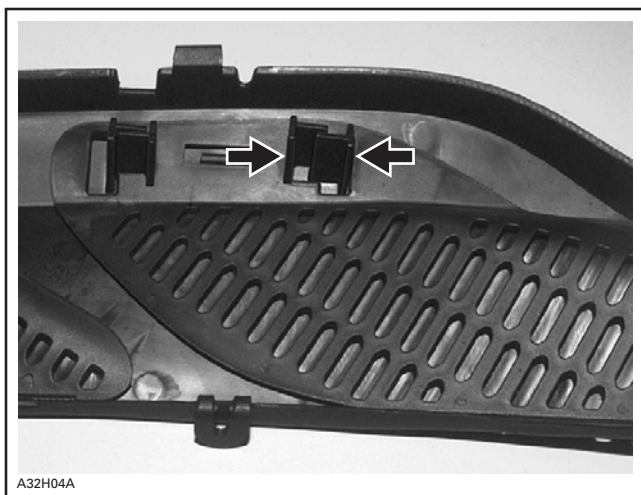

A32H04A

TO OPEN, SQUEEZE OPENING TABS BETWEEN THUMB AND INDEX

45) Storage Compartment

A storage compartment is provided inside rear portion of seat.

WARNING

All storage compartments must be properly latched and they must not contain any heavy or breakable objects.

46) Tool Bag

A tool bag containing tools for basic maintenance is supplied with the vehicle. Tool bag is located in engine compartment above left hand side toe-hold.



A32B01A

TYPICAL — TOOL BAG

47) Fuses

Charging System Fuse

Charging system is protected with 30 ampere rated fuse. See following illustration for fuse holder location. If charging system does not operate, check fuse condition and replace it if necessary.

Accessories Fuse

Accessories are protected with 20 ampere rated fuse. See following illustration for fuse holder location. If no current is present at outlet, check fuse condition and replace it if necessary.

Headlight Fuse

Headlight is protected with 20 ampere rated fuse. See following illustration for fuse holder location. If headlight does not light up, check fuse condition and replace it if necessary.

Electronic Module Fuse

Electronic module is protected with 5 ampere rated fuse. See following illustration for fuse holder location. If electronic module does not operate, check fuse condition and replace it if necessary.

CAUTION: Do not use a higher rated fuse as this can cause severe damage to electric components and/or fire.



WARNING

If fuse has burnt out source of malfunction should be determined and corrected before restarting. See an authorized SKI-DOO dealer for servicing.

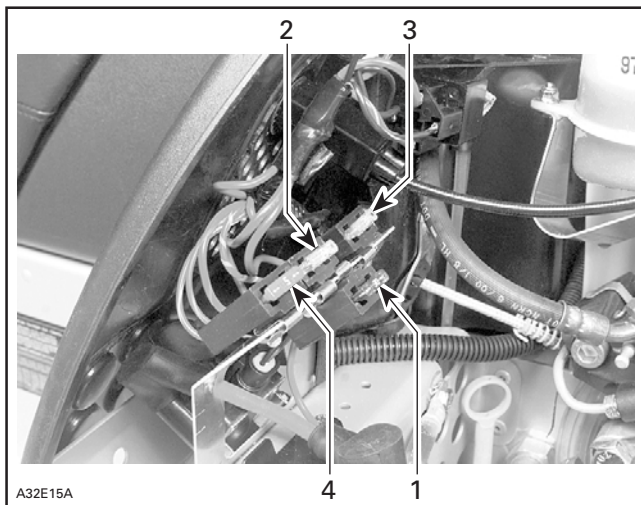

A32E15A

1. 30 A charging system fuse
2. 20 A headlight fuse
3. 20 A accessories fuse
4. 5 A electronic module fuse

To remove fuse from holder, pull fuse out. Check if filament is melted.

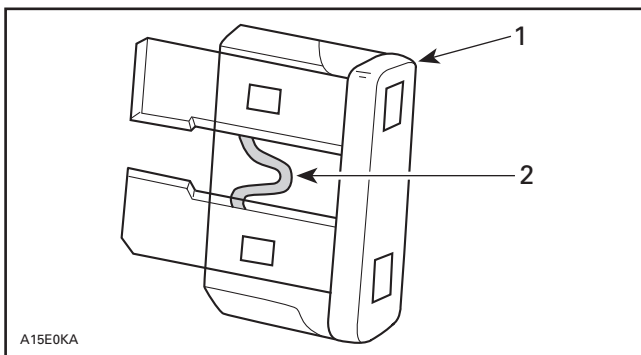

A15E0KA

1. Fuse
2. Check if melted

Electric Fuel Level Gauge Fuse

See an authorized SKI-DOO dealer for fuse replacement.

48) Spare Spark Plug Holder

To keep spare spark plugs dry and prevent shocks that might affect the adjustment or break them, a holder is provided on the right side of oil tank.

Firmly tighten them into the holder with spark plug socket (in tool kit) to ensure that they will not be loosened by vibrations.

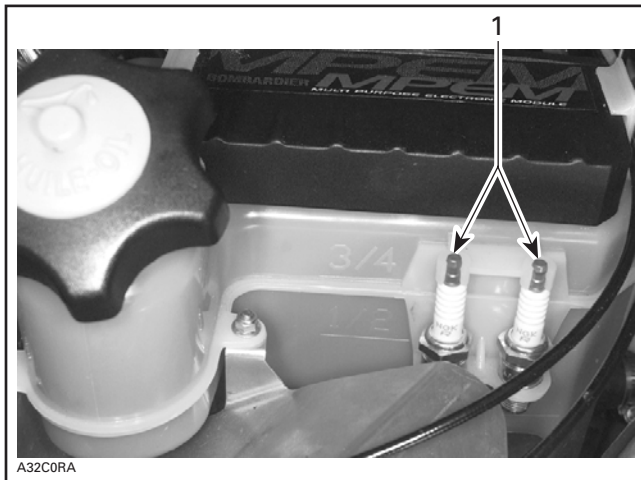

1. Spare spark plugs installed in holder

NOTE: Adjust spare spark plug gap according to SPECIFICATIONS before installation.

NOTE: Spare spark plugs are not supplied with the snowmobile.

49) Spare Drive Belt Holder

A spare drive belt can be stored in holder at front section of bottom pan.

NOTE: Spare drive belt is not supplied with the snowmobile.

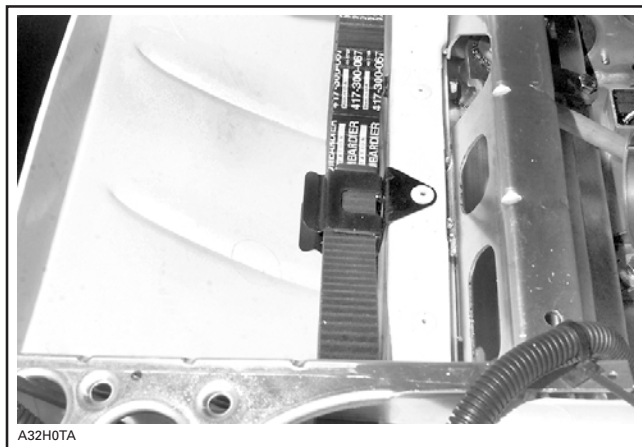

TYPICAL — SPARE DRIVE BELT INSTALLED IN HOLDER

50) Front Grab Handles/Front Bumper

To be used whenever front of snowmobile requires manual lifting.

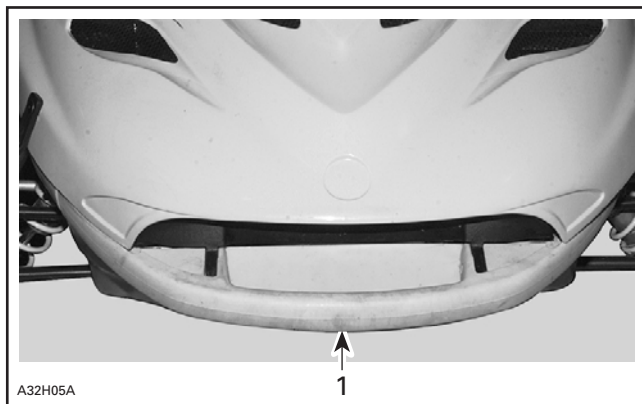

1. Front grab handles

CAUTION: Do not use skis to pull or lift snowmobile.

51) Convertible Ski Stance

Summit Models Only

Ski stance (distance between each skis) is adjustable. See an authorized SKI-DOO dealer.

52) Adjustable Suspensions

For factory recommended adjustments refer to decal on belt guard. It describes settings for optimum comfort according to load for your SKI-DOO model.

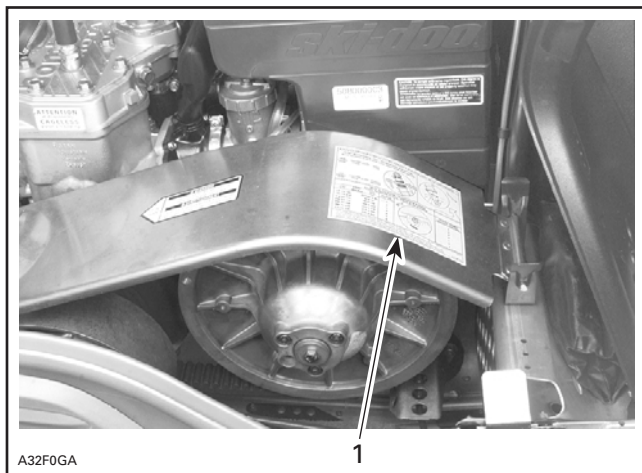

TYPICAL

1. Decal

General

Snowmobile handling and comfort depend upon suspension adjustments.

Choice of suspension adjustments vary with carrying load, driver's weight, personal preference, riding speed and field condition.

NOTE: Some adjustments may not apply to your snowmobile. Use special keys in tool bag.

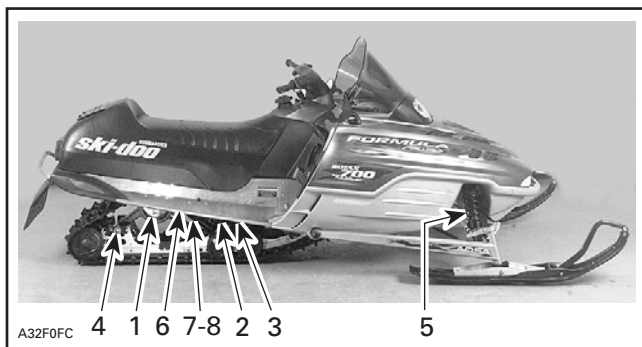

TYPICAL

1. Rear springs for comfort and ride height
2. Center spring for steering behavior
3. Coupling blocks — Handling
4. Stopper strap for snowmobile weight transfer
5. Front springs for handling
6. Rear shock motion ratio — Damping strength
7. Rear shock valving — Damping strength
8. Air shock absorber — Comfort and ride height

Guidelines to Adjust Suspension

The best way to set up suspension, is to start from factory settings then customize each adjustment one at a time. Adjustments 2 through 7 are interrelated. It may be necessary to readjust center spring after adjusting front springs for instance. Test run the snowmobile under the same conditions; trail, speed, snow, driver riding position, etc. Change one adjustment and retest. Proceed methodically until you are satisfied.

WARNING

Always completely stop vehicle and engine before attempting any suspension adjustments.

CAUTION: Whenever adjusting rear suspension, check track tension and adjust as necessary.

Slight suspension bottoming occurring under the worst riding conditions indicates a good choice of spring preload.

NOTE: Some models are equipped with Take/Apart (T/A) shocks. These can be rebuilt or recalibrated. See an authorized SKI-DOO dealer.

1. Rear Springs — Comfort and Ride Height

Grasp rear bumper and lift until suspension is fully extended. From this point, rear of snowmobile should collapse by 50 to 75 mm (2 to 3 in) when driver and passenger (if so applicable) take place.



TYPICAL — PROPER ADJUSTMENT

A. 50 to 75 mm (2 to 3 in)



TYPICAL — TOO SOFT OF ADJUSTMENT



Turn the left side adjustment cam in a clockwise direction, the right side cam in a counterclockwise direction. Left and right adjustment cams may be set at different position.

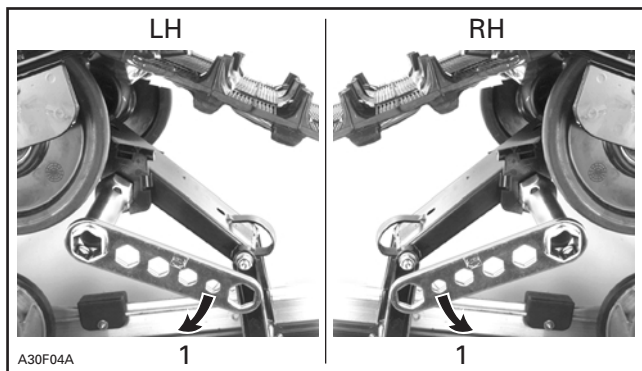

TYPICAL

1. Increase spring preload



TYPICAL — TOO HARD OF ADJUSTMENT



Turn the left side adjustment cam in a counterclockwise direction, the right side cam in a clockwise direction. Left and right adjustment cams may be at different position.

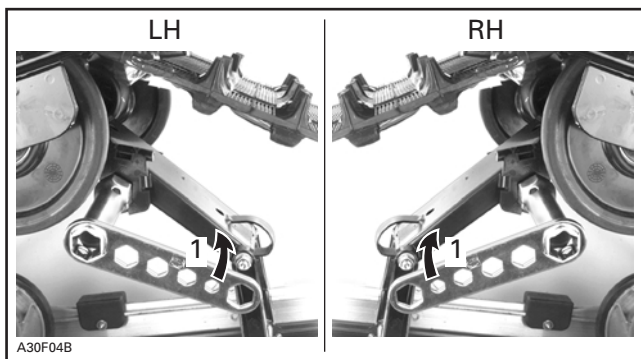

TYPICAL

1. Decrease spring preload

2. Center Spring — Steering Behavior

Ride at moderate speed on a trail.

If steering is too easy or too hard to turn, adjust center spring accordingly.



A32F0EA

TYPICAL — GOOD ADJUSTMENT AT MODERATE SPEED

1. *Steering easy to turn*



TYPICAL — TOO SOFT OF ADJUSTMENT

1. Steering hard to turn

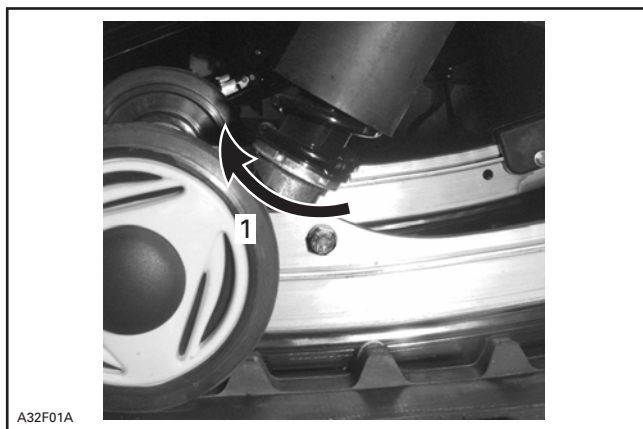

TYPICAL

1. Use adjuster wrench provided in tool bag to increase preload

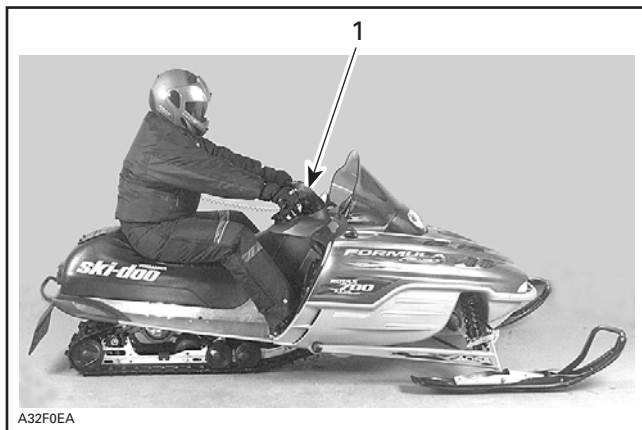

TYPICAL — TOO HARD OF ADJUSTMENT

1. *Steering less aggressive*

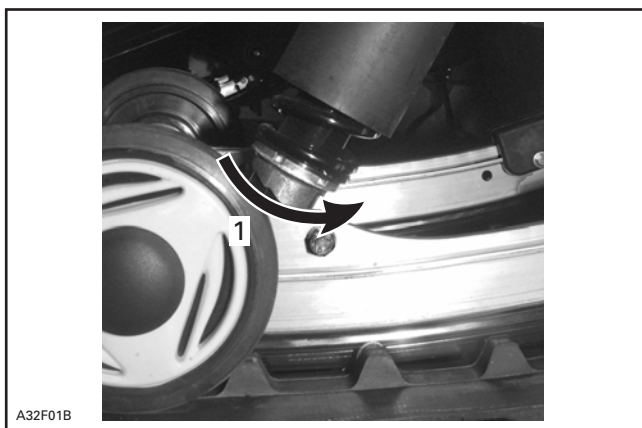

TYPICAL

1. *Use adjuster wrench provided in tool bag to decrease preload*

3. Coupling Blocks — Handling

Ride at moderate speed and check for desired handling.

All Models Except Summit

When driver and passenger (if applicable) take place the coupling blocks should be centered between rubber stoppers. This condition is achieved when a proper rear spring preload is done. See above rear spring adjustment.

If handling requires adjustment, turn both left and right blocks by 90°.

There are only two adjustment positions. Thicker part of block must be facing rearward or downward.

WARNING

Both blocks must be set at the same position. Otherwise vehicle behavior may be unpredictable and suspension may become warped.

Use tool provided in tool bag to adjust coupling blocks.

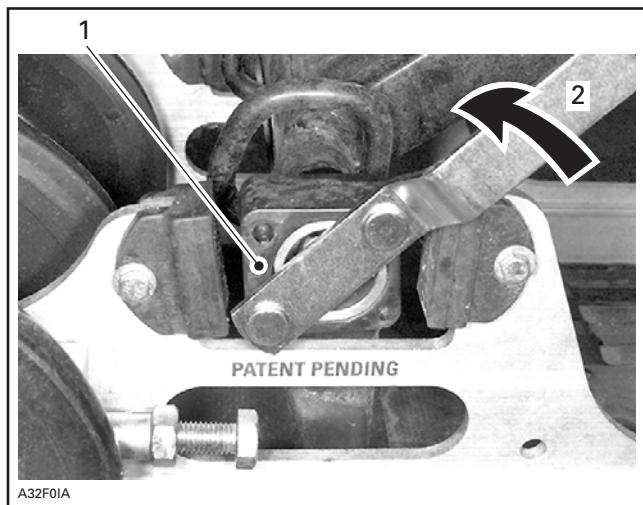

COUPLING BLOCK — RIGHT SIDE VIEW (“R” — RIGHT EMBOSSED ON BLOCK)

1. Thicker part of block facing rearward (fully coupled suspension) — less track grip and more skis steering
2. Turn block in this direction to adjust to the other position

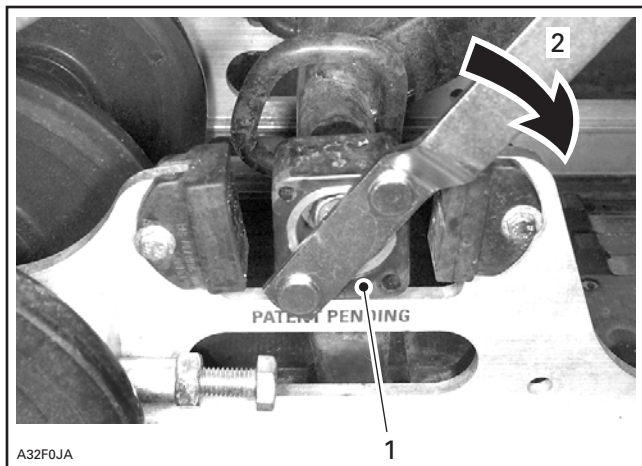

COUPLING BLOCK — RIGHT SIDE VIEW (“R” — RIGHT EMBOSSED ON BLOCK)

1. Thicker part of block facing downward (partly coupled suspension) — more track grip and less skis steering
2. Turn block in this direction to adjust to the other position

4. Stopper Strap — Weight Transfer

Ride at low speed then fully accelerate. Note steering behavior. Adjust stopper strap length accordingly.

At rest with driver and passenger (if applicable), stopper strap should have a free play of 12 mm (1/2 in).

CAUTION: Whenever stopper strap length is changed, track tension must be readjusted.

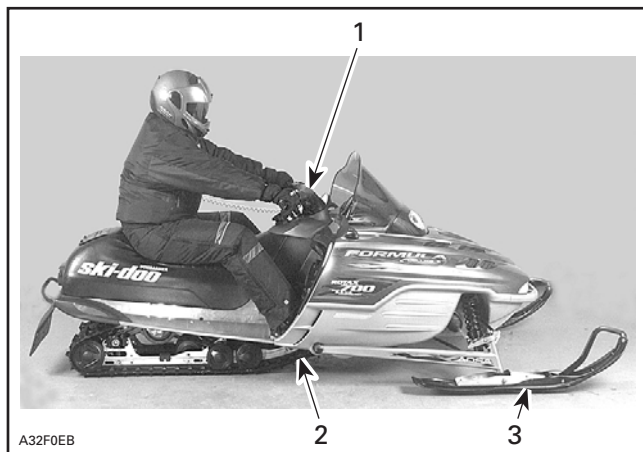

TYPICAL — GOOD ADJUSTMENT AT FULL ACCELERATION

1. Comfortable steering
2. Good weight transfer to the track
3. Light pressure of skis on the ground

All Models Except Summit Models



TYPICAL — TOO LONG STRAP

1. Skis lift off the ground

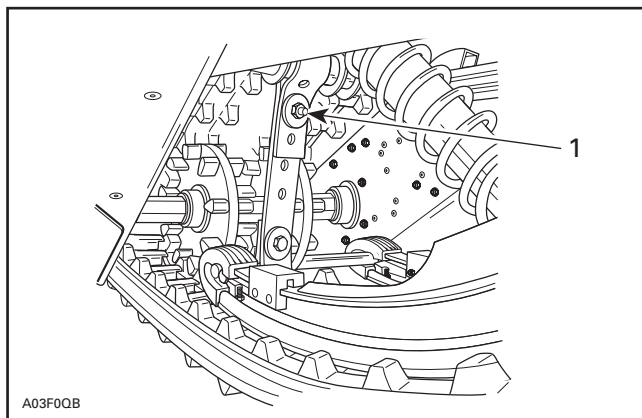

TYPICAL

1. Reduce strap length by bolting to a different hole



TYPICAL — TOO SHORT STRAP

1. Heavy steering

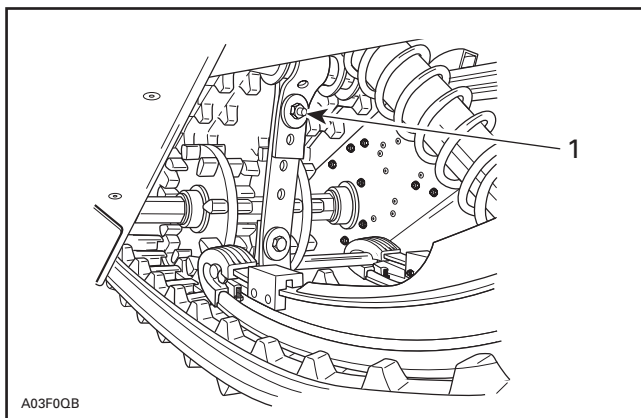

TYPICAL

1. Increase strap length by bolting to a different hole

Summit Models



TOO LONG STRAP

1. Skis lift off the ground

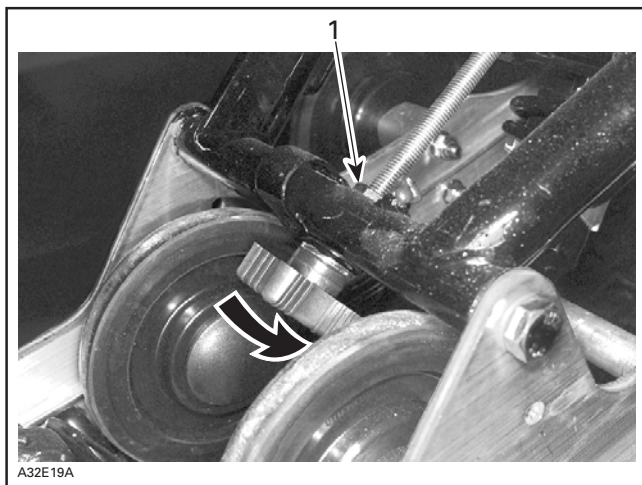

1. Loosen lock nut, turn knob accordingly then retighten lock nut



TOO SHORT STRAP

1. Heavy steering

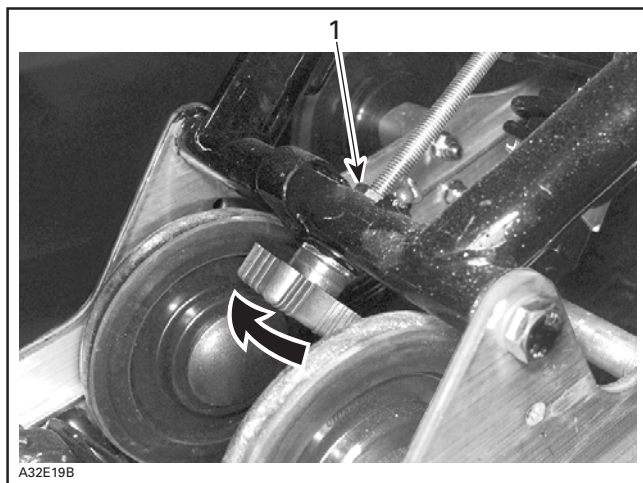

1. Loosen lock nut, turn knob accordingly then retighten lock nut

5. Front Springs — Handling

Ride at moderate speed and check for proper handling.

Adjust front springs accordingly.

WARNING

Always adjust both front springs to same position.



TYPICAL — PROPER ADJUSTMENT

1. *Good handling and comfortable steering*

Some Models



TYPICAL — TOO SOFT OF ADJUSTMENT

1. Bad handling

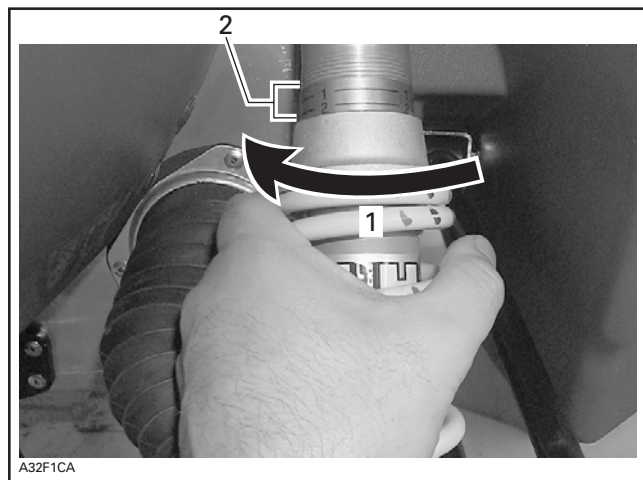

1. Increase spring preload
2. Position number



A32F0EA

TYPICAL — TOO HARD OF ADJUSTMENT

1. Steering hard to turn

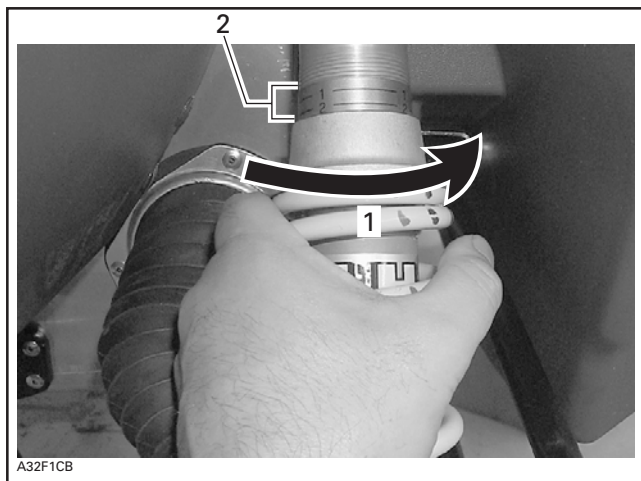

A32F1CB

1. Decrease spring preload

2. Position number

CAUTION: Make sure that both front springs are still preloaded when front of vehicle is off the ground.

Some Models

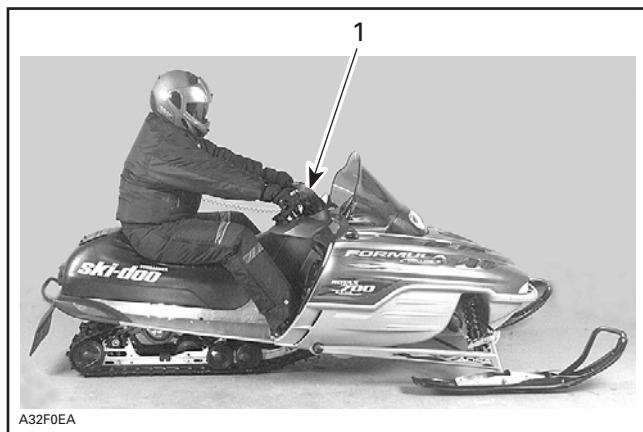

TOO SOFT OF ADJUSTMENT

1. Bad handling

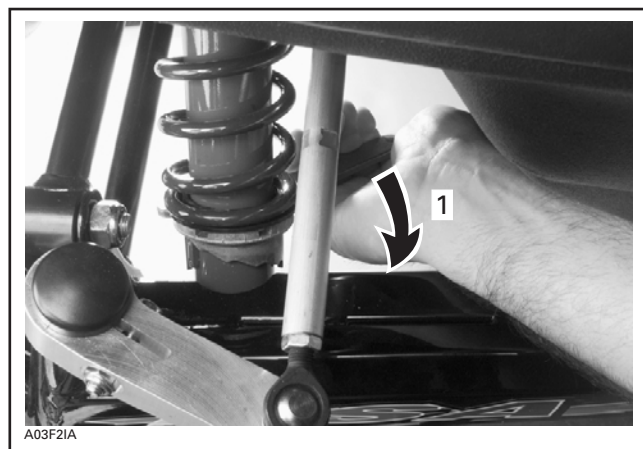

1. Increase spring preload



A32F0EA

TOO HARD OF ADJUSTMENT

1. Steering hard to turn

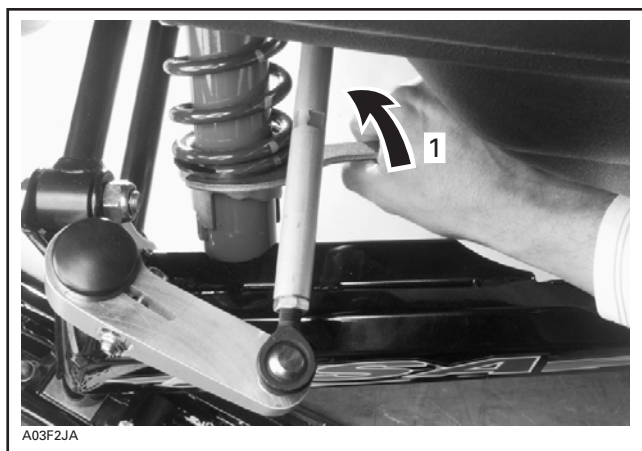

A03F2JA

1. Decrease spring preload

6. Rear Shock Motion Ratio — Damping Strength

Some Models Only

Rear shock motion ratio can be adjusted according to driver and passenger weight and/or trail condition.

There are two adjustment positions.

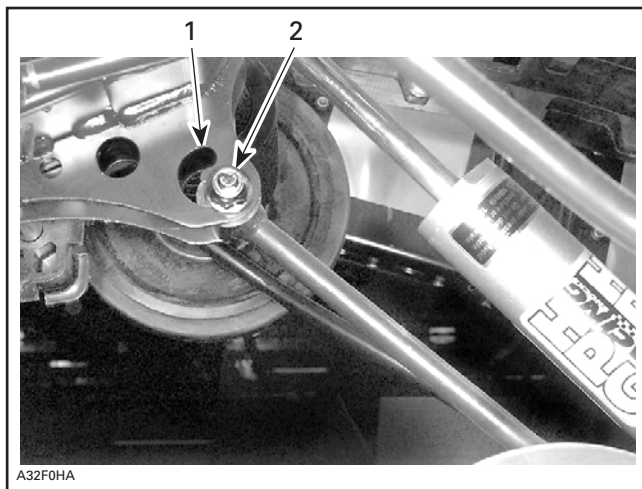

SC-10 AND SC-10 II SUSPENSIONS

- 1. Soft position*
- 2. Firm position*

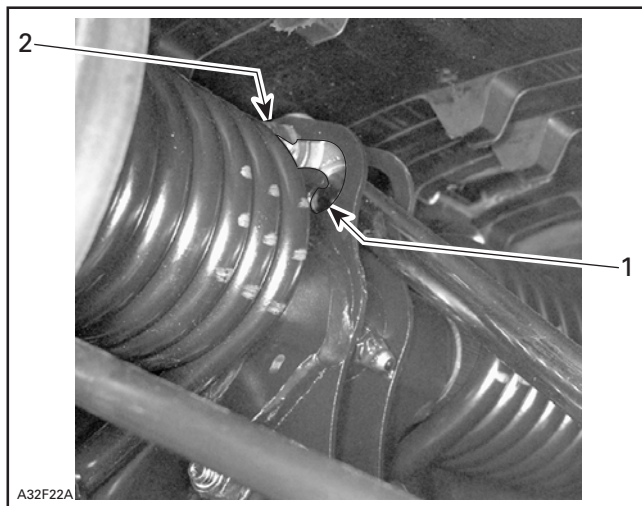

SC-10 III SUSPENSION

1. Soft position
2. Firm position

To adjust, loosen nut, move bolt to desired position then torque nut to 24 N•m (18 lbf•ft).

7. Rear Shock Valving — Damping Strength

Legend SE Only

Rear shock valving can be adjusted according to driver and passenger weight and/or trail condition. There is two positions which can be selected using dash-mounted switch: SPORT and COMFORT. A pilot lamp will light up when SPORT valving is selected.

Run vehicle at least 2 minutes to warm up shock before changing valving.

8. Air Shock Absorber — Comfort and Ride Height

Grand Touring SE Only

After all adjustments are performed, rear air shock absorber can be adjusted as necessary. Use the console mounted switch.

TROUBLESHOOTING CHART

PROBLEM	CORRECTIVE MEASURES
Front suspension wandering	<ul style="list-style-type: none">- Check ski alignment and camber angle adjustment. See an authorized SKI-DOO dealer.- Reduce ski ground pressure.<ul style="list-style-type: none">• Reduce front suspension spring preload.• Increase center spring preload.• Reduce rear spring preload.
Snowmobile seems unstable and seems to pivot around its center	<ul style="list-style-type: none">- Reduce rear suspension front arm pressure.<ul style="list-style-type: none">• Reduce center spring preload.• Increase rear spring preload.• Increase front suspension spring preload.
Steering feels too heavy	<ul style="list-style-type: none">- Reduce ski ground pressure.<ul style="list-style-type: none">• Reduce front suspension spring preload.• Increase center spring preload.
Rear of snowmobile seems too stiff	<ul style="list-style-type: none">- Reduce rear spring preload.
Rear of snowmobile seems too soft	<ul style="list-style-type: none">- Increase rear spring preload.
Rear suspension front shock absorber is frequently bottoming	<ul style="list-style-type: none">- Lengthen stopper strap.- Increase center spring preload.
Track slides too much at start	<ul style="list-style-type: none">- Lengthen stopper strap.- Change driving position.- Turn coupling blocks.

In Deep Snow

When operating the snowmobile in deep snow, it may be necessary to vary the position of front spring, rear suspension, stopper strap and/or riding position, to change the angle at which the track rides on the snow. Operator's familiarity with the various adjustments as well as snow conditions will dictate the most efficient combination.

FUEL AND OIL

Recommended Fuel

Use regular unleaded gasoline, available from most service stations or oxygenated fuel containing less than 10% of ethanol or 5% of methanol. The gasoline used must have an octane number $(R + M)/2$ of 87 or higher.

NOTE: In most service station pump octane number corresponds to $(R + M)/2$ octane number.

CAUTION: Never experiment with other fuels or fuel ratios. The use of unrecommended fuel can result in snowmobile performance deterioration and damage to critical parts in the fuel system and engine components. Do not mismatch oil reservoir cap with fuel tank cap. Oil reservoir cap is identified OIL.

WARNING

Fuel may be pressurized, open cap slowly. Fuel is flammable and explosive. Never use an open flame to check fuel level. Never smoke or allow flame or spark in vicinity. Never top up the fuel tank before placing the vehicle in a warm area. As temperature increases, fuel expands and may overflow. Always wipe off any fuel spillage from the vehicle.

Fuel System Antifreeze

When using oxygenated fuel, additional gas line antifreeze or water absorbing additives are not required and should be not used.

When using non-oxygenated fuel, we highly recommend the use of isopropyl base gas line antifreeze in a proportion of 150 mL (5 U.S. oz) of gas line antifreeze added to 40 liters (10-1/2 U.S. gal) of gas.

This precaution is in order to reduce the risk of frozen carburetor(s) which may lead, in certain cases, to high fuel consumption or severe damage to engine.

IMPORTANT: Use only **methyl hydrate free** gas line antifreeze, Kleen-Flo* or equivalent.

Recommended Oil

CAUTION: Use only oil that flows at - 40°C (- 40°F). Do not mismatch oil reservoir cap with fuel tank cap. Oil reservoir cap is identified OIL.

Oil is contained in the oil injection reservoir.

Use only two-stroke engine injection oil sold by authorized SKI-DOO dealers.

MODEL	OIL TYPE
All	BOMBARDIER FORMULA XP-S synthetic injection oil (or equivalent) OR BOMBARDIER injection oil (or equivalent) ① ②

- ① If BOMBARDIER injection oil is not available, API TC high-quality ashless two-stroke injection oil may be used.
- ② BOMBARDIER FORMULA XP-S synthetic injection oil and BOMBARDIER injection oil are compatible, they can be mixed together.

BOMBARDIER injection oil is a special blend of basic oil and additives especially selected to ensure unequalled lubrication, engine cleanliness and minimum spark plug fouling. The BOMBARDIER FORMULA XP-S synthetic injection oil **provides superior lubrication**, reduced engine component wear and oil deposit, thus maintaining maximum-level performance and antifriction properties. This synthetic injection oil meets the latest ASTM and JASO standards by ensuring high biodegradability and low exhaust smoke.

CAUTION: Never use four-stroke petroleum or synthetic motor oil and never mix these with outboard motor oil. Do not use NMMA TC-W, TC-W2 or TC-W3 outboard motor oils. Avoid mixing different brands of API TC oil as resulting chemical reactions may cause severe engine damage.

Always maintain a sufficient amount of recommended oil in the injection oil reservoir.

CAUTION: Check level and refill every time you refuel. Do not mismatch oil reservoir cap with fuel tank cap. Install cap that is identified OIL.

WARNING

Wipe off any oil spills. Oil is highly flammable.

COLD WEATHER CARBURETION MODIFICATIONS

All vehicles have been calibrated for - 20°C (- 4°F). They can be operated at warmer winter temperatures without problems.

CAUTION: For colder temperatures than - 20°C (- 4°F), carburetor(s) must be recalibrated to avoid engine damage. Refer to an authorized SKI-DOO dealer.

Refer also to RIDING AT HIGH ALTITUDES in following pages.

BREAK-IN PERIOD

Engine

CAUTION: A break-in period of 10 operating hours — 500 km (300 miles) — is required before running the snowmobile at full throttle.

During break-in period, maximum throttle should not exceed 3/4. However, brief full acceleration and speed variations contribute to a good break-in. Continued wide open throttle accelerations, prolonged cruising speeds and engine overheating are detrimental during the break-in period.

To assure additional protection during the initial engine break-in, 500 mL (18 imp. oz) of recommended injection oil (P/N 413 802 900 — 12 x 1 L), should be added to fuel for the first full filling of fuel tank. Always remove and clean spark plugs after engine break-in.

Belt

A new drive belt requires a break-in period of 50 km (30 miles). Avoid strong acceleration/deceleration, pulling a load or high speed cruising.

10-Hour Inspection

As with any precision piece of mechanical equipment, we suggest that after the first 10 hours of operation — 500 km (300 miles) — or 30 days after the purchase, whichever comes first, your snowmobile be checked by an authorized SKI-DOO dealer. This inspection will give you the opportunity to discuss the unanswered questions you may have encountered during the first hours of operation.

The 10-hour inspection is at the expense of the snowmobile owner.

PRE-OPERATION CHECK

WARNING

The pre-operation check is very important prior to operating the vehicle. Always check the proper operation of critical controls, safety features and mechanical components before starting. If not done as specified here, severe injury or death might occur.

- Verify that track and idler wheels are unfrozen and free to turn.

WARNING

Always use a mechanical snowmobile stand to properly support vehicle during any track verification. Slowly accelerate engine in order to rotate track at very low speed when it is not on ground.

- Activate the brake control lever and make sure the brake fully applies before the brake control lever touches the handlebar grip. It must fully return when released.
- Check the parking device. Apply parking brake and check if it operates properly.
- Activate the throttle control lever several times to check that it operates easily and smoothly.

WARNING

Throttle lever must operate easily and smoothly. It must return to idle position when released.

- Check operation of ignition switch (fan cooled models only), headlight switch (HI-LO), taillight, brake light, indicator lights and tether and engine cut-out switches.
- Verify that skis and steering operate freely. Check corresponding action skis versus handlebar.
- Check fuel and injection oil for levels and leaks. Replenish as necessary and see an SKI-DOO authorized dealer in case of any leaks.
- Open or close heated carburetor valve according to outside temperature.

- Verify that air filter(s) is free of snow, if so equipped.

WARNING

All adjustable features should be positioned at optimal setting. Securely tighten all adjustment locks.

- All storage compartments must be properly latched and they must not contain any heavy or breakable objects.

PRE-OPERATION CHECK LIST

ITEM	OPERATION	✓
Track and idler wheels	Check for free movement.	
Brake lever	Check proper action.	
Parking device	Check proper action.	
Throttle lever	Check proper action.	
Switches and lights	Check proper action.	
Heated carburetor valve	Check for proper position according to outside temperature.	
Skis and steering	Check proper action.	
Fuel and oil	Check for proper level and leaks.	
Air filter	Check for free of snow.	
Adjustable features	Check for optimal adjustment and securely tightened adjustment locks.	
Storage compartment	Check for proper latching and no heavy or breakable objects.	

OPERATING INSTRUCTIONS

WARNING

Proceed with pre-operation check list before riding.

Principle of Operation

Propulsion

Depressing throttle lever increases engine RPM causing the drive pulley to engage. For most models engine RPM must be between 2500 and 4200 before drive pulley engagement will occur.

Outer sheave of drive pulley moves toward inner sheave, forcing drive belt to move upward on the drive pulley and simultaneously forcing the sheaves apart on the driven pulley.

The driven pulley senses the load on the track and limits the belt movement. The result is a continuous change in the ratio of the two pulleys which maximizes acceleration and forward movement of the vehicle.

WARNING

Do not operate engine with hood open or belt guard removed.

Power is transferred to the track through the chaincase and drive axle.

WARNING

Always use a mechanical snowmobile stand to properly support vehicle during any track verification. Slowly accelerate engine in order to rotate track at very low speed when it is not on ground.

Turning

Handlebar controls the direction of travel of the vehicle. As the handlebar is rotated to right or left, the skis are turned in the direction of intended travel.

WARNING

Fast reverse while turning, could result in loss of stability.

Starting the Engine

WARNING

Operator and passenger (if applicable) must be properly seated before starting engine.

- Re-check throttle control lever operation.
- Ensure that engine cut-out switch is in the ON position.
- Ensure that tether cut-out cap is set in place and that cord is attached to your clothing.

Initial Cold Starting

NOTE: Do not operate the throttle lever during starting.

When Temperature Is Below - 10°C (+ 15°F)

Set the choke lever to the second position.

Grasp starter handle firmly and crank engine or use electric starter on so equipped models.

After the engine is started, close off choke to ensure proper air-fuel mix when speed drops below 2000 RPM.

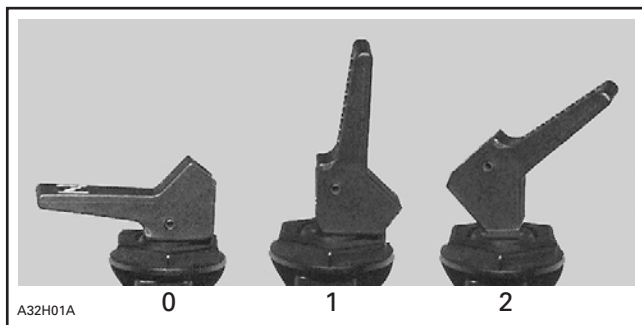

0. OFF
1. Position 1
2. Position 2

When Temperature Is above - 10°C (above + 15°F)

Set the choke lever to the first position.

Grasp starter handle firmly and crank engine or use electric starter on so equipped models.

After the engine is started, close off choke to ensure proper air-fuel mix.

Warm Engine Starting

Start the engine without any choke. If the engine will not start after two pulls of the rope or two 5 second attempts with the electric starter move choke lever to position 1. Start the engine without activating the throttle lever. As soon as the engine starts move the choke lever to OFF.

Manual Starting

Insert the key in the ignition switch and turn to ON position (fan cooled models only).

Grasp manual starter handle firmly and crank engine.

WARNING

Do not apply throttle while starting.

Electric Starting (some models only)

Fan Cooled Models

Insert key in ignition switch.

Turn key clockwise until starter engages.

Release key immediately when engine has started.

Liquid Cooled Models

Push the start/reverse button.

Release start/reverse button when engine has started.

All Models

NOTE: If for any reason, the snowmobile cannot be started electrically, place ignition key to ON position and start engine manually.

CAUTION: Do not use electric starter more than 15 seconds. A rest period should be observed between the cranking cycles to let starter cool down. Using electric starter when engine has started could damage starter mechanism.

Emergency Starting

The engine can be started with the emergency starter rope supplied with the tool kit.

Remove belt guard.

WARNING

Do not wind starting rope around your hand. Hold rope by the handle only. Do not start the snowmobile by the drive pulley unless it is a true emergency situation. Have the snowmobile repaired as soon as possible.

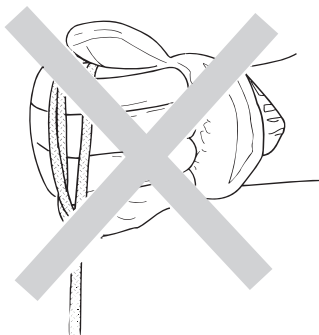

A07D0UA

Attach one end of emergency rope to rewind handle.

NOTE: The spark plug socket can be used as an emergency handle.

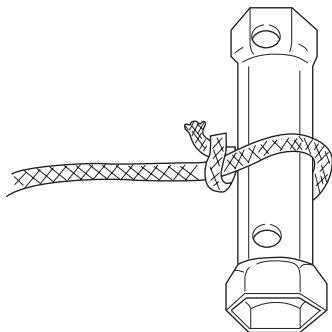

A17B01A

TYPICAL

Attach the other end of emergency rope to the starter clip supplied in the tool kit.

Hook up clip on drive pulley.

Wind the rope tightly around drive pulley. When pulled, pulley must rotate counterclockwise.

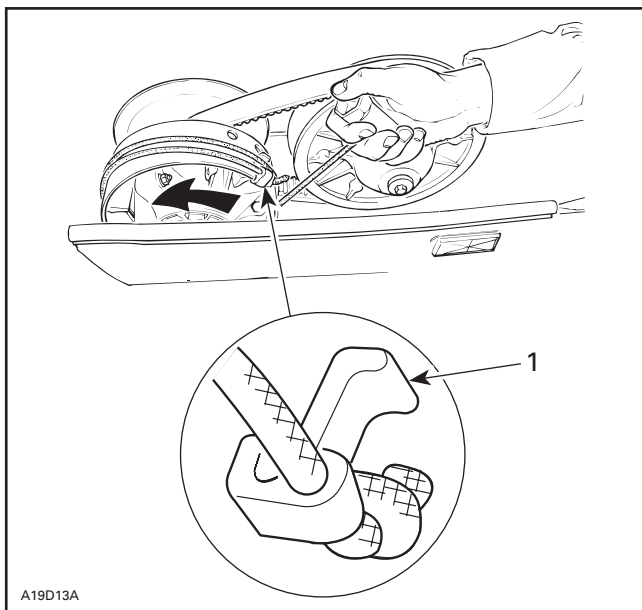

A19D13A

TYPICAL — TRA TYPE DRIVE PULLEY

1. Clip

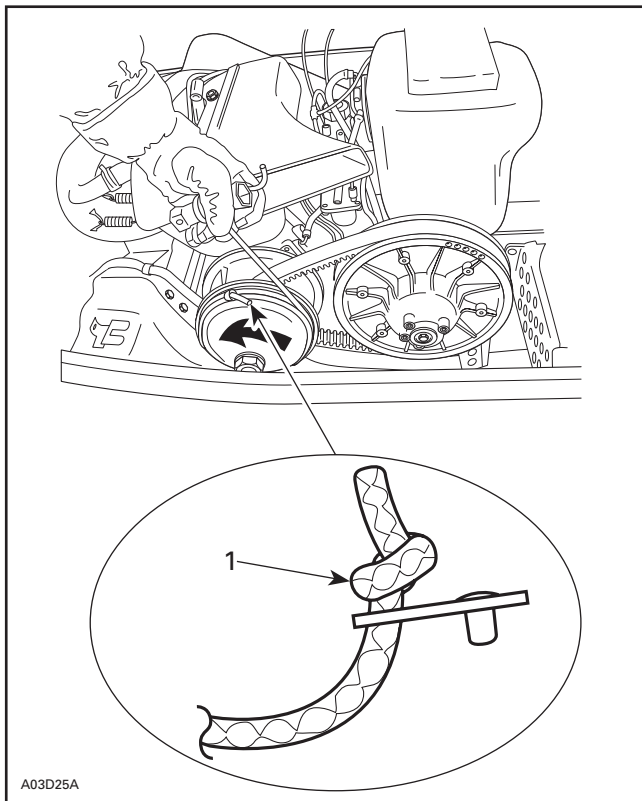

A03D25A

TYPICAL — BOMBARDIER LITE DRIVE PULLEY TYPE

1. Knot on this side

Start engine as described in COLD ENGINE STARTING or WARM ENGINE STARTING according to engine temperature.

Pull the rope using a sharp, crisp pull so the rope comes free of the drive pulley.

⚠ WARNING

When starting the snowmobile in an emergency situation using drive pulley, do not reinstall the belt guard and return slowly to have snowmobile repaired.

Shutting Off the Engine

Release throttle lever and wait until engine has returned to idle speed.

Shut off the engine using either ignition switch (fan cooled models only), engine cut-out switch or tether cut-out switch.

WARNING

Never leave key and tether cord on vehicle when not in operation.

VEHICLE WARM-UP

Before every ride, vehicle has to be warmed up as follows.

Snowmobile must be securely supported by the rear bumper using a mechanical snowmobile stand. Track must be 100 mm (4 in) off the ground.

Start engine and allow it to warm up two or three minutes at idle speed.

Release parking brake.

WARNING

Make sure mechanical snowmobile stand is stable. Stay clear of the front of vehicle and the track. Do not use too much throttle during warm-up or when track is free-hanging.

Apply throttle until drive pulley engages. Let track rotate at low speed for several turns. The lower the vehicle temperature is the longer vehicle warm-up should be.

Shut off the engine and remove the snowmobile mechanical stand.

Skis may be frozen on the ground. Grasp both skis by their loops and lift them.

After restarting engine, the vehicle must be driven at low speed for the first 2 or 3 minutes. After that, it may be driven up to the legal speed limit as per normal safety practices.

POST-OPERATION CARE

Shut off the engine. Install rear of vehicle on a snowmobile mechanical stand.

Remove snow and ice from rear suspension, track, front suspension, steering mechanism and skis.

Protect vehicle with a snowmobile cover.

SPECIAL OPERATIONS

Riding at High Altitudes

If you ride at altitudes above 600 m (2000 ft), your snowmobile should have modifications. Refer to an authorized SKI-DOO dealer. Summit models are factory calibrated for high altitude. These models must be converted for sea level utilization.

CAUTION: Do not change original factory calibration if snowmobile is used below 600 m (2000 ft) (except Summit models).

Engine Overheating

Engine overheating indicator will light up if engine is too hot.

Reduce snowmobile speed and run snowmobile in loose snow or stop engine immediately.

Check for adequate coolant level. See an authorized SKI-DOO dealer.

Fuel Flooded Engine

All Models

 **WARNING**

Do not hold throttle partially or fully open when starting a fuel flooded engine.

Install new spark plugs and restart engine.

Rear Suspension Slider Shoe Sticking

All Models

Slider shoes are cooled and lubricated by snow. When riding at moderate or high speed on a thin-snow-covered surface, slider shoes may stick on track metallic guides.

Run snowmobile on a surface covered by snow or drive snowmobile at very slow speed.

Have slider shoes inspected by an authorized SKI-DOO dealer.

PERIODIC MAINTENANCE CHART

WARNING

Observe WARNINGS and CAUTIONS mentioned throughout this guide which are pertinent to the item being checked. When component conditions seem less than satisfactory, replace with genuine BOMBARDIER parts or approved equivalents.

Some items may not apply to your particular model. Refer to LUBRICATION and MAINTENANCE section of *Shop Manual* for more details.

① 10-HOUR OR 500 km (300 miles) INSPECTION

(To be performed by SKI-DOO dealer)

② WEEKLY OR EVERY 240 km (150 miles)



③ MONTHLY OR EVERY 800 km (500 miles)

④ ONCE A YEAR OR EVERY 3200 km (2000 miles)

⑤ STORAGE (To be performed by SKI-DOO dealer)

⑥ PRESEASON PREPARATION (To be performed by SKI-DOO dealer)

PERIODIC MAINTENANCE CHART		①	②	③	④	⑤	⑥
	Starting Rope Condition					✓	✓
	Engine Head Screws	✓			✓	✓	
	Engine Mount Nuts or Screws	✓			✓	✓	
	Exhaust System	✓		✓		✓	
	Engine Lubrication					✓	✓
	Cooling System Condition	✓			✓		✓
	Coolant Replacement					✓	
	Condition of Seals					✓	✓
	Injection Oil Filter Condition			✓			
	Injection Oil Filter Replacement						✓
	Oil Injection Pump Adjustment	✓			✓		✓
	Fuel Stabilizer					✓	
	Fuel Filter Replacement						✓
	Fuel Lines and Connections	✓				✓	✓
	Carburetor Adjustment	✓			✓		✓
	Carburetor Cleaning						✓
	Throttle Cable Inspection	✓			✓	✓	✓
	Air Filter Cleaning			✓			✓
	Drive Belt Condition	✓	✓				✓
	Condition of Drive and Driven Pulleys	✓		✓		✓	
	Cleaning of Drive and Driven Pulleys						✓
	Retorquing of Drive Pulley Screw	✓					
	Driven Pulley Preload	✓			✓		

PERIODIC MAINTENANCE CHART		①	②	③	④	⑤	⑥
	Brake Fluid Level	✓	✓			✓	✓
	Brake Fluid (change once a year)					✓	
	Brake Condition	✓	✓			✓	✓
	Drive Chain Tension	✓		✓		✓	
	Countershaft Lubrication**	✓		✓		✓	
	Chaincase Oil Level	✓		✓			✓
	Chaincase Oil Change	✓				✓	
	Lubrication of Drive Axle End Bearing**	✓		✓		✓	
	Handlebar Bolts. Retorque to 26 N•m (19 lbf•ft)	✓				✓	
	Steering and Front Suspension Mechanism Lubrication**	✓		✓		✓	
	Steering and Front Suspension Mechanism Condition	✓		✓		✓	
	Wear and Condition of Skis and Runners	✓	✓			✓	
	Steering and Ski Leg Camber Adjustment	✓		✓		✓	
	Suspension Adjustments	AS REQUIRED					
	Suspension Lubrication**				✓	✓	
	Suspension Condition	✓		✓	✓	✓	
	Suspension Stopper Strap Condition				✓	✓	
	Track Condition	✓		✓		✓	
	Track Tension and Alignment	✓	AS REQUIRED				
	Spark Plugs*	✓		✓			✓
	Engine Timing	✓					✓
	Battery	✓		✓		✓	✓
	Headlight Beam Aiming				✓		✓
	Wiring Harnesses, Cables and Lines	✓		✓		✓	
	Operation of Lighting System (HI/LO Beam, Brake Light, etc.), Test Operation of Engine Cut-Out Switch and Tether Cut-Out Switch	✓	✓				✓
	Rags in Air Intake and Exhaust System					✓	✓
	Engine Compartment	✓		✓		✓	
	Vehicle Cleaning and Protection	✓		✓		✓	

* Before installing new properly gapped spark plugs at preseason preparation, it is suggested to burn excess storage oil by starting the engine with the old spark plugs. Only perform this operation in a well ventilated area.

** Lubricate whenever the vehicle is used in wet conditions (wet snow, rain, puddles).

FLUID LEVELS

WARNING

It is recommended that the assistance of an authorized SKI-DOO dealer be periodically obtained on other components/systems not covered in this guide. Unless otherwise specified, engine must be cold and not running. The tether cord cap must be removed for all maintenance procedures.

CAUTION: Vehicle must be on a level surface before checking any fluid levels.

Brake System

Hydraulic Brake Only

Check brake fluid (DOT 4) in reservoir on handlebar for minimum level. Add fluid (DOT 4) as required.

CAUTION: Use only (DOT 4) brake fluid from a sealed container. Never use any other types of fluid.

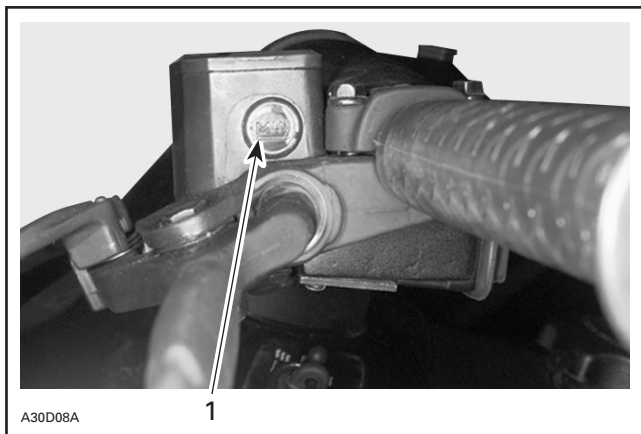

TYPICAL — BRAKE FLUID RESERVOIR

1. Minimum

Chaincase Oil Level

With snowmobile on a level surface, check the oil level by removing dipstick. Oil level must be between lower and upper marks.

NOTE: It is normal to find metallic particles stuck to dipstick magnet. If bigger pieces of metal are found, see an authorized SKI-DOO dealer.

Remove metal particles from magnet.

Refill up to upper mark using BOMBARDIER synthetic chaincase oil (P/N 413 803 300 — 12 x 355 mL).

CAUTION: Use BOMBARDIER synthetic chaincase oil or a suitable equivalent when servicing. Do not mix synthetic oil with other oils.

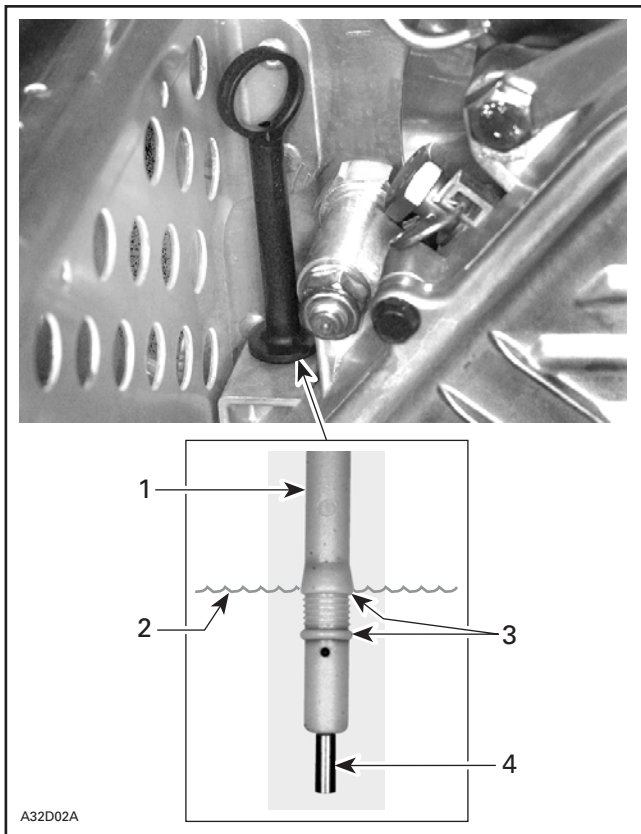

TYPICAL

1. Dipstick
2. Oil level
3. Level between marks
4. Magnet

Oil Injection System

Always maintain a sufficient amount of recommended oil in the injection oil reservoir.

CAUTION: Never allow oil reservoir to be almost empty. Do not mismatch oil reservoir cap with fuel tank cap. Install cap that is identified OIL.

WARNING

Check level and refill every time you refuel. Do not overfill. Wipe off any spillage. Oil is highly flammable when heated.

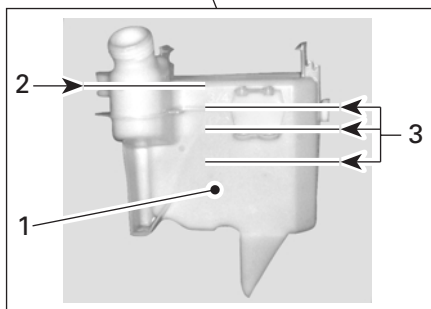
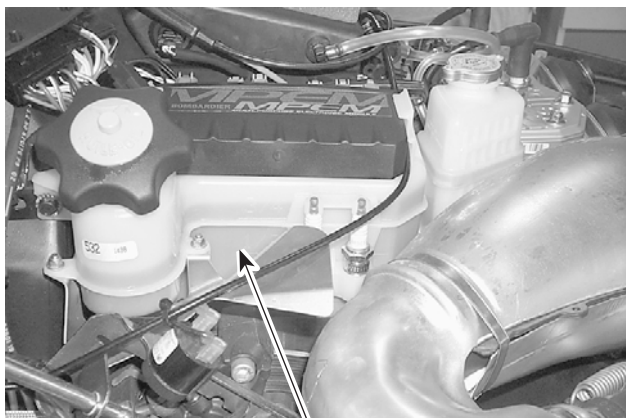

A32C27A

1. Injection oil reservoir
2. Maximum level indicator: 13 mm (1/2 in) from top
3. Level marks (1/4, 1/2, 3/4)

Cooling System

Check coolant level at room temperature. Liquid should be at level mark (engine cold) of coolant tank.

NOTE: When checking level at low temperature it may be slightly lower than mark.

If additional coolant is necessary or if entire system has to be refilled, refer to an authorized SKI-DOO dealer.

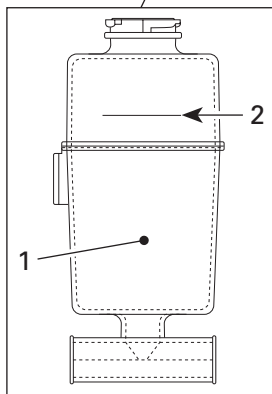

A32C29A

1. Coolant tank
2. COLD LEVEL line

MAINTENANCE

WARNING

It is recommended that the assistance of an authorized SKI-DOO dealer be periodically obtained on other components/systems not covered in this guide. Unless otherwise specified, engine must be cold and not running. The tether cord cap must be removed for all maintenance procedures.

Vehicle Cleaning and Protection

Remove any dirt or rust.

To clean the entire vehicle, use only flannel cloths or equivalent.

CAUTION: It is necessary to use flannel cloths or equivalent on windshield and hood to avoid damaging further surfaces to clean.

To clean the entire vehicle, including bottom pan and metallic parts use BOMBARDIER Cleaner (P/N 293 110 001 (spray can 400 g) and P/N 293 110 002 (4 L)).

CAUTION: Do not use Bombardier Cleaner on decals or vinyl.

For vinyl and plastic parts, use Vinyl & Plastic Cleaner (P/N 413 711 200 (6 x 1 L)).

To remove scratches on windshield or hood use BOMBARDIER Scratch Remover Kit (P/N 861 774 800).

CAUTION: Never clean plastic parts or hood with strong detergent, degreasing agent, paint thinner, acetone, products containing chlorine, etc.

Clean sheaves of both pulleys using BOMBARDIER Parts Cleaner (P/N 413 711 809).

Inspect the hood and repair any damage.

Touch up all metal spots where paint has been scratched off. Spray all metal parts including shock chromed rods with BOMBARDIER LUBE (P/N 293 600 016).

Wax the hood and the painted portion of the frame for better protection.

NOTE: Apply wax on glossy finish only. Protect the vehicle with a cover to prevent dust accumulation during storage.

CAUTION: The snowmobile has to be stored in a cool and dry place and covered with an opaque tarpaulin. This will prevent sun rays and grime from affecting plastic components and vehicle finish.

Lift rear of vehicle until track is clear of the ground. Install on a snowmobile mechanical stand.

NOTE: Do not release track tension.

Belt Guard Removal and Installation

1. Turn off engine cut-out switch. Open hood.
2. Open retainer to release pin then pull belt guard out of vehicle.

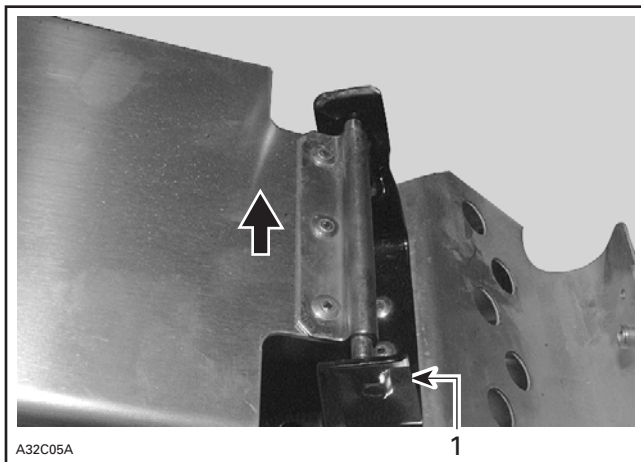

TYPICAL

1. *Pin retainer*

When reinstalling belt guard, position its cut-away toward front of snowmobile. Refer to decal in belt guard.

Place belt guard in front tabs first, then snap rear part in retainer.

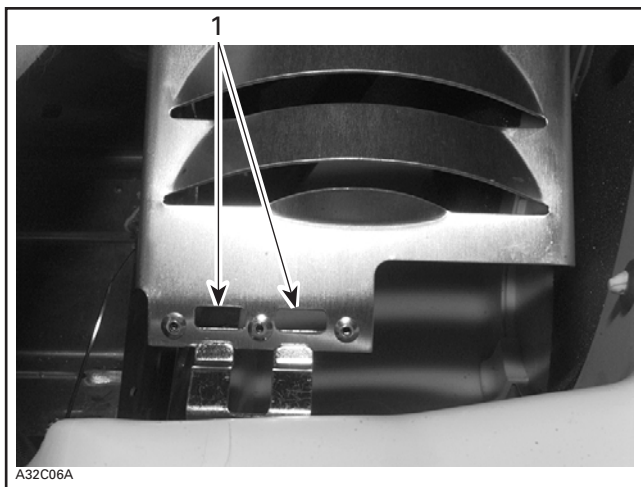

TYPICAL

1. Slots

NOTE: Belt guard is purposely made slightly oversize to maintain tension on its pins and retainers preventing undue noise and vibration. It is important that this tension be maintained when reinstalling.

Drive Belt Removal/Installation

NOTE: Removal and installation of drive belt is easier when driven pulley is held with brake so that it can not rotate. Apply parking brake, for this purpose.

Turn off engine cut-out switch.

Open hood and remove belt guard.

Open the driven pulley with the drive belt installer/remover provided in tool bag.

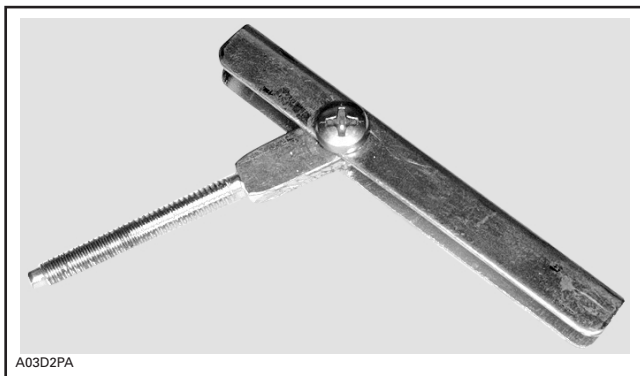

DRIVE BELT INSTALLER/REMOVER

Screw drive belt installer/remover in the free threaded hole and tighten to open the pulley. Remove belt.

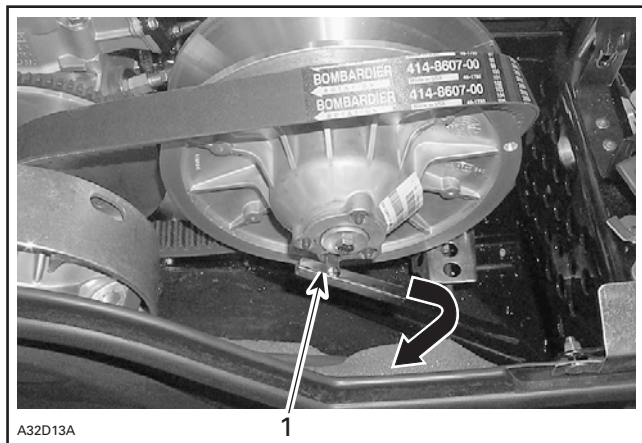

A32D13A

1

TYPICAL

1. Tighten to open pulley

Slip the belt over the top edge of the sliding half of driven pulley, as shown in previous photo.

Remove access panel from bottom pan.

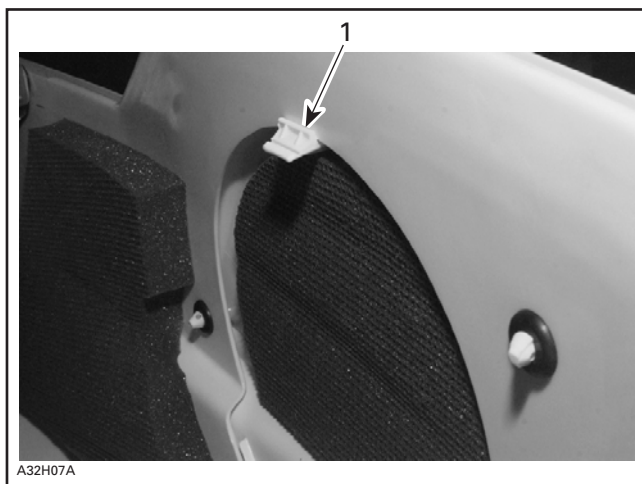

A32H07A

1. Push tab down and remove panel out of bottom pan



A32H06A

PULL PANEL OUT OF BOTTOM PAN

Slip belt under drive pulley then, remove it from vehicle.

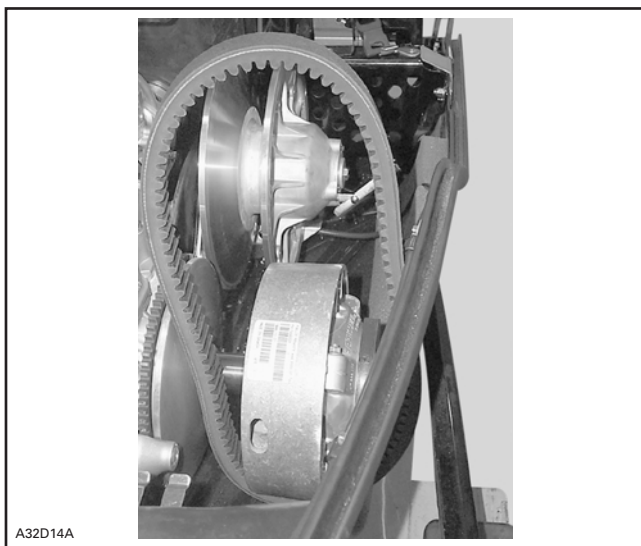

A32D14A

TYPICAL

Clean sheaves of both pulleys using BOMBARDIER Parts Cleaner (P/N 413 711 809).

To install the drive belt, reverse the removal procedure, however pay attention to the following:

The maximum drive belt life span is obtained when the belt has the proper rotation direction. See arrow on belt.

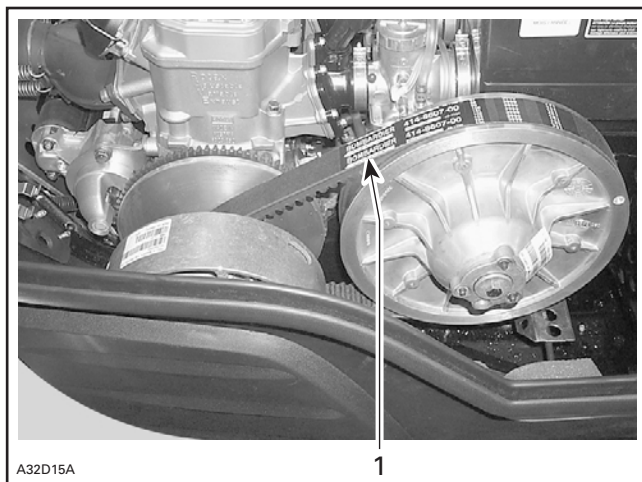

TYPICAL

1. Arrow pointing front of vehicle

CAUTION: Do not force or use tools to pry the belt into place, as this could cut or break the cords in the belt.

To install the drive belt, first place belt between drive pulley sheaves. Then, between driven pulley sheaves, finishing with bottom.

Remove drive belt installer/remover. Reinstall access panel and belt guard.

Drive Chain Tension

Remove hair pin.

Fully tighten tensioner adjustment screw by hand, then back off only far enough for hair pin to engage in locking hole.

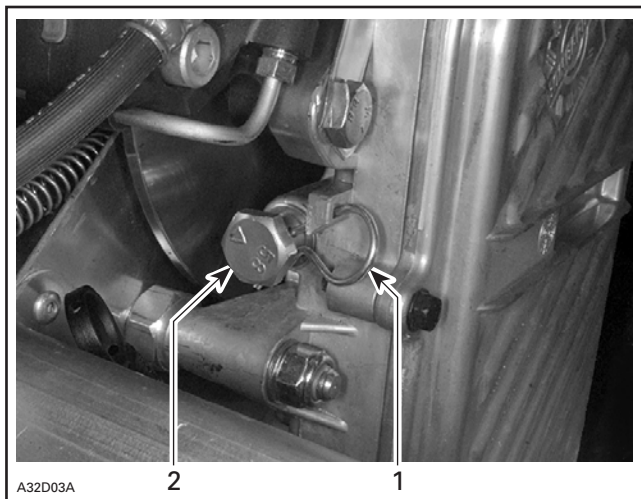

TYPICAL

1. Hair pin
2. Adjustment screw

TRA Drive Pulley Adjustment

The drive pulley is factory calibrated to transmit maximum engine power at a predefined RPM. Refer to SPECIFICATIONS at the end of this guide. Factors such as ambient temperature, altitude or surface condition may vary this critical engine RPM thus affecting snowmobile efficiency.

Summit Models Only

Refer to decal on pulley belt guard to adjust TRA pulley accordingly to different high altitudes.

All Models

This adjustable drive pulley allows setting maximum engine RPM in the vehicle to maintain maximum power.

Calibration screws should be adjusted so that actual maximum engine RPM in vehicle matches with the maximum horsepower RPM.

NOTE: Use precision digital tachometer for engine RPM adjustment.

NOTE: The adjustment has an effect on high RPM only.

To adjust, turn calibration screws.

Calibration screw has a notch on top of its head.

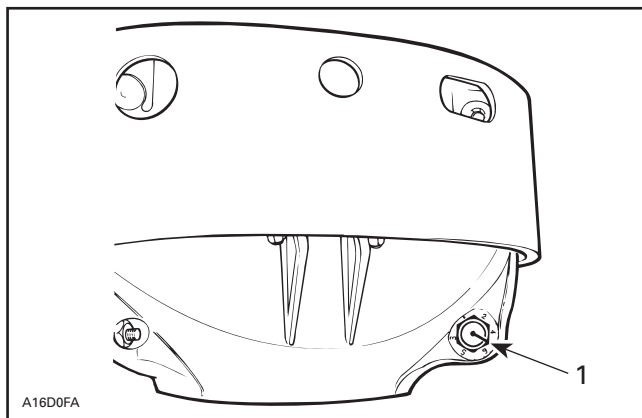

1. Notch

Governor cup has 6 positions numbered 2 to 6. Note that in position 1 the number is substituted by a dot (due to its location on casting).

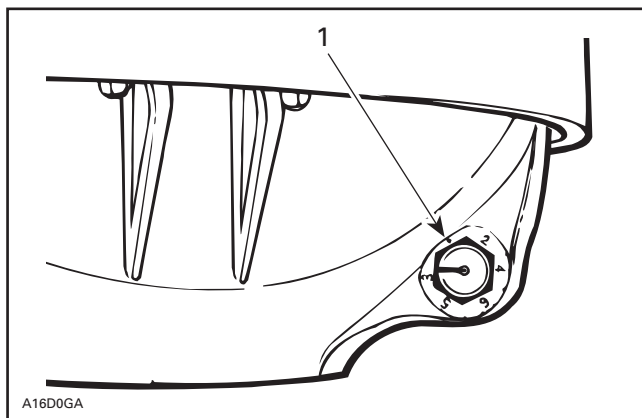

1. Position 1 (not numbered)

Each number modifies maximum engine RPM by about 200 RPM. Lower numbers decrease engine RPM in steps of 200 RPM and higher numbers increase it in steps of 200 RPM.

Example:

Calibration screw is set at position 4 and is changed to position 6. So maximum engine RPM is increased by 400 RPM.

CAUTION: Do not adjust TRA drive pulley so that engine turns over maximum power RPM. Refer to SPECIFICATIONS.

To adjust:

Just loosen locking nut enough to push calibration screw **partially** out and adjust to desired position. Do not completely remove the locking nut. Torque locking nuts to 10 N•m (89 lbf•in).

CAUTION: Do not completely remove calibration screw or its inside washer will fall off. Always adjust all 3 calibration screws and make sure they are all set at the same number.

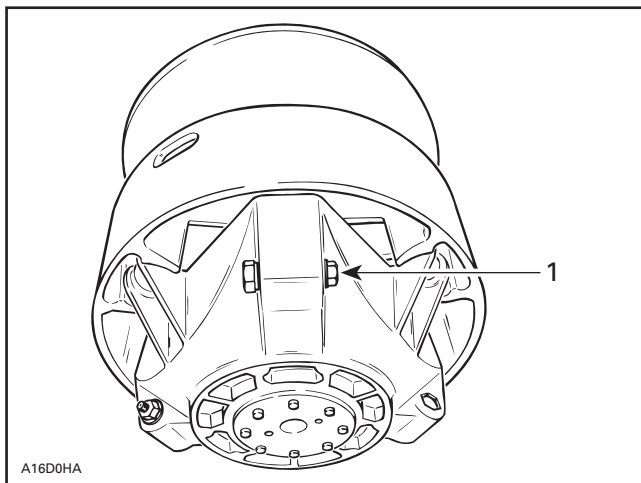

1. Loosen just enough to permit rotating of calibrate screw

WARNING

Always reinstall belt guard. Do not operate engine with hood open or belt guard removed. Improper servicing, modification or poor adjustment may affect drive pulley performance and belt life. Always refer to the *Shop Manual* or obtain authorized SKI-DOO dealer advice before servicing or modifying the drive or driven pulleys. Always respect maintenance schedules.

Drive Belt Condition

Inspect belt for cracks, fraying or abnormal wear (uneven wear, wear on one side, missing cogs, cracked fabric). If abnormal wear is noted, probable cause could be pulley misalignment, excessive RPM with frozen track, fast starts without warm-up period, burred or rusty sheave, oil on belt or distorted spare belt. Contact an authorized SKI-DOO dealer.

Check the drive belt width. Replace the drive belt if width is less than the minimum width recommended in SPECIFICATIONS section.

Brake Condition

WARNING

The brake mechanism on your snowmobile is an essential safety device. Keep this mechanism in proper working condition. Above all, do not operate the snowmobile without an effective brake system. Periodically verify the condition/wear of the brake pads.

Brake Adjustment

Mechanical Brake

The brake mechanism is a self-adjusting type. If a quicker brake response is desired, strongly squeeze the brake lever several times, this will actuate the adjusting mechanism.

Hydraulic Brake

A hydraulic brake is not adjustable. See an authorized SKI-DOO dealer if any problems.

Rear Suspension Condition

Visually inspect all suspension components including slider shoes, springs, wheels, etc.

NOTE: During normal driving, snow will act as a lubricant and coolant for the slider shoes. Extensive riding on ice or sanded snow, will create excessive heat build-up and cause premature slider shoe wear.

Suspension Stopper Strap Condition

Inspect stopper strap for wear and cracks, bolt and nut for tightness. If loose inspect holes for deformation. Replace as required. Torque nut to 9 N•m (80 lbf•in).

Track Condition

Lift the rear of the snowmobile and support it off the ground. With the engine **off**, rotate the track by hand, and inspect condition. If worn or cut, or if track fibers are exposed, or if missing or defective inserts or guides are noted; contact an authorized SKI-DOO dealer.

CAUTION: Do not modify track, including by installing traction enhancing products. This may weaken the track and cause it to break without warning.

WARNING

Do not operate or rotate a track if torn, damaged or excessively worn (fibers showing.)

Track Tension and Alignment

Tension

NOTE: Ride the snowmobile in snow about 15 to 20 minutes prior to adjusting track tension.

Lift rear of snowmobile and support it with a **snowmobile mechanical stand**.

Allow the suspension to extend normally and check gap half-way along slider shoe. The gap should be as given in SPECIFICATIONS. If the track tension is too loose, track will have a tendency to thump.

NOTE: A belt tension tester (P/N 414 348 200) may be used to measure deflection as well as force applied.

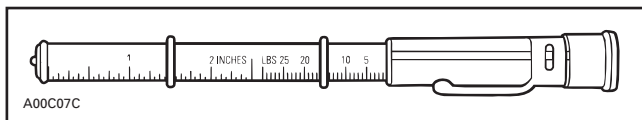

BELT TENSION TESTER

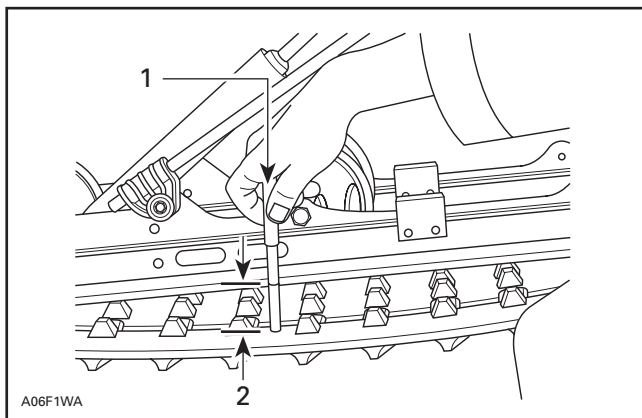

TYPICAL

1. 7.3 kg (16 lb)
2. Deflection

CAUTION: Too much tension will result in power loss and excessive stresses on suspension components.

To adjust tension:

- On some models, remove wheel cap.
- Loosen the rear idler wheel retaining screws.
- Turn adjustment screws to adjust.

If correct tension is unattainable, contact an authorized SKI-DOO dealer.

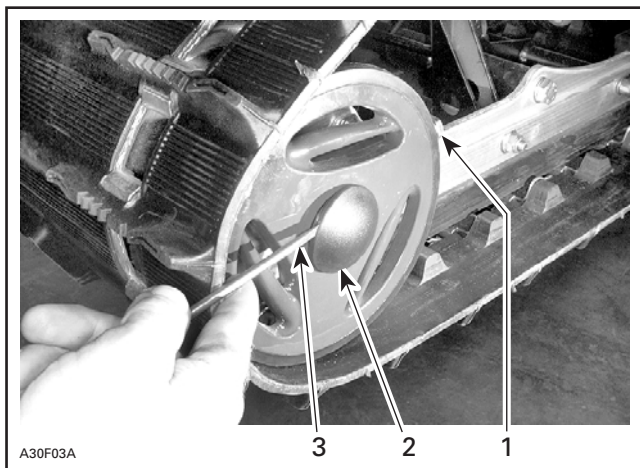

TYPICAL

1. Adjustment screw
2. Loosen screw
3. Wheel cap removing

Alignment

NOTE: Track tension and alignment are inter-related. Do not adjust one without the other.

⚠ WARNING

Before checking track alignment, ensure that the track is free of all particles which could be thrown out while track is rotating. Keep hands, tools, feet and clothing clear of track. Ensure no one is standing in close proximity to the snowmobile.

Start the engine and accelerate slightly so that track barely turns. This must be done in a short period of time (1 to 2 minutes). Check that the track is well centered; equal distance on both sides between edges of track guides and slider shoes.

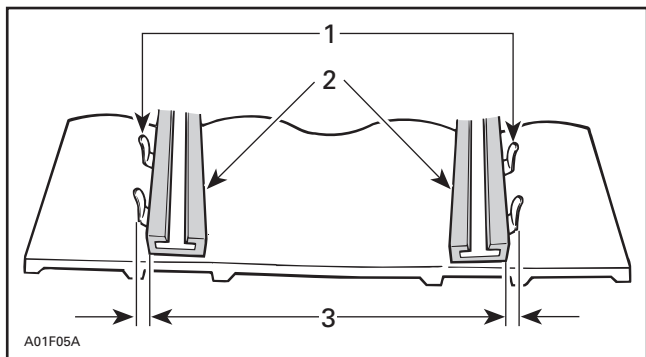

TYPICAL

1. Guides
2. Slider shoes
3. Equal distance

To correct, **stop the engine**: Loosen rear wheel screws tighten the adjustment screw on side where the slider shoe is the farthest from the track insert guides.

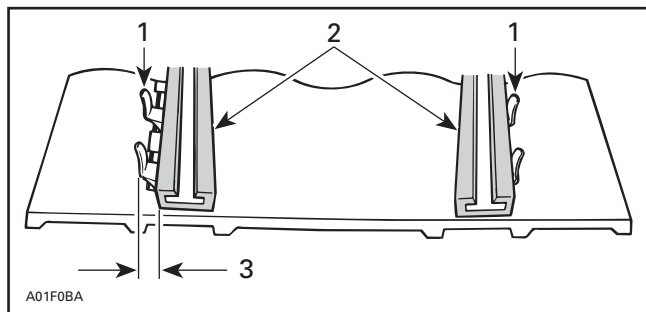

TYPICAL

1. Guides
2. Slider shoes
3. Tighten on this side

Retighten wheel screws to 48 N•m (35 lbf•ft).

WARNING

Properly tighten wheel screws, otherwise the track will “lock”.

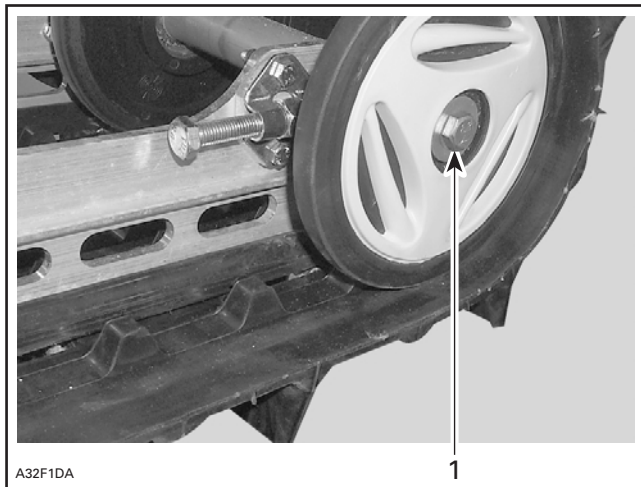

TYPICAL

1. Retighten to 48 N•m (35 lbf•ft)

Restart engine and rotate track slowly to recheck alignment.
Reposition snowmobile on ground.

Steering and Front Suspension Mechanism

Visually inspect steering and front suspension mechanism for tightness of components (steering arms, control arms and links, tie rods, ball joints, ski coupler bolts, etc.) If necessary, contact an authorized SKI-DOO dealer.

Wear and Condition of Skis and Runners

Check the condition of the skis, ski runners and ski runner carbides. If worn, contact your authorized SKI-DOO dealer for replacement.

WARNING

Excessively worn skis and/or ski runners will affect snowmobile control.

Exhaust System

The tail pipes of the muffler should be centered with the exit holes in the bottom pan. Exhaust system must be free of rust or leaks. Make sure that gear clamps are properly tightened.

The exhaust system is designed to reduce noise and to improve the total performance of the engine. Modification may be in violation of local laws.

CAUTION: If any exhaust system component is removed, modified or damaged, severe engine damage may result.

Air Filter Cleaning

Leaving the snowmobile uncovered during a snowfall or riding in deep powder snow may block air filter and choke the engine.

While riding in deep powder snow, periodically stop and check air silencer filters for snow. Remove filters and shake them as required.



PRIMARY FILTER LOCATION



REMOVAL OF RIGHT SIDE PRIMARY FILTER GRILL



REMOVAL OF FILTER FROM ITS GRILL

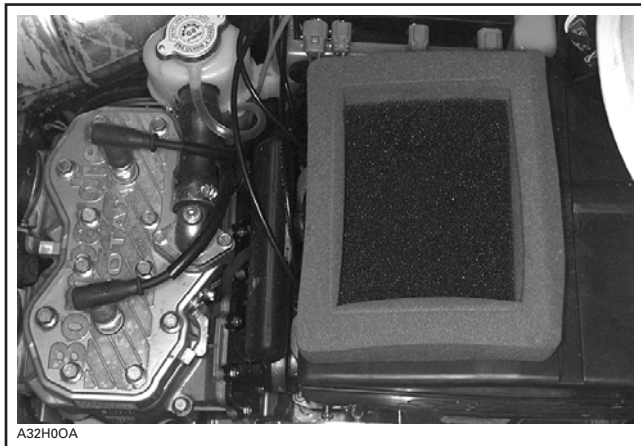

A32H00A

TYPICAL — SECONDARY FILTER INSTALLED ON AIR SILENCER

Check that the air silencer is clean and dry and properly reinstall the filter.

CAUTION: Snowmobile engines have been calibrated with the filter installed. Operating the snowmobile without it may cause engine damage.

Headlight Beam Aiming

Turn knob to adjust beam height.

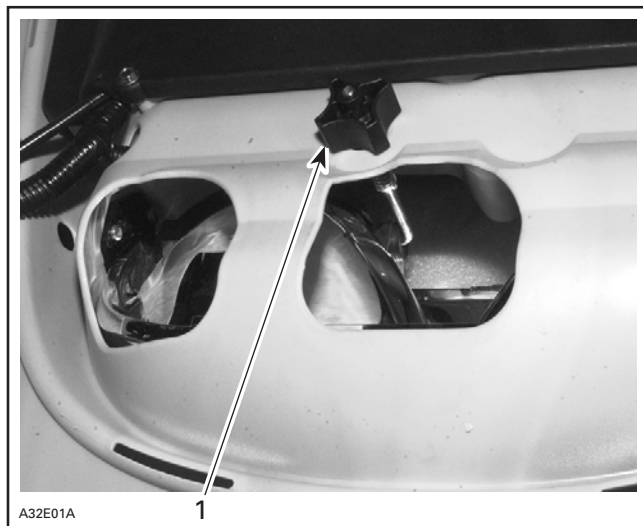

TYPICAL

1. Knob

Bulb Replacement

Always check light operation after bulb replacement.

Headlight

CAUTION: Never touch glass portion of an halogen bulb with bare fingers, it shortens its operating life. If glass is touched, clean it with isopropyl alcohol which will not leave a film on the bulb.

If any headlight bulb is burnt, remove windshield and unplug burnt bulb connector. Remove the rubber boot.



1. *Bulb connector*
2. *Rubber boot*

Turn bulb locking ring counterclockwise to remove it. Detach the bulb and replace. Properly reinstall parts.

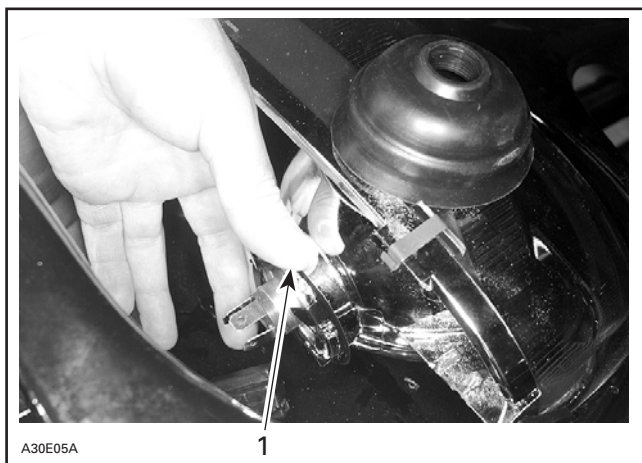

1. *Locking ring*

Instrument(s)

All Models

Remove air duct from underneath hood.

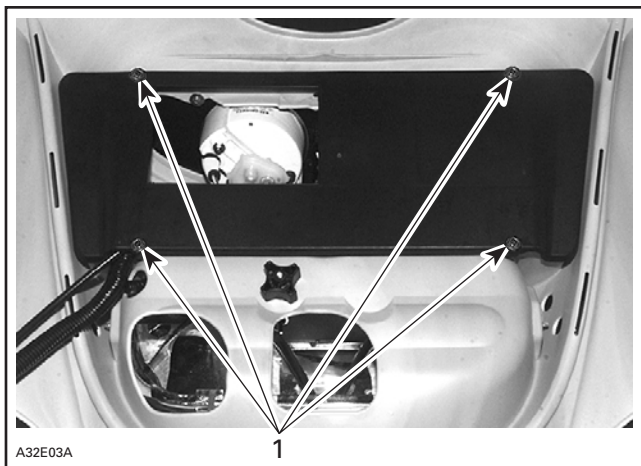

TYPICAL

1. Remove these screws

STORAGE AND PRESEASON PREPARATION

WARNING

Have an authorized SKI-DOO dealer inspect fuel and oil systems integrity as specified in **Periodic Maintenance Chart**.

Storage

It is during summer, or when a snowmobile is not in use for more than one month that proper storage is a necessity.

To prepare your snowmobile, follow the **Periodic Maintenance Chart** in MAINTENANCE.

CAUTION: Do not run engine during storage period.

Preseason Preparation

Refer to an authorized SKI-DOO dealer.

CAUTION: Have carburetor(s) cleaned-up before restarting engine.

TROUBLESHOOTING

SYMPTOM: <i>Engine turns over but fails to start.</i>	
POSSIBLE CAUSES	WHAT TO DO
1. Engine cut-out switch or tether switch is in the OFF position.	Place all switches in the ON position.
2. Mixture not rich enough to start cold engine.	Check fuel tank level and check starting procedure, particularly use of the choke.
3. Flooded engine (spark plug wet when removed).	Do not choke. Remove wet spark plug and crank engine several times. Install clean dry properly gapped spark plug. Start engine following usual starting procedure. If engine continues to flood, see an authorized SKI-DOO dealer.
4. No fuel to the engine (spark plug dry when removed).	Check fuel tank level; check fuel filter; replace if clogged; check condition of fuel and impulse lines and their connections. If a failure of the fuel pump or carburetor has occurred, contact an authorized SKI-DOO dealer.
5. Spark plug/ignition (no spark).	Remove spark plug(s) then reconnect to spark cap. Check that engine cut-out switch is at the ON position and the tether cut-out switch cap is snapped over the receptacle. Start engine with spark plug(s) grounded to engine away from spark plug hole. If no spark appears, replace spark plug with new ones properly gapped. If trouble persists, contact an authorized SKI-DOO dealer.
6. Engine compression.	As the engine is pulled over with the rewind starter, "cycles" of resistance should be felt as piston goes past top dead center (each piston). If no pulsating resistance is felt, it suggests a major loss of compression. Contact an authorized SKI-DOO dealer.

SYMPTOM: Engine lacks acceleration or power.

POSSIBLE CAUSES	WHAT TO DO
1. DESS has not read tether cord. Engine can not exceed 3000 RPM.	DESS pilot lamp blinks once every 3 seconds. Properly install tether cord.
2. DESS is activated. Engine can not exceed 3000 RPM.	DESS pilot lamp blinks rapidly. Install appropriate tether cord.
3. Fouled or defective spark plug.	Check item 5 of "Engine turns over but fails to start".
4. Lack of fuel to engine.	Check item 4 of "Engine turns over but fails to start".
5. Carburetor adjustments.	Contact an authorized SKI-DOO dealer.
6. Drive belt worn too thin.	If the drive belt has lost more than 3 mm (1/8 in) of its original width, it will affect vehicle performance.
7. Drive and driven pulleys require servicing.	Contact an authorized SKI-DOO dealer.
8. Engine is overheating.	Check coolant level, pressure cap, thermostat and for air locks in cooling system.

SYMPTOM: Engine backfires.

POSSIBLE CAUSES	WHAT TO DO
1. DESS has not read tether cord. Engine can not exceed 3000 RPM.	DESS pilot lamp blinks once every 3 seconds. Properly install tether cord.
2. DESS is activated. Engine can not exceed 3000 RPM.	DESS pilot lamp blinks rapidly. Install appropriate tether cord.
3. Faulty spark plug (carbon accumulation) or wrong gap.	See item 5 of "Engine turns over but fails to start".
4. Engine is running too hot.	See item 8 of "Engine lacks acceleration or power".
5. Ignition timing is incorrect or there is an ignition system failure.	Contact an authorized SKI-DOO dealer.

SYMPTOM: <i>Engine misfires.</i>	
POSSIBLE CAUSES	WHAT TO DO
1. DESS has not read tether cord. Engine can not exceed 3000 RPM.	DESS pilot lamp blinks once every 3 seconds. Properly install tether cord.
2. DESS is activated. Engine can not exceed 3000 RPM.	DESS pilot lamp blinks rapidly. Install appropriate tether cord.
3. Fouled/defective/ worn spark plugs or wrong gap.	Clean/verify spark plug and heat range. Replace as required.
4. Too much oil supplied to engine.	Improper oil pump adjustment, refer to an authorized SKI-DOO dealer.
5. Water in fuel.	Drain fuel system and refill with fresh fuel.

SYMPTOM: <i>Snowmobile cannot reach full speed.</i>	
POSSIBLE CAUSE	WHAT TO DO
1. DESS has not read tether cord. Engine can not exceed 3000 RPM.	DESS pilot lamp blinks once every 3 seconds. Properly install tether cord.
2. DESS is activated. Engine can not exceed 3000 RPM.	DESS pilot lamp blinks rapidly. Install appropriate tether cord.
3. Drive belt.	Check item 6 of "Engine lacks acceleration or power".
4. Incorrect track adjustment.	See maintenance section and/or SKI-DOO dealer for proper alignment and tension adjustments.
5. Pulleys misaligned.	Contact an authorized SKI-DOO dealer.
6. Engine.	See items 3 to 8 of "Engine lacks acceleration or power".

SPECIFICATIONS

GENERAL		MX-Z 380 F LEGEND 380 F GRAND TOURING 380 F	MX-Z 500 F LEGEND 500 F GRAND TOURING 500 F
Engine			
– Maximum Power Engine Speed	RPM	6900	7000
Drive Belt			
– Part Number		415 060 600	415 060 600
– Width of a New Belt	mm (in)	34.7 (1.366)	34.7 (1.366)
– Wear Limit Width	mm (in)	32.3 (1.272)	32.3 (1.272)
Spark Plug			
– Type		NGK BR 9 ES	NGK BR 9 ES
– Gap	± 0.05 mm (± .002 in)	0.45 (.018)	0.45 (.018)
Track			
– Tension	mm (in)	35 - 40 (1-3/8 - 1-9/16) ①	35 - 40 (1-3/8 - 1-9/16) ①
– Alignment		②	②
FLUIDS			
Fuel			
– Type		Regular Unleaded ③	Regular Unleaded ③
– Tank Capacity	L (U.S. gal)	37.0 (9.8)	37.0 (9.8)
Oil (engine)			
– Type		④	④
– Tank Capacity	L (U.S. oz)	3.5 (118)	3.5 (118)
Chaincase Oil			
– Type		⑥	⑥
– Capacity	mL (U.S. oz)	250 (8.5)	250 (8.5)
Cooling System			
– Type		Forced Air	Forced Air
– Capacity	L (U.S. oz)	N.A.	N.A.
Brake System Fluid			
– Type		N.A.	DOT 4

① to ⑦ and N.A.: see below.

GENERAL		SUMMIT 500 F	MX-Z 500/600 LEGEND 500/600
Engine			
- Maximum Power Engine Speed	RPM	7000	8000
Drive Belt			
- Part Number		415 060 600	414 860 700
- Width of a New Belt	mm (in)	34.7 (1.366)	34.9 (1.374)
- Wear Limit Width	mm (in)	32.3 (1.272)	32.5 (1.280)
Spark Plug			
- Type		NGK BR 9 ES	493: NGK BR 9 ES 593: NGK BR 9 ECS
- Gap	± 0.05 mm (± .002 in)	0.45 (.018)	493: 0.45 (.018) 593: 0.50 (.020)
Track			
- Tension	mm (in)	35 - 40 (1-3/8 - 1-9/16) ①	30 - 35 (1-3/16 - 1-3/8) ①
- Alignment		②	②
FLUIDS			
Fuel			
- Type		Regular Unleaded ③	Regular Unleaded ③
- Tank Capacity	L (U.S. gal)	37.0 (9.8)	37.0 (9.8)
Oil (engine)			
- Type		④	④
- Tank Capacity	L (U.S. oz)	3.5 (118)	3.5 (118)
Chaincase Oil			
- Type		⑤	⑤
- Capacity	mL (U.S. oz)	250 (8.5)	250 (8.5)
Cooling System			
- Type		Forced Air	⑦
- Capacity	L (U.S. oz)	N.A.	3.8 (128)
Brake System Fluid			
- Type		DOT 4	DOT 4

① to ⑦ and N.A.: see below.

GENERAL		GRAND TOURING 500/600	SUMMIT 600/700 GRAND TOURING 700
Engine			
– Maximum Power Engine Speed	RPM	8000	8000
Drive Belt			
– Part Number		414 860 700	417 300 127
– Width of a New Belt	mm (in)	34.9 (1.374)	36.35 (1.431)
– Wear Limit Width	mm (in)	32.5 (1.280)	33.95 (1.337)
Spark Plug			
– Type		493: NGK BR 9 ES 593: NGK BR 9 ECS	NGK BR 9 ECS
– Gap	± 0.05 mm (± .002 in)	493: 0.45 (.018) 593: 0.50 (.020)	0.50 (.020)
Track			
– Tension	mm (in)	30 - 35 (1-3/16 - 1-3/8) ①	30 - 35 (1-3/16 - 1-3/8) ①
– Alignment		②	②
FLUIDS			
Fuel			
– Type		Regular Unleaded ③	Regular Unleaded ③
– Tank Capacity	L (U.S. gal)	37.0 (9.8)	37.0 (9.8)
Oil (engine)			
– Type		④	④
– Tank Capacity	L (U.S. oz)	3.5 (118)	3.5 (118)
Chaincase Oil			
– Type		⑤	⑤
– Capacity	mL (U.S. oz)	250 (8.5)	250 (8.5)
Cooling System			
– Type		⑦	⑦
– Capacity	L (U.S. oz)	4.0 (135)	4.0 (135)
Brake System Fluid			
– Type		DOT 4	DOT 4

① to ⑦ and N.A.: see below.

GENERAL		MX-Z 700 LEGEND 700	MX-Z 800 LEGEND 800
Engine			
- Maximum Power Engine Speed	RPM	8000	7850
Drive Belt			
- Part Number		417 300 127	417 300 127
- Width of a New Belt	mm (in)	36.35 (1.431)	36.35 (1.431)
- Wear Limit Width	mm (in)	33.95 (1.337)	33.95 (1.337)
Spark Plug			
- Type		NGK BR 9 ECS	NGK BR 9 ECS
- Gap	± 0.05 mm (± .002 in)	0.50 (.020)	0.50 (.020)
Track			
- Tension	mm (in)	30 - 35 (1-3/16 - 1-3/8) ①	30 - 35 (1-3/16 - 1-3/8) ①
- Alignment		②	②
FLUIDS			
Fuel			
- Type		Regular Unleaded ③	Regular Unleaded ③
- Tank Capacity	L (U.S. gal)	37.0 (9.8)	37.0 (9.8)
Oil (engine)			
- Type		④	④
- Tank Capacity	L (U.S. oz)	3.5 (118)	3.5 (118)
Chaincase Oil			
- Type		⑤	⑤
- Capacity	mL (U.S. oz)	250 (8.5)	250 (8.5)
Cooling System			
- Type		⑦	⑦
- Capacity	L (U.S. oz)	3.8 (128)	3.8 (128)
Brake System Fluid			
- Type		DOT 4	DOT 4

① to ⑦ and N.A.: see below.

GENERAL		SUMMIT 800 GRAND TOURING 800
Engine		
– Maximum Power Engine Speed	RPM	7850
Drive Belt		
– Part Number		417 300 127
– Width of a New Belt	mm (in)	36.35 (1.431)
– Wear Limit Width	mm (in)	33.95 (1.337)
Spark Plug		
– Type		NGK BR 9 ECS
– Gap	± 0.05 mm (± .002 in)	0.50 (.020)
Track		
– Tension	mm (in)	30 - 35 (1-3/16 - 1-3/8) ①
– Alignment		②
FLUIDS		
Fuel		
– Type		Regular Unleaded ③
– Tank Capacity	L (U.S. gal)	37.0 (9.8)
Oil (engine)		
– Type		④
– Tank Capacity	L (U.S. oz)	3.5 (118)
Chaincase Oil		
– Type		⑤
– Capacity	mL (U.S. oz)	250 (8.5)
Cooling System		
– Type		⑦
– Capacity	L (U.S. oz)	4.0 (135)
Brake System Fluid		
– Type		DOT 4

① to ⑦ and N.A.: see below.

Because of our ongoing commitment to product quality and innovation, Bombardier reserves the right, at any time, to make changes in design and specifications and/or to make additions to, or improvements in its products without imposing any obligation upon itself to install them on its products previously manufactured.

- ① Measure gap between slider shoe and bottom inside of track when exerting a downward pull of 7.3 kg (16 lbf) to the track.
- ② Equal distance between edges of track guides and slider shoes.
- ③ Regular unleaded gasoline with a minimum octane number of 87 (R + M)/2.
- ④ BOMBARDIER FORMULA XP-S synthetic injection oil (or equivalent) OR BOMBARDIER injection oil (or equivalent).
- ⑤ BOMBARDIER synthetic chaincase oil (P/N 413 803 300 — 12 x 355 mL).
- ⑥ BOMBARDIER chaincase oil (P/N 413 801 900 — 16 x 250 mL).
- ⑦ BOMBARDIER premixed coolant (P/N 413 711 802 — 16 x 1 L).

N.A.: Not applicable

CHANGE OF ADDRESS OR OWNERSHIP

If your address or owner has changed, be sure to fill out and mail the card provided on next page.

Such notification is likewise necessary for your own safety even after expiration of the original warranty, since Bombardier will be in a position to contact you if correction to your snowmobile becomes necessary.

NOTICE TO ALL NEW OWNERS

Make sure to mail the *Change of Ownership Card* as you are entitled to the unexpired portion of the warranty.

STOLEN UNITS

If the event that your snowmobile is stolen, you should notify your area distributor's warranty department of such.

Please provide your name, address, phone number, vehicle serial number and date it was stolen.

Bombardier will provide a list of stolen units to all SKI-DOO dealers on a monthly basis to aid in recovery of such units to their owners.

AFFIX
PROPER
POSTAGE

BOMBARDIER
RECREATIONAL PRODUCTS
WARRANTY DEPARTMENT
75 J.A. BOMBARDIER ST.
SHERBROOKE (QUEBEC)
CANADA J1L 1W3

BOMBARDIER
RECREATIONAL PRODUCTS



* Trademarks of Bombardier Inc. and/or its subsidiaries.
© 2001 Bombardier Inc. All rights reserved.
Printed in Canada.

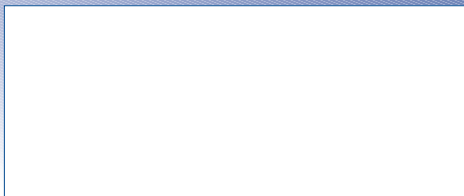

ski-doo[®]
2002