

1985

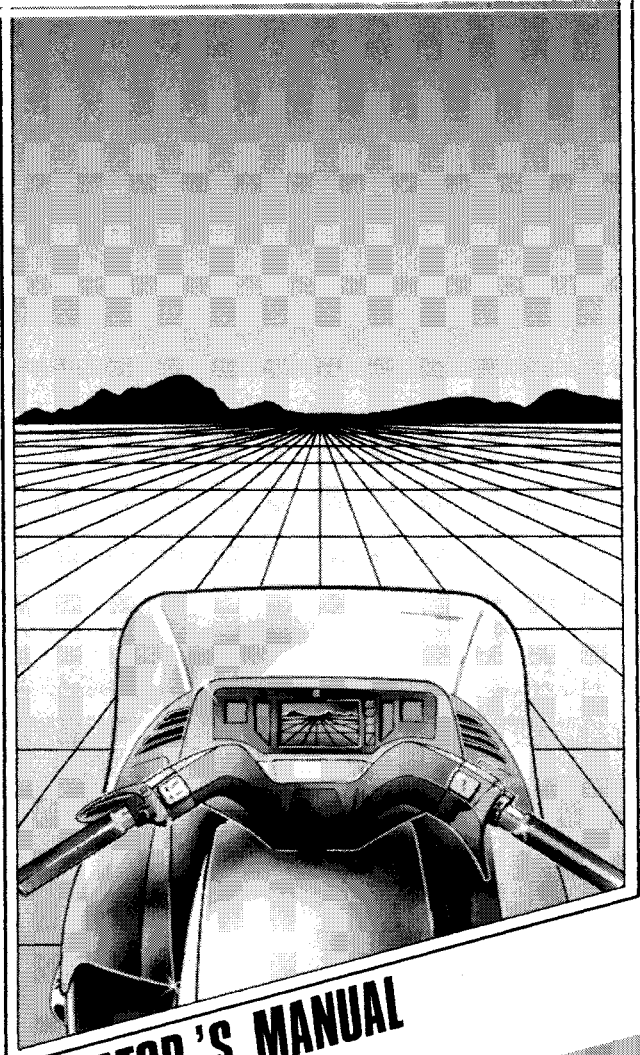

**OPERATOR'S MANUAL**

**SAFARI\***  
377 377E 447 Grand Luxe LC

**MIRAGE III\***

414 5480 00

model \_\_\_\_\_

V.I.N. \_\_\_\_\_

purchase date \_\_\_\_\_

warranty expiry date \_\_\_\_\_

To be completed by dealer at time of sale

DEALER IMPRINT AREA

AFTER SALES SERVICE  
BOMBARDIER INC.  
VALCOURT, QUEBEC  
CANADA, JOE 2LO



The following are trademarks of Bombardier Inc.

BOMBARDIER	EVEREST	MOTO-SKI
SKI-DOO	CITATION	FUTURA
ALPINE	OLYMPIQUE	SPIRIT
BLIZZARD	T'NT	NUVIK
CARRY-BOOSE	SKANDIC	MIRAGE
ELAN	NORDIK	SUPER SONIC
ELITE	SAFARI	ULTRA SONIC
GRAND PRIX SPECIAL		SONIC
		FORMULA

# FOREWORD

---

The operator manual and the Snowmobile Safety Handbook have been prepared to acquaint the owner / operator of a new snowmobile with the various vehicle controls, maintenance and safe operating instructions. Each is indispensable for the proper use of the product, and should be kept with the vehicle at all times.

Should you have any questions pertaining to the warranty and its application, please consult the "Often Asked Questions" section of this manual, or your selling dealer.

This manual uses the following symbols.



**WARNING:** Identifies an instruction which, if not followed, could cause personal injury.



**CAUTION:** Denotes an instruction which, if not followed, could severely damage vehicle components.



**NOTE:** Indicates supplementary information needed to fully complete an instruction.

Although the mere reading of such information does not eliminate the hazard, your understanding of the information will promote its correct use.



**WARNING:** The engines and the corresponding components identified in this manual should not be utilized on product(s) other than those mentioned on the cover page of this manual.

Most specifications are given in both metric and customary units. Where precise accuracy is not required, some conversions are rounded to even numbers for easier use.

A shop manual can be obtained for complete service, maintenance and repair information.

# SAFETY IN MAINTENANCE

---

## Observe the following precautions:

- Throttle mechanism should be checked for free movement before starting engine.
- The snowmobile engine can be stopped by activating the emergency cut-out or tether switches or turning off the key.
- Clean and check operation of the headlight tail light and brake light.
- Engine should be running only when belt guard and/or pulley guard is secured in place.
- Never run the engine without drive belt installed. Running an unloaded engine can prove to be dangerous.
- Never run the engine when the track is raised off the ground.
- It can be dangerous to run engine with the hood removed.
- Gasoline is flammable and explosive under certain conditions. Always manipulate in a well ventilated area. Do not smoke or allow open flames or sparks in the vicinity. If gasoline fumes are noticed while driving, the cause should be determined and corrected without delay.
- Maintain your vehicle in top mechanical condition at all times.
- Your snowmobile is not designed to be driven or operated on black top, bare earth, or other abrasive surfaces. On such surfaces abnormal and excessive wear of critical parts is inevitable.
- Your snowmobile is not designed to be operated on public streets, road or highways. In most States and Provinces, it is considered an illegal operation.
- Installation of other than standard equipment, including ski-spreaders, bumpers, pack racks, etc., could severely affect the stability and safety of your vehicle. Avoid adding on accessories that alter the basic vehicle configuration.
- Whenever the vehicle is parked outdoors, overnight or for a long period, it is suggested to protect it against the inclemency of the weather with a snowmobile cover.
- Do not lubricate throttle and/or brake cables and housings.
- Only perform procedures as detailed in this manual. Unless otherwise specified, engine should be turned OFF for all lubrication and maintenance procedures.
- **Liquid cooled model:** Since engine cooling is fully in effect only when the vehicle is in motion and driven on snow, it is not recommended that you allow the engine to idle for more than brief periods and/or you drive the vehicle on icy surface. Prolonged idling and/or continuous driving on ice may cause engine damage.
- **Liquid cooled model:** When removing coolant tank cap, first place a cloth over cap then turn cap to its first step to release pressure. Never drain or refill the cooling system when engine is hot.
- Should removal of a nylon lock nut be required when undergoing repairs/disassembly, always replace by new ones. Tighten as specified in the applicable Shop Manual.

---

PLEASE READ AND UNDERSTAND  
ALL WARNINGS AND CAUTIONS IN  
THIS MANUAL AND ON THE VEHICLE.

---

**THIS MANUAL SHOULD REMAIN WITH THE VEHICLE AT  
THE TIME OF RESALE.**

# INDEX

---

<b>THE 1985 "LIMITED WARRANTY"</b> .....	<b>4</b>
<b>OFTEN ASKED QUESTIONS</b> .....	<b>6</b>
<b>LISTING OF AREA DISTRIBUTORS</b> .....	<b>8</b>
<b>HOW TO IDENTIFY YOUR SNOWMOBILE</b> .....	<b>9</b>
<b>CONTROLS/INSTRUMENTS</b>	
Throttle lever, brake lever, ignition switch, light switch, headlamp dimmer switch, emergency cut-out switch, tether cut-out switch, rewind starter handle, primer, adjustable steering handle, speedometer, tachometer, temperature gauge, injection oil level pilot lamp, high beam pilot lamp, fuel gauge/tank cap, electric fuel gauge, hood opening, retractable headlamp lever, seat belt, tool box, fuse holders .....	<b>10</b>
<b>BREAK-IN PERIOD</b>	
Break-in, 10 hour-inspection, inspection check list .....	<b>14</b>
<b>FUEL</b>	
Recommended gasoline, recommended oil, oil injection system .....	<b>16</b>
<b>PRE-START CHECK</b>	
Check points .....	<b>17</b>
<b>STARTING PROCEDURE</b>	
Manual starting, electric starting, before riding, emergency starting . . .	<b>18</b>
<b>LUBRICATION</b>	
Frequency, steering mechanism, drive axle, slide suspension, chaincase oil level, oil injection system, rotary valve system .....	<b>19</b>
<b>MAINTENANCE</b>	
Maintenance chart, belt guard removal, drive belt removal, drive belt condition, new drive belt, brake condition, brake adjustment, spark plugs, battery, suspension condition, stopper strap condition, suspension adjustment, track condition, track tension and alignment, drive pulley, steering mechanism, steering adjustment, muffler attachments, engine head nuts, engine mount nuts, carburetor adjustment, oil injection system, cooling system, fan belt, headlamp beam aiming, bulb replacement, general inspection .	<b>22</b>
<b>STORAGE</b>	
Track, suspension, skis, controls, chaincase, drive pulley, cooling system, engine and primer lubrication, fuel tank and carburetor, battery, chassis, general inspection .....	<b>31</b>
<b>PRE-SEASON PREPARATION</b>	
Pre-season preparation chart .....	<b>36</b>
<b>TROUBLE SHOOTING GUIDE</b> .....	<b>37</b>
<b>TOOLS</b> .....	<b>39</b>
<b>SPECIFICATIONS</b> .....	<b>40</b>
<b>WIRING DIAGRAMS</b> .....	<b>42</b>
<b>SI INFORMATION GUIDE</b> .....	<b>45</b>
<b>CHANGE OF ADDRESS OR OWNERSHIP</b> .....	<b>47</b>

# **THE 1985 LIMITED WARRANTY**\_\_\_\_\_

## **1 - PERIOD**

BOMBARDIER® INC. as manufacturer, warrants FROM THE DATE OF FIRST CONSUMER SALES, every 1985 BOMBARDIER® snowmobile, sold as NEW AND UNUSED, by an authorized BOMBARDIER dealer for a period of:

- 12 consecutive months.

## **2 - WHAT BOMBARDIER WILL DO**

BOMBARDIER will repair and/or replace, at its option, components defective in material and/or workmanship (under normal use and service,) with a genuine BOMBARDIER component without charge for parts or labour, at any authorized BOMBARDIER dealer during said warranty period.

## **3 - CONDITION TO HAVE WARRANTY WORK PERFORMED**

Present to the servicing dealer, the hard copy of the BOMBARDIER Warranty Registration card received by the customer from the selling dealer at time of purchase.

## **4 - WARRANTY TRANSFER**

This warranty is transferable to subsequent owner(s) for remainder of warranty period from original date of sale.

## **5 - EXCLUSIONS - ARE NOT WARRANTED**

- Normal wear on all items such as, but not limited to:
  - drive belts
  - slider shoes
  - spark plugs
  - bulbs
  - runners on skis
- Replacement parts and/or accessories which are not genuine BOMBARDIER parts and/or accessories.
- Damage resulting from installation of parts other than genuine BOMBARDIER parts.
- Damage caused by failure to provide proper maintenance as detailed in the Operator Manual. The labour, parts and lubricants costs of all maintenance services, including tune-ups and adjustments will be charged to the owner.
- Wet cells battery.
- Vehicles designed and/or used for racing purposes.
- All optional accessories installed on the vehicle.  
(The normal warranty policy for parts and accessories, if any, applies).
- Damage resulting from accident, fire or other casualty, misuse, abuse or neglect.
- Damage resulting from operation of the snowmobile on surfaces other than snow.

- 
- Damage resulting from modification to the snowmobile not approved in writing by BOMBARDIER.
  - Losses incurred by the snowmobile owner other than parts and labour, such as, but not limited to, transportation, towing, telephone calls, taxis, or any other incidental or consequential damages.

## **6 - BATTERY WARRANTY:**

- 12 consecutive months. (Pro-rated.)

100% warranty coverage will start on the date the snowmobile was purchased and run to the following April 30th. The remainder of the 12 months period will be pro-rated as follows:

- 50% from April 30th to December 1st.
- 40% from December 1st to December 31st.
- 30% from January 1st to end of warranty.

## **7 - EXPRESSED OR IMPLIED WARRANTIES**

**This warranty gives you specific rights, and you may also have other legal rights which may vary from state to state, or province to province. Where applicable this warranty is expressly in lieu of all other expressed or implied warranties of BOMBARDIER, its distributors and the selling dealer, including any warranty of merchantability of fitness for any particular purpose; otherwise the implied warranty is limited to the duration of this warranty. However, some states or provinces do not allow limitations on how long an implied warranty lasts, so the above limitation may not apply.**

**Neither the distributor, the selling dealer, nor any other person has been authorized to make any affirmation, representation or warranty other than those contained in this warranty, and if made, such affirmation, representation or warranty shall not be enforceable against BOMBARDIER or any other person.**

**Some states or provinces do not allow the exclusion or limitation of incidental or consequential damages, so the above limitation or exclusion may not apply.**

**BOMBARDIER INC. reserves the right to modify its warranty policy at any time, being understood that such modification will not alter the warranty conditions applicable to vehicles sold while the above warranty is in effect.**

## **8 - CONSUMER ASSISTANCE**

If a servicing problem or other difficulty occurs, we suggest the following:

1. Try to resolve the problem at the dealership with the Service Manager or Owner.
2. If this fails, contact your area distributor listed in the Operator Manual.
3. Then if your grievance still remains unsolved, you may write to us:

Bombardier Inc.  
Service Department  
Recreational Products Division  
Valcourt, Quebec, Canada, JOE 2LO

February 1984  
Bombardier Inc.  
Valcourt, Quebec, Canada, JOE 2LO

®\*Trademarks of Bombardier Inc.

## OFTEN ASKED QUESTIONS

---

Q: Why must my snowmobile be registered? After all I do have my original invoice as proof of when I purchased my snowmobile.

*A: Your warranty is valid at any authorized dealer of the product. Your registration is the key element in providing the servicing dealer with the necessary data to complete warranty claim forms. This information is also used to notify owners in the event of a safety recall.*

Q: I bought my snowmobile in O'King County but I snowmobile in Washington County. Can the dealer in Washington County accept to perform warranty work on my snowmobile?

*A: Yes, any authorized dealer in North America can perform warranty repairs, providing the customer warranty registration card is presented.*

Q: Where can I find information on the lubrication and maintenance of my snowmobile?

*A: In this Operator Manual provided with the vehicle at the time of first sale.*

Q: Will the entire warranty be void or cancelled, if I do not operate or maintain my new snowmobile exactly as specified in the Operator's Manual?

*A: The warranty of the new snowmobile cannot be "Voided" or "Cancelled". However, if a particular failure is caused by operation or maintenance other than is shown in the Operator Manual, THAT failure may not be covered under warranty. This includes service work performed by the customer, especially the critical adjustments to ignition, timing, carburation and oil injection/or oil mixture.*

Q: Would you give some examples of abnormal use or strain, neglect or abuse?

*A: These terms are general and overlap each other in areas. Some specific examples may include: running the machine out of oil, chain failure caused by a lack of lubrication, operating the machine with a broken or damaged part which causes another part to fail, and so on. If you have any specific questions on operation or maintenance, please contact your dealer for advice.*

Q: What costs are my responsibility during the warranty period?

*A: The customer's responsibility includes all costs of normal maintenance services, non-warranty repairs, accidents and collision damage, as well as oils, and spark plugs, and incidental or consequential damages costs as explained in the warranty.*



---

Q: Are "Genuine" Bombardier replacement parts used in warranty repairs covered by warranty?

*A: Yes. When installed by an authorized dealer, any "genuine" Bombardier part used in warranty repairs assumes the remaining warranty that exists on the machine.*

Q: If I sell my snowmobile within the warranty period, will the new owner qualify for the balance of the warranty?

*A: Yes, provided the unit has already been registered with the manufacturer. Note that the change of ownership card in this manual should be completed and sent to Bombardier Inc.*

Q: How can I receive the best owner assistance?

*A: The satisfaction and goodwill of the owners of Bombardier products are of primary concern to your dealer and Bombardier Inc. Normally, any problems that arise in connection with the sales transaction or the operation of your snowmobile will be handled by your Dealers Sales or Service Departments. It is recognized, however, that despite the best intentions of everyone concerned, misunderstandings will sometimes occur. If you have a problem that has not been handled to your satisfaction through normal channels, we suggest that you discuss your problem with a member of dealership management. Frequently, complaints are the result of a breakdown in communications and can quickly be resolved by a member of the dealership management. If the problem already has been reviewed with the Sales Manager or Service Manager, contact the Dealer himself or the General Manager.*

# LISTING OF AREA DISTRIBUTORS

---

## CANADIAN DISTRIBUTORS

BOMBARDIER INC.  
EASTERN CANADA DISTRIBUTION DIVISION  
Atlantic Branch  
P.O. Box 670  
Shediac, New Brunswick, E0A 3G0  
(506) 386-6117  
**Magdalen Island, Nova Scotia, New  
Brunswick, Prince Edward Island**

Quebec Branch  
1350 Nobel Boulevard  
Boucherville, Quebec, J4B 1A1  
(514) 655-6121  
**Province of Quebec**

Ontario Branch  
230 Bayview Drive  
Barrie, Ontario, L4N 4Y8  
(705) 728-8600  
**Province of Ontario**

BROOKS EQUIPMENT LIMITED  
1616 King, Edward Street  
P.O. Box 985  
Winnipeg, Manitoba, R3C 2V8  
(204) 633-7247  
**British Columbia, Manitoba, Saskatchewan,  
Alberta, Yukon**

CHARLES R. BELL LIMITED  
**Newfoundland, Labrador**  
Offices  
- Riverside Drive  
P.O. Box 1050  
Corner Brook, Newfoundland, A2H 6J3  
(709) 634-3533  
- 81 Kenmount Road  
P.O. Box 8127  
St-John's, Newfoundland, A1B 3N1  
(709) 722-6700

HUDSON'S BAY CO. LTD.  
165 Hymus Blvd  
Pointe-Claire, Quebec, H9R 1G2  
(514) 697-8500  
**North-West Territories, Franklin District &  
Keewatin**

## AMERICAN DISTRIBUTORS

BOMBARDIER CORPORATION  
**All States (excluding Alaska)**

SERVICE OFFICES  
- P.O. Box 670  
Shediac, New Brunswick, E0A 3G0  
(506) 386-6117

- 4505 West Superior Street  
P.O. Box 6106  
Duluth, Minnesota 55806  
(218) 628-2881

- P.O. Box 1569  
Idaho Falls, Idaho, 83401  
(208) 529-9510

NATIONAL SALES OFFICE  
- O'Hare Lake Plaza  
2350 Devon Avenue  
Suite 150  
Des Plaines, Illinois 60018  
(312) 298-9540

MILLER EQUIPMENT AND RECREATIONAL  
CENTER  
1049 Whitney Road  
Anchorage, Alaska 99501  
(907) 274-9513  
**Alaska**

# HOW TO IDENTIFY YOUR SNOWMOBILE

The main components of your snowmobile (engine, track and frame) are identified by different serial numbers. It may sometimes become necessary to locate these numbers for warranty purposes or to trace your snowmobile in the event of theft.

LIQUID COOLED

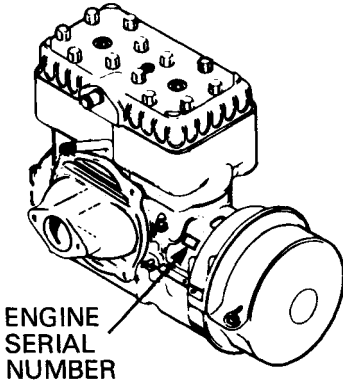

ENGINE SERIAL NUMBER

FAN COOLED

ENGINE SERIAL NUMBER

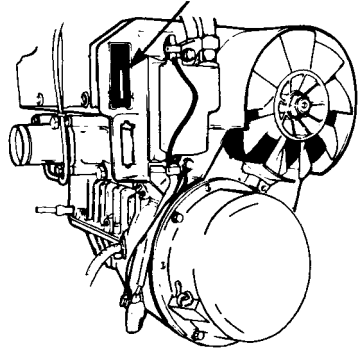

TRACK SERIAL NUMBER

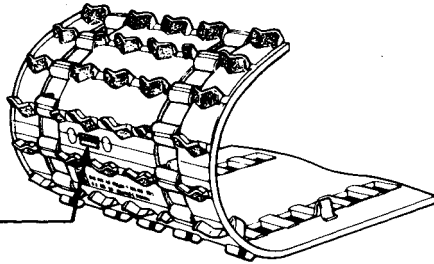

VEHICLE SERIAL NUMBER

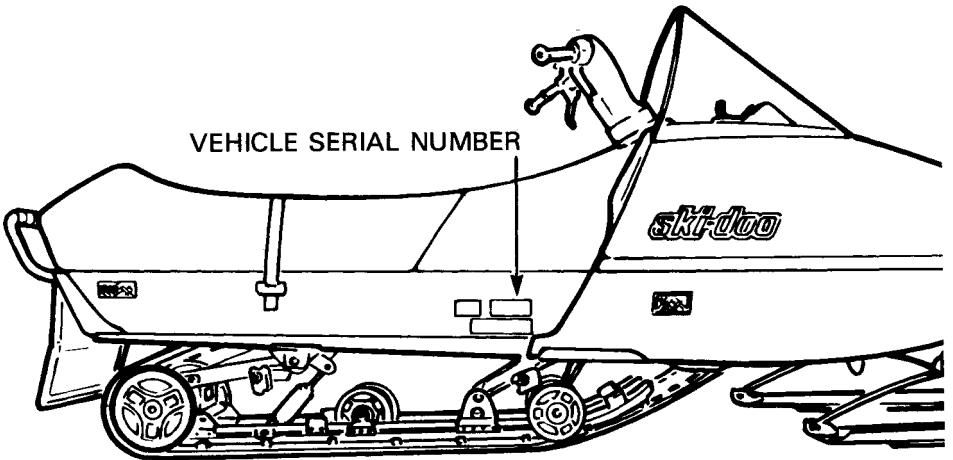

○ NOTE: We strongly recommend that you take note of all the serial numbers on your vehicle and supply them to your insurance company. It will surely help in the event a snowmobile is stolen.

# CONTROLS/INSTRUMENTS

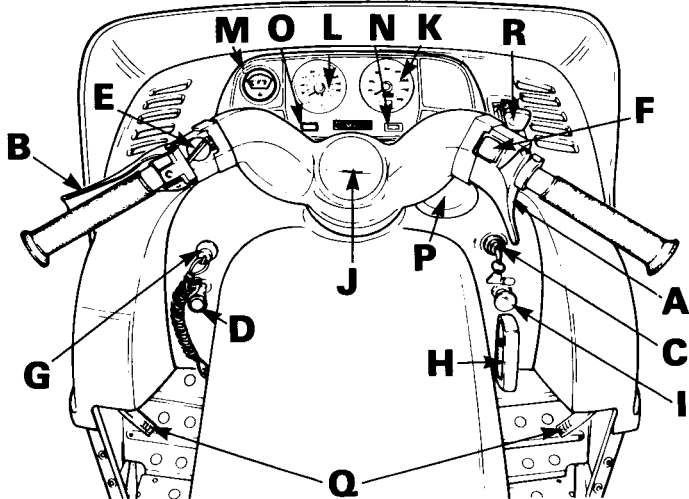

- A) Throttle lever
- B) Brake lever
- C) Ignition switch
- D) Light switch (Electric model)
- E) Headlamp dimmer switch
- F) Emergency cut-out switch
- G) Tether cut-out switch
- H) Rewind starter handle
- I) Primer
- J) Adjustable steering handle
- K) Speedometer (Optional on some models)
- L) Tachometer (Optional on some models)
- M) Temperature gauge (On liquid cooled model only)
- N) Injection oil level pilot lamp (Optional on some models)
- O) High beam pilot lamp (Optional on some models)
- P) Fuel Gauge/Tank Cap
- Q) Hood opening
- R) Retractable headlamp lever (Not applicable for Mirage III)

## A) Throttle Lever

Located on the right side of handlebar. When compressed, it controls the engine speed and the engagement of the transmission. When released, engine speed returns automatically to idle.

## B) Brake Lever

Located on the left side of handlebar. When compressed, the brake is applied. When released, it automatically returns to its original position. Braking effect is proportionate to the pressure applied on the lever and to the type of terrain and its snow coverage.

## C) Ignition Switch

### Manual model

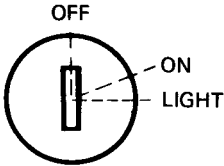

Key operated 3 position switch. To start engine, first turn key clockwise to ON position. To stop engine, turn key counter-clockwise to OFF position.

To put lights on while engine is running, turn key to LIGHT position.

### Electric model

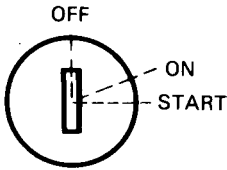

Key operated, 3 position switch. To start engine, turn key fully clockwise to START position and hold. Return key to ON position immediately when engine has started. To stop engine, turn key counter-clockwise to OFF position.

**CAUTION:** Holding key in START position when engine has started could damage starter mechanism.

## D) Light Switch

### (Electric model)

To illuminate headlamp and taillight, pull switch knob. (Ignition switch must be turned to ON position).

## E) Headlamp Dimmer Switch

The dimmer switch allows correct selection of headlamp beam. To obtain high or low beam simply flick switch.

## F) Emergency Cut-Out Switch

To stop the engine in an emergency, push the button to the lower off position and simultaneously apply the brakes. To start engine, button must be at the upper on position.

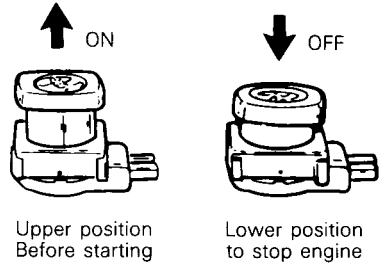

The driver of this vehicle should familiarize himself with the function of this device by using it several times on first outing. Thereby being mentally prepared for emergency situations requiring its use.

**WARNING:** If the switch has been used in an emergency situation the source of malfunction should be determined and corrected before re-starting engine.

## G) Tether Cut-Out Switch

Attach tether cord to wrist or other convenient location of the driver's clothing. Snap tether cut-out cap over receptacle before starting engine.

If emergency engine "shut off" is required, completely pull cap from safety switch and engine power will be automatically shut "off".

**NOTE:** The cap must be installed on the safety switch at all times in order to operate the vehicle.

**WARNING:** If the switch is used in an emergency situation the source of malfunction should be determined and corrected before re-starting engine.

---

## H) Rewind Starter Handle

Auto rewind type located on right hand side of vehicle. To engage mechanism, pull handle.

## I) Primer

Pull and push button (2-3 times) to activate primer. The primer should always be used for cold engine starts. After engine is warm however, it is not necessary to use primer when starting.

## J) Adjustable Steering Handle

- Remove steering pad.
- Loosen the four (4) retaining screws.
- Adjust the handle to the desired position.

◆ **WARNING:** Do not adjust too high as the brake lever may contact the windshield when turning.

- Lock the steering handle in place by tightening the four (4) retaining screws to 26 N•m (19 lbf•ft).
- Reinstall steering pad.

## K) Speedometer

### (Optional on some models)

The speedometer is linked directly to the drive axle. Direct-reading dial indicates the speed of the vehicle. Odometer records the total distance travelled in kilometers.

## L) Tachometer

### (Optional on some models)

The tachometer registers the impulses of magneto. Direct-reading dial indicates the number of revolutions per minute (RPM) of the engine.

▼ **CAUTION:** The tachometer is protected by a fuse, if tachometer stops operating check fuse condi-

tion and if necessary replace. The fuse is 0.1 amp. Do not use a higher rated fuse as this can cause severe damage to the tachometer.

## M) Temperature gauge

### (On liquid cooled model only)

The gauge indicates engine coolant temperature. Normal operating temperature is 50°C (120°F). However, coolant temperature can vary depending on driving condition. If coolant temperature exceeds 95°C (200°F) reduce speed and run vehicle in loose snow or stop engine immediately.

◆ **WARNING:** To remove coolant tank cap, place a cloth over the cap and unscrew it to the first step to release the pressure. If this notice is disregarded, loss of fluid and possible severe burns could occur.

## N) Injection Oil Level Pilot Lamp

### (Optional on some models)

Will light up when injection oil level is low. Check level and replenish as soon as possible.

▼ **CAUTION:** Do not run engine until it is out of oil. Serious engine damage will occur.

Whenever brake lever is compressed, oil level pilot lamp should light up. If not, replace lamp.

## O) High Beam Pilot Lamp

### (Optional on some models)

Lights up when headlamp is on high beam.

---

## **P) Fuel Gauge/Tank Cap**

Unscrew fuel tank cap and withdraw dipstick to check fuel level.

◆ **WARNING:** Never use a lit match or open flame to check fuel level.

## **Q) Hood Opening**

Pull down the latches to unlock the hood from the anchor.

○ **NOTE:** Always lift hood gently up until stopped by restraining device.

◆ **WARNING:** It is dangerous to run an engine with the hood open, unfastened or removed. Personal injury could result.

## **R) Retractable Headlamp Lever**

**(Not applicable for Mirage III)**

Push lever forward to expose headlamp. To retract, pull lever backward.

## **Seat belt**

Located in middle of seat on 2 (two) passengers model.

## **Tool Box**

Located under the hood. To gain access, tilt hood. Ideal location for spare plugs, rope, first aid kit, flashlight, etc...

## **Fuse Holders**

### **Starter (electric model)**

Starting system is protected with a 30 amperes rated fuse. Fuse holder is located near the starter. If starter does not operate, check fuse condition and if necessary replace.

### **Ignition switch (electric model)**

Ignition switch and instruments are protected with a 15 amperes rated fuse. Fuse holder is located near the injection oil tank. If instruments stop operating, check fuse condition and if necessary replace.

### **Tachometer (optional on some models)**

The tachometer is protected with 0.1 ampere rated fuse. Fuse holder is located under the hood behind the tachometer. If it stops operating, check fuse condition and replace if necessary.

# BREAK-IN PERIOD

---

## Engine

With Bombardier-Rotax snowmobile engines, a break-in period is required before running the vehicle at full throttle. Engine's manufacturer recommendation is 10 to 15 operating hours. During this period, maximum throttle should not exceed  $\frac{3}{4}$ , however, brief full acceleration and speed variations contribute to a good break-in. Continued wide open throttle accelerations, prolonged cruising speeds, and lugging are detrimental during the break-in period.

 **CAUTION: Remove and clean spark plugs after engine break-in.**

## Belt

A new drive belt requires a break-in period of 15-25 km (10-15 miles).

## 10-Hour Inspection

As with any precision piece of mechanical equipment, we suggest that after the first 10 hours of operation or 30 days after the purchase, whichever comes first, your vehicle be checked by your dealer. This inspection will give you the opportunity to discuss the unanswered questions you may have encountered during the first hours of operation. Remember that it is easier to remedy at this time than to allow the snowmobile to operate until a possible failure occurs.

---

The 10 hour inspection is at the expense of the vehicle owner.

---



<b>10-HOUR INSPECTION CHECKLIST</b>	
Engine timing	
Fan belt tension	
Spark plugs condition: (Remove and clean)	
Carburetor adjustment	
Oil injection pump adjustment	
Engine head nuts	
Engine mount nuts	
Muffler attachment	
Chaincase oil level	
Injection system oil level	
Rotary valve oil level	
Engine coolant level	
Brake operation and lining condition	
Ski alignment (runners condition)	
Steering arm, retorque to 50 N•m (37 lbf•ft)	
Handlebar bolts, retorque to 26 N•m (19 lbf•ft)	
Pulley alignment and drive belt condition	
Track condition, tension and alignment	
Lubrication (steering, suspension, drive axle)	
Electrical wiring (loose connections, stripped wires, damaged insulation), tighten all loose bolts, nuts and linkage	
Operation of lighting system (HI / LO beam, brake light, etc.), test operation of emergency cut-out switch and tether switch	
Battery electrolyte level	

**We recommend that you have your dealer sign this inspection list.**

\_\_\_\_\_  
Date of 10 hour inspection

\_\_\_\_\_  
Dealer signature

# FUEL

## Recommended Gasoline

Use **regular leaded** gasoline available from all service stations.

▼ **CAUTION:** Never experiment with different fuel or fuel ratios. Never use naphtha, methanol, gasohol or similar products.

◆ **WARNING:** Never "top up" the gas tank before placing the vehicle in a warm area. At certain temperatures, gasoline will expand and overflow. Always wipe off any gasoline spillage from the snowmobile.

## Recommended Oil

Use "Bombardier Snowmobile Injection Oil" (P/N 496 0133 00 - 1 liter) available from your dealer. This type of oil will flow at temperatures as low as minus 40°C (-40°F).

If "Bombardier Snowmobile Injection Oil" is unavailable, substitute with BLIZZARD OIL. (P/N 496 0135 00 - 500 ml).

▼ **CAUTION:** Never use outboard or straight mineral oils.

## Oil Injection System

Always maintain a sufficient amount of Bombardier Snowmobile injection oil in the injection oil tank.

## Fan cooled model

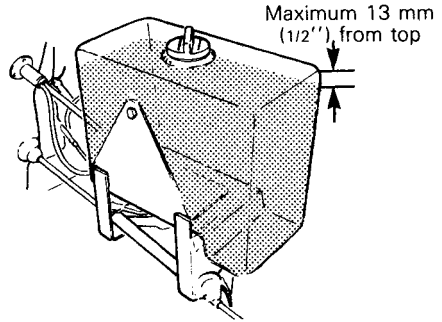

## Liquid cooled model

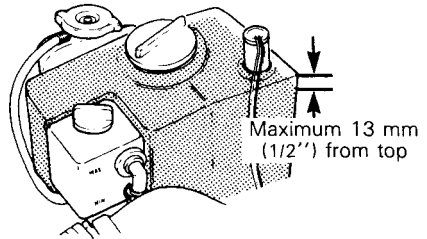

▼ **CAUTION:** Check level and refill every time you refuel.

○ **NOTE:** To assure additional protection during the initial engine break-in, 500 ml (18 imp. oz.) of BLIZZARD OIL should be added to the first full fuel tank filling.

# PRE-START CHECK

---

## Check Points

- **ACTIVATE THE THROTTLE CONTROL LEVER SEVERAL TIMES** to check that it operates easily and smoothly. The throttle control lever must return to idle position when released.
- Check that the skis and the track are not frozen to the ground or snow surface and that steering operates freely.
- Activate the brake control lever and make sure the brake fully applies before the brake control lever touches the handlebar grip.
- Check injection oil level.
- **Liquid cooled model:** Check coolant level. Liquid should be 25 mm (1 in.) below filler neck. If additional coolant is necessary or if entire system has to be refilled, use a solution of 3 parts of anti-freeze for 2 parts of water (60% anti-freeze, 40% water). See cooling system in storage.

○ **NOTE:** Always use ethylene-glycol anti-freeze containing corrosion inhibitors specifically recommended for aluminum engines.

◆ **WARNING:** Before removing the radiator pressure cap place a cloth over the cap and unscrew it to the first step to release the pressure. Never drain or refill the cooling system when engine is hot. Loss of fluid and possibility of severe burns could occur, if this notice is disregarded.

- Check fuel level.
- Verify that the path ahead of the vehicle is clear of bystanders and obstacles.

◆ **WARNING:** Only start your snowmobile once all components are checked and functioning properly.

# STARTING PROCEDURE

---

Test throttle control lever.

Check that the emergency cut-out switch is in the ON position.

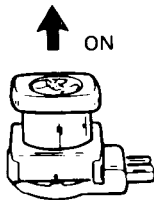

Upper position  
before starting engine

Ensure the tether cut-out cap is in position and that the cord is attached to your clothing.

Activate the primer (2 or 3 times).

○ **NOTE:** The use of the primer is not necessary when the engine is warm.

## Manual Starting

Insert the key in the ignition and turn to ON position.

Grasp manual starter handle firmly and pull slowly until a resistance is felt then pull vigorously. Slowly release the re-wind starter handle.

◆ **WARNING:** Do not apply throttle while starting.

## Electric Starting

▼ **CAUTION:** Never operate your snowmobile with the battery removed or disconnected.

Insert key in ignition switch.

Turn ignition key clockwise until starter engages.

▼ **CAUTION:** To avoid starter overheating, the cranking period should never exceed 30 seconds and a rest period should be observed between the cranking cycles to let starter cool down.

Release key immediately when engine has started. If engine does not start on first try, key must be turned fully back to OFF each time.

◆ **WARNING:** Do not apply throttle while starting.

○ **NOTE:** If for some reason the vehicle cannot be started electrically, place ignition key to ON position and start engine manually.

## Before Riding

Check operation of the emergency cut-out switch, and tether switch. Restart engine.

◆ **WARNING:** If engine does not shut-off when applying the emergency cut-out switch and or when pulling the tether cut-out cap, stop the engine by turning off the ignition key. Do not operate the vehicle further, see your dealer.

Allow the engine to warm before operating at full throttle.

## Emergency Starting

Should the rewind starter rope fray and break, the engine can be started with an emergency starter rope.

◆ **WARNING:** Do not start the vehicle by the drive pulley unless it is a true emergency situation, have the vehicle repaired as soon as possible.

Attach emergency rope to starter grip. Remove the belt guard from the vehicle and wind the emergency rope tight around the drive pulley between the sliding half and the roller guard. Start the engine as per usual manual starting.

◆ **WARNING:** When starting the vehicle in an emergency situation by the drive pulley, do not make a knot at the end of the emergency rope and do not reinstall the belt guard.

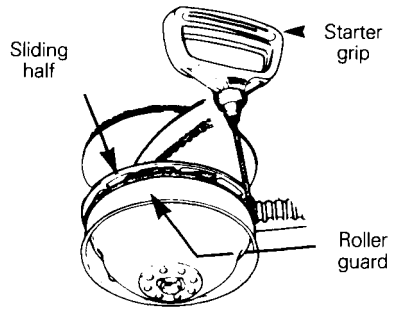

## LUBRICATION

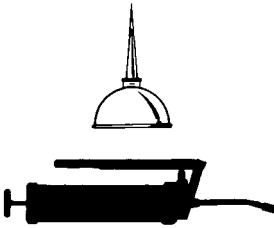

other components/systems not covered in this manual. Unless otherwise specified, engine should be turned OFF for all lubrication and maintenance procedures.

### Frequency

Routine maintenance is necessary for all mechanized products, and the snowmobile is no exception. A weekly vehicle inspection contributes to the life span of the snowmobile as well as retains safe and dependable operation. It is recommended that the steering system and suspension be lubricated monthly or every 40 hours of operation. If the vehicle is operated in wet snow or in severe conditions these items should be lubricated more frequently.

◆ **WARNING:** Only perform such procedures as detailed in this manual. It is recommended that dealer assistance be periodically obtained on

### Steering Mechanism

◆ **WARNING:** Do not lubricate throttle and/or brake cables and housings.

Lubricate the ski legs and spring coupler bolts at grease fittings until new grease appears at joints.

Coat spring slider cushion with grease.

Oil ball joints and steering column bushings.

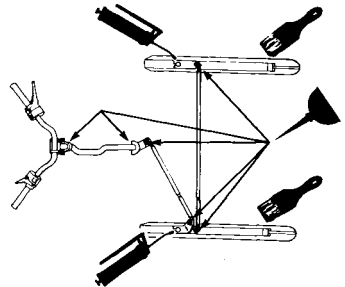

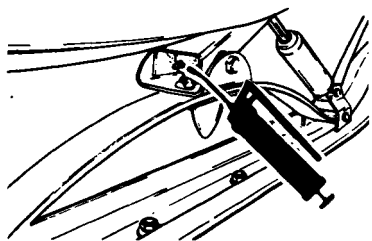

## Drive Axle

Lubricate at grease fitting using low temperature grease.

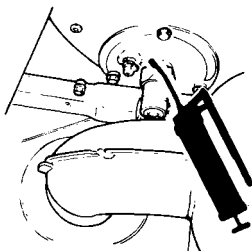

**CAUTION:** When lubricating the drive axle bearing, do not apply excessive grease as the seal will be pushed out of its housing. Check seal position with finger.

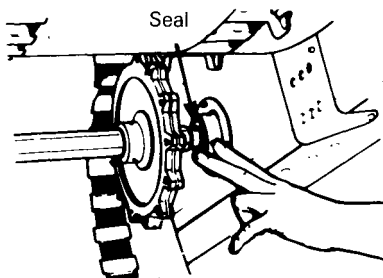

## Slide Suspension

Lubricate idler wheels at grease fittings until grease appears at joints. Use low temperature grease only.

Also lubricate front & rear arms at grease fittings.

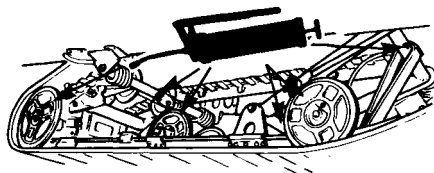

**NOTE:** A needle fitted onto grease gun must be used to lubricate idler wheels.



## Chaincase Oil Level

Using the spark plug socket, remove the filler cap then using a rigid wire as a "dipstick" check oil level. The oil level on the "dipstick" should be 50-65 mm (2" to 2 1/2"). Replenish as necessary.

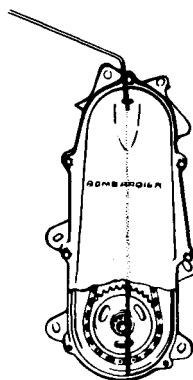

**NOTE:** The chaincase oil capacity is approximately 200 ml (7 oz.).

## Oil Injection System

Always maintain a sufficient amount of Bombardier Snowmobile Injection Oil in the injection oil tank.

### Fan cooled model

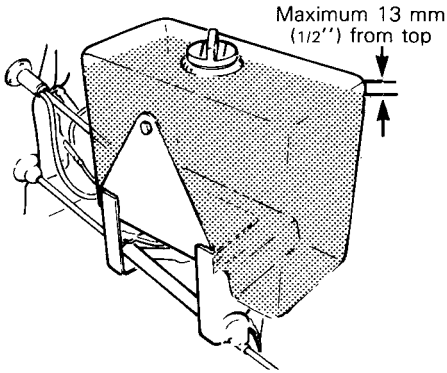

### Liquid cooled model

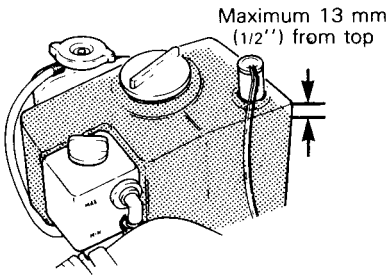

**CAUTION:** Check level and refill every time you refuel.

## Rotary Valve System

Check reservoir oil level frequently. Level should be between level lines of plastic reservoir. If necessary replenish to maximum oil level line using Bombardier snowmobile Injection oil available from your dealer.

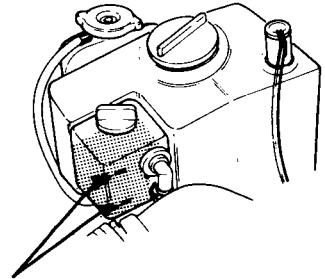

Oil level lines

# MAINTENANCE

The following Maintenance Chart indicates regular servicing schedules to be performed by you or your servicing dealer. If these services are performed as suggested, your snowmobile will give you many years of low-cost use.

**WARNING:** Only perform such procedures as detailed in this manual. It is recommended that dealer assistance be periodically obtained on other components/systems not covered in this manual. Unless otherwise specified, engine should be turned OFF for all lubrication and maintenance procedures.

<b>MAINTENANCE CHART</b>	Weekly or every 240 km (150 mi)	Monthly or every 800 km (500 mi)	Once year or every 3200 km (2000 mi)	Refer to page
Drive belt condition	•			23
Brake condition	•			24
Brake adjustment		•		24
Spark plugs		•		24
Battery (Electric model)	•			25
Suspension condition		•		25
Suspension stopper strap condition			•	25
Suspension adjustment	(as required)			25
Track condition		•		26
Track tension and alignment		•		26
Drive pulley		•		27
Steering mechanism		•		27
Steering adjustment		•		27
Muffler attachment		•		28
Engine head nuts			•	28
Engine mount nuts			•	29
Carburetor adjustment			•	29
Injection oil filter condition		•		29
Oil injection pump adjustment			•	29
Fan belt (Fan cooled model)			•	30
Cooling system (Liquid cooled model)			•	30
Headlamp beam aiming			•	30
General inspection		•		31

○ **NOTE:** The ten hour inspection is a very important part of proper service and maintenance.



## Belt Guard Removal

◆ **WARNING:** Engine should be running only when belt guard is secured in place.

1. Tilt the hood.
2. Pull out both retaining pins.

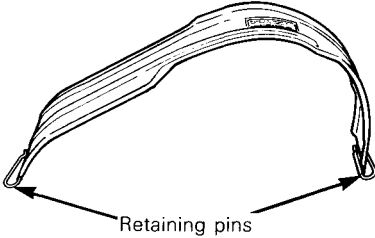

3. Lift and remove the belt guard assembly.

## Drive Belt Removal

◆ **WARNING:** Never start or run engine without the drive belt installed. Running an unloaded engine is dangerous..

1. Remove the belt guard.
2. Unlock and raise driven pulley support.

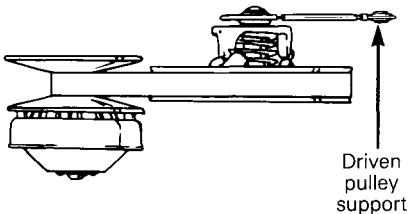

3. Open the driven pulley by twisting and pushing the sliding half. Hold in fully open position.



4. Slip slackened belt over the top edge of the sliding half.



5. Slip the belt out from the drive pulley and remove completely from vehicle.

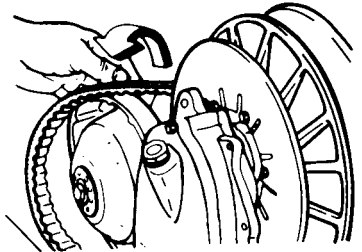

To install the drive belt, reverse the procedure.

## Drive Belt Condition

Inspect belt for cracks, fraying or abnormal wear (uneven wear, wear on one side, missing cogs, cracked fabric). If abnormal wear is noted, probable cause could be pulley misalignment, excessive R.P.M. with frozen track, fast starts without warm-up period, burred sheave, oil on belt or distorted spare belt. Contact your dealer.

Check the drive belt width. If less than 32 mm (1 1/4 in), replace the drive belt.

## New Drive Belt

When installing a new drive belt, break-in period of 25 km (15 miles) is strongly recommended.

○ **NOTE:** Always store a spare belt in a manner to allow its natural shape to be maintained.

## Brake Condition

The brake mechanism on your snowmobile is an essential safety device. Keep this mechanism in proper working condition. Above all, do not operate your snowmobile without an effective brake system.

◆ **WARNING:** Brake pads less than 3 mm (1/8") thick must be replaced. Replacement must be performed by an authorized dealer.

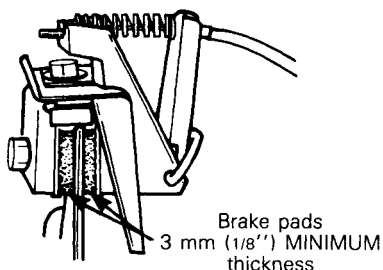

## Brake Adjustment

The brake mechanism is a self-adjusting type. If a quicker brake response is desired, strongly pull the brake lever several times, this will actuate the self-adjusting mechanism.

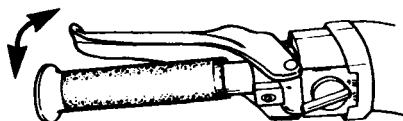

Strongly pull

After the adjustment, brake should apply fully when lever is approximately 13 mm (1/2") from handlebar grip. If not, do not tamper with the brake, contact your servicing dealer.

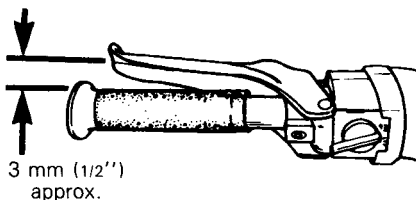

## Spark Plugs

Disconnect the spark plug wires and remove the spark plugs.

Check the condition of the plugs.

- A brownish tip reflects ideal conditions. (Carburetor adjustments, spark plug heat range, etc., are correct.)
- A black insulator tip indicates fouling caused by: carburetor idle speed mixture and/or high speed mixture too rich, incorrect fuel mixture ratio, wrong type of spark plug (heat range), or excessive idling.
- A light grey insulator tip indicates a lean mixture caused by: carburetor high speed mixture adjusted too lean, wrong spark plug heat range, incorrect fuel mixture ratio, or a leaking seal or gasket.

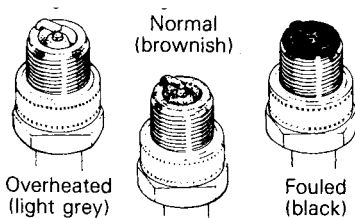

▼ **CAUTION:** If spark plug condition is not ideal, contact your authorized dealer.

Check spark plug gap using a wire feeler gauge.

Reinstall plugs and connect wires.

## Battery

### (Electric model)

Check electrolyte level weekly. Electrolyte level must be at upper level line on battery casing.

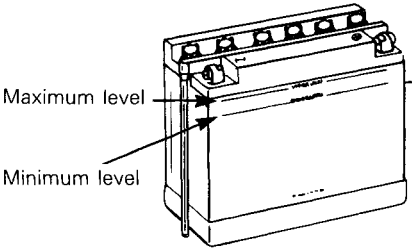

If necessary add distilled water. Battery connections must also be free of corrosion. If cleaning is necessary remove corrosion using a stiff brush then clean with a solution of baking soda and water. Rinse and dry well.

**CAUTION:** Do not allow cleaning solution to enter battery. It will destroy the chemical properties of the electrolyte.

After reconnecting battery, coat battery terminals and connectors with petroleum jelly to prevent corrosion. Check that battery is well secured and that battery vent tube is not kinked or blocked.

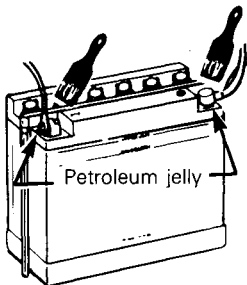

**WARNING:** Vent tube must be free and open. If not, it will restrict ventilation and create a gas accumulation that could result in an explosion. Avoid skin contact with electrolyte.

**CAUTION:** Prior to charging the battery, always remove it from the vehicle to prevent electrolyte spillage.

**NOTE:** Always keep battery fully charged. (To charge, refer to "Battery" in "Storage" section).

## Suspension Condition

Visually inspect all suspension components including slider shoes, springs, wheels, etc...

**NOTE:** During normal driving, snow will act as a lubricant and coolant for the slider shoes. Extensive riding on ice or sanded snow, will create excessive heat build-up and cause premature slider shoe wear.

## Stopper Strap Condition

Inspect strap for wear and cracks, bolt and nut for tightness. If loose inspect holes for deformation, replace as required. Torque nut to 10 N•m (7 lbf•ft).

## Suspension Adjustment

The suspension is adjustable. The front adjustment for surface condition, the rear for driver's weight. Use the special key located in tool box.

Adjuster blocks

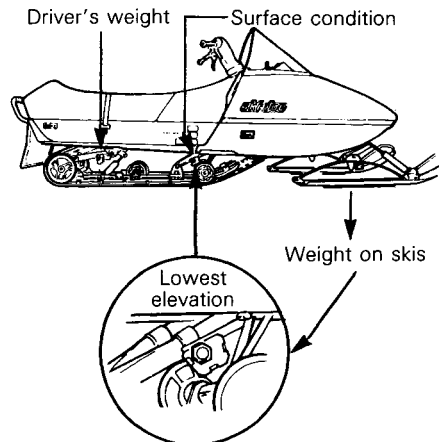

When the front adjuster blocks are at the lowest elevation more weight is distributed on the skis.

At the highest position the weight is transferred from the skis to the track. The rear adjuster blocks should be adjusted to suit the driver's preference.

○ **NOTE:** For deep snow condition or hill climbing, it is recommended to place the front adjuster blocks on the highest position.

▼ **CAUTION:** Always turn the left side adjuster blocks in a clockwise direction, the right side blocks in a counter-clockwise direction. Left and right adjuster blocks of each adjustment must always be set at the same elevation.

## Track Condition

Lift the rear of the vehicle and support it off the ground. With the engine off, rotate the track by hand, and inspect condition. If worn or cut, or if track fibers are exposed, or if missing or defective inserts or guides are noted; contact your dealer.

◆ **WARNING:** Do not operate a snowmobile with a cut, torn or damaged track.

## Track Tension and Alignment

### Tension:

Lift the rear of vehicle and support with a mechanical stand. Allow the slide to extend normally. The gap should be 13 mm (1/2") between the slider shoe and the bottom inside of the track. If the track tension is too loose, the track will have a tendency to thump.

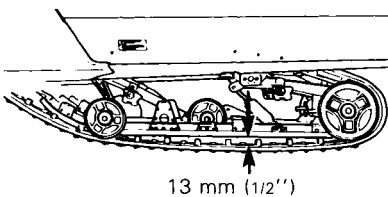

▼ **CAUTION:** Too much tension will result in power loss and excessive stresses on suspension components.

If necessary to adjust; loosen the rear idler wheel retaining screw and the adjuster bolt lock nut; then loosen or tighten the adjuster bolts located on the inner side of the rear idler wheels. If correct tension is unattainable, contact your dealer.

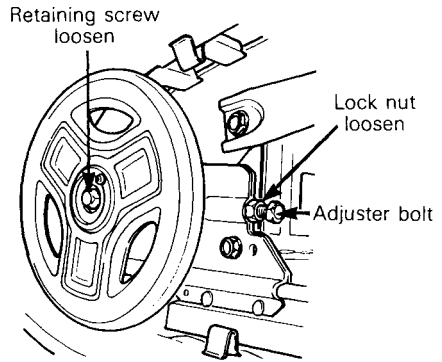

○ **NOTE:** Track tension and alignment are inter-related. Do not adjust one without the other.

### Alignment

Start the engine and accelerate slightly so that track turns **slowly**. Check that the track is well centered; equal distance on both sides between edges of track guides and slider shoes.

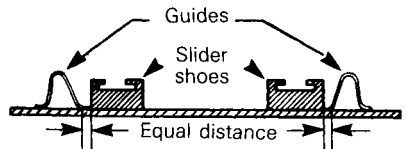

**WARNING:** Before checking track alignment, ensure that the track is free of all particles which could be thrown out while track is rotating. Keep hands, tools, feet and clothing clear of track. Ensure no-one is standing in close proximity to the vehicle.

To correct, stop the engine, loosen the rear idler wheels retaining screws then loosen the lock nuts and tighten the adjuster bolt on side where the slider shoe is the farthest to the track insert guides.

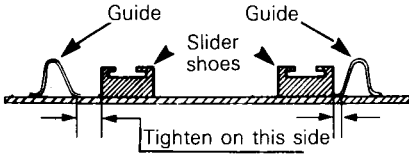

Tighten lock nuts and recheck the alignment. Ensure to retighten the idler wheel retaining screws.

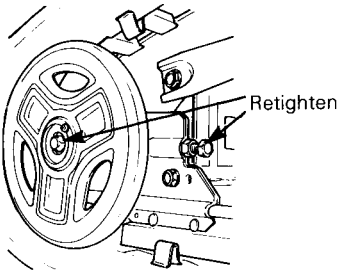

## Drive Pulley

Inspect the Duralon bushing condition by checking the free-play of the sliding half pulley. This is achieved by restraining the inner half and checking if the sliding half moves in the direction of the arrows more than 3 mm (1/8''). If so, contact your dealer.

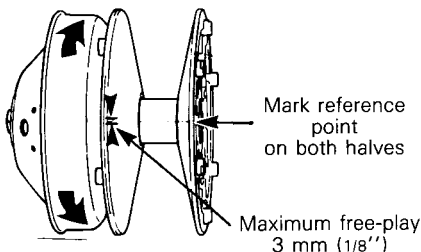

## Steering Mechanism

Inspect the steering mechanism for tightness of components (steering arms, tie rods, ball joints, spring coupler bolts, etc.). If necessary, replace or retighten.

Torque steering arm bolts as illustrated below:

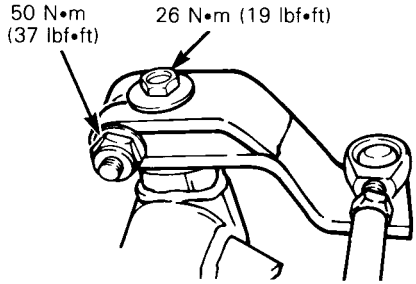

Check the condition of the skis and the ski runners. Replace if more than half worn.

## Steering Adjustment

Skis should have a toe out of 3 mm (1/8''). To check, measure the distance between each ski at the front and rear of the leaf springs. The front distance should be 3 mm (1/8'') more than the rear when the handlebar is horizontal.

**IMPORTANT:** Close the front of the skis manually to eliminate all slack from the steering mechanism.

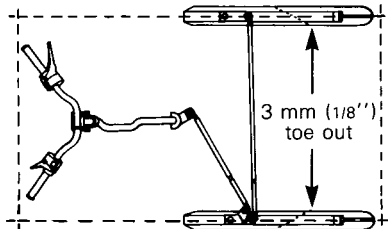

If adjustment is required:

Loosen the lock nuts of the longest tie rod. Turn the tie rod manually until the skis are properly aligned. Firmly retighten the lock nuts.

The handlebar should also be horizontal when the skis are pointed toward the front.

To adjust:

Loosen the lock nuts of the shortest tie rod. Turn the tie rod manually until the handlebar is horizontal. Retighten the lock nuts firmly.

**WARNING:** The ball joint socket must run parallel with the steering arm. The socket must be restrained when tightening the tie rod end lock nuts.

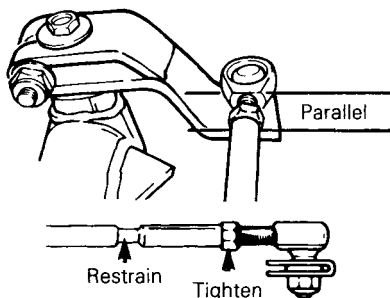

## Muffler Attachment

The engine/exhaust system parts are vital toward efficient muffler function. Check all attachments. Replace the springs and/or tighten if necessary.

**CAUTION:** Do not operate vehicle with muffler disconnected otherwise serious engine damage will occur.

## Engine Head Nuts

With the engine cold, check that the engine head nuts are tight and equally torqued as follow:

Engine type*	Torque N•m (lbf•ft)
377 FC	21 (15)
447 FC	23 (17)
532 LC	21 (15)

\*FC = Fan cooled  
LC = Liquid cooled

Respect tightening sequence as follow:

### Fan cooled engine

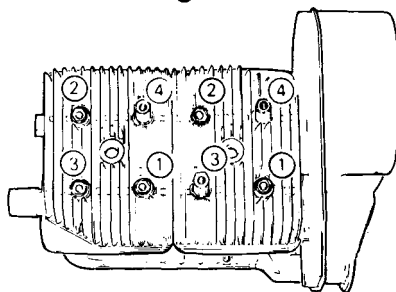

### Liquid cooled engine

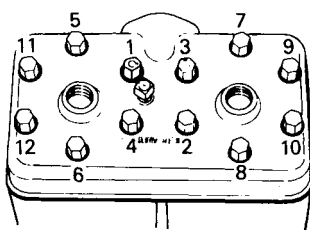

**IMPORTANT:** The engine head nut torque should be checked after the first 5 hours of operation.

## Engine Mount Nuts

Check the engine mount nuts for tightness. Retighten if necessary.

## Carburetor Adjustment

▼ **CAUTION:** Never operate your snowmobile with the air intake silencer disconnected. Serious engine damage will occur if this notice is disregarded.

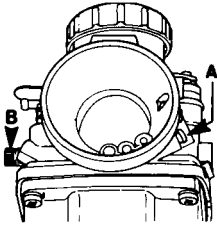

### A) Air Screw Adjustment

Completely close the air screw (until a slight reseating resistance is felt) then back off screw: 1 1/2 turn.

### B) Idle Speed Adjustment

Turn the idle speed screw clockwise until it contacts the throttle slide then continue turning two (2) additional turns. This will provide a preliminary idle speed setting. Start engine and allow it to warm then adjust idle speed to 1800-2000 R.P.M. by turning idle speed screw clockwise or counter-clockwise.

▼ **CAUTION:** Do not attempt to set the idle speed by using the air screw. Severe engine damage can occur. If idle speed is unattainable contact your authorized dealer.

## Oil Injection System

### Injection Oil Filter Condition

Inspect oil filter at least once a month. Insure that filter is not obstructed by foreign particles; if so, see your dealer.

▼ **CAUTION:** An obstructed injection oil filter will cause oil starvation resulting in serious engine damage.

○ **NOTE:** After a storage period, it is **important** that your **dealer** replaces the injection oil filter and that he verifies the oil flow of the injection pump.

### Injection Pump Adjustment

Proper oil injection pump adjustment is very important. Any delay in the opening of the pump can result in serious engine damage.

▼ **CAUTION:** The carburetor must be adjusted before adjusting the oil injection pump.

To check adjustment: eliminate the throttle cable free-play by pressing the throttle lever until a light resistance is felt then hold in place. The aligning marks on the pump casting and lever must align perfectly. If not, contact your dealer.

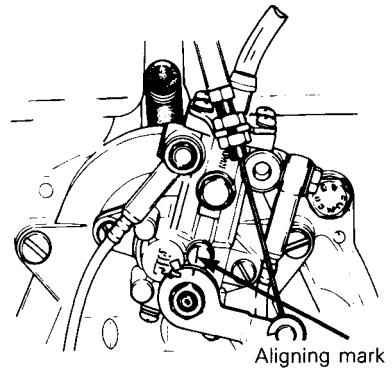

○ **NOTE:** Injection pump should be adjusted by your dealer.

## Cooling System

### (Liquid cooled model)

Check condition and tightness of hoses and clamps. Using a hydrometer check that the anti-freeze solution is strong enough for the temperature in which the vehicle is operated.

○ **NOTE:** Should the coolant temperature raise above recommended range 50°C-95°C (120°-200°F), hose off grime from the heat exchanger (underneath the frame above the track).

## Fan Belt

### (Fan cooled model)

Inspect belt for cracks, uneven wear, etc. Check fan belt tension, 9-10 mm (3/8") free-play should exist when deflection is correct.

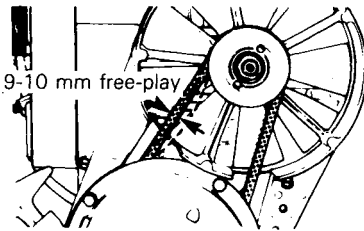

If belt seems damaged or if tension is incorrect, contact your dealer immediately.

◆ **WARNING:** If fan protector is removed, always reinstall after servicing.

## Headlamp Beam Aiming

The angle of the headlamp beam has been pre-adjusted prior to delivery. Should you wish re-adjustment, place the vehicle on a flat surface 7.6 m (25') from a wall or screen.

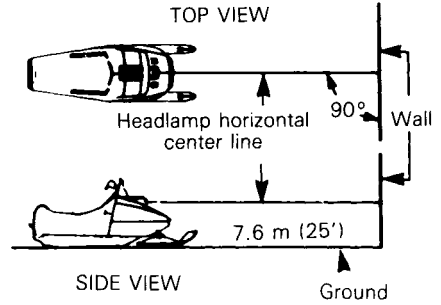

With the suspension correctly adjusted, the rider seated on the vehicle and the high beam ON check that the center of high intensity zone of high beam is 50 mm (2") below horizontal line of headlamp height.

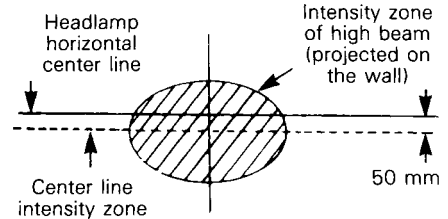

To adjust, remove the four caps, turn upper or lower adjusting screws to obtain desired beam position.

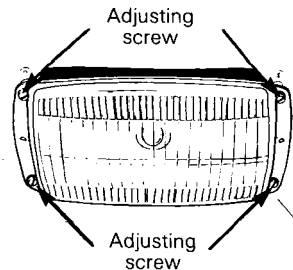



## Bulb Replacement

If the headlamp bulb is burnt, tilt hood, unplug the connector from the headlamp. Remove the rubber boot and unfasten bulb retainer clips. Detach the bulb and replace.

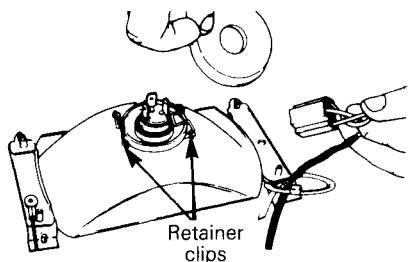

If taillight bulb is burnt, expose the bulb by removing the red plastic lens. To remove, unfasten the two (2) screws.

◆ **WARNING:** Always check light operation after bulb replacement.

▼ **CAUTION:** On models without any accessory mounted in dash, unused female and tab connector

housings (8 circuits) are free inside of cab. **Do not connect these housings together.** Electrical problem will occur.

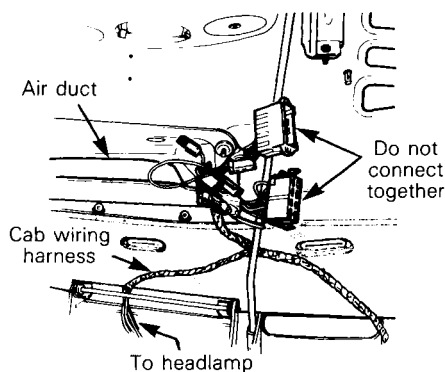

## General Inspection

Check the electrical wiring and components, retighten loose connections. Check for stripped wires or damaged insulation. Thoroughly inspect the vehicle and tighten loose bolts, nuts and linkage. Inspect skis and ski runners for wear.

## STORAGE

It is during summer, or when a vehicle is not in use for any length of time that proper storage is a necessity. Storage of the snowmobile during long period of inactivity consists of checking and replacing missing, broken or worn parts, proper lubrication and treatment to insure that parts do not become rusted; cleaning items such as carburetor of oil mixtures, to prevent gum varnish formation within the carburetor; and in general, preparing the vehicle so that when the time comes to use the snowmobile again it will be in top condition.

◆ **WARNING:** Only perform such procedures as detailed in this manual. It is recommended that dealer assistance be periodically obtained on other components/systems not cov-

ered in this manual. Unless otherwise specified, engine should be turned OFF.

## Track

Inspect the track for wear, cuts, missing track guides and broken rods. Make any necessary replacement.

◆ **WARNING:** Do not operate a snowmobile with a cut, torn or damage track.

Lift the rear of vehicle until track is clear of the ground then support with a brace or trestle. The snowmobile should be stored in such a way that the track does not stay in contact with the cement floor or bare ground.

○ **NOTE:** The track should be rotated periodically, (every 40 days). Do not release track tension.

**CAUTION:** To prevent track damage, temperature in the storage area must not exceed 38°C (100°F).

## Suspension

Remove any dirt or rust. Grease all components equipped with grease fittings. Wipe off surplus. Replace worn slider shoes.

## Skis

Wash or brush all dirt or rust accumulation from the skis and springs. Grease the ski legs at the grease fittings. Check the condition of the skis, ski runners and leaf springs. Replace if weak or worn more than half.

## Controls

Lubricate the steering mechanism. Inspect all components for tightness, (spring coupler bolts, steering arm locking bolts, tie rods, ball joints, etc.) Tighten if necessary. Oil moving joints of the brake mechanism.

**WARNING:** Do not lubricate the throttle and/or brake cables and housings. Avoid getting oil on the brake pads.

Coat all electrical connections and switches with a greaseless metal protector. If unavailable, use petroleum jelly.

## Chaincase

Drain the chaincase and refill to proper level, using fresh chaincase oil. To drain, remove the chaincase cover.

## Drive Pulley

Inspection and cleaning must be performed by the dealer at the end of each season.

## Cooling System

The engine cooling system should be drained and refilled with a new coolant mixture before each storage period.

**WARNING:** Never drain or refill the cooling system when engine is hot.

To drain cooling system:

- Use a length of hose long enough to drain coolant into a container lower than engine.
- Remove the engine coolant hose from water pump.
- Connect "drain hose" onto water pump.
- Put both hose ends into the container.
- Then, remove coolant tank cap and lift the rear of the vehicle to drain the heat exchangers.
- Remove the engine bleed screw.

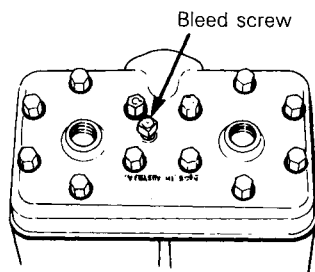
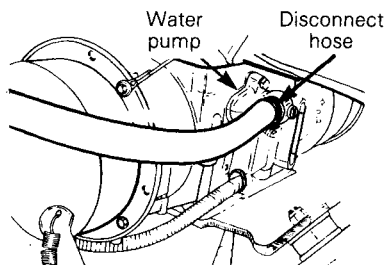

**CAUTION:** To prevent rust formation or freezing condition, always replenish the system with 60% antifreeze and 40% water. Pure anti-freeze without water produces pre-

**mature freezing. Always use ethylene-glycol antifreeze containing corrosion inhibitors specifically recommended for aluminum engines.**

To refill cooling system:

- Remove "drain hose" and reinstall initial one.
- Put back the rear of vehicle on the ground.
- Refill coolant tank slowly until coolant overfills at bleed hole.
- Reinstall bleed screw.
- Continue to pour coolant in the tank until level reaches 25 mm (1 in) below filler neck.
- With the coolant tank cap still removed, start engine and let it warm up to reach its normal operating temperature and thermostat open. Allow it running a few minutes more.
- Stop engine and check coolant level. Refill as required then put back the cap.

## Engine and Primer Lubrication

Engine internal parts must be lubricated to protect them from possible rust formation during the storage period.

To perform the storage procedures (engine and primer valve) proceed as follows:

1. Lift the rear of the vehicle and support it off the ground.

**WARNING:** Ensure the track is free of all particles which could be thrown out while it is rotating. Keep hands, tools, feet and clothing clear of track. Ensure no-one is standing in close proximity to the vehicle.

2. Start the engine and allow it to run at idle speed until the engine reaches its operational temperature.
3. Stop the engine.
4. Disconnect the inlet primer hose from the primer valve.

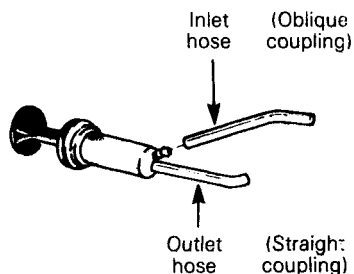

5. Plug inlet primer hose to prevent gasoline from draining.
6. Using an appropriate hose, connect one end of the hose to the inlet of the primer valve and place the other end in a Bombardier Snowmobile Injection Oil container.
7. Activate the primer in order to fill it with oil.
8. Restart engine and run at idle.
9. Using the primer valve, inject oil until the engine dies or until a sufficient quantity of oil has entered the engine (approximately 25 complete strokes of the primer).
10. The engine stopped, remove the spark plugs and pour approximately 85 ml (3 imp. oz.) of oil into the cylinders.
11. Crank the engine to allow the crankshaft to turn 2 or 3 revolutions.

12. Reinstall the spark plugs and the inlet primer hose.

Do not run engine during storage period.

## Fuel Tank and Carburetor

Remove the cap then using a syphon, remove the gasoline from tank.

◆ **WARNING:** Gasoline is flammable and explosive under certain conditions. Always manipulate in a well ventilated area. Do not smoke or allow open flames or sparks in the vicinity.

Carburetor must be dried out completely to prevent gum formation during the storage period.

Once the fuel tank is emptied, remove the float chamber drain plug from carburetor. Drain carburetor.

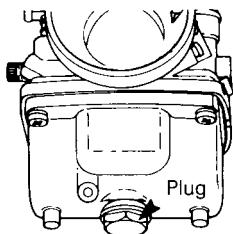

Reinstall plug.

Check all fuel lines, replace if necessary.

## Battery

### (Electric model)

1. Disconnect the battery cables and remove the battery retainer cover.

▼ **CAUTION:** Be careful not to ground positive terminal with the chassis. Always disconnect black negative cable first.

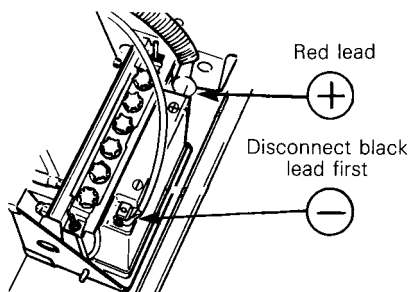

2. Remove the battery vent tube from the vent hole.
3. Lift out the battery.
4. Clean outside surface of battery with solution of baking soda and water. Remove all deposits from posts then rinse with clear tap water.

▼ **CAUTION:** Do not allow cleaning solution to enter battery interior since it will destroy the electrolyte.

5. Check electrolyte level. Refill if necessary with distilled water. Fully charge battery at a maximum rate of 2.0 amps.

▼ **CAUTION:** Prior to charging the battery, always remove it from the vehicle to prevent electrolyte spillage.

◆ **WARNING:** Gases given off by a battery being charged are highly explosive. Always charge in a well ventilated area. Keep battery away from cigarettes or open flames. Avoid skin contact with electrolyte.

6. Coat electrical connections and switches with a greaseless metal protector, if unavailable, use petroleum jelly.
7. Store unit in a cool, dry place.

---

○ **NOTE:** To prevent battery from discharging, store it on a wooden shelf away from moisture. A stored battery must be recharged at least every 40 days.

## **Chassis**

Clean the vehicle thoroughly, removing all dirt and grease accumulation.

▼ **CAUTION:** Plastic alloy components such as fuel tank, windshield, controls, etc., can be cleaned using mild detergents or isopropyl alcohol. Do not use strong soaps, degreasing solvents, abrasive cleaners, paint thinners, etc.

Inspect the hood and repair any damage. Clean the frame. For the unpainted aluminum portion use only "Aluminum cleaner" and follow instructions on the container.

Touch up all metal spots where paint has been scratched off. Spray all bare metal parts with metal protector. Wax the hood and the painted portion of the frame for better protection.

○ **NOTE:** Apply wax on glossy finish only. Protect the vehicle with a cover to prevent dust accumulation during storage.

▼ **CAUTION:** If for some reason the snowmobile has to be stored outside it is necessary to cover it with an opaque tarpaulin. This caution will prevent the sun rays and the grime from affecting the plastic components and the vehicle finish.

## **General Inspection**

Check the electrical wiring and components, retighten loose connections. Check for stripped wires or damaged insulation.

Thoroughly inspect the vehicle and tighten loose bolts, nuts and linkage.

○ **NOTE:** Leave the drive belt off the pulleys for the entire storage period.

## **Suspension Stopper Strap**

Replace annually and/or as condition dictates. Torque nut to 10 N•m (7 lbf•ft).

# PRE-SEASON PREPARATION

To simplify the pre-season preparation we have drawn up a small chart. The chart indicates servicing points to be performed by you and your servicing dealer. If these services are performed as suggested, your vehicle will give you many hours of fun and low cost use.

**IMPORTANT:** Observe all Warnings and Cautions mentioned throughout this manual which are pertinent to the item being checked. When component conditions seem less than satisfactory, replace with genuine Bombardier parts or suitable equivalents.

<b>PRE-SEASON PREPARATION CHART</b>	TO BE PERFORMED BY DEALER	●
	TO BE PERFORMED BY OWNER	○
Change spark plugs*		○
Check chaincase oil level		○
Check rotary valve oil level		○
Replace fuel filter (located inside fuel tank)		○
Check track tension and alignment		○
Lubricate suspension		○
Inspect drive belt and install		○
Check steering alignment and ski runner condition		○
Inspect condition of starting rope		○
Check tightness of all bolts, nuts and linkage		○
Refill gas tank		○
Check throttle cable for damage and free operation		●
Check electrical wiring (broken wire, damaged insulation)		○
Inspect seals for possible cuts or leaks		●
Check coolant condition and level		○
Replace injection oil filter		●
Refill injection oil tank		●
Inspect brake condition and operation		●
Set engine timing		●
Check pulleys, verify components and clean. Lubricate.		●
Adjust carburetor		●
Adjust oil injection pump		●



\*NOTE: Before installing new spark plugs, it is suggested to burn the excess storage oil by starting the engine, using the old spark plugs.



CAUTION: Only perform this procedure in a well ventilated area.

# TROUBLE SHOOTING GUIDE

○ NOTE: The possible causes have been listed in an order of frequency. Therefore, items should be checked out in the same order as mentioned in the trouble shooting guide.

SYMPTOMS	POSSIBLE CAUSES	SOLUTIONS
Engine turns over but fails to start or starts with difficulty	1. No fuel to the engine	Check the tank level and fill it up. Check for possible clogging of fuel line, item 4.
	2. Flooded engine	Remove wet spark plugs, turn ignition to OFF and crank engine several times. Install clean dry spark plugs. Start engine following usual starting procedure. If engine continues to flood, see your dealer.
	3. Spark plug/ignition	Check for fouled or defective spark plug. Disconnect spark plug wire, unscrew plug and remove from cylinder head. Reconnect wire and ground exposed plug on engine cowl, <b>being careful to hold away from spark plug hole.</b> Follow engine starting procedure and check for spark. If no sparks appear, replace spark plug. If trouble persists, contact your dealer.
	4. Clogged fuel line (water or dirt)	Remove and clean the fuel filter. Change filter cartridge if necessary. Check condition and connections of fuel lines. Check the cleanliness of fuel tank.
	5. Incorrect carburetor adjustment	Contact your dealer.
	6. Incorrect injection pump adjustment	Contact your dealer.
	7. Engine timing	Engine timing may be incorrect or out of adjustment. Contact your dealer.
	8. Poor engine compression	Running with a lean fuel mixture may produce excessive engine wear resulting in poor engine compression. If this occurs, contact your dealer at once.
Engine will not turn manually	1. Seized engine	In the case of a seized engine contact your dealer.

<b>SYMPTOMS</b>	<b>POSSIBLE CAUSES</b>	<b>SOLUTIONS</b>
Engine lacks acceleration or power	1. Fouled or defective spark plug	Check item 3 of "Engine turns over but fails to start or starts with difficulty"
	2. Clogged fuel line (water or dirt)	Check fuel line condition. (See item 4 of "Engine turns over but fails to start or starts with difficulty").
	3. Carburetor	Contact your dealer.
	4. Ignition	First check item 2 and 3 of "Engine turns over but fails to start or starts with difficulty". If the ignition system still seems faulty, contact your dealer.
	5. Engine	If unable to locate specific symptoms, contact your dealer.
Engine continually backfires	1. Spark plug	Check item 3 of "Engine turns over but fails to start or starts with difficulty".
	2. Overheated	Carburetor too lean, see your dealer.
	3. Engine timing incorrectly set	Contact your dealer.
Snowmobile cannot reach full speed	1. Drive Belt	Check for damaged or worn drive belt. Replace if necessary.
	2. Incorrect track adjustment	Check track tension and alignment. Readjust to specifications. (See Maintenance Section).
	3. Engine	Check item 1 to 5 of "Engine lacks acceleration or power."
	4. Pulley misaligned	Contact your dealer.



# TOOLS

As standard equipment each new snowmobile is supplied with basic tools such as screwdriver, wrenches, emergency starter rope, etc...

## Standard Tools

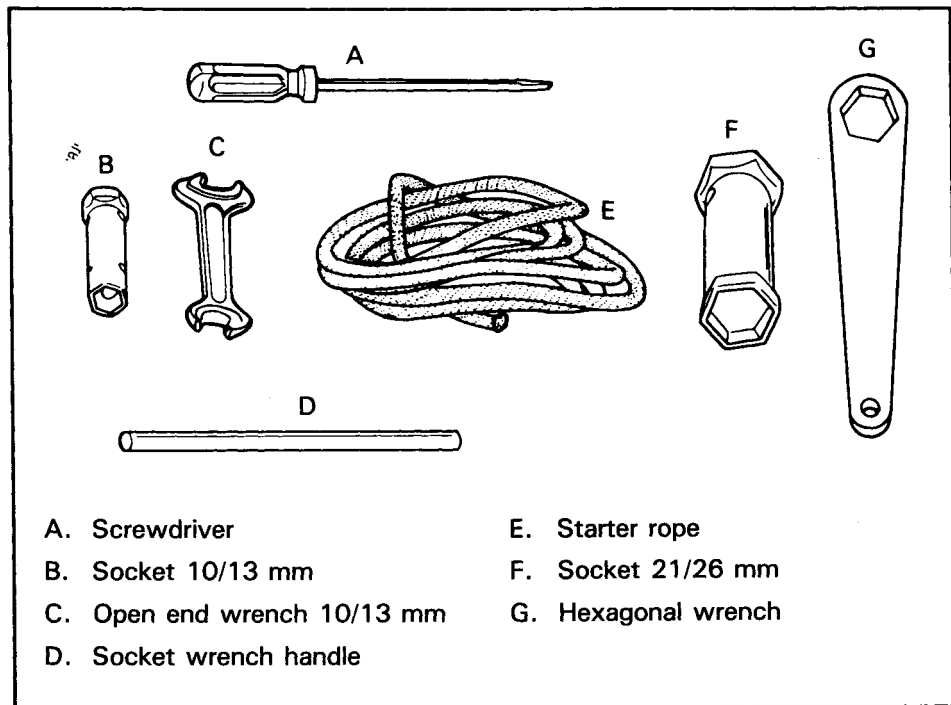

# SPECIFICATIONS

	<b>Safari 377, 377E Mirage III</b>	<b>Safari 447</b>	<b>Safari Grand Luxe LC</b>
<b>ENGINE</b>			
Type	377	447	532
No. of cylinders	2	2	2
Bore	62 mm (2.441")	67.5 mm (2.657")	72 (2.835")
Stroke	61 mm (2.401")	61 mm (2.401")	64 mm (2.520")
Displacement	368.3 cm <sup>3</sup> (22.48 in <sup>3</sup> )	436.6 cm <sup>3</sup> (26.64 in <sup>3</sup> )	521.2 cm <sup>3</sup> (31.80 in <sup>3</sup> )
Compression ratio (corrected)	6.9:1	6.3:1	6.8:1
Maximum R.P.M.	7500	7500	7500
Carburetor type	Mikuni VM 34-309	Mikuni VM 34-310	Mikuni VM 34-312
Carburetor adjustment:			
— air screw	1 1/2 turn	1 1/2 turn	1 1/2 turn
— idle speed	1800-2000 R.P.M.	1800-2000 R.P.M.	1800-2000 R.P.M.
Fan belt free-play	9-10 mm (3/8")	9-10 mm (3/8")	N.A.
Rotary valve oil — SI	N.A.	N.A.	568 ml
reservoir — Imp.	N.A.	N.A.	20 oz
Cooling system — SI	N.A.	N.A.	4.5 L
capacity — Imp.	N.A.	N.A.	160 oz
— U.S.	N.A.	N.A.	154 oz
Antifreeze/water mixture (% by volume)	N.A.	N.A.	60/40
Thermostat	N.A.	N.A.	43°C (110°F)
Radiator pressure cap	N.A.	N.A.	1.9 kPa (13 lb/in <sup>2</sup> )
Torque:			
— engine head nuts	M8: 21 N•m (15 lbf•ft)	M8: 23 N•m (17 lbf•ft)	M8: 21 N•m (17 lbf•ft)
— crankcase nuts	M6: 9 N•m (7 lbf•ft)	M6: 9 N•m (7 lbf•ft)	M6: 9 N•m (7 lbf•ft)
	M8: 21 N•m (15 lbf•ft)	M8: 21 N•m (15 lbf•ft)	M8: 21 N•m (15 lbf•ft)
— magneto ring nut	M22: 85 N•m (63 lbf•ft)	M22: 85 N•m (63 lbf•ft)	M22: 85 N•m (63 lbf•ft)
— fan nut	M16: 65 N•m (48 lbf•ft)	M16: 65 N•m (48 lbf•ft)	N.A.
— crankcase engine support nuts	M10: 38 N•m (28 lbf•ft)	M10: 38 N•m (28 lbf•ft)	M10: 38 N•m (28 lbf•ft)
— exhaust manifold bolts	M8: 21 N•m (15 lbf•ft)	M8: 21 N•m (15 lbf•ft)	M8: 21 N•m (15 lbf•ft)
— electrical starter bolts	M8: 21 N•m (15 lbf•ft)	N.A.	M8: 21 N•m (15 lbf•ft)
	M5: 4 N•m (3 lbf•ft)	N.A.	M5: 4 N•m (3 lbf•ft)
<b>CHASSIS</b>			
Overall length	266.7 cm (105")	279.4 cm (110")	279.4 cm (110")
Overall width	96.5 cm (38")	96.5 cm (38")	96.5 cm (38")
Overall height	Safari: 96.5 cm (38") Mirage III: 99 cm (39")	96.5 cm (38")	96.5 cm (38")
Ski stance (center to center)	81.9 cm (32.25")	81.9 cm (32.25")	81.9 cm (32.25")
Ski alignment (toe out)	3 mm (1/8")	3 mm (1/8")	3 mm (1/8")
Torque:			
— steering arm/ski leg bolt	50 N•m (37 lbf•ft)	50 N•m (37 lbf•ft)	50 N•m (37 lbf•ft)
— steering column/handlebar	26 N•m (19 lbf•ft)	26 N•m (19 lbf•ft)	26 N•m (19 lbf•ft)
Weight	177 kg (390 lb) manual 191 kg (422 lb) electric	182 kg (402 lb)	209 kg (460 lb)
Bearing area	6645 cm <sup>2</sup> (1030 in <sup>2</sup> ) manual 7065 cm <sup>2</sup> (1095 in <sup>2</sup> ) electric	7594 cm <sup>2</sup> (1177 in <sup>2</sup> )	7594 cm <sup>2</sup> (1177 in <sup>2</sup> )
Ground pressure	2.61 kPa (.379 lb/in <sup>2</sup> ) manual 2.65 kPa (.385 lb/in <sup>2</sup> ) electric	2.36 kPa (.342 lb/in <sup>2</sup> )	2.70 kPa (.391 lb/in <sup>2</sup> )

	<b>Safari 377, 377E Mirage III</b>	<b>Safari 447</b>	<b>Safari Grand Luxe LC</b>
<b>POWER TRAIN</b>			
Track:			
— width	38.1 cm (15") manual 41.9 cm (16 1/2") electric	41.9 cm (16 1/2")	41.9 cm (16 1/2")
— length	290 cm (114")	315 cm (124")	315 cm (124")
— tension	13 mm (1/2") gap between slider shoe and bottom inside of track.		
— alignment	Equal distance between edges of track guides and slider shoes.		
Standard gear ratio	16/34	19/39	21/37
Drive belt:			
— number	414 5233 00	414 5233 00	414 5233 00
— Max. width	34.9 mm (1 3/8")	34.9 mm (1 3/8")	34.9 mm (1 3/8")
— Min. width	31.7 mm (1 1/4")	31.7 mm (1 1/4")	31.7 mm (1 1/4")
Chaincase oil	200 ml (7 oz)	200 ml (7 oz)	200 ml (7 oz)
<b>ELECTRICAL</b>			
Lighting system (output)	12 V. 160 W	12 V. 160 W	12 V. 160 W
Bulb:			
— headlamp	60/60 W	60/60 W	60/55 W hal.
— tail/stop	5/21 W	5/21 W	5/21 W
— speedometer	N.A.	5W	5W
— tachometer	N.A.	N.A.	5W
— temperature gauge	N.A.	N.A.	5 W
Fuse:			
— ignition switch	15A (electric model)	N.A.	15 A
— starter solenoid	30A (electric model)	N.A.	30 A
— tachometer	N.A.	N.A.	0.1 A
Spark plug			
— type	Nippondenso W24ESRU	Nippondenso W24ESRU	NGK BR8ES
— gap	0.4 mm (0.016")	0.4 mm (0.016")	0.4 mm (0.016")
Ignition timing:			
— timing mark (B.T.D.C.)	2.31mm (.091")	1.88 mm (.074")	1.75 mm (.069")
— stroboscopic timing	20° @ 6000 R.P.M.	18° @ 6000 R.P.M.	17° @ 6000 R.P.M.
<b>FUEL</b>			
Gas type	Regular leaded or unleaded		
Fuel tank capacity			
— SI	28.6 liters	28.6 liters	28.6 liters
— Imp.	6.3 gals	6.3 gals	6.3 gals
— U.S.	7.6 gals	7.6 gals	7.6 gals
Injection oil			
Type	Bombardier snowmobile injection oil		
Tank capacity			
— SI	2.6 liters	2.6 liters	2.6 liters
— Imp.	92 oz	92 oz	92 oz
— U.S.	88 oz	88 oz	88 oz
<b>BRAKE</b>			
Type	Disc, self-adjusting	Disc, self-adjusting	Disc self-adjusting
Lining minimum thickness	3 mm (1/8")	3 mm (1/8")	3 mm (1/8")
Control lever adjustment	13 mm (1/2") minimum distance from handlebar grip when fully applied.		

N.A.: Not applicable

Hal.: halogen

*Bombardier Inc. reserves the right to make changes in design and specifications and/or to make additions to, or improvements in its product without imposing any obligation upon itself to install them on its products previously manufactured.*

# WIRING DIAGRAM

## Safari 377, 447 & Mirage III

**WARNING:** Ensure all terminals are properly crimped on the wires and all connector housings are properly fastened.

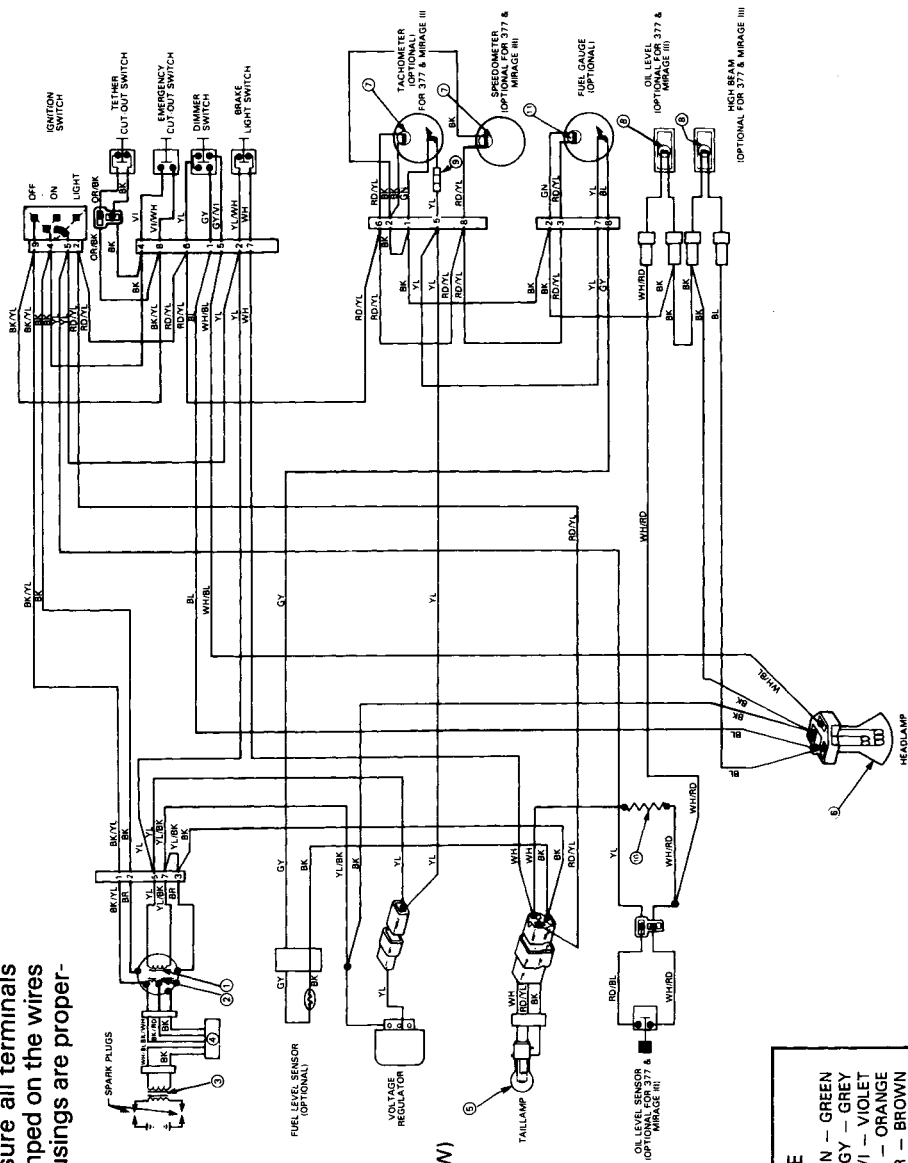

- ① LIGHTING COIL (160W)
- ② GENERATOR COIL
- ③ IGNITION COIL
- ④ AMPLIFIER
- ⑤ BULB 5-21W
- ⑥ BULB 60-60W
- ⑦ BULB 5W
- ⑧ LAMP 10W
- ⑨ FUSE 0.1 A
- ⑩ RESISTOR 30 Ω
- ⑪ BULB 2W

COLOUR CODE	
BK	— BLACK
WH	— WHITE
RD	— RED
BL	— BLUE
YL	— YELLOW
GN	— GREEN
GY	— GREY
VI	— VIOLET
OR	— ORANGE
BR	— BROWN

# WIRING DIAGRAM

## Safari 377E

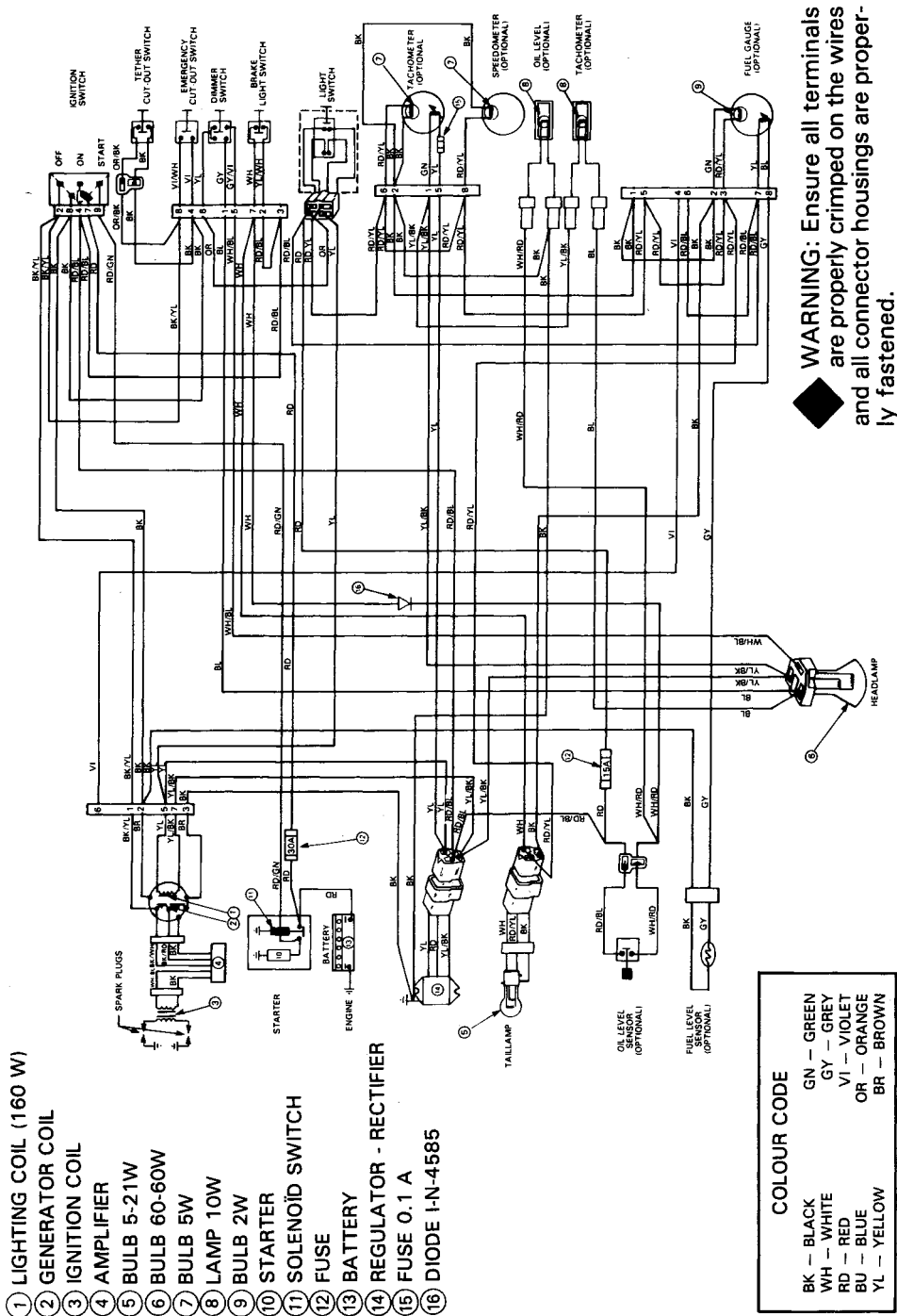

# WIRING DIAGRAM

## SAFARI Grand Luxe LC

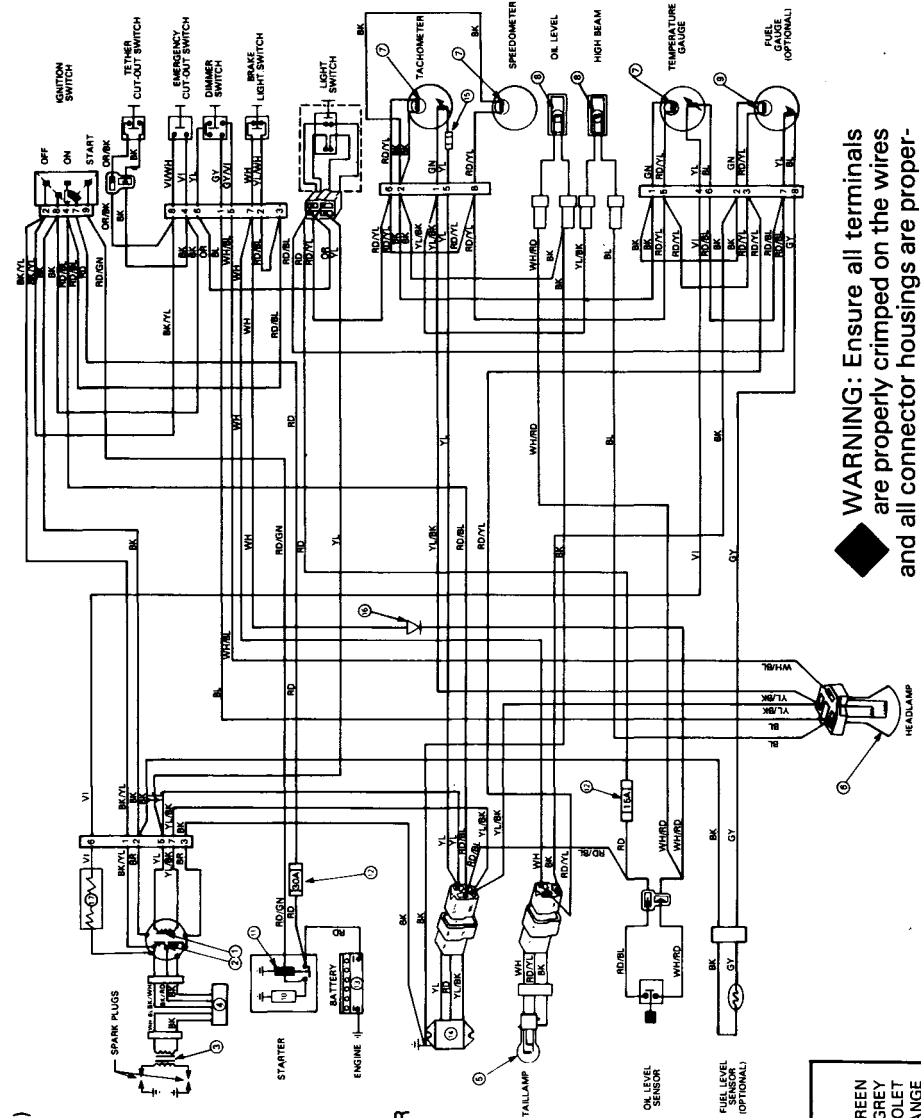

- 1 LIGHTING COIL (160 W)
- 2 GENERATOR COIL
- 3 IGNITION COIL
- 4 AMPLIFIER
- 5 BULB 5-21W
- 6 BULB 60-55W
- 7 BULB 5W
- 8 LAMP 10W
- 9 BULB 2W
- 10 STARTER
- 11 SOLENOID SWITCH
- 12 FUSE
- 13 BATTERY
- 14 REGULATOR - RECTIFIER
- 15 FUSE 0.1 A
- 16 DIODE I-N-4585
- 17 TEMPERATURE SENSOR

COLOUR CODE	
BK	BLACK
GN	GREEN
WH	WHITE
GY	GREY
RD	RED
VI	VIOLET
OR	ORANGE
BL	BLUE
YL	YELLOW
BR	BROWN

**WARNING:** Ensure all terminals are properly crimped on the wires and all connector housings are properly fastened.

# SI\* INFORMATION GUIDE

---

## BASE UNITS

DESCRIPTION	UNIT	SYMBOL
length	meter	m
mass	kilogram	kg
liquid	liter	L
temperature	celsius	°C
pressure	kilopascal	kPa
torque	Newton meter	N•m
speed	kilometer per hour	km/h

---

## PREFIXES

PREFIX	SYMBOL	MEANING	VALUE
kilo	k	one thousand	1,000
centi	c	one hundredth of a	0.01
milli	m	one thousandth of a	0.001

\*THE INTERNATIONAL SYSTEM OF UNITS (SYSTEME INTERNATIONALE) ABBREVIATES "SI" IN ALL LANGUAGES.

# NOTES

---



# CHANGE OF ADDRESS OR OWNERSHIP

Any change in address or ownership should be brought to the attention of the manufacturer by completing and sending out the card supplied below.

**NOTICE TO ALL NEW OWNERS:** Make sure to receive the warranty registration card from the previous owner, at the time the ownership is transferred. Also enclose a photocopy of this registration card when informing of a change of ownership.

## CHANGE OF ADDRESS

VEHICLE IDENTIFICATION NUMBER

--	--	--	--	--	--	--	--	--	--	--	--	--	--	--	--	--	--	--	--

OLD ADDRESS:

NAME \_\_\_\_\_

NO \_\_\_\_\_ STREET \_\_\_\_\_ APT. \_\_\_\_\_

CITY \_\_\_\_\_ STATE/PROVINCE \_\_\_\_\_ ZIP / POSTAL CODE \_\_\_\_\_

NEW ADDRESS:

NAME \_\_\_\_\_

NO \_\_\_\_\_ STREET \_\_\_\_\_ APT. \_\_\_\_\_

CITY \_\_\_\_\_ STATE/PROVINCE \_\_\_\_\_ ZIP / POSTAL CODE \_\_\_\_\_

## CHANGE OF OWNERSHIP

VEHICLE IDENTIFICATION NUMBER

--	--	--	--	--	--	--	--	--	--	--	--	--	--	--	--	--	--	--	--

The ownership of this vehicle is transferred

FROM:

NAME \_\_\_\_\_

NO \_\_\_\_\_ STREET \_\_\_\_\_ APT. \_\_\_\_\_

CITY \_\_\_\_\_ STATE/PROVINCE \_\_\_\_\_ ZIP / POSTAL CODE \_\_\_\_\_

TO:

NAME \_\_\_\_\_

NO \_\_\_\_\_ STREET \_\_\_\_\_ APT. \_\_\_\_\_

CITY \_\_\_\_\_ STATE/PROVINCE \_\_\_\_\_ ZIP / POSTAL CODE \_\_\_\_\_

---

**BOMBARDIER INC.**  
ATT.: WARRANTY DEPARTMENT  
VALCOURT, QUEBEC  
CANADA, JOE 2L0

---

**BOMBARDIER INC.**  
ATT.: WARRANTY DEPARTMENT  
VALCOURT, QUEBEC  
CANADA, JOE 2L0