

# ***Blizzard***<sup>®</sup> ***9700***

**1983  
OPERATOR'S  
MANUAL**



414 4806 03

model \_\_\_\_\_

V.I.N. \_\_\_\_\_

purchase date \_\_\_\_\_

warranty expiry date \_\_\_\_\_

To be completed by dealer at time of sale.

**DEALER IMPRINT AREA**

TECHNICAL PUBLICATIONS  
AFTER SALES SERVICE DEPARTMENT  
BOMBARDIER INC.  
VALCOURT, QUEBEC  
CANADA, J0E 2L0

The following are trademarks of Bombardier Inc.

|                    |           |             |
|--------------------|-----------|-------------|
| BOMBARDIER         | EVEREST   | MOTO-SKI    |
| SKI-DOO            | CITATION  | FUTURA      |
| ALPINE             | OLYMPIQUE | SPIRIT      |
| BLIZZARD           | T'NT      | NUVIK       |
| CARRY-BOOSE        | NORDIK    | MIRAGE      |
| ELAN               | SKANDIC   | SUPER SONIC |
| ELITE              |           | ULTRA SONIC |
| GRAND PRIX SPECIAL |           | SONIC       |

# FOREWORD

The Operator's Manual and the Snowmobile Safety Handbook have been prepared to acquaint the owner / operator of a new snowmobile with the various vehicle controls, maintenance and safe operating instructions. Each is indispensable for the proper use of the product, and should be kept with the vehicle at all times.

Should you have any questions pertaining to the warranty and its application, please consult the "Often Asked Question" section of this manual, or your selling dealer.

This manual uses the following symbols.

 **WARNING:** Identifies an instruction which, if not followed, could cause personal injury.

 **CAUTION:** Denotes an instruction which, if not followed, could severely damage vehicle components.

 **NOTE:** Indicates supplementary information needed to fully complete an instruction.

Although the mere reading of such information does not eliminate the hazard, your understanding of the information will promote its correct use.

Most specifications are given in both metric and customary units. Where precise accuracy is not required, some conversions are rounded to even numbers for easier use.

A shop manual can be obtained for complete service, maintenance and repair information.

# SAFETY IN MAINTENANCE

## Observe the following precautions:

- Throttle mechanism should be checked for free movement before starting engine.
  - The snowmobile engine can be stopped by activating the emergency cut-out or tether switches or turning off the key.
  - Clean and check operation of the headlight, tail light and brake light.
  - Engine should be running only when belt guard and/or pulley guard is secured in place.
  - Never run the engine without drive belt installed. Running an unloaded engine can prove to be dangerous.
  - Never run the engine when the track is raised off the ground.
  - It can be dangerous to run engine with the hood removed.
  - Gasoline is flammable and explosive under certain conditions. Always manipulate in a well ventilated area. Do not smoke or allow open flames or sparks in the vicinity. If gasoline fumes are noticed while driving, the cause should be determined and corrected without delay.
  - Maintain your vehicle in top mechanical condition at all times.
  - Your snowmobile is not designed to be driven or operated on black top, bare earth, or other abrasive surfaces. On such surfaces abnormal and excessive wear of critical parts is inevitable.
  - Your snowmobile is not designed to be operated on public streets, road or highways. In most States and Provinces, it is considered an illegal operation.
  - Installation of other than standard equipment, including ski-spreaders, bumpers, pack racks, etc., could severely affect the stability and safety of your vehicle. Avoid adding on accessories that alter the basic vehicle configuration.
  - Whenever the vehicle is parked outdoors, overnight or for a long period, it is suggested to protect it against the inclemency of the weather with a snowmobile cover.
  - Do not lubricate throttle and/or brake cables and housings.
  - Only perform procedures as detailed in this manual. Unless otherwise specified, engine should be turned OFF for all lubrication and maintenance procedures.
  - Since engine cooling is fully in effect only when the vehicle is in motion and driven on snow, it is not recommended that you allow the engine to idle for more than brief periods and/or you drive the vehicle on icy surface. Prolonged idling and/or continuous driving on ice may cause engine damage.
  - When removing coolant tank cap, first place a cloth over cap then turn cap to its first step to release pressure. Never drain or refill the cooling system when engine is hot.
  - This vehicle is designed for the driver only. No provisions have been made for a passenger.
- 
- PLEASE READ AND UNDERSTAND ALL WARNINGS AND CAUTIONS IN THIS MANUAL AND ON THE VEHICLE.
- 
-  **WARNING:** Should removal of a nylon lock nut be required when undergoing repairs/disassembly, always replace by new ones. Tighten as specified in the applicable Shop Manual.

**THIS MANUAL SHOULD REMAIN WITH THE VEHICLE AT THE TIME OF RESALE.**

# INDEX

|  |           |
|--|-----------|
| <b>THE 1983 "LIMITED WARRANTY</b> .....  | <b>4</b>  |
| <b>OFTEN ASKED QUESTIONS</b> .....   | <b>6</b>  |
| <b>LISTING OF AREA DISTRIBUTORS</b> .....  | <b>8</b>  |
| <b>HOW TO IDENTIFY YOUR SNOWMOBILE</b> .....   | <b>9</b>  |
| <b>CONTROLS/INSTRUMENTS</b>  |           |
| Throttle lever, brake lever, ignition/light switch, headlamp dimmer switch, emergency cut-out switch, tether cut-out switch, rewind starter handle, primer, adjustable steering handle, speedometer, tachometer, temperature gauge, high beam indicator, fuel gauge, fuel tank cap, hood opening, tool bag, fuse holder .....  | <b>10</b> |
| <b>BREAK-IN PERIOD</b>   |           |
| Break-in, 10 hour-inspection, inspection check list .....  | <b>13</b> |
| <b>FUEL</b>  |           |
| Recommended gasoline, recommended oil .....  | <b>15</b> |
| <b>PRE-START CHECK</b>   |           |
| Check points .....   | <b>16</b> |
| <b>STARTING PROCEDURE</b>  |           |
| Manual starting, before riding, emergency starting .....   | <b>17</b> |
| <b>LUBRICATION</b>   |           |
| Frequency, steering mechanism, drive axle, slide suspension, chaincase oil level, rotary valve system .....  | <b>18</b> |
| <b>MAINTENANCE</b>   |           |
| Chart, belt guard removal, drive belt removal, drive belt condition, new drive belt, brake condition, brake adjustment, spark plugs, suspension condition, suspension adjustment, track condition, track tension and alignment, drive pulley, steering mechanism, steering adjustment, muffler attachment, engine head nuts, engine mount nuts, carburetors adjustment, cooling system, headlamp beam aiming, bulb replacement, general inspection ..... | <b>20</b> |
| <b>STORAGE</b>   |           |
| Track, suspension, skis, controls, chaincase, drive pulley, engine and primer lubrication, fuel tank & carburetors, cooling system, chassis, general inspection .....  | <b>28</b> |
| <b>PRE-SEASON PREPARATION</b>  |           |
| Pre-season preparation chart .....   | <b>32</b> |
| <b>TROUBLE SHOOTING</b> .....  | <b>33</b> |
| <b>TOOLS</b> .....   | <b>35</b> |
| <b>SPECIFICATIONS</b> .....  | <b>36</b> |
| <b>WIRING DIAGRAM</b> .....  | <b>38</b> |
| <b>SI METRIC INFORMATION GUIDE</b> .....   | <b>39</b> |
| <b>CHANGE OF ADDRESS OR OWNERSHIP</b> .....  | <b>41</b> |

# THE 1983 "LIMITED WARRANTY"

## 1 - PERIOD

BOMBARDIER® INC. as manufacturer, warrants FROM THE DATE OF FIRST CONSUMER SALES, every 1983 SKI-DOO® / MOTO-SKI® snowmobile, sold as NEW AND UNUSED, by an authorized SKI-DOO or MOTO-SKI dealer respectively, for a period of:

- 12 consecutive months.

## 2 - WHAT BOMBARDIER WILL DO

BOMBARDIER will repair and/or replace, at its option, components defective in material and/or workmanship (under normal use and service,) with a genuine BOMBARDIER component without charge for parts or labour, at any authorized SKI-DOO or MOTO-SKI dealer during said warranty period.

## 3 - CONDITION TO HAVE WARRANTY WORK PERFORMED

Present to the servicing dealer, the hard copy of the BOMBARDIER Customer Registration card received by the customer from the selling dealer at time of purchase.

## 4 - WARRANTY TRANSFER

This warranty is transferable to subsequent owner(s) for remainder of warranty period from original date of sale.

## 5 - EXCLUSIONS - ARE NOT WARRANTED

- Normal wear on all items such as, but not limited to:
  - drive belts
  - slider shoes
  - spark plugs
  - bulbs
  - runners on skis
- Replacement parts and/or accessories which are not genuine BOMBARDIER parts and/or accessories.
- Damage resulting from installation of parts other than genuine BOMBARDIER parts.
- Damage caused by failure to provide proper maintenance as detailed in the Operator Manual. The labour, parts and lubricants costs of all maintenance services, including tune-ups and adjustments will be charged to the owner.
- Wet cells battery.
- Vehicles designed and/or used for racing purposes.
- All optional accessories installed on the vehicle.  
(The normal warranty policy for parts and accessories, if any, applies).
- Damage resulting from accident, fire or other casualty, misuse, abuse or neglect.
- Damage resulting from operation of the snowmobile on surfaces other than snow.
- Damage resulting from modification to the snowmobile not approved in writing by BOMBARDIER.
- Losses incurred by the snowmobile owner other than parts and labour, such as, but not limited to, transportation, towing, telephone calls, taxis, or any other incidental or consequential damages.

## **6 - BATTERY WARRANTY:**

- 12 consecutive months. (Pro-rated.)

100% warranty coverage will start on the date the snowmobile was purchased and run to the following April 30th. The remainder of the 12 months period will be pro-rated as follows:

- 50% from April 30th to December 1st.
- 40% from December 1st to December 31st.
- 30% from January 1st to end of warranty.

**Some states or provinces do not allow the exclusion or limitation of incidental or consequential damages, so the above limitation or exclusion may not apply.**

## **7 - EXPRESSED OR IMPLIED WARRANTIES**

**This warranty gives you specific rights, and you may also have other legal rights which may vary from state to state, or province to province. Where applicable this warranty is expressly in lieu of all other expressed or implied warranties of BOMBARDIER, its distributors and the selling dealer, including any warranty of merchantability of fitness for any particular purpose; otherwise the implied warranty is limited to the duration of this warranty. However, some states or provinces do not allow limitations on how long an implied warranty lasts, so the above limitation may not apply.**

**Neither the distributor, the selling dealer, nor any other person has been authorized to make any affirmation, representation or warranty other than those contained in this warranty, and if made, such affirmation, representation or warranty shall not be enforceable against BOMBARDIER or any other person.**

**BOMBARDIER INC. reserves the right to modify its warranty policy at any time, being understood that such modification will not alter the warranty conditions applicable to vehicles sold while the above warranty is in effect.**

## **8 - CONSUMER ASSISTANCE**

If a servicing problem or other difficulty occurs, we suggest the following:

1. Try to resolve the problem at the dealership with the Service Manager or Owner.
2. If this fails, contact your area distributor listed in the Operator Manual.
3. Then if your grievance still remains unsolved, you may write to us:

Bombardier Inc.  
Service Department  
Recreational Products Division  
Valcourt, Quebec, Canada, JOE 2LO

April 1982  
Bombardier Inc.  
Valcourt, Quebec, Canada, JOE 2LO

© \*Trademarks of Bombardier Inc.

## OFTEN ASKED QUESTIONS

Q: Why must my snowmobile be registered? After all I do have my original invoice as proof of when I purchased my snowmobile.

*A: Your warranty is valid at any authorized dealer of the product. Your registration is the key element in providing the servicing dealer with the necessary data to complete warranty claim forms. This information is also used to notify owners in the event of a safety recall.*

Q: I bought my snowmobile in O'King County but I snowmobile in Washington County. Can the dealer in Washington County accept to perform warranty work on my snowmobile?

*A: Yes, any authorized dealer in North America can perform warranty repairs, providing the customer warranty registration card is presented.*

Q: Where can I find information on the lubrication and maintenance of my snowmobile?

*A: In this Operator Manual provided with the vehicle at the time of first sale.*

Q: Will the entire warranty be void or cancelled, if I do not operate or maintain my new snowmobile exactly as specified in the Operator's Manual?

*A: The warranty of the new snowmobile cannot be "Voided" or "Cancelled". However, if a particular failure is caused by operation or maintenance other than is shown in the Operator Manual, THAT failure may not be covered under warranty. This includes service work performed by the customer, especially the critical adjustments to ignition, timing, carburation and oil injection/or oil mixture.*

Q: Would you give some examples of abnormal use or strain, neglect or abuse?

*A: These terms are general and overlap each other in areas. Some specific examples may include: running the machine out of oil, chain failure caused by a lack of lubrication, operating the machine with a broken or damaged part which causes another part to fail, and so on. If you have any specific questions on operation or maintenance, please contact your dealer for advice.*



Q: What costs are my responsibility during the warranty period?

*A: The customer's responsibility includes all costs of normal maintenance services, non-warranty repairs, accidents and collision damage, as well as oils, and spark plugs, and incidental or consequential damages costs as explained in the warranty.*

Q: Are "Genuine" Bombardier replacement parts used in warranty repairs covered by warranty?

*A: Yes. When installed by an authorized dealer, any "genuine" Bombardier part used in warranty repairs assumes the remaining warranty that exists on the machine.*

Q: If I sell my snowmobile within the warranty period, will the new owner qualify for the balance of the warranty?

*A: Yes, provided the unit has already been registered with the manufacturer. Note that the change of ownership card in this manual should be completed and sent to Bombardier Inc.*

Q: How can I receive the best owner assistance?

*A: The satisfaction and goodwill of the owners of Bombardier products are of primary concern to your dealer and Bombardier Inc. Normally, any problems that arise in connection with the sales transaction or the operation of your snowmobile will be handled by your Dealers Sales or Service Departments. It is recognized, however, that despite the best intentions of everyone concerned, misunderstandings will sometimes occur. If you have a problem that has not been handled to your satisfaction through normal channels, we suggest that you discuss your problem with a member of dealership management. Frequently, complaints are the result of a breakdown in communications and can quickly be resolved by a member of the dealership management. If the problem already has been reviewed with the Sales Manager or Service Manager, contact the Dealer himself or the General Manager.*

# LISTING OF AREA DISTRIBUTORS

## CANADIAN DISTRIBUTORS

### Ski-Doo & Moto-Ski

BROOKS EQUIPMENT LIMITED  
1616 King, Edward Street  
P.O. Box 985  
Winnipeg, Manitoba, R3C 2V8  
(204) 633-7247  
**British Columbia**

BOMBARDIER INC.  
EASTERN CANADA DISTRIBUTION DIVISION  
Atlantic Branch  
P.O. Box 670  
Shediac, New Brunswick, E0A 3G0  
(506) 386-6117  
**Magdalen Island, Nova Scotia, New Brunswick, Prince Edward Island**

BOMBARDIER INC.  
EASTERN CANADA DISTRIBUTION DIVISION  
(Quebec Branch)  
1350 Nobel Boulevard  
Boucherville, Quebec, J4B 1A1  
(514) 527-2469 or 655-6121  
**Province of Quebec**

BOMBARDIER INC.  
EASTERN CANADA DISTRIBUTION DIVISION  
Ontario Branch  
230 Bayview Drive  
Barrie, Ontario, L4N 4Y8  
(705) 728-8600  
**Province of Ontario**

TRACT EQUIPMENT  
14325 - 114th Avenue  
Edmonton, Alberta, T5M 2Y8  
(403) 452-9910  
**Alberta, District of Mackenzie N.W.T., Yukon**

### Ski-Doo only

BROOKS EQUIPMENT LIMITED  
1616 King, Edward Street  
P.O. Box 985  
Winnipeg, Manitoba, R3C 2V8  
(204) 633-7247  
**Manitoba, Saskatchewan**

HUDSON'S BAY CO. LTD.  
165 Hymus Blvd  
Pointe-Claire, Québec, H9R 1G2  
(514) 697-8500  
**North-West Territories, Franklin District & Keewatin**

J. W. RANDALL LIMITED  
West Street  
C.P. 1050  
Corner Brook, Newfoundland, A2H 6G7  
(709) 634-3533  
**Newfoundland, Labrador**

### Moto-Ski only

CONSOLIDATED TURF (1965) EQUIP. LTD  
972 Powell Avenue  
Winnipeg, Manitoba, R3H 0H6  
(204) 633-7276  
**Manitoba, Saskatchewan and a few countries in Ontario**

EQUIPEMENTS ARNAUD LIMITÉE  
469 Arnaud Avenue  
Sept-Îles, Quebec, G4R 3B3  
(418) 962-5545  
**Labrador City, Wabush, Sept-Îles**

CHARLES R. BELL LIMITED  
P.O. Box 8127  
81 Kenmount Road  
St-John's, Newfoundland, A1B 3N1  
(709) 722-6700  
**Newfoundland and territory of Labrador (excluding Labrador City and Wabush)**

## AMERICAN DISTRIBUTORS

### Ski-Doo & Moto-Ski

BOMBARDIER CORPORATION  
**All States (excluding Alaska)**

FIELD OFFICES  
- East Main Street Road  
Malone, New York 12953  
(518) 483-4411

- 4505 West Superior Street  
P.O. Box 6106  
Duluth, Minnesota 55806  
(218) 628-2881

- P.O. Box 1569  
Idaho Falls, Idaho, 83401  
(208) 529-9510

MILLER EQUIPMENT AND RECREATIONAL CENTER  
1049 Whitney Road  
Anchorage, Alaska 99501  
(907) 274-9513  
**Alaska**

# HOW TO IDENTIFY YOUR SNOWMOBILE

The main components of your snowmobile (engine, track and frame) are identified by different serial numbers. It may sometimes become necessary to locate these numbers for warranty purposes or to trace your snowmobile in the event of theft.

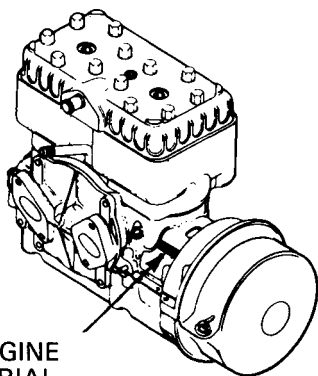

ENGINE  
SERIAL  
NUMBER

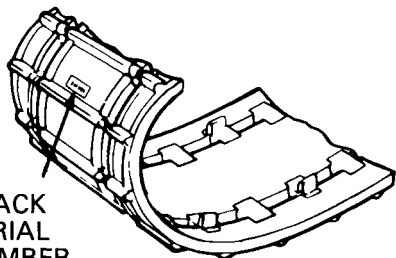

TRACK  
SERIAL  
NUMBER

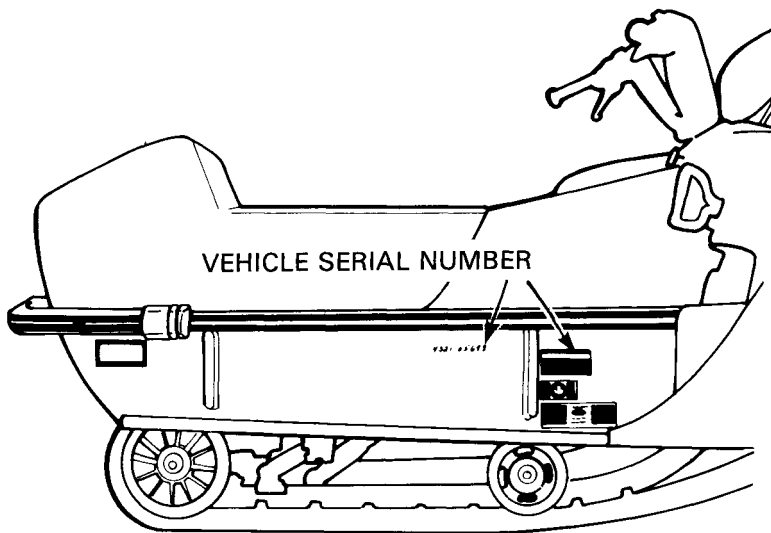

VEHICLE SERIAL NUMBER

○ **NOTE:** We strongly recommend that you take note of all the serial numbers on your vehicle and supply them to your insurance company. It will surely help in the event a snowmobile is stolen.

# CONTROLS INSTRUMENTS

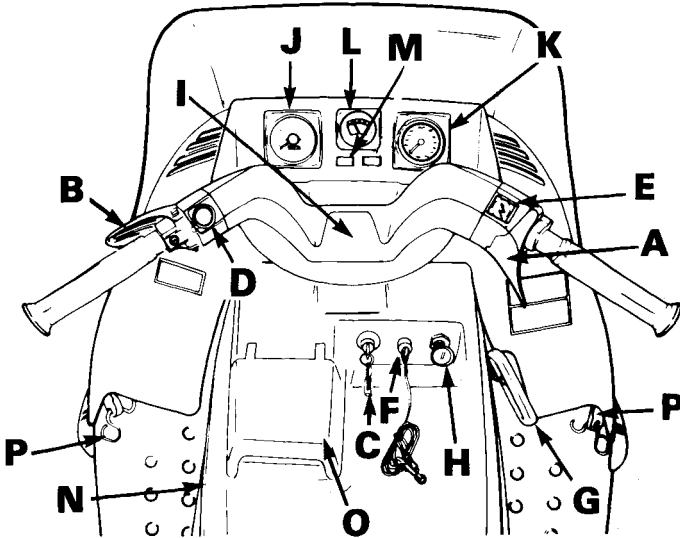

- A) Throttle lever
- B) Brake lever
- C) Ignition/light switch
- D) Headlamp dimmer switch
- E) Emergency cut-out switch
- F) Tether cut-out switch
- G) Rewind starter handle
- H) Primer

- I) Adjustable steering handle
- J) Speedometer
- K) Tachometer
- L) Temperature gauge
- M) High beam indicator
- N) Fuel gauge
- O) Fuel tank cap
- P) Hood opening

## A) Throttle Lever

Located on right side of handlebar. When compressed, it controls the engine speed and the engagement of the transmission. When released, engine speed returns automatically to idle.

## B) Brake Lever

Located on the left side of handlebar. When compressed, the brake is applied. When released, it automatically returns to its original position. Braking effect is proportionate to the pressure applied on the lever and to the type of terrain and its snow coverage.

## C) Ignition/Light Switch

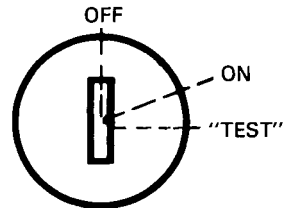

Key operated, 3 position switch. To start engine, first turn key clockwise to ON position. To stop engine, turn key counter-clockwise to OFF position.

The lights are automatically ON whenever the engine is running.

## D) Headlamp Dimmer Switch

The dimmer switch, located on left side of handlebar, allows correct selection of headlamp beam. To obtain high or low beam simply flick the switch.

## E) Emergency Cut-Out Switch

A push pull type switch located on the right side of the handlebar. To stop the engine in an emergency, push the button to the lower off position and simultaneously apply the brakes. To start engine, button must be at the upper on position.

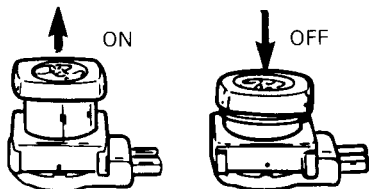

Upper position  
before starting

Lower position  
to stop engine

The driver of this vehicle should familiarize himself with the function of this device by using it several times on first outing. Thereby being mentally prepared for emergency situations requiring its use.

◆ **WARNING:** If the switch has been used in an emergency situation the source of malfunction should be determined and corrected before restarting engine.

## F) Tether Cut-Out Switch

A pull switch located below the handlebar. Attach tether cord to wrist or other convenient location then snap tether cut-out cap over receptacle before starting engine.

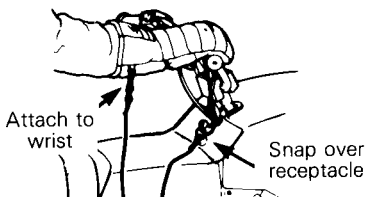

If emergency engine "shut off" is required completely pull cap from safety switch and engine power will be automatically shut "off".

○ **NOTE:** The cap must be installed on the safety switch at all times in order to operate the vehicle.

◆ **WARNING:** If the switch is used in an emergency situation the source of malfunction should be determined and corrected before restarting engine.

## G) Rewind Starter Handle

Auto rewind type located on right hand side of vehicle. To engage mechanism, pull handle.

## H) Primer

A push-pull button located below handlebar. Pull and push button (2-3 times) to activate primer. The primer should always be used for cold engine starts. After engine is warm however, it is not necessary to use primer when starting.

## I) Adjustable steering handle

- Remove steering pad.
- Loosen the four (4) retaining screws.
- Adjust the handle to the desired position.

◆ **WARNING:** Do not adjust too high as the brake lever may contact the windshield when turning.

- Lock the steering handle in place by tightening the four (4) retaining screws to 26 N•m (19 ft-lbs).
- Reinstall steering pad.

## J) Speedometer

The speedometer is linked directly to the drive axle. Direct-reading dial indicates the speed of the vehicle. Odometer records the total distance travelled in kilometers.

## K) Tachometer

The tachometer registers the impulses of magneto. Direct-reading dial indicates the number of revolutions per minute (RPM) of the engine.

**CAUTION:** The tachometer is protected by a fuse, if tachometer stops operating check fuse condition and if necessary replace. The fuse is 0.1 amp. Do not use a higher rated fuse as this can cause severe damage to the tachometer.

## L) Temperature Gauge

The gauge indicates engine coolant temperature. Normal operating temperature is 50°C (120°F). However, coolant temperature can vary depending on driving condition. If coolant temperature exceeds 95°C (200°F) reduce speed and run vehicle in loose snow or stop engine immediately.

**WARNING:** To remove coolant tank cap, place a cloth over the cap and unscrew it to the first step to release the pressure. If this notice is disregarded loss of fluid and possible severe burns could occur.

## M) High Beam Indicator

Lights up when headlamp is on high beam.

## N) Fuel Gauge

The fuel gauge is located on the left side of the fuel tank. The gauge function on the principle of communicating vessels, so the fuel level inside the tank is directly related with the level indicated on the gauge.

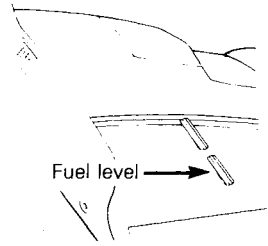

**WARNING:** Never use a lite match or open flame to check fuel level.

## O) Fuel Tank Cap

Accessible under fuel tank cover. Lift cover, unscrew cap. Plastic retainer will stop cap from falling.

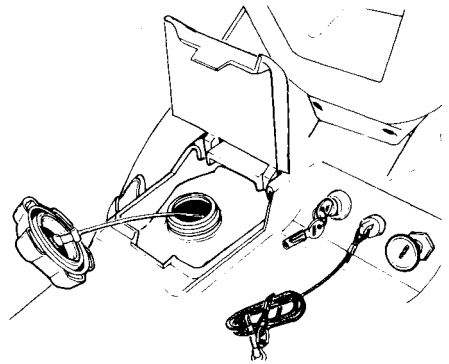

## P) Hood Opening

Pull down the latch to unhook the hood from the anchor.

**NOTE:** Always lift hood gently up until stopped by restraining device.

**WARNING:** It is dangerous to run an engine with the hood open or removed. Personal injury could result.

**CAUTION:** Prior to re-securing the hood latch, position the bottom edge of the hood into the hood guide located on each side of the frame.

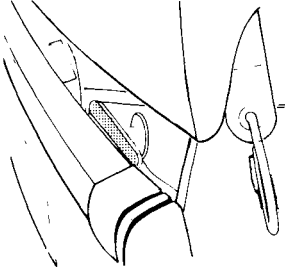

## Tool Bag

Located under the hood on top of belt guard. To gain access, tilt hood. Ideal location for spare plugs, rope, first aid kit, flashlight, etc.

## Fuse Holder

The tachometer is protected with a 0.1 ampere rated fuse. Fuse holder is located under the hood behind the tachometer. If it stops operating, check fuse condition and replace if necessary.

# BREAK-IN PERIOD

## Break-in

With Bombardier-Rotax snowmobile engines, a break-in period is required before running the vehicle at full throttle. Engine's manufacturer recommendation is 10 to 15 operating hours. During this period, maximum throttle should not exceed  $3/4$ , however, brief full acceleration and speed variations contribute to a good break-in. Continued wide open throttle accelerations, prolonged cruising speeds, and lugging are detrimental during the break-in period.

**CAUTION:** Remove and clean spark plugs after engine break-in.

**NOTE:** A new drive belt requires a break-in period of 15-25 km (10-15 miles).

## 10-Hour Inspection

As with any precision piece of mechanical equipment, we suggest that after the first 10 hours of operation or 30 days after the purchase, whichever comes first, your vehicle be checked by your dealer. This inspection will give you the opportunity to discuss the unanswered questions you may have encountered during the first hours of operation. Remember that it is easier to remedy at this time than to allow the snowmobile to operate until a possible failure occurs.

---

**The 10 hours inspection is at the expense of the vehicle owner.**

---

| <b>10-HOUR INSPECTION CHECK LIST</b>   |  |
|--|--|
| Engine head nuts   |  |
| Engine mount nuts  |  |
| Muffler attachment   |  |
| Spark plugs condition  |  |
| Carburetors adjustment   |  |
| Engine timing  |  |
| Pulley alignment and drive belt condition  |  |
| Chaincase and rotary valve oil levels  |  |
| Engine coolant level   |  |
| Brake operation and lining condition   |  |
| Ski alignment (runners condition)  |  |
| Steering arm, retorque to 42 N•m (31 ft-lbs)   |  |
| Handlebar bolts, retorque to 26 N•m (19 ft-lbs)  |  |
| Suspension and steering condition and lubrication  |  |
| Track condition, tension and alignment   |  |
| Electrical wiring (loose connections, stripped wires, damaged insulation), tighten all loose bolts, nuts and linkage                 |  |
| Operation of lighting system (HI / LO beam, brake light, etc.), test operation of emergency cut-out switch and tether cut-out switch |  |

**We recommend that you have your dealer sign this inspection .**

\_\_\_\_\_  
Date of 10 hour inspection

\_\_\_\_\_  
Dealer signature



# FUEL

Oil must be added to the gasoline in pre-measured amounts then both oil and gasoline should be thoroughly mixed together before fueling the tank.

## Recommended Gasoline

Use premium leaded or unleaded gasoline (octane number of 92 or higher).

**CAUTION:** Never experiment with different fuel or fuel ratios. Never use naphtha, methanol or similar products.

**WARNING:** Never "top up" the gas tank before placing the vehicle in a warm area. At certain temperatures, gasoline will expand and overflow. Always wipe off any gasoline spillage from the snowmobile.

## Recommended Oil

Use "Bombardier Snowmobile Injection Oil" (P/N 496 0133 00 - 1 liter) available from your dealer. This type of oil will flow at temperatures as low as minus 40°C (-40°F).

It is a blend of specially selected base oils and additives which provides outstanding lubrication, engine cleanliness and minimum spark plug fouling.

If "Bombardier Snowmobile Injection Oil" is unavailable, substitute with "Bombardier 50:1 Snowmobile Oil".

**CAUTION:** Never use outboard or straight mineral oils.

## Fuel Mixture Ratio

The importance of using the correct fuel mixture cannot be overstressed. An incorrect fuel ratio results in serious engine damage. Recommended fuel ratio is 30/1.

## SI UNITS

500 ml oil to 15 liters = 30/1

## IMPERIAL UNITS

16 oz. oil to 3 Imp. gals = 30/1

or

500 ml oil to 3.3 Imp. gals = 30/1

## U.S. UNITS

13 oz. oil to 3 U.S. gals = 30/1

**NOTE:** To facilitate fuel mixing, oil should be kept at room temperature.

## Fuel Mixing Procedure

To mix the gasoline and oil always use a separate clean container. Never mix directly in your snowmobile tank. For best results, acquire two containers, either plastic or metal. Draw from one until empty then use the second one.

**WARNING:** Gasoline is flammable and explosive under certain conditions. Always manipulate in a well ventilated area. Do not smoke or allow open flames or sparks in the vicinity. If gasoline fumes are noticed while driving, the cause should be determined and corrected without delay. Never add fuel while the engine is running. Avoid skin contact with fuel at below freezing temperatures.

1. Pour approximately 4 liters (1 gallon) of gasoline into a clean container.

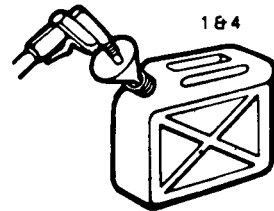

2. Add the full amount of oil required.

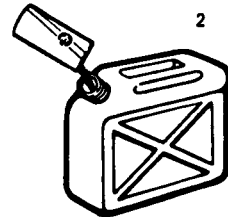

3. Replace the container cap and shake the container thoroughly.

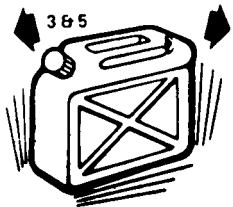

4. Add the remainder of the gasoline.

5. Once again thoroughly agitate the container. Then using a funnel with a FINE MESH SCREEN to prevent the entry of foreign particles, pour the mixture into the snowmobile tank.

◆ **WARNING:** To prevent fuel spillage, a funnel must always be used when filling the gas tank.

○ **NOTE:** When using pre-mixed fuel, always shake the container thoroughly as the oil has a tendency to settle.

## PRE-START CHECK

### Check Points

- **ACTIVATE THE THROTTLE CONTROL LEVER SEVERAL TIMES** to check that it operates easily and smoothly. The throttle control lever must return to idle position when released.
- Check that the skis and the track are not frozen to the ground or snow surface and that steering operates freely.
- Activate the brake control lever and make sure the brake fully applies before the brake control lever touches the handlebar grip.
- Check coolant level. Liquid should be 19-25 mm (3/4-1 in.) below filler neck. If additional coolant is necessary or if entire system has to be refilled, use a solution of 3 parts of anti-freeze for 2 parts of water (60% anti-freeze, 40% water). See cooling system in storage.

○ **NOTE:** Always use ethylene-glycol anti-freeze containing corrosion inhibitors specifically recommended for aluminium engines.

◆ **WARNING:** Before removing the radiator pressure cap place a cloth over the cap and unscrew it to the first step to release the pressure. Never drain or refill the cooling system when engine is hot. Loss of fluid and possibility of severe burns could occur, if this notice is disregarded.

- Check fuel level.
- Verify that the path ahead of the vehicle is clear of bystanders and obstacles.

◆ **WARNING:** Only start your snowmobile once all components are checked and functioning properly.

# STARTING PROCEDURE

Test throttle control lever.

Check that the emergency cut-out switch is in the ON position.

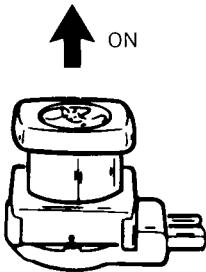

Upper position  
before starting engine

Ensure the tether cut-out cap is in position and that the cord is attached to your clothing.

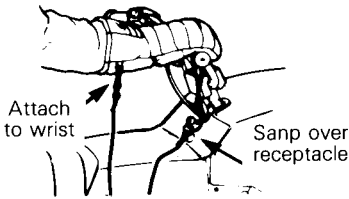

Activate the primer (2 or 3 times).

○ **NOTE:** Primer is not necessary when the engine is warm.

## Manual Starting

Insert the key in the ignition and turn to ON position.

Grasp manual starter handle firmly and pull slowly until a resistance is felt then pull vigorously. Slowly release the rewind starter handle.

◆ **WARNING:** Do not apply throttle while starting.

Should the rewind starter rope fray and break, the engine can be started with an emergency starter rope.

## Before riding

Check operation of the emergency cut-out switch, and tether switch. Restart engine.

◆ **WARNING:** If engine does not shut-off when applying the emergency cut-out switch and or when pulling the tether cut-out cap, stop the engine by turning off the ignition key. Do not operate the vehicle further, see your dealer.

Allow the engine to warm before operating at full throttle.

## Emergency Starting

◆ **WARNING:** Do not start the vehicle by the drive pulley unless it is a true emergency situation, have the vehicle repaired as soon as possible.

Attach emergency rope to starter grip. Remove the belt guard from the vehicle and wind the emergency rope tight around the drive pulley between the sliding half and the roller guard. Start the engine as per usual manual starting.

◆ **WARNING:** When starting the vehicle in an emergency situation by the drive pulley, do not make a knot at the end of the emergency rope and do not reinstall the belt guard.

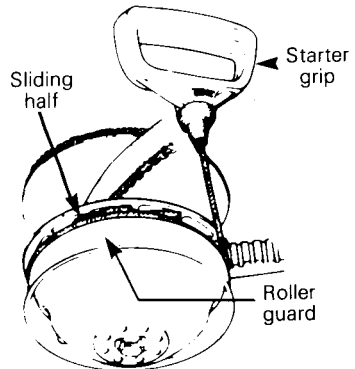

# LUBRICATION

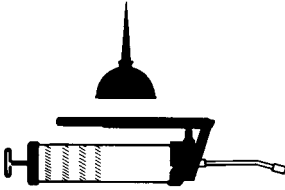

## Frequency

Routine maintenance is necessary for all mechanized products, and the snowmobile is no exception. A weekly vehicle inspection contributes to the life span of the snowmobile as well as retains safe and dependable operation. It is recommended that the steering system and suspension be lubricated monthly or every 40 hours of operation. If the vehicle is operated in wet snow or in severe conditions these items should be lubricated more frequently.

◆ **WARNING:** Only perform such procedures as detailed in this manual. It is recommended that dealer assistance be periodically obtained on other components/systems not covered in this manual. Unless otherwise specified, engine should be turned OFF for all lubrication and maintenance procedures.

## Steering Mechanism

◆ **WARNING:** Do not lubricate throttle and/or brake cables and housings.

Lubricate the ski legs at grease fittings until new grease appears at joints.

Coat spring slider cushions with grease.

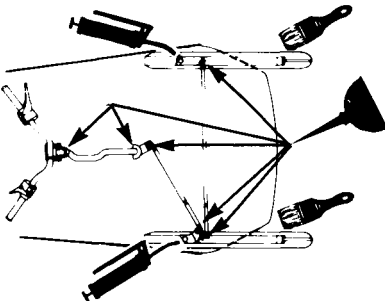

Oil spring coupler bolts, ball joints and steering column bushings.

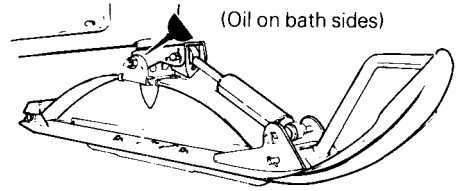

## Drive Axle

Lubricate at grease fitting using low temperature grease.

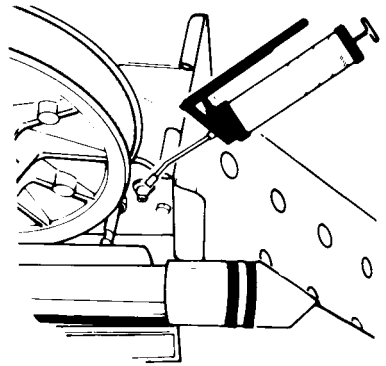

▲ **CAUTION:** When lubricating the drive axle bearing, do not apply excessive grease as the seal will be pushed out of its housing. Check seal position with finger.

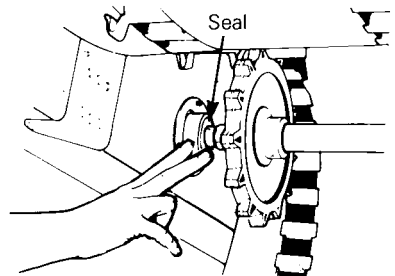

## Slide Suspension

Grease front idler wheels at grease fittings.

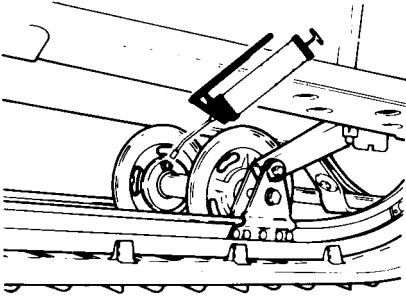

## Chaincase Oil Level

Check the oil level by removing the oil level cap plug.

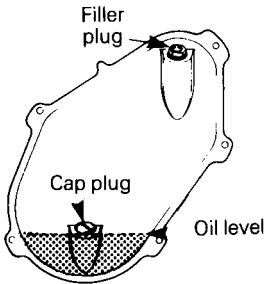

The oil should be level with the bottom of the oil level orifice.

○ **NOTE:** The chaincase oil capacity is approximately 200 mL (7 oz.).

## Rotary Valve System

Check reservoir oil level frequently. Level should be between level lines of plastic reservoir. If necessary replenish to maximum oil level line using Bombardier snowmobile injection oil available from your dealer.

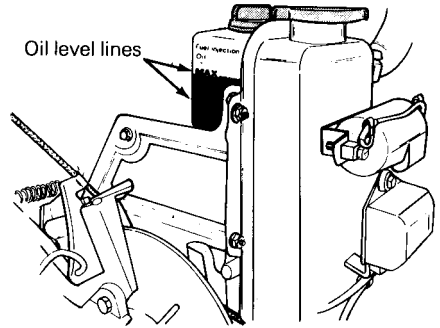

# MAINTENANCE

The following Maintenance Chart indicates regular servicing schedules to be performed by you or your servicing dealer. If these services are performed as suggested, your snowmobile will give you many years of low-cost use.

**WARNING:** Only perform such procedures as detailed in this manual. It is recommended that dealer assistance be periodically obtained on other components/systems not covered in this manual. Unless otherwise specified, engine should be turned OFF for all lubrication and maintenance procedures.

| <b>SERVICE AND MAINTENANCE CHART</b> | Weekly or every 240 km (150 m) | Monthly or every 800 km (500 m) | Once a year or every 3200 km (2000 m) | Refer to page |
|--------------------------------------|--------------------------------|---------------------------------|---------------------------------------|---------------|
| Drive belt condition                 | ●                              |                                 |                                       | 21            |
| Brake condition                      | ●                              |                                 |                                       | 22            |
| Brake adjustment                     |                                | ●                               |                                       | 22            |
| Spark plugs                          |                                | ●                               |                                       | 22            |
| Suspension condition                 |                                | ●                               |                                       | 23            |
| Suspension adjustment                | (as required)                  |                                 |                                       | 23            |
| Track condition                      |                                | ●                               |                                       | 23            |
| Track tension and alignment          |                                | ●                               |                                       | 23            |
| Drive pulley                         |                                | ●                               |                                       | 24            |
| Steering mechanism                   |                                | ●                               |                                       | 25            |
| Steering adjustment                  |                                | ●                               |                                       | 25            |
| Muffler attachment                   |                                | ●                               |                                       | 26            |
| Engine head nuts                     |                                |                                 | ●                                     | 26            |
| Engine mount nuts                    |                                |                                 | ●                                     | 26            |
| Carburetors adjustment               |                                |                                 | ●                                     | 26            |
| Cooling system                       |                                |                                 | ●                                     | 27            |
| Headlamp beam aiming                 |                                |                                 | ●                                     | 27            |
| General inspection                   |                                | ●                               |                                       | 28            |

**NOTE:** The ten hour inspection is a very important part of proper service and maintenance.

## Belt Guard Removal

◆ **WARNING:** Engine should be running only when belt guard is secured in place.

1. Tilt the hood, remove both belt guard retaining clips (A).
2. Pull out both retaining pins (B):

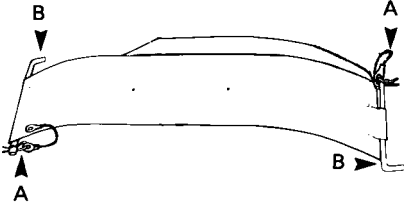

◆ **WARNING:** At the removal or installation of the belt guard front retaining pin be careful not to burn yourself on the exhaust system.

3. Lift and remove the belt guard assembly.

## Drive Belt Removal

◆ **WARNING:** Never start or run engine without the drive belt installed. Running an unloaded engine is dangerous.

1. Tilt the hood and remove the belt guard.
2. Open the driven pulley by twisting and pushing the sliding half. Hold in fully open position.

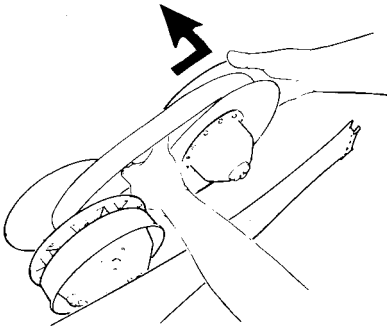

3. Slip the belt over the top edge of the fixed half.

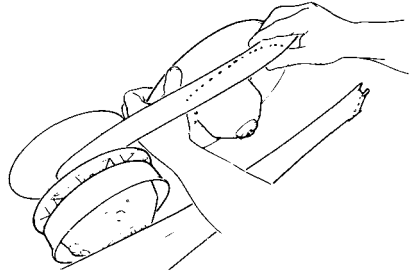

4. Slip the belt out from the drive pulley and remove completely from the vehicle. To install the drive belt, reverse the procedure.

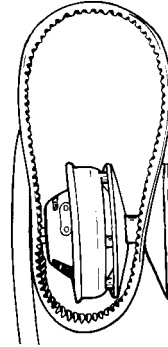

## Drive Belt Condition

Inspect belt for cracks, fraying or abnormal wear (uneven wear, wear on one side, missing cogs, cracked fabric). If abnormal wear is noted, probable cause could be pulley misalignment, excessive R.P.M. with frozen track, fast starts without warm-up period, burred sheave, oil on belt or distorted spare belt. Contact your dealer.

Check the drive belt width. If less than 32 mm (1 1/4 in), replace the drive belt.

## New Drive Belt

When installing a new drive belt, break-in period of 25 km (15 miles) is strongly recommended.

○ **NOTE:** Always store a spare belt in a manner to allow its natural shape to be maintained.

## Brake Condition

The brake mechanism on your snowmobile is an essential safety device. Keep this mechanism in proper working condition. Above all, do not operate your snowmobile without an effective brake system.

◆ **WARNING:** Brake pads less than 3 mm (1/8") thick must be replaced. Replacement must be performed by an authorized dealer.

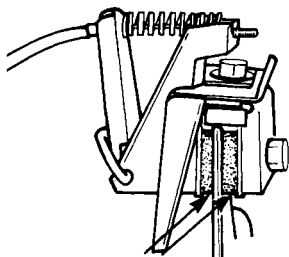

Brake pads  
3 mm (1/8") MINIMUM  
thickness

## Brake Adjustment

The brake mechanism is a self-adjusting type. If a quicker brake response is desired, strongly pull the brake lever several times, this will actuate the self adjusting mechanism.

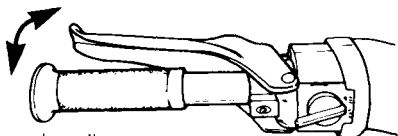

Strongly pull

After the adjustment, brake should apply fully when lever is approximately 13 mm (1/2") from handlebar grip. If not, do not tamper with the brake, contact your servicing dealer.

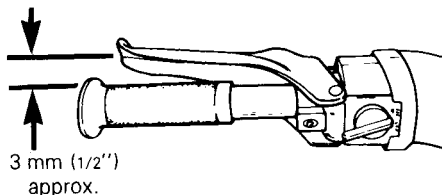

## Spark Plugs

Disconnect the spark plug wires and remove the spark plugs.

Check the condition of the plugs.

- A brownish tip reflects ideal conditions. (Carburetor adjustments, spark plug heat range, etc.; are correct).
- A black insulator tip indicates fouling caused by: carburetor idle speed mixture too rich, incorrect fuel mixture ratio, wrong type of spark plug (heat range), or excessive idling.
- A light grey insulator tip indicates a lean mixture caused by; carburetor high speed mixture adjusted too lean, wrong spark plug heat range, incorrect fuel mixture ratio, or a leaking seal or gasket.

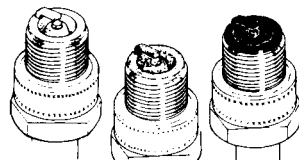

Overheated  
(light grey)

Normal  
(brownish)

Fouled  
(black)

▼ **CAUTION:** If spark plug condition is not ideal, contact your authorized dealer.

Check spark plug gap using a wire feeler gauge.

Reinstall plugs and connect wires.



## Suspension Condition

Visually inspect all suspension components including slider shoes, springs, wheels, etc...

○ **NOTE:** During normal driving, snow will act as a lubricant and coolant for the slider shoes. Extensive riding on ice or sanded snow will create excessive heat build-up and cause premature slider shoe wear.

## Suspension Adjustment

The suspension is adjustable. The front adjustment for surface condition, the rear for driver's weight. Use the special key located in tool box.

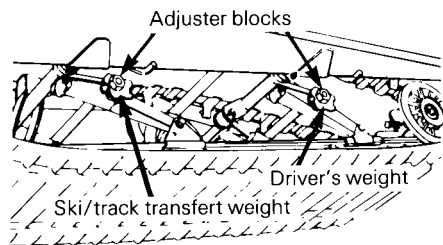

When the front adjuster blocks are at the lowest elevation more weight is distributed on the skis.

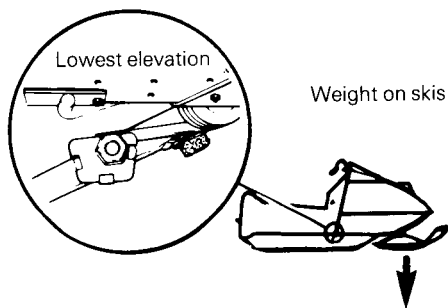

At the highest position the weight is transferred from the skis to the track. The rear adjuster blocks should be adjusted to suit the driver's preference.

○ **NOTE:** For deep snow condition or hill climbing, it is recommended to place the front adjuster blocks on the highest position.

▼ **CAUTION:** Always turn the left side adjuster blocks in a clockwise direction, the right side blocks in a counter-clockwise direction. Left and right adjuster blocks of each adjustment must always be set at the same elevation.

## Track Condition

Lift the rear of the vehicle and support it off the ground. With the engine off, rotate the track by hand, and inspect condition. If worn or cut, or if track fibers are exposed, or if missing or defective inserts or guides are noted; contact your dealer.

◆ **WARNING:** Do not operate a snowmobile with a cut, torn or damaged track.

## Track Tension and Alignment

### Tension:

Lift the rear of vehicle and support with a mechanical stand. Allow the slide to extend normally. The gap should be between 9.5 mm (3/8") and 13 mm (1/2") between the slider shoe and the bottom inside of the track when a weight of 2.95 kg (6.5 lbs) is applied on track. If the track tension is too loose, the track will have a tendency to thump.

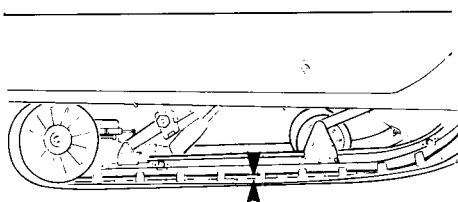

9.5 mm to 13 mm (3/8 to 1/2")

▼ **CAUTION:** Too much tension will result in power loss and excessive stresses on suspension components.

If necessary to adjust; loosen the rear idler wheel retaining screw and the adjuster bolt lock nut; then loosen or tighten the adjuster bolts located on the inner side of the rear idler wheels. If correct tension is unattainable, contact your dealer.

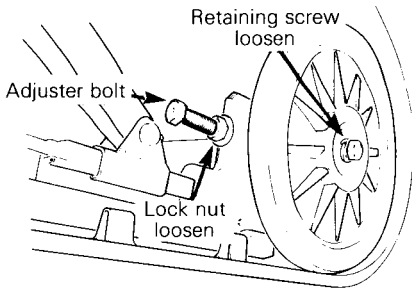

○ **NOTE:** Track tension and alignment are inter-related. Do not adjust one without the other.

**Alignment**

Start the engine and accelerate slightly so that track turns **slowly**. Check that the track is well centered; equal distance on both sides between edges of track guides and slider shoes.

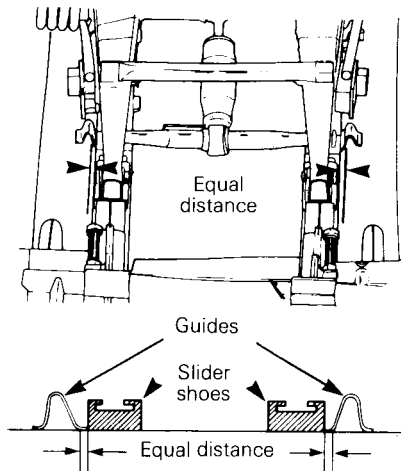

◆ **WARNING:** Before checking track alignment, ensure that the track is free of all particles which could be thrown out while track is rotating.

**Keep hands, tools, feet and clothing clear of track. Ensure no-one is standing in close proximity to the vehicle.**

To correct, stop the engine loosen the rear idler wheels retaining screws then loosen the lock nuts and tighten the adjuster bolt on side where the slider shoe is the furthest to the track insert guides.

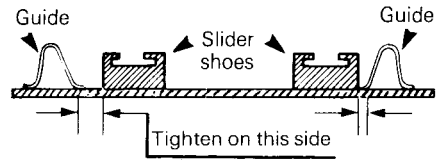

Tighten lock nuts and recheck the alignment. Ensure to retighten the idler wheel retaining screws.

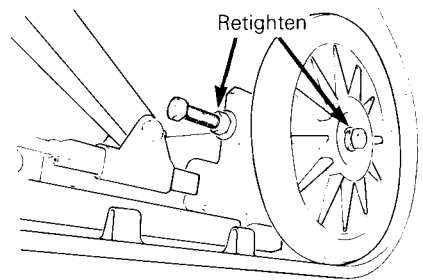

**Drive Pulley**

Inspect the Duralon bushing condition by checking the free-play of the sliding half pulley. This is achieved by restraining the inner half and checking if the sliding half moves in the direction of the arrows more than 3 mm (1/8"). If so, contact your dealer.

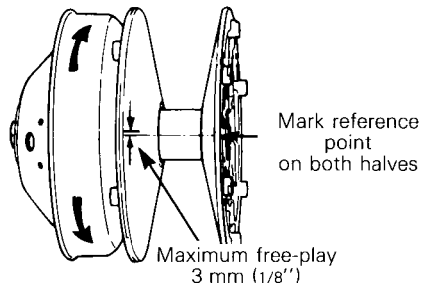

## Steering Mechanism

Inspect the steering mechanism for tightness of components (steering arms, tie rods, ball joints, spring coupler bolts, etc.). If necessary, replace or re-tighten.

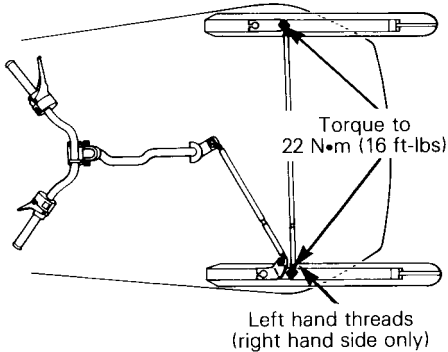

**CAUTION:** Do not overtighten the left hand threaded ball joint jam nut.

**WARNING:** The ball joint socket must run parallel with the steering arm. The socket must be restrained when tightening the tie rod end lock nuts.

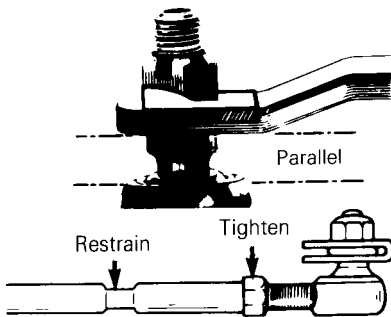

Check the condition of the skis and the ski runners. Replace if worn more than half.

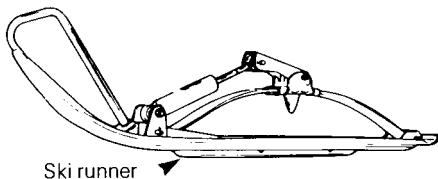

## Steering Adjustment

Skis should have a toe out of 3 mm (1/8"). To check, measure the distance between each ski at the front and rear of the leaf springs. The front distance should be 3 mm (1/8") more than the rear when the handlebar is horizontal.

**IMPORTANT:** Close the front of the skis manually to eliminate all slack from the steering mechanism.

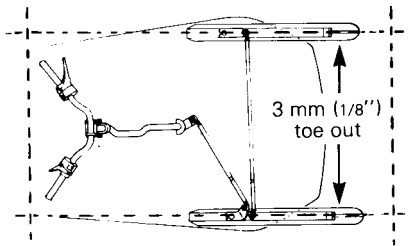

If adjustment is required:

Loosen the lock nuts of the longest tie rod. Turn the tie rod manually until the skis are properly aligned. Firmly re-tighten the lock nuts.

The handlebar should also be horizontal when the skis are pointed toward the front.

To adjust:

Loosen the lock nuts of the shortest tie rod. Turn the tie rod manually until the handlebar is horizontal. Retighten the lock nuts firmly.

## Muffler attachment

The engine/exhaust system parts are vital toward efficient muffler function. Check all attachments. Replace the springs and/or tighten if necessary.

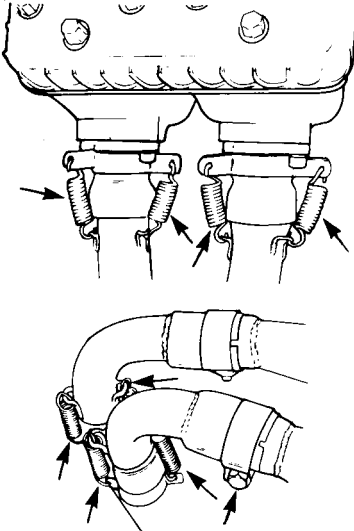

Check for tightness

**CAUTION:** Do not operate vehicle with muffler disconnected otherwise serious engine damage will occur.

## Engine Head Nuts

With the engine cold, check that the engine head nuts are tight and equally torqued to 22 N•m (16 ft-lbs). Follow the illustrated sequence.

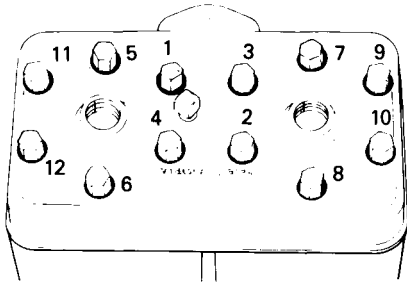

**IMPORTANT:** The engine head nut torque should be checked after the first 5 hours of operation.

## Engine Mount Nuts

Check the engine mount nuts for tightness. Retighten if necessary.

## Carburetors Adjustment

**CAUTION:** Never operate your snowmobile with the air intake silencer disconnected. Serious engine damage will occur if this notice is disregarded.

### A) Air Screw Adjustment

Completely close the air screw (until a slight reseating resistance is felt) then back off screw: 1 turn.

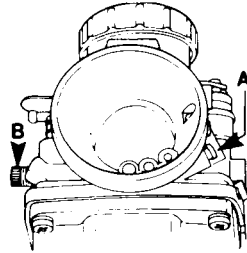

### B) Idle Speed Adjustment

Turn idle speed screw clockwise until it contacts the throttle slide then continue turning two (2) additional turns. This will provide a preliminary idle speed setting. Start engine and allow it to warm then adjust idle speed to 1800-2000 R.P.M. by turning idle speed screw clockwise or counter-clockwise.

**CAUTION:** Do not attempt to set the idle speed by using the air screw. Severe engine damage can occur. If idle speed is unattainable contact your authorized dealer.

## Cooling System

Check condition of hoses and clamps tightness. Using a hydrometer check that the anti-freeze solution is strong enough for the temperature in which the vehicle is operated.

**NOTE:** Should the coolant temperature raise above recommended range 50°-95°C (120°-200°F), hose off grime from the heat exchanger (underneath the frame above the track).

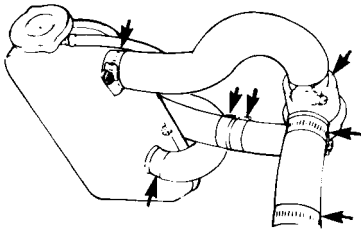

Check clamp tightness

## Headlamp Beam Aiming

The angle of the headlamp beam has been pre-adjusted prior to delivery. Should you wish re-adjustment, place the vehicle on a flat surface 7.6 m (25') from a wall or screen.

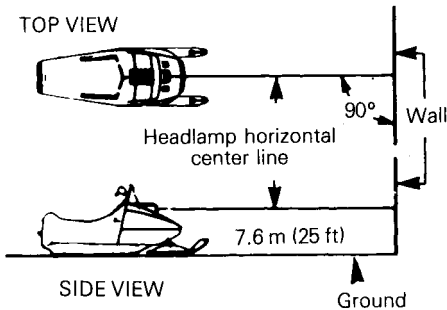

With the suspension correctly adjusted, the rider seated on the vehicle and the high beam ON check that the center of high intensity zone of high beam is 50 mm (2") below horizontal line of headlamp height.

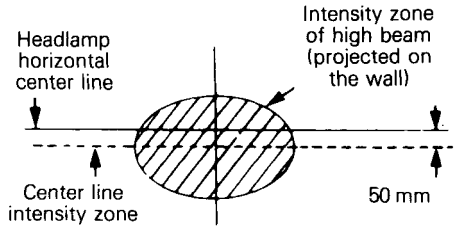

To adjust, remove headlamp ring, turn upper or lower adjusting screws to obtain desired beam position.

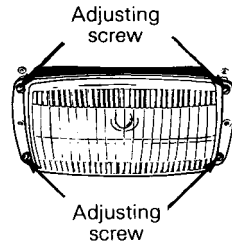

## Bulb Replacement

If the headlamp bulb is burnt, tilt hood, unplug the connector from the headlamp. Remove the rubber boot and unfasten bulb retainer clips. Detach the bulb and replace.

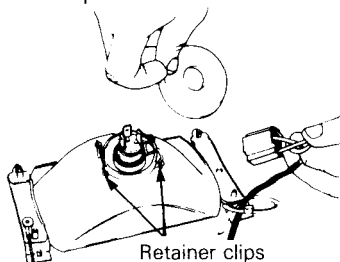

If taillight bulb is burnt, expose the bulb by removing the red plastic lens. To remove, unfasten the two (2) screws.

◆ **WARNING:** Always check light operation after bulb replacement.

## General Inspection

Check the electrical wiring and components, retighten loose connections. Check for stripped wires or damaged insulation. Thoroughly inspect the vehicle and tighten loose bolts, nuts and linkage. Inspect skis and ski runners for wear.

## STORAGE

**IMPORTANT:** It is during summer, or when a vehicle is not in use for any length of time that proper storage is a necessity. Storage of the snowmobile during long period of inactivity consists of checking and replacing missing, broken or worn parts: Proper lubrication and treatment to insure that parts do not become rusted; cleaning items such as carburetors of oil mixtures, to prevent gum varnish formation within the carburetors; and in general, preparing the vehicle so that when the time comes to use the snowmobile again it will be in top condition.

◆ **WARNING:** Only perform such procedures as detailed in this manual. It is recommended that dealer assistance be periodically obtained on other components/systems not covered in this manual. Unless otherwise specified, engine should be turned OFF for all lubrication and maintenance procedures.

### Track

Inspect the track for wear, cuts, missing track guides and broken rods. Make any necessary replacement.

◆ **WARNING:** Do not operate a snowmobile with a cut, torn or damage track.

Lift the rear of vehicle until track is clear of the ground then support with a brace or trestle. The snowmobile should be stored in such a way that the track does not stay in contact with the cement floor or bare ground.

○ **NOTE:** The track should be rotated periodically, (every 40 days). Do not release track tension.

▼ **CAUTION:** To prevent track damage, temperature in the storage area must not exceed 38°C (100°F).

### Slide Suspension

Remove any dirt or rust. Grease idler wheels at grease fittings. Wipe off surplus. Replace worn slider shoes.

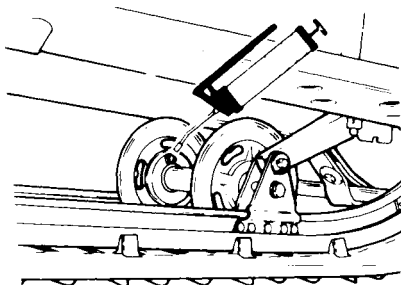

## Skis

Wash or brush all dirt or rust accumulation from the skis and springs. Grease the ski legs at the grease fittings. Check the condition of the skis, ski runners and leaf springs. Replace if weak or worn more than half.

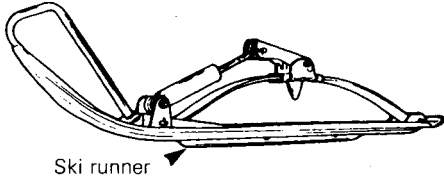

## Controls

Lubricate the steering mechanism. Inspect all components for tightness, (spring coupler bolts, steering arm locking bolts, tie rods, ball joints, etc.). Tighten if necessary. Oil moving joints of the brake mechanism.

**WARNING:** Do not lubricate the throttle and/or brake cables and housings. Avoid getting oil on the brake pads.

Coat all electrical connections and switches with a greaseless metal protector. If unavailable, use petroleum jelly.

## Chaincase

Drain the chaincase and refill to proper level, using fresh chaincase oil. To drain, remove the chaincase cover.

## Drive Pulley

Inspection and cleaning must be performed by the dealer at the end of each season.

## Engine and Primer Lubrication

Engine internal parts must be lubricated to protect cylinder walls from possible rust formation during the storage period.

To perform the storage procedures (engine and primer valve) proceed as follows:

## Engine

1. Start the engine and allow it to run at idle speed until the engine reaches its operational temperature.
2. Stop the engine, remove the air silencer box, start the engine.
3. Using Bombardier Snowmobile Injection Oil, squirt oil into the carburetors throat until the engine dies.
4. Remove the spark plug(s) and pour approximately 85 ml (3 fl. oz. Imp., 3 fl. oz. U.S.) of oil into the cylinders.
5. Crank the engine to allow the crankshaft to turn 2 or 3 revolutions.
6. Reinstall the spark plugs and the air intake silencer.

Do not run engine during storage period.

## Primer Valve

1. Disconnect the inlet primer hose from the primer valve.

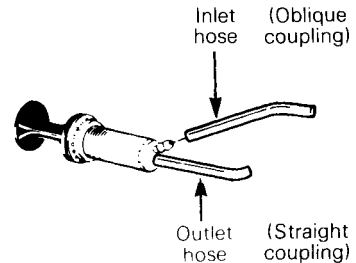

2. Hold the hose higher than the gas tank to prevent gasoline from draining.
3. Using an appropriate hose, connect one end of the hose to the inlet of the primer valve and place the other end in a Bombardier Snowmobile Injection Oil container.
4. Activate the primer in order to fill it with oil.
5. Reinstall the inlet primer hose to the primer valve.

## Fuel Tank and Carburetors

Remove the cap then using a syphon, remove the gasoline from tank.

▼ **WARNING:** Gasoline is flammable and explosive under certain conditions. Always manipulate in a well ventilated area. Do not smoke or allow open flames or sparks in the vicinity.

Carburetors must be dried out completely to prevent gum formation during the storage period.

Once the fuel tank is emptied, remove the float chamber drain plug on each carburetor. Drain carburetor.

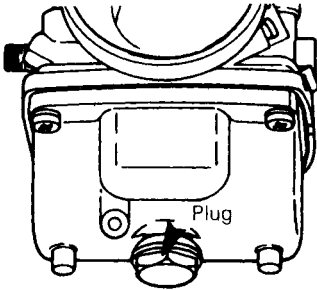

Reinstall plugs.

Check all fuel lines, replace if necessary.

## Cooling System

The engine cooling system should be drained and refilled with a new coolant mixture before each storage period.

◆ **WARNING:** Never drain or refill the cooling system when engine is hot.

To drain the cooling system, siphon the coolant mixture from the coolant tank, using a primer pump and a length of plastic hose and steel tubing inserted as deep as possible into the lower hose of the tank.

◆ **WARNING:** Use PRIMER PUMP to siphon the coolant mixture. Do not siphon with your mouth. The coolant mixture is poison and can be fatal if swallowed.

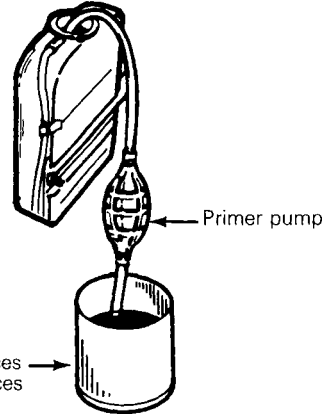

When the coolant level is low enough, remove the engine filler plug.

▼ **CAUTION:** To prevent rust formation in the cooling system, always replenish the system with the recommended solution (60% antifreeze 40% water).

○ **NOTE:** Always use ethylene-glycol anti-freeze containing corrosion inhibitors specifically recommended for aluminium engines.

To refill the cooling system:

- Remove engine filler plug.

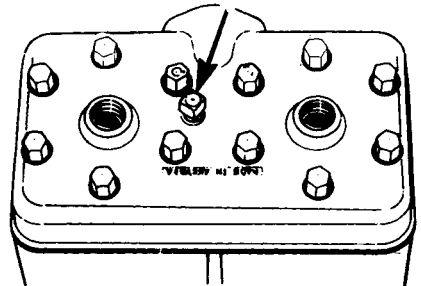



- Refill tank until coolant overfills at filler hole.
- Reinstall filler plug.

Continue to pour the liquid in the coolant tank until level reaches 2.5 mm (1") below filler neck.

Reinstall tank cap and start engine; let engine run until it reaches its operating temperature and thermostat opens. Allow it to run a few minutes more. Stop engine and check coolant level, refill as necessary.

**◆ WARNING:** Before removing the cap place a cloth over the coolant tank and release the cap to the first step to release the pressure. Loss of fluid and possibility of severe burns could occur, if this notice is disregarded.

## Chassis

Clean the vehicle thoroughly, removing all dirt and grease accumulation.

**▼ CAUTION:** Plastic alloy components such as fuel tank, windshield, controls, etc., can be cleaned using mild detergents or isopropyl alcohol. Do not use strong soaps, degreasing solvents, abrasive cleaners, paint thinners, etc.

Inspect the hood and repair any damage. Repair kits are available at your authorized dealer. Clean the frame. For the aluminum portion use only "Aluminum cleaner" and follow instructions on the container.

Touch up all metal spots where paint has been scratched off. Spray all bare metal parts with metal protector. Wax the hood for better protection.

**○ NOTE:** Apply wax on glossy finish of hood only. Protect the vehicle with a cover to prevent dust accumulation during storage.

**▼ CAUTION:** If for some reason the snowmobile has to be stored outside it is necessary to cover it with an opaque tarpaulin. This caution will prevent the sun rays and the grime from affecting the plastic components and the vehicle finish.

## General Inspection

Check the electrical wiring and components, retighten loose connections. Check for stripped wires or damaged insulation.

Thoroughly inspect the vehicle and tighten loose bolts, nuts and linkage.

**○ NOTE:** Leave the drive belt off the pulleys for the entire storage period.

# PRE-SEASON PREPARATION

To simplify the pre-season preparation we have drawn up a small chart. The chart indicates servicing points to be performed by you and your servicing dealer. If these services are performed as suggested, your vehicle will give you many hours of fun and low cost use.

**IMPORTANT:** Observe all Warnings and Cautions mentioned throughout this manual which are pertinent to the item being checked. When component conditions seem less than satisfactory, replace with genuine Bombardier parts or suitable equivalents.

| <b>PRE-SEASON PREPARATION CHART</b>                       | TO BE PERFORMED BY DEALER | ● |
|---|---------------------------|---|
|   | TO BE PERFORMED BY OWNER  | ○ |
| Change spark plugs*                                       |                           | ○ |
| Check chaincase and rotary valve oil levels               |                           | ○ |
| Replace fuel filter (filter is located inside fuel tank)  |                           | ○ |
| Refill gas tank   |                           | ○ |
| Check track condition, tension and alignment              |                           | ○ |
| Check and lubricate suspension                            |                           | ○ |
| Inspect drive belt and install                            |                           | ○ |
| Check throttle cable for damage and free operation        |                           | ○ |
| Check steering alignment and ski runners condition        |                           | ○ |
| Check electrical wiring (broken wire, damaged insulation) |                           | ○ |
| Inspect condition of starting rope                        |                           | ○ |
| Check tightness of all bolts, nuts and linkage            |                           | ○ |
| Check coolant condition and level                         |                           | ● |
| Inspect seals for possible cuts or leaks                  |                           | ● |
| Inspect brake condition and operation                     |                           | ● |
| Set engine timing   |                           | ● |
| Check pulleys, verify components and clean. Lubricate.    |                           | ● |
| Adjust carburetors  |                           | ● |

○ **NOTE:** Before installing new spark plugs, it is suggested to burn excess storage oil by starting the engine, using the old spark plugs. Only perform this operation in a well ventilated area.

# TROUBLE SHOOTING

○ **NOTE:** The possible causes have been listed in an order of frequency. Therefore, items should be checked out in the same order as mentioned in the trouble shooting guide.

| SYMPTOMS   | POSSIBLE CAUSES                        | WHAT TO DO  |
|--|--|---|
| Engine turns over but fails to start or starts with difficulty | 1. No fuel to the engine               | Check the tank level and fill it up. Check for possible clogging of fuel line, item 4.  |
|  | 2. Flooded engine                      | Remove wet spark plugs, turn ignition to OFF and crank engine several times. Install clean dry spark plugs. Start engine following usual starting procedure. If engine continues to flood, see your dealer.   |
|  | 3. Spark plug/ignition                 | Check for fouled or defective spark plug. Disconnect spark plug wire, unscrew plug and remove from cylinder head. Reconnect wire and ground exposed plug on engine cowl, <b>being careful to hold away from spark plug hole.</b> Follow engine starting procedure and check for spark. If no sparks appear, replace spark plug. If trouble persists, contact your dealer. |
|  | 4. Clogged fuel line (water or dirt)   | Remove and clean the fuel filter. Change filter cartridge if necessary. Check condition and connections of fuel lines. Check the cleanliness of fuel tank.  |
|  | 5. Incorrect carburetor adjustment     | Contact your dealer.  |
|  | 6. Incorrect injection pump adjustment | See your dealer.  |
|  | 7. Engine timing                       | Engine timing may be faulty or out of adjustment. Contact your dealer.  |
|  | 8. Poor engine compression             | Running with a lean fuel mixture may produce excessive engine wear resulting in poor engine compression. If this occurs, contact your dealer at once.   |
| Engine will not turn manually                                  | 1. Seized engine                       | In the case of a seized engine contact your dealer.   |

| <b>SYMPTOMS</b>                    | <b>POSSIBLE CAUSES</b>               | <b>WHAT TO DO</b>   |
|------------------------------------|--------------------------------------|---|
| Engine lacks acceleration or power | 1. Fouled or defective spark plug    | Check item 3 of "Engine turns over but fails to start or starts with difficulty"  |
|                                    | 2. Clogged fuel line (water or dirt) | Check fuel line condition. (See item 4 of "Engine turns over but fails to start or starts with difficulty").  |
|                                    | 3. Carburetor                        | Contact your dealer.  |
|                                    | 4. Ignition                          | First check item 2 and 3 of "Engine turns over but fails to start or starts with difficulty". If the ignition system still seems faulty, contact your dealer. |
|                                    | 5. Engine                            | If unable to locate specific symptoms, contact your dealer.   |
| Engine continually backfires       | 1. Spark plug                        | Check item 3 of "Engine turns over but fails to start or starts with difficulty".   |
|                                    | 2. Overheated                        | Coolant level too low. Refill. Carburetor too lean, see your dealer..   |
|                                    | 3. Engine timing incorrectly set     | Contact your dealer.  |
| Snowmobile cannot reach full speed | 1. Drive Belt                        | Check for damaged or worn drive belt. Replace if necessary.   |
|                                    | 2. Incorrect track adjustment        | Check track tension and alignment. Readjust to specifications. (See Maintenance Section).   |
|                                    | 3. Engine                            | Check item 1 to 5 of "Engine lacks acceleration or power."  |
|                                    | 4. Pulley misaligned                 | Contact your dealer.  |

# TOOLS

As standard equipment each new snowmobile is supplied with a basic tool kit such as screwdriver, wrenches, emergency starter rope, etc...

## Standard Tools

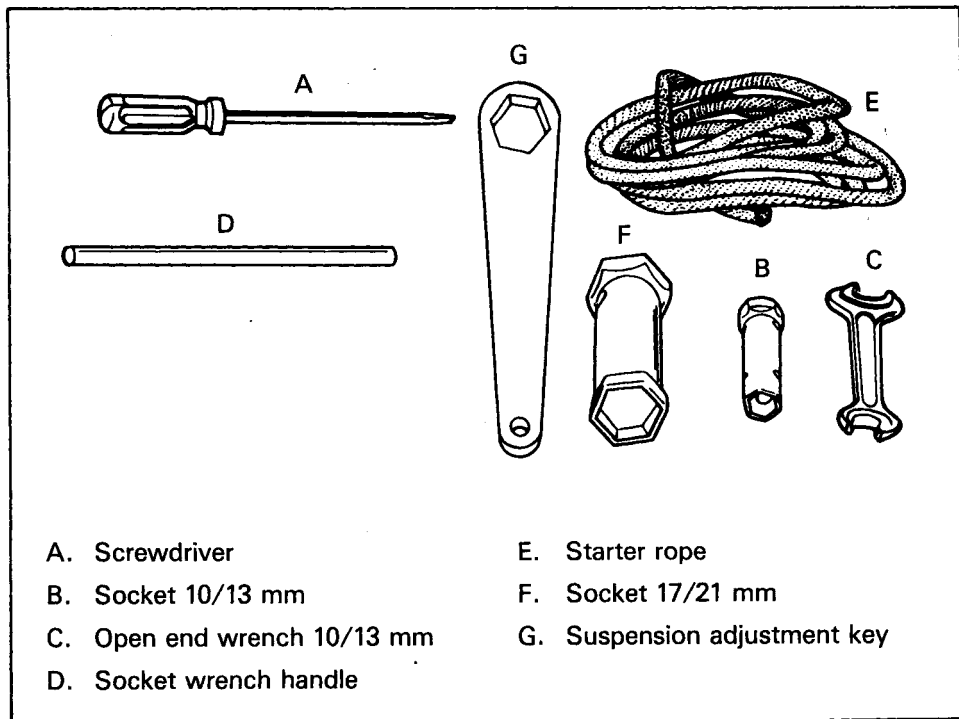

# SPECIFICATIONS

## ENGINE

|                                 |             |   |
|---------------------------------|-------------|---|
| Type                            |             | 534   |
| No. of cylinders                |             | 2   |
| Bore                            |             | 72 mm (2.834")                                |
| Stroke                          |             | 64 mm (2.519")                                |
| Displacement                    |             | 521.2 cm <sup>3</sup> (31.8 in <sup>3</sup> ) |
| Compression ratio (corrected)   |             | 6.5   |
| Maximum R.P.M.                  |             | 8750  |
| Carburetor type                 |             | 2 X Mikuni VM 40                              |
| Carburetor adjustment:          |             |   |
| — air screw                     |             | 1 turn out                                    |
| — idle speed                    |             | 1800-2000 R.P.M.                              |
| Rotary valve oil reservoir      | — SI        | 450 ml  |
|                                 | — Imp./U.S. | 16 ounces app.                                |
| Cooling system capacity         | — SI        | 4.2 liters                                    |
|                                 | — Imp.      | 148 ounces                                    |
|                                 | — U.S.      | 142 ounces                                    |
| Antifreeze/water mixture        |             | 60/40   |
| Thermostat                      |             | 50°C (122°F)                                  |
| Radiator pressure cap           |             | 13 lbs  |
| Torque:                         |             |   |
| — engine head nuts              |             | M8: 22 N•m (16 ft-lbs)                        |
| — crankcase nuts                |             | M8: 22 N•m (16 ft-lbs)                        |
|                                 |             | M6: 9 N•m (6 ft-lbs)                          |
| — magneto ring nut              |             | M22: 95 N•m (70 ft-lbs)                       |
| — crankcase engine support nuts |             | M10: 38 N•m (28 ft-lbs)                       |
| — exhaust manifold bolts        |             | M8: 22 N•m (16 ft-lbs)                        |

## CHASSIS

|                               |  |  |
|-------------------------------|--|--|
| Overall length                |  | 264 cm (104")                                |
| Overall width                 |  | 100 cm (39.5")                               |
| Overall height                |  | 96.5 cm (38")                                |
| Ski stance (center to center) |  | 85.1 cm (33.5")                              |
| Ski alignment (toe out)       |  | 3 mm (1/8")                                  |
| Torque:                       |  |  |
| — steering arm/ski leg bolt   |  | 43 N•m (32 ft-lbs)                           |
| — steering column/handlebar   |  | 26 N•m (19 ft-lbs)                           |
| Weight                        |  | 223 kg (492 lbs)                             |
| Bearing area                  |  | 7239 cm <sup>2</sup> (1122 in <sup>2</sup> ) |
| Ground pressure               |  | 3.02 kPa (.438 lbs/in <sup>2</sup> )         |

|                          |   |
|--------------------------|---|
| <b>POWER TRAIN</b>       |   |
| Track:                   |   |
| — width                  | 41.9 cm (16 1/2")   |
| — length                 | 289.6 cm (114")   |
| — tension                | 13 mm (1/2") gap between slide shoe and bottom inside of track.       |
| — alignment              | Equal distance between edges of track guides and slider shoes.        |
| Standard gear ratio      | 21/38   |
| Drive belt:              |   |
| — number                 | 414 5059 00   |
| — Max. width             | 35 mm (1 3/8")  |
| — Min. width             | 32 mm (1 1/4")  |
| Chaincase oil            | 200 mL (7 oz)   |
| <b>ELECTRICAL</b>        |   |
| Lighting system (output) | 12 V. 160 watts   |
| Bulb:                    |   |
| — headlamp               | 60/60 W   |
| — tail/stop              | 5/21 W  |
| — speedometer            | 5W  |
| — tachometer             | 5W  |
| Fuse:                    |   |
| — tachometer             | 0.1 A   |
| Spark plug               |   |
| — type                   | NGK BR-8ES  |
| — gap                    | 0.4 mm (0.016")   |
| Ignition timing:         |   |
| — timing mark (B.T.D.C.) | 1.75 mm (.069") direct (17°)  |
| — stroboscopic timing    | 6000 R.P.M.   |
| <b>FUEL</b>              |   |
| Gas type                 | Premium leaded or unleaded (92 octane min.)                           |
| Fuel tank capacity       |   |
| — SI                     | 27 liters   |
| — Imp.                   | 6 gals  |
| — U.S.                   | 7.2 gals  |
| Recommended oil          | Bombardier snowmobile injection oil                                   |
| Fuel mixture ratio       | 30:1  |
| <b>BRAKE</b>             |   |
| Type                     | Disc, self adjusting  |
| Lining minimum thickness | 3 mm (1/8")   |
| Control lever adjustment | 13 mm (1/2") minimum distance from handlebar grip when fully applied. |

*Bombardier Inc. reserves the right to make changes in design and specifications and/or to make additions to, or improvements in its product without imposing any obligation upon itself to install them on its products previously manufactured.*

# WIRING DIAGRAM

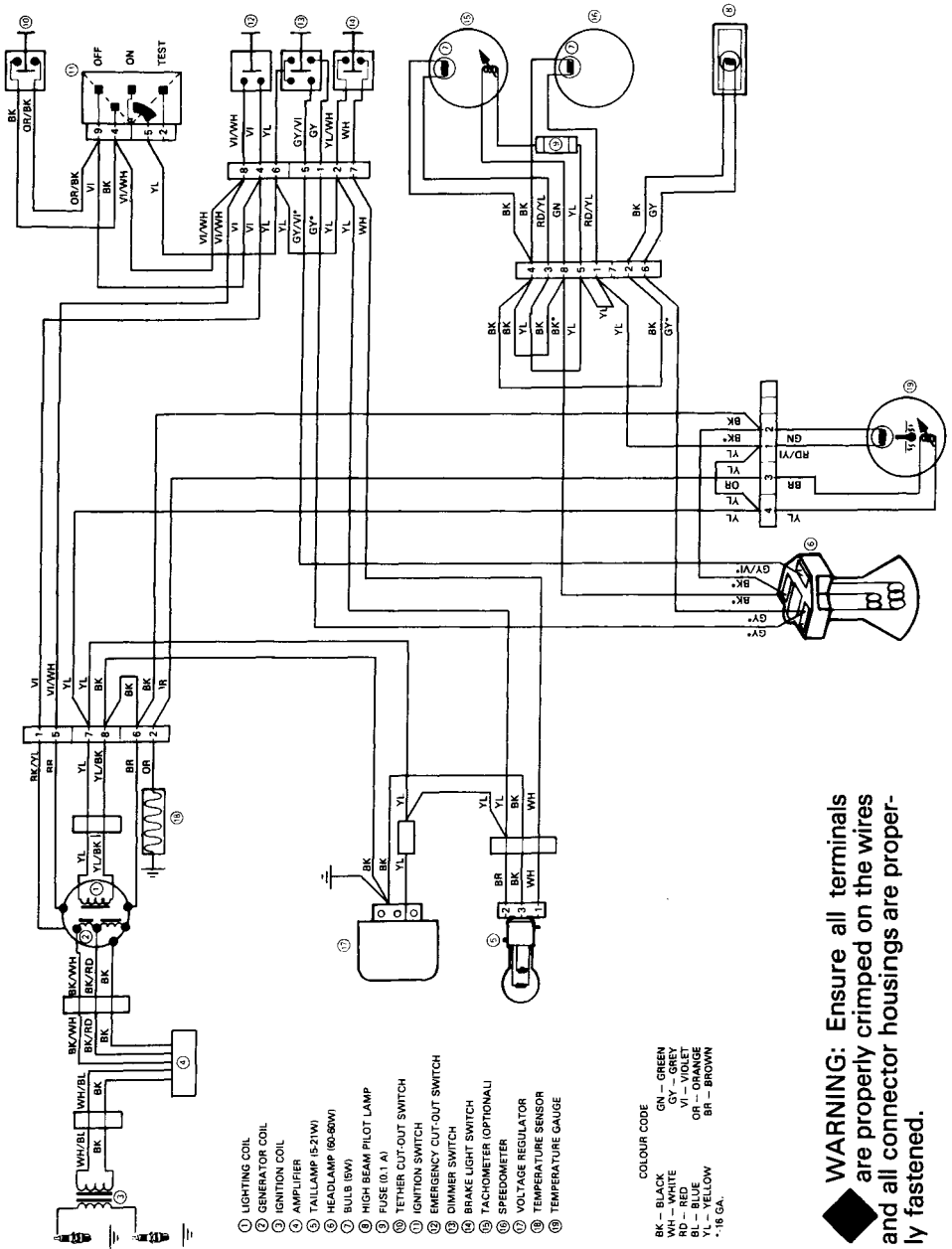

**WARNING:** Ensure all terminals are properly crimped on the wires and all connector housings are properly fastened.



# SI\* METRIC INFORMATION GUIDE

## BASE UNITS

| DESCRIPTION | UNIT               | SYMBOL |
|-------------|--------------------|--------|
| length      | meter              | m      |
| mass        | kilogram           | kg     |
| liquid      | liter              | L      |
| temperature | celsius            | °C     |
| pressure    | kilopascal         | kPa    |
| torque      | Newton meter       | N•m    |
| speed       | kilometer per hour | km/h   |

---

## PREFIXES

| PREFIX | SYMBOL | MEANING             | VALUE |
|--------|--------|---------------------|-------|
| kilo   | k      | one thousand        | 1,000 |
| centi  | c      | one hundredth of a  | 0.01  |
| milli  | m      | one thousandth of a | 0.001 |

\*THE INTERNATIONAL SYSTEM OF UNITS (SYSTEME INTERNATIONAL) ABBREVIATES "SI" IN ALL LANGUAGES.



# CHANGE OF ADDRESS AND OWNERSHIP

Any change in address or ownership should be brought to the attention of the manufacturer by completing and sending out the card supplied below.

NOTICE TO ALL NEW OWNERS: Make sure to receive the warranty registration card from the previous owner, at the time the ownership is transferred. Also enclose a photocopy of this registration card when informing of a change of ownership.

## CHANGE OF ADDRESS



VEHICLE IDENTIFICATION NUMBER

|  |  |  |  |  |  |  |  |  |  |  |  |  |  |  |  |  |  |  |  |
|--|--|--|--|--|--|--|--|--|--|--|--|--|--|--|--|--|--|--|--|
|  |  |  |  |  |  |  |  |  |  |  |  |  |  |  |  |  |  |  |  |
|--|--|--|--|--|--|--|--|--|--|--|--|--|--|--|--|--|--|--|--|

OLD ADDRESS:

NAME

NO

STREET

APT.

CITY

STATE/PROVINCE

ZIP / POSTAL CODE

NEW ADDRESS:

NAME

NO

STREET

APT.

CITY

STATE/PROVINCE

ZIP / POSTAL CODE

## CHANGE OF OWNERSHIP



VEHICLE IDENTIFICATION NUMBER

|  |  |  |  |  |  |  |  |  |  |  |  |  |  |  |  |  |  |  |  |
|--|--|--|--|--|--|--|--|--|--|--|--|--|--|--|--|--|--|--|--|
|  |  |  |  |  |  |  |  |  |  |  |  |  |  |  |  |  |  |  |  |
|--|--|--|--|--|--|--|--|--|--|--|--|--|--|--|--|--|--|--|--|

The ownership of this vehicle is transferred

FROM:

NAME

NO

STREET

APT.

CITY

STATE/PROVINCE

ZIP / POSTAL CODE

TO:

NAME

NO

STREET

APT.

CITY

STATE/PROVINCE

ZIP / POSTAL CODE





**BOMBARDIER INC.**  
ATT.: WARRANTY DEPARTMENT  
VALCOURT, QUEBEC  
CANADA, JOE 2L0

**BOMBARDIER INC.**  
ATT.: WARRANTY DEPARTMENT  
VALCOURT, QUEBEC  
CANADA, JOE 2L0