



EVEREST®

444



1979
OPERATOR
MANUAL



model _____

V.I.N. _____

purchase date _____

warranty expiry date _____

DEALER IMPRINT AREA

Text by:

Technical Information Centre
After Sales Service Department
Bombardier Limited
Valcourt, Quebec
Canada, J0E 2L0

Suggested Retail Price: \$2.75
(First copy free with unit purchased)

The following are trademarks of Bombardier Limited.

BOMBARDIER	EVEREST	MOTO-SKI
SKI-DOO	MIRAGE	FUTURA
ALPINE	NORDIC	SPIRIT
BLIZZARD	OLYMPIQUE	NUVIK
CARRY-BOOSE	SKI-BOOSE	SONIC
ELAN	T'NT	
ELITE		

FOREWORD

CONGRATULATIONS... You are now the proud owner of a new 1979 snowmobile. This vehicle is the result of incomparable teamwork between Bombardier designers, engineers and technicians. Consequently, this vehicle is designed and engineered with safety, handling, comfort and quietness in mind.

The information has been prepared to acquaint the owner/operator of a new snowmobile with the various vehicle controls, owner-related maintenance, and safe operating instructions. This is accomplished via 'The Snowmobile Safety Handbook Booklet' and the 'Operator Manual'. Each is inseparable toward proper use of the product, and should be kept with the vehicle at all times.

Should you have any questions pertaining to the warranty and its application, please consult the "Often Asked Question" section of this manual, or your selling dealer.

This manual emphasizes particular information denoted by the wording and symbols:

 **WARNING:** Identifies an instruction which, if not followed, could cause personal injury.

 **CAUTION:** Denotes an instruction which, if not followed, could severely damage vehicle components.

 **NOTE:** Indicates supplementary information needed to fully complete an instruction.

Although the mere reading of such information does not eliminate the hazard, your understanding of the information will promote its correct use.

Ride safe and have fun.

Recreational Products Group
Bombardier Limited,
Valcourt, Quebec, Canada

PLEASE ENSURE YOUR WARRANTY BY REGISTERING YOUR SNOWMOBILE THROUGH YOUR DEALER, AT THE FACTORY.

SAFETY IN MAINTENANCE

Observe the following precautions:

- Throttle mechanism should be checked for free movement before starting engine.
- Engine should be running only when pulley guard is secured in place.
- Never run engine without drive belt installed. Running an unloaded engine can prove to be dangerous.
- Never run the engine when the track of the vehicle is raised off the ground.
- It can be dangerous to run engine with the cab open.
- Since engine cooling is mainly in effect when the vehicle is in motion, it is recommended that you do not allow the engine to idle for more than brief periods. Prolonged idling may cause engine damage.
- Gasoline is flammable and explosive under certain conditions. Always perform procedures in a well ventilated area. Do not smoke or allow open flames or sparks in the vicinity. If gasoline fumes are noticed while driving, the cause should be determined and corrected without delay.
- Your snowmobile is not designed to be operated on public streets, road or highways. In most States and Provinces, it is considered an illegal operation.
- Maintain your vehicle in top mechanical condition at all times.
- Your snowmobile is not designed to be driven or operated on black top, bare earth, or other abrasive surfaces. On such surfaces abnormal and excessive wear of critical parts is inevitable.
- Only perform procedures as detailed in this manual. Unless otherwise specified, engine should be turned OFF for all lubrication and maintenance procedures.
- Installation of other than "stock" equipment, including ski-spreaders, bumpers, pack racks, etc., could severely affect the stability and safety of your vehicle. Avoid adding on" accessories that alter the basic vehicle configuration.
- The snowmobile engine can be stopped by activating the emergency cut-out or tether switches, or turning off the key.
- When removing coolant tank cap, first place a cloth over cap then turn cap to its first step to release pressure.

Please read and understand all other warnings contained elsewhere.

THIS MANUAL SHOULD REMAIN WITH THE VEHICLE AT THE TIME OF RESALE.

INDEX

CONTROLS/INSTRUMENTS

Throttle control lever, brake control lever, ignition switch, light switch, emergency cut-out switch, headlamp dimmer switch, rewind starter, primer, tachometer, speedometer, temperature gauge, tether cut-out switch, lighter, handle heat switch, mirror, cab opening, tool box, fuel gauge, fuse holder 4

BREAK-IN PERIOD

Inspection, inspection check list 7

FUEL MIXING

Recommended gasoline, recommended oil, fuel mixture ratio, fuel mixing procedure 9

PRE-START CHECK

Check points 10

STARTING PROCEDURE

Emergency starting 11

LUBRICATION

Pulley guard removal, drive belt removal, steering mechanism, chaincase oil level, suspension, rotary valve system 12

MAINTENANCE

Spark plugs, battery, suspension condition, track, suspension adjustment, track tension and alignment, carburetor adjustment, drive belt, steering mechanism, brake, steering, engine head nuts, engine mount nuts, exhaust system, cooling system, general inspection, headlamp beam aiming, bulb replacement 14

STORAGE

Cooling system, track, suspension, ski assembly, fuel tank, carburetor, cylinder lubrication, drive pulley, chaincase, controls, battery, chassis, general inspection 20

PRE-SEASON PREPARATION

Pre-season preparation chart 24

TROUBLE SHOOTING GUIDE

..... 25

TOOLS

..... 27

SPECIFICATIONS

..... 28

HOW TO IDENTIFY YOUR SNOWMOBILE

..... 29

THE 1979 "LIMITED WARRANTY"

..... 30

OFTEN ASKED QUESTIONS

..... 32

CONSUMER GUIDE

..... 34

LISTING OF AREA DISTRIBUTORS

..... 35

CHANGE OF ADDRESS OR OWNERSHIP

..... 37

CONTROLS/INSTRUMENTS

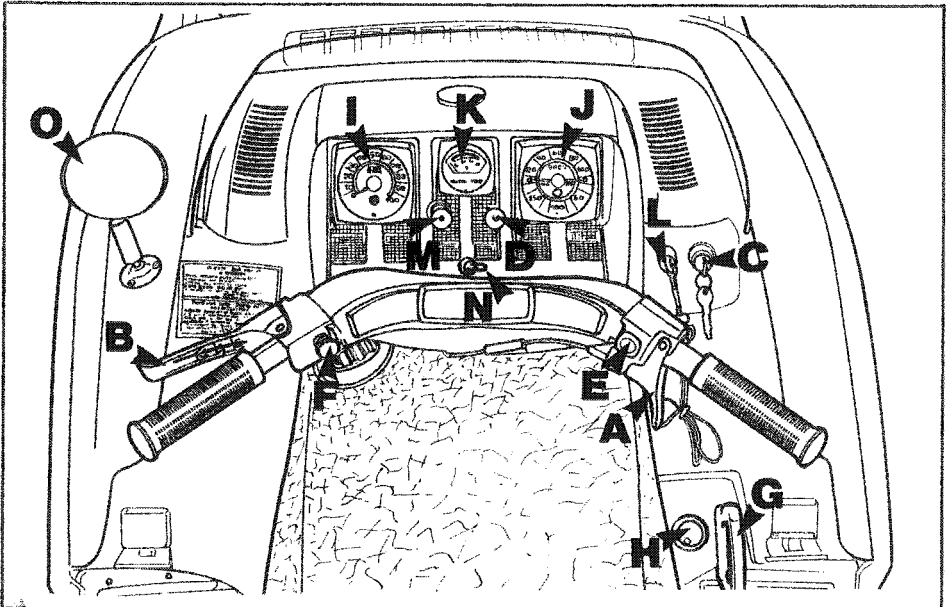

- | | |
|-----------------------------|--------------------------|
| A) Throttle Control Lever | I) Tachometer |
| B) Brake Control Lever | J) Speedometer |
| C) Ignition Switch | K) Temperature Gauge |
| D) Light Switch | L) Tether Cut-Out Switch |
| E) Emergency Cut-Out Switch | M) Lighter |
| F) Headlamp Dimmer Switch | N) Handle Heat Switch |
| G) Rewind Starter Handle | O) Mirror |
| H) Primer | |

A) Throttle Control Lever

Located on right side of handlebar. When compressed, it controls the **engine speed** and the **engagement of the transmission**. When released, engine speed returns automatically to idle.

B) Brake Control Lever

Located on the left side of handlebar. When compressed, the brake is applied. When released, it automatically returns to its original position. Braking effect is proportionate to the pressure applied on the lever.

C) Ignition / Light Switch

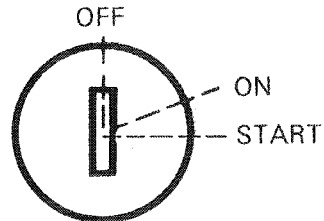

Key operated, 3 position switch. To start engine, turn key fully clockwise to **START** position and hold. Return key to **ON** position **immediately** engine has started. To **stop engine**, turn key counter clockwise to **OFF** position.

D) Light Switch

A push pull switch type, to illuminate headlamp and taillight, pull switch knob. (Ignition switch must be turned to ON position).

E) Emergency Cut-Out Switch

A push button switch located on right side of handlebar. To stop the engine in an emergency, press button down into **lower** position.

Before re-starting engine always depress button into released **upper** position. The driver of this vehicle should familiarize himself with the function of this device by using it several times on first outing. Thereby being mentally prepared for emergency situations requiring its use.

WARNING: If the button has been used in an emergency situation the source of malfunction should be determined and corrected before restarting engine.

F) Headlamp Dimmer Switch

The dimmer switch, located on left side of handlebar, allows correct selection of headlamp beam. To obtain high or low beam simply depress switch.

G) Rewind Starter Handle

Auto rewind type located on right hand side of vehicle. To engage mechanism, pull handle.

H) Primer

A push-pull button located alongside manual starter handle. Pull and push button (2-3 times) to activate primer. The primer should always be used for cold engine starts. After engine is warm however, it is not necessary to use primer when starting.

I) Tachometer

The tachometer registers the impulses

of magneto. Direct-reading dial indicates the number of revolutions per minute (RPM) of the engine.

CAUTION: The tachometer is protected by a fuse, if tachometer stops operating check fuse condition and if necessary replace. The fuse is 0.1 amp. Do not use a higher rated fuse as this can cause severe damage to the tachometer.

J) Speedometer

The speedometer is linked directly to the drive axle. Direct-reading dial indicates the speed of the vehicle. Odometer records the total distance travelled.

K) Temperature Gauge

The gauge indicates engine coolant temperature. Normal operating temperature is 50°C (120°F). However, coolant temperature can vary depending on driving condition. If coolant temperature exceeds 95° C (200° F) reduce speed and run vehicle in loose snow or stop engine immediately.

WARNING: To remove coolant tank cap, place a cloth over the cap and unscrew it to the first step to release the pressure. If this notice is disregarded loss of fluid and possible severe burns could occur.

L) Tether Cut-Out Switch

A pull switch located on the right side of cab. Attach tether cord to wrist or other convenient location then snap tether cut-out cap over receptacle before starting engine.

If emergency engine "shut off" is required completely pull cap from safety switch and engine power will be automatically shut "off".

NOTE: The cap must be installed on the safety switch at all times in order to operate the vehicle.

WARNING: If the switch is used in an emergency situation the source of malfunction should be determined and corrected before restarting engine.

M) Lighter

Push in to activate, lighter pops up automatically when lite.

N) Handle Heat Switch

ON-OFF switch located between the lighter and the light switch. Places switch to ON position and handlebar grips will warm.

O) Mirror

Adjust the mirror so you can just see the rear side of your seat in the in-board portion of the mirror.

WARNING: This mirror is of the convex type (identified by its curved surface) to provide widervision. Note that the vehicles or objects seen in such a mirror will appear smaller and farther away than they really are.

Cab Opening

To open cab, lift both handle to disengage latches. Always lift up cab gently up until stopped by restraining device.

WARNING: It is dangerous to run engine with cab open. Personal injury could result.

Tool Box

Located under the cab. To gain access tilt cab. Ideal location for belt, rope, etc. Spare spark plugs can be screwed on the bracket provided in the box.

Fuel Gauge

To check fuel level simply unscrew fuel tank cap and withdraw dipstick.

Fuse Holder

Starter

Located in the engine compartment, at the right hand front portion/bottom plate level.

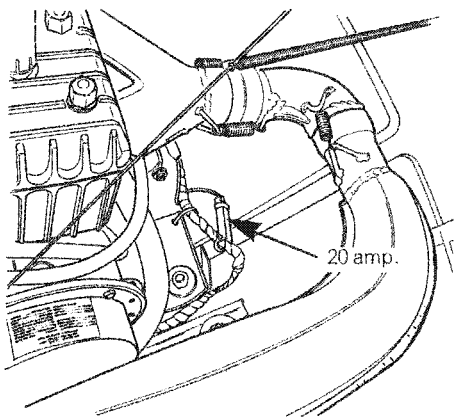

Instrument

Located on the ignition switch wiring harness.

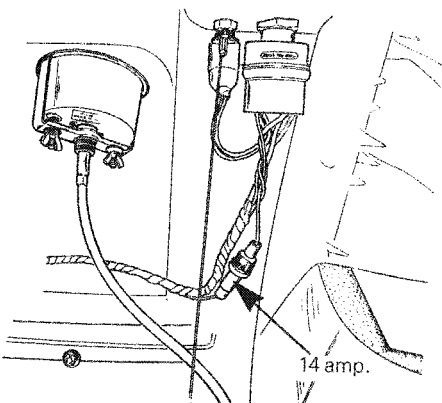

BREAK-IN PERIOD

With Bombardier-Rotax snowmobile engines, a break-in period is required before running the vehicle at full throttle. Engine's manufacturer recommendation is 10 to 15 operating hours. During this period, a richer mixture is needed (i.e. 40 parts of gas for 1 part of 50 / 1 Bombardier oil). Maximum throttle should not exceed $\frac{3}{4}$, however, brief full acceleration and speed variations contribute to a good break-in. Continued wide open throttle accelerations, prolonged cruising speeds, and lugging are detrimental during the break-in period.

10-Hour Inspection

As with any precision piece of mechanical equipment, we suggest that after the first 10 hours of operation or 30 days after the purchase, whichever comes first, that your vehicle be checked by your dealer. This inspection will give you the opportunity to discuss the unanswered questions you may have encountered during the first hours of operation. Remember that it is easier to remedy at this time than to allow the snowmobile to operate until a possible failure occurs.

The 10 hours inspection is at the expense of the vehicle owner.

10-HOUR INSPECTION CHECK LIST

✓

Engine timing	
Spark plug(s) condition	
Carburetor adjustment	
Engine head nuts	
Engine mount nuts	
Muffler attachment	
Chain case oil level	
Coolant level	
Battery electrolyte level	
Brake operation and lining condition	
Skis alignment (runners condition)	
Pulley alignment and drive belt condition	
Track condition, tension and alignment	
Lubricate (steering suspension)	
Electrical wiring (loose connections, stripped wires, damaged insulation), tighten all loose bolts, nuts and linkage	
Operation of lighting system (HI / LO beam, brake light, etc.). test operation of emergency cut-out switch and tether cut-out switch	

We recommend that you have your dealer sign this inspection.

Date of 10 hour inspection

Dealer signature

FUEL MIXING

◆ **WARNING:** Never use a lite match or open flame to check fuel level.

Oil must be added to the gasoline in pre-measured amounts then both oil and gasoline should be thoroughly mixed together before fueling the tank.

Recommended Gasoline

The correct gasoline is regular gasoline (not less than 92 octane), available from all service stations.

▼ **CAUTION:** Never experiment with different fuel or fuel ratios. Never use low lead or non leaded gasoline, naphtha, methanol or similar products.

Recommended Oil

Use concentrated Bombardier snowmobile oil available from your dealer. This type of oil has specially formulated oil bases to meet the lubrication requirements of the Bombardier-Rotax engine.

If Bombardier snowmobile oil is unavailable substitute with a high-quality 2 cycle snowmobile oil. The oil / gas mix must meet the vehicle requirements. See oil manufacturer recommendations on container.

▼ **CAUTION:** Never use outboard or straight mineral oils.

Fuel Mixture Ratio

The importance of using the correct fuel mixture cannot be overstressed. An incorrect fuel ratio results in serious engine damage. Recommended fuel ratio is 50 / 1.

S.I. Measure

400 mL oil to 20 liters = 50 / 1

Imperial Measure

1 can 16 oz oil to 5 imp. gals = 50 / 1

U.S. Measure

1 can 12 oz oil to 5 U.S. gals = 50 / 1

○ **NOTE:** To facilitate fuel mixing oil should be kept at room temperature.

Fuel Mixing Procedure

To mix the gasoline and oil always use a separate clean container. Never mix directly in your snowmobile tank. For best results, acquire two containers, either plastic or metal. Draw from one until empty then use the second one.

◆ **WARNING:** Gasoline is flammable and explosive under certain conditions. Always perform procedures in a well ventilated area. Do not smoke or allow open flames or sparks in the vicinity. If gasoline fumes are noticed while driving, the cause should be determined and corrected without delay. Never add fuel while engine is running. Avoid skin contact with fuel at below freezing temperatures.

1. Pour approximately one gallon of gasoline into a clean container.

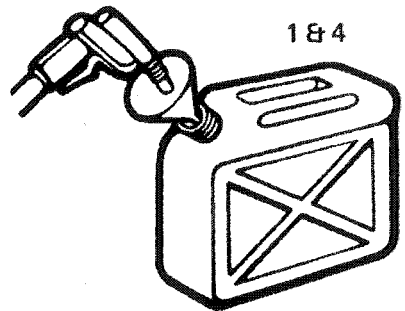

PRE-START CHECK.

2. Add the full amount of oil.

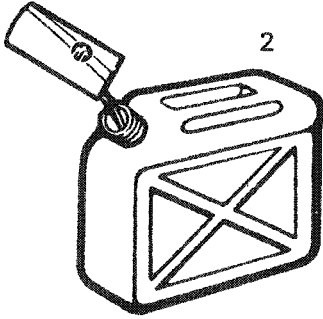

○ **NOTE:** To facilitate fuel mixing oil should be kept at room temperature.

3. Replace container cap and shake the container thoroughly.

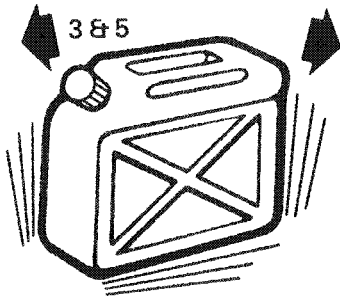

4. Add the remainder of the gasoline.
5. Once again thoroughly agitate the container. Then using a funnel with a fine mesh screen to prevent the entry of water and foreign particles, transfer mixture from container into the snowmobile tank.

○ **NOTE:** When using pre-mixed fuel, always shake the container thoroughly as the oil has a tendency to settle.

◆ **WARNING:** Never 'top up' gas tank before placing vehicle in a warm area. At certain temperatures, gasoline will expand and overflow.

Check Points

- **Activate the throttle control lever several times** to check that it operates easily and smoothly. The throttle control lever must return to idle position when released.
- Check that the skis and the track are not frozen to the ground or snow surface and that steering operates freely.
- Activate the brake control lever and make sure the brake fully applies before the brake control lever touches the handlebar grip.
- Check coolant level. Liquid should be 2.5 cm (1") below filler neck. If additional coolant is necessary, always use a 50/50 (50 parts of water for 50 parts of anti-freeze) solution. When entire system has to be refilled, use a solution of 3 parts of anti-freeze for 2 parts of water. See cooling system in storage.
- ◆ **WARNING:** Before removing the cap place a cloth over the coolant tank and release the cap to the first step to release the pressure. Loss of fluid and possibility of severe burns could occur, if this notice is disregarded.
- Check fuel level.
- Verify that the path ahead of the vehicle is clear of bystanders and obstacles.
- ◆ **WARNING:** Only start your snowmobile once all components are checked and functioning properly.

STARTING PROCEDURE

Upper position
before starting
engine.

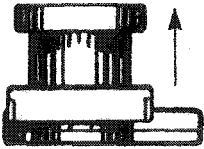

Lower position
to stop engine.

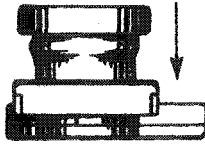

1. Insert key in ignition switch.
2. Test throttle control lever.
3. Activate primer (2 or 3 times). Primer is not necessary if engine is warm.
4. Make sure the tether cut-out cap is in position and that the cord is attached to your body. Check that the emergency cut-out button is in the released upper position.
5. Turn ignition key clockwise until starter engages. Release key immediately engine has started. If engine does not start on first try, key must be turned fully back to OFF each time.

◆ **WARNING:** Do not apply throttle while starting.

6. Check operation of the emergency cut-out switch, and tether switch. Restart engine.

◆ **WARNING:** If engine does not shut-off when applying the emergency cut-out switch and or when pulling the tether cut-out cap, stop the engine by turning off the ignition key. Do not operate the vehicle further, see your dealer.

7. Allow the engine to warm before operating at full throttle.

▼ **CAUTION:** Since engine cooling is in effect only when the vehicle is in motion, it is recommended that you do not allow the engine to idle for more than brief periods. Prolonged idling may cause engine damage.

○ **NOTE:** If for some reasons, the vehicle cannot be started electrically, place ignition key to ON position and start engine manually.

Emergency Starting

Should the rewind starter rope fray and break, the engine can be started with an emergency starter rope.

Remove pulley guard from vehicle and wind the emergency rop tight around the drive pulley between the sliding half and the roller guard. Start engine as per usual manual starting.

◆ **WARNING:** Do not start the vehicle by the drive pulley unless it is a true emergency situation, have the vehicle repaired as soon as possible.

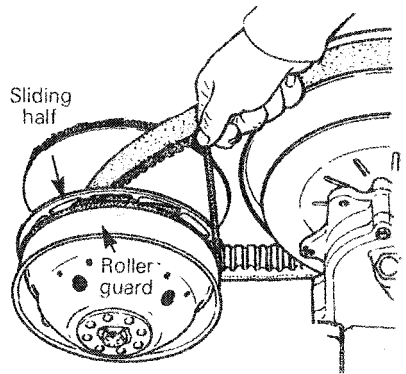

◆ **WARNING:** When starting the vehicle in an emergency situation by the drive pulley, do not make a knot at the end of the emergency rope and do not reinstall the pulley guard.

LUBRICATION

Frequency

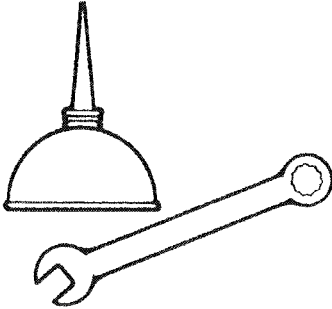

Routine maintenance is necessary for all mechanized products, and the snowmobile is no exception. A weekly vehicle inspection contributes to the life span of the snowmobile as well as retain safe and dependable operation. It is recommended that the steering system and suspension, be lubricated monthly or every 40 hours of operation. If the vehicle is operated in wet snow or in severe conditions these items should be lubricated more frequently.

◆ **WARNING:** Only perform such procedures as detailed in this manual. It is recommended that dealer assistance be periodically obtained on other components / systems not covered in this manual. Unless otherwise specified, engine should be turned OFF for all lubrication and maintenance procedures.

Pulley Guard Removal

◆ **WARNING:** Engine should be running only when pulley guard is secured in place.

1. Tilt cab, unscrew wing nut (A) and pull out retaining clips (B & C).

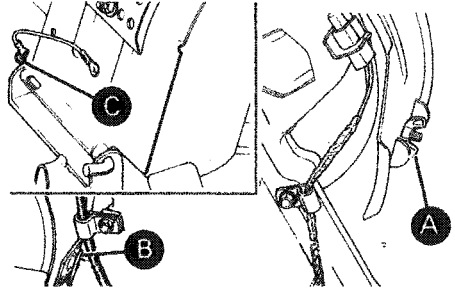

2. Disengage guard from rear and middle brackets then disengage pin from front bracket. Remove complete assembly.

Drive Belt Removal

◆ **WARNING:** Never start or run engine without drive belt installed. Running an unloaded engine is dangerous.

1. Tilt cab and remove pulley guard. Unlock and raise driven pulley support.

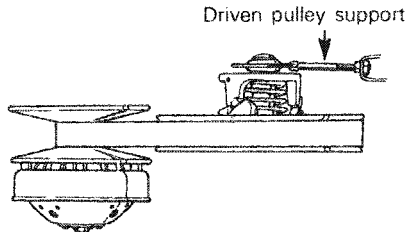

2. Open the driven pulley by twisting and pushing the sliding half. Hold in fully open position.

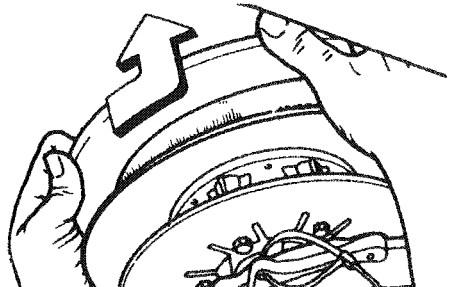

- Slip slackened belt over the top edge of the sliding half.

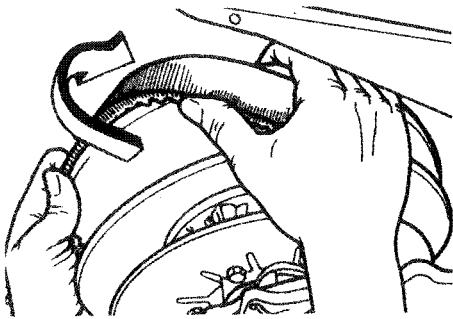

- Slip the belt out from the drive pulley and remove completely from vehicle. To install drive belt, reverse procedure.

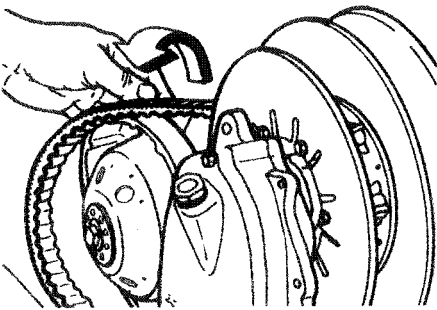

◆ **WARNING:** Do not lubricate throttle and / or brake cable and housings.

Chaincase Oil Level

Using the spark plug socket, remove the filler cap then using a rigid wire as a "dipstick" check oil level. The oil level on the "dipstick" should be 7.5 to 8.5 cm (3" to 3½"). Replenish as necessary. The chaincase oil capacity is approximately 256 ml (9 oz).

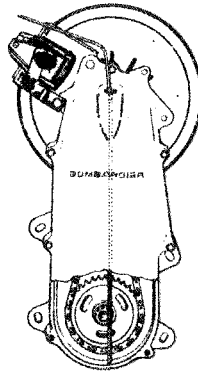

Suspension

Using a low pressure grease gun, lubricate the five (5) idler wheels, with low temperature grease. Pump 3 to 4 times through the grease fitting located on each cap of idler wheel. Wipe off excess.

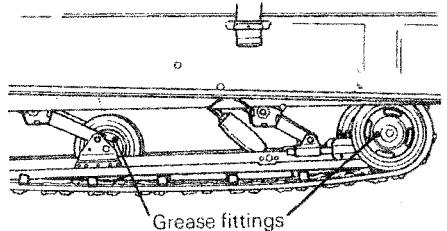

Steering Mechanism

Lubricate ski legs at grease fittings until new grease appears at joints. Oil spring coupler bolts.

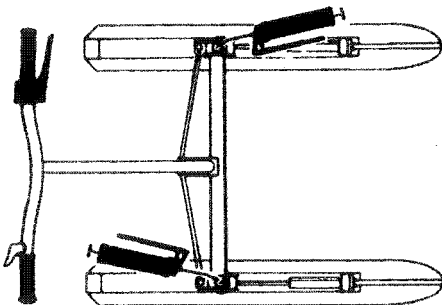

Rotary Valve System

Check reservoir oil level frequently. If necessary, replenish oil level using "Castrol Injector Oil", or equivalent, available from your dealer.

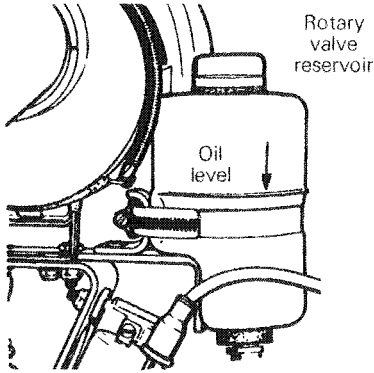

The following Maintenance Chart indicates regular servicing schedules to be performed by you or your servicing dealer. If these services are performed as suggested, your snowmobile will give you many years of low-cost use.

◆ **WARNING:** Only perform such procedures as detailed in this manual. It is recommended that dealer assistance be periodically obtained on other components / systems not covered in this manual. Unless otherwise specified, engine should be turned OFF for all lubrication and maintenance procedures.

Code	Weekly	Page
W1	Spark Plugs	14
W2	Battery	15
W3	Suspension Condition	15
W4	Track	16
W5	Suspension Adjustment	16
W6	Carburetor Adjustment	17
W7	Drive Belt	18
W8	Steering Mechanism	18
Code	Monthly	Page
M1	Brake	18
M2	Steering Adjustment	19
M3	Engine Head Nuts	19
M4	Engine Mount Nuts	19
M5	Exhaust system	19
M6	Cooling System	20
M7	Vehicle General Inspection	19
	Headlamp Adjustment	20

(W1) Spark Plugs

1. Disconnect spark plug wires and remove spark plugs.
2. Check condition of plugs.
 - A brownish tip reflects ideal conditions (correct carburetor adjustment, spark plug heat range, etc.).
 - A black insulator tip indicates fouling caused by: carburetor idle speed mixture and / or high speed mixture too rich, incorrect fuel mixing ratio, wrong type of spark plug (heat range), or excessive idling.
 - A light grey insulator tip indicates a lean mixture caused by: carburetor high speed mixture adjusted too lean, wrong spark plug heat range, incorrect fuel mixture ratio, or a leaking seal or gasket.

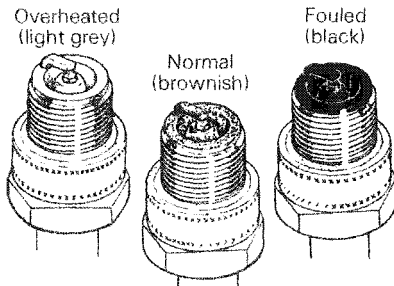

▼ **CAUTION:** If spark plug condition is not ideal, contact your dealer.

3. Reinstall plugs and connect wires.

(W2) Battery

Check electrolyte level. Electrolyte level must be at upper level line on battery casing.

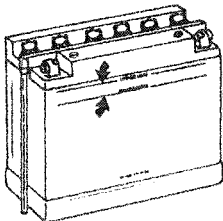

If necessary add distilled water. Battery connections must also be free of corrosion. If cleaning is necessary remove corrosion using a stiff brush then clean with a solution of baking soda and water. Rinse and dry well.

▼ **CAUTION:** Do not allow cleaning solution to enter battery. It will destroy the chemical properties of the electrolyte.

After reconnecting battery coat battery terminals and connectors with petroleum jelly to prevent corrosion. Check that battery is well secured and that battery overflow tube is not blocked or kinked.

◆ **WARNING:** Overflow tube must be free and open. A kinked or bent tube will restrict ventilation and create gas accumulation that could result in an explosion. Avoid skin contact with electrolyte.

▼ **CAUTION:** Prior to charging the battery, always remove it from the vehicle to prevent electrolyte spillage.

(W3) Suspension Condition

Visually inspect suspension springs. Replace any weak or broken spring. Inspect shoe condition and replace as necessary.

○ **NOTE:** During normal driving, snow will act as a lubricant and coolant for the slider shoes. Extensive riding on ice or sanded snow, (not to mention dirt, asphalt, etc. never recommended) will create excessive heat build-up and cause premature slider shoe wear.

(W4) Track Condition

Lift rear of vehicle and support it off the ground. With engine off, rotate track by hand, and inspect condition. If worn, cut or the track fiber is exposed or missing or defective inserts or guides are noted, contact your dealer.

WARNING: Do not operate a snowmobile with a cut, torn or damage track.

(W5) Suspension Adjustment

The suspension is adjustable, the front adjustment for surface condition, the rear for driver's weight.

When the front adjuster blocks are at the lowest elevation more weight is distributed on skis. At the highest position the weight is transferred from the skis to the track. The rear adjuster blocks should be adjusted to suit the driver's preference.

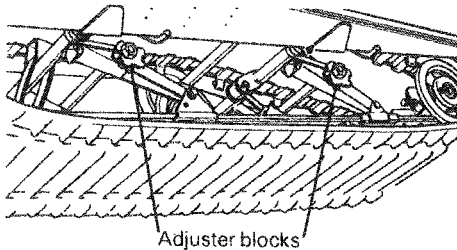

CAUTION: Always turn left side adjuster blocks in a clockwise direction, the right side blocks in a counter-clockwise direction. Left and right adjuster blocks of each adjustment must always be set at the same elevation.

Track Tension and Alignment

Lift rear of vehicle and support with a mechanical stand. Allow slide to extend normally. A gap of 13 mm (1/2 inch) should exist between slider shoe and bottom inside of track.

If track tension is too loose, the track will have a tendency to thump.

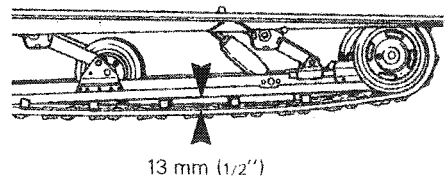

CAUTION: Too much tension will result in power loss and excessive stresses on suspension components.

If necessary to adjust, loosen or tighten adjuster bolts located on inner side of rear idler wheels. If correct tension is unobtainable, contact your dealer.

NOTE: Track tension and alignment are inter-related. Do not adjust just one without the other.

Start the engine and accelerate slightly so that track turns **slowly**. Check that track is well centered I.E. equal distance on both sides between edges of track guides and slider shoes.

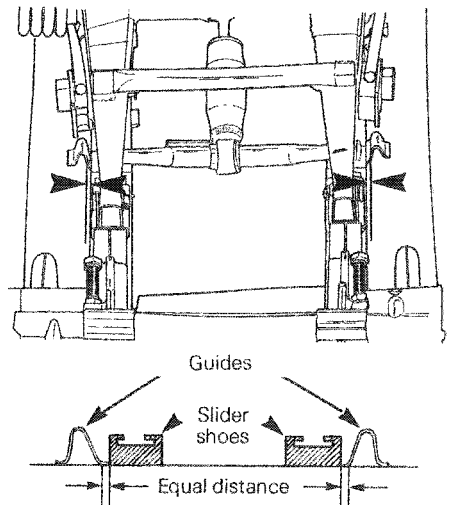

◆ **WARNING:** Before checking track alignment, ensure that the track is free of all particles which could be thrown out while track is rotating. Keep hands, tools, feet and clothing clear of track. Ensure no-one is standing in close proximity to the vehicle.

To correct, stop engine loosen the rear idler wheels retaining screws then loosen the lock nuts and tighten the adjuster bolt on side where the slider shoe is the furthest to the track insert guides.

Tighten lock nuts and recheck alignment. Ensure to retighten the idler wheel retaining screws.

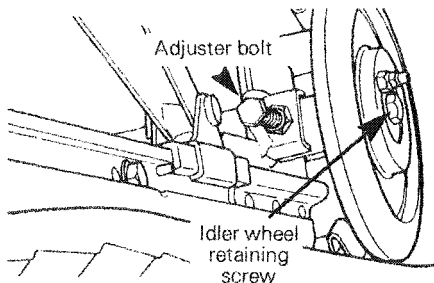

(W6) Carburetor Adjustment

▼ **CAUTION:** Never operate your snowmobile with the air intake silencer disconnected. Serious engine damage will occur if this notice is disregarded.

The carburetor adjustments are:

- A) Air Screw
- B) Throttle Slide Adjustment
- C) Idle Speed

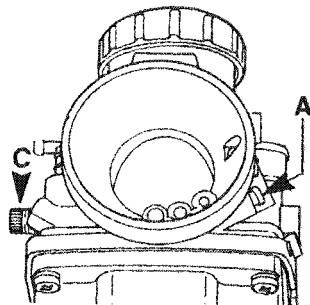

A) Air Screw Adjustment

Completely close the air screw (until a slight reseating resistance is felt) then back off screw: 1 1/2 turn + 1/4 - 0.

B) Throttle Slide Adjustment

◆ **WARNING:** Ensure the engine is turned **OFF**, prior to the throttle slide adjustment.

With the throttle cable adjuster jam nut unlocked, press the throttle lever against the handle grip. Unscrew the cable adjuster by hand to obtain maximum carburetor slide opening. (With the air silencer removed, check with your finger if the carburetor slide is well seated against the carburetor top portion). Then, screw the cable adjuster in two turns in order to nullify any possible tension on the throttle cable and tighten the cable adjuster jam nut.

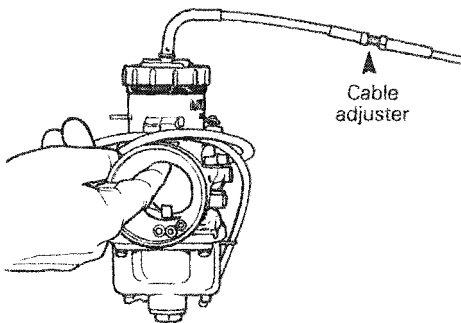

◆ **WARNING:** It is important that the throttle slide adjustment be performed to ensure proper functioning of the throttle mechanism.

C) Idle Speed Adjustment

Turn idle speed screw clockwise until it contacts the throttle slide then continue turning two (2) additional turns. This will provide a preliminary idle speed setting. Start engine and allow it to warm then adjust idle speed to 1500 1800 R.P.M. by turning idle speed screw clockwise or counter-clockwise.

▼ **CAUTION:** Do not attempt to set the idle speed by using the air screw. Severe engine damage can occur. If idle speed is unobtainable contact your authorized dealer.

Air Silencer

At cold temperature and/or when the vehicle is operated in powdered snow, the air intake silencer elbow must be turned toward the rear of the vehicle. The elbow may be turned to the front of the vehicle only when the vehicle is operated at warm temperature.

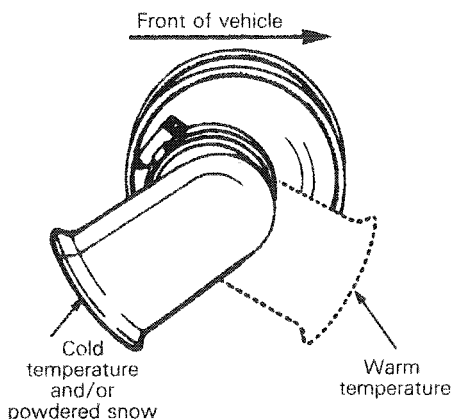

▼ **CAUTION:** Never operate your snowmobile with the air silencer box disconnected. Serious engine damage will occur if this notice is disregarded.

(W7) Drive Belt

Inspect belt for cracks, fraying or abnormal wear (uneven wear, wear on one side, etc.). If abnormal wear is noted, probable cause is pulley misalignment. Contact your dealer. Check drive belt width, the drive belt width should not be less than 30 mm (1 3/16"), wide.

○ **NOTE:** When installing a new drive belt, a break-in period of 15 25 km (10-15 miles) is strongly recommended.

(W8) Steering Mechanism

Inspect steering mechanism for tightness of components (steering arms, tie rods, ball joints, spring coupler bolts, etc.). If necessary, replace or retighten.

Check condition of skis and ski runners. Replace if worn.

(M1) Brake

The brake mechanism is self-adjusting, therefore, periodic adjustment is not required. However, check operation of brake mechanism by depressing brake control lever. Brake should apply fully when lever is 13 mm (1/2 in.) approx. from handlebar grip. If not, do not tamper with the brake, contact your servicing dealer.

◆ **WARNING:** Brake linings less than 3 mm (1/8") must be replaced. Replacement must be performed by an authorized dealer.

(M2) Steering

Skis should have a toe out of 3 mm (1/8 in.). To check, measure distance between each ski at front and rear of leaf springs. The front distance should be 3 mm (1/8 in.) more than the rear when the handlebar is horizontal.

IMPORTANT: Close front of skis manually to take all slack from steering mechanism.

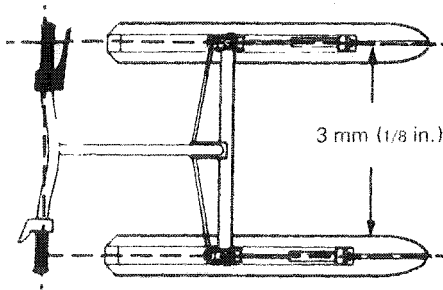

If adjustment is required:

Unscrew the nuts locking the tie rods in place. Turn one or both tie rods until skis are parallel to each other. Then, measuring at front of leaf springs, add an additional 1.6 mm (1/16 in.) on each side by rotating turnbuckles. Tighten the nuts firmly against the tie rod. Check tightness of the steering arm locking bolts, ball joints wear, etc.

WARNING: The ball joint socket must run parallel with the steering arm. The socket must be restrained when tightening the tie rod end lock nuts. Ensure at least half of the ball joint threads are inserted into the tie rod.

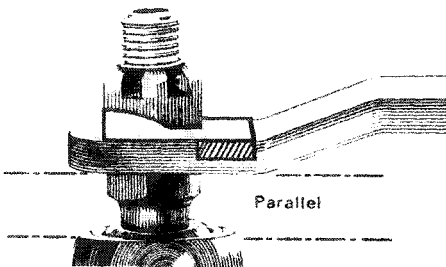

(M3) Engine Head Nuts

After the first 5 hours of operation, check that engine head nuts are tight and equally torqued 39 N•m (28 ft-lbs) **when engine is cold.**

(M4) Engine Mount Nuts

Check engine mount nuts for tightness. Retighten if necessary.

(M5) Exhaust System

The engine/muffler attaching parts are vital toward efficient muffler function. Check all attachments. Replace springs and/or tighten if necessary.

CAUTION: Do not operate vehicle with muffler disconnected other wise serious engine damage will occur.

(M6) Cooling System

Place a cloth over the coolant tank cap and release it to the first step to check that the cap pressurizes the system. If not, install a new 13 lb cap. Do not exceed the 13 lb. pressure. Using an hydrometer check that the anti-freeze solution is strong enough for the temperature in which the vehicle is operated.

(M7) General Inspection

Check electrical wiring and components, retighten loose connections. Check for stripped wires or damaged insulation. Thoroughly inspect the vehicle and tighten loose bolts, nuts and linkage. Inspect skis and ski runners for wear.

CAUTION: When replacing bolts, nuts, wires, etc., use only genuine Bombardier parts or equivalent being the same type and having the same construction and resistance.

Headlamp Beam Aiming

The angle of the headlamp beam has been pre-adjusted prior to delivery. Should you wish re-adjustment, place vehicle on a flat surface 7.6 m (25') from a wall or screen.

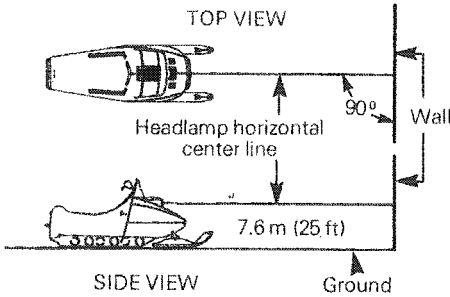

With the suspension correctly adjusted, the rider seated on the vehicle and the high beam ON. Check that the center of high intensity zone of high beam is 50 mm (2") below horizontal line of headlamp height.

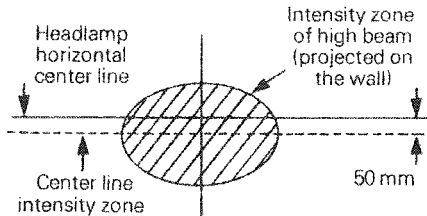

To adjust, remove headlamp chrome ring, turn upper or lower adjusting screws to obtain desired beam position.

Bulb Replacement

If headlamp is burnt, tilt cab. Unplug connector from headlamp. Remove rubber boot and unfasten bulb retainer clips. Detach bulb and replace. If tail-light bulb is burnt, expose bulb by removing red plastic lens. To remove, unscrew the two (2) Phillips head screws. Verify all lights after replacement.

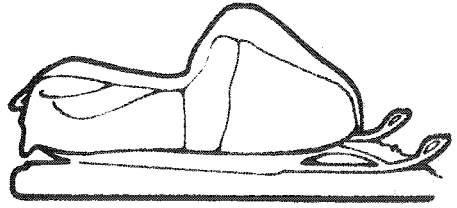

Storage of the snowmobile during long periods of inactivity consists of checking and replacing missing, broken or worn parts proper lubrication and treatments to insure that parts do not become rusted; cleaning items such as carburetor of oil mixtures, to prevent gum varnish formation within the carburetor, and in general, preparing the vehicle so that when the time comes to use the snowmobile again it will start and be in top condition.

WARNING: Only perform such procedures as detailed in this manual. It is recommended that dealer assistance be periodically obtained on other components/systems not covered in this manual. Unless otherwise specified, engine should be turned OFF for all lubrication and maintenance procedures.

Cooling System

To drain the cooling system, remove the coolant tank cap and disconnect the by-pass hose from the engine head fitting. Keep the fitting blocked and the by-pass hose as low as possible to drain the system.

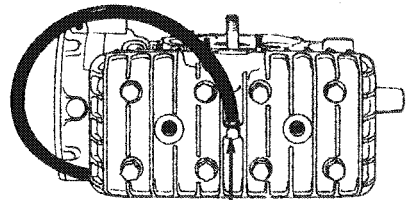

By-pass hose fitting

However, to completely drain the system, it is necessary to blow into the tank through the vent tube, while blocking the filler neck with one hand to prevent air leak.

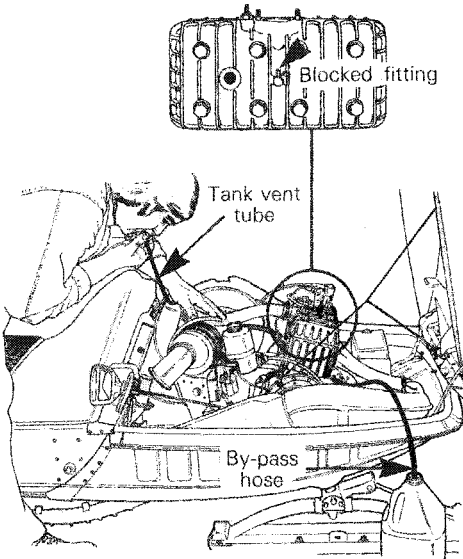

CAUTION: To prevent rust formation in the cooling system, always replenish the system with the recommended solution (60% anti-freeze 40% water).

To refill the cooling system, disconnect by-pass hose and keep it near fitting on cylinder head; refill tank and blow into it through the vent tube, while maintaining the hand over the filler neck until the liquid comes out at the by-pass hose and the fitting on cylinder head.

NOTE: Ensure to maintain a certain coolant level in the tank while performing this procedure.

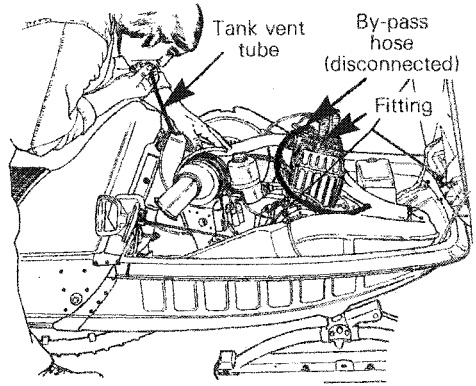

Reconnect by-pass hose and continue to pour the liquid in the coolant tank until the coolant level reaches 25 mm (1") below filler neck.

Reinstall tank cap and start engine; let engine run until it reaches its operating temperature and thermostat opens. Allow it to run a few minutes more. Stop engine and check coolant level; refill as necessary.

WARNING: Before removing the cap place a cloth over the coolant tank and release the cap to the first step to release the pressure. Loss of fluid and possibility of severe burns could occur, if this notice is disregarded.

Track

Inspect track for cuts, missing track inserts and/or guides and broken rods. Make any necessary replacement. Lift rear of vehicle until track is clear of ground then support with brace or trestle. The snowmobile should be stored in such a way that track does not stay in contact with cement floor or bare ground.

○ **NOTE:** The track should be rotated periodically, (every 40 days). Do not release track tension.

▼ **CAUTION:** To prevent track damage, temperature in the storage area must not exceed 38°C (100°F).

Suspension

Remove any dirt or rust. Grease idler wheels at grease fittings. Wipe off surplus. Replace worn slider shoes.

Skis Assembly

Wash or brush all dirt or rust accumulation from skis and springs. Grease ski legs at grease fittings. Check condition of skis, ski runners and leaf springs. Replace if worn or weak.

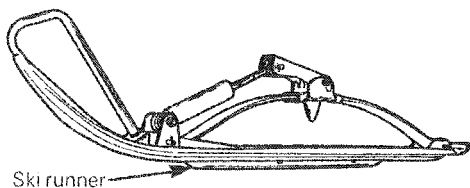

Apply metal protector on ski assembly. If unavailable, wipe the entire ski with cloth soaked in oil to prevent rust formation.

Fuel Tank

Remove cap then using a syphon, remove gasoline from tank.

◆ **WARNING:** Gasoline is flammable and explosive under certain conditions. Always perform procedures in a well ventilated area. Do not smoke or allow open flames or sparks in the vicinity.

Carburetor

The carburetor must be dried out completely to prevent gum formation during the storage period.

Assure that carburetor inlet fuel line is disconnected. Remove plug of the float chamber. Drain carburetor.

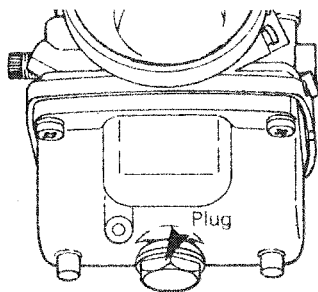

Reinstall plug and connect fuel line.

Cylinder Lubrication

Engine internal parts must be lubricated to protect cylinder walls from possible rust formation during the storage period.

○ **NOTE:** This operation should be repeated every 40 days during storage.

Remove spark plugs. Operate rewind starter to bring piston at top position. Pour the equivalent of one spoonful of oil into spark plug hole.

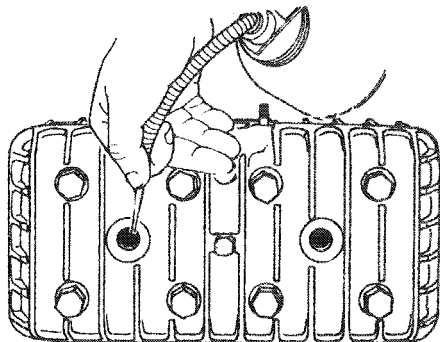

Slowly crank engine several times using manual starter. Repeat above steps for other cylinder. Install spark plugs.

▼ **CAUTION:** To prevent ignition system damage, make sure that the cut-out button is in the lower position.

Drive Pulley

Inspection and cleaning must be performed by the dealer at the end of each season.

Chaincase

Drain the chaincase completely and refill to proper level using fresh chaincase oil. To drain, remove chaincase cover.

Controls

Lubricate steering mechanism. Inspect components for tightness, (spring coupler bolts, steering arm locking bolts, tie rods, ball joints, etc.). Tighten if necessary. Oil moving joints of brake mechanism.

◆ **WARNING:** Do not lubricate throttle and/or brake cables housings. Avoid getting oil on brake linings.

Coat electrical connections and switches with a greaseless metal protector. If unavailable, use petroleum jelly.

Battery

Remove battery from vehicle and clean outside surface of battery with solution of baking soda and water. Remove all deposits from posts then rinse with clear tap water.

▼ **CAUTION:** Do not allow cleaning solution to enter battery interior since it will destroy the electrolyte.

Check electrolyte level. Refill if necessary with distilled water. Fully charge battery. (A stored battery should be recharged at least every 40 days).

▼ **CAUTION:** Prior to charging the battery, always remove it from the vehicle to prevent electrolyte spillage.

◆ **WARNING:** Gases given off by a battery being charged are highly explosive. Always charge in a well ventilated area. Keep battery away from cigarettes or open flames. Avoid skin contact with electrolyte.

Coat battery terminals with petroleum jelly and store unit in a cool, dry place.

IMPORTANT: Lack of preventive maintenance could void battery warranty.

Chassis

Clean the vehicle thoroughly, removing all dirt and grease accumulation.

▼ **CAUTION:** Plastic alloy components such as throttle and brake control handles, windshield, etc., can be cleaned using mild detergents or isopropyl alcohol. Do not use strong soaps, degreasing solvents, abrasive cleaners, paint thinners, gasoline, etc.

Inspect cab and repair damage. Clean frame with "Aluminum cleaner" and follow instructions on container.

Touch up all metal spots where paint has been scratched off. Spray all bare metal parts of vehicle with metal protector. Wax the cab for better protection.

○ **NOTE:** Apply wax on glossy finish of cab only. Protect the vehicle with a clean cover to prevent dust accumulation during storage.

▼ **CAUTION:** If for some reason the snowmobile has to be stored outside it is necessary to cover it with an opaque tarpaulin. This caution will prevent the sun rays affecting the plastic components and the vehicle finish.

General Inspection

Check electrical wiring and components, retighten loose connections. Check for stripped wires or damage insulation.

Thoroughly inspect the vehicle and tighten loose bolts, nuts and linkage.

PRE-SEASON PREPARATION

Snow is falling and you are now anticipating the next snowmobile safari. If you have observed and adhered to the storage procedures outlined in this manual, your vehicle preparation become a relatively easy task.

To simplify the pre-season preparation we have drawn up a small chart. The chart indicates servicing points to be performed by you and your servicing dealer. If these services are performed as suggested, your vehicle will give you many hours of fun and low cost use.

IMPORTANT: Observe all Warnings and Cautions mentioned throughout this manual which are pertinent to the item being checked. When component conditions seem less than satisfactory, replace with genuine Bombardier parts or approved equivalents.

PRE-SEASON PREPARATION CHART

To be performed by dealer ●	To be performed by owner ○
Change spark plugs	○
Check chaincase oil level	○
Check drive pulley condition and clean	●
Check ski alignment / ski runners	○
Replace fuel filter	○
Connect fuel lines and check attaching points	○
Check track condition, tension and alignment	○
Lubricate suspension	○
Inspect drive belt and install	○
Check throttle cable for damage and free operation	○
Inspect brake condition and operation	○
Inspect oil seals for possible cuts or leaks	●
Test battery, clean and install	●
Set engine timing, if necessary, replace breaker points	●
Check coolant level and condition	●
Check electrical wiring (broken wire, damaged insulation.)	○
Inspect condition of starting rope	○
Check tightness of all bolts, nuts and linkage	○
Refill gas tank	○
Adjust carburetor	●
Check oil level rotary valve reservoir	○

TROUBLE SHOOTING

SYMPTOMS	POSSIBLE CAUSES	WHAT TO DO
Engine lacks acceleration or power	1. Fouled or defective spark plug	Check item 2 of "Engine turns over but fails to start or starts with difficulty".
	2. Clogged fuel line (water or dirt)	Check fuel line condition. (See item 5 of "Engine turns over but fails to start or starts with difficulty".)
	3. Carburetor	Readjust the carburetor. (See Maintenance section). If trouble persists, contact your dealer.
	4. Faulty ignition	First check item 2 and 3 of "Engine turns over but fails to start or starts with difficulty". If the ignition system still seems faulty, contact your dealer.
	5. Engine	If unable to locate specific symptoms, contact your dealer.
Engine continually backfires	1. Faulty spark plug	Check item 2 of "Engine turns over but fails to start or starts with difficulty".
	2. Overheated	Carburetor set too lean. Contact your dealer. Replenish coolant level. Check for restricted or leaking hose (or gasket), replace as required. Air in cooling system, bleed the system. Engine coolant pump inoperative, see your dealer.
	3. Engine timing incorrectly set	Contact your dealer.
Snowmobile cannot reach full speed	1. Drive belt	Check for damaged or worn drive belt. Replace if necessary.
	2. Incorrect track adjustment	Check track tension and alignment. Readjust to specifications. (See Maintenance section).
	3. Faulty engine	Check item 1 to 5 of "Engine lacks acceleration or power".
	4. Pulley misaligned	Contact your dealer.



SYMPTOMS	POSSIBLE CAUSES	WHAT TO DO
Engine turns over but fails to start or starts with difficulty	1. No fuel to the engine	Check the tank level and fill up with correct gas-oil mixture. Check for possible clogging of fuel, item 5.
	2. Spark plug	Check for fouled or defective spark plug. Disconnect spark plug wire, unscrew plug and remove from cylinder head. Reconnect wire and ground exposed plug on engine, being careful to hold away from spark plug hole. Follow engine starting procedure and check for spark. If no sparks appear, replace spark plug. If trouble persists, check item 3.
	3. Faulty ignition	Disconnect spark plug wire from plug, unscrew the spark plug cap then hold wire about 3 mm (1/8") from the cylinder head. Follow engine starting procedure and if no sparks appear, it means a faulty ignition system. Do not attempt to repair. Contact your dealer.
	4. Flooded engine	Remove wet spark plugs, turn ignition to OFF and crank engine several times. Install clean dry spark plugs. Start engine following usual starting procedure. If engine continues to flood, see your dealer.
	5. Clogged fuel line (water or dirt)	Change filter cartridge. Check condition and connections of fuel lines. Check the cleanliness of fuel tank.
	6. Faulty carburetor	First make primary adjustments on carburetors. (See Maintenance Section). If carburetors are still faulty, contact your dealer for repair.
	7. Too much oil in fuel	Drain the fuel tank and refill with the correct gas/oil mixture.
	8. Engine timing	Engine timing may be defective or out of adjustment. Contact your dealer.
	9. Poor engine compression	Running with a lean fuel mixture may produce excessive engine wear resulting in poor engine compression. If this occurs, contact your dealer at once.
Engine will not turn manually	1. Seized engine	In the case of seized engine contact your dealer. Seizure is a direct result of poor lubrication or use of improper type of oil. Incorrect fuel/oil ratio.

TOOLS

As standard equipment each new snowmobile is supplied with a basic tool kit such as screwdriver, wrenches, emergency starter rope, etc...

Standard Tools

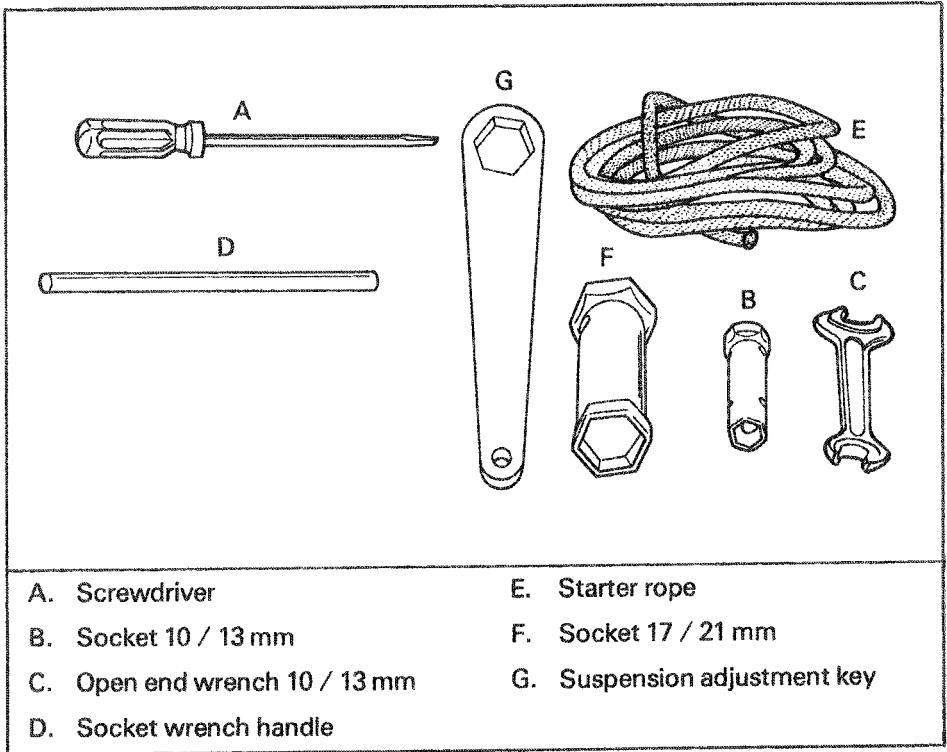

SPECIFICATIONS

EVEREST 444 LC	
ENGINE	
No. of cylinders	2
Bore	69.5 mm (2.736 in.)
Stroke	57.5 mm (2.264 in.)
Displacement	436.3 cm ³ (26.6 in. ³)
Compression ratio (corrected)	6.7
Carburetor type	Mikuni VM 34-150
Carburetor adjustment:	
— air screw	1 1/2 turn out + 1/4 - 0
— idle speed	1500-1800 R.P.M.
Engine head nuts (torque)	39 N•m (28 ft-lbs)
Cooling system	4.26 liters
capacity	150 ounces
	144 ounces
Thermostat	110°F
Radiator pressure cap	13 lbs
CHASSIS	
Overall length	268.6 cm (105 3/4 in.)
Overall width	92.1 cm (36 1/4 in.)
Overall height	104.1 cm (41 in.)
Ski stance (center to center)	71.2 cm (28 in.)
Ski alignment (toe out)	3 mm (1/8")
Weight	215.5 kg (475 lbs)
Bearing area	8710 cm ² (1350 in. ²)
Ground pressure	2.456 kPa (.352 lb-in. ²)
POWER TRAIN	
Track dimensions	41.9 cm (16 1/2") x 314.9 cm (124")
Track tension	13 mm (1/2") gap that should exist between slide shoe and bottom inside of track
Track alignment	Equal distance between edges of track guides and slider shoes
Std. gear ratio	20/34
Chaincase oil capacity	256 mL (9 oz.)
Drive belt (minimum width)	3 cm (1 3/16")
ELECTRICAL	
Lighting system (output)	12 volts, 140 watts
Headlamp bulb	45/45 W
Tail/stop light	5/21 W
Spark plug (Bosch) (normal use)	W-260-MZ-2
(severe use)	W-280-MZ-2
Spark plug (gap)	0.50 mm (.020")
Breaker points (gap)	0.35-0.45 mm (.014-.018 in.)
Advanced ignition timing (B.T.D.C.)	2.25-2.45 mm (0.088-0.096")
FUEL	
Tank	27.3 liters
capacity	6 gals
	7.2 gals
Gasoline	Regular
Gas/oil ratio	50/1
BRAKE	
Brake type	Disc, self-adjusting
Brake adjustment (control lever)	13 mm (1/2") minimum distance from handlebar grip when fully applied
Brake lining (minimum thickness)	3 mm (1/8")

*International System

Bombardier Limited reserves the right to make changes in design and specifications and/or to make additions to, or improvements in its product without imposing any obligation upon itself to install them on its product previously manufactured.

HOW TO IDENTIFY YOUR SNOWMOBILE

The main components of your snowmobile (engine, track and frame) are identified by different serial numbers. It may sometimes become necessary to locate these numbers for warranty purposes or to trace your snowmobile in the event of theft.

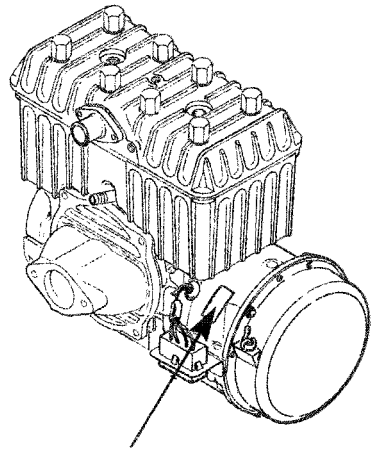

ENGINE
SERIAL
NUMBER

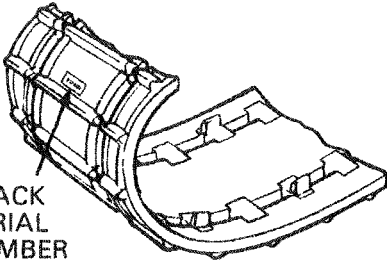

TRACK
SERIAL
NUMBER

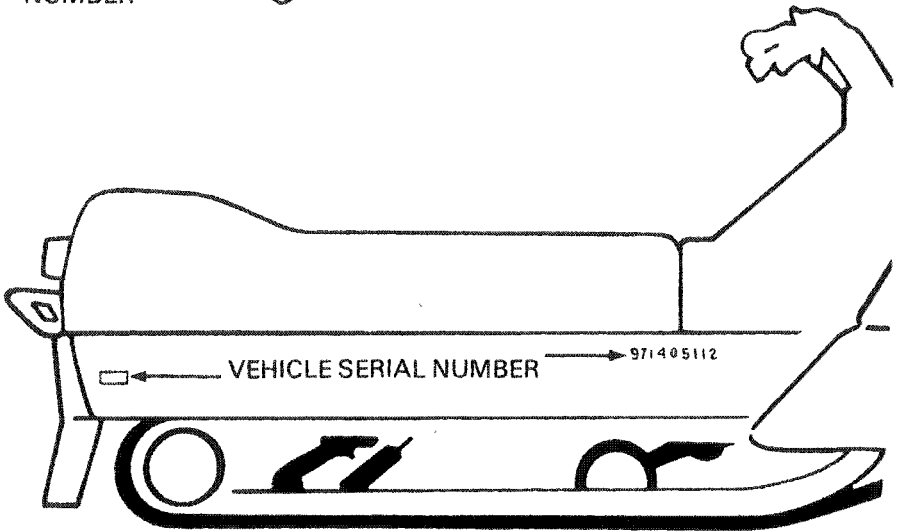

VEHICLE SERIAL NUMBER

971405112

○ **NOTE:** We strongly recommend that you take note of all the serial numbers on your vehicle and supply them to your insurance company. It will surely help in the event a snowmobile is stolen.

LIMITED WARRANTY SKI-DOO® SNOWMOBILES

BOMBARDIER Limited as manufacturer, warrants FROM THE DATE OF FIRST CONSUMER SALE, every 1979 Ski-Doo® snowmobile, sold as NEW AND UNUSED, by an authorized SKI-DOO dealer, subject to the following limitations and conditions, for a period of:

- **two (2) seasons maximum** for models:
Elan®, Olympique*, Citation*, Everest®, Elite®.
- Warranty **STARTS** on the date of sale to the first consumer and **ENDS** the **SECOND APRIL 30TH** following the date warranty coverage started.
- **Ninety (90) consecutive** days for the following models:
Blizzard® 5500-7500-9500 and Alpine® subject to the following:
 1. When a sale is made after **MARCH 31ST** of a given year but before **THE 1ST DAY OF DECEMBER** of the same year, the warranty will start on **DECEMBER 1ST** following the date of sale.
 2. When a sale is made on / or after **JANUARY 2ND** of a given year, the unused portion of the **90 days** warranty as of **MARCH 31ST**, of that year will be carried over to the next season, beginning the **1ST DAY OF DECEMBER**.

Any 1979 model not listed above is not warranted.

WHAT BOMBARDIER WILL DO

BOMBARDIER will repair and / or replace, at its option, components defective in **material and / or workmanship (under normal use and service,)** with a genuine BOMBARDIER component without charge for parts or labour at any authorized SKI-DOO dealer during said warranty period.

EXCLUSIONS

Items and components:

Any of the following expendable items and / or components that are damaged or worn due to normal use: variable speed drive belt, windshield, filters, ignition breaker points, condensers, spark plugs, light bulbs, protective lenses, brake linings, ski runner shoes, slider shoes on suspension and variable speed pulleys, labels, soft trim, appearance items, lubricants and paints and all tune-ups and adjustments required, seized, melted or holed piston.

Also excluded are:

- Damage resulting from installation of parts other than genuine BOMBARDIER parts.
- Damage caused by failure to provide **proper maintenance** as detailed in the **Operator Manual** supplied with each SKI-DOO snowmobile. The labour, parts and lubricants cost of all maintenance services, including tune-ups and adjustments will be charged to the owner.
- Damage resulting from improper servicing or adjustment of the drive pulley assembly. **The drive pulley assembly is factory sealed, and can only be serviced by an authorized SKI-DOO dealer.**
- Vehicles used for racing purposes.
- Vehicles used for rental or other business purposes.
- All optional accessories installed on the vehicle.
(The normal warranty policy for parts and accessories if any, applies).

- Damage resulting from operation of the snowmobile on surfaces other than snow.
- Damage resulting from accident, fire or other casualty, misuse, abuse or neglect.
- Damage resulting from modification to the snowmobile not approved in writing by BOMBARDIER.
- Losses incurred by the snowmobile owner other than parts and labour, such as, but not limited to, transportation, towing, telephone calls, taxis, or any other incidental or consequential damages.

Some states or provinces do not allow the exclusion or limitation of incidental or consequential damages, so the above limitation or exclusion may not apply.

CONDITION TO HAVE WARRANTY WORK PERFORMED

Present, to the servicing dealer, the hard copy of the SKI-DOO Customer Registration card given by the selling dealer at time of purchase.

EXPRESSED OR IMPLIED WARRANTIES

This warranty gives you specific rights, and you may also have other legal rights which may vary from **state to state, or province to province.**

Where applicable this warranty is expressly in lieu of all other expressed or implied warranties of BOMBARDIER, its distributors and the selling dealer, including any warranty of merchantability of fitness for any particular purpose; otherwise the implied warranty is limited to the duration of this warranty. However, some states or provinces do not allow limitations on how long an implied warranty lasts, so the above limitation may not apply.

Neither the distributor, the selling dealer, nor any other person has been authorized to make any affirmation, representation or warranty other than those contained in this warranty, and if made, such affirmation, representation or warranty shall not be enforceable against BOMBARDIER or any other person.

CONSUMER ASSISTANCE

If a servicing problem or other difficulty occurs, we suggest the following:

1. Try to resolve the problem at the dealership with the Service Manager or Owner.
2. If this fails, contact your area distributor listed in the operator manual.
3. Then if your grievance still remains unsolved, you may write to us:

Bombardier Limited
 Customer Relations Dept.
 Recreational Product Group
 Valcourt, Quebec, Canada, JOE 2L0

Bombardier Limited reserves the right to modify its warranty policy at any time, being understood that such modification will not alter the warranty conditions applicable to vehicles sold while the above warranty is in effect.

JANUARY 1978

BOMBARDIER LIMITED
 Valcourt, Quebec, Canada, JOE 2L0

*Trademark of Bombardier Limited

® Registered Trademark of Bombardier Limited



OFTEN ASKED QUESTIONS

Q: Why must my snowmobile be registered? After all I do have my original invoice as proof of when I purchased my snowmobile.

A: The information provided by the Customer Warranty Registration card is computerized, and all warranty claims thereafter, are processed by the computer. Without this valuable information on the Warranty Registration Card, we cannot acknowledge warranty or notify owners of a possible recall.

Q: How do I know my vehicle has been registered at the factory?

A: When you bought your snowmobile the dealer should have completed, signed and forwarded us the manufacturer's copy of the Customer Warranty Registration. The hard copy of the card is your proof that the snowmobile is registered.

 Recreational Products Produits Récréatifs		CUSTOMER WARRANTY REGISTRATION ENREGISTREMENT DE LA GARANTIE			
Model No./No du Modèle	Serial No./No de série	Engine Ser. No./No Sér. du Moteur	Track Ser. No./No Sér. Chen.		
<input type="text"/>	<input type="text"/>	* <input type="text"/>	* <input type="text"/>		
Dealer's Name Nom du Concessionnaire	Distributor Code/ Code du distribut.	Dealer Code/ Code du concess.	Date of Sale/ Date de la vente		
<input type="text"/>	<input type="text"/>	<input type="text"/>	<input type="text"/> M. <input type="text"/> D./J. <input type="text"/> Y./A.		
Customer Name Mr./M. Nom du client	First Name/Prénom	Family Name/Nom de famille			
Mrs./Mme Miss/Mlle	<input type="text"/>				
Address/Adresse	<input type="text"/>				
City/Ville	<input type="text"/>				
State/Province—Zip code/Code postal	<input type="text"/>				<input type="text"/>
 	Manufacturer's copy / Copie du manufacturier				<small>Part no. / No de pièce 484 0259 00</small>
* If applicable / s'il y a lieu					

Q: If I sell my snowmobile within the warranty period, will the new owner qualify for the balance of the warranty?

A: Yes, provided the unit has already been registered with the manufacturer.

Q: I bought my snowmobile in O'King County but I snowmobile in Washington County. Can the dealer in Washington County accept to perform warranty work on my snowmobile?

A: *Yes, any authorized dealer in North America can perform warranty repairs, providing the customer warranty registration card is presented.*

Q: Manufacturer does not accept warranty work on seized, scored or melted pistons, why?

A: *From testing and experience, we know that such piston failures can only be caused by detonation or pre-ignition, which are directly related to the following factors and therefore, are beyond the manufacturer's control.*

- *Lean carburetor settings.*
- *Use of no-lead or low-lead gasoline or use of regular gasoline when premium is recommended.*
- *Incorrect oil / gas mixture (too little or too much oil).*
- *Poor quality, outboard or straight mineral oils.*
- *Removal of intake silencer.*
- *Retarded or advanced ignition timing.*
- *Hot spark plug(s) (improper heat range).*

Q: Where can I find information on the lubrication and maintenance of my snowmobile?

A: *In the Operator Manual provided with the vehicle at the time of first sale.*

Q: As I read through the warranty, I find that expendable items are not covered. What are some examples of expendable items?

A: *Expendable items are those subject to wear and tear through normal use. To list a few, light bulbs, spark plugs, brake linings, belts, suspension and ski runner shoes, etc...*

CONSUMER GUIDE

WHEN YOU BUY...

our product you will receive:

SERVICE — from the product itself

SERVICE — from the dealer who sells the product
If, however, the service or product is unsatisfactory,

1st

Return to your dealer's service department and discuss the details of the problem with the manager. He is in a position to help you with all maintenance and service needs. If the matter cannot be resolved, he may want to bring the sales manager or the general manager into discussion.

If the dealer cannot solve the situation.

2nd

Write to your nearest area distributor.

TELL HIM THE FACTS

- Vehicle identification number.
- Date of purchase.
- Name and address of your selling dealer.
- Your name, address and phone number.
- The specific problem.

The matter will receive immediate attention from the distributor's service department.

If at this point your grievance still remains unresolved, contact

3rd

**Bombardier Limited,
Valcourt, P.O. JOE 2L0
Att'n Customer relations**

Provide all necessary details (including names of persons previously contacted). Your problem will be reviewed and instructions will be provided to the persons responsible for product service in your area or we may contact you directly.

LISTING OF AREA DISTRIBUTORS

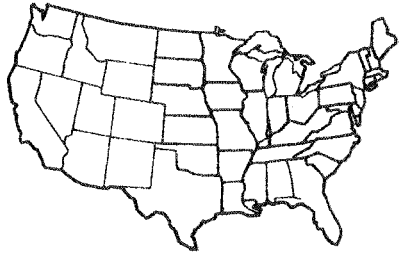

CANADIAN DISTRIBUTORS

ALPINE DISTRIBUTORS LTD
3206 -- 28th Street
P. O. Box 159
Vernon, British Columbia
V1T 6M2
(604) 545-1314
British Columbia

BOMBARDIER LIMITED
Eastern Canada Distribution Division
Atlantic Branch
P. O. Box 670
Shediac, New Brunswick, E0A 3G0
New Brunswick, Nova Scotia, Prince Edward Island,
Magdalen Island

BOMBARDIER LIMITED
Eastern Canada Distribution Division
Quebec Branch
Valcourt, Québec, J0E 2L0
(514) 532-2211
Quebec, Eastern Ontario

BOMBARDIER LIMITED
Eastern Canada Distribution Division
Ontario Branch
28 Currie Street
Barrie, Ontario, L4M 4S2
(705) 728-8500
Ontario, ~~less~~ Eastern of Ontario

BROOKS EQUIPMENT
1616 King Edward Street
P. O. Box 985
Winnipeg, Manitoba, R3C 2V8
(204) 633-7247
Manitoba, Saskatchewan

HUDSON'S BAY CO.
165 Hymus Boulevard
Pointe-Claire, Quebec, M4W 1A8
(514) 697-8500
North-West Territories, Franklin District & Keewatin

J.W. RANDALL LTD
P. O. Box 757
West Street
Corner Brook, Newfoundland, A2H 6G7
(709) 634-3533
Newfoundland, Labrador

TRACT EQUIPMENT LIMITED
14325, 114th Avenue
Edmonton, Alberta, T5M 2Y8
(403) 452-9910
Alberta, Dist. McKenzie, Yukon, N.W.T.

AMERICAN DISTRIBUTORS

CRAIG TAYLOR EQUIPMENT CO.
1049 Whitney Road
P. O. Box 3338
Anchorage, Alaska 99501
(907) 274-9513-14-15
Alaska

ELLIOTT & HUTCHINS INC.
East Main Street Road
Malone, New York
(518) 483-4411
Connecticut, Delaware, Maryland, Massachusetts, New Jersey,
New York, Pennsylvania, Rhode Island, District of Columbia

TIMBERLAND MACHINES INC.
10 North Main Street
Lancaster, New Hampshire 03584
(603) 788-4738
Maine, New Hampshire, Vermont

BOMBARDIER CORPORATION
4505 West Superior Street
P. O. Box 6106
Duluth, Minnesota 55806
(218) 628-2881
North Dakota, South Dakota, Minnesota, Wisconsin, Iowa,
Illinois, Missouri, Michigan, Indiana, Ohio, Tennessee,
Kentucky, West Virginia

BOMBARDIER WEST INC.
609 West Broadway
Idaho Falls, Idaho 83401
(208) 523-6870
California, Nevada, Montana, Idaho, Wyoming, Utah, Colorado,
New Mexico, Arizona, Kansas, Nebraska, Washington, Oregon

THROUGHOUT THE WORLD

BOMBARDIER-ROTAX GmbH
Vienna Branch, P. O. Box 88
Donaufelderstrasse 73-79
1210 Vienna
Austria

COLBJORNSEN & CO. A / S
P. O. Box 80, 1341 Bekkestua
Norway

KY LAATUVAUNU
Italahdenkatu 25
SF-00210 Helsinki 21
Finland

MOVAC AB
BOX 791
S901 -- 10, Umäa
Sweden

CHANGE OF ADDRESS AND OWNERSHIP

Any change in address or ownership should be brought to the attention of the manufacturer by completing and sending out the card supplied below. This will help us to maintain our files up-to-date.

CHANGE OF ADDRESS

VEHICLE IDENTIFICATION NUMBER

--	--	--	--	--	--	--	--	--	--	--	--	--	--	--	--	--	--	--	--

OLD ADDRESS:

NAME		
_____	_____	_____
NO	STREET	APT.
_____	_____	_____
CITY	STATE	ZIP / POSTAL CODE

NEW ADDRESS:

NAME		
_____	_____	_____
NO	STREET	APT.
_____	_____	_____
CITY	STATE	ZIP / POSTAL CODE

CHANGE OF OWNERSHIP

VEHICLE IDENTIFICATION NUMBER

--	--	--	--	--	--	--	--	--	--	--	--	--	--	--	--	--	--	--	--

The ownership of this vehicle is transferred

FROM:

NAME		
_____	_____	_____
NO	STREET	APT.
_____	_____	_____
CITY	STATE	ZIP / POSTAL CODE

TO:

NAME		
_____	_____	_____
NO	STREET	APT.
_____	_____	_____
CITY	STATE	ZIP / POSTAL CODE



BOMBARDIER LIMITED
ATT.: WARRANTY DEPARTMENT
VALCOURT, QUEBEC
CANADA, J0E 2L0

BOMBARDIER LIMITED
ATT.: WARRANTY DEPARTMENT
VALCOURT, QUEBEC
CANADA, J0E 2L0