

ski-doo® **74**
elan*

Owner's Manual

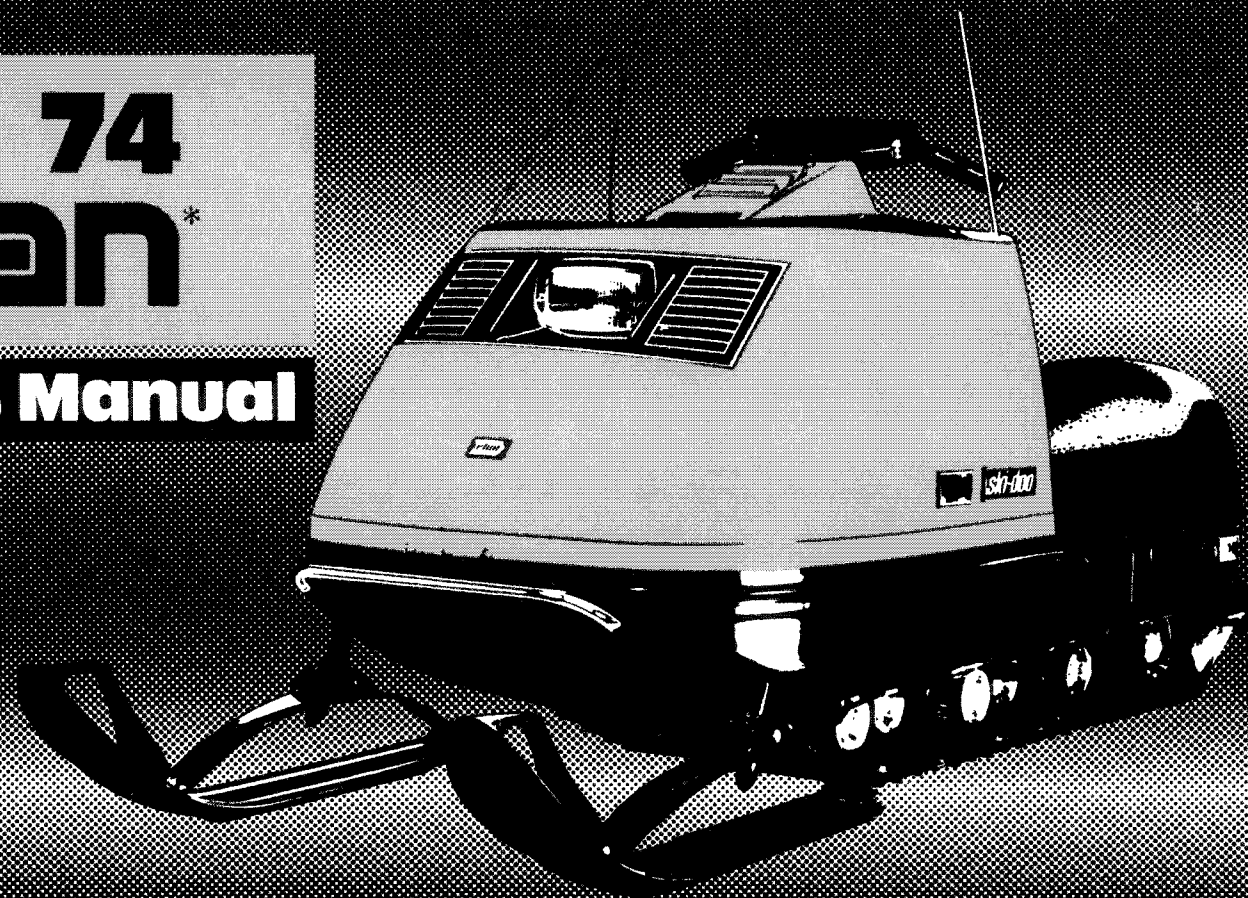

*Registered trademark of Bombardier, Inc.

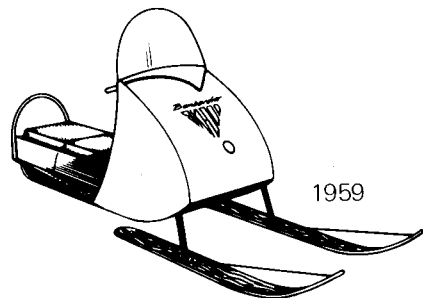

THE YEAR OF OUR MILLIONTH MACHINE

We wish J. Armand Bombardier could be around to see that millionth machine come off the production line this year. What would the inventor of the snowmobile think about today's jet-age styling? Or the incredible technical advances under the sleek cowling? We think he'd be amazed -- and proud.

In this year of the millionth machine, J. Armand Bombardier would have a lot to be proud about. First of all, a million is an impressive number of machines. But there's something more important than quantity. The Ski-Doo* line-up of today reflects all the experience and know-how gained from the making of a million machines.

At Bombardier, we've had time to learn all the tricks of power and flotation. We've found out the pitfalls of operating an engine in freezing conditions over every conceivable winter terrain. And our experience shows. It shows in Ski-Doo* styling, performance and dependability.

Another thing our founder wouldn't recognize is the factory. From its start in a small garage, it's grown into the most advanced snowmobile factory in the world. Bombardier employs designers, engineers, specialists and craftsmen by the thousand. They put every Ski-Doo* through its paces, both in the versatile test laboratory, and on our outdoor speed track.

We've discovered that the best testing ground of all is the race track. We're in racing not only to win, but to learn. This year, we've been able to make some pretty impressive technical improvements to all our machines -- improvements made on the track to help you on the trail.

It adds up to a machine you can depend on, all the time. Your Ski-Doo* will give you excellent performance in all weathers, on all terrains. Look after it well, and it will serve you well. Your Ski-Doo dealer is always ready with information, parts and accessories. He is backed up by an international Ski-Doo distributor and Dealer network whose factory trained personnel are equipped to give you prompt and efficient service wherever you are in snow country.

Ride safe ... and have fun!

Laurent Beaudoin
President
Bombardier Limited

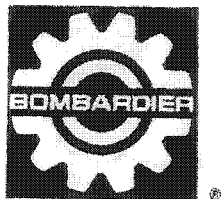

INDEX

*The following are trademarks of Bombardier Limited.

Ski-Doo	T'NT	Bombardier
Ski-Boose	Elan	Elite
Nordic	Blizzard	Everest
Alpine	Carry-Boose	

PATENTS and DESIGNS

This vehicle is covered by one or more of the following patents and design registrations.

Canadian Patents: 605, 317 - 710, 592 - 724, 395 - 853, 505 - 895, 749 - 897, 747 - 914, 457 - 916, 204

United States Patents: 2,899, 242 - 3,066,546 - 3,536,153 - 3,637,254 - 3,666,323 - 3,673,884 - 3,693,884 - 3,693,992 - 3,704,918.

Canadian Designs: D1/217 F/28172 -D1/249 F/31317 and 316 -D32,479 - D32,535 - D32,655 to 657 - D32,661 to '669 - 33,982 -33,933 - 34,006 and '007.

United States Design Patents:

Des. 221,332 to '334-

Des 221,637 and '638-

Des. 222,244 to '247

Others: Swedish Design No. 6038-

Swiss Design No. 104,756-

Norwegian Design No. 51,444.

Other patent and design applications pending.

WHAT YOU SHOULD KNOW	
BEFORE FIRST RIDE.....	2
SERVICE AREAS	3
DO'S	4
DONT'S.....	5
GOOD DRIVING TECHNIQUE... ..	6, 7
CONTROLS/INSTRUMENTS.....	8, 9
FUEL MIXING	10,11
BREAK-IN PERIOD, PRE-START CHECK.....	12,13
IN CASE OF EMERGENCY.....	13
STARTING PROCEDURE	14
LUBRICATION	15, 16, 17
MAINTENANCE	18, 19, 20, 21, 22
EMERGENCY GUIDE.....	23
TROUBLE SHOOTING	24, 25
OFF SEASON STORAGE... ..	26, 27, 28
PRE SEASON PREPARATION.....	29
SPECIFICATIONS	30, 31
WARRANTY	32



WHAT YOU SHOULD KNOW . . . before first ride.

To many of us, Winter is a revealing experience. Weather, atmospheric conditions, snow surfaces, individual driving habits and vehicle usage have considerable affects. We ask that you familiarize yourself with them . . . **read** the owner's manual; it has been prepared to acquaint you with the operation of your vehicle, its safety aspects and systems as well as preventative maintenance procedures that must be periodically upheld . . . all aimed toward a more enjoyable Winter season.

Observe the following precautions:

- Throttle mechanism should be checked for free movement **before** starting engine.
- Engine should be running **only when** pulley guard is secured in place.
- **Never** run engine without drive belt installed. Running an unloaded engine

can prove to be dangerous.

- **Never** run the engine at high R.P.M. when the tracks of the vehicle are raised off the ground.
- It can be dangerous to run engine with the **cab open**.
- Prolonged sitting while riding over rough terrain may cause kidney and/or spinal discomfort, specially for the driver or passenger having an existing back weakness.
- Gasoline is flammable and explosive under certain conditions. Always perform procedures in a well ventilated area. Do not smoke or allow open flames or sparks in the vicinity. If gasoline fumes are noticed while driving, the cause should be determined and corrected without delay.
- **Under no circumstances** should you wear loose clothing or scarves that could become entangled with moving

parts of your snowmobile.

- Your snowmobile **is not** designed to be operated on public streets, road or highways. In most States and Provinces, it is considered an **illegal** operation.
 - Hidden telephone guy wires or roadside ditches can cause serious **accidents**.
 - Your snowmobile **is not** designed to be driven or operated on black top, bare earth, or other abrasive surfaces. Abnormal and excessive wear of critical parts is inevitable.
 - **Always** wear an approved snowmobile safety helmet. Be informed on local laws legislating the sport.
 - Maintain your vehicle in top mechanical condition at all times.
- Please read and understand all other warnings contained elsewhere in this manual.**

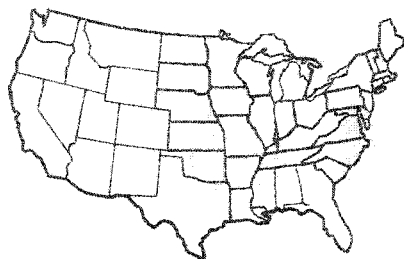

We recommend you contact your local Authorized Ski-Doo dealer when your Ski-Doo snowmobile requires service. However, for further inquiries, you may contact your Regional Distributor listed below.

SERVICE AREAS

CANADIAN DISTRIBUTORS

Name of Distributors	Coverage Area
ALPINE DISTRIBUTORS 3206 - 28th Ave., Vernon, B.C.	British Columbia
ATLANTIC SKI-DOO LTD. P.O. Box 670, Shediac, N.B.	Prince Edward Island Magdalen Island Nova Scotia New Brunswick
BOMBARDIER ONTARIO LTD. 28 Currie St., Barrie, Ont.	Ontario
BOMBARDIER QUE. LTD. 1350 Nobel St. Boucherville, Que.	Quebec
BROOKS EQUIPMENT LTD. Box 985, Winnipeg 21, Man.	Manitoba Saskatchewan
HUDSON'S BAY CO. 121 Richmond W., Toronto, Ont.	North-West Territories
J. W. RANDALL LTD. P.O. Box 757, Corner Brook, Newfoundland	Newfoundland
TRACT EQUIPMENT LTD. 14325 - 114th Ave., Edmonton, Alta.	Yukon Alberta

AMERICAN DISTRIBUTORS

Name of Distributors	Coverage Area
BOMBARDIER EAST INC. Railroad St., Lee, Massachusetts 01238	Massachusetts Connecticut Rhode Island
BOMBARDIER WEST INC. 609 West Broadway, Idaho Falls, Idaho 83401	California Nevada Montana Idaho Wyoming Utah Colorado
CRAIG TAYLOR EQUIPMENT CO. P.O. Box 3338, Anchorage, Alaska 99501	Alaska New Mexico Arizona Kansas Nebraska Washington Oregon
ELLIOTT & HUTCHINS INC. East Main Street Road, Malone, New York 12953	New York Pennsylvania New Jersey Maryland Delaware District of Columbia Virginia
HALVORSON INCORPORATED 325 South Lake Avenue, Duluth 2, Minn. 55802	North Dakota South Dakota Minnesota Wisconsin Iowa Illinois Missouri Upper Michigan
HEATH INTERNATIONAL INC. 33737 - 32 Mile Road, Richmond, Mich. 48062	Lower Michigan Indiana Ohio Tennessee Kentucky Virginia
TIMBERLAND MACHINES INC 10 Main St. North, Lancaster, New Hampshire 03584	Maine New Hampshire Vermont

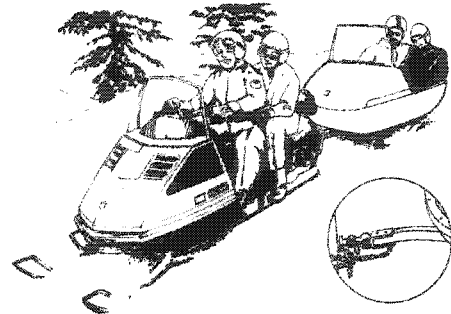
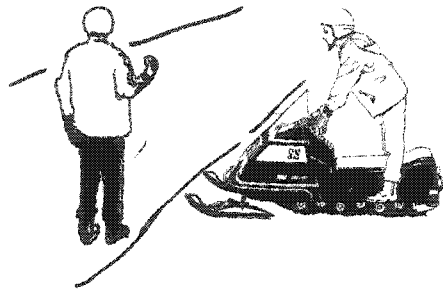

DO'S

- Register your Ski-Doo snowmobile at your nearest Licensing Bureau, where State or Provincial Laws require it, and affix registration to the vehicle. Carry your registration certificate with you. It provides proof of ownership in the event that the vehicle becomes lost or stolen.
- Obtain your State or Provincial booklet on snowmobiling. It gives valuable information on the neighbouring snowmobile trails and the laws governing snowmobiling in your particular area.
- Observe all posted snowmobile signs. Not all private landowners allow snowmobiling on their property. You can have just as much fun, even more so, by traveling elsewhere.

- When with others, limit your actions to the experience of the main body. Show the inexperienced driver how to properly handle a snowmobile.
- Always travel with at least one other snowmobile, especially in unfamiliar terrain or on trail rides. Even in snowmobiling, a pair beats one of a kind.
- If you are planning to explore new areas, leave word of your approximate whereabouts and estimated time of return with someone.
- Always make a full stop then look carefully in both directions before crossing roads. When traveling in pairs or in a group, have one member direct the others across singly.

- Use a rigid hitch or tow-bar when pulling any sled or trailer behind your Ski-Doo snowmobile. Rigid hitches prevent tailgate collision when going downhill or on sudden stops.
- Be extremely careful when giving children a ride. Go more slowly and check frequently. Small children, are far safer in a Ski-Boose* sled than on the seat of your snowmobile.
- When trailering your Ski-Doo snowmobile, secure it solidly at both ends, protect it with a bright cover (Ski-Doo* cover) then check that trailer hitch and safety chain are secure and that brake, flashers, position and parking lights are all in working order.

*Registered Trademark of Bombardier Limited

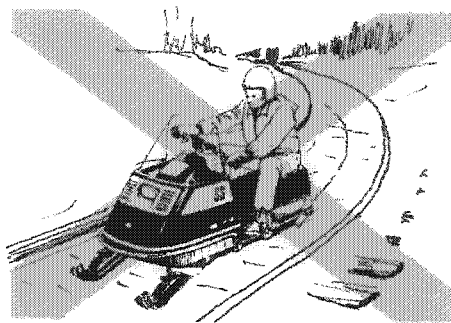

DON'TS

- Don't cut across in front of the line of travel of another snowmobile. Don't tailgate; collision, or the threat of it, is serious with any moving vehicle.
- Don't risk injury or damage to your machine with needless and foolish stunting. Don't "jump" your snowmobile. This part of snowmobiling should be left to the professional "stunt" men.
- **Never** ride on railway tracks. The sound of your moving vehicle drown out noise of approaching trains. Your vehicle may also become caught in track junctions. In many States and Provinces snowmobiling on railway tracks constitutes an infraction of the law.
- Never cut through fences or attempt to run over them.

- Don't cross a river or lake without first being positive that the thickness of the ice is sufficient to support both you and your vehicle. **Your life may depend on it.** If at all in doubt, take an alternate route.
- Unless you are certain of a fueling stop, never travel further than $\frac{1}{2}$ of the fuel remaining in your tank. Even then, leave yourself a safety margin. Remember that a snowmobile does not necessarily travel the same distance each time on the same amount of fuel. A lot depends on speed, snow conditions of the trail and adjustment of the carburetor.
- Don't drive your snowmobile in the vicinity of skiers and keep off ski trails. Always respect the rights of those who enjoy winter in another way.

- **"If you drink don't snowmobile! If you snowmobile, don't drink!"** Remember alcohol and gasoline don't mix.
- Don't lend your snowmobile to inexperienced or under-age drivers. In many cases it is the vehicle owner and not the rider that is responsible for mishaps. Check State or Provincial minimum age limits for drivers.
- Don't leave your keys in the ignition switch. It presents an invitation to thieves and a danger to children.
- Don't get hands or feet in track or moving parts. If your vehicle gets "bogged" down, stand to one side, squeeze the throttle lightly, lift the rear grab handle, and walk out the machine.

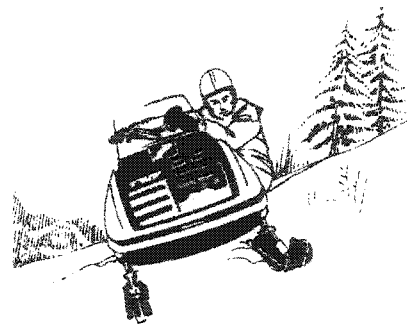
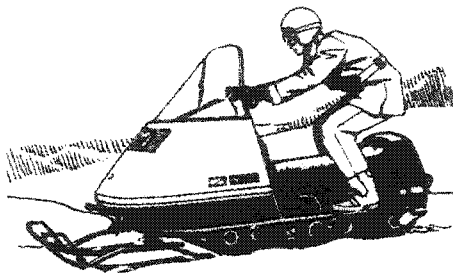
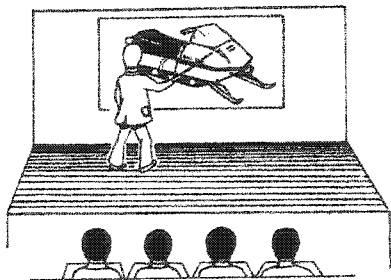

GOOD DRIVING TECHNIQUE

Everyone knows, or should know, the difference between a good snowmobiler and a poor one. Most beginners think that snowmobiling is just a matter of starting the engine and riding away. It's not so. There are right and wrong ways to go about it. Here are some of the preferred methods.

Tips

Where possible, enter a snowmobile training program. Thoroughly know your vehicle and how to drive it before attempting difficult or rapid manoeuvres.

Slide Suspension.

During normal driving, snow will act as a lubricant and coolant for the slider shoes. Extensive riding on ice or sanded snow, (not to mention dirt, asphalt, etc. never recommended) will create excessive heat build up and cause premature slider shoe wear.

Driving Positions.

There are three driving positions on a snowmobile—Standing, Kneeling or Sitting. Each presents certain advantages depending on the nature of the terrain, snow conditions, the turns you desire or the personal preference of the driver.

Standing—This position is undoubtedly the best for climbing steep hills, traveling a short stretch of bumpy trail or when manoeuvring in deep snow. In this position, however, always keep your knees slightly flexed to absorb surface shocks.

Kneeling—crossing a steep slope, for example, from side to side, you will find the kneeling position a definite advantage. Place one foot on the footboard (on the high side of the hill), the opposite knee on the seat then lean into the hill.

Warning: Side hills and steep slopes are not recommended for a beginner.

An alternate recommended kneeling position and one that is frequently used, is to place both knees on the seat, with one foot on each side, loosely pressing against the seat.

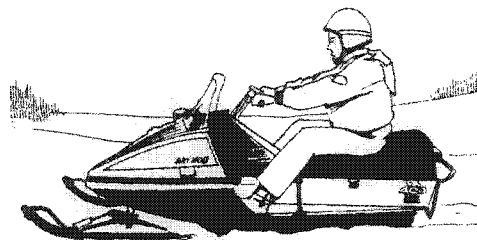
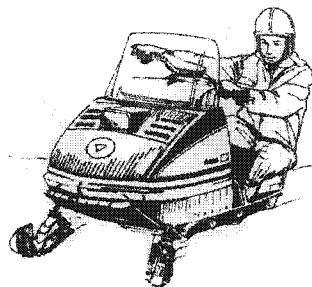
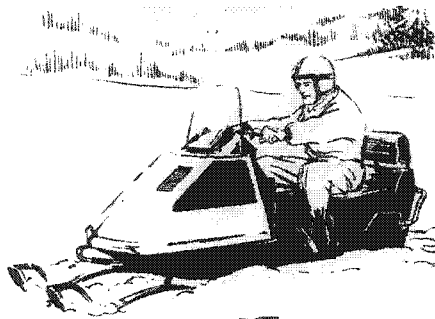

Sitting—for all normal driving. Feet should be on the footboards, body mid-way back on the seat. **Avoid** placing your foot inside the support braces of the footboard.

Warning: Prolonged sitting while riding over rough terrain may cause kidney and/or spinal discomfort, specially for the driver or passenger having an existing back weakness.

Turning.

To snowmobile properly you must learn to "body english", (using the weight or position of your body). Shifting to left or right as the turn demands and keeping your center of gravity as low as possible will give you the mark of an experienced snowmobiler.

Moving your body weight toward the front of the vehicle, particularly in hard-packed snow, adds pressure to the skis and ski runners so that they bite more deeply into the snow surface.

Icy Surface.

Ice or extremely hard-packed snow can be difficult to negotiate as both skis and track do not have much traction. Best advice is to slow down and avoid rapid acceleration or braking.

Deep Snow.

Use the standing position recommended earlier and if your vehicle continues to make reasonable headway, responding to light changes in acceleration, you are safe enough to explore new areas. If not, turn in as wide an arc as possible and look for firmer trails.

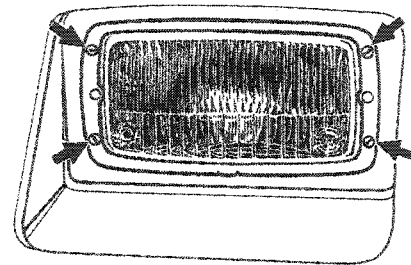
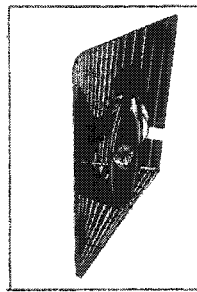
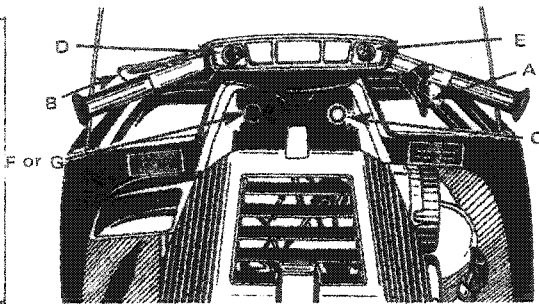
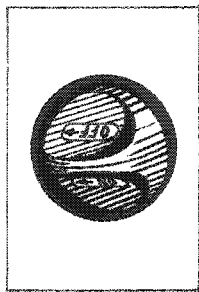

CONTROLS/INSTRUMENTS

Steering

Rotation of the handlebar causes a push-pull action on the steering linkage and forces the skis to turn in the required direction. Incorporated in the padded handlebar are the dimmer switch, kill button, brake and throttle levers.

Throttle Lever (A)

Located on right side of handlebar. When depressed, the lever controls the **engine speed** and the **engagement of the transmission**. When lever is released the engine speed returns automatically to idle.

Brake Lever (B)

Located on left side of handlebar. When lever is depressed, the brake is applied. When released, it automatically returns to its original position. Braking effect is proportionate to the applied pressure on

the lever.

Ignition/Lights Switch (C)

(Manual Models only)

Key operated, 3 position switch (OFF/ON/LIGHTS). To start engine, first turn key clockwise to ON position. To stop engine, turn key counter-clockwise to OFF position. Turning key fully clockwise, with engine running, illuminates both headlamp and taillight.

Ignition/Light Switch (C)

(Electric Model only)

Key operated, 4 position switch (OFF/LIGHTS/ON/START). To start engine, turn key fully clockwise to START position and hold. Return key to ON position immediately engine has started. To illuminate both headlamp and taillight turn key to LIGHTS position.

Headlamp Dimmer Switch (D)

The dimmer switch, located on left side of handlebar, allows correct selection of headlamp beam. To obtain Hi or Low beam simply depress switch.

Note: The angle of your headlamp beam has been pre-adjusted prior to delivery. Should you wish readjustment, remove headlamp chrome ring and turn upper or lower adjusting screws to obtain desired beam position.

Kill Button (E)

A push button switch located on right side of handlebar. For emergency stops, press button down into **lower** position. Before re-starting engine always depress button into released **upper** position.

The driver of this vehicle should familiarize himself with the function of this

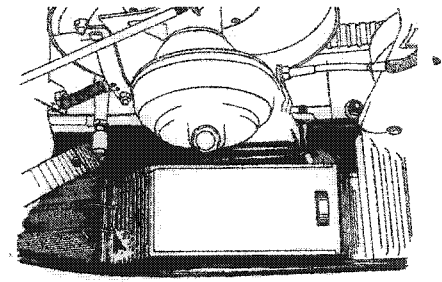
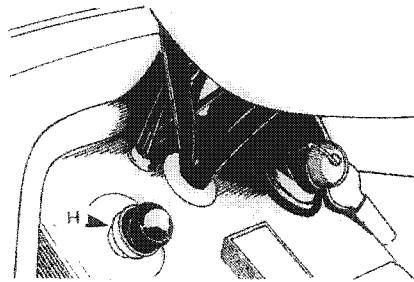

device by using it several times on first outing, thereby being mentally prepared for emergency situations requiring its use. After such a situation, the source of malfunction should be determined and corrected **before** re-starting engine.

Decompressor (F)

(Single cylinder engine only)

Two position, (OFF/ON), push-pull knob, located on left of dashpanel. To engage, pull decompressor knob fully out.

Caution: The decompressor provides easier starting by reducing engine compression. However, leaving decompressor engaged while running will damage your engine. Use decompressor when starting but always disengage immediately engine has started.

Choke (G)

(250, 250E and 250T models)

Two position, (OFF/ON) dial knob, located on lower left side of console. To engage choke, turn dial clockwise to ON position. To disengage, turn to OFF position.

(SS models)

A push-pull button located on left of dashpanel. Pull button to engage choke, push to disengage.

The choke should always be used for easier cold engine starts. After engine is warmed up however, it is not necessary to use choke when starting.

Note: The purpose of the choke is to reduce the amount of air flowing through the carburetor, in effect enriching the

fuel/air mixture.

Primer (H)

(250T model only)

Located on left side of dashpanel. To be used in conjunction with choke for easier cold engine starts. Simply depress rubber bulb once or twice before starting engine.

Manual Starter

Auto-rewind type located at lower right side of console. To start engine, pull handle. (See Starting Procedure).

Warning: It can be dangerous to run engine with cab open.

Tool Box

Sliding cover box located under the cab, alongside the chaincase. To remove box from vehicle, unlock latch, disengage from footrest and lift from vehicle.

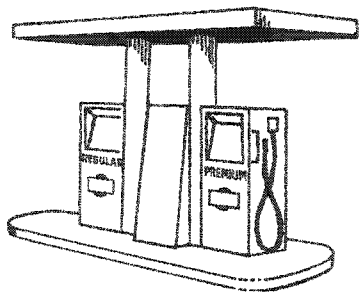

50:1

FUEL MIXING

With Ski-Doo snowmobiles, the **oil** must be added to the **gasoline** in pre-measured amounts then both oil and gasoline should be thoroughly mixed together **before** fueling the tank.

Which Gasoline to Use

On single cylinder models, the correct gasoline is **regular** gasoline, (not less than 92 octane) available from all service stations.

On twin cylinder models, the correct gasoline to be used is **premium** (not less than 98 octane).

Caution: Never experiment with other than recommended fuels or fuel ratios. Never use no lead gasoline †, naphtha, methanol or similar products.

†Tests are not conclusive enough therefore we do not recommend the use of no-lead gasolines.

Which Oil to Use

Use **concentrated** Ski-Doo oil available from your Ski-Doo dealer. This type of oil has specially formulated oil bases to meet the lubrication requirements of the Bombardier-Rotax engine.

Caution: The carburetors of the Ski-Doo snowmobile have been calibrated for a mixture of gasoline and concentrated Ski-Doo oil.

Unless absolutely necessary, do not use regular snowmobile oil, if such oil is used, observe mixing instructions on the container. Never use outboard or straight mineral oils.

Fuel Mixing Ratio

The importance of using the correct fuel mixture cannot be overstressed. Prior experience has shown that an incorrect fuel ratio results in serious engine damage.

Recommended fuel ratio is 50/1.

5 gallons recommended gasoline plus 1 can of Ski-Doo concentrated oil = correct fuel mixture.

Note: To facilitate fuel mixing, oil should be kept at room temperature.

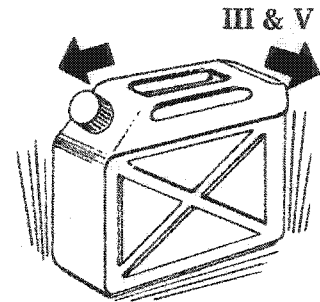
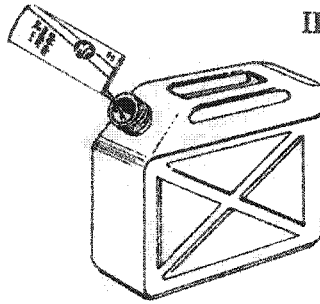
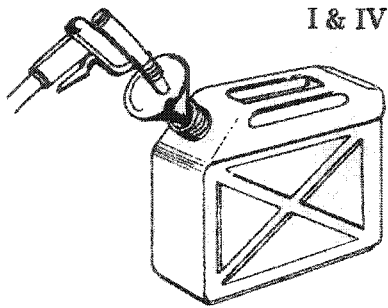

FUEL MIXING

Fuel Mixing Procedure

To mix the gasoline and oil always use a separate clean container. Never mix directly in your snowmobile tank. For best results, acquire two containers, either plastic or metal. Draw from one until empty then use the second one.

Warning: Gasoline is flammable and explosive under certain conditions. Always perform procedures in a well ventilated area. Do not smoke or allow open flames or sparks in the vicinity. If gasoline fumes are noticed while driving, the cause should be determined and corrected without delay. Never add fuel while engine is running.

1. Pour approximately one gallon of gasoline into a clean container.
2. Add the full amount of concentrated Ski-Doo oil.
3. Shake the container thoroughly.
4. Add the remainder of the gasoline.
5. Once again thoroughly agitate the container. Using a funnel with a fine mesh screen to prevent the entry of water and foreign particles, transfer mixture from container into the snowmobile tank.

Note: When using pre-mixed fuel, always shake the container thoroughly as the oil has a tendency to settle.

Warning: Never 'top up' gas tank before placing vehicle in a warm area. At certain temperatures, gasoline will expand and overflow.

Fuel consumption

A good idea is for you to rate the fuel consumption of your snowmobile at the first opportunity. Starting with a full fuel tank, mark the time of your departure then note time elapsed until tank is half-full. Repeat on different occasions to get a mean average of your snowmobiles' consumption and length of running time under varying conditions.

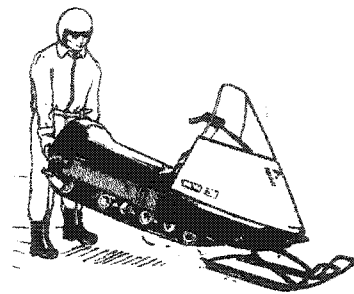
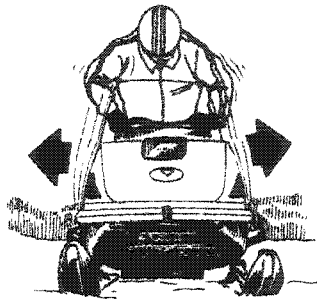
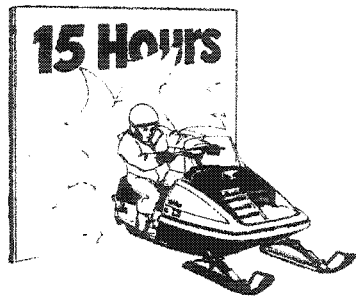

BREAK-IN PERIOD

With Ski-Doo snowmobile engines, a break-in period is required **before** running the vehicle at full throttle. Manufacturer's recommendation for the Bombardier-Rotax engine is 10 to 15 operating hours. During this period, maximum throttle should not exceed $\frac{3}{4}$. However, brief full accelerations and speed variations contribute to a good break-in. Continued wide open throttle accelerations, prolonged 'cruising' speeds and lugging are detrimental during the break-in period.

Inspection

After the break-in period, we suggest that each Ski-Doo snowmobile has an inspection check. This inspection is at the discretion and expense of the vehicle owner.

PRE-START CHECK

Fuel Tank Quantity

Check that there is sufficient fuel in the tank for your trip. A good habit to acquire is to refill the tank before starting out each day.

Since mixed fuel has a tendency to settle overnight, agitate the fuel in the tank by standing on the footboards and rocking the vehicle from side to side.

Track (Daily, before first run)

Under certain climatic conditions, the track of a snowmobile left outdoors overnight may freeze to the ground or snow surface. Always make sure that the track is free before attempting to start the vehicle. (This procedure will eliminate unnecessary drive belt wear).

Steering Operation

Check operation of steering mechanism by rotating the handlebar several times from side to side. If roughness or binding is felt, check for ice or snow that may be blocking the mechanism.

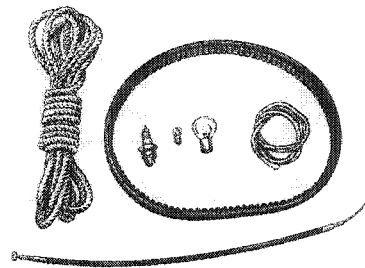
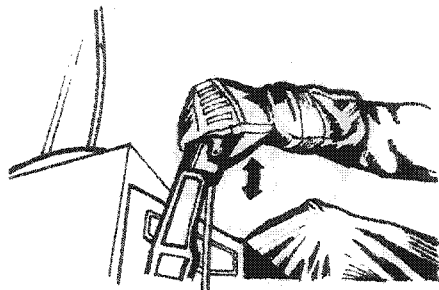

IN CASE OF EMERGENCY

Throttle and Brake

Depress and release levers several times to check that they operate easily and smoothly. The throttle lever should return to the idle position when released. The brake lever should be fully applied when it has minimum clearance from the handlebar grip (see Maintenance, Brake). If the levers do not return swiftly, remove cables and/or housings and replace. Re-check lever operation.

Warning: Throttle mechanism should be checked for free movement before starting engine. Once all components are checked and functioning properly, you can start your Ski-Doo snowmobile.

Emergency situations are accepted hazards with any moving vehicle. A hidden rock or stump on the trail, a burnt light bulb while driving at night, an empty fuel tank while miles from anywhere, can all cause varying degrees of inconvenience. Unlike an automobile, which has a distinct advantage in that service stations are usually within walking distance, **snowmobiles are specifically designed to travel off the highways.** When the unexpected happens, the driver often has only his own ingenuity and that of his companions to return home safely. Fortunately, 9 out of 10 difficulties encountered on the trail can be fixed on the spot. However, you must carry at least a minimum assortment of Tools and Spare Parts to enable you to effect minor repairs.

Emergency Materials

In addition to those tools which the manufacturer provides, you should carry the following:

Tools: General Purpose Pliers—Adjustable Wrench ($\frac{3}{4}$ " opening)—Flashlight.

Spare Parts: Spark Plug—Drive belt—Headlamp and Taillight bulbs—Throttle Cable and Housing—Starting and towing rope—Fuse (electric models).

Important: Always carry spare plugs and drive belt. Check condition of spark plug frequently and look for signs of a fouled or defective plug.

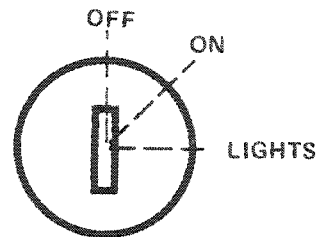
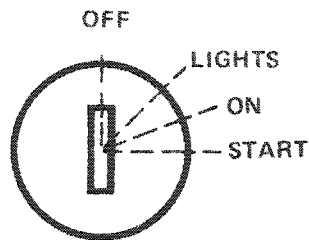
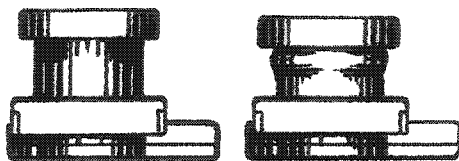

▲ Up before starting engine

▼ Down to stop engine

STARTING PROCEDURE

Warning: Never run the engine at high RPM when the track of the vehicle is raised off the ground.

Note: Before starting the engine make sure the kill button is in the released up-position.

Electric Starting:

1. Insert key in ignition switch.
2. Pull decompressor knob fully out.
3. Engage choke. (Choke is not necessary if engine is warmed up).
4. Test throttle operation then apply throttle lever slightly.
5. Turn ignition key clockwise until starter engages.

Caution: Do not engage starter longer than 30 seconds. If engine does not

start on first try, key must be turned fully back to OFF each time. Allow starter to cool for 2 minutes before repeating procedure.

6. **Release** throttle and key **immediately** engine has started.

7. Disengage choke and push in decompressor knob.

8. Allow the engine to warm up before operating at full throttle

Caution: Never operate the Ski-Doo snowmobile with the battery removed or disconnected.

Manual Starting

1. Insert key in ignition and turn to ON position.
2. Pull decompressor knob fully out. (Single cylinder only)

3. Engage choke. (Choke is not necessary if engine is warmed up).

4. Test throttle operation then apply throttle lever slightly.

5. Grasp manual starter handle firmly and pull slowly until a resistance is felt then pull vigorously and engine will start. Allow handle to return **slowly** to its original position. If engine does not start, repeat the procedure.

Note: Do not pull starting rope to its fullest extent or allow starting handle to "fly back" to its original position.

6. **Release** throttle, disengage choke and push in decompressor, **immediately** engine has started.

7. Allow the engine to warm up before operating at full throttle.

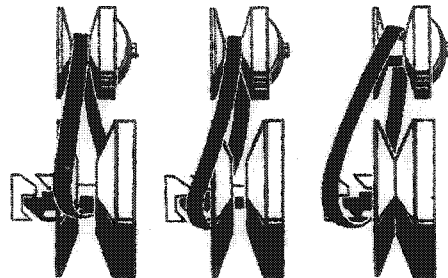
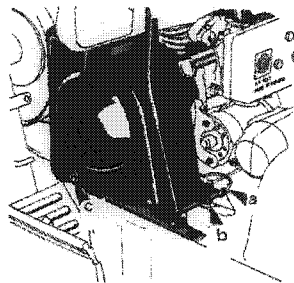
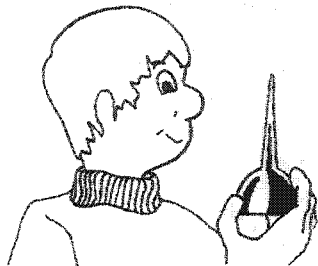

LUBRICATION

Frequency of Lubrication

It is recommended that the steering mechanism and suspension be lubricated monthly or after every 40 hours of operation. However, if the vehicle is operated in wet snow, the suspension and steering system should be lubricated more frequently.

Caution: Both pulleys of the S.S. model, and the driven pulley of other Elan models do not require lubrication. Lubricant will destroy bushing material.

Cab Latches

For those procedures that require cab open, unlock latches on both sides where cab meets frame then lift cab gently up until stopped by restraining device.

Console Removal

For any procedure that may require removal of the console, proceed as follows:

1. Unlock latch and push (jerk) the console in a downward movement.
2. On single cylinder models, slide manual starter handle (right hand side) through slot.
3. Tilt console away from engine and release (unhook) the spring attaching console to engine. To reinstall, reverse procedure.

Pulley Guard Removal

1. Tilt cab and remove console.
2. Pull out retaining clip and pull on spring bolt to disengage pin from bracket.
3. Push pulley guard forward to disengage from frame and lift out from vehicle.

Warning: Engine should be running only when pulley guard is secured in place.

Drive Belt Removal

1. Tilt cab, remove console and pulley guard. (On SS models, unlock and raise driven pulley support).
2. Open the driven pulley, (larger pulley, most forward). Twist and push the sliding half then **hold** in open position.
3. Pull the bottom of belt in toward the front of the driven pulley then slip slackened belt over the top edge of the sliding half.
4. Slip the belt out from the drive pulley (centrifugal governor) and remove completely from vehicle by passing it between muffler and end of driven pulley. To install drive belt, reverse procedure.

Warning: Never run the engine without drive belt installed. Running an unloaded engine can prove to be dangerous.

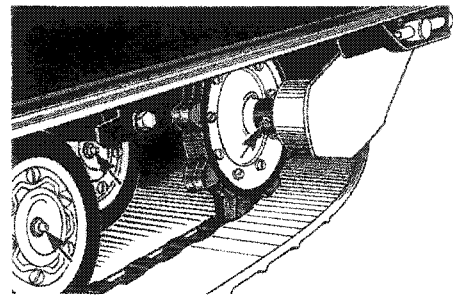
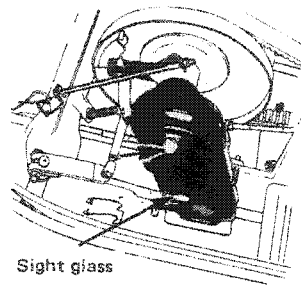
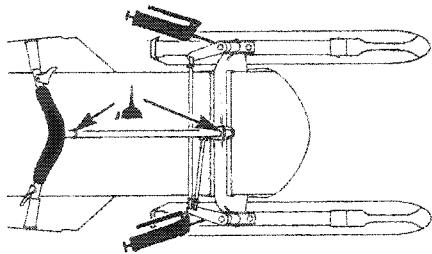

Steering Mechanism

Using light machine oil, lubricate the two steering column bushings. Lubricate the ski legs at grease fittings until new grease appears at the joints.

Chaincase

Each week, check oil level through sight glass of chaincase. The oil level should not be below the bottom of the sight glass. The chaincase has an oil capacity of approximately 8 ozs. To replenish, remove filler cap and refill to level.

Note: Tool box must be removed in order to check chaincase oil level.

Bogie Wheels

Lubricate the suspension bogie wheels with low-temp. grease, using a low pressure grease gun. Pump through the grease fitting at the centre of each wheel until new grease appears at the joint of inner side of shaft.

Rear Axle

Lubricate the rear axle with low-temp. grease. Pump grease through the rear axle fittings.

Caution: Always use a low-pressure grease gun.

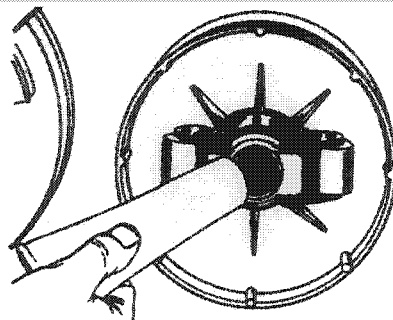
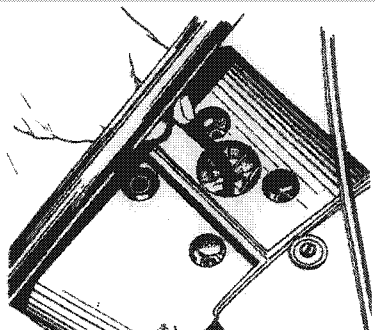

Drive Pulley

(All models except SS)

The drive pulley requires lubrication bi-monthly or every 20 hrs of operation.

1. With cab tilted, remove console, pulley guard and drive belt.
2. Remove centrifugal governor as follows:
 - Remove spark plug and position the piston 3/4" to 1 1/4" **before** top dead center, making sure that the piston closes the exhaust port.
 - Access by the spark plug hole and pack the cylinder with 3/16" dia. rope.

Note: On twin cylinder engine, both spark plugs should be removed and the rope inserted into the left side cylinder (P.T.O. side).

- Pull manual starter to rotate crankshaft until piston bears against "cushioning".
 - Unscrew centrifugal bolt, remove centrifugal governor, outer pulley half and spring. Pull rope from spark plug hole.
3. Thoroughly clean the inner pulley shaft using fine steel wool and a clean cloth. Inspect all components for excessive wear.
 4. Apply a light coat of low temp. grease on the attaching points of the centrifugal levers.
 5. Install spring and outer pulley. Pack inside of pulley. shaft with low temp. grease.

6. Rotate crankshaft until same piston (clutch side) is 3/4" approx. **after** top dead center. Insert rope into same cylinder.

7. Using light machine oil, lubricate the governor bolt threads. Install governor and torque bolt to 33-40 ft/lbs.

Warning: Make sure that the governor bolt is fully tightened before removing rope from cylinder.

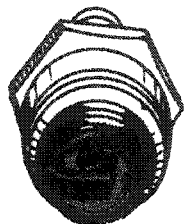

Carbonized

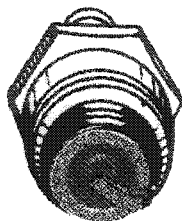

Normal

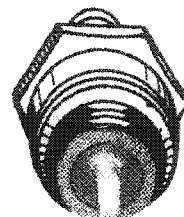

Burnt

MAINTENANCE

Code	Weekly	Page
W1	Spark Plug	18
W2	Battery (electrolyte level)	18
W3	Suspension Springs	18
W4	Track	19
W5	Track Tension	19
W6	Track Alignment	19
W7	Carburetor Adjustment	20
W8	Drive Belt Condition	21
W9	Steering Mechanism	21
W10	Ski	21
Code	Weekly	Page
M1 †	Battery (connections)	21
M2	Carburetor Flange Nuts	21
M3	Drive Belt Wear	21
M4	Brake	21
M5	Steering Adjustment	22
M6	Engine Head Nuts	22
M7	Engine Mount Nuts	22
M8	Muffler Attachment	22
M9	Vehicle General Inspection	22

†Electric Model only)

(W1) Spark Plug

1. Disconnect spark plug wire and remove spark plug.

2. Check condition of plug.

- A brownish tip reflects ideal conditions. (Correct carburetor adjustment, spark plug heat range; etc.).
- A black insulator tip indicates fouling caused by: carburetor idle speed mixture too rich, incorrect fuel mixing ratio, wrong type of spark plug (heat range), or excessive idling.
- A light grey insulator tip indicates a lean mixture caused by: carburetor idle speed mixture adjusted too lean, wrong spark plug heat range, incorrect fuel mixing ratio, or a leaking seal or gasket.

Caution: If, when checking spark plug color, you find that the engine is not running under ideal conditions, contact your authorized Ski-Doo dealer.

3. Reinstall plug and connect wire.

(W2) Battery

Remove battery caps then check electrolyte level at each cell. Electrolyte level must touch bottom of filler hole. If necessary, add distilled water up to this level.

(W3) Suspension Springs

With engine **off**, visually inspect bogie wheel springs and link plate springs. Replace any weak or broken spring.

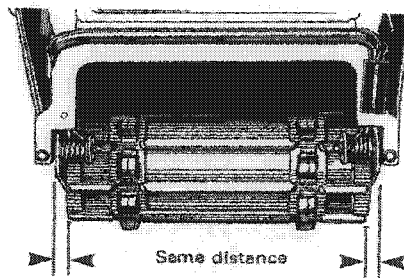
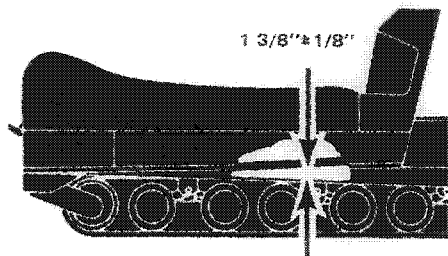

(W4) Track

Lift the rear of the vehicle and support it off the ground so that the track is free to turn. With engine **off**, rotate track by hand and visually inspect track condition. If bad cuts or missing inserts are noted see your dealer.

Note: Without these inserts continual abrasion would wear and cut the track therefore, always replace a missing or damaged insert as soon as possible.

(W5) Track Tension

(Bogie wheel suspension)

Lift the rear of vehicle and support it off the ground. Using a rule, check the track tension from the middle set of bogie wheels. The track tension (distance between top inside edge of track and the bottom of the footboard) should be 1 3/8 inch plus or minus 1/8 inch.

If track tension is too loose, the track will have a tendency to thump. If too tight, performance will be affected.

If necessary to adjust:

1. Using wrench, loosen both track adjusters by unscrewing the lock nuts situated on the inner side of the suspension springs.
2. Adjust to proper tension by turning adjuster bolts clockwise to tighten track, counter-clockwise to slacken. Adjust both sides equally.
3. Proceed with track alignment.

Note: Track tension and alignment are inter-related. Do not adjust one without checking the other.

(W6) Track Alignment

(Bogie wheel suspension)

After track tension has been corrected,

start the engine and accelerate slightly so that track turns **slowly**. Check that track is well centered and turns evenly on the rear sprockets. The distance between the edges of the track and the link plate should be the same on both sides. Misalignment can cause excessive wear of track edges and sprocket teeth.

To adjust:

1. Using wrench, turn track adjuster screw clockwise on the side where the track is closest to the link plate until track aligns.
2. Firmly retighten adjuster lock nuts.
3. Rotate track slowly and recheck alignment.

Warning: Before checking track alignment, ensure that the track is free of all particles which could be thrown out while track is rotating. Keep hands, feet and clothing clear of track.

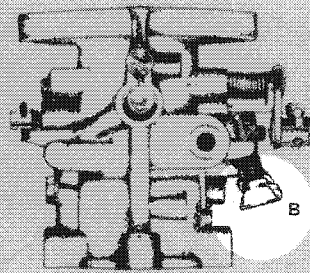
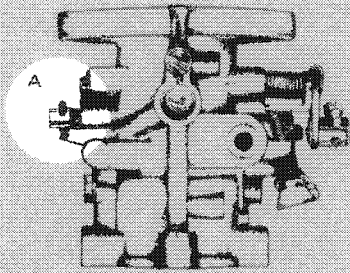

(W7) Carburetor Adjustment

The carburetor adjustments for the Ski-Doo snowmobile are: Maximum Throttle Opening, Idle Speed Mixture and Idle Speed.

Note: A relationship exists between each adjustment. Do not correct one without checking the other.

Maximum Throttle Opening

With engine **off**, unscrew the Idle Speed Adjusting Screw until a gap exists between screw end and carburetor shaft lever. Depress the throttle lever at handlebar and hold. Butterfly should be horizontal when the lever gently touches the handlebar grip.

To adjust for maximum opening, loosen screw at point where cable joins carburetor lever. Hold throttle lever to handlebar. With finger, hold carburetor lever in fully

open position (UP), pull cable downward until taut. Retighten screw.

Warning: Before starting engine, carburetor or throttle lever must return to idle position by contacting the tip of Idle Speed Adjusting Screw. Never start engine unless this situation is verified.

Idle Mixture Adjustment (A)

A primary adjustment (with engine **off**), should be made by first turning Idle Mixture Screw fully clockwise until closed. Back off screw 3/4 of a turn counter-clockwise.

Turning screw clockwise produces a leaner mixture, (more air/less fuel), counter-clockwise, a richer mixture (less air/more fuel).

Note: Do not close too tightly as needle and/or needle seat can be damaged.

For final adjustment, start engine and allow it to warm up. Turn Idle Mixture Screw until engine reaches maximum R.P.M. and obtain a steady idle and a fast response of the engine to the throttle.

Idle Speed Adjustment (B)

Turn the Idle Speed Adjusting Screw clockwise to increase idling speed, counter-clockwise to decrease.

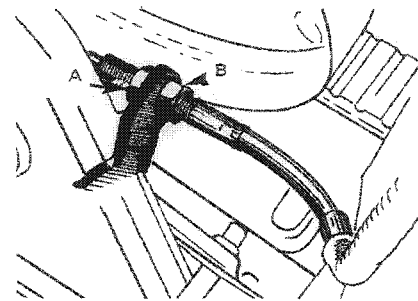
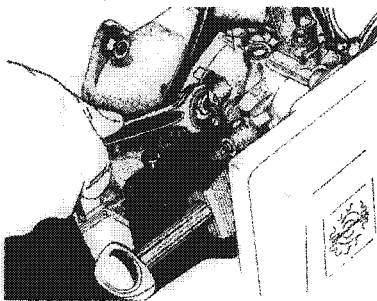
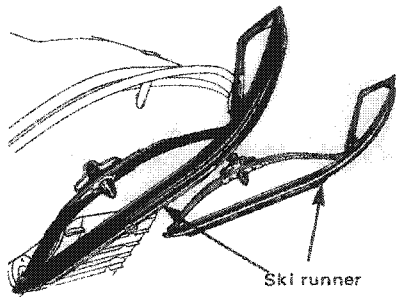

(W8) Drive Belt Condition

To check the condition of the drive belt:

1. With cab tilted, remove the console.
2. Remove pulley guard and drive belt.
3. Check condition of belt. Inspect for cracks, fraying or abnormal wear. (Uneven wear, wear on one side, etc.). If abnormal wear is noted, probable cause is misalignment of drive and driven pulleys. Contact your dealer.

(W9) Steering Mechanism

Inspect steering mechanism for tightness of components (steering arms, tie rods, etc.). Retighten if necessary.

(W10) Ski

Check condition of skis and ski runners. Replace if worn.

(M1) Battery Connections

Check that battery connections are tight and free of corrosion. If not, remove corrosion using a stiff brush then clean with a solution of baking soda and water. Rinse and dry well. After reconnecting, coat battery terminals and connectors with petroleum jelly to prevent corrosion. Check that battery is well secured.

Caution: Do not allow cleaning solution to enter battery. It will destroy the chemical properties of the electrolyte.

(M2) Carburetor Flange Nuts

After the first 2 hours of operation, check tightness of carburetor flange nuts. Open tab locks, tighten nuts and close tab lock.

Caution: The tab locks should be changed after being opened three times.

(M3) Drive Belt Wear

Tilt cab, remove console and pulley guard. Inspect drive belt for wear. If belt is less than 7/8" wide, it should be replaced.

(M4) Brake

The brake mechanism on your snowmobile is an essential safety device. Keep this mechanism in proper working condition. Above all, do not operate your snowmobile without an effective brake system. Check operation of brake mechanism by depressing brake lever. Brake should apply fully while lever is still 1 inch minimum from handlebar grip.

If a **minor** adjustment is indicated: Slacken off cable housing nut **(A)** and tighten nut **(B)** to increase lever clearance. Turn each nut vice versa to decrease.

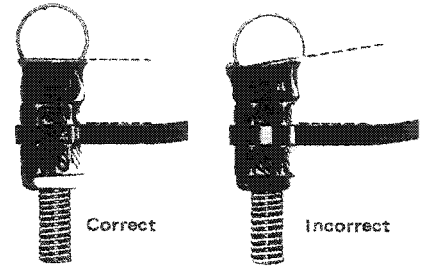
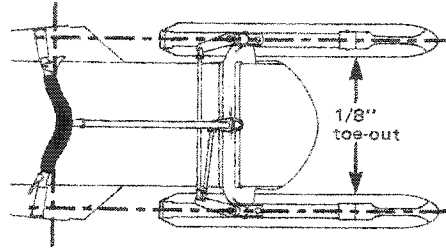
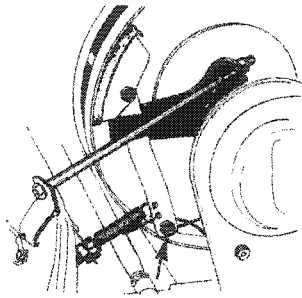

To proceed with **major** adjustment: Slacken off the nut retaining brake cable to lower brake lever. Adjust cable to required length and retighten nut. Ensure that **minor** adjustment nuts are located approximately half way on adjuster threads.

Note: Always check the stop light to see if it functions after performing brake adjustment. If necessary, loosen stop light switch lock nuts and adjust.

(M5) Steering Adjustment

Skis should have a toe out of 1/8". To check, measure distance between skis at front and rear of leaf springs. If necessary to adjust:

1. Using a wrench, loosen the lock nuts of the **longer** tie rod.
2. Turn tie rod manually until skis are

properly aligned.

3. Firmly retighten lock nuts. Handlebar should also be horizontal when the skis are pointed toward front. To adjust:

1. Using a wrench, loosen the lock nuts of the **shorter** tie rod.
2. Turn tie rod manually until handlebar is horizontal.
3. Retighten lock nuts firmly.

Warning: The cut off section of the ball joint must run parallel with the steering arm. When tightening lock nuts, restrain the ball joint with appropriate size wrench.

(M6) Engine Head Nuts

After the first 5 hours of operation, check that engine head nuts are tight and equally torqued (16 to 18 ft/lbs when **cold**). Repeat monthly.

(M7) Engine Mount Nuts

With cab tilted, remove console and pulley guard then check engine mount nuts. Retighten if necessary.

(M8) Muffler Attachment

The engine/muffler attaching parts are vital toward efficient muffler function. Check all attachments and tighten if necessary.

(M9) Vehicle General Inspection

Check electrical wiring, retighten loose connections. Inspect vehicle and tighten loose bolts, nuts and linkage.

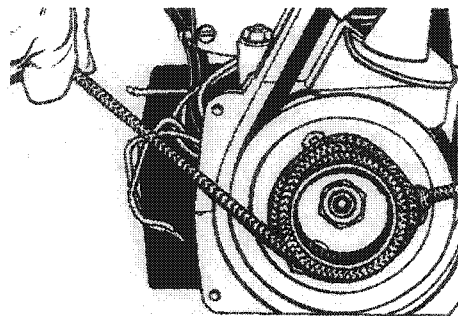
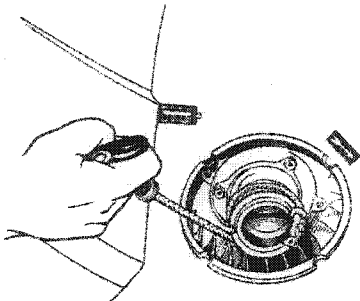
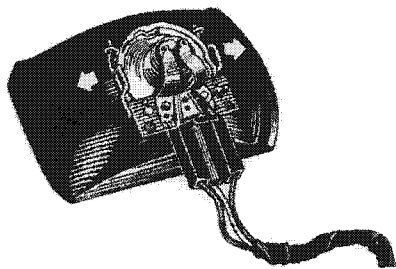

EMERGENCY GUIDE

Burnt Light Bulb

If headlamp is burnt, stop engine, unlock cab latches (2) and tilt cab. Unfasten bulb retainer clips. Detach bulb and replace. If taillight bulb is burnt, expose bulb by removing red plastic lens. To remove, unscrew the two (2) Phillips head screws.

Note: Immediately replace a burnt light bulb. This will prevent the other bulbs from burning out.

Broken Throttle Cable

Remove throttle cable and replace. Check lever operation. If necessary replace housing. **Do not** start the engine until lever returns swiftly.

Broken Rewind Starter Rope

Abuse of the rewind starter may cause the rope to fray and break. Should this situation arise, remove starter unit using 10 mm wrench supplied in tool kit. Transfer rope grip to your emergency rope. Place starter unit in rear compartment. Make a knot at the end of emergency starter rope and wind rope around starter pulley. Pull vigorously as per usual manual start. See your dealer for immediate repair or replacement of starter unit.

Assisting Stranded Vehicles

More than common courtesy dictates that you go to the aid of any snowmobile stranded in the field. Should another vehicle suffer a major breakdown and have to be towed, use one of the following procedures.

On hard pack snow:

Remove the drive belt. Tie the front bumper to your rear bumper. Tow the vehicle and driver back slowly.

In deep snow:

Remove the drive belt. Tie both skis to your rear bumper. Taking the driver with you as a passenger, tow the vehicle back slowly.

Important:

Special attention should be given to the drive components of your vehicle when hauling another of greater weight. Hauling greater weights than your own can cause component damage.

TROUBLE SHOOTING GUIDE

Symptoms	Possible Causes	What To Do
Engine turns over but fails to start or starts with difficulty	1. No fuel to the engine	Check the tank level and fill up with correct gas-oil mixture. Check for possible clogging of fuel line, item 5.
	2. Spark plug	Check for fouled or defective spark plug. Disconnect spark plug wire, unscrew plug and remove from cylinder head. Reconnect wire and ground exposed plug on engine head, being careful to hold away from spark plug hole . Follow engine starting procedure and check for spark. If no sparks appear, replace spark plug. If trouble persists, check item 3.
	3. Faulty ignition	Disconnect spark plug wire from plug, unscrew the spark plug cap then hold wire about 1/8" from the cylinder head. Follow engine starting procedure and if no sparks appear, it means a faulty ignition system. Do not attempt to repair. Contact your dealer.
	4. Flooded engine	Disengage choke, wait 60 seconds or more then depress throttle lever fully and try to start engine. Release throttle lever immediately after engine starts.
	5. Clogged fuel line (water or dirt)	Remove and clean the fuel filter. Change filter cartridge if necessary. Check condition and connections of fuel lines. Check the cleanliness of the fuel tank. Clean tank if necessary. (See Fuel Tank, Storage Section).
	6. Faulty Carburetor	First make primary adjustments on carburetor (See Maintenance Section). If carburetor is still faulty, contact your dealer for repair.
	7. Too much oil in fuel	Drain the fuel tank and refill with the correct gas / oil mixture.
	8. Breaker points	Breaker points may be worn or out of adjustment. Contact your dealer.
	9. Poor engine compression	Running with a lean fuel mixture may produce excessive engine wear resulting in poor engine compression. If this occurs, contact your dealer at once.
Engine will not turn manually	1. Seized engine	In the case of a seized engine, contact your dealer. Seizure is a direct result of poor lubrication.

Symptoms	Possible Causes	What to do
Engine will not start (electric model only). Note: If failure is in starting system, engine will start manually	1. Battery	Check condition at battery by turning lights ON. If lights are dim or out, battery may be discharged or defective. Contact your dealer. If battery is good, check item 2.
	2. Poor connections	Check for loose or corroded battery or starter connections. Tighten and clean if necessary. Try to restart engine electrically.
	3. Starter	If connections are tight and battery is in working order probable cause of trouble is defective starter. Contact your dealer for repair.
Engine lacks acceleration or power	1. Fouled or defective spark plug	Check item 2 of "Engine turns over but fails to start or starts with difficulty".
	2. Clogged fuel line (water or dirt)	Check fuel line condition. (See item 5 of "Engine turns over but fails to start or starts with difficulty").
	3. Carburetor	Readjust the carburetor. (See Maintenance Section). If trouble persists, contact your dealer.
	4. Defective ignition	First check item 2 and 3 of "Engine turns over but fails to start or starts with difficulty". If the ignition system still seems defective, contact your dealer.
	5. Engine	If unable to locate specific symptoms, contact your dealer.
Engine continually backfires	1. Faulty spark plug	Check item 2 of "Engine turns over but fails to start or starts with difficulty".
	2. Overheated	Contact your dealer.
	3. Engine timing incorrectly set	Contact your dealer.
Snowmobile cannot reach full speed	1. Drive belt	Check for defective or worn drive belt. Replace if necessary.
	2. Incorrect track adjustment	Check track tension and alignment. Readjust to specifications. (See Maintenance Section).
	3. Faulty engine	Check item 1 to 5 of "Engine lacks acceleration or power".
	4. Pulley misaligned	Contact your dealer.

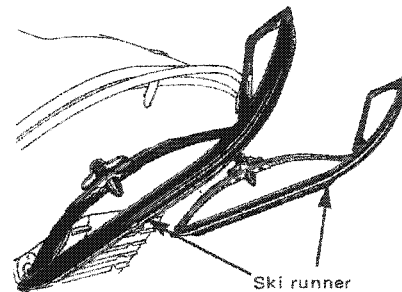
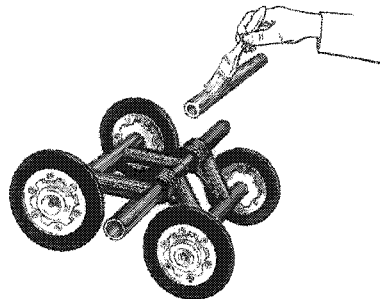
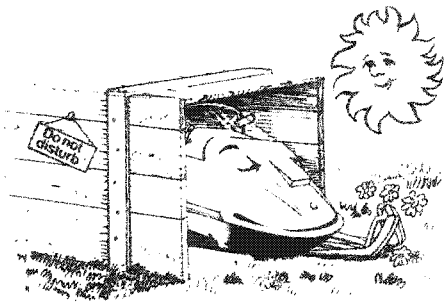

OFF-SEASON STORAGE

It is during Summer, or when a vehicle is not in use for any length of time that proper storage is a **necessity**. Storage of the Ski-Doo snowmobile during long periods of inactivity consists of checking and replacing missing or worn parts: Proper lubrication and treatments to insure that parts do not become rusted; Cleaning items such as carburetor of oil gas mixtures, to prevent gum varnish formation within the carburetor; Battery recharging (electric models); and in general, preparing the vehicle so that when the time comes to use the snowmobile again it will start and be in top condition.

Important: The necessity of proper storage cannot be overstressed. If you lack the time or proper tools, see your authorized Ski-Doo Dealer.

(S1) Track

1. Inspect track for cuts, missing track inserts or broken rods and make any necessary replacement.
2. Lift rear of vehicle until track is clear of ground then support with brace or trestle. The Ski-Doo snowmobile should be stored in such a way that track does not stay in contact with cement floor or bare ground.

Note: The track should be rotated periodically, (every 40 days).

(S2) Suspension (Bogie Wheels)

1. Remove the bogie wheel sets.
2. Remove cross shaft from bogie wheel set. Clean bogie wheel assembly and cross shaft of dirt or rust.
3. Grease each bogie wheel until all old grease is flushed out.
4. Spray bogie wheel springs with metal protector. If unavailable, wipe with cloth

- or rag soaked in oil. Check condition of shaft and replace if bent or worn. Apply a coat of low temp. grease on cross shaft.
5. Reassemble entire bogie wheel set, making sure assembly moves freely.
 6. Reinstall bogie wheel sets.
 7. Lubricate rear hub through grease fittings.

Note: Position the rear bogie wheel set so that the single wheel is towards back of vehicle.

(S3) Ski Assembly

1. Wash or brush all dirt or rust accumulation from skis and springs.
2. Grease ski legs at grease fittings.
3. Check condition of ski runners. Replace if worn.
4. Apply metal protector on ski assembly. If unavailable, wipe the entire ski with cloth soaked in oil to prevent rust formation

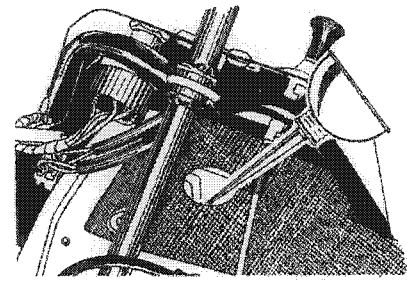
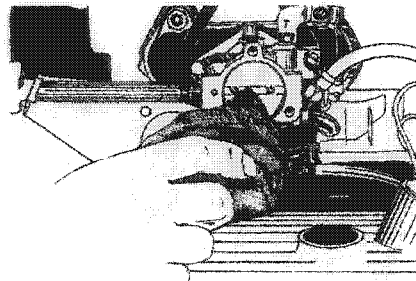
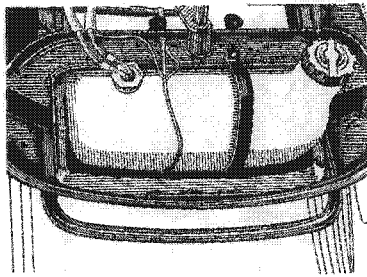

(S4) Fuel Tank

1. Disconnect fuel lines at fuel tank.
2. Remove screw holding tank retainer strap then remove fuel tank from vehicle and drain it.
3. Rinse inside of tank thoroughly with fresh gasoline.
4. Reinstall fuel tank.

Warning: Gasoline is flammable and explosive under certain conditions. Always perform procedures in a well ventilated area. Do not smoke or allow open flames or sparks in the vicinity.

(S5) Carburetor

The carburetor must be dried out completely to prevent gum formation during the storage period.

1. Assure that inlet fuel line is disconnected then start the engine and run it out of gas.

2. Engage choke (turn to ON), then pack the carburetor throat with a clean piece of cloth and turn the engine a few more times. The suction should eliminate the remaining fuel.

3. The air filter incorporated within the console should be cleaned. To do so, remove the bolts and nuts securing back cover of console door and remove foam filter. The filter can be washed in soap and water.

(S6) Cylinder Lubrication

Engine internal parts must be lubricated to protect cylinder walls from possible rust formation during storage

1. Remove spark plug.
2. Operate rewind starter to bring piston at **top** position.
3. Pour about one spoonful of Ski-Doo oil into spark plug hole.
4. Slowly crank engine 10 to 12 times using manual starter.

Caution: To prevent magneto damage, make sure that the ignition switch is at the OFF position.

5. On twin cylinder engine, repeat above steps for other cylinder. Install spark plug.

Note: This operation should be repeated every 40 days during storage.

(S7) Chaincase

Drain the chaincase completely and refill with 8 ozs of fresh Ski-Doo chaincase oil. To drain, open access plug, (lower plug) and tilt vehicle hard left.

(S8) Controls

1. Oil steering mechanism. Inspect components for tightness, (tie rods, ball joints, etc.). Tighten if necessary.

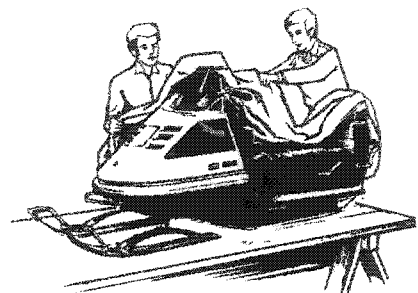
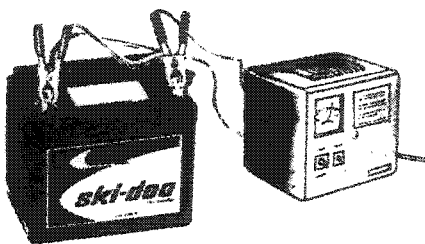

2. Oil moving joints of brake mechanism. **Avoid getting oil on brake lining.**
3. Coat all electrical connections and switches with a greaseless metal protector. If unavailable, use petroleum jelly.

(S9) Pulleys

1. Open the driven pulley (twist and push sliding half) then thoroughly clean driven pulley shaft.
2. On SS models, clean drive pulley shaft as described for other models in Lubrication Section. **Do not** lubricate.
3. On all models, except SS, clean and lubricate drive pulley as outlined in Lubrication Section.
4. Spray internal pulley surfaces with metal protector.

Note: Leave drive belt off during storage period.

(S10) Battery

1. Disconnect battery and remove from vehicle.
2. Clean outside surface of battery with solution of baking soda and water. Remove all deposits from connection posts then rinse with clear tap water.

Caution: Do not allow cleaning solution to enter battery interior since it will destroy the electrolyte.

3. Check electrolyte level in each cell. Refill if necessary using distilled water.
4. Fully charge battery.

Warning: Gases given off by a battery being charged are highly explosive. Always charge in a well ventilated area. Keep battery away from cigarettes or open flames.

5. Coat battery terminals with petroleum jelly.
6. Store the battery in a cool, dry place.

Note: A stored battery will gradually lose its charge and begin to sulphate. If allowed to continue, the battery will become useless and cannot be salvaged. Fully recharge (trickle charge), at least every 40 days. Lack of preventive maintenance could void warranty on this item.

(S11) Chassis

1. Clean the vehicle thoroughly using mild detergents or isopropyl alcohol.
2. Inspect cab and repair damage.
3. Wax the complete cab for better protection.
4. Touch up all worn metal spots where paint has been scratched off.
5. Spray all bare metal parts of vehicle with metal protector.
6. Protect the vehicle with a Ski-Doo cover to prevent dust accumulation during storage.

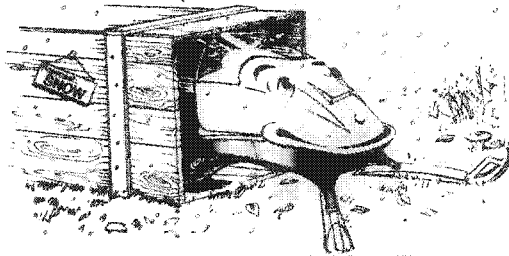

PRE-SEASON PREPARATION

Snow is falling and you are now anticipating the next snowmobile safari. If you have observed and adhered to the storage procedures outlined in this manual, your vehicle preparation becomes a relatively easy task.

To simplify the pre-season preparation we have drawn up a small check list.

Many items have been forementioned in the Lubrication or Maintenance sections of this manual therefore quick and easy reference is possible.

Again we mention, should you lack the time or tools to complete the task, to contact the Ski-Doo dealer of your choice and obtain his professional assistance.

- Spark plug; Change.
- Chain case; Check oil level.

- Pulleys; Clean, lubricate and align drive and driven pulleys.
- Skis; Align.
- Fuel Filter; Change.
- Fuel lines; Connect then check attaching points at tank and carburetor.
- Track; Check tension and alignment.
- Suspension; Lubricate, wipe off excess grease.
- Drive belt; Inspect and install.
- Cables; Check for damage.
- Brake; Inspect lining, adjust.
- Oil seals; Inspect for possible cuts or leaks.
- Engine Timing; Replace breaker points. Set timing.
- Wiring; Check electrical wiring for broken or damaged insulation. Inspect connections.
- Manual Starter; Inspect condition of starting rope.

- Fasteners; Check tightness of all nuts, bolts and linkage. Pay particular attention to engine head nuts—16-18 ft/lbs torque. Governor bolt 33-40 ft/lbs torque.
- Gas Tank; Refill
- Carburetor; Adjust

IMPORTANT: Observe all Warnings and Cautions mentioned throughout this manual which are pertinent to the item being checked. When component conditions seem less than satisfactory, replace with genuine Bombardier parts.

SPECIFICATIONS

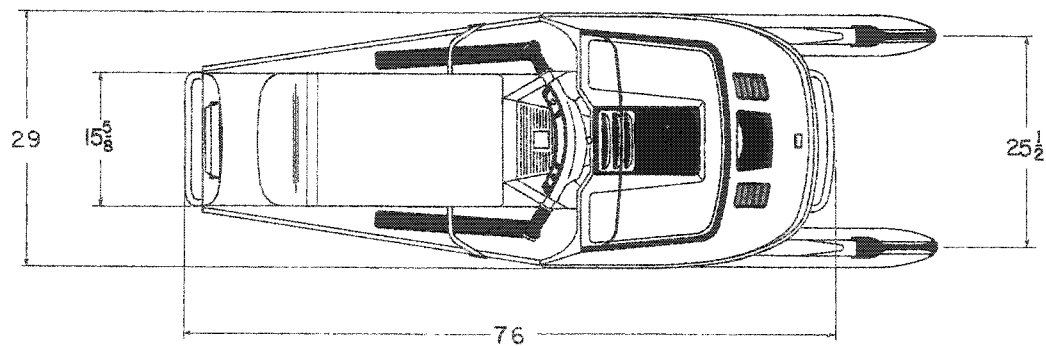
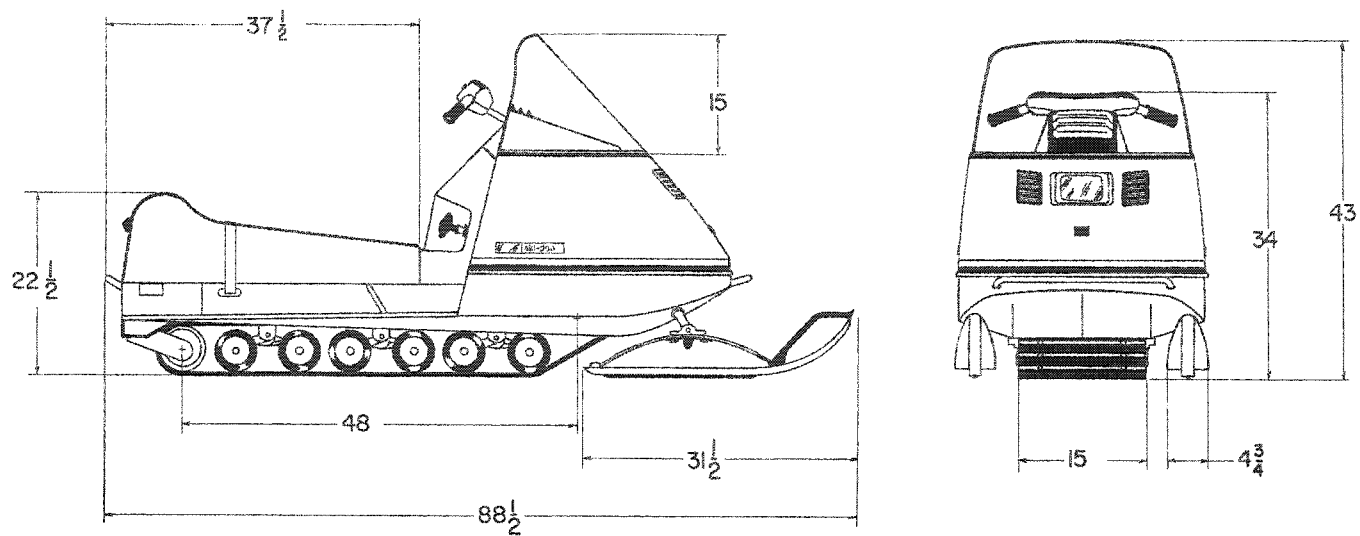

SPECIFICATIONS

MODEL	ELAN	250	250E	250T	250SS	294SS
Engine	No. of Cylinders	1	1	2	2	2
	Bore	69mm	69mm	54mm	54mm	57mm
	Stroke	69mm	69mm	54mm	54mm	57.5mm
	Displacement	246.8cc	246.8cc	247.3cc	247.3cc	293.3cc
	Compression Ratio	7.5/1	7.5/1	11.8/1	11.8/1	11.8/1
	Carburetor	1 X HR	1 X HR	1 X HR	1 X HR	1 X HR
Chassis	Overall Length	88 1/2"	88 1/2"	88 1/2"	88 1/2"	88 1/2"
	Overall Width	29"	29"	29"	30 1/2"	30 1/2"
	Height	43"	43"	43"	43"	43"
	Height w/o Windshield	34"	34"	34"	34"	34"
	Weight (lbs)	280	315	285	315	330
	Bearing Area	1070 sq.in.	1070 sq.in.	1070 sq.in.	1070 sq.in.	1070 sq.in.
	Ground Pressure (P.S.I.)	0.262	0.294	0.266	0.294	0.308
Power Train	Track Width	15"	15"	15"	15"	15"
	Std Gear Ratio	10/25	10/25	14/35	13/34	15/34
Electrical System	Brake Light Coil	23 watts	23 watts	18 watts	18 watts	18 watts
	Lighting Coil	75 watts	75 watts	55 watts	55 watts	55 watts
	Headlamp (watt)	60/60	35/35	35/35	35/35	35/35
	Tail/Stop Light	8/23	8/23	5/18	5/18	5/18
	Spark Plug (Bosch)	M175T1	M175T1	W240T1	W260T1	W260T1
	Spark Plug Gap	.020"	.020"	.020"	.020"	.020"
Voltage Regulator	No	No	Yes	Yes	Yes	
Fuel	Tank Capacity - Imp.	3.5 gals	3.5 gals	3.5 gals	3.5 gals	3.5 gals
	Tank Capacity - U.S.	4.4 gals	4.4 gals	4.4 gals	4.4 gals	4.4 gals
	Gasoline	Regular	Regular	Premium	Premium	Premium
	Gas/Oil Ratio	50/1	50/1	50/1	50/1	50/1
Brake	Type	Drum	Drum	Drum	Drum	Drum

1974 SKI-DOO* WARRANTY

Bombardier Limited (Bombardier) as manufacturer, warrants every 1974 Ski-Doo* snowmobile, (except T'NT F/A)* Ski-Boose* or Carry-Boose* tow sled, SOLD AS A NEW VEHICLE BY AN AUTHORIZED SKI-DOO DEALER, to be free from defects in material, and workmanship under normal use and service, for a period of 12 consecutive months from first date of sale. If defective, repair and/or replacement is valid only at an authorized dealer in Canada or in the United States.

CONDITIONS

- Proof of ownership submitted to the servicing dealer, by means of the Ski-Doo service card.
- Proper maintenance; to be performed at owner's expense.

Guidelines for proper use and maintenance are detailed in each owner's manual.

EXCLUSIONS: Non-warrantable

- Variable speed drive belt, windshield, filters, ignition breaker points, condensers, spark plugs, light bulbs, protective lenses, brake linings, ski runner shoes, slider shoes on suspension and variable speed pulleys, fasteners, labels, soft trim, appearance items, lubricants and paints and all tune-ups and adjustments required.
- Repairs resulting from installation of parts other than genuine Bombardier parts.

- Blizzard models and any vehicle used for racing purpose.
- Any losses incurred to the vehicle owner other than parts and labour.

This warranty is expressly in lieu of all other expressed or implied warranties of Bombardier, its distributors and the selling dealer, including any implied warranty of merchantability of fitness for any particular purpose. Neither Bombardier, its distributors nor the selling dealer shall be responsible, under any circumstances, for any loss or damage as a result of hidden defects, accidents, misuses or other faults.

Neither the distributor, the selling dealer nor any other person has been authorized to make any affirmation, representation or warranty other than those contained in this warranty and if made, such affirmation, representation or warranty shall not be enforceable against Bombardier or any other person.

January 1973
BOMBARDIER LIMITED
Valcourt, Québec, Canada.

Important: Off-season storage and pre-season preparation are at the discretion and expense of the owner. However, any failure which occurs as a result of inadequate seasonal preparation shall not be covered under warranty.

SKI-DOO * SHOP MANUALS

1970- 1971

Completely illustrated, with over three hundred full size pages, the content includes entire sections on Engine—Carburetor— Chassis— Suspension—Electrics—etc. Covers both 1970 and 1971 vehicles.

1972

Over two hundred pages of up-to-date information on Repairs and Servicing Completely illustrated. Everything you'll ever need to know about servicing your 1972 Ski-Doo snowmobile.

1973

Supplement edition of the '72 Shop Manual. Includes the latest design changes and servicing techniques for '73 vehicles.

1974

Complete step by step procedures for vehicle repair. Illustrated. Covers 1974 vehicles. Also included adjustment data on vehicles built '63 through '74.

Reserve your copy now! Send certified cheque or money order to:

Canada

Bombardier Limited,
Technical Information Centre,
8600 Decarie Blvd.,
Montreal 307, P.Q.

U.S.A.

Bombardier East Inc.,
Railroad Street,
Lee, Massachusetts, 01238

To be completed and returned with
a money order or a certified cheque
(Postage included)

NAME

(BLOCK LETTERS)

STREET

CITY

STATE / PROV.

ZIP CODE

SEND ME

1970-71 SHOP MANUAL

1972 SHOP MANUAL

1973 SUPPLEMENT

1974 SHOP MANUAL

*Trademark Bombardier Limited

NOTE: *In the event of change of ownership, complete the notice of transfer form below in order to qualify the new owner for balance of warranty. All such transfers should be reported to an authorized Ski-Doo dealer for modification of the Ski-Doo Service Card. In the event of a lost Service Card, contact the original selling dealer for completion of the "Request for New Service Card" form. For a \$2.00 handling charge, Bombardier will mail your new personalized Service Card to you.*

**Bombardier Limited,
Valcourt, Québec, Canada.**

NOTICE OF TRANSFER

Model Vehicle Serial No
The ownership of this vehicle is transferred
From

Signature of registered owner

To
Full name of purchaser *Block letters*

Address _____
No Street or Village

City County
Date

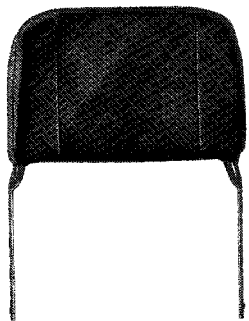

Backrest

- Easily installed on Ski-Doo* snowmobiles.
- Can be attached at two locations—center for driver only rear for passenger.
- Attractive sturdy leatherette and metal construction also available chrome coated.
- Highly recommendable for all snowmobiles carrying more than one passenger.

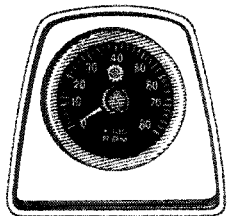

Tachometer

The tachometer registers the impulses of the magneto. Direct-reading dial indicates (in thousands) the number of revolutions per minute (R.P.M.) of the engine. Vital towards maximum performance and engine diagnosis.

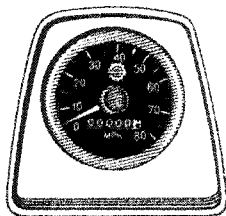

Speedometer

Linked directly to the drive axle. Direct-reading dial indicates the speed of the vehicle in miles per hour (M.P.H.). 6 digit Odometer records the number of miles travelled.

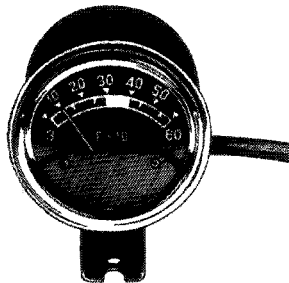

Temperature Gauge

Developed for observing changes in cylinder head temperatures. Features; high sensitivity . . . quick response . . . special heat compensating bi-metal . . . internal illumination and quick connect pick-up unit. Applicable to all models.

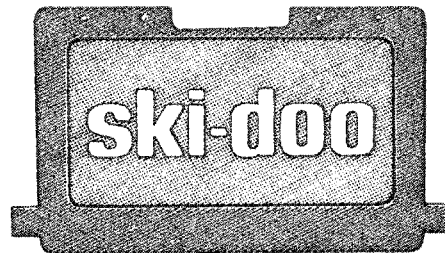

Snow Guard

- Prevents snow from blinding trailing snowmobilers.
- Strong thick rubber ensures long lasting durability.
- Perfectly flexible even under extreme cold.
- A must for all racing snowmobiles and an added precaution for snowmobilers on safari.
- Applicable to all models.

All genuine Ski-Doo parts and accessories are specifically designed to provide you with peak performance. Whether it's for comfort or safety, you know that you can depend on genuine Ski-Doo parts and accessories available only at Ski-Doo dealers across the country.

. . . and the Bombardier corporation is behind them all.

*Trademark Bombardier Limited

This manual has been published by the Technical Information Centre, Bombardier Limited, 8600 Decarie Blvd., Montreal 307, Quebec, Canada.

Suggested Retail Price \$1.00

(First copy free with unit purchased)

Arts Graphiques
de Bombardier Ltée

480-0072 Litho'd in Canada