

*ski-doo*\*

**TNT**

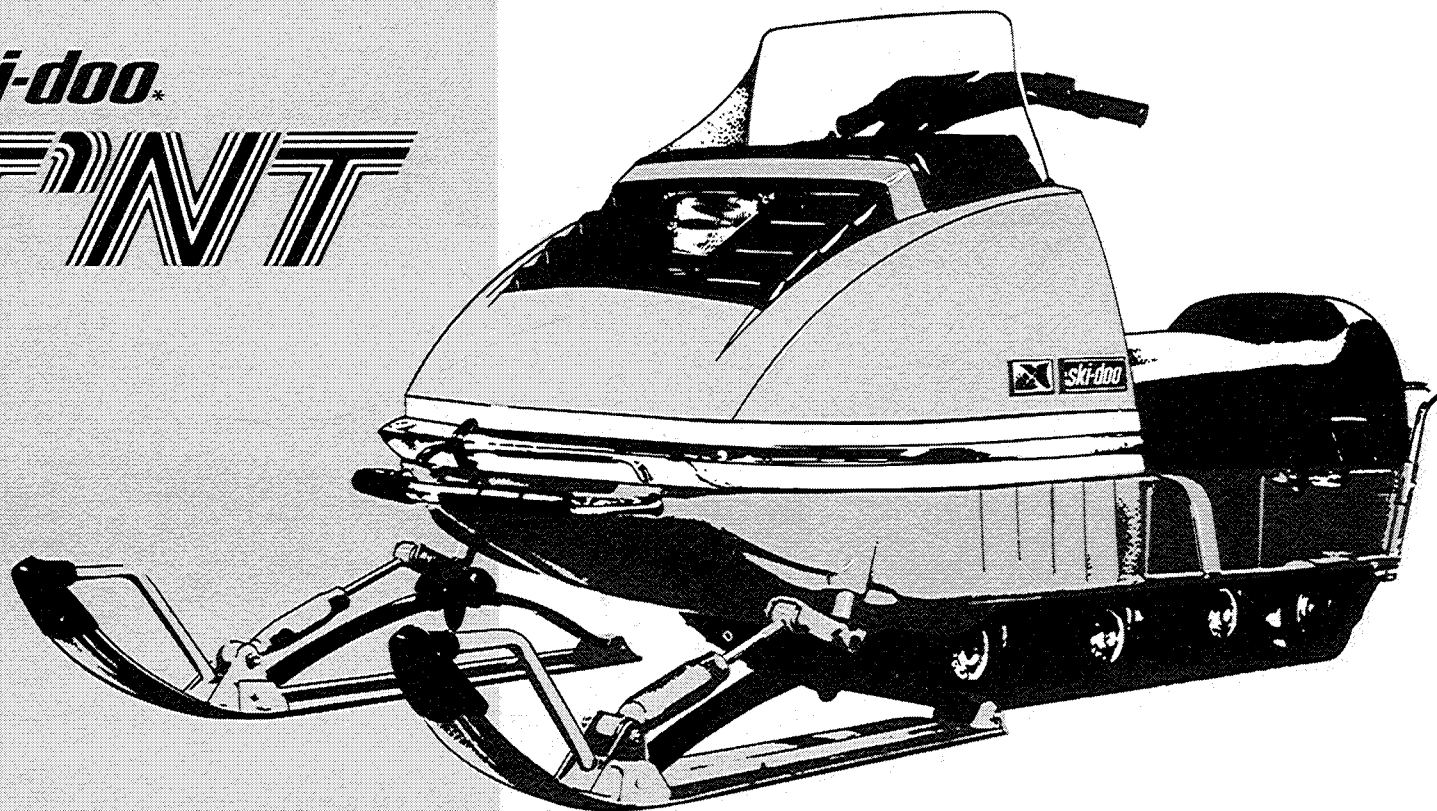

**'73 Owner's Manual**

Trademark Bombardier Limited



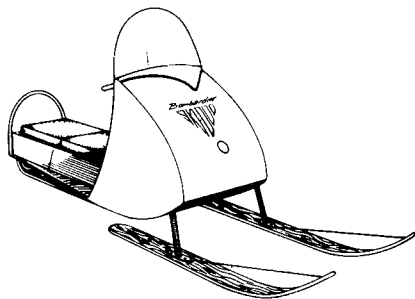

## THE COMPANY THAT CHANGED WINTER HAS CHANGED

In 1957 and 1958, tests began on what is considered the forerunner of the Ski-Doo®. We experimented with many different frames and engines—in search of a light machine for one or two passengers. By the fall of '58, the first prototype was ready. Initial tests made it obvious the machine could hold its own in the recreation market. Production began one year later and 225 machines were sold at about \$1,000 each.

Like its predecessors the '73 Ski-Doo snowmobile is a combination of lightness, economy, strength and dependability. And yet, with all this, it has one other additional feature—personality.

Each model in each series has a complexity of characteristics that distinguishes itself as part of a bold breed . . . **the Ski-Doo snowmobiles.**

At Bombardier, we fully realize that the purchase of a snowmobile is a very important decision. For this reason, we have ensured that each Ski-Doo snowmobile is backed up by an international Ski-Doo Distributor and Dealer Network whose factory trained personnel are equipped to give you prompt and efficient service wherever you are in Snow Country.

Furthermore, each dealer is prepared to serve you with information, parts and accessories. Feel free to contact him.

At this time we would like to thank you for your patronage and welcome you to Winter. Enjoy yourself but remember Safety depends on you, the driver, the condition of your vehicle and nature of the terrain.

All of the information, illustrations and component/system descriptions contained in this manual are correct at the time of publication. However, Bombardier Limited reserves the right to make changes in design and specifications, and/or to make additions to or improvements in its products without imposing any obligations upon itself to install them on its products previously manufactured.

This manual has been published by the Technical Information Centre, Bombardier Limited, 8600 Decarie Blvd., Montreal 307, Quebec, Canada.





## INDEX

\*The following are trade marks of Bombardier Limited

**Ski-Doo**      **Valmont**      **Skandic**  
**Ski-Boose**   **T'NT**        **Carry-Boose**  
**Nordic**       **Élan**            **Bombardier**  
**Alpine**       **Blizzard**

### **PATENTS and DESIGNS**

This vehicle is covered by one or more of the following patents and design registrations

Canadian Patents 605,317 - 710,592 -  
724,395 - 853,505

United States Patents 2,899,242 -3,066,546 -  
3,536,153

Canadian Designs DI/217 F/28172 -DI/249  
F/31317 and '316 -D32,479 - D32,535 -  
D32,655 to '657 - D32,661 to '669 -  
33,982 -33,933 - 34,006 and '007

United States Design Patents  
Des 221,332 to '334 -  
Des 221,637 and '638 -  
Des 222,244 to '247

Others Swedish Design No 6038 -  
Swiss Design No 104,756 -  
Norwegian Design No 51,444

<b>WHAT YOU SHOULD KNOW BEFORE FIRST RIDE.....</b>	<b>2</b>
<b>SERVICE AREAS .....</b>	<b>3</b>
<b>DO'S .....</b>	<b>4</b>
<b>DONT'S.....</b>	<b>5</b>
<b>GOOD DRIVING TECHNIQUE... </b>	<b>6, 7</b>
<b>CONTROLS/INSTRUMENTS.....</b>	<b>8, 9</b>
<b>FUEL MIXING.....</b>	<b>10,11</b>
<b>BREAK-IN PERIOD, PRE-START CHECK.....</b>	<b>12,13</b>
<b>IN CASE OF EMERGENCY.....</b>	<b>13</b>
<b>STARTING PROCEDURE .....</b>	<b>14</b>
<b>LUBRICATION .....</b>	<b>15, 16, 17</b>
<b>MAINTENANCE ....</b>	<b>18, 19, 20, 21, 22</b>
<b>EMERGENCY GUIDE.....</b>	<b>23</b>
<b>TROUBLE SHOOTING .....</b>	<b>24, 25</b>
<b>OFF SEASON STORAGE... </b>	<b>26, 27, 28</b>
<b>PRE SEASON PREPARATION .....</b>	<b>29</b>
<b>SPECIFICATIONS .....</b>	<b>30, 31</b>
<b>WARRANTY .....</b>	<b>32</b>



## WHAT YOU SHOULD KNOW . . . before first ride.

To many of us, Winter is a revealing experience. Weather, atmospheric conditions, snow surfaces, individual driving habits and vehicle usage have considerable affects. We ask that you familiarize yourself with them. **read** the owner's manual, it has been prepared to acquaint you with the operation of your vehicle, its safety aspects and systems as well as preventative maintenance procedures that must be periodically upheld . . . all aimed toward a more enjoyable Winter season.

### Observe the following precautions:

- Throttle mechanism should be checked for free movement **before** starting engine
- Engine should be running **only when** pulley guard is secured in place
- **Never** run engine without drive belt installed. Running an unloaded engine

can prove to be dangerous

- **Never** run the engine at high R P M. when the track of the vehicle is raised off the ground
- It can be dangerous to run engine with the **cab open**.
- Prolonged sitting while riding over rough terrain may cause kidney and/or spinal discomfort, specially for the driver or passenger having an existing back weakness.
- Gasoline is flammable and explosive under certain conditions. Always perform procedures in a well ventilated area. Do not smoke or allow open flames or sparks in the vicinity. If gasoline fumes are noticed while driving, the cause should be determined and corrected without delay
- **Under no circumstances** should you wear loose clothing or scarves that

could become entangled with moving parts of your snowmobile

- Your snowmobile **is not** designed to be operated on public streets, roads or highways. In most States and Provinces, it is considered an **illegal** operation.
  - Hidden telephone guy wires or roadside ditches can cause serious **accidents**.
  - Your snowmobile **is not** designed to be driven or operated on black top, bare earth, or other abrasive surfaces. Abnormal and excessive wear of critical parts is inevitable.
  - **Always** wear an approved snowmobile safety helmet. Be informed on local laws legislating the sport.
  - Maintain your vehicle in top mechanical condition at all times
- Please read and understand all other warnings contained elsewhere in this manual.**



We recommend you contact your local Authorized Ski-Doo dealer when your Ski-Doo snowmobile requires service. However, for further inquiries, you may contact your Regional Distributor listed below.

## SERVICE AREAS

### CANADIAN DISTRIBUTORS

Name of Distributors	Coverage Area
ALPINE DISTRIBUTORS 3206 - 28th Ave . Vernon, B C	British Columbia
ATLANTIC SKI-DOO LTD P O Box 670, Shediac, N B	Prince Edward Island Magdalen Island Nova Scotia New Brunswick
BOMBARDIER ONTARIO LTD 28 Currie St . Barrie, Ont	Ontario
BOMBARDIER QUE LTD 1350 Nobel St Boucherville, Que	Quebec
BROOKS EQUIPMENT LTD Box 985, Winnipeg 21, Man	Manitoba Saskatchewan
HUDSON'S BAY CO 121 Richmond W Toronto, Ont	North-West Territories
J W RANDALL LTD P O Box 757, Corner Brook, Newfoundland	Newfoundland
TRACT EQUIPMENT LTD 14325 - 114th Ave . Edmonton, Alta	Yukon Alberta

### AMERICAN DISTRIBUTORS

Name of Distributors	Coverage Area
BOMBARDIER EAST INC: Railroad St . Lee, Massachusetts 01238	Massachusetts Connecticut Rhode Island
BOMBARDIER WEST INC 609 West Broadway, Idaho Falls, Idaho 83401	California New Mexico Nevada Arizona Montana Kansas Idaho Nebraska Wyoming Washington Utah Oregon Colorado
CRAIG TAYLOR EQUIPMENT CO P O Box 3338, Anchorage, Alaska 99501	Alaska
ELLIOTT & HUTCHINS INC East Main Street Road, Malone, New York 12953	New York Pennsylvania New Jersey Maryland Delaware District of Columbia Virginia

HALVORSON INCORPORATED  
325 South Lake Avenue,  
Duluth 2, Minn 55802

North Dakota  
South Dakota  
Minnesota  
Wisconsin  
Iowa  
Illinois  
Missouri  
Upper Michigan

HEATH INTERNATIONAL INC  
33737 - 32 Mile Road,  
Richmond, Mich 48062

Lower Michigan  
Indiana  
Ohio  
Tennessee  
Kentucky  
W Virginia

TIMBERLAND MACHINES INC  
10 Main St North, Lancaster,  
New Hampshire 03584

Maine  
New Hampshire  
Vermont

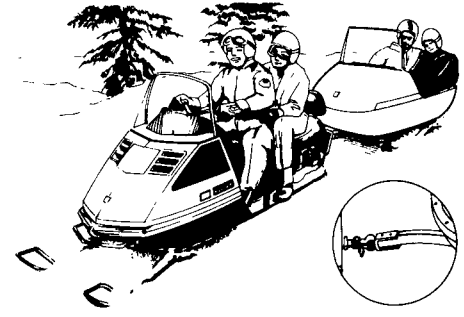
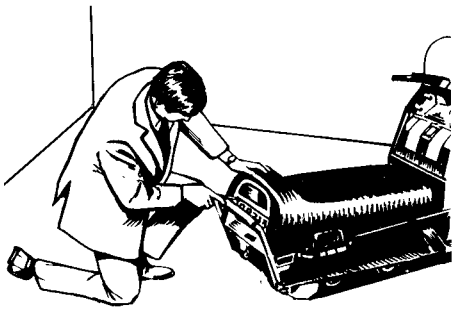

## DO'S

- Register your Ski-Doo snowmobile at your nearest Licensing Bureau, where State or Provincial Laws require it, and affix Registration Plate to the vehicle. Carry your registration certificate with you. It provides proof of ownership in the event that the vehicle becomes lost or stolen.
- Obtain your State or Provincial booklet on snowmobiling. It gives valuable information on the neighbouring snowmobile trails and the laws governing snowmobiling in your particular area.
- Observe all posted snowmobile signs. Not all private landowners allow snowmobiling on their property. You can have just as much fun, even more so, by traveling elsewhere.

- When with others, limit your actions to the experience of the main body. Show the inexperienced driver how to properly handle a snowmobile.
- Always travel with at least one other snowmobile, especially in unfamiliar terrain or on trail rides. Even in snowmobiling, a pair beats one of a kind.
- If you are planning to explore new areas, leave word of your approximate whereabouts and estimated time of return with someone.
- Always make a full stop then look carefully in both directions before crossing roads. When traveling in pairs or in a group, have one member direct the others across singly.

- Use a rigid hitch or tow-bar when pulling any sled or trailer behind your Ski-Doo snowmobile. Rigid hitches prevent tailgate collision when going downhill or on sudden stops.
- Be extremely careful when giving children a ride. Go more slowly and check frequently. Small children, are far safer in a Ski-Boose\* sled than on the seat of your snowmobile.
- When trailering your Ski-Doo snowmobile, secure it solidly at both ends, protect it with a bright cover (Ski-Doo\* cover) then check that trailer hitch and safety chain are secure and that brake, flashers, position and parking lights are all in working order.

\*Trademark Bombardier Limited



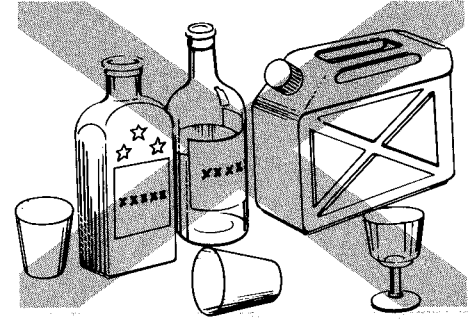
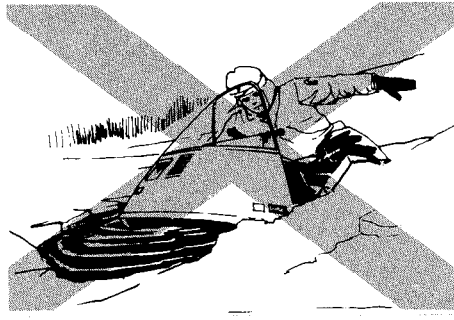
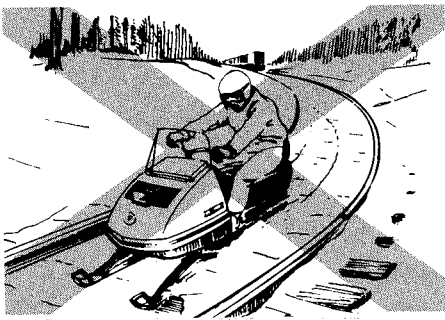

## DON'TS

- Don't cut across in front of the line of travel of another snowmobile. Don't tail-gate, collision, or the threat of it, is serious with any moving vehicle
- Don't risk injury or damage to your machine with needless and foolish stunting. Don't "jump" your snowmobile. This part of snowmobiling should be left to the professional "stunt" men
- **Never** ride on railway tracks. The sound of your moving vehicle drown out noise of approaching trains. Your vehicle may also become caught in track junctions. In many States and Provinces snowmobiling on railway tracks constitutes an infraction of the law
- Never cut through fences or attempt to run over them
- Don't cross a river or lake without first being positive that the thickness of the ice is sufficient to support both you and your vehicle. **Your life may depend on it.** If at all in doubt, take an alternate route
- Unless you are certain of a fueling stop, never travel further than 1/2 of the fuel remaining in your tank. Even then, leave yourself a safety margin. Remember that a snowmobile does not necessarily travel the same distance each time on the same amount of fuel. A lot depends on speed, snow conditions of the trail and adjustment of the carburetor
- Don't drive your snowmobile in the vicinity of skiers and keep off ski trails. Always respect the rights of those who enjoy winter in another way
- **"If you drink don't snowmobile! If you snowmobile, don't drink!"** Remember alcohol and gasoline don't mix
- Don't lend your snowmobile to inexperienced or under-age drivers. In many cases it is the vehicle owner and not the rider that is responsible for mishaps. Check State or Provincial minimum age limits for drivers
- Don't leave your keys in the ignition switch. It presents an invitation to thieves and a danger to children
- Don't get hands or feet in track or moving parts. If your vehicle gets "bogged" down, stand to one side, squeeze the throttle lightly, lift the rear grab handle, and walk out the machine

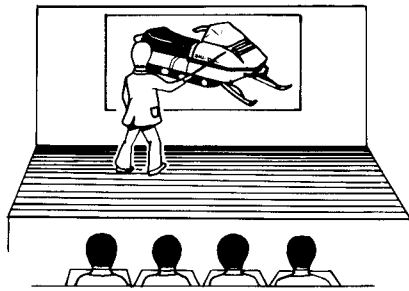

## GOOD DRIVING TECHNIQUE

Everyone knows, or should know, the difference between a good snowmobiler and a poor one. Most beginners think that snowmobiling is just a matter of starting the engine and riding away. It's not so. There are right and wrong ways to go about it. Here are some of the preferred methods.

### Tips

Where possible, enter a snowmobile training program. Thoroughly know your vehicle and how to drive it before attempting difficult or rapid maneuvers.

### Slide Suspension

During normal driving, snow will act as a lubricant and coolant for the slider shoes. Extensive riding on ice or sanded snow, (not to mention dirt, asphalt, etc. never recommended) will create excessive heat build up and cause premature slider shoe wear.

### Driving Positions.

There are three driving positions on a snowmobile—Standing, Kneeling or Sitting. Each presents certain advantages depending on the nature of the terrain, snow conditions, the turns you desire or the personal preference of the driver.

**Standing**—This position is undoubtedly the best for climbing steep hills, traveling a short stretch of bumpy trail or when maneuvering in deep snow. In this position, however, always keep your knees slightly flexed to absorb surface shocks.

**Kneeling**—crossing a steep slope, for example, from side to side, you will find the kneeling position a definite advantage. Place one foot on the footboard (on the high side of the hill), the opposite knee on the seat then lean into the hill.

**Warning: Side hills and steep slopes are not recommended for a beginner.**

An alternate recommended kneeling position and one that is frequently used, is to place both knees on the seat, with one foot on each side, loosely pressing against the seat.

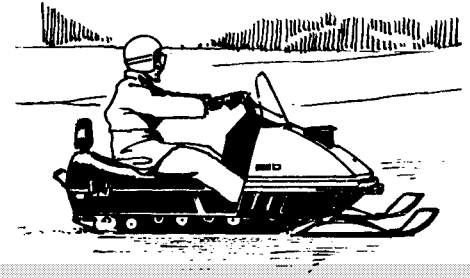

**Sitting**—for all normal driving Feet should be on the footboards, body mid-way back on the seat. **Avoid** placing your foot inside the support braces of the footboard

**Warning: Prolonged sitting while riding over rough terrain may cause kidney and/or spinal discomfort, specially for the driver or passenger having an existing back weakness.**

### **Turning.**

To snowmobile properly you must learn to “body english”. (using the weight or position of your body) Shifting to left or right as the turn demands and keeping your center of gravity as low as possible will give you the mark of an experienced snowmobiler

Moving your body weight toward the front of the vehicle, particularly in hard-packed snow, adds pressure to the skis and ski runners so that they bite more deeply into the snow surface

### **Icy Surface.**

Ice or extremely hard-packed snow can be difficult to negotiate as both skis and track do not have much traction Best advice is to slow down and avoid rapid acceleration or braking

### **Deep Snow.**

Use the standing position recommended earlier and if your vehicle continues to make reasonable headway, responding to light changes in acceleration, you are safe enough to explore new areas If not, turn in as wide an arc as possible and look for firmer trails

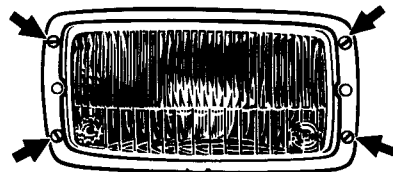
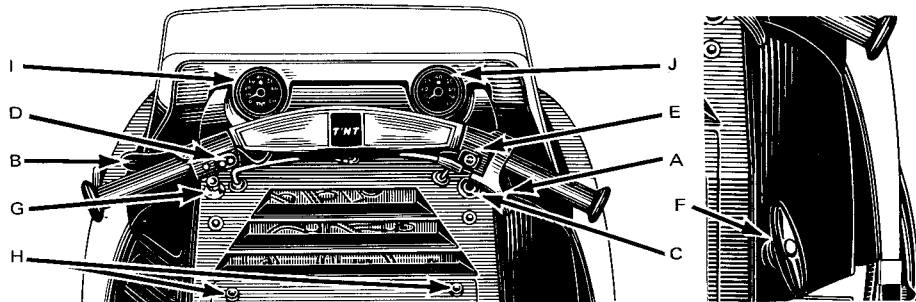

## CONTROLS/INSTRUMENTS

### Steering

Rotation of the handlebar causes a push-pull action on the steering linkage and forces the skis to turn in the required direction. Incorporated in the crash padded handlebar are the dimmer switch, kill button, brake and throttle levers.

### Throttle lever (A)

Located on right side of handlebar. When depressed, the lever controls the **engine speed** and the **engagement of the transmission**. When lever is released the engine speed returns automatically to idle.

### Brake lever (B)

Located on left side of handlebar. When lever is depressed, the brake is applied. When released, it automatically returns

to its original position. Braking effect is proportionate to the applied pressure on the lever.

### Ignition/Lights Switch (C)

Key operated, 3 position switch (OFF/ON/LIGHTS). To start engine, first turn key clockwise to ON position. To stop engine, turn key counter-clockwise to OFF position. Turning key fully clockwise, with engine running, illuminates both headlamp and taillight.

### Headlamp Dimmer Switch (D)

The dimmer switch, located on left side of handlebar, allows correct selection of headlamp beam. To obtain Hi or Low beam simply depress switch.

**Note:** The angle of your headlamp beam has been pre-adjusted prior to delivery. Should you wish readjustment, remove headlamp chrome ring and turn upper or lower adjusting screws to obtain desired beam position.

### Kill Button (E)

A push button switch located on right side of handlebar. For emergency stops, press button down into **lower** position. Before re-starting engine always depress button into released **upper** position.

The driver of this vehicle should familiarize himself with the function of this de-

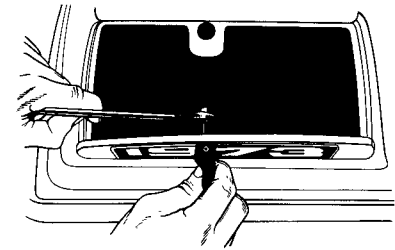
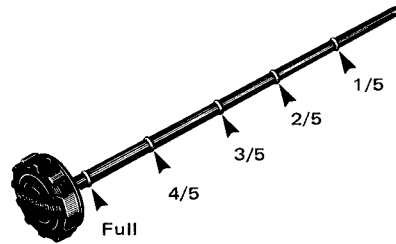
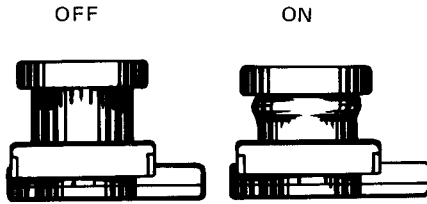

vice by using it several times on first outing, thereby being mentally prepared for emergency situations requiring its use. After such a situation, the source of malfunction should be determined and corrected **before** re-starting engine.

### Manual Starter (F)

Auto-rewind type located at lower right side of console. To start engine, pull handle. (See Starting Procedure)

### Choke (G)

Two position, (OFF/ON) push-pull knob located on upper left side of console. To engage choke, pull knob to ON position. To disengage, fully push knob to OFF position. The choke should be used for easier cold engine starts. After engine is warmed up, however, it is not necessary to use choke when starting.

### Access Door (H)

To gain access to the carburetor turn

the two access door buttons then tilt and remove door.

**Warning: Never operate your snowmobile with the air silencer tube removed or air silencer box door open. Serious engine damage will occur if this notice is disregarded.**

### Tachometer (I)

The tachometer registers the impulses of the magneto. Direct-reading dial indicates (in thousands) the number of revolutions per minute (RPM) of the engine.

### Speedometer (J)

The speedometer is linked directly to the drive axle. Direct-reading dial indicates the speed of the vehicle in miles per hour (MPH). 6-digit Odometer records the number of miles travelled.

### Cab Latches

For those procedures that require cab open, unlock latches on both sides where cab meets frame then lift cab gently up until stopped by restraining device.

**Warning: It can be dangerous to run engine with cap open.**

### Rear Compartment

Recessed underseat compartment. Ideal location for spare plugs, belt, rope, etc. Pressure lock fastened. To adjust lock simply tighten or slacken adjusting nut.

### Fuel Gauge

Graduated dipstick gauge with screw on fuel tank cap. Unscrew cap and withdraw dipstick to check fuel level.

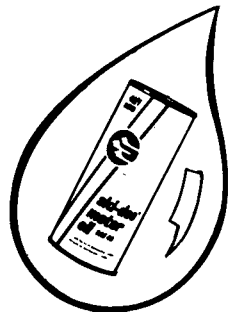
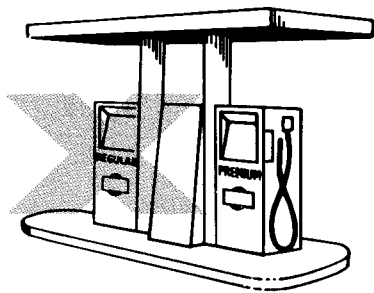

# 40:1

## FUEL MIXING

With Ski-Doo snowmobiles, the **oil** must be added to the **gasoline** in pre-measured amounts then both oil and gasoline should be thoroughly mixed together **before** fueling the tank

### Which Gasoline to Use

On all models the correct gasoline is **Premium** gasoline (not less than 98 octane) available from all service stations

**Caution:** Never experiment with different fuel or fuel ratios. Never use regular or no lead gasoline,† naphta, methanol or similar products

† Tests are not conclusive enough therefore we do not recommend the use of no-lead gasolines

### Which Oil to Use

Use **concentrated** Ski-Doo\* oil available from your Ski-Doo dealer. This type of oil has specially formulated oil bases to meet the lubrication requirements of the Bombardier-Rotax engine.

**Caution:** The carburetors of the 1973 Ski-Doo snowmobile have been calibrated for a mixture of gasoline and concentrated Ski-Doo oil.

Unless absolutely necessary, do not use regular snowmobile oil. If such oil is used, observe mixing instructions on the container. Never use outboard or straight mineral oils.

### Fuel Mixing Ratio

The importance of using the correct fuel mixture cannot be overstressed. Prior experience has shown that an incorrect fuel ratio results in serious engine damage. The correct fuel/oil ratio is 40/1. **5 gallons, premium gasoline plus 1 pint Ski-Doo oil = correct fuel mixture.**

**Note:** To facilitate fuel mixing, oil should be kept at room temperature.

\*Trademark Bombardier Limited

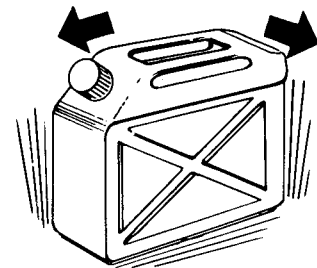
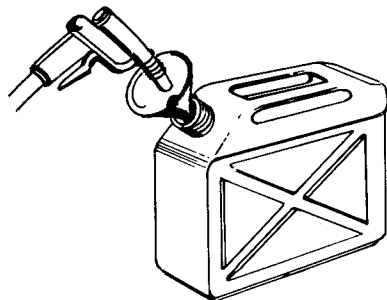
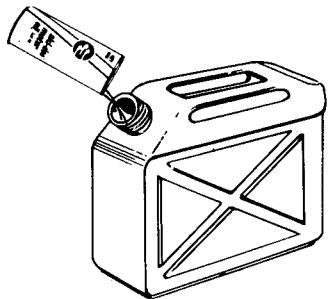

## FUEL MIXING

### Fuel Mixing Procedure

To mix the gasoline and oil always use a separate clean container. Never mix directly in your snowmobile tank. For best results, acquire two containers, either plastic or metal. Draw from one until empty then use the second one.

**Warning: Gasoline is flammable and explosive under certain conditions. Always perform procedures in a well ventilated area. Do not smoke or allow open flames or sparks in the vicinity. If gasoline fumes are noticed while driving, the cause should be determined and corrected without delay. Never add fuel while engine is running.**

- Pour the full amount of Ski-Doo oil required for the total mixture into the container
- Add approximately half the amount of gasoline to be mixed
- Shake the container thoroughly
- Add the remainder of the gasoline
- Once again thoroughly agitate the container
- Using a funnel with a fine mesh screen to prevent the entry of water and foreign particles, transfer mixture from container into the snowmobile tank.

**Note:** When using pre-mixed fuel, always shake the container thoroughly as the oil has a tendency to settle.

**Warning: Never 'top up' gas tank before placing vehicle in a warm area. At certain**

**temperatures, gasoline will expand and overflow.**

### Fuel consumption

A good idea is for you to rate the fuel consumption of your snowmobile at the first opportunity. Starting with a full fuel tank, mark the time of your departure then note time elapsed until tank is half-full. Repeat on different occasions to get a mean average of your snowmobiles' consumption and length of running time under varying conditions.

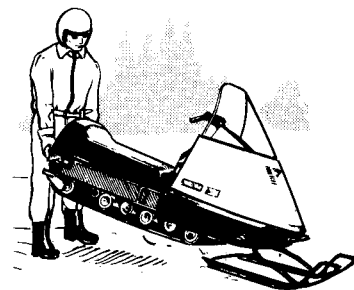
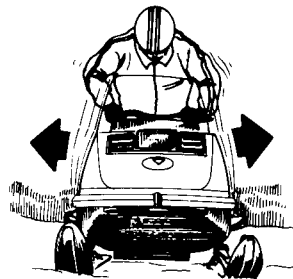

## BREAK-IN PERIOD

With Ski-Doo snowmobile engines, a break-in period is required **before** running the vehicle at full throttle. Manufacturer's recommendation for the Bombardier-Rotax engine is 10 to 15 operating hours. During this period, maximum throttle should not exceed  $\frac{3}{4}$ . However, brief full accelerations and speed variations contribute to a good break-in. Continued wide open throttle accelerations, prolonged 'cruising' speeds and lugging are detrimental during the break-in period.

### Inspection

After the break-in period, we suggest that each Ski-Doo snowmobile has an inspection check. This inspection is at the discretion and expense of the vehicle owner.

## PRE-START CHECK

### Fuel Tank Quantity

Check that there is sufficient fuel in the tank for your trip. A good habit to acquire is to refill the tank before starting out each day.

Since mixed fuel has a tendency to settle overnight, agitate the fuel in the tank by standing on the footboards and rocking the vehicle from side to side.

### Track (Daily, before first run)

Under certain climatic conditions, the track of a snowmobile left outdoors overnight may freeze to the ground or snow surface. Always make sure that the track is free before attempting to start the vehicle. (This procedure will eliminate unnecessary drive belt wear.)

### Steering Operation

Check operation of steering mechanism by rotating the handlebar several times from side to side. If roughness or binding is felt, check for ice or snow that may be blocking the mechanism.



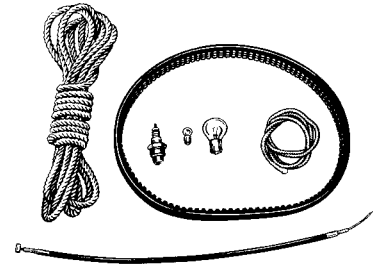

## IN CASE OF EMERGENCY

### Throttle and Brake

Depress and release levers several times to check that they operate easily and smoothly. The throttle lever should return to the idle position when released. The brake lever should be fully applied when it has minimum clearance from the handlebar grip (see Maintenance Brake). If the levers do not return swiftly, remove cables and/or housings and replace. Re-check lever operation.

**Warning:** Throttle mechanism should be checked for free movement before starting engine. Once all components are checked and functioning properly, you can start your Ski-Doo snowmobile.

Emergency situations are accepted hazards with any moving vehicle. A hidden rock or stump on the trail, a burnt light bulb while driving at night, an empty fuel tank while miles from anywhere, can all cause varying degrees of inconvenience. Unlike an automobile, which has a distinct advantage in that service stations are usually within walking distance, **snowmobiles are specifically designed to travel off the highways.**

When the unexpected happens, the driver often has only his own ingenuity and that of his companions to return home safely. Fortunately, 9 out of 10 difficulties encountered on the trail can be fixed on the spot. However, you must carry at least a minimum assortment of Tools and Spare Parts to enable you to effect minor repairs.

### Emergency Materials

In addition to those tools which the manufacturer provides, you should carry the following:

**Tools:** General Purpose Pliers—Adjustable Wrench ( $\frac{3}{4}$ " opening)—Flashlight

**Spare Parts:** Spark Plug—Drive belt—Headlamp and Taillight bulbs—Throttle Cable and Housing—Starting and towing rope.

**Important:** Always carry spare plugs and drive belt. Check condition of spark plug frequently and look for signs of a fouled or defective plug.

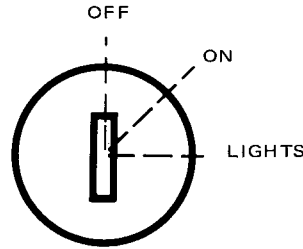
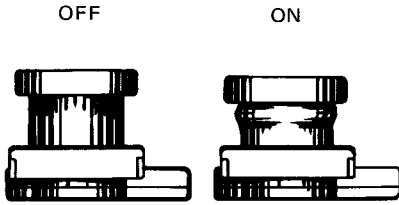

## STARTING PROCEDURE:

**Warning: Never run the engine at high RPM when the track of the vehicle is raised off the ground.**

**Note:** Before starting the engine make sure the kill button is in the released upper position

### To start the engine:

- 1 Insert key in ignition and turn to ON position
- 2 Engage choke (Choke is not necessary if engine is warmed up)
- 3 Test throttle operation then apply throttle lever slightly
- 4 Grasp manual starter handle firmly and pull slowly until a resistance is felt then pull vigorously and engine will start. Allow handle to return **slowly** to its original position. If engine does not

start, repeat the procedure

**Note:** Do not pull starting rope to its fullest extent or allow starting handle to "fly back" to its original position

5 **Release** throttle and disengage choke, **immediately** engine has started

6 Allow the engine to warm up before operating at full throttle

### Flooding

If cold engine is difficult to start, continued choking will only lead to a 'flooded' condition

If engine has not started after the first few tries but appears ready to start, return choke to OFF position. Depress throttle lever fully and try to start the engine

**Warning: Release throttle lever immediately after engine starts.**

If engine will not start, check for possible cause

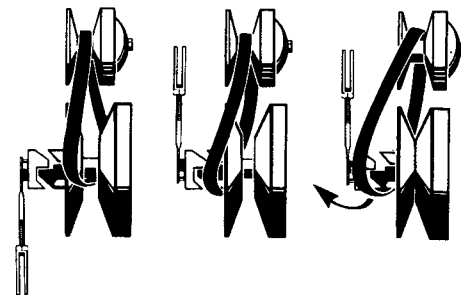
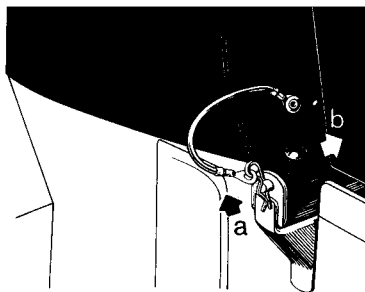

## LUBRICATION

<b>Code Weekly (10 hours)</b>		<b>Page</b>
W1	Steering Mechanism	16
W2	Chain Case Oil Level	16
W3	Bogie Wheels	16
W4	Rear Axle	16
<b>Code Bi-Monthly (20 hours)</b>		<b>Page</b>
BM1	Drive Pulley	17
<b>Code Monthly (40 hours)</b>		<b>Page</b>
M1	Driven Pulley	17

Above items in the lubrication chart will be serviced during all dealer inspections

### Pulley Guard Removal

- 1 Tilt cab
- 2 Pull out retaining clip and push on spring bolt to disengage pin from bracket
- 3 Move pulley guard forward to disengage it from chain case bracket

**Warning: Engine should be running only when pulley guard is secured in place.**

### Drive Belt Removal

- 1 Tilt cab and remove pulley guard
- 2 Unlock and raise driven pulley support
- 3 Open the driven pulley, (larger pulley, most forward) Twist and push the sliding half then **hold** in open position
- 4 Pull the bottom of belt in toward the front of the driven pulley then slip slackened belt over the top edge of the sliding half
- 5 Slip the belt out from the drive pulley (centrifugal governor) and remove completely from vehicle by passing it between muffler and end of driven pulley

To install drive belt, reverse procedure

**Warning: Never run the engine without drive belt installed. Running an unloaded engine can prove to be dangerous.**

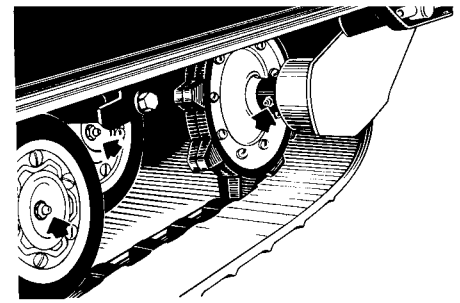
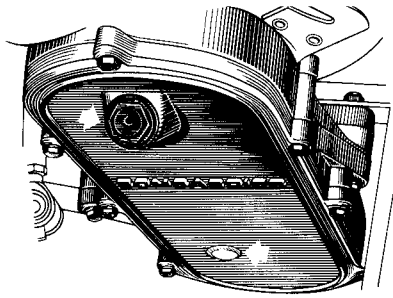
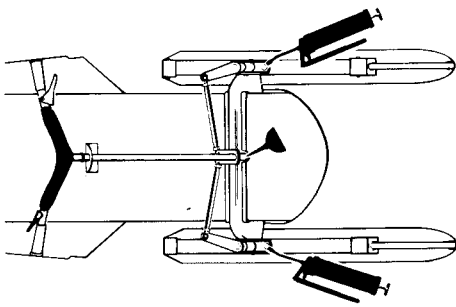

### **(W1) Steering Mechanism**

Using light machine oil, lubricate the lower steering column bushing. Lubricate the ski legs at grease fittings until new grease appears at the joints.

### **(W2) Chain Case (Oil Level)**

Check oil level through sight glass of chain case. The oil level should not be below the level line of the sight glass. The chain case has an oil capacity of approximately 9 ozs. To replenish, remove filler cap using a spark plug wrench. Refill to level line.

### **(W3) Bogie Wheels**

Lubricate the suspension bogie wheels with low-temp grease, using a low-pressure grease gun. Pump through the grease fitting at the centre of each wheel until new grease appears at the joint of inner side of shaft.

### **(W4) Rear Axle**

Lubricate the rear axle with low-temp grease. Pump grease through the rear axle fittings.

**Caution:** Always use a low-pressure grease gun.

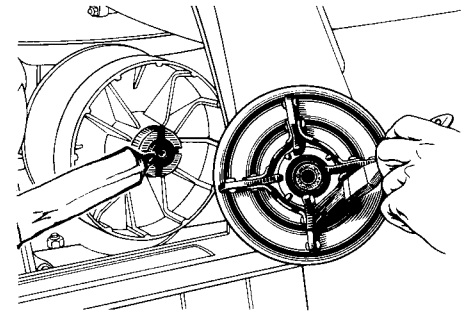
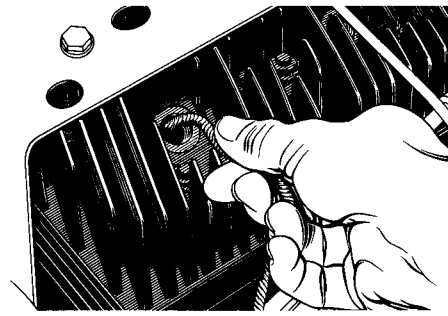
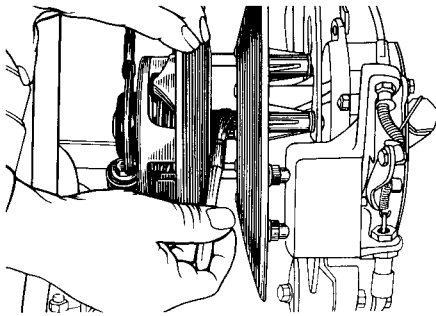

### (BM1) Drive Pulley

- 1 With cab tilted, remove pulley guard and drive belt
- 2 Remove centrifugal governor as follows
  - Remove both spark plugs and position P.T.O. (drive pulley side) piston  $\frac{3}{4}$ " to  $1\frac{1}{4}$ " **before** top dead center, making sure that the piston closes the exhaust port
  - Accede by the spark plug hole and pack the same P.T.O. cylinder with  $\frac{3}{16}$ " dia. rope.
  - Pull manual starter to rotate crankshaft until piston bears against "cushioning".
  - Unscrew centrifugal bolt, remove centrifugal governor, outer pulley half and spring. Pull rope from spark plug hole.
3. Thoroughly clean the inner pulley

shaft using fine steel wool and clean cloth. Inspect all components for excessive wear.

4. Apply a light coat of low temp. grease to the four (4) flyweights of the centrifugal governor.
- 5 Install spring and outer pulley half. Making sure that the aligning mark on inner pulley half coincides with the aligning mark of the outer half pulley half, pack inside of pulley shaft with low temp. grease.
- 6 Using light machine oil, lubricate the governor bolt threads. Install governor and torque bolt to 33-40 ft/lbs

**Note:** Installation procedure is reversed insuring that the rope is inserted into the same cylinder when piston is  $\frac{3}{4}$ " approx. **after** top dead center.

**Warning:** Make sure that the gover-

**nor bolt is fully tightened before removing rope from cylinder.**

### (M1) Driven Pulley

With cab tilted, lubricate the driven pulley shaft as follows

- 1 Remove pulley guard and drive belt. Open the driven pulley (Twist and push sliding half)
- 2 Thoroughly clean the driven pulley shaft
3. Apply a light coat of low temp. grease on the shaft.

**Note:** Activate the sliding half several times to distribute lubricant over full length of shaft. Be careful that lubricant does not get on inner halves of pulley. Always lubricate lightly and wipe off surplus

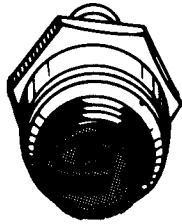

Carbonized

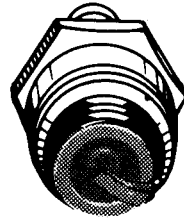

Normal

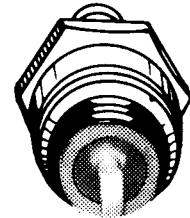

Burnt

## MAINTENANCE

Code	Weekly	Page
W1	Spark Plugs	18
W2	Suspension Springs	18
W3	Track	18
W4	Track Tension	19
W5	Track Alignment	19
W6	Carburetor Adjustment	20
W7	Drive Belt Condition	21
W8	Steering Mechanism	21
Code	Monthly	Page
M1	Carburetor Flange Nuts	21
M2	Drive Belt Wear	21
M3	Brake	21
M4	Steering Adjustments	22
M5	Engine Head Nuts	22
M6	Engine Mount Nuts	22
M7	Vehicle General Inspection	22

Above items will be serviced during all dealer inspections

### (W1) Spark Plugs

The standard plug on the T'NT snowmobile has been selected as the one most suitable for high speed riding (see specifications). However, for trail riding, a spark plug with a **hotter** heat range must be installed.

- 1 Tilt cab and disconnect spark plug wires
- 2 Remove spark plugs using box wrench supplied in tool kit
- 3 Check condition of plugs

- A Brownish tip reflects ideal conditions (proper carburetor adjustment, spark plug heat range, etc )
- A black insulator tip indicates fouling caused by: carburetor idle speed mixture and/or high speed mixture too rich. Incorrect fuel mixing ratio, wrong type of spark plug (heat range), or excessive idling.

- A light grey insulator tip indicates a lean mixture caused by, carburetor idle speed mixture adjusted too lean, wrong spark plug heat range, incorrect fuel mixing ratio, or a leaking seal or gasket

**Caution:** If when checking spark plug color, you find that the engine is not running under ideal conditions, contact your authorized Ski-Doo dealer

- 4 Check spark plug gap using a wire feeler gauge Gap must be .020" Adjust and/or replace if necessary
- 5 Reinstall plugs and connect wires

### (W2) Suspension Springs

With engine **off**, visually inspect bogie wheel springs and link plate springs Replace any weak or broken spring

### (W3) Track

Lift the rear of the vehicle and support it off the ground so that the track is free to turn With engine **off**, rotate track by

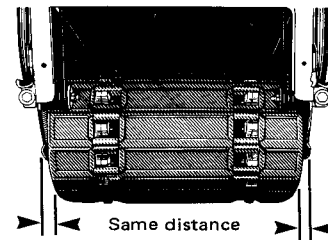
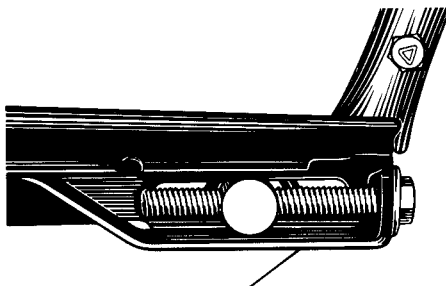
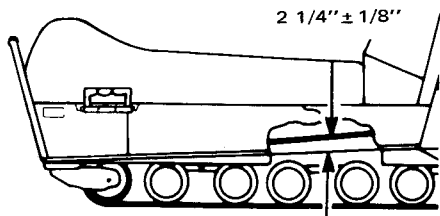

hand and visually inspect track condition. If bad cuts or missing inserts are noted, see your dealer.

**Note:** Without these inserts continual abrasion would wear and cut the track; therefore, always replace a missing or damaged insert as soon as possible.

#### (W4) Track Tension

Lift the rear of vehicle and support it off the ground. Using a rule, check the track tension from the middle set of bogie wheels. The track tension (distance between top inside edge of track and the bottom of the footboard) should be 2 ¼ inch plus or minus ⅛ inch.

If track tension is too loose, the track will have a tendency to thump. If too tight, performance will be affected.

If necessary to adjust:

- 1 Using wrench, loosen both track adjusters by unscrewing the lock nuts situ-

ated on the inner side of the suspension springs.

- 2 Adjust to proper tension by turning adjuster bolts clockwise to tighten track, counter-clockwise to slacken. Adjust both sides equally.

- 3 Proceed with track alignment.

**Note:** Track tension and alignment are inter-related. Do not adjust one without checking the other.

#### (W5) Track Alignment

After track tension has been corrected, start the engine and accelerate slightly so that track turns **slowly**. Check that track is well centered and turns evenly on the rear sprockets. The distance between the edges of the track and the link plates should be the same on both sides. Misalignment can cause excessive wear of track edges and sprocket teeth.

To adjust:

- 1 Using wrench, turn track adjuster screw clockwise on the side where the track is closest to the link plate until track aligns.

- 2 Firmly retighten adjuster lock nuts.

- 3 Rotate track slowly and recheck alignment.

**Warning:** Before checking track alignment, ensure that the track is free of all particles which could be thrown out while track is rotating. Keep hands, feet and clothing clear of track.

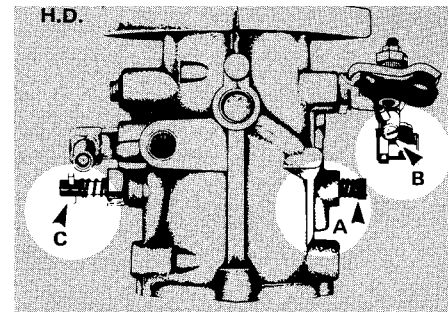
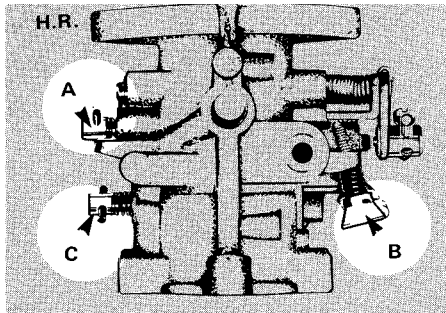

## (W6) Carburetor Adjustment

The carburetor adjustments for the Ski-Doo snowmobile are Maximum Throttle Opening, Idle Speed Mixture, Idle Speed and High Speed Mixture

**Note:** A relationship exists between each adjustment. Do not correct one without checking the other.

### Maximum Throttle Opening

With engine **off**, unscrew the Idle Speed Adjusting Screw until a gap exists between screw end and carburetor shaft lever. Depress the throttle lever at handlebar and hold. Throttle butterfly should be fully open when the lever gently touches the handlebar grip.

To adjust for maximum opening, loosen screw at point where cable joins carburetor lever. Hold throttle lever to handlebar. With finger, hold carburetor lever in fully open position (UP), pull cable downward until taut. Retighten screw

**Warning:** Before starting engine, carburetor throttle lever must return to idle position by contacting with the tip of Idle Speed Adjusting Screw. Never start engine unless this situation is verified.

### Idle Mixture Adjustment (A)

A primary adjustment (with engine **off**), should be made by first turning Idle Mixture Screw fully clockwise until closed. Back off screw  $\frac{3}{4}$  of a turn counter-clockwise.

Turning screw clockwise produces a leaner mixture, (more air/less fuel), counter-clockwise, a richer mixture (less air/more fuel).

**Note:** Do not close too tightly as needle and/or needle seat can be damaged.

For final adjustment, start engine and allow it to warm up. Turn Idle Mixture Screw until engine reaches maximum R.P.M. and obtain a steady idle and a

fast response of the engine to the throttle.

### Idle Speed Adjustment (B)

Turn the Idle Speed Adjusting Screw clockwise to increase idling speed, counter-clockwise to decrease.

### High Speed Mixture (C)

**Warning:** High Speed Mixture adjustment must be carried out only by an authorized Ski-Doo dealer.

For primary adjustment however, with engine **off**, turn High Speed Mixture Adjusting Screw fully clockwise until it closes. (Do not close too tightly as screw and/or screw seat can be damaged). Back off screw  $1\frac{1}{4}$  turns counter-clockwise. Run the vehicle for at least one mile then check spark plug color. If 'brownish', carburetor setting is correct. If not, see spark plug condition.



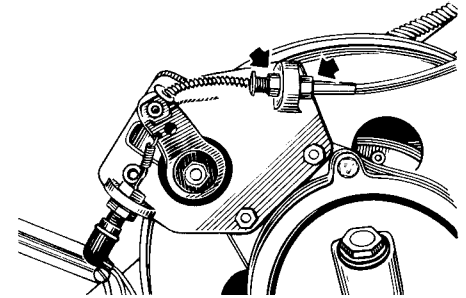
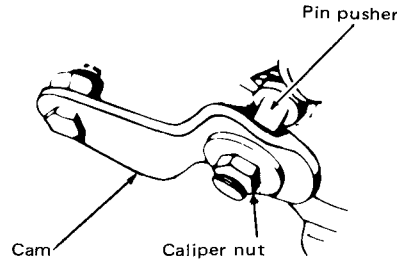
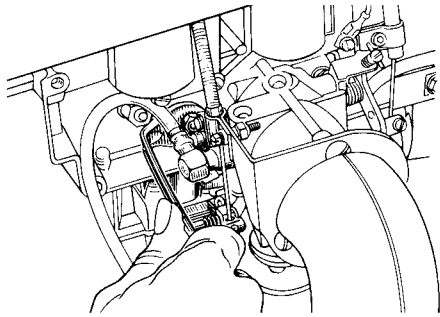

### (W7) Drive Belt Condition

Remove drive belt. Check condition of belt. Inspect for cracks, fraying or abnormal wear (Uneven wear, wear on one side, etc.) If abnormal wear is noted, probable cause is misalignment of drive and driven pulleys. Contact your dealer.

### (W8) Steering Mechanism

Inspect steering mechanism for tightness of components (coupler bolts, steering arms, tie rods etc.) Tighten if necessary.

### (M1) Carburetor Flange Nuts

After the first 2 hours of operation, check tightness of carburetor flange nuts. Open tab locks, tighten nuts and close tab lock.

**Caution:** The tab locks should be changed after being opened three times.

### (M2) Drive Belt Wear

Tilt cab and remove pulley guard. Inspect drive belt for wear. If belt is less than  $\frac{7}{8}$ " wide it should be replaced.

### (M3) Brake

The brake mechanism on your snowmobile is an essential safety device. Keep this mechanism in proper working condition. Above all, do not operate your snowmobile without an effective brake system.

Check operation of brake mechanism by depressing brake lever. Brake should apply fully while lever is still 1 inch minimum from handlebar grip.

### Adjustment

1. Ensure that cable housing nuts are located approximately half way on housing threads.
2. Slacken off the cable retaining bolt and manoeuvre the lower brake lever and brake cable until the pin pushers are seated directly in the deepest section of the cam of the brake lever. Lock cable in position.
3. Tighten the caliper nut until a disc/puck friction is felt. Back off nut slightly.
4. Check brake operation.

**Note:** Always check the stop light to see if it functions after performing brake adjustment. If necessary, loosen stop light switch lock nuts and adjust to proper length.

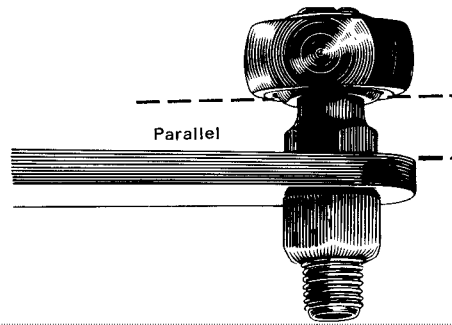
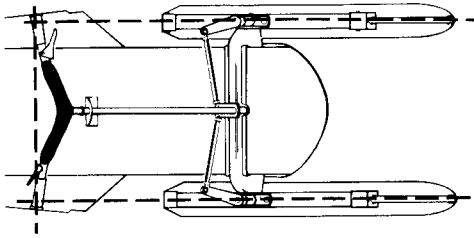

#### (M4) Steering Adjustment

Skis should be parallel to each other. To check, use metal tape and measure distance between skis at front and back. The skis should also be parallel to vehicle when handlebar is horizontal. If adjustment is required:

- 1 Unscrew the nuts locking the tie rods in place
- 2 Turn one or both tie rods until ski alignment is correct
- 3 Tighten the nuts firmly against the tie rod. Firmly tighten the steering arm bolts.

**Note:** In case of serious misalignment, contact your dealer.

**Warning:** The socket must run parallel with the steering arm. The socket must be restrained when tightening the tie rod end lock nuts.

#### (M5) Engine Head Nuts

With cab tilted, check that engine head nuts are tight and equally torqued. (16 to 18 ft/lbs when **cold**)

#### (M6) Engine Mount Nuts

With cab tilted, remove pulley guard then check engine mount nuts. Retighten if necessary.

#### (M7) Vehicle General Inspection

With cab tilted, check electrical wiring and components, retighten loose connections. Check for stripped wires or damaged insulation. Repair or replace as necessary. Thoroughly inspect the vehicle and tighten loose bolts, nuts and linkage. Close cab and clean the chassis.

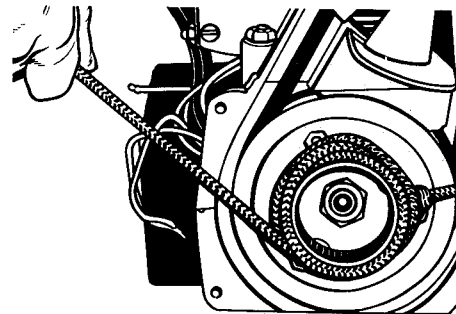
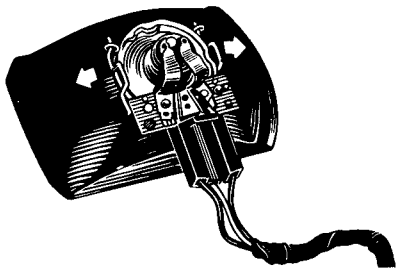

## EMERGENCY GUIDE

### **Burnt Light Bulb**

If headlamp is burnt, stop engine, unlock cab latches (2) and tilt cab. Unfasten bulb retainer clips. Detach bulb and replace. If taillight bulb is burnt, expose bulb by removing red plastic lens. To remove, unscrew the two (2) Phillips head screws.

### **Broken Throttle Cable**

Remove throttle cable and replace. Check lever operation. If necessary, replace housing. **Do not** start the engine until lever returns swiftly.

### **Broken Rewind Starter Rope**

Abuse of the rewind starter may cause the rope to fray and break. Should this situation arise, remove starter unit using 10 mm wrench supplied in tool kit. Transfer rope grip to your emergency rope. Place starter unit in rear compartment. Make a knot at the end of emergency starter rope and wind rope around starter pulley. Pull vigorously as per usual manual start. See your dealer for immediate repair or replacement of starter unit.

### **Assisting Stranded Vehicles**

More than common courtesy dictates that you go to the aid of any snowmobile stranded in the field. Should another vehicle suffer a major breakdown and have to be towed, use one of the following procedures.

On hard pack snow

Remove the drive belt. Tie the front bumper to your rear bumper. Tow the vehicle and driver back slowly.

In deep snow,

Remove the drive belt. Tie both skis to your rear bumper. Taking the driver with you as a passenger, tow the vehicle back slowly.

### **Important:**

Special attention should be given to the drive components of your vehicle when hauling another of greater weight. Hauling greater weights than your own can cause component damage.

## TROUBLE SHOOTING GUIDE

Symptoms	Possible Causes	What To Do
Engine turns over but fails to start or starts with difficulty	1. No fuel to the engine	Check the tank level and fill up with correct gas-oil mixture. Check for possible clogging of fuel line, item 5.
	2. Spark plug	Check for fouled or defective spark plug. Disconnect spark plug wire, unscrew plug and remove from cylinder head. Reconnect wire and ground exposed plug on engine head, being careful to hold away from spark plug hole. Follow engine starting procedure and check for spark. If no sparks appear, replace spark plug. If trouble persists, check item 3.
	3. Faulty ignition	Disconnect spark plug wire from plug, unscrew the spark plug cap then hold wire about 1/8" from the cylinder head. Follow engine starting procedure and if no sparks appear, it means a faulty ignition system. Do not attempt to repair. Contact your dealer.
	4. Flooded engine	Disengage choke, wait 60 seconds or more then depress throttle lever fully and try to start engine. <b>Release throttle lever immediately after engine starts.</b>
	5. Clogged fuel line (water or dirt)	Remove and clean the fuel filter. Change filter cartridge if necessary. Check condition and connections of fuel lines. Check the cleanliness of the fuel tank. Clean tank if necessary. (See Fuel Tank, Storage Section).
	6. Faulty Carburetor	First make primary adjustments on carburetor (See Maintenance Section). If carburetor is still faulty, contact your dealer for repair.
	7. Too much oil in fuel	Drain the fuel tank and refill with the correct gas/oil mixture.
	8. Breaker points	Breaker points may be worn or out of adjustment. Contact your dealer.
	9. Poor engine compression	Running with a lean fuel mixture may produce excessive engine wear resulting in poor engine compression. If this occurs, contact your dealer at once.
Engine will not turn manually	1. Seized engine	In the case of a seized engine, contact your dealer. Seizure is a direct result of poor lubrication.

Symptoms	Possible Causes	What To Do
<b>Engine lacks acceleration or power</b>	<b>1. Fouled or defective spark plug</b>	Check item 2 of "Engine turns over but fails to start or starts with difficulty"
	<b>2. Clogged fuel line (water or dirt)</b>	Check fuel line condition. (See item 5 of "Engine turns over but fails to start or starts with difficulty").
	<b>3. Carburetor</b>	Readjust the carburetor (See Maintenance Section) If trouble persists, contact your dealer
	<b>4. Defective ignition</b>	First check item 2 and 3 of "Engine turns over but fails to start or starts with difficulty" If the ignition system still seems defective, contact your dealer
	<b>5. Engine</b>	If unable to locate specific symptoms, contact your dealer
<b>Engine continually backfires</b>	<b>1. Faulty spark plug</b>	Check item 2 of "Engine turns over but fails to start or starts with difficulty"
	<b>2. Overheated</b>	Carburetor set too lean. Contact your dealer.
	<b>3. Engine timing incorrectly set</b>	Contact your dealer
<b>Snowmobile cannot reach full speed</b>	<b>1. Drive belt</b>	Check for defective or worn drive belt Replace if necessary
	<b>2. Incorrect track adjustment</b>	Check track tension and alignment Readjust to specifications (See Maintenance Section)
	<b>3. Faulty engine</b>	Check items 1 to 5 of "Engine lacks acceleration or power"
	<b>4. Pulley misaligned</b>	Contact your dealer

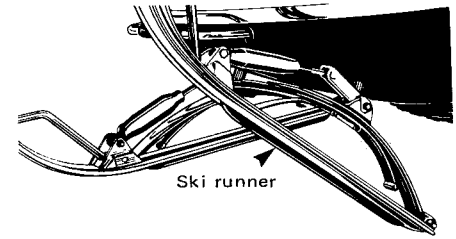
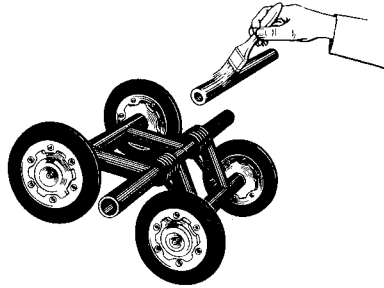
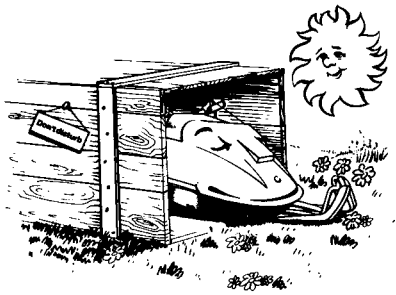

## OFF SEASON STORAGE

It is during Summer, or when a vehicle is not in use for any length of time that proper storage is a **necessity**. Storage of the Ski-Doo snowmobile during long periods of inactivity consists of checking and replacing missing or worn parts. Proper lubrication and treatments to insure that parts do not become rusted. Cleaning items such as carburetor of oil gas mixtures, to prevent gum varnish formation within the carburetor, and in general, preparing the vehicle so that when the time comes to use the snowmobile again it will start and be in top condition.

**Important:** The necessity of proper storage cannot be overstressed. If you lack the time or proper tools, see your authorized Ski-Doo Dealer.

### (S1) Track

1. Inspect track for cuts, missing track inserts or broken rods and make any necessary replacement.
2. Lift rear of vehicle until track is clear of ground then support with brace or trestle. The Ski-Doo snowmobile should be stored in such a way that track does not stay in contact with cement floor or bare ground.

**Note:** The track should be rotated periodically, (every 40 days)

### (S2) Suspension (Bogie Wheels)

1. Remove the bogie wheel sets.  
**Note:** Identify the location of each bogie wheel set. The rear set is equipped with larger diameter springs.
2. Remove cross shaft from bogie wheel set. Clean bogie wheel assembly and cross shaft of dirt or rust.
3. Grease each bogie wheel until all old grease is flushed out.

4. Spray bogie wheel springs with metal protector. If unavailable, wipe with cloth or rag soaked in oil. Check condition of shaft and replace if bent or worn. Apply a coat of low temp grease on cross shaft.
5. Reassemble entire bogie wheel set, making sure assembly moves freely.
6. Reinstall bogie wheel sets.
7. Lubricate rear hub through grease fittings.

### (S3) Ski Assembly

1. Wash or brush all dirt or rust accumulation from skis and springs.
2. Grease ski legs at grease fittings.
3. Check condition of ski runners. Replace if worn.
4. Apply metal protector on ski assembly. If unavailable, wipe the entire ski with cloth soaked in oil to prevent rust formation.

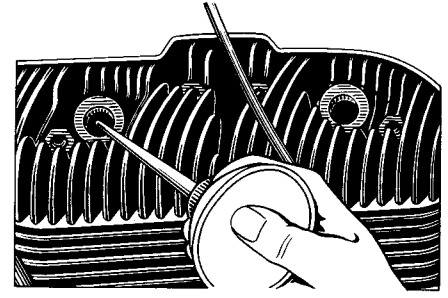
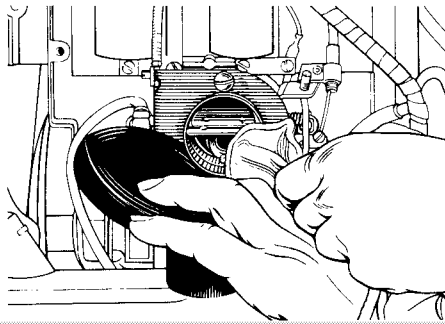
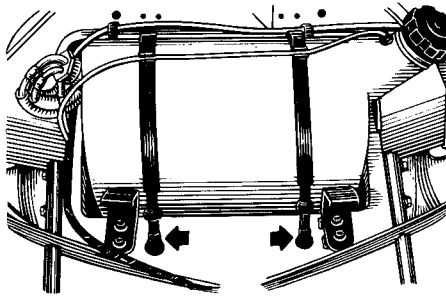

#### (S4) Fuel Tank

- 1 Disconnect fuel lines at fuel tank
- 2 Remove tank retainer straps by pulling and disengaging knobs from frame slots. Remove fuel tank from vehicle and drain it
- 3 Rinse inside of tank thoroughly with fresh gasoline
- 4 Reinstall fuel tank

**Warning: Gasoline is flammable and explosive under certain conditions. Always perform procedures in a well ventilated area. Do not smoke or allow open flames or sparks in the vicinity.**

#### (S5) Carburetor

The carburetor must be dried out completely to prevent gum formation during the storage period

- 1 Assure that inlet fuel line is disconnected then start the engine and run it

out of gas

- 2 Pull out air silencer tube from carburetor, engage choke (pull to ON), then pack the carburetor throat with a clean piece of cloth and turn the engine a few more times. The suction should eliminate the remaining fuel

**Note:** An alternate procedure is to use "Stabil", an excellent product in the prevention of gum formation. Ask for it at your Ski-Doo Dealer then follow the mixing directions on the can. Pour mixture into clean container, insert fuel lines into mixture. Run engine for 2 minutes

- 3 Remove upper column and console
- 4 Remove air silencer box. Clean with gasoline

**Warning: Make sure the box is dry before re-installing it.**

#### (S6) Cylinder Lubrication

Engine internal parts must be lubricated to protect cylinder walls from possible rust formation during the storage period

- 1 Remove spark plugs
- 2 Operate rewind starter to bring piston at **top** position
- 3 Pour about one spoonful of oil into spark plug hole
- 4 Slowly crank engine 10 to 12 times using manual starter

**Caution:** To prevent magneto damage, make sure that the ignition switch is at OFF position

- 5 Repeat above steps for other cylinder
- 6 Install spark plugs

**Note:** This operation should be repeated every 40 days during storage

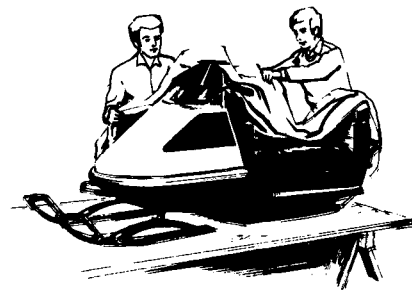
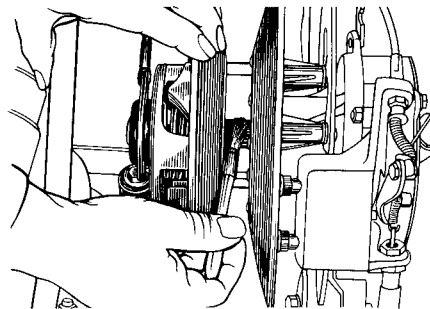
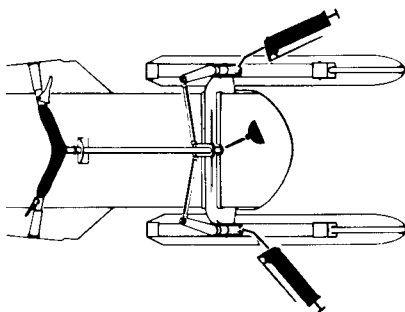

### (S7) Chain Case

Drain the chain case completely and refill with 9 ozs of fresh Ski-Doo\* chain case oil. To drain, remove chain case cover.

### (S8) Controls

1 Oil steering mechanism. Inspect components for tightness, (spring coupler bolts, tie rods, spherical ball joints, etc.) Tighten if necessary.

2 Oil moving joints of brake mechanism. **Avoid getting oil on brake lining.**

3 Coat all electrical connections and switches with a greaseless metal protector. If unavailable, use petroleum jelly.

### (S9) Pulleys

1 Tilt cab, remove pulley guard and drive belt.

2 Thoroughly clean the driven pulley shaft. Apply a light coat of low temp. grease on the shaft.

3 Activate the sliding half several times to distribute lubricant.

4 Lubricate drive pulley following the procedure detailed in Lubrication Section.

5 Spray internal pulley surfaces with metal protector.

**Note:** Leave drive belt off during entire storage period.

### (S10) Chassis

1 Clean the vehicle thoroughly, removing all dirt and grease accumulation.

2 Inspect cab and repair damage. Repair kits are available at your authorized Ski-Doo dealer.

3 Wax the complete cab for better protection.

4 Touch up all worn metal spots where paint has been scratched off. Ask your dealer about Ski-Doo\* paints.

5 Spray all bare metal parts of vehicle with metal protector.

6 Protect the vehicle with a Ski-Doo\* cover to prevent dust accumulation during storage.

\*Trademark Bombardier Limited



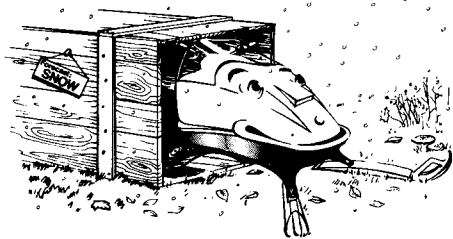

## PRE-SEASON PREPARATION

Snow is falling and you are now anticipating the next snowmobile safari. If you have observed and adhered to the storage procedures outlined in this manual, your vehicle preparation becomes a relatively easy task.

To simplify the pre-season preparation we have drawn up a small check list.

Many items have been forementioned in the Lubrication or Maintenance sections of this manual therefore quick and easy reference is possible. Again we mention, should you lack the time or tools to complete the task, to contact the Ski-Doo dealer of your choice and obtain his professional assistance.

- Spark plug, Change
- Chain case, Check oil level
- Pulleys, Clean, lubricate and align drive and driven pulleys

- Skis, Aligned
- Fuel Filter, Change
- Fuel lines, Connect then check attaching points at tank and carburetor
- Track, Check tension and alignment
- Suspension, Lubricate, wipe off excess grease
- Drive belt, Inspect and install
- Cables, Check for damage
- Brake, Inspect lining, adjust
- Oil seals, Inspect for possible cuts or leaks
- Engine Timing Replace breaker points Set timing
- Wiring Check electrical wiring for broken or damaged insulation Inspect connections
- Manual Starter Inspect condition of starting rope
- Fasteners Check tightness of all nuts, bolts and linkage Pay particular attention to engine head nuts—16-18

ft/lbs torque Governor bolt 33-40 ft/lbs torque

- Gas Tank Refill
- Carburetor Adjust

**IMPORTANT: Observe all Warnings and Cautions mentioned throughout this manual which are pertinent to the item being checked. When component conditions seem less than satisfactory, replace with genuine Bombardier parts.**

## SPECIFICATIONS

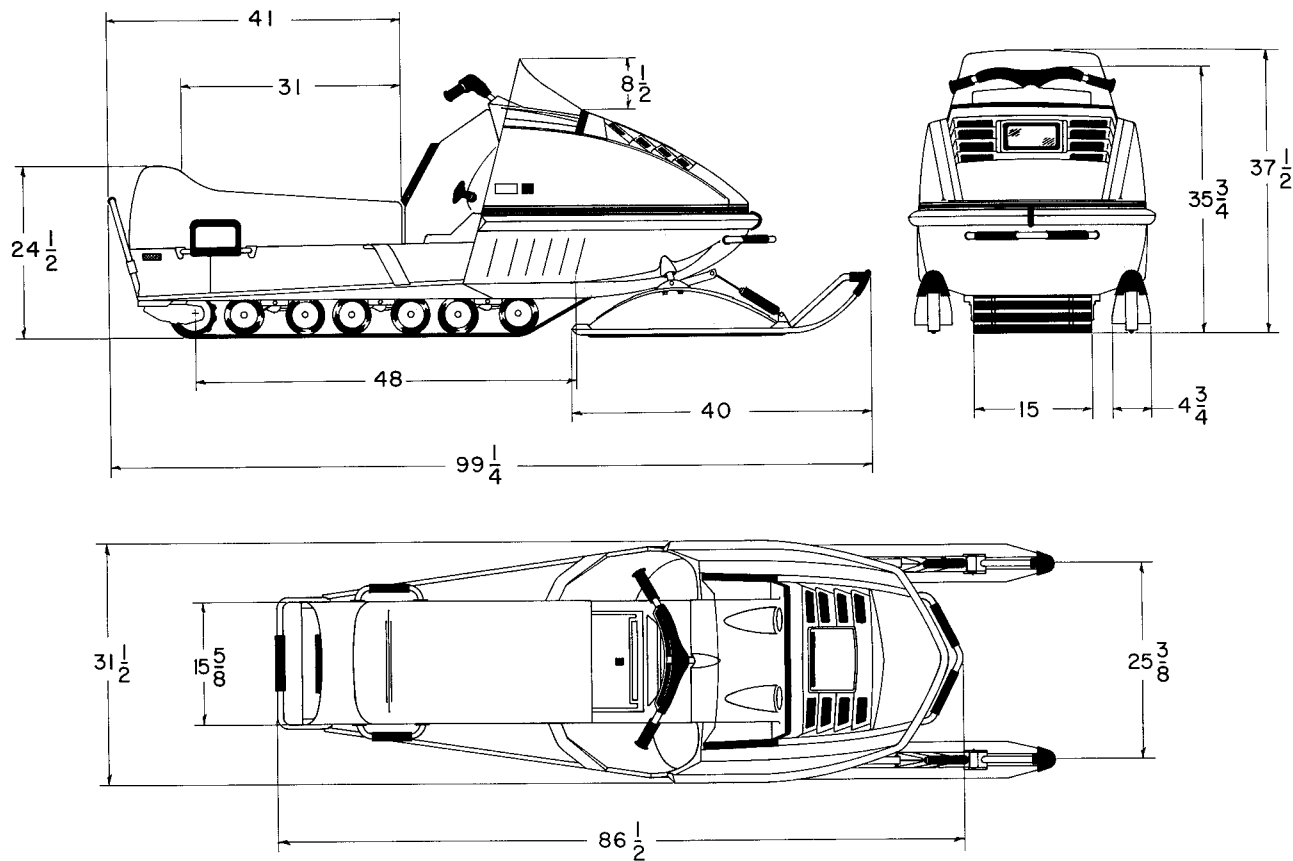

## SPECIFICATIONS

MODEL	T'NT	294	340	440
Engine	Number of cylinders	Two	Two	Two
	Bore	57 m.m.	59.5 m.m.	67.5 m.m.
	Stroke	57.5 m.m.	61 m.m.	61 m.m.
	Displacement	293.3 c.c.	339.2 c.c.	436.6 c.c.
	Compression Ratio	11.8:1	11.3:1	10.5:1
	Carburetor (Tillotson)	2 X HR	1 X HD	1 X HD
	Starting	Manual	Manual	Manual
Chassis	Overall length	99 1/4"	99 1/4"	99 1/4"
	Overall width	31 1/2"	31 1/2"	31 1/2"
	Height	37 1/2"	37 1/2"	37 1/2"
	Height w/o windshield	35 3/4"	35 3/4"	35 3/4"
	Weight (lbs)	375	390	405
	Bearing area	1092 sq.in.	1092 sq.in.	1092 sq.in.
	Ground Pressure (P.S.I.)	.343	.357	.371
Power Train	Track width	15"	15"	15"
	Std. gear ratio	N.A.	16/34	N.A.
Electrical System	Brake light coil output	18	23	23
	Lighting coil output	55	75	75
	Headlamp (watt)	45/45	60/60	60/60
	Tail/stop light	8/23	8/23	8/23
	Spark plug (Bosch)	Contact your Ski-Doo dealer for correct spark plug heat range.		
	Spark plug gap	.020"	.020"	.020"
	Breaker points gap	.014" - .018"	.014" - .018"	.014" - .018"
Voltage regulator	Yes	Yes	Yes	
Fuel	Tank capacity – Imp.	4.7	4.7	4.7
	– U.S.	6	6	6
	Gasoline	Premium	Premium	Premium
	Gas/Oil ratio	40:1	40:1	40:1
Brake	Type	Disc	Disc	Disc

## 1973 SKI-DOO WARRANTY

Bombardier Limited (Bombardier) as manufacturer, warrants every 1973 Ski-Doo snowmobile, Ski-Boose or Carry-Boose tow sled, SOLD AS A NEW VEHICLE, BY AN AUTHORIZED SKI-DOO DEALER, to be free from defects in material, and workmanship under normal use and service, for a period of ninety (90) days subject to the following coverage period

- 1 Beginning no sooner than from the date of delivery to the first retail buyer, for a period of ninety (90) consecutive days
- 2 Since snow is required for snowmobiling, all deliveries **prior to December 15th, 1972**, shall be covered under this warranty from **December 15th, 1972 to March 15th, 1973**.
- 3 All units delivered on or after **January 2nd, 1973**, but prior to **March 31st, 1973**, shall have a warranty carry-over into the next season, starting on **December 15th, 1973**, for the unused portion of the ninety (90) day warranty

### CONDITIONS

- 1 That maintenance be performed, at the owner's expense, as set down in the applicable owner's manual. Any failure which occurs as a result of inadequate maintenance† or improper use shall not be assumed by this warranty.
- 2 Any damages to any part of the above-mentioned vehicles and their components caused through improper use or maintenance or by any part installed which is not a genuine Ski-Doo replacement part, or not installed by an authorized Ski-Doo dealer, voids any future warranty

coverage to the affected parts

- 3 This warranty does not apply to any defect which results from
    - i) misuse or accident,
    - ii) Installation of repair parts other than genuine Bombardier replacement parts or,
    - iii) Repairs by any person other than an authorized Ski-Doo snowmobile dealer;
    - iv) Lack of preventative maintenance,
    - v) Alterations or modifications other than those approved in writing by Bombardier.
  - 4 Proof of ownership and warranty registration must be submitted to the service dealer by means of the Ski-Doo Service Card
- † **Guidelines for proper use and maintenance are detailed in each owner's manual.**

### EXCLUSIONS

- **Maintenance Items and Services** are considered non-warrantable and necessary to proper functioning of the vehicle, and without limiting the foregoing the following parts and services are excluded:
- Variable speed drive belt, fan belt, windshield, filters, ignition breaker points and condensers, spark plugs, light bulbs and protective lenses, brake linings, ski runner shoes, slider shoes on variable speed pulleys, all fasteners, labels, soft trim and appearance items, lubricants and paints, and all tune-ups or adjustments required.

- Any part damaged through lack of lubrication unless it is proven to be attributable to a manufacturing defect.
- Blizzard models or any of the vehicles referred to in this text which may have been used for racing or professional competition.
- Any damages resulting from an accident unless such damages are proven to result from a manufacturing defect.
- Any losses incurred to the vehicle owner other than the parts and labour required to repair the warrantable defect.

This warranty is expressly in lieu of all other expressed or implied warranties of Bombardier, its distributors and the selling dealer, including any implied warranty of merchantability or fitness for any particular purpose. Neither Bombardier, its distributors nor the selling dealer shall be responsible, under any circumstances, for any loss or damage as a result of hidden defects, accidents, misuses or other faults.

Neither the distributor, the selling dealer nor any other person has been authorized to make any affirmation, representation or warranty other than those contained in this warranty and if made, such affirmation, representation or warranty shall not be enforceable against Bombardier or any other person.

**BOMBARDIER LIMITED**  
**FEBRUARY 2, 1972**

**NOTE:** *In the event of change of ownership, complete the notice of transfer form below in order to qualify the new owner for balance of warranty. All such transfers should be reported to an authorized Ski-Doo dealer for modification of the Ski-Doo Service Card. In the event of a lost Service Card, contact the original selling dealer for completion of the "Request for New Service Card" form. For a \$2.00 handling charge, Bombardier will mail your new personalized Service Card to you.*

**Bombardier Limited,**  
**Valcourt, Québec, Canada. February 1972.**

**NOTICE OF TRANSFER**

Model  Vehicle Serial No

The ownership of this vehicle is transferred  
 From \_\_\_\_\_

\_\_\_\_\_  
 Signature of registered owner

To \_\_\_\_\_  
 Full name of purchaser *Block letters*

Address \_\_\_\_\_  
 No Street or Village

\_\_\_\_\_  
 City County  
 Date



## SKI-DOO \* SHOP MANUALS

**1970-1971** Completely illustrated, with over three hundred full size pages, the content includes entire sections on Engine—Carburetor—Chassis—Suspension—Electrics—etc Lists step by step procedures for Repairs—Servicing and much much more Covers both 1970 and 1971 vehicles. \$8 95

**1972** Over two hundred pages of up-to-date information on Repairs and Servicing Completely illustrated Everything you'll ever need to know about servicing your 1972 Ski-Doo snowmobile \$7 95

**1973** Supplement edition of the '72 Shop Manual Includes the latest design changes and servicing techniques for '73 vehicles \$5 00

**Reserve your copy now! Send certified cheque or money order to:**  
**Canada**

Bombardier Limited,  
Technical Information Centre,  
8600 Decarie Blvd ,  
Montreal 307, P Q

**U.S.A.**

Bombardier East Inc ,  
Railroad Street,  
Lee, Massachusetts, 01238

To be completed and returned with  
a money order or a certified cheque  
(Postage included)

NAME \_\_\_\_\_

(BLOCK LETTERS)

STREET \_\_\_\_\_

CITY \_\_\_\_\_

STATE / PROV. \_\_\_\_\_

ZIP CODE \_\_\_\_\_

SEND ME \_\_\_\_\_

1970-71 SHOP MANUAL \$8.95

1972 SHOP MANUAL \$7 95

1973 SUPPLEMENT \$5 00   
(Available December '72)

\*Trademark Bombardier Limited

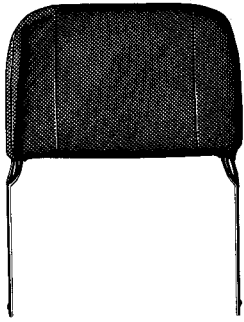

### Backrest

- Easily installed on Ski-Doo® snowmobiles
- Can be attached at two locations—center for driver only rear for passenger
- Attractive sturdy leatherette and metal construction also available chrome coated
- Highly recommendable for all snowmobiles carrying more than one passenger

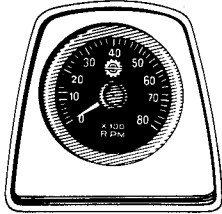

### Tachometer

The tachometer registers the impulses of the magneto. Direct-reading dial indicates (in thousands) the number of revolutions per minute (R P M ) of the engine. Vital towards maximum performance and engine diagnosis.

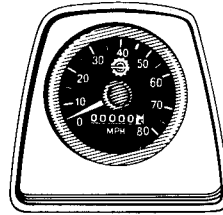

### Speedometer

Linked directly to the drive axle. Direct-reading dial indicates the speed of the vehicle in miles per hour (M P H ). 6 digit Odometer records the number of miles travelled.

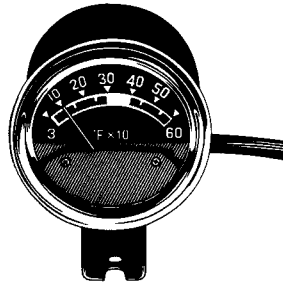

### Temperature Gauge

Developed for observing changes in cylinder head temperatures. Features, high sensitivity, quick response, special heat compensating bi-metal internal illumination and quick connect pick-up unit. Applicable to all models.



### Snow Guard

- Prevents snow from blinding trailing snowmobilers
- Strong, thick rubber ensures long lasting durability
- Perfectly flexible even under extreme cold
- A must for all racing snowmobiles and an added precaution for snowmobilers on safari
- Applicable to all models

All genuine Ski-Doo parts and accessories are specifically designed to provide you with peak performance. Whether it's for comfort or safety, you know that you can depend on genuine Ski-Doo parts and accessories available only at Ski-Doo dealers across the country.

**... and the Bombardier corporation is behind them all.**

\*Trademark Bombardier Limited