

ski-doo.

Nordic

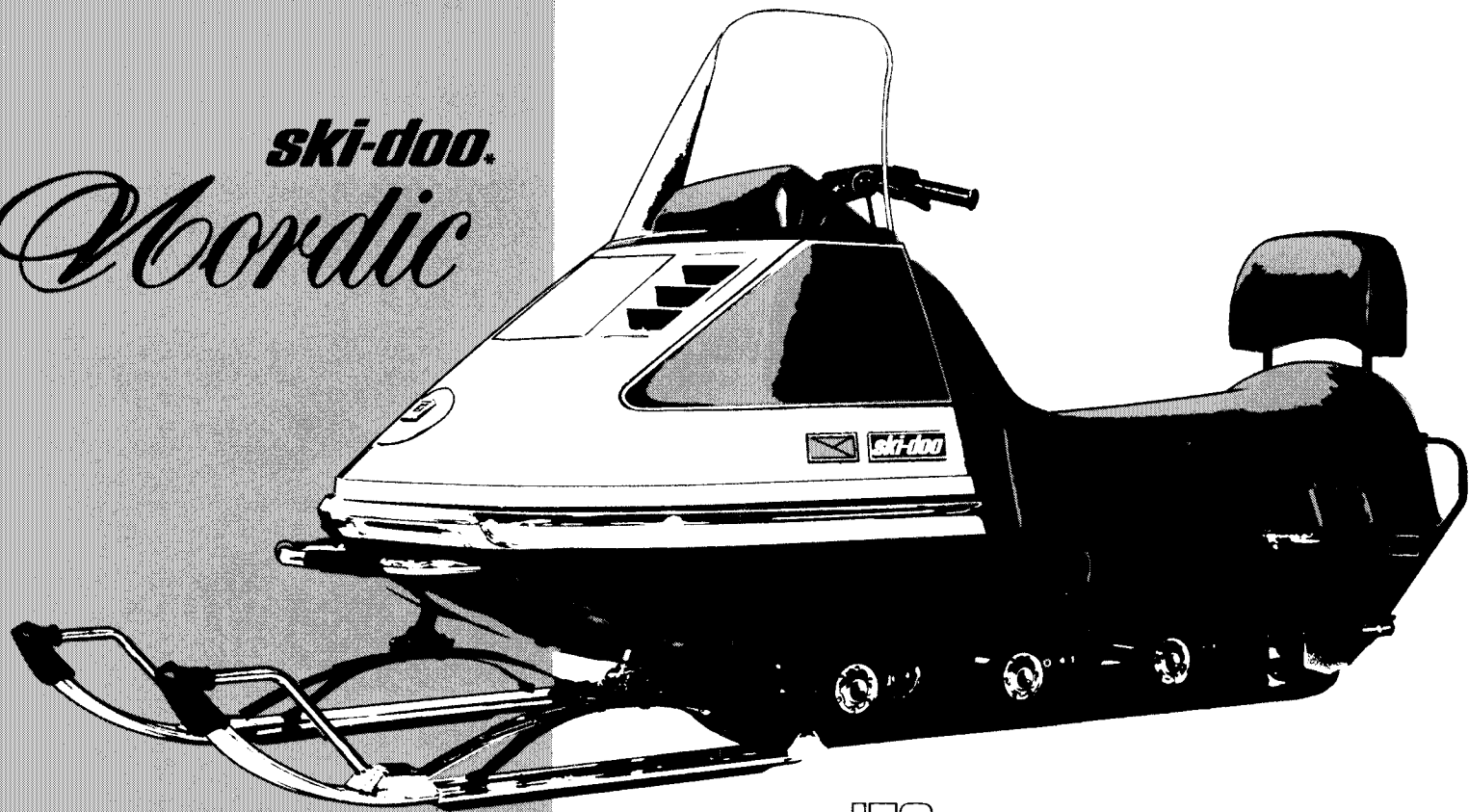

*Trademark Bombardier Limited

'73 Owner's Manual

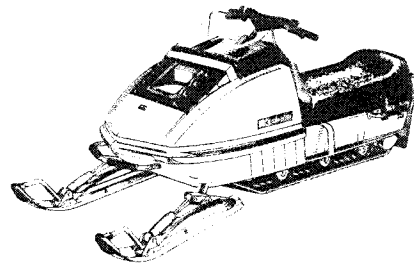
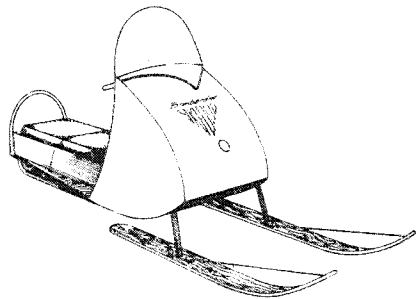

THE COMPANY THAT CHANGED WINTER HAS CHANGED

In 1957 and 1958, tests began on what is considered the forerunner of the Ski-Doo*. We experimented with many different frames and engines—in search of a light machine for one or two passengers. By the fall of '58, the first prototype was ready. Initial tests made it obvious the machine could hold its own in the recreation market. Production began one year later and 225 machines were sold at about \$1,000 each.

Like its predecessors the '73 Ski-Doo snowmobile is a combination of lightness, economy, strength and dependability. And yet, with all this, it has one other additional feature . . . personality.

Each model in each series has a complexity of characteristics that distinguishes itself as part of a bold breed . . . the Ski-Doo snowmobiles.

At Bombardier, we fully realize that the purchase of a snowmobile is a very important decision. For this reason, we have ensured that each Ski-Doo snowmobile is backed up by an international Ski-Doo Distributor and Dealer Network whose factory trained personnel are equipped to give you prompt and efficient service wherever you are in Snow Country.

Furthermore, each dealer is prepared to serve you with information, parts and accessories. Feel free to contact him.

At this time we would like to thank you for your patronage and welcome you to Winter. Enjoy yourself but remember: Safety depends on you, the driver, the condition of your vehicle and nature of the terrain.

All of the information, illustrations and component/system descriptions contained in this manual are correct at the time of publication. However, Bombardier Limited reserves the right to make changes in design and specifications, and/or to make additions to or improvements in its products without imposing any obligations upon itself to install them on its products previously manufactured.

This manual has been published by the Technical Information Centre, Bombardier Limited, 8600 Decarie Blvd., Montreal 307, Quebec, Canada.

*Trademark Bombardier Limited

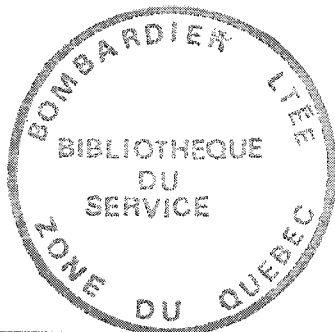

INDEX

*The following are trade marks of Bombardier Limited.

Ski-Doo **Valmont** **Skandic**
Ski-Boose **T'NT** **Carry-Boose**
Nordic **Élan** **Bombardier**
Alpine **Blizzard**

PATENTS and DESIGNS

This vehicle is covered by one or more of the following patents and design registrations.

Canadian Patents: 605,317 - 710,592 - 724,395 - 853,505.

United States Patents: 2,899,242 - 3,066,546 - 3,536,153.

Canadian Designs: DI/217 F/28172 -DI/249 F/31317 and '316 -D32,479 - D32,535 - D32,655 to '657 - D32,661 to '669 - 33,982 -33,933 - 34,006 and '007.

United States Design Patents:

Des. 221,332 to '334 -

Des. 221,637 and '638 -

Des. 222,244 to '247.

Others: Swedish Design No. 6038 -

Swiss Design No. 104,756 -

Norwegian Design No. 51,444.

WHAT YOU SHOULD KNOW	
BEFORE FIRST RIDE.....	2
SERVICE AREAS	3
DO'S	4
DONT'S.....	5
GOOD DRIVING TECHNIQUE... 6,7	
CONTROLS/INSTRUMENTS.....	8, 9
FUEL MIXING.....	10,11
BREAK-IN PERIOD	
PRE-START CHECK.....	12
IN CASE OF EMERGENCY	13
STARTING PROCEDURE	14
LUBRICATION	15, 16, 17
MAINTENANCE	18, 19, 20, 21, 22
EMERGENCY GUIDE.....	23
TROUBLE SHOOTING	24, 25
OFF SEASON	
STORAGE	26,27, 28, 29
PRE SEASON PREPARATION	30
SPECIFICATIONS	31
WARRANTY	32

All rights reserved ©Bombardier Limited 1972



WHAT YOU SHOULD KNOW . . . before first ride.

To many of us, Winter is a revealing experience. Weather, atmospheric conditions, snow surfaces, individual driving habits and vehicle usage have considerable affects. We ask that you familiarize yourself with them . . . **read** the owner's manual; it has been prepared to acquaint you with the operation of your vehicle, its safety aspects and systems as well as preventative maintenance procedures that must be periodically upheld . . . all aimed toward a more enjoyable Winter season.

Observe the following precautions:

- Throttle mechanism should be checked for free movement **before** starting engine.
- Engine should be running **only when** pulley guard is secured in place.
- **Never** run engine without drive belt installed. Running an unloaded engine

can prove to be dangerous.

- **Never** run the engine at high R.P.M. when the track of the vehicle is raised off the ground.
- It can be dangerous to run engine with the **cab open**.
- Prolonged sitting while riding over rough terrain may cause kidney and/or spinal discomfort, specially for the driver or passenger having an existing back weakness.
- Gasoline is flammable and explosive under certain conditions. Always perform procedures in a well ventilated area. Do not smoke or allow open flames or sparks in the vicinity. If gasoline fumes are noticed while driving, the cause should be determined and corrected without delay.
- **Under no circumstances** should you wear loose clothing or scarves that

could become entangled with moving parts of your snowmobile.

- Your snowmobile **is not** designed to be operated on public streets, roads or highways. In most States and Provinces, it is considered an **illegal** operation.
 - Hidden telephone guy wires or roadside ditches can cause serious **accidents**.
 - Your snowmobile **is not** designed to be driven or operated on black top, bare earth, or other abrasive surfaces. Abnormal and excessive wear of critical parts is inevitable.
 - **Always** wear an approved snowmobile safety helmet. Be informed on local laws legislating the sport.
 - Maintain your vehicle in top mechanical condition at all times.
- Please read and understand all other warnings contained elsewhere in this manual.**

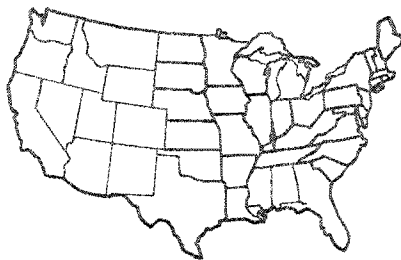

We recommend you contact your local Authorized Ski-Doo dealer when your Ski-Doo snowmobile requires service. However, for further inquiries, you may contact your Regional Distributor listed below.

SERVICE AREAS

CANADIAN DISTRIBUTORS

Name of Distributors	Coverage Area
ALPINE DISTRIBUTORS 3206 - 28th Ave., Vernon, B.C.	British Columbia
ATLANTIC SKI-DOO LTD. P.O. Box 670, Shediac, N.B.	Prince Edward Island Magdalen Island Nova Scotia New Brunswick
BOMBARDIER ONTARIO LTD. 28 Currie St., Barrie, Ont.	Ontario
BOMBARDIER QUE. LTD. 1350 Nobel St. Boucherville, Que.	Quebec
BROOKS EQUIPMENT LTD. Box 985, Winnipeg 21, Man.	Manitoba Saskatchewan
HUDSON'S BAY CO. 121 Richmond W. Toronto, Ont.	North-West Territories
J. W. RANDALL LTD. P.O. Box 757, Corner Brook, Newfoundland	Newfoundland
TRACT EQUIPMENT LTD. 14325 - 114th Ave., Edmonton, Alta.	Yukon Alberta

AMERICAN DISTRIBUTORS

Name of Distributors	Coverage Area
BOMBARDIER EAST INC. Railroad St., Lee, Massachusetts 01238	Massachusetts Connecticut Rhode Island
BOMBARDIER WEST INC. 609 West Broadway, Idaho Falls, Idaho 83401	California Nevada Montana Idaho Wyoming Utah Colorado
CRAIG TAYLOR EQUIPMENT CO. P.O. Box 3338, Anchorage, Alaska 99501	Alaska
ELLIOTT & HUTCHINS INC. East Main Street Road, Malone, New York 12953	New York Pennsylvania New Jersey Maryland Delaware District of Columbia Virginia

HALVORSON INCORPORATED
325 South Lake Avenue,
Duluth 2, Minn. 55802

North Dakota
South Dakota
Minnesota
Wisconsin
Iowa
Illinois
Missouri
Upper Michigan

HEATH INTERNATIONAL INC.
33737 - 32 Mile Road,
Richmond, Mich. 48062

Lower Michigan
Indiana
Ohio
Tennessee
Kentucky
W. Virginia

TIMBERLAND MACHINES INC
10 Main St. North, Lancaster,
New Hampshire 03584

Maine
New Hampshire
Vermont

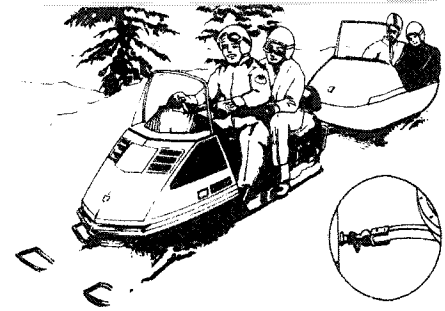
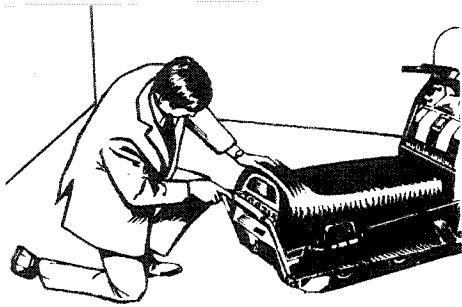

DO'S

- Register your Ski-Doo snowmobile at your nearest Licensing Bureau, where State or Provincial Laws require it, and affix Registration Plate to the vehicle. Carry your registration certificate with you. It provides proof of ownership in the event that the vehicle becomes lost or stolen.
- Obtain your State or Provincial booklet on snowmobiling. It gives valuable information on the neighbouring snowmobile trails and the laws governing snowmobiling in your particular area.
- Observe all posted snowmobile signs. Not all private landowners allow snowmobiling on their property. You can have just as much fun, even more so, by traveling elsewhere.

- When with others, limit your actions to the experience of the main body. Show the inexperienced driver how to properly handle a snowmobile.
- Always travel with at least one other snowmobile, especially in unfamiliar terrain or on trail rides. Even in snowmobiling, a pair beats one of a kind.
- If you are planning to explore new areas, leave word of your approximate whereabouts and estimated time of return with someone.
- Always make a full stop then look carefully in both directions before crossing roads. When traveling in pairs or in a group, have one member direct the others across singly.

- Use a rigid hitch or tow-bar when pulling any sled or trailer behind your Ski-Doo snowmobile. Rigid hitches prevent tailgate collision when going downhill or on sudden stops.
- Be extremely careful when giving children a ride. Go more slowly and check frequently. Small children, are far safer in a Ski-Boose* sled than on the seat of your snowmobile.
- When trailering your Ski-Doo snowmobile, secure it solidly at both ends, protect it with a bright cover (Ski-Doo* cover) then check that trailer hitch and safety chain are secure and that brake, flashers, position and parking lights are all in working order.

*Trademark Bombardier Limited

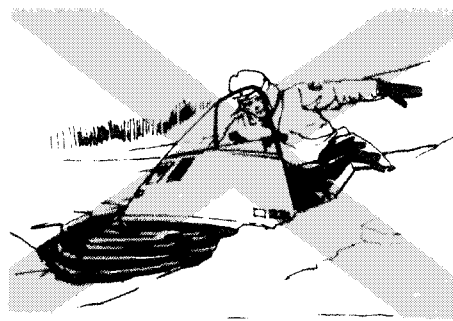
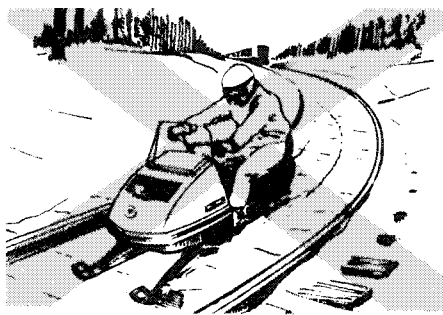

DON'TS

- Don't cut across in front of the line of travel of another snowmobile. Don't tailgate; collision, or the threat of it, is serious with any moving vehicle.
- Don't risk injury or damage to your machine with needless and foolish stunting. Don't "jump" your snowmobile. This part of snowmobiling should be left to the professional "stunt" men.
- **Never** ride on railway tracks. The sound of your moving vehicle drown out noise of approaching trains. Your vehicle may also become caught in track junctions. In many States and Provinces snowmobiling on railway tracks constitutes an infraction of the law.
- Never cut through fences or attempt to run over them.

- Don't cross a river or lake without first being positive that the thickness of the ice is sufficient to support both you and your vehicle. **Your life may depend on it.** If at all in doubt, take an alternate route.
- Unless you are certain of a fueling stop, never travel further than $\frac{1}{2}$ of the fuel remaining in your tank. Even then, leave yourself a safety margin. Remember that a snowmobile does not necessarily travel the same distance each time on the same amount of fuel. A lot depends on speed, snow conditions of the trail and adjustment of the carburetor.
- Don't drive your snowmobile in the vicinity of skiers and keep off ski trails. Always respect the rights of those who enjoy winter in another way.

- **"If you drink don't snowmobile! If you snowmobile, don't drink!"** Remember alcohol and gasoline don't mix.
- Don't lend your snowmobile to inexperienced or under-age drivers. In many cases it is the vehicle owner and not the rider that is responsible for mishaps. Check State or Provincial minimum age limits for drivers.
- Don't leave your keys in the ignition switch. It presents an invitation to thieves and a danger to children.
- Don't get hands or feet in track or moving parts. If your vehicle gets "bogged" down, stand to one side, squeeze the throttle lightly, lift the rear grab handle, and walk out the machine.

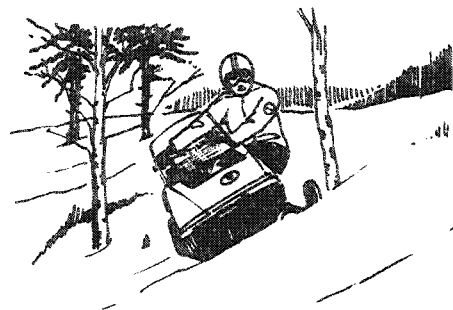
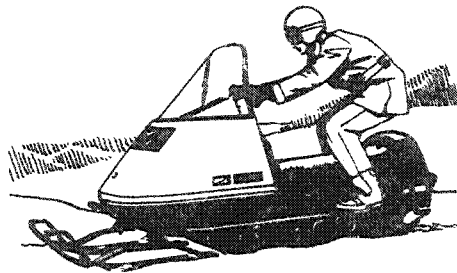

GOOD DRIVING TECHNIQUE

Everyone knows, or should know, the difference between a good snowmobiler and a poor one. Most beginners think that snowmobiling is just a matter of starting the engine and riding away. It's not so. There are right and wrong ways to go about it. Here are some of the preferred methods.

Tips

Where possible, enter a snowmobile training program. Thoroughly know your vehicle and how to drive it before attempting difficult or rapid maneuvers.

Driving Positions.

There are three driving positions on a snowmobile—Standing, Kneeling or Sitting. Each presents certain advantages depending on the nature of the terrain, snow conditions, the turns you desire or the personal preference of the driver.

Standing—This position is undoubtedly the best for climbing steep hills, traveling a short stretch of bumpy trail or when maneuvering in deep snow. In this position, however, always keep your knees slightly flexed to absorb surface shocks.

Kneeling—crossing a steep slope, for example, from side to side, you will find the kneeling position a definite advantage. Place one foot on the footboard (on the high side of the hill), the opposite knee on the seat then lean into the hill.

Warning: Side hills and steep slopes are not recommended for a beginner.

An alternate recommended kneeling position and one that is frequently used, is to place both knees on the seat, with one foot on each side, loosely pressing against the seat.

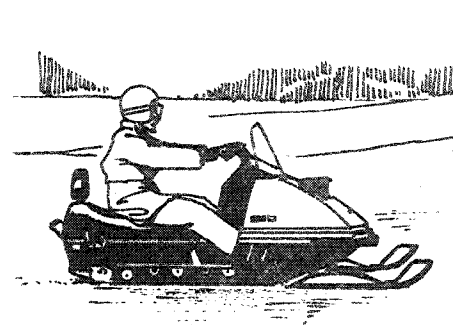
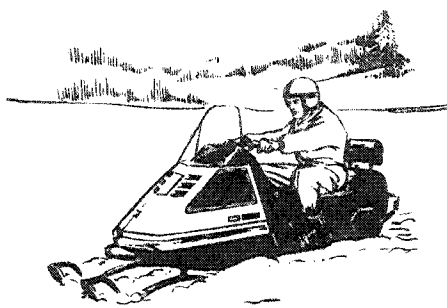

Sitting—for all normal driving. Feet should be on the footboards, body mid-way back on the seat. **Avoid** placing your foot inside the support braces of the footboard.

Warning: Prolonged sitting while riding over rough terrain may cause kidney and/or spinal discomfort, specially for the driver or passenger having an existing back weakness.

Turning.

To snowmobile properly you must learn to "body english", (using the weight or position of your body). Shifting to left or right as the turn demands and keeping your center of gravity as low as possible will give you the mark of an experienced snowmobiler.

Moving your body weight toward the front of the vehicle, particularly in hard-packed snow, adds pressure to the skis and ski runners so that they bite more deeply into the snow surface.

Icy Surface.

Ice or extremely hard-packed snow can be difficult to negotiate as both skis and track do not have much traction. Best advice is to slow down and avoid rapid acceleration or braking.

Deep Snow.

Use the standing position recommended earlier and if your vehicle continues to make reasonable headway, responding to light changes in acceleration, you are safe enough to explore new areas. If not, turn in as wide an arc as possible and look for firmer trails.

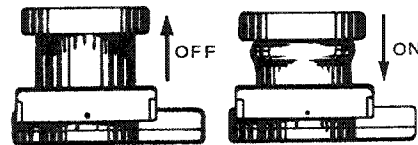
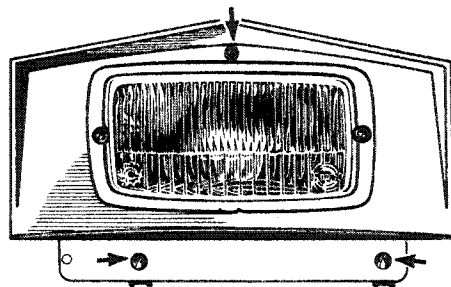
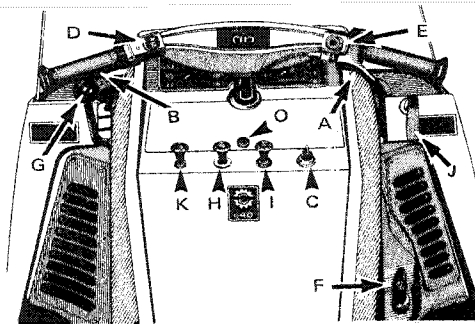

CONTROLS/INSTRUMENTS

Steering

Rotation of the handlebar causes a push-pull action on the steering linkage and forces the skis to turn in the required direction.

Throttle Lever (A)

When depressed, the lever controls the **engine speed** and the **engagement of the transmission**. When lever is released the engine speed returns automatically to idle.

Brake Lever (B)

When lever is depressed, the brake is applied. When released, it automatically returns to its original position. Braking effect is proportionate to the applied pressure on the lever.

Ignition Switch (C)

Key operated, 3 position switch (OFF/ON/START). To start engine, turn key fully clockwise to START position and hold. Return key to ON position **immediately** engine has started.

Headlamp Dimmer Switch (D)

The dimmer switch allows correct selection of headlamp beam. To obtain Hi or Low beam simply depress switch. A Hi beam indicator is mounted in the tachometer dial.

Note: The angle of your headlamp beam has been pre-adjusted prior to delivery. Should you wish readjustment, turn upper or lower adjusting screws to obtain desired beam position.

Kill Button (E)

For emergency stops, press button down into **lower** position. Before re-starting engine always depress button

into released **upper** position.

The driver of this vehicle should familiarize himself with the function of this device by using it several times on first outing, thereby being mentally prepared for emergency situations requiring its use. After such a situation, the source of malfunction should be determined and corrected **before** re-starting engine.

Manual Starter (F)

Auto-rewind type located at lower right side of console. To start engine, pull handle. (See Starting Procedure).

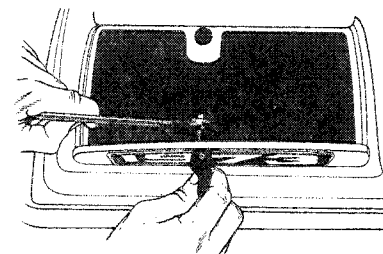
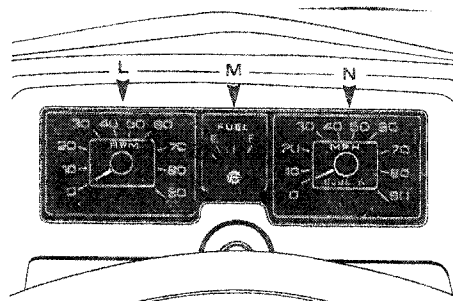
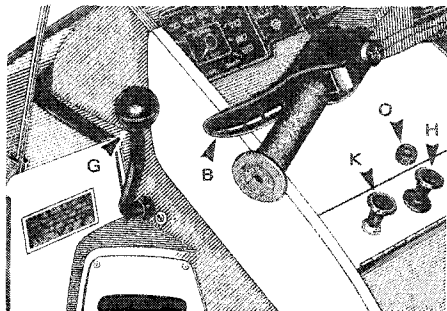

Gear Shift Lever (G)

Three position lever, (FORWARD/PARK/REVERSE). Push **up** for forward, **center** for park and **down** for reverse.

Warning: Do not re-position gear shift lever while snowmobile is in motion.

Choke (H)

Pull button to engage choke, push to disengage. The choke should always be used for easier cold engine starts. After engine is warmed up however, it is not necessary to use choke when starting.

Lighter (I)

Push in to activate, lighter pops up automatically when lit.

Headlamp Retract Lever (J)

Two position (PUSH/PULL) lever. To expose headlamp, pull lever. Push to retract.

Light Switch (K)

With engine running, engage switch to

illuminate both headlamp and taillight.

Tachometer (L)

Direct-reading dial indicates (in thousands), the number of revolutions per minute (R.P.M.), of the engine.

Fuel Gauge (M)

Direct-reading dial indicates the amount of fuel in the tank.

Speedometer (N)

Direct-reading dial indicates the speed of the vehicle in miles per hour (M.P.H.). 6-digit odometer records the number of miles travelled.

Upper Access Door Lock (O)

To gain access to spark plugs, turn door lock then lift door and remove.

Lower Access Door

Lift lower access door to gain access to carburetor.

Caution: Serious engine damage may occur if your vehicle is operated with the carburetor air intake tube removed.

Rear Compartment

Recessed underseat compartment. Ideal location for spark plugs, belt, rope, etc. Pressure lock fastened. To adjust, simply tighten or slacken adjusting nut.

Tips

Emergency materials should be wrapped in foam or similar material. This will prevent possible damage to breakable items when traveling over rough or bumpy terrain.

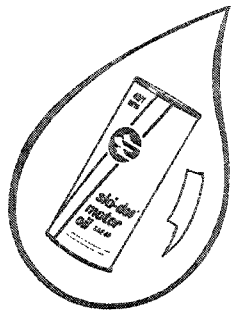
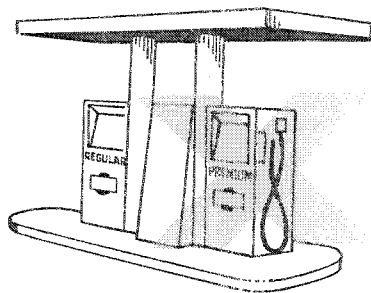

40:1

FUEL MIXING

With Ski-Doo snowmobiles, the **oil** must be added to the **gasoline** in pre-measured amounts then both oil and gasoline should be thoroughly mixed together **before** fueling the tank.

Which Gasoline to Use

The correct gasoline is **Regular** gasoline, (not less than 88 octane), available from all service stations.

Caution: Never experiment with other than recommended fuels or fuel ratios. Never use no lead gasoline †, naphta, methanol or similar products.

† Tests are not conclusive enough therefore we do not recommend the use of no-lead gasolines

Which Oil to Use

Use **concentrated** Ski-Doo® oil available from your Ski-Doo dealer. This type of oil has specially formulated oil bases to meet the lubrication requirements of the Bombardier-Rotax engine.

Caution: The carburetors of the 1973 Ski-Doo snowmobile have been calibrated for a mixture of gasoline and concentrated Ski-Doo oil. Unless absolutely necessary, do not use regular snowmobile oil. If such oil is used, observe mixing instructions on the container. Never use outboard or straight mineral oils.

Fuel Mixing Ratio

The importance of using the correct fuel mixture cannot be overstressed. Prior experience has shown that an incorrect fuel ratio results in serious engine damage. The correct fuel/oil ratio is 40/1.

5 gallons, regular gasoline plus 1 pint concentrated Ski-Doo oil = correct fuel mixture.

Note: To facilitate fuel mixing, oil should be kept at room temperature.

*Trademark Bombardier Limited

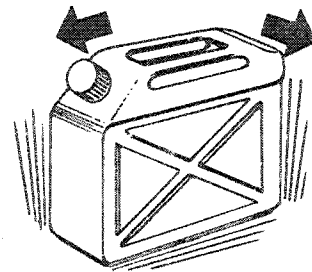
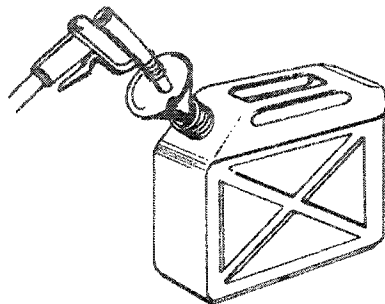
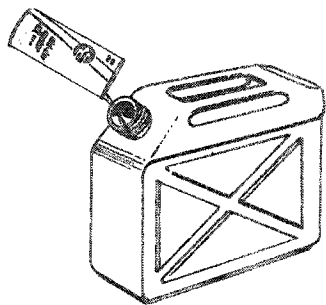

FUEL MIXING

Fuel Mixing Procedure

To mix the gasoline and oil always use a separate clean container. Never mix directly in your snowmobile tank. For best results, acquire two containers, either plastic or metal. Draw from one until empty then use the second one.

Warning: Gasoline is flammable and explosive under certain conditions. Always perform procedures in a well ventilated area. Do not smoke or allow open flames or sparks in the vicinity. If gasoline fumes are noticed while driving, the cause should be determined and corrected without delay. Never add fuel while engine is running.

- Pour the full amount of Ski-Doo oil required for the total mixture into the container.
- Add approximately half the amount of gasoline to be mixed.
- Shake the container thoroughly.
- Add the remainder of the gasoline.
- Once again thoroughly agitate the container.
- Using a funnel with a fine mesh screen to prevent the entry of water and foreign particles, transfer mixture from container into the snowmobile tank.

Note: When using pre-mixed fuel, always shake the container thoroughly as the oil has a tendency to settle.

Warning: Never 'top up' gas tank before placing vehicle in a warm area. At certain

temperatures, gasoline will expand and overflow.

Fuel consumption

A good idea is for you to rate the fuel consumption of your snowmobile at the first opportunity. Starting with a full fuel tank, mark the time of your departure then note time elapsed until tank is half-full. Repeat on different occasions to get a mean average of your snowmobiles' consumption and length of running time under varying conditions.

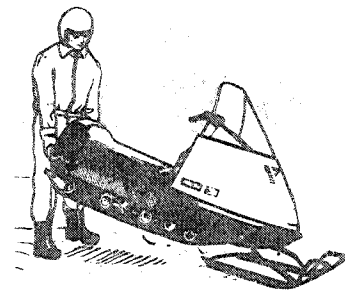
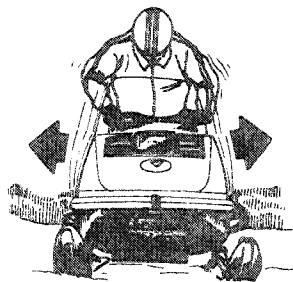
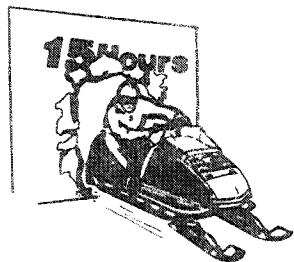

BREAK-IN PERIOD

With Ski-Doo snowmobile engines, a break-in period is required **before** running the vehicle at full throttle. Manufacturer's recommendation for the Bombardier-Rotax engine is 10 to 15 operating hours. During this period, maximum throttle should not exceed $\frac{3}{4}$. However, brief full accelerations and speed variations contribute to a good break-in. Continued wide open throttle accelerations, prolonged 'cruising' speeds and lugging are detrimental during the break-in period.

Inspection

After the break-in period, we suggest that each Ski-Doo snowmobile has an inspection check. This inspection is at the discretion and expense of the vehicle owner.

PRE-START CHECK

Fuel Tank Quantity

Check that there is sufficient fuel in the tank for your trip. A good habit to acquire is to refill the tank before starting out each day.

Since mixed fuel has a tendency to settle overnight, agitate the fuel in the tank by standing on the footboards and rocking the vehicle from side to side.

Track (Daily, before first run)

Under certain climatic conditions, the track of a snowmobile left outdoors overnight may freeze to the ground or snow surface. Always make sure that the track is free before attempting to start the vehicle. (This procedure will eliminate unnecessary drive belt wear).

Steering Operation

Check operation of steering mechanism by rotating the handlebar several times from side to side. If roughness or binding is felt, check for ice or snow that may be blocking the mechanism.

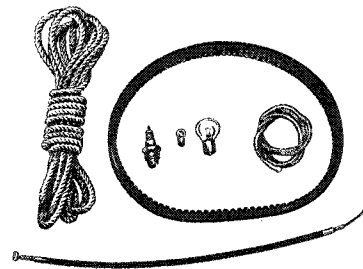
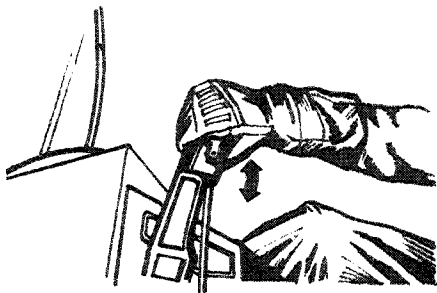

IN CASE OF EMERGENCY

Throttle and Brake

Depress and release levers several times to check that they operate easily and smoothly. The throttle lever should return to the idle position when released. The brake lever should be fully applied when it has minimum clearance from the handlebar grip (see Maintenance, Brake). If the levers do not return swiftly, remove cables and/or housings and replace. Re-check lever operation.

Warning: Throttle mechanism should be checked for free movement before starting engine. Once all components are checked and functioning properly, you can start your Ski-Doo snowmobile.

Emergency situations are accepted hazards with any moving vehicle. A hidden rock or stump on the trail, a burnt light bulb while driving at night, an empty fuel tank while miles from anywhere, can all cause varying degrees of inconvenience. Unlike an automobile, which has a distinct advantage in that service stations are usually within walking distance, **snowmobiles are specifically designed to travel off the highways.**

When the unexpected happens, the driver often has only his own ingenuity and that of his companions to return home safely. Fortunately, 9 out of 10 difficulties encountered on the trail can be fixed on the spot. However, you must carry at least a minimum assortment of Tools and Spare Parts to enable you to effect minor repairs.

Emergency Materials

In addition to those tools which the manufacturer provides, you should carry the following:

Tools: General Purpose Pliers—Adjustable Wrench ($\frac{3}{4}$ " opening)—Flashlight.

Spare Parts: Spark Plug—Drive belt—Headlamp and Taillight bulbs—Throttle Cable and Housing—Starting and towing rope—Fuse (electric models).

Important: Always carry spare plugs and drive belt. Check condition of spark plug frequently and look for signs of a fouled or defective plug.

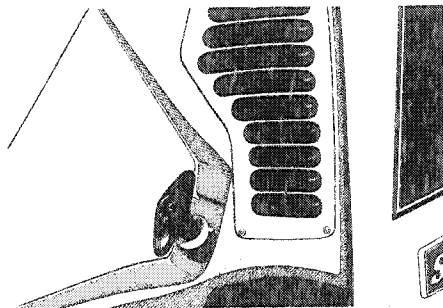
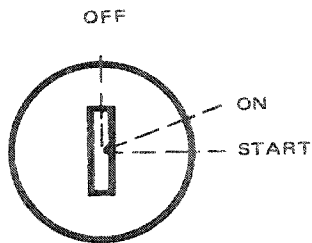

STARTING PROCEDURE:

Warning: Ensure the gear shift lever is in **PARK** position before starting engine. Never run the engine at high R.P.M. when the shift lever is in **PARK** or when the track of the vehicle is raised off the ground.

Note: Before starting the engine make sure the kill button is in the released upper position.

1. Insert key in ignition switch.
2. Engage choke. (Choke is not necessary if engine is warmed up).
3. Test throttle operation then apply throttle lever slightly.
4. Turn ignition key clockwise until starter engages.

Caution: Do not engage starter longer than 30 seconds. If engine does not start on first try, key must be turned fully back to OFF each time. Allow starter to cool for 2 minutes before repeating procedure.

5. **Release** throttle and key **immediately** engine has started. Disengage choke.

6. Allow the engine to warm up before operating at full throttle.

Caution: Never operate the Ski-Doo snowmobile with the battery removed or disconnected.

A manual starter is standard equipment on all Ski-Doo snowmobiles. If for some reason the vehicle cannot be started electrically proceed as follows:

1. Insert key in ignition and turn to ON position.
2. Engage choke. (Choke is not neces-

sary if engine is warmed up)

3. Test throttle operation then apply throttle lever slightly.

4. Grasp manual starter handle firmly and pull slowly until a resistance is felt then pull vigorously and engine will start. Allow handle to return **slowly** to its original position. If engine does not start, repeat the procedure.

Note: Do not pull starting rope to its fullest extent or allow starting handle to "fly back" to its original position.

5. **Release** throttle and disengage choke **immediately** engine has started.

6. Allow the engine to warm up before operating at full throttle.

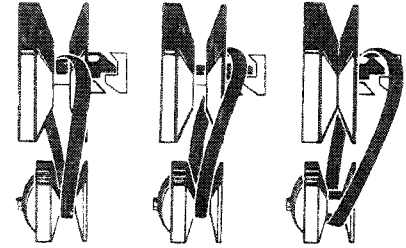
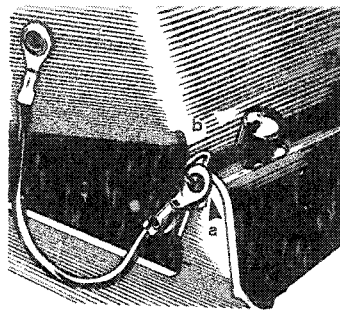
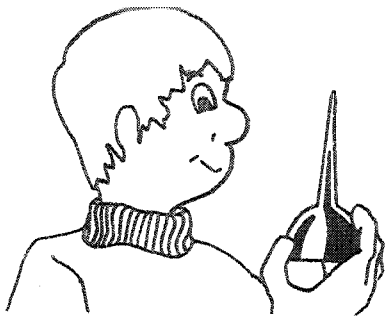

LUBRICATION

Code	Weekly (10 hours)	Page
W1	Steering Mechanism	16
W2	Gear Box Oil Level	16
W3	Bogie Wheels	16
W4	Rear Axle	17
Code	Monthly (40 hours)	Page
M1	Driven Pulley	17

Above items in the lubrication chart will be serviced during all dealer inspections.

Pulley Guard Removal

1. Tilt cab.
2. Pull out retaining clip and pull on spring bolt to disengage pin from bracket.
3. Push pulley guard forward to disengage from gear box bracket. Lift from vehicle.

Warning: Engine should be running only when pulley guard is secured in place.

Drive Belt Removal

1. Tilt cab and remove pulley guard.
2. Open the driven pulley, (larger pulley most forward). Twist and push the sliding half then **hold** in open position.
3. Pull the bottom of belt in toward the front of the driven pulley then slip slackened belt over the top edge of the sliding half.
4. Slip the belt out from the drive pulley (centrifugal governor), and remove completely from vehicle by passing it between muffler and end of driven pulley. To install drive belt, reverse procedure.

Warning: Never run the engine without drive belt installed. Running an unloaded engine can prove to be dangerous.

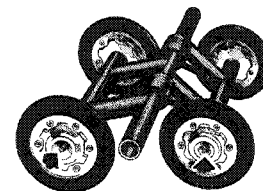
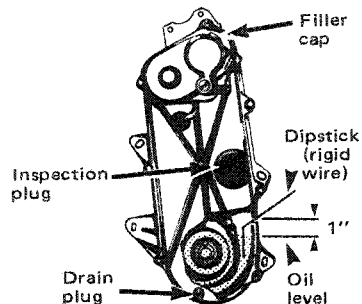
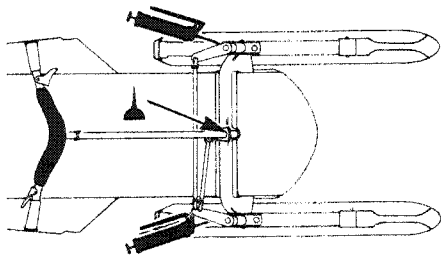

(W1) Steering Mechanism

Using light machine oil, lubricate the lower steering column bushing. Lubricate the ski legs at grease fittings until new grease appears at the joint.

(W2) Gear Box

Remove oil level inspection plug then using a length of rigid wire as a dipstick, check oil level. The gear box has an oil capacity of approx. 10 ozs. To replenish supply, remove filler cap then using a funnel, pour in required amount of Ski-Doo* chain case oil.

(W3) Bogie Wheels

Lubricate the suspension bogie wheels with low temp grease, using a low pressure grease gun. Pump through the grease fitting at the centre of each wheel until new grease appears at the joint of inner side of shaft.

*Trademark Bombardier Limited

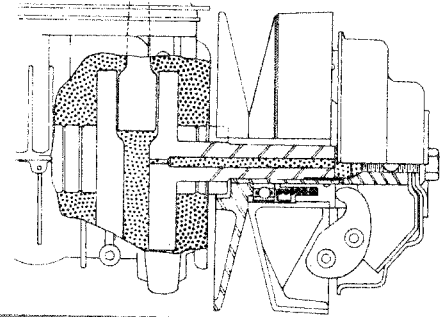
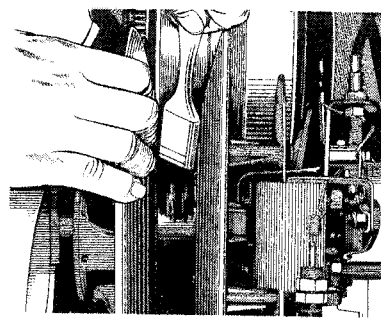
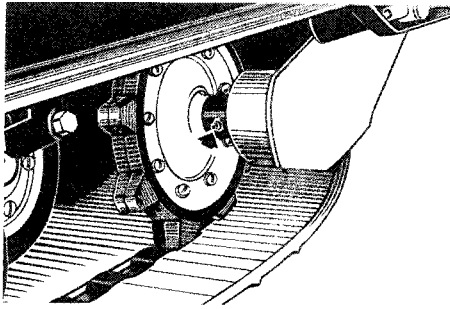

(W4) Rear Axle

Lubricate the rear axle with low-temp. grease. Pump grease through the rear axle fittings.

Caution: Always use a low-pressure grease gun.

(M1) Driven Pulley

With cab tilted and drive belt removed, lubricate the driven pulley shaft as follows:

1. Open the driven pulley. (Twist and push sliding half).
2. Thoroughly clean the driven pulley shaft.
3. Apply a light coat of low temp. grease on the shaft.

Note: Activate the sliding half several times to distribute lubricant over full length of shaft. Be careful that lubricant does not get on inner halves of pulley. Always lubricate lightly and wipe off surplus.

Drive Pulley Mechanism

Unlike other models in the Ski-Doo snowmobile series, your Nordic 640ER model is equipped with a drive pulley that is self-lubricating.

This unique lubricating action is achieved through a crankshaft drilling which draws adequate quantities of lubricant from the engine and directs it over the drive pulley mechanism.

This system requires no manual lubrication during the snowmobiling season.

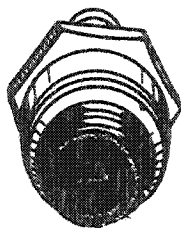

Carbonized

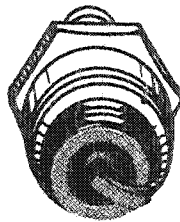

Normal

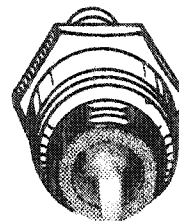

Burnt

MAINTENANCE

Code	Weekly	Page
W1	Spark Plug	18
W2	Battery (electrolyte level)	19
W3	Suspension Springs	19
W4	Track	19
W5	Track Tension	19
W6	Track Alignment	19
W7	Carburetor Adjustment	20
W8	Drive Belt Condition	21
W9	Drive Chain Tension	21
W10	Steering Mechanism	21
Code	Monthly	Page
M1	Battery (connections)	21
M2	Carburetor Flange Nuts	21
M3	Drive Belt Wear	21
M4	Brake	21
M5	Steering Adjustment	22
M6	Engine Head Nuts	22
M7	Engine Mount Nuts	22
M8	Vehicle General Inspection	22

(W1) Spark Plug

1. Unlock and remove upper access door. Disconnect spark plug wires and remove plugs.

2. Check condition of plugs.

- A brownish tip reflects ideal conditions (proper carburetor adjustment, spark plug heat range, etc.).
- A black insulator tip indicates fouling caused by: carburetor idle speed mixture too rich. Incorrect fuel mixing ratio, wrong type of spark plug (heat range), or excessive idling.
- A light grey insulator tip indicates a lean mixture caused by: carburetor idle speed mixture adjusted too lean, wrong spark plug heat range, incorrect fuel mixing ratio, or a leaking seal or gasket.

Caution: Having a spark plug with too hot a heat range will cause serious engine damage if the severity of engine operating conditions are greater than the plugs' intended range.

3. Check spark plug gap using a wire feeler gauge. Gap must be .020".
4. Reinstall plugs and connect wires.

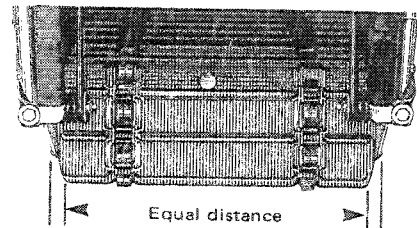
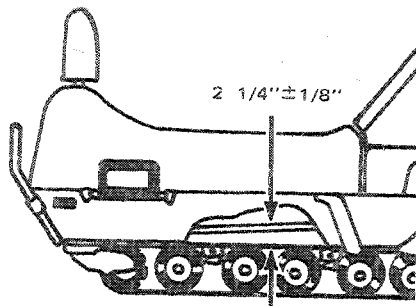

(W2) Battery

Remove battery caps then check electrolyte level at each cell. Electrolyte level must touch bottom of filler hole. If necessary, add distilled water.

(W3) Suspension Springs

With engine **off**, visually inspect bogie wheel springs and link plate springs. Replace any weak or broken spring.

(W4) Track

Lift the rear of the vehicle and support it off the ground so that the track is free to turn. With engine **off**, rotate track by hand and visually inspect track condition. If bad cuts or missing inserts are noted, see your dealer.

Note: Without these inserts continual abrasion would wear and cut the track therefore, always replace a missing or damaged insert as soon as possible.

(W5) Track Tension

With rear of vehicle off the ground, check the track tension from the middle set of bogie wheels. The track tension (distance between top inside edge of track and bottom of footboard) should be 2 1/4 inch plus or minus 1/8 inch.

If track tension is too loose, the track will have a tendency to thump. If too tight, performance will be affected.

If necessary to adjust:

1. Using wrench, loosen both track adjusters by unscrewing the lock nuts situated on the inner side of the suspension springs.
2. Adjust to proper tension by turning adjuster bolts, clockwise to tighten track, counter-clockwise to slacken. Adjust both sides equally.
3. Proceed with track alignment.

Note: Track tension and alignment are inter-related. **Do not** adjust one without

checking the other.

(W6) Track Alignment

After track tension has been corrected, start the engine and accelerate slightly so that track turns **slowly**. Check that track is well centered and turns evenly on the rear sprockets. The distance between the edges of the track and the link plates should be the same on both sides. Misalignment can cause excessive wear of track edges and sprocket teeth.

To adjust:

1. Using wrench, turn track adjuster screw clockwise on the side where the track is closest to the link plate until track aligns.
2. Firmly retighten adjuster lock nuts.
3. Rotate track slowly and recheck alignment.

Warning: Before checking track

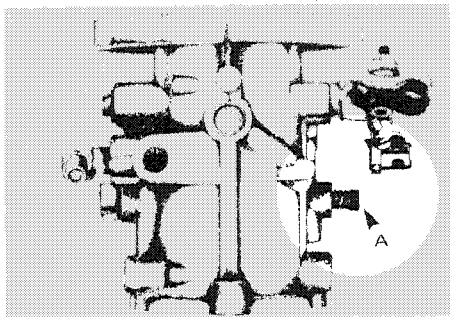

alignment, ensure that the track is free of all particles which could be thrown out while track is rotating. Keep hands, feet and clothing clear of track.

(W7) Carburetor Adjustment

The carburetor adjustments for the Ski-Doo snowmobile are: Maximum Throttle Opening, Idle Speed Mixture and Idle Speed.

Note: A relationship exists between each adjustment. Do not correct one without checking the other.

Maximum Throttle Opening

With engine **off**, unscrew the Idle Speed Adjusting Screw until a gap exists between screw end and carburetor shaft lever. Depress the throttle lever at handlebar and hold. Butterfly should be horizontal when the lever gently touches the handlebar grip.

To adjust for maximum opening, loosen screw at point where cable joins carburetor lever. Hold throttle lever to handlebar. With finger, hold carburetor lever in fully open position (UP), pull cable downward until taut. Retighten screw.

Warning: Before starting engine, carburetor throttle lever must return to idle position by contacting with the tip of Idle Speed Adjusting Screw. Never start engine unless this situation is verified.

Idle Mixture Adjustment (A)

A primary adjustment (with engine **off**), should be made by first turning Idle Mixture Screw fully clockwise until closed. Back off screw $\frac{3}{4}$ of a turn counter-clockwise.

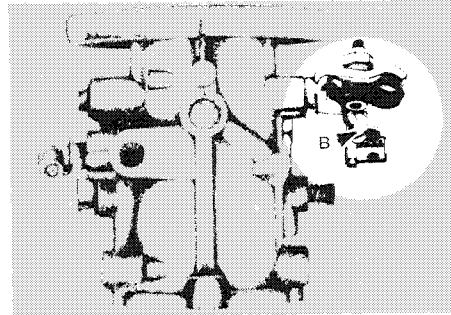

Turning screw clockwise produces a leaner mixture, (more air/less fuel), counter-clockwise, a richer mixture (less air/more fuel).

Note: Do not close too tightly as needle and/or needle seat can be damaged.

For final adjustment, start engine and allow it to warm up. Turn Idle Mixture Screw until engine reaches maximum R.P.M. and obtain a steady idle and a fast response of the engine to the throttle.

Idle Speed Adjustment (B)

Turn the Idle Speed Adjusting Screw clockwise to increase idling speed, counter-clockwise to decrease.

Caution: Never operate vehicle with air intake tube removed as serious engine damage may occur.

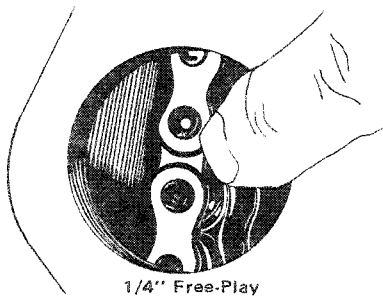

1/4" Free-Play

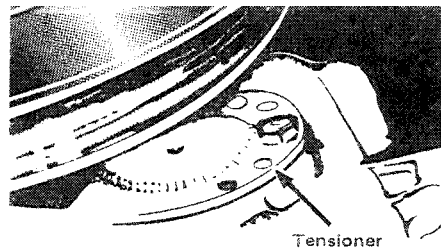

Tensioner

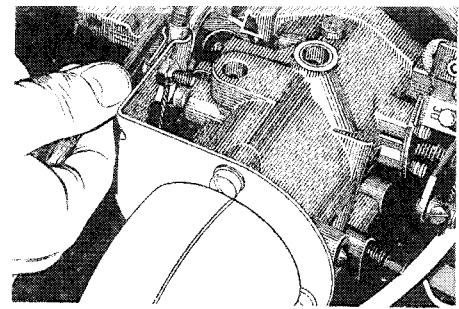

(W8) Drive Belt Condition

Remove drive belt. Check condition of belt. Inspect for cracks, fraying or abnormal wear. (Uneven wear, wear on one side, etc.). If abnormal wear is noted, probable cause is misalignment of drive and driven pulleys. Contact your dealer.

(W9) Drive Chain Tension.

Note: Chain tension should be checked after the first 2 hours of operation.

To check chain tension:

1. Start engine and drive vehicle forward for a short distance. **Stop engine** and tilt cab.
2. Remove inspection plug and check chain free-play. (The free-play should be 1/4 inch).

If necessary to adjust:

- Remove cap screw locking chain tensioner in place. Chain tensioner is located on driven pulley side.

- Rotate tensioner to obtain correct free-play. Install cap screw.

(W10) Steering Mechanism

Inspect steering mechanism for tightness of components (steering arms, tie rods, etc.). Tighten if necessary.

(M1) Battery Connections

Check that battery connections are tight and free of corrosion. If not, remove corrosion using a stiff brush then clean with a solution of baking soda and water. Rinse and dry well. After reconnecting, coat battery terminals and connectors with petroleum jelly to retard corrosion. Check that battery is well secured.

Caution: Do not allow cleaning solution to enter battery. It will destroy the chemical properties of the electrolyte.

(M2) Carburetor Flange Nuts

After the first 2 hours of operation, check tightness of carburetor flange nuts. Open tab lock, tighten nuts and

close tab lock.

Caution: The tab locks should be changed after being opened three times.

(M3) Drive Belt Wear

Tilt cab and remove pulley guard. Inspect drive belt for wear. If belt is less than 3/8" wide it should be replaced.

(M4) Brake

The brake mechanism on your snowmobile is an essential safety device. Keep this mechanism in proper working condition. Above all, do not operate your snowmobile without an effective brake system.

Check operation of brake mechanism by depressing brake lever. Brake should apply fully while lever is still 1 inch minimum from handlebar grip.

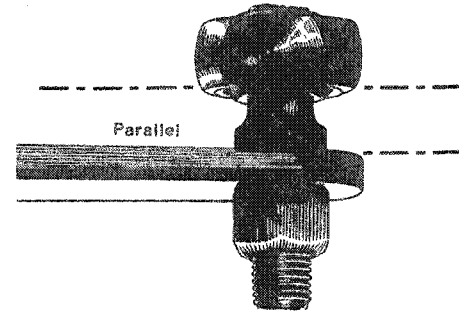
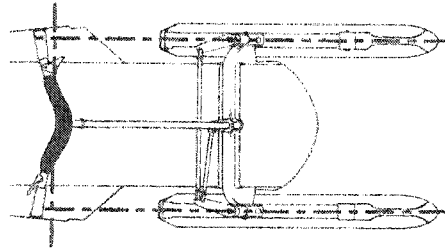
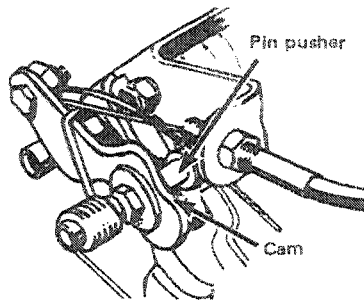

Adjustment

1. Ensure that cable housing nuts are located approximately half way on housing threads.
2. Slacken off the cable retaining bolt and manoeuvre the lower brake lever and brake cable until the pin pushers are seated directly in the deepest section of the cam of the brake lever. Lock cable in position.
3. Tighten the caliper nut until a disc/puck friction is felt. Back off nut slightly.
4. Check brake operation.

Note: Always check the stop light to see if it functions after performing brake adjustment. If necessary, loosen stop light switch lock nuts and adjust.

(M5) Steering Adjustment

Skis should be parallel to each other. To check, use metal tape and measure distance between skis at front and back. If

out of alignment:

1. Using wrench, loosen the lock nuts of the **longer** tie rod.
 2. Turn tie rod manually until skis are parallel to each other.
 3. Firmly retighten lock nuts.
- Skis should also be parallel to the vehicle when handlebar is horizontal. If not:
1. Using wrench, loosen the lock nuts of the **shorter** tie rod.
 2. Turn tie rod manually until handlebar is horizontal.
 3. Retighten lock nuts firmly.

Note: In case of serious misalignment, contact your dealer.

Warning: The socket must run parallel with the steering arm. The socket must also be restrained when tightening the tie rod end lock nuts.

(M6) Engine Head Nuts

With cab tilted and upper access door removed, check that engine head nuts are tight and equally torqued. (16 to 18 ft/lbs when **cold**).

(M7) Engine Mount Nuts

With cab tilted, remove pulley guard then check engine mount nuts. Retighten if necessary.

(M8) Vehicle General Inspection

Check electrical wiring, retighten loose connections. Inspect for and tighten loose bolts, nuts and linkage.

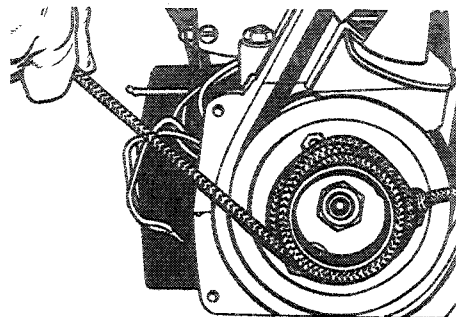
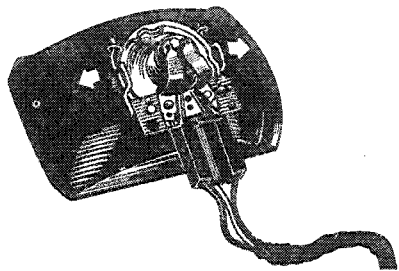

EMERGENCY GUIDE

Burnt Light Bulb

If headlamp is burnt, stop engine, unlock cab latches (2) and tilt cab. Unfasten bulb retainer clips. Detach bulb and replace. If taillight bulb is burnt, expose bulb by removing red plastic lens. To remove, unscrew the two (2) Phillips head screws.

Broken Throttle Cable

Remove throttle cable and replace. Check lever operation. If necessary replace housing. **Do not** start the engine until lever returns swiftly.

Broken Rewind Starter Rope

Abuse of the rewind starter may cause the rope to fray and break. Should this situation arise, remove starter unit using 10 mm wrench supplied in tool kit. Transfer rope grip to your emergency rope. Place starter unit in rear compartment. Make a knot at the end of emergency starter rope and wind rope around starter pulley. Pull vigorously as per usual manual start. See your dealer for immediate repair or replacement of starter unit.

Assisting Stranded Vehicles

More than common courtesy dictates that you go to the aid of any snowmobile stranded in the field. Should another vehicle suffer a major breakdown and have to be towed, use one of the following procedures.

On hard pack snow:

Remove the drive belt. Tie the front bumper to your rear bumper. Tow the vehicle and driver back slowly.

In deep snow:

Remove the drive belt. Tie both skis to your rear bumper. Taking the driver with you as a passenger, tow the vehicle back slowly.

Important:

Special attention should be given to the drive components of your vehicle when hauling another of greater weight. Hauling greater weights than your own can cause component damage.

TROUBLE SHOOTING GUIDE

Symptoms	Possible Causes	What To Do
Engine turns over but fails to start or starts with difficulty	1. No fuel to the engine	Check the tank level and fill up with correct gas-oil mixture. Check for possible clogging of fuel line, item 5.
	2. Spark plug	Check for fouled or defective spark plug. Disconnect spark plug wire, unscrew plug and remove from cylinder head. Reconnect wire and ground exposed plug on engine head, being careful to hold away from spark plug hole. Follow engine starting procedure and check for spark. If no sparks appear, replace spark plug. If trouble persists, check item 3.
	3. Faulty ignition	Disconnect spark plug wire from plug, unscrew the spark plug cap then hold wire about 1/8" from the cylinder head. Follow engine starting procedure and if no sparks appear, it means a faulty ignition system. Do not attempt to repair. Contact your dealer.
	4. Flooded engine	Disengage choke, wait 60 seconds or more then depress throttle lever fully and try to start engine. Release throttle lever immediately after engine starts.
	5. Clogged fuel line (water or dirt)	Remove and clean the fuel filter. Change filter cartridge if necessary. Check condition and connections of fuel lines. Check the cleanliness of the fuel tank. Clean tank if necessary. (See Fuel Tank, Storage Section).
	6. Faulty Carburetor	First make primary adjustments on carburetor (See Maintenance Section). If carburetor is still faulty, contact your dealer for repair.
	7. Too much oil in fuel	Drain the fuel tank and refill with the correct gas/oil mixture.
	8. Breaker points	Breaker points may be worn or out of adjustment. Contact your dealer.
	9. Poor engine compression	Running with a lean fuel mixture may produce excessive engine wear resulting in poor engine compression. If this occurs, contact your dealer at once.
Engine will not turn manually	1. Seized engine	In the case of a seized engine, contact your dealer. Seizure is a direct result of poor lubrication.

Symptoms	Possible Causes	What To Do
Engine will not start (electric model only). Note: If failure is in starting system, engine will start manually	1. Poor connections or Burnt Fuse	Check for loose or corroded battery and starter connections. Tighten and clean, also check fuse located on red wire leading from rectifier. Try to restart engine electrically. If engine still does not start, check item 2.
	2. Battery	Check condition of battery by turning lights ON. If lights are dim or out, battery may be discharged or defective. Contact your dealer to charge or replace.
	3. Starter	If wire connections are tight and fuse and battery are all in working order, most probable cause of trouble is defective starter. Contact your dealer for repair.
Engine lacks acceleration or power	1. Fouled or defective spark plug	Check item 2 of "Engine turns over but fails to start or starts with difficulty"
	2. Clogged fuel line (water or dirt)	Check fuel line condition. (See item 5 of "Engine turns over but fails to start or starts with difficulty").
	3. Carburetor	Readjust the carburetor. (See Maintenance Section). If trouble persists, contact your dealer.
	4. Defective ignition	First check item 2 and 3 of "Engine turns over but fails to start or starts with difficulty". If the ignition system still seems defective, contact your dealer.
	5. Engine	If unable to locate specific symptoms, contact your dealer.
Engine continually backfires	1. Faulty spark plug	Check item 2 of "Engine turns over but fails to start or starts with difficulty"
	2. Overheated	Contact your dealer.
	3. Engine timing incorrectly set	Contact your dealer.
Snowmobile cannot reach full speed	1. Drive belt	Check for defective or worn drive belt. Replace if necessary.
	2. Incorrect track adjustment	Check track tension and alignment. Readjust to specifications. (See Maintenance Section).
	3. Faulty engine	Check items 1 to 5 of "Engine lacks acceleration or power"
	4. Pulley misaligned	Contact your dealer.

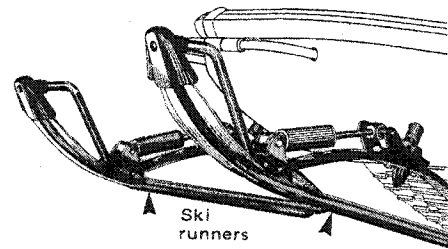
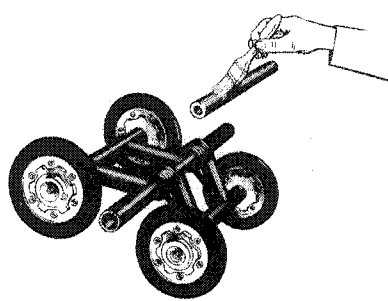
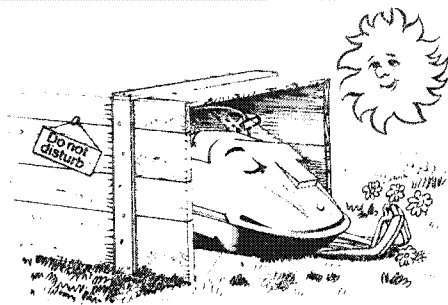

OFF-SEASON STORAGE

It is during Summer, or when a vehicle is not in use for any length of time that proper storage is a **necessity**.

Storage of the Ski-Doo snowmobile during long periods of inactivity consists of checking and replacing missing or worn parts. Proper lubrication and treatments to insure that parts do not become rusted; Cleaning items such as carburetor of oil gas mixtures, to prevent gum varnish formation within the carburetor; Battery recharging (electric models); and in general, preparing the vehicle so that when the time comes to use the snowmobile again it will start and be in top condition.

Important: The necessity of proper storage cannot be overstressed. If you lack the time or proper tools, see your authorized Ski-Doo Dealer.

(S1) Track

1. Inspect track for cuts, missing track inserts or broken rods and make any necessary replacement.
2. Lift rear of vehicle until track is clear of ground then support with brace or trestle. The Ski-Doo snowmobile should be stored in such a way that track does not stay in contact with cement floor or bare ground.

Note: The track should be rotated periodically, (every 40 days).

(S2) Suspension

1. Remove the bogie wheel sets.
2. Remove cross shaft from bogie wheel set. Clean bogie wheel assembly and cross shaft of dirt or rust.
3. Grease each bogie wheel until all old grease is flushed out.
4. Spray bogie wheel springs with metal protector. If unavailable, wipe with cloth

or rag soaked in oil. Check condition of shaft and replace if bent or worn. Apply a coat of low temp. grease on cross shaft.

5. Reassemble entire bogie wheel set, making sure assembly moves freely.
6. Reinstall bogie wheel sets.
7. Lubricate rear hub through grease fittings.

(S3) Ski Assembly

1. Wash or brush all dirt or rust accumulation from skis and springs.
2. Grease ski legs at grease fittings.
3. Check condition of ski runners. Replace if worn.
4. Apply metal protector on ski assembly. If unavailable, wipe the entire ski with cloth soaked in oil to prevent rust formation.

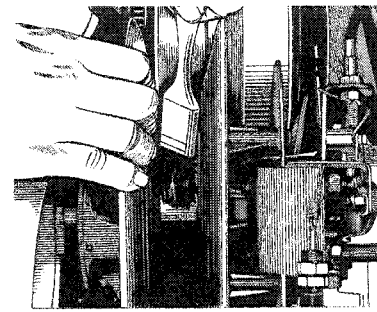
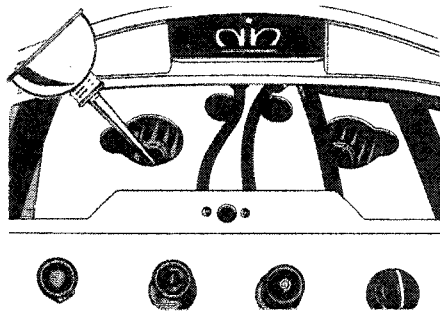
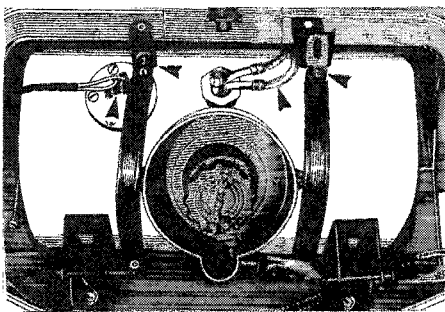

(S4) Fuel Tank

1. Disconnect fuel lines at fuel tank.
2. Disconnect electrical wiring from fuel gauge sender unit.
3. Remove tank retainer strap bolts. Pull tank from vehicle and drain it.
4. Rinse inside of tank thoroughly with fresh gasoline.
5. Reinstall fuel tank.

Warning: Gasoline is flammable and explosive under certain conditions. Always perform procedures in a well ventilated area. Do not smoke or allow open flames or sparks in the vicinity.

(S5) Carburetor

The carburetor must be dried out completely to prevent gum formation during the storage period.

1. Assure that inlet fuel line is disconnected then start the engine and run it out of gas.

2. Pull out air silencer tube from carburetor, engage choke then pack the carburetor throat with a clean piece of cloth and turn the engine a few more times. The suction should eliminate the remaining fuel.

(S6) Cylinder Lubrication

Engine internal parts must be lubricated to protect cylinder walls from possible rust formation during storage.

1. Remove spark plug.
2. Operate rewind starter to bring piston at **top** position.
3. Pour about one spoonful of Ski-Doo* oil into spark plug hole.
4. Slowly crank engine 10 to 12 times using manual starter.

Caution: To prevent magneto damage, make sure that the ignition switch is at the OFF position

5. Repeat above steps for other cylinder. Install spark plugs.

Note: This operation should be repeated every 40 days during storage.

(S7) Gear Box

Remove drain plug and drain content. Refill with 10 ozs. of fresh Ski-Doo* chain case oil.

(S8) Driven Pulley

1. Tilt cab, remove pulley guard and drive belt.
2. Thoroughly clean the driven pulley shaft. Apply a light coat of low temp. grease on the shaft.
3. Activate the sliding half several times to distribute lubricant.
4. Spray internal pulley surfaces with metal protector.

Note: Leave drive belt off during entire storage period.

*Trademark Bombardier Limited

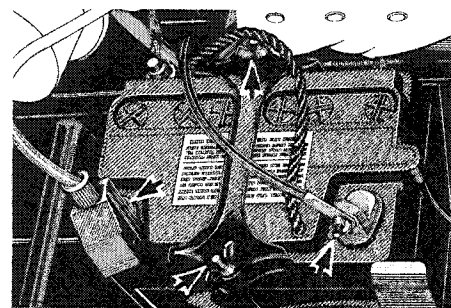
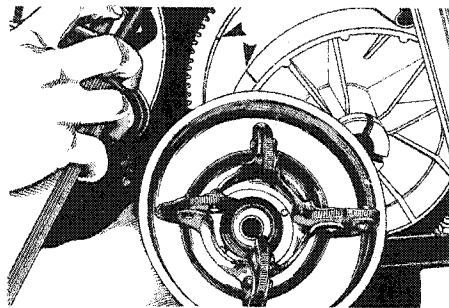
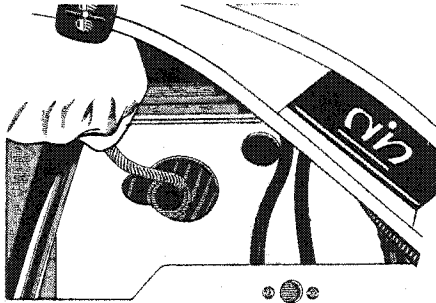

(S9) Drive Pulley

1. With cab tilted, remove pulley guard and drive belt.
2. Remove centrifugal governor as follows:
 - Remove both spark plugs and position P.T.O. (drive pulley side) piston $\frac{3}{4}$ " to $1\frac{1}{4}$ " **before** top dead center, making sure that the piston closes the exhaust port.
 - Accede by the spark plug hole and pack the same P.T.O. cylinder with $\frac{3}{16}$ " dia. rope.
 - Pull manual starter to rotate crankshaft until piston bears against "cushioning"
 - Unscrew centrifugal bolt, remove centrifugal governor, outer pulley half and spring. Pull rope from spark plug hole.
3. Thoroughly clean the inner pulley shaft using fine steel wool and clean

cloth. Inspect all components for excessive wear.

4. Spray the centrifugal governor assembly and pulley halves with metal protector.
5. Install spring and outer pulley half. Making sure that the aligning mark on inner pulley half coincides with the aligning mark of the outer half pulley half, inject light machine oil into the pulley shaft.
6. Using light machine oil, lubricate the governor bolt threads. Install governor and torque bolt to 33-40 ft/lbs.

Note: Installation procedure is reversed insuring that the rope is inserted into the same cylinder when piston is $\frac{3}{4}$ " approx. **after** top dead center.

Warning: Make sure that the governor bolt is fully tightened before removing rope from cylinder.

(S10) Battery

1. Disconnect battery and remove from vehicle.
2. Clean outside surface of battery with solution of baking soda and water. Remove all deposits from connection posts and rinse with clear tap water.

Caution: Do not allow cleaning solution to enter battery interior since it will destroy the electrolyte.

3. Check electrolyte level in each cell. Refill if necessary using distilled water.
4. Fully charge battery.

Warning: Gases given off by a battery being charged are highly explosive. Always charge in a well ventilated area. Keep battery away from cigarettes or open flames.

5. Coat battery terminals with petroleum jelly.
6. Store the battery in a cool, dry place.

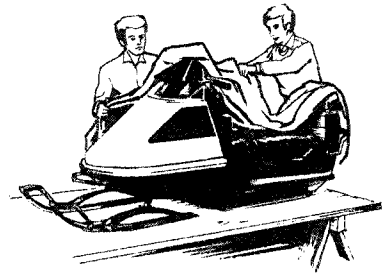
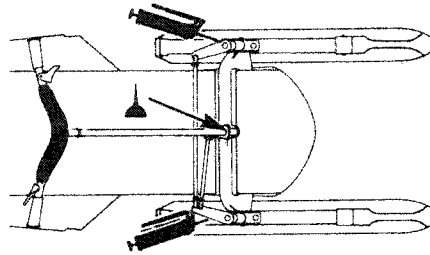
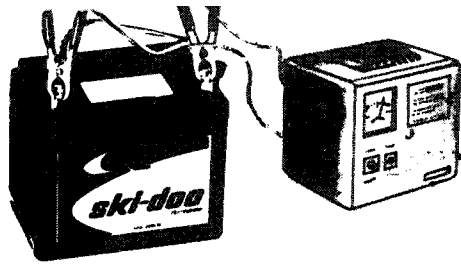

Note: A stored battery will gradually lose its charge and begin to sulphate. If allowed to continue, the battery will become useless and cannot be salvaged. Fully recharge (trickle charge), at least every 40 days.

(S11) Controls

1. Oil steering mechanism. Inspect components for tightness, (tie rods, spherical ball joints, etc). Tighten if necessary.
2. Oil moving joints of brake mechanism. **Avoid getting oil on brake lining.**
3. Coat all electrical connections and switches with a greaseless metal protector. If unavailable, use petroleum jelly.

(S12) Chassis

1. Clean the vehicle thoroughly, removing all dirt and grease accumulation.
2. Inspect cab and repair damage. Repair kits are available at your authorized Ski-Doo dealer.
3. Wax the complete cab for better protection.
4. Touch up all worn metal spots where paint has been scratched off. Ask your dealer about Ski-Doo* paints.
5. Spray all bare metal parts of vehicle with metal protector.
6. Protect the vehicle with a Ski-Doo* cover to prevent dust accumulation during storage.

Caution: Polycarbonate cab can be cleaned using mild detergents or isopropyl alcohol. Strong soaps, degreasing solvents, abrasive cleaners, paint thinners etc . . . should not be used at any time.

*Trademark Bombardier Limited

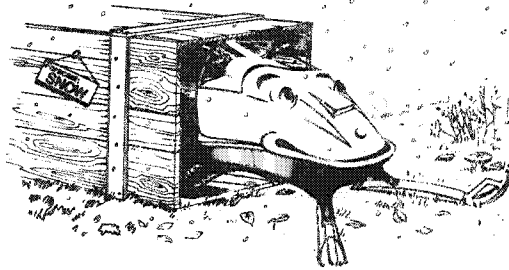

PRE-SEASON PREPARATION

Snow is falling and you are now anticipating the next snowmobile safari. If you have observed and adhered to the storage procedures outlined in this manual, your vehicle preparation becomes a relatively easy task.

To simplify the pre-season preparation we have drawn up a small check list.

Many items have been forementioned in the Lubrication or Maintenance sections of this manual therefore quick and easy reference is possible.

Again we mention, should you lack the time or tools to complete the task, to contact the Ski-Doo dealer of your choice and obtain his professional assistance.

- Spark plug: Change
- Gear box: Check oil level
- Pulleys: Clean, lubricate and align drive and driven pulleys.

- Skis: Aligned.
- Fuel Filter: Change.
- Fuel lines: Connect then check attaching points at tank and carburetor.
- Track: Check tension and alignment.
- Suspension: Lubricate, wipe off excess grease.
- Drive belt: Inspect and install.
- Cables: Check for damage.
- Brake: Inspect lining, adjust.
- Oil seals: Inspect for possible cuts or leaks.
- Battery: Test, clean and install.
- Engine Timing: Replace breaker points. Set timing.
- Wiring: Check electrical wiring for broken or damaged insulation. Inspect connections.
- Manual Starter: Inspect condition of starting rope.
- Fasteners: Check tightness of all nuts, bolts and linkage. Pay particular at-

tention to engine head nuts—16-18 ft/lbs torque. Governor bolt 33-40 ft/lbs torque.

- Gas Tank: Refill.
- Carburetor: Adjust

IMPORTANT: Observe all Warnings and Cautions mentioned throughout this manual which are pertinent to the item being checked. When component conditions seem less than satisfactory, replace with genuine Bombardier parts.

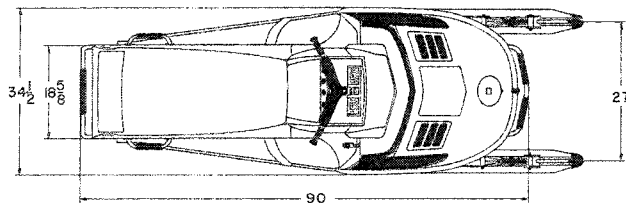
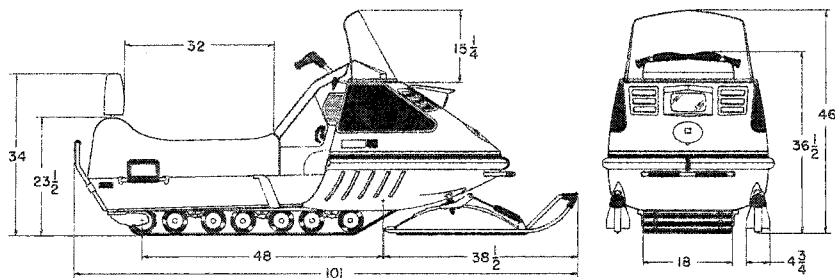

SPECIFICATIONS

ITEM	NORDIC	640ER
Engine	No. of Cylinders	Two
	Bore	76 mm
	Stroke	70 mm
	Displacement	635.1 cc
	Compression Ratio	9:1
	Carburetor (Tillotson)	HD
	Starting	Electric
	Horse Power	N.A.
Chassis	Overall length	101"
	Overall width	34 1/2"
	Height	46"
	Height w/o windshield	36 1/2"
	Weight (lbs)	495
	Bearing area	1242 sq.in.
	Ground pressure (p.s.i.)	.398
Power Train	Track width	18"
	Std. gear ratio	19/33
Electrical System	Lighting coil output	120 watt
	Headlamp (watt)	60/60
	Tail/Stop light	8/23
	Spark plug (Bosch) *	M-280-T-31
	Spark plug gap	.020"
Breaker points gap	.014" - .018"	
Fuel	Tank capacity - Imp.	5.1
	- U.S.	6.37
	Gasoline	Regular
	Gas/oil ratio	40/1
Brake	Type	Disc

* The above spark plug is recommended when operating the vehicle at full throttle. However, when prevailing conditions do not permit such operation, contact your dealer for correct spark plug heat range.

1973 SKI-DOO WARRANTY

Bombardier Limited (Bombardier) as manufacturer, warrants every 1973 Ski-Doo snowmobile, Ski-Boose or Carry-Boose tow sled, SOLD AS A NEW VEHICLE, BY AN AUTHORIZED SKI-DOO DEALER, to be free from defects in material, and workmanship under normal use and service, for a period of ninety (90) days subject to the following coverage period:

1. Beginning no sooner than from the date of delivery to the first retail buyer, for a period of ninety (90) consecutive days.
2. Since snow is required for snowmobiling; all deliveries **prior to December 15th, 1972**, shall be covered under this warranty from **December 15th, 1972 to March 15th, 1973**.
3. All units delivered on or after **January 2nd, 1973**, but prior to **March 31st, 1973**, shall have a warranty carry-over into the next season, starting on **December 15th, 1973**, for the unused portion of the ninety (90) day warranty.

CONDITIONS

1. That maintenance be performed, at the owner's expense, as set down in the applicable owner's manual. Any failure which occurs as a result of inadequate maintenance † or improper use shall not be assumed by this warranty.
2. Any damages to any part of the above-mentioned vehicles and their components caused through improper use or maintenance or by any part installed which is not a genuine Ski-Doo replacement part, or not installed by an authorized Ski-Doo dealer, voids any future warranty

coverage to the affected parts.

3. This warranty does not apply to any defect which results from:
 - i) misuse or accident;
 - ii) Installation of repair parts other than genuine Bombardier replacement parts or;
 - iii) Repairs by any person other than an authorized Ski-Doo snowmobile dealer;
 - iv) Lack of preventative maintenance;
 - v) Alterations or modifications other than those approved in writing by Bombardier.
 4. Proof of ownership and warranty registration must be submitted to the service dealer by means of the Ski-Doo Service Card.
- † **Guidelines for proper use and maintenance are detailed in each owner's manual.**

EXCLUSIONS

- **Maintenance Items and Services** are considered non-warrantable and necessary to proper functioning of the vehicle, and without limiting the foregoing the following parts and services are excluded
- Variable speed drive belt, fan belt, windshield, filters, ignition breaker points and condensers, spark plugs, light bulbs and protective lenses, brake linings, ski runner shoes, slider shoes on variable speed pulleys, all fasteners, labels, soft trim and appearance items, lubricants and paints, and all tune ups or adjustments required

- Any part damaged through lack of lubrication unless it is proven to be attributable to a manufacturing defect.
- Blizzard models or any of the vehicles referred to in this text which may have been used for racing or professional competition.
- Any damages resulting from an accident unless such damages are proven to result from a manufacturing defect.
- Any losses incurred to the vehicle owner other than the parts and labour required to repair the warrantable defect.

This warranty is expressly in lieu of all other expressed or implied warranties of Bombardier, its distributors and the selling dealer, including any implied warranty of merchantability or fitness for any particular purpose. Neither Bombardier, its distributors nor the selling dealer shall be responsible, under any circumstances, for any loss or damage as a result of hidden defects, accidents, misuses or other faults.

Neither the distributor, the selling dealer nor any other person has been authorized to make any affirmation, representation or warranty other than those contained in this warranty and if made, such affirmation, representation or warranty shall not be enforceable against Bombardier or any other person.

BOMBARDIER LIMITED
FEBRUARY 2, 1972

NOTE: *In the event of change of ownership, complete the notice of transfer form below in order to qualify the new owner for balance of warranty. All such transfers should be reported to an authorized Ski-Doo dealer for modification of the Ski-Doo Service Card. In the event of a lost Service Card, contact the original selling dealer for completion of the "Request for New Service Card" form. For a \$2.00 handling charge, Bombardier will mail your new personalized Service Card to you.*

Bombardier Limited,
Valcourt, Québec, Canada. February 1972.

NOTICE OF TRANSFER

Model Vehicle Serial No.

The ownership of this vehicle is transferred
 From

 Signature of registered owner

To
 Full name of purchaser *Block letters*

Address _____
 No Street or Village

 City County
 Date

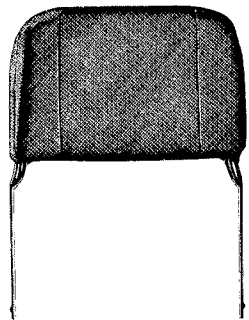

Backrest

- Easily installed on Ski-Doo® snowmobiles.
- Can be attached at two locations--center for driver only rear for passenger.
- Attractive sturdy leatherette and metal construction also available chrome coated.
- Highly recommendable for all snowmobiles carrying more than one passenger.

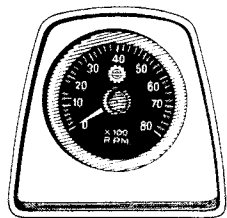

Tachometer

The tachometer registers the impulses of the magneto. Direct-reading dial indicates (in thousands) the number of revolutions per minute (R.P.M.) of the engine. Vital towards maximum performance and engine diagnosis.

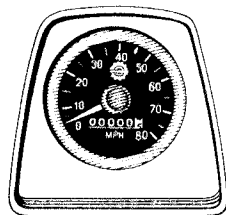

Speedometer

Linked directly to the drive axle. Direct-reading dial indicates the speed of the vehicle in miles per hour (M.P.H.). 6 digit Odometer records the number of miles travelled.

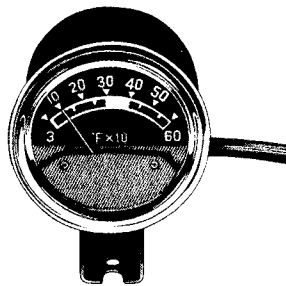

Temperature Gauge

Developed for observing changes in cylinder head temperatures. Features: high sensitivity . . . quick response . . . special heat compensating bi-metal . . . internal illumination and quick connect pick-up unit. Applicable to all models.



Snow Guard

- Prevents snow from blinding trailing snowmobilers.
- Strong thick rubber ensures long lasting durability.
- Perfectly flexible even under extreme cold.
- A must for all racing snowmobiles and an added precaution for snowmobilers on safari.
- Applicable to all models.

All genuine Ski-Doo parts and accessories are specifically designed to provide you with peak performance. Whether it's for comfort or safety, you know that you can depend on genuine Ski-Doo parts and accessories available only at Ski-Doo dealers across the country.

. . . and the **Bombardier corporation** is behind them all.

*Trademark Bombardier Limited

SKI-DOO * SHOP MANUALS

1970-1971 Completely illustrated, with over three hundred full size pages, the content includes entire sections on Engine—Carburetor—Chassis—Suspension—Electrics—etc. Lists step by step procedures for Repairs—Servicing and much much more. Covers both 1970 and 1971 vehicles. \$8.95.

1972 Over two hundred pages of up-to-date information on Repairs and Servicing. Completely illustrated. Everything you'll ever need to know about servicing your 1972 Ski-Doo snowmobile. \$7.95.

1973 Supplement edition of the '72 Shop Manual. Includes the latest design changes and servicing techniques for '73 vehicles. \$5.00.

Reserve your copy now! Send certified cheque or money order to:

Canada

Bombardier Limited,
Technical Information Centre,
8600 Decarie Blvd.,
Montreal 307, P.Q.

U.S.A.

Bombardier East Inc.,
Railroad Street,
Lee, Massachusetts, 01238

To be completed and returned with
a money order or a certified cheque
(Postage included)

NAME _____

(BLOCK LETTERS)

STREET _____

CITY _____

STATE / PROV. _____

ZIP CODE _____

SEND ME _____

1970-71 SHOP MANUAL \$8.95

1972 SHOP MANUAL \$7.95

1973 SUPPLEMENT \$5.00
(Available December '72)

*Trademark Bombardier Limited