

'72 Owner's Manual

ski-doo

élan



EXTERNAL FEATURES

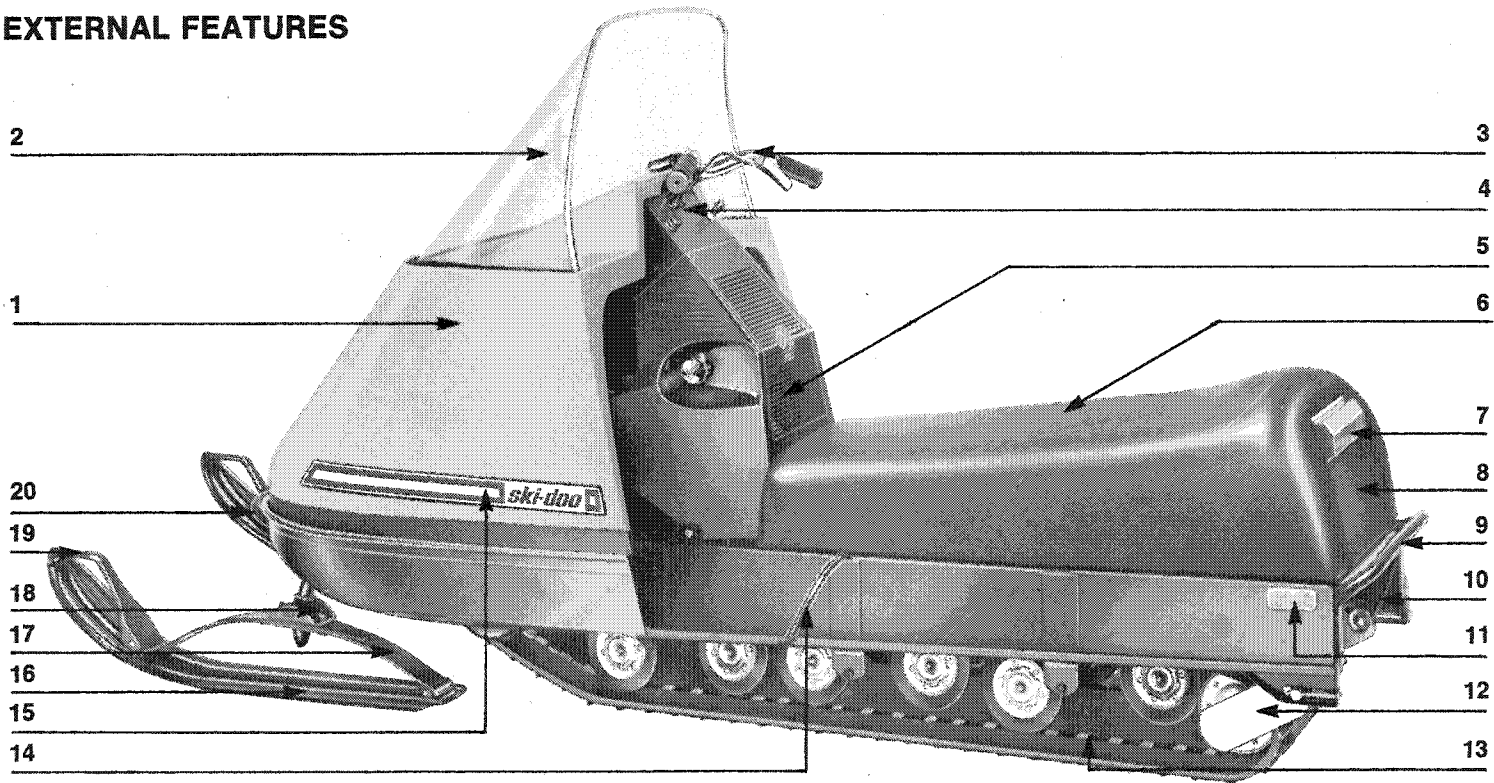

- 1. Polycarbonate Cab
- 2. Windshield
- 3. Handlebars
- 4. Dashpanel
- 5. Console

- 6. Inclined Seat
- 7. Taillight
- 8. Compartment Door
- 9. Rear Bumper
- 10. Suspension Spring

- 11. Rear Reflector
- 12. Link Plate
- 13. Track Insert
- 14. Stirrup
- 15. Side Reflective Stripe

- 16. Ski
- 17. Leaf Springs
- 18. Ski-Leg Stopper
- 19. Ski Handle (reinforcement)
- 20. Front Bumper

INTERNAL FEATURES

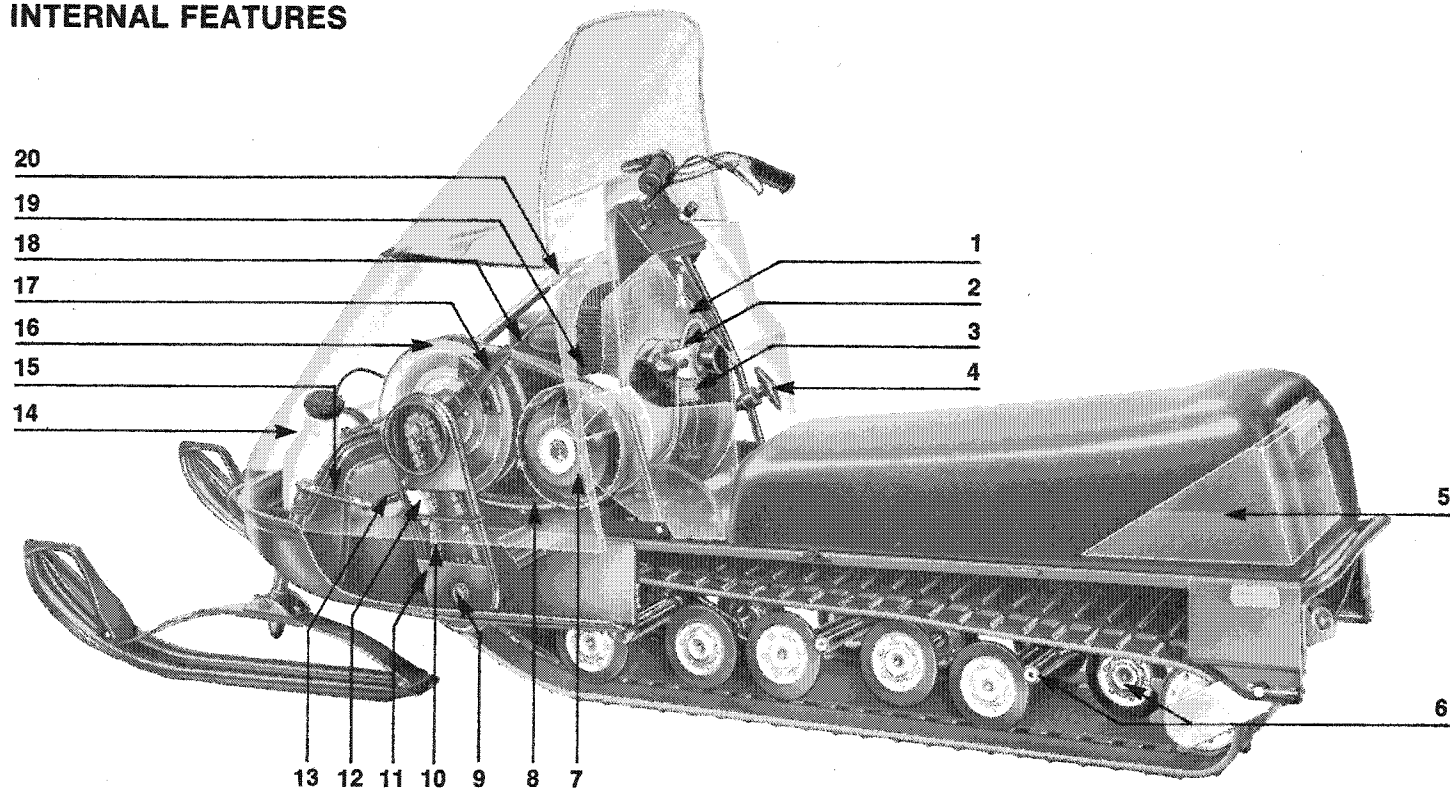

- 1. Throttle Cable
- 2. Carburetor
- 3. Fuel Filter
- 4. Manual Starter
- 5. Storage Compartment

- 6. Bogie Wheel Set
- 7. Drive Pulley
- 8. Drive Belt
- 9. Drive Axle
- 10. Drive Chain

- 11. Chain Case
- 12. Self Tensioner
- 13. Tie Rod
- 14. Fuel Tank
- 15. Steering Arm

- 16. Driven Pulley
- 17. Brake Shoe Lever
- 18. Muffler
- 19. Engine
- 20. Steering Column



We are proud that you have chosen the Bombardier Ski-Doo* snowmobile for your Winter recreational enjoyment and wish to extend our congratulations on your membership into the World's Largest Snowmobiling Fraternity — The Ski-Doo snowmobilers.

Whichever model you have selected from the Nineteen-Seventy-Two Ski-Doo snowmobile series, you will find that it has been engineered and designed not only to introduce today's standards but so that you, the owner, will benefit of the knowledge obtained through our policy of continuous testing and improvement.

As impatient as you may be to try your new Ski-Doo snowmobile, we strongly recommend that you read the entire Owner's Manual before replacing it in the storage compartment.

This Owner's Manual was prepared to acquaint you with the operation of the vehicle and to inform you of the routine maintenance procedures that must be periodically upheld.

*Trademark of Bombardier Limited

At Bombardier, we fully realize that the purchase of a snowmobile is a very important decision. For this reason, we have ensured that each Ski-Doo snowmobile is backed up by an international Ski-Doo Distributor and Dealer Network who's factory trained personnel are equipped to give you prompt and efficient service wherever you are in Snow Country.

Furthermore, each dealer is prepared to serve you with information, parts and accessories. Feel free to contact him.

**Lift cover flap
for illustrated listing
of internal and
external features**



Bombardier Ltd. reserves the right to make changes in design and specifications, and/or to make additions to or improvements in its products without imposing any obligations upon itself to install them on its products previously manufactured.

This manual has been published by the Technical Information Centre, Bombardier Ltd., 8600 Decarie Blvd., Montreal 307, Quebec.

*The following are trade marks of Bombardier Limited

**Ski-Doo
Ski-Boose
Nordic
Alpine
Valmont
T'NT
Élan
Blizzard
Skandic
Carry-Boose
Bombardier and the crest.**



INDEX

GENERAL INTRODUCTION	1
SERVICE AREAS	2
SERIES INTRODUCTION	3
SPECIFICATIONS	4
CLOTHING	5
safety clothing, chill factor	
DRIVING HINTS	6, 7
driving positions — turning — surface conditions — quick tips.	
DO'S	8
DON'TS	9
CONTROLS/INSTRUMENTS	10, 11
steering — throttle lever — brake lever — ignition/light switch — choke — decompressor — manual starter — fuel level.	
FUEL MIXING	12, 13
which gasoline to use — which oil to use — fuel mixing ratio — fuel mixing procedure — fuel saving tips.	
PRE-START CHECK	14
fuel tank quantity — track — steering operation — throttle and brake — (BREAK-IN).	



STARTING PROCEDURE	15
electric starting — manual starting.	
CUTAWAY VIEW	16
LUBRICATION	17, 18
console removal — drive belt removal — ski assembly — steering mechanism — throttle and brake — chain case oil level — bogie wheels — rear axle — driven pulley — drive pulley.	
MAINTENANCE	19, 20, 21, 22
spark plug — battery — suspension springs — track tension — track alignment — carburetor adjustment — drive belt condition — battery connections — carburetor flange nuts — muffler attachment — drive belt wear — brake — steering adjustment — engine head nuts — engine mount nuts — electrical wiring — vehicle general inspection.	

TOOL KIT and USES	
IN CASE OF EMERGENCY	23
emergency materials — assisting stranded vehicles.	
EMERGENCY GUIDE	24
TROUBLE SHOOTING GUIDE ..	25, 26
STORAGE	27, 28, 29
track — suspension — ski assembly — fuel tank — carburetor — cylinder lubrication — chain case — controls — pulleys — battery — chassis.	
HOW TO IDENTIFY YOUR SKI-DOO SNOWMOBILE	29
frame, engine and track serial numbers — parts and service.	
GLOSSARY	30
SERVICE	31
WARRANTY	32

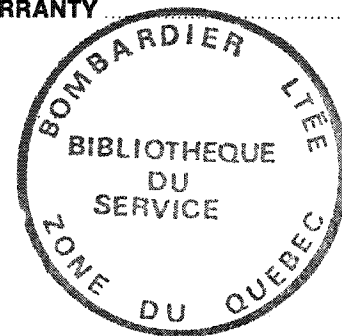

SERVICE AREAS

We recommend you contact your local Authorized Ski-Doo dealer when your Ski-Doo snowmobile requires service. However, for further inquiries, you may contact your Regional Distributor listed below.

CANADIAN DISTRIBUTORS (Recreational Products Division).

Name of Distributors

ALPINE DISTRIBUTORS
3206 - 28th Ave., Vernon, B.C.

ATLANTIC SKI-DOO LTD.
P.O. Box 670, Shediac, N.B.

BOMBARDIER ONTARIO LTD.
28 Currie St., Barrie, Ont.

BOMBARDIER QUE. LTD.
9851 Blvd. Ray Lawson, Montreal 438, Que.

BROOKS EQUIPMENT LTD.
P.O. Box 985, Winnipeg 21, Man.

HUDSON'S BAY CO.
121 Richmond W., Toronto, Ont.

J. W. RANDALL LTD.
P.O. Box 757, Corner Brook, Newfoundland

TRACT EQUIPMENT LTD.
14325 - 114th Ave., Edmonton, Alta.

Coverage Area

British Columbia

Prince Edward Island
Magdalen Island
Nova Scotia
New Brunswick

Ontario

Quebec

Manitoba
Saskatchewan

North-West
Territories

Newfoundland

Yukon
Alberta

AMERICAN DISTRIBUTORS (Recreational Products Division).

Name of Distributors

BOMBARDIER EAST INC.
Railroad St., Lee, Massachusetts 01238

Coverage Area

Massachusetts
Connecticut
Rhode Island

BOMBARDIER WEST INC.
609 West Broadway, Idaho Falls, Idaho 83401

CRAIG TAYLOR EQUIPMENT CO.
P.O. Box 3338, Anchorage, Alaska 99501

ELLIOTT & HUTCHINS INC.
East Main Street Road, Malone, New York 12953

HALVORSON INCORPORATED
325 South Lake Avenue, Duluth 2, Minn. 55802

HEATH INTERNATIONAL INCORPORATED
33737 - 32 Mile Road, Richmond, Mich. 48062

TIMBERLAND MACHINES INC.
10 Main St. North, Lancaster, New Hampshire 03584

California
Nevada
Montana
Idaho
Wyoming
Utah
Colorado
New Mexico
Arizona
Kansas
Nebraska
Washington
Oregon

Alaska

New York
Pennsylvania
New Jersey
Maryland
Delaware
District of Columbia
Virginia

North Dakota
South Dakota
Minnesota
Wisconsin
Iowa
Illinois
Missouri
Upper Michigan

Lower Michigan
Indiana
Ohio
Tennessee
Kentucky
W. Virginia

Maine
New Hampshire
Vermont



For the first time snowmobiler or family that wants more than one, the lightweight Élan* snowmobile is the perfect machine. A full performance vehicle with a lengthy 15" deep-profile track . . . surer brake system . . . and an effective suspension that is second to none. The lightness and surefootedness of Élan enables you to break-trail where other snowmobiles dare to tread.

Size up to Élan. Facts prove it's as easy to handle as it is to own. In two models — manual or electric start.

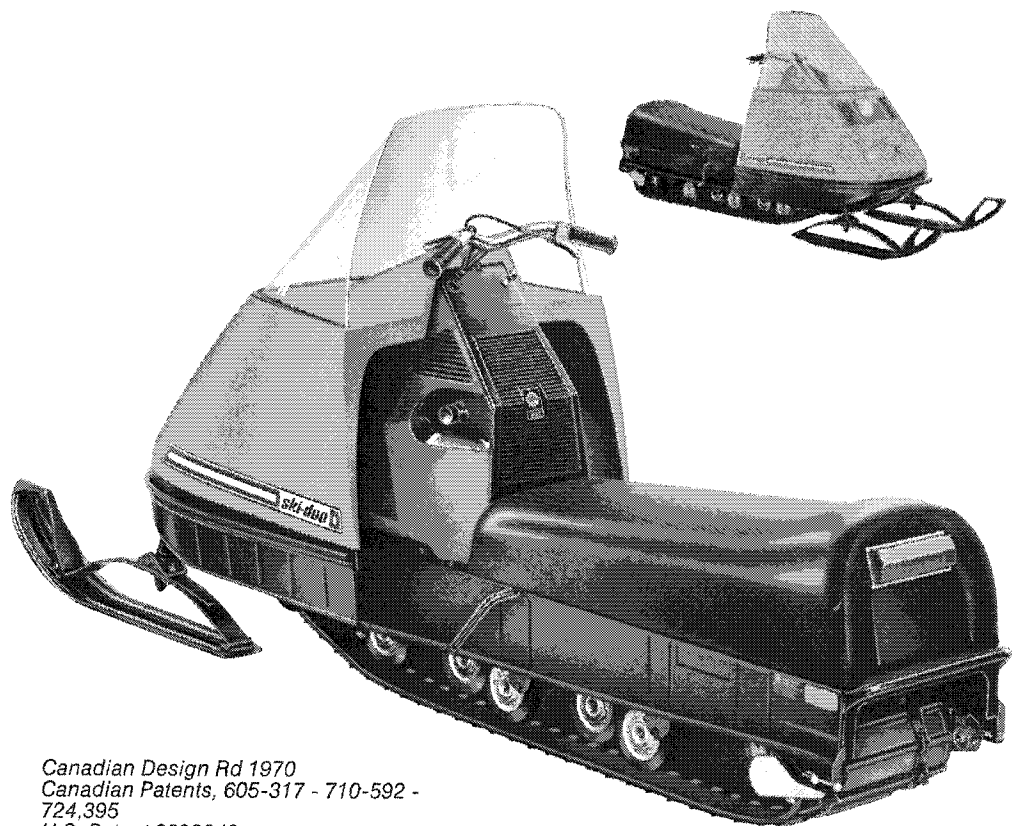

STANDARD FEATURES INCLUDE: Polycarbonate cab • Improved braking system • Ski stopper • Windshield rubber moulding • Console • Reinforced frame.

Canadian Design Rd 1970
Canadian Patents, 605-317 - 710-592 -
724,395
U.S. Patent 2899242
Designs registered in Switzerland, Sweden,
Norway.

*Trademark of Bombardier Limited

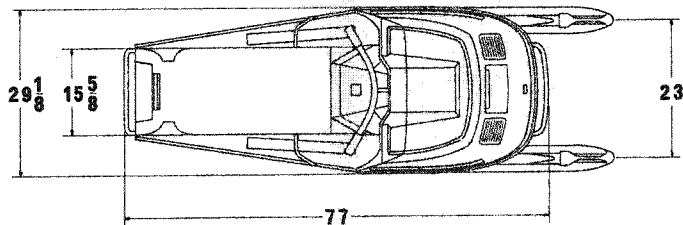
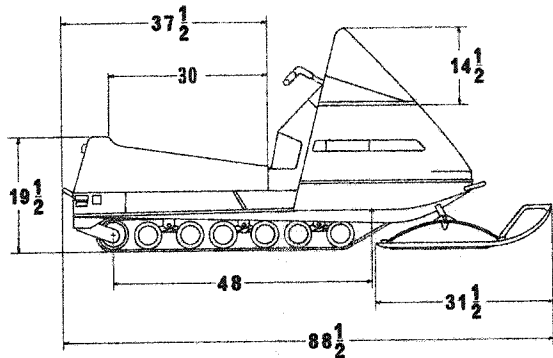
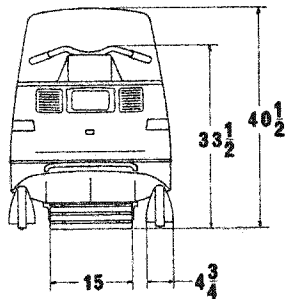

SPECIFICATIONS

ITEM	ÉLAN	250	250E
Engine	No. of Cylinders	ONE	ONE
	Bore	69m.m.	69m.m.
	Stroke	66m.m.	66m.m.
	Displacement	246.8 c.c.	246.8 c.c.
	Horse Power	12	12
	Compression Ratio	7.5:1	7.5:1
Chassis	Overall length	88½"	88½"
	Overall width	29⅞"	29⅞"
	Height w/o Windshield	33½"	33½"
	Weight (lb.)	252	288
	Bearing Area	1070 sq. in	1070 sq. in.
	Ground Pressure (P.S.I.)	0.236	0.269
	Max. Load Capacity	200 lbs.	200 lbs.
Power Train	Track (Width)	15"	15"
	Standard Gear Ratio	10/25	10/25
Ignition	Starting	Manual	Electric
	Lighting coil (Watts)	40 W.	75 W.
	Spark plug # (Bosch)	M-240-T-1	M-240-T-1
	Spark plug (Gap)	.020"	.020"
	Breaker Points (Gap)	.014"-.018"	.014"-.018"
Fuel	Tank Capacity — Imp.	3.5 gals.	3.5 gals.
	— U.S.	4.38 gals.	4.38 gals.
	Mixing Ratio Gas/Oil	20:1	20:1
Brake	Type	Pivoting	Pivoting
Accessories	Speedometer - Tachometer	Optional	Optional

■ The above spark plug number is recommended when operating the vehicle at full throttle. However, when prevailing conditions do not permit such operation a hotter plug (M-225-T-1) can be installed to prevent possible fouling. To prevent piston failure, always reinstall standard plug for high speed operation.

CLOTHING

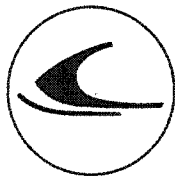

To hundreds of thousands of enthusiasts, snowmobiling has added an entirely new dimension to WINTER. However, to truly enjoy the fun, there is one item that is as indispensable as your snowmo-

bile — **warm, safety clothing.**

Safety Clothing

Helmet (C.S.A. and U.S. government Z. 90 approved).

Snowmobile suit: Reinforced at stress areas — wind and water resistant.

Boots: Lightweight and waterproof.

Mitts: Strong — Padded — Windproof.

Goggles or Visor: Interchangeable lenses.

Tuque.

Chill Factor

As the Chart shows, even moderate temperatures, when coupled with vehicle speed or wind velocity, produce a chill factor often as much as 20 to 30 degrees below thermometer readings.

Bombardier Limited, the people who know snowmobiling best have considered your comfort and safety with a complete line of cold weather clothing. From

underwear to outerwear in high-fashion styling, these garments and accessories have been laboratory and field tested to keep you warm and give you the comfort and freedom of movement that the sport demands.

Marketed by Ski-Doo® Sports Limited and stocked exclusively by authorized Ski-Doo dealers displaying the Ski-Doo Sports Logo, you are guaranteed warmer, safer winters when you wear certified Ski-Doo sportswear.

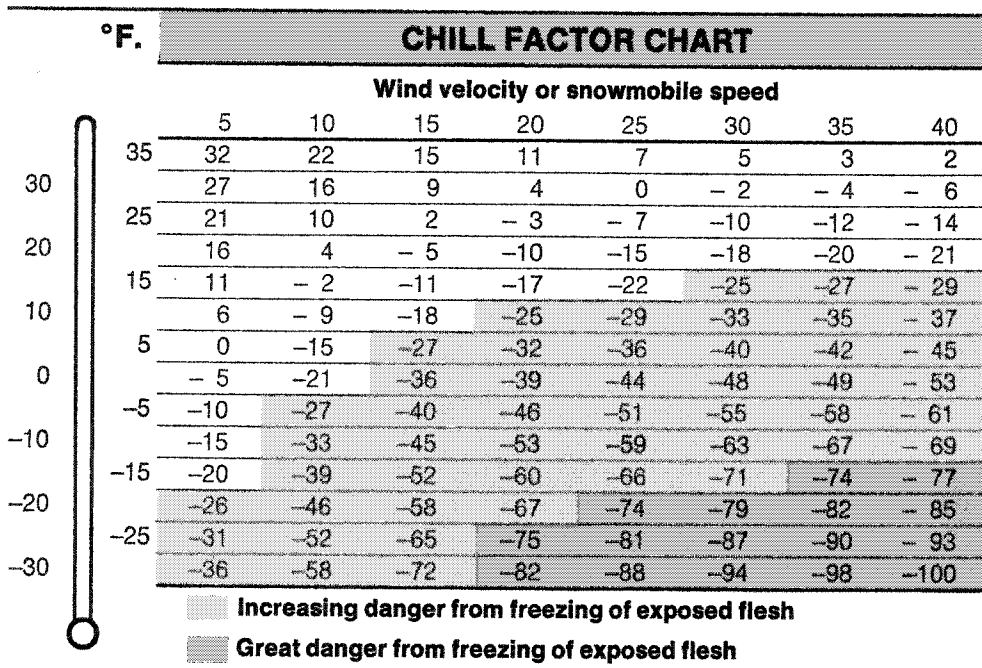

*Trademark of Bombardier Limited

DRIVING HINTS

Driver confidence and capability are the keys to full enjoyment of your new Ski-Doo snowmobile. For your first few runs, select a large, clear, flat area then practice the uses and responses of the various controls and get the feel and balance of your vehicle.

When first using throttle and brake, most beginners press and release the levers too quickly, causing a corresponding "jerking" of the machine. Instead, squeeze the levers firmly and smoothly so acceleration and braking are even.

When braking, remember that snowmobiles have a broad, flat track in continuous contact with the ground, so that the vehicle immediately starts to slow of its own accord as soon as the throttle lever is released. For most circumstances, this natural slowing action plus a gentle pressure on the brake are more than sufficient to stop the vehicle.

Driving Positions

There are 3 main driving positions on a snowmobile — (1) Standing, (2) Kneeling, and (3) Sitting.

Each presents certain advantages depending on the nature of the terrain, the snow conditions, speed of the vehicle, the turns you desire or the personal preference of the driver.

(1) Standing — a position often adopted by beginners, allows for better weight

distribution and permits you to respond to the movement of your snowmobile with surer control. With this position, however, always keep your knees slightly flexed to absorb surface shocks.

The position is undoubtedly the best for steep hills, climbing or going down, a short stretch of very bumpy trail or when manoeuvring in deep snow.

(2) Kneeling — crossing a steep slope, for example, from side to side, you will find the kneeling position a definite advantage. Place one foot on the footboard (on the high side of the hill), the opposite knee on the seat, then lean into the hill. If leaning left, your left foot should be on the footboard, your right knee on the seat, and vice-versa.

WARNING: Side hills and steep slopes are not recommended for a beginner.

An alternate recommended kneeling position and one that is frequently used, is to place both knees on the seat, with one foot on each side, loosely pressing against the seat. This position is useful should you encounter bumpy trails where sitting is uncomfortable.

(3) Sitting — for all normal driving, the most comfortable position is the sitting position. Toes should be held loosely in the stirrups, body about midway back on the seat and body weight distributed evenly between the seat and footboards.

Quick Tips

When necessary to turn your snowmobile around by hand, always lift back end rather than front.

If you have to turn your vehicle around by hand in deep or loosely packed snow, first press down firmly on the tips of your skis. This will raise the trailing edges, so that they do not dig in while vehicle is being turned.

Turning

In turning, you will quickly find that often you cannot rely on the handlebars alone to turn within the circle you desire. Part



of the fun of snowmobiling is that each turn depends on 4 factors — the radius of the turn, vehicle speed, snow conditions and the weight on the skis.

To make those tight, fast turns that are the mark of the experienced driver, you must learn to use the weight or position of your body, shifting to left or right as the turn demands and keeping your centre of gravity as low as possible.

In soft or lightly packed snow, the theory of weight shifting is that by leaning the body toward the inner side of the turn you increase the pressure on that edge of the track and correspondingly lighten the other edge. In effect, you create a bank of snow under the lighter edge, so that the vehicle is banked when turning. On hard packed snow, leaning in toward the turn and at the same time keeping your centre of gravity as low as possible, counterbalances the natural tendency of any vehicle to tilt when turning.

Also, moving your body weight toward the front of the vehicle, particularly, in hard-packed snow, adds pressure to the skis and ski runners so that they bite more deeply into the snow surface.

IMPORTANT: Thoroughly know your vehicle and how to drive it before attempting difficult or rapid manoeuvres.

Surface Conditions

Deep Snow — Your new Ski-Doo snow-

mobile is designed to negotiate almost any snow surface, including deep or newly-fallen snow. Two things are important however, — (1) don't overload your machine (i.e. travel alone, not with passengers) and (2) maintain a reasonable forward speed at all times. Don't accelerate beyond the track's ability to cope with the surface underneath, and don't stop.

Use the standing position recommended earlier and if your vehicle continues to make reasonable headway, responding to light changes in acceleration, you are safe enough to explore new areas. If not,



turn in as wide an arc as possible and look for firmer trails.

Icy Surface — Ice or extremely hard-packed snow can be difficult to negotiate as both skis and track do not have much traction. Best advice is to slow down and avoid rapid acceleration or braking.

Tips

Three good tips to follow to minimize your chances of being stranded are (1) stay on known trails and familiar terrain, (2) travel with friends or in company with other snowmobiles, and (3) do regular lubrication and maintenance faithfully.



DO'S

- Register your Ski-Doo snowmobile at your nearest Licensing Bureau, where State or Provincial Laws require it, and affix Registration Plate to the vehicle. Carry your registration certificate with you. It provides proof of ownership in the event that the vehicle becomes lost or stolen.
- Obtain your State or Provincial booklet on snowmobiling. It gives valuable information on the neighbouring snowmobile trails and the laws governing snowmobiling in your particular area.
- Always carry emergency materials and supplies. Your local Ski-Doo dealer has a Safety Centre prepared specially for you.
- Let every riding member of your family read the **entire** Owner's Manual. The knowledge and confidence gained will reduce the risk element.
- Observe all posted snowmobile signs. Not all private landowners allow snowmobiling on their property. You can have just as much fun, even more so, by traveling elsewhere.
- Before you start out, check to be sure that you and each member of your party are equipped with sufficient warm clothing and safety helmets.
- When snowmobiling with others, limit your actions to the experience of the main body. Show the inexperience driver how to properly handle a snowmobile.

- Use the 'buddy' system. Always travel with at least one other snowmobile, especially in unfamiliar terrain or on trail rides. Even in snowmobiling, a pair beats one of a kind.
- If you are planning to explore new areas, leave word of your approximate whereabouts and estimated time of return with someone. Remember, a snowmobile can often travel farther in 15 minutes than you can walk in a day.
- Always make a full stop, then look carefully in both directions before crossing roads. When traveling in pairs or in a group, have one member direct the others across, singly.
- Use a rigid hitch or tow-bar when pulling any sled or trailer behind your Ski-Doo snowmobile. Rigid hitches prevent tailgate collision when going downhill or on sudden stops.
- Be extremely careful when giving children a ride. Go more slowly and check frequently. Small children, are far safer in a Ski-Boose* sled than on the seat of your snowmobile.
- When trailering your Ski-Doo snowmobile, secure it solidly at both ends, protect it with a bright cover (Ski-Doo* cover) then check that trailer hitch and safety chain are secure and that brake, flashers and parking lights are all in working order.

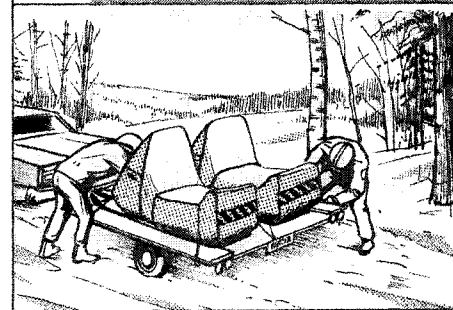
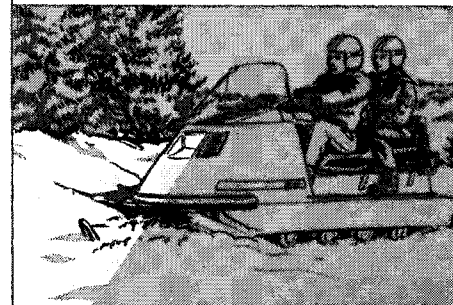
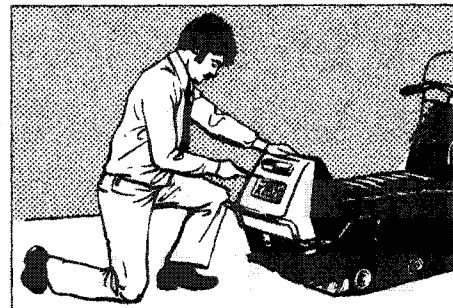

DONT'S

- Don't cut across in front of the line of travel of another snowmobile. Don't tail-gate; collision, or the threat of it, is serious with any moving vehicle.
- Don't risk injury or damage to your machine with needless and foolish stunting. Don't "jump" your snowmobile. This part of snowmobiling should be left to the professional "stunt" men.
- NEVER ride on railway tracks. The sounds of your moving vehicle drown out noise of approaching trains. Your vehicle may also become caught in track junctions. In many States and Provinces snowmobiling on railway tracks constitutes an infraction of the law.
- Never cut through fences or attempt to run over them. Give a wide berth to telephone poles. **Hidden guy wires, unseen from a distance, can cause serious accidents.**
- Don't lend your snowmobile to inexperienced or under-age drivers. In many cases it is the vehicle owner and not the rider that is responsible for mishaps. Check State or Provincial minimum age limits for drivers.
- Unless you are certain, of a fueling stop, never travel further than 1/2 of the fuel remaining in your tank. Even then, leave yourself a safety margin. Remember that a snowmobile does not necessarily travel the same distance each time

on the same amount of fuel. A lot depends on speed, the snow conditions of the trail and the adjustment of the carburetor.

- Don't drive your snowmobile in the vicinity of skiers and keep off ski trails. Always respect the rights of those who enjoy winter in another way.
- Don't smoke while refueling or while checking fuel level. Even mixed fuel gives off dangerous fumes.
- **"If you drink don't snowmobile! If you snowmobile, don't drink!"** Remember alcohol and gasoline don't mix.
- Don't overload your snowmobile. A Ski-Boose sled or other trailer carries far more than your snowmobile can, without noticeable loss of efficiency or maneuverability.
- Don't cross a river or lake without first being positive that the thickness of the ice is sufficient to support both you and your vehicle. **Your life may depend on it.** If at all in doubt, take an alternate route.
- **Don't ride on public streets, roads or highways.** The single largest cause of accidents have occurred when snowmobiles and automobiles mix.
- Don't leave your keys in the ignition switch. It prevents an invitation to thieves and a danger to children.

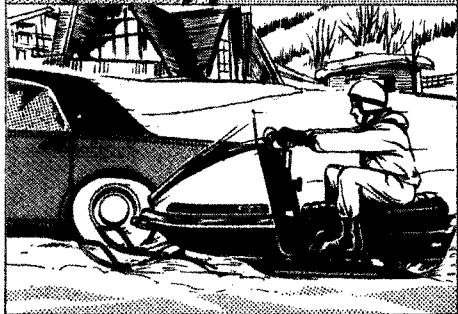
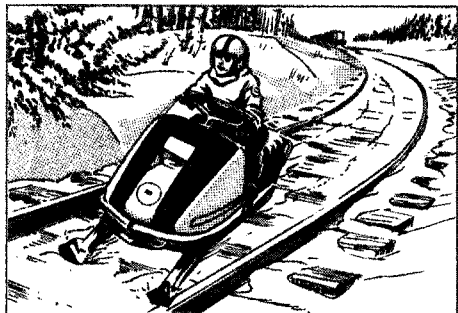

CONTROLS/INSTRUMENTS

Steering

Your Ski-Doo snowmobile follows the direction in which the handlebars are rotated. To turn to the right, rotate handlebars right. To turn to the left, rotate left.

Throttle Lever (A)

Located on right handlebar. When lever is depressed, engine speed increases. When released, it automatically returns to IDLE. Engine speed is proportionate to the applied pressure on the lever.

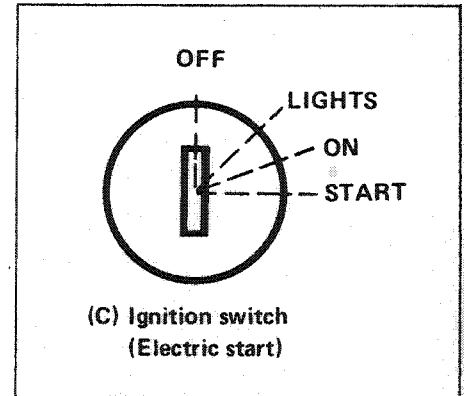
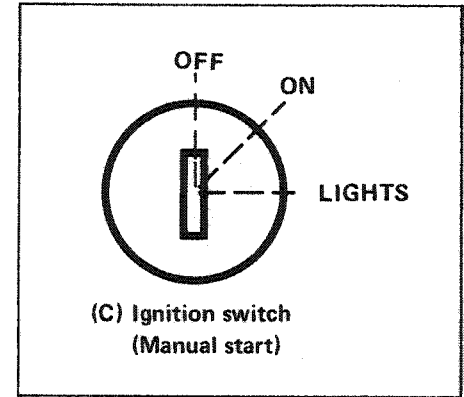
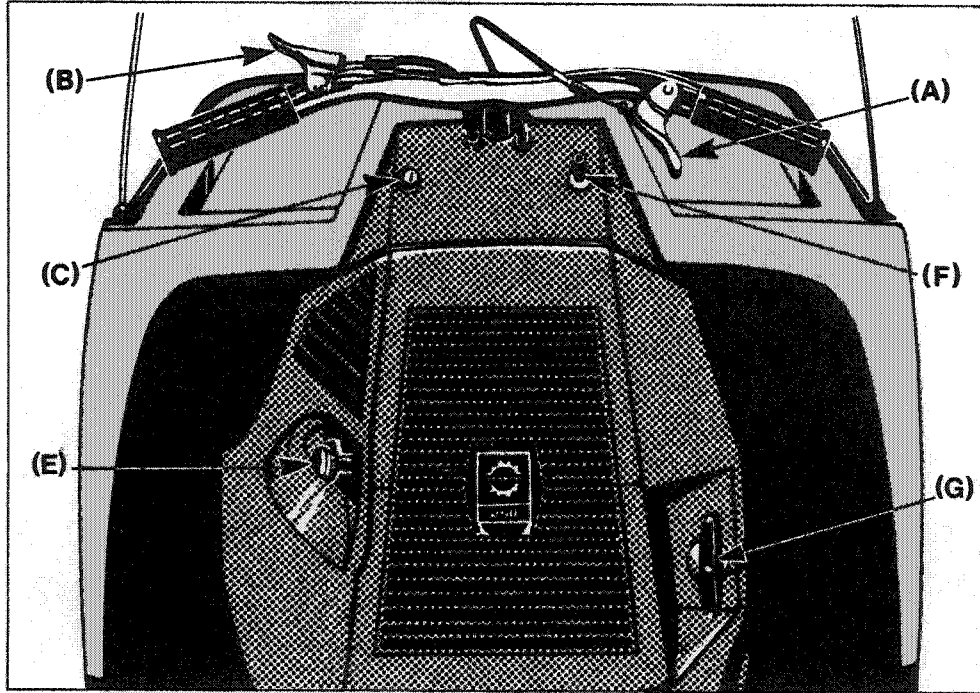

Brake Lever (B)

Located on left handlebar. When lever is depressed, the brake is applied. When released, it automatically returns to its original position. Braking effect is proportionate to the applied pressure on the lever.

Ignition/Lights Switch (C)

(Manual Model only)

Key operated, 3 position switch (OFF/ON/LIGHTS). To start engine, first turn key clockwise to ON position. To stop engine, turn key counter-clockwise to OFF position. Turning key fully clockwise, with engine running, illuminates both headlamp and taillight.

Ignition/Lights Switch

(Electric Model only)

Key operated, 4 position switch, (OFF/LIGHTS/ON/START). To start engine, turn key fully clockwise to START position and **hold**. Return key to ON position **immediately** engine has started. To illuminate both headlamp and taillight turn key to LIGHTS position.

Choke (E)

Two position, (OFF/ON) dial knob, located on lower left side of console. To engage choke, turn dial clockwise to ON position. To disengage, turn counter-

clockwise to OFF position. The choke should always be used for easier cold engine starts. After engine is warmed up however, it is not necessary to use choke when starting.

Note: *The purpose of the choke is to reduce the amount of air flowing through the carburetor, in effect enriching the fuel/air mixture. However, leaving choke on after engine has started activates carbon formation inside the engine. Therefore, always turn choke knob to OFF, once engine has started. NEVER OPERATE YOUR VEHICLE WITH CHOKE ON.*

Decompressor (F)

Two position, (OFF/ON), push-pull knob, located on right of dashpanel. To engage, pull decompressor knob fully out.

Note: *The decompressor provides easier starting by reducing engine compression. However, leaving decompressor engaged while running will damage your engine. Use decompressor when starting, but ALWAYS DISENGAGE IMMEDIATELY ENGINE HAS STARTED.*

Manual Starter (G)

Auto-rewind type located on engine flywheel side, (lower right side). To start engine, pull handle. (See Starting Procedure, page 15).

Fuel Level

Fuel level can easily be checked, at any time, by opening cab and glancing at tank. To fill fuel tank, simply unlock cab latches (1 on each side, where cab joins frame) then tilt cab gently upward and forward until stopped by restraining cable. Unscrew fuel tank cap.

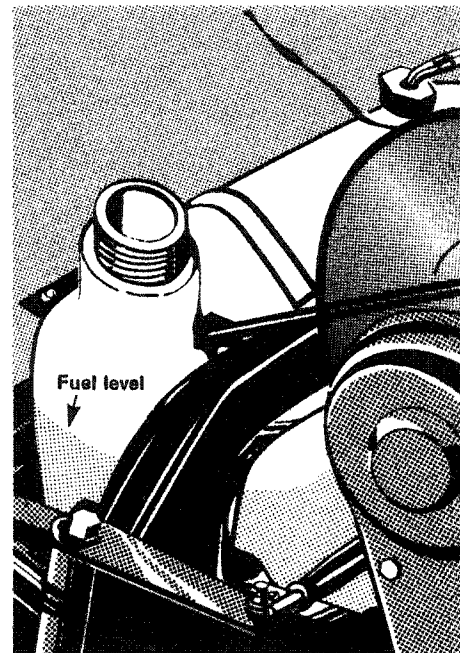

FUEL MIXING

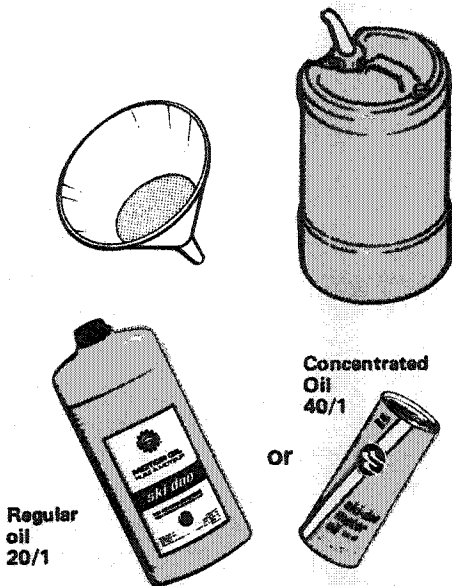

With Ski-Doo snowmobiles, the OIL must be added to the GASOLINE in pre-measured amounts then both oil and gasoline should be thoroughly mixed together, BEFORE fueling the tank.

The importance of using the correct fuel mixture cannot be over-stressed. Prior experience has shown that the largest cause of engine damage is from incorrect fuel mixtures.

Which Gasoline to Use

The correct gasoline for your Ski-Doo snowmobile is **regular** gasoline, (not less than 88 octane), available from all service stations.

CAUTION: Never experiment with differing fuels or fuel ratios. Never use premium gasoline, naphta, methanol or similar products.

Which Oil to Use

Use only Ski-Doo* oil available in **regular** or **concentrated** form. Both types have especially formulated oil bases to meet the lubrication requirements of the Bombardier-Rotax engine.

CAUTION: Unless absolutely necessary (in case of emergency) do not use out-board or straight mineral oil. Never use multi-viscosity oils.

Fuel Mixing Ratio

When using REGULAR SKI-DOO OIL, the correct mixture is 20/1.

5 GALLONS, REGULAR GASOLINE plus 1 QUART, REGULAR SKI-DOO OIL = CORRECT FUEL MIXTURE.

When using CONCENTRATED SKI-DOO OIL, the correct mixture is 40/1.

5 U.S. GALLONS or 4 IMPERIAL GAL-

LONS plus 1 PINT CONCENTRATED SKI-DOO OIL = CORRECT FUEL MIXTURE.

Note: To facilitate fuel mixing, concentrated Ski-Doo oil should be kept at room temperature.

Fuel Consumption Table

Throttle	R.P.M.	H.P.	Time ■
Full	5500	12	2h. 48m.
¾	5500	9	3h. 15m.
½	5000	6	4h. 48 m.
¼	4500	3	8h. 36m.

Fuel tank capacity
3.5 imp. gals./4.38 U.S. gals.

■ Running time (in hours and minutes).

The Fuel Consumption table above must be construed as approximate only. Results have been obtained by running static tests under full load, but cannot take into account such factors as snow conditions, carburetor adjustments, etc.

IMPORTANT: One cause of difficulty on the trail is running out of fuel. Be sure it does not happen to you. Don't explore new areas unless you have established fuel stops or are certain of an adequate fuel supply.

*Trademark of Bombardier Limited

Fuel Mixing Procedure

To mix the gasoline and oil always use a separate clean container. Never mix directly in your snowmobile tank.

WARNING: Gasoline is flammable and explosive under certain conditions. Always stop the engine and do not smoke or allow open flames or sparks near the vehicle when refueling. If gasoline fumes are noticed while driving, the cause should be determined and corrected without delay.

Note: For best results, acquire two containers either plastic or metal.

Draw from one until empty then use the second one. Meanwhile, refill the first as soon as convenient.

1. Pour the full amount of Ski-Doo oil required for the total mixture into the container.
2. Add approximately half the amount of gasoline to be mixed.
3. Shake the container thoroughly.
4. Add the remainder of the gasoline.
5. Once again thoroughly agitate the container.
6. Using a funnel with a fine mesh screen to prevent the entry of water and

foreign particles, transfer the mixture from the container into the Ski-Doo snowmobile gas tank.

CAUTION: Avoid fuel splashing or spilling onto adjacent drive belt.

Fuel Saving Tips

While waiting for companions to catch up, or when stopping to rest on the trail, turn your ignition OFF. Not only do you save fuel, but you lessen the chance of spark plug fouling. Besides, a warmed-up Ski-Doo snowmobile engine is exceptionally easy to start.

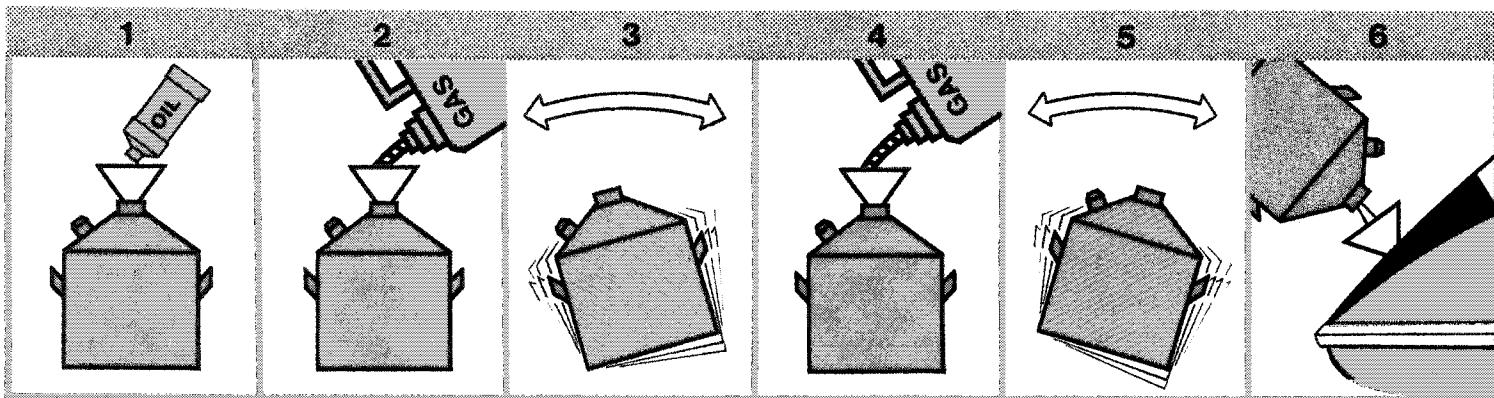

PRE-START CHECK

Fuel Tank Quantity

Check that there is sufficient fuel in the tank for your trip. A good habit to acquire is to refill the tank before starting out each day.

Since mixed fuel has a tendency to settle overnight, agitate the fuel in the tank by standing on the footboards and rocking the vehicle from side to side.

Track (Daily, before first run)

Under certain climatic conditions, the track of a snowmobile left outdoors overnight may freeze to the ground or snow surface. Always make sure that the track is free before attempting to **start** the vehicle. (This procedure will eliminate unnecessary drive belt wear).

Steering Operation

Check operation of steering mechanism by rotating the handlebars several times from side to side. If roughness or binding is felt, check for ice or snow that may be blocking the mechanism.

Throttle and Brake

Depress and release levers several times to check that they operate easily and smoothly. The throttle lever should return to the idle position when released. The brake lever should be fully applied when it is $\frac{1}{4}$ " (minimum clearance) from the handlebar grip. If the levers do not return

swiftly, remove cables and/or housings and replace. Re-check lever operation. **Do not start the engine until levers return swiftly.**

WARNING: Always check throttle and brake operation before starting engine.

YOU MAY NOW START YOUR SKI-DOO SNOWMOBILE.

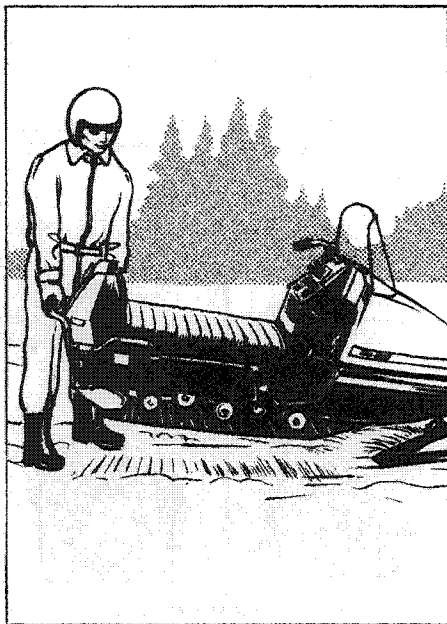

BREAK-IN PERIOD

With Ski-Doo snowmobile engines, a break-in period is required before running the vehicle at full throttle.

Manufacturer's recommendation for the Bombardier-Rotax engine is ten (10) operating hours or the equivalent fuel consumption. (See page 12 for the equivalent fuel consumption of your vehicle). During this period, maximum throttle should not exceed $\frac{3}{4}$, except momentarily to attain cruising speed or avoid emergency. Before you took delivery of your new Ski-Doo snowmobile, the carburetor was adjusted by your Dealer for a rich fuel mixture. This permits better lubrication and cooling of the engine. Do not readjust, regardless of excessive smoke in the exhaust.

Inspection

As with any precision piece of mechanical equipment, **we suggest** that after the first 10 hours of operation or 30 days after purchase whichever comes first, that each Ski-Doo snowmobile has an inspection check. This inspection, which should take approximately $1\frac{1}{2}$ hrs., is at the discretion and expense of the vehicle owner.

STARTING PROCEDURE

WARNING: Never run the engine at **HIGH R.P.M.** when the track of the vehicle is raised off the ground.

Electric Starting

For Models with electric starter:

1. Insert key in ignition switch (C).
2. Pull decompressor knob (F) fully out.
3. Engage choke (E). (Choke is not necessary if engine is warmed up.)
4. Test throttle operation then apply throttle lever (A) slightly.

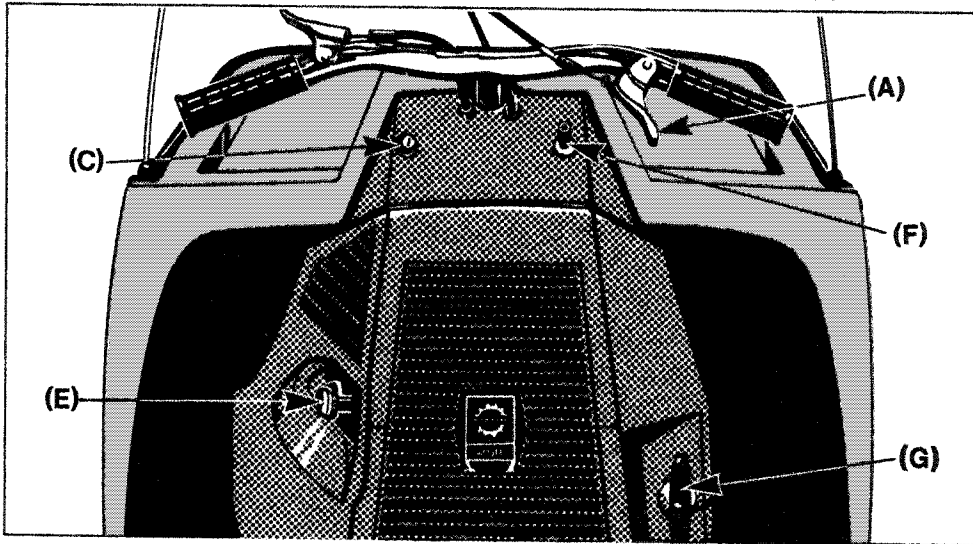

5. Turn ignition key clockwise until starter engages.

CAUTION: Do not engage starter longer than 30 seconds.

If engine does not start on first try, key must be turned fully back to OFF each time. Allow starter to cool for 2 minutes before repeating procedure.

6. **Release** throttle and return key to ON *immediately* engine has started.

7. Disengage choke (E) and PUSH IN DECOMPRESSOR knob (F).

CAUTION: Never operate the Ski-Doo snowmobile with the battery removed or disconnected.

8. Allow the engine to warm up **before** operating at full throttle.

Manual Starting

Every Ski-Doo snowmobile is equipped with a manual starter (auto-rewind type) located on the right hand side of the engine. To start the engine manually:

1. Insert key in ignition (C) and turn to ON position.
2. Pull decompressor knob (F) fully out.
3. Engage choke (E). (Choke is not necessary if engine is warmed up).
4. Test throttle operation then apply throttle lever (A) slightly.
5. Grasp manual starter handle (G) firmly and pull slowly until a resistance is felt then pull vigorously and engine will start. Then pull handle to return slowly to its original position. If engine does not start, repeat the procedure.

Note: Do not pull starting rope to its full extent or allow starting handle to "fly back" to its original position.

6. **Release** throttle (A), disengage choke (E) and PUSH IN decompressor (F), immediately engine has started.

7. Allow the engine to warm up **before** operating at full throttle.

MAINTENANCE AND LUBRICATION

WEEKLY
MONTHLY

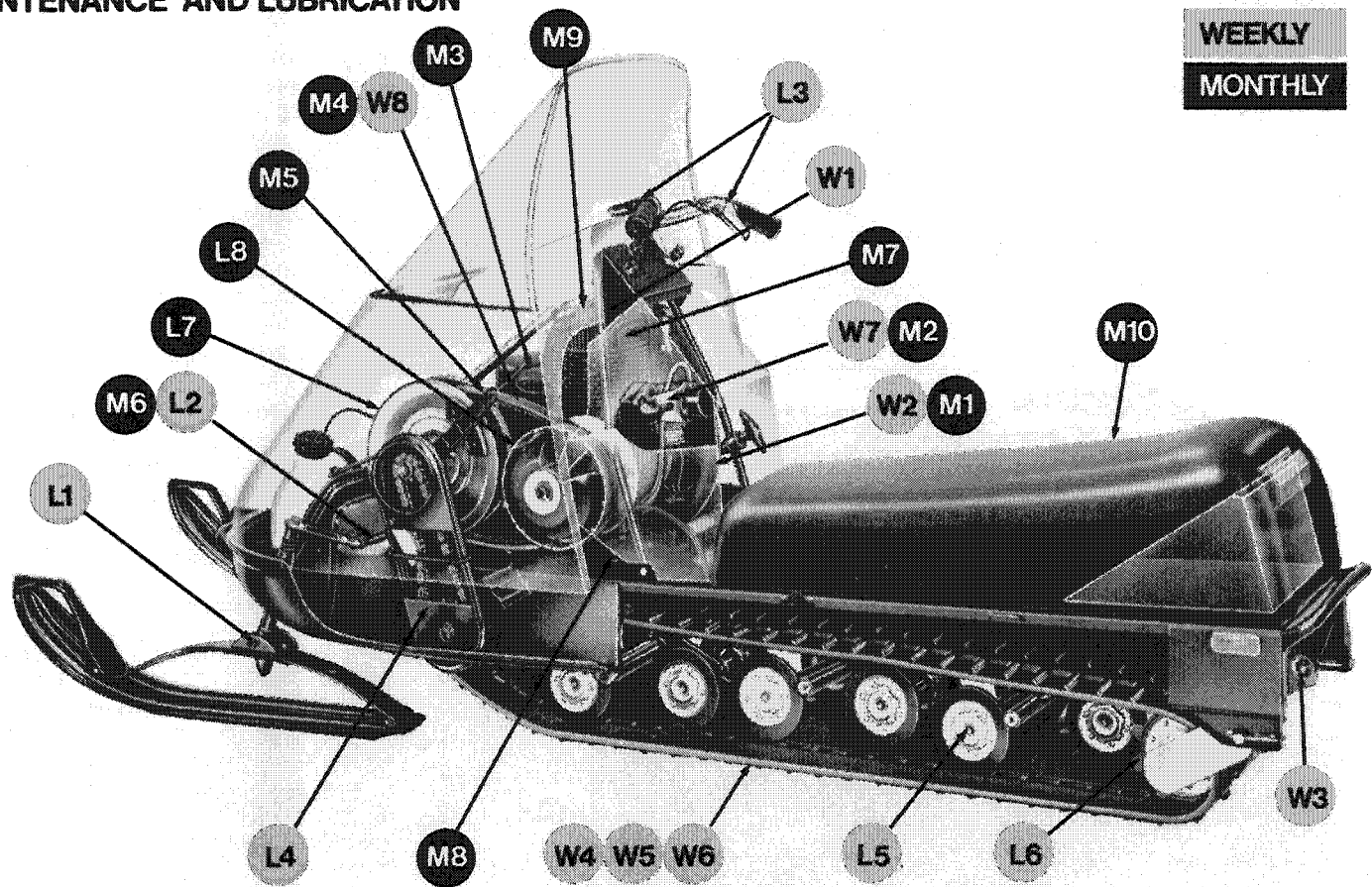

LUBRICATION

Code •	Weekly	Page
L1	Ski Assembly	17
L2	Steering Mechanism	17
L3	Throttle and Brake	17
L4	Chain Case Oil Level	18
L5	Bogie Wheels	18
L6	Rear Axle	18

Code •	Monthly	Page
L7	Driven pulley	18
L8	Drive pulley	18

• For reference to location of Part or Component, see Cutaway view, page 16.

Above items in the lubrication chart will be serviced during all dealer inspections.

Console Removal

For any procedure that may require removal of the console, proceed as follows:

1. Push (jerk) the console in a downward movement.
2. Slide manual starter handle (right hand side) through slot.
3. Tilt console away from engine and release (unhook) the spring attaching console to engine.

To reinstall, follow REVERSE procedure.

WARNING: Never start the engine without console installed.

Drive Belt Removal

To remove drive belt:

1. Tilt cab and remove console.
2. Open the driven pulley, (larger pulley, most forward). Twist and push the sliding half then hold in open position.
3. Pull the bottom of belt in toward the driven pulley then slip slackened belt over the top edge of the sliding half.
4. Slip the belt out from the drive pulley (centrifugal governor) and remove completely from vehicle by passing it between muffler and end of driven pulley.

To install drive belt, follow REVERSE procedure (See Fig. 1).

WARNING: Never start the engine without drive belt installed.

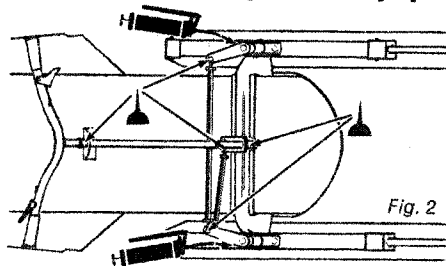
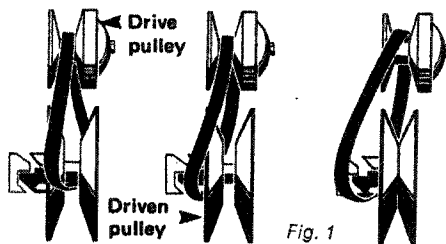

(L1) Ski Assembly

Oil spring coupler bolts with Ski-Doo oil.

(L2) Steering Mechanism

Using Ski-Doo oil, or light machine oil, lubricate both ends of each tie-rod and the (2) steering bushings.

Grease the ski legs, at grease fittings, until new grease appears at the joints (See Fig. 2).

(L3) Throttle and Brake

Oil brake and throttle cable slugs so they rotate freely in the levers. Using light machine oil, lubricate throttle lever shaft and pivoting slug of carburetor. (See Fig. 3).

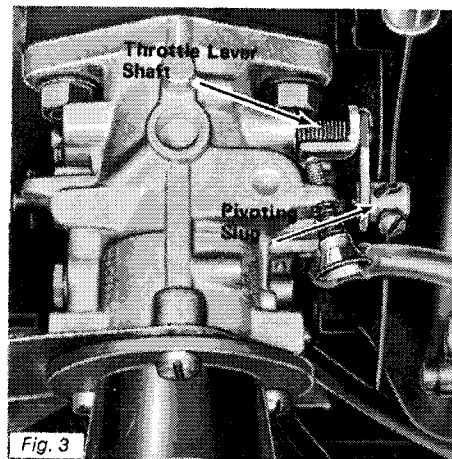

(L4) Chain Case Oil Level

Remove oil level inspection plug (smallest plug) on chaincase and check if oil is visible at bottom lip of hole. If not, fill to this level with Ski-Doo* chain case oil (Fig. 4).

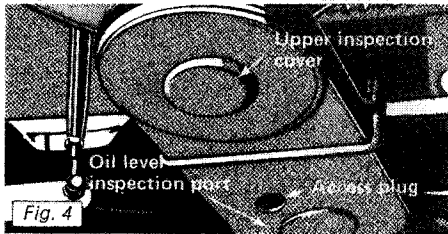

The chain case has an oil capacity of approx. 8 ozs. To replenish supply, remove upper inspection cover and fold it into a V shape, using cover as a funnel, refill chaincase to required level.

(L5) Bogie Wheels

Grease the suspension bogie wheels with low-temp. grease, using a low pressure grease gun. Pump through the grease fitting at the centre of each wheel until new grease appears at the joints of inner side of shaft (See Fig. 5).

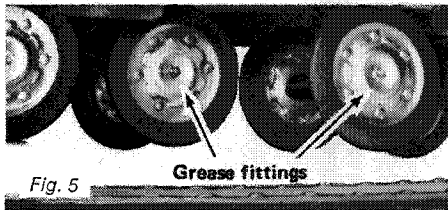

(L6) Rear Axle

Lubricate the rear axle with low-temp. grease. Pump grease through the rear axle fittings (See Fig. 6).

CAUTION: Always use a low-pressure grease gun.

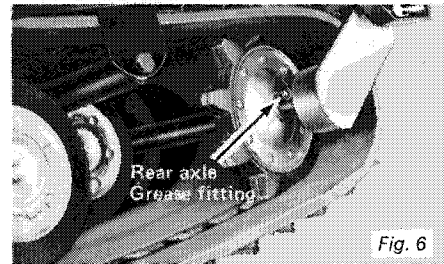

(L7) Driven Pulley

With cab tilted, lubricate the driven pulley shaft, as follows:

1. Remove console and drive belt (See Fig. 1). Open the driven pulley (Twist and push sliding half).
2. Thoroughly clean the driven pulley shaft.
3. Apply a light coat of Ski-Doo* clutch lube on the shaft (See Fig. 7).

Note: Activate the sliding half several times to distribute lubricant over full length of shaft. Be careful that lubricant does not get on inner halves of pulley.

CAUTION: Excess lubricant on pulley shaft can penetrate drive belt causing slippage and deterioration. Always lubricate lightly and wipe off surplus.

*Trademark of Bombardier Limited

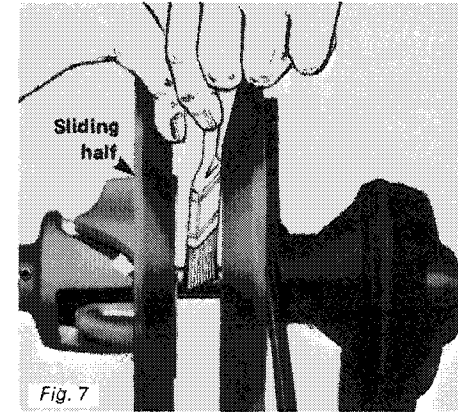

(L8) Drive Pulley (or each 40 hours)

1. With cab tilted, remove console and drive belt. (See Fig. 1).

2. Remove centrifugal governor as follows:

- Remove spark plug and position the piston $\frac{3}{4}$ to $1\frac{1}{4}$ " BEFORE top dead center making sure that the piston closes the exhaust port.

- Accede by the spark plug hole and pack the cylinder with $\frac{3}{8}$ " dia. rope (See Fig. 8).

- Pull manual starter to rotate crankshaft until piston bears against "cushioning".

- Unscrew centrifugal bolt, remove centrifugal governor then pull out rope from spark plug hole.

3. Thoroughly clean the inner pulley

shaft using fine steel wool and a clean cloth.

4. Apply a light coat of Ski-Doo* clutch lube to the four (4) flyweights of the centrifugal governor.

5. Making sure that the aligning mark on inner pulley half coincides with the aligning mark of the outer pulley half, pack inside of pulley shaft with Ski-Doo* clutch lube (See Fig. 9).

6. Using light machine oil, lubricate the governor bolt threads and install governor. **Fully tighten** governor bolt.

Note: Installation procedure is reversed, insuring that the rope is inserted into cylinder when piston is 3/4" approx. AFTER top dead center.

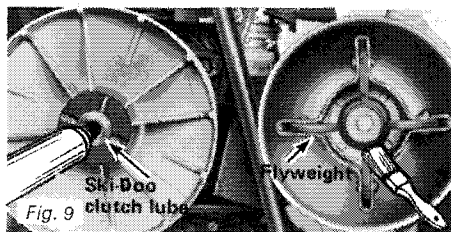
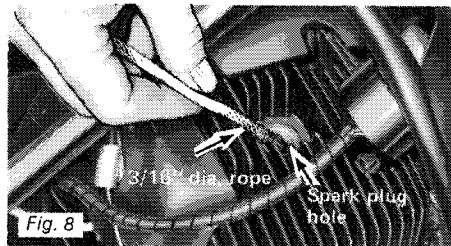

MAINTENANCE

Code •	Weekly	Page
W1	Spark Plug	19
W2†	Battery (electrolyte level)	20
W3	Suspension Springs	20
W4	Track	20
W5	Track Tension	20
W6	Track Alignment	20
W7	Carburetor Adjustment	20
W8	Drive Belt Condition	21

Code •	Monthly	Page
M1†	Battery (connections)	21
M2	Carburetor Flange Nuts	21
M3	Muffler Attachment	22
M4	Drive Belt Wear	22
M5	Brake	22
M6	Steering Adjustment	22
M7	Engine Head Nuts	22
M8	Engine Mount Nuts	22
M9	Electrical Wiring	22
M10	Vehicle General Inspection	22

• For reference to location of Part or Component, see Cutaway view, page 16.

†(Electric Model only).

Above items will be serviced during all dealer inspections.

(W1) Spark Plug

1. Tilt cab. Disconnect spark plug wire.
2. Remove spark plug using box wrench, supplied in the tool kit (See Fig. 10).

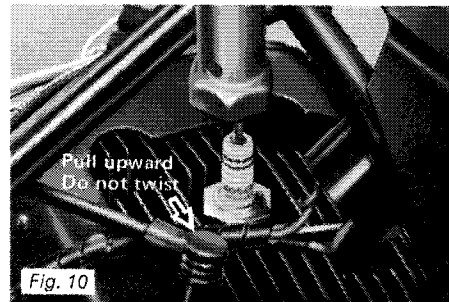

3. Check condition of spark plug. Normal color is "brownish"(See Fig. 11). If spark plug color is abnormal (black or light grey) the engine is not running under ideal conditions, due to either

- Use of incorrect fuel mixture. (See Fuel Mixing, page 12).
- Carburetor incorrectly set. (See Carburetor Adjustment, page 20).
- Wrong type of spark plug. (See Specifications, page 4 for correct spark plug heat range.

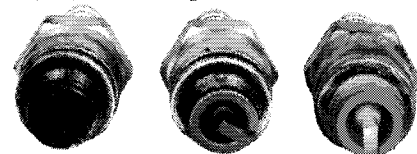

Carbonized

Normal

Burnt

Fig. 11

4. Check spark plug gap using a wire feeler gauge. Gap must be .020", adjust and/or replace if necessary. Reinstall plug.

(W2) Battery (Electric Model only)

Remove battery caps then check electrolyte level at each cell. Electrolyte level must touch bottom of filler hole. If necessary, add Distilled Water up to this level.

(W3) Suspension Springs

With engine off, visually inspect bogie wheel springs and link plate springs. Replace any weak or broken springs.

(W4) Track

Lift the rear of the vehicle and support it off the ground so that the track is free to turn. With engine turned OFF, rotate track by hand and visually inspect track condition. If bad cuts or missing inserts (See Glossary, page 30) are noted, see your dealer.

Note: Without these inserts continual abrasion would wear and cut the track therefore, always replace a missing or damaged insert(s) as soon as possible.

(W5) Track Tension

Lift the rear of vehicle and support it off the ground. Using a rule, check the track tension from the middle set of bogie wheels. The track tension (distance between top inside edge of track and the bottom of the footboard) should be $1\frac{3}{8}$ inch plus or minus $\frac{1}{8}$ inch (See Fig. 12).

Fig. 12

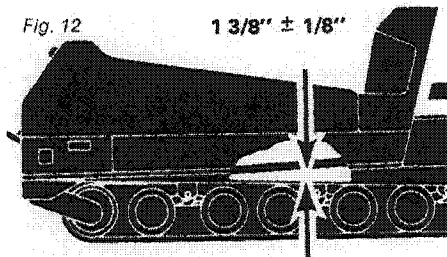

If track tension is too loose, the track will have a tendency to thump. If too tight, performance will be affected.

If necessary to adjust:

1. Using wrench, loosen both track adjusters by unscrewing the lock nuts situated on the inner side of the suspension springs (See Fig. 13).
2. Adjust to proper tension by turning adjuster bolts, clockwise to tighten track, counter-clockwise to slacken. Adjust both sides equally (See Fig. 14).
3. Proceed to track alignment.

Note: Track tension and alignment are inter-related. DO NOT adjust one without checking the other.

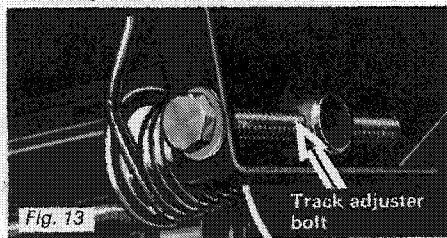

(W6) Track Alignment

After track tension has been corrected, start the engine and accelerate slightly so that track turns **slowly**. Check that track is well centered and turns evenly on the rear sprockets.

The distance between the edges of the track and the link plates should be the same on both sides. Misalignment can cause excessive wear of track edges and sprocket teeth.

To adjust:

1. Using wrench, turn track adjuster screw clockwise on the side where the track is closest to the link plate until track aligns. (See Fig. 14).
2. Firmly retighten adjuster lock nuts.
3. Rotate track slowly and recheck alignment.

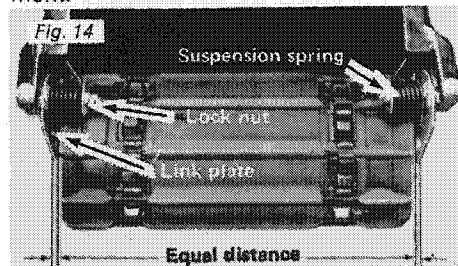

(W7) Carburetor Adjustment

There are (3) different adjustments for the carburetor:

- (1) Maximum Throttle Opening, (2) Idle Speed Mixture, and (3) Idle Speed.

Note: A relationship exists between each adjustment. Do not correct one without checking the other.

WARNING: Do not remove the console to perform idle mixture and/or idle speed adjustments. Instead, using a long, thin screwdriver accede by the choke knob orifice of the console to perform the idle mixture adjustment and through the console grill to perform the idle speed adjustment.

Maximum Throttle Opening

With engine OFF, unscrew the Idle Speed Adjusting screw until a gap exists between screw end and carburetor shaft lever. Depress the throttle lever at handlebar and hold. Butterfly should be horizontal when the lever gently touches the handlebar grip.

To adjust for maximum opening, loosen screw at point where cable joins carburetor lever.

With finger, hold carburetor lever in fully open position (UP), pull cable downward until taut. Retighten screw.

WARNING: Make sure the throttle butterfly closes after releasing throttle lever and, before starting the engine.

Idle Mixture Adjustment

A primary adjustment (with engine OFF) should be made by first turning idle mixture screw fully clockwise until closed. Back off screw $\frac{3}{4}$ of a turn counter-clockwise. (See Fig. 15).

Turning screw clockwise produces a leaner mixture; (more air/less fuel); counter-clockwise, a richer mixture (less air/more fuel).

Note: Do not close too tightly as needle and/or needle seat can be damaged.

For final adjustment, start engine and allow it to warm up. Turn idle mixture screw until engine reaches maximum R.P.M. and obtain a steady idle and a fast response of the engine to the throttle.

Idle Speed Adjustment

Turn the idle speed adjusting screw clockwise to increase idling speed, counter-clockwise to decrease. (See Fig. 15).

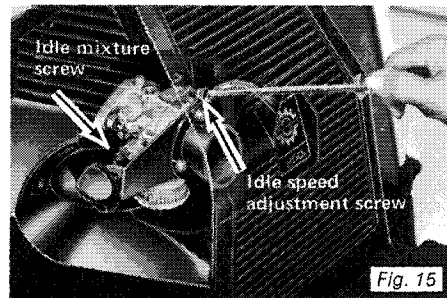

Fig. 15

(W8) Drive Belt Condition

To check the condition of the drive belt:

1. With cab tilted, remove the console.
2. Remove drive belt as detailed in Lubrication Section. Page 17.
3. Check condition of belt. Inspect for cracks, fraying or abnormal wear. (Uneven wear, wear on one side, etc.). If ab-

normal wear is noted, probable cause is misalignment of drive and driven pulleys. Contact your dealer.

(M1) Battery Connections

Check that battery connections are tight and free of corrosion. If not, remove corrosion, using a stiff brush then clean with a solution of baking soda and water. Rinse and dry well. After reconnecting, coat battery terminals and connectors with petroleum jelly to retard corrosion. Check that battery is well secured.

CAUTION: Do not allow cleaning solution to enter battery. It will destroy the chemical properties of the electrolyte.

(M2) Carburetor Flange Nuts

After the first 2 hours of operation, check tightness of carburetor flange nuts. Use the 13mm open end wrench provided in the tool kit, and tighten. (See Fig. 16).

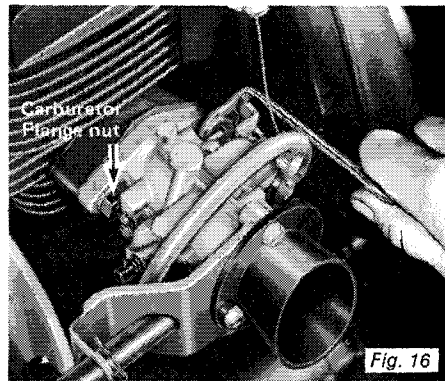
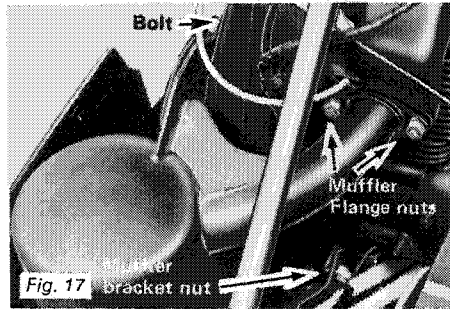

Fig. 16

(M3) Muffler Attachment

With cab tilted, tighten the nuts and the bolt attaching muffler flange and brackets to engine. (See Fig. 17). Loose muffler attaching parts will greatly reduce muffler life.



(M4) Drive Belt Wear

Tilt cab and remove console. Inspect drive belt for wear. If belt is less than $\frac{7}{8}$ " wide, it should be replaced.

(M5) Brake

Check condition of brake mechanism by depressing brake lever. Brake should apply fully when lever is $\frac{1}{4}$ " min. from handlebar.

If adjustment is necessary:

1. With cab tilted, loosen brake cable at point where it joins the brake shoe lever, noting carefully how cable has been secured by manufacturer (See Fig. 18).
2. If brake lever is too low, shorten brake cable. Grasp free end of cable with pliers

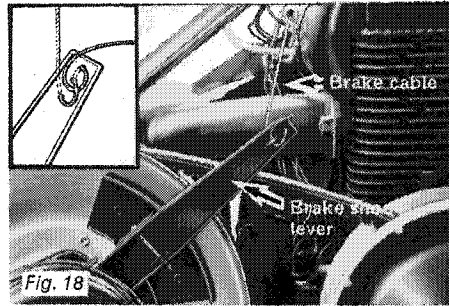

and pull evenly. Resecure cable.

3. If brake lever is too high, lengthen brake cable. Depress brake lever slowly and firmly to position desired. Resecure cable.

(M6) Steering Adjustments

Skis should be parallel to each other. To check, use metal tape and measure distance between skis at front and back. If out of alignment:

1. Using wrench, loosen the lock nuts (2) of the LONGER tie rod.
2. Turn tie rod manually, until skis are parallel to each other. (See Fig. 19).
3. Retighten lock nuts (2) firmly.

Skis should also be parallel to the vehicle when handlebars are horizontal. If not:

1. Using wrench, loosen the lock nuts (2) of the SHORTER tie rod.
2. Turn tie rod manually, until handlebar is horizontal.
3. Retighten lock nuts (2) firmly.

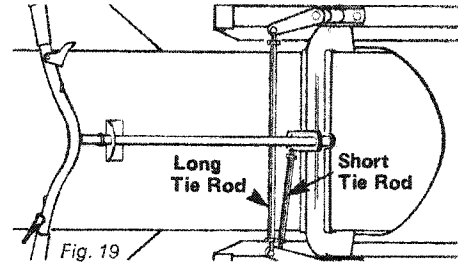

(M7) Engine Head Nuts

With cab tilted, check that engine head nuts are tight and equally torqued, (16 to 18 ft./lbs when COLD).

(M8) Engine Mount Bolts

With cab tilted, remove console then check engine mount bolts. Retighten if necessary.

(M9) Electrical Wiring

With cab tilted, check electrical wiring and components, retighten loose connections. Check for stripped wires or damaged insulations. Repair or replace as necessary.

(M10) Vehicle General Inspection

With cab tilted, thoroughly inspect the vehicle and tighten loose bolts, nuts and linkages. Close cab and clean the chassis throughout. Wax the cab for greater protection. Special Ski-Doo* paints, for necessary touch ups, are available at your dealer.

TOOL KIT AND USES

As standard equipment, Bombardier Ltd. equips each new Ski-Doo snowmobile with the following tools:

Screwdriver

Use for Carburetor Pivoting Slug Screw; to pry off Taillight lens; to open Chain Case Access Covers; etc.

Box Wrench (22/26mm)

Use 22mm end to remove and replace "W" type Spark Plug, 26mm end for "M" type Spark Plug.

Box Wrench (11/13mm)

Use 11mm end to remove Air Silencer (Skandic* Model). Use 13mm end for Engine Head Nuts, Transmission Gear Box Nuts (Alpine/Valmont only).

Pin (8 x 130mm)

Use as handle for Box Wrench.

Open End Wrench (11/13mm)

Use 11mm end for Carburetor Studs (Skandic* Model only). Use 13mm end for left side Carburetor Flange Nut, left side Muffler Flange Nut (single cylinder models only).

Angular Wrench (10/13mm)

Use 10mm end for Rewind Starter Unit bolts. Use 13mm end for right side Carburetor and/or Muffler Flange Nuts.

IN CASE OF EMERGENCY

Emergency situations are accepted hazards with any moving vehicle. A hidden rock or stump on the trail, a blown fuse or burn light bulb while driving at night, an empty fuel tank while miles from anywhere, can all cause varying degrees of inconvenience.

Unlike an automobile, which has a distinct advantage in that service stations are usually within walking distance, **snowmobiles are specifically designed to travel OFF the highways.** When the unexpected happens, the driver often has only his own ingenuity and that of his companions to return home safely.

Fortunately, 9 out of 10 difficulties encountered on the trail can be fixed on the spot. However, you must carry at least a minimum assortment of Tools and Spare Parts to enable you to effect minor repairs.

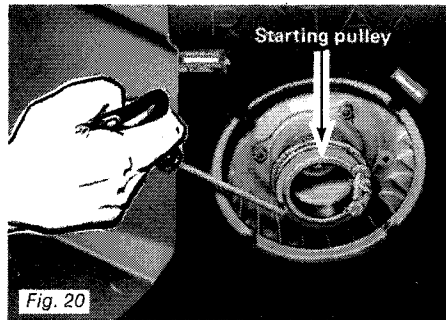

Emergency

In addition to those tools which the manufacturer provides, you should carry the following:

Tools

General Purpose Pliers – Adjustable Wrench (3/4" opening) – Flashlight – Fuel de-icer.

Spare Parts

Spark Plug — Drive belt — Headlamp and Taillight bulbs — Light Fuse (Electric model only) — Throttle Cable and Housing — Starting or towing rope.

IMPORTANT: Always carry spare plugs and drive belt. Check condition of spark plug frequently (See Fig. 11) and look for signs of a fouled or defective plug. Next to "out of fuel" worn spark plug can cause trouble on the trail.

Assisting Stranded Vehicles

It is an unwritten law of snowmobiling that you go to the aid of any snowmobile stranded in the field. Should another vehicle have to be towed:

1. Remove the drive belt. (See Fig. 1).
2. Tie both skis to your vehicle.
3. Taking the driver with you as a passenger, tow the vehicle back slowly.

For short distances, or if tow rope is unavailable, you may push both vehicle and driver.

EMERGENCY GUIDE

The following charts list the "most likely to occur" problems, their possible causes and remedies. Should you encounter trouble on the trail, first identify the symptoms then rectify, using your manual to assist you.

Trouble	You Should Carry	What To Do
Burnt Light Bulb	Spare headlamp and Taillight bulbs	If headlamp is burnt, stop engine , unlock cab latches (2) and tilt cab. Unfasten bulb retainer clips. Detach bulb and replace. If taillight bulb is burnt, expose bulb by removing red plastic lens. To remove, pry off red plastic lens using flat bladed screwdriver.
Broken Throttle Cable	Spare throttle cable and housing Pliers	Remove throttle cable and replace. Check lever operation. If necessary replace housing. Do not start the engine until levers return swiftly. (See Throttle and Brake, page 14).
Broken Rewind Starter rope	Spare Rope or length of similar diameter Rope. 10mm Wrench	If rope is broken inside starter unit, remove starter unit, using 10mm wrench supplied in Tool Kit. Make a knot at end of remaining rope at end opposite handle. Insert knot in notch of starting pulley. (See Fig. 20). Wind remainder of rope around pulley. Pull vigorously, as per usual manual start. If rope is broken at handle, remove starter unit. Fish rope out, being careful to retain all loose parts of unit. Insert knotted end in notch of starting pulley and wind remainder around pulley. Start in usual manner. See your dealer for immediate repair or replacement.
Broken Ski or Spring	Adjustable Wrench (min. 3/4" opening)	In case of major damage, remove ski coupler bolt, using wrench. Remove ski and return on remaining ski. Shift body weight to keep vehicle in balance.
Fuse (Electric Model only)	Spare Light Fuse. Flashlight	If both headlamp and taillight go out at same time, most possible cause is burnt fuse. Check light fuse filament, if broken, replace. Light fuse is in fuse holder on red wire going from ignition to light switch.
Out of Fuel		In emergency, fuel can be siphoned from companion or passing vehicle. To siphon, disconnect both fuel lines of vehicle with fuel, at carburetor. Position vehicle with fuel higher than vehicle with empty fuel tank. Run longer line into empty fuel tank, (or container, if available). Placing hand over open filler neck of tank with fuel, to form a seal and build pressure, blow into open end of shorter fuel line until flow starts.

TROUBLE SHOOTING GUIDE

Symptoms	Possible Causes	What To Do
Engine turns over but fails to start or starts with difficulty	1 — No fuel to the engine	Check the tank level and fill up with correct gas-oil mixture. (Refer to Fuel Mixing, Page 12). Check for possible clogging of fuel line, item 5.
	2 — Spark plug	Check for fouled or defective spark plug. (See Fig. 11). Disconnect spark plug wire, unscrew plug and remove from cylinder head. Reconnect wire and ground exposed plug to engine head, being careful to hold away from spark plug hole. Follow engine starting procedure and check for spark. If no sparks appear, replace spark plug. If trouble persists, check item 3.
	3 — Faulty ignition	Disconnect spark plug wire from plug, unscrew the spark plug cap then hold wire about 1/8" from the cylinder head. Follow engine starting procedure and if no sparks appear, it means a faulty ignition system. Do not attempt to repair. Contact your dealer.
	4 — Flooded engine	Turn choke knob to OFF, wait 60 seconds or more then depress throttle lever fully and try to start engine. Release throttle lever immediately after engine starts.
	5 — Clogged fuel line (water or dirt)	Remove and clean the fuel filter. Change filter cartridge if necessary. Check the cleanliness of the fuel tank. Clean tank if necessary. (See Fuel Tank, Page 27).
	6 — Idle speed adjustment	Screw in the idle speed mixture adjusting screw and turn it back 3/4 of a turn. Make final adjustment with engine running and warmed up. (See Fig. 15).
	7 — Faulty carburetor	First make primary adjustments on carburetor. (See Maintenance Section, Page 20). If carburetor is still faulty, contact your dealer for repair.
	8 — Too much oil in fuel	Drain the fuel tank and refill with the correct gas/oil mixture. (Refer to Fuel Mixing, Page 12).
	9 — Breaker points	Breaker points may be worn or out of adjustment. Contact your dealer.
	10 — Poor engine compression	Running with a lean fuel mixture may produce excessive engine wear resulting in poor engine compression. If this occurs, contact your dealer at once.
Engine will not turn manually	1 — Seized engine	In the case of a seized engine, contact your dealer. Seizure is a direct result of poor lubrication.

Symptoms	Possible Causes	What To Do
Engine will not start (electric model only) Note: If failure is in starting system, engine will start manually	1 — Poor connections	Check for loose or corroded battery and starter connections. Tighten and clean if necessary. Try to restart engine electrically. If engine still does not start, check item 2.
	2 — Battery	Check condition of battery by turning lights ON. If lights are dim or out, battery may be discharged or defective. Contact your dealer to charge or replace.
	3 — Starter	If wire connections are tight and fuse and battery are all in working order, most probable cause of trouble is defective starter. Contact your dealer for repair.
Engine lacks acceleration or power	1 — Fouled or defective spark plug	Change your spark plug. Fouled spark plug may be cleaned, regapped and tested by your dealer. Check for defective spark plug, (See Fig. 11), and change if necessary. (See Fig. 10).
	2 — Clogged fuel line (water or dirt)	Remove and clean fuel filter. Change filter cartridge if necessary. Check fuel line condition and connections. Check cleanliness of fuel tank. Clean if necessary.
	3 — Carburetor	Readjust the carburetor (See Page 20). If the trouble persists, contact your dealer.
	4 — Defective ignition	First check items 2 and 3 of "Engine turns over but fails to start or starts with difficulty". If the ignition system still seems defective, contact your dealer.
	5 — Engine	If unable to locate specific symptoms, contact your dealer.
Engine continually backfires	1 — Faulty spark plug	Check item 1 of "Engine lacks acceleration or power".
	2 — Overheated	Carburetor set to lean. Readjust.
	3 — Engine timing incorrectly set	Contact your dealer.
Snowmobile cannot reach full speed	1 — Drive belt	Check for defective or worn drive belt. Replace if necessary. (See Page 17).
	2 — Pulley misaligned	If the drive and driven pulleys are not aligned correctly, contact your dealer.
	3 — Incorrect track adjustment	Check track tension and alignment. Readjust to specifications. (See Maintenance Section, Page 20).
	4 — Faulty engine	Check items 1 to 5 of "Engine lacks acceleration or power".

STORING PROCEDURE

It is during Summer, or when a vehicle is not in use for a month or more, that proper storage is a **necessity**.

"Storage of the Ski-Doo snowmobile during long periods of inactivity consists of checking and replacing missing or worn parts: Proper lubrication to insure that parts do not become rusted: Cleaning items such as carburetor of oil gas mixtures, to prevent gum varnish formation within the carburetor; Battery recharging (electric models only); and in general, preparing the vehicle so that when the time comes to use the snowmobile again it will start and be in top condition".

IMPORTANT: The necessity of proper storage cannot be overstressed. If you lack the time or proper tools, be sure to see your authorized Ski-Doo Dealer.

(S1) Track

1. Inspect track for cuts, missing track inserts or broken rods and make any necessary replacements.

2. Lift rear of vehicle until track is clear of ground then support with brace or trestle. The Ski-Doo snowmobile should be stored in such a way that track does not stay in contact with cement floor or bare ground.

Note: Due to the material change of the '72 track, we recommend to keep the

spring tension applied. However, the track should be rotated periodically, (every 40 days).

(S2) Suspension

1. Remove the bogie wheel sets from the vehicle.

2. Remove cross shaft from bogie wheel set. Clean bogie wheel assembly and cross shaft of dirt or rust.

3. Grease each bogie wheel until all old grease is flushed out. (See Fig. 5).

4. Spray bogie wheel springs with Ski-Doo* metal protector. If unavailable, wipe with cloth or rag soaked in oil.

Check condition of shaft and replace if bent or worn. Apply a coat of low temp. grease on cross shaft. (See Fig. 21).

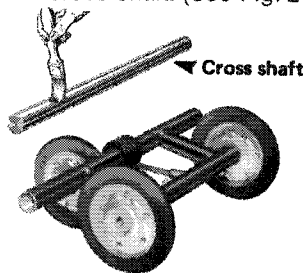

Fig. 21

5. Reassemble entire bogie wheel set, making sure assembly moves freely.

6. Reinstall bogie wheel set.

7. Repeat above steps on remaining bogie wheel sets.

8. Lubricate rear hub through grease fittings.

(S3) Ski Assembly

1. Wash or brush all dirt or rust accumulation from skis and springs.

2. Grease ski legs at grease fittings.

3. Check condition of ski runners. Replace if worn.

4. Apply Ski-Doo* metal protector on ski assembly. If unavailable, wipe the entire ski with cloth soaked in oil to prevent rust formation.

(S4) Fuel Tank

1. Disconnect fuel lines by pulling plastic lines away from tank. (See Fig. 22).

2. Using screwdriver, unscrew tank retainer strap then remove fuel tank from vehicle and drain it.

3. Rinse inside of tank thoroughly with fresh gasoline.

4. Reinstall fuel tank.

WARNING: Gasoline is flammable and explosive under certain conditions. Always perform this procedure in a well ventilated area. Do not smoke or allow open flames or sparks near the vehicle.

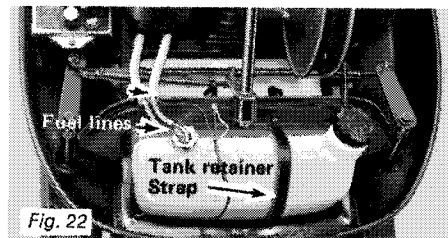

Fig. 22

(S5) Carburetor

The carburetor must be dried out completely to prevent gum formation during the storage period.

1. Assure that fuel lines are disconnected then start the engine and run it out of gas.
2. Engage choke, (turn to ON), then pack the carburetor throat with a clean piece of cloth and turn the engine a few more times. The suction should eliminate the remaining fuel. (See Fig. 23).

Note: An alternate procedure is to use *Stabil*, an excellent product in the prevention of gum formation. Ask for it at your Ski-Doo dealer then follow the mixing directions on the can. Pour mixture into clean container, insert fuel lines (previously disconnected) into mixture. Run engine for 2 minutes.

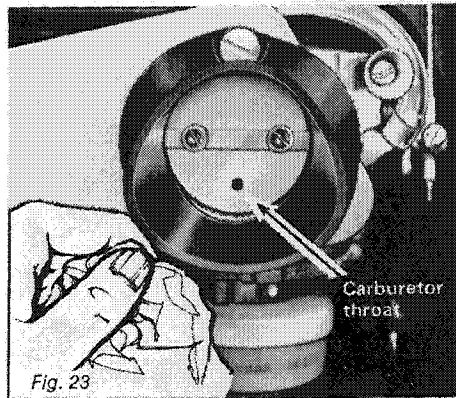

(S6) Cylinder Lubrication

Engine internal parts must be lubricated to protect cylinder walls from possible rust formation during the storage period.

1. Remove spark plug (See Fig. 10). Check condition, replace if necessary.
2. Connect ignition wire to spark plug and ground plug on engine head. This will prevent magneto damage.
3. Operate rewind starter to bring piston at TOP position.
4. Pour about **one** spoonful of Ski-Doo* oil into spark plug hole. (See Fig. 24).
5. Slowly crank engine 10 to 12 times using manual starter.
6. Install spark plug.

Note: This operation should be repeated every 40 days during storage.

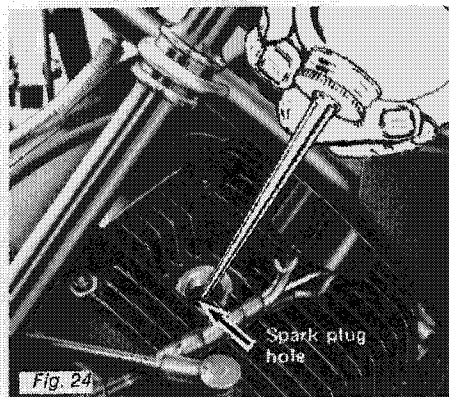

(S7) Chain Case

Drain the chain case completely and re-fill with 8 ozs. of fresh Ski-Doo* chain case oil. To drain, open access plug, (lower plug) and tilt vehicle hard left. (See Fig. 4).

(S8) Controls

1. Oil steering mechanism linkage (See Fig. 2).
2. Oil moving joints of brake mechanism.

Avoid getting oil on brake shoe.

3. Coat all electrical connections and switches with Ski-Doo* metal protector (greaseless).

If unavailable, use petroleum jelly.

(S9) Pulleys

1. Tilt cab and remove console and drive belt. (See Fig. 1).
2. Thoroughly clean the driven pulley shaft. Apply a light coat of Ski-Doo* clutch lube on shaft (See Fig. 7).
3. Activate the sliding half several times to distribute lubricant.
4. Lubricate drive pulley following the procedure detailed in Lubrication Section (L8).
5. Spray internal pulley surfaces with Ski-Doo* metal protector.

Note: Leave drive belt OFF during entire storage period.

*Trademark of Bombardier Limited

(S10) Battery

(Electric Model only)

1. Tilt cab then disconnect battery and remove from snowmobile.
2. Clean outside surface of battery with solution of baking soda and water. Remove all deposits from connection posts and rinse with clear tap water.

CAUTION: Do not allow cleaning solution to enter battery interior since it will destroy the electrolyte.

3. Check electrolyte level in each cell. Refill if necessary using Distilled water.
4. Fully charge battery. (See Fig. 25).

Note: A stored battery will gradually lose its charge and begin to sulphate. If allowed to continue, the battery will become useless and cannot be salvaged. Fully recharge (trickle charge) at least every 40 days.

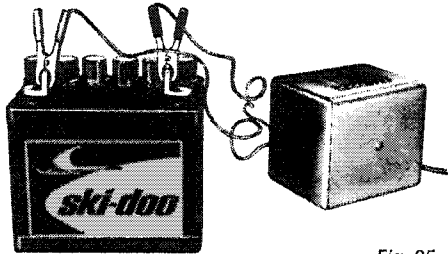

Fig. 25

5. Spray battery terminals with Ski-Doo* metal protector (greaseless). If unavailable, use petroleum jelly.
6. Store the battery in a cool, dry place.

(S11) Chassis

1. Clean the vehicle thoroughly, removing all dirt and grease accumulation.
2. Inspect cab and repair damage. Repair kits are available at your authorized Ski-Doo dealer.
3. Wax the complete cab for better protection.
4. Touch up all worn metal spots where paint has been scratched or peeled off. Ask your dealer about Ski-Doo* paints.
5. Spray all bare metal parts of vehicle with Ski-Doo* metal protector.
6. Protect the vehicle with a Ski-Doo* cover to prevent dust accumulation during storage.

Note: For more technical information on the service of your Ski-Doo snowmobile, Bombardier Limited has published the 1972 Ski-Doo Shop Manual, available from your local authorized Ski-Doo dealer.

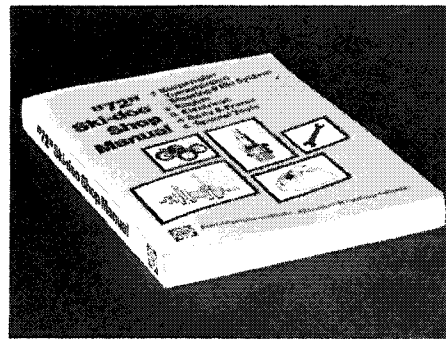

HOW TO IDENTIFY YOUR SKI-DOO SNOWMOBILE

The frame, engine and track of each Ski-Doo snowmobile are separately identified with individual serial numbers.

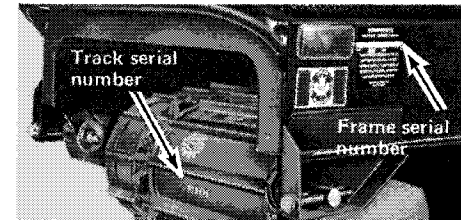

Useful in the event of Warranty claims, loss, theft, or dispute, they are prominently displayed and easy to locate.

Vehicle Serial Number (Frame)

The serial plate is located on the right side of frame, at rear.

Engine

The identification plate is located at the right side of the engine, on the fan cowl, above the manual starter handle.

Track

The serial number is stamped directly into the track, at one of the recesses formed by the track ribs. To locate, turn back slowly until number appears between the rear sprockets.

IMPORTANT: Your Dealer retains a file copy of your registration. Should you lose or misplace your Service Card, he will be more than pleased to assist you.

GLOSSARY

Bogie Wheels

The wheels that form part of the suspension system. They absorb shock, act as stabilizers, and exert downward pressure on the track so that it will have continued contact with the snow surface.

Bore

The inside diameter of the cylinder.

Brake Drum

The outer side wall of the fixed half of the driven pulley. The pressure of a brake shoe, or disc puck, applied against the brake drum, or brake drum disk, is the principle used to slow or stop the vehicle.

Breaker Points

An electric switch which controls the firing time of the spark plug.

Cam Slider Shoes

Nylon reinforcements that aid in the friction-free in and out movement of the sliding half of the driven pulley.

Carburetor Flange

That part of the carburetor body by which the carburetor is secured to the engine.

Centrifugal Governor

The cup portion of the drive pulley containing four flyweights.

Chain Tensioner

Self-adjusting, friction-free block, used to maintain correct drive chain tension.

Ski Runners

Replaceable steel rods located under the skis, that aid steering control and also prevent ski wear on hard surfaces.

Sprockets

Polyurethane or rubber toothed wheels, located on drive and rear axles. The drive sprockets transmit power from the drive axle to the track. Rear sprockets aid in proper alignment of the running track.

Stroke

The depth of travel of the piston. Stroke multiplied by the surface area of the cylinder is the displacement.

Throttle

A butterfly valve governing the ratio of fuel mixture entering the engine.

Tie Rods

Steel rods which link the steering column to the steering arms. Lengthening or shortening the tie rods determines ski alignment.

Cross Shaft

A transverse shaft that attaches the bogie wheel set to the frame.

Drive Chain

Links the driven pulley shaft with the drive axle.

Drive Pulley

A variable pitch pulley which transmits power from the engine to the driven pulley by means of a drive belt.

Driven Pulley

A variable pitch pulley which transmits power from the drive pulley to the drive axle by means of a drive chain.

Displacement

The volume of air displaced by a piston in a single stroke, measured in cubic centimeters.

Electrolyte

The solution in a battery (distilled water and sulphuric acid) which acts on the battery plates to produce electric current.

Inserts

Steel clips that protect the track sprockets and track against wear.

Link Plate

A pivoting steel plate that links the rear axle to the frame.

Rectifier

An electrical device used to convert alternating current into direct current thereby allows battery charging.

QUALITY ASSURED! WARRANTY PROTECTED!

Years of experience in workmanship and modern production engineering and quality control methods assure you, the customer, that SKI-DOO snowmobiles for '72 means reliability, performance and quality.

To follow through our quality assurance plan the Ski-Doo snowmobile dealer completes an 18 point inspection and pre-delivery set-up procedure. Part of this procedure includes making up your personalized: "SKI-DOO SERVICE CARD" which you have in your possession on the day you become a proud Ski-Doo snowmobile owner. This card is your identification and assurance that Warranty will be honoured by any authorized Ski-Doo snowmobile dealer. Be sure to have the "Ski-Doo Service Card" with you at all times as it will be required by the dealer when effecting any warranty service.

Although we do not make it an obligation to follow a strict preventative maintenance schedule, our warranty does require that your Ski-Doo snowmobile be reasonably maintained and serviced.

Please take the time to read this manual thoroughly and understand your maintenance and warranty responsibilities.

Carelessness doesn't pay!

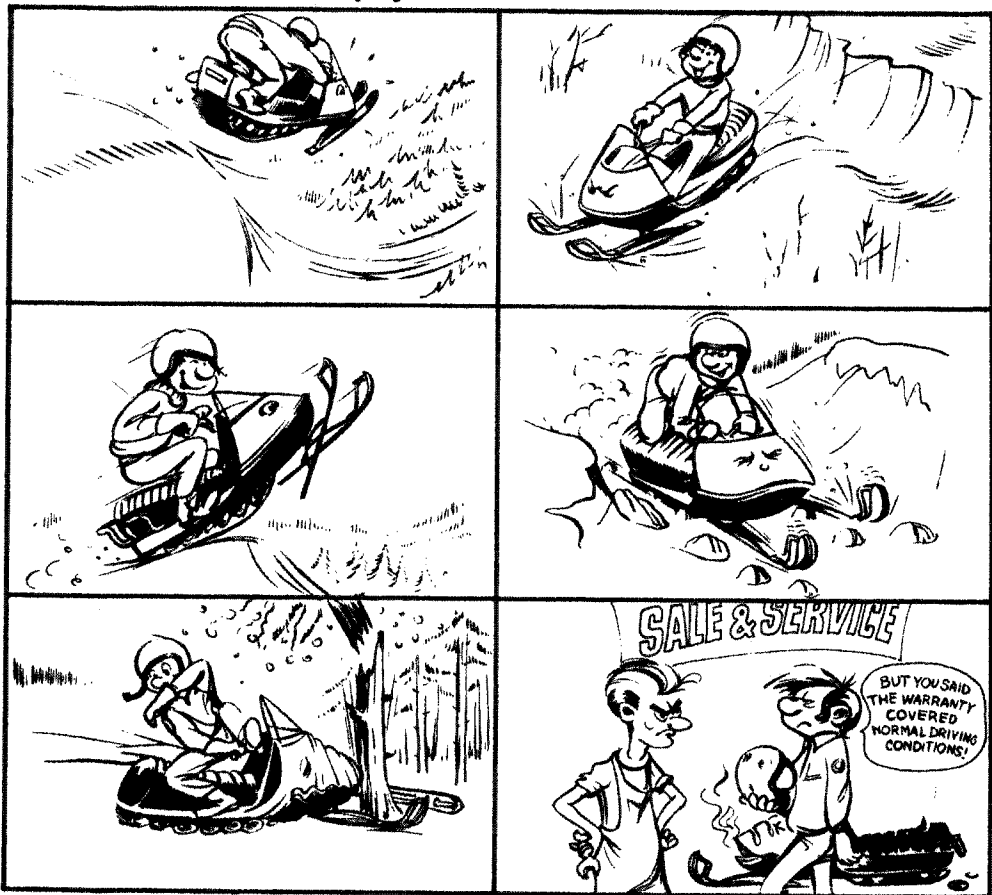



WARRANTY 1972 SKI-DOO SNOWMOBILE — U.S.A. and CANADA

Bombardier Limited (Bombardier), as manufacturer, warrants every 1972 Ski-Doo snowmobile **sold as a new vehicle, by an authorized Ski-Doo dealer**, to be free from defects in material, and workmanship under normal use and service, for a period of ninety (90) days from the date of the original retail purchase, subject to the following exceptions:

1. Should the date of said original retail purchase be within ninety (90) days immediately preceding March 31, the warranty period shall be for a period of ninety (90) days, beginning on the date of said retail purchase until March 31 and the balance of said warranty period shall be carried over into the following winter season beginning with the date of the first snowfall, but not later than the **next 15th day** of December.
2. Should the date of said original retail purchasing be on or after March 31, the said warranty period shall be for a period of ninety (90) days, beginning on the date of the first snowfall during the following winter season, but not later than the **next 15th day** of December.
3. This warranty does not apply to Ski-Doo snowmobiles used for racing purposes nor to Blizzard Ski-Doo snowmobile models.

An exception to the above warranty period is that transmission drive belts are warranted for thirty days from date of retail purchase of the Ski-Doo snowmobile subject to the aforementioned exceptions.

Bombardier's obligation under this warranty is strictly limited to the repair or replacement at its option, of any part or parts thereof which shall, within the specified warranty period, be returned to an authorized Ski-Doo dealer at such dealer's place of business and, which examination shall disclose to the satisfaction of Bombardier to have been thus defective. The repair or replacement of defective parts under this warranty will be made by such dealer, without charge for parts or labour, under the following conditions only:

1. That proof of ownership and warranty registration be submitted to the dealer by means of the Ski-Doo Service Card.
2. That warranty repairs be effected at the Dealer's place of business.

This warranty does not apply to normal maintenance services, (including but not limited to normal wear on rubber drive belts, slider shoes on transmission cams and slide rail suspensions, including all engine or other adjustments and alignments) or to replacement of service items (including but not limited to spark plugs, ignition points and condensers, filters, brake linings, light bulbs and lenses, ski-runner shoes, paints, lubricants or fasteners) made in connection with such services, or to normal deterioration of soft trim and appearance items due to wear and exposure.

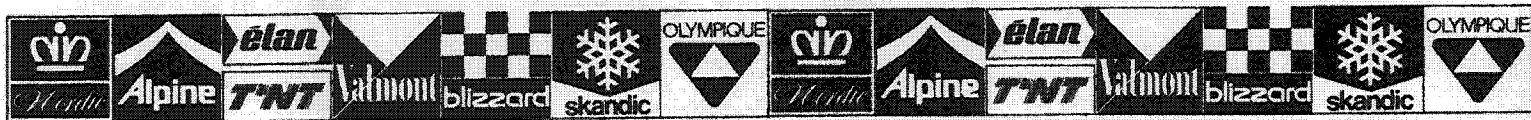



This warranty does not apply to any defect which results from: I) misuse or accident; II) installation of repair parts other than genuine Bombardier replacement parts or; III) repairs by any person other than an authorized Ski-Doo snowmobile dealer; IV) lack of preventative maintenance; V) alterations or modifications other than those approved in writing by Bombardier.

Operating a Ski-Doo snowmobile in a race, or modifying it with high performance parts (whether or not such parts are supplied by Bombardier or are installed by an authorized Ski-Doo snowmobile dealer) or operating a Ski-Doo snowmobile on surfaces other than snow or ice, will be considered a misuse.

This warranty is expressly in lieu of all other expressed or implied warranties of Bombardier, its distributors and the selling dealer, including any implied warranty of merchantability or fitness for any particular purpose. Neither Bombardier, its distributors nor the selling dealer shall be responsible, under any circumstances, for any loss or damage as a result of hidden defects, accidents, misuses or other faults.

Neither the distributor, the selling dealer nor any other person has been authorized to make any affirmation, representation or warranty other than those contained in this warranty and if made, such affirmation, representation or warranty shall not be enforceable against Bombardier or any other person.

This warranty does not apply to any losses resulting from:

- Traveling time, mileage, telephone calls, telegrams, taxi or towing charges or the rental of a vehicle during the period of repair.
- Transportation of the vehicle, engine, parts or accessories.

NOTE: *In the event of change of ownership, complete the notice of transfer form below in order to qualify the new owner for balance of warranty. All such transfers should be reported to an authorized Ski-Doo dealer for modification of the Ski-Doo Service Card.*

In the event of a lost Service Card, contact the original selling dealer for completion of the "Request for New Service Card" form. For a \$2.00 handling charge, Bombardier will mail your new personalized Service Card to you.

**Bombardier Limited,
Valcourt, Québec, Canada. May 1971.**

NOTICE OF TRANSFER

Vehicle Serial No.

The ownership of this vehicle is transferred

From

Signature of registered owner

Full name of purchaser

To

Block letters

Address

No

Street or Village

City County

Date

Purchaser's Signature

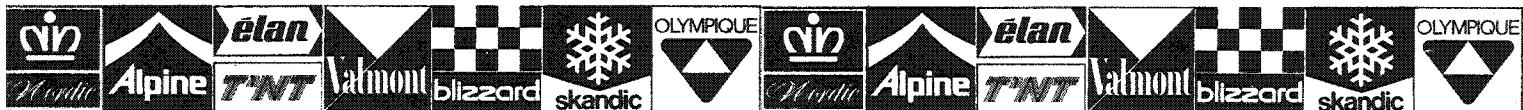

Ski-Doo* Sports clothing and accessories

A. Covers are available for each Ski-Doo* snowmobile model. Features include phosphorescent stripes for night visibility, flannellette lining windshield pocket for protection against scratches, and side attachment cords to protect against flapping.

B. Snowmobilers can choose from three different styles of goggles: the "junior", the "regular" and the "T'NT".* The goggles have air vents to prevent fogging and come with interchangeable green and yellow lenses.

C. Very useful to the snowmobiler is this saddle bag. It is made of waterproof leather and has phosphorescent safety stripes for night outings. Repair kits or any other necessary items can be tucked away in the saddle bag for safaris.

D. Three different styles of snowmobiling helmets — all exceeding government specifications — are available. They provide sturdy protection with a polycarbonate shell lined with styrofoam, phosphorescent stripes on the side for night snowmobiling and quick release adjustable chin strap with comfortable chin cup. There are also two shades of snap-on visors — clear or tinted — for extra face protection from the wind, tree branches, and sun.

E. For snowmobiling and après-sports, Ski-Doo Sports has a variety of knits; suits, sweaters with matching tuques. They come in a multitude of colours. Six different styles of sweaters for the family and three elegant knit suits, one available for couples as well as children, the two others for ladies only.

F. To really enjoy snowmobiling, it is important to be dressed properly. Ski-Doo Sports, the "couturier" of snowmobile and winter fashions offers as many as twelve different styles in 1972. Clothing is made of water-resistant nylon or synthetic leather, both are lined with orlon fleece. Not to mention the array of accessories: boots, mitts, hats and many other items.

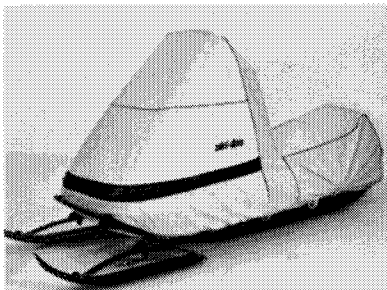

A



B



D



F

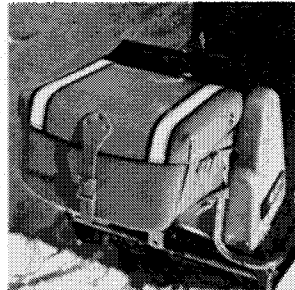

C



E

Ski-Doo Sports Ltd. is a subsidiary of Bombardier Limited

June 71 * Trade marks of Bombardier Limited, Valcourt, Quebec, Canada.

Litho'd in Canada. 480-0038

BOMBARDIER LIMITED



All rights reserved © Bombardier Limited 1971