

can-amTM



2008

**Operator's
Guide**

**Includes
Safety, Vehicle
and Maintenance Information**

DS 250TM

⚠ WARNING

Read this guide thoroughly. It contains important safety information.

Minimum recommended operator age: 16 years. Do not remove this Operator's Guide from the vehicle.

2 1 9 0 0 0 5 0 6



This Operator's Guide utilizes the following symbols to emphasize particular information:

 The Safety Alert Symbol indicates a potential personal injury hazard.

 **WARNING** Indicates a potential hazard that, if not avoided, could result in serious injury or death.

CAUTION: Denotes an instruction which, if not followed, could severely damage vehicle components.

NOTE: Indicates supplementary information needed to fully complete an instruction.

 **WARNING**

YOUR VEHICLE CAN BE HAZARDOUS TO OPERATE. A collision or rollover can occur quickly, even during routine maneuvers such as turning and driving on hills or over obstacles, if you fail to take proper precautions. For your safety, understand and follow all the warnings contained in this Operator's Guide and the labels on your vehicle. **Failure to follow these warnings can result in SEVERE INJURY OR DEATH!** Keep this Operator's Guide with the vehicle at all times.

 **WARNING**

Disregarding any of the safety precautions and instructions contained in this Operator's Guide, *SAFETY VIDEO* and on-product labels could cause injury including the possibility of death!

All safety documentation should remain with the vehicle at the time of sale.

All content of the *SAFETY INFORMATION* section should be interpreted by the reader as a warning which, if not followed, may result in injury including the possibility of death.

The following trademarks are the property of Bombardier Recreational Products Inc.:

Can-Am™

XP-S™

DS 250™

FOREWORD

Congratulations on your purchase of a new Can-Am™ ATV. It is backed by the BRP warranty and a network of authorized Can-Am distributors/dealers ready to provide the parts, service or accessories you may require.

Your distributor/dealer is committed to your satisfaction. He has taken training to perform the initial setup and inspection of your vehicle as well as completed the final adjustment before you took possession. At delivery, your distributor/dealer would have explained the operation, maintenance and safety features of the vehicle. We trust you have taken full advantage of this! If you need more complete servicing information, please ask your distributor/dealer.

At delivery, you were also informed of the warranty coverage and signed the *PREDELIVERY CHECK LIST* to ensure your new vehicle was prepared to your entire satisfaction.

You are invited to contact our customer assistance center should you experience problems which cannot be resolved by an authorized Can-Am distributor/dealer.

It is understood that this Operator's Guide may be translated into another language. In the event of any discrepancy, the English version shall prevail. Throughout this document the masculine is used to denote the masculine or feminine.

If you want to view and/or print an extra copy of your Operator's Guide, simply visit the following website www.operatorsguide.brp.com. Also note that the guide is available in several languages.

The information and components/system descriptions contained in this document are correct at the time of publication. BRP, however, maintains a policy of continuous improvement of its products without imposing upon itself any obligation to install them on products previously manufactured. Due to late changes, some differences between the manufactured product and the descriptions and/or specifications in this guide may occur. BRP reserves the right at any time to discontinue or change specifications, designs, features, models or equipment without incurring any obligation upon itself.

The illustrations in this document show the typical construction of the different assemblies and may not reproduce the full detail or exact shape of the parts. However, they represent parts that have the same or similar function.

The use of RIGHT and LEFT indications in the text always refers to driving position (when sitting on vehicle).

Specifications are given in the international metric system with the SAE U.S. equivalent in parenthesis. Where precise accuracy is not required, some conversions are rounded off for easier use.

We recommend genuine BRP products for replacement parts and accessories. They've been especially designed for your vehicle and manufactured to meet BRP's demanding standards.

A *SHOP MANUAL* can be obtained for complete service and maintenance information and more repair information.

TABLE OF CONTENTS

While reading this Operator's Guide, remember that:

WARNING

Indicates a potential hazard that, if not avoided, could result in serious injury or death.

NOTICE	7
European Community	7
INTRODUCTION	8

SAFETY INFORMATION

SPECIAL SAFETY MESSAGES	10
OPERATION WARNINGS	13
RIDING THE VEHICLE	39
Pre-Operation Check	39
Clothing	41
Carrying Loads	42
Hauling a Trailer (if so equipped)	42
Working with your Vehicle	42
Recreational Riding	42
Environment.....	43
Design Limitation	43
Off-Highway Operation.....	44
General Operating and Safety Precautions	44
Uphill Driving	44
Downhill Driving	45
Side Hilling.....	45
Drop-Offs	45
Riding Techniques	45
Routine Maintenance.....	52
HANG TAG	53
ON-PRODUCT LABELS	54

VEHICLE INFORMATION

HOW TO IDENTIFY YOUR VEHICLE	58
BREAK-IN PERIOD	61
CONTROLS/INSTRUMENTS/EQUIPMENT	62
1) Throttle Lever	64
2) Front Brake Lever.....	64
3) Rear Brake Lever.....	64

4) Parking Brake.....	64
5) Transmission Lever	65
6) Multi-Switch Housing.....	66
7) Indicator Lamps	68
8) Ignition Switch	68
9) Fuel Tank Cap	69
10) Fuel Valve	69
11) Front/Rear Brake Pedal	70
12) Footpeg.....	70
13) Tool Kit.....	70
14) Radiator Cap	71
15) Fuse.....	71
16) Vehicle Lock.....	71
17) Horn Button	72
18) Hazard Warning Switch	72
19) Seat Latch.....	72
20) 12-Volt Power Outlet.....	73
21) Speedometer	73
22) Dipstick.....	73
23) Front Brakes Fluid Reservoir	74
24) Rear Brake Fluid Reservoirs	74
25) Engine Coolant Reservoir.....	74
LIQUIDS.....	76
Fuel.....	76
Engine Oil.....	76
Gearbox Oil.....	78
Engine Coolant.....	78
Brake Fluid.....	79
OPERATING INSTRUCTIONS.....	81
General.....	81
Pre-Operation Check	81
Starting the Engine	82
Shifting the Transmission	82
Stopping the Engine	83
Post-Operation Care.....	83
SPECIAL PROCEDURES.....	84
Engine Overheat	84
Turn Over	84
Vehicle Immersion	84

CARGO AND TRANSPORTATION	85
TROUBLESHOOTING	87
SPECIFICATIONS	91

MAINTENANCE INFORMATION

MAINTENANCE CHART	96
GENERAL	100
ENGINE	101
Air Filter	101
Air Filter Housing Draining	101
Oil Change and Oil Strainer Cleaning	102
Radiator	103
Engine Coolant Replacement	103
Air Injection Valve Filter Cleaning	104
CARBURETOR	106
TRANSMISSION	107
Drive Belt	107
CVT Cover Drain Tube	107
GEARBOX	108
Oil Change	108
FUEL SYSTEM	109
Throttle Cable Lubrication	109
Throttle Lever Adjustment	110
ELECTRICAL	111
Spark Plug	111
Battery	111
Fuse	112
Bulb Replacement	112
DRIVE TRAIN	116
Drive Chain	116
Sprocket and Pinion	117
Wheel	117
Wheel Bearing/Bushings Condition	117
Tires/Wheels	118
SUSPENSION	119
Adjustment	119
Lubrication	119
Inspection	119
BRAKE	121
Inspection	121
Parking Brake	121
Brake Cable Lubrication	122

BODY/FRAME	123
Engine Area	123
Hitch/Trailer Ball Condition (if so equipped)	123
Frame Fasteners	123
Seat Fasteners	123
Vehicle Cleaning and Protection.....	123
STORAGE AND PRESEASON PREPARATION	124

WARRANTY

BRP INTERNATIONAL LIMITED WARRANTY: 2008 CAN-AM™ ATV	126
BRP EUROPEAN UNION MEMBER STATES LIMITED WARRANTY: 2008 CAN-AM™ ATVS	130
PRIVACY OBLIGATION/DISCLAIMER	134
CHANGE OF ADDRESS/OWNERSHIP	135

NOTICE

This Operator's Guide has been prepared to acquaint the owner/operator of a new vehicle with the various vehicle controls, maintenance and safe operating instructions. It is indispensable for the proper use of the product.

This Operator's Guide uses the following symbols.

WARNING

Indicates a potential hazard that, if not avoided, could result in serious injury or death.

CAUTION: Denotes an instruction which, if not followed, could severely damage vehicle components.

NOTE: Indicates supplementary information needed to fully complete an instruction.

Although the mere reading of such information does not eliminate the hazard, the understanding and application of the information will promote the correct use of this vehicle.

To fully appreciate the pleasures, enjoyment and excitement of using this vehicle, there are some basic rules that **MUST** be observed and followed by any user.

European Community

This warning applies only in the European Countries where on road usage is allowed.

WARNING

On road use:

- This vehicle is built for OFF-ROAD purposes only. It may be used for short distances on paved surfaces at reduced speed, in order to move the vehicle from an off-road location to another.
- When driving this vehicle on roads, always refrain from speeding and substantially reduce vehicle speed when turning.
- Failure to do so can cause a loss of vehicle control, possibly resulting in serious injury.

Front winch:

- The front winch hook of the so equipped vehicle must be removed and stored when riding the vehicle on public trails and/or roads.
- Failure to do so can increase the risk of injury to bystanders.

INTRODUCTION

Your distributor/dealer should have provided you with some basic information on the particular controls and features of your new vehicle. Please take the time to study this Operator's Guide and all on-product warning labels as well as the *SAFETY VIDEO* that came with this vehicle. They more completely describe what you should know about this vehicle before riding it.

Whether you are a new user or an experienced rider, it is important for your personal safety that you know the controls and features of this vehicle. Equally important is knowing how to properly ride.

Irrespective of your age, experience or state regulations, it is always prudent for you or any other person who may ride your vehicle, to take an approved safe riding course. Please check with your distributor/dealer or local authorities for availability in your area. If you are a completely new rider, this should be done before your first ride. Your instructor should be able to provide advice on local conditions and safe riding practices particular to the area.

Riding conditions vary from place to place. Each is subject to weather conditions which may radically change from time to time and from season to season.

Riding on sand is different than riding on snow or through forests or marshes. Each location may require a greater degree of awareness and skill. Show good judgement. Always proceed with caution. Please do not take any unnecessary risks that could leave you stranded or possibly injured.

The contents of this Operator's Guide provide riding information which has been proven reliable by other users. They are not intended as a definitive means of avoiding accidents. How you apply this information, coupled with your mental and physical condition, the particular terrain hazard and your risk acceptance level will have an effect on your riding experience. Have fun... and ride responsibly.

This Operator's Guide has been prepared to acquaint the owner/operator of a new vehicle with the various vehicle controls, maintenance and safe operating instructions. They are indispensable for the proper use of the product.

We would be pleased to receive any comments on the content and format of this Operator's Guide, the *SAFETY VIDEO* or on-product warnings labels.

SAFETY INFORMATION

SPECIAL SAFETY MESSAGES

THIS VEHICLE IS NOT A TOY AND CAN BE HAZARDOUS TO OPERATE.

This vehicle handles differently from other vehicles including motorcycles and cars. A collision or rollover can occur quickly, even during routine maneuvers such as turning and driving on hills or over obstacles, if you fail to take proper precautions.

SEVERE INJURY OR DEATH can result if you do not follow these instructions:

- ⚠ Read this Operator's Guide and all on-product warning labels carefully and follow the operating procedures described. Watch and pay attention to the *SAFETY VIDEO* before operation.
- ⚠ Never operate this vehicle without proper instruction. **Take a training course.** All operators should receive training from a certified instructor. Contact an authorized Can-Am distributor/dealer to find out about available training course nearest you.
- ⚠ Always follow this age recommendation: A person under 16 years old should never operate this vehicle.
- ⚠ Never carry a passenger on this vehicle.
- ⚠ Never operate this vehicle on any paved surfaces unless it is for short distances, at reduced speed and in order to move the vehicle from an off-road location to another.
- ⚠ Always respect the road traffic law when you operate this vehicle on the roadway, even a dirt or gravel road.

- ⚠ Never take place on this vehicle without wearing an approved helmet that fits properly. You should also wear eye protection (goggles or face shield), gloves, boots, long sleeved shirt or jacket, and long pants.
- ⚠ Never consume alcohol or drugs before or while riding this vehicle.
- ⚠ Never operate at excessive speeds. Always go at a speed that is proper for the terrain, visibility, and operating conditions, and your experience.
- ⚠ Never attempt wheelies, jumps, or other stunts.
- ⚠ Always inspect your vehicle each time you use it to make sure it is in safe operating condition. Always follow the inspection and maintenance procedures and schedules described in this Operator's Guide.
- ⚠ Always keep both hands on the handlebars and both feet on the footrests of the vehicle during operation.
- ⚠ Always go slowly and be extra careful when operating on unfamiliar terrain. Always be alert to changing terrain conditions when operating this vehicle.
- ⚠ Never operate on excessively rough, slippery or loose terrain until you have learned and practiced the skills necessary to control this vehicle on such terrain. Always be especially cautious on these kinds of terrain.
- ⚠ Always follow proper procedures for turning as described further in this Operator's Guide. Practice turning at low speeds before attempting to turn at faster speeds. Do not turn at excessive speed.

- ⚠ Never operate this vehicle on hills too steep for the vehicle or for your abilities. Practice on smaller hills before attempting larger hills.
- ⚠ Always follow proper procedures for climbing hills as described further in this Operator's Guide. Check the terrain carefully before you start up any hill. Never climb hills with excessively slippery or loose surfaces. Shift your weight forward. Never open the throttle suddenly or make sudden gear changes. Never go over the top of any hill at high speed.
- ⚠ Always follow proper procedures for going down hills and for braking on hills as described further in this Operator's Guide. Check the terrain carefully before you start down any hill. Shift your weight backward. Never go down a hill at high speed. Avoid going down a hill at an angle that would cause the vehicle to lean sharply to one side. Go straight down the hill where possible.
- ⚠ Always follow proper procedures for crossing the side of a hill as described further in this Operator's Guide. Avoid hills with excessively slippery or loose surfaces. Shift your weight to the uphill side of the vehicle. Never attempt to turn the vehicle around on any hill until you have mastered the turning technique described in this Operator's Guide on level ground. Avoid crossing the side of a steep hill if possible.
- ⚠ Always use proper procedures if you stall or roll backwards when climbing a hill. To avoid stalling, use proper gear and maintain a steady speed when climbing a hill. If you stall or roll backwards, follow the special procedure for braking described in this Operator's Guide. Dismount on the uphill side or to a side if pointed straight uphill. Turn the vehicle around and remount, following the procedure described further in this Operator's Guide.
- ⚠ Always check for obstacles before operating in a new area. Never attempt to operate over large obstacles, such as large rocks or fallen trees. Always follow proper procedures when operating over obstacles as described further in this Operator's Guide.
- ⚠ Always be careful when skidding or sliding. Learn to safely control skidding or sliding by practicing at low speeds and on level smooth terrain. On extremely slippery surfaces, such as ice, go slowly and be very cautious in order to reduce the chance of skidding out of control.
- ⚠ Never operate this vehicle in fast flowing water or in water deeper than that specified in this Operator's Guide. Remember that wet brakes may have reduced stopping ability. Test your brakes after leaving water. If necessary, apply them several times to let friction dry out the pads.
- ⚠ Always be sure there are no obstacles or people behind the vehicle when you operate in reverse. When it is safe to proceed in reverse, go slowly.
- ⚠ Always use the size and type tires specified further in this Operator's Guide. Always maintain proper tire pressure as described further in this Operator's Guide.

- ⚠ Never modify this vehicle through improper installation or use of accessories. Only use BRP's approved accessories. NEVER install passenger seat.
- ⚠ Never exceed the stated load limits for this vehicle including operator, all other loads and added accessories. Cargo should be properly distributed and securely attached. Reduce speed and follow instructions in this manual for carrying cargo or pulling a trailer. Allow greater distance for braking.
- ⚠ **FOR MORE INFORMATION ABOUT ATV SAFETY**, contact an authorized Can-Am distributor/dealer to find out about available training courses nearest you.

OPERATION WARNINGS

While reading this Operator's Guide, remember that:

WARNING

Indicates a potential hazard that, if not avoided, could result in serious injury or death.

NOTE: The following illustrations are general representations only. Your model may differ.

WARNING



V00A0AQ

POTENTIAL HAZARD

Operating this vehicle without proper instruction.

WHAT CAN HAPPEN

The risk of an accident is greatly increased if the operator does not know how to operate this vehicle properly in different situations and on different types of terrain.

HOW TO AVOID THE HAZARD

Beginning and inexperienced operators should complete a training course. They should then regularly practice the skills learned in the course and the operating techniques described in this Operator's Guide.

For more information about the training course, contact an authorized Can-Am distributor/dealer.



V00A01Q

POTENTIAL HAZARD

Failure to follow the age recommendations for this vehicle.

WHAT CAN HAPPEN

A lack of respect for this age recommendation can lead to severe injury or death of the child.

Even though a child may be within the age group for which this vehicle is recommended, he may not have the skills, abilities, or judgment needed to operate this vehicle safely and may be involved in a serious accident.

HOW TO AVOID THE HAZARD

No one under 16 should operate this vehicle.

 **WARNING**



V00A02Q

POTENTIAL HAZARD

Carrying a passenger on this vehicle.

WHAT CAN HAPPEN

Greatly reduces your ability to balance and control this vehicle.

Could cause an accident, resulting in harm to you and/or your passenger.

HOW TO AVOID THE HAZARD

Never carry passenger. Even with a long seat that provides unrestricted operator movement, it is not designed nor intended to carry passenger(s).

WARNING



V00A04Q

POTENTIAL HAZARD

Operating this vehicle on public streets or roads.

WHAT CAN HAPPEN

You can collide with another vehicle. Paved surfaces may seriously affect handling and control of the vehicle, and may cause the vehicle to go out of control.

HOW TO AVOID THE HAZARD

If an road usage is allowed in your area, operate your vehicle on paved surface for short distance and for the only purpose of moving the vehicle from an off-road usage to another.

Always operate the vehicle at low speed (never exceed 65 km/h (40 MPH)) and reduce the speed before making a turn.

Always respect all road traffic laws when operating your vehicle on public streets or roads.

WARNING



V00A06Q

POTENTIAL HAZARD

Riding this vehicle without wearing an approved helmet, eye protection and protective clothing.

WHAT CAN HAPPEN

The following items concern all ATV's operator:

- riding without an approved helmet increases the chances of a severe head injury or death in the event of an accident
- riding without eye protection can result in an accident and increases the chances of a severe injury in the event of an accident
- riding without protective clothing increases the chances of severe injury in the event of an accident.

HOW TO AVOID THE HAZARD

Always wear an approved helmet that fits properly. You should also wear:

- eye protection (goggles or face shield)
- gloves and boots
- long sleeved shirt or jacket
- long pants.

WARNING



V00A07Q

POTENTIAL HAZARD

Riding this vehicle after consuming alcohol or drugs.

WHAT CAN HAPPEN

- Could seriously affect your judgment.
- Could cause you to react more slowly.
- Could affect your balance and perception.
- Could result in an accident or death.

HOW TO AVOID THE HAZARD

Never consume alcohol or drugs before or while riding this vehicle.

 **WARNING**

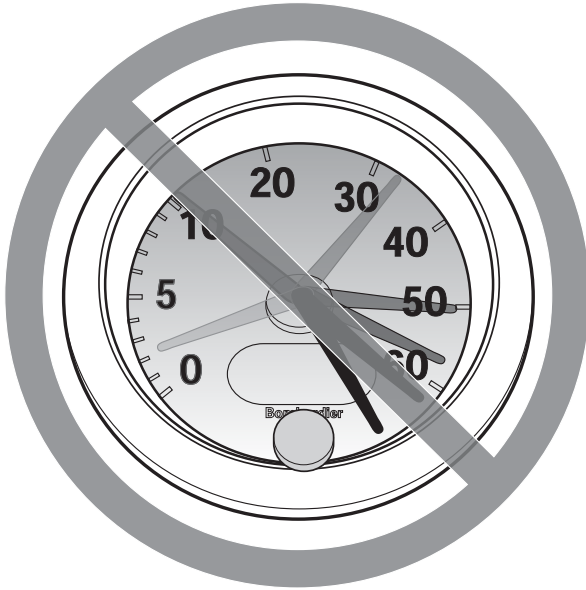

V00A08Q

POTENTIAL HAZARD

Operating this vehicle at excessive speeds.

WHAT CAN HAPPEN

Increases your chances of losing control of the vehicle, which can result in an accident.

HOW TO AVOID THE HAZARD

Always travel at a speed which is proper for the terrain, visibility and operating conditions, and your experience. The maximum speed authorized with this vehicle is 65 km/h (40 MPH). Always reduce speed before making a turn.

⚠ WARNING

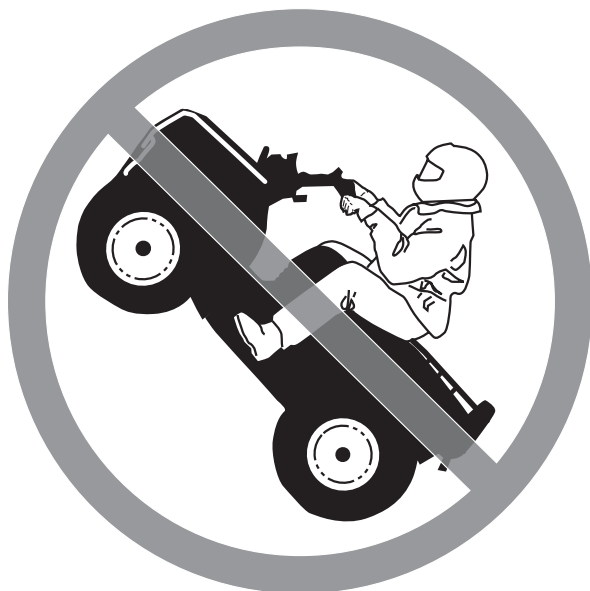

V00A09Q

POTENTIAL HAZARD

Attempting wheelies, jumps and other stunts.

WHAT CAN HAPPEN

Increases the chance of an accident, including an overturn.

HOW TO AVOID THE HAZARD

Never attempt stunts, such as wheelies or jumps. Do not try to show off.

 **WARNING**

POTENTIAL HAZARD

Failure to inspect the vehicle before operating.

Failure to properly maintain the vehicle.

WHAT CAN HAPPEN

Increases the possibility of an accident or equipment damage.

HOW TO AVOID THE HAZARD

Always inspect your vehicle each time you use it to make sure the vehicle is in safe operating condition.

Always follow the inspection and maintenance procedures and schedules described further in this Operator's Guide.

 **WARNING**

POTENTIAL HAZARD

Riding on frozen waterways.

WHAT CAN HAPPEN

Severe injury or death can result if the vehicle and/or operator break through the ice.

HOW TO AVOID THE HAZARD

Never ride this vehicle on a frozen surface before you are sure the ice is thick enough and sound enough to support the vehicle and its load, as well as the force that is created by a moving vehicle.

WARNING



V00A0BQ

POTENTIAL HAZARD

Removing hands from handlebar or feet from the footrests during operation.

WHAT CAN HAPPEN

Removing even one hand or foot can reduce your ability to control the vehicle or could cause you to lose your balance and fall off the vehicle. If you remove a foot from the footrests, your foot or leg may come into contact with the rear wheels, which could injure you or cause an accident.

HOW TO AVOID THE HAZARD

Always keep both hands on the handlebar and both feet on the footrests during vehicle operation.

⚠ WARNING



V00A0CQ

POTENTIAL HAZARD

Failure to use extra care when operating this vehicle on unfamiliar terrain.

WHAT CAN HAPPEN

You can come upon hidden rocks, bumps, or holes, without enough time to react.

Could result in the vehicle overturning or loss of control.

HOW TO AVOID THE HAZARD

Go slowly and be extra careful when operating on unfamiliar terrain.

Always be alert to changing terrain conditions when operating the vehicle.

WARNING



V00A00Q

POTENTIAL HAZARD

Failure to use extra care when operating on excessively rough, slippery or loose terrain.

WHAT CAN HAPPEN

Could cause loss of traction or vehicle control, which could result in an accident, including an overturn.

HOW TO AVOID THE HAZARD

Do not operate on excessively rough, slippery or loose terrain until you have learned and practiced the skills necessary to control this vehicle on such terrain.

Always be especially cautious on these kinds of terrain.

⚠ WARNING



V00A0EQ

POTENTIAL HAZARD

Turning improperly.

WHAT CAN HAPPEN

Vehicle could go out of control, causing a collision or overturn.

HOW TO AVOID THE HAZARD

Always follow proper procedures for turning as described further in this Operator's Guide. Practice turning at low speeds before attempting to turn at faster speeds.

Do not turn at excessive speed.

⚠ WARNING



V00A0QQ

POTENTIAL HAZARD

Operating on excessively steep hills.

WHAT CAN HAPPEN

The vehicle can overturn more easily on extremely steep hills than on level surfaces or small hills.

HOW TO AVOID THE HAZARD

Never operate this vehicle on hills too steep for the vehicle or for your abilities.

Practice on smaller hills before attempting larger hills.

 **WARNING**



V00A0FQ

POTENTIAL HAZARD

Climbing hills improperly.

WHAT CAN HAPPEN

Could cause loss of control or cause vehicle to overturn.

HOW TO AVOID THE HAZARD

Always follow proper procedures for climbing hills as described further in this Operator's Guide.

Always check the terrain carefully before you start up any hill.

Never climb hills with excessively slippery or loose surfaces.

Shift your weight forward.

Never open the throttle suddenly or make sudden gear changes. The vehicle could flip over backwards.

Never go over the top of any hill at high speed. An obstacle, a sharp drop, or another vehicle or person could be on the other side of the hill.

 **WARNING**



V00A0GQ

POTENTIAL HAZARD

Going down a hill improperly.

WHAT CAN HAPPEN

Could cause loss of control or cause vehicle to overturn.

HOW TO AVOID THE HAZARD

Always follow proper procedures for going down hills as described further in this Operator's Guide. **NOTE:** A special technique is required when braking as you go down a hill.

Always check the terrain carefully before you start down any hill.

Shift your weight backward.

Never go down a hill at high speed.

Avoid going down a hill at an angle which would cause the vehicle to lean sharply to one side. Go straight down the hill where possible.

⚠ WARNING



V00A0HQ

POTENTIAL HAZARD

Improperly crossing hills or turning on hills.

WHAT CAN HAPPEN

Could cause loss of control or cause vehicle to overturn.

HOW TO AVOID THE HAZARD

Never attempt to turn the vehicle around on any hill until you have mastered the turning technique as described further in this Operator's Guide on level ground. Be very careful when turning on any hill.

Avoid crossing the side of a steep hill if possible.

When crossing the side of a hill:

Always follow proper procedures as described further in this Operator's Guide.

Avoid hills with excessively slippery or loose surfaces.

Shift your weight to the uphill side of the vehicle.

WARNING



V00A010

POTENTIAL HAZARD

Stalling, rolling backwards or improperly dismounting while climbing a hill.

WHAT CAN HAPPEN

Could result in vehicle overturning.

HOW TO AVOID THE HAZARD

Use proper gear and maintain steady speed when climbing a hill.

If you lose all forward speed:

Keep your weight uphill. Never open the throttle suddenly or make sudden gear changes. The vehicle could flip over backwards.

Apply the brakes.

Lock parking brake after you are stopped.

Dismount on uphill side, or to a side if pointed straight uphill.

If you begin rolling backwards:

Keep your weight uphill. Never open the throttle suddenly or make sudden gear changes. The vehicle could flip over backwards.

Never apply the rear brake while rolling backwards.

Apply the front brake gradually.

When fully stopped, apply rear brake as well and lock parking brake.

Dismount on uphill side, or to a side if pointed straight uphill.

Turn the vehicle around and remount, following the procedure described further in this Operator's Guide.

⚠ WARNING



V00A0.JQ

POTENTIAL HAZARD

Improperly operating over obstacles.

WHAT CAN HAPPEN

Could cause loss of control or a collision.

Could cause the vehicle to overturn.

HOW TO AVOID THE HAZARD

Before operating in a new area, check for obstacles.

Never attempt to ride over large obstacles, such as large rocks or fallen trees.

When you go over obstacles, always follow proper procedures as described further in this Operator's Guide.

⚠ WARNING



V00A0KQ

POTENTIAL HAZARD

Skidding or sliding improperly.

WHAT CAN HAPPEN

You may lose control of this vehicle.

You may also regain traction unexpectedly, which may cause the vehicle to overturn.

HOW TO AVOID THE HAZARD

Learn to safely control skidding or sliding by practicing at low speeds and on level smooth terrain.

On extremely slippery surfaces, such as ice, go slowly and be very cautious in order to reduce the chance of skidding or sliding out of control.

WARNING



V00A0LQ

POTENTIAL HAZARD

Operating this vehicle through deep or fast flowing water.

WHAT CAN HAPPEN

Tires may float, causing loss of traction and loss of control, which could lead to an accident.

HOW TO AVOID THE HAZARD

Never operate this vehicle in fast flowing water or in water deeper than that specified further in this Operator's Guide.

Check water depth and current before you attempt to cross any water. Water should not go above footrests.

Remember that wet brakes may have reduced stopping ability. Test your brakes after leaving water. If necessary, apply them several times to let friction dry out the pads.

⚠ WARNING



V00A0MQ

POTENTIAL HAZARD

Improperly operating in reverse.

WHAT CAN HAPPEN

You could hit an obstacle or person behind the vehicle, resulting in serious injury.

HOW TO AVOID THE HAZARD

When you select reverse gear, make sure there are no obstacles or people behind the vehicle. When it is safe to proceed, go slowly.

 **WARNING**



V00A00Q

POTENTIAL HAZARD

Operating this vehicle with improper tires, or with improper or uneven tire pressure.

WHAT CAN HAPPEN

Use of improper tires on this vehicle, or operation of this vehicle with improper or uneven tire pressure, may cause loss of control, tire blow outs, tire to move around on its rim and increases the risk of an accident.

HOW TO AVOID THE HAZARD

Always use the size and type of tires specified further in this Operator's Guide for this vehicle.

Always maintain proper tire pressure as described further in this Operator's Guide.

Always replace wheels or tires that are damaged.

⚠ WARNING



V00A0N0

POTENTIAL HAZARD

Operating this vehicle with improper modifications.

WHAT CAN HAPPEN

Improper installation of accessories or modification of this vehicle may cause changes in handling which in some situations could lead to an accident.

HOW TO AVOID THE HAZARD

Never modify this vehicle through improper installation or use of accessories. All parts and accessories added to this vehicle should be approved by BRP and should be installed and used according to instructions. If you have questions, consult an authorized Can-Am distributor/dealer.

NEVER install passenger seat or use the racks to carry a passenger.

Modification of the vehicle to increase speed and performance may violate the terms and conditions of your vehicle limited warranty. In addition, certain modifications including the removal of engine or exhaust components are illegal under most laws.

⚠ WARNING



V00A0PQ

POTENTIAL HAZARD

Overloading this vehicle or carrying or towing cargo improperly.

WHAT CAN HAPPEN

Could cause changes in vehicle handling which could lead to an accident.

HOW TO AVOID THE HAZARD

Never exceed the stated load capacity for this vehicle including operator, as well as other loads and added accessories.

Cargo should be properly distributed and securely attached.

Reduce speed when carrying cargo or pulling a trailer. Allow greater distance for braking.

Always follow the instructions in this Operator's Guide for carrying cargo or pulling a trailer.

 **WARNING**



V03M01Q

POTENTIAL HAZARD

Transporting flammable or dangerous material can lead to explosions.

WHAT CAN HAPPEN

This can cause serious injury or death.

HOW TO AVOID THE HAZARD

Never transport flammable or dangerous material.

While reading this Operator's Guide, remember that:

 **WARNING**

Indicates a potential hazard that, if not avoided, could result in serious injury or death.

RIDING THE VEHICLE

To fully appreciate the pleasures and excitement of riding this vehicle, there are some basic rules and tips that you **MUST** follow. Some may be new to you while others may be common sense or obvious. Nonetheless, we ask that you take a few minutes to read this Operator's Guide completely before you operate this vehicle.

Information in this Operator's Guide is limited. It is strongly recommended that you obtain further information and training from your local authorities, ATV clubs or a recognized ATV training organization.

BRP does not recommend anyone under the age of 16 to ride a vehicle having an engine higher than 90 cc. For the child's safety, we strongly recommend you also follow and enforce this recommendation. You are the sole judge of a rider's capability to understand the risks and operate a vehicle safely.

Persons with cognitive or physical impairments or who are high risk takers have an increased exposure to over-turns or collisions which may result in injury including death.

Become completely familiar with the operational controls and the general operation of the vehicle before venturing into off road conditions. Practice driving in a suitable area free of hazards and feel the response of each control. Drive at low speeds. Higher speeds require greater experience, knowledge and suitable riding conditions.

Not all vehicles are the same. Each has its own unique performance characteristics, controls and features. Each will ride and handle differently.

Never assume that the vehicle will go everywhere safely. Sudden changes in terrain caused by holes, depressions, banks, softer or harder "ground" or other irregularities may cause the vehicle to topple or become unstable. To avoid this, slow down and always observe the terrain ahead. If the vehicle does begin to topple or tipover, it is usually the best advice to immediately get off... **AWAY** from the direction of the tipover!

Pre-Operation Check

WARNING

The pre-operation check is very important prior to operating the vehicle. Always check the proper operation of critical controls, safety features and mechanical components before starting. If not done, severe injury or death might occur.

Before using this vehicle, the operator should always:

- Remove vehicle lock.
- Apply parking brake and check if it operates properly.
- Check tire pressure and condition.
- Check wheels and bearings for wear and damage.
- Check location of controls and ensure they work properly.
- Verify if steering operates freely.
- Activate throttle control lever several times to ensure it operates freely. It must return to idle position when released.
- Activate the brake lever and brake pedal to make sure the brakes fully apply. Lever and pedal must fully return when released.

- Ensure transmission lever is working then reset in NEUTRAL position.
- Check drive chain for adjustment and lubrication.
- Check sprockets for wear and damages.
- Check tightening of rear axle fasteners.
- Check swing arm, if any lateral play is detected **DO NOT USE THE VEHICLE.**
- Check fuel, oil and coolant levels.
- Check for oil leaks on the engine and gearbox.
- Ensure fuel valve is in fully open position (ON).
- Clean headlamps, direction indicator lamps and brake lamp.
- Ensure front access compartment cover is properly latched.
- Ensure seat is properly latched.
- If you transport cargo, respect load capacity.
- If you are pulling a trailer or other equipment, ensure it respects the tongue capacity and towing capacity. Ensure trailer is properly secured to hitch.
- Look and feel for loose parts while engine is off. Check fasteners.
- Ensure the path of travel is free of persons and obstacles.
- Check operation of ignition switch, engine start button, engine stop switch, headlamp and direction switches as well as hazard warning button.
- Start engine, remove parking brake and drive forward slowly a few feet then apply all brakes individually to test them.

Correct any problem you may have found before riding. See an authorized Can-Am distributor/dealer as necessary.

Clothing

Actual weather conditions should help you decide how to dress. However, it is important that the operator always wear the appropriate protective clothing and apparel, including an approved helmet, eye protection, boots, gloves, long sleeved shirt and pants. This type of clothing will provide you protection from some of the minor hazards you may encounter en route. Operator must never wear loose clothing such as a scarf that may get entangled in the vehicle or on tree branches and shrubs. Depending on conditions, antifogging goggles or sunglasses may be required. Different colored lenses available for goggles or sunglasses help you distinguish terrain variations. Sunglasses should only be worn during the daytime.

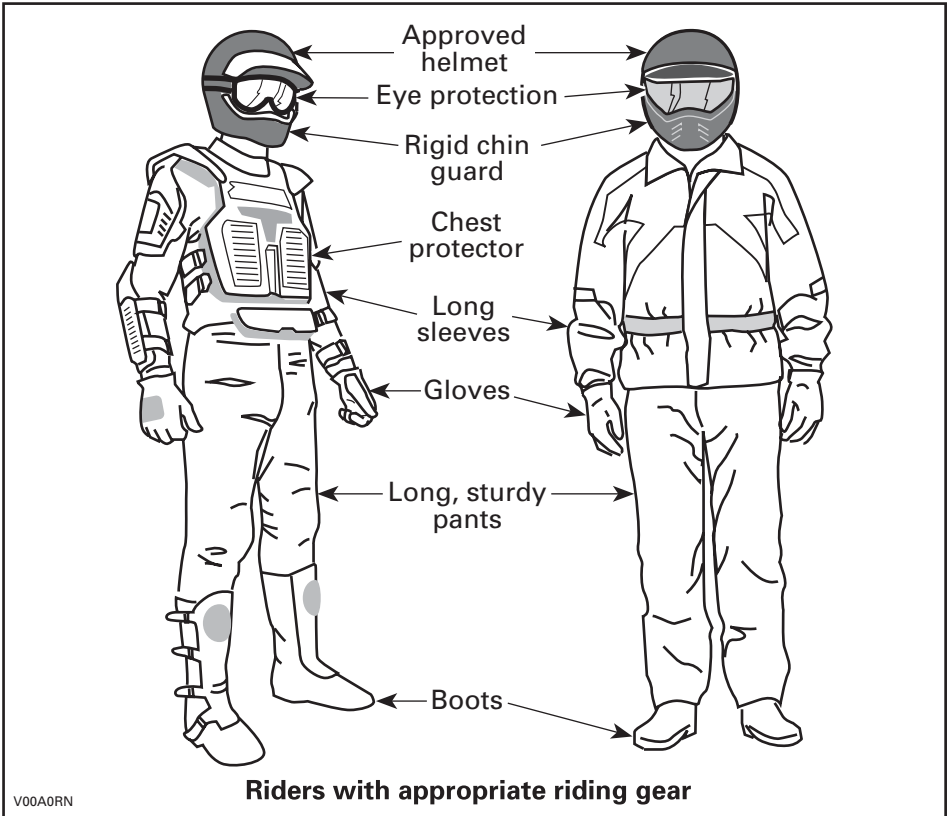

V00A0RN

Riders with appropriate riding gear

Carrying Loads

Any load carried on the vehicle will affect the stability and control of the vehicle. For this reason, do not exceed the load limits of the vehicle's manufacturer. Always make sure the load is secured and cannot interfere with your proper control. Always be aware that the "load" may slide or fall off and create an accident. Avoid loads that may protrude sideways and get snagged or caught in brush or other obstacles. Avoid covering and obstructing the headlamp or brake lamp with the cargo.

This vehicle is designed specifically to carry an operator only. Even with a long seat that provide unrestricted operator movements, they are not designed nor intended to carry passenger(s). NEVER install passenger seat or use the racks or their location to carry passenger(s) (if so equipped). Carrying passenger(s) may affect the stability and your control of the vehicle.

Hauling a Trailer (if so equipped)

Riding this vehicle with a trailer substantially increases the risk of toppling, especially on inclined slopes. If a trailer is used behind the vehicle make sure that its hitch is compatible with the one on the vehicle. Make sure the trailer is horizontal with the vehicle. (In some instances a special extension may have to be installed on the vehicle hitch). Use security chains to secure the trailer with the vehicle. This vehicle may require additional stopping distance if hauling heavy loads, especially on inclined surfaces. Be careful not to skid or slide. When stopped or parked, block the vehicle and trailer wheels from possible movement. Always make sure load is evenly distributed on the trailer. Use caution when disconnecting a loaded trailer; it or its load may topple on you or others. Do not turn at high speeds.

Working with your Vehicle

Your vehicle can help you perform some LIGHT tasks. A variety of accessories are available from your authorized Can-Am distributor/dealer. However, always respect the load and capacities of the vehicle. Overloading of the vehicle can overstress the components and cause failure. To prevent possible injury, it is equally important to follow the instructions and warnings that accompany the accessory. Avoid any physical exertion through lifting or pulling of heavy loads or manpowering the vehicle. (Continue to read *RECREATIONAL RIDING* below.)

Recreational Riding

Respect the rights and limitations of others. Stay away from areas designated for other types of off road use. This includes snowmobile trails, equestrian trails, cross country ski trails, mountain bike trails etc. Never assume there are no other users on the trail. Always stay to the complete right of the trail and do not zig zag to one side of the trail then the other. Be prepared to stop or pull off to the side if another trail user appears in front of you.

Join a local ATV club. They will provide you with a map and advice or inform you where you can ride. If a club does not exist in your area, help start one. Group riding and club activities provide a pleasurable, social experience.

Always keep a safe distance from other riders. Your judgment of speed, terrain conditions, weather, mechanical condition of your vehicle and the "trust in judgment" you have in others around you will help you make a better choice of appropriate safe distance. This vehicle, like any other motorized vehicle, cannot stop "on a dime".

Always operate this vehicle at low speed, do not exceed 65 km/h (40 MPH), and reduce the speed before making a turn when the vehicle is operated on the roadway.

Before you ride, tell someone where you are planning to travel and your expected time of return. Never consume alcohol or drugs before or while riding!

Depending on the length of your ride, carry additional tools or emergency equipment. Find out where you can get additional gasoline and oil. Be prepared for the possible conditions you may encounter. An emergency first aid kit should always be a consideration.

Environment

One of the benefits of this vehicle is that it can take you off the beaten path away from most communities. However, you should always respect nature and the rights of others to enjoy it. Do not ride in environmentally sensitive areas. Do not drive over forest crops or shrubs... nor cut down trees or take down fencing... nor spin your wheels and destroy the terrain. "Tread Lightly".

Chasing wildlife is in many areas illegal. Wildlife can die of exhaustion after being chased by a motorized vehicle. If you encounter animals on the trail, stop and observe quietly and with caution. It will be one of the better memories of your life.

Observe the rule... "what you take in, carry out". Do not litter. Do not start campfires unless you have permission to do so... and then only ... away from dry areas. The hazards you may create on the trail may cause injury to others or yourself, even at a later date.

Respect farm lands. Always obtain the permission of the landowner before riding on private land. Respect crops, farm animals and property lines. If you come to a closed a gate, close it again after yourself.

Finally, do not pollute streams, lakes or rivers and do not modify the engine or muffling system, or remove any of its components.

Design Limitation

Although the vehicle is exceptionally rugged for its class, it is still a light vehicle by definition and its operation must be restricted to its proper purpose.

The addition of weight to any part of the vehicle changes its gravitational stability and modifies its performance.

Off-Highway Operation

The very nature of off-highway operation is dangerous. Any terrain, which has not been specially prepared to carry vehicles, presents an inherent danger where angularity, terrain substance and exact steepness are unpredictable. The terrain itself presents a continual element of danger, which must be knowingly accepted by anyone venturing over it.

An operator who takes a vehicle off-road should always exercise the utmost care in selecting the safest path and keeping close watch on the terrain ahead of him. On no account should the vehicle be operated by anyone who is not completely familiar with the driving instructions applicable to the vehicle, nor should it be operated on steep or treacherous terrain.

General Operating and Safety Precautions

Care, caution, experience and driving skill are the best precautions against the hazards of vehicle operation.

Whenever there is the slightest doubt that the vehicle can safely negotiate an obstacle or a particular piece of terrain, always choose an alternate route.

In off-road operation, power and traction, not speed, are important. Never drive faster than visibility and your own ability to select a safe route permit.

Constantly watch the terrain ahead for sudden changes in slopes or obstacles, such as rocks or stumps, that may cause loss of stability, resulting in tipover or rollover.

Never operate the vehicle if the controls do not function normally.

When operating in reverse, check that the path behind the vehicle is free of people or obstacles. Proceed slowly and avoid sharp turns.

When stopped or parked, always apply the parking brake. This is especially important when parking on a slope. On very steep inclines or if the vehicle is carrying cargo, the wheels should be blocked using rocks or bricks. Remember to turn the fuel valve to the closed position.

Uphill Driving

Due to configuration, this vehicle has excellent climbing ability, so much so that tipover is possible before traction is lost. For example, it's common to encounter terrain situations where the top of the hill has eroded to a point that the hill peak rises very sharply. The vehicle can readily negotiate such a condition, however, in doing so, when the front of the vehicle is driven to a point that the vehicle's balance changes rearward tipover can occur.

The same situation may apply if an embedded object causes the front of the vehicle to climb more than desired. If such a situation occurs take an alternate route. Be aware of side hilling dangers when doing so.

It is also wise to know the terrain condition on the other side of the hill or bank. All too often there exists a sharp drop-off that is impossible to negotiate or descend.

Downhill Driving

This vehicle can climb slopes that are steeper than it can safely descend. Therefore, it is essential to assure that a safe route exists to descend a slope before you climb it.

Decelerating while negotiating a slippery downhill slope could "toboggan" the vehicle. Maintain steady speed and/or accelerate slightly to regain control.

Side Hilling

Whenever possible, such operation should be avoided. If necessary, do so with extreme caution. Side hilling on steep inclines could result in rollover. In addition, slippery or unfirm surfaces could result in uncontrollable side sliding. Do not attempt to turn the vehicle downhill with the slide. Avoid all objects or depressions that will intensify the raising of one side of the vehicle higher than the other, thus causing rollover.

Drop-Offs

This vehicle will "bottom-out" and usually stop if either the front or rear wheels are driven over a drop-off. If the drop is sharp or deep, the vehicle will nose dive and tipover.

WARNING

Avoid negotiating drop-offs. Reverse and select an alternate route.

Riding Techniques

Riding your vehicle too fast for the conditions may result in injury. Apply only enough throttle to proceed safely. Statistics show that high speed turns usually result in mishaps and injury. Always remember that this vehicle is heavy! Its pure weight alone may entrap you should it fall and pin you down.

This vehicle is not designed for jumping nor can it, or you, absorb the energy of high impacts such as jumping. Performing "wheelies" can cause the vehicle to flip over onto you. Both practices have a high risk for you and should be avoided at all times.

To maintain proper control it is strongly advised that you keep your hands on the handlebar and within easy reach of all controls. The same holds true for your feet. To minimize the possibility of any leg or foot injury, keep your feet on the footrests at all times. Do not direct your toes outwards nor place your foot out to assist turning as they can be hit or snagged by passing obstacles or may contact the wheels.

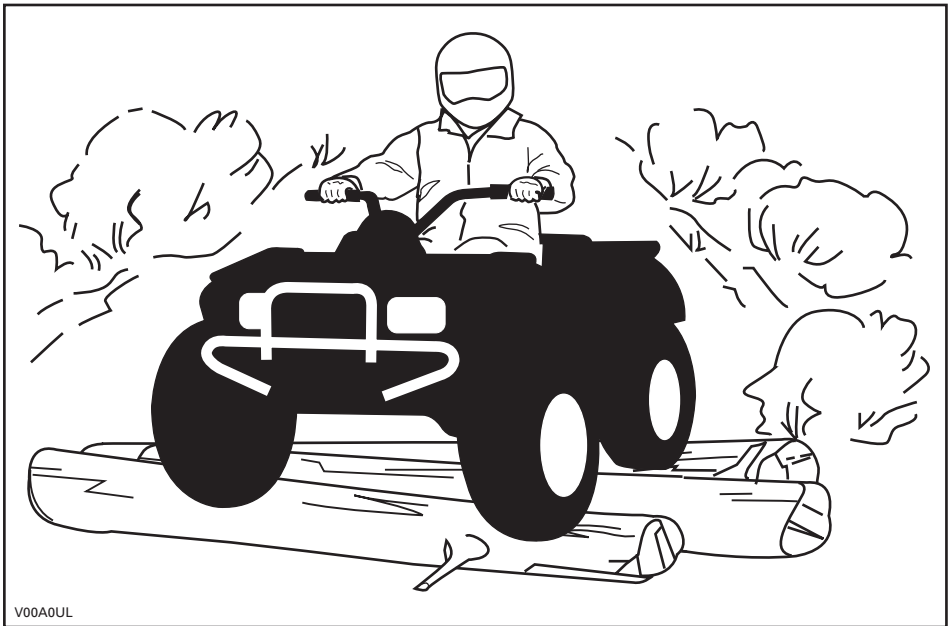

Even though there is an adequate suspensions system on this vehicle there are "washboard" or rough terrain conditions that will make you feel uncomfortable and even cause back injury. "Posting" or riding in a crouched position will often be required. Slow down and allow your flexed legs to absorb impact.

If a road usage is allowed in your area, operate your vehicle on paved surface only for short distance and for the only purpose of moving the vehicle from an off-road usage to another. Always operate your vehicle at low speed (never exceed 65 km/h (40 MPH)) and reduce the speed before making a turn. Always respect all road traffic laws when operating your vehicle on public roads or streets. If you have to cross a road, the lead driver should get off his vehicle to observe and give direction to the other riders. The last person after crossing then assists the lead driver to cross. Do not travel on sidewalks. They are designated for pedestrian use.

Water can be a unique hazard. If it is too deep the vehicle may "float" and topple. Check the water depth and current before you attempt to cross any water. Water should not go above the footrest. Be wary of slippery surfaces such as rocks, grass, logs, etc., both in the water and on its banks. A loss of traction may occur. Do not attempt to enter the water at high speed. The water will act as a brake and could throw you.

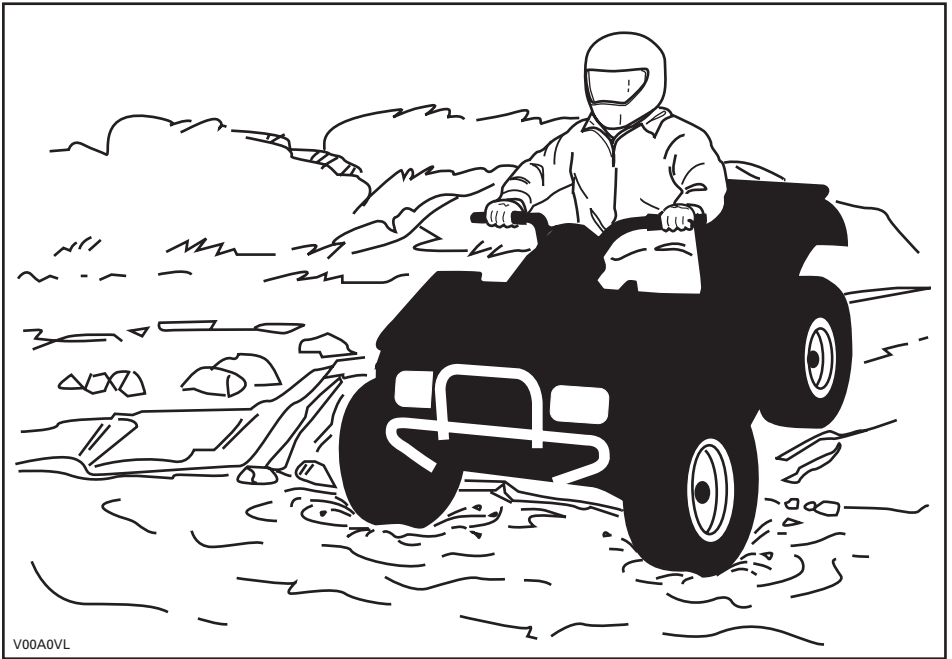

Water will affect the braking ability of your vehicle. Make sure you dry the brakes by applying them several times after the vehicle leaves the water.

Mud or marsh lands may be encountered near water. Be prepared for sudden "holes" or changes in depth. Similarly so, be watchful of hazards such as rocks, logs, etc., partially covered by vegetation.

If your trip crosses frozen waterways, make sure that the ice is thick enough and sound enough to support the total weight of yourself, the vehicle and its load. Be ever watchful of open water... it is a sure indication that the ice thickness will vary. If in doubt, do not attempt to cross.

Ice will also affect the control of vehicle. Slow down and do not "gun" the throttle. This will only result in spinning of the tires and possible tipover of the vehicle. Avoid rapid braking. This again will possibly result in an uncontrolled slide and tipover of the vehicle. Slush should be avoided at all times since it could block the operation or controls of the vehicle.

Sand and riding on sand dunes or on snow is another unique experience but there are some basic precautions that should be observed. Wet, deep or fine sand/snow may create a loss of traction and cause the vehicle to slide, drop off or become "bogged" down. If this occurs look for a firmer base. Again, the best advice is to slow down and be watchful of the conditions.

When riding in sand dunes it is advisable to equip the vehicle with an antenna type safety flag. This will help make your location more visible to others over the next sand dune. Proceed carefully should you see another safety flag ahead. Since the antenna type safety flag can snag and rebound on your body if caught, do not use it in areas where there are low hanging branches or obstacles.

Riding on loose stones or gravel is very similar to riding on ice. They will affect the steering of vehicle... possibly causing it to slide and tipover especially at high speeds. In addition, braking distance may be affected. Remember that "gunning" the throttle or sliding may cause loose stones to be ejected rearwards into the path of another rider's way. Never do it deliberately.

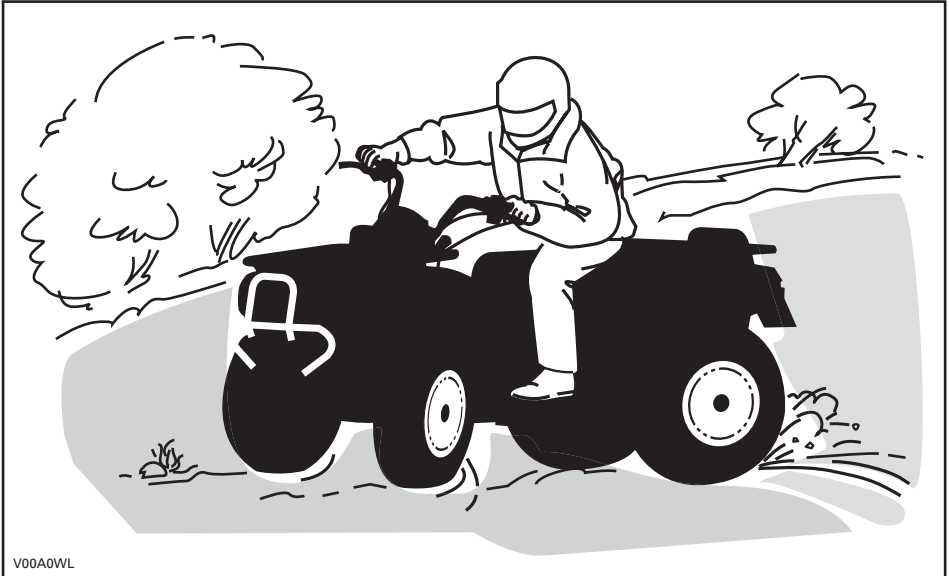

V00A0WL

If you do get into a slide or skid, it may help to turn the handlebar into the direction of the skid until you regain control. Never jam the brakes and lock the wheels.

Respect and follow all posted trail signs. They are there to help you and others.

Obstacles in the "trail" should be traversed with caution. This includes loose rocks, fallen trees, slippery surfaces, fences, posts, and embankments and depressions. You should avoid them whenever possible. Remember that some obstacles are too large or dangerous to cross and should be avoided. Small rocks or fallen trees may be safely crossed... approach at a 90° angle. Stand on the footrests while keeping your knees flexed. Adjust speed without losing momentum and do not "gun" the throttle. Hold handlebar firmly. Place your body weight rearwards and proceed. Do not try to lift the vehicle front wheels off the ground. Be aware that the object may be slippery or may move while crossing.

When driving on hills or slopes two things are highly important... be prepared for slippery surfaces or terrain variations and obstacles and... use proper body positioning.

Uphill

Keep your body weight forward towards the top of the hill. Keep your feet on the footpegs and shift into low gear then accelerate and when necessary, change gear quickly as you climb. Do not over-speed since this may cause the front of the vehicle to lift from the ground and fall back on you. If the hill is too steep and you cannot proceed or the vehicle begins to roll backwards, apply the brake, being careful not to slide. Dismount then use the "U" turn or "K" turn (while walking back, next to the vehicle on the up hill side and with a hand on the brake lever, slowly back the rear of the vehicle toward the top of the hill then drive downhill). Always walk or dismount on the upside of the slope while keeping clear of the vehicle and its rotating wheels. Do not try to hold on to the vehicle if it begins to topple. Stay clear. Do not ride over the crest of the hill at high speed. Obstacles, including sharp drop-offs, may exist.

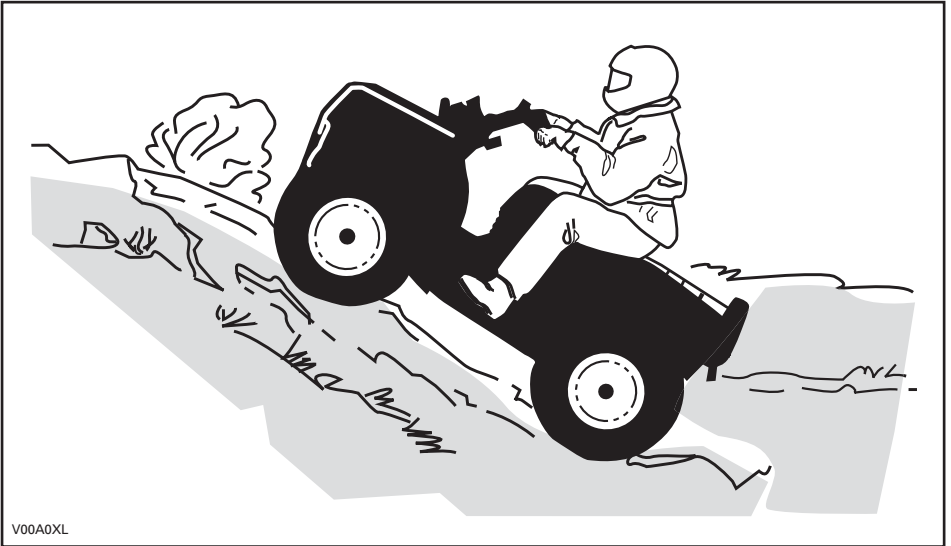

V00A0XL

Downhill

Keep your body weight rearwards. Apply the brake gradually to prevent skidding. Do not "coast" down the slope using solely engine compression or in neutral gear.

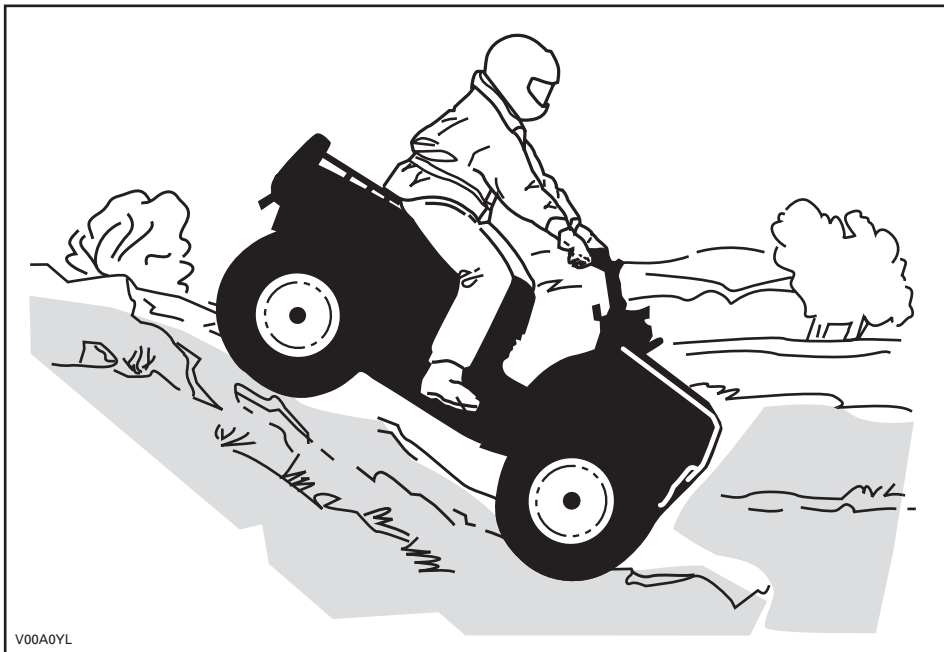

While reading this Operator's Guide, remember that:

WARNING

Indicates a potential hazard that, if not avoided, could result in serious injury or death.

Side Hilling

This is one of the **most risky** types of riding since it may drastically change the balance of the vehicle. It should be avoided wherever possible. If it is necessary to do so however, it is important that you **ALWAYS** keep your body weight on the upside of the slope... and be prepared to dismount on that side should the vehicle begin to topple. **Do not try to stop or save the vehicle from damage.**



Routine Maintenance

Once your ride completed, it is wise to remove any build up of snow, ice, mud and grime. Not only will this help you keep your vehicle longer and in good condition for resale but will eliminate potential hazards the next time you use the vehicle. Wash your vehicle in warm soapy water then allow it to dry. (A towel may help). Do not wash your vehicle outside during freezing weather. Apply appropriate lubrication as described in the *MAINTENANCE* section.

Part of your responsibility towards safety is to respect the contents of this Operator's Guide. It provides valuable advice on how to properly take care of your vehicle. If further assistance is required your authorized Can-Am distributor/dealer is always willing to help.













Modification of the vehicle to increase speed and performance may violate the terms and conditions of your vehicle limited warranty. In addition, certain modifications including the removal of engine or exhaust components are illegal under most laws.

Changing the wheel and/or tire size may affect the stability of the vehicle. Incorrect tire pressure may lead to blow outs or cause a tire to move around on its rim and become lost or damaged. Wheels or tires which are damaged should always be replaced.

HANG TAG

This vehicle comes with a hang tag and labels containing important safety information.

Any person who rides this vehicle should read and understand this information before riding.

<p style="text-align: center;">R RECREATIONAL MODEL</p> <p style="text-align: center;">THIS ATV IS FOR RECREATIONAL USE.</p> <p style="text-align: center;">OPERATOR ONLY-NO PASSENGERS</p> <p style="text-align: center;">NO OPERATOR UNDER AGE 16</p> <hr/> <p style="text-align: center;">THIS CATEGORY R (RECREATIONAL) ATV IS FOR OFF ROAD USE ONLY. IT IS MAINLY FOR GENERAL RECREATIONAL USE BUT IT MAY ALSO BE USED FOR UTILITY PURPOSES.</p> <hr/> <p style="text-align: center;">TRAINING COURSES TO TEACH ATV RIDING SKILLS ARE AVAILABLE. FOR INFORMATION CONTACT YOUR DEALER.</p> <hr/> <p style="text-align: center;">CHECK WITH YOUR DEALER TO FIND OUT ABOUT STATE OR LOCAL LAWS REGARDING ATV OPERATION.</p> <p style="text-align: center;">THIS HANGTAG IS NOT TO BE REMOVED BEFORE SALE.</p> <p>V07M11L 704900930</p>	<p style="text-align: center;">⚠ WARNING</p> <p style="text-align: center;">Improper ATV use can result in SEVERE INJURY or DEATH.</p> <table border="0" style="width: 100%; text-align: center;"><tr><td></td><td></td><td></td><td></td></tr><tr><td>ALWAYS USE AN APPROVED HELMET AND PROTECTIVE GEAR.</td><td>NEVER USE ON PUBLIC ROADS.</td><td>NEVER CARRY PASSENGERS.</td><td>NEVER USE WITH DRUGS OR ALCOHOL.</td></tr></table> <p>NEVER operate:</p> <ul style="list-style-type: none">• without proper training or instructions.• at speeds too fast for your skills or the conditions.• on public roads - a collision can occur with another vehicle.• with a passenger - passengers affect balance and steering and increase risk of losing control. <p>ALWAYS:</p> <ul style="list-style-type: none">• use proper riding techniques to avoid vehicle overturns on hills and rough terrain and in turns.• avoid paved surfaces - pavement may seriously affect handling and control. <p style="text-align: center;">LOCATE AND READ OPERATOR'S GUIDE. FOLLOW ALL INSTRUCTIONS & WARNINGS.</p>					ALWAYS USE AN APPROVED HELMET AND PROTECTIVE GEAR.	NEVER USE ON PUBLIC ROADS.	NEVER CARRY PASSENGERS.	NEVER USE WITH DRUGS OR ALCOHOL.
									
ALWAYS USE AN APPROVED HELMET AND PROTECTIVE GEAR.	NEVER USE ON PUBLIC ROADS.	NEVER CARRY PASSENGERS.	NEVER USE WITH DRUGS OR ALCOHOL.						

ON-PRODUCT LABELS

The following labels are on your vehicle and they should be considered permanent parts of the vehicle. If missing or damaged, they can be replaced free of charge. See an authorized Can-Am distributor/dealer.

NOTE: The following illustrations used in this Operator's Guide are a general representation only. Your model may differ.

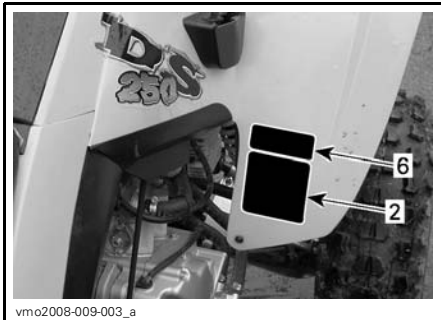
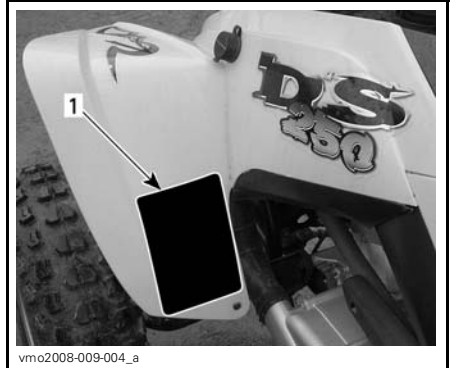
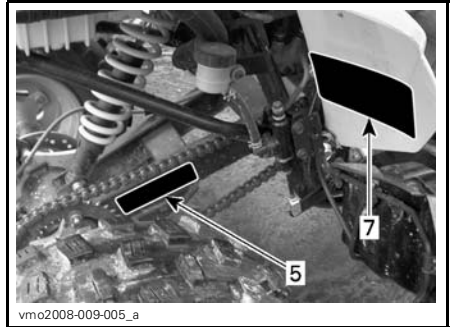

Label 1

⚠ WARNING

Improper ATV use can result in SEVERE INJURY or DEATH.



ALWAYS USE AN APPROVED HELMET AND PROTECTIVE GEAR.



NEVER USE ON PUBLIC ROADS.



NEVER CARRY PASSENGERS.



NEVER USE WITH DRUGS OR ALCOHOL.

NEVER operate:

- without proper training or instructions.
- at speeds too fast for your skills or the conditions.
- on public roads - a collision can occur with another vehicle.
- with a passenger - passengers affect balance and steering and increase risk of losing control.

ALWAYS:

- use proper riding techniques to avoid vehicle overturns on hills and rough terrain and in turns.
- avoid paved surfaces - pavement may seriously affect handling and control.

LOCATE AND READ OPERATOR'S GUIDE.
FOLLOW ALL INSTRUCTIONS & WARNINGS.

704 900 001

V01M01Z

Label 2

⚠ WARNING



Operating this ATV if you are under the age of 16 increases your chance of SEVERE INJURY or DEATH.

NEVER operate this ATV if you are under age 16.

704 900 011

V01M02Z

Label 3

⚠ WARNING



NEVER ride as a passenger. Passengers can cause a loss of control, resulting in SEVERE INJURY or DEATH.

704 900 005

V01M07Z

Label 4

⚠ WARNING

Improper tire pressure or overloading can cause loss of control, resulting in SEVERE INJURY or DEATH.

LOAD	COLD TIRE PRESSURE
UP TO (XXX)kg	FRONT: MAX: XX kPa (XX psi) MIN: XX kPa (XX psi)
BEAR (XXX)kg	REAR: MAX: XX kPa (XX psi) MIN: XX kPa (XX psi)

ALWAYS maintain proper tire pressure as shown.

NEVER set tire pressure below minimum. It could cause the tire to chafe from the rim.

NEVER exceed the vehicle load capacity of XXX kg (XXXlb) including weight of operator, cargo, accessories and trailer tongue weight.

ATV LOADING and TRAILER TOWING

- Cargo loading or trailer towing can affect stability and handling.
- When loaded with cargo or towing a trailer:
 - reduce speed.
 - allow more distance to stop.
 - avoid hills and rough terrain.

vmo2006-007-002_aen

Label 5

DRIVE CHAIN

DRIVE CHAIN MUST BE WELL ADJUSTED AND LUBRICATED. FREE PLAY IS 15-25mm (5/8-1") WITH DRIVER ON VEHICLE. SEE OWNERS MANUAL FOR COMPLETE INSTRUCTIONS.

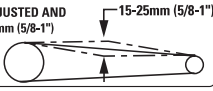

vmo2006-014-002_aen

Label 6

CAUTION

- **ATV MUST** be stopped before shifting transmission lever.
- **Always** apply foot brake to shift from NEUTRAL (N).

704 900 218

V06M0EY

Label 7

EMISSION CONTROL INFORMATION THIS VEHICLE MEETS U.S. ENVIRONMENTAL PROTECTION AGENCY AND CALIFORNIA REGULATIONS FOR MODEL YEAR 2004		REGISTRATIONSERIE DU VIN LE DISPOSITIF ANTIPOLLUTION DE VÉHICULE S'ADAPTANT AUX NORMES 2004 DE L'EPA, S.A. LA RÈGLEMENTATION CALIFORNIENNE.	
ENGINE FAMILY	XXX	FAMILLE DE MOTEUR	
FEL	XXX	LEF	
ENGINE DISPLACEMENT	XXX	CYLINDRÉE	
EXHAUST EMISSION CONTROL SYSTEM	XXX	SYSTÈME DE CONTRÔLE DES ÉMISSIONS	
FUEL	XXX	ESSENCE	
ENGINE OIL	XXX	HUILE À MOTEUR	
IDLE SPEED	XXX	VITESSE DE MARCHÉ	
SPARK PLUG TYPE	XXX	TYPE DE BOUCIE	
SPARK PLUG GAP	XXX	ÉCARTEMENT DES ÉLECTRODES	

SEE OPERATOR'S GUIDE FOR MAINTENANCE SPECIFICATIONS / VOIR GUIDE DU CONDUCTEUR POUR LES DONNÉES SPÉCIFICATIONS D'ENTRETIEN
BOWMAN/BI RECREATIONAL PRODUCTS, INC.

vmo2006-005-012

Label 8

WARNING

This warning applies only in European
Countries where on road usage is allowed.

On Road Use

This ATV is built for "OFF ROAD" purposes only.
It may be used for short distances on paved surfaces
at reduced speed, in order to move the vehicle from
an off road location to another.

When driving this ATV on roads, always refrain from
speeding and substantially reduce vehicle speed
when turning.

Failure to do so can cause a loss of vehicle control,
possibly resulting in serious injury or death.

Front Winch

The front winch hook of the so equipped ATV's must be
removed and stored when riding the vehicle on public
trails and/or roads.

Failure to do so can increase the risk of injury to
 bystanders.

704 900 400

vmo2006-006-009_aen

Label 9

DA FJND OG LÆS BRUGERVEJLEDNINGEN.
OVERHOLD ALLE INSTRUKTIONER OG
ADVARSLER.

NL ZOEK DE GEBRUIKERSHANDLEIDING OP
EN LEES HEM. HOUD U AAN ALLE
AANWIJZINGEN EN WAARSCHUWINGEN.

FR LOCALISER ET LIRE LE GUIDE DE
L'OPÉRATEUR. SUIVRE TOUTS LES
CONSIGNES ET AVERTISSEMENTS.

FI PÄIKÄNNÄ JA LUE KÄYTTÄJÄN OPAS.
NUODATA KAIKKIA KÄYTTÖOHJEITA
JA VAROITUKSIA.

DE BETRIEBSANLEITUNG AUSFINDIG
MACHEN UND LESEN.
ALLE ANWEISUNGEN UND
WARHNHWEISE BEFOLGEN.

EL ΣΡΕΪΤΕ ΚΑΙ ΔΙΑΒΑΣΤΕ ΤΟΝ ΟΔΗΓΟ
ΧΡΗΣΗΣ. ΑΚΟΛΟΥΘΗΣΤΕ ΟΛΕΣ ΤΙΣ
ΟΔΗΓΙΕΣ ΚΑΙ ΠΡΟΕΙΔΟΤΗΧΕΙΕΣ.

IT LEGGERE IL MANUALE
DELL'OPERATORE. SEGUIRE TUTTE LE
ISTRUZIONI E AVVERTENZE.

PT LOCALIZAR E LER O GUIA DE OPERAÇÃO.
OBSERVAR TODAS AS INSTRUÇÕES E
MENSAGENS DE AVISO.

ES UBICAR Y LEER LA GUIA DEL
OPERADOR. ATENDERSE A TODAS LAS
INSTRUCCIONES Y MENSAJES
DE ADVERTENCIA.

SV TA REDA PÅ INSTRUKTIONSBOKEN
OCH LÄS DEN. UPPMÄRKSAMMA
ALLA ANVISNINGAR OCH VARNINGAR.

704 901 177

vmo2006-014-003_a

56

SAFETY INFORMATION

VEHICLE INFORMATION

HOW TO IDENTIFY YOUR VEHICLE

The main components of your vehicle (engine and frame) are identified by different serial numbers. It may sometimes become necessary to locate these numbers for warranty purposes or to trace your vehicle in the event of loss. These numbers are required by the authorized Can-Am distributor/dealer to complete warranty claims properly. No warranty will be allowed by BRP if the engine identification number (EIN) or vehicle identification number (VIN) is removed or mutilated in any way. We strongly recommend that you take note of all the serial numbers on your vehicle and supply them to your insurance company.

Vehicle Identification Number Location



vmo2006-014-004_a

1. VIN (Vehicle Identification Number)
2. Model

Engine Identification Number Location



vmo2006-014-005_a

Compliance Label

This label indicates vehicle's compliance in many countries.

LABEL LOCATION	
All DS 250	Right front lower tube of the frame (between A-arms)



BREAK-IN PERIOD

Engine

A break-in period of 10 operating hours is required before running the vehicle at sustained full throttle.

CAUTION: Never mix oil with fuel. This vehicle has a 4-stroke engine. Oil must be added to engine base only.

During this period, maximum throttle should not exceed $3/4$. However, brief full acceleration and speed variations contribute to a good break-in. Continued wide open throttle accelerations, prolonged cruising speeds and engine overheating are detrimental during the break-in period.

Belt

A new belt requires a break-in period of 50 km (30 mi). Avoid strong acceleration/deceleration, pulling a load or high speed cruising.

10-Hour Inspection

NOTE: The 10-hour inspection is at the expense of the vehicle owner.

As with any precision piece of mechanical equipment, we suggest that after the first 10 hours, 200 km (125 mi) or 30 days after the purchase, whichever comes first, your vehicle be inspected by an authorized Can-Am distributor/dealer. This inspection will give you the opportunity to discuss the unanswered questions you may have encountered during the first hours of operation.

While reading this Operator's Guide, remember that:

WARNING

Indicates a potential hazard that, if not avoided, could result in serious injury or death.

CONTROLS/INSTRUMENTS/EQUIPMENT

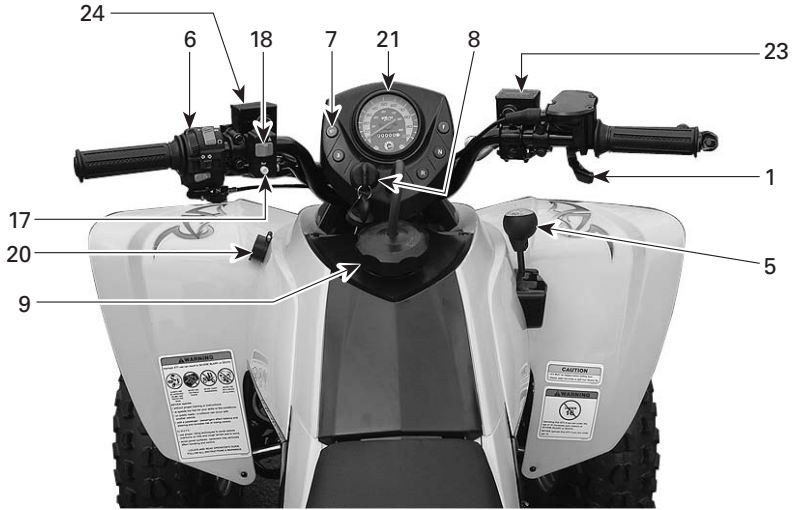

vmo2006-014-006_b

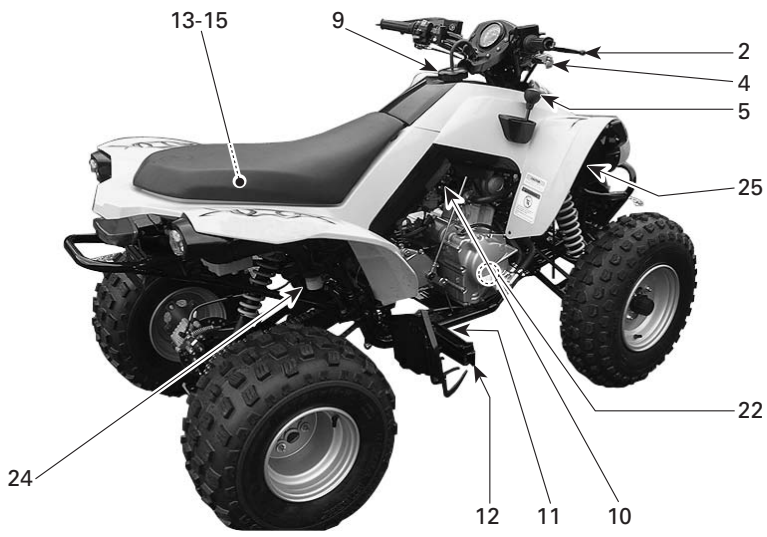

vmo2006-014-007_b

While reading this Operator's Guide, remember that:

WARNING

Indicates a potential hazard that, if not avoided, could result in serious injury or death.

NOTE: This section gives basic functions of the various controls of your vehicle. For more details of how to operate one control in conjunction with some others, refer to *OPERATING INSTRUCTIONS* further in this section.

1) Throttle Lever

When pushed, it increases the engine speed that allows the engagement of the transmission on the selected gear.

When released, the engine speed should return automatically to idle and the vehicle will gradually slow down.

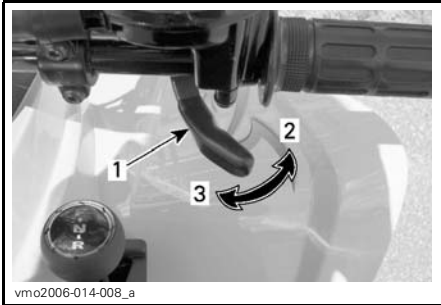

1. Throttle lever
2. To accelerate
3. To decelerate

2) Front Brake Lever

When compressed, the front brakes are applied. When released, it should automatically return to its original position. Braking effect is proportional to the force applied on the lever and to the type and condition of the terrain.

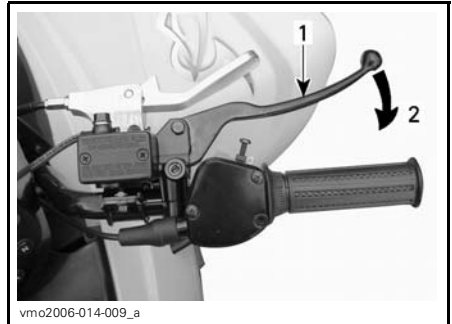

1. Brake lever
2. To apply brake

3) Rear Brake Lever

When compressed, the rear brake is applied. When released, it should automatically return to its original position. Braking effect is proportional to the force applied on the lever and to the type and condition of the terrain.

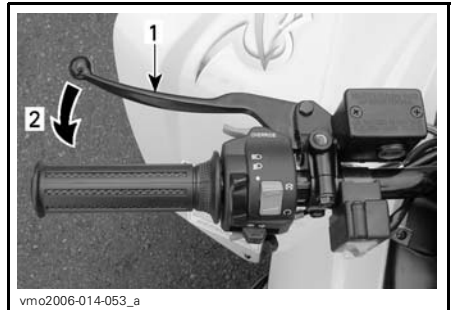

1. Brake lever
2. To apply brake

4) Parking Brake

When applied, it prevents the vehicle from moving. Useful when the brake needs to be locked for example such as doing a K-turn, during transportation or when the vehicle is not in operation.

WARNING

Always use the parking brake **and** engage the FORWARD position on the transmission lever when the vehicle is not in operation.

WARNING

Make sure parking brake is fully disengaged before operating the vehicle. Riding the vehicle with a continuous pressure on the brakes may cause damage to the brake system and cause loss of braking capacity and/or fire.

To engage mechanism: Pull parking brake lever until it is locked in place.

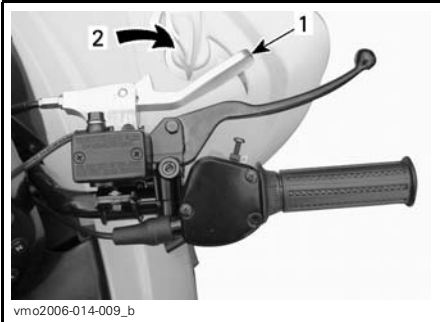

ON POSITION

1. Brake lever lock
2. Pull to apply parking brake

To release mechanism: Push parking brake back in place. Brake lever should return to rest position. Always release parking brake before riding.

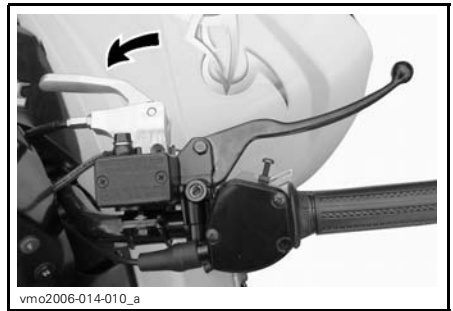

OFF POSITION

5) Transmission Lever

A 3-position lever.

CAUTION: Always completely stop the vehicle and apply the brake prior to moving the transmission lever.

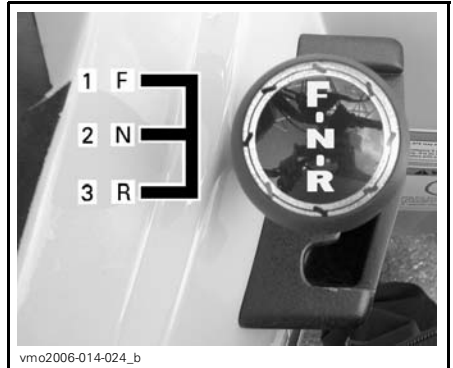

TRANSMISSION LEVER PATTERN

1. Forward (F)
2. Neutral (N)
3. Reverse (R)

To change the transmission position, completely stop vehicle, apply brakes then move lever to the desired position while moving lever forward or backward. Do not force lever.

NOTE: Any shifting attempt at high RPM or without brakes applied will stop engine.

R: Reverse

This allows the vehicle to go backward. This vehicle is equipped with a reverse speed limiter system. Refer to *VERRIDE BUTTON* further, for more informations.

WARNING

Before moving vehicle in reverse, ensure the path behind is clear of obstacles or bystanders. Remain seated.

N: Neutral

This position disengages the transmission to allow manual vehicle movement or towing.

F: Forward

It is the normal driving range. It allows the vehicle to reach its maximum speed.

6) Multi-Switch Housing

The controls located on this multi-switch housing are:

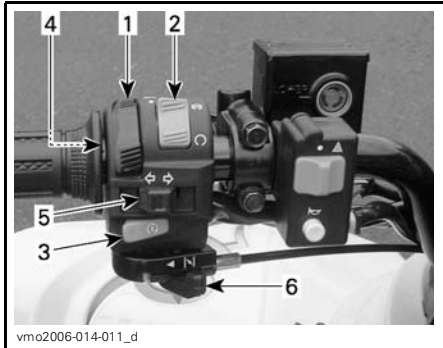

TYPICAL — MULTI-SWITCH HOUSING

1. Headlamp switch
2. Engine stop switch
3. Engine start button
4. Override button
5. Direction indicator switch
6. Choke lever

Headlamp Switch

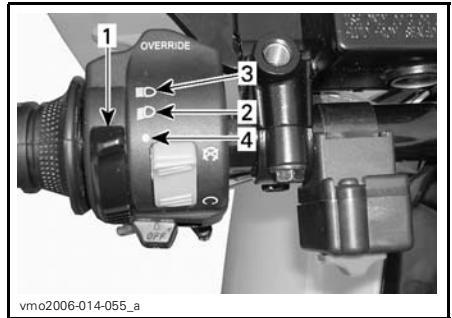

HEADLAMP SWITCH FUNCTIONS

1. Headlamp switch
2. Low beam and taillight
3. High beam and taillight
4. OFF position

Engine Stop Switch

This switch can be used to stop engine and as an emergency control.

To stop engine, fully release throttle lever then use the engine stop switch.

NOTE: While engine can be stopped by turning ignition key to OFF position, we recommend the engine be stopped by the engine stop switch.

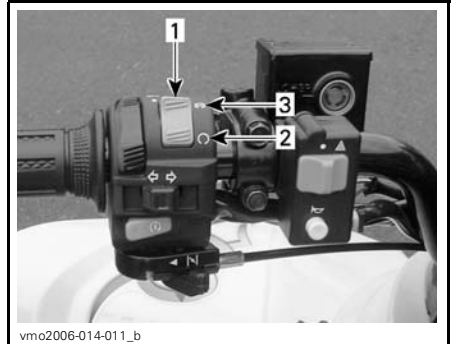

1. Engine stop switch
2. RUN position
3. OFF position

Engine Start Button

To start engine, place the engine stop switch to RUN position.

Press and hold the engine start button, release immediately after engine is started.

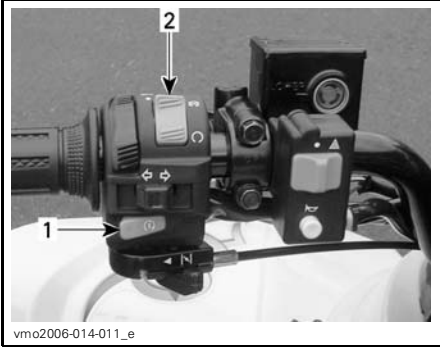

- 1. Engine start button
- 2. Engine stop switch

NOTE: The engine will not turn if the engine stop switch is turned to OFF position.

Override Button

This button is used to override the reverse speed limiter system while power backing up. Press and hold the override button then depress throttle lever gradually.

⚠ WARNING

Never activate the override button if throttle lever is already depressed as loss of control may result, causing severe personal injury or death.



- 1. Override button

Direction Indicator Switch

To activate the direction indicator lamps, push the switch button on the right side or the left side, depending which direction you picked. Push on switch button to reset when the turn is completed.



- 1. Direction indicator switch

Choke Lever

This device features a variable lever to ease engine cold start.

Position OFF is for normal use with a warm engine.



vmo2006-014-025

TYPICAL — CHOKE LEVER IN THE OFF POSITION

The full choke position is used for lower engine temperature.



vmo2006-014-026

TYPICAL — CHOKE LEVER IN THE FULL CHOKE POSITION

The other positions between OFF and FULL position, will be use depending on the engine temperature.

7) Indicator Lamps



vmo2006-014-027_b

High Intensity (BLUE)



Indicates HIGH BEAM is selected on the headlamps.

Engine Temperature/Oil Pressure Lamp (RED)



This light turns on when the ignition switch is turned ON and remains on until engine is running. When this indicator light is ON, it indicates the engine is overheating. If engine overheats, refer to *ENGINE OVERHEAT* in *SPECIAL PROCEDURES*.

Forward Lamp (BLUE)



Indicates the transmission is in forward position.

Reverse Lamp (RED)



Indicates the transmission is in reverse position.

Neutral Lamp (GREEN)



Indicates the transmission is in neutral position.

Direction Indicator (GREEN)



When the indicator light blinks, it indicates which direction indicator, left or right, is in operation.

8) Ignition Switch

Key-operated, 2-position switch.

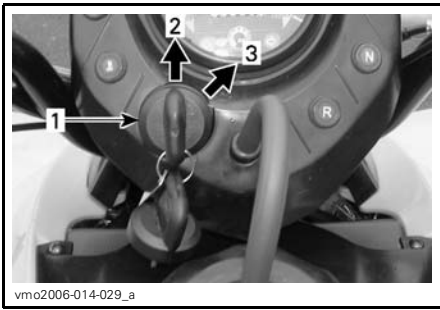

TYPICAL

1. Ignition switch
2. OFF position
3. ON position (position light on)

Insert key in switch and turn to ON position. To remove key, turn key to OFF position then pull it out.

Remember that having the lights on (headlamps and/or position light) without the engine running discharges the battery. Always turn ignition to OFF position after engine has been stopped.

NOTE: While engine can be stopped by turning ignition key to OFF position, we recommend the engine be stopped by the engine stop switch.

9) Fuel Tank Cap

CAUTION: Never place anything over fuel tank cap because the vent hole on the top of fuel tank cap can be blocked and the engine could misfire.

Unscrew counterclockwise and remove cap to allow fuel tank filling then fully tighten clockwise.

NOTE: Ensure that vent tube is properly installed.

⚠ WARNING

Always stop engine before refueling. Open cap slowly. If a differential pressure condition is noticed (whistling sound heard when loosening fuel tank cap) have vehicle inspected and/or repaired before further operation. Fuel is flammable and explosive under certain conditions. Never use an open flame to check fuel level. Never smoke or allow flame or spark in vicinity. Always work in a well-ventilated area. Never top up the fuel tank before placing the vehicle in a warm area. As temperature increases, fuel expands and may overflow. Always wipe off any fuel spillage from the vehicle.



TYPICAL

1. Fuel tank cap

10) Fuel Valve

This is a 3-position rotary valve. Rotate the knob to align its pointer to the desired position.

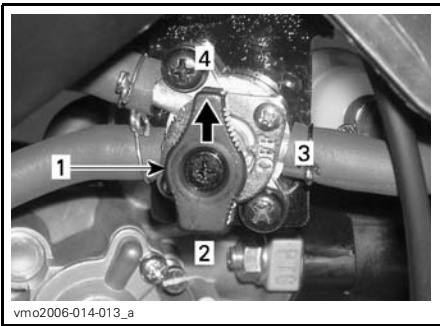

1. Align the pointer toward the desired position
2. RES. (reserve)
3. OFF
4. ON

OFF

Stops fuel supply to carburetor.

CAUTION: Turn valve to OFF position when vehicle is not being operated or when transporting.

ON

Allows fuel to flow to carburetor. This is the normal position for operation of the vehicle.

RES. (RESERVE)

When fuel is exhausted in the fuel tank when in the ON position, an emergency supply of fuel is available by turning the tab to RES. The reserve contains approximately 10% of the fuel tank capacity. Use only this position when the ON supply is empty.

When down to the reserve, refuel as soon as possible. Ensure to turn the valve back to the ON position after refuelling.

CAUTION: Improper opening of fuel valve will restrict the flow of fuel. Make sure valve is fully opened while running.

11) Front/Rear Brake Pedal

When pressed down, both front and rear brakes are applied. When released, it should return to its original position. Braking effect is proportional to the force applied on the pedal and to the type and condition of the terrain.

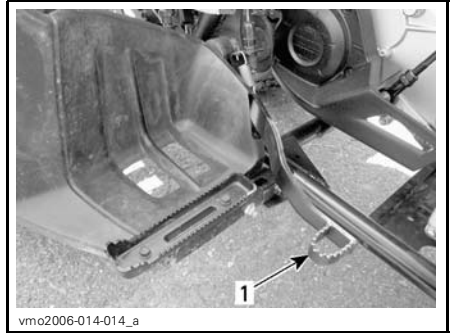

1. Front/rear brake pedal

12) Footpeg

Use this area to maintain your feet stable.

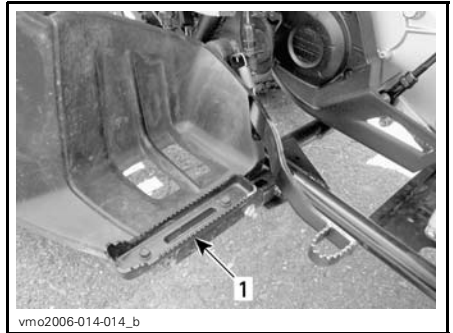

1. Footpeg

13) Tool Kit

The tool kit is located in the service compartment underneath the seat.

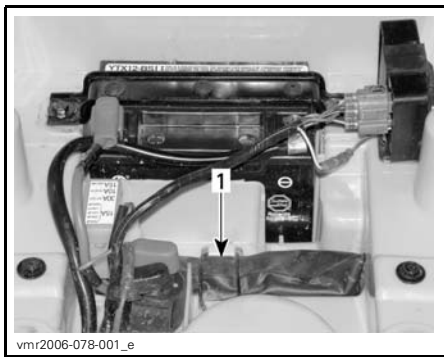

vmr2006-078-001_e

SERVICE COMPARTMENT UNDERNEATH SEAT

1. Tool kit

14) Radiator Cap

Located under front access cover. It provides access to the radiator filling neck.

WARNING

In order to avoid potential burns, do not remove the radiator cap if the engine is hot.

Press and turn radiator cap counter-clockwise to remove. When finished, properly reinstall radiator cap and access cover.



vmo2006-014-031_b

1. Radiator cap

15) Fuse

The electrical system is protected with fuses. Refer to *MAINTENANCE* section for details.

The fuse holder is located in the service compartment underneath the seat.

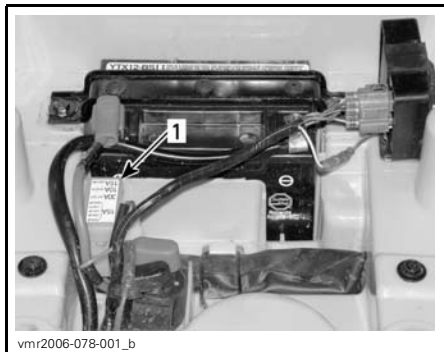

vmr2006-078-001_b

SERVICE COMPARTMENT UNDERNEATH SEAT

1. Fuse holder

16) Vehicle Lock

The vehicle lock is located on the steering stem directly below the steering head.

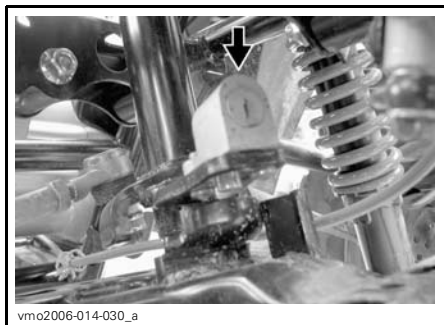

vmo2006-014-030_a

VEHICLE LOCK

- Turn the handlebar fully to the left.
- Insert the ignition switch key into the lock.
- Turn the key clockwise to lock the handlebar.
- Remove the ignition switch key.

- When unlocking, simply turn the key counterclockwise.

NOTE:

- As a safety precaution, or for theft prevention, lock the handlebar when parked.
- Once locked, turn the handlebar on both sides to make sure it is properly locked.
- When leaving the vehicle, remember to remove the key.

17) Horn Button

To activate horn, press the button. Release immediately after horn is set off.

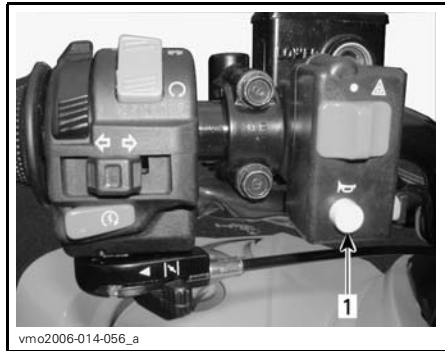

1. Horn button

18) Hazard Warning Switch

Device fitted to the vehicle that operates a simultaneous flashing of all direction indicators, used when the vehicle is stationary to indicate that the vehicle is temporarily obstructing traffic.



1. Hazard warning switch

To activate: turn the ignition switch ON and use the toggle warning switch.

NOTE: Once hazards lights are turned on, ignition switch can be turned OFF and key removed.

To deactivate (ignition switch in ON position): use the toggle warning switch.

(ignition switch in OFF position): turn the ignition switch ON and use the toggle warning switch.

NOTE: Having the hazard lights on (even with the ignition switch in OFF position) for a long period of time without the engine running will discharge the battery.

19) Seat Latch

Located underneath the rear fender, it allows the removal of the seat to gain access to the service compartment.

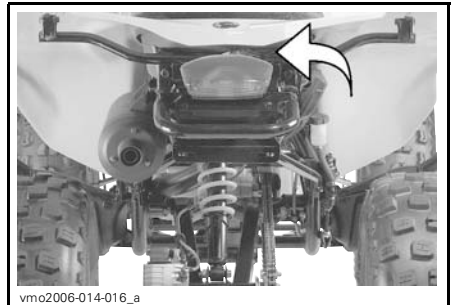

vmo2006-014-016_a

Seat Removal

Unlock seat using latch lever.
Gently lift rear of seat while pulling rearward to release.



1. Seat latch

Seat Installation

Insert seat tab into frame hook.
When seat rests in its position, firmly push seat down to latch.

NOTE: A distinctive snap will be felt. Double check that the seat is secure by giving it a tug to confirm proper latching.

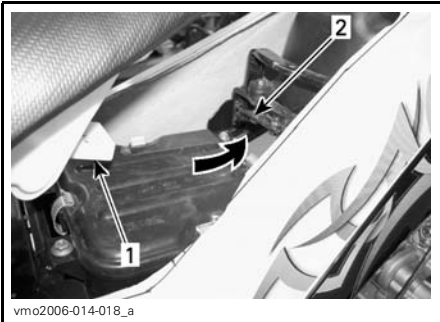

1. Tab
2. Hook

WARNING

Make sure seat is securely latched before riding.

20) 12-Volt Power Outlet

Convenient for handheld spotlight or other portable equipment.

Remove protective cap to use. Always reinstall it after use to protect against weather.

Do not exceed the rating capacity. See *SPECIFICATIONS*.

An auxiliary supply is available to connect additional accessories. Two wires are hidden in the wiring harness at the rear of vehicle. See an authorized Can-Am distributor/dealer for more details.

21) Speedometer

This vehicle is equipped with a speedometer. It indicates the speed of the vehicle in MPH and km/h.

The speedometer is backlit when the ignition switch is turned to ON position.

Odometer

Odometer records the total distance traveled in kilometers.

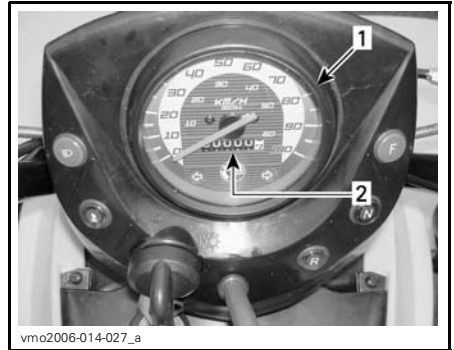

1. Speedometer
2. Odometer

22) Dipstick

Located on the right side of engine. Allow to check the oil level in the engine.

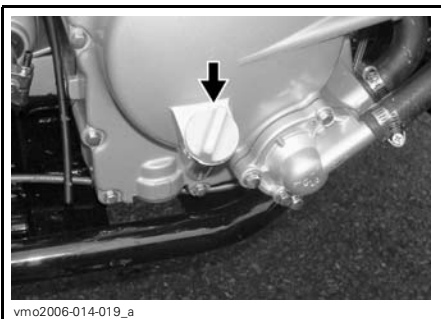

vmo2006-014-019_a

DIPSTICK — RH SIDE OF ENGINE

Refer to *LIQUID* to check the engine oil level correctly.

23) Front Brakes Fluid Reservoir

Located above front brake lever on RH side of handlebar.



vmr2006-085-005_a

RH FRONT BRAKES FLUID RESERVOIR

24) Rear Brake Fluid Reservoirs

Located above rear brake lever on LH side of handlebar and underneath RH side of rear fender.

NOTE: Rear brake pedal activates the front and rear brakes.



vmr2006-085-004

LH REAR BRAKE FLUID RESERVOIR

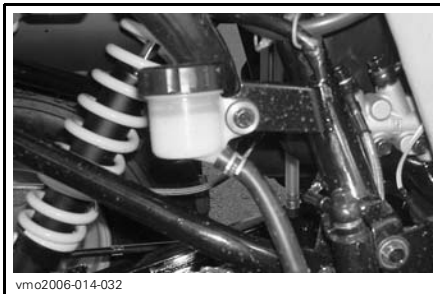

vmo2006-014-032

RH REAR BRAKE FLUID RESERVOIR

25) Engine Coolant Reservoir

Coolant reservoir is located underneath RH front fender.

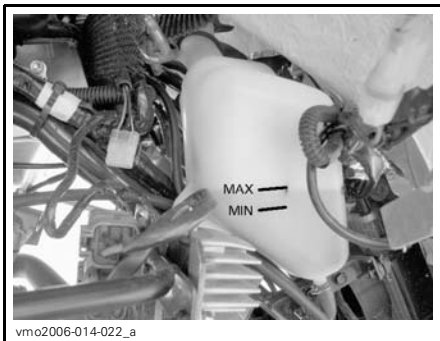

vmo2006-014-022_a

COOLANT RESERVOIR

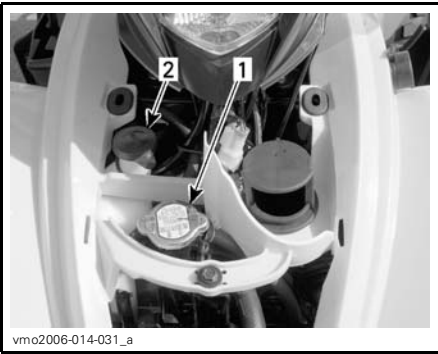

UNDERNEATH FRONT ACCESS COVER

1. Radiator cap
2. Coolant reservoir cap

LIQUIDS

While reading this Operator's Guide, remember that:

WARNING

Indicates a potential hazard that, if not avoided, could result in serious injury or death.

NOTE: This section specifies the recommended liquids and procedures to check their levels. Refer to *MAINTENANCE* for procedures to replace the liquids.

Fuel

Recommended Fuel

Use regular unleaded gasoline, available from most service stations or oxygenated fuel containing a maximum total of 10% of ethanol or methanol or both. The gasoline used must have the following recommended minimum octane number.

OCTANE NUMBER
92 RON

CAUTION: Never experiment with other fuels. The use of unrecommended fuel can result in vehicle performance deterioration and damage to critical parts in the fuel system and engine components.

Fuel Level

WARNING

Always stop engine before refueling. Open cap slowly. If a differential pressure condition is noticed (whistling sound heard when loosening fuel tank cap) have vehicle inspected and/or repaired before further operation. Fuel is flammable and explosive under certain conditions. Never use an open flame to check fuel level. Never smoke or allow flame or spark in vicinity. Always work in a well-ventilated area. Never top up the fuel tank before placing the vehicle in a warm area. As temperature increases, fuel expands and may overflow. Always wipe off any fuel or oil spillage from the vehicle.

Engine Oil

Recommended Oil

Use 4-stroke engine oil that meets or exceeds the requirements for API service classification SM, SL or SJ. Always check the API service label on the oil container, it must contain at least one of the above standards.

Oil Viscosity

SAE 5W30 oil is recommended for all seasons.

However during the hottest days of the summer the BRP XP-S™ 10W40 mineral oil (P/N 219 700 346) can be used.

NOTE: For improved overall performance and all season application, use XP-S 5W40 synthetic oil (P/N 293 600 039).

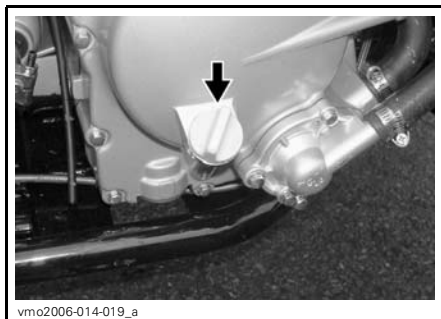
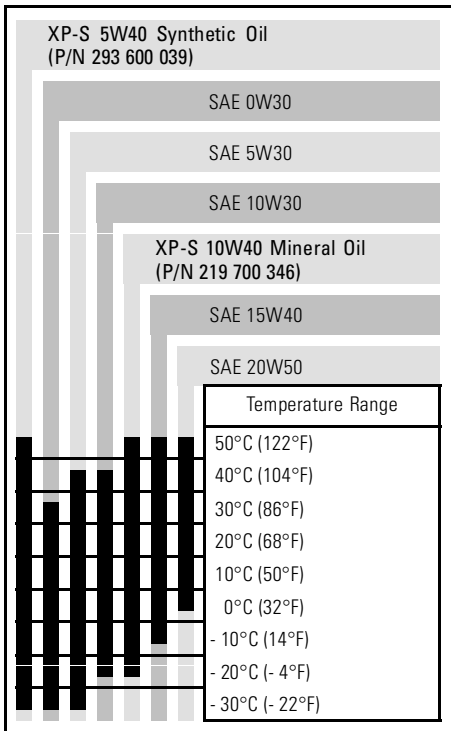

RH SIDE OF ENGINE

With vehicle on a level surface and engine cold, not running, check the oil level as follows:

1. Unscrew dipstick then remove it and wipe clean.
2. Reinstall dipstick (do not screw it in).
3. Remove and check oil level. It should be near or equal to the upper mark.

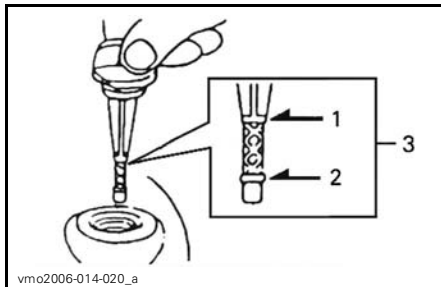

1. Full
2. Add
3. Operating range

Oil Level

CAUTION: Check level frequently and refill if necessary. **Do not overfill.** Operating the engine with an improper level may severely damage engine. Wipe off any spillage.

To add oil, remove dipstick.

Place a funnel into the dipstick tube to avoid spillage.

Add a small amount of recommended oil and recheck oil level.

Repeat the operation until oil level reaches the dipstick's full mark. **Do not overfill.**

Properly tighten dipstick.

Gearbox Oil

Recommended Oil

Use XP-S chaincase oil (P/N 413 801 900) or an equivalent.

CAUTION: Do not use unrecommended other types of oil when servicing. Do not mix with other types of oil.

Gearbox Oil Level

See an authorized Can-Am distributor/dealer.

Engine Coolant

Recommended Coolant

Always use ethylene-glycol antifreeze containing corrosion inhibitors specifically for internal combustion aluminum engines.

Cooling system must be filled with BRP premixed coolant (P/N 219 700 362) or with distilled water and antifreeze solution (50% water, 50% antifreeze).

Coolant Level

Coolant reservoir is located underneath RH front fender.

WARNING

Check coolant level with engine cold. Never add coolant in cooling system when engine is hot.

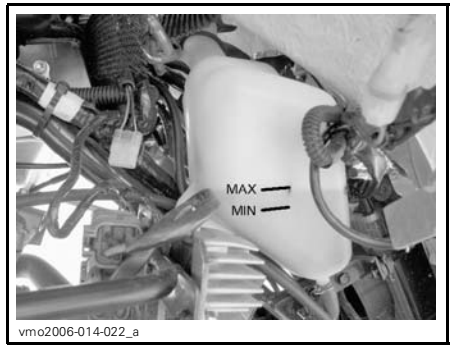

COOLANT LEVEL

With vehicle on a level surface, liquid should be between MIN. and MAX. level marks of coolant reservoir.

NOTE: When checking level at temperature lower than 20°C (68°F), it may be slightly lower than MIN. mark.

To gain access to coolant reservoir, remove front fender access cover.

Pull on upper portion of cover to remove tab from rubber grommets.

Pull cover downward to release lower tabs from front fender.

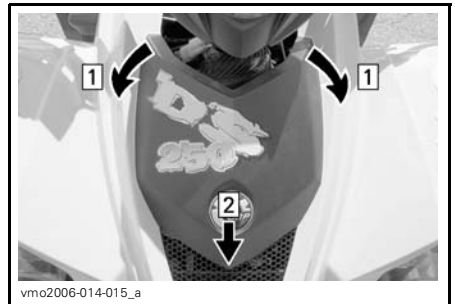

Step 1: Pull front tab from grommets

Step 2: Pull cover downward to release

Add coolant up to MAX. mark if required. Use a funnel to avoid spillage. **Do not overfill.**

Properly reinstall and tighten filler cap.

Reinstall front fender access cover.

If the coolant is added in the coolant reservoir, check the level in the radiator reservoir, too. Add coolant if necessary.

⚠ WARNING

In order to avoid potential burns, do not remove the radiator cap if the engine is hot.

NOTE: A cooling system that frequently requires coolant is the indication of leaks or engine problems. See an authorized Can-Am distributor/dealer.

To gain access to the radiator, remove front fender access cover (see procedure above).

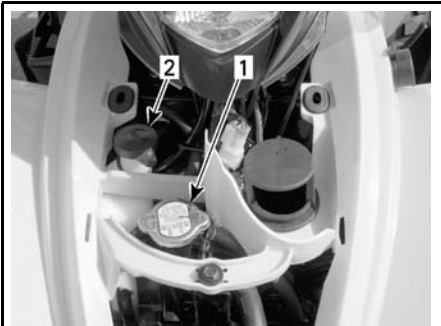

vmc2006-014-031_a

TYPICAL

1. Radiator cap
2. Coolant reservoir cap

Brake Fluid

Recommended Fluid

Always use brake fluid meeting the specification DOT 4 only.

CAUTION: To avoid serious damage to the braking system, do not use fluids other than the recommended one, nor mix different fluids for topping up.

Fluid Level

With vehicle on a level surface, check brake fluid in reservoir for proper level. It should be above MIN. mark.

Add fluid as required. **Do not overfill.** Clean filler cap before removing.

CAUTION: Use only DOT 4 brake fluid from a sealed container. Do not use brake fluid taken from old or already opened containers.

NOTE: A low level may indicate leaks or worn brake pads. See an authorized Can-Am distributor/dealer.

Handlebar Fluid Reservoirs

Turn handlebar in the straight-ahead position to ensure reservoirs are leveled. Check the brake fluid level, the reservoir is full when the fluid reaches the top of window.

Visually inspect lever boot condition. Check for cracks, tears, etc. Replace if damaged.



vmr2006-085-004
TYPICAL — LH REAR BRAKE FLUID RESERVOIR

Rear Fluid Reservoir

With vehicle on a level surface, brake fluid should be between MIN. and MAX. level marks.

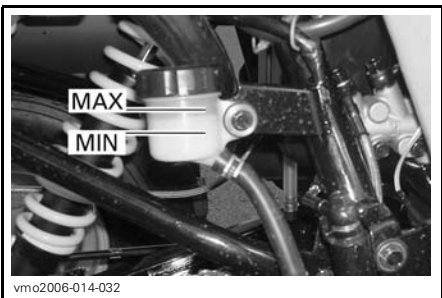

vmo2006-014-032

UNDERNEATH RH REAR FENDER

While reading this Operator's Guide, remember that:

⚠ WARNING

Indicates a potential hazard that, if not avoided, could result in serious injury or death.

OPERATING INSTRUCTIONS

General

Transmission lever must be on NEUTRAL and brakes applied (front or rear) to allow engine starting.

To start engine, place the engine stop switch to RUN position, insert key in ignition switch and turn to the ON position then press the engine start button.

NOTE: For your convenience, an override mode allows the engine to be started with the transmission lever in any position. Press and hold the front brake lever while pressing the engine start button.

Pre-Operation Check

WARNING

The pre-operation check is very important prior to operating the vehicle. Always check the proper operation of critical controls, safety features and mechanical components before starting. If not done as specified here, severe injury or death might occur.

Before using this vehicle, the operator should always:

- Apply parking brake and check if it operates properly.
- Check tire pressure and condition.
- Check wheels and bearings for wear and damage.
- Check location of controls and ensure they work properly.
- Verify if steering operates freely.
- Activate throttle control lever several times to ensure it operates freely. It must return to idle position when released.

- Activate the brake levers and brake pedal to make sure the brakes fully apply. Levers and pedal must fully return when released.
- Ensure transmission lever is working then reset in NEUTRAL position.
- Check drive chain for adjustment and lubrication.
- Check sprockets for wear and damages.
- Check tightening of rear axle fasteners.
- Check swing arm, if any lateral play is detected **DO NOT USE THE VEHICLE.**
- Check fuel, oil and coolant levels.
- Check for oil leaks on the engine and gearbox.
- Ensure fuel valve is in fully open position (ON).
- Clean headlamps and taillight.
- Ensure front access compartment cover is properly latched.
- Ensure seat is properly tightened.
- If you transport cargo, respect load capacity.
- If you are pulling a trailer or other equipment, ensure it respects the tongue capacity and towing capacity. Ensure trailer is properly secured to hitch.
- Look and feel for loose parts while engine is off. Check fasteners.
- Ensure the path of travel is free of persons and obstacles.
- Check operation of ignition switch, start button, engine stop switch and headlamps.
- Start engine, remove parking brake and drive forward slowly a few feet then apply all brakes individually to test them.

Correct any problem you may have found before riding. See an authorized Can-Am distributor/dealer as necessary.

Starting the Engine

Initial Cold Starting

Insert key in ignition switch and turn to ON position.

NOTE: Do not forget, place the engine stop switch to RUN position and apply brakes (front or rear).

In cold weather, colder than 0°C (32°F), place the choke lever to full choke position.

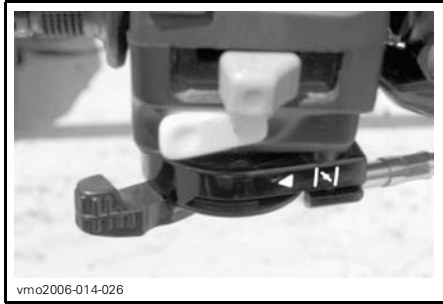

FULL CHOKE POSITION

Press the engine start button and hold until engine starts.

CAUTION: Do not hold the engine start button more than 20 seconds. A rest period should be observed between the cranking cycles to let starter cool down. Pay attention not to discharge battery.

NOTE: Throttle assist may be used to help engine starting faster. Press the throttle lever slightly. If too much throttle is used the choke system will not be activated.

Release the engine start button immediately when engine has started.

After a few seconds, move the choke lever from full choke position to an intermediate position until the best engine RPM is achieved.

NOTE: Overusing choke may flood engine and make it hard to start. Refer to *SPECIAL PROCEDURES* if it occurs.

When the engine is warm, push the choke lever to OFF and release brakes.



CHOKE LEVER IN THE OFF POSITION

Warm Engine Starting

Start the engine as explained above but without the choke. If the engine does not start after two 5-second attempts with the electric starter, move the choke lever and place it between the FULL and the OFF position. Start the engine without activating the throttle lever. After a few seconds, push the choke lever to OFF.

Shifting the Transmission

Let engine idle to warm up.

Apply brakes and select the gear range "F".

Release brakes.

CAUTION: Make sure parking brake is fully disengaged before operating the vehicle.

Gradually press the throttle lever to increase engine speed and thus engaging the continuously variable transmission (CVT).

At the opposite, when the throttle lever is released, the engine speed decreases.

NOTE: Engine will stop if any shifting is done at high RPM.

Using the Reverse

CAUTION: When changing from forward to reverse, or vice-versa, always completely stop the vehicle and apply the brake prior to moving the transmission lever.

The same procedures as *SHIFTING THE TRANSMISSION* above apply except for the following.

Set the transmission lever in REVERSE position.

Stopping the Engine



Avoid parking vehicle on slope.

Release throttle and completely stop the vehicle.

Apply the parking brake.

Set transmission lever in FORWARD position.

Push the engine stop switch in OFF position.

Turn key in ignition switch to OFF position.

Remove key from ignition switch.

Post-Operation Care

When vehicle is used in salt-water environment (beach area, launching/loading boats etc.), rinsing the vehicle with fresh water is necessary to preserve vehicle and its components. Metallic parts lubrication is highly recommended. Use XP-S Lube (P/N 293 600 016) or an equivalent. This must be performed at the end of each operating day.

When vehicle is operated in muddy conditions, rinsing the vehicle is recommended to preserve vehicle and its components and to keep lights clean.

NOTE: Never use a high pressure washer to clean the vehicle **USE LOW PRESSURE ONLY** (like a garden hose). The high pressure can cause electrical or mechanical damages.

SPECIAL PROCEDURES

Engine Overheat

If engine overheats and indicator light turns on, try the following:

- Check and clean radiator fins. See *MAINTENANCE* section.

WARNING

The radiator can be very hot, wear gloves before touching radiator.

- Reduce vehicle speed but try to keep vehicle moving to supply air to radiator. If engine is still overheating after approximately one minute, stop vehicle and set transmission to NEUTRAL and apply parking brake. Stop engine.
- Let engine cool down. Check coolant level and refill if possible.

WARNING

In order to avoid potential burns, do not remove the radiator cap or refill cooling system when engine is hot.

- Restart the engine, if the light does not turn off right after engine starting, stop engine and disconnect the temperature sensor.

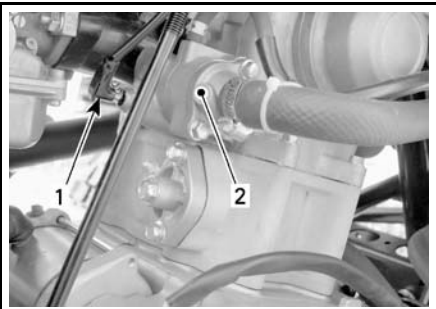

vmo2006-014-034_a

1. Temperature sensor
2. Thermostat housing

Restart engine. If the light turn off and the engine is cold or warm, not hot, a potential problem with the sensor or engine part is possible. Use the vehicle as little as possible and see an authorized Can-Am distributor/dealer as soon as possible.

Turn Over

When vehicle is turned over or stays tilted on the side, replace the vehicle in its normal operating position (on all four wheels) and wait 3 to 5 minutes before starting engine. Before starting engine, check engine oil and coolant levels and refill if necessary.

Vehicle Immersion

Should the vehicle become immersed, it will be necessary to take it to an authorized Can-Am distributor/dealer as soon as possible. **DO NOT START THE ENGINE!**

CAUTION: Immersion of the vehicle can cause serious damage if the correct restart procedure is not followed.

CARGO AND TRANSPORTATION

While reading this Operator's Guide, remember that:

WARNING

Indicates a potential hazard that, if not avoided, could result in serious injury or death.

Cargo

WARNING

If your vehicle is equipped to carry loads with optional racks and/or trailer hitch approved by BRP, vehicle handling, stability and braking distance will be affected. Correct loading and weight distribution are therefore important. Never overload, tow or carry cargo improperly. Always ensure the cargo is safely secured and properly distributed on the rack(s) before operating the vehicle. Safely reduce speed according to terrain conditions when carrying cargo or pulling a trailer. Allow greater distance for braking. Always secure cargo as low as possible on the rack(s) to reduce the effect of a higher center of gravity. Failure to follow the recommendations here could cause changes in vehicle handling which could lead to an accident resulting in severe injuries including the possibility of death.

When transporting cargo on the vehicle, respect these maximum loads.

MAXIMUM LOAD		
Total load allowed	150 kg (330 lb)	Includes operator, all other loads and added accessories

Transportation

When transporting a vehicle, secure vehicle to trailer or in pickup box with suitable tie-downs. Using ordinary ropes is not recommended.

WARNING



V00A174

Never tip this vehicle on end for transporting. We recommend that you carry the vehicle in its normal operating position (on all 4 wheels).

- Place the fuel valve to OFF position.
- Select the FORWARD position and set the parking brake to ON position.
- Secure the vehicle by the front and rear bumpers.

CAUTION: Attaching vehicle at other locations may damage the vehicle.

Front Location



FRONT BUMPER STRAP LOCATIONS

Rear Location

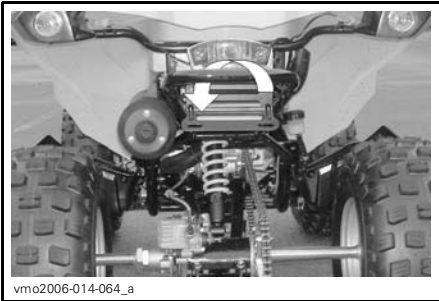

REAR BUMPER STRAP LOCATION



WARNING

Do not tow this vehicle behind a car or other vehicle. Use a trailer.

TROUBLESHOOTING

ENGINE DOES NOT TURN

1. Ignition switch is in the OFF position.

- Place switch to the ON position.

2. Engine stop switch.

- Make sure that the engine stop switch is in ON position.

3. Transmission is not set on NEUTRAL.

- Set transmission in NEUTRAL and apply brakes (front or rear).

4. Brakes are not applied.

- Apply brakes (front or rear) and set transmission in NEUTRAL.

5. Burnt fuse.

- Check main fuse condition.

6. Weak battery or loose connections.

- Check charging system fuse.
- Check connections and terminals condition.
- Have the battery checked.
- Contact an authorized Can-Am distributor/dealer.

ENGINE TURNS OVER BUT FAILS TO START

1. Mixture not rich enough to start cold engine.

- Check fuel tank level and check starting procedure, particularly use of the choke.

2. Flooded engine (spark plug wet when removed).

- Turn ignition switch to ON position and ensure choke is not applied.
- Ensure the transmission lever is on NEUTRAL position.
- Fully press throttle lever and hold while starting the engine.
- As soon as the engine starts, release throttle lever. Do not race engine.
- **If it does not work:** clean the spark plug cap area then remove it. Remove the spark plug (tools are supplied in tool kit), refer to SPARK PLUG REMOVAL further in this guide.
- Crank engine several times. Install new spark plug if possible or clean and dry spark plug.
- Start engine as explained above. If engine continues to flood, see an authorized Can-Am distributor/dealer.
- Make sure to verify that there is no fuel in engine oil, if so, replace engine oil.

3. No fuel to the engine (spark plug dry when removed).

- Check fuel tank level; turn fuel valve to ON (also try on RES.). A failure of the fuel pump or carburetor may have occurred.
- Contact an authorized Can-Am distributor/dealer.

ENGINE TURNS OVER BUT FAILS TO START (cont'd)

4. Spark plug/ignition (no spark).

- Check main fuse condition.
- Remove spark plug then reconnect to spark plug cap.
- Check that ignition switch and/or engine stop switch is/are at the ON position.
- Start engine with spark plug grounded to the engine away from spark plug hole. If no spark appears, replace spark plug.
- If trouble persists, contact an authorized Can-Am distributor/dealer.

5. Engine compression.

- If no pulsating resistance is felt, it suggests a major loss of compression.
- Contact an authorized Can-Am distributor/dealer.

ENGINE LACKS ACCELERATION OR POWER

1. Fouled or damaged spark plug.

- Check item ENGINE TURNS OVER BUT FAILS TO START.

2. Lack of fuel to engine.

- Check item ENGINE TURNS OVER BUT FAILS TO START.

3. Carburetor adjustments.

- Contact an authorized Can-Am distributor/dealer.

4. Engine is overheating.

- Check ENGINE OVERHEATING in SPECIAL PROCEDURES.
- If overheating persists, contact an authorized Can-Am distributor/dealer.

5. Air filter/box plugged or dirty.

- Check air filter and clean if necessary.
- Check deposits in air filter housing drain.
- Check the position of the air intake tube.

6. CVT dirty or worn-out.

- Contact an authorized Can-Am distributor/dealer.

7. Parking brake is applied.

- Disengage parking brake.

8. Improper valves adjustment.

- Contact an authorized Can-Am distributor/dealer.

ENGINE BACKFIRE

1. Exhaust system leakage.

- Contact an authorized Can-Am distributor/dealer.

2. Engine is running too hot.

- See ENGINE LACKS ACCELERATION OR POWER.

3. Ignition timing is incorrect or there is an ignition system failure.

- Contact an authorized Can-Am distributor/dealer.

ENGINE BACKFIRE (cont'd)

4. Improper carburetor setting.

- *Contact an authorized Can-Am distributor/dealer.*

5. Fouled/damaged/worn spark plug.

- *Clean/verify spark plug and heat range. Replace as required.*

6. Antipollution system failed.

- *Contact an authorized Can-Am distributor/dealer.*

ENGINE MISFIRE

1. Fouled/damaged/worn spark plug.

- *Clean/verify spark plug and heat range. Replace as required.*

2. Water in fuel.

- *Drain fuel system and refill with fresh fuel.*

UNUSUAL ENGINE NOISE

1. Valve adjustment.

- *Contact an authorized Can-Am distributor/dealer.*

2. Chain tensioner plugged.

- *Contact an authorized Can-Am distributor/dealer.*

3. Timing chain wear.

- *Contact an authorized Can-Am distributor/dealer.*

4. CVT contamination.

- *Contact an authorized Can-Am distributor/dealer.*

VEHICLE CANNOT REACH FULL SPEED

1. Engine.

- *See ENGINE LACKS ACCELERATION OR POWER.*

2. Parking brake.

- *Ensure parking brake is completely removed.*

3. Air filter/box plugged or dirty.

- *Check air filter and clean if necessary.*
- *Check deposits in air filter housing drain.*
- *Check the position of the air intake tube.*

4. CVT dirty or worn-out.

- *Contact an authorized Can-Am distributor/dealer.*

TRANSMISSION LEVER IS HARD TO MOVE

1. Transmission gears are in a position that prevents the transmission lever to work.

- *Rock the vehicle back and forth to move the gears in the transmission and allow the transmission lever to be set.*

TRANSMISSION LEVER IS HARD TO MOVE (cont'd)

2. Engine idle speed is set too high.

- *Adjust the idle speed. Refer to the SPECIFICATIONS.*

3. CVT dirty or worn-out.

- *Contact an authorized Can-Am distributor/dealer.*

THE RPM INCREASES BUT THE VEHICLE DOES NOT MOVE

1. The transmission is in NEUTRAL position.

- *Set transmission in REVERSE or FORWARD.*

2. CVT dirty or worn-out.

- *Contact an authorized Can-Am distributor/dealer.*

3. Water in the CVT housing.

- *Contact an authorized Can-Am distributor/dealer.*

SPECIFICATIONS

VEHICLE MODEL		DS 250
ENGINE		
Type	4 stroke. Single overhead camshaft engine, liquid cooled	
Number of cylinder	Single cylinder	
Number of valves	4 valves with mechanical lifters (adjustable)	
Displacement	249.4 cc (15.22 cu. in)	
Bore	71 mm (2.8 in)	
Stroke	63 mm (2.5 in)	
Starting system	Electric starter	
Compression ratio	10.6:1	
Lubrication	Forced circulation and splashing	
Air filter	Sponge wet type	
TRANSMISSION		
Transmission	Continuously Variable Transmission (CVT) HI range (F), neutral and reverse	
COOLING		
Type	Liquid cooled	
Radiator	Front mounted	
CARBURETION		
Carburetor	Type	KEHIN PTG-23 with manual choke
Choke	Variable	
Idle speed	± 100	1700 RPM
ELECTRICAL		
Magneto generator	Type	338 W @ 5000 RPM
Ignition type	CDI (Capacitor Discharge Ignition)	
Ignition timing	Not adjustable	
Spark plug	Make	NGK
	Type	CR8E
	Gap	0.8 mm (.031 in)
Number of spark plug	1	
Battery	Type	Dry type battery
	Volt	12 volts, 10 A•h (Ampere-hour)

VEHICLE MODEL		DS 250
ELECTRICAL (cont'd)		
Starting system		Electric start
Headlamp bulb		2 x 31.5 W
Taillight bulb		1 x 5/21 W
Turn signal light bulb		4 x 21 W
Indicator lamps		1.7 W
Fuses	Fan motor	10 A
	Headlamp	15 A
	Other lights	15 A
	Main fuse	30 A
DRIVE TRAIN		
Rear axle		Chain driven/solid axle
Turning radius		3.5 m (138 in) at low speed
SUSPENSION		
Front	Type	Independent suspension — double A-arm, 2 shock absorbers (oil)
	Travel	140 mm (5.5 in)
Rear	Type	Rigid swing-arm, 1 shock absorber (oil)
	Travel	170 mm (6.7 in)
TIRES		
Pressure	Front	34 kPa (5.0 PSI) recommended 26 kPa (3.8 PSI) minimum
	Rear	
Size	Front	22 x 7-10
	Rear	20 x 11-9
WHEELS		
Size	Front	AT 10 x 5.5
	Rear	AT 9 x 8
Wheel nuts torque		50 N•m (37 lbf•ft)
BRAKES		
Front		Hydraulic, 2 discs
Rear		Hydraulic, 1 disc
Parking device		Separate RH lock lever on handlebar

VEHICLE MODEL		DS 250	
LOADING CAPACITY			
Total vehicle load allowed		150 kg (330 lb) includes operator, all other loads and added accessories	
DIMENSIONS			
Dry mass		195 kg (429 lb)	
Overall length		1.830 m (72 in)	
Overall width		1.030 m (40.5 in)	
Overall height		1.105 m (43.5 in)	
Seat height		800 mm (31.5 in)	
Wheel base		1.187 m (47 in)	
Ground clearance	Center of vehicle	260 mm (10.2 in)	
LIQUIDS AND GREASES			
Engine oil type		SAE 5W30. API classification SM, SL or SJ. Refer to <i>OIL VISCOSITY CHART</i>	
Gearbox oil		85W-140 or XP-S chaincase oil	
Coolant		Ethylene-glycol/water mix (50% coolant, 50% distilled water). Use BRP premixed coolant or a coolant specially designed for aluminum engines	
Fuel	Type	Regular unleaded gasoline	
	Octane	92 RON or higher	
Brake		Brake fluid, DOT 4	
CAPACITIES			
Fuel tank		12.5 L (3.3 U.S. gal)	
Engine		1.4 L (1.48 U.S. quarts) Oil change: 1.2 L (1.27 U.S. quarts)	
Gearbox oil		Oil change: 800 mL (27 U.S. oz.)	
Coolant		850 mL (28.7 U.S. quarts) (engine and radiator)	

A: ampere

RPM: Revolution Per Minute

W: watt

Because of our ongoing commitment to product quality and innovation, BRP reserves the right, at any time, to make changes in design and specifications and/or to make additions to, or improvements in its products without imposing any obligation upon itself to install them on its products previously manufactured.

MAINTENANCE INFORMATION

MAINTENANCE CHART

The maintenance is very important, if you are not familiar with safe service practices and adjustment procedures, see your authorized Can-Am distributor/dealer.

PERIODIC MAINTENANCE CHART						
A: ADJUST C: CLEAN I: INSPECT L: LUBRICATE R: REPLACE T: PROCEED WITH TASK	INITIAL INSPECTION 10 H OR 30 DAYS OR 200 KM (125 mi)					
	(To be performed by an authorized Can-Am dealer. The initial maintenance is very important and must not be neglected.)					
	25 H OR 500 KM (310 mi)					
	50 H OR 1000 KM (620 mi)					
	100 H OR 1 YEAR OR 2000 KM (1250 mi)					
200 H OR 2 YEARS OR 4000 KM (2485 mi)						
TO BE PERFORMED BY						
PART/TASK						LEGEND
ENGINE/TRANSMISSION						
Engine oil level ⁽²⁾			EVERY RIDE			Customer
Engine oil	R		R			Dealer
Engine oil strainer	C					Dealer
Gearbox oil	I				R	Dealer/ Customer
Valve clearance adjustment	T			T		Dealer
Engine mounting fasteners	I			I		Dealer
Exhaust system	I			I		Dealer
Condition of engine seals	I			I		Dealer
Engine coolant ⁽²⁾	I			I ⁽³⁾	R	Customer
Radiator cap/cooling system pressure test	T				T	Dealer
Radiator condition/cleanliness ⁽⁴⁾	I		I			Customer
Drive belt				I		Dealer
Drive and driven pulleys condition/cleanliness				I, C		Dealer
CVT air inlet/outlet duct condition/cleanliness	I, C		I, C			Dealer

- (2) Pre-ride inspection item.
- (3) Every 100 hours, check coolant strength.
- (4) More often under severe use such as dusty area, sand, snow, wet or muddy conditions.

PERIODIC MAINTENANCE CHART

A: ADJUST
 C: CLEAN
 I: INSPECT
 L: LUBRICATE
 R: REPLACE
 T: PROCEED WITH TASK

INITIAL INSPECTION 10 H OR 30 DAYS OR 200 KM (125 mi)

(To be performed by an authorized Can-Am dealer. The initial maintenance is very important and must not be neglected.)

25 H OR 500 KM (310 mi)

50 H OR 1000 KM (620 mi)

100 H OR 1 YEAR OR 2000 KM (1250 mi)

200 H OR 2 YEARS OR 4000 KM (2485 mi)

TO BE PERFORMED BY

PART/TASK

LEGEND

FUEL SYSTEM

PART/TASK	I	C	L	R	BY	
Air filter/air injection valve filter		I, C ⁽⁴⁾		R ⁽⁴⁾	Customer	(1) Emission-related component. (4) More often under severe use such as dusty area, sand, snow, wet or muddy conditions.
Fuel filter	I			I, R	Dealer	
Fuel lines, connections and fuel tank pressure test	I			I	Dealer	
Carburetor ⁽¹⁾	A			A	Dealer	

ELECTRICAL

PART/TASK	I	C	L	R	BY	
Spark plug ⁽⁵⁾	I			R	Customer	(2) Pre-ride inspection item. (5) Make sure the spark plug is correctly gapped.
Ignition timing	I		I		Dealer	
Battery connections	I		I		Customer	
Wiring harnesses, cables and lines	I			I	Dealer	
Condition of ignition switch, engine start button and engine stop switch ⁽²⁾	I			I	Customer	
Condition of lighting system (HI/LO intensity, brake lamp, headlamp aiming, etc.) ⁽²⁾	I			I	Customer	

DRIVE TRAIN

PART/TASK	I	C	L	R	BY	
Drive chain lubrication					EVERY RIDE	Customer
Drive chain slider condition					EVERY RIDE	Customer
Drive chain adjustment					EVERY RIDE	Customer
Drive chain sprockets	I			I	Customer	—
Wheel bearings				I	Customer	

PERIODIC MAINTENANCE CHART

A: ADJUST
 C: CLEAN
 I: INSPECT
 L: LUBRICATE
 R: REPLACE
 T: PROCEED WITH TASK

INITIAL INSPECTION 10 H OR 30 DAYS OR 200 KM (125 mi)

(To be performed by an authorized Can-Am dealer. The initial maintenance is very important and must not be neglected.)

25 H OR 500 KM (310 mi)

50 H OR 1000 KM (620 mi)

100 H OR 1 YEAR OR 2000 KM (1250 mi)

200 H OR 2 YEARS OR 4000 KM (2485 mi)

TO BE PERFORMED BY

PART/TASK

LEGEND

STEERING

Handlebar fasteners ⁽²⁾	I				I		Dealer
Throttle/housing/cable condition ⁽²⁾	I, A			I, A, L			Customer
Choke ⁽²⁾	I				I, A		Customer
Steering system (column, bearing, etc.) ⁽⁴⁾	I				I		Dealer
Tie rod ends	I	I					Dealer
Wheel nuts/studs ⁽²⁾	I		I				Customer
Tires pressure and wear ⁽²⁾	EVERY RIDE						Customer
Front wheels alignment	I				I		Dealer
Ball joints		I					Dealer

⁽²⁾ Pre-ride inspection item.
⁽⁴⁾ More often under severe use such dusty area, sand, snow, wet or muddy conditions.

SUSPENSION

Swing arm ⁽²⁾					I		Customer
Shock absorbers ⁽²⁾				I			Customer
A-arms				I			Customer

⁽²⁾ Pre-ride inspection item.

BRAKE

Brake fluid ⁽²⁾	I	I				R ⁽⁶⁾	Customer
Parking brake cable adjustment ⁽⁶⁾	A	A					Customer
Brake pads ⁽⁶⁾			I ⁽⁴⁾				Customer
Brake system (discs, hoses, etc.) ⁽⁶⁾					I		Customer

⁽²⁾ Pre-ride inspection item.
⁽⁴⁾ More often under severe use such dusty area, sand, snow, wet or muddy conditions.
⁽⁶⁾ Brake fluid replacement or any brake system repairs must be performed by an authorized Can-Am dealer.

PERIODIC MAINTENANCE CHART

A: ADJUST
 C: CLEAN
 I: INSPECT
 L: LUBRICATE
 R: REPLACE
 T: PROCEED WITH TASK

INITIAL INSPECTION 10 H OR 30 DAYS OR 200 KM (125 mi)

(To be performed by an authorized Can-Am dealer. The initial maintenance is very important and must not be neglected.)

25 H OR 500 KM (310 mi)

50 H OR 1000 KM (620 mi)

100 H OR 1 YEAR OR 2000 KM (1250 mi)

200 H OR 2 YEARS OR 4000 KM (2485 mi)

TO BE PERFORMED BY

PART/TASK

LEGEND

BODY/FRAME

Frame	I	Dealer	—
Hitch/trailer ball condition (if installed)	EVERY RIDE	Customer	
Frame fasteners	I	Customer	
Seat fasteners	EVERY RIDE	Customer	
Engine and vehicle cleaning and protection	EVERY RIDE	Customer	

GENERAL

While reading this Operator's Guide, remember that:

WARNING

Indicates a potential hazard that, if not avoided, could result in serious injury or death.

WARNING

Unless otherwise specified, engine should not be running for all maintenance procedures.

Before performing any service or inspection operation on the vehicle, wait until the engine and exhaust have cooled down to avoid potential burns.

WARNING

Should removal of a locking device (e.g. lock tabs, self-locking fasteners, etc.) be required when undergoing disassembly/assembly, always replace with a new one.

The following covers the maintenance items that can be performed by the customer if desired. Other items found in *MAINTENANCE CHART* must be performed by an authorized Can-Am distributor/dealer.

NOTE: Among other things, this section gives the procedures to replace the liquids. Refer to *LIQUIDS* for procedures to check levels and refill.

ENGINE

Air Filter

Removal/Cleaning

CAUTION: Never remove or modify any component in the air filter housing. The engine carburetion is calibrated to operate specifically with these components. Otherwise, engine performance degradation or damage can occur.

Remove seat.

Release clamps and remove air filter housing cover.

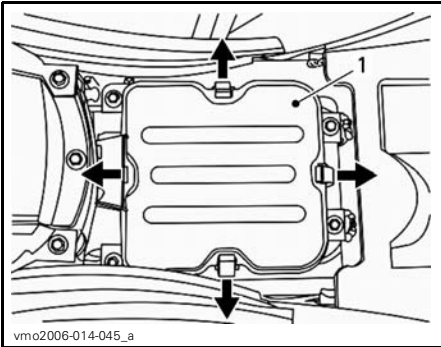

1. Air filter housing cover

Loosen clamp and remove retaining screw, then remove air filter.

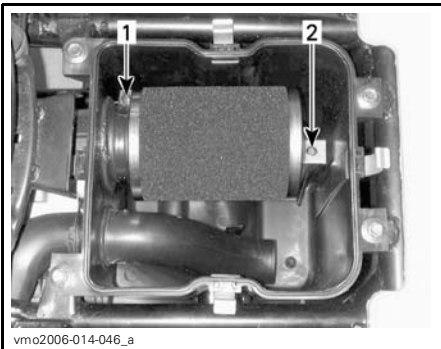

1. Clamp
2. Retaining screw

Pour cleaning solution (P/N 219 700 341) or an equivalent into a bucket. Put the filter in to soak.

While filter soaks, clean inside the air filter housing.

Rinse the filter with warm water until all cleaning solution disappears.

NOTE: If the air filter foam is still dirty, replace it with a new one.

Then, let the filter dry completely.

When the filter is dried, re-oiled with air filter oil (P/N 219 700 340) or an equivalent.

CAUTION: Engine performance degradation or severe damages can occur if the air filter is not properly maintained and/or if it not well oiled.

Installation

Properly reinstall removed parts in the reverse order of their removal.

NOTE: Make sure that air filter housing cover is installed properly.

Air Filter Housing Draining

CAUTION: Never remove or modify any component in the air filter housing. The engine carburetion is calibrated to operate specifically with these components. Otherwise, engine performance degradation or damage can occur.

Periodically inspect air filter housing drain tube for liquid or deposits.

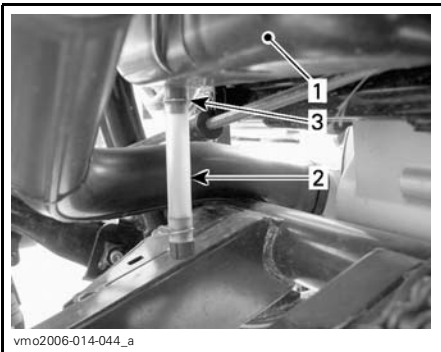

vmo2006-014-044_a

TYPICAL

1. Air filter housing
2. Drain tube
3. Clamp

NOTE: If vehicle is used in dusty area, inspect more frequently than specified in *MAINTENANCE CHART*.

If liquid/deposits are found, squeeze and remove the clamp. Pull drain tube out and empty it.

CAUTION: Do not start engine when liquid/deposits are found in the drain tube.

When liquid/deposits are found, the air filter must be inspected/dried/replaced depending on its condition.

Oil Change and Oil Strainer Cleaning

Oil change should be done with a warm engine.

WARNING

The engine oil can be very hot. In order to avoid potential burns, do not remove the engine drain plug or the oil strainer cover if the engine is hot. Wait until engine oil is warm.

Ensure vehicle is on a level surface.

Remove dipstick.

Clean the drain plug area.

Place a drain pan under the engine drain plug area.

Unscrew drain plug.

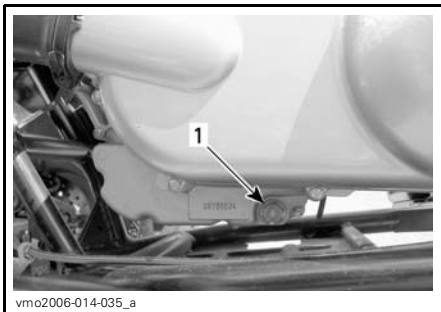

vmo2006-014-035_a

LH SIDE UNDERNEATH CVT COVER

1. Oil drain plug

Unscrew the oil strainer cover.

Allow enough time for oil to flow out of oil strainer hole.

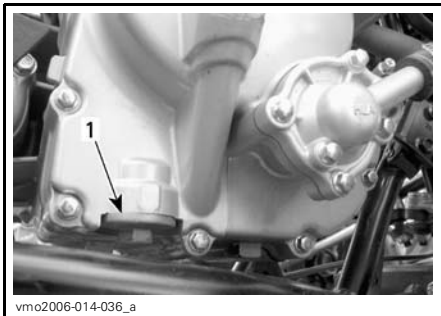

vmo2006-014-036_a

RH SIDE OF ENGINE

1. Oil strainer cover

Remove oil strainer and spring.

To clean oil strainer, use a solvent then dry with compressed air.

WARNING

Always wear eye protector. Chemicals can cause a rash break out and an injury to your eyes.

NOTE: Check cover O-ring and replace it if necessary.

Wipe out any oil spillage on engine.

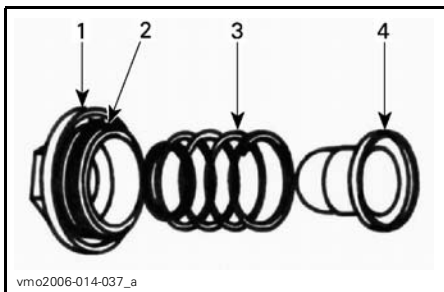

1. Cover
2. O-ring
3. Spring
4. Strainer

Reinstall oil strainer, spring, O-ring and torque cover to 15 N•m (133 lbf•in).

Verify drain plug washer condition and replace it if necessary.

Clean washer area on engine and drain plug then reinstall plug and torque it to 39 N•m (29 lbf•ft).

Refill engine at the proper level with the recommended oil. Refer to *SPECIFICATIONS* for capacity.

NOTE: Engine oil quantity is also written on the dipstick.

Start engine and let idle for a few minutes. Ensure oil strainer and drain plug areas are not leaking.

Stop engine. Wait a while to allow oil to flow down to crankcase then check oil level. Refill as necessary.

Dispose of oil as per your local environmental regulations.

Radiator

Periodically check the radiator area for cleanliness.

Inspect radiating fins. They must be clean, free of mud, dirt, leaves and any other deposit that would prevent the radiator to cool properly.

Remove as much deposits as you can with your hands. If water is available in proximity, try rinsing the radiating fins.

If available, use a garden hose to rinse the radiating fins.

⚠ WARNING

Never clean radiator with your hands when it is hot. Let the radiator cool down before cleaning.

CAUTION: Be careful not to damage the radiating fins when cleaning. Do not use any object/tool that could damage the fins. The fins are purposely thin parts to allow efficient cooling. **WHEN HOSING, USE LOW PRESSURE ONLY. NEVER USE A HIGH PRESSURE WASHER.**

See an authorized Can-Am distributor/dealer to check the performance of the cooling system.

Engine Coolant Replacement

⚠ WARNING

In order to avoid potential burns, do not remove the radiator cap or loosen the coolant drain plug if the engine is hot.

Remove front fender access cover.

Turn the radiator cap counterclockwise and remove it.

Unscrew the drain plug located on the right side of engine and drain the coolant into a suitable container.

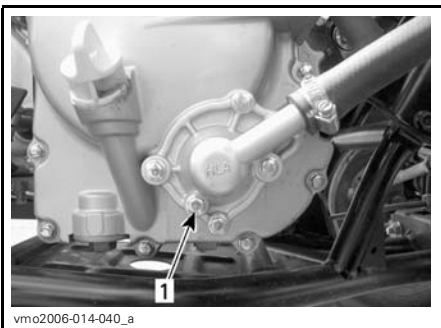

1. Cooling drain plug

Unplug the by-pass hose on the top of thermostat housing.

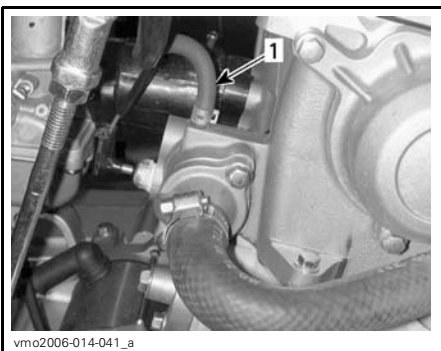

1. By-pass hose

Drain the system completely and reinstall the drain plug.

Pinch hose between radiator and thermostat housing with a large hose pincher (P/N 529 032 500).



HOSE PINCHER LOCATION

Lift the front of vehicle high enough to have front wheels off the ground.

Fill the radiator until the coolant comes out by the thermostat housing by-pass hose hole. Install the by-pass hose then remove the hose pincher.

NOTE: If no coolant comes out by the by-pass hose hole, squeeze the lower radiator hose several times until coolant comes out.

Complete the radiator filling.

Check the level in the coolant reservoir and refill if necessary.

Run engine at idle with the radiator cap off. Slowly add additional coolant if necessary.

At this point, wait until engine reaches normal operating temperature. Depress the throttle lever two or three times; then add coolant if required.

Install radiator cap. Inspect all connections for leaks and check coolant level in the reservoir.

Air Injection Valve Filter Cleaning

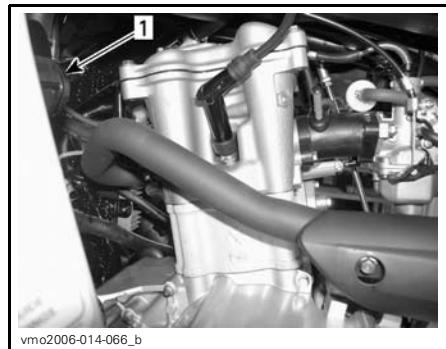

LH SIDE OF ENGINE

1. Air injection valve

Disconnect hoses from air injection valve.

Remove air injection valve from its support.

While holding one half, turn the other half counterclockwise to open.

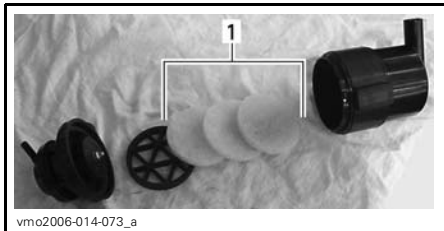

1. Filters

Pour cleaning solution (P/N 219 700 341) or an equivalent into a bucket. Put filters in to soak.

While filters soaks, clean inside the air injection valve.

Rinse filters with warm water until all cleaning solution disappears.

NOTE: If air filters are still dirty, replace them with new ones.

Then, let filters dry completely.

When finished, properly reinstall removed parts in the reverse order of their removal.

CARBURETOR

See an authorized Can-Am distributor/dealer each year to verify and clean the fuel system.

TRANSMISSION

Drive Belt

See an authorized Can-Am dealer to inspect and/or replace the drive belt.

CVT Cover Drain Tube

Any time you suspect that water has entered the CVT cover, drain the CVT housing by removing the drain tube.

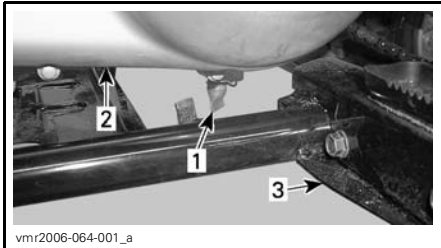

vmr2006-064-001_a

1. CVT cover drain tube
2. CVT cover
3. LH footrest

GEARBOX

Oil Change

Place the vehicle on a level surface.

Remove the drive chain protector.



1. Drive chain protector

Clean fill and drain plug areas.

Remove gearbox fill plug.

Place a drain pan under the gearbox drain plug area then remove plug.

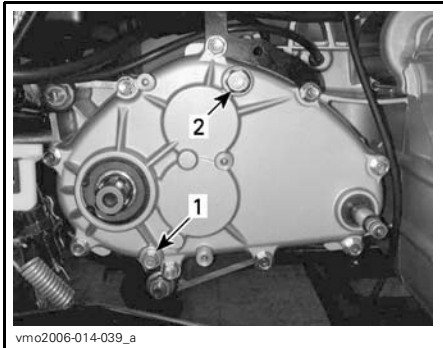

1. Gearbox drain plug
2. Gearbox fill plug

NOTE: To completely drain the gearbox, place a jack under the left footpeg and tilt the vehicle toward the right side.

When the gearbox is empty, install and torque the drain plug at 9 N•m (80 lbf•in) and replace the vehicle on the ground.

Refill gearbox, using 800 mL (27 U.S. oz) of XP-S chaincase oil (P/N 413 801 900) or an equivalent.

NOTE: Gearbox oil quantity is also written on the gearbox cover.

CAUTION: Do not use other unrecommended types of oil when servicing. Do not mix with other types of oil.

Reinstall and torque oil fill plug to 39 N•m (29 lbf•ft).

FUEL SYSTEM

Throttle Cable Lubrication

The throttle cable must be lubricated with silicone cable lubricant (P/N 293 600 041) or an equivalent.

WARNING

Always use a silicone-based lubricant. Using another lubricant (like water-based lubricant) could cause the throttle lever/cable sticking or stiffness.

Open the throttle lever housing.

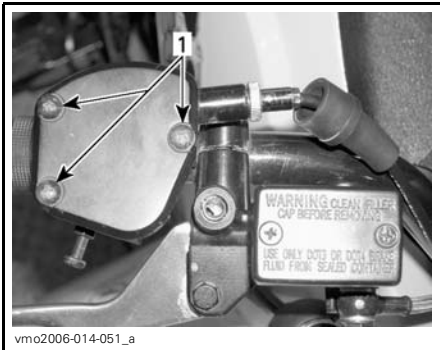

1. Remove screws

Slide the rubber protector to expose the cable adjuster.

Unscrew the lock nut of the cable adjuster then screw in the adjuster to release the cable tension.

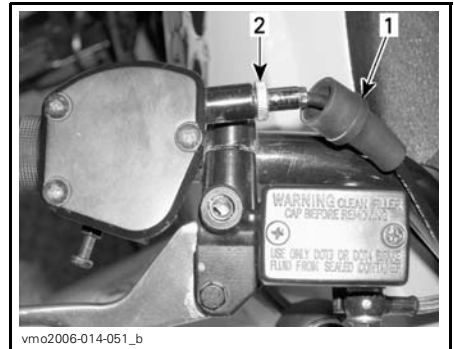

1. Rubber protector
2. Cable adjuster

Remove the cable from the throttle lever.

NOTE: Slide cable in clip slot and remove the end of cable from clip.

Remove the carburetor cap on top of the carburetor. Place the carburetor cap far from carburetor body.

Install the cable luber (P/N 529 035 738) on the cable.

Insert the needle of spray can in the cable luber hole.

WARNING

Always wear eye protection and gloves when you lubricate a cable.

NOTE: Place a rag around the cable luber to prevent the lubricant splash.

Add lubricant until it runs out at carburetor end of the throttle cable.

Let the cable hang during approximately 15 minutes or until no lubricant flows out of cable.

Reinstall carburetor cap.

Reinstall and adjust the cable.

Throttle Lever Adjustment

Slide rubber protector back to expose throttle cable adjuster.

Loosen lock nut then turn the adjuster to obtain correct throttle lever free play.

NOTE: Measure throttle free play at the tip of throttle lever.

Tighten lock nut and reinstall protector.

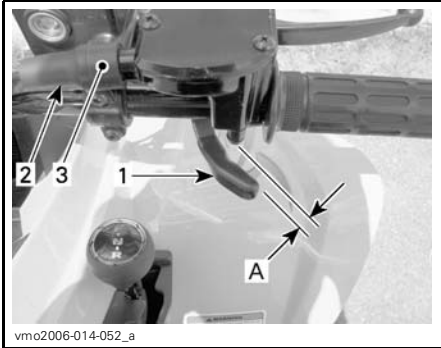

1. Throttle lever
2. Protector
3. Cable adjuster

A. 1 to 3 mm (.039 to .118 in)

With the transmission lever on NEUTRAL position, start the engine. Check if the throttle cable is adjusted correctly by turning handlebar fully right then fully left. If the engine RPM increases, readjust the throttle lever free play.

ELECTRICAL

WARNING

Unless otherwise informed, always turn ignition switch to the OFF position before performing any maintenance or repair on electrical system.

Spark Plug

Removal

Unplug spark plug cable.

Unscrew spark plug one turn.

Clean spark plug and cylinder head with pressurized air if possible.

WARNING

Always wear safety goggles when using pressurized air.

Unscrew spark plug completely then remove them.

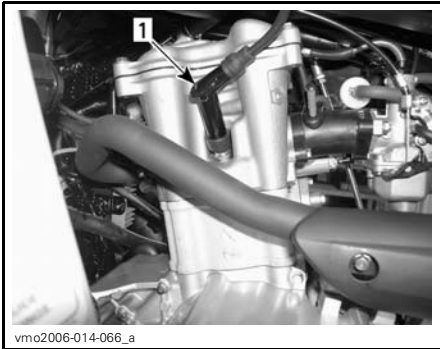

LH SIDE OF ENGINE
1. Spark Plug

Installation

Prior to installation make sure that contact surface of cylinder head and spark plug is free of grime.

Using a feeler gauge, set the spark plug gap to 0.8 mm (0.31 in).

Apply anti-seize lubricant over spark plug threads to prevent a possible seizure.

Screw spark plug into cylinder head by hand and tighten with a torque wrench and a proper socket.

Torque spark plug to 11 N•m (97 lbf•in).

Battery

WARNING

Never charge a battery while installed in vehicle.

These vehicles are equipped with a VRLA battery (Valve Regulated Lead Acid). It is a maintenance-free type battery, there is no need to add water to adjust electrolyte level.

CAUTION: Never remove the battery sealing cap.

Clean battery post with a wire brush. Apply dielectric grease (P/N 293 550 004) or an equivalent on post to protect against oxidation.

Removal

Disconnect BLACK (-) cable first then RED (+) cable.

WARNING

Always respect this order for disassembly; disconnect BLACK (-) cable first.

Remove the holding strap.

Remove battery from vehicle.

Cleaning

Clean battery, battery casing, cables and battery posts using a solution of baking soda and water.

Remove corrosion from battery cable terminals and battery posts using a firm wire brush. Battery top should be cleaned by soft brush and any grease-cutting soap or baking soda solution.

Installation

Reinstall battery in vehicle.

WARNING

Connect RED (+) cable first then BLACK (-) cable. Always connect RED (+) cable first.

Fuse

If fuses are damaged, replace them by one of the same rating.

CAUTION: Do not use a higher rated fuse as this can cause severe damage.

Fuses are located underneath the seat in the service compartment. Remove the seat to allow an access at the fuse holder.



1. Fuse holder

To remove fuse from holder, unclip and remove holder cover then pull fuse out. Check if filament is melted.

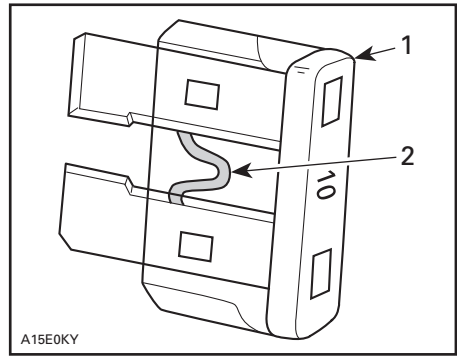

1. Fuse
2. Check if melted

Bulb Replacement

WARNING

Always turn the ignition switch to OFF position before replacing a defective bulb.

Always check light operation after replacement.

Headlamp

CAUTION: Never touch glass portion of an halogen bulb with bare fingers, it shortens its operating life. If glass is touched, clean it with isopropyl alcohol which will not leave a film on the bulb.

To unplug connector, remove rubber protector from headlamp housing, then pull on connector using a wiggle movement.

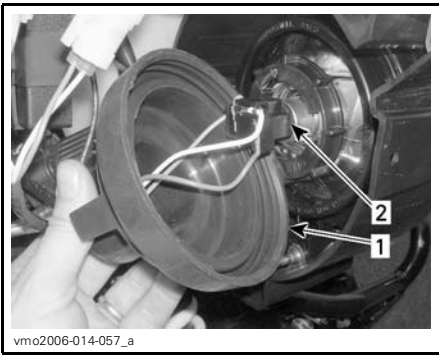

vmo2006-014-057_a

1. Remove rubber protector
2. Pull on connector using a wiggle movement

Unlock bulb holder by turning it counterclockwise.

Replace bulb.

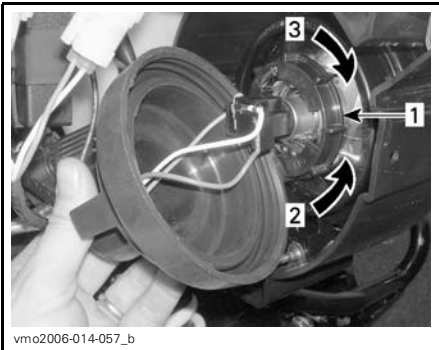

vmo2006-014-057_b

1. Bulb holder
2. Unlock (open)
3. Lock (close)

Properly reinstall removed parts in the reverse order of their removal.

Adjust Beam Aiming as Follows:

Turn knob to adjust beam height orientation to your convenience. Adjust both headlamps evenly.

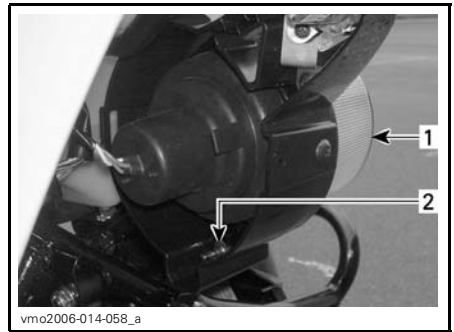

vmo2006-014-058_a

1. Headlamp housing
2. Beam height adjustment

Taillight

Unscrew lens screws to expose bulb.

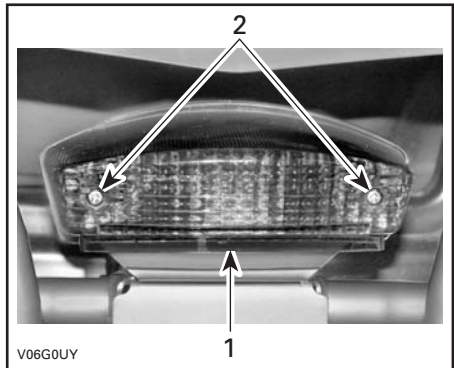

V06G0UY

- TYPICAL**
1. Lens
 2. Screws

Push bulb in and hold while turning counterclockwise to release.

Install the new bulb by first pushing in while turning clockwise. Reinstall lens.

Front Direction Indicator Lamps

Remove rubber protector then pull on rubber bulb housing to gain access to bulb.

Replace bulb.



vmo2006-014-071

PULL ON BULB HOUSING TO REMOVE

Rear Direction Indicator Lamps

Unscrew housing cover screws and lower housing retaining screws.

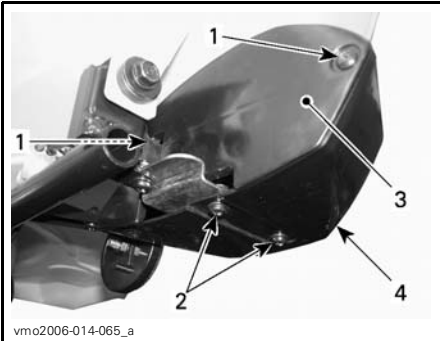

vmo2006-014-065_a

1. Housing cover screws
2. Lower housing screws
3. Housing cover
4. Housing

Release housing from rear fender then remove lamp housing.



vmo2006-014-067_a

RELEASE HOUSING FROM REAR FENDER

Remove lamp lens.



vmo2006-014-068_a

PULL ON LENS TO REMOVE

1. Lamp lens

Push bulb in and hold while turning counterclockwise to release.

Install the new bulb by first pushing in while turning clockwise.

Properly reinstall removed parts in the reverse order of their removal.

Position Light



vmo2006-014-069_a

BULB ACCESS

Pull on rubber bulb housing to gain access to bulb.

Replace bulb.

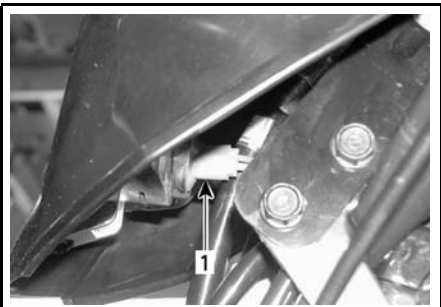

vmo2006-014-070_a

1. *Bulb housing*

DRIVE TRAIN

Drive Chain

Adjust and lubricate drive chain before each use.

WARNING

Place ignition switch to the OFF position before checking, adjusting or lubricating the drive chain.

CAUTION: Never operate this vehicle with the drive chain too loose or too tight as severe damage to the drive components can occur.

Inspection

This vehicle is equipped with O-ring sealed permanently greased pins and rollers. Before operating the vehicle, always inspect the drive chain.

Check the free play of drive chain and adjust if necessary.

Check for damage or missing O-ring or rollers.

Cleaning and Lubrication

CAUTION: Never wash the chain with a high pressure washer or gasoline. Damage to the O-ring will result, causing premature wear and drive chain failure.

Clean the side surfaces of the chain with a dry cloth.

NOTE: Do not brush chain.

Lubricate only with an approved O-ring chain lubricant. Other commercial chain lubricants may contain solvent which could damage the O-rings.

Adjustment

NOTE: Never adjust drive chain with the driver seated on the vehicle. Remove all load on vehicle.

Select a level surface and set transmission to NEUTRAL.

Loosen chain tensioner lock bolts and caliper support bolt.

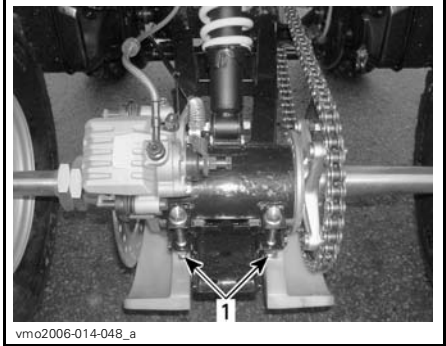

TYPICAL

1. Chain tensioner lock bolts

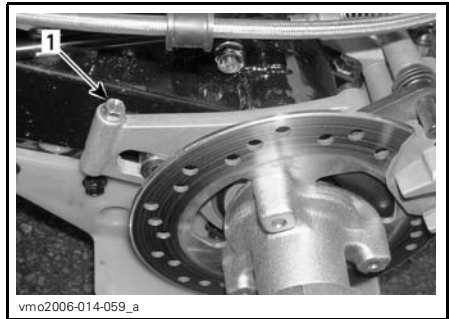

1. Caliper support bolt

Insert adjuster lock through sprocket hub and into chain tensioner.

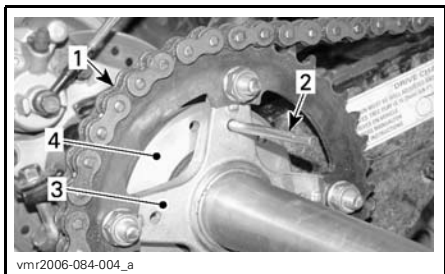

1. Drive chain
2. Adjuster lock
3. Sprocket hub
4. Chain tensioner

Adjust chain deflection by slowly moving the vehicle forward or backward.

The deflection on the top of the chain should be between 15 and 25 mm (5/8 and 1 in).

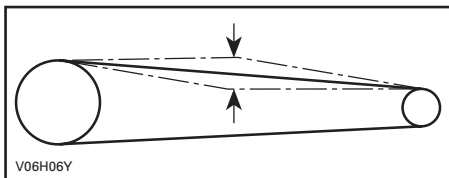

Tighten the chain tensioner lock bolts to 62 N•m (46 lbf•ft) and caliper support bolt to 12 N•m (106 lbf•in).

CAUTION: Never operate this vehicle with the drive chain too loose or too tight as severe damage to the drive components can occur.

When the adjustment is done, repeat the above procedure to check the deflection several times at different spots on the chain.

Sprocket and Pinion

Check the sprocket axle and pinion for distortion, excessive wear or other damages.

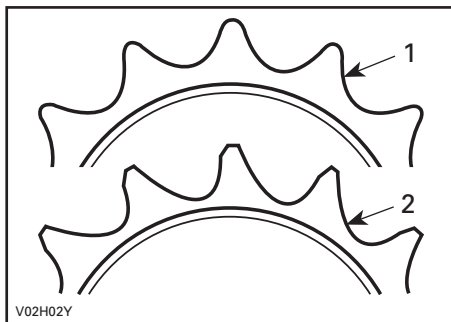

1. Good
2. Replace

CAUTION: Replace chain, sprocket axle and pinion together to prevent rapid chain and sprocket wear. Install a new retaining ring each time the pinion is removed.

Wheel

Occasionally, wheel nuts should be removed to apply anti-seize lubricant on studs to ease future removal. This is particularly important when vehicle is used in salt-water environment or in mud. Remove one nut at a time, lubricate then retorque to 50 N•m (37 lbf•ft).

Wheel Bearing/Bushings Condition

Push and pull the wheels from the upper edge to feel the play. See an authorized Can-Am distributor/dealer if there is any play.

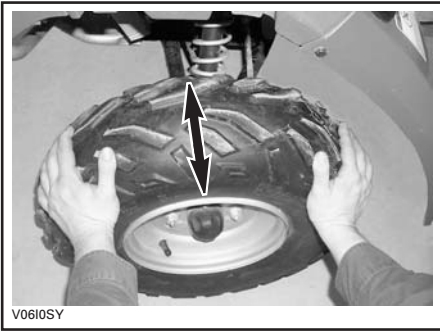

TYPICAL

Tires/Wheels

Tire Pressure

WARNING

Tire pressure greatly affects vehicle handling and stability. Underpressure may cause tire to deflate and rotate on wheel. Overpressure may burst the tire. Always follow recommended pressure. Since tires are low-pressure types, a manual pump should be used.

Check pressure when tires are “cold” before using the vehicle. Tire pressure changes with temperature and altitude. Recheck pressure if one of these conditions has changed.

For your convenience, a pressure gauge is supplied in tool kit.

TIRE PRESSURE		
UP to 150 kg (330 lb)	MAX.	FRONT/REAR 34 kPa (5 PSI)
	MIN.	26 kPa (3.8 PSI)

Although the tires are specifically designed for off-road use, a flat may still occur. Therefore, it is recommended to carry a tire pump and a repair kit.

Tire/Wheel Condition

Check tire for damage and wear. Replace if necessary.

Do not rotate tires. The front and rear tires have a different size. The tires are directional and their rotation must be kept in a specific direction for proper operation.

Wheel Removal

Loosen nuts then lift vehicle. Place a support under vehicle. Remove nuts then remove wheel.

At installation, it is recommended to apply anti-seize lubricant on threads. Gently tighten nuts in a criss-cross sequence then apply a final torque of 50 N•m (37 lbf•ft).

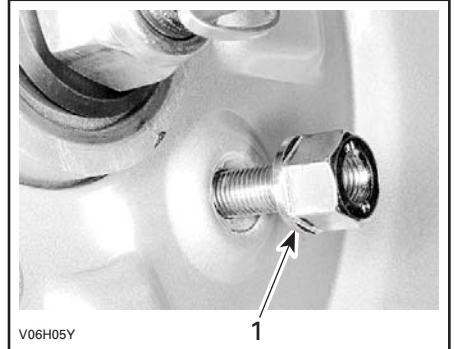

TYPICAL

1. Taper side of nut

CAUTION: Always use the recommended wheel nuts. Using a different nut could cause damages to the rim.

SUSPENSION

Adjustment

WARNING

Adjust both springs to the same length. Uneven adjustment can cause poor handling and loss of stability and/or control, and increase the risk of an accident.

Spring preload may vary from rider to rider depending upon their weight. Preload can be changed by setting both lock nuts up or down to compress the spring to different lengths.

Shorten the spring for a firmer ride and rough road condition.

Lengthen the spring for a light load and a smooth road condition.



FRONT SUSPENSION

A. Same length on both sides

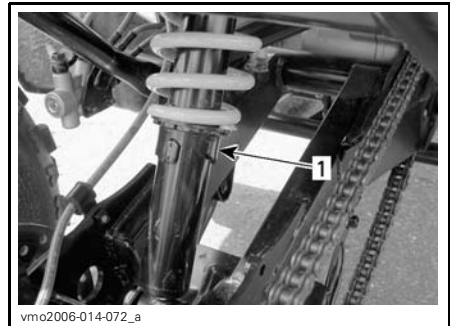

REAR SUSPENSION

1. Preload cam

Lubrication

Swing Arm

Lubricate swing arm pivots. Use synthetic grease (P/N 293 550 033) or an equivalent.

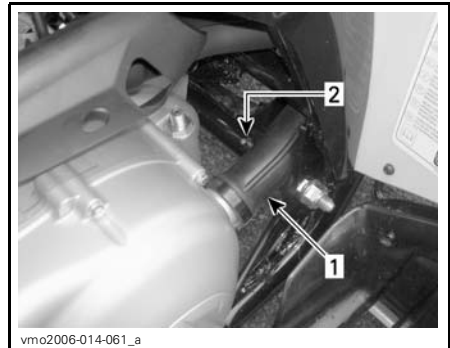

LH SIDE OF VEHICLE

1. CVT duct
2. Grease fitting

Inspection

Front and Rear Suspension

Inspect shock absorbers for oil leaks and fasteners for tightness. See an authorized Can-Am distributor/dealer as necessary.

Swing Arm

Check swing arm for distortion, cracks or bending. See an authorized Can-Am distributor/dealer if any problem is detected.

A-Arms

Check A-arms for cracks, bending or other damages. See an authorized Can-Am distributor/dealer as necessary.

BRAKE

Inspection

Front Brakes

The front braking system is a hydraulic type and no adjustment is required.

Rear Brake

The rear brake employs two systems. The first system uses a cable; an adjustment is necessary. See *PARKING BRAKE* cable adjustment.

The second system is hydraulic and requires no adjustment.

Front and Rear Brakes

Check the following to keep the brakes in a good operating condition:

- brake fluid level
- parking brake cable adjustment
- brake system for fluid leaks
- brake cleanliness
- brake for spongy feel
- brake discs for excessive wear and surface condition
- brake pads for wear, damage or looseness.

SERVICE LIMITS	
Brake pads thickness	2 mm (.079 in)
Brake discs thickness	2 mm (.079 in)
Maximum discs warpage	0.15 mm (.010 in)

See your authorized Can-Am dealer if a problem is detected concerning the brake system.

WARNING

The brake fluid replacement or brake system maintenance and repairs should be performed by an authorized Can-Am dealer.

Parking Brake

Cable Adjustment

Ensure that parking brake is in OFF position (not locked).

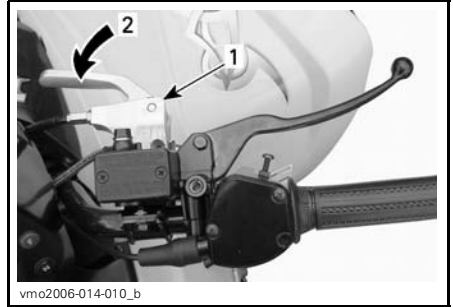

1. Brake lever
2. OFF position

Loosen rear caliper cable adjuster locking nut.

Turn cable adjuster clockwise until a small resistance is felt.

Turn cable adjuster counterclockwise just enough so that there is no contact between cable adjuster and caliper piston.

Tighten lock nut and verify that parking brake is working properly.

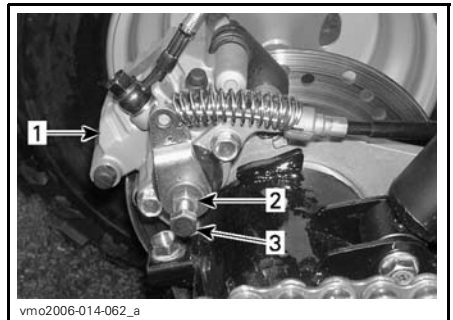

1. Rear caliper
2. Lock nut
3. Cable adjuster

CAUTION: Make sure that rear wheels are locked when parking brake is in ON position and that wheels moves freely when parking brake is in OFF position.

Brake Cable Lubrication

Remove cable from hand lever.

Put the cable luber (P/N 529 035 738) on the cable.

Insert the needle of the spray can in the hole.

Spray a small quantity of silicone cable lubricant (P/N 293 600 041) or and equivalent. Repeat this procedure until the silicone lubricant exits the other end of the cable.

WARNING

Always use a silicone-based lubricant. Using another lubricant (like water-based lubricant) could cause brake cable sticking or stiffness.

BODY/FRAME

Engine Area

Check engine area for any damage and leaks. Ensure all hose clamps are properly secured and no hose is cracked, kinked or otherwise damaged.

Inspect muffler, battery and reservoir fastening devices.

Check electrical connections for corrosion and tightness.

Replace or have damaged parts repaired.

Hitch/Trailer Ball Condition (if so equipped)

Check tightness of fasteners and tightness/condition of trailer ball. Properly retighten as necessary and replace ball if worn.

Frame Fasteners

Check fastener condition and tightness on the vehicle. Retighten as required.

Seat Fasteners

Check tightness of seat fasteners. Retorque or replace if necessary.

Vehicle Cleaning and Protection

Never use the high pressure washer to clean the vehicle **USE LOW PRESSURE ONLY (like a garden hose)**. The high pressure can cause electrical or mechanical damages.

Painted parts which are damaged should be properly repainted to prevent rust.

When required, wash the body with hot water and soap (only use mild detergent). Apply non-abrasive wax.

CAUTION: Never clean plastic parts with strong detergent, degreasing agent, paint thinner, acetone, etc.

STORAGE AND PRESEASON PREPARATION

WARNING

Have an authorized Can-Am distributor/dealer inspect fuel system integrity as specified in *MAINTENANCE CHART*.

When a vehicle is not in use for more than one month, proper storage is a necessity.

See an authorized Can-Am distributor/dealer for proper procedures.

When using your vehicle after storage, a preparation is required. See an authorized Can-Am distributor/dealer for proper procedures.

WARRANTY

BRP INTERNATIONAL LIMITED WARRANTY: 2008 CAN-AM™ ATV

1) SCOPE OF THE LIMITED WARRANTY

Bombardier Recreational Products Inc. ("BRP")* warrants its 2008 Can-Am ATV from defects in material or workmanship for the period and under the conditions described below.

All genuine Can-Am ATV parts and accessories, installed by an authorized Can-Am distributor/dealer (as hereinafter defined) at the time of delivery of the 2008 Can-Am ATV, carry the same warranty as that of the Can-Am ATV.

Use of the product for racing or any other competitive activity, at any point, even by a previous owner will render this warranty null and void.

2) EXCLUSIONS – ARE NOT WARRANTED

The following are not warranted under any circumstances:

- Normal wear and tear;
- Routine maintenance items, tune ups, adjustments;
- Damage caused by failure to provide proper maintenance and/or storage, as described in the Operator's Guide;
- Damage resulting from removal of parts, improper repairs, service, maintenance, modifications or use of parts not manufactured or approved by BRP or resulting from repairs done by a person that is not an authorized servicing Can-Am distributor/dealer;
- Damage caused by abuse, abnormal use, neglect or operation of the product in a manner inconsistent with the recommended operation described in the Operator's Guide;
- Damage resulting from accident, submersion, fire, theft, vandalism or any act of God;
- Operation with fuels, oils or lubricants which are not suitable for use with the product (see the Operator's Guide);
- Water or snow ingestion;
- Incidental or consequential damages, or damages of any kind including without limitation towing, storage, telephone, rental, taxi, inconvenience, insurance coverage, loan payments, loss of time, loss of income.

3) LIMITATIONS OF LIABILITY

THIS WARRANTY IS EXPRESSLY GIVEN AND ACCEPTED IN LIEU OF ANY AND ALL OTHER WARRANTIES, EXPRESSED OR IMPLIED, INCLUDING WITHOUT LIMITATION ANY WARRANTY OF MERCHANTABILITY OR FITNESS FOR A PARTICULAR PURPOSE. TO THE EXTENT THAT THEY CANNOT BE DISCLAIMED, THE IMPLIED WARRANTIES ARE LIMITED IN DURATION TO THE LIFE OF THE EXPRESS WARRANTY. INCIDENTAL AND CONSEQUENTIAL DAMAGES ARE EXCLUDED FROM COVERAGE UNDER THIS WARRANTY. SOME JURISDICTIONS DO NOT ALLOW FOR THE DISCLAIMERS, LIMITATIONS AND EXCLUSIONS IDENTIFIED ABOVE, AS A RESULT, THEY MAY NOT APPLY TO YOU. THIS WARRANTY GIVES YOU SPECIFIC RIGHTS, AND YOU MAY ALSO HAVE OTHER LEGAL RIGHTS WHICH MAY VARY FROM COUNTRY TO COUNTRY.

Neither the distributor, any Can-Am dealer nor any other person has been authorized to make any affirmation, representation or warranty regarding the product, other than those contained in this limited warranty, and if made, shall not be enforceable against BRP.

BRP reserves the right to modify this warranty at any time, being understood that such modification will not alter the warranty conditions applicable to the products sold while this warranty is in effect.

4) WARRANTY COVERAGE PERIOD

This warranty will be in effect from the date of delivery to the first retail consumer or the date the product is first put into use, whichever occurs first and for a period of:

SIX (6) CONSECUTIVE MONTHS, for private use or commercial use.

The repair or replacement of parts or the performance of service under this warranty does not extend the life of this warranty beyond its original expiration date.

5) CONDITIONS TO HAVE WARRANTY COVERAGE

This warranty coverage is available **only** if **each** of the following conditions has been fulfilled:

- The 2008 Can-Am ATV must be purchased as new and unused by its first owner from a Can-Am distributor/dealer authorized to distribute Can-Am ATVs in the country in which the sale occurred (“Can-Am distributor/dealer”);
- The BRP specified pre-delivery inspection process must be completed and documented;
- The product must have undergone proper registration by an authorized Can-Am distributor/dealer;
- The 2008 Can-Am ATV must be purchased in the country or union of countries in which the purchaser resides;
- Routine maintenance outlined in the Operator’s Guide must be timely performed in order to maintain warranty coverage. BRP reserves the right to make warranty coverage contingent upon proof of proper maintenance.

BRP will not honour this limited warranty to any private use owner or commercial use owner if the preceding conditions have not been met. Such limitations are necessary in order to allow BRP to preserve both the safety of its products, and also that of its consumers and the general public.

6) WHAT TO DO TO OBTAIN WARRANTY COVERAGE

The customer must notify a servicing Can-Am distributor/dealer within two (2) days of the appearance of a defect, and provide it with reasonable access to the product and reasonable opportunity to repair it. The customer must also present to the authorized Can-Am distributor/dealer, proof of purchase of the product and must sign the repair/work order prior to starting the repair in order to validate the warranty repair. All parts replaced under this limited warranty become the property of BRP.

7) WHAT BRP WILL DO

BRP's obligations under this warranty are limited to, at its sole discretion, repairing parts found defective under normal use, maintenance and service; or replacing such parts with new genuine Can-Am ATV parts without charge for parts and labour, at any authorized Can-Am distributor/dealer.

BRP reserves the right to improve or modify products from time to time without assuming any obligation to modify products previously manufactured.

8) TRANSFER

If the ownership of a product is transferred during the warranty coverage period, this warranty shall also be transferred and be valid for the remaining coverage period provided BRP or an authorized Can-Am distributor/dealer receives a proof that the former owner agreed to the transfer of ownership, in addition to the co-ordinates of the new owner.

9) CONSUMER ASSISTANCE

- a) In the event of a controversy or a dispute in connection with this limited warranty, BRP suggests that you try to resolve the issue at the dealership level. We recommend discussing the issue with the authorized dealer's service manager or owner.
- b) If further assistance is required, the distributor's service department should be contacted in order to resolve the matter. You will find your distributor's coordinates on www.brp.com.
- c) If the matter still remains unresolved then contact BRP by writing to us at the address listed below.

For countries within Europe, Middle East, Africa, Russia & CIS, please contact our European office:

BRP EUROPE N.V.

Consumer Service Center
Skaldenstraat 125
9042 Gent
Belgium
Tel.: + 32-9-218-26-00

For Scandinavian countries, please contact our Finland office:

BRP FINLAND OY

Service Department
Ahjotie 30
Fin-96320 Rovaniemi
Finland
Tel.: + 358 16 3208 111

For all other countries, please contact your local distributor or our North America office:

BOMBARDIER RECREATIONAL PRODUCTS INC.

Consumer Services Group
75, J.-A. Bombardier Street
Sherbrooke, Québec J1L 1W3
Tel.: 819 566-3366

* For the territory covered by this limited warranty, products are distributed and serviced by Bombardier Recreational Products Inc. or its affiliates.

© 2007 Bombardier Recreational Products Inc. All rights reserved.

™ Trademark of Bombardier Recreational Products Inc. or its affiliates.

BRP EUROPEAN UNION MEMBER STATES LIMITED WARRANTY: 2008 CAN-AM™ ATVS

1) SCOPE OF THE LIMITED WARRANTY

Bombardier Recreational Product Inc. ("BRP")* warrants its new and unused model-year 2008 Can-Am ATVs sold by authorized BRP distributors/dealers ("Distributors/Dealers") in the European Union member states from defects in material or workmanship for the period and under the conditions described below.

All genuine Can-Am ATV parts and accessories, installed by an authorized BRP Distributors/Dealers at the time of delivery of the 2008 Can-Am ATV, carry the same warranty as that of the ATV.

Use of the product for racing or any other competitive activity, at any point, even by a previous owner, will render this warranty null and void.

2) EXCLUSIONS – ARE NOT WARRANTED

The following are not warranted under any circumstances:

- Normal wear and tear;
- Routine maintenance items, tune ups, adjustments;
- Damage caused by failure to provide proper maintenance and/or storage, as described in the Operator's Guide;
- Damage resulting from removal of parts, improper repairs, service, maintenance, modifications or use of parts not manufactured or approved by BRP or resulting from repairs done by a person that is not an authorized servicing Distributor/Dealer;
- Damage caused by abuse, abnormal use, neglect or operation of the product in a manner inconsistent with the recommended operation described in the Operator's Guide;
- Damage resulting from accident, submersion, fire, theft, vandalism or any act of God;
- Operation with fuels, oils or lubricants which are not suitable for use with the product (see the Operator's Guide);
- Water or snow ingestion;
- Incidental or consequential damages, or damages of any kind including without limitation towing, storage, telephone, rental, taxi, inconvenience, insurance coverage, loan payments, loss of time, loss of income.

3) LIMITATIONS OF LIABILITY

THIS WARRANTY IS EXPRESSLY GIVEN AND ACCEPTED IN LIEU OF ANY AND ALL OTHER WARRANTIES, EXPRESSED OR IMPLIED, INCLUDING WITHOUT LIMITATION ANY WARRANTY OF MERCHANTABILITY OR FITNESS FOR A PARTICULAR PURPOSE. TO THE EXTENT THAT THEY CANNOT BE DISCLAIMED, THE IMPLIED WARRANTIES ARE LIMITED IN DURATION TO THE LIFE OF THE EXPRESS WARRANTY. INCIDENTAL AND CONSEQUENTIAL DAMAGES ARE EXCLUDED FROM COVERAGE UNDER THIS WARRANTY. SOME JURISDICTIONS DO NOT ALLOW FOR THE DISCLAIMERS, LIMITATIONS AND EXCLUSIONS IDENTIFIED ABOVE, AS A RESULT, THEY MAY NOT APPLY TO YOU. THIS WARRANTY GIVES YOU SPECIFIC RIGHTS, AND YOU MAY ALSO HAVE OTHER LEGAL RIGHTS WHICH MAY VARY FROM COUNTRY TO COUNTRY.

Neither the distributor, any BRP Distributor/Dealer nor any other person has been authorized to make any affirmation, representation or warranty regarding the product, other than those contained in this limited warranty, and if made, shall not be enforceable against BRP.

BRP reserves the right to modify this warranty at any time, being understood that such modification will not alter the warranty conditions applicable to the products sold while this warranty is in effect.

4) WARRANTY COVERAGE PERIOD

This warranty will be in effect from the date of delivery to the first retail consumer or the date the product is first put into use, whichever occurs first and for a period of:

TWENTY-FOUR (24) CONSECUTIVE MONTHS for private and commercial use.

The repair or replacement of parts or the performance of service under this warranty does not extend the life of this warranty beyond its original expiration date.

Note that the duration and any other modalities of the warranty coverage are subject to the applicable national or local legislation in your country.

5) CONDITIONS TO HAVE WARRANTY COVERAGE

This warranty coverage is available **only** if **each** of the following conditions has been fulfilled:

- The 2008 Can-Am ATV must be purchased as new and unused by its first owner from a Can-Am Distributor/Dealer authorized to distribute Can-Am ATVs in the country in which the sale occurred;
- The BRP specified pre-delivery inspection process must be completed and documented;
- The product must have undergone proper registration by an authorized Can-Am Distributor/Dealer;
- The 2008 Can-Am ATV must be purchased in the country or union of countries in which the purchaser resides;
- Routine maintenance outlined in the Operator's Guide must be timely performed in order to maintain warranty coverage. BRP reserves the right to make warranty coverage contingent upon proof of proper maintenance.

BRP will not honour this limited warranty to any private use owner or commercial use owner if the preceding conditions have not been met. Such limitations are necessary in order to allow BRP to preserve both the safety of its products, and also that of its consumers and the general public.

6) WHAT TO DO TO OBTAIN WARRANTY COVERAGE

The customer must notify a servicing BRP Distributor/Dealer within two (2) months of the appearance of a defect, and provide it with reasonable access to the product and reasonable opportunity to repair it. The customer must also present to the authorized BRP Distributor/Dealer, proof of purchase of the product and must sign the repair/work order prior to starting the repair in order to validate the warranty repair. All parts replaced under this limited warranty become the property of BRP.

Note that the notification period is subject to the applicable national or local legislation in your country.

7) WHAT BRP WILL DO

BRP's obligations under this warranty are limited to, at its sole discretion, repairing parts found defective under normal use, maintenance and service, or replacing such parts with new genuine Can-Am parts without charge for parts and labor, at any authorized BRP Distributor/Dealer during the warranty coverage period.

BRP reserves the right to improve or modify products from time to time without assuming any obligation to modify products previously manufactured.

8) TRANSFER

If the ownership of a product is transferred during the warranty coverage period, this warranty shall also be transferred and be valid for the remaining coverage period provided BRP or an authorized BRP Distributor/Dealer receives a proof that the former owner agreed to the transfer of ownership, in addition to the co-ordinates of the new owner.

9) CONSUMER ASSISTANCE

- a) In the event of a controversy or a dispute in connection with this limited warranty, BRP suggests that you try to resolve the issue at the dealership level. We recommend discussing the issue with the authorized Distributor/Dealer's service manager or owner.
- b) If further assistance is required, the distributor's service department should be contacted in order to resolve the matter. You will find your distributor's coordinates on www.brp.com.
- c) If the matter still remains unresolved then contact BRP at the address listed below.

For countries within Europe, Middle East, Africa, Russia & CIS, please contact our European office:

BRP EUROPE N.V.

Consumer Service Center
Skaldenstraat 125
9042 Gent
Belgium
Tel.: + 32-9-218-26-00

For Scandinavian countries, please contact our Finland office:

BRP FINLAND OY

Service Department
Ahjotie 30
Fin-96320 Rovaniemi
Finland
Tel.: + 358 16 3208 111

For all other countries, please contact your local distributor or our North America office:

BOMBARDIER RECREATIONAL PRODUCTS INC.

Consumer Services Group
75, J.-A. Bombardier Street
Sherbrooke, Québec J1L 1W3
Tel.: 819 566-3366

* For the territory covered by this limited warranty, products are distributed and serviced by Bombardier Recreational Products Inc. or its affiliates.

© 2007 Bombardier Recreational Products Inc. All rights reserved.

™ Trademark of Bombardier Recreational Products Inc. or its affiliates.

PRIVACY OBLIGATION/DISCLAIMER

We wish to inform you that your coordinates will be used for safety and warranty purposes. Sometimes, we also use the coordinates of our clients to inform them about our products and to present them offers. Should you prefer not to receive information on our product, services and offers, please let us know by writing to the address below.

Also note that, from time to time, carefully selected and trustworthy organizations may be permitted to use the coordinates of our clients to promote quality products and services. If you prefer not to have your name and address released, please let us know by writing to the address below.

BRP EUROPEAN DISTRIBUTION

Warranty Department
Chemin de Messidor 5-7
1006 Lausanne Switzerland
Fax Number: + 41213187801

ATV MODEL No. _____

VEHICLE
IDENTIFICATION NUMBER (V.I.N.) _____

ENGINE
IDENTIFICATION NUMBER (E.I.N.) _____

Owner: _____
NAME

No. STREET APT

CITY STATE/PROVINCE ZIP/POSTAL CODE

Purchase Date _____
YEAR MONTH DAY

Warranty Expiry Date _____
YEAR MONTH DAY

To be completed by the dealer at the time of the sale.

DEALER IMPRINT AREA

V00A21L

Please verify with your dealer to ensure your vehicle has been registered with BRP.

While reading this Operator's Guide, remember that:

 **WARNING**

Indicates a potential hazard that, if not avoided, could result in serious injury or death.



WARNING

THIS VEHICLE CAN BE HAZARDOUS TO OPERATE.

A collision or rollover can occur quickly, even during routine manoeuvres such as turning and driving on hills or over obstacles, if you fail to take proper precautions.

SEVERE INJURY OR DEATH can result if you do not follow these instructions:

- **BEFORE YOU OPERATE THIS VEHICLE, READ THIS OPERATOR'S GUIDE AND ALL ON-PRODUCT LABELS.**
- **NEVER OPERATE THIS VEHICLE WITHOUT PROPER INSTRUCTIONS.** Beginners should complete a certified training course.
- **NEVER CARRY A PASSENGER.** You increase your risk of losing control if you carry a passenger.
- **NEVER OPERATE THIS VEHICLE ON ANY PAVED SURFACE** unless it is for short distances, at reduced speed and in order to move the vehicle from an off-road location to another.
- **ALWAYS RESPECT THE ROAD TRAFFIC LAWS** when you operate this vehicle on the roadway, even a dirt or gravel road.
- **ALWAYS WEAR AN APPROVED HELMET,** eye protection, and protective clothing.
- **NEVER CONSUME ALCOHOL OR DRUGS** before or while operating this vehicle.
- **NEVER OPERATE THIS VEHICLE AT EXCESSIVE SPEEDS.** You increase your risk of losing control if you operate this vehicle at speeds too fast for the terrain, visibility conditions, or your experience. The maximum speed authorized with this vehicle is 65 Km/h (40 Mph).
- **NEVER ATTEMPT WHEELIES, JUMPS, OR OTHER STUNTS.**

219 000 506

CA

OPERATOR'S GUIDE, DS250 CE / ENGLISH
GUIDE DU CONDUCTEUR, DS250 CE / ANGLAIS

FAIT AU / MADE IN CANADA

U/M:P.C.