

SEA-DOO®



2016 OPERATOR'S GUIDE

Includes Safety, Watercraft and
Maintenance Information



RXT™ / GTX† / WAKE™ PRO SERIES

WARNING

Read this guide thoroughly.
It contains important safety information.
Minimum recommended operator's age: 16 years old.
Keep this Operator's Guide in the watercraft.

2 1 9 0 0 1 6 9 0

Original Instructions

WARNING

Disregarding any of the safety precautions and instructions contained in this Operator's Guide, *SAFETY DVD* video and on-product safety labels could cause injury including the possibility of death!

CALIFORNIA PROPOSITION 65 WARNING

WARNING

This vehicle contains or emits chemicals known to the state of California to cause cancer and birth defects or other reproductive harm.



In Canada, products are distributed by Bombardier Recreational Products Inc. (BRP).

In USA, products are distributed by BRP US Inc.

This is a non-exhaustive list of trademarks that are the property of Bombardier Recreational Products Inc. or its affiliates:

4-TEC™	iBR™	RXT™-XT™
ACE™	iControl™	RXT™-XT™ aS™
D.E.S.S.™	iS™	Sea-Doo®
GTX™	iTC™	T.O.P.S.™
GTX Limited™	O.T.A.S.™	VTST™
GTX Limited iS™	Rotax®	WAKE™ PRO 215
GTX S™	RXT™	XPST™

FOREWORD

Deutsch	Dieses Handbuch ist möglicherweise in Ihrer Landessprache verfügbar. Bitte wenden Sie sich an Ihren Händler oder besuchen Sie: www.operatorsguide.brp.com .
English	This guide may be available in your language. Check with your dealer or go to: www.operatorsguide.brp.com .
Español	Es posible que este manual esté disponible en su idioma. Consulte a su distribuidor o visite: www.operatorsguide.brp.com .
Français	Ce guide peut être disponible dans votre langue. Vérifier avec votre concessionnaire ou aller à: www.operatorsguide.brp.com .
日本語	このガイドは、言語によって翻訳版が用意されています。ディーラーに問い合わせるか、次のアドレスでご確認ください： www.operatorsguide.brp.com .
Nederlands	Deze handleiding kan beschikbaar zijn in uw taal. Vraag het aan uw dealer of ga naar: www.operatorsguide.brp.com .
Norsk	Denne boken kan finnes tilgjengelig på ditt eget språk. Kontakt din forhandler eller gå til: www.operatorsguide.brp.com .
Português	Este manual pode estar disponível em seu idioma. Fale com sua concessionária ou visite o site: www.operatorsguide.brp.com .
Suomi	Käyttöohjekirja voi olla saatavissa omalla kielelläsi. Tarkista jälleenmyyjältä tai käy osoitteessa: www.operatorsguide.brp.com .
Svenska	Denna bok kan finnas tillgänglig på ditt språk. Kontakta din återförsäljare eller gå till: www.operatorsguide.brp.com .

Congratulations on your purchase of a new Sea-Doo® personal watercraft (PWC). It is backed by the BRP warranty and a network of authorized Sea-Doo personal watercraft dealers ready to provide the parts, service or accessories you may require.

Your dealer is committed to your satisfaction. He has taken training to perform the initial setup and inspection of your watercraft as well as completed the final adjustment before you took possession. If you need more complete servicing information, please ask your dealer.

At delivery, you were also informed of the warranty coverage and signed the *PREDELIVERY CHECK LIST* to ensure your new watercraft was prepared to your entire satisfaction.

Know Before you Go

To learn how to reduce the risk for you or other persons being injured or killed, read the following sections before you operate the watercraft:

- *SAFETY INFORMATION*
- *WATERCRAFT INFORMATION*.

Read and understand all safety labels on your watercraft and watch attentively your *SAFETY DVD* video.

Failure to follow the warnings contained in this Operators' Guide can result in serious injury or death.

BRP highly recommends that you take a safe boating course. Please check with your dealer or local authorities for availability in your area.

In certain areas, an operator competency card is mandatory to operate a pleasure craft.

⚠ WARNING

Get familiar with this PWC; it may exceed the performance of other PWCs you have ridden.

RXT-X and RXT-X aS Models

⚠ WARNING

This is a high performance PWC. Inexperienced riders may overlook risks and be surprised by the specific behavior of this PWC in any water condition.

Safety Messages

This Operator's Guide utilizes the following symbols and words to emphasize particular information:

The safety alert symbol ⚠ indicates a potential injury hazard.

⚠ WARNING

Indicates a potential hazard which, if not avoided, could result in serious injury or death.

⚠ CAUTION Indicates a potentially hazardous situation which, if not avoided, could result in minor or moderate injury.

NOTICE Indicates an instruction which, if not followed, could severely damage watercraft components or other property.

About this Operator's Guide

This Operator's Guide has been prepared to acquaint the owner/operator or passenger with this personal watercraft and its various controls, maintenance and safe riding instructions.

Keep this Operator's Guide in the watercraft as you can refer to it for operation, instructing others, maintenance and troubleshooting.

Note that this guide is available in several languages. In the event of any discrepancy, the English version shall prevail.

If you want to view and/or print an extra copy of your Operator's Guide, simply visit the following website www.operatorsguide.brp.com.

The informations contained in this document are correct at the time of publication. However, BRP maintains a policy of continuous improvement of its products without imposing upon itself any obligation to install them on products previously manufactured. Due to late changes, some differences between the manufactured product and the descriptions and/or specifications in this guide may occur. BRP reserves the right at any time to discontinue or change specifications, designs, features, models or equipment without incurring any obligation upon itself.

This Operator's Guide and the *SAFETY DVD* video should remain with the watercraft when it's sold.

TABLE OF CONTENTS

FOREWORD	1
Know Before you Go	1
Safety Messages	2
About this Operator's Guide	2

SAFETY INFORMATION

GENERAL PRECAUTIONS	10
Avoid Carbon Monoxide Poisoning	10
Avoid Gasoline Fires and Other Hazards	10
Avoid Burns from Hot Parts	10
Accessories and Modifications	10
SPECIAL SAFETY MESSAGES	11
Reminders Regarding Safe Operation	11
Water Sports (Towing with the Watercraft)	15
Hypothermia	16
Safe Boating Courses	17
ACTIVE TECHNOLOGIES (iCONTROL)	18
Introduction	18
iTC (intelligent Throttle Control)	18
iBR (intelligent Brake and Reverse System)	19
iS (intelligent Suspension) (GTX Limited iS 260 Only)	20
SAFETY EQUIPMENT	21
Required Safety Equipment	21
Additional Recommended Equipment	23
PRACTICE EXERCISES	24
Where to Practice Exercises	24
Practice Exercises	24
Important Factors Not to Neglect	25
NAVIGATION RULES	26
Operating Rules	26
FUELING	28
Fueling Procedure	28
Fuel Requirements	28
TRAILERING INFORMATION	30
IMPORTANT ON-PRODUCT LABELS	32
Watercraft Safety Labels	32
Compliance Labels	40
PRE-RIDE INSPECTION	44
What to Do Before Launching the Watercraft	44
What to Do After Launching the Watercraft	48

WATERCRAFT INFORMATION

CONTROLS	52
1) Handlebar	53
2) Throttle Lever	53
3) iBR Lever (intelligent Brake and Reverse)	54
4) Engine Cut-Off Switch	54
5) Engine START/STOP Button	55
6) VTS (Variable Trim System) Button (all Models Except GTX 155 and GTX S 155)	56
7) Sport Button	56
8) ECO Button	56
9) MODE/SET Buttons	57
10) UP/DOWN Buttons	57
11) Cruise Button (Except RXT-X and RXT-X aS Models)	57
INFORMATION CENTER (GAUGES)	58
Information Center Description	58
1) Speedometer	60
2) Tachometer	60
3) Multifunction Gauge	60
4) Indicator Lights	62
5) Fuel Level Indication	63
6) VTS Position	63
7) iS Position (GTX Limited iS Only)	63
8) Numerical Display	64
9) Multifunction Display	66
10) Water Depth Display (GTX Limited and GTX Limited iS Models)	66
11) Lake Water Temperature Display (GTX Limited and GTX Limited iS Models)	66
12) Hour Meter Display (HR)	66
13) iBR Position	67
14) Compass	67
15) Touring Mode Indicator (all Models Except RXT-X/RXT-X aS)	67
16) Sport Mode Indicator	68
17) Boost Gauge (RXT-X/RXT-X aS)	68
Navigating the Multifunction Display	68
Changing Numerical Display Indication	71
Resetting Numerical Display Indication	72
Multifunction Gauge Setup	72
EQUIPMENT	74
1) Glove Box	74
2) Front Storage Bin	75
3) Rear Storage Bins	77
4) Fire Extinguisher Holder	78
5) Seat	78
6) Passenger Handholds	79
7) Boarding Step (If Equipped)	79

EQUIPMENT (cont'd)	
8) Boarding Platform	80
9) Speed-Ties (GTX Limited and GTX Limited iS Models)	80
10) Front and Rear Eyelets	82
11) Mooring Cleats	83
12) Bilge Drain Plugs	83
13) Adjustable Sponsons (RXT-X aS)	83
14) Adjustable Trim Tabs (RXT-X aS)	85
15) Bow Stabilizer (RXT-X aS)	86
16) Ski/Wakeboard Post (WAKE Pro model)	86
17) Wakeboard Rack (WAKE Pro model)	87
18) Steering Tilt Handle	89
19) Adjustable Ergonomic Steering (AES) (RXT-X/RXT-X aS)	90
SUSPENSION	91
iS (intelligent Suspension) (GTX Limited iS)	91
aS (adjustable Suspension) (RXT-X aS)	94
S (Manual Suspension) (GTX S 155)	95
BREAK-IN PERIOD	97
Operation During Break-In Period	97
OPERATING INSTRUCTIONS	98
Boarding the Watercraft	98
How to Start Engine	102
How to Stop the Engine	102
How to Steer the Watercraft	103
How to Engage Neutral	104
How to Engage Forward	105
How to Engage and Use Reverse	105
How to Engage and Use Braking	106
How to Use the Variable Trim System (VTS)	107
General Operating Recommendations	111
OPERATING MODES	114
Touring Mode	114
Sport Mode	114
ECO Mode (Fuel Economy Mode)	116
Cruise Mode	117
Slow Speed Mode (all Models Except RXT-X and RXT-X aS)	119
Ski Mode	121
Learning Key Mode	124
SPECIAL PROCEDURES	126
Jet Pump Water Intake and Impeller Cleaning	126
Capsized Watercraft	128
Submerged Watercraft	129
Water-Flooded Engine	129
Towing the Watercraft in Water	129

MAINTENANCE

MAINTENANCE SCHEDULE 132

MAINTENANCE PROCEDURES 136

 Engine Oil 136

 Engine Coolant 138

 Ignition Coils 139

 Spark Plugs 141

 Exhaust System 142

 Ride Plate and Water Intake Grate 144

 Sacrificial Anode 145

 Ski/Wakeboard Post (Wake) 145

 Fuses 145

WATERCRAFT CARE 148

 Post-Operation Care 148

 Watercraft Cleaning 148

STORAGE AND PRESEASON PREPARATION 149

 Storage 149

 Preseason Preparation 152

TECHNICAL INFORMATION

WATERCRAFT IDENTIFICATION 154

 Hull Identification Number 154

 Engine Identification Number 154

RF D.E.S.S. KEY 155

ENGINE EMISSIONS INFORMATION 156

 Manufacturer's Responsibility 156

 Dealer's Responsibility 156

 Owner Responsibility 156

 EPA Emission Regulations 156

SPECIFICATIONS 157

TROUBLESHOOTING

TROUBLESHOOTING GUIDELINES 166

MONITORING SYSTEM 171

 Fault Codes 171

 Indicator Lights and Message Display Information 172

 Beeper Code Information 174

WARRANTY

BRP LIMITED WARRANTY – USA AND CANADA: 2016 SEA-DOO® PERSONAL WATERCRAFT 178

US EPA EMISSION-RELATED WARRANTY 182

CALIFORNIA AND NEW YORK EMISSION CONTROL WARRANTY STATEMENT FOR MODEL YEAR 2016 SEA-DOO® PERSONAL WATERCRAFT..... 185

BRP INTERNATIONAL LIMITED WARRANTY: 2016 SEA-DOO® PERSONAL WATERCRAFT..... 189

BRP LIMITED WARRANTY FOR THE EUROPEAN ECONOMIC AREA, THE COMMONWEALTH OF THE INDEPENDENT STATES, TURKEY: 2016 SEA-DOO® PERSONAL WATERCRAFT..... 194

CUSTOMER INFORMATION

PRIVACY INFORMATION 200

CHANGE OF ADDRESS/OWNERSHIP..... 201

SAFETY INFORMATION

GENERAL PRECAUTIONS

Avoid Carbon Monoxide Poisoning

All engine exhaust contains carbon monoxide, a deadly gas. Breathing carbon monoxide can cause headaches, dizziness, drowsiness, nausea, confusion and eventually death.

Carbon monoxide is a colorless, odorless, tasteless gas that may be present even if you do not see or smell any engine exhaust. Deadly levels of carbon monoxide can collect rapidly, and you can quickly be overcome and unable to save yourself. Also, deadly levels of carbon monoxide can linger for hours or days in enclosed or poorly ventilated areas. If you experience any symptoms of carbon monoxide poisoning, leave the area immediately, get fresh air and seek medical treatment.

To prevent serious injury or death from carbon monoxide:

- Never run the watercraft in poorly ventilated or partially enclosed areas such as boat houses, seawalls or other boats in close proximity. Even if you try to ventilate engine exhaust, carbon monoxide can rapidly reach dangerous levels.
- Never run the watercraft outdoors where engine exhaust can be drawn into a building through openings such as windows and doors.
- Never stand behind the watercraft while the engine is running. A person standing behind a running engine may inhale high concentrations of exhaust fumes. Inhalation of concentrated exhaust fumes that contain carbon monoxide can result in CO poisoning, serious health problems and death.

Avoid Gasoline Fires and Other Hazards

Gasoline is extremely flammable and highly explosive. Fuel vapors can spread and be ignited by a spark or

flame many feet away from the engine. To reduce the risk of fire or explosion, follow these instructions:

- Use only an approved red gasoline container to store fuel.
- Strictly adhere to the instructions in *FUELING* section.
- Never start watercraft if gasoline or gasoline vapor odors is present in the engine compartment.
- Never start or operate the engine if the fuel cap is not properly secured.
- Do not carry gasoline containers in the front storage compartment or anywhere else on the watercraft.

Gasoline is poisonous and can cause injury or death.

- Never siphon gasoline with your mouth.
- If you swallow gasoline, get any in your eyes, or inhale gasoline vapors, see a doctor immediately.

If gasoline is spilled on you, wash thoroughly with soap and water and change your clothes.

Avoid Burns from Hot Parts

Certain components may become hot during operation. Avoid contact during and shortly after operation to avoid burns.

Accessories and Modifications

Do not make unauthorized modifications, or use accessories that are not approved by BRP. Since these changes have not been tested by BRP, they may increase the risk of accidents or injuries, and they can make the watercraft illegal for use on water.

See your authorized Sea-Doo dealer for available accessories for your watercraft.

SPECIAL SAFETY MESSAGES

Reminders Regarding Safe Operation

The performance of this watercraft may significantly exceed that of other watercrafts you may have operated. Make sure you read and understand the content of this Operator's Guide to become completely familiar with the controls and operation of the watercraft before embarking on your first trip, or taking on a passenger(s). If you have not had the opportunity to do so, practice driving solo in a suitable traffic free area to become accustomed to the feel and response of each control. Be fully familiar with all controls before accelerating above idle speed. Do not assume that all PWCs handle identically. Each model differs, often substantially.

Always keep in mind that as the throttle lever is returned to the idle position, less directional control is available. To turn the watercraft, both steering and throttle are necessary. Do not release the throttle when trying to steer away from objects. You need throttle to steer. If engine is shut off, directional control is lost.

Although most watercrafts have no means of braking, advancement in technologies now permit us to offer models that are equipped with a braking system called the iBR™ system. Practice braking maneuvers in a safe traffic-free area to become familiar with handling under braking and with stopping distances under various operating conditions.

Stopping distance will vary depending on initial speed, load, wind, number of riders and water conditions. The amount of braking power commanded by the operator using the iBR lever (Intelligent Brake and Reverse) will also affect stopping distance.

When braking, riders must brace themselves against the deceleration force to prevent from moving forward on the watercraft and losing balance.

When operating an iBR equipped watercraft, be aware that other boats following or operating in close proximity may not be able to stop as quickly.

When at speed and the brake is first applied, a plume of water will shoot up in the air behind the watercraft which may cause the operator of a following watercraft to momentarily lose sight of your PWC. It is important to inform the operator of a watercraft who intends to follow in a convoy formation, of the braking and maneuvering capability of your PWC, what the plume of water indicates, and that a greater distance should be maintained between watercrafts.

When actuating the iBR control lever while the watercraft has some forward speed, the braking mode will engage and generate a deceleration proportional to the iBR lever position. The more you pull in the iBR lever, the greater the braking force becomes. Be careful to gradually actuate the iBR lever to adjust the intensity of the braking force, and to simultaneously release the throttle lever.

Keep the tether cord clip attached to the operators' PFD or wrist (wrist strap required) at all times and keep it free from snagging on the handlebars to help ensure the engine stops should the operator fall off. After riding, remove the tether cord from the engine cut-off switch to avoid unauthorized use by children or others. If the operator falls off the watercraft and the tether cord is not attached as recommended, the watercraft engine will not stop.

Ride within your limits and level of riding ability.

Avoid aggressive maneuvers to reduce the risk of loss of control, ejection and collision. Understand and respect the performance of your watercraft.

Avoid riding in very rough waters or practicing extreme maneuvers like jumping wakes or waves.

The brake feature of the iBR system cannot prevent your PWC from drifting due to current or wind. It has no braking effect on the rearward velocity. Also note that your engine must be running to be able to use the brake.

The personal watercrafts' jet thrust can cause injury. The jet pump may pick up debris and throw it rearward causing a risk of injuring people, damaging the jet pump, or other property.

Observe the instructions on all safety labels. They are there to help assure that you have a safe and enjoyable outing.

Do not store any objects in areas that are not designed specifically for storage.

Riding with passenger(s), pulling tubes, a skier, or a wake boarder makes the PWC handle differently and requires greater skill.

Certain PWC models come equipped with tow eyelets or a ski pole (Wake only) which, can be used to attach a tow rope for a skier, tube or wake boarder. Do not use these attachment points or any other portion of the watercraft to tow a para-sail or any other craft. Personal injury or severe damage may occur.

Combustion engines need air to operate; consequently this PWC cannot be totally watertight. Any maneuvers such as turning constantly in tight circles, plunging the bow through waves, or capsizing the watercraft, that cause the air inlet openings to be under water may cause severe engine problems due to water ingestion. Refer to *HOW TO STEER WATERCRAFT* in the *OPERATING INSTRUCTIONS* section and the *WARRANTY* section contained in this Operator's Guide.

Engine exhaust contains carbon monoxide (CO), which can cause serious health problems or death if inhaled in sufficient quantities. Do not operate the PWC in a confined area or allow CO to accumulate around the PWC, or in enclosed or sheltered areas such as when docked, or when rafting. Be aware of the risk of CO emanations from exhaust of other PWCs.

Know the waters in which the watercraft is to be operated. Current, tides, rapids, hidden obstacles, wakes and waves etc. can affect safe operation. It is not advisable to operate the watercraft in rough waters or inclement weather.

In shallow water, proceed with caution and at very low speeds. Grounding or abrupt stops may result in injury and watercraft damage. Debris may also be picked up and thrown rearward by the jet pump onto people or property.

Always ride responsibly and safely. Use common sense and courtesy.

Respect no wake zones, the environment, and the rights of other users of the waterways. As the operator and owner of a PWC, you are responsible for damage by the wake of your PWC. Do not let anyone throw refuse overboard.

While your watercraft has the capacity of operating at high speeds, it is strongly recommended that high speed operation only be applied when ideal conditions exist and are permitted. Higher speed operation requires a higher degree of skill and increases the risk of severe injuries.

The forces generated on the body of riders while turning, negotiating waves or wakes, operating in choppy waters, or falling off the watercraft, especially at higher speeds, may cause injury including the possibility of broken bones or more serious bodily injuries. Remain flexible and avoid sharp turns.

PWCs are not designed for night-time operation.

Certain PWC models are equipped with an intelligent suspension (GTX Limited iS). Although the system absorbs part of the vertical forces and therefore reduces the impact force to the body, it cannot eliminate it completely. To prevent you and your passenger(s) from being bounced and eventually be ejected from the watercraft, reduce your speed.

Before Getting Underway

For safety reasons and proper care, always perform the pre-ride inspection as specified in your Operator's Guide before operating your watercraft.

Do not exceed the payload or passenger capacities for your watercraft. Overloading can affect maneuverability, stability and performance. Also, heavy seas reduce capacity. A payload or person capacity plate is not an excuse for failure to use common sense or good judgment.

Regularly inspect the PWC, hull, engine, safety equipment, and all other boating gear and keep them in safe operating condition.

Be sure you have the minimum required safety equipment, PFDs and any additional gear needed for your cruise.

Check that all lifesaving equipment, including fire extinguisher, are in safe operating condition and easily accessible. Show all passengers where this equipment is stored on the PWC, and make sure they know how to use it.

Keep an eye on the weather. Check local weather broadcasts before departure. Be alert to changing conditions.

Keep accurate and up-to-date charts of the boating area on board. Before getting underway, check water conditions in the planned boating area.

Ensure there is enough fuel on board for the planned trip. Always verify fuel level before use and during the ride. Apply the principle of 1/3 of the fuel to reach your destination, 1/3 to return, and keep 1/3 in reserve. Allow for changes due to adverse weather or other delays.

Operator and Passenger Awareness

Read and understand all safety labels on the Sea-Doo PWC, the Operator's Guide, all other safety documents, and watch the *SAFETY DVD* video before operating the PWC.

Respect applicable laws. Check local and federal boating laws applicable to the waterways where you intend to use your watercraft. Learn the local navigation rules. Know and understand the applicable navigation system (such as buoys and signs).

Remember that sun, wind, fatigue or illness may impair your judgement and reaction time.

Operation of this PWC by a person under 16 years of age, or a person with a disability that impairs vision, reaction time, judgment, or operation of the controls is NOT recommended.

Always properly use the tether cord when operating the watercraft and ensure that all passengers are familiar with its use.

Ensure that any operator and all passengers know how to swim and how to re-board the PWC from the water. Boarding in deep water can be strenuous. Practice in chest-deep water before operating or embarking your watercraft in deep water. Ensure that any operator and all passengers wear a PFD at all times and take extra precautions when boating.

Never turn handlebar while someone is near the rear of watercraft. Keep away from steering moving parts (nozzle, iBR gate, linkages, etc.).

Do not start the engine or operate the watercraft if anyone is in the water nearby, or near the rear of the watercraft.

Be aware of the iBR gate movement when starting the engine, shutting down the engine or using the iBR lever. Automatic movement of the gate may squeeze fingers or toes of people taking a hold on the back or your PWC.

The operator and passenger(s) should be properly seated and have a firm grip on a handhold before starting the watercraft, and at all times when the watercraft is in motion. All passenger(s) should be instructed to use the handholds provided, or to hold on to the waist of the person in front of them. Each passenger must be able to simultaneously place both feet firmly flat against each footwell when properly seated. When going over waves, passenger(s) may raise their body slightly off the seat to absorb the shocks with their legs.

When braking or decelerating, riders must brace themselves against the deceleration force to prevent from moving forward on the watercraft and losing balance.

When accelerating on a PWC with a passenger(s), whether from a complete stop or while underway, always do so progressively. Fast acceleration may cause your passenger(s) to lose their balance and fall rearward off the watercraft. Make sure that your passenger(s) are aware of or can anticipate any rapid acceleration.

Severe internal injuries can occur if water is forced into body cavities as a result of falling into water or being near a jet thrust nozzle. Consequently, the wear of a bottom wet suit is highly recommended.

Keep away from the intake grate while the engine is running. Items such as long hair, loose clothing, or PFD straps can become entangled in moving parts.

If the throttle lever is depressed while braking, the iBR system will disable the throttle command by the user. When releasing the iBR lever while the throttle lever is still depressed, the throttle command will regain control and generate an acceleration after a short delay. Release throttle lever if acceleration is not needed.

Before reboarding, make sure engine is off and tether cord is removed from the engine cut-off switch.

To prevent accidental starting, always detach the tether cord from the engine cut-off switch when swimmers are boarding, nearby, or during removal of any weeds or debris from the intake grate.

On a PWC, never place your feet and legs in the water to aid turning.

Operation by Minors

Minors should always be supervised by an adult whenever operating a watercraft. Laws regarding the minimum age and licensing requirements of minors may vary from one jurisdiction to another. Be sure to contact the local boating authorities for information regarding the legal operation of a PWC in the intended jurisdiction of use. BRP recommends a minimum operator age of 16 years old.

Drugs and Alcohol

Never use your PWC with drugs or alcohol. Like driving a car, driving a watercraft requires the operator to be sober, attentive and alert. Operating a watercraft while intoxicated or under the influence of drugs is not only dangerous, but it is also a Federal offense carrying a significant penalty. These laws are vigorously enforced. The use of drugs and alcohol, singly or in combination, decreases reaction time, impedes judgment, impairs vision, and inhibits your ability to safely operate a watercraft.

⚠ WARNING

Alcohol consumption and boating do not mix! Operating with the use of drugs or alcohol endangers the lives of your passengers, other boaters, and yourself. Federal laws prohibit operating a watercraft with the use of drugs or alcohol.

Water Sports (Towing with the Watercraft)**⚠ WARNING**

Avoid personal injury! Your PWC is not designed for and should not be used for pulling another craft, parasails, kites, gliders, or any device which can become airborne. Use your watercraft only for water sports it was designed for.

Water skiing, wakeboarding, or riding a towed inflatable apparatus are some of the more popular water sports. Taking part in any water sport requires increased safety awareness by the participant and the watercraft operator. If you have never towed someone behind your PWC before, it is a good idea to spend some hours as an observer, working with and learning from an experienced operator. It is also important to be aware of the skill and experience of the person being towed.

Everyone participating in a water sport should observe these guidelines:

- Riding with passenger(s) or pulling a tube, skier or wakeboarder makes the watercraft handle differently and requires greater skill.
- Always respect the safety and comfort of your passenger(s) and person being towed on skis, wakeboard or other water products.

- Always carry an observer when pulling a tube, skier or wakeboarder to observe the person being towed and inform the operator about the participants' hand signals. The operator must focus his attention on operating the watercraft and the waters ahead.
- Proceed with only as much speed as required and follow the observers' instructions.
- When pulling a tube, skier, or a wakeboarder, do not make tight sharp turns or use the braking system unless absolutely necessary. Remember that although this PWC is manoeuvrable and has stopping capabilities, the person in tow may not be able to avoid an obstacle, or the PWC with which it is being towed.
- Allow only capable swimmers to take part in any water sport.
- Always wear an approved personal flotation device (PFD). Wearing a properly designed PFD helps a stunned or unconscious person stay afloat.
- Be considerate to others you share the water with.
- Both the operator and observer should monitor the location of the tow rope when participating in watersports. A slack tow rope can become entangled with a person(s) or objects on the PWC or in the water, particularly when making a tight turn or circling, and cause serious personal injury.
- Do not tow a person in any water sport on a short tow rope such that the person inhales exhaust fumes in concentration. Inhalation of concentrated exhaust fumes, which contain carbon monoxide, can result in CO poisoning, personal injury and death.

- Use a tow rope of sufficient length and size and make sure it is adequately secured to your watercraft. Always store tow rope when not in use. While some watercrafts are equipped or can be fitted with a specially designed towing mechanism, avoid installing a tow pole on a PWC. It can become a hazard should someone fall on it.
- Give immediate attention to a person who has fallen. He or she is vulnerable in the water alone and may not be seen by other boaters.
- Approach a person in the water from the lee side (opposite the direction of the wind). Turn off the motor before coming close to the person.
- Participate in water sports only in safe areas. Stay away from other boats, channels, beaches, restricted areas, swimmers, and heavily traveled waterways and underwater obstructions.
- Turn off the engine and anchor the watercraft before swimming.
- Swim only in areas designated as safe for swimming. These are usually marked with a swim area buoy. Do not swim alone or at night.

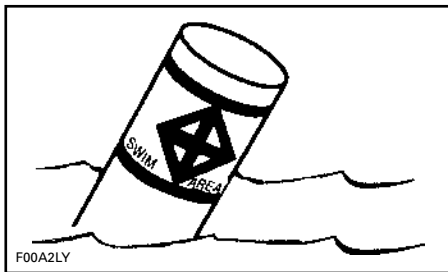

SWIM AREA BUOY

- Do not water ski between sunset and sunrise. It is illegal in most areas.

- Do not drive the watercraft directly behind a water skier, tuber or wakeboarder. At 40 km/h (25 MPH) per hour, the watercraft will overtake a person who falls in the water 60 m (197 ft) in front of your watercraft in about 5 seconds.
- Shut off the engine and remove the tether cord from the engine cut-off switch when anyone is in the water nearby.
- Stay at least 45 m (148 ft) away from areas marked by a diver down float.

Avoid personal injury! Do not allow anyone near the propulsion system or intake grate, even when the engine is off. Items such as long hair, loose clothing or personal flotation device straps can become entangled in moving parts resulting in serious injury or drowning. In shallow water, shells, sand, pebbles or other objects could be drawn up by the jet pump and be thrown rearward.

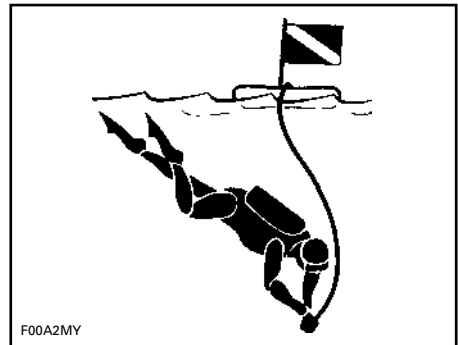

DIVER DOWN FLOAT

For more information on approved, legal and safe practice of water sports, please contact the local legal authority on water sports safety for the area you plan to practice in.

Hypothermia

Hypothermia, the loss of body heat resulting in a subnormal body temperature, is a significant cause of death in

boating accidents. After an individual has succumbed to hypothermia, he or she will lose consciousness and then drown.

PFDs can increase survival time because of the insulation they provide.

Naturally, the warmer the water, the less insulation one will require. When operating in cold water (below 4°C (40°F)) consideration should be given to using a coat or jacket style PFD as they cover more body area than the vest style PFDs.

Some points to remember about hypothermia protection:

- While afloat in the water, do not attempt to swim unless it is to reach a nearby boat, fellow survivor, or a floating object onto which you can lean or climb. Unnecessary swimming increases the rate of body heat loss. In cold water, drown-proof methods that require putting your head in the water are not recommended. Keep your head out of the water. This will greatly lessen heat loss and increase your survival time.
- Maintain a positive attitude about your survival and rescue. This will improve your chances of extending your survival time until you can be rescued. Your will to live does make a difference!
- If there is more than one person in the water, huddling together is recommended. This action tends to reduce the rate of heat loss and thus increase the survival time.
- Always wear your PFD. It won't help you fight off the effects of hypothermia if you don't have it on when you go into the water.

Safe Boating Courses

Many countries recommend or require a boating safety course. Check with your local competent authorities.

Check local and federal boating laws applicable to the waterways where you intend to use your watercraft. Learn the local navigation rules. Know and understand the applicable navigation system (such as buoys and signs).

ACTIVE TECHNOLOGIES (iCONTROL)

Introduction

NOTE: Some functions or features described in this section may not apply to every PWC model, or may be available as an option.

iControl™ (intelligent Control systems) provides an environment whereby the operator can control many systems without taking his hands off the handlebars.

All controls are at the operator's fingertips and activated by pressing a button or pulling a lever. The operator's attention can thus remain focused on the water and driving the watercraft.

Each control is electronic and provides a command signal to an electronic module whose function is to assure proper operation of its system within set parameters.

The various systems grouped under iControl are the:

- iTCT™ (intelligent Throttle Control)
- iBR (intelligent Brake and Reverse)
- iST™ (intelligent suspension) (GTX Limited iS 260 Only)
- O.T.A.S.™ (Off Throttle Assisted Steering).

These systems function together to provide features such as cruise control, slow speed mode and braking, improved watercraft response to operator inputs, increased maneuverability and control.

It is extremely important for operators to read all information contained in this Operator's Guide so as to become familiar with this watercraft, its systems, controls, capabilities and limitations.

iTC (intelligent Throttle Control)

The system uses an electronic throttle control (ETC) that provides command signals to the ECM (Engine Control Module). With this system, there is no need for a traditional throttle cable.

The iTC allows the following operating modes:

- Touring mode
- Sport mode
- ECO mode
- Cruise mode (if equipped)
- Slow speed mode (if equipped with cruise mode)
- Ski mode (if equipped).

The OTAS (Off throttle Assisted Steering) is also controlled by the iTC.

Touring Mode

The Touring mode is the default riding mode.

In touring mode, available engine power and acceleration is reduced when accelerating from a complete stop and when operating in the low engine power range under certain conditions.

ECO Mode

When ECO mode (FUEL ECONOMY mode) is selected, fuel consumption is reduced for any given RPM. This mode is ideal when cruising and maximum fuel efficiency is desired.

Refer to *OPERATING MODES* for detailed instructions.

Sport Mode

In sport mode, maximum engine power is available throughout the engine operational range.

Refer to *OPERATING MODES* for detailed instructions.

Cruise Mode

Cruise mode allows the operator to set a desired maximum speed of the watercraft when operating above 3800 RPM.

Cruise mode limits watercraft speed but does not maintain it. The operator must hold the throttle lever depressed to maintain forward speed,

unlike an automotive type cruise control which maintains a constant speed while throttle pedal is released.

As you proceed under a constant cruising speed setting, hold the throttle lever fully depressed in order to keep your full attention to maintaining good situational awareness.

Refer to *CRUISE MODE* in *OPERATING MODES* for detailed instructions.

Slow Speed Mode

Slow speed mode is a function of cruise mode which allows the operator to adjust and set idle speed corresponding to a watercraft speed of 1.6 km/h to 11 km/h (1 MPH to 7 MPH). The throttle lever should not be depressed while operating in slow speed mode.

Refer to *OPERATING MODES* for detailed instructions.

Ski Mode

Ski mode allows for a controlled launch and accurately maintained maximum towing speed when towing a skier or wake boarder.

Refer to *OPERATING MODES* for detailed instructions.

O.T.A.S. System (Off-Throttle Assisted Steering)

The O.T.A.S. (Off-Throttle Assisted Steering) system provides additional maneuverability in off-throttle situations.

Limitations

The O.T.A.S. system cannot help you maintain control or prevent collisions in all situations.

The O.T.A.S. system is electronically activated when the operator initiates a full turn and releases the throttle at the same time.

Refer to *HOW TO STEER THE WATERCRAFT* in *OPERATING INSTRUCTIONS* section for details.

Learning Key

The Sea-Doo LK™ learning key limits the speed of the watercraft therefore enabling first time users and less experienced operators to learn how to operate the watercraft while gaining the necessary confidence and control.

Limitations

The ability of a novice to operate the watercraft can be exceeded even when a learning key is used.

Refer to *OPERATING MODES* for information on using and programming learning keys.

iBR (intelligent Brake and Reverse System)

This watercraft uses an electronically controlled braking and reverse system called the iBR system (intelligent Brake and Reverse).

The iBR module controls the position of the iBR gate to provide forward thrust, reverse thrust, braking thrust, and neutral.

The operator commands the position of the iBR gate using either the throttle lever for forward thrust, or the iBR lever for neutral, reverse, and for the braking function.

NOTE: The iBR lever can only be used to command a change in the gate position if the engine is running.

Using the iBR system significantly reduces the stopping distance of this watercraft and can increase its maneuverability as it can be used in a straight line, in a turn, at high or low speeds, or to propel the watercraft in reverse for docking or maneuvering in very close quarters.

Under ideal conditions, experienced operators were consistently able to reduce the stopping distance of a watercraft equipped with an iBR system by approximately 33%, from an initial speed of 80 km/h (50 MPH).

Limitations

Even when equipped with an iBR system, watercrafts do not have the ability of land based vehicles.

Stopping distance will vary notably depending on initial speed, load, wind, current, water conditions and the amount of braking.

The iBR system has no effect on the rearward motion.

It cannot prevent your watercraft from drifting in current or wind.

The iS system incorporates a function known as DOCK MODE. When activated manually or automatically, DOCK MODE moves the suspension down to lower the center of gravity of the watercraft. This function is useful when transporting the watercraft, operating at slow speed or when O.T.A.S. is activated as it reduces the possibility of overturning.

Limitations

Although the system absorbs partially the vertical forces transferred to the occupants when riding, it cannot eliminate them completely. Sudden jolts can cause the suspension to bottom.

WARNING

- It is important to inform the operator of a watercraft who intends to follow in a convoy formation, of the braking and maneuvering capability of your PWC, what the plume of water indicates, and that a greater distance must be maintained between watercraft.
- Be aware that other boats following or operating in close proximity may not be able to stop as quickly.

iS (intelligent Suspension) (GTX Limited iS 260 Only)

The suspension system of this watercraft is designed so that the occupants sit on what is known as the moving deck. When the suspension system is active, the moving deck is usually in an "up" position. This means the moving deck is raised above the fixed deck sufficiently for the suspension system to absorb the up and down movement of the watercraft as it travels through the water.

SAFETY EQUIPMENT

Required Safety Equipment

The operator and the passenger(s) must wear an approved Personal Flotation Device (PFD) that is suitable for PWC use.

Operator and passenger(s) should have ready access to shatterproof glasses should riding conditions or personal preference warrant.

Wind, water spray and speed may cause a person's eyes to water and create blurred vision.

As the owner of the watercraft, you are responsible for assuring that all required safety equipment is aboard. You should also consider supplying additional equipment as needed for your safety and that of your passengers. Check state and local regulations about required safety equipment.

Safety equipment required by regulations is mandatory. If local regulations require additional equipment, it must be approved by a competent authority. Minimum requirements include the following:

- Personal flotation devices (PFDs)
- A buoyant heaving line of 15 m (50 ft) minimum
- A watertight flashlight or approved flares
- Signaling device
- Sound producing devices (air horn or whistle).

Recommended Protection Gears

The operator and passenger(s) of PWCs must wear protective gear, including:

- A wet suit bottom, or thick tightly woven and snug fitting clothing that provides equivalent protection. As an example, thin bike shorts would not be appropriate. Severe internal injuries can occur if water is forced into body cavities as a result of falling in the water or being near jet thrust nozzle. Normal swimwear does not adequately protect against forceful entry of water into the lower male or female body opening(s).
- Footwear, gloves, safety goggles or glasses are also recommended. Some type of lightweight, flexible foot protection is recommended. This will help reduce possible injury, should you step on sharp underwater objects.

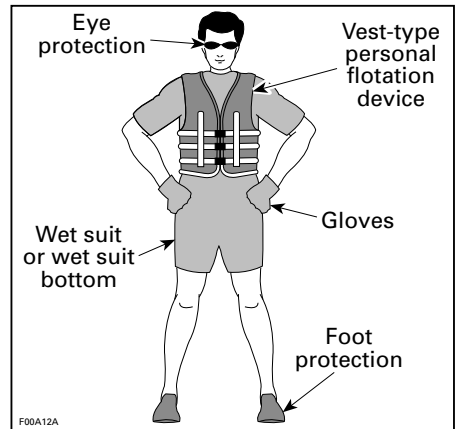

Personal Flotation Devices (PFDs)

Each person on a recreational watercraft must wear a personal flotation device (PFD) at all times. Ensure that these PFDs meet your country regulations.

A PFD provides buoyancy to help keep the head and face above the water, and to help maintain a satisfactory body position while in the water. Body weight and age should be considered when selecting a PFD. The buoyancy provided by the PFD should support your weight in water. The size of the PFD should be appropriate for the wearer. Body weight and chest size are common methods used to size PFDs. It is your responsibility to ensure that you have the proper number and types of PFDs on board to comply with federal and local regulations, and that your passengers know where they are and how to use them.

PFD Types

There are five types of approved PFDs.

PFD Type I, Wearable, has the greatest required buoyancy. Its design allows for turning most unconscious persons in the water from face down position to a vertical or slightly backward, face-up position. It can greatly increase the chances of survival. Type I is most effective for all waters, especially offshore when rescue may be delayed. It is also the most effective in rough waters.

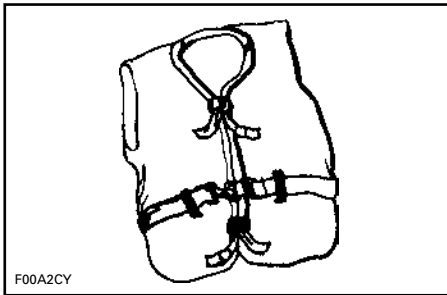

TYPE I — WEARABLE

PFD Type II, Wearable, turns its wearer in the same way as Type I, but not as effectively. The Type II does not turn as many persons under the same conditions as a Type I. You may prefer to use this PFD where there is a prob-

ability of quick rescue such as in areas where other people are commonly involved in water activities.

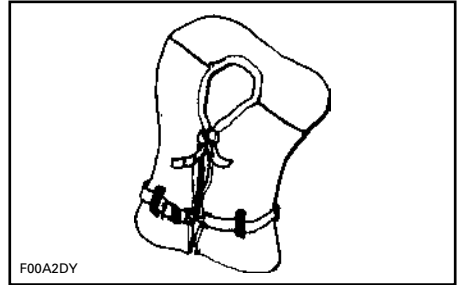

TYPE II — WEARABLE

PFD Type III, Wearable, allows wearers to place themselves in a vertical or slightly backward position. It does not turn the wearer. It maintains the wearer in a vertical or slightly backward position and has no tendency to turn the wearer face down. It has the same buoyancy as a Type II PFD and may be appropriate in areas where other people are commonly involved in water activities.

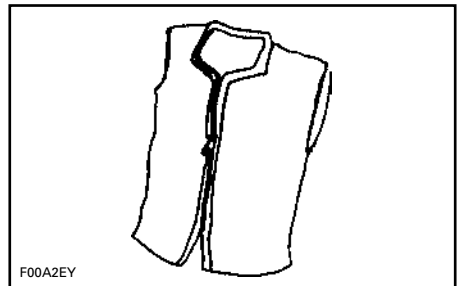

TYPE III — WEARABLE

PFD Type V, Wearable, must be worn. When inflated, it provides buoyancy equivalent to Type I, II or III PFDs. When it is deflated, however, it may not support some people.

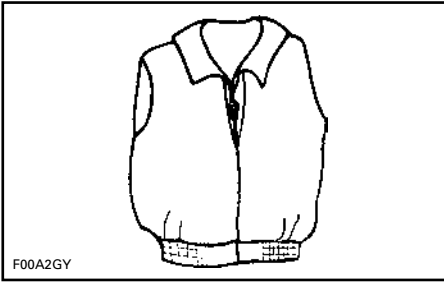

TYPE V — WEARABLE

Helmets

Some Important Considerations

Helmets are designed to offer some degree of protection in case of impacts to the head. In most motorized sports, the benefits of wearing a helmet clearly outweigh the drawbacks. However, in the case of motorized watersports such as riding personal watercraft, this is not necessarily true as there are some particular risks associated with the water.

Benefits

A helmet helps to reduce the risk of injury in case of a head impact against a hard surface such as another craft in the case of a collision. Similarly, a helmet with a chin guard might help prevent injuries to the face, jaw or teeth.

Risks

On the other hand, in some situations when falling off the watercraft, helmets have a tendency to catch the water, like a "bucket", and put severe stresses on the neck or spine. This could result in choking, severe or permanent neck or spine injury or death.

Helmets may also interfere with peripheral vision and hearing, or increase fatigue which, could contribute to increase the risk of a collision.

Weighing the Risks vs Benefits

In order to decide whether or not you should wear a helmet, it is best to consider the particular environment you will be riding in, as well as other factors such as personal experience. Will there be a lot of traffic on the water? What is your riding style?

The Bottom Line

Since each option minimizes some risks, but increases others, before each ride you must decide whether to wear or not wear a helmet based on your particular situation.

If you decide to wear a helmet, you must then decide what type is the most appropriate for the circumstances. Look for helmets that meet DOT or Snell standards, and if possible, choose one designed for motorized watersports.

Additional Recommended Equipment

It is recommended that you acquire additional equipment for safe, enjoyable cruising. This list, which is not all inclusive, includes items you should consider acquiring.

- Local map
- First aid kit
- Tow rope
- Flares
- Mooring cords.

A cellular telephone in a waterproof bag or container has also been found to be beneficial to boaters when in distress or just for contacting someone on shore.

PRACTICE EXERCISES

It is always a good idea to practice and get familiar with all controls, functions and handling characteristics of your watercraft before venturing on the water.

Always secure the tether cord to the engine cut-off switch and the clip to your PFD or a wrist strap.

Where to Practice Exercises

Find a suitable area to practice the exercises. Ensure the area meet the following requirements:

- No traffic
- No obstacles
- No swimmers
- No current
- Ample space to maneuver
- Water depth is adequate.

Practice Exercises

Practice **alone** the following exercises.

Turning

Practice turning in circles in both directions at slow speed. When comfortable with the exercise, increase difficulty by making some figure 8.

When this is mastered, repeat the above exercises but at increased speed.

Stopping Distances

Practice stopping the watercraft in a straight line at various speeds and braking force.

Remember that watercraft speed, load, water conditions, current and wind also affect stopping distances.

Reverse

Practice reverse operation to learn how the watercraft operates in reverse and reacts with steering inputs.

NOTE: Always perform this exercise at slow speeds.

Avoiding an Obstacle

Practice obstacle avoidance (choose a virtual point on the water) by steering watercraft and maintaining throttle.

Repeat exercise, but this time release throttle while turning.

NOTE: With this exercise, you will learn that you need throttle to steer the watercraft in a different direction.

Docking

Practice docking using the throttle, iBR lever and steering to become familiar with the response of the PWC and to develop good control skills.

NOTE: Remember that steering direction is reversed when backing.

Slow Speed Mode, Ski Mode and Cruise Mode

If your watercraft has any of these modes, it is also important to understand their operation and to become familiar with these features prior to using them on a ride with other people.

WARNING

The ski and the cruise modes are not an automatic pilot; they will not drive the watercraft for you.

Important Factors Not to Neglect

In addition, always remember that the following conditions have a direct impact on how your watercraft will behave and respond to different inputs:

- Loads
- Currents
- Wind
- Water conditions.

Make sure to be alert to these conditions, and adapt accordingly. If possible, practice further in these conditions.

For delicate maneuvers, the best advice is always to try to reduce your speed to a minimum.

NAVIGATION RULES

Operating Rules

Operating a watercraft can be compared with driving on unmarked highways and roads. To prevent collisions or avoid other boaters, a system of operating rules must be followed. It's not only common sense... it's the law!

Generally keep to your right and safely avoid collisions by keeping a safe distance from other watercrafts, boats, people and objects.

The following illustration identifies different parts of the boat that are used as directional reference points, the bow being the front of the boat. The port side of boat (left side) is visually identifiable by a RED light off the bow, and the starboard side (right side) by a GREEN light.

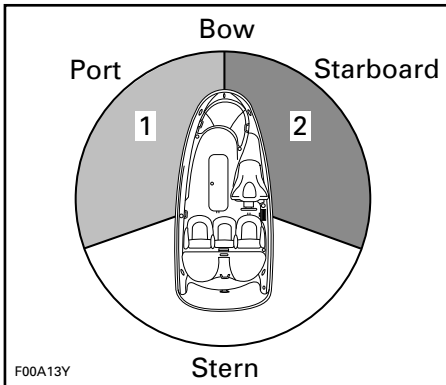

TYPICAL - DIRECTIONAL REFERENCE POINTS

1. RED light
2. GREEN light (yield zone)

Crossing

Give the right of way to a watercraft ahead and to your right. Never cross in front of a boat, you should see his RED light, he should see your GREEN light (he has the right of way).

Personal watercrafts (PWC) do not have these colored lights, but the rule still applies.

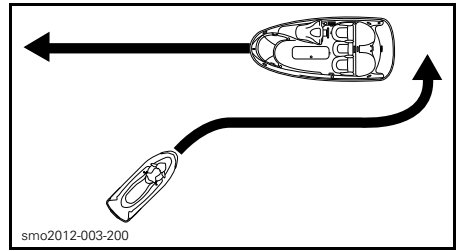

TYPICAL

Like a street traffic light, if you see a **RED** light, **STOP**, give the right of way. The other boat is to your right and it has the right of way.

If you see a **GREEN** light, **pass with caution**. The other boat is to your left, you have the right of way.

Meeting Head-On

Keep right.

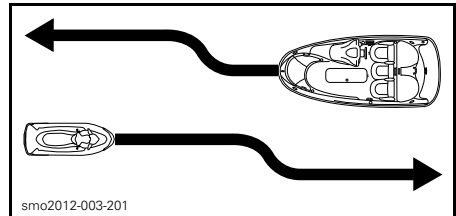

TYPICAL

Passing

Give the right of way to other crafts and keep clear.

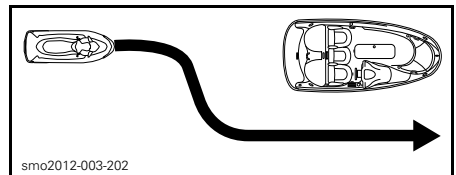

TYPICAL

Navigation System

Navigational aids, such as signs or buoys, can assist you in identifying safe waters. Buoys will indicate whether you should keep to the right (starboard) or to the left (port) of the

buoy, or to which channel you can continue. They may also indicate whether you are entering a restricted or controlled area such as a no wake or low speed zone. They may also indicate hazards or pertinent boating information. Markers may be located on shore or on the water. They can also indicate speed limits, no power craft or boating, anchorage and other useful information. (The shape of each type of marker will provide assistance).

Make sure you know and understand the navigation system applicable to the waterways where you intend to use the watercraft.

Collision Avoidance

Do not release the throttle when trying to steer away from an obstacle. Engine power and jet pump thrust is required to steer the watercraft.

Always keep a constant lookout for other water users, other boats or objects, especially when turning. Be alert for conditions that may limit your visibility or block your vision of others.

Respect the rights of other recreationists and/or bystanders and always keep a safe distance from all other watercrafts, boats, people and objects.

Do not wake or wave jump, ride the surf line or attempt to spray or splash others with your watercraft. You may misjudge the ability of the watercraft or your own riding skills and strike a boat or person.

This watercraft has the capability of turning more sharply than other boats, however, unless in an emergency, do not negotiate sharp, high speed turns. Such maneuvers make it hard for others to avoid you or understand where you are going. Also, you and/or your passenger(s) could be thrown from the watercraft.

Unlike most other watercrafts, this PWC has a braking system (iBR).

When operating an iBR equipped watercraft, be aware that other boats following or operating in close proximity may not be able to stop as quickly.

When at speed and the brake is first applied, a plume of water will shoot up in the air behind the watercraft indicating a braking manoeuvre.

It is important to inform the operator of a watercraft who intends to follow in a convoy formation of the braking and maneuvering capability of your PWC, what the plume of water indicates, and that a greater distance should be maintained between both of you.

Stopping distance will vary depending on initial speed, load, wind and water conditions.

Although the preferable manoeuvre to avoid an obstacle is to steer away while applying throttle, the iBR can also be used by fully braking and turning in the direction to avoid the obstacle.

FUELING

Fueling Procedure

⚠ WARNING

Fuel is flammable and explosive under certain conditions. Always work in a well ventilated area. Do not smoke or allow open flames or sparks in the vicinity.

Turn off engine.

⚠ WARNING

Always stop the engine before refueling.

Do not allow anyone to remain on the watercraft.

Tie watercraft securely to the fueling pier.

Have a fire extinguisher close at hand.

Lightly press down on the fuel cap with your LH hand as you pull up on the latch with your fingers to release it. The cap will pop open as it is pushed open by spring pressure.



sdd2009-001-054_a

TYPICAL - FUEL TANK CAP LOCATION

⚠ WARNING

Fuel tank may be pressurized, place one hand over the fuel cap when releasing the cap retaining latch.

Insert the gas pump spout into the filler neck and fill the fuel tank.

⚠ WARNING

To prevent fuel back-flow, fill tank slowly so the air can escape from the fuel tank.

Stop filling immediately after the release of the gas pump nozzle handle and wait a moment before removing the spout. Do not retract the gas pump nozzle to put more fuel in fuel tank.

⚠ WARNING

Do not overfill or top off the fuel tank and leave the watercraft in the sun. As temperature increases, fuel expands and may overflow.

Close the fuel tank cap and ensure it is properly latched.

⚠ WARNING

Always wipe off any fuel spillage from the watercraft.

After refueling always open the seat, remove the ventilation box (as applicable), and ensure there is no gasoline vapor odor inside the engine compartment.

⚠ WARNING

Do not start watercraft if gasoline or gasoline vapor odor is present.

Fuel Requirements

NOTICE Always use fresh gasoline. Gasoline will oxidize; the result is loss of octane, volatile compounds, and the production of gum and varnish deposits which can damage the fuel system.

Alcohol fuel blending varies by country and region. Your vehicle has been designed to operate using the recommended fuels, however, be aware of the following:

- Use of fuel containing alcohol above the percentage specified by government regulations is not recommended and can result in the following problems in the fuel system components:
 - Starting and operating difficulties.
 - Deterioration of rubber or plastic parts.
 - Corrosion of metal parts.
 - Damage to internal engine parts.
- Inspect frequently for the presence of fuel leaks or other fuel system abnormalities if you suspect the presence of alcohol in gasoline exceeds the current government regulations.
- Alcohol blended fuels attract and hold moisture which may lead to fuel phase separation and can result in engine performance problems or engine damage.

Recommended Fuel

GTX and GTX S Models

Use common unleaded gasoline with an AKI (RON+MON)/2 octane rating of 87, or an RON octane rating of 91.

All Models except GTX and GTX S

Use premium unleaded gasoline with an AKI (RON+MON)/2 octane rating of 91, or an RON octane rating of 95.

All Models

NOTICE Never experiment with other fuels. Engine or fuel system damages may occur with the use of an inadequate fuel.

NOTICE Do NOT use fuel from fuel pumps labeled E85.

Use of fuel labeled E15 is prohibited by U.S. EPA Regulations.

TRAILERING INFORMATION

NOTICE The span of the trailer wood bunks including bunk width should be adjusted to provide support throughout the full length of the hull. The ends of both trailer wood bunks should not exceed the length of the watercraft.

Ensure the trailer wheels are positioned so that the center of gravity of the watercraft is slightly ahead of the wheels to properly support the weight of the watercraft.

WARNING

Never tip this watercraft on end for transporting. We recommend that you carry the watercraft in its normal operating position.

Check the applicable laws and regulations in your area concerning towing a trailer, especially for the following items:

- Brake system
- Tow vehicle weight
- Mirrors.

Take the following precautions when towing the watercraft:

- Respect tow vehicle maximum weight capacity and the tongue weight capacity as recommended by manufacturer.
- Tie the watercraft to both front and rear (bow/stern) eyelets so that it is firmly secured on the trailer. Use additional tie-downs if necessary.
- Ensure fuel tank cap, front storage compartment cover, glove box cover, boarding platform and seat are properly latched.
- Observe trailering safety precautions.

NOTICE Do not route ropes or tie-downs over the seat or grab handle as they could be permanently damaged. Wrap ropes or tie-downs with rags or similar protectors where they can come into contact with the watercraft body.

GTX Limited and GTX Limited iS Models

WARNING

Ensure the watercraft moving deck is down in the DOCK MODE position before trailering. This will lower the center of gravity and improve trailer stability.

All Models

WARNING

Make sure seat is securely latched prior to trailering.

A Sea-Doo cover can protect the watercraft, particularly when driving on dirt roads, to prevent dirt entry through the air inlet openings.

WARNING

When trailering the watercraft, NEVER leave any equipment on the watercraft.

WAKE™ Pro Model

WARNING

NEVER leave a wakeboard installed on the rack. Otherwise, wake board fin(s) could cause injury to bystanders or wakeboard could fly off on the road.

 **WARNING**

Bungee cords are under tension and could spring back and whip someone when released. Use caution.

NOTE: When trailering 2 watercrafts, it may be necessary to remove the inner wakeboard rack.

IMPORTANT ON-PRODUCT LABELS

Watercraft Safety Labels

These labels are affixed to the vehicle for the safety of the operator, passenger (2-UP) or bystanders

The labels illustrated on the following pages are on your watercraft. If missing or damaged, they can be replaced free of charge. See an authorized Sea-Doo dealer.

Please read the following labels carefully before operating this watercraft.

NOTE: The first illustration of the watercraft indicates the approximate locations of the various labels. A dotted line indicates that the label is not on the outer surface, and that the seat or a cover of some type must be opened to see the label.

NOTE: In the event of any discrepancy between this guide and the vehicle, the safety labels on the vehicle have precedence over the labels in this guide.

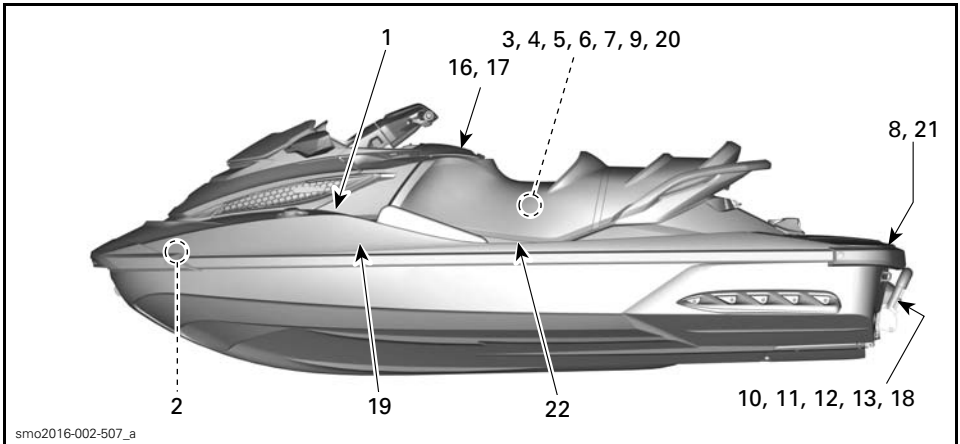

TYPICAL - GTX LIMITED

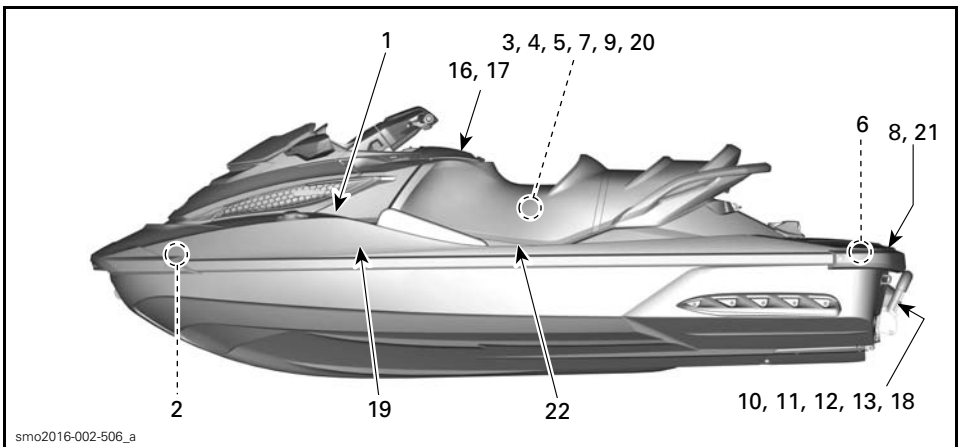

TYPICAL - GTX LIMITED iS

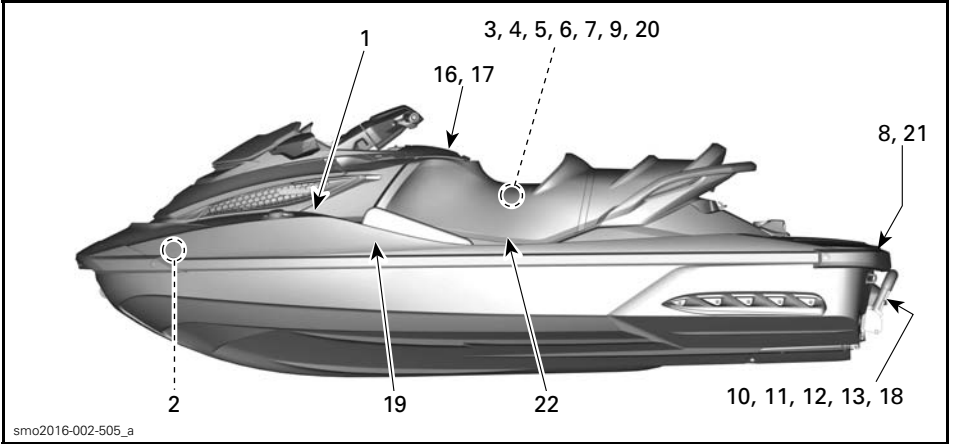

TYPICAL - GTX LIMITED 300

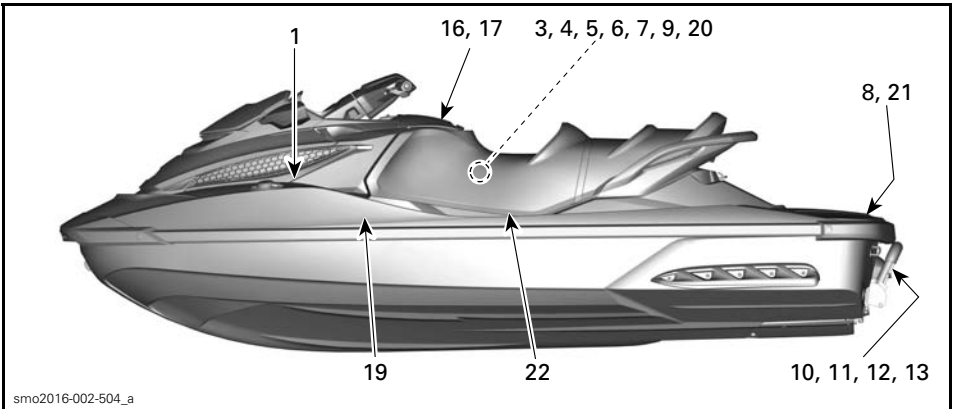

TYPICAL - GTX

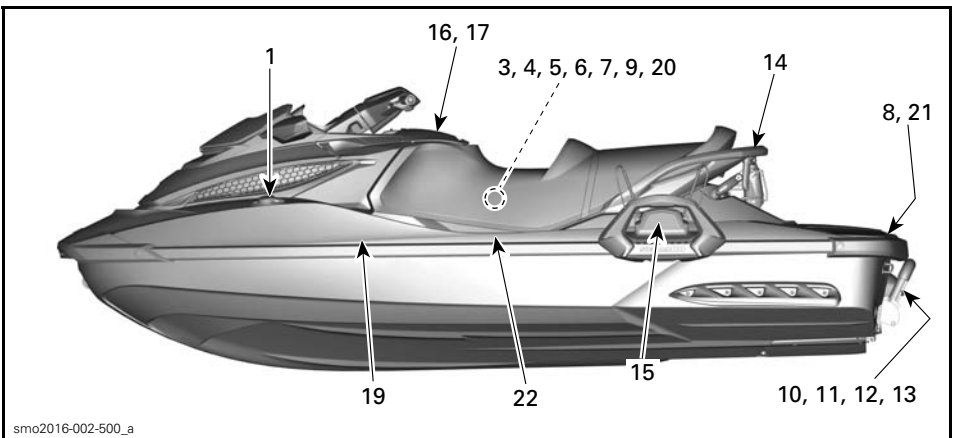

WAKE PRO

IMPORTANT ON-PRODUCT LABELS

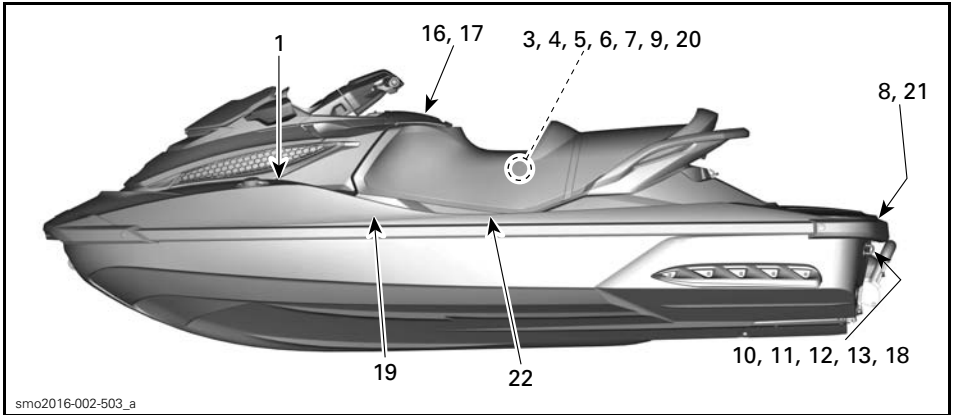

RXT 260

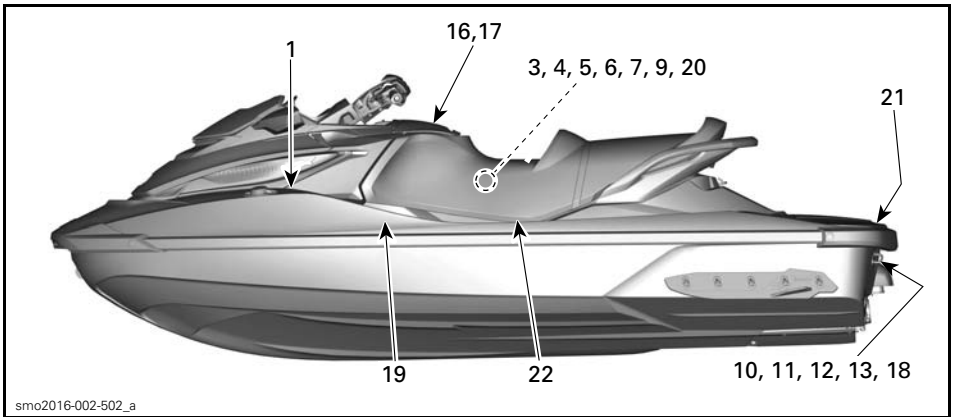

RXT-X 300

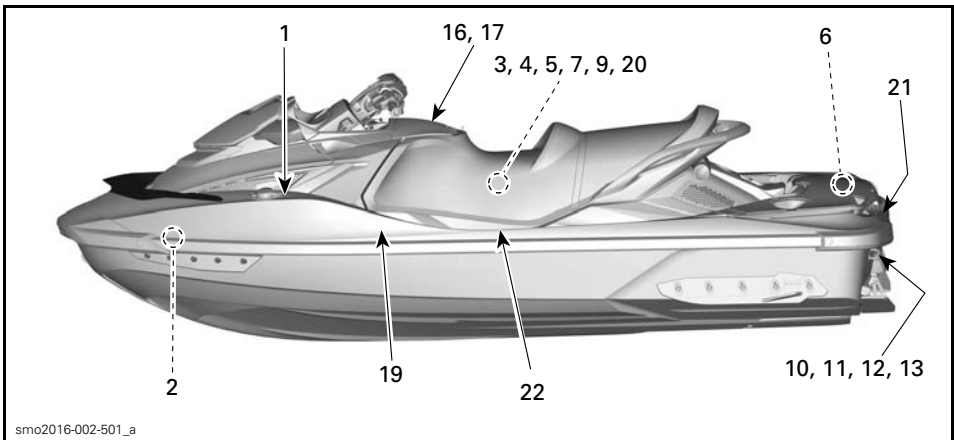

RXT-X aS

⚠ WARNING

- After refueling, always open the seat and the ventilation box (if applicable) to ensure there is no gasoline vapor odor inside the engine compartment.
- Gasoline vapor may cause fire or explosion.
- Do not overfill gas tank.
- Keep the craft away from open flames and sparks.
- Do not start watercraft if liquid gasoline or gasoline vapor odor is present.
- Always replace ventilation box (if applicable) and close seat before starting.

⚠ AVERTISSEMENT

- Après avoir fait le plein, toujours ouvrir le siège et la boîte de ventilation (si applicable) afin de s'assurer qu'il n'y a pas d'émanation d'essence dans le compartiment moteur.
- Les vapeurs d'essence peuvent provoquer un incendie ou une explosion.
- Éviter de trop remplir le réservoir d'essence.
- Garder la motomarine à l'écart des flammes et des étincelles.
- Toujours remettre la boîte de ventilation (si applicable) en place et refermer le siège avant de démarrer la motomarine.

NOTICE
 Recommended for supercharged engine: premium unleaded gasoline 91 pump octane or higher. Minimum required: unleaded gasoline 87 pump octane.

AVIS
 Recommandé pour moteur suralimenté: essence sans plomb 91 octane ou plus. Minimum requis: essence sans plomb 87 octane.

219903495

219903495

LABEL 1: TYPICAL



smo2009-002-103_a

LABEL 2: TYPICAL

⚠ CAUTION

ENGINE OIL AND CERTAIN COMPONENTS IN THE ENGINE COMPARTMENT MAY BE HOT. DIRECT CONTACT MAY RESULT IN SKIN BURN.

CHECKING ENGINE OIL LEVEL

- Make sure engine is at operating temperature.
(Never let engine run out of water without the flush kit connected as it may damage the engine)
- Vehicle must be level to perform verification.
- Let engine running at idle for at least 30 seconds.
- Stop engine and wait at least 30 seconds.
- Remove the ventilation box to access engine compartment.
- Check oil level using the dipstick.

219903084

LABEL 3: iS MODELS

⚠ CAUTION

ENGINE OIL AND CERTAIN COMPONENTS IN THE ENGINE COMPARTMENT MAY BE HOT. DIRECT CONTACT MAY RESULT IN SKIN BURN.

CHECKING ENGINE OIL LEVEL

- Make sure engine is at operating temperature.
(Never let engine run out of water without the flush kit connected as it may damage the engine)
- Vehicle must be level to perform verification.
- Let engine running at idle for at least 30 seconds.
- Stop engine and wait at least 30 seconds.
- Check oil level using the dipstick.

219903184A

219903184

LABEL 3: FIXED DECK MODELS

⚠ WARNING

EACH TIME A GASOLINE VAPOR ODOR CHECK IS PERFORMED

- Always remove this ventilation box to access the engine compartment.
- Gasoline vapor may cause fire or explosion.
- Do not start watercraft if liquid gasoline or gasoline vapor odor is present.
- Always replace ventilation box and close seat before starting.

smo2009-002-105_aen

LABEL 4: TYPICAL

⚠ WARNING / AVERTISSEMENT

When disconnecting coil from sparkplug, always disconnect coil from main harness first. Never check for engine ignition spark from an open coil and/or sparkplug in the engine compartment as spark may cause fuel vapor to ignite.

Lorsque vous déconnectez la bobine d'allumage de la bougie, toujours déconnecter la bobine d'allumage du harnais principal en premier. Ne jamais vérifier si le circuit d'allumage du moteur produit une étincelle en utilisant la bobine d'allumage et/ou la bougie dans le compartiment moteur car une étincelle pourrait entraîner l'allumage des vapeurs d'essence.

F18L0NY

LABEL 5: TYPICAL

NOTICE

- To comply with noise regulations, this engine is designed to operate with an air intake silencer.
- Operation without air intake silencer or with one not properly installed may cause engine damage.

219903177 219903177A

LABEL 7: TYPICAL

⚠ WARNING

- Remove battery from boat before charging.
- Do not overcharge battery.
- Improper charging of battery can cause explosion.

219903082 219903082B

LABEL 6: TYPICAL

⚠ WARNING

AVOID SERIOUS INJURY OR DEATH:

- Engine must be turned off before re-boarding.
- Keep away from propulsion system and intake grate.

WHEN RE-BOARDING:

- Re-board one person at a time.
- Stay centered to keep balance.

Never use the boarding step (if so equipped) for pulling, towing, jumping or boarding a PWC that is out of water or any purpose for which it was not designed.

219904252 219904252

LABEL 8 - ON FIXED DECK AND aS MODELS

⚠ WARNING

AVOID SERIOUS INJURY OR DEATH:

- Engine must be turned off before re-boarding.
- Keep away from propulsion system and intake grate.

WHEN RE-BOARDING:

- Re-board one person at a time.
- Stay centered to keep balance.

Never use the boarding step (if so equipped) for pulling, towing, jumping or boarding a PWC that is out of water or any purpose for which it was not designed.

219904254 219904254

LABEL 8 - ON S AND iS MODELS



LABEL 9: TYPICAL



LABEL 13: TYPICAL

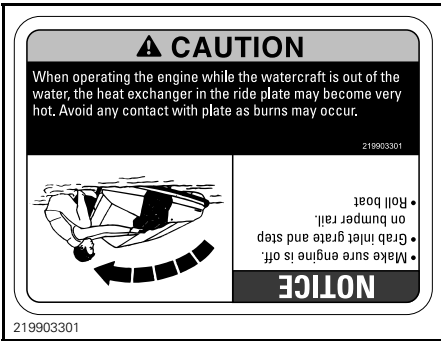

LABEL 10: TYPICAL

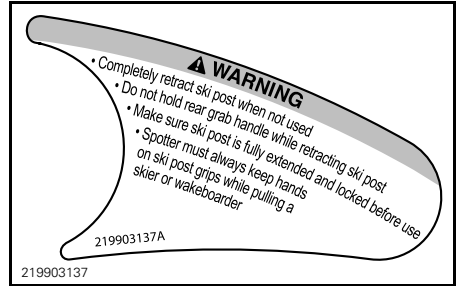

LABEL 14: TYPICAL

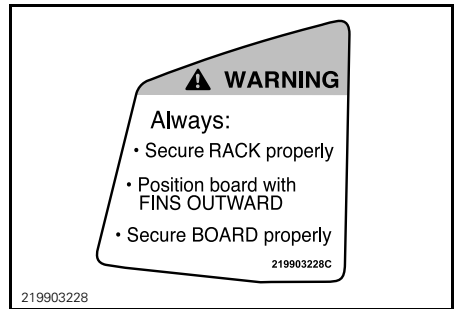

LABEL 15: TYPICAL

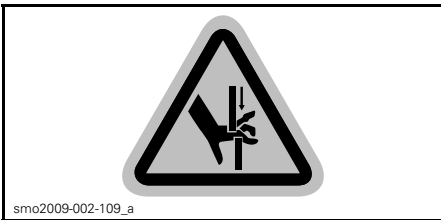

LABEL 11: TYPICAL

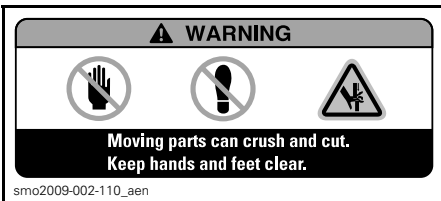

LABEL 12: TYPICAL

⚠ WARNING

Collisions result in more **INJURIES AND DEATHS** than any other type of accident for personal watercraft (PWC).

TO AVOID COLLISIONS:

SCAN CONSTANTLY for people, objects, and other watercraft. Be alert for conditions that limit your visibility or block your vision of others.

OPERATE DEFENSIVELY at safe speeds and keep a safe distance away from people, objects, and other watercraft.

- Do not follow directly behind PWCs or other boats.
- Do not go near others to spray or splash them with water.
- Avoid sharp turns or other maneuvers that make it hard for others to avoid you or understand where you are going.
- Avoid areas with submerged objects or shallow water.

TAKE EARLY ACTION to avoid collisions. Remember, generally PWCs and other boats do not have brakes.

DO NOT RELEASE THROTTLE WHEN TRYING TO STEER away from objects - you need throttle to steer. Always check throttle and steering controls for proper operation before starting PWC. Follow navigation rules and province/ state and local laws that apply to PWCs.

See Operator's Guide for more information.

IBR INSTRUCTIONS

IBR INTELLIGENT BRAKE AND REVERSE FUNCTIONS:

How to brake

- Squeeze brake lever

How to reverse

- **Maintain** brake lever engaged

How to go forward

- Tap throttle lever to engage forward movement from neutral position.
- Squeeze throttle lever to accelerate.

How to get to neutral

- Tap brake lever

Refer to the operator's guide for more information.

219904763

219904763

LABEL 16: GTX, GTX LIMITED, LIMITED-iS, WAKE AND RXT MODELS

⚠ WARNING

Get familiar with this PWC; it may exceed the performance of Other PWCs you may have ridden. This is a high performance PWC. Inexperienced riders may overlook risks and be surprised by the specific behavior of this PWC in any water condition.

219904764

219904764

LABEL 16: RXT-X AND RXT-X AS MODELS

⚠ WARNING

To reduce the risk of **SEVERE INJURY** or **DEATH**:

WEAR A PERSONAL FLOTATION DEVICE (PFD).
All riders must wear a Coast Guard approved PFD that is suitable for personal watercraft (PWC) use.

WEAR PROTECTIVE CLOTHING. Severe internal injuries can occur if water is forced into body cavities as a result of falling into water or being near jet thrust nozzle. Normal swimwear does not adequately protect against forceful water entry into lower body opening(s) of males or females. All riders must wear a wet suit bottom or clothing that provides equivalent protection (see Operator's Guide). Footwear, gloves and goggles/glasses are recommended.

KNOW BOATING LAWS. BRP recommends a minimum operator age of 16 years old. Know the operator age and training requirements for your province/state. A boating safety course is recommended and may be required in your province/state.

ATTACH ENGINE SHUT-OFF CORD (LANYARD) to PFD and keep it free from handlebars so that engine stops if operator falls off. After riding, remove cord from PWC to avoid unauthorized use by children or others.

RIDE WITHIN YOUR LIMITS AND AVOID AGGRESSIVE MANEUVERS to reduce the risk of loss of control, ejection, and collision. This is a high performance boat – not a toy. Sharp turns or jumping wakes or waves can increase the risk of back/spinal injury (paralysis), facial injuries, and broken legs, ankles, and other bones. Do not jump wakes or waves.

DO NOT APPLY THROTTLE WHEN ANYONE IS AT REAR OF PWC.
turn engine off or keep engine at idle. Water and/or debris exiting jet thrust nozzle can cause severe injury.

KEEP AWAY FROM INTAKE GRATE
while engine is on. Items such as long hair, loose clothing, or PFD straps can become entangled in moving parts resulting in severe injury or drowning.

NEVER RIDE AFTER CONSUMING DRUGS OR ALCOHOL.
READ AND FOLLOW OPERATOR'S GUIDE.



Jet Thrust Nozzle

Intake Grate



PFD

Wet Suit Bottom

219904765

219904765

LABEL 17

NOTICE

It is very important to flush the exhaust system with fresh water (from 1-1/2 to 2 minutes) after each use in salt water or foul water.

219904387

LABEL 18 - 260 ENGINE ONLY

Compliance Labels



LABEL 19

EMISSION CONTROL INFORMATION		EC 121
THIS ENGINE IS CERTIFIED TO OPERATE ON UNLEADED GASOLINE AND CONFORMS TO U.S. EPA & CALIFORNIA EMISSION / EVAP REGULATIONS FOR MARINE SI ENGINES.		
ENGINE FAMILY	FAMILLE DE MOTEUR	
FEL	LIMITE DES ÉMISSIONS DE LA FAMILLE	
ENGINE DISPLACEMENT	CYLINDRÉE	
EXHAUST EMISSION CONTROL SYSTEM	SYSTÈME DE CONTRÔLE DES ÉMISSIONS	
POWER	PUISSANCE	
RENSEIGNEMENTS SUR LE DISPOSITIF ANTIPOLLUTION		
CE MOTEUR EST CERTIFIÉ POUR FONCTIONNER À L'ESSENCE SANS PLOMB ET IL RÉPOND AUX NORMES [] DE L'EPA DES E.-U. & RÉGLEMENTATIONS CALIFORNIENNES POUR LES MOTEURS MARINS À ALLUMAGE COMMANDÉ.		
SEE OPERATOR'S GUIDE FOR MAINTENANCE SPECIFICATIONS VOIR GUIDE DU CONDUCTEUR POUR LES SPÉCIFICATIONS D'ENTRETIEN		
BOMBARDIER RECREATIONAL PRODUCTS INC.		
219904642		219904642

LABEL 20 - INSIDE NORTH AMERICA ONLY

<p>THIS BOAT IS NOT REQUIRED TO COMPLY WITH THE FOLLOWING U.S. COAST GUARD SAFETY STANDARDS IN EFFECT ON THE DATE OF CERTIFICATION:</p> <ul style="list-style-type: none"> • FUEL SYSTEM • DISPLAY OF CAPACITY INFORMATION • SAFE LOADING • FLotation • POWERED VENTILATION <p>AS AUTHORIZED BY U.S. COAST GUARD GRANT OF EXEMPTION (CGB 88-001).</p> <p>BOMBARDIER RECREATIONAL PRODUCTS INC. 565 DE LA MONTAGNE STREET VALCOURT, QUÉBEC CANADA J0E 2L0</p> <p style="text-align: center;">ASSEMBLED IN CANADA</p>	219903510
--	-----------

219903510

LABEL 21 - TYPICAL

Models with Suspension

The EPA compliance label is located on the front ventilation box riser.

It can be seen by opening the front cover, removing the front storage bin and looking aft.



TYPICAL

1. Compliance label
2. Ventilation box
3. Riser

Models Without Suspension

On these models, the EPA compliance label is located on the RH side of a deck riser just below the glove box.

To view the label, open the seat and look to the right of the seat hinge near the top of the riser.

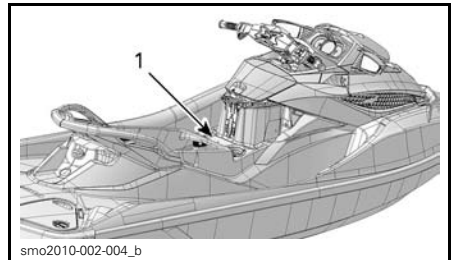

TYPICAL - GTX155, RXT-X AND WAKE PRO MODELS

1. EPA label location

Watercraft Inside North-America
 GTX S, GTX LTD iS, and RXT-X aS

GTX, GTX LTD, RXT, RXT-X,
 and Wake

CANADIAN COMPLIANCE NOTICE	
AVIS DE CONFORMITÉ CANADIEN	
MAXIMUM RECOMMENDED SAFE LIMITS LIMITES MAXIMALES DE SÉCURITÉ RECOMMANDÉES	
Max.  = 3	227 kg 500 lbs/lb
Max.  +  =	227 kg 500 lbs/lb
CATEGORY / CATÉGORIE: C	
MAXIMUM WAVE / VAGUE MAXIMALE 2.0 m	
MAXIMUM WIND SPEED / VITESSE DE VENT MAXIMALE 33.0 knots/noeuds	
BOMBARDIER RECREATIONAL PRODUCTS INC.	
VALCOURT, QUÉBEC, CANADA (YDV)	
MODEL / MODÈLE: XXXXXXXXX	
<p>THE MANUFACTURER DECLARES THAT THIS PRODUCT COMPLIES WITH THE CONSTRUCTION REQUIREMENTS OF THE SMALL VESSEL REGULATIONS, AS THEY READ ON THE DAY ON WHICH THE CONSTRUCTION OF THE VESSEL WAS STARTED OR ON THE DAY ON WHICH THE VESSEL WAS IMPORTED.</p> <p>LE FABRICANT ATTESTE QUE CE PRODUIT EST CONFORME AUX EXIGENCES DE CONSTRUCTION DU RÈGLEMENT SUR LES PETITS BÂTIMENTS EN VIGUEUR À LA DATE DU DÉBUT DE SA CONSTRUCTION OU DE SON IMPORTATION.</p>	
MAXIMUM CAPACITIES ABOVE INFORMATION ALSO APPLIES IN THE U.S.A.	CAN ICES-2 / NMB-2*

smo2015-002-002_a

LABEL 22 - CANADIAN COMPLIANCE NOTICE (CAN MODELS ONLY)

CANADIAN COMPLIANCE NOTICE	
AVIS DE CONFORMITÉ CANADIEN	
MAXIMUM RECOMMENDED SAFE LIMITS LIMITES MAXIMALES DE SÉCURITÉ RECOMMANDÉES	
Max.  = 3	272 kg 600 lbs/lb
Max.  +  =	272 kg 600 lbs/lb
CATEGORY / CATÉGORIE: C	
MAXIMUM WAVE / VAGUE MAXIMALE 2.0 m	
MAXIMUM WIND SPEED / VITESSE DE VENT MAXIMALE 33.0 knots/noeuds	
BOMBARDIER RECREATIONAL PRODUCTS INC.	
VALCOURT, QUÉBEC, CANADA (YDV)	
MODEL / MODÈLE: XXXXXXXXX	
<p>THE MANUFACTURER DECLARES THAT THIS PRODUCT COMPLIES WITH THE CONSTRUCTION REQUIREMENTS OF THE SMALL VESSEL REGULATIONS, AS THEY READ ON THE DAY ON WHICH THE CONSTRUCTION OF THE VESSEL WAS STARTED OR ON THE DAY ON WHICH THE VESSEL WAS IMPORTED.</p> <p>LE FABRICANT ATTESTE QUE CE PRODUIT EST CONFORME AUX EXIGENCES DE CONSTRUCTION DU RÈGLEMENT SUR LES PETITS BÂTIMENTS EN VIGUEUR À LA DATE DU DÉBUT DE SA CONSTRUCTION OU DE SON IMPORTATION.</p>	
MAXIMUM CAPACITIES ABOVE INFORMATION ALSO APPLIES IN THE U.S.A.	CAN ICES-2 / NMB-2*

smo2015-001-001_a

LABEL 22 - CANADIAN COMPLIANCE NOTICE (CAN MODELS ONLY)

Watercraft Outside North America
 GTX S, GTX LTD iS, and RXT-X aS

GTX, GTX LTD, RXT, RXT-X,
 and Wake

CANADIAN COMPLIANCE NOTICE	
AVIS DE CONFORMITÉ CANADIEN	
MAXIMUM RECOMMENDED SAFE LIMITS LIMITES MAXIMALES DE SÉCURITÉ RECOMMANDÉES	
Max.  = 3	227 kg 500 lbs/lb
Max.  +  =	227 kg 500 lbs/lb
CATEGORY / CATÉGORIE: C	
MAXIMUM WAVE / VAGUE MAXIMALE 2.0 m	
MAXIMUM WIND SPEED / VITESSE DE VENT MAXIMALE 33.0 knots/noeuds	
BOMBARDIER RECREATIONAL PRODUCTS INC.	
VALCOURT, QUÉBEC, CANADA (YDV)	
MODEL / MODÈLE: XXXXXXXXX	
<p>THE MANUFACTURER DECLARES THAT THIS PRODUCT COMPLIES WITH THE CONSTRUCTION REQUIREMENTS OF THE SMALL VESSEL REGULATIONS, AS THEY READ ON THE DAY ON WHICH THE CONSTRUCTION OF THE VESSEL WAS STARTED OR ON THE DAY ON WHICH THE VESSEL WAS IMPORTED.</p> <p>LE FABRICANT ATTESTE QUE CE PRODUIT EST CONFORME AUX EXIGENCES DE CONSTRUCTION DU RÈGLEMENT SUR LES PETITS BÂTIMENTS EN VIGUEUR À LA DATE DU DÉBUT DE SA CONSTRUCTION OU DE SON IMPORTATION.</p>	
MAXIMUM CAPACITIES ABOVE INFORMATION ALSO APPLIES IN THE U.S.A.	

smo2015-002-001_a

LABEL 22 - TYPICAL (WATERCRAFT OUTSIDE NORTH AMERICA)

CANADIAN COMPLIANCE NOTICE	
AVIS DE CONFORMITÉ CANADIEN	
MAXIMUM RECOMMENDED SAFE LIMITS LIMITES MAXIMALES DE SÉCURITÉ RECOMMANDÉES	
Max.  = 3	272 kg 600 lbs/lb
Max.  +  =	272 kg 600 lbs/lb
CATEGORY / CATÉGORIE: C	
MAXIMUM WAVE / VAGUE MAXIMALE 2.0 m	
MAXIMUM WIND SPEED / VITESSE DE VENT MAXIMALE 33.0 knots/noeuds	
BOMBARDIER RECREATIONAL PRODUCTS INC.	
VALCOURT, QUÉBEC, CANADA (YDV)	
MODEL / MODÈLE: XXXXXXXXX	
<p>THE MANUFACTURER DECLARES THAT THIS PRODUCT COMPLIES WITH THE CONSTRUCTION REQUIREMENTS OF THE SMALL VESSEL REGULATIONS, AS THEY READ ON THE DAY ON WHICH THE CONSTRUCTION OF THE VESSEL WAS STARTED OR ON THE DAY ON WHICH THE VESSEL WAS IMPORTED.</p> <p>LE FABRICANT ATTESTE QUE CE PRODUIT EST CONFORME AUX EXIGENCES DE CONSTRUCTION DU RÈGLEMENT SUR LES PETITS BÂTIMENTS EN VIGUEUR À LA DATE DU DÉBUT DE SA CONSTRUCTION OU DE SON IMPORTATION.</p>	
MAXIMUM CAPACITIES ABOVE INFORMATION ALSO APPLIES IN THE U.S.A.	

smo2015-001-002_a

LABEL 22 - TYPICAL (WATERCRAFT OUTSIDE NORTH AMERICA)

Australian Models Only

AUSTRALIAN BUILDERS PLATE
 Imported by BRP Australia Pty Ltd
 DATE 2014

Max persons	3 = 225 kg
Max load	= 273 kg
Buoyancy Basic Flotation	

WARNING

Alteration of the boat's hull or permanent fittings may invalidate the particulars on this plate.

Information determined - ISO 13590

219904405

LABEL 23 - ALL MODELS EXCEPT RXT-X aS AND GTX LIMITED iS

AUSTRALIAN BUILDERS PLATE
 Imported by BRP Australia Pty Ltd
 DATE 2014

Max persons	3 = 225 kg
Max load	= 227 kg
Buoyancy Basic Flotation	

WARNING

Alteration of the boat's hull or permanent fittings may invalidate the particulars on this plate.

Information determined - ISO 13590

219904406

LABEL 23 - RXT-X aS AND GTX LIMITED iS

PRE-RIDE INSPECTION

We encourage you to have an Annual Safety Inspection of your vehicle. Please contact an authorized BRP dealer for further details. Though not required, it is recommended that an authorized BRP dealer performs the preseason preparation of your vehicle. Each visit to your authorized BRP dealer is a great opportunity for your dealer to verify if your vehicle is included in any safety campaign. We also urge you to visit your authorized BRP dealer in a timely manner if you become aware of any safety related campaigns.

WARNING

Perform a pre-ride inspection before each ride to detect potential problems during operation. The pre-ride inspection can help you monitor wear and deterioration before they become a problem. Correct any problems that you discover to reduce the risk of a breakdown or crash.

Before performing the pre-ride inspection, read and understand the *CONTROLS* section.

What to Do Before Launching the Watercraft

WARNING

Engine should be off and the tether cord cap should always be removed from the engine cut-off switch prior to verifying any of the following points. Only start watercraft once all items have been checked and operate properly.

NOTE: Before starting the engine and taking off, it is recommended to shake vertically the rear of the watercraft to shake away any sand that may have accumulated near the propulsion and reverse systems.

Check the items listed in the following table before launching the watercraft.

ITEM	OPERATION	✓
Hull	Inspect.	
Jet pump water intake	Inspect/clean.	
Drain plugs	Tighten.	
Fuel tank	Refill.	
Engine compartment	Check for any visible fluid leaks and gasoline vapor odor.	
Engine oil level	Check/refill.	
Engine coolant level	Check/refill.	
Steering system	Check operation.	
Throttle lever	Check operation.	
iBR lever	Check operation.	

ITEM	OPERATION	✓
Intelligent Suspension (iS) (GTX Limited iS 260 only)	Check operation.	
Front storage compartment cover, boarding platform and seat	Ensure they are closed and latched.	
Self-contained removable storage bin	Ensure it is installed on watercraft and properly closed and latched.	
Wakeboard rack (WAKE Pro model)	<ul style="list-style-type: none"> – Ensure rack is properly installed and secured. – Make sure bungee cords are in good condition. – Ensure wakeboard is correctly installed in rack and secured. 	
Ski/wakeboard post (WAKE Pro model)	Inspect and check operation.	
Engine START/STOP button	Check operation.	
Engine cut-off switch	Check operation.	

Hull

Inspect hull for cracks and other damages.

Jet Pump Water Intake

Remove weeds, shells, debris or anything else that could restrict the flow of water and damage the propulsion unit. Clean as necessary. If any obstruction cannot be removed, refer to an authorized Sea-Doo dealer for servicing.

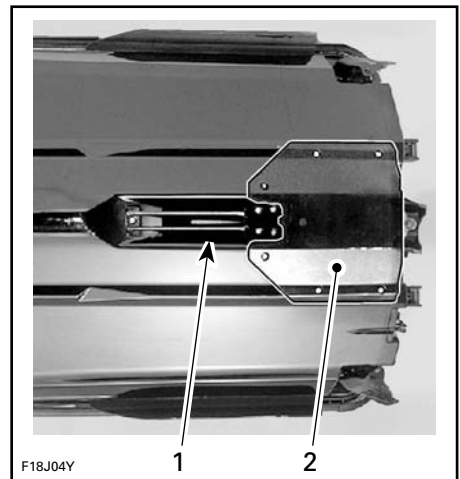

TYPICAL — INSPECT THESE AREAS

1. Water intake
2. Ride plate

Drain Plugs

Secure bilge drain plugs.

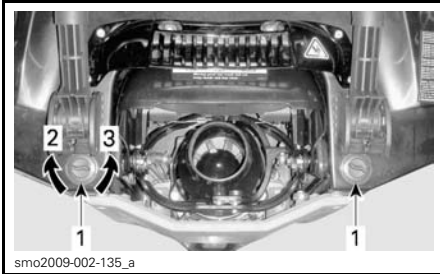

TYPICAL - BILGE DRAIN PLUG LOCATIONS

1. Bilge drain plugs
2. Tighten
3. Untighten

⚠ WARNING

Ensure bilge drain plugs are properly secured prior to launching the watercraft in water.

Fuel Tank

Fill the fuel tank.

⚠ WARNING

Strictly adhere to instructions detailed in *FUELING PROCEDURE*.

Engine Compartment

Inspect the engine compartment for fuel vapor odor.

⚠ WARNING

Should any leak or gasoline odor be present, do not apply electrical power or start the engine. You should seek service from an authorized Sea-Doo dealer, repair shop, or person of your own choosing for maintenance, repair, or replacement. Please refer to the *US EPA EMISSIONS-RELATED WARRANTY* contained herein for information about warranty claims.

To access the engine compartment, open the seat.

Models with Suspension

Also remove the ventilation box by depressing the 3 locking tabs and lifting it off the deck extension.

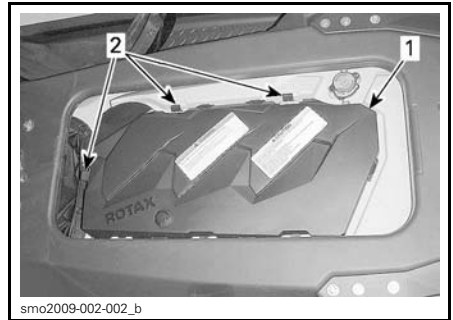

1. Ventilation box
2. Locking tabs



VENTILATION BOX REMOVED

Engine Oil

Ensure oil level is within specification as described in *MAINTENANCE PROCEDURES* section.

Engine Coolant

Ensure coolant level is within specification as described in *MAINTENANCE PROCEDURES* section.

All Models Except iS

Check for coolant leaks on engine, in bilge and from ride plate.

⚠ CAUTION When operating the engine with the watercraft out of the water, the engine and heat exchanger in the ride plate may become very hot. Avoid any contact with hot engine parts and the ride plate as burns may occur.

Steering System

Assisted by another person, check steering operation for free movement.

When the handlebar is horizontal, the jet pump nozzle should be in the straight ahead position. Ensure the jet pump nozzle pivots easily and in the same direction as the handlebar (e.g.: when handlebar is turned to the left, the nozzle opening must point towards the LH side of watercraft).

⚠ WARNING

Check handlebar and corresponding steering nozzle operation before starting. Never turn handlebar while someone is near the rear of the watercraft. Keep away from steering moving parts (nozzle, iBR gate, linkages etc.).

Throttle Lever

Check the Electronic Throttle Control lever (ETC) for free and smooth operation. It should return to its initial position immediately after it is released.

⚠ WARNING

Check throttle lever operation before starting the engine. If any friction is felt in the throttle lever, refer to an authorized Sea-Doo dealer.

iBR Lever

Check the iBR lever for free and smooth operation. It should return to its initial position immediately after it is released.

⚠ WARNING

Check iBR lever operation before starting the engine. If any friction is felt in the iBR lever, refer to an authorized Sea-Doo dealer.

iS Suspension (GTX Limited iS 260 only)

1. Press briefly the START/STOP button to wake-up the ECM.
2. Switch to manual suspension mode. Refer to *IS (INTELLIGENT SUSPENSION) (GTX LIMITED IS)*.

Storage Compartments, Boarding Platform and Seat

Ensure all required safety and survival equipment and any additional cargo is properly stored in the storage bins provided.

Ensure the self-contained storage bin cover, front cover, glove box, boarding platform, access panels, and seat are closed and latched.

⚠ WARNING

Ensure the seat, boarding platform, access panels, and all storage compartment covers are securely latched.

Models with Suspension

Ensure there are no items of cargo, or other material, between the moving deck and fixed deck.

⚠ WARNING

Do not store cargo or material of any type in the space between the moving and fixed deck, or near the rear suspension control arm. These areas must remain free of all obstructions to permit free movement of the deck and any water which may accumulate in the foot well areas. Use only provide storage compartments.

Wakeboard Rack (WAKE Pro model)

⚠ WARNING

Ensure wakeboard rack is properly secured to watercraft body, and that the wakeboard is properly positioned and secured to the rack prior to using watercraft. Ensure wakeboard retaining straps are in good condition.

Ski/Wakeboard Post (WAKE Pro model)

Make sure ski/wakeboard post is fully extended and locked before use. Completely retract and lock when not used.

⚠ WARNING

Use caution with skier/wakeboarder in tow as tow rope may backlash to watercraft when released. Never perform a sharp turn when towing a skier, wakeboarder or any toy. Always store tow rope when not in use.

NOTICE The ski/wakeboard post is designed for towing a skier or wakeboarder with a maximum gross weight of 114 kg (250 lb).

Engine Cut-Off Switch and Engine START/STOP Button

Press the start button once without installing the tether cord on the engine cut-off switch.

Install the tether cord cap on the engine cut-off switch.

Press the START/STOP button to start the engine, then stop it by pressing the START/STOP button a second time.

NOTE: To allow engine starting, the tether cord cap must be properly installed on the engine cut-off switch within 5 seconds of pressing the START/STOP button.

Restart the engine, then stop it by removing the tether cord from the engine cut-off switch.

⚠ WARNING

Should the tether cord cap be loose or fail to remain on the engine cut-off switch, replace the tether cord immediately in order to avoid unsafe use. If removing the tether cord cap from the engine cut-off switch or pressing the START/STOP button does not stop the engine, do not use the watercraft. See your authorized Sea-Doo dealer.

What to Do After Launching the Watercraft

Check the items listed in the following table after launching the watercraft and before going for a ride.

ITEM	OPERATION	✓
Information Center	Check operation.	
Intelligent Brake and Reverse System (iBR)	Check operation.	
Variable Trim System (VTS)	Check operation.	

Information Center (Gauge)

1. Press START/STOP button and install tether cord on the engine cut-off switch.
2. As the information center cycles through its self-test function, ensure all indications come on.

⚠ WARNING

Always attach the tether cord clip to your PFD or to the wrist (wrist strap required).

iBR System

NOTICE Ensure there is sufficient space ahead and behind watercraft to safely carry out the iBR system test to avoid a collision. Watercraft will move during test.

1. Remove the moorings securing the watercraft to the dock.
2. Start the engine and ensure the watercraft does not move.
3. On the left handlebar, depress the iBR lever completely in, the watercraft should move slowly backwards.
4. Release the iBR lever, there should not be any reverse thrust.

WARNING

Always ensure proper iBR system operation before taking the watercraft out for a ride.

Variable Trim System (VTS)

With the engine running in forward thrust, use the VTS™ system to move the jet pump nozzle up, and then down alternately to check VTS operation. Confirm the VTS position indicator movement in the information center.

Also test the VTS preset trim positions (if equipped).

***This page is
intentionally blank***

WATERCRAFT INFORMATION

CONTROLS

NOTE: Some vehicle safety labels are not shown on illustrations. For information on vehicle safety labels, refer to *WATERCRAFT SAFETY LABELS* subsection.



GTX 155/GTS S 155

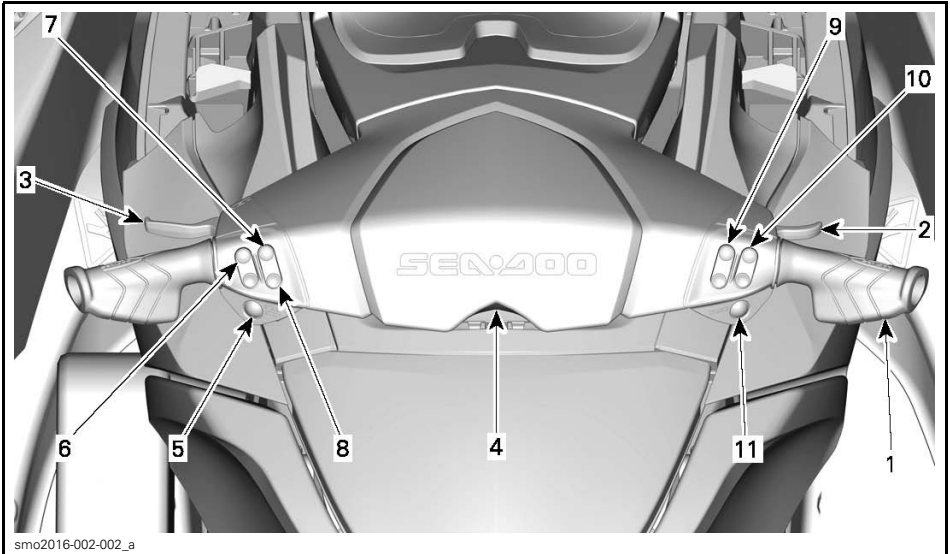

GTX LIMITED/GTX iS LIMITED/RXT/WAKE PRO

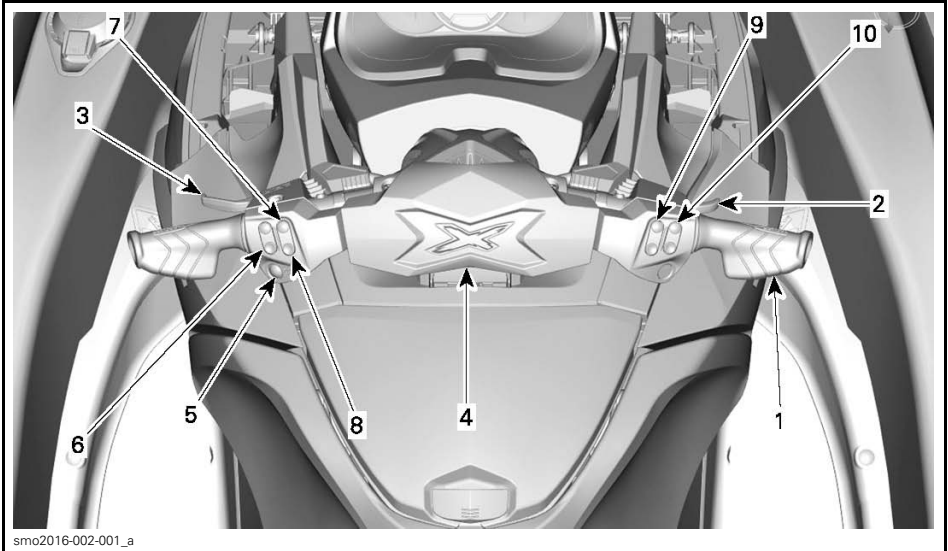

smo2016-002-001_a

RXT-X/RXT-X aS

NOTE: Some indications, functions and features described in this section may not apply to every PWC model, or may be available as an option.

1) Handlebar

The handlebar controls the direction of the watercraft. During forward operation, turning the handlebar to the right steers the watercraft to the right and inversely.

⚠ WARNING

Check handlebar and corresponding steering nozzle operation before starting. Never turn handlebar while someone is near the rear of the watercraft. Keep away from propulsion system.

When operating in reverse, steering direction is reversed. Turning the handlebar to the right while backing up steers the watercraft to the left.

2) Throttle Lever

The throttle lever on the RH handlebar controls electronically the engine speed.

To increase or maintain watercraft speed, pull the throttle lever with your finger.

To decrease watercraft speed, release the throttle lever.

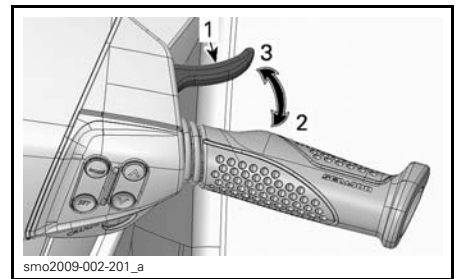

smo2009-002-201_a

1. Throttle lever
2. To accelerate
3. To decelerate

The throttle lever is spring loaded and should return to rest position (idle) when not pressed.

3) iBR Lever (intelligent Brake and Reverse)

The iBR lever on the LH handlebar can electronically command:

- Brake
- Reverse
- Neutral.

NOTE: A minimum of 25% of iBR lever stroke is required to activate iBR functions.

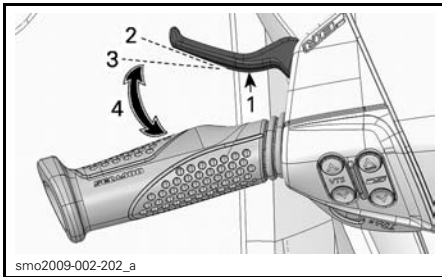

TYPICAL

1. iBR lever
2. Lever rest position
3. 25% stroke required to activate iBR functions
4. Operating range

At speed above 14 km/h (9 MPH), pulling the iBR lever will engage the brake.

NOTE: If water current is 14 km/h (9 MPH) or above, the reverse can not be engaged as the speed threshold for the reverse is exceeded.

At speed below 14 km/h (9 MPH), pulling the iBR lever will engage reverse.

When the iBR lever is released after braking or reverse operation, the neutral is engaged.

⚠ WARNING

If throttle lever is still pulled in when releasing the iBR lever, forward movement will be initiated after a short delay. If forward acceleration is not desired, release the throttle lever.

NOTE: The neutral position can be fine tuned by trimming the iBR system.

Refer to *OPERATING INSTRUCTIONS* for detailed instructions.

4) Engine Cut-Off Switch

The engine cut-off switch is located in the middle of the handlebar.

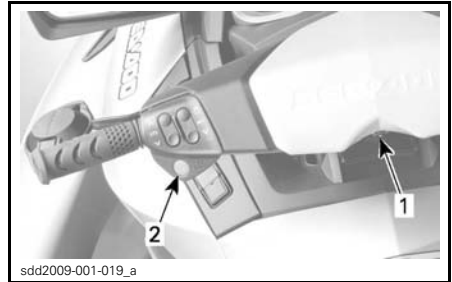

TYPICAL

1. Engine cut-off switch
2. START/STOP button

To allow engine starting, the tether cord cap must be securely snapped to the engine cut-off switch.

⚠ WARNING

Always attach the tether cord clip to the operator's personal flotation device (PFD) or wrist (wrist strap required).



TYPICAL

1. Tether cord cap on the engine cut-off switch
2. Tether cord secured to operator's PFD

To stop engine, pull the tether cord cap from the engine cut-off switch.

⚠ WARNING

Should the engine be stopped, the brake function and all watercraft directional control is lost.

⚠ WARNING

Always disconnect tether cord when watercraft is not in operation in order to prevent accidental engine starting or to avoid unauthorized use by others, children, and to prevent theft.

Radio Frequency Digitally Encoded Security System (RF D.E.S.S.)

The tether cord cap contains an electronic circuit (D.E.S.S.™ key) that is programmed to give it a unique electronic serial number. This is the equivalent of a conventional key.

The D.E.S.S. system reads the key installed on the engine cut-off switch and only allows engine starting for keys it recognizes.

The D.E.S.S. system brings great flexibility. You can buy additional tether cords and have the D.E.S.S. keys programmed for your watercraft.

A total of ten D.E.S.S. keys can be programmed.

To have a key programmed to your watercraft, see your authorized BRP Sea-Doo dealer.

RF D.E.S.S. Key Recognition

Two short beeps indicate the system is ready to allow engine starting. Otherwise, refer to the *TROUBLESHOOTING* section.

RF D.E.S.S. Key Types

Two types of keys can be used:

- Normal key
- Learning key.

To ease key recognition, the tether cord float comes in different colors.

KEY TYPE	FLOAT COLOR
Normal	Yellow or Black
Learning	Green

The information center displays the type of D.E.S.S. key used.

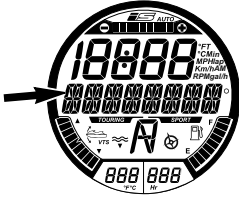

TYPE OF KEY IS DISPLAYED HERE

Message possibilities:

- NORMAL KEY
- LEARNING KEY.

The Sea-Doo learning key, limits the speed of the watercraft and the engine torque, therefore enabling first time users and less experienced operators to learn how to operate the watercraft while gaining the necessary confidence and control.

The learning mode offer also the possibility of setting the maximum speed of the watercraft.

For more information on learning keys, refer to *OPERATING MODES* section.

5) Engine START/STOP Button

The engine START/STOP button is located on the LH handlebar.

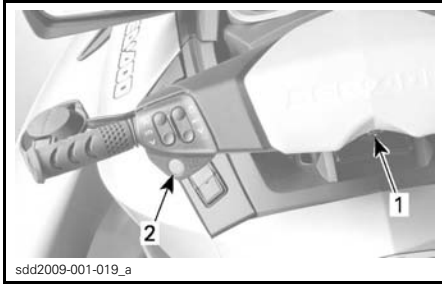

TYPICAL

1. Engine cut-off switch
2. START/STOP button

Engine Starting and Stopping

Refer to *OPERATING INSTRUCTIONS* for complete procedures on how to start and stop the engine.

Waking Up the Electrical System

Press the START/STOP button once without installing the tether cord on the engine cut-off switch.

This will power up the electrical system; the information center will cycle through a self-test function and will then go blank after a few seconds.

The electrical system will stay powered up for approximately 3 minutes after the START/STOP button was depressed.

This function allows the suspension to be activated (if applicable) without starting the engine.

NOTE: If the START/STOP button is pressed and held without the tether cord installed, the information center displays will stay on as long as the START/STOP button is held.

6) VTS (Variable Trim System) Button (all Models Except GTX 155 and GTX S 155)

This watercraft is equipped with a programmable high performance VTS.

It provides watercraft pitch trim adjustments by adjusting the vertical position of the jet nozzle.

The VTS can be electrically trimmed to desired attitude, or to one of two pre-set trim positions.

Press VTS control button (up or down button) to adjust riding attitude of the watercraft.

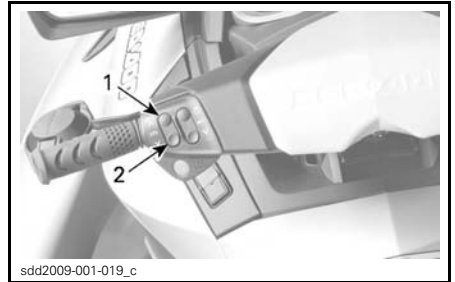

TYPICAL - VTS CONTROL BUTTON

1. Bow up
2. Bow down

Refer to *OPERATING INSTRUCTIONS* section for details.

7) Sport Button

The Sport button is located on the LH handlebar.

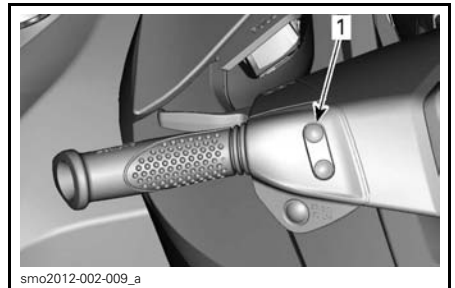

TYPICAL

1. Sport button

It is used to activate or deactivate SPORT mode.

Refer to *OPERATING MODES* subsection for details.

8) ECO Button

The ECO button is located on the LH handlebar.

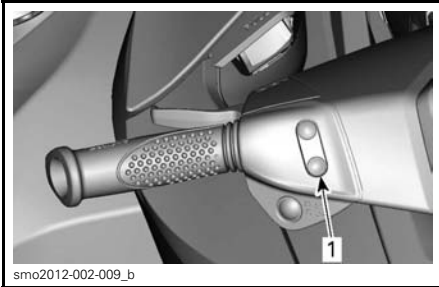

smo2012-002-009_b

TYPICAL

1. ECO button

It is used to activate or deactivate ECO mode.

Refer to *OPERATING MODES* subsection for details.

9) MODE/SET Buttons

These buttons are located on the RH side handlebar.

Press MODE button to scroll through various functions available through the information center.

Press SET button to select the desired function, navigate through a function submenu, or to save any modified settings.

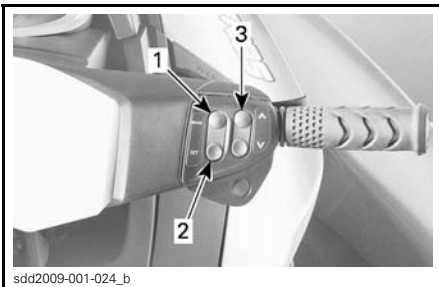

sdd2009-001-024_b

TYPICAL

1. MODE
2. SET
3. UP/DOWN button

10) UP/DOWN Buttons

These buttons are located on the RH side of the handlebar.

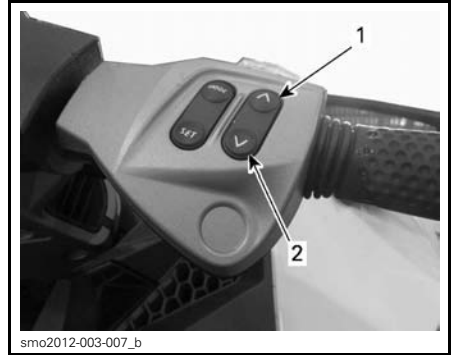

smo2012-003-007_b

TYPICAL

1. Up button
2. Down button

The UP/DOWN buttons are used to make a selection or change a settings through the information center.

11) Cruise Button (Except RXT-X and RXT-X aS Models)

The Cruise button is located on the RH side of the handlebar, just below the UP and DOWN button.

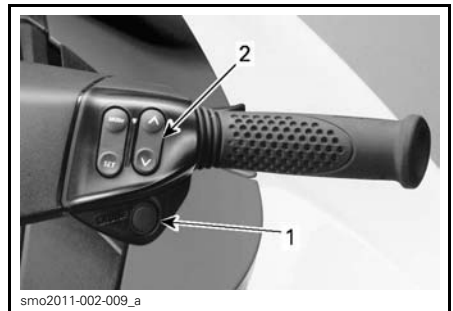

smo2011-002-009_a

TYPICAL

1. Cruise button
2. UP and DOWN button

It is used to activate or deactivate CRUISE mode or to engage SLOW SPEED mode.

Refer to *OPERATING MODES* for detailed instructions.

INFORMATION CENTER (GAUGES)

WARNING

Do not adjust the display while riding, you could lose control.

Information Center Description

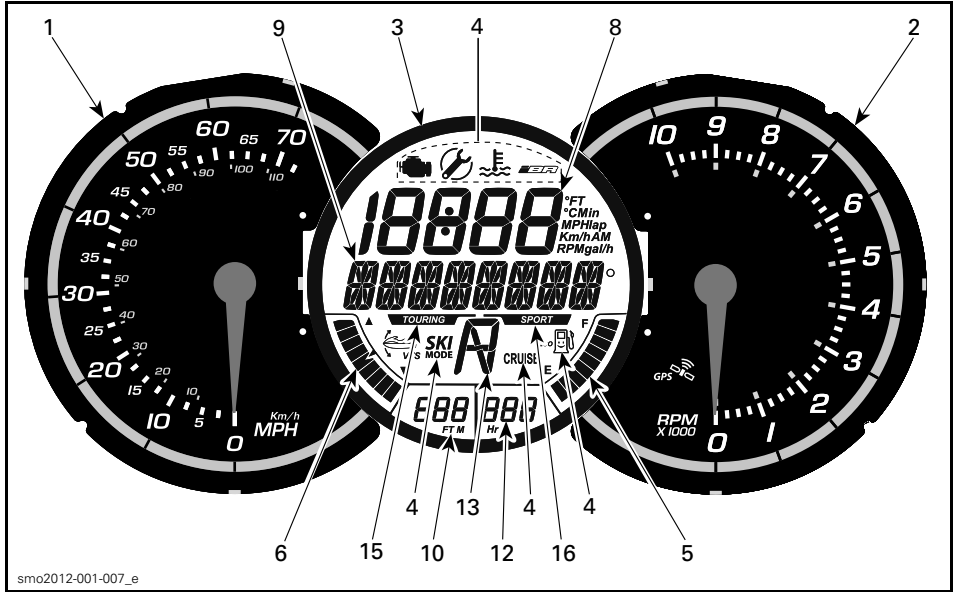

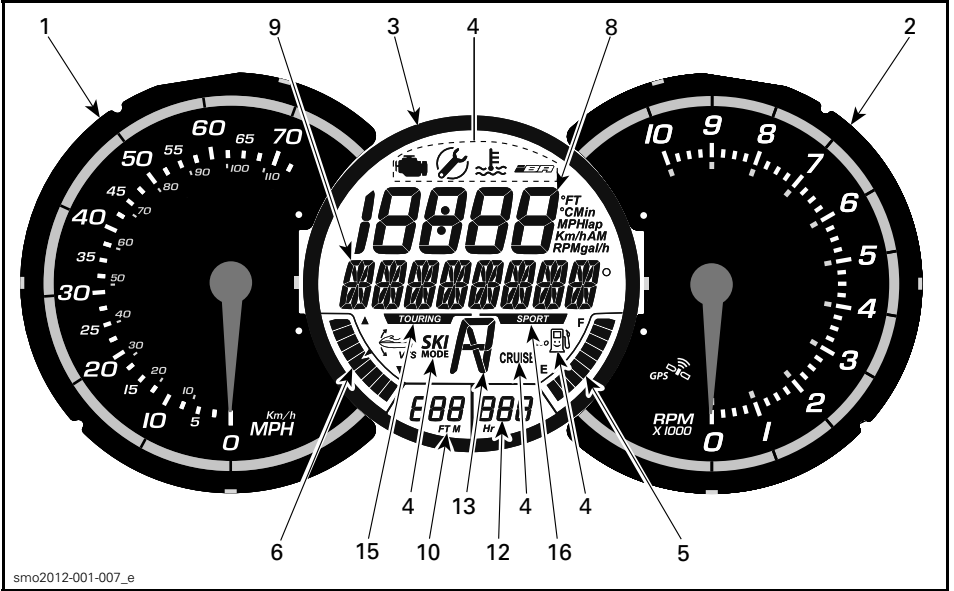

GTX 155/GTX S 155

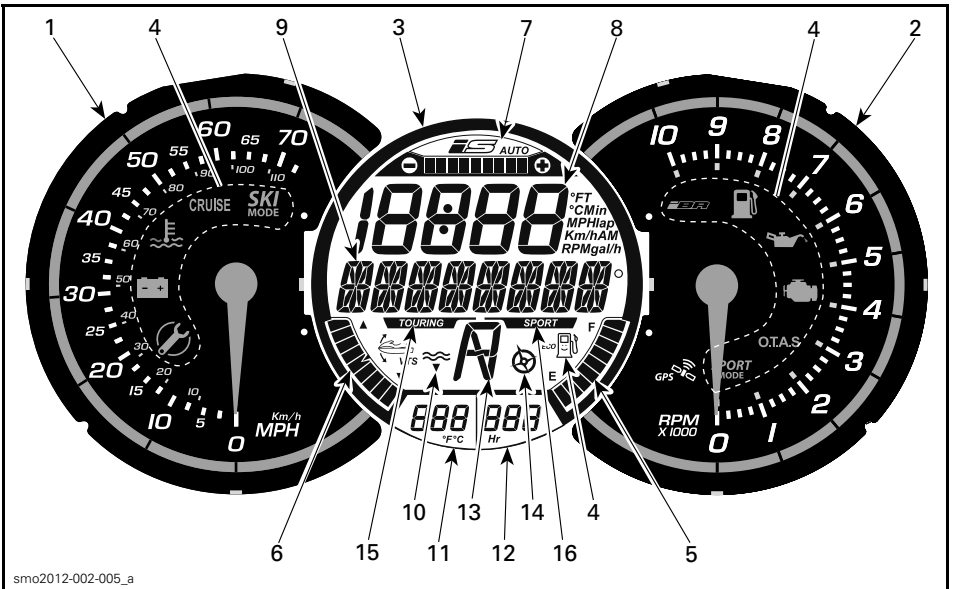

GTX LIMITED/GTX IS LIMITED/RXT/WAKE PRO

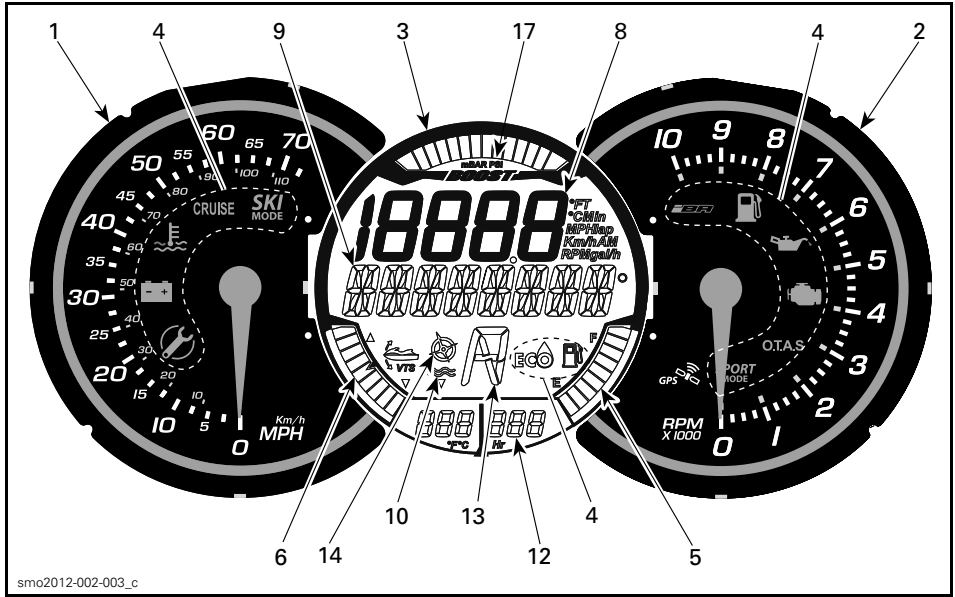

RXT-X/RXT-X aS

1) Speedometer

The speedometer, located in the LH side of the information center, provides an analog indication of the speed of the watercraft in miles per hour (MPH) and kilometers per hour (km/h).

The speed indication is based on a GPS (Global Positioning System) incorporated within the information center.

If for some reason the GPS signal is lost, a default mode is used whereby, the speed is calculated using information received from other systems to provide an estimated watercraft speed.

2) Tachometer

The tachometer provides an analog indication of the revolutions per minute (RPM) of the engine. Multiply the indicated number by 1000 to obtain the actual engine RPM.

3) Multifunction Gauge

The multifunction gauge, located in the center of the information center, is capable of displaying different indications simultaneously.

Numerical and multifunction displays in the digital screen indicator can be used to display various indications, or for selecting modes of operation and changing settings as explained in their respective sections.

Multifunction Gauge Features

	GTX 155 GTX S 155	GTX LIMITED	GTX LIMITED iS	RXT	RXT-X/ RXT-X aS	WAKE PRO
TOURING mode indicator	X	X	X	X	N.A.	X
SPORT mode indicator	X	X	X	X	N.A.	X
Fuel level indication	X	X	X	X	X	X
Hour meter display	X	X	X	X	X	X
Water depth indication	-	X	X	-	-	-
ECO mode indicator	X	X	X	X	X	X
CRUISE mode indicator	X	N.A.	N.A.	N.A.	N.A.	N.A.
iBR position indicator	X	X	X	X	X	X
SKI mode indicator	-	N.A.	N.A.	N.A.	N.A.	N.A.
VTS position indication	X	X	X	X	X	X
Boost gauge	N.A.	N.A.	N.A.	N.A.	X	N.A.
iS indicator	N.A.	N.A.	X	N.A.	N.A.	N.A.







X = Indicates a standard feature
 - = See a Sea-Doo dealer for availability.
 N.A. = Not Available or Not Active

4) Indicator Lights

Indicator lights (pilot lamps), inform you of a selected function or a system anomaly.

An indicator light may be accompanied by a scrolling message in the multifunction display.

See the following table for information on the usual pilot lamps. Refer to *MONITORING SYSTEM* for details on malfunction pilot lamps.

PILOT LAMPS (ON)	MESSAGE DISPLAY	DESCRIPTION
	MAINTENANCE REMINDER	Maintenance required. You may seek service from an authorized Sea-Doo dealer, repair shop, or person of your own choosing for maintenance, repair, or replacement. Please refer to the <i>US EPA EMISSIONS-RELATED WARRANTY</i> contained herein for information about warranty claims.
	LOW-FUEL	Low fuel level, approx. 25% tank capacity, 14 L (3.7 U.S. gal.) or fuel level sensor disconnected.
	Scrolling SLOW SPEED MODE message	CRUISE mode or SLOW SPEED MODE engaged. Refer to <i>OPERATING MODES</i> subsection.
	Scrolling SKI MODE messages	Ski Mode activated. Refer to <i>OPERATING MODES</i> subsection.
	Scrolling SPORT MODE messages	Sport Mode activated. Refer to <i>OPERATING MODES</i> subsection.
ALL MODELS EXCEPT RXT-X/RXT-X aS MODELS		
	FUEL ECO	Fuel Economy Mode activated. Refer to <i>OPERATING MODES</i> subsection.
RXT-X/RXT-X aS		
	FUEL ECO	Fuel Economy Mode activated. Refer to <i>OPERATING MODES</i> subsection.

5) Fuel Level Indication

A bar gauge located in the bottom RH side of the multifunction display continuously indicates the amount of fuel in the fuel tank while riding.

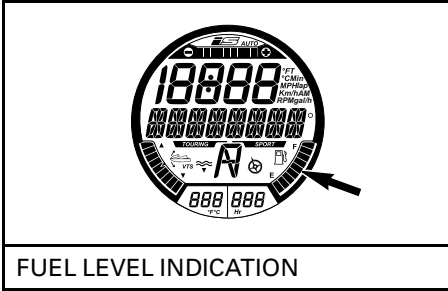

When the fuel tank is full, 8 segments (bars) of the indicator are turned on. The top segment is not used.

Low Fuel Level Warning

It is active when there is only 2 segments of fuel indicated (approximately 25% fuel tank capacity or 14 L (3.7 U.S. gal.).

All Models Except GTX 155 and GTX S 155

LOW FUEL LEVEL WARNING	
Last 2 fuel gauge segments	ON
Fuel tank symbol (LED)	
Audible warning (one long beep)	Periodically
Scrolling LOW FUEL WARNING message	

GTX 155 and GTX S 155 Models

LOW FUEL LEVEL WARNING	
Last 2 fuel gauge segments	Flashing
Fuel tank symbol (LCD)	
Audible warning (one long beep)	Periodically
Scrolling LOW FUEL WARNING message	

6) VTS Position

The VTS position indication located in the bottom LH side of the digital screen shows the riding attitude of the watercraft.

A single segment of a bar gauge type indicator is turned on to indicate the relative position of the watercraft bow.

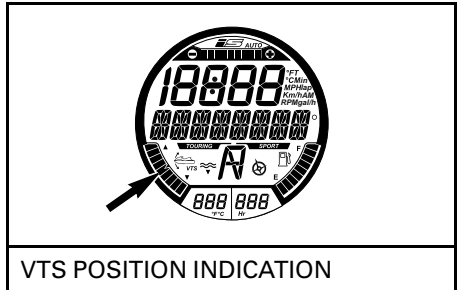

Refer to *OPERATING INSTRUCTIONS* for more details on using the VTS.

7) iS Position (GTX Limited iS Only)

The iS display (intelligent Suspension) provides a visual indication of the relative height of the suspension.

It also indicates if the suspension is in AUTO mode of operation.

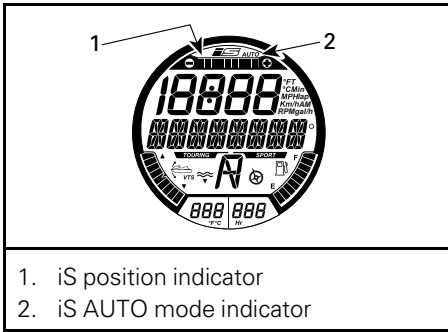

When the suspension system is operating in AUTO mode, the AUTO indicator and all bar segments of the position indicator will be on.

When the suspension height is adjusted manually using the UP/DOWN buttons (while in iS mode), the system switches to MANUAL mode of operation. The AUTO indication disappears and only one bar segment of the position indicator will be on.

Refer to *OPERATING INSTRUCTIONS* for more information on using the suspension.

8) Numerical Display

The numerical display is used to provide a variety of indications as selected by the operator using the DISPLAY function in the multifunction display.

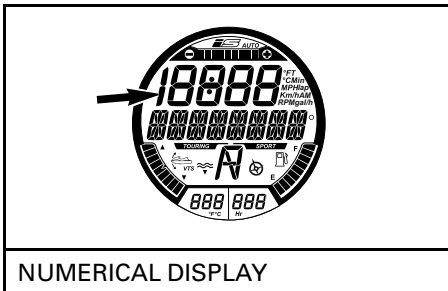

The available indications are dependent on the watercraft model or option installed.

AVAILABLE INDICATIONS IN NUMERICAL DISPLAY	GTX 155, GTX S 155	GTX LIMITED, GTX LIMITED iS	RXT	RXT-X aS, RXT-X	WAKE PRO
Watercraft speed	Indication by default				
Engine RPM	X	X	X	X	X
Engine temperature	-	-	-	X	-
Lake water temperature	N.A.	X	N.A.	N.A.	N.A.
Clock	X	X	X	X	X
Learning key settings	X	X	X	X	X
CRUISE SPEED setting	X	X	X	-	X
SLOW SPEED MODE setting	X	X	X	-	X
VTS preset	-	X	X	X	X
VTS settings (through gauge)	X	N.A.	N.A.	N.A.	N.A.
SKI MODE settings	-	-	-	-	X
Fuel consumption (instant and average)	X	X	X	X	X
Fuel autonomy (distance and time to empty)	-	X	-	X	-
Lap timer	-	-	-	X	-
Top speed/RPM Average speed/RPM	-	-	-	X	-
Altitude	N.A.	X	N.A.	N.A.	N.A.
X = An X indicates a standard feature - = See a Sea-Doo dealer for availability. N.A. = Not Available					

When the information center is first powered up, the numerical display defaults to the last selected indication.

9) Multifunction Display

The multifunction display is used to:

- Display the WELCOME message on power up.
- Display the KEY recognition message.
- Provide various indications as selected by the operator.
- Activating and setting various functions and modes of operation.
- Display scrolling messages of function activation or system faults.
- Display fault codes.

NOTE: The default indication in the multifunction display is the compass direction.

10) Water Depth Display (GTX Limited and GTX Limited iS Models)

The water depth display provides an indication of the lake water depth.

The system is capable of indicating water depth under the hull in single increments up to 50 m (164 ft).

NOTE: Under certain conditions, the display may stop indicating. The display ability to provide an indication of the water depth depends on the conditions of use.

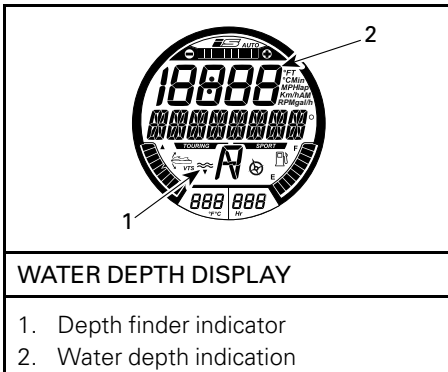

NOTE: The water depth indication is only available when a depth sounder is installed and detected.

⚠ WARNING

Never use the depth sounder as a warning device to ride in shallow water.

11) Lake Water Temperature Display (GTX Limited and GTX Limited iS Models)

Continuously displays surface water temperature.

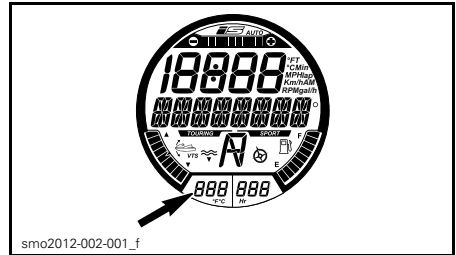

The numerical display may also be selected to display water temperature. See *NUMERICAL DISPLAY* in this section.

To change the unit of measurement (°C or °F), see your authorized Sea-Doo dealer.

12) Hour Meter Display (HR)

Continuously displays the accumulated engine hours.

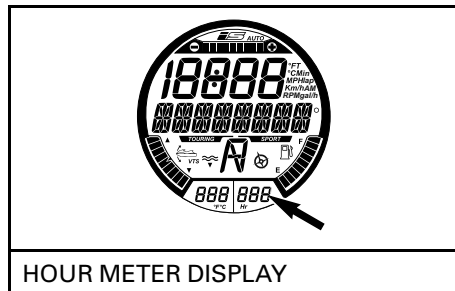

13) iBR Position

Provides an indication of the iBR gate position.

- N (neutral)
- F (forward)
- R (reverse).

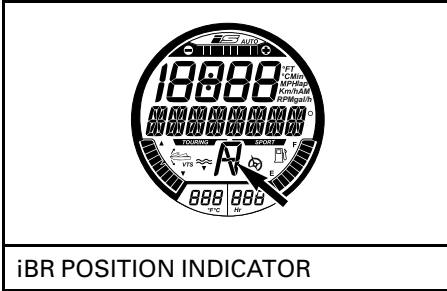

iBR POSITION INDICATOR

14) Compass

A GPS incorporated in the information center provides the indication in the multifunction display.

The cardinal points, intermediate cardinal points, as well as the azimuth the watercraft is travelling are displayed in the multifunction display by default when the watercraft is moving.

For a compass indication to be displayed, the GPS must have a good link with the navigation satellites.

All Models Except GTX 155 and GTX S 155

This is confirmed when the COMPASS active indicator is visible in the digital screen.

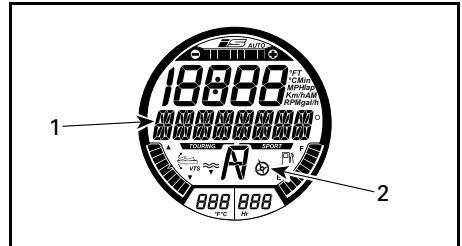

COMPASS (ALL MODELS EXCEPT RXT-X/RXT-X aS)

1. Compass indication
2. Compass active indicator

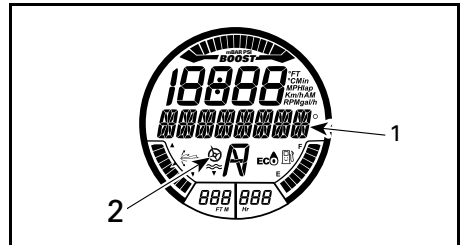

COMPASS (RXT-X/RXT-X aS MODELS)

1. Compass indication
2. Compass active indicator

NOTE: The compass indication is only available above 5 km/h (3 MPH).

⚠ WARNING

Use the compass as a guide only.
Not to be used for precision navigation purposes.

15) Touring Mode Indicator (all Models Except RXT-X/RXT-X aS)

When the TOURING mode indicator is ON, the default TOURING mode is active.

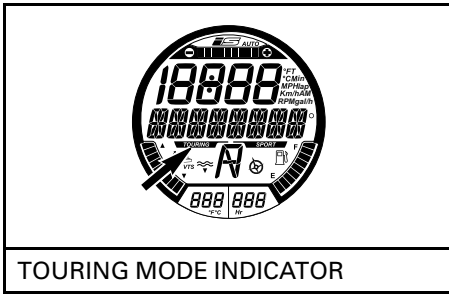

For more information on the touring mode, refer to *OPERATING MODES* subsection.

16) Sport Mode Indicator

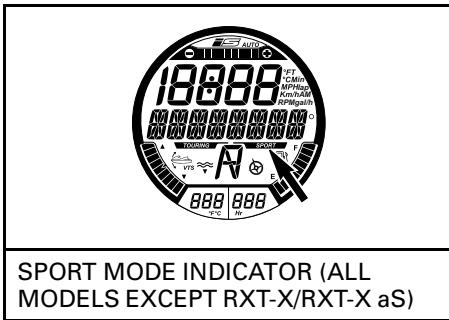

When sport mode of operation is selected, the sport mode indicator will come on and stay on until sport mode is deactivated, or the watercraft is shut down.

NOTE: The sport mode is not the default riding mode. To be active, it must be selected after starting the engine.

For instructions on how to engage sport mode, refer to *OPERATING MODES* subsection.

GTX Limited/GTX Limited iS/RXT/WAKE PRO

In addition to the sport mode indicator in the multifunction display, a SPORT MODE indicator light turns ON in the tachometer.

RXT-X/RXT-X aS

There is no sport mode indicator in the multifunction display, only a SPORT MODE indicator light turns ON in the tachometer.

17) Boost Gauge (RXT-X/RXT-X aS)

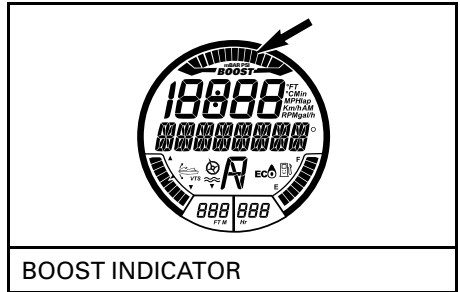

The boost gauge indicates the manifold pressure of the engine provided by the supercharger.

Navigating the Multifunction Display

When the electrical system is powered up and the cluster has completed its self test function, a WELCOME ABOARD SEA-DOO scrolling message will appear for a few seconds. After the welcome message, nothing will appear in the display until the watercraft is operated.

When the watercraft is being operated, the multifunction display provides an indication of compass heading or scrolling messages from the monitoring system.

The multifunction display is also used to display a menu for the selection of various functions which, permit changing the numerical display indication, system modes of operation, settings, active system fault codes, and a lap timer.

⚠ WARNING

Selecting various numerical displays, system modes of operation or changing settings should only be carried out with the watercraft stopped. Selecting these various functions while operating the watercraft at speed is not recommended as it deters your attention from situational awareness.

NOTE: The fault code function is only available when there is an active fault. The settings and key mode functions are only available when the engine is shut off. The key mode function is only available with a normal key.

Function Description

Lap Timer

The lap timer can be used to record up to 50 individual lap times.

To activate and use the lap timer, carry out the following:

1. Press the MODE button repeatedly until LAP TIME is visible in the multi-function display.

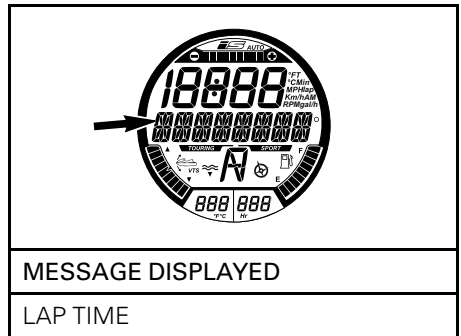
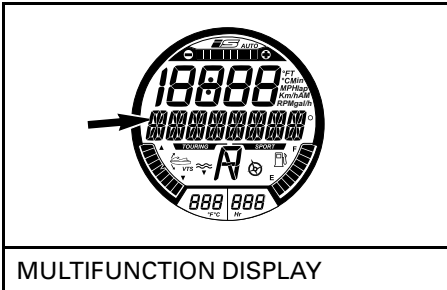

2. Press the SET button to enter the function, the lap timer will be activated and visible in the display.

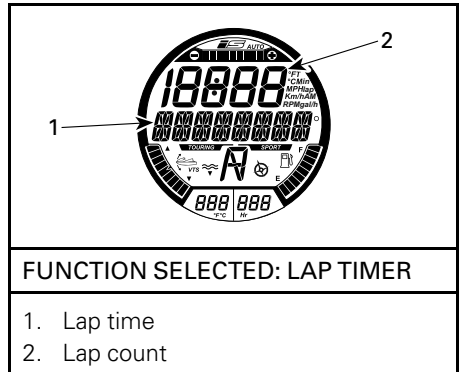

3. To start the timer, press the SET button.

NOTE: To change the unit of measurement or the language displayed, see your authorized Sea-Doo dealer.

Selecting Functions

When operating at speed, the multi-function display normally provides an indication of the compass direction and azimuth the watercraft is traveling.

To select the various functions available through the multifunction display, press the MODE button repeatedly until the desired function is visible:

- LAP TIME
- SKI MODE
- LAP TIME
- FUEL CONSUMPTION
- VTS MODE
- DISPLAY
- FAULT CODES
- KEY MODE
- SETTINGS.

Then press the SET button to enter that function.

NOTE: The timer starts immediately when pressing the SET button.

4. To record each lap time, press the SET button at the start of each lap.

NOTE: The lap time will be recorded, the lap counter in the numerical display will count the number of laps recorded, and the timer will continue to run.

5. To save the last lap and stop the timer, press the MODE button.

To view each lap time, use the UP or DOWN button. The lap counter will indicate which lap is indicated.

To view the cumulative lap time of all laps recorded, use the UP or DOWN button until ALL is visible in the lap counter.

MESSAGE DISPLAYED: LAP TIMER
<ol style="list-style-type: none"> 1. Total time 2. ALL is displayed here

To reset the lap timer and lap counter, press and hold the SET button until the timer and counter are reset to 0 (zero).

Ski Mode

Ski mode is used for repeated controlled launches when towing a skier or wakeboarder. Refer to *OPERATING MODES* for more details.

Fuel Consumption

The FUEL CONSUMPTION function is used to display the watercrafts fuel consumption in four different ways.

- Instant fuel flow per hour (gal/h or l/h)

- Average fuel flow per hour (gal/h or l/h)
- Distance to empty (Mi or Km)
- Time to empty (h or min).

The fuel consumption functions are not continuously active.

A fuel consumption function becomes active only when selected as the indication in the numerical display.

When the LOW FUEL indications come on in the multifunction gauge, the "TIME TO EMPTY" and "DISTANCE TO EMPTY" functions will indicate "0" (zero) if they are the selected indication.

To display the watercraft fuel consumption, carry out the following:

1. Press the MODE button repeatedly until FUEL CONSUMPTION is visible in the multifunction display.

MESSAGE DISPLAYED
FUEL CONSUMPTION

2. Press the UP or DOWN button to toggle to the desired fuel consumption display mode.

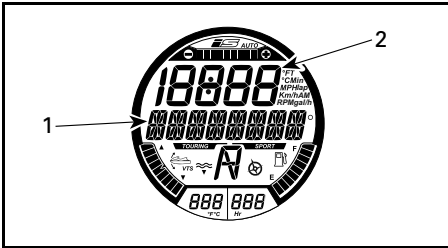

FUEL CONSUMPTION DISPLAY MODE

1. INSTANT FUEL CONSUMPTION message
2. Fuel consumption value

3. Press the SET button to save the setting and return to the main display.

NOTE: The fuel consumption value will be displayed in the numerical display. Double click the SET button to reset the average fuel consumption indication. The display will momentarily indicate zero (0).

VTS Mode

The VTS MODE function is used to manually set the VTS or change VTS PRESET settings. Refer to *OPERATING INSTRUCTIONS* subsection for details.

Display

The DISPLAY function is used to change the indication in the numerical display. Refer to *CHANGING NUMERICAL DISPLAY INDICATION*.

Fault Codes

The FAULT CODES function is used to display active fault codes. Refer to *MONITORING SYSTEM* subsection.

Key Mode

The KEY MODE function is used for changing LEARNING key settings. Refer to *OPERATING MODES* subsection for details.

Settings

The SETTINGS function is used for:

- Clock setting. Refer to *MULTI-FUNCTION GAUGE SETUP*
- iBR override function for maintenance.

Changing Numerical Display Indication

To change the indication in the numerical display, carry out the following:

1. Press the MODE button on the RH handlebar repeatedly until DISPLAY is visible in the multifunction display.

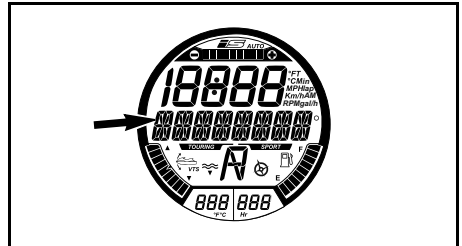

MESSAGE DISPLAYED

DISPLAY

2. Press the SET button to enter the DISPLAY function.
3. Press the UP or DOWN button until the preferred available indication appears.
 - RPM
 - SPEED
 - LAKE TEMPERATURE (only on models GTX Limited and GTX Limited iS 260)
 - DEPTH
 - ENGINE TEMP
 - ALTITUDE
 - TOP SPEED
 - AVG SPEED
 - TOP RPM
 - AVG RPM
 - CLOCK.

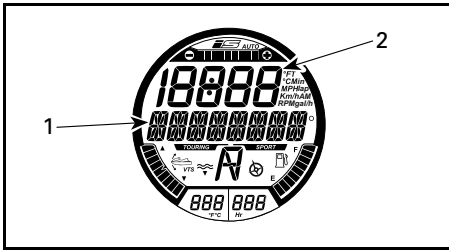

NUMERICAL DISPLAY SELECTION

1. Type of selected numerical display indication
2. Applicable value

4. Press the SET button to select and save the preferred indication, or wait for the display function to time out. The last indication visible will be automatically saved.

The following abbreviations are used in the numerical display:

- FT or M
- RPM
- MPH or Km/h
- °F or °C
- AM or PM
- Gal/h or l/h.

Resetting Numerical Display Indication

The following numerical display indications can be reset:

- Average fuel consumption
- Top speed
- Average speed
- Top RPM
- Average RPM.

To reset indications, double click the SET button. The numerical display will momentarily indicate zero (0).

NOTE: Each of these functions become active **ONLY** when selected as the numerical display indication.

Multifunction Gauge Setup

Changing Clock Setting

1. Press the MODE button repeatedly until SETTINGS is visible in the multifunction display.

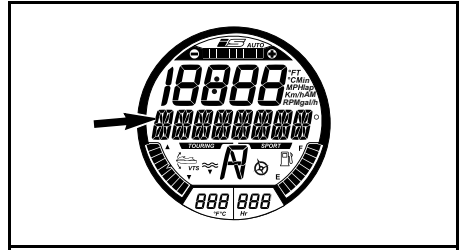

MESSAGE DISPLAYED

SETTINGS

2. Press the UP or DOWN button repeatedly until CLOCK is visible.

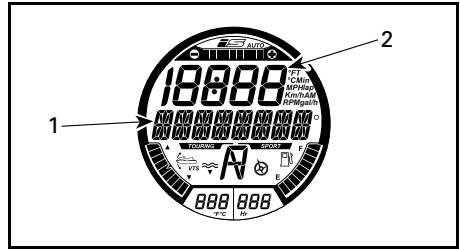

FUNCTION SELECTED - CLOCK

1. CLOCK message
2. Time

3. Press the SET button to enter the function. CHANGE CLOCK OFF-SET message will be displayed.

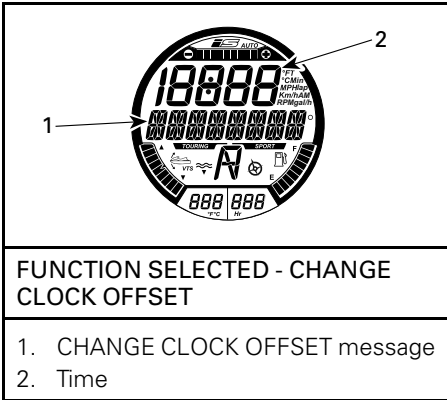

4. Press the UP or DOWN button to adjust the clock to the correct local time.
5. Press the SET button to save the setting and return to the main display.

NOTE: The clock uses the GPS signal to maintain the appropriate time referenced to Greenwich Mean Time (GMT). When setting the clock, only the hour indication may be changed.

Units of Measurement and Language Setting

The multifunction gauge is capable of displaying information in metric or imperial units and in various languages.

To change the units of measurement or to change the language displayed in the multifunction gauge, see your authorized Sea-Doo dealer.

EQUIPMENT

NOTE: Illustrations may not be accurate for every model and are only provided as a visual guide.

NOTE: Some vehicle safety labels are not shown on illustrations. For information on vehicle safety labels, refer to *WATERCRAFT SAFETY LABELS* subsection.

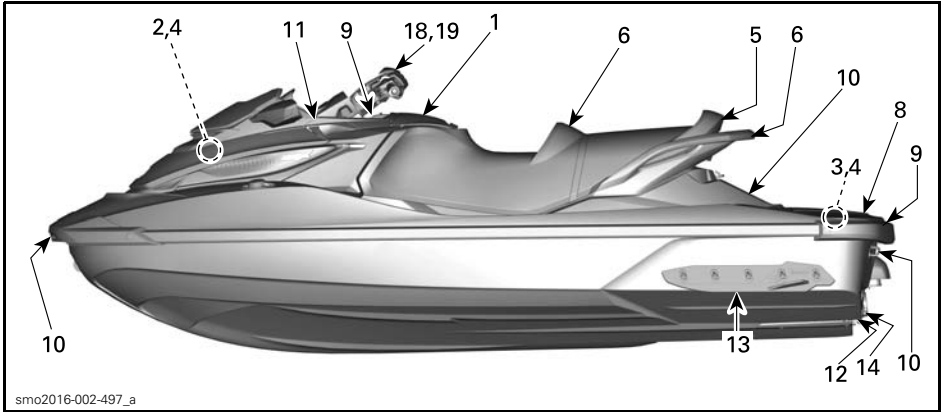

TYPICAL

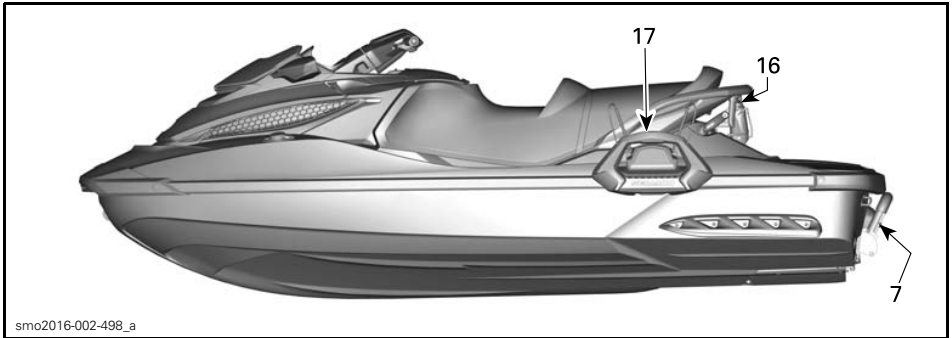

WAKE PRO MODELS

1) Glove Box

A small, storage compartment for personal articles.

Pull up on cover latch to open glove box.

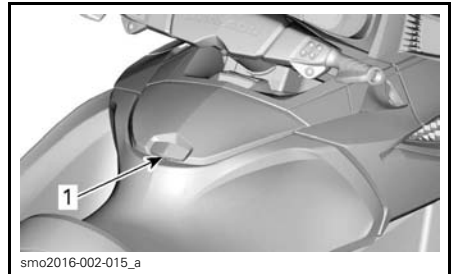

TYPICAL — GLOVE BOX

1. Cover latch

Glove Box Organizer (GTX Limited and GTX Limited iS Models)

A removable glove box organizer can be used for storing and carrying personal items.

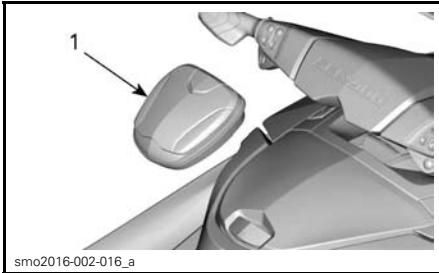

TYPICAL

1. glove box organizer

Glove Box Liner Bag (GTX Limited and GTX Limited iS Models)

A glove box liner bag protects items stored in the glove box. The liner bag is easily removed from the glove box by pulling it out using the two eyelets.



GLOVE BOX LINER BAG

2) Front Storage Bin

A watertight storage bin that can be used to carry larger personal articles is located under the front cover. The storage bin is self-contained and removable.



FRONT STORAGE BIN

Storage Bin Access

Open the front storage compartment cover by pulling upwards on the two cover latch handles (one each side).



TYPICAL - STORAGE BIN ACCESS

1. Front cover latch handles (one each side)

How to Open Storage Bin Cover

Release cover latches then pull on cover handle to open.

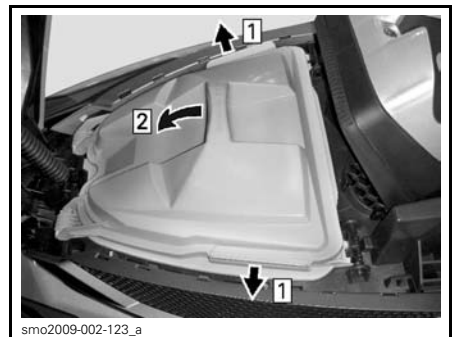

HOW TO OPEN STORAGE BIN

Step 1: Release cover latches

Step 2: Pull cover open

NOTICE The maximum load allowable for the front storage bin is 9 kg (20 lb) evenly distributed.

⚠ WARNING

Never leave any heavy or breakable objects loose in the front storage bin. Do not overload. Never operate the watercraft with any storage compartment cover open.

Storage Bin Removal

Ensure the latches on the storage bin cover are properly locked.

Push back on the latches that lock the storage bin in position. Then pull up on the storage bin handle while tilting the bin forward to release the front tabs, and remove it from the watercraft.

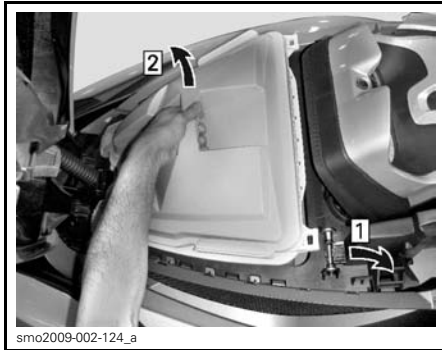

STORAGE BIN REMOVAL

Step 1: Push back on storage bin latches

Step 2: Lift and tilt forward to release front tabs

⚠ WARNING

On models with 1630 ACE™ HO engines, never store or carry anything underneath storage bin, or between the moving deck and fixed deck.

Storage Compartment Under Storage Compartment (1630 ACE HO Engine)

An additional storage compartment is located under the storage bin and can be accessed by removing the storage bin.

⚠ WARNING

Never leave any heavy or breakable objects loose in this storage compartment. Do not overload.

Storage Bin Installation

As you insert the storage bin in the front storage compartment, tilt it forward to insert the storage bin front tabs in their retainers underneath the storage cover shock support.

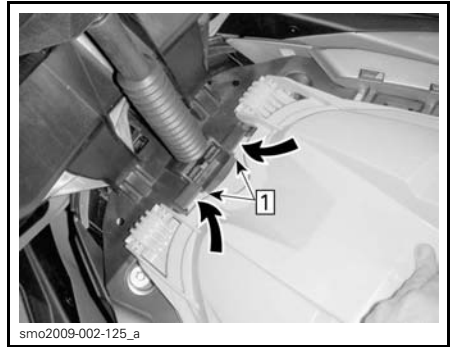

Step 1: Insert storage bin front tabs

Push down on aft end of storage bin to secure in place with locking latches (one each side).



Step 1: Push down onto latches to secure

Ensure storage bin is properly inserted in the locking latches, and ensure the latches are locked forward.

NOTICE Never operate the watercraft if the storage bin is not properly secured.

All Models Without Suspension

NOTICE Do not operate watercraft if the front storage bin is not installed, otherwise water will enter bilge.

3) Rear Storage Bins

Models with Suspension

Two storage bins are located under the rear boarding platform. They are ideal for storing items such as a towrope, first aid kit, fire extinguisher, and other items.

When the boarding platform is closed, it serves as the cover for both storage bins.

The RH storage bin is specially designed for storing an approved fire extinguisher (sold separately).



1. Fire extinguisher holder location

The RH storage bin can be removed for servicing the watercraft.

To remove storage bin, pull off the two plastic rivets within the bin (fore and aft) then lift the storage bin out of the fixed deck.



BATTERY AND FUSE ACCESS - RH STORAGE BIN REMOVED

NOTICE Never operate the watercraft without both rear storage bins installed. Always ensure the rear boarding platform is properly closed and latched over the storage bins. If not properly latched, water rushing over the platform during extreme maneuvers may open the platform and dislodge the RH storage bin. Should this happen, water will enter the bilge and may lead to engine damages or electrical problems.

4) Fire Extinguisher Holder

Models with Suspension

Use the support inside the RH storage bin under the rear boarding platform, and secure the extinguisher using the rubber tie-down.

Refer to *REAR STORAGE BINS* for illustration.

NOTE: Fire extinguisher is sold separately.

Models Without Suspension

The fire extinguisher support is located under the front storage bin.

5) Seat

This model comes equipped with an ergonomic seat narrowing towards the front with knee grab design allowing you to position your legs towards the inside of the footwells, minimizing upper body fatigue and granting you more control when cornering.

This seat is designed for an operator and a passenger.

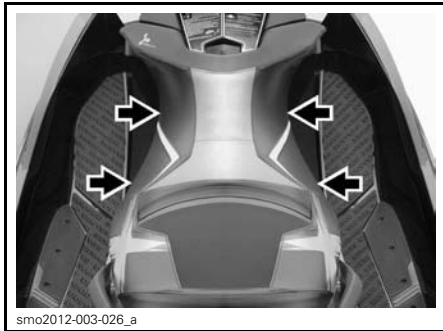

smo2012-003-026_a

ERGONOMIC SEAT

Seat Removal (1503 4-TEC™ Engine)

To remove the seat, pull up on the latch handle and lift the back end of the seat.

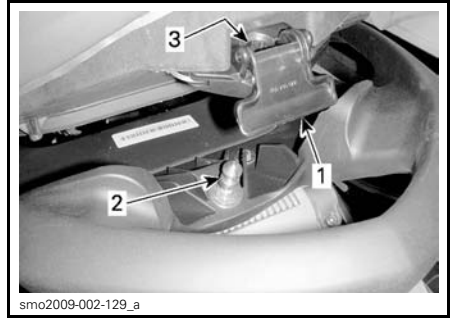

smo2009-002-129_a

TYPICAL - SEAT LATCH

1. Seat latch handle
2. Latch pin
3. Pin insertion hole

Then pull the seat up and backwards to remove the seat from the watercraft.

Seat Opening (1630 ACE HO Engine)

To lift the seat, pull up on the latch handle and lift the back end of the seat.

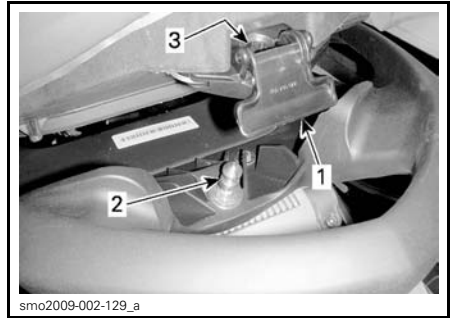

smo2009-002-129_a

TYPICAL - SEAT LATCH

1. Seat latch handle
2. Latch pin
3. Pin insertion hole

Seat Installation (1503 4-TEC Engine)

To install the seat, insert the forward end of the seat in it's retainer.



smo2012-003-013_a

1. Forward seat retainer

Align the seat latch with the latch pin and firmly press down on the rear portion of the seat to lock it in place.

Pull up on the rear portion of the seat to ensure it is properly latched.

CAUTION Ensure the latch is properly locked onto the pin.

Seat Installation (1603 Engine)

Lower seat and push to lock into place.

Pull up on the rear portion of the seat to ensure it is properly latched.

CAUTION Ensure the latch is properly locked onto the pin.

6) Passenger Handholds

The seat strap provides a handhold for a passenger to hold on to when riding.

The sides of the molded grab handle at the rear of the seat also provide a handhold for a passenger. The rear portion of the molded grab handle provides a handhold for the skier/wakeboarder (if applicable) spotter or boarding the watercraft from the water.

NOTICE Never use the molded grab handle to tow anything or to lift the watercraft.

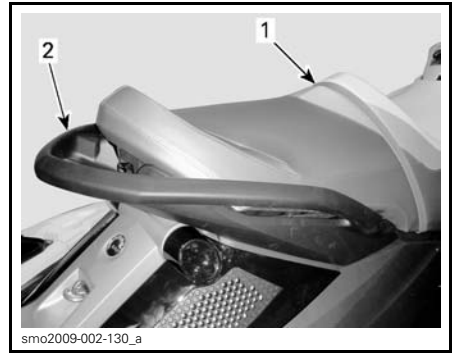

smo2009-002-130_a

TYPICAL - PASSENGER HANDHOLDS

1. Seat strap
2. Molded grab handle

7) Boarding Step (If Equipped)

A convenient step used for boarding the watercraft from the water.

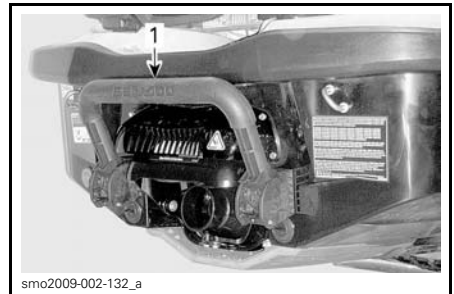

smo2009-002-132_a

TYPICAL

1. Boarding step

WARNING

The engine must be shut off before attempting to board the watercraft using the boarding step.

Pull down the step with your hand and hold until a foot or a knee is put on the step.



BOARDING STEP HELD DOWN FOR BOARDING FROM WATER

NOTICE

- Never use the step for boarding a watercraft that is out of water.
- Never use the step for pulling, towing, diving or jumping, or any other purpose other than as a boarding step.
- Stay on center of the step.
- Only one person at a time on the step.

⚠ WARNING

Be aware of the iBR gate movement when starting the engine, shutting down the engine or using the iBR lever. Automatic movement of the gate may squeeze fingers or toes of people taking a hold on the back or your PWC.

8) Boarding Platform

A boarding platform covers the rear deck area.

Two indentations in the platform are used as foot rests for the rear facing spotter when towing a skier or tuber.

Models with Suspension

Two grab handles near the rear edge of the platform provide hand holds for a person boarding from the water.

The platform also serves as a water-tight cover for two rear storage bins that are accessible when opening the

platform. It is hinged to the fixed deck at the rear, and held closed by two latches at its front corners.

To open the boarding platform, pull up on each latch handle and lift the deck fully up. A cylinder on the left side is capable of holding the platform open.

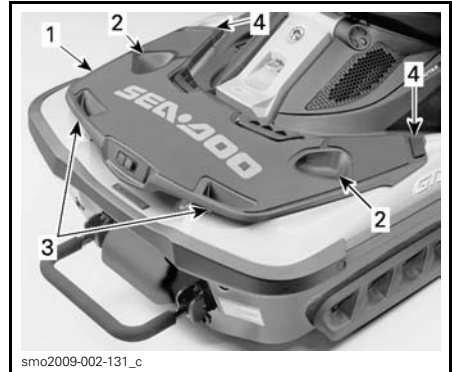

GTX LIMITED iS MODEL ILLUSTRATED

1. Boarding platform
2. Spotter foot rests
3. Grab handles
4. Latch handles

9) Speed-Ties (GTX Limited and GTX Limited iS Models)

Two speed-ties are provided for mooring of the watercraft.

One speed-tie is located just below the LH handlebar, the other is located in the center rear edge of the boarding platform.

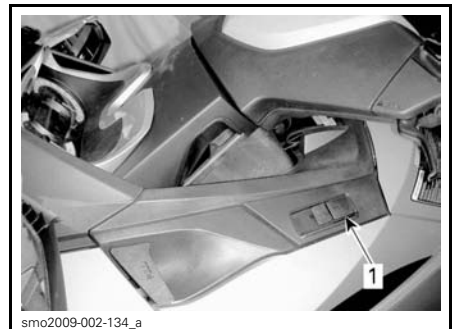

1. Front speed-tie



smo2009-002-131_d

1. Rear speed-tie

⚠ WARNING

- Do not use retractable ropes when watercraft engine is running.
- Do not use to tow a watercraft. Do not use to pull a person or any object behind or to the side of the watercraft.
- Do not use speed-tie rope as a tie-down on a trailer.

NOTICE

- This system is designed for temporary use in normal conditions. Do not use as a permanent mooring system, or in extreme conditions (strong winds, waves, etc.).
- Regularly inspect rope condition; do not tie up watercraft with a damaged rope. Replacing BRP rope by any other rope will void the speed-tie warranty.
- If speed ties are used in salt water conditions, the rope should be regularly rinsed thoroughly with fresh water to prevent salt buildup in the rope and speed-tie mechanism. This will help extend the life of the rope and ensure proper operation the mechanism.

NOTE: The rope of the speed-tie is a wear item that is not covered under normal warranty.

Refer to *MAINTENANCE* section for speed-tie cleaning instructions.

Mooring your PWC Using the Speed-Ties

1. With your watercraft parallel to the dock and at a standstill next to the dock mooring cleat, release the front speed-tie by lifting the lever.
2. Grasp and pull on the mooring line stopper to extract enough line to reach and tie off to the mooring cleat.

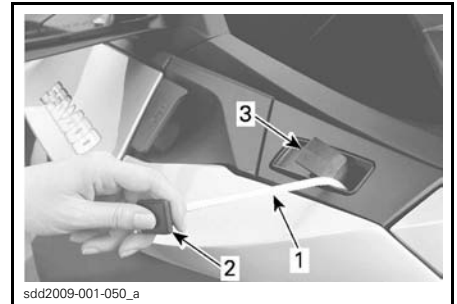

sdd2009-001-050_a

TYPICAL - FRONT SPEED TIE

1. Speed-tie mooring line
 2. Mooring line stopper
 3. Speed-tie locking lever
3. Push down on the speed-tie locking lever to lock the mooring line.
- NOTICE** Always ensure the speed-tie rope is properly locked. Make sure mooring rope is not in contact with any components that could lead to watercraft damaged or premature rope wear.
4. When speed-tie rope is secured to the dock cleat with the watercraft still parallel to the dock, carefully step onto the dock. Step from the foot well or seat of the watercraft, **do not** stand on the rail of the watercraft as this could cause it to become unstable.
 5. Hold the watercraft parallel with the dock and repeat the tying operation with the rear speed-tie. When using the rear rope, be careful not to fall.

NOTE: Docking procedure is basically the same if there are passengers aboard. However, the operator should ask that passengers remain still and maintain their weight centered over the seat during docking. The passengers must step onto the dock only after front mooring rope is secured to dock cleat. The operator must remain on the watercraft to keep the watercraft parallel with the dock during passengers landing.

NOTICE

- Do not moor watercraft with only one retractable rope. Always use front and rear systems together.
- During mooring, do not over-tighten ropes. Always leave a little slack. Take tides into consideration if applicable. Always moor watercraft with the rope and not with its plastic end.
- The mooring system does not protect watercraft against impacts with the dock. Use dock bumpers (cushions) in combination with retractable ropes to protect your watercraft.
- Always moor watercraft to a dock of appropriate height using strong mooring cleats.

Casting Off Using Speed-Ties

1. When casting off, first untie the rear speed-tie. Retract the mooring rope, hold the mooring rope stopper near its receptacle and lift the locking lever. Once the mooring rope is retracted, snap the mooring rope stopper into its receptacle.
2. Step onto the watercraft. Be sure to position your weight over the center of the watercraft as much as possible to maintain watercraft stability.
3. Carefully move to the operators' position.

4. Release the front mooring rope from the dock cleat, retract it and lock the stopper as with the rear speed-tie.
5. Push or drift the watercraft away from the dock.

⚠ CAUTION Be careful when retracting mooring rope. Always hold the stopper near its receptacle before unlocking the lever. Do not stand in the path of a retracting rope.

⚠ CAUTION Ensure that ropes are properly retracted and that stoppers are properly snapped in before starting watercraft.

10) Front and Rear Eyelets

Eyelets can be used for mooring, towing and as tie-down points when trailering your watercraft.

Front Eyelet

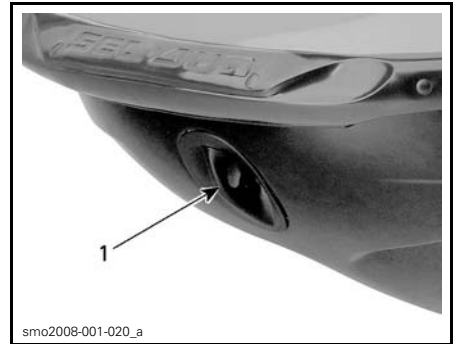

TYPICAL
1. Front eyelet

Rear Eyelets



smo2011-002-010_a

TYPICAL

1. Eyelet

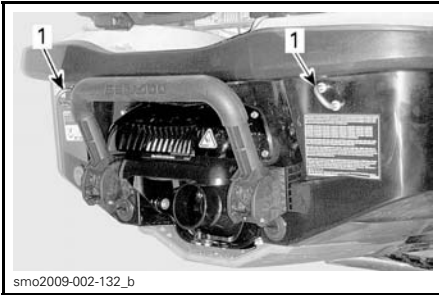

smo2009-002-132_b

TYPICAL

1. Eyelets

11) Mooring Cleats

These cleats can be used for temporary docking such as when refueling.

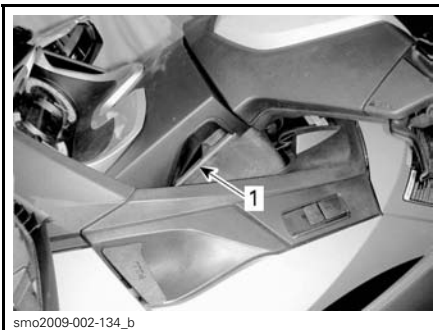

smo2009-002-134_b

TYPICAL

1. Mooring cleats

NOTICE Never use mooring cleats to pull or lift the watercraft.

12) Bilge Drain Plugs

Unscrew drain plugs whenever watercraft is on the trailer. This will allow water accumulated in the bilge to be evacuated and helps to reduce condensation.

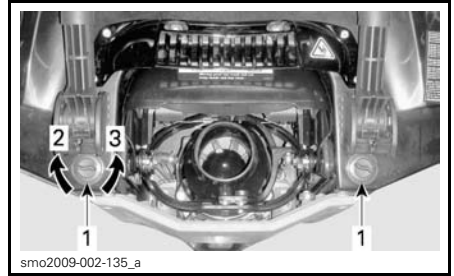

smo2009-002-135_a

TYPICAL

1. Drain plugs
2. Tighten
3. Loosen

NOTICE Ensure drain plugs are properly secured prior to launching the watercraft in water.

13) Adjustable Sponsons (RXT-X aS)

The adjustable sponsons change the lateral grip of the watercraft.

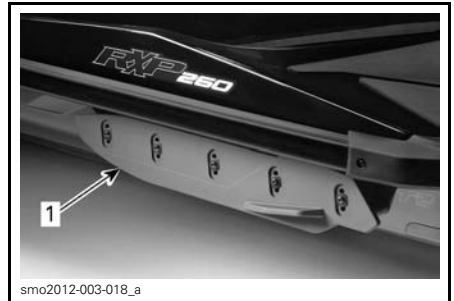

smo2012-003-018_a

TYPICAL - LH SIDE SHOWN

1. Adjustable sponson

Sponson Adjustment Guideline

The sponsons offer 3 possible height settings.

NOTE: When adjusting the sponsons to a different setting than factory (Sport), the trim tabs should be left to factory setting (0).

⚠ WARNING

After adjusting sponsons, always familiarize yourself with the new handling characteristics of the watercraft.

SPONSON ADJUSTMENT GUIDELINE	
Race	Increase lateral grip for faster turning response. Race position is NOT recommended when riding with passenger(s).
Sport (factory setting)	Offer a balance combination between Race and Freeride positions. Preferred position for overall riding conditions (especially rough water) or if riding with passenger(s).
Freeride	Decrease lateral grip for a more playful behavior.

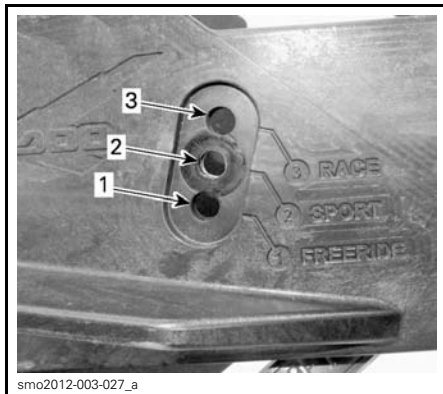

1. Freeride
2. Sport (factory setting)
3. Race

How to Adjust Sponson

NOTE: It is highly recommended to have this adjustment carried out by your Sea-Doo dealer.

Remove and DISCARD the 5 self-adhesive screws.

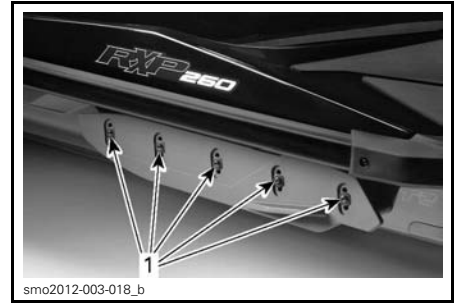

1. Self-adhesive screws

Reposition sponson to desired position.

Install **NEW** self-adhesive screws and torque to specification.

⚠ WARNING

Whenever the sponsons are adjusted, the self-adhesive screws must be replaced and torqued to specification. Otherwise, loss of sponson may occur which could cause a loss of control of the watercraft.

TIGHTENING TORQUE	
Sponson screws (P/N 250 000 572) (NEW SCREWS REQUIRED)	18 N•m ± 2 N•m (159 lbf•in ± 18 lbf•in)

Proceed the same way for the other side.

⚠ WARNING

Both sponsons must be installed and adjusted at the same height. Missing sponsons or improper adjustment will affect handling and stability, which could cause a loss of control of the watercraft.

14) Adjustable Trim Tabs (RXT-X aS)

The adjustable trim tabs change the bow attitude of the watercraft.



RH SIDE - TRIM TAB

Trim Tab Adjustment Guideline

With properly adjusted trim tabs, the watercraft should have a neutral attitude, especially when riding in rough waters (waves or choppy water).

The trim tabs provide 5 different settings.

NOTE: When adjusting the trim tabs to a different setting than factory (0), the adjustable sponsons should be left to factory setting (Sport).

See table below for trim tab adjustment characteristics and effects, according to condition.

⚠ WARNING

After trim tab adjustment, always familiarize yourself with the new behavior of the watercraft.

TRIM TAB ADJUSTMENT GUIDELINE

TRIM TAB POSITION	BOW ATTITUDE	WATER CONDITION	STEERING RESPONSE	PWC SPEED (CALM WATER)

NOTE: F (0) = factory position.

How to Adjust Trim Tabs

Remove bolt and lock nut from link rod.

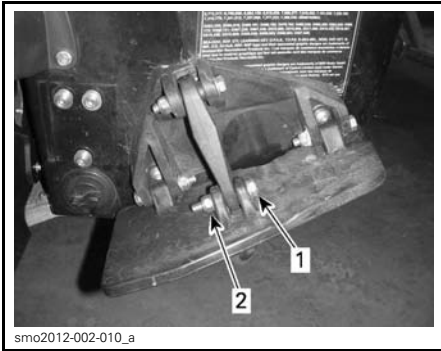

1. Bolt
2. Lock nut

Adjust trim tab to desired position.



1. Trim tab positions

Install a **NEW** lock nut and tighten to specification.

⚠ WARNING

Locking devices when removed must be replaced.

TIGHTENING TORQUE

Link rod lock nut	13 N•m ± 1 N•m (115 lb•in ± 9 lb•in)
-------------------	---

Proceed the same way for the other side.

⚠ WARNING

Both trim tabs must be adjusted at the same height. Improper adjustment will affect handling and stability, which could cause a loss of control of the watercraft.

15) Bow Stabilizer (RXT-X aS)

The bow stabilizers located on each side of the hull gives the following benefits in rough water conditions:

- Reduce bow diving
- Better hull tracking
- Diminish splash.

16) Ski/Wakeboard Post (WAKE Pro model)

Pull up on the knob to extend the post. Ensure both sections of post are fully extended and properly locked before attaching ski or wakeboard rope.

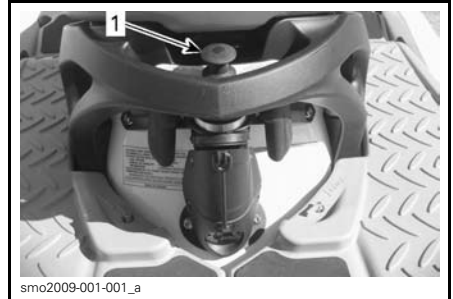

TYPICAL - SKI/WAKEBOARD POST
RETRACTED

1. Pull on this knob to extend



smo2009-001-002

SKI/WAKEBOARD POST EXTENDED

To retract the post, push straight down on the top of the post.

If the post becomes difficult to extend or retract, simultaneously push in on both sides of the locking clip toward front of watercraft.

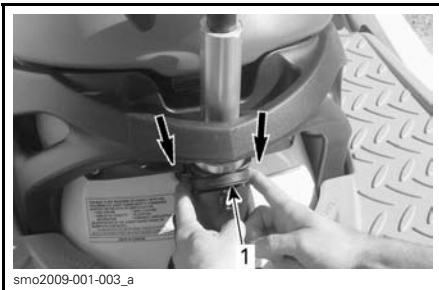

smo2009-001-003_a

PUSH TOWARD FRONT TO UNLOCK AND REMOVE POST

1. Locking clip

⚠ WARNING

Make sure ski/wakeboard post is fully extended and locked before use. Completely retract and lock when not used. Use caution with skier/wakeboarder in tow as tow rope may backlash to watercraft when released. Never perform a sharp turn when towing a skier, wakeboarder or any toy. Always store tow rope when not in use.

NOTICE The ski/wakeboard post is designed for towing a skier or wakeboarder with a maximum gross weight of 114 kg (250 lb).

Always have one person other than the operator as an observer.

NOTE: The handles on the ski/wakeboard post are provided as a handhold for the observer.

NOTICE Never use the ski/wakeboard post to tow other watercrafts. Respect the maximum load limit rating of the ski/wakeboard post. Overloading can affect maneuverability, stability and performance.

17) Wakeboard Rack (WAKE Pro model)

A convenient removable rack to carry a wakeboard on the watercraft when on the water.

NOTE: The wakeboard rack can be installed on the LH side of the watercraft.

To install:

1. Insert the hooks on the lower portion of the rack into the lower retaining bracket located on the hull under the LH side bumper.



smo2010-002-007_a

RETAINING BRACKETS FOR WAKEBOARD RACK

1. Lower retaining bracket
2. Upper retaining bracket

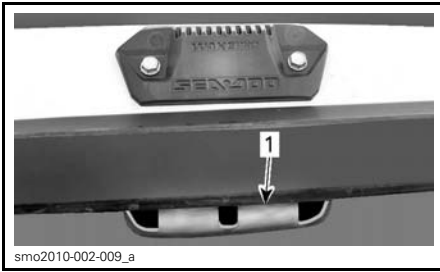

1. Hooked portion of rack in lower bracket

2. Rotate the rack upwards and push the top of the rack inboard until the handle locks into the top retaining bracket.

⚠ WARNING

If rack is not properly secured on the watercraft, it could become loose and detach unexpectedly, creating a risk of injury to people nearby. Periodically ensure the rack is properly locked on its support.

3. When installing a wakeboard on the rack, position wakeboard fin(s) outward with the heel of the boots facing down near freeboard of the PWC.
4. Secure wakeboard using bungee cords.

⚠ WARNING

To avoid possible injuries and cuts from the wakeboards fin(s), always place FIN(S) OUTWARDS.



WAKEBOARD INSTALLED WITH FINS OUTWARD

5. After installation, pull and push wakeboard to ensure it is tightly secured to rack.

⚠ WARNING

If the wakeboard is not properly secured on the rack, it could become loose and detach unexpectedly, creating a risk of injury to people nearby. To avoid:

- Inspect bungee cords condition and replace if damaged.
- Secure wakeboard properly on rack.
- Periodically ensure the board is properly attached.

NOTE: When the wakeboard is removed from its rack, secure the bungee cords so that they will not move freely when riding watercraft.

NOTICE The rack is designed to hold one wakeboard. Do not use to hold more than one wakeboard or to transport skis or any other object. Do not use rack(s) as mooring points or to reboard.

⚠ WARNING

With wakeboard and/or rack installed, operate with extra caution:

- NEVER perform aggressive maneuvers including a spin-out.
- NEVER jump waves.
- Use common sense and limit speed.

Otherwise, the wakeboard could detach or occupants could fall off and injure themselves against the wakeboard or rack.

⚠ WARNING

When trailering the watercraft, NEVER leave a wakeboard installed on the rack. Otherwise, wakeboard fin(s) could cause injury to bystanders or wakeboard could fly off on the road. The bungee cords are under tension and could spring back and whip someone when released. Use caution.

To remove the wakeboard rack, depress the lever at the top of the rack and remove it from its retaining brackets.



smo2010-002-010_a

WAKEBOARD RACK REMOVAL

1. Press this handle to release wakeboard rack

18) Steering Tilt Handle

The handlebar position can be adjusted to suit rider preferences.

To perform this adjustment, pull on the release handle at the base of the steering column just ahead of the glove box, and tilt the handlebars to the desired position.

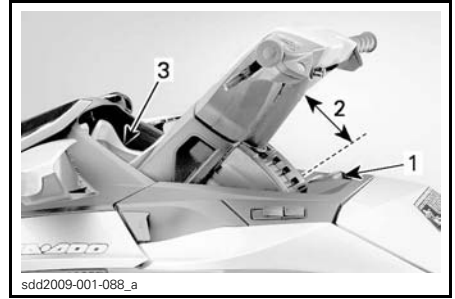

sdd2009-001-088_a

TYPICAL

1. Release handle
2. Available tilt adjustment
3. Multifunction gauge

When the handlebars are at the desired position, release the latch handle and ensure the latch pawl properly engages a groove in the steering column. Also ensure the latch handle is in the forward position.

⚠ WARNING

To prevent sudden movement of the steering column, always ensure the pawl on the steering column latch is properly engaged in one of the grooves on the steering column.

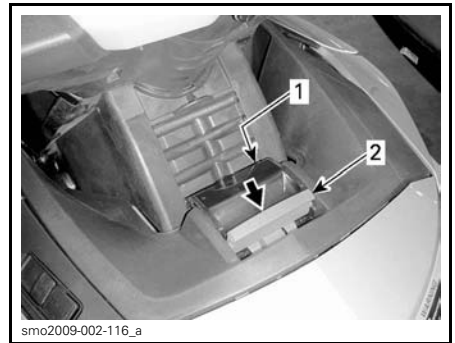

smo2009-002-116_a

STEERING COLUMN ADJUSTMENT LATCH NOT SECURED

1. Latch pawl engaged in steering column groove
2. Release handle unlocked

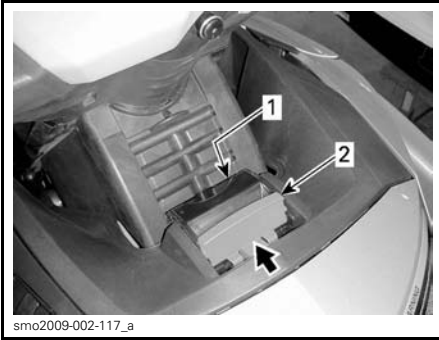

**STEERING COLUMN ADJUSTMENT LATCH
PROPERLY SECURED**

1. Latch pawl engaged
2. Release handle locked forward

19) Adjustable Ergonomic Steering (AES) (RXT-X/RXT-X aS)

The handlebar width and angular position of the controls may be adjusted to driver preference by extending and rotating the handlebar extension tubes.

NOTE: To carry out the ergonomic adjustments, see an authorized Sea-Doo dealer.

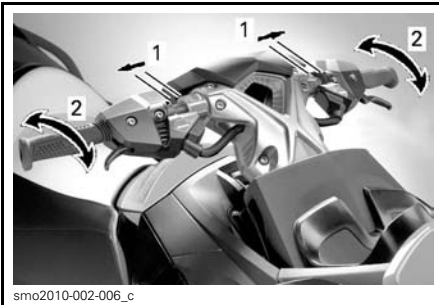

ERGONOMIC ADJUSTMENTS

1. Handlebar width adjustment
2. Angular position adjustment of controls

SUSPENSION

iS (intelligent Suspension) (GTX Limited iS)

The intelligent suspension system (iS), allows the moving deck to move independently of the fixed deck, isolating rider and passenger(s) from the impact of rough water.

⚠ WARNING

Although the suspension system absorbs part of the vertical forces and therefore reduces the impact force to the body, it cannot eliminate it completely. To prevent you and your passenger from being bounced and eventually ejected from the watercraft, reduce your speed.

⚠ WARNING

Avoid riding in very rough waters or practicing extreme maneuvers like jumping wakes or waves.

The iS system provides multiple modes of operation.

Automatic Suspension Mode

The system always starts up in AUTOMATIC SUSPENSION mode and shuts down in DOCK mode.

The suspension will automatically move up to a factory preset height. This height is ideal for most riding conditions at cruising speeds.

The iS system constantly monitors the stroke of the suspension and automatically compensates for changing water conditions and passenger load.

The moving deck height proportionally elevates the center of gravity of the watercraft.

NOTE: When performing certain maneuvers at low speed the watercraft's propensity to overturn can increase.

Manual Suspension Mode

MANUAL SUSPENSION mode allows fine-tuning the suspension calibration to the operator's preference. The SUSPENSION HEIGHT can be adjusted using the UP or DOWN button while in IS MODE.

SUSPENSION HEIGHT can be adjusted a total of nine increments.

NOTE: Changing the suspension height using the UP/DOWN buttons puts the iS system in MANUAL SUSPENSION mode. The AUTO mode is deactivated.

Manually Adjusting Ride Height

While in IS MODE, press the UP or DOWN button once to move the suspension to the next height increment, or press and hold the button until the desired ride height is obtained.

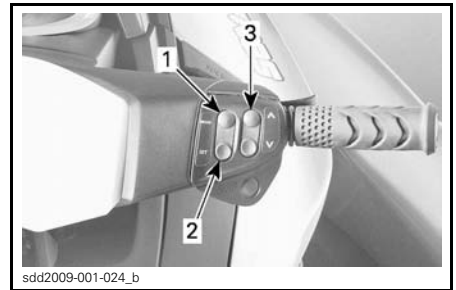

TYPICAL

1. MODE
2. SET
3. UP and DOWN button

The following indications of manual suspension mode can be observed in the digital screen of the information center:

- A scrolling message in the digital screen that states MANUAL SUSPENSION.
- The AUTO indication in the iS display will disappear.
- The suspension position indicator will indicate the relative SUSPENSION HEIGHT (only one segment of the indicator will be on).

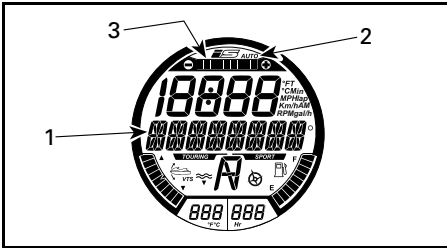

AUTOMATIC SUSPENSION MODE

1. MANUAL SUSPENSION message is displayed here
2. AUTO mode indicator OFF
3. Relative suspension position indication

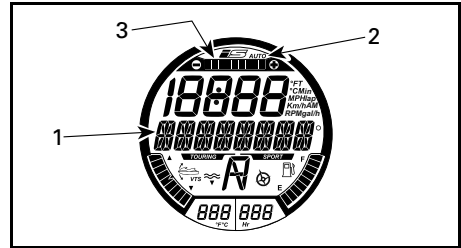

AUTOMATIC SUSPENSION MODE

1. AUTOMATIC SUSPENSION message is displayed here
2. AUTO mode indicator ON
3. All segments of suspension position indicator ON

Reverting Back to AUTO MODE

To revert back to AUTO selection mode without stopping the engine, proceed as follows:

- Press the MODE button repeatedly until the IS MODE message appears in the multifunction display.
- Press the SET button.
- A scrolling message in the multifunction display stating DOUBLE_CLICK_UP_FOR_AUTO_MODE appears.
- Double click on UP button.

The AUTO mode is confirmed by:

- A scrolling message in the digital screen stating AUTOMATIC SUSPENSION.
- The AUTO indication in the iS display will appear.
- All segments of the suspension position indicator will be on.

Dock Modes

The iS system can be set to DOCK MODE AUTO or DOCK MODE OFF.

Dock Mode AUTO

In DOCK MODE AUTO, the suspension lowers to DOCK mode height to lower the center of gravity when certain conditions are met.

- When the engine is shut down after normal operation of the watercraft.
- If O.T.A.S. is activated *SEE ACTIVE TECHNOLOGIES (iCONTROL)*.
- If the operator releases the throttle to idle RPM for approximately 10 seconds.

NOTE: When the suspension moves down to dock mode height, a DOCK MODE ON message will scroll across in the multifunction display.

Dock Mode OFF

If the suspension is set to DOCK MODE OFF, the suspension will not lower itself to DOCK mode height when the throttle is released to idle for more than ten seconds. However, it will lower itself automatically when:

- The engine is shut off
- When O.T.A.S. is activated.

If the suspension is in the up position with the watercraft powered up and the DOWN button is double clicked while in the IS MODE, the suspension will lower itself to DOCK mode height even if the suspension is set to DOCK MODE OFF.

If the suspension is in the down position (dock mode height) with the watercraft powered up and the UP button is double clicked while in the IS MODE, the suspension will move up to the factory preset height.

⚠ WARNING

When performing certain maneuvers at low speed or when docking, the watercraft's propensity to overturn can increase. The more riders (or weight) on the moving deck, the more unstable the watercraft may become.

NOTE: DOCK MODE AUTO is always active when using a learning key.

Selecting DOCK MODE AUTO or DOCK MODE OFF

Selecting DOCK MODE AUTO or DOCK MODE OFF is only available when the engine is not running and when using a normal key.

To change the DOCK mode of operation, carry out the following steps.

1. Press the START/STOP button to power up the information center.
2. Install the tether cord on the engine cut-off switch.
3. Press the MODE button repeatedly until SETTINGS is displayed in the Information Center.

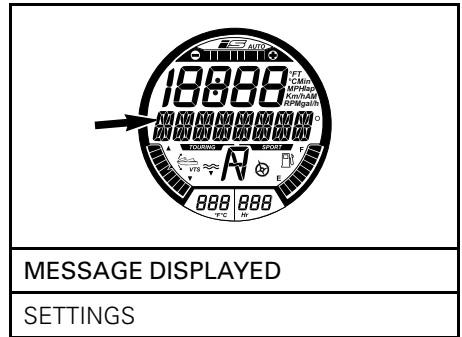

4. Press the SET button to display DOCK MODE.

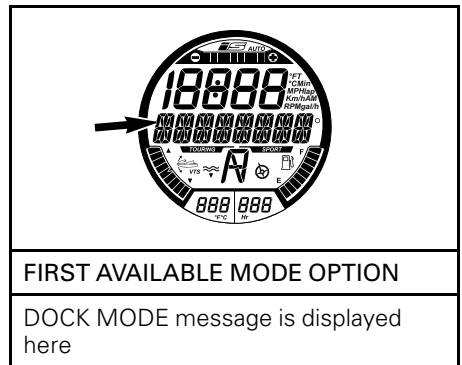

5. Press the SET button to display DOCK MODE AUTO.

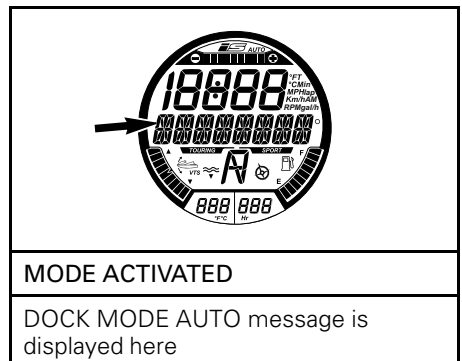

6. Press the UP or DOWN button to toggle the display to DOCK MODE OFF.

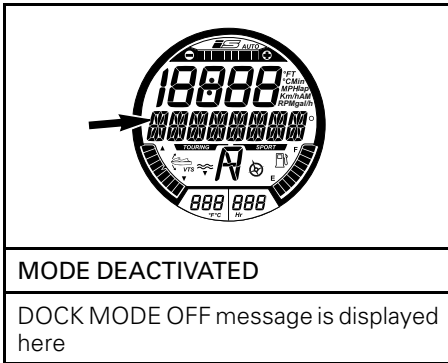

- Press the SET button, or wait for the function to time out to save the setting and return to main display.

You may now start the engine and drive away using the selected DOCK MODE.

CAUTION Operating the watercraft in DOCK MODE OFF prevents the suspension from automatically moving to the "down" position when operating the watercraft at slow speed or when stopping. This maintains a higher center of gravity, reduces stability, and makes the watercraft more prone to overturning.

aS (adjustable Suspension) (RXT-X aS)

The adjustable Suspension (aS) allows the moving deck to move independently of the fixed deck, isolating rider and passenger from the impact of rough water.

With the aS feature, the moving deck may be adjusted mechanically to absorb (dampen) water shocks according to the driver riding style and water conditions.

WARNING

Although the suspension system absorbs part of the vertical forces and therefore reduces the impact force to the body, it cannot eliminate it completely. To prevent you and your passenger from being bounced and eventually ejected from the watercraft, reduce your speed.

WARNING

Avoid riding in very rough waters or practicing extreme maneuvers like jumping wakes or waves.

Spring Preload Adjustment

The spring preload can be easily adjusted using a 1/2" drive nut (adjuster).

The spring preload adjuster is located under the seat.

RIDERS TOTAL WEIGHT (KG/LBS)	NBR OF CLICKS ON SPRING ADJUSTER (CLOCKWISE*)
57 kg (126 lb)	0
73 kg (161 lb)	2
89 kg (196 lb)	4
105 kg (231 lb)	6
120 kg (265 lb)	8
136 kg (300 lb)	10
152 kg (335 lb)	12
168 kg (370 lb)	14
184 kg (406 lb)	16
200 kg (441 lb)	18

* 0 is set at fully unscrewed position (counterclockwise).

Damping Adjustment

The aS Suspension damping may be personally adjustable according to the driving preferences and water conditions.

Damping adjustment is carried out via the remote nitrogen reservoir in the glove box.

A blue knob located in glove box allows the damper adjustment for this purpose.

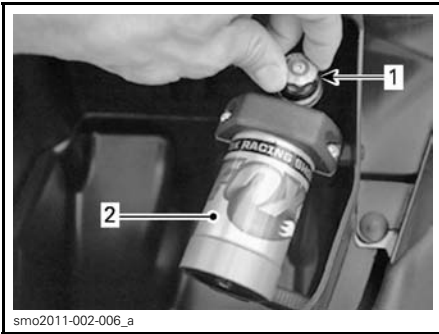

smo2011-002-006_a

1. Blue knob
2. Nitrogen gas damper

TYPICAL CONDITIONS	NBR OF CLICKS ON DAMPER ADJUSTER (CLOCKWISE*)
Calm water	0
	5
Rough water	10
	15
Offshore	20
* 0 is set at fully unscrewed position (counterclockwise).	

NOTE: These adjustments are provided as guidelines to ensure optimum suspension performance. Personal preference may dictate different settings than those recommended.

S (Manual Suspension) (GTX S 155)

The Manual suspension (S) allows the moving deck to move independently of the fixed deck, isolating rider and passenger from the impact of rough water.

The moving deck may be adjusted mechanically to absorb (dampen) water shocks according to the driver's weight.

⚠ WARNING

Although the suspension system absorbs part of the vertical forces and therefore reduces the impact force to the body, it cannot eliminate it completely. To prevent you and your passenger from being bounced and eventually ejected from the watercraft, reduce your speed.

⚠ WARNING

Avoid riding in very rough waters or practicing extreme maneuvers like jumping wakes or waves.

Spring Preload Adjustment

The spring preload can be easily adjusted using a 1/2" drive nut (adjuster).

The spring preload adjuster is located under the seat.

RIDERS TOTAL WEIGHT (KG/LBS)	NBR OF CLICKS ON SPRING ADJUSTER (CLOCKWISE*)
68 kg (150 lb)	0
79 kg (174 lb)	2
90 kg (198 lb)	4
102 kg (225 lb)	6
113 kg (249 lb)	8
125 kg (276 lb)	10
136 kg (300 lb)	12
147 kg (324 lb)	14
159 kg (351 lb)	16
170 kg (375 lb)	18
* 0 is set at fully unscrewed position (counterclockwise).	

BREAK-IN PERIOD

Operation During Break-In Period

A break-in period of 10 operating hours is required before running the watercraft at sustained full throttle.

During this period, maximum throttle should not exceed 1/2 to 3/4 opening. However, brief full acceleration and speed variations contribute to a good break-in.

NOTICE Continued wide open throttle accelerations or operation, prolonged cruising speeds are detrimental during the break-in period.

NOTE: 215, 260 and 300 engines: During the first 5 hours of operation, the engine management limits the engine maximum speed for engine protection. The engine performance will progressively increase during this period.

OPERATING INSTRUCTIONS

⚠ WARNING

Always perform the *PRE-RIDE INSPECTION* before operating this watercraft. Be sure to read the *SAFETY INFORMATION* and the *WATERCRAFT INFORMATION* sections and be thoroughly familiar with the iControl technology.

Should any control or instruction not be fully understood, refer to an authorized Sea-Doo dealer.

Boarding the Watercraft

As with any watercraft, boarding should be done carefully and engine must not be running.

⚠ WARNING

Engine must be **OFF** when boarding the watercraft or when using the boarding step.

Boarding from a Dock

When boarding from a dock, slowly place one foot on the watercraft footboard nearest the dock while holding the handlebar, and at the same time, transfer the body weight to the other side in order to balance the watercraft.

Then bring the other foot over the seat and place it on the other footboard. Push the watercraft away from the dock.



Boarding from Shallow Water

In shallow water, board the watercraft from either the side or the rear.

⚠ WARNING

- Keep limbs away from jet or intake grate.
- Never use propulsion system as a supporting point to board the watercraft.

Ensure there is at least 90 cm (3 ft) of water underneath the lowest rear portion of the hull.

Take into account that the hull will be lower in the water when all passengers are aboard. Be certain to maintain the specified depth so sand, pebbles and rocks will not be drawn up in the jet pump.

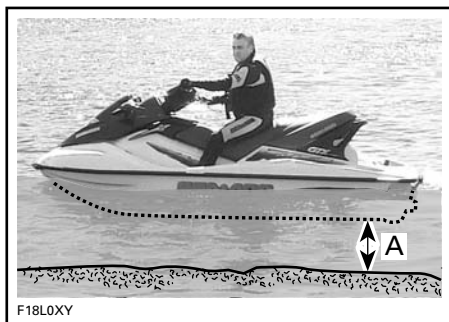

- A. Maintain at least 90 cm (3 ft) underneath the lowest rear portion of the hull when all passengers are aboard

NOTICE

- Starting the engine or riding the watercraft in shallower water may damage the impeller or other jet pump components.
- Stay on center of the step.
- Only one person at a time on the step.

⚠ WARNING**Watercraft with iBR system:**

- Be aware of the iBR gate movement when starting the engine, shutting down the engine or using the iBR lever. Automatic movement of the gate may squeeze fingers or toes of people taking a hold on the back or your PWC.
- Never use iBR gate as a supporting point to board the watercraft.

Boarding in Deep Water**⚠ WARNING**

- Keep limbs away from propulsion system or intake grate.
- Never use propulsion systems a supporting point to board the watercraft.
- Inexperienced riders should practice how to board the watercraft close to shore (all methods explained here) before venturing into deep water.

⚠ WARNING**Watercraft with iBR system:**

- Be aware of the iBR gate movement when starting the engine, shutting down the engine or using the iBR lever. Automatic movement of the gate may squeeze fingers or toes of people taking a hold on the back or your PWC.
- Never use propulsion system or iBR gate as a supporting point to board the watercraft.

Operator Alone**Models Without a Boarding Step**

1. Using one hand, grab the rear handle.

2. With the other hand on the boarding platform, lift your body until you can lay one knee on the boarding platform.
3. Lay the other knee on the boarding platform.



smo2009-002-144

4. Take hold of the seat strap to help maintain your balance and step forward onto the footboards on either side of the seat.



smo2009-002-145

Sit astride the seat.

Models with a Boarding Step

Swim to the rear of the watercraft.

Using one hand, lower the boarding step.



smo2009-002-140

Using the other hand, take hold of the edge of the boarding platform, then pull yourself up so that you can knee onto the boarding step.



Take hold of the seat strap to help maintain your balance and step forward onto the footboards on either side of the seat.

NOTICE

- Stay on center of the step.
- Only one person at a time on the step.

Reach forward with one hand and take hold of the molded handle behind the seat, then stand on the boarding step.



Sit astride the seat.

Operator with a Passenger

The operator climbs on the watercraft in the same way as explained previously.

In choppy water, while in the water, the passenger may hold the watercraft steady to help the operator climb aboard.

With both hands on the handle behind the seat, step up onto the boarding platform.



NOTICE

- Stay on center of the step.
- Only one person at a time on the step.

The passenger then climbs onto the watercraft while the operator maintains balance by sitting as close as possible to the console.



smo2009-002-147

TYPICAL - MODEL WITH BOARDING STEP SHOWN



smo2009-002-148

TYPICAL - MODEL WITH BOARDING STEP SHOWN



smo2009-002-149



smo2009-002-150

How to Start Engine

WARNING

Before starting the engine, the operator and passenger(s) should always:

- Be properly seated on the watercraft.
- Have a firm grip on a handhold or hold on to the waist of the person in front of them.
- Wear appropriate protective clothing including a PFD approved by local authorities and a wet suit bottom.

NOTICE Ensure there is at least 90 cm (3 ft) of water under the lowest rear portion of the hull when all passengers are aboard prior to starting the engine. Otherwise damage to the impeller or other jet pump components may occur.

1. Attach the tether cord clip to your PFD or to the wrist (wrist strap required).
2. Firmly grip handlebar with your left hand and place both feet on the footboards.
3. Press the engine START/STOP button to wake up the electrical system.
4. As the information center cycles through its self test function, install the tether cord on the engine cut-off switch.

WARNING

The tether cord should always be attached to the operators personal flotation device or to the wrist (wrist strap required) when starting or operating the watercraft.

5. Depress the START/STOP button to start the engine.

NOTE: The START/STOP button must be activated within 5 seconds after the tether cord cap is installed on the engine cut-off switch to allow engine starting.

NOTICE In the event the engine does not start right away, do not hold START/STOP button more than 10 seconds to avoid starter overheating. A rest period should be observed between the cranking cycles to allow the starter to cool down. Refer to *TROUBLESHOOTING* section.

6. Release engine START/STOP button after engine is started.

WARNING

The tether cord should always be attached to the operators personal flotation device when starting or operating the watercraft.

NOTE: The tether cord must be installed on the engine cut-off switch within 5 seconds of pressing the START/STOP button to allow engine starting. If you hear anything other than 2 short beeps when installing the tether cord, it indicates a condition that should be corrected. Refer to the *TROUBLESHOOTING* section for BEEP code signal identification.

NOTE: The engine can be restarted within 3 minutes when stopped using the START/STOP button. After this delay, resume the starting procedure.

How to Stop the Engine

WARNING

To maintain watercraft directional control, the engine should be running until the watercraft is stopped.

To shut off the engine, press the engine START/STOP button or pull off the tether cord cap from the engine cut-off switch.

⚠ WARNING

Never leave the tether cord on the engine cut-off switch when disembarking watercraft to prevent theft, accidental engine starting, and to avoid unauthorized use by children or others.

If the engine is shut off using the START/STOP button and the tether cord is left on the engine cut-off switch, the information center and all electrical power will shut off after approximately three minutes to prevent battery discharge.

How to Steer the Watercraft

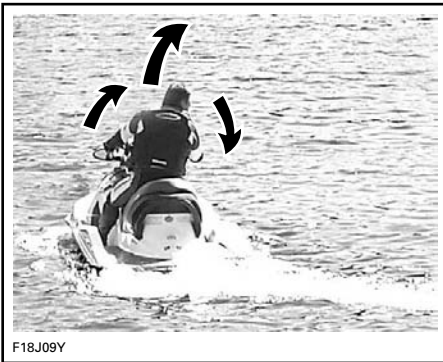

F18J09Y

Turning the handlebar pivots the jet pump nozzle which controls the watercraft direction. Turning the handlebar to the right will turn the watercraft to the right and inversely. The throttle should be applied to turn the watercraft.

⚠ WARNING

Throttle should be applied and handlebar turned to change the direction of the watercraft. Steering efficiency will differ depending on the amount of throttle applied, the number of passengers, the load, the water conditions and the environmental factors such as the wind.

Unlike a car, a watercraft needs some throttle to turn. Practice in a safe area applying the throttle and turning away from an imaginary object. This is a good collision avoidance technique.

⚠ WARNING

Directional control is reduced when the throttle is released and lost when the engine is off.

The watercraft behaves differently with a passenger and requires greater skill. The passenger(s) should always grip the seat strap, the molded grab handle, or the waist of the person ahead of them. Reduce speed and avoid sharp turns. Avoid choppy water conditions when carrying a passenger.

Tight Turns and Other Special Maneuvers

Any tight turns or special maneuvers that will cause the air inlet openings to be kept under water for a prolonged time, water will seep into the bilge.

Combustion engines need air to operate; consequently this watercraft cannot be totally watertight.

NOTICE If the air inlet openings are kept under water, such as turning constantly in tight circles, plunging the bow through waves, or capsizing the watercraft, water may seep into the bilge, which may cause severe damage to internal parts of the engine. Refer to the *WARRANTY* section contained in this guide.

O.T.A.S. System (Off-Throttle Assisted Steering)

The O.T.A.S. (Off-Throttle Assisted Steering) system provides additional maneuverability in off-throttle situations.

If the driver releases the throttle to idle when initiating a full turn, the O.T.A.S. system will be electronically activated. O.T.A.S. will slightly increase engine speed to help turning.

When the handlebar is brought back towards its center position, the throttle reverts to idle.

We recommend that you familiarize yourself with this feature during your first ride.

How to Engage Neutral

⚠ WARNING

The drive shaft and impeller are always turning when the engine is running, even when the iBR gate is set to the neutral position. Keep away from the propulsion system of the watercraft.

When the watercraft is first started, the iBR system automatically sets the iBR gate to the neutral position by default.

If the gate is in forward thrust position, tap the iBR lever. The gate will move to neutral.

If braking or reverse is used, the iBR gate will move to the neutral position when the iBR lever is released, if throttle is not applied.

NOTE: The throttle lever must be fully released for the iBR gate to move to the neutral position when the iBR lever is released.

If the engine is stopped in forward or reverse, the iBR gate will move to the neutral position on engine shutdown.

How to Trim the Neutral Position of the iBR

When in NEUTRAL, if the watercraft creeps forward or backward, the iBR system may be trimmed.

NOTE: Movement of the watercraft when operating in neutral may be due to wind or water current.

If the watercraft is moving forwards, momentarily press the VTS DOWN button or DOWN button (if vehicle is not equipped with VTS switch).

If the watercraft is moving backwards, momentarily press the VTS UP button or UP button (if vehicle is not equipped with VTS switch).

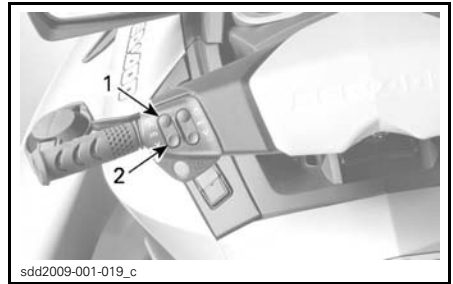

TYPICAL - VTS CONTROL BUTTON

1. Bow up
2. Bow down

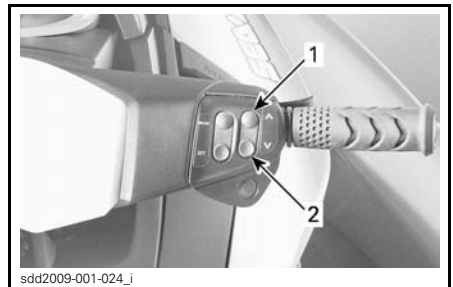

TYPICAL - TRIMMING THE iBR NEUTRAL POSITION

1. UP button (to stop rearward movement)
2. DOWN button (to stop forward movement)

NOTE: Press the VTS UP/DOWN button or UP/DOWN button (if vehicle is not equipped with VTS switch) repeatedly until proper adjustment of the neutral position is attained and the watercraft stops moving.

How to Engage Forward

To engage forward thrust from neutral, tap on the throttle lever. The gate will move to forward thrust position and the watercraft will accelerate forward.

To engage forward thrust from reverse, release the iBR lever while applying throttle moderately.

To re-engage forward thrust from braking, simultaneously pull in the throttle lever while releasing the iBR lever. The watercraft will accelerate forward after a short delay.

How to Engage and Use Reverse

Reverse can only be engaged between idle speed and the threshold forward speed of 14 km/h (9 MPH).

To engage reverse thrust, the iBR lever on the LH handlebar must be pulled in at least 25% of the lever travel.

When operating the iBR lever in reverse mode, the throttle lever can be used to control engine RPM, and thus the amount of reverse thrust produced.

By modulating both the iBR and throttle levers simultaneously, reverse thrust can be more precisely controlled. Too much RPM will create water turbulence and reduce reverse efficiency.

NOTE: Engine power will be reduced to idle whenever the iBR lever position is changed.

Release the iBR lever to end reverse operation.

To stop rearward velocity after iBR lever release, apply enough throttle to stop rearward movement.

⚠ WARNING

The brake function has no effect when travelling in reverse.

Available engine power is limited in reverse mode, which limits reverse speed. However, speeds above 14 km/h (9 MPH) may be obtained in reverse depending on conditions.

⚠ WARNING

Only use reverse at slow speed and for the shortest time possible. Always ensure the path behind is clear of objects, obstacles and people.

When operating in reverse, turn the handlebar in the opposite direction that you want to move the rear of the watercraft.

For example, to steer the rear of the watercraft to port (left), turn the handlebar to starboard (right).



TYPICAL - STEERING DIRECTION REVERSED WHEN BACKING

⚠ CAUTION Steering direction in reverse thrust is opposite of forward thrust. To steer the stern to port (left) in reverse, turn the handlebar to starboard (right). To steer the stern to starboard (right), turn the handlebar to port (left). Reverse thrust operation should be practiced in open waters in order to become fully familiar with the controls and watercraft handling characteristics before operating in close quarters.

How to Engage and Use Braking

⚠ WARNING

- The engine must be running to be able to use the brake.
- The brake is only applicable when operating in forward movement, it has no effect on rearward velocity.
- The brake cannot prevent your PWC from drifting due to current or wind.

The braking function can only be engaged during forward operation at or above the threshold speed of 14 km/h (9 MPH).

Braking is engaged and controlled when the iBR lever on the LH handlebar is pulled in at least 25% of its travel.

⚠ WARNING

Braking should be practiced in open waters and at gradually increasing speeds in order to become fully familiar with the controls and watercraft handling characteristics.

When iBR lever is applied, the throttle lever command is overridden and engine throttle control is now dependant on the iBR lever position. Braking can thus be modulated by using only the iBR lever.

Watercraft deceleration is proportional to the braking force. The more the iBR lever is pulled in, the greater the braking force applied.

NOTE: Be careful to gradually actuate the iBR lever to adjust intensity of the braking force and simultaneously release the throttle lever.

⚠ CAUTION When braking, riders must brace themselves against the deceleration force to prevent from moving forward on the watercraft and losing balance. The operator should always keep both hands on the handlebars, and all passengers should maintain a firm grip of a handhold or the waist of the person in front of them.

⚠ WARNING

Stopping distance will vary depending on initial speed, load, wind, number of riders, water conditions, and the amount of braking power commanded by the operator. Always adjust your riding style accordingly.

When the watercraft slows to less than 14 km/h (9 MPH), braking mode ends and reverse mode is engaged. Release the iBR lever once the watercraft is stopped. Otherwise, a rearward movement will be initiated.

⚠ CAUTION As the watercraft slows to a stop, the wake created by the watercraft will catch up and tend to push the watercraft forward. Ensure there are no obstacles or bathers in the direction of travel.

If the throttle lever is still pulled in when releasing the iBR lever, the watercraft will accelerate forward after a short delay. Acceleration will be proportional to the throttle lever position.

⚠ WARNING

If forward acceleration is not desired when the brake lever is released, release the throttle lever.

When at speed and the brake is first applied, a plume of water will shoot up in the air behind the watercraft which may cause the operator of a following watercraft to momentarily lose sight of your PWC.

⚠ WARNING

- It is important to inform the operator of a watercraft who intends to follow in a convoy formation, of the braking and maneuvering capability of your PWC, what the plume of water indicates, and that a greater distance must be maintained between watercrafts.
- Be aware that other boats following or operating in close proximity may not be able to stop as quickly.

Braking in a Turn

Throttle must be applied for turning to ensure directional control. However braking can be initiated during a turn using the iBR lever as previously described. Get ready to maintain your balance while the wake is crossing your PWC.

⚠ CAUTION As the watercraft slows to a stop while braking in a turn, the wake created by the watercraft will catch up and tend to push the watercraft sideways. Be prepared to maintain balance as the wake crosses the watercraft.

How to Use the Variable Trim System (VTS)

The variable trim system (VTS) changes the vertical position of the jet pump nozzle to provide the operator with a fast, effective system to compensate for load, thrust, riding position and water conditions. Correctly adjusted, it can improve handling, reduce porpoising, and position the watercraft at its best riding attitude to attain maximum performance.

When first using the watercraft, the operator should become familiar with the use of the variable trim system (VTS) at varying speeds and water conditions. A mid-range trim is generally used when cruising. Experience alone will dictate the best trim for the conditions. During the watercraft break-in period, when lower speeds are recommended, it is an excellent opportunity to become familiar with trim adjustment and its effects.

When the nozzle is positioned in an upward angle, the water thrust directs the bow of the watercraft upward. This position is used to optimize high speed.

When the nozzle is directed downward, the bow is forced downward and increases the watercraft turning capabilities. As with any watercraft, speed and operator body position and movement (body English), will determine the degree and sharpness of the watercraft turn. Porpoising can be reduced or eliminated if the nozzle is downward and speed is adjusted proportionately.

NOTE: VTS position is indicated on a bar gauge in the information center.

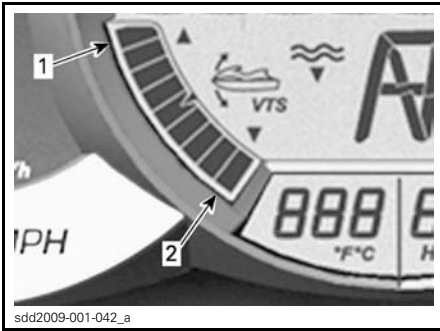

INFORMATION CENTER — VTS POSITION INDICATOR

1. Bow up
2. Bow down

The VTS system allows for manually adjusting the trim position of the nozzle, or selecting two preset trim positions and recording or changing preset trim positions on certain models.

VTS Trimming Methods

AVAILABLE VTS TRIMMING METHODS	GTX GTX S 155	GTX LIMITED GTX LIMITED iS	RXT RXT-X RXT-X aS	WAKE PRO
VTS trim button	N.A.	X	X	X
VTS "double click" trimming	N.A.	X	X	X
VTS "presets"	N.A.	X	X	X
VTS trimming through multifunction gauge	X	N.A.	N.A.	N.A.
X = Indicates a standard feature N.A. = Not Available				

Trimming the VTS Using the VTS Button

Nine trim positions are available.

With the watercraft operating in forward thrust, proceed as follows.

NOTE: Pressing the VTS trim button without the engine in forward thrust will only change the indication. The nozzle will move to the selected VTS trim position when forward thrust is engaged.

1. Press the VTS UP button once to trim the bow of the watercraft up to the next up trim position.

2. Press the VTS DOWN button once to trim the bow of the watercraft down to the next down trim position.

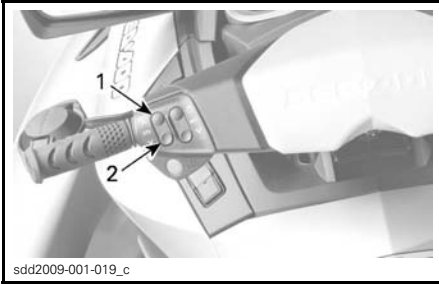

sdd2009-001-019_c

TYPICAL - VTS CONTROL BUTTON

1. Bow up
2. Bow down

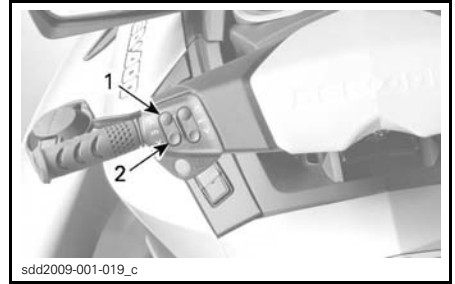

sdd2009-001-019_c

TYPICAL - DOUBLE-CLICK UP OR DOWN TO USE PRESET POSITIONS

1. Highest preset position on UP button
2. Lowest preset position on DOWN button

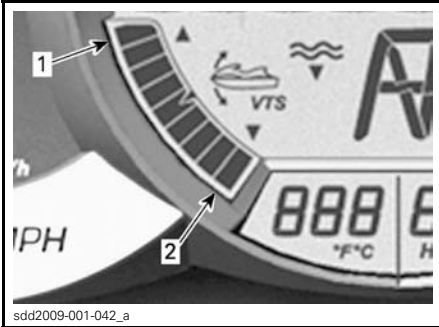

sdd2009-001-042_a

INFORMATION CENTER — VTS POSITION INDICATOR

1. Bow up
2. Bow down

NOTE: If the VTS UP or Down button is pressed and held, the pump nozzle will keep moving until the button is released at the desired trim attitude or the maximum trim position (up or down) is reached.

Using Preset Trim Positions

Two preset trim positions can be selected.

To select the highest trim position recorded, double-click on the VTS UP button (bow up).

To select the lowest trim position recorded, double-click on the VTS DOWN button (bow down).

NOTE: If only one preset trim position is recorded, double-click either UP or DOWN of the VTS button.

Recording Preset Trim Positions

Two different VTS trim positions may be recorded for quickly selecting the preferred watercraft trim attitude.

To record VTS preset trim positions:

1. Turn ON the electrical power by pressing the START/STOP button once.
2. Installing the tether cord on the engine cut-off switch.
3. On the RH handlebar, press the MODE button repeatedly until VTS MODE is displayed.

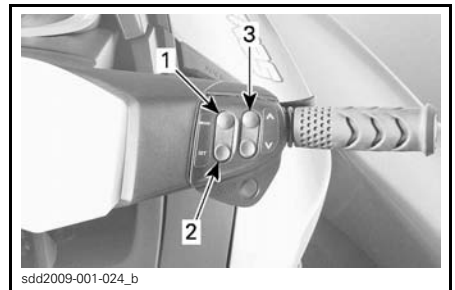

sdd2009-001-024_b

TYPICAL

1. MODE button
2. SET button
3. UP/DOWN button

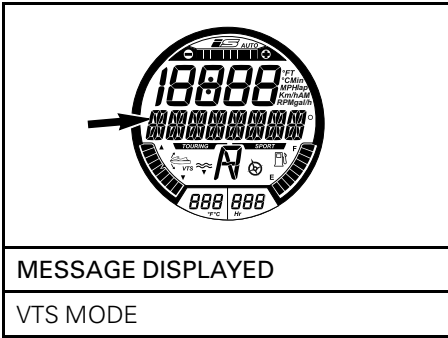

4. On the RH handlebar, press the SET button to display PRESET 1.
5. Press the VTS UP or DOWN button to change the PRESET 1 VTS position. Gauge will display setting 1 through 9 in the digital screen above PRESET 1.

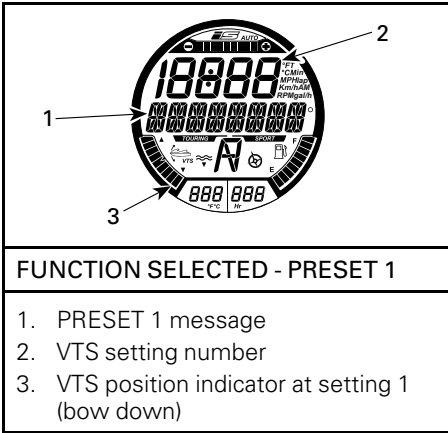

6. Press the SET button to save PRESET 1 and display PRESET 2.
7. Press the VTS UP or DOWN button to change the PRESET 2 VTS position. Gauge will display setting 1 through 9 in the digital screen above PRESET 2.

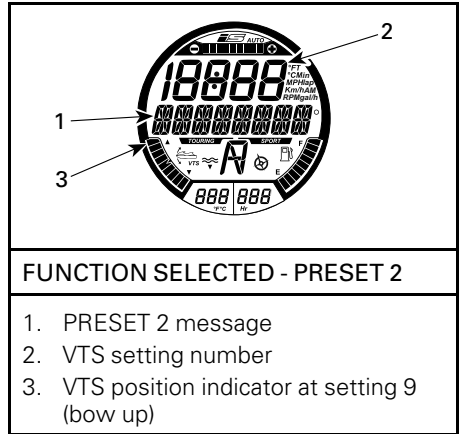

8. Press the SET button to save the settings and return to the main display.

The VTS system will compare the pre-set trim settings recorded, the highest position will be assigned to the UP button (bow up), the lowest to the DOWN button (bow down).

If both trim positions are identical, both buttons will have the same trim settings.

Trimming the VTS Using the Gauge

1. With the engine running in forward thrust, press the MODE button to display the VTS function in the multifunction display.
2. On the RH handlebar, press the UP or DOWN button to change the VTS setting.

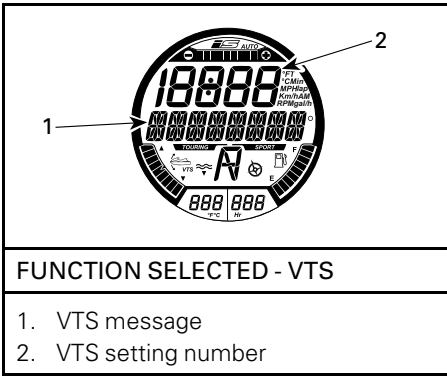

3. Confirm VTS operation by looking for the VTS position indicator movement in the digital display.
4. Press the SET button to save the desired setting and return to the main display.

NOTE: The available VTS settings are between 1 and 9.

NOTE: The VTS system cannot be fully tested without the engine operating in forward thrust. If the engine is not running in forward thrust, only the VTS indication will change when the VTS control switches are pressed; the nozzle will not change position.

General Operating Recommendations

Rough Water or Poor Visibility Operation

Avoid operation in these conditions. If you must do so, proceed with caution using minimum speed.

Crossing Waves

The operator must grip the handlebar firmly and keep both feet on the footboards.

The passenger must grip the handholds with both hands and keep both feet on the footboards.

Reduce speed.

Always be prepared to steer and maintain your balance as necessary.

When going over waves, raise your body slightly off the seat to absorb the shocks with your legs.

When crossing wakes, always keep a safe distance from watercraft ahead.

⚠ WARNING

When crossing wakes, slow down. Operator and passenger(s) should brace themselves and adopt a semi-standing position to help absorb the bumps. Do not jump waves or wakes.

NOTE: Some watercraft models are equipped with a suspension system (iS) that is capable of smoothing out the bumps when riding through rough water or a wake. Adopting a semi-standing position may be necessary in very rough water or large wakes. Operator should reduce speed as required to prevent losing control of the watercraft, or prevent personnel from being ejected.

Stopping/Docking

When the throttle is released, the watercraft is slowed by water drag against the hull. The stopping distance will vary depending on the watercraft size, weight, speed, water surface condition, presence and direction of wind and current.

The iBR system can also be used for slowing down or for stopping more quickly, and for increasing maneuverability especially when docking.



The operator should practice in open waters at various speeds to become familiarized with the stopping distances under different conditions. Stopping using the iBR system in a straight line and in a turn should be practiced extensively to become familiar with the handling characteristics of the watercraft under partial or full braking conditions.

⚠ WARNING

Always practice braking in open waters ensuring there are no watercrafts or boats in your immediate vicinity, especially astern. Other users of the waterways may not be able to maneuver or stop in time to avoid you should you unexpectedly come to a full stop in front of them.

When at speed and the brake is first applied, a plume of water will shoot up in the air behind the watercraft and may cause the operator of a following watercraft to momentarily lose sight of your PWC.

⚠ WARNING

It is important to inform the operator of a watercraft who intends to follow in a convoy formation of the braking and maneuvering capability of your PWC, what the plume of water indicates, and that a greater distance should be maintained between both of you.

The operator should also practice docking with an imaginary dock using the various controls available (iBR lever and throttle lever).

Release the throttle at a sufficient distance before the expected landing area.

Reduce speed to idle.

Maneuver using a combination of the iBR lever and throttle lever, shifting to neutral, reverse, or forward as required.

Remember that when operating in reverse, steering direction is reversed. Turning the handlebars to the left will move the stern to the right when backing up, and vice-versa.

⚠ WARNING

Directional control is reduced when the throttle is released and/or when engine is off. Steering direction is reversed when operating the watercraft in reverse.

Beaching

NOTICE It is not recommended to run the watercraft to the beach.

Drive slowly towards the beach and shut off the engine before the water is less than 90 cm (3 ft) deep under the lowest rear portion of the hull. Then pull the watercraft to the beach.

NOTICE Riding the watercraft in shallow water may result in damage to the impeller, iBR components, or other jet pump components. Always shut off the engine before water is less than 90 cm (3 ft) deep and never use reverse or braking.



F18A03Y

OPERATING MODES

OPERATING MODE AVAILABLE	GTX 155, GTX S 155	GTX LIMITED, GTX LIMITED IS	RXT	RXT-X aS, RXT-X	WAKE PRO
Touring mode	X	X	X	X	X
Sport mode	X	X	X	X	X
ECO mode	X	X	X	X	X
Cruise mode	X	X	X	-	X
Slow speed mode	X	X	X	-	X
Ski mode	-	-	-	-	X
Learning key mode	X	X	X	X	X

X = Indicates a **standard** feature
 - = See a Sea-Doo dealer for availability.
 N.A. = Not Available

Touring Mode

By default, the watercraft is set to TOURING mode of operation when started.

All Models Except RXT-X/RXT-X aS

A TOURING mode indicator is ON in the multifunction gauge to confirm the active mode of operation.

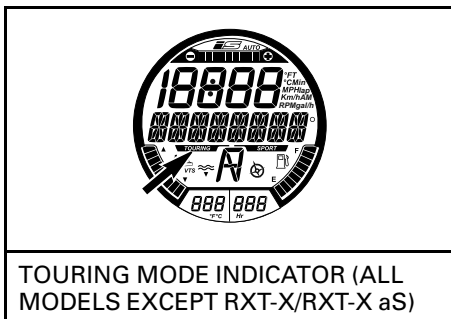

Sport Mode

When selected, SPORT MODE provides for instant throttle response and more rapid accelerations than TOURING MODE.

NOTE: Sport mode is not available if using a LEARNING key.

Once activated, SPORT MODE will remain active until it is deactivated by the operator, or the engine is shut down whereby it defaults back to TOURING MODE.

Activating Sport Mode

To quickly activate sport mode while riding at speed, carry out the following:

⚠ WARNING

When activating sport mode, be sure to maintain situational awareness of other watercrafts, obstacles, or persons in the water.

1. Depress and hold the SPORT button for at least 3 seconds.

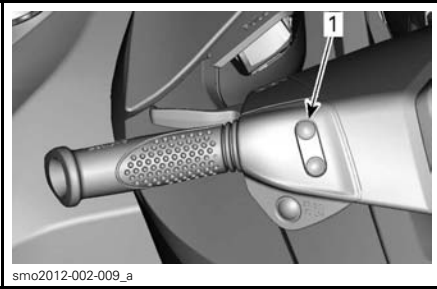

TYPICAL

1. Sport button

The following message will be displayed:

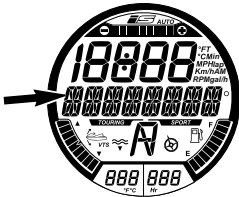

MESSAGE DISPLAYED

ENTERING SPORT MODE -
INCREASED ACCELERATION -
INSTRUCT PASSENGERS TO HOLD -
PRESS_SPORT_BUTTON

⚠ WARNING

Ensure passengers are advised that sport mode provides for increased accelerations and that they are to hold on tightly.

2. Press the SET button again to activate sport mode.

A scrolling SPORT MODE ACTIVATED message will momentarily confirm that sport mode has been activated.

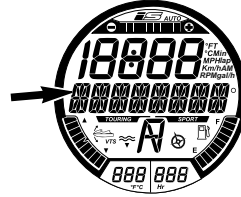

MESSAGE DISPLAYED

SPORT MODE ACTIVATED

NOTE: After a few seconds, the gauge will revert to its normal display.

3. Ensure the SPORT mode indicator is turned on.

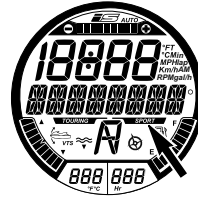

SPORT MODE INDICATOR (ALL MODELS EXCEPT RXT-X)

NOTE: The SPORT mode indicator will come on and stay on as long as sport mode is active.

RXT-X/RXT-X aS

There is no SPORT mode indicator in the multifunction display, but only a SPORT MODE indicator light in the tachometer.

Deactivating Sport Mode

To quickly deactivate sport mode while riding at speed, carry out the following:

⚠ WARNING

When deactivating sport mode, be sure to maintain situational awareness of other watercrafts, obstacles, or persons in the water.

1. Depress and hold the SPORT button for at least 3 seconds.

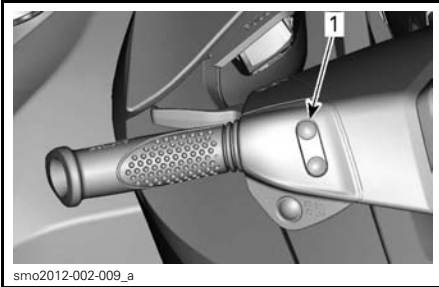

TYPICAL
1. Sport button

NOTE: The following message will scroll in the multifunction display: SPORT MODE DEACTIVATED.

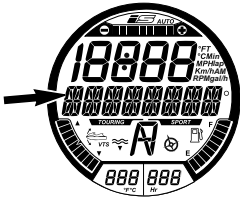

MESSAGE DISPLAYED

SPORT MODE DEACTIVATED

NOTE: After a few seconds, the gauge will revert to its normal display.

All Models Except RXT-X/RXT-X aS

2. Ensure the TOURING mode indicator is on.



TOURING MODE INDICATOR (ALL MODELS EXCEPT RXT-X/RXT-X aS)

ECO Mode (Fuel Economy Mode)

How to Activate ECO Mode

1. Depress the ECO button for at least 1 second.

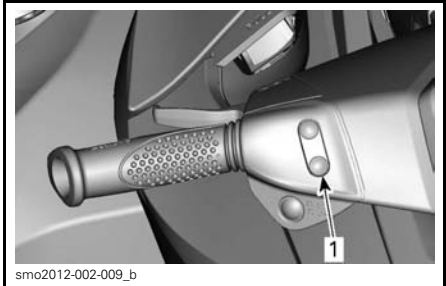

TYPICAL
1. ECO button

The following message will be displayed on the multifunction display:

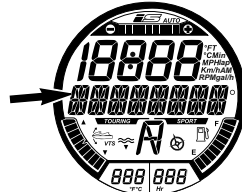

MESSAGE DISPLAYED

ECO MODE

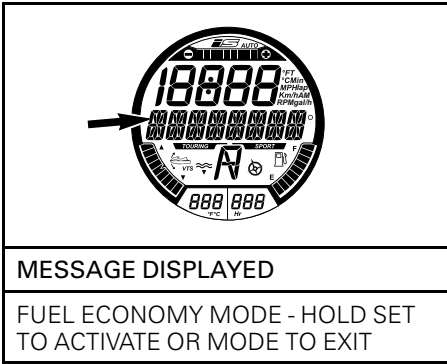

The ECO mode indicator will also be activated.

How to Deactivate ECO Mode

1. Depress the ECO button for at least 1 second.

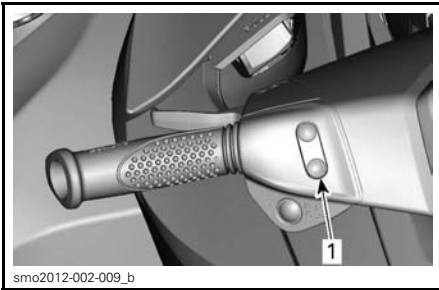

TYPICAL

1. ECO button

The ECO mode indicator will be deactivated.

Cruise Mode

Cruise mode is a function of iTC (intelligent Throttle Control) system that allows the operator to set the desired maximum watercraft speed.

This is useful when cruising for long distances, operating in limited speed zones, or towing a tuber, skier or wake boarder.

The operator must keep the throttle depressed to maintain forward speed.

Once the maximum cruise speed is set, the operator can vary the watercraft speed from idle speed up to the set cruise speed using the throttle lever. The set cruise speed will not be exceeded even if the throttle lever is fully depressed.

As you proceed under a constant cruising speed setting, keep your attention level up to maintain good situational awareness.

Slowing down is a matter of releasing the throttle lever further than the set point, or by pulling the iBR lever in.

If the iBR lever is pulled in for braking, CRUISE mode is overridden but **not deactivated**.

Once the iBR lever is released and the throttle is pulled in to engage forward thrust, the cruise function will reengage to limit the watercraft speed as it was set before.

Prerequisite for Cruise Mode Activation

NOTE: Cruise mode is not available if slow speed mode or ski mode is engaged.

CRUISE MODE can be activated:

- At idle in forward thrust
- Whenever at constant speed.

Activating Cruise Mode

1. Maintain a constant speed.
2. Press and hold the cruise button for approximately 1 second.

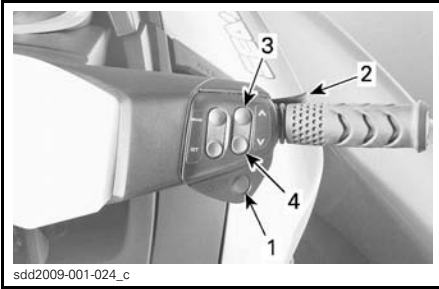

sdd2009-001-024_c

TYPICAL

1. CRUISE button
2. Throttle lever
3. UP button
4. DOWN button

You will hear a beep indicating that you are now in cruise mode, and a green CRUISE indicator light will be lit.

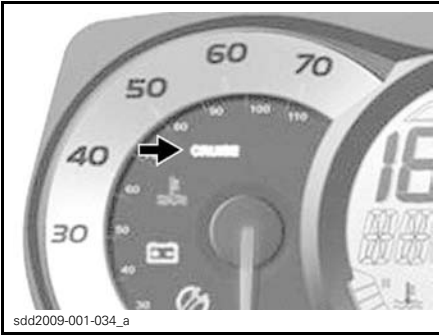

sdd2009-001-034_a

TYPICAL - CRUISE MODE INDICATOR LIGHT

NOTE: Activating cruise mode of operation only limits the maximum speed available when depressing the throttle lever. The throttle lever must be held in to maintain forward speed. Watercraft speed can be varied from idle up to the set cruise speed using the throttle lever once the cruise function is activated. Watercraft speed may vary depending on water conditions during use.

Cruise Mode Activation at Idle Speed

NOTE: This function is available up to approximately 10 km/h (6 MPH).

To activate and preset CRUISE MODE at idle speed in forward thrust:

1. Press and hold the cruise button until the following message appears in the multifunction display.

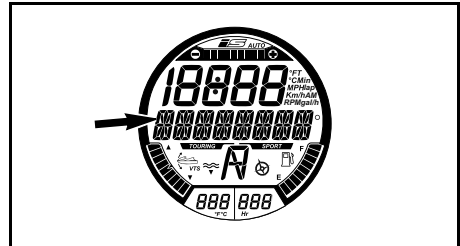

MESSAGE DISPLAYED

CRUISE MODE _ SELECT SPEED _
PRESS SET TO ACCEPT OR MODE TO
EXIT

2. Press the UP button until the desired cruise speed is indicated in the numerical display. The following message will scroll in the multifunction display.

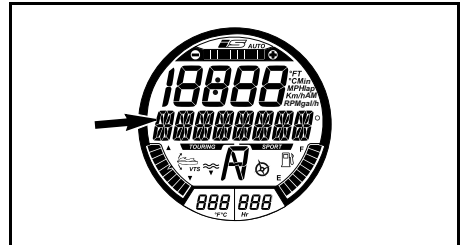

MESSAGE DISPLAYED

CRUISE MODE _ SPEED ADJUSTING

3. Press the SET button to save the cruise speed selected and engage cruise speed function. The following message will scroll in the multifunction display.

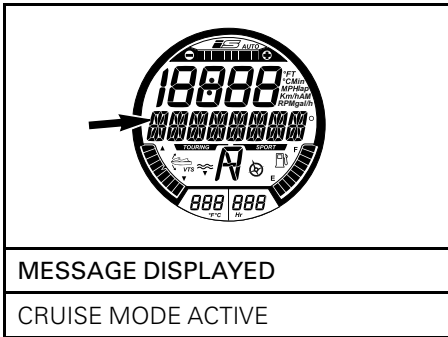

Changing Set Cruise Speed

To increase or decrease the set cruise speed:

1. Keep throttle lever fully depressed.
2. Press the UP/DOWN button.

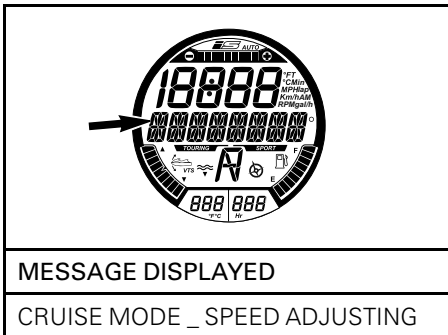

3. Press the UP/DOWN button to adjust speed accordingly.

Deactivating Cruise Mode

To deactivate cruise mode:

1. Release the throttle lever.
2. Press the cruise button.

Deactivation of cruise mode is indicated by:

- The CRUISE indicator light in the speedometer display will go off.
- A BEEP will be heard.

NOTE: If the throttle lever is not fully released when the cruise button is pressed to deactivate cruise mode, the BEEP will not be heard and the cruise light will remain on. The speed limiting function of cruise mode will stay active until the throttle is fully released, then the BEEP will be heard and the cruise light will go out.

Slow Speed Mode (all Models Except RXT-X and RXT-X aS)

The Intelligent Throttle Control also allows for a Slow Speed Mode where the driver can adjust and set idle speed. This is useful when operating in slow speed zones where the driver must be especially attentive to possible obstacle avoidance.

The operator can set idle speed between 1.6 km/h to 11 km/h (1 MPH to 7 MPH).

If you accelerate above approximately 14 km/h (9 MPH), Slow Speed Mode will be deactivated and the engine will return to idle RPM when the throttle is released.

Should a situation arise where the operator must stop or accelerate quickly away from a hazardous situation, pulling in the iBR lever, or pulling in on the throttle lever will deactivate slow speed mode and normal control of the watercraft will be returned to the operator.

Activating Slow Speed Mode

To activate slow speed mode of operation:

1. Release the throttle lever to idle RPM.
2. Pull in and release the iBR lever to engage neutral.
3. Press and hold the cruise button for approximately 1 second.

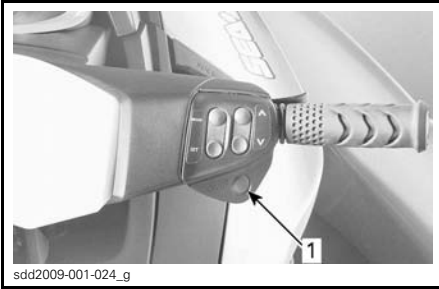

TYPICAL

1. CRUISE button

The CRUISE indicator will come on in the speedometer or multifunction display to indicate cruise activation.

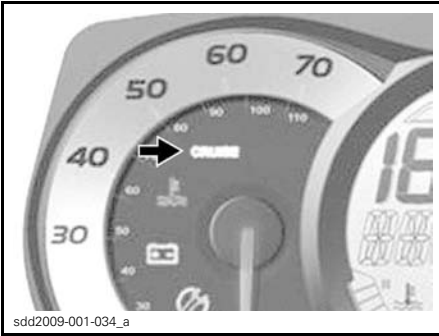

TYPICAL - CRUISE MODE INDICATOR LIGHT IN SPEEDOMETER

A message will scroll in the multifunction display to specify that you are now in slow speed mode.

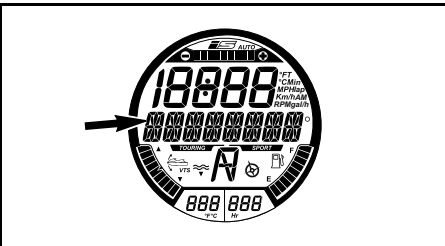

MESSAGE DISPLAYED

SLOW SPEED MODE _ SPEED ADJUSTING

The default slow speed setting of 1 will also come on for a few seconds in the numerical display.

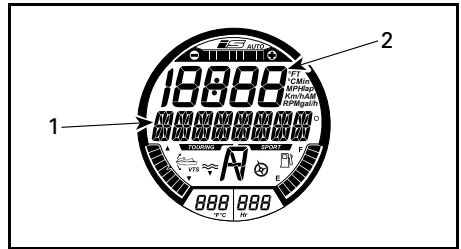

SLOW SPEED MODE INDICATION

1. SLOW SPEED MODE ACTIVATED message
2. Slow speed setting is displayed here for a few seconds

NOTE: The scrolling SLOW SPEED MODE message repeats itself as long as slow speed mode is activated. The numerical display reverts back to the previous indication after a few seconds.

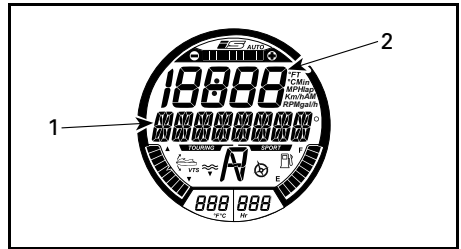

SLOW SPEED MODE INDICATION

1. SLOW SPEED MODE message
2. Numerical display reverts to previous indication

Changing Set Slow Speed

To increase or decrease the set slow speed, press the UP/DOWN button on the RH handlebar once, or repeatedly.

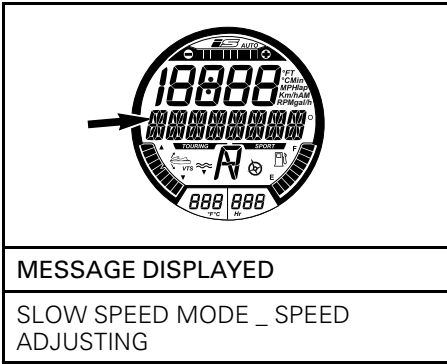

The setting point indication in the digital screen will come back on to indicate the slow speed setting change.

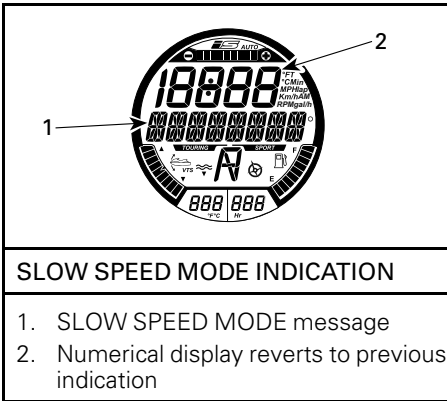

The displays will revert back to their previous indication a few seconds after the last activation of the UP or DOWN button.

NOTE: There are 5 slow speed settings available (1 through 5). Adjust slow speed mode to desired speed.

The following message will scroll across the multifunction display periodically as a reminder.

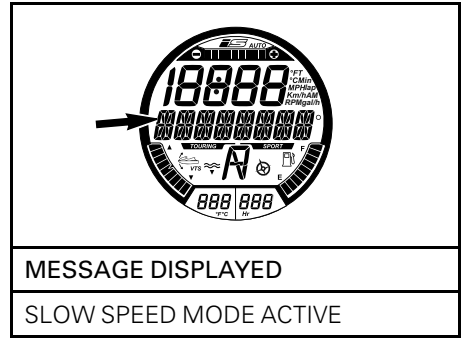

The displays will revert back to their previous indication a few seconds after the last activation of the UP or DOWN button.

Deactivating Slow Speed Mode

The slow speed mode can be deactivated using any of the following methods:

- Pressing the cruise button.
- Depressing the iBR lever.
- Accelerating past the set slow speed.

When deactivating SLOW SPEED MODE by pressing the cruise button, or accelerating using the throttle lever, the iBR gate stays in the forward position.

When using the iBR lever, the iBR gate will move towards the reverse position, then neutral when the lever is released.

SLOW SPEED MODE deactivation will be indicated in the following manner:

- The CRUISE indicator will go out
- The scrolling SLOW SPEED MODE ACTIVE message will cease.

Ski Mode

Ski mode allows for repeated and precisely controlled launches, and a set towing speed, specifically for towing a skier or wake boarder.

Ski mode is not available if using a LEARNING key.

RAMP Function

The RAMP function offers a pre-programmed setting for launching and accelerating the PWCr.

RAMP 1 provides:

- Slowest launch (smoothest)
- Slowest acceleration rate
- Slowest TARGET SPEED range.

RAMP 5 provides:

- Quickest launch
- Quickest acceleration rate
- Highest TARGET SPEED range.

TARGET SPEED Function

The TARGET SPEED function limits the maximum towing speed.

Once the RAMP has been selected, an average PWC target speed for that RAMP will be visible in the numerical display.

The average speed displayed and the speed range available is dependent on the RAMP selected. The higher the RAMP number, the higher the speed range.

The operator may increase or decrease the target speed to any value within the selected RAMP speed range.

NOTE: If the desired target speed cannot be set in the selected RAMP, you must exit then reengage SKI MODE, and select a different RAMP.

Engaging and Using Ski Mode

To engage ski mode, carry out the following steps:

1. Release throttle lever.

NOTE: Ski mode cannot be engaged if the throttle lever is not fully released, and if CRUISE or SLOW SPEED mode is engaged. A message will appear in the multifunction display advising you of the situation. Follow the instructions in the display.

2. Press the MODE button repeatedly until SKI MODE is visible in the multifunction display.



TYPICAL
1. MODE button

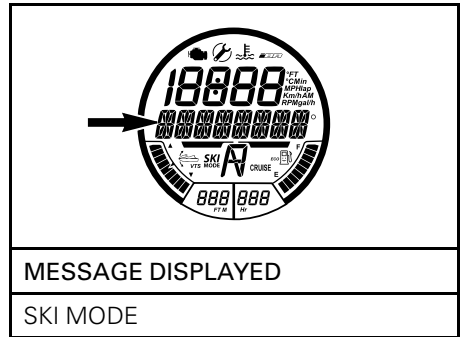

3. Press SET to enter the function. The multifunction gauge message will change to RAMP. The RAMP setting number will be visible in the numerical display.



TYPICAL
1. SET button

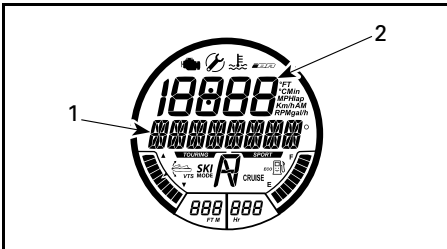

FIRST SETTING AVAILABLE - RAMP

1. RAMP message
2. Ramp setting

4. To change the RAMP setting, press the UP/DOWN button until the desired ramp number is visible in the numerical display.
5. Press SET to lock in the ramp setting; the multifunction display will change to the TARGET SPEED setting function.

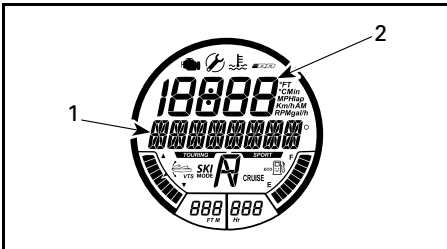

SECOND SETTING AVAILABLE - TARGET SPEED

1. TARGET SPEED message
2. Target speed setting

6. Press the UP/DOWN button to increase or decrease the target speed.
7. Press SET to lock in the target speed; the display will switch to the following scrolling message.

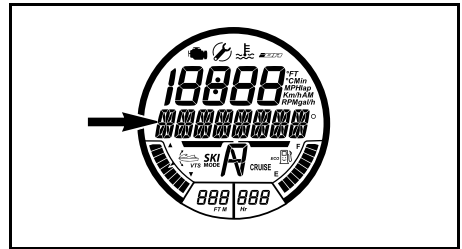

MESSAGE DISPLAYED

SKI MODE_PRESS_SET_TO START OR MODE TO EXIT

NOTE: A BEEP will be heard every 5 seconds as a SKI MODE engaged reminder.

8. Press SET again; the following confirmation message will appear.

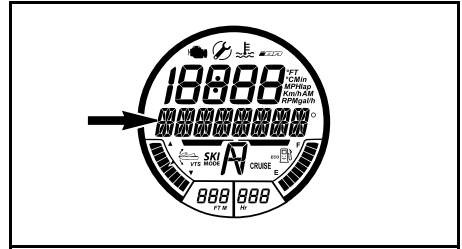

MESSAGE DISPLAYED

SKI MODE
ACTIVE_PRESS_MODE_AND
RETURN TO IDLE TO CANCEL

NOTE: The SKI MODE indicator will also come ON and blink when ski mode becomes active. It will be ON steady when the operator pulls and holds the throttle lever all the way in to the handlebar.

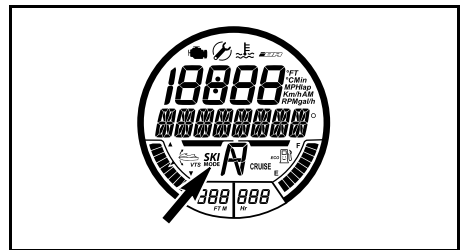

SKI MODE INDICATOR

9. To launch the PWC in ski mode, pull in and hold the throttle lever all the way to the handlebar grip. The PWC will accelerate to the set TARGET SPEED and the SKI MODE indicator will be on steady.
10. To increase or decrease the TARGET SPEED during a ski run, press the UP/DOWN button, **do not** release the throttle lever.

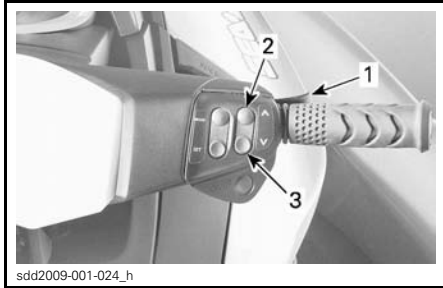

TYPICAL

1. Hold throttle lever in
2. Press UP button to increase speed
3. Press DOWN button to decrease speed

NOTE: If the throttle is partly released during a ski run, the SKI MODE indicator light will start to blink and the speed adjust function using the UP/DOWN arrow button will be deactivated.

11. To end a ski run or to pick up a fallen skier or wakeboarder, fully release the throttle to regain normal throttle control.

NOTE: When the throttle is fully released during ski mode operation, the system returns to ski mode engaged status. The SKI MODE indicator light will go out but, ski mode will remain engaged and a message to that effect will reappear in the multifunction display.

12. Press SET to reactivate ski mode and fully pull in the throttle lever to start another ski run.

Deactivating Ski Mode

To exit ski mode at any given point during the ski mode setting process, press the MODE button.

To end a ski run and completely deactivate ski mode, release the throttle to idle, then press the MODE button.

Learning Key Mode

There are 5 speed settings available. By default, the speed setting is no 3.

Changing Learning Key Speed Settings

NOTE: Changing key settings is only available when the engine is not running.

To change learning key settings, carry out the following:

1. Press the START/STOP button to wake up the electrical system and install the NORMAL key on the engine cut-off switch.
2. Wait for the information center to complete its self-test and display the key recognition message.
3. Press the MODE button repeatedly until KEY MODE is visible in the digital screen of the information center.

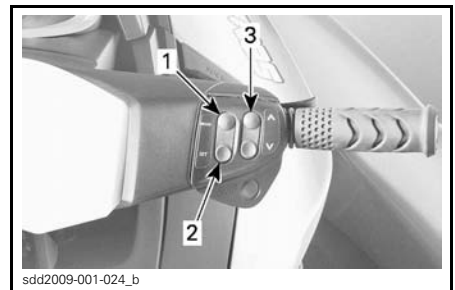

TYPICAL - GAUGE CONTROL BUTTONS

1. MODE button
2. SET button
3. UP/DOWN button

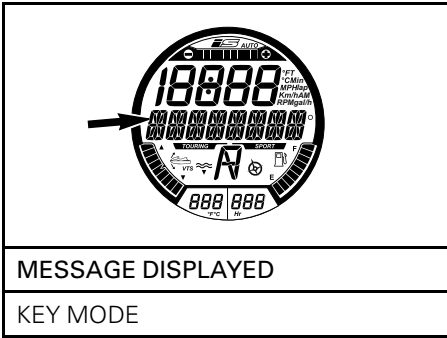

4. Press the SET button once to enable learning key mode setting function. The display will change to L-Key.

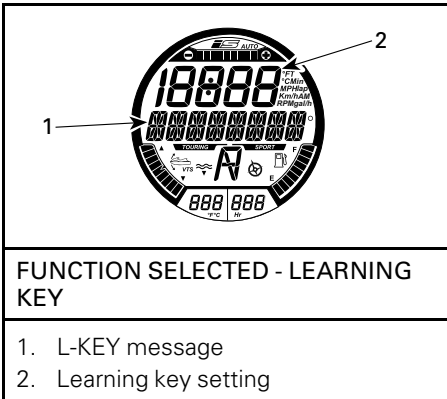

5. Press the UP or DOWN button to toggle the key setting between 1 and 5. See table for speed limitations according to setting.

6. Press the SET button once to save the setting, twice to exit the function, or simply wait for the function to time-out. The change in key setting will automatically be saved.

NOTE: The key speed setting is applicable to any key of the same type used on a specific watercraft. The same key type used on a different watercraft may therefore have a different key speed setting.

D.E.S.S. KEY TYPE	KEY SPEED SETTING	APPROX. MAX. SPEED
LEARNING KEY	5	80 km/h (50 MPH)
	4	74 km/h (46 MPH)
	3	68 km/h (42 MPH)
	2	60 km/h (37 MPH)
	1	51 km/h (32 MPH)

SPECIAL PROCEDURES

Jet Pump Water Intake and Impeller Cleaning

⚠ WARNING

Keep away from intake grate while engine is running. Items such as long hair, loose clothing or personal flotation device straps can become entangled in moving parts.

Weeds, shells or debris can get caught on the intake grate, drive shaft and/or impeller. A clogged water intake may cause troubles such as:

- **Cavitation:** Engine speed is high but watercraft moves slowly due to reduced jet thrust, jet pump components may be damaged.
- **Overheating:** Since the jet pump operation controls the flow of water to cool the exhaust system, a clogged intake will cause the engine to overheat and damage engine internal components.

A weed clogged area can be cleaned as follows:

⚠ WARNING

If it is necessary to reach in to remove any foreign object caught in the propulsion system, the tether cord **MUST BE REMOVED** from the engine cut-off switch.

In-Water Cleaning

Rock the watercraft several times while repeatedly pressing engine START/STOP button for short period without starting engine. Most of the time, this will remove the blockage. Start engine and make sure watercraft operates properly.

If the aforementioned method does not work, the following can be performed:

- With engine running and before applying throttle, pull the iBR lever in to select reverse operation and vary throttle quickly several times.
- Repeat procedure if necessary.

If system is still blocked, move the watercraft out of the water for cleaning. Refer to *ON-BEACH WATER CLEANING*.

On-Beach Water Cleaning

⚠ WARNING

The tether cord **MUST BE REMOVED** from the engine cut-off switch to prevent accidental engine starting before cleaning the jet pump area.

Place a cardboard or a carpet beside the watercraft to prevent scratching when turning the watercraft for cleaning.

Rotate the watercraft to any side for cleaning.

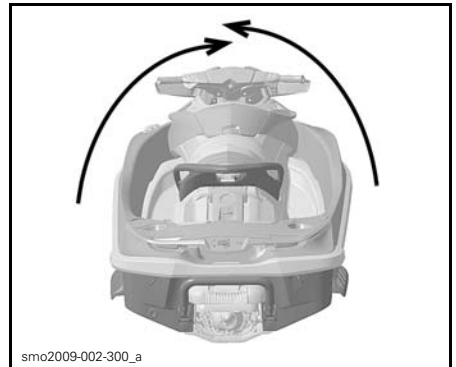

TYPICAL

Clean the water intake area. If the system is still clogged, refer to an authorized Sea-Doo dealer for servicing.

NOTICE Inspect water intake grate for damage. Refer to an authorized Sea-Doo dealer for repair as necessary.

For ease of access to the jet pump area, move the iBR to the forward position, refer to *iBR OVERRIDE FUNCTION* for detailed instructions.

iBR Override Function

When the iBR override function is activated, it allows the user to electrically move the iBR gate and nozzle through its full range of motion using the VTS control button.

NOTE: The iBR override function is only available when the engine is not running.

⚠ WARNING

When moving the iBR gate using the iBR override function, ensure no one is near the rear of the watercraft. Movement of the gate may squeeze fingers.

NOTICE An object or tool caught in the iBR system when using the iBR override function may cause damage to the iBR components. Remove all rigid foreign objects that may obstruct the iBR gate travel before moving it.

⚠ WARNING

If it is necessary to reach in to remove any foreign object caught in the propulsion system, strictly observe the following before proceeding:

- Remove tether cord from the engine cut-off switch.
- Wait at least 5 minutes.
- Do not press on START/STOP button. Should the START/STOP button is pressed, wait another 5 minutes.

Activating iBR Override Function

To activate the iBR override function, carry out the following step.

1. Power up the electrical system by pressing the START/STOP button.
2. Install the tether cord on the engine cut-off switch.

NOTE: The tether cord must be installed to ensure the information center will not shut off all indications after its self test function. Electrical power will stay on for approximately 3 minutes.

3. Pull in and hold the iBR lever for the entire procedure.

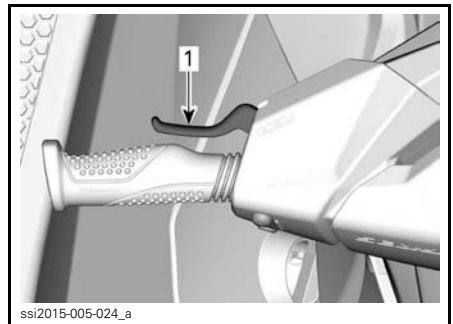

1. iBR lever pulled and held

4. When the following message appears in the multifunction gauge, press the SET button.

MULTIFUNCTION GAUGE MESSAGE

"ENTERING iBR OVERRIDE - PRESS SET BUTTON"

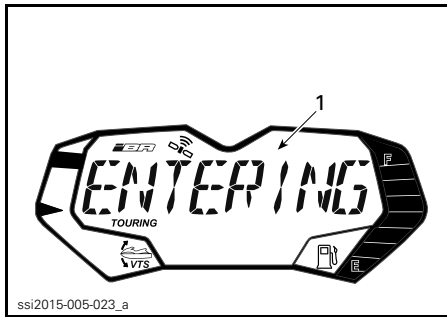
**TYPICAL**

1. Multifunction gauge message

After a few seconds, the following message will repeatedly scroll across the multifunction gauge.

MULTIFUNCTION GAUGE MESSAGE

"IBR OVERRIDE ON- RELEASE
LEVER TO EXIT"

5. While still holding the iBR lever in, press the VTS UP/DOWN button or the UP/DOWN button (if vehicle is not equipped with VTS switch) to move the iBR gate to the desired position. Ensure the VTS indication in the multifunction gauge changes with the iBR gate movement. If the iBR gate moves upwards, the indication moves upwards.
6. Release the iBR lever.
7. Remove the tether cord from the engine cut-off switch.

⚠ WARNING

If it is necessary to reach in to remove any foreign object caught in the propulsion system, strictly observe the following before proceeding:

- Remove tether cord from the engine cut-off switch.
- Wait at least 5 minutes.
- Do not press on START/STOP button. Should the START/STOP button be pressed, wait another 5 minutes.

Deactivating iBR Override Function

To deactivate the iBR override function, release the iBR lever. The IBR OVERRIDE ON- RELEASE LEVER TO EXIT message will cease to scroll in the multifunction gauge.

NOTE: When the engine is started, the iBR gate will move to the neutral position.

⚠ WARNING

When moving the iBR gate using the iBR override function, ensure no-one stands near the rear of the watercraft. Movement of the gate may squeeze fingers.

Capsized Watercraft

NOTE: Some vehicle safety labels are not shown on illustrations. For information on vehicle safety labels, refer to *WATERCRAFT SAFETY LABELS* subsection.

The watercraft is designed so that it should not turn over easily. Two sponsors mounted on the side of the hull assist watercraft stability. If it turns over, it will remain capsized.

⚠ WARNING

When watercraft is capsized, do not attempt to restart the engine. Operator and passengers should always wear approved personal flotation devices.

To turn the watercraft upright, ensure the engine is off and the D.E.S.S. key is **NOT** on its post, then grab the inlet grate, step on a side bumper rail and use your weight to rotate the watercraft towards you.

NOTE: A label on the stern near the flushing connector provides instructions on how to turn the watercraft right side up. The label is upside down so that it can be read when the watercraft is overturned.



TYPICAL

The 4-TEC™ engine features a tip-over protection system (T.O.P.S.™). When the watercraft tips over, the engine is automatically stopped.

When the watercraft is returned to its normal operating position, the engine can be started normally.

NOTICE If the watercraft has been capsized for more than 5 minutes, do not attempt to crank the engine to avoid water ingestion that would damage the engine. See an authorized Sea-Doo dealer as soon as possible.

NOTICE If the engine does not crank, do not attempt to start it anymore. Otherwise, the engine could be damaged. See an authorized Sea-Doo dealer as soon as possible.

As soon as possible, check for presence of water in the bilge. Drain as necessary when back to the shore.

Submerged Watercraft

To limit damages to the engine, perform the following procedure as soon as possible.

Drain bilge.

If it was submerged in salt water, spray bilge and all components with fresh water using a garden hose to stop the salt corroding effect.

NOTICE Never try to crank or start the engine. Water trapped in intake manifold would flow towards the engine and possibly cause severe engine damage.

Bring the watercraft to an authorized Sea-Doo dealer as soon as possible to have it serviced.

NOTICE The longer the delay before you have the engine serviced, the greater the damage to the engine will be.

Water-Flooded Engine

NOTICE Never try to crank or start the engine. Water trapped in intake manifold would flow towards the engine and possibly cause severe engine damage.

Bring the watercraft to an authorized Sea-Doo dealer as soon as possible to have it serviced.

NOTICE The longer the delay before you have the engine serviced, the greater the damage to the engine will be. Failure to have the engine properly serviced may cause severe engine damage.

Towing the Watercraft in Water

Special precautions should be taken when towing a Sea-Doo watercraft in water.

The maximum recommended towing speed is 24 km/h (15 MPH).

This will prevent the exhaust system from filling with water, which may lead to water being injected into and filling the engine. Without the engine running, there isn't any exhaust pressure to push the water out the exhaust outlet.

NOTICE Failure to follow these instructions may result in damage to the engine. If you must tow a stranded watercraft in water, be sure not to exceed the maximum towing speed of 24 km/h (15 MPH).

If you have to tow the watercraft faster than the maximum recommended speed, clamp the cross over hose.

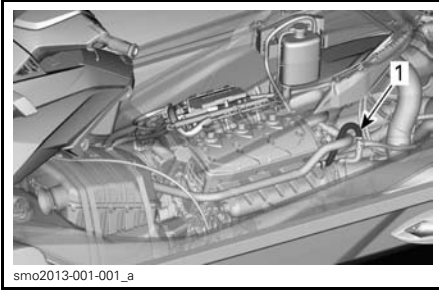

1. Cross over hose

MAINTENANCE

MAINTENANCE SCHEDULE

Maintenance is very important for keeping the watercraft in a safe operating condition. The watercraft should be serviced as per the maintenance schedule.

A repair shop or person of the owner's choosing may maintain, replace, or repair emission control devices and systems. These instructions do not require components or service by BRP or authorized Sea-Doo dealers. Although an authorized Sea-Doo dealer has an in-depth technical knowledge and tools to service the Sea-Doo personal watercraft, the emission-related warranty is not conditioned on the use of an authorized Sea-Doo dealer or any other establishment with which BRP has a commercial relationship. For emission-related warranty claims, BRP is limiting the diagnosis and repair of emission-related parts to the authorized Sea-Doo dealers. For more information, please refer to the *US EPA EMISSION-RELATED WARRANTY* contained herein. Proper maintenance is the owner's responsibility. A warranty claim may be denied if, among other things, the owner or operator caused the problem through improper maintenance or use.

You must follow the instructions for fuel requirements in the fueling section of this manual. Even if gasoline containing greater than ten volume percent ethanol is readily available, the US EPA issued a prohibition against the use of gasoline containing greater than 10 vol% ethanol that applies to this vehicle. The use of gasoline containing greater than 10 vol% ethanol with this engine may harm the emission control system.

Disregard the information pertaining to the following systems if the watercraft is not equipped with these features:

- iBR (intelligent Brake and Reverse)
- iS (intelligent Suspension) (GTX LTD iS only)
- aS (adjustable Suspension) (RXT-X aS only)

Carry out all maintenance as listed in the schedule whenever the hours or time is reached.

NOTE: As an example, at 200 hours or 2 years, complete all items in this table and ALSO all items in the EVERY 100 hours or 1 year table.

WARNING

Failure to properly maintain the watercraft according to the maintenance schedule and procedures can make it unsafe to operate.

The maintenance schedule does not exempt the pre-ride inspection.

FIRST 50 HOURS OR 1 YEAR
Replace engine oil and filter
Inspect the exhaust system (daily flushing in salt water or dirty water use)
Inspect fuel cap, filler neck, fuel tank, fuel tank straps, fuel lines and connections
Test the fuel system for leaks
Inspect the throttle body
Check for fault codes
Inspect spark plugs
Inspect electrical connections and fastening (ignition system, starting system, fuel injectors, fuse boxes etc.)
Test the engine cut-off switch and the monitoring beeper
Verify the steering cable and connections
Verify steering nozzle bushings
Verify O.T.A.S. operation
Inspect carbon ring and drive shaft rubber boot (more frequently when using PWC in foul or dirt water)
Inspect impeller, impeller boot and wear ring condition
Verify iBR gate backlash
Inspect iBR protective guard
The following must be performed each month:
Inspect battery condition
Verify battery connections
Inspect sacrificial anode (more often in salt water use) and change when necessary

EVERY 100 HOURS OR 1 YEAR
Replace engine oil and filter
Inspect engine rubber mounts
Spray an anticorrosion lubricant to metallic components in engine compartment (every 10 hours in salt water use)
Inspect and flush the exhaust system
Inspect the cooling system (coolant level, hoses and fasteners for leaks)

EVERY 100 HOURS OR 1 YEAR

Lubricate and verify the iTC lever for proper operation (Depress and release the lever to check for freedom of movement. If any friction is felt, the lever must be taken apart, cleaned, inspected for wear and lubricated)

Inspect fuel cap, filler neck, fuel tank, fuel tank straps, fuel lines and connections (At storage period or after 100 hours of use whichever comes first)

Test the fuel system for leaks

Inspect the throttle body

Inspect the air intake silencer

Check for fault codes

Inspect and lubricate ignition coils (1503 4-TEC engines)

Inspect ignition coils (1630 ACE HO engines)

Inspect electrical connections and fastening (ignition system, starting system, fuel injectors, fuse boxes etc.)

Test the engine cut-off switch and the monitoring beeper

Verify the steering cable and connections

Verify steering nozzle bushings

Verify O.T.A.S. operation

Inspect carbon ring and drive shaft rubber boot (more frequently when using PWC in foul or dirt water)

Inspect impeller, impeller boot and wear ring condition

Verify the impeller shaft radial play

Inspect the jet pump housing

Verify and lubricate splines of the drive shaft and impeller

Measure impeller and impeller wear ring clearance

Lubricate and verify the iBR lever for proper operation (Depress and release the lever to check for freedom of movement. If any friction is felt, the lever must be taken apart, cleaned, inspected for wear and lubricated)

Verify iBR gate backlash

Verify iVTS trim ring, reverse support and iBR gate

Inspect iBR protective guard

Inspect iS system (leaks, pump reservoir oil level and position sensor operation)

Inspect aS system (leaks, remote reservoir (mounts, adjustment knob tightening)

Inspect hull, ride plate and water inlet grate for damages

EVERY 100 HOURS OR 1 YEAR

The following must be performed every 100 hours (irrespective of the number of years):

Replace spark plugs (1630 ACE HO engines)

The following must be performed every 100 hours or at storage period (whichever comes first):

Impeller shaft seal, sleeve, O-ring and impeller cover

EVERY 200 HOURS OR 2 YEARS

1503 4-TEC engines: Replace spark plugs

The following must be performed every 200 hours (irrespective of the number of years):

1503 4-TEC engines: Replace the supercharger clutch

MAINTENANCE FREE
(1630 ACE HO engines)

1630 ACE HO engines: The supercharger is **maintenance free** *.

*Inspect supercharger **every 200 hours** (irrespective of the number of years) when vehicle is used in intense conditions such as off-shore riding, continuous operation at wide open throttle, etc.

NOTICE Do not attempt to replace components of the supercharger assembly as the unit is factory- balanced to precise specifications. Failure to follow this recommendation may lead to supercharger and / or engine damage.

EVERY 300 HOURS OR 5 YEARS

Replace the coolant

MAINTENANCE PROCEDURES

This section includes instructions for basic maintenance procedures.

WARNING

Turn off the engine and follow these maintenance procedures when performing maintenance. If you do not follow proper maintenance procedures you can be injured by hot parts, moving parts, electricity, chemicals or other hazards.

WARNING

Should removal of a locking device (e.g. lock tabs, self-locking fasteners, etc.) be required, always replace with a new one.

NOTICE Never leave any object, rag, tool, etc., in the engine compartment or in the bilge.

Engine Oil

Recommended Engine Oil

Models with 155 Engine

Use XPS 4-STROKE SYNTH. BLEND OIL (P/N 293 600 121). (If the recommended XPS TM engine oil is not available, use 5W40 or 10W40 API SERVICE SJ, SL, SM or SN oil).

Always check the API service label certification on the oil container, it must contain at least one of the above standards.

Models with 215, 260 and 300 Engines

Use XPS 4-STROKE SYNTH. BLEND OIL (P/N 293 600 121).

NOTICE These engines have been developed and validated using the BRP XPS 4-Stroke Synthetic Blend Oil. BRP recommends the use of its XPS 4-Stroke Synthetic Blend Oil at all times. If the recommended XPS engine oil is not available, use a 10W40 mineral engine oil compatible with wet clutches such as JASO MA certified oils. Damages caused by oil which is not suitable for the engine may not be covered by the BRP limited warranty.

NOTICE NEVER use fully synthetic oil. This would impair the proper operation of the supercharger clutch. Do not add any additives to the recommended oil. Oils for API service classification SM or SN contain additives (friction modifiers) that may cause inappropriate slippage of the supercharger and eventually lead to premature wear.

Engine Oil Level

NOTICE Check level frequently and refill if necessary. Do not overfill. Operating the engine with an improper level may severely damage engine.

CAUTION  Certain components in the engine compartment may be very hot. Direct contact may result in skin burn.

Oil level can be checked with watercraft either in or out of water.

If Watercraft is Out of the Water

NOTICE Watercraft must be level.

⚠ CAUTION When operating the engine while the watercraft is out of water, the heat exchanger in the ride plate may become very hot. Avoid any contact with the ride plate as burns may occur.

1. Raise trailer tow pole, then block in position when bumper rail is level.
2. Open the seat.

Models Equipped with a Suspension

3. Remove the ventilation box from the deck extension to gain partial access to engine compartment.

NOTE: To remove the ventilation box, simply release the 3 clips retaining it and lift it off the deck extension.

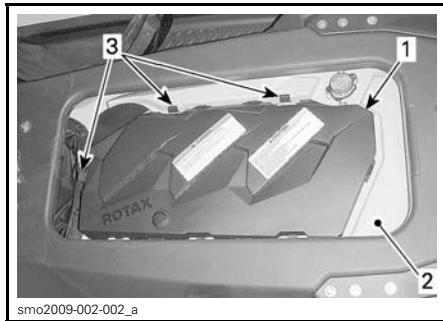

1. Ventilation box
2. Deck extension
3. Retaining clips

All Models

4. Install a garden hose on the exhaust system flushing connector. Refer to **EXHAUST SYSTEM** in this section and follow the procedure.

NOTICE

- Never run engine without supplying water to the exhaust system. Failure to cool exhaust system may severely damage it.
- Never run engine longer than 2 minutes. Drive line seal has no cooling when watercraft is out of water.

5. With the engine already at normal operating condition, let engine idle for 30 seconds then stop engine.
6. Wait at least 30 seconds for the oil to settle in the engine, then pull dipstick out and wipe clean.

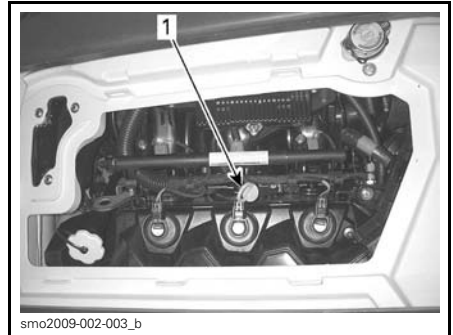

TYPICAL - ALL MODELS EXCEPT MODELS WITH 300 ENGINES

1. Oil dipstick location

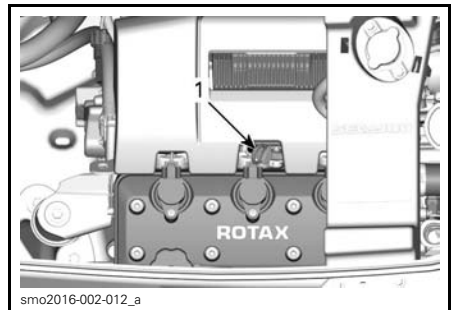

TYPICAL - MODELS WITH 300 ENGINES

1. Oil dipstick location

7. Reinstall dipstick, push in completely.
8. Remove dipstick again and read oil level. It should be between the FULL and ADD marks.

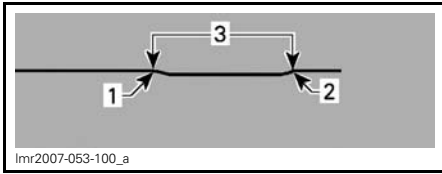

TYPICAL

1. Full
2. Add
3. Operating range

NOTE: On 1630 ACE HO engines, there is a 1 L (1.06 qt (U.S. liq.)) between Min and Max reading.

9. Add oil to ensure the level is between marks as required.

To add oil:

- Unscrew oil cap.
- Place a funnel in the oil filler neck opening.
- Add the recommended oil to the proper level.

NOTE: Do not overfill.

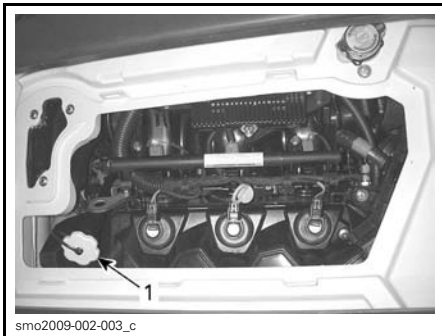

TYPICAL - ALL MODELS EXCEPT MODELS WITH 300 ENGINES

1. Oil filler cap location

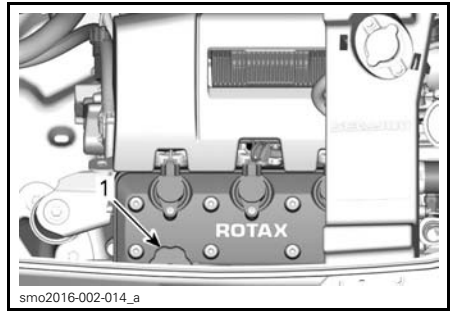

TYPICAL - MODELS WITH 300 ENGINES

1. Oil filler cap location

NOTE: Every time oil is added in the engine, the complete procedure explained in this section must be carried out again. Otherwise, you will obtain a false oil level reading.

10. Properly reinstall oil cap and dipstick.

NOTICE Ensure that oil filler cap is properly closed. Otherwise big quantities of oil can spill out the oil filler cap.

Engine Oil Change and Oil Filter Replacement

The oil change and filter replacement may be performed by an authorized Sea-Doo dealer, repair shop, or person of your own choosing.

Engine Coolant

Recommended Engine Coolant

Always use LONG LIFE ANTIFREEZE (P/N 219 702 685) or equivalent. If the recommended coolant is not available, use a low silicate, extended life ethylene-glycol premixed coolant (50%-50%) specifically formulated for internal combustion aluminum engines.

To prevent antifreeze deterioration, always use the same brand and grade. Never mix different brands or grades unless cooling system is completely flushed and refilled.

Engine Coolant Level

⚠ WARNING

Check coolant level with engine cold. Never add coolant in cooling system when engine is hot.

⚠ CAUTION Certain components in the engine compartment may be very hot. Direct contact may result in skin burn.

Open seat.

Remove ventilation box. Refer to ENGINE OIL LEVEL for the procedure.

Locate the expansion tank cap.

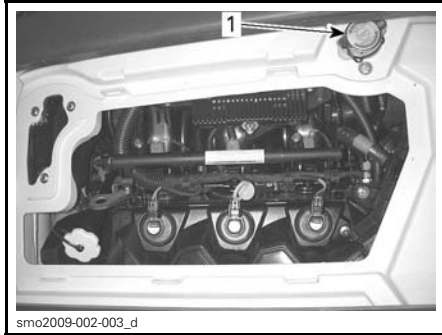

TYPICAL - ALL MODELS EXCEPT MODELS WITH 300 ENGINE

1. Expansion tank cap

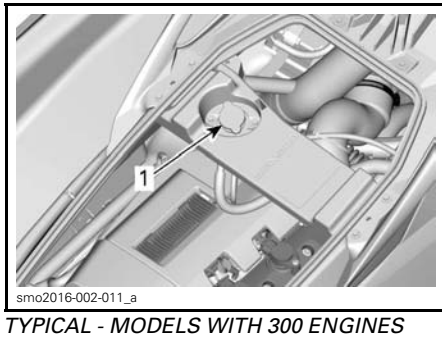

TYPICAL - MODELS WITH 300 ENGINES

1. Expansion tank cap

With watercraft on a level surface, coolant level should be between MIN. and MAX. marks on coolant reservoir when engine is cold.

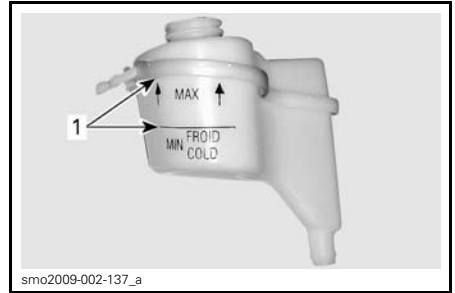

TYPICAL - COOLANT EXPANSION TANK

1. Level between marks when engine is cold

NOTE: The watercraft is level when it is in water. When on a trailer, raise trailer tow pole and block in this position when bumper rail is level.

Add coolant, see *RECOMMENDED ENGINE COOLANT* for specification, to adjust coolant level between marks as required. Use a funnel to avoid spillage. Do not overfill.

Properly reinstall and tighten filler cap, then reinstall ventilation box and close seat.

NOTE: A cooling system that frequently requires coolant is an indication of leaks or engine problems. See an authorized Sea-Doo dealer.

Engine Coolant Replacement

Coolant replacement should be performed by an authorized Sea-Doo dealer.

Ignition Coils

Ignition Coil Access

Models Equipped with a Suspension

1. Open seat.
2. Remove rear ventilation box.

Models Without Suspension

1. Open seat.
2. Remove engine cover.

Ignition Coil Removal (1503 4-TEC Engine Only)

1. Disconnect ignition coil connector.

NOTICE Do not remove the ignition coil before disconnecting the input connector or the wires may be damaged. Do not pry up ignition coil with a screwdriver to avoid damage.

NOTE: Twist ignition coil in both directions as you pull it up to ease removal.

Remove ignition coil from spark plug.

Ignition Coil Removal (1630 ACE HO Engine Only)

1. Disconnect ignition coil connector.

NOTICE Do not pry on ignition coil using any tool.

2. Remove ignition coil retaining screw.
3. Remove ignition coil from spark plug by rotating coil side to side as you pull up.

Ignition Coil Lubrication (1503 4-TEC Engine Only)

1. Pull rubber seal down.

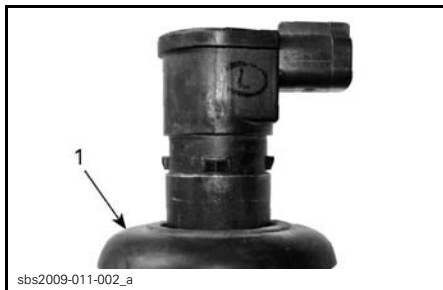

1. Rubber seal pulled down

2. Apply DOW CORNING 111 (P/N 413 707 000) or equivalent to rubber seal seat as shown.

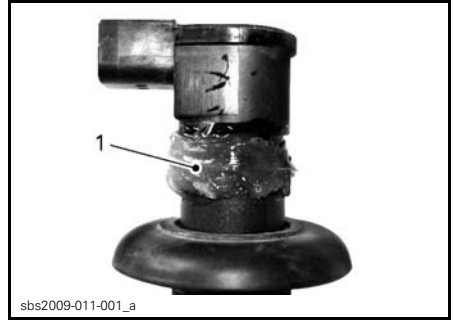

1. Apply product here

3. Pull rubber seal back on its seat making sure the tabs on the ignition coil and the slots in the seal properly match together.

4. Leave a ring of grease on top of the seal as shown to act as a water barrier. Wipe off the excess.

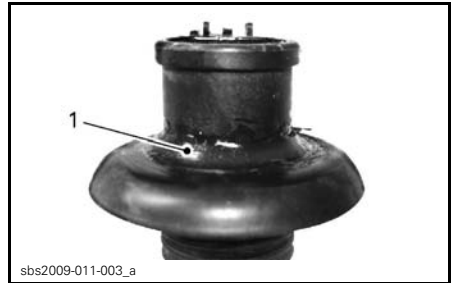

1. Correctly shaped excess of product

5. Apply DOW CORNING 111 (P/N 413 707 000) or equivalent on rubber seal contact area.

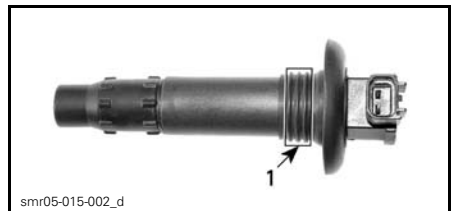

1. Apply product here

Ignition Coil Installation (1503 4-TEC Engine)

NOTE: Prior to inserting the ignition coil on its spark plug, apply sealant as described in *IGNITION COIL LUBRICATION*.

1. Install coil in cylinder head hole.
2. Push the ignition coil down to securely install it on the spark plug tip.
3. Ensure the seal seats properly with top surface of engine valve cover.

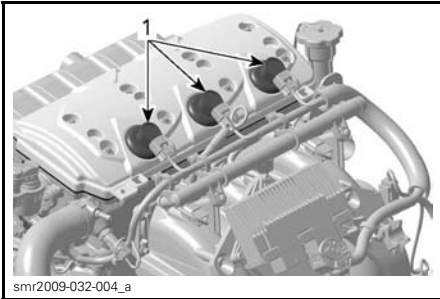

smr2009-032-004_a

TYPICAL

1. Seal properly seated

Ignition Coil Installation (1630 ACE HO Engine)

1. Install ignition coil on spark plug.
2. Align the retaining screw hole of the ignition coil with the threaded hole on the valve cover.
3. Push the ignition coil all the way down until it rests on the valve cover.
4. Install and tighten retaining screw.

TIGHTENING TORQUE	
Ignition coil retaining screw	9 N•m ± 1 N•m (80 lbf•in ± 9 lbf•in)

5. Reconnect ignition coil connector.

Spark Plugs

Spark Plug Removal

1. Open seat.

2. Remove rear ventilation box (as applicable).
3. Disconnect the ignition coil input connector.
4. Remove ignition coil. Refer to *IGNITION COIL REMOVAL*.

⚠ WARNING

Never remove an ignition coil from a spark plug without disconnecting it from the wiring harness. Flammable vapors may be present in the bilge. Should the tether cord be installed on the engine cut-off switch, a spark could be generated at the coil spark plug end which could cause an explosion.

5. Using a spark plug socket, release the torque applied to the spark plug.

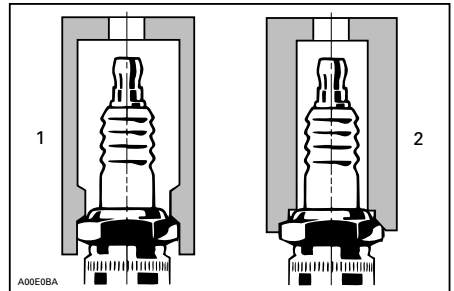

1. Approved socket
 2. Improper socket
6. Clean the spark plug and cylinder head with pressurized air.
 7. Unscrew spark plug then use the ignition coil to take spark plug out of spark plug hole.

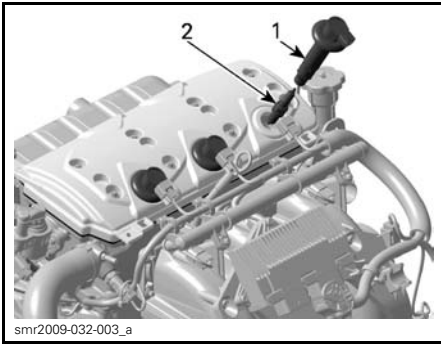

1. Ignition coil
2. Spark plug

Spark Plug Installation

Prior to installation, ensure the contact surfaces of the cylinder head and spark plug are free of grime.

1. Using a wire feeler gauge, set electrode gap as specified in the the *SPECIFICATIONS*.
2. Apply LOCTITE 767 (ANTISEIZE LUBRICANT) (P/N 293 800 070) over the spark plug threads to prevent possible seizure.
3. Hand screw spark plug into cylinder head. Then, tighten the spark plug clockwise to specification using an approved spark plug socket.
4. Install ignition coil. Refer to *IGNITION COIL INSTALLATION*.
5. Close seat.

Exhaust System

Exhaust System Flushing

Flushing the exhaust system and intercooler (supercharged models) with fresh water is essential to neutralize corroding effects of salt or other chemical products present in water. It will help to remove sand, salt, shells or other particles in water jackets and/or hoses.

All Models Except 260 and 300 Engine

Flushing the exhaust system with fresh water is essential to neutralize corroding effects of salt or other chemical products present in water. It will help to clean up sand, salt, shells or other particles in water jackets (exhaust system, intercooler (supercharged engines) and hoses).

Exhaust system flushing should be performed when the watercraft is not expected to be used further the same day or when the watercraft is stored for any extended time.

NOTICE Failure to flush the system, when necessary, will severely damage exhaust system. Make sure engine operates during entire procedure.

⚠ WARNING

Perform these operations in a well ventilated area. Certain components in the engine compartment may be very hot. Direct contact may result in skin burn. Do not touch any electrical part or jet pump area when engine is running.

⚠ WARNING

When operating the engine while the watercraft is out of the water, the heat exchanger in the ride plate may become very hot. Avoid any contact with ride plate as burns may occur.

Connect a garden hose to connector located at the rear of watercraft. Do not open water tap yet.

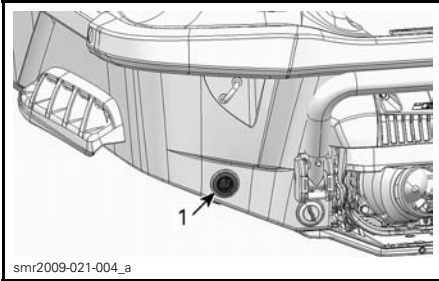

1. Water inlet connector

NOTE: The following tool is recommended when a quick connect adapter is used to ease garden hose installation.

RECOMMENDED TOOL	
<p>FLUSHING CONNECTOR ADAPTER (P/N 295 500 473)</p>	

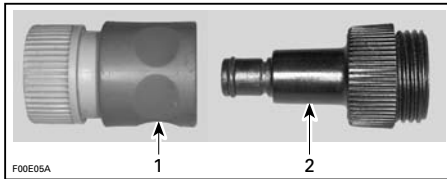

1. Quick connect adapter
2. Flushing connector adapter

To flush the exhaust system, start the engine then immediately open the water tap.

NOTICE Always start the engine before opening the water tap. Open water tap immediately after engine is started to prevent overheating. Never run engine without supplying water to the exhaust system when watercraft is out of water.

Run the engine about 20 seconds at a fast idle between 4000 - 5000 RPM.

NOTICE Never run engine longer than 2 minutes. Drive line seal has no cooling when watercraft is out of water.

Ensure water flows out of jet pump while flushing.

Close the water tap, then stop the engine.

NOTICE Always close the water tap before stopping the engine.

Disconnect the garden hose.

NOTICE Remove flushing connector adapter after operation (if used).

Models with 260 and 300 Engine

NOTICE If watercraft is used in salt water, exhaust system must be flushed daily to avoid serious damage to mechanical components.

Flushing should be performed when the watercraft is not expected to be used further the same day or when the watercraft is stored for any extended time.

<p>⚠ WARNING</p> <p>Perform this operation in a well ventilated area.</p>
--

Proceed as follows:

Clean jet pump by spraying water in its inlet and outlet and then apply a coating of XPS Lube or equivalent.

⚠ CAUTION When operating the engine while the watercraft is out of the water, the heat exchanger in the ride plate may become very hot. Avoid any contact with ride plate as burns may occur.

Connect a garden hose to the connector located at the rear of watercraft (on the port side of the stern). Do not open water tap at this time.

NOTICE Always run the engine before opening the water tap. If not, water will get inside the engine.

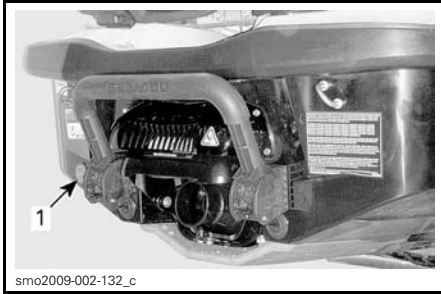

smo2009-002-132_c

TYPICAL

1. Flushing connector location

NOTE: An optional quick connect hose adapter and hose fitting can be used (P/N 295 500 473). No hose pincher is required to flush engine.



smo2009-002-138

QUICK CONNECT HOSE ADAPTER

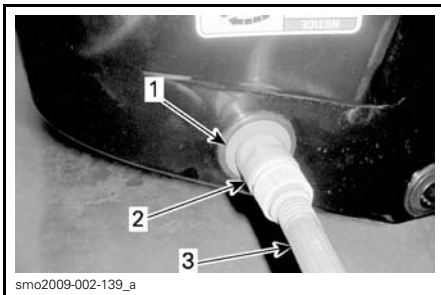

smo2009-002-139_a

TYPICAL

1. Hose adapter (optional, not mandatory)
2. Quick connect fitting (optional, not mandatory)
3. Garden hose

To flush, start engine then immediately open the water tap.

⚠ CAUTION Certain components in the engine compartment may be very hot. Direct contact may result in skin burn. Do not touch any electrical parts or jet pump area when engine is running.

NOTICE Never flush a hot engine. Always start the engine before opening the water tap. Open water tap immediately after engine is started to prevent overheating.

Run the engine 90 seconds at idle speed.

NOTICE Never run engine without supplying water to the exhaust system when watercraft is out of water.

Ensure water flows out of jet pump while flushing. Otherwise, refer to an authorized Sea-Doo dealer for servicing.

NOTICE Never run engine longer than 2 minutes. Drive line seal has no cooling when watercraft is out of water.

Close the water tap, run the engine at 5000 RPM for 5 seconds and stop the engine.

NOTICE Always close the water tap before stopping the engine. If not, water will get inside the engine.

NOTICE Remove quick connect adapter after flushing operation (if used).

Ride Plate and Water Intake Grate

Ride Plate and Water Intake Grate Inspection

Inspect ride plate and jet pump water intake grate for damage. See your Sea-Doo dealer to have any damaged part repaired or replaced.

⚠ WARNING

The tether cord must always be removed from the engine cut-off switch prior to inspecting the intake grate.

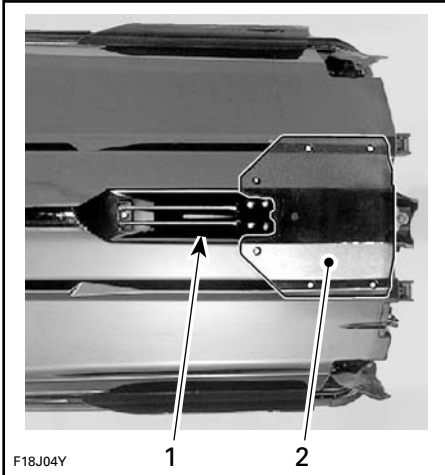

TYPICAL — INSPECT THESE AREAS
 1. Water intake
 2. Ride plate

Sacrificial Anode

Sacrificial Anode Inspection

Sacrificial anodes are present on:

- Pump
- Ride plate
- Intercooler (1630 ACE HO engine).

Check for wear. If worn more than half, see an authorized Sea-Doo dealer for anode replacement.

Ski/Wakeboard Post (Wake)

Ski/Wakeboard Post Inspection

Check ski/wakeboard post operation. Ensure it slides up and down easily. Check locking mechanism operation. Check fasteners tightness. If some-

thing is found defective, don't use ski/wakeboard post and see an authorized Sea-Doo dealer for repair.

Ski/Wakeboard Post Lubrication

Clean ski/wakeboard post and apply a light coat of SUPER LUBE GREASE (P/N 293 550 030) or equivalent.

Lubricate post throughout its length. Wipe off all excess grease and reinstall post. Extend and retract several times to distribute the lubricant.

Fuses

Fuse Removal and Installation

Use the fuse remover/installer included in the fuse box to ease fuse removal.

Fuse Inspection

If an electrical problem occurs, check the fuses. If a fuse is burnt, replace by one of the same rating.

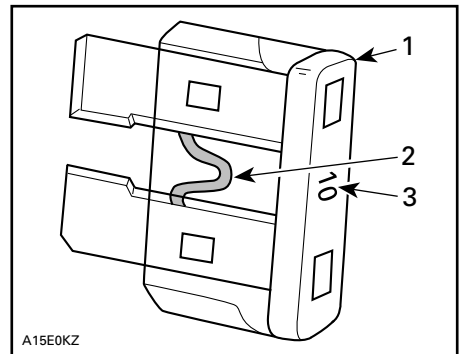

TYPICAL
 1. Fuse
 2. Check if melted
 3. Ampere rating

⚠ WARNING

Do not use a higher rated fuse as this can cause severe damage. If a fuse has burnt out, the source of the malfunction should be determined and corrected before restarting. See an authorized Sea-Doo dealer for servicing.

Fuse Location

All fuses are located inside a single fuse box.

To access the fuse box:

Models with Suspension

Open the boarding platform.

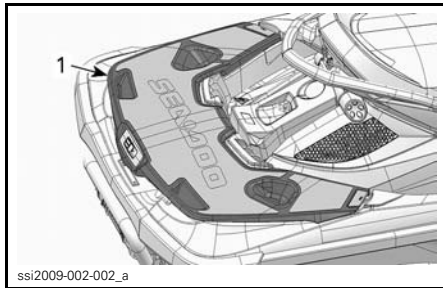

1. Boarding platform

Remove the two plastic rivets securing the RH aft storage bin and remove the storage bin from the fixed deck. The fuse box is located just under the storage bin, attached to the front of the battery holder.

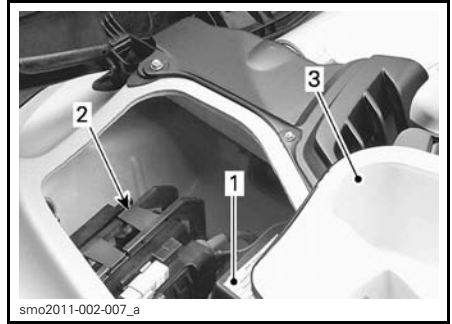

TYPICAL

- 1. Fuse box
- 2. Battery holder
- 3. Storage bin

Models Without Suspension

Open or remove seat.

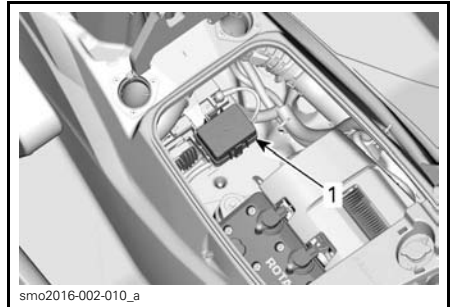

TYPICAL

- 1. Fuse box

All Models

To remove a fuse box cover, squeeze locking tabs together, hold and pull fuse box cover to open.

NOTE: Fuse ratings and positions are illustrated on the fuse box cover.

Fuse Description

FUSE	RATING	DESCRIPTION
1	5A	iS Control (intelligent Suspension) (GTX Limited iS only)
2	15 A	Diagnostic connector
3	3 A	START/STOP button

FUSE	RATING	DESCRIPTION
4	3 A	GPS
5	30 A	iBR
6	30 A	Charge
7	30 A	iS
8	30 A	Battery
9	—	Not used
10	—	Not used
11	3 A	Depth sounder (if so equipped)
12	3 A	Gauge, OTAS and CAPS
13	10 A	Cylinder 1 (ignition coil and injection)
14	10 A	Cylinder 2 (ignition coil and injection)
15	10 A	Cylinder 3 (ignition coil and injection)
16	5 A	Starter solenoid
17	5 A	iBR control
18	10 A	Fuel pump
19	15 A	ECM

WATERCRAFT CARE

Remove the watercraft from the water every day.

Post-Operation Care

Exhaust System Flushing

The exhaust system should be flushed daily when watercraft is used in salt or foul water.

Refer to *MAINTENANCE PROCEDURES*.

NOTE: On supercharged models, the intercooler is flushed at the same time.

Additional Care for Foul Water or Salt Water Operation

When the watercraft is operated in foul water and particularly in salt water, additional care should be taken to protect the watercraft and its components.

Rinse watercraft bilge area with fresh water.

Never use a high pressure washer to clean the bilge. **USE LOW PRESSURE ONLY (such as a garden hose).**

High pressure can cause damages to electrical or mechanical systems.

⚠ CAUTION Allow engine to cool before performing any maintenance.

NOTICE Failure to perform proper care such as: watercraft rinsing, exhaust system flushing and anticorrosion treatment, when watercraft is used in salt water, will result in damage to the watercraft and its components. Never leave the watercraft stored in direct sunlight.

Watercraft Cleaning

Body and Hull

Occasionally, wash the hull and various body components with water and soap (use only mild detergent). Remove any

marine organisms from engine and/or hull. Apply non-abrasive wax such as silicone wax.

NOTICE Never clean fiberglass and plastic parts with strong detergent, degreasing agent, paint thinner, acetone, or other strong chemical or petroleum type cleaner.

Stains may be removed from the seat and fiberglass using XPS ALL PURPOSE CLEANER (P/N 219 701 709) or the equivalent.

To clean the carpets, use 3M™ Citrus Base Cleaner (24 oz spray can) or an equivalent.

⚠ WARNING

Never apply plastic or vinyl protector on the carpets or seat as the surface will become slippery and the occupants may slip off the watercraft.

Respect the environment by ensuring fuel, oil or cleaning solutions do not drain into the waterways.

Speed-Tie Rope

A minimum of maintenance is required to keep the speed-tie unit and the mooring rope in serviceable condition.

Clean the locking mechanism and mooring rope with fresh water to remove salt, sand or other deposits.

NOTICE Do not use a high pressure washer to clean the speed-tie unit.

Let dry.

STORAGE AND PRESEASON PREPARATION

Storage

WARNING

Because fuel and oil are flammable, you should have an authorized Sea-Doo dealer, repair shop, or person of your own choosing to inspect the fuel system integrity as specified in the periodic inspection chart.

It is recommended that the watercraft be serviced by an authorized Sea-Doo dealer, repair shop, or person of your own choosing for storage, however the following operations can be performed by you with a minimum of tools.

NOTE: Carry out the following tasks in the same order as detailed in this section.

NOTICE Do not run the engine during the storage period.

Propulsion System

Jet Pump Cleaning

Clean jet pump by spraying water in its inlet and outlet and then apply a coat of XPS LUBE (P/N 293 600 016) or equivalent.

WARNING

Always remove tether cord from the engine cut-off switch to prevent unexpected engine starting before cleaning the jet pump area. Engine must not be running for this operation.

Jet Pump Inspection

See your authorized Sea-Doo dealer.

Fuel System

Fuel System Protection

XPS FUEL STABILIZER (P/N 413 408 601) (or equivalent) should be added in the fuel tank to prevent fuel deterioration and fuel system gumming. Follow stabilizer manufacturers' instructions for proper use.

NOTICE It is highly recommended to add fuel stabilizer at storage in order to maintain fuel system in good condition. Fuel stabilizer should be added prior to engine lubrication and fuel tank top up to ensure fuel system components protection against varnish deposits.

Fill up fuel tank completely as explained in *FUELING* section. Make sure there is no water inside fuel tank.

NOTICE Should any water be trapped inside fuel tank, severe internal damage will occur to the fuel injection system.

Engine and Exhaust

Exhaust System Flushing

Perform procedure as described in *MAINTENANCE PROCEDURES*.

Engine Oil and Filter Replacement

The oil change and filter replacement may be performed by an authorized Sea-Doo dealer, repair shop, or person of your own choosing.

Models with 260 and 300 Engine

It is important to expel any trapped water that may have accumulated from condensation in the intercooler.

Proceed as follows:

Models With Suspension

1. Open the boarding platform and remove the RH storage bin.

Models Without Suspension

2. Lift seat.

All Models

3. Ensure there is an alignment line drawn on the intercooler inlet hose. This will ensure the hose is not twisted or kinked on reinstallation.
4. Loosen the clamp retaining the intercooler inlet hose.
5. Remove the intercooler inlet hose from the intercooler.

NOTE: This hose feeds the hot, compressed air from the engine supercharger to the intercooler inlet.

6. For iS models, drape a couple of shop rags or a plastic bag over the iS module to protect it from any expelled water from the intercooler.

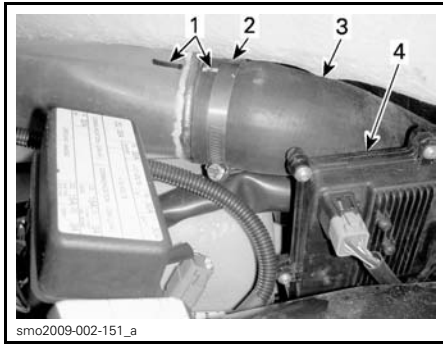

TYPICAL - 1503 4-TEC ENGINES WITH SUSPENSION

1. Hose alignment lines
2. Hose clamp
3. Intercooler inlet hose
4. iS module

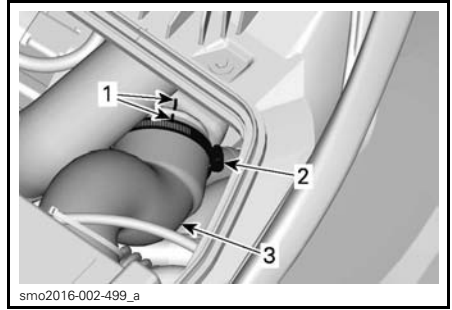

TYPICAL - 1630 ACE HO ENGINES

1. Hose alignment lines
2. Hose clamp
3. Intercooler inlet hose

Models With Suspension

7. Start and rev the engine up to 4000 RPM several times.

NOTE: Ensure air intake system does not aspirate foreign objects which may cause severe engine or damage.

8. Stop engine.

Models Without Suspension

9. The 1630 ACE HO engine intercooler air side is self-draining into the intercooler inlet-side manifold. By disconnecting the intercooler inlet hose, the presence of condensed water can be visually assessed and properly drained off without the engine running.

10. Reinstall the intercooler air outlet hose, ensure it is properly aligned as prior to removal to ensure proper engine operation.

Exhaust System Draining

In areas where temperature may freeze, water trapped in the exhaust system and intercooler must be removed.

Using the flushing connector located on the port (LH) side of the stern, inject pressurized air at 379 kPa (55 PSI) into system until there is no more water flowing from jet pump.

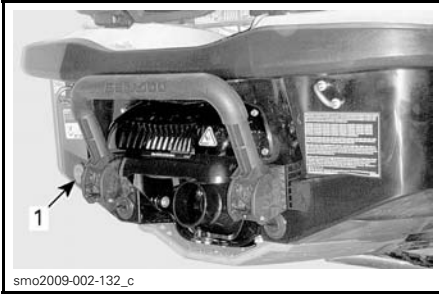

smo2009-002-132_c

TYPICAL

1. Flushing connector

The following hose can be fabricated to ease draining procedure.

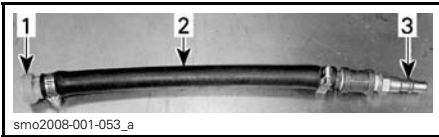

smo2008-001-053_a

TYPICAL

1. Flushing connector adapter
2. Hose 12.7 mm (1/2 in)
3. Air hose male adapter

NOTICE Failure to drain the exhaust system may cause severe damage to the intercooler (super-charged models) and exhaust manifold.

Remove special tools.

Engine Internal Lubrication

1. Open the seat.
Remove the air ventilation box over the engine (as applicable).
2. Remove ignition coils, refer to *MAINTENANCE PROCEDURES*.
3. Remove spark plugs, refer to *MAINTENANCE PROCEDURES*.
4. Spray XPS LUBE (P/N 293 600 016) or equivalent in spark plug holes.
5. To prevent fuel from being injected and to disable the ignition during engine cranking, fully depress throttle lever and HOLD against handlebar.

6. Press the START/STOP button to crank the engine a few turns. This will distribute the oil on the cylinder walls.
7. Apply anti-seize lubricant on spark plug threads, then reinstall them in the engine. Refer to *MAINTENANCE PROCEDURES*.
8. Install the ignition coils, refer to *MAINTENANCE PROCEDURES*.

Engine Coolant Test

If antifreeze is not replaced, test its density.

The antifreeze replacement and a density test should be performed by an authorized Sea-Doo dealer.

NOTE: Antifreeze should be replaced every 300 hours or every 5 years to prevent antifreeze deterioration.

NOTICE Improper antifreeze density may result in freezing of the liquid in the cooling system if the watercraft is stored in an area where the freezing point is attained. This would seriously damage the engine.

Electrical System**Battery Removal and Charging**

Contact your authorized Sea-Doo dealer.

⚠ WARNING

Never charge or boost the battery while installed in the watercraft.

Engine Compartment**Engine Compartment Cleaning**

Clean the bilge with hot water and detergent or with bilge cleaner. Rinse thoroughly. Lift front end of watercraft to completely drain bilge through the bilge drain plugs.

Anticorrosion Treatment

Wipe off any residual water in the engine compartment.

Spray XPS LUBE (P/N 293 600 016) or equivalent over all metallic components in engine compartment.

NOTE: The seat should be left partially open during storage. This will prevent engine compartment condensation and possible corrosion.

Body and Hull

Body and Hull Cleaning

Wash the body with a soap and water solution (use only mild detergent). Rinse thoroughly with fresh water. Remove marine organisms from the hull.

NOTICE Never clean fiberglass and plastic parts with strong detergent, degreasing agent, paint thinner, acetone, or other strong chemical or petroleum cleaners.

Body and Hull Repair

If any repairs are needed to body components or to the hull, contact your authorized Sea-Doo dealer.

Body and Hull Protection

Apply a good quality marine wax to the body.

If the watercraft is to be stored outside, cover it with an opaque tarpaulin to prevent sun rays and grime from affecting the plastic components, watercraft finish, as well as preventing dust accumulation.

NOTICE The watercraft should never be left in water for storage. Never leave the watercraft stored in direct sunlight. Never store watercraft in a plastic bag.

Preseason Preparation

Maintenance preparation must be performed in conjunction with *MAINTENANCE SCHEDULE*.

Ensure to perform all tasks included in the **100 HOURS OR 1 YEAR** table.

Preseason maintenance preparation may be performed by an authorized Sea-Doo dealer, repair shop or person of your own choosing.

NOTE: Though not required, it is recommended that an authorized Sea-Doo dealer perform preseason maintenance preparation at the same time that any safety-related factory campaigns are performed by the authorized Sea-Doo dealer.

WARNING

Only perform procedures as detailed in the *MAINTENANCE SCHEDULE*. It is recommended that the assistance of an authorized Sea-Doo dealer be periodically obtained on other components and systems not covered in this guide.

NOTICE When component conditions seem less than satisfactory, replace using genuine BRP parts, or equivalents.

TECHNICAL INFORMATION

WATERCRAFT IDENTIFICATION

The main components of the watercraft (engine and hull) are identified by different serial numbers. It may sometimes become necessary to locate these numbers for warranty purposes or to trace the watercraft in the event of theft.

Hull Identification Number

The Hull Identification Number (HIN) is located on footboard at the rear of watercraft.



TYPICAL

1. Hull Identification Number (HIN)

It is composed of 12 digits:

YDV	12345	L	8	09	
					Model year
					Year of production
					Month of production
					Serial number (a letter may also be used as a digit)
					Manufacturer

Engine Identification Number

The Engine Identification Number (EIN) is located on the front end of the engine.

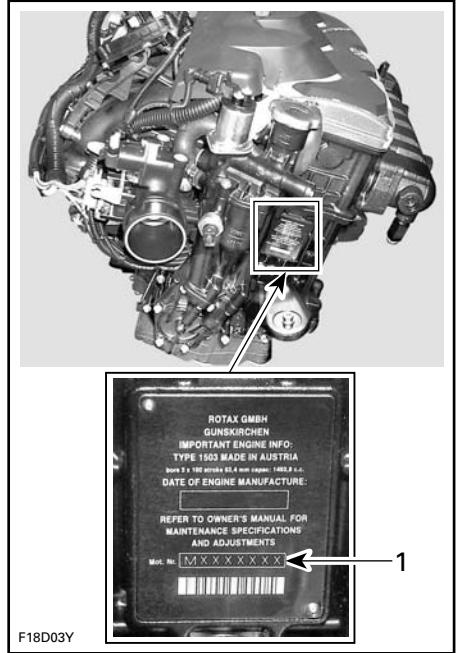

TYPICAL

1. Engine Identification Number (EIN)

RF D.E.S.S. KEY

Radio Frequency Digitally Encoded Security System (RF D.E.S.S.)

Industries Canada Certification:
12006A-M01456

This device complies with RSS-GEN and RSS-210 of Industry Canada.

FCC Certification: 2ACERM01456

The following device is in compliance with FCC part 15C.

Warning to the user: Any changes /modifications not approved by the manufacturer could void the user's authority to operate the equipment.

European Conformity:

The following device is in compliance with the following standards:

ETSI EN 300 330-2

ETSI EN 60950-1

ENGINE EMISSIONS INFORMATION

Manufacturer's Responsibility

Beginning with 1999 model year engines, PWC manufacturers of marine engines must determine the exhaust emission levels for each engine horsepower family and certify these engines with the United States of America Environmental Protection Agency (EPA). An emissions control information label, showing emission levels and engine specifications, must be placed on each watercraft at the time of manufacture.

Dealer's Responsibility

When performing service on all 1999 and more recent Sea-Doo watercraft that carry an emissions control information label, adjustments must be kept within published factory specifications.

Replacement or repair of any emission related component must be executed in a manner that maintains emission levels within the prescribed certification standards.

Dealers are not to modify the engine in any manner that would alter the horsepower or allow emission levels to exceed their predetermined factory specifications.

Exceptions include manufacturer's prescribed changes, such as altitude adjustments for example.

Owner Responsibility

The owner/operator is required to have engine maintenance performed to maintain emission levels within prescribed certification standards.

The owner/operator is not to, and should not allow anyone to modify the engine in any manner that would alter the horsepower or allow emissions levels to exceed their predetermined factory specifications.

EPA Emission Regulations

All 1999 and more recent Sea-Doo watercraft manufactured by BRP are certified to the EPA as conforming to the requirements of the regulations for the control of air pollution from new watercraft engines. This certification is contingent on certain adjustments being set to factory standards. For this reason, the factory procedure for servicing the product must be strictly followed and, whenever practicable, returned to the original intent of the design.

The responsibilities listed above are general and in no way a complete listing of the rules and regulations pertaining to the EPA requirements on exhaust emissions for marine products. For more detailed information on this subject, you may contact:

U.S. Environmental Protection Agency
Office of Transportation and Air Quality
1200 Pennsylvania Ave. NW
Mail Code 6403J
Washington D.C. 20460

EPA INTERNET WEB SITE:
<http://www.epa.gov/otaq>

SPECIFICATIONS

1503 4-TEC engines

ENGINE		
Engine type	ROTAX® 1503 4-TEC™, 4-stroke, Single Over Head Camshaft (SOHC)	
Declared Power ⁽¹⁾	155	106 kW @ 7300 RPM
	215	152 kW @ 8000 RPM
	260	179 kW @ 8000 RPM
Induction	155	Naturally-Aspirated
	215/260	Supercharged intercooled
Number of cylinders	3	
Number of valves	12 valves with hydraulic lifters (no adjustment)	
Bore	100 mm (3.9 in)	
Stroke	63.4 mm (2.5 in)	
Displacement	1 493.8 cm ³ (91 in ³)	
Compression ratio	155	10.6:1
	215/260	8.4:1

⁽¹⁾ Declared power as per ISO 8665 at propeller-shaft.

LUBRICATION SYSTEM		
Lubrication	Oil type	XPS 4-stroke synthetic blend oil (summer) (P/N 293 600 121) or a 10W40 mineral engine oil compatible with wet clutches
	Capacity	3 L (3.2 qt (U.S. liq.)) oil change w/filter 4.8 L (5.1 qt (U.S. liq.))total

COOLING SYSTEM	
Type	Closed loop cooling system
Coolant	See <i>ENGINE COOLANT</i> in the <i>MAINTENANCE PROCEDURES</i> section of this guide
Cooling system capacity	5.5 L (5.8 qt (U.S. liq.)) total

SPECIFICATIONS

FUEL SYSTEM			
Fuel injection type			Multipoint fuel injection with iTC (intelligent Throttle Control). Single throttle body (60 mm) with an actuator
Fuel type	Inside North America ((RON + MON)/2)	GTX 155 GTX S 155	87
		GTX LTD 215 RXT 260 GTR 215 Wake PRO 215 GTX LTD iS 260 RXT-X aS 260	91 or higher
	Outside North America (RON)	GTX 155 GTX S 155	91
		GTX LTD 215 RXT 260 GTR 215 Wake PRO 215 GTX LTD iS 260 RXT-X aS 260	95 or higher
Fuel tank capacity (including reserve)	GTX 155 GTX LTD 215 RXT 260 GTR 215 Wake PRO 215		60 L (16 U.S. gal.)
	GTX S 155 GTX LTD iS 260 RXT-X aS 260		70 L (18 U.S. gal.)

ELECTRICAL SYSTEM		
Ignition system type		IDI (Inductive Discharge Ignition)
Battery		12 V, 18 A•h
Spark plug	Make and type	NGK DCPR8E or equivalent
	Gap	0.7 mm to 0.8 mm (.028 in to .031 in)
PROPULSION		
Jet pump	Type	Axial flow single stage
Drive shaft	Coupling type	Crowned splines, direct drive
IBR AND VTS		
VTS system		Electronically-controlled through the VTS control button with 2 preset positions

SPECIFICATIONS

WEIGHT AND LOADING CAPACITY		
Dry weight	GTX	399 kg (879 lb)
	GTX S	462 kg (1,018 lb)
	GTX LTD RXT RXT RS WAKE PRO	406 kg (894 lb)
	GTX LTD iS	471 kg (1,038 lb)
	RXT-X aS RXT-X aS RS	466 kg (1,028 lb)
	Number of passenger (driver incl.)	
Load limit (passenger(s) and luggages)	GTX S GTX LTD iS RXT-X aS RXT-X aS RS	227 kg (500 lb)
	GTX GTX LTD RXT RXT RS WAKE PRO	272 kg (600 lb)
Storage capacity	GTX S GTX LTD iS RXT-X aS RXT-X aS RS	63 L (16.6 U.S. gal.)
	GTX GTX LTD RXT RXT RS WAKE PRO	162 L (42.8 U.S. gal.)

DIMENSIONS		
Overall length		353.5 cm (139.2 in)
Overall width		122.4 cm (48.2 in)
Overall height	GTX GTX LTD RXT RXT RS WAKE PRO	116.6 cm (45.9 in)
	GTX S GTX LTD iS	111.4 cm (43.9 in)
	RXT-X aS RXT-X aS RS	118.1 cm (46.5 in)
MATERIALS		
Impeller material		Stainless steel
Impeller housing/stator		Aluminum/aluminum

1630 ACE HO engines

ENGINE	
Engine type	ROTAX® 1630 ACE™ HO, 4-stroke, Single Over Head Camshaft (SOHC)
Declared Power ⁽¹⁾	217 kW @ 8000 RPM
Induction	Supercharged intercooled
Number of cylinders	3
Number of valves	12 valves with hydraulic lifters (no adjustment)
Bore	100 mm (3.9 in)
Stroke	69.2 mm (2.7 in)
Displacement	1 630.5 cm ³ (99.5 in ³)
Compression ratio	8.4:1

⁽¹⁾ Declared power as per ISO 8665 at propeller-shaft.

LUBRICATION SYSTEM		
Lubrication	Oil type	XPS 4-stroke synthetic blend oil (summer) (P/N 293 600 121) or a 10W40 mineral engine oil compatible with wet clutches such as JASO MA certified oils.
	Capacity	3 L (3.2 qt (U.S. liq.)) oil change w/filter 5 L (5.3 qt (U.S. liq.))total

COOLING SYSTEM	
Type	Closed loop cooling system
Coolant	See <i>ENGINE COOLANT</i> in the <i>MAINTENANCE PROCEDURES</i> section of this guide
Cooling system capacity	5.5 L (5.8 qt (U.S. liq.)) total

FUEL SYSTEM		
Fuel injection type		Multipoint fuel injection with iTC (intelligent Throttle Control). Single throttle body (60 mm (2.36 in)) with an actuator
Fuel type	Inside North America ((RON + MON)/2)	91 or higher
	Outside North America (RON)	95 or higher
Fuel tank capacity (including reserve)		60 L (16 U.S. gal.)

ELECTRICAL SYSTEM		
Ignition system type		IDI (Inductive Discharge Ignition)
Battery		Sealed, 12 V, 18 A•h
Spark plug	Make and type	NGK KR9C-G or equivalent
	Gap	0.7 mm to 0.8 mm (.028 in to .031 in)

PROPULSION		
Jet pump	Type	Axial flow single stage
Drive shaft	Coupling type	Crowned splines, direct drive

IBR AND VTS	
VTS system	Electronically-controlled through the VTS control button with 2 preset positions

SPECIFICATIONS

WEIGHT AND LOADING CAPACITY		
Dry weight	GTX Limited	412 kg (909 lb)
	RXT-X Series	415 kg (914 lb)
Number of passenger (driver incl.)	GTX Limited RXT-X Series	3
Load limit (passenger and luggages)	GTX Limited RXT-X Series	272 kg (600 lb)
Storage capacity	GTX Limited RXT-X Series	162 L (42.8 U.S. gal.)

DIMENSIONS		
Overall length	GTX Limited RXT-X Series	353.5 cm (139 in)
Overall width	GTX Limited RXT-X Series	122.4 cm (48.2 in)
Overall height	GTX Limited	116.6 cm (45.9 in)
	RXT-X Series	118.1 cm (46.5 in)

MATERIALS	
Impeller material	Stainless steel
Impeller housing/stator	Aluminum/aluminum

NOTE: BRP reserves the right to make changes in design and specifications and/or to make additions to, or improvements in its products without imposing any obligation upon itself to install them on its products previously manufactured.

TROUBLESHOOTING

TROUBLESHOOTING GUIDELINES

ENGINE WILL NOT START

1. **Tether cord removed.**
 - Press *START/STOP* button.
 - Install tether cord cap over engine cut-off switch within 5 seconds after depressing the *START/STOP* button.
 - After double "beep", press *START/STOP* button.
2. **ECM does not recognize the D.E.S.S. key.**
 - Refer to an authorized *Sea-Doo* dealer.
3. **Burnt fuse: main, electric starter or ECM.**
 - Check wiring then replace fuse(s).
4. **Discharged battery.**
 - Refer to an authorized *Sea-Doo* dealer.

WARNING

Do not charge or boost the battery while installed on the watercraft. Electrolyte is poisonous and dangerous. Avoid contact with eyes, skin and clothing.

5. **Battery connections, corroded or loose. Bad ground.**
 - Refer to an authorized *Sea-Doo* dealer.
6. **Water-flooded engine.**
 - Refer to *WATER-FLOODED ENGINE* in *SPECIAL PROCEDURES*.
7. **Faulty sensor or ECM.**
 - Seek service from an authorized *Sea-Doo* dealer, repair shop, or person of your own choosing for maintenance, repair, or replacement. Please refer to the *US EPA EMISSIONS-RELATED WARRANTY* contained herein for information about warranty claims.
8. **Seized jet pump.**
 - Try to clean. Otherwise, refer to an authorized *Sea-Doo* dealer.

ENGINE CRANKS SLOWLY

1. **Loose battery cable connections.**
 - Check/clean/tighten.
2. **Discharged or weak battery.**
 - Refer to an authorized *Sea-Doo* dealer.
3. **Worn starter.**
 - Refer to an authorized *Sea-Doo* dealer.

ENGINE TURNS NORMALLY BUT WILL NOT START

1. **Fuel tank empty or water-contaminated.**
 - Refill. Siphon and fill with fresh fuel.

ENGINE TURNS NORMALLY BUT WILL NOT START (cont'd)

2. Fouled/defective spark plugs.

- *Replace.*

3. Blown fuse.

- *Check wiring then replace fuse(s).*

4. Water-flooded engine.

- *Refer to WATER-FLOODED ENGINE in SPECIAL PROCEDURES.*

5. Engine management system fault detected (check engine pilot lamp is ON).

- *Seek service from an authorized Sea-Doo dealer, repair shop, or person of your own choosing for maintenance, repair, or replacement. Please refer to the US EPA EMISSIONS-RELATED WARRANTY contained herein for information about warranty claims.*

6. Faulty fuel pump.

- *Seek service from an authorized Sea-Doo dealer, repair shop, or person of your own choosing for maintenance, repair, or replacement. Please refer to the US EPA EMISSIONS-RELATED WARRANTY contained herein for information about warranty claims.*

ENGINE MISFIRES, RUNS IRREGULARLY

1. Fouled/defective/worn spark plugs.

- *Replace.*

2. Fuel: Level too low, stale or water-contaminated.

- *Siphon and/or refill.*

3. Faulty ignition coil(s).

- *Seek service from an authorized Sea-Doo dealer, repair shop, or person of your own choosing for maintenance, repair, or replacement. Please refer to the US EPA EMISSIONS-RELATED WARRANTY contained herein for information about warranty claims.*

4. Clogged injectors.

- *Seek service from an authorized Sea-Doo dealer, repair shop, or person of your own choosing for maintenance, repair, or replacement. Please refer to the US EPA EMISSIONS-RELATED WARRANTY contained herein for information about warranty claims.*

5. Engine management system fault detected (check engine pilot lamp is ON).

- *Refer to MONITORING SYSTEM.*

ENGINE SMOKE

1. Oil level too high.

- *Seek service from an authorized Sea-Doo dealer, repair shop, or person of your own choosing for maintenance, repair, or replacement. Please refer to the US EPA EMISSIONS-RELATED WARRANTY contained herein for information about warranty claims.*

ENGINE SMOKE (cont'd)

2. Water ingestion, coolant leak or damaged cylinder head gasket.

- *Seek service from an authorized Sea-Doo dealer, repair shop, or person of your own choosing for maintenance, repair, or replacement. Please refer to the US EPA EMISSIONS-RELATED WARRANTY contained herein for information about warranty claims.*

3. Internal engine damage.

- *Seek service from an authorized Sea-Doo dealer, repair shop, or person of your own choosing for maintenance, repair, or replacement. Please refer to the US EPA EMISSIONS-RELATED WARRANTY contained herein for information about warranty claims.*

ENGINE OVERHEATS

1. Clogged exhaust system.

- *Flush exhaust system.*

2. Engine coolant level too low.

- *Refer to MAINTENANCE PROCEDURES.*

3. Quick connect adapter left in flushing connector.

- *Remove adapter from flushing connector and retry watercraft. If problem persists, seek service from an authorized Sea-Doo dealer, repair shop, or person of your own choosing for maintenance, repair, or replacement. Please refer to the US EPA EMISSIONS-RELATED WARRANTY contained herein for information about warranty claims.*

ENGINE LACKS ACCELERATION OR POWER

1. Learning key used.

- *Use a Normal key.*

2. Not in Sport mode.

- *Select Sport mode.*

3. Jet pump water intake clogged.

- *Clean. Refer to JET PUMP WATER INTAKE AND IMPELLER CLEANING in SPECIAL PROCEDURES section.*

4. Damaged impeller or worn-out wear ring.

- *Replace. Refer to an authorized Sea-Doo dealer.*

5. Engine oil level too high.

- *Seek service from an authorized Sea-Doo dealer, repair shop, or person of your own choosing for maintenance, repair, or replacement. Please refer to the US EPA EMISSIONS-RELATED WARRANTY contained herein for information about warranty claims.*

6. Weak spark.

- *Refer to ENGINE MISFIRES, RUNS IRREGULARLY.*

7. Engine management system fault detected (check engine pilot lamp is ON).

- *Refer to MONITORING SYSTEM.*

ENGINE LACKS ACCELERATION OR POWER (cont'd)

8. Clogged injectors.

- *Seek service from an authorized Sea-Doo dealer, repair shop, or person of your own choosing for maintenance, repair, or replacement. Please refer to the US EPA EMISSIONS-RELATED WARRANTY contained herein for information about warranty claims.*

9. Low fuel pressure.

- *Seek service from an authorized Sea-Doo dealer, repair shop, or person of your own choosing for maintenance, repair, or replacement. Please refer to the US EPA EMISSIONS-RELATED WARRANTY contained herein for information about warranty claims.*

10. Water in fuel.

- *Siphon and replace.*

11. Engine damaged by water ingestion.

- *Refer to an authorized Sea-Doo dealer.*

WATERCRAFT CAN NOT REACH TOP SPEED

1. Jet pump water intake clogged.

- *Clean. Refer to JET PUMP WATER INTAKE AND IMPELLER CLEANING in SPECIAL PROCEDURES section.*

2. Damaged impeller or worn-out wear ring.

- *Replace. Refer to an authorized Sea-Doo dealer.*

3. Engine management system fault detected (check engine pilot lamp is ON).

- *Refer to MONITORING SYSTEM.*

4. Faulty supercharger and/or intercooler (supercharged models).

- *Seek service from an authorized Sea-Doo dealer, repair shop, or person of your own choosing for maintenance, repair, or replacement. Please refer to the US EPA EMISSIONS-RELATED WARRANTY contained herein for information about warranty claims.*

WATERCRAFT STAYS IN NEUTRAL AFTER OPERATING THE iBR LEVER

1. The iBR gate stays in neutral.

- *Release the throttle to idle RPM.*
- *Press the CRUISE button to activate the slow speed mode.*
- *Return to shore using the slow speed mode. Refer to an authorized Sea-Doo dealer.*

iBR WILL NOT RETURN TO NEUTRAL POSITION (iBR INDICATOR LIGHT ON)

1. iBR jammed with debris.

- *Clean and check for damage in the iBR gate and nozzle area.*

2. iBR system malfunction.

- *Remove tether cord, wait four minutes, reinstall key and check iBR light to ensure fault is cleared.*
- *Refer to an authorized Sea-Doo dealer if fault persists or reoccurs frequently.*

iBR WILL NOT RETURN TO NEUTRAL POSITION (iBR INDICATOR LIGHT OFF)

1. **Throttle lever not fully released during operation.**
 - *Release throttle lever fully to ensure iBR gate returns to neutral.*
2. **Throttle lever does not fully return to null when released.**
 - *Refer to an authorized Sea-Doo dealer.*

ABNORMAL NOISE FROM PROPULSION SYSTEM

1. **Weeds or debris jammed around impeller.**
 - *Clean. Refer to JET PUMP WATER INTAKE AND IMPELLER CLEANING in SPECIAL PROCEDURES section.*
 - *Check for damage.*
2. **Damaged impeller shaft or drive shaft.**
 - *Refer to an authorized Sea-Doo dealer.*
3. **Water intrusion in jet pump causing bearing seizure.**
 - *Refer to an authorized Sea-Doo dealer.*

WATER FOUND IN BILGE

1. **Bailer system malfunction.**
 - *Have system inspected by an authorized Sea-Doo dealer.*
2. **Exhaust system leak.**
 - *Refer to an authorized Sea-Doo dealer.*
3. **Carbon ring at drive shaft worn.**
 - *Refer to an authorized Sea-Doo dealer.*

MONITORING SYSTEM

A system monitors the electronic components of the EMS (engine management system) iBR, iS, and other components of the electrical system. When a fault occurs, it sends visual messages through the information center and/or audible signals through a beeper to inform you of a particular condition.

A fault code may also be recorded.

When a minor or transient fault occurs, the fault message and beeper will cease automatically if the condition that caused the fault does not exist anymore.

Releasing the throttle and letting the engine return to idle speed may allow normal operation to come back. If this does not work, try removing and reinstalling the tether cord on the engine cut-off switch.

The electronic system will react differently depending on the fault type. In severe failure, the engine may not be allowed to be started. In other cases, the engine will operate in limp home mode (reduced speed).

When a fault occurs, please refer to the *US EPA EMISSIONS-RELATED WARRANTY* contained herein for information about warranty claims..

Fault Codes

When a fault occurs, a numerical fault code may be recorded depending on the fault type and system.

These fault codes are used by authorized Sea-Doo dealers for troubleshooting the watercraft systems when comparing them to a fault list.

Fault codes can be viewed in the information center multifunction display however, this function is only available if a fault is still active.

If there is an active fault code, it may be viewed by the operator on the multifunction display. The operator may then choose to call his authorized

Sea-Doo dealer to pass on the fault code. The dealer will then advise the operator on the steps to take to solve the problem, or to stop using the watercraft and to bring it in to the dealer for repairs.

Displaying Fault Codes

Press the MODE button repeatedly until the FAULT CODE function is visible in the multifunction display.

Press the SET or the UP or DOWN button to enter the function and display the first fault code, then press the UP or DOWN button repeatedly to display each subsequent code.

NOTE: When the last fault code has been displayed and the button is pressed again, the system loops back to the first fault code displayed, and all fault codes can again be displayed. If there was one active fault code when entering the FAULT CODE mode, and it becomes occurred (no longer active), a NO ACTIVE FAULT CODE message will scroll in the display.

To exit the FAULT CODE display function, the MODE or SET button must be pressed once. There is no time out on this function.

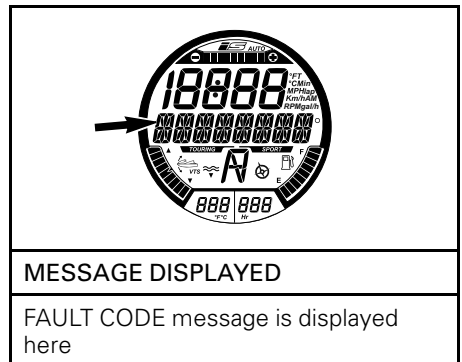

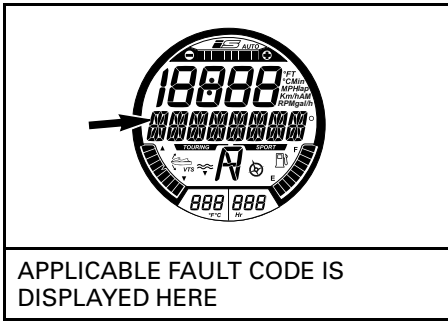







Indicator Lights and Message Display Information

The indicator lights (pilot lamps) and messages displayed in the information center will inform you of a particular condition or if an anomaly occurs.

For information on usual indicator lights, refer to *INFORMATION CENTER (GAUGE)*.

PILOT LAMPS (ON)	MESSAGE DISPLAY	DESCRIPTION
	LOW or HIGH BATTERY VOLTAGE	Low/high battery voltage
	HIGH TEMPERATURE	Engine or exhaust system overheating
	CHECK ENGINE or LIMP HOME MODE	Check engine (minor fault req. maint.) or LIMP HOME MODE (major eng. fault)
	LOW OIL PRESSURE	Low oil pressure
	IBR MODULE ERROR	Light is steady with a buzzer and a check engine light: iBR system fault (refer to an authorized Sea-Doo dealer)
	–	Light is flashing: iBR system fault (refer to an authorized Sea-Doo dealer)
	–	Light is steady with no buzzer: iBR system still functional but needs to be inspected by an authorized Sea-Doo dealer
	–	OTAS system fault

MESSAGE DISPLAY INFORMATION	
RIGHT KEYPAD ERROR	Gauge control button malfunction
LOW OIL PRESSURE	Engine low oil pressure detected
HIGH EXHAUST TEMPERATURE	High exhaust temperature detected
HIGH TEMPERATURE	High engine temperature detected
CHECK ENGINE	Engine system malfunction or maintenance required
HIGH BATTERY VOLTAGE	High battery voltage detected
LOW BATTERY VOLTAGE	Low battery voltage detected
LIMP HOME MODE	Major fault detected, engine power limited
FUEL SENSOR DEFECTIVE	Fuel level sensor fault
WATER TEMP SENSOR DEFECTIVE	Problem in iBR, not sending water temperature info.
CALIBRATION CHECKSUM ERROR	Cluster programming corrupted
iBR MODULE ERROR	iBR system malfunction
MAINTENANCE REQUIRED	Watercraft maintenance required

NOTICE Running engine with low oil pressure may severely damage the engine.

Beeper Code Information

BEEPER CODES	DESCRIPTION
1 long beep (while installing tether cord on watercraft engine cut-off switch)	Bad D.E.S.S. system connection. Reinstall tether cord cap correctly on the engine cut-off switch.
	Wrong D.E.S.S. key. Use a tether cord that has been programmed for the watercraft.
	Defective D.E.S.S. key. Use another tether cord with programmed D.E.S.S. key.
	Defective engine cut-off switch. Refer to an authorized Sea-Doo dealer.
	Improper operation of ECM or defective wiring harness. Seek service from an authorized Sea-Doo dealer, repair shop, or person of your own choosing for maintenance, repair, or replacement. Please refer to the <i>US EPA EMISSIONS-RELATED WARRANTY</i> contained herein for information about warranty claims.
A 2 seconds beep every 15 minutes interval	Watercraft is upside down. Turn watercraft upright. Refer to <i>SPECIAL PROCEDURES</i> .
	Engine management system fault. Seek service from an authorized Sea-Doo dealer, repair shop, or person of your own choosing for maintenance, repair, or replacement. Please refer to the <i>US EPA EMISSIONS-RELATED WARRANTY</i> contained herein for information about warranty claims.
	iBR system fault. Refer to an authorized Sea-Doo dealer.
A 2 seconds beep every 5 minutes interval	Low fuel level. Refill fuel tank. If problem persists, refer to an authorized Sea-Doo dealer.
	Fuel tank level sensor or circuit malfunction. Refer to an authorized Sea-Doo dealer.

BEEPER CODES	DESCRIPTION
Continuously beeps	<p>High engine temperature coolant. See <i>ENGINE OVERHEATING</i>.</p>
	<p>High exhaust temperature. Seek service from an authorized Sea-Doo dealer, repair shop, or person of your own choosing for maintenance, repair, or replacement. Please refer to the <i>US EPA EMISSIONS-RELATED WARRANTY</i> contained herein for information about warranty claims.</p>
	<p>Low oil pressure. Turn off engine as soon as possible. Check oil level and refill. Seek service from an authorized Sea-Doo dealer, repair shop, or person of your own choosing for maintenance, repair, or replacement. Please refer to the <i>US EPA EMISSIONS-RELATED WARRANTY</i> contained herein for information about warranty claims.</p>

NOTICE If the monitoring beeper continuously sounds, stop engine as soon as possible.

***This page is
intentionally blank***

WARRANTY

BRP LIMITED WARRANTY – USA AND CANADA: 2016 SEA-DOO® PERSONAL WATERCRAFT

1. SCOPE

Bombardier Recreational Products Inc. (“BRP”)* warrants its model-year 2016 Sea-Doo personal watercraft sold by authorized BRP Dealers (as defined below) in the United States of America (“USA”) and in Canada from defects in material or workmanship for the period and under the conditions described below. This limited warranty will become null and void if: (1) the Sea-Doo personal watercraft was used for racing or any other competitive activity, at any point, even by a previous owner; or (2) the Sea-Doo personal watercraft has been altered or modified in such a way so as to adversely affect its operation, performance or durability, or has been altered or modified to change its intended use.

2. LIMITATIONS OF LIABILITY

THIS WARRANTY IS EXPRESSLY GIVEN AND ACCEPTED IN LIEU OF ANY AND ALL OTHER WARRANTIES, EXPRESSED OR IMPLIED, INCLUDING WITHOUT LIMITATION ANY WARRANTY OF MERCHANTABILITY OR FITNESS FOR A PARTICULAR PURPOSE. TO THE EXTENT THAT THEY CANNOT BE DISCLAIMED, THE IMPLIED WARRANTIES ARE LIMITED IN DURATION TO THE LIFE OF THE EXPRESS WARRANTY. INCIDENTAL AND CONSEQUENTIAL DAMAGES ARE EXCLUDED FROM COVERAGE UNDER THIS WARRANTY. SOME STATES/PROVINCES DO NOT ALLOW FOR THE DISCLAIMERS, LIMITATIONS AND EXCLUSIONS IDENTIFIED ABOVE, AS A RESULT, THEY MAY NOT APPLY TO YOU. THIS WARRANTY GIVES YOU SPECIFIC RIGHTS, AND YOU MAY ALSO HAVE OTHER LEGAL RIGHTS WHICH MAY VARY FROM STATE TO STATE, OR PROVINCE TO PROVINCE.

Neither the distributor, any BRP dealer nor any other person has been authorized to make any affirmation, representation or warranty regarding the product, other than those contained in this limited warranty, and if made, shall not be enforceable against BRP. BRP reserves the right to modify this warranty at any time, being understood that such modification will not alter the warranty conditions applicable to the products sold while this warranty is in effect.

3. EXCLUSIONS – ARE NOT WARRANTED

The following are not warranted under any circumstances:

- Normal wear and tear;
- Routine maintenance items, tune ups, adjustments;
- Damage caused by failure to provide proper maintenance and/or storage, as described in the Operator’s Guide;
- Damage resulting from removal of parts, improper repairs, service, maintenance, modifications or use of parts not manufactured or approved by BRP or resulting from repairs done by a person that is not an authorized servicing BRP dealer;
- Damage caused by abuse, abnormal use, neglect, or operation of the product in a manner inconsistent with the recommended operation described in the Operator’s Guide;
- Damage resulting from accident, submersion, fire, theft, vandalism or any act of God;

- Operation with fuels, oils or lubricants which are not suitable for use with the product (see the Operator’s Guide);
- Damage from rust, corrosion or exposure to the elements;
- Damage from cooling system or jet pump blockage by foreign material;
- Water damages caused by water ingestion;
- Damages related to gel coat finish including but not limited to cosmetic gel coat finish, blisters or fiberglass delamination caused by blisters, crazing, spider or hairline cracks; and
- Incidental or consequential damages, or damages of any kind including without limitation towing, storage, telephone, rental, taxi, inconvenience, insurance coverage, loan payments, loss of time, loss of income.

4. WARRANTY COVERAGE PERIOD

This limited warranty will be in effect from (1) the date of delivery to the first retail consumer or (2) the date the product is first put into use, whichever occurs first and for the applicable period below:

1. TWELVE (12) CONSECUTIVE MONTHS for private use owners.
2. FOUR (4) CONSECUTIVE MONTHS for commercial use owners. A personal watercraft is used commercially when it is used in connection with generating income or any work or employment during any part of the warranty period. A personal watercraft is also used commercially when, at any point during the warranty period, it has commercial tags or is licensed for commercial use. This is a minimal warranty period which can be extended by any applicable warranty promotional program, as the case may be.
3. For emission-related components; please also refer to the *US EPA EMISSION-RELATED WARRANTY* contained herein.
4. For Sea-Doo personal watercrafts produced by BRP for sale in the State of California or New York that are originally sold to a resident or subsequently warranty registered to a resident in the State of California or New York, please also refer to the applicable California and New York Emissions Control Warranty Statement contained herein.

The repair or replacement of parts or the performance of service under any applicable warranty does not extend the life of such warranty beyond its original expiration date.

5. CONDITIONS REQUIRED FOR WARRANTY COVERAGE

This limited warranty coverage is available **only** if **each** of the following conditions has been fulfilled:

- The 2016 Sea-Doo personal watercraft must be purchased as new and unused by its first owner from a BRP dealer authorized to distribute Sea-Doo personal watercraft in the country in which the sale occurred;
- The BRP specified predelivery inspection process must be completed and documented and signed by the purchaser;
- The 2016 Sea-Doo personal watercraft must have undergone proper registration by an authorized BRP dealer;

- The 2016 Sea-Doo personal watercraft must be purchased in the country in which the purchaser resides; and
- Routine maintenance outlined in the Operator's Guide must be timely performed in order to maintain warranty coverage. BRP reserves the right to make warranty coverage contingent upon proof of proper maintenance.

BRP will not honour this limited warranty to any private use owner or commercial use owner if one of the preceding conditions has not been met. Such limitations are necessary in order to allow BRP to preserve both the safety of its products, and also that of its consumers and the general public.

6. WHAT TO DO TO OBTAIN WARRANTY COVERAGE

The customer must cease using the Sea-Doo personal watercraft upon the appearance of an anomaly. The customer must notify an authorized servicing BRP dealer within three (3) days of the appearance of a defect, and provide it with reasonable access to the product and reasonable opportunity to repair it. The customer must also present to the authorized BRP dealer, proof of purchase of the product and must sign the repair/work order prior to the start of the repair in order to validate the warranty repair. All parts replaced under this limited warranty become the property of BRP.

7. WHAT BRP WILL DO

BRP's obligations under this warranty are limited to, at its sole discretion, repairing parts found defective under normal use, maintenance and service, or replacing such parts with new genuine BRP parts without charge for parts and labor, at any authorized BRP dealer during the applicable warranty coverage period under the conditions described herein. No claim of breach of warranty shall be the cause for cancellation or rescission of the sale of the Sea-Doo personal watercraft to the owner.

In the event that service is required outside of the country of original sale, the owner will bear responsibility for any additional charges due to local practices and conditions, such as, but not limited to freight, insurance, taxes, license fees, import duties, and any and all other financial charges, including those levied by governments, states, territories and their respective agencies.

BRP reserves the right to improve or modify products from time to time without assuming any obligation to modify products previously manufactured.

8. TRANSFER

If the ownership of a product is transferred during the warranty coverage period, this warranty shall also be transferred and be valid for the remaining coverage period provided that BRP is notified of such transfer of ownership in the following way:

1. The former owner contacts BRP (at the phone number provided below) or an authorized BRP dealer and gives the coordinates of the new owner; or
2. BRP or an authorized BRP dealer receives a proof that the former owner agreed to the transfer of ownership, in addition to the coordinates of the new owner.

9. CONSUMER ASSISTANCE

In the event of a controversy or a dispute in connection with this BRP limited warranty, BRP suggests that you try to resolve the issue at the dealership level. We recommend discussing the issue with the authorized BRP dealer's service manager or owner.

If the issue has not yet been resolved, please contact us:

<http://www.sea-doo.com/form/contact-us.html>

Tel.: 1-888-272-9222

* In the USA, products are distributed and serviced by BRP US Inc.
© 2015 Bombardier Recreational Products Inc. All rights reserved.
® Registered trademark of Bombardier Recreational Products Inc. or its affiliates.

US EPA EMISSION-RELATED WARRANTY

Bombardier Recreational Products Inc. ("BRP")* warrants to the ultimate purchaser and each subsequent purchaser that this new engine, including all parts of its exhaust emission control system and its evaporative emission control system, meets two conditions:

1. It is designed, built, and equipped so it conforms at the time of sale to the ultimate purchaser with the requirements of 40 CFR 1045 and 40 CFR 1060.
2. It is free from defects in materials and workmanship that may keep it from meeting the requirements of 40 CFR 1045 and 40 CFR 1060.

Where a warrantable condition exists, BRP will repair or replace, as it elects, any part or component with a defect in materials or workmanship that would increase the engine's emissions of any regulated pollutant within the stated warranty period at no cost to the owner, including expenses related to diagnosing and repairing or replacing emission-related parts. All defective parts replaced under this warranty become the property of BRP.

For all emission-related warranty claims, BRP is limiting the diagnosis and repair of emission-related parts to the authorized Sea-Doo dealers, unless for emergency repairs as required by item 2 of the following list.

As a certifying manufacturer, BRP will not deny emission-related warranty claims based on any of the following:

1. Maintenance or other service BRP or BRP's authorized facilities performed.
2. Engine/equipment repair work that an operator performed to correct an unsafe, emergency condition attributable to BRP as long as the operator tries to restore the engine/equipment to its proper configuration as soon as possible.
3. Any action or inaction by the operator unrelated to the warranty claim.
4. Maintenance that was performed more frequently than BRP specify.
5. Anything that is BRP fault or responsibility.
6. The use of any fuel that is commonly available where the equipment operates unless BRP written maintenance instructions state that this fuel would harm the equipment's emission control system and operators can readily find the proper fuel. See maintenance information section and fuel requirements of fueling section.

Emission-Related Warranty Period

The emission-related warranty is valid for the following period whichever comes first:

	HOURS	MONTHS
Exhaust emission-related components	175	30
Evaporative emission-related components	N/A	24

Components Covered

The emission-related warranty covers all components whose failure would increase an engine's emissions of any regulated pollutant, including the following listed components:

1. For exhaust emissions, emission-related components include any engine parts related to the following systems:
 - Air-induction system
 - Fuel system
 - Ignition system
 - Exhaust gas recirculation systems
2. The following parts are also considered emission-related components for exhaust emissions:
 - Aftertreatment devices
 - Crankcase ventilation valves
 - Sensors
 - Electronic control units
3. The following parts are considered emission-related components for evaporative emissions:
 - Fuel tank
 - Fuel cap
 - Fuel line
 - Fuel line fittings
 - Clamps*
 - Pressure relief valves*
 - Control valves*
 - Control solenoids*
 - Electronic controls*
 - Vacuum control diaphragms*
 - Control cables*
 - Control linkages*
 - Purge valves
 - Vapor hoses
 - Liquid/vapor separator
 - Carbon canister
 - Canister mounting brackets
 - Carburetor purge port connector
4. Emission-related components also include any other part whose only purpose is to reduce emissions or whose failure will increase emissions without significantly degrading engine/equipment performance.

*As related to the evaporative emission control system

Limited Applicability

As a certifying manufacturer, BRP may deny emission-related warranty claims for failures that have been caused by the owner's or operator's improper maintenance or use, by accidents for which the manufacturer has no responsibility, or by acts of God. For example, an emission-related warranty claim need not be honored for failures that have been directly caused by the operator's abuse of the engine/equipment or the operator's use of the engine/equipment in a manner for which it was not designed and are not attributable to the manufacturer in any way.

* In the USA, products are distributed and serviced by BRP US Inc.

CALIFORNIA AND NEW YORK EMISSION CONTROL WARRANTY STATEMENT FOR MODEL YEAR 2016 SEA-DOO® PERSONAL WATERCRAFT

For California and New York, your 2016 Sea-Doo personal watercraft has a special environmental label required by the California Air Resources Board. The label has 1, 2, 3 or 4 stars. A hangtag, provided with your personal watercraft, describes the meaning of the star rating system.

The Star Label Means Cleaner Marine Engines

The Symbol for Cleaner Marine Engines:



F18L3CQ

Cleaner Air and Water

For a healthier lifestyle and environment.

Better Fuel Economy

Burns up to 30 - 40 percent less gas and oil than conventional carbureted two-stroke engines saving money and resources.

Longer Emission Warranty

Protects consumer for worry free operation.

One Star – Low Emission

The one-star label identifies personal watercraft, outboard, stern drive and inboard engines that meet the Air Resources Board's Personal Watercraft and Outboard marine engine 2001 exhaust emission standards. Engines meeting these standards have 75% lower emissions than conventional carbureted two-stroke engines. These engines are equivalent to the U.S. EPA's 2006 standards for marine engines.

Two Stars – Very Low Emission

The two-star label identifies personal watercraft, outboard, stern drive and inboard engines that meet the Air Resources Board's Personal Watercraft and Outboard marine engine 2004 exhaust emission standards. Engines meeting these standards have 20% lower emissions than One Star - Low-Emission engines.

Three Stars – Ultra Low Emission

The three-star label identifies engines that meet the Air Resources Board's Personal Watercraft and Outboard marine engine 2008 exhaust emission standards or the Stern drive and Inboard marine engine 2003 exhaust emission standards. Engines meeting these standards have 65% lower emissions than One Star – Low Emission engines.

Four Stars – Super Ultra Low Emission

The four-star label identifies engines that meet the Air Resources Board's Stern-drive and Inboard marine engine 2012 exhaust emission standards. Personal Watercraft and Outboard marine engines may also comply with these standards. Engines meeting these standards have 90% lower emissions than One Star – Low Emission engines.

For more information: Cleaner Watercraft – Get the Facts
1 800 END-SMOG
www.arb.ca.gov

Your Emission Control Warranty Rights and Obligations

The California Air Resources Board, the New York State Department of Environmental Conservation and Bombardier Recreational Products Inc. ("BRP") are pleased to explain the emission control system warranty on your Model Year 2016 Sea-Doo personal watercraft. In California, new personal watercraft engines must be designed, built and equipped to meet the State's stringent anti-smog standards. BRP must warrant the emission control system on your personal watercraft engine for the period of time listed below provided there has been no abuse, neglect or improper maintenance of your personal watercraft engine.

Your emission control system may include parts such as the fuel injection system, the ignition system and catalytic converter. Also included may be hoses, belts, connectors and other emission related assemblies.

Where a warrantable condition exists, BRP will repair your personal watercraft engine at no cost to you including diagnosis, parts and labor provided that such work is performed by an authorized BRP dealer.

Manufacturer's Limited Warranty Coverage

This emission limited warranty covers Model Year 2016 Sea-Doo personal watercrafts certified and produced by BRP for sale in California or New York, that are originally sold in California or New York to a California or New York resident or subsequently warranty registered to a California or New York resident. The BRP limited warranty conditions for Sea-Doo personal watercrafts are still applicable to these models with the necessary modifications. Select emission control parts of your 2016 Sea-Doo personal watercrafts are warranted from the date of delivery to the first retail consumer for a period of 4 years, or for 250 hours of use, whichever occurs first. However, warranty coverage based on the hourly period is only permitted for personal watercraft equipped with the appropriate hour meters or their equivalent. If any emission-related part on your engine is defective under warranty, the part will be repaired or replaced by BRP.

Parts covered for a Model Year 2016 Sea-Doo® personal watercraft:

Idle bypass valve	Air intake adapter
Throttle position sensor	Spark plugs
Intake manifold air pressure sensor	Ignition coils
Intake manifold air temperature sensor	Air box
Engine temperature sensor	Intake and exhaust valve and seals
Knock sensor	Intake manifold
Engine control module ECM	Crankcase ventilation valve
Throttle body	Throttle body seal
Fuel rail	Intake manifold seal
Fuel injectors	Wire harness and connectors
Fuel pressure regulator	Fuel filter
Fuel pump	Supercharger

The emission warranty covers damage to other engine components that is caused by the failure of a warranted part. The BRP Operator's Guide provided contains written instructions for the proper maintenance and use of your personal watercraft. All emission warranty parts are warranted by BRP for the entire warranty period of the personal watercraft, unless the part is scheduled for replacement as required maintenance in the Operator's Guide.

Emission warranty parts that are scheduled for replacement, as required maintenance, are warranted by BRP for the period of time before the first scheduled replacement date for that part. Emission warranty parts that are scheduled for regular inspection, but not regular replacement, are warranted by BRP for the entire warranty period of the personal watercraft. Any emission warranty part repaired or replaced under the terms of this warranty statement is warranted by BRP for the remainder of the warranty period of the original part. All parts replaced under this limited warranty become the property of BRP.

Maintenance receipts and records should be transferred to each subsequent owner of the personal watercraft.

Owner's Warranty Responsibilities

As the owner of a 2016 Sea-Doo personal watercraft, you are responsible for the performance of the required maintenance listed in your Operator's Guide. BRP recommends that you retain all receipts covering maintenance of your personal watercraft engine, but BRP cannot deny warranty solely for the lack of receipts or your failure to ensure the performance of all scheduled maintenance.

As the owner of a Sea-Doo® personal watercraft, you should however be aware that BRP may deny you warranty coverage if your engine(s) or a part has failed due to abuse, neglect, improper maintenance or unapproved modifications.

You are responsible for presenting your engine to an authorized BRP Dealer as soon as a problem exists. The warranty repairs will be completed in a reasonable amount of time, not to exceed 30 days.

If you have any questions regarding your warranty rights and responsibilities or for the name and location of the nearest authorized BRP Dealer you should contact the Customer Assistance Center at 1 715 848-4957.

BRP INTERNATIONAL LIMITED WARRANTY: 2016 SEA-DOO® PERSONAL WATERCRAFT

1. SCOPE OF THE LIMITED WARRANTY

Bombardier Recreational Products Inc. ("BRP")* warrants its 2016 SEA-DOO PERSONAL WATERCRAFTS ("personal watercraft") sold by distributors or dealers authorized by BRP to distribute Sea-Doo Personal watercrafts ("Sea-Doo Distributor/Dealer") outside of the fifty United States, Canada, member states of the European Economic Area (which is comprised of the member states of the European Union plus Norway, Iceland and Liechtenstein) ("EEA"), member states of the Commonwealth of the Independent States (including Ukraine and Turkmenistan) ("CIS") and Turkey, from defects in material or workmanship for the period and under the conditions described below.

All genuine BRP personal watercraft parts and accessories, installed by an authorized Sea-Doo Distributor/Dealer at the time of delivery of the 2016 Sea-Doo personal watercraft, carry the same warranty as that of the personal watercraft.

This limited warranty will become null and void if: (1) the personal watercraft was used for racing or any other competitive activity, at any point, even by a previous owner; or (2) the personal watercraft has been altered or modified in such a way so as to adversely affect its operation, performance or durability or (3) the personal watercraft has been altered or modified to change its intended use.

2. LIMITATIONS OF LIABILITY

TO THE EXTENT PERMITTED BY LAW, THIS WARRANTY IS EXPRESSLY GIVEN AND ACCEPTED IN LIEU OF ANY AND ALL OTHER WARRANTIES, EXPRESSED OR IMPLIED, INCLUDING WITHOUT LIMITATION ANY WARRANTY OF MERCHANTABILITY OR FITNESS FOR A PARTICULAR PURPOSE. TO THE EXTENT THAT THEY CANNOT BE DISCLAIMED, THE IMPLIED WARRANTIES ARE LIMITED IN DURATION TO THE LIFE OF THE EXPRESS WARRANTY. INCIDENTAL AND CONSEQUENTIAL DAMAGES ARE EXCLUDED FROM COVERAGE UNDER THIS WARRANTY. SOME JURISDICTIONS DO NOT ALLOW FOR THE DISCLAIMERS, LIMITATIONS AND EXCLUSIONS IDENTIFIED ABOVE, AS A RESULT, THEY MAY NOT APPLY TO YOU. THIS WARRANTY GIVES YOU SPECIFIC RIGHTS AND YOU MAY ALSO HAVE OTHER LEGAL RIGHTS WHICH MAY VARY FROM COUNTRY TO COUNTRY. (FOR PRODUCTS PURCHASED IN AUSTRALIA SEE CLAUSE 4 BELOW).

Neither the Sea-Doo Distributor/Dealer nor any other person has been authorized to make any affirmation, representation or warranty regarding the product, other than those contained in this limited warranty, and if made, shall not be enforceable against BRP.

BRP reserves the right to modify this warranty at any time, being understood that such modification will not alter the warranty conditions applicable to the products sold while this warranty is in effect.

3. EXCLUSIONS – ARE NOT WARRANTED

The following are not warranted under this limited warranty under any circumstances:

- Replacement of parts due to normal wear and tear;

- Routine maintenance parts and services, including but not limited to tune ups, adjustments, oil, lubricant and coolant changes, spark plug replacement, water pumps and the like;
- Damage caused by negligence or failure to provide proper maintenance and/or storage, as described in the Operator's Guide;
- Damage resulting from removal of parts, improper repairs, service, maintenance, modification or use of parts or accessories not manufactured or approved by BRP which in its reasonable judgment are either incompatible with the product or adversely affect its operation, performance and durability, or resulting from repairs done by a person that is not an authorized servicing Sea-Doo Distributor/Dealer;
- Damage caused by abuse, misuse, abnormal use, neglect, racing, improper operation or operation of the product in a manner inconsistent with the recommended operation described in the Operator's Guide;
- Damage resulting from external damage, accident, submersion, fire, foreign object or water ingestion, theft, vandalism or any act of God;
- Operation with fuels, oils or lubricants which are not suitable for use with the product (see the Operator's Guide);
- Damage resulting from rust, corrosion or exposure to the elements;
- Damages from cooling system or jet pump blockage by foreign material;
- Damages to gel coat finish including but not limited to cosmetic gel coat finish defects, blisters, starring, crazing and fiberglass delamination caused by blisters, crazing, spider or hairline cracks; and
- Incidental or consequential damages, or damages of any kind including without limitation towing, storage, transportation expenses, telephone, rental, taxi, inconvenience, insurance coverage, loan payments, loss of time, loss of income or time missed for downtime experience due to service work.

4. WARRANTY COVERAGE PERIOD

This limited warranty will be in effect from (1) the date of delivery to the first retail consumer or (2) the date the product is first put into use, whichever occurs first and for a period of:

1. TWELVE (12) CONSECUTIVE MONTHS for private, recreational use,
2. FOUR (4) CONSECUTIVE MONTHS for commercial use,
This is a minimal warranty period which can be extended by any applicable warranty promotional program, as the case may be. A personal watercraft is used commercially when it is used in connection with generating income or any work or employment during any part of the warranty period. A personal watercraft is also used commercially when, at any point during the warranty period, it has commercial tags or is licensed for commercial use.

The repair or replacement of parts or the performance of service under this warranty does not extend the life of this warranty beyond its original expiration date.

Note that the duration and any other modalities of the warranty coverage are subject to the applicable national or local legislation in the customer's country.

FOR PRODUCTS SOLD IN AUSTRALIA ONLY

Nothing in these Warranty terms and conditions should be taken to exclude, restrict or modify the application of any condition, warranty, guarantee, right or remedy conferred or implied under the Competition and Consumer Act 2010 (Cth), including the Australian Consumer Law or any other law, where to do so would contravene that law, or cause any part of these terms and conditions to be void. The benefits given to you under this limited warranty are in addition to other rights and remedies that you have under Australian law.

Our goods come with guarantees that cannot be excluded under the Australian Consumer Law. You are entitled to a replacement or refund for a major failure and for compensation for any other reasonably foreseeable loss or damage. You are also entitled to have the goods repaired or replaced if the goods fail to be of acceptable quality and the failure does not amount to a major failure.

5. CONDITIONS TO HAVE WARRANTY COVERAGE

This warranty coverage is available **only** if **each** of the following conditions has been fulfilled:

- The 2016 Sea-Doo personal watercraft must be purchased as new and unused by its first owner from a Sea-Doo Distributor/Dealer authorized to distribute Sea-Doo personal watercrafts in the country in which the sale occurred;
- The BRP specified pre-delivery inspection process must be completed and documented;
- The 2016 Sea-Doo personal watercraft must have undergone proper registration by an authorized Sea-Doo Distributor/Dealer;
- The 2016 Sea-Doo personal watercraft must have been purchased in the country or union of countries in which the purchaser resides.
- Routine maintenance outlined in the Operator's Guide must be timely performed in order to maintain warranty coverage. BRP reserves the right to make warranty coverage contingent upon proof of proper maintenance.

BRP will not honor this limited warranty to any private use owner or commercial use owner if one of the preceding conditions has not been met. Such limitations are necessary in order to allow BRP to preserve both the safety of its products, and also that of its consumers and the general public.

6. WHAT TO DO TO OBTAIN WARRANTY COVERAGE UNDER THIS WARRANTY

The customer must cease using the Sea-Doo personal watercraft upon the appearance of an anomaly. The customer must notify a servicing Sea-Doo Distributor/Dealer within two (2) days of the appearance of a defect, and provide it with reasonable access to the product and reasonable opportunity to repair it. The customer must also present to the authorized Sea-Doo Distributor/Dealer, proof of purchase of the product and must sign the repair/work order prior to starting the repair in order to validate the warranty repair. All parts replaced under this limited warranty become the property of BRP.

Note that the notification period is subject to the applicable national or local legislation in customer's country.

7. WHAT BRP WILL DO

To the extent permitted by law, BRP's obligations under this warranty are limited to, at its sole discretion, repairing parts found defective under normal use, maintenance and service, or replacing such parts with new genuine BRP parts without charge for parts and labor, at any authorized Sea-Doo Distributor/Dealer during the warranty coverage period under the conditions described herein. BRP's responsibility is limited to making the required repairs or replacements of parts. No claim of breach of warranty shall be cause for cancellation or rescission of the sale of the Sea-Doo personal watercraft to the owner. You may have other legal rights which may vary from country to country.

In the event that service is required outside of the country of original sale, the owner will bear responsibility for any additional charges due to local practices and conditions, such as, but not limited to, freight, insurance, taxes, license fees, import duties, and any and all other financial charges, including those levied by governments, states, territories and their respective agencies.

BRP reserves the right to improve or modify products from time to time without assuming any obligation to modify products previously manufactured.

8. TRANSFER

If the ownership of a product is transferred during the warranty coverage period, this limited warranty, subject to its terms and conditions, shall also be transferred and be valid for the remaining coverage period provided BRP or an authorized Sea-Doo Distributor/Dealer receives a proof that the former owner agreed to the transfer of ownership, in addition to the coordinates of the new owner.

9. CONSUMER ASSISTANCE

1. In the event of a controversy or a dispute in connection with this limited warranty, BRP suggests that you try to resolve the issue at the Sea-Doo Distributor/Dealer level. We recommend discussing the issue with the authorized Sea-Doo Distributor/Dealer's service manager or owner.
2. If further assistance is required, the Sea-Doo Distributor/Dealer service department should be contacted in order to resolve the matter.
3. If the matter still remains unresolved then contact BRP by writing at the address listed below.

For countries within Middle East and Africa, please contact our European office:

BRP EUROPE N.V.

Consumer Assistance Center
Skaldenstraat 125
9042 Gent
Belgium
Tel.: +32 9 218 26 00

For all other countries, please contact your local Sea-Doo Distributor/Dealer (visit our website at www.brp.com for contact information), or contact our North American office at:

BOMBARDIER RECREATIONAL PRODUCTS INC.

Consumer Assistance Center
75 J.-A. Bombardier Street
Sherbrooke QC J1L 1W3
Tel.: +1 819 566-3366

* For the territory covered by this limited warranty, products are distributed and serviced by Bombardier Recreational Products Inc. or its affiliates.
© 2015 Bombardier Recreational Products Inc. All rights reserved.
® Registered trademark of Bombardier Recreational Products Inc.

BRP LIMITED WARRANTY FOR THE EUROPEAN ECONOMIC AREA, THE COMMONWEALTH OF THE INDEPENDENT STATES, TURKEY: 2016 SEA-DOO® PERSONAL WATERCRAFT

1. SCOPE OF THE LIMITED WARRANTY

Bombardier Recreational Products Inc. ("BRP")* warrants its 2016 SEA-DOO PERSONAL WATERCRAFT ("personal watercraft") sold by distributors or dealers authorized by BRP to distribute Sea-Doo personal watercrafts ("Sea-Doo Distributor/Dealer") in member states of the European Economic Area (which is comprised of the member states of the European Union plus Norway, Iceland and Liechtenstein) ("EEA"), in member states of the Commonwealth of the Independent States (including Ukraine and Turkmenistan) ("CIS") and Turkey from defects in material or workmanship for the period and under the conditions described below.

All genuine BRP personal watercraft parts and accessories, installed by an authorized Sea-Doo Distributors/Dealers at the time of delivery of the 2016 Sea-Doo personal watercraft carry the same warranty as that of the personal watercraft.

This limited warranty will become null and void if: (1) the personal watercraft was used for racing or any other competitive activity, at any point, even by a previous owner; or (2) the personal watercraft has been altered or modified in such a way so as to adversely affect its operation, performance or durability, or (3) the personal watercraft has been altered or modified to change its intended use.

2. LIMITATIONS OF LIABILITY

TO THE EXTENT PERMITTED BY LAW, THIS WARRANTY IS EXPRESSLY GIVEN AND ACCEPTED IN LIEU OF ANY AND ALL OTHER WARRANTIES, EXPRESSED OR IMPLIED, INCLUDING WITHOUT LIMITATION ANY WARRANTY OF MERCHANTABILITY OR FITNESS FOR A PARTICULAR PURPOSE. TO THE EXTENT THAT THEY CANNOT BE DISCLAIMED, THE IMPLIED WARRANTIES ARE LIMITED IN DURATION TO THE LIFE OF THE EXPRESS WARRANTY. INCIDENTAL AND CONSEQUENTIAL DAMAGES ARE EXCLUDED FROM COVERAGE UNDER THIS WARRANTY. SOME JURISDICTIONS DO NOT ALLOW FOR THE DISCLAIMERS, LIMITATIONS AND EXCLUSIONS IDENTIFIED ABOVE, AS A RESULT, THEY MAY NOT APPLY TO YOU. THIS WARRANTY GIVES YOU SPECIFIC RIGHTS, AND YOU MAY ALSO HAVE OTHER LEGAL RIGHTS WHICH MAY VARY FROM COUNTRY TO COUNTRY.

Neither the Sea-Doo Distributor/Dealer nor any other person has been authorized to make any affirmation, representation or warranty regarding the product, other than those contained in this limited warranty, and if made, shall not be enforceable against BRP.

BRP reserves the right to modify this warranty at any time, being understood that such modification will not alter the warranty conditions applicable to the products sold while this warranty is in effect.

3. EXCLUSIONS – ARE NOT WARRANTED

The following are not warranted under this limited warranty under any circumstances:

- Replacement of parts due to normal wear and tear;

- Routine maintenance parts and services, including but not limited to tune ups, adjustments, oil, lubricant and coolant changes, spark plug replacement, water pumps and the like;
- Damage caused by negligence or failure to provide proper maintenance and/or storage, as described in the Operator’s Guide;
- Damage resulting from removal of parts, improper repairs, service, maintenance, modification or use of parts or accessories not manufactured or approved by BRP which in its reasonable judgement are either incompatible with the product or adversely affect its operation, performance and durability, or resulting from repairs done by a person that is not an authorized servicing Sea-Doo Distributor/Dealer;
- Damage caused by abuse, misuse, abnormal use, neglect, racing, improper operation or operation of the product in a manner inconsistent with the recommended operation described in the Operator’s Guide;
- Damage resulting from external damage, accident, submersion, fire, foreign object or water ingestion, theft, vandalism or any act of God;
- Operation with fuel, oils or lubricants which are not suitable for use with the product (see the Operator’s Guide);
- Damage resulting from rust, corrosion or exposure to the elements;
- Damages from cooling system or jet pump blockage by foreign material;
- Damages to gel coat finish including but not limited to cosmetic gel coat finish defects, blisters, starrng, crazing and fiberglass delamination caused by blisters, crazing, spider or hairline cracks; and
- Incidental or consequential damages, or damages of any kind including without limitation towing, storage, transportation expenses, telephone, rental, taxi, inconvenience, insurance coverage, loan payments, loss of time, loss of income; or time missed for downtime experience due to service work.

4. WARRANTY COVERAGE PERIOD

This limited warranty will be in effect from (1) the date of delivery to the first retail consumer or (2) the date the product is first put into use, whichever occurs first and for a period of:

1. Twenty four (24) CONSECUTIVE MONTHS, for private, recreational use,
2. FOUR (4) CONSECUTIVE MONTHS for commercial use,
 A personal watercraft is used commercially when it is used in connection with generating income or any work or employment during any part of the warranty period. A personal watercraft is also used commercially when, at any point during the warranty period, it has commercial tags or is licensed for commercial use.

The repair or replacement of parts or the performance of service under this warranty does not extend the life of this warranty beyond its original expiration date.

Note that the duration and any other modalities of the warranty coverage are subject to the applicable national or local legislation in the customer's country.

5. CONDITIONS TO HAVE WARRANTY COVERAGE

This warranty coverage is available **only** if each of the following conditions has been fulfilled:

- The 2016 Sea-Doo personal watercraft must be purchased as new and unused by its first owner from a Sea-Doo Distributor/Dealer authorized to distribute Sea-Doo personal watercrafts in the country in which the sale occurred;
- The BRP specified pre-delivery inspection process must be completed and documented;
- The 2016 Sea-Doo personal watercraft must have undergone proper registration by an authorized Sea-Doo Distributor/Dealer;
- The 2016 Sea-Doo personal watercraft must be purchased within the EEA by an EEA resident, in the CIS for residents of the countries comprised in such area and in Turkey for residents of Turkey; and
- Routine maintenance outlined in the Operator's Guide must be timely performed in order to maintain warranty coverage. BRP reserves the right to make warranty coverage contingent upon proof of proper maintenance.

BRP will not honor this limited warranty to any private use owner or commercial use owner if one of the preceding conditions has not been met. Such limitations are necessary in order to allow BRP to preserve both the safety of its products, and also that of its consumers and the general public.

6. WHAT TO DO TO OBTAIN WARRANTY COVERAGE UNDER THIS WARRANTY

The customer must cease using the Sea-Doo personal watercraft upon the appearance of an anomaly. The customer must notify a servicing Sea-Doo Distributor/Dealer within two (2) months of the appearance of a defect, and provide it with reasonable access to the product and reasonable opportunity to repair it. The customer must also present to the authorized Sea-Doo Distributor/Dealer, proof of purchase of the product and must sign the repair/work order prior to starting the repair in order to validate the warranty repair. All parts replaced under this limited warranty become the property of BRP.

Note that the notification period is subject to the applicable national or local legislation in customer's country.

7. WHAT BRP WILL DO

To the extent permitted by law, BRP's obligations under this warranty are limited to, at its sole discretion, repairing parts found defective under normal use, maintenance and service, or replacing such parts with new genuine Sea-Doo parts without charge for parts and labor, at any authorized Sea-Doo Distributor/Dealer during the warranty coverage period under the conditions described herein. BRP's responsibility is limited to making the required repairs or replacements of parts. No claim of breach of warranty shall be cause for cancellation or rescission of the sale of the Sea-Doo personal watercraft to the owner. You may have other legal rights which may vary from country to country.

In the event that service is required outside of the country of original sale, or for EEA residents, if service is required outside of the EEA, for CIS residents, if service is required outside of the CIS, the owner will bear responsibility for any additional charges due to local practices and conditions, such as, but not limited

to, freight, insurance, taxes, license fees, import duties, and any and all other financial charges, including those levied by governments, states, territories and their respective agencies.

BRP reserves the right to improve or modify products from time to time without assuming any obligation to modify products previously manufactured.

8. TRANSFER

If the ownership of a product is transferred during the warranty coverage period, this warranty shall also be transferred and be valid for the remaining coverage period provided BRP or an authorized Sea-Doo Distributor/Dealer receives a proof that the former owner agreed to the transfer of ownership, in addition to the coordinates of the new owner.

9. CONSUMER ASSISTANCE

1. In the event of a controversy or a dispute in connection with this limited warranty, BRP suggests that you try to resolve the issue at the Sea-Doo Distributor/Dealer level. We recommend discussing the issue with the authorized Sea-Doo Distributor/Dealer's service manager or owner.
2. If further assistance is required, the Sea-Doo Distributor/Dealer service department should be contacted in order to resolve the matter.
3. If the matter still remains unresolved then contact BRP at the address listed below.

For countries within EEA, CIS or Turkey, except Scandinavian countries please contact our European office:

BRP EUROPE N.V.

Consumer Assistance Center
Skaldenstraat 125
9042 Gent
Belgium
Tel.: +32 9 218 26 00

For Scandinavian countries, please contact our Finland office:

BRP FINLAND OY

Service Department
Isoaavantie 7
FIN-96320 Rovaniemi
Finland
Tel.: +358 163 208 111

You can find your Sea-Doo Distributor/Dealer's coordinates on **www.brp.com**.

* In the EEA, products are distributed and serviced by BRP European Distribution S.A. and other affiliates or subsidiaries of BRP.

© 2015 Bombardier Recreational Products Inc. All rights reserved.

® Registered trademarks of Bombardier Recreational Products Inc.

ADDITIONAL TERMS AND CONDITIONS FOR FRANCE ONLY

The following terms and conditions are applicable to products sold in France only:

The seller shall deliver goods that are complying with the contract and shall be responsible for defects existing upon delivery. The seller shall also be responsible for defects resulting from packaging, assembling instructions or the installation when it is its responsibility per the contract or if accomplished under its responsibility. To be compliant with the contract, the good shall:

1. Be fit for normal use for goods similar thereto and, if applicable:
 - Correspond to the description provided by the seller and have the qualities presented to the buyer through sample or model;
 - Have the qualities that a buyer may legitimately expect considering the public declarations of the seller, the manufacturer of its representative, including in advertising or labeling; or
2. Have the characteristics mutually agreed upon as between the parties or be fit for the specific use intended by the buyer and brought to the attention of the seller and which accepted.

The action for failure to comply is prescribed after two years after delivery of the goods. The seller is responsible for the warranty for hidden defects of the good sold if such hidden defects are rendering the good unfit for the intended use, or if they diminish its use in such a way that the buyer would not have acquired the good or would have given a lesser price, had he known. The action for such hidden defects shall be taken by the buyer within 2 years of the discovery of the defect.

CUSTOMER INFORMATION

PRIVACY INFORMATION

BRP wishes to inform you that your coordinates will be used for safety and warranty related purposes. Furthermore, BRP and its affiliates may use its customer list to distribute marketing and promotional information about BRP and related products.

To exercise your right to consult or correct your data, or to be removed from the addressee-list for direct marketing, please contact BRP.

By E-mail: **privacyofficer@brp.com**

By mail: BRP
Senior Legal Counsel-Privacy Officer
726 St-Joseph
Valcourt QC
Canada
JOE 2L0

CHANGE OF ADDRESS/OWNERSHIP

If your address has changed or if you are the new owner of the boat, be sure to notify BRP by either:

- Mailing one of the following card below;
- **North America Only:** calling at 1-888-272-9222;
- Contacting an authorized BRP distributor/dealer.

In case of change of ownership, please join a proof that the former owner agreed to the transfer.

Notifying BRP, even after the expiration of the limited warranty, is very important as it enables BRP to reach the boat owner if necessary, like when safety recalls are initiated. It is the owner's responsibility to notify BRP.

STOLEN UNITS: In the event that your boat is stolen, you should notify your area's distributor warranty department of such. We will ask you to provide your name, address, phone number, Hull Identification Number and date it was stolen.

North America

BOMBARDIER RECREATIONAL PRODUCTS INC.

Warranty Department
75 J.-A. Bombardier Street
Sherbrooke, QC J1L 1W3
Canada

Scandinavian countries

BRP FINLAND OY

Service Department
Isoaavantie 7
FIN-96320 Rovaniemi
Finland

Other countries in the world

BRP EUROPEAN DISTRIBUTION

Avenue d'Ouchy 4-6
1006 Lausanne
Switzerland

***This page is
intentionally blank***

CHANGE OF ADDRESS

CHANGE OF OWNERSHIP



VEHICLE IDENTIFICATION NUMBER

Model Number

Vehicle Identification Number (V.I.N.)

OLD ADDRESS
OR PREVIOUS OWNER:

NAME

NO. STREET APT

CITY STATE/PROVINCE ZIP/POSTAL CODE

COUNTRY TELEPHONE

NEW ADDRESS
OR NEW OWNER:

NAME

NO. STREET APT

CITY STATE/PROVINCE ZIP/POSTAL CODE

COUNTRY TELEPHONE

E-MAIL ADDRESS

V00A2F

CHANGE OF ADDRESS

CHANGE OF OWNERSHIP



VEHICLE IDENTIFICATION NUMBER

Model Number

Vehicle Identification Number (V.I.N.)

OLD ADDRESS
OR PREVIOUS OWNER:

NAME

NO. STREET APT

CITY STATE/PROVINCE ZIP/POSTAL CODE

COUNTRY TELEPHONE

NEW ADDRESS
OR NEW OWNER:

NAME

NO. STREET APT

CITY STATE/PROVINCE ZIP/POSTAL CODE

COUNTRY TELEPHONE

E-MAIL ADDRESS

V00A2F

***This page is
intentionally blank***

CHANGE OF ADDRESS CHANGE OF OWNERSHIP 

VEHICLE IDENTIFICATION NUMBER

Model Number

Vehicle Identification Number (V.I.N.)

OLD ADDRESS
OR PREVIOUS OWNER:

NAME

NO.

STREET

APT

CITY

STATE/PROVINCE

ZIP/POSTAL CODE

COUNTRY

TELEPHONE

NEW ADDRESS
OR NEW OWNER:

NAME

NO.

STREET

APT

CITY

STATE/PROVINCE

ZIP/POSTAL CODE

COUNTRY

TELEPHONE

E-MAIL ADDRESS

V00A2F

CHANGE OF ADDRESS CHANGE OF OWNERSHIP 

VEHICLE IDENTIFICATION NUMBER

Model Number

Vehicle Identification Number (V.I.N.)

OLD ADDRESS
OR PREVIOUS OWNER:

NAME

NO.

STREET

APT

CITY

STATE/PROVINCE

ZIP/POSTAL CODE

COUNTRY

TELEPHONE

NEW ADDRESS
OR NEW OWNER:

NAME

NO.

STREET

APT

CITY

STATE/PROVINCE

ZIP/POSTAL CODE

COUNTRY

TELEPHONE

E-MAIL ADDRESS

V00A2F

***This page is
intentionally blank***

NOTE

WATERCRAFT MODEL No. _____

HULL
IDENTIFICATION NUMBER (H.I.N.) _____

ENGINE
IDENTIFICATION NUMBER (E.I.N.) _____

Owner: _____
NAME

No. STREET APT

CITY STATE/PROVINCE ZIP/POSTAL CODE

Purchase Date _____
YEAR MONTH DAY

Warranty Expiry Date _____
YEAR MONTH DAY

To be completed by the authorized Sea-Doo dealer at the time of the sale.

DEALER IMPRINT AREA



219 001 690

OPERATOR'S GUIDE, RXT/ GTX / WAKE PRO SERIES / ENGLISH
GUIDE DU CONDUCTEUR, SÉRIE RXT/ GTX / WAKE PRO / ANGLAIS

FAIT AU / MADE IN CANADA

U/M:P:C

©™ AND THE BRP LOGO ARE TRADEMARKS OF BOMBARDIER RECREATIONAL PRODUCTS INC. OR ITS AFFILIATES.
©2015 BOMBARDIER RECREATIONAL PRODUCTS INC. ALL RIGHTS RESERVED. PRINTED IN CANADA.
† IS A TRADEMARK OF CASTROL LTD USED UNDER LICENSE.