

**BOMBARDIER**  
RECREATIONAL PRODUCTS



# SAFETY HANDBOOK

## 2002

704 200 086

 **WARNING**

Read this guide thoroughly.  
It contains important safety information.  
Minimum recommended operator age:  
16 years old.

Particularly important information in this *Safety Handbook* is designated by the following:



The Safety Alert Symbol means ATTENTION!



## WARNING

Identifies an instruction which if not followed, may cause injuries including the possibility of death.

**CAUTION:** Denotes an instruction which if not followed, may damage the ATV and/or components.



## WARNING

**YOUR ATV CAN BE HAZARDOUS TO OPERATE.** A collision or rollover can occur quickly, even during routine maneuvers such as turning and driving on hills or over obstacles, if you fail to take proper precautions.

For your safety, understand and follow all the warnings contained in the *Operator's Guide*, the *Safety Handbook* and the labels on your vehicle. **Failure to follow these warnings can result in SEVERE INJURY OR DEATH.**

Keep this *Operator's Guide* and the *Safety Handbook* with the vehicle at all times.



## WARNING

Disregarding any of the safety precautions and instructions contained in the *Operator's Guide*, *Safety Handbook*, *Safety Video* and on the product could cause injury... including the possibility of death!

All safety documentation should remain with the ATV at the time of sale.

The safety documents utilize the following symbols to emphasis particular information:

All content of the *Safety Handbook* should be interpreted by the reader as a warning which if not followed, may result in injury including the possibility of death.

For more information about ATV safety, call the Specialty Vehicle Institute of America (SVIA) at 1-800-887-2887 or in Canada, the Canada Safety Council (CSC) at 1-613-739-1535 ext 227.

## ATV SAFETY ALERT WARNING

**This vehicle can be hazardous to operate.** A collision or rollover can occur quickly, even during routine maneuvers such as turning and driving on hills or over obstacles if you fail to take proper precautions.

- ⚠ Locate and read the *Operator's Guide*, *Safety Handbook* and all warnings labels before operation.
- ⚠ Locate and watch the *Safety Video* before operation.
- ⚠ Severe injury including death can result from ignoring warnings or through improper use of this ATV.
- ⚠ Never operate this ATV without proper instruction.
- ⚠ Never carry passenger(s).
- ⚠ Never operate this ATV on a paved surface or on public roads.
- ⚠ Always wear the appropriate protective clothing and apparel, including an approved helmet, eye protection, boots, gloves, long sleeved shirt and pants.
- ⚠ Never consume alcohol or drugs while or before riding an ATV.
- ⚠ Never operate this ATV at excessive speeds.
- ⚠ Never attempt wheelies or jumps or other stunts.
- ⚠ Adult vehicle only.

---

# TABLE OF CONTENTS

While reading this *Safety Handbook*, remember that:

## WARNING

Indicates a potential hazard that could result in serious injury or death.

<b>SPECIAL SAFETY MESSAGES .....</b>	<b>2</b>
<b>INTRODUCTION .....</b>	<b>4</b>
<b>LOCATION OF IMPORTANT LABELS .....</b>	<i>(see Operator's Guide)</i>
<b>OPERATION WARNINGS .....</b>	<b>5</b>
<b>SAFETY WARNING .....</b>	<b>31</b>
Carrying Loads/Passenger(s) .....	32
Hauling a Trailer .....	32
<b>RIDING TIPS .....</b>	<b>33</b>
Clothing .....	34
Working with your ATV .....	35
Recreational Riding .....	35
Environment .....	35
Design Limitation .....	36
Off-Highway Operation .....	36
General Operating and Safety Precautions .....	36
Pre-Operation Check .....	<i>(see Operator's Guide)</i>
Stability .....	37
Uphill Driving .....	39
Downhill Driving .....	39
Side Hilling .....	39
Drop-Offs .....	39
Riding Techniques .....	40

---

# SPECIAL SAFETY MESSAGES

## AN ATV IS NOT A TOY AND CAN BE HAZARDOUS TO OPERATE.

An ATV handles differently from other vehicles including motorcycles and cars. A collision or rollover can occur quickly, even during routine maneuvers such as turning and driving on hills or over obstacles, if you fail to take proper precautions.

**SEVERE INJURY OR DEATH** can result if you do not follow these instructions:

- ⚠ Read the *Operator's Guide*, the *Safety Handbook* and all labels carefully and follow the operating procedures described. Watch the *Safety Video* before operation.
- ⚠ Never operate an ATV without proper instruction. **Take a training course.** Beginners should receive training from a certified instructor. Contact an authorized ATV dealer to find out about the training courses nearest you or call the Specialty Vehicle Institute of America (SVIA) at 1-800-887-2887 or in Canada, the Canada Safety Council (CSC) at 1-613-739-1535 ext 227.
- ⚠ Always follow this age recommendation: A child under 16 years old should never operate this ATV.
- ⚠ Never carry a passenger on an ATV.
- ⚠ Never operate an ATV on any paved surfaces, including sidewalks, driveways, parking lots and streets.
- ⚠ Never operate an ATV on any public street, road or highway, even a dirt or gravel one.
- ⚠ Never operate an ATV without wearing an approved helmet that fits properly. You should also wear eye protection (goggles or face shield), gloves, boots, long sleeved shirt or jacket, and long pants.
- ⚠ Never consume alcohol or drugs before or while operating this ATV.
- ⚠ Never operate at excessive speeds. Always go at a speed that is proper for the terrain, visibility, and operating conditions, and your experience.
- ⚠ Never attempt wheelies, jumps, or other stunts.
- ⚠ Always inspect your ATV each time you use it to make sure it is in safe operating condition. Always follow the inspection and maintenance procedures and schedules described in the *Operator's Guide* and the *Safety Handbook*.
- ⚠ Always keep both hands on the handlebars and both feet on the footpegs of the ATV during operation.
- ⚠ Always go slowly and be extra careful when operating on unfamiliar terrain. Always be alert to changing terrain conditions when operating the ATV.
- ⚠ Never operate on excessively rough, slippery or loose terrain until you have learned and practiced the skills necessary to control the ATV on such terrain. Always be especially cautious on these kinds of terrain.
- ⚠ Always follow proper procedures for turning as described in the *Operator's Guide* and the *Safety Handbook*. Practice turning at low speeds before attempting to turn at faster speeds. Do not turn at excessive speed.
- ⚠ Never operate the ATV on hills too steep for the ATV or for your abilities. Practice on smaller hills before attempting larger hills.

- ⚠ Always follow proper procedures for climbing hills as described in the *Operator's Guide* and the *Safety Handbook*. Check the terrain carefully before you start up any hill. Never climb hills with excessively slippery or loose surfaces. Shift your weight forward. Never open the throttle suddenly or make sudden gear changes. Never go over the top of any hill at high speed.
- ⚠ Always follow proper procedures for going down hills and for braking on hills as described in the *Operator's Guide* and the *Safety Handbook*. Check the terrain carefully before you start down any hill. Shift your weight backward. Never go down a hill at high speed. Avoid going down a hill at an angle that would cause the vehicle to lean sharply to one side. Go straight down the hill where possible.
- ⚠ Always follow proper procedures for crossing the side of a hill as described in the *Operator's Guide* and the *Safety Handbook*. Avoid hills with excessively slippery or loose surfaces. Shift your weight to the uphill side of the ATV. Never attempt to turn the ATV around on any hill until you have mastered the turning technique described in the *Operator's Guide* and the *Safety Handbook* on level ground. Avoid crossing the side of a steep hill if possible.
- ⚠ Always use proper procedures if you stall or roll backwards when climbing a hill. To avoid stalling, use proper gear and maintain a steady speed when climbing a hill. If you stall or roll backwards, follow the special procedure for braking described in the *Operator's Guide* and the *Safety Handbook*. Dismount on the uphill side or to a side if pointed straight uphill. Turn the ATV around and re-mount, following the procedure described in the *Operator's Guide* and the *Safety Handbook*.
- ⚠ Always check for obstacles before operating in a new area. Never attempt to operate over large obstacles, such as large rocks or fallen trees. Always follow proper procedures when operating over obstacles as described in the *Operator's Guide* and the *Safety Handbook*.
- ⚠ Always be careful when skidding or sliding. Learn to safely control skidding or sliding by practicing at low speeds and on level, smooth terrain. On extremely slippery surfaces, such as ice, go slowly and be very cautious in order to reduce the chance of skidding out of control.
- ⚠ Never operate an ATV in fast flowing water or in water deeper than that specified in the *Operator's Guide* and the *Safety Handbook*. Remember that wet brakes may have reduced stopping ability. Test your brakes after leaving water. If necessary, apply them several times to let friction dry out the pads.
- ⚠ Always be sure there are no obstacles or people behind you when you operate in reverse. When it is safe to proceed in reverse, go slowly.
- ⚠ Always use the size and type tires specified in the *Operator's Guide*. Always maintain proper tire pressure as described in this guide.
- ⚠ Never modify an ATV through improper installation or use of accessories.
- ⚠ Never exceed the stated load limits for an ATV. Cargo should be properly distributed and securely attached. Reduce speed and follow instructions in the *Operator's Guide* and the *Safety Handbook* for carrying cargo or pulling a trailer. Allow greater distance for braking.
- ⚠ **FOR MORE INFORMATION ABOUT ATV SAFETY**, call the Specialty Vehicle Institute of America (SVIA) at 1-800-887-2887 or in Canada, the Canada Safety Council (CSC) at 1-613-739-1535 ext 227.

---

# INTRODUCTION

Your selling dealer should have provided you with some basic information on the particular controls and features of your new ATV. Please take the time to study the *Operator's Guide* and warning labels that came with the ATV. It more completely describes what you should know about the ATV before riding it.

Whether you are a new user or an experienced rider, it is important for your personal safety that you know the controls and features of the ATV. Equally important is knowing how to properly ride.

Irrespective of your age, experience or state regulations, it is always prudent for you or any other person who may ride your ATV, to take an approved ATV safe riding course. Please check with your dealer or local authorities for availability in your area. If you are a completely new ATV rider, this should be done before your first ride. Your ATV instructor should be able to provide advice on local conditions and safe riding practices particular to the areas.

Riding conditions vary from place to place. Each is subject to weather conditions which may radically change from time to time and from season to season. Riding on sand is different than riding on snow or through forests or marshes. Each location may require a greater degree of awareness and skill. Always proceed with caution. Please do not take any unnecessary risks that could leave you stranded or possibly injured.

The contents of this *Safety Handbook* and the *Operator's Guide* provide riding information which has been proven reliable by other ATV users. They are not intended as a definitive to avoiding accidents. How you apply this information, coupled with your mental and physical condition, the particular terrain hazard and your acceptance level to risk will have an effect on your riding experience. Have fun... and ride responsibly.

The *Operator's Guide* and *Safety Handbook* has been prepared to acquaint the owner/operator of a new vehicle with the various vehicle controls, maintenance and safe operating instructions. They are indispensable for the proper use of the product.

We would be pleased to receive any comments on the content and format of the *Operator's Guide*, *Safety Handbook*, *Safety Video* or on-product warnings.

# OPERATION WARNINGS

While reading this *Safety Handbook*, remember that:

## WARNING

Indicates a potential hazard that could result in serious injury or death.

The following warnings and their format have been requested by the United States Consumer Product Safety Commission and are required to be in the *Operator's Guide* and *Safety Handbook* for all ATV's.

**NOTE:** The following illustrations are general representations only. Your model may differ.

## WARNING



V00A0AQ

### **POTENTIAL HAZARD**

Operating this ATV without proper instruction.

### **WHAT CAN HAPPEN**

The risk of an accident is greatly increased if the operator does not know how to operate the ATV properly in different situations and on different types of terrain.

### **HOW TO AVOID THE HAZARD**

Beginning and inexperienced operators should complete the certified training course offered by Bombardier Inc. They should then regularly practice the skills learned in the course and the operating techniques described in the *Operator's Guide* and the *Safety Handbook*.

For more information about the training course, contact an authorized ATV dealer or call Bombardier Inc. at 1-819-566-3366.



V00A01Q

**POTENTIAL HAZARD**

Failure to follow the age recommendations for this ATV.

**WHAT CAN HAPPEN**

Use by children of ATVs that are not recommended for their age can lead to severe injury or death of the child.

Even though a child may be within the age group for which an ATV is recommended, he or she may not have the skills, abilities, or judgment needed to operate the ATV safely and may be involved in a serious accident.

**HOW TO AVOID THE HAZARD**

No one under 16 should operate a Bombardier ATV.



**⚠ WARNING**



V00A02Q

**POTENTIAL HAZARD**

Carrying a passenger on this ATV.

**WHAT CAN HAPPEN**

Greatly reduces your ability to balance and control this ATV.

Could cause an accident, resulting in harm to you and/or your passenger.

**HOW TO AVOID THE HAZARD**

Never carry a passenger. The long seat is to allow the operator to shift position as needed during operation. It is not for carrying passengers.

## WARNING

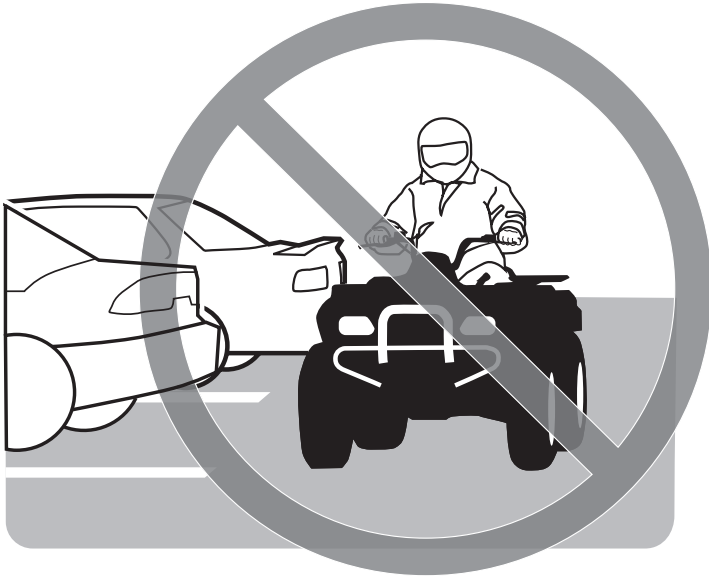

V00A03Q

### **POTENTIAL HAZARD**

Operating this ATV on paved surfaces.

### **WHAT CAN HAPPEN**

The ATV's tires are designed for off-road use only, not for use on pavement. Paved surfaces may seriously affect handling and control of the ATV, and may cause the vehicle to go out of control.

### **HOW TO AVOID THE HAZARD**

Never operate the ATV on any paved surfaces, including sidewalks, driveways, parking lots and streets.

**⚠ WARNING**



V00A04Q

**POTENTIAL HAZARD**

Operating this ATV on public streets, roads or highways.

**WHAT CAN HAPPEN**

You can collide with another vehicle.

**HOW TO AVOID THE HAZARD**

Never operate this ATV on any public street, road or highway, even a dirt or gravel one. In many states it is illegal to operate ATVs on public streets, roads and highways.

## WARNING



V00A06Q

### **POTENTIAL HAZARD**

Operating this ATV without wearing an approved motorcycle helmet, eye protection and protective clothing.

### **WHAT CAN HAPPEN**

Operating without an approved motorcycle helmet increases your chances of a severe head injury or death in the event of an accident.

Operating without eye protection can result in an accident and increases your chances of a severe injury in the event of an accident.

Operating without protective clothing increases your chances of severe injury in the event of an accident.

### **HOW TO AVOID THE HAZARD**

Always wear an approved motorcycle helmet that fits properly. You should also wear:

- eye protection (goggles or face shield)
- gloves
- boots
- long sleeved shirt or jacket
- long pants.

## WARNING



V00A07Q

### **POTENTIAL HAZARD**

Operating this ATV after consuming alcohol or drugs.

### **WHAT CAN HAPPEN**

- Could seriously affect your judgment.
- Could cause you to react more slowly.
- Could affect your balance and perception.
- Could result in an accident.

### **HOW TO AVOID THE HAZARD**

Never consume alcohol or drugs before or while driving this ATV.

## WARNING

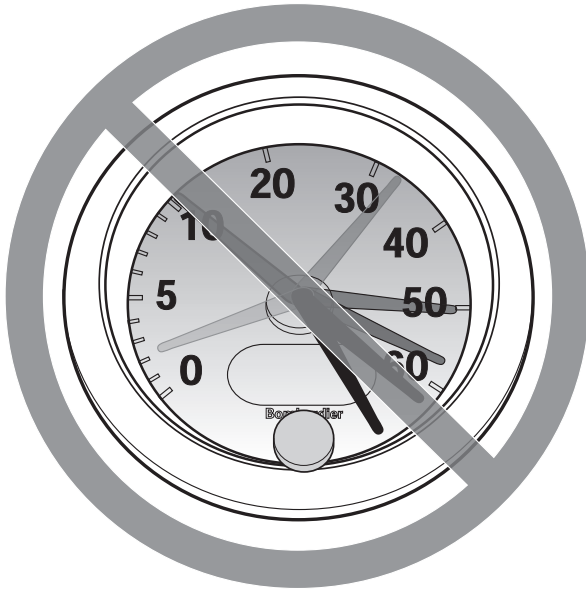

V00A08Q

### **POTENTIAL HAZARD**

Operating this ATV at excessive speeds.

### **WHAT CAN HAPPEN**

Increases your chances of losing control of the ATV, which can result in an accident.

### **HOW TO AVOID THE HAZARD**

Always travel at a speed which is proper for the terrain, visibility and operating conditions, and your experience.

**⚠ WARNING**



V00A09Q

**POTENTIAL HAZARD**

Attempting wheelies, jumps and other stunts.

**WHAT CAN HAPPEN**

Increases the chance of an accident, including an overturn.

**HOW TO AVOID THE HAZARD**

Never attempt stunts, such as wheelies or jumps. Don't try to show off.

## **WARNING**

### **POTENTIAL HAZARD**

Failure to inspect the ATV before operating.  
Failure to properly maintain the ATV.

### **WHAT CAN HAPPEN**

Increases the possibility of an accident or equipment damage.

### **HOW TO AVOID THE HAZARD**

Always inspect your ATV each time you use it to make sure the ATV is in safe operating condition.

Always follow the inspection and maintenance procedures and schedules described in the *Operator's Guide* and the *Safety Handbook*.



**⚠ WARNING**



V00A0BQ

**POTENTIAL HAZARD**

Removing hands from handlebars or feet from footpegs during operation.

**WHAT CAN HAPPEN**

Removing even one hand or foot can reduce your ability to control the ATV or could cause you to lose your balance and fall off the ATV. If you remove a foot from the footpegs, your foot or leg may come into contact with the rear wheels, which could injure you or cause an accident.

**HOW TO AVOID THE HAZARD**

Always keep both hands on the handlebars and both feet on the footpegs of your ATV during operation.

## WARNING

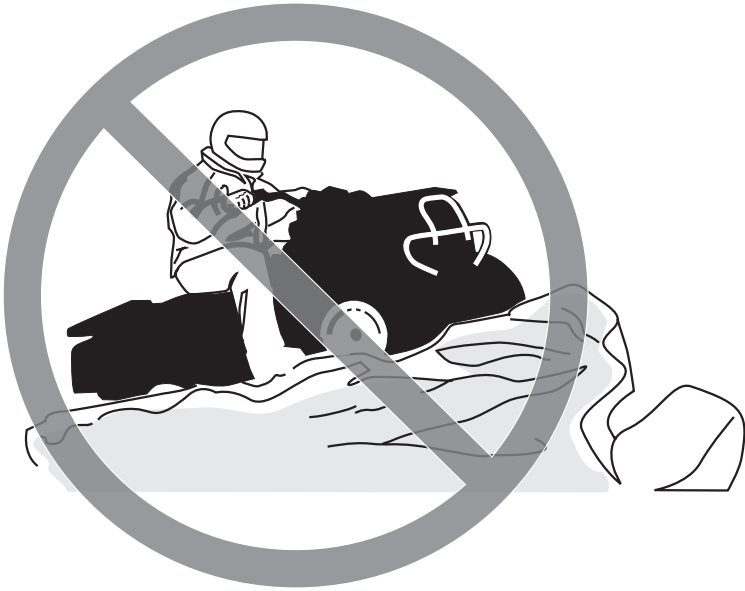

V00A0CQ

### **POTENTIAL HAZARD**

Failure to use extra care when operating this ATV on unfamiliar terrain.

### **WHAT CAN HAPPEN**

You can come upon hidden rocks, bumps, or holes, without enough time to react.

Could result in the ATV overturning or going out of control.

### **HOW TO AVOID THE HAZARD**

Go slowly and be extra careful when operating on unfamiliar terrain.

Always be alert to changing terrain conditions when operating the ATV.

## WARNING



V00A0DQ

### **POTENTIAL HAZARD**

Failure to use extra care when operating on excessively rough, slippery or loose terrain.

### **WHAT CAN HAPPEN**

Could cause loss of traction or vehicle control, which could result in an accident, including an overturn.

### **HOW TO AVOID THE HAZARD**

Do not operate on excessively rough, slippery or loose terrain until you have learned and practiced the skills necessary to control the ATV on such terrain.

Always be especially cautious on these kinds of terrain.

**⚠ WARNING**



V00A0EQ

**POTENTIAL HAZARD**

Turning improperly.

**WHAT CAN HAPPEN**

ATV could go out of control, causing a collision or overturn.

**HOW TO AVOID THE HAZARD**

Always follow proper procedures for turning as described in the *Operator's Guide* and the *Safety Handbook*. Practice turning at low speeds before attempting to turn at faster speeds.

Do not turn at excessive speed.

**⚠ WARNING**



V00A00Q

**POTENTIAL HAZARD**

Operating on excessively steep hills.

**WHAT CAN HAPPEN**

The vehicle can overturn more easily on extremely steep hills than on level surfaces or small hills.

**HOW TO AVOID THE HAZARD**

Never operate the ATV on hills too steep for the ATV or for your abilities. Practice on smaller hills before attempting larger hills.

## WARNING



V00A0FQ

### **POTENTIAL HAZARD**

Climbing hills improperly.

### **WHAT CAN HAPPEN**

Could cause loss of control or cause ATV to overturn.

### **HOW TO AVOID THE HAZARD**

Always follow proper procedures for climbing hills as described in the *Operator's Guide* and the *Safety Handbook*.

Always check the terrain carefully before you start up any hill.

Never climb hills with excessively slippery or loose surfaces.

Shift your weight forward.

Never open the throttle suddenly or make sudden gear changes. The ATV could flip over backwards.

Never go over the top of any hill at high speed. An obstacle, a sharp drop, or another vehicle or person could be on the other side of the hill.

**⚠ WARNING**



V00A0GQ

**POTENTIAL HAZARD**

Going down a hill improperly.

**WHAT CAN HAPPEN**

Could cause loss of control or cause ATV to overturn.

**HOW TO AVOID THE HAZARD**

Always follow proper procedures for going down hills as described in the *Operator's Guide* and the *Safety Handbook*.

**NOTE:** A special technique is required when braking as you go down a hill.

Always check the terrain carefully before you start down any hill.

Shift your weight backward.

Never go down a hill at high speed.

Avoid going down a hill at an angle which would cause the vehicle to lean sharply to one side. Go straight down the hill where possible.

## WARNING



V00A0HQ

### **POTENTIAL HAZARD**

Improperly crossing hills or turning on hills.

### **WHAT CAN HAPPEN**

Could cause loss of control or cause ATV to overturn.

### **HOW TO AVOID THE HAZARD**

Never attempt to turn the ATV around on any hill until you have mastered the turning technique as described in the *Operator's Guide* and the *Safety Handbook* on level ground. Be very careful when turning on any hill.

Avoid crossing the side of a steep hill if possible.

#### **When crossing the side of a hill:**

Always follow proper procedures as described in the *Operator's Guide* and the *Safety Handbook*.

Avoid hills with excessively slippery or loose surfaces.

Shift your weight to the uphill side of the ATV.



**⚠ WARNING**



V00A01Q

**POTENTIAL HAZARD**

Stalling, rolling backwards or improperly dismounting while climbing a hill.

**WHAT CAN HAPPEN**

Could result in ATV overturning.

**HOW TO AVOID THE HAZARD**

Use proper gear and maintain steady speed when climbing a hill.

**If you lose all forward speed:**

Keep weight uphill.

Apply the brakes.

Lock parking device after you are stopped.

**If you begin rolling backwards:**

Keep weight uphill.

Never apply the rear brake while rolling backwards.

Apply the front brake gradually.

When fully stopped, apply rear brake as well and lock parking device.

Dismount on uphill side, or to a side if pointed straight uphill.

Turn the ATV around and remount, following the procedure described in the *Operator's Guide* and the *Safety Handbook*.

## WARNING



V00A0JQ

### **POTENTIAL HAZARD**

Improperly operating over obstacles.

### **WHAT CAN HAPPEN**

Could cause loss of control or a collision. Could cause the ATV to overturn.

### **HOW TO AVOID THE HAZARD**

Before operating in a new area, check for obstacles.

Never attempt to ride over large obstacles, such as large rocks or fallen trees.

When you go over obstacles, always follow proper procedures as described in the *Operator's Guide* and the *Safety Handbook*.

**⚠ WARNING**



V00A0KQ

**POTENTIAL HAZARD**

Skidding or sliding improperly.

**WHAT CAN HAPPEN**

You may lose control of this ATV.

You may also regain traction unexpectedly, which may cause the ATV to overturn.

**HOW TO AVOID THE HAZARD**

Learn to safely control skidding or sliding by practicing at low speeds and on level, smooth terrain.

On extremely slippery surfaces, such as ice, go slowly and be very cautious in order to reduce the chance of skidding or sliding out of control.

## WARNING



V00A0LQ

### **POTENTIAL HAZARD**

Operating this ATV through deep or fast flowing water.

### **WHAT CAN HAPPEN**

Tires may float, causing loss of traction and loss of control, which could lead to an accident.

### **HOW TO AVOID THE HAZARD**

Never operate this ATV in fast flowing water or in water deeper than that specified in the *Operator's Guide* and the *Safety Handbook*.

Remember that wet brakes may have reduced stopping ability. Test your brakes after leaving water. If necessary, apply them several times to let friction dry out the pads.

**⚠ WARNING**



V00A0MQ

**POTENTIAL HAZARD**

Improperly operating in reverse.

**WHAT CAN HAPPEN**

You could hit an obstacle or person behind you, resulting in serious injury.

**HOW TO AVOID THE HAZARD**

When you select reverse gear, make sure there are no obstacles or people behind you. When it is safe to proceed, go slowly.

**⚠ WARNING**



V00A00Q

**POTENTIAL HAZARD**

Operating this ATV with improper tires, or with improper or uneven tire pressure.

**WHAT CAN HAPPEN**

Use of improper tires on this ATV, or operation of this ATV with improper or uneven tire pressure, may cause loss of control, and increases the risk of an accident.

**HOW TO AVOID THE HAZARD**

Always use the size and type, tires specified in the *Operator's Guide* for this vehicle.

Always maintain proper tire pressure as described in the *Operator's Guide* and the *Safety Handbook*.

**⚠ WARNING**



V00A0NQ

**POTENTIAL HAZARD**

Operating this ATV with improper modifications.

**WHAT CAN HAPPEN**

Improper installation of accessories or modification of this vehicle may cause changes in handling which in some situations could lead to an accident.

**HOW TO AVOID THE HAZARD**

Never modify this ATV through improper installation or use of accessories. All parts and accessories added to this vehicle should be genuine Bombardier or equivalent components designed for use on this ATV and should be installed and used according to instructions. If you have questions, consult an authorized Bombardier ATV dealer.

**⚠ WARNING**



V00A0PQ

**POTENTIAL HAZARD**

Overloading this ATV or carrying or towing cargo improperly.

**WHAT CAN HAPPEN**

Could cause changes in vehicle handling which could lead to an accident.

**HOW TO AVOID THE HAZARD**

Never exceed the stated load capacity for this ATV.

Cargo should be properly distributed and securely attached.

Reduce speed when carrying cargo or pulling a trailer. Allow greater distance for braking.

Always follow the instructions in the *Operator's Guide* and the *Safety Handbook* for carrying cargo or pulling a trailer.

While reading this *Safety Handbook*, remember that:

**⚠ WARNING**

Indicates a potential hazard that could result in serious injury or death.



---

## **SAFETY WARNING**

To fully appreciate the pleasures and excitement of riding an ATV, there are some basic rules and tips that you should follow. Some may be new to you while others may be common sense or obvious. Irrespective, we ask that you take a few minutes to read the *Safety Handbook* and the *Operator's Guide* completely before you operate the ATV.

Information in this *Safety Handbook* and the *Operator's Guide* is limited. It is strongly recommended that you obtain further information and training from your local authorities, ATV clubs or a recognized ATV training organization such as the Specialty Vehicle Institute of America or the Canada Safety Council.

The U.S. Consumer Product Safety Commission and all ATV manufacturers do not recommend anyone under the age of 16 to ride an ATV having an engine higher than 90 cc. For the child's safety, we strongly recommend you also follow and enforce this recommendation. You are the sole judge of a rider's capability to understand the risks and operate an ATV safely.

Persons with cognitive or physical impairments or are high risk takers have an increased exposure to overturns or collisions which may result in injury including death.

Become completely familiar with the operational controls and the general operation of the ATV before venturing into off road conditions. Practice driving in a suitable area free of hazards and feel the response of each control. Drive at low speeds. Higher speeds requires greater experience, knowledge and suitable riding conditions.

Not all ATV's are the same. Each has its own unique performance characteristics, controls and features. Each will ride and handle differently.

Never assume that the ATV will go everywhere safely. Sudden changes in terrain caused by holes, depressions, banks, softer or harder "ground" plus others, may cause the ATV to topple or become unstable. To avoid this, slow down and always observe the terrain ahead. If the ATV does begin to topple or tipover, it is usually the best advice to immediately get off... AWAY from the direction of the tipover!

## **Carrying Loads/Passenger(s)**

Any load carried on the ATV's carrying rack(s) will affect the stability and control of the ATV. For this reason, do not exceed the load limits of the ATV manufacturer. Always make sure the load is secured and cannot interfere with your proper control. Always be aware that the "load" may slide or fall off and create an accident. Avoid loads that may protrude sideways and get snagged or caught in brush or other obstacles. Avoid covering and obstructing the headlamp or taillights with the cargo. Always make sure any storage compartment latches are closed. If a removable compartment cover is removed to carry a load, make sure that the load is secure and that smaller objects cannot "fly out". Secure compartment cover to the rear rack.

All ATV's are intended for an operator only. Even with a long seat that provides unrestricted operator movement, they are not designed nor intended to carry passenger(s). Do not install passenger seats or use the racks or their location to carry passenger(s). Carrying a passenger (s) will affect the stability and your control of the ATV.

## **Hauling a Trailer**

Riding an ATV with a trailer substantially increases the risk of toppling, especially on inclined slopes. If a trailer is used behind the ATV make sure that its hitch is compatible with the one on the ATV. Make sure the trailer is horizontal with the ATV. (In some instances a special extension may have to be installed on the ATV hitch). Use security chains to secure the trailer with the ATV. The ATV may require additional stopping distance if hauling heavy loads, especially on inclined surfaces. Be careful not to skid or slide. When stopped or parked, block the ATV and trailer wheels from possible movement. Always make sure load is evenly distributed on the trailer. Apply caution when disconnecting a loaded trailer, it or its load may topple on you or others. Do not turn at high speeds.

---

## RIDING TIPS

While reading this *Safety Handbook*, remember that:

### WARNING

Indicates a potential hazard that could result in serious injury or death.

### WARNING

The pre-operation check is very important prior to operating the vehicle. Always check the proper operation of critical controls, safety features and mechanical components before starting. If not done, severe injury or death might occur.

Before using an ATV you should always:

- a) Disengage the parking device.
- b) Check the steering operation.
- c) Test throttle operation.
- d) Check brake functions.
- e) Check engine cut off switch function.
- f) Verify operation and cleanliness of headlamp and taillight.
- g) Verify fuel and oil levels.
- h) Inspect tires and wheel rims for excessive wear or damage.
- i) Check tire air pressure.
- j) Secure all cargo and storage compartments.
- k) Check drive chain adjustment (if applicable).

Proceed only if all items are satisfactory.

## Clothing

Actual weather conditions should help you decide how to dress. However, it is important that you always wear the appropriate protective clothing and apparel, including an approved helmet, eye protection, boots, gloves, long sleeved shirt and pants. Never wear loose clothing such as a scarf that may get entangled in the ATV or on tree shrubs and branches. Depending on conditions, a fog free visor or protective goggles may be required. This type of clothing will provide you protection from some of the minor hazards you may encounter on route. Sun glasses should only be worn during the daytime. Different colored lenses available for goggles or glasses help you distinguish terrain variations.

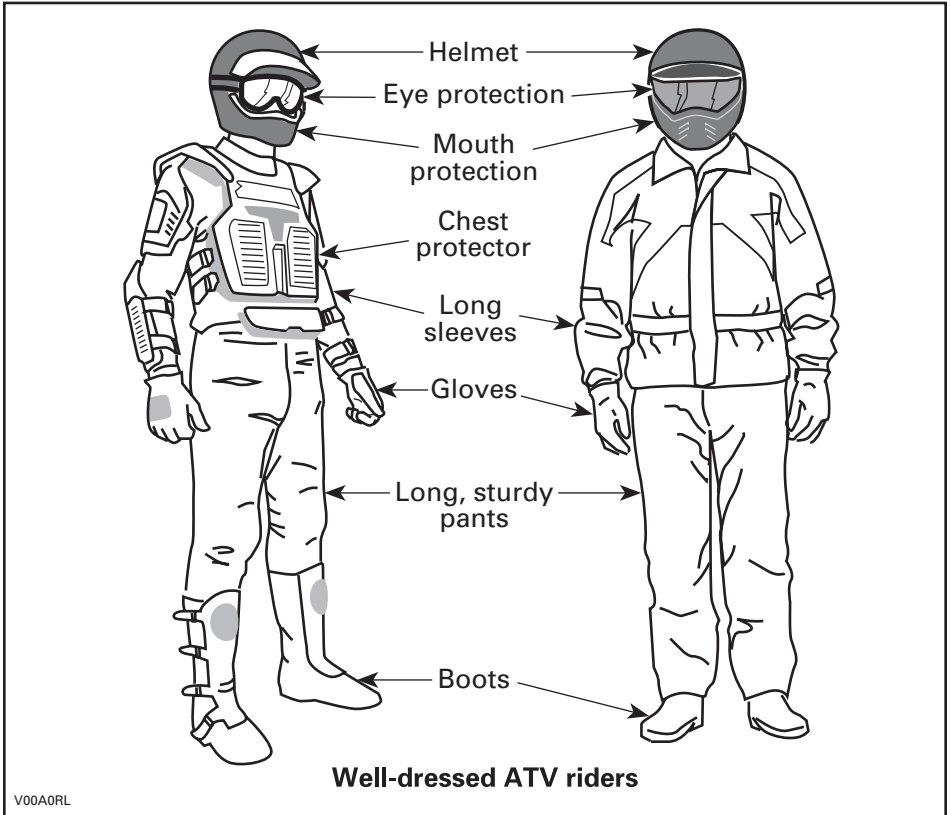

## **Working with your ATV**

Your ATV can help you perform a number of different LIGHT tasks ranging from snow removal to pulling wood or carrying cargo. A variety of accessories are available from your ATV dealer. However, always respect the load and capacities of the ATV. Overloading of the ATV can overstress the components and cause failure. To prevent possible injury, it is equally important to follow the instructions and warnings that accompany the accessory. Avoid any physical exertion through lifting or pulling of heavy loads or manpowering the ATV. (Continue to read **Recreational Riding** below).

## **Recreational Riding**

Respect the rights and limitations of others. Stay away from areas designated for other types of off road use. This includes snowmobile trails, equestrian trails, cross country ski trails, mountain bike trails etc. Never assume there are no other users on the trail. Always stay to the complete right of the trail and do not zig zag to one side of the trail then the other. Be prepared to stop or pull off to the side if another trail user appears in front of you.

Join a local ATV club. They will provide you with a map and advice or inform you where you can ride. If a club doesn't exist in your area, help start one. Group riding and club activities provide a pleasurable, social experience.

Always keep a safe distance from other riders. Your judgment of speed, terrain conditions, weather, mechanical condition of your ATV and the "trust in judgment" you have in others around you will help you make a better choice of appropriate safe distance. ATV's, like any other vehicle, cannot stop "on a dime".

Before you ride, tell someone where you are planning to travel and your expected time of return. Never consume alcohol or drugs before or while riding!

Depending on the length of your ride, carry additional tools or emergency equipment. Find out where you can get additional gasoline and oil. Be prepared for the possible conditions you may encounter. An emergency first aid kit should always be a consideration.

## **Environment**

One of the benefits of an ATV is that it can take you off the beaten path away from most communities. However, you should always respect nature and the rights of others to enjoy it. Do not ride in environmentally sensitive areas. Do not drive over crops or tree shrubs... nor cut down trees or take down fencing... nor spin your wheels and destroy the terrain. "Tread Lightly".

Chasing wildlife is in many areas illegal. Wildlife can die of exhaustion after being chased by an ATV. If you encounter animals on the trail, stop and observe quietly and with caution. It will be one of the better memories of your life.

Observe the rule... "what you take in, carry out". Do not litter. Do not start campfires unless you have permission to do so... and only then... away from dry areas. The hazards you may create on the trail may cause injury to others or yourself, even at a later date.

Respect farm lands. Always obtain the permission of the landowner before riding on private land. Respect crops, farm animals and property lines. If you come to a closed a gate, close it again after you.

Finally, do not pollute streams, lakes or rivers and do not modify the engine or muffling system, or remove any of its components.

While reading this *Safety Handbook*, remember that:

## **WARNING**

Indicates a potential hazard that could result in serious injury or death.

### **Design Limitation**

The fundamental design concept is a compromise between ruggedness which call for strength and weight, and light-footedness. Although the vehicle is exceptionally rugged for its class, it is still a light vehicle by definition and its operation must be restricted to its proper purpose.

The addition of weight to any part of the vehicle changes its gravitational stability and modifies its performance.

### **Off-Highway Operation**

The very nature of off-highway operation is dangerous. Any terrain, which has not been specially prepared to carry vehicles, presents an inherent danger where angularity, terrain substance and exact steepness are unpredictable. The terrain itself presents a continual element of danger, which must be knowingly accepted by anyone venturing over it.

An operator who takes a vehicle off-road should always exercise the utmost care in selecting the safest path and keeping close watch on the terrain ahead of him. On no account should the vehicle be operated by anyone who is not completely familiar with the driving instructions applicable to the vehicle, or should it be operated on steep or treacherous terrain.

### **General Operating and Safety Precautions**

Care, caution, experience and driving skill are the best precautions against the hazard of ATV operation.

Whenever there is the slightest doubt that the vehicle can safely negotiate an obstacle of a particular piece of terrain, always choose an alternate route.

In off-road operation, power and traction, not speed, are important. Never drive faster than visibility and your own ability to select a safe route permits.

Constantly watch the terrain ahead for sudden changes in slopes or obstacles, such as rocks or stumps, that may cause loss of stability, resulting in tip-over or roll-over.

Never operate the vehicle if the controls do not function normally.

## Stability

All vehicles have a center of gravity. This is a calculated point, normally within the structure of the vehicle, about which all the weight of the vehicle is distributed.

When center of gravity of the vehicle passes beyond an imaginary line drawn vertically from the further-most point of support of the wheels, the vehicle will tip-over or roll-over.

The following illustrations are not intended to depict actual center of gravity of the vehicle, but are provided as way of demonstrating the stability principle.

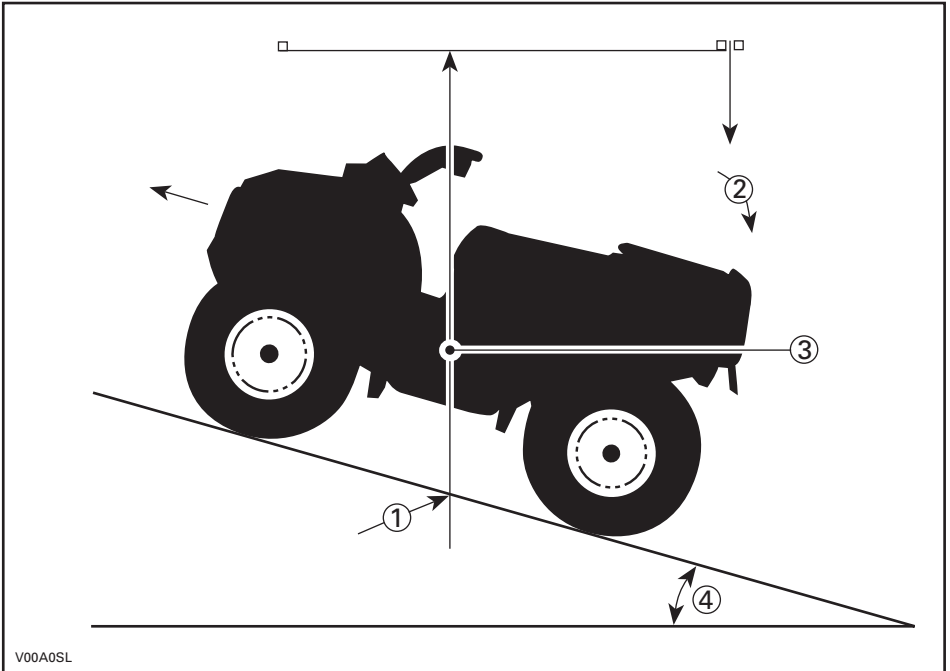

1. *Furthermost point of support*
2. *Tip-over*
3. *Center of gravity*
4. *Hill incline*

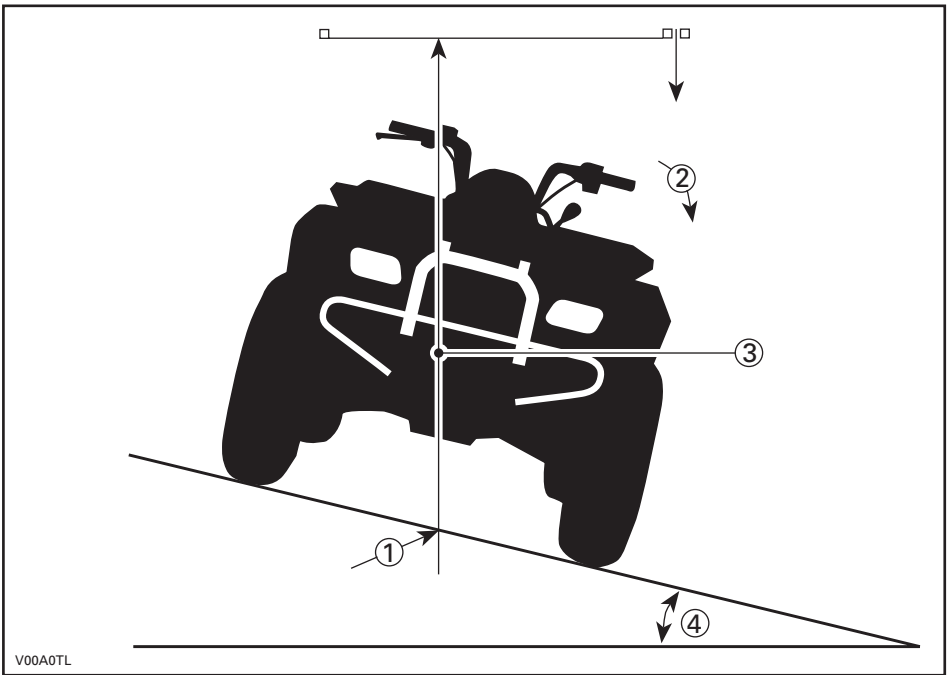

1. *Furthermost point of support*
2. *Tip-over*
3. *Center of gravity*
4. *Hill incline*

This can be likened to the action of a seesaw with the vertical line forming the pivot of the seesaw. When more weight is placed on one side rather than on the other, the seesaw will move in that direction.

While these limits can be determined with accuracy under ideal conditions, the skill and ability of the operator, the loading of the vehicle and actual terrain conditions, constantly influence and change these limits during operation of the vehicle.

Therefore, one must evaluate every situation carefully and as a separate case. Never assume that the vehicle can cross a certain part of terrain, because it has passed there before, or because the terrain appears to be within the known performance limits of the vehicle.

While reading this *Safety Handbook*, remember that:

**⚠ WARNING**

Indicates a potential hazard that could result in serious injury or death.



## **Uphill Driving**

Due to configuration, ATV's have excellent climbing ability, so much so that tip-over is possible before traction is lost. For example, its common to encounter terrain situations where the top of the hill has eroded to a point that the hill peak rises very sharply. The ATV can readily negotiate such a condition, however, in doing so, when the front of the vehicle is driven to a point that the vehicle's balance changes rearward roll over can occur.

The same situation may apply if an embedded object causes the front of the vehicle to climb more than desired. If such a situation occurs take an alternate route. Be aware of sidehilling dangers when doing so.

It is also wise to know the terrain condition on the other side of the hill or bank. All too often there exists a sharp drop-off that is impossible to negotiate or descend.

## **Downhill Driving**

As a rule, ATV's can climb slopes that are steeper than they can safely descend. Therefore, it is essential to assure that a safe route exists to descend a slope before you climb it.

Decelerating while negotiating a slippery downhill slope could "toboggan" the vehicle. Maintain steady speed and/or accelerate slightly to regain control.

## **Side Hilling**

Whenever possible, such operation should be avoided. If necessary, do so with extreme caution. Sidehilling on steep inclines could result in roll-over. In addition, slippery or unfirm surfaces could result in uncontrollable side sliding. Do not attempt to turn the vehicle downhill with the slide. Avoid all objects or depressions that will intensify the raising of one side of the vehicle higher than the other, thus causing roll-over.

## **Drop-Offs**

An ATV will "bottom-out" and usually stop if either the front or rear wheels are driven over a drop-off. If the drop is sharp or deep, the vehicle will nose dive and tip-over.

### **WARNING**

**Avoid negotiating drop-offs. Reverse and select an alternate route.**

## Riding Techniques

Riding your ATV too fast for the conditions may result in injury. Apply only enough throttle to proceed safely. Statistics show that high speed turns usually result in mishaps and injury. Always remember that an ATV is heavy! It's pure weight alone may entrap you should it fall and pin you down.

ATV's are not designed for jumping nor can they, or you, absorb the energy of high impacts such as jumping. Performing "wheelies" can cause the ATV to flip over onto you. Both practices have a high risk and should be avoided at all times.

To maintain proper control it is strongly advised that you keep your hands on the handlebar and within easy reach of all controls. The same holds true for your feet. To minimize the possibility of any leg or foot injury, keep your feet on the footpegs at all times. Do not direct your toes outwards nor place your foot out to assist turning as they can be hit or snagged by passing obstacles or may contact the wheels.

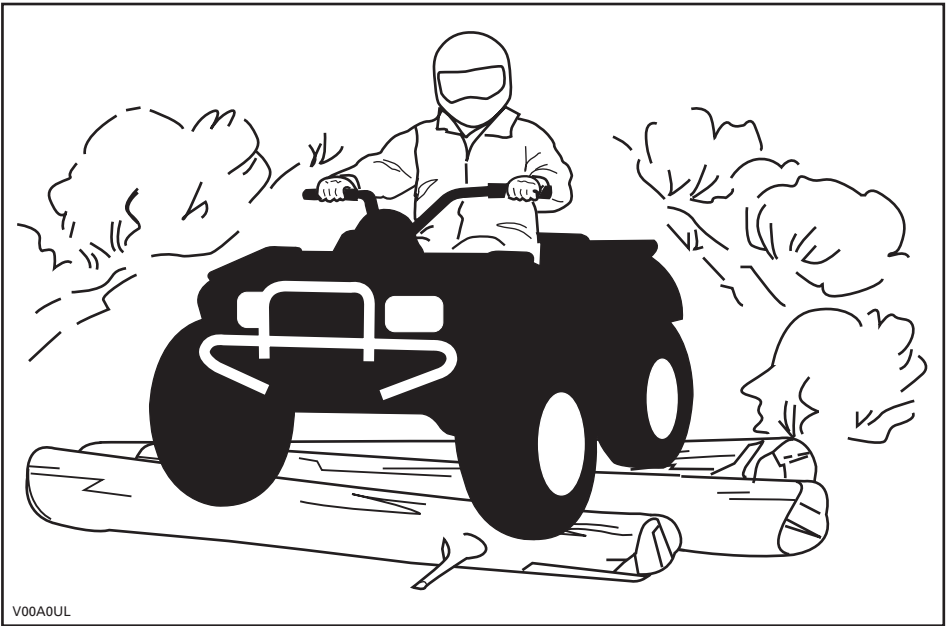

Even though there is an adequate suspensions system on an ATV there are "washboard" or rough terrain conditions that will make you feel uncomfortable and even cause back injury. "Posting" or riding in a crouched position will often be required. Slow down and allow your flexed legs to absorb impact.

An ATV is not designed for riding on roads or highways. (In most places it is an illegal practice). Riding your ATV on roads or highways could cause a collision to occur with another vehicle. ATV tires are not suited for paved road use. Pavement may seriously affect the handling and control of the ATV. Riding on roads or soft shoulders may confuse other road users, especially if your lights are on. If you have to cross a road, the lead driver should get off his ATV then observe and give directions to the other ATV riders. The last person after crossing then assists the lead driver to cross. Do not travel on sidewalks. They are designated for pedestrian use.

Water can be a unique hazard. If it is too deep the ATV may “float” and topple. Check the water depth and current before you attempt to cross any water. Water should not go above the footrest. Be wary of slippery surfaces such as rocks, grass, logs, etc., both in the water and on its banks. A loss of traction may occur. Do not attempt to enter the water at high speed. The water will act as a brake and could throw you.

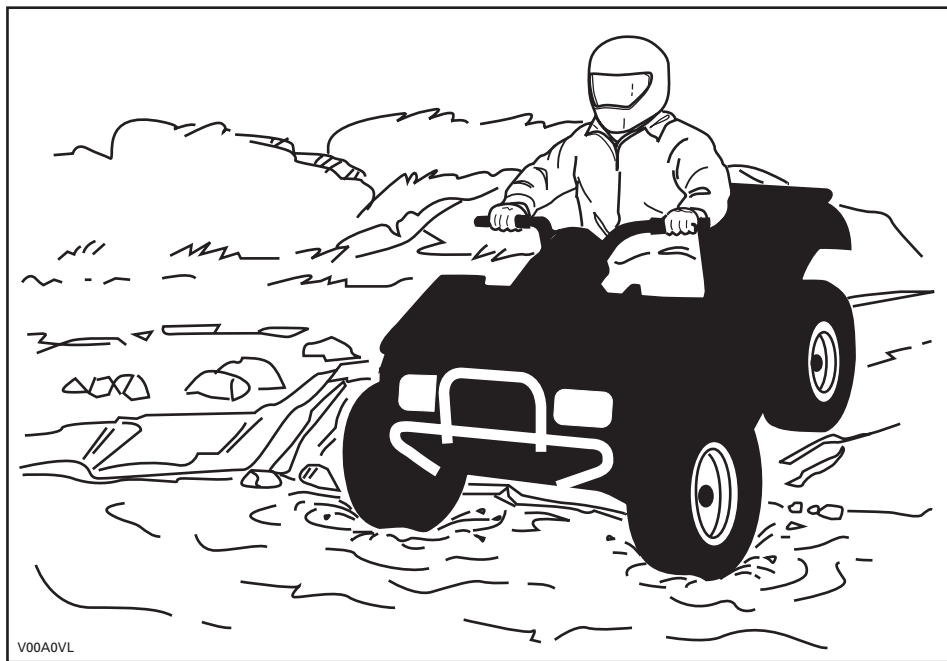

Water will affect the braking ability of your ATV. Make sure you dry the brakes by applying them several times after the ATV leaves the water.

Mud or marsh lands may be encountered near water. Be prepared for sudden “holes” or change in depth. Similarly so, be watchful of hazards such as rocks, logs, etc., partially covered by vegetation.

If your trip crosses frozen waterways, make sure that the depth of the ice is sufficient to support the total weight of yourself, the ATV and its load. Be ever watchful of open water... it is a sure indication that the ice depth will vary. If in doubt, do not attempt to cross.

Ice will also affect the control of an ATV. Slow down and do not “gun” the throttle. This will only result in spinning of the tires and possible tipover of the ATV. Avoid rapid braking. This again will possibly result in an uncontrolled slide and tipover of the ATV. Slush should be avoided at all times since it could block the operation or controls of the ATV.

Sand and riding on sand dunes or on snow is another unique experience but there are some basic precautions that should be observed. Wet, deep or fine sand/snow may create a loss of traction and cause the ATV to slide, drop off or become “bogged” down. If this occurs look for a firmer base. Again, the best advice is to slow down and be watchful of the conditions.

When riding in sand dunes it is advisable to equip the ATV with an antenna type safety flag. This will help make your location more visible to others over the next sand bank. Proceed carefully should you see another safety flag ahead. Since the antenna type safety flag can snag and rebound on your body if caught, do not use it in areas where there are low hanging branches or obstacles.

Loose stones or gravel are very similar to riding on ice. It will affect the steering of an ATV... causing it to possibly slide and tipover especially at high speeds. In addition, braking distance may be effected. Remember that “gunning” the throttle or sliding may cause loose stones to be ejected rearwards into the path of another ATV rider.

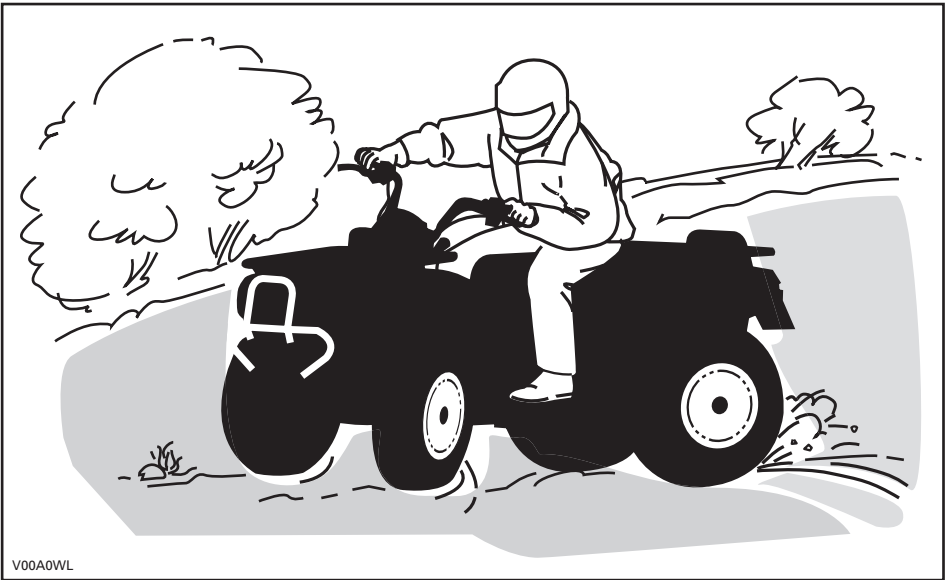

If you do get into a slide or skid, it may help to turn the handlebar into the direction of the skid until you regain control. Never jam the brakes and lock the wheels.

Respect and follow all posted trail signs. They are there to help you and others.

Obstacles in the “trail “should be traversed with caution. This includes loose rocks, fallen trees, slippery surfaces, fences, posts, and embankments and depressions. You should avoid them whenever possible. Remember that some obstacles are too large or dangerous to cross and should be avoided. Small rocks or fallen trees may be safely crossed... approach at a 90° angle. Stand on the footrests while keeping your knees flexed. Adjust speed without losing momentum and don't “gun” the throttle. Hold handgrips firmly. Place your body weight rearwards and proceed. Don't try to lift the ATV front wheels off the ground. Be aware that the object may be slippery or may move while crossing.

When driving on hills or slopes two things are highly important... be prepared for slippery surfaces or terrain variations and obstacles and... use proper body positioning.

While reading this *Safety Handbook*, remember that:

 **WARNING**

Indicates a potential hazard that could result in serious injury or death.

## Uphill

Keep your body weight forward towards the top of the hill. Keep your feet on the footpegs and shift into low gear then accelerate and when necessary, change gear quickly as you climb. Do not over-speed since this may cause the front of the ATV to lift from the ground and fall back on you. If the hill is too steep and you cannot proceed or the ATV begins to roll backwards, apply the brake, being careful not to slide. Dismount then use the "K" turn or "U" turn (While walking back, next to the ATV on the up hill side and with a hand on the brake lever, slowly back the rear of the ATV toward the top of the hill then drive downhill). Always walk or dismount on the upside of the slope while keeping clear of the ATV and its rotating wheels. Do not try to hold on to an ATV if it begins to toppling. **Stay clear.** Do not ride over the crest of the hill at high speed. Obstacles, including sharp drop-offs, may exist.

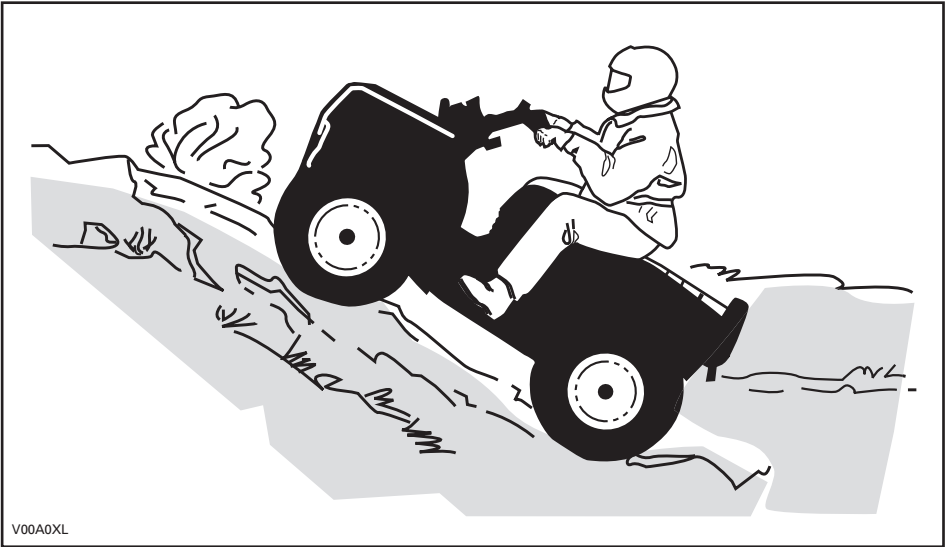

V00A0XL

## Downhill

Keep your body weight rearwards. Apply the brake gradually to prevent skidding. Do not "coast" down the slope using solely engine compression or in neutral gear.

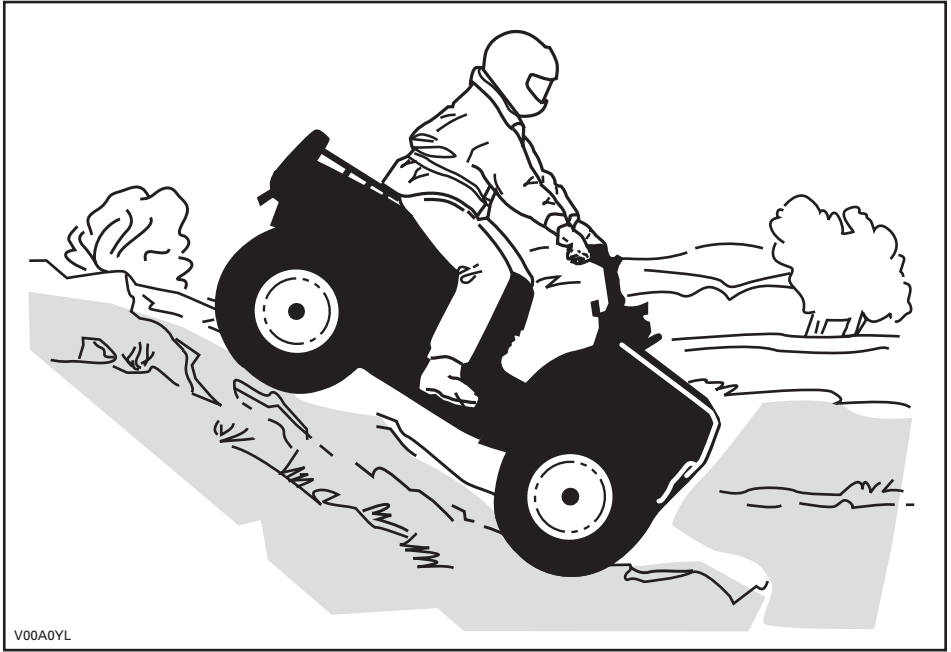

## Side-Hilling

This is one of the **most risky** types of riding since it may drastically change the balance of the ATV. It should be avoided wherever possible. If it is necessary to do so however, it is important that you **ALWAYS** keep your body weight on the upside of the slope... and be prepared to dismount on that side should the ATV begin to topple. **Don't try to stop or save the ATV from damage.**



When operating in reverse, check that the path behind you is free of people or obstacles. Proceed slowly and avoid any sharp turns.

When stopped or parked always apply the parking device. This is especially important when parking on a slope. On very steep inclines or if the ATV is carrying a cargo, the wheels should be blocked using rocks or bricks. Remember to turn the fuel valve to the closed position.



## **Routine Maintenance**

Once completing your ride it is wise to remove any build up of snow, ice, mud and grime. Not only will this help you keep the ATV longer and in good condition for resale but will eliminate potential hazards the next time you use the ATV. Wash the ATV in warm soapy water then allow it to dry. (A towel may help). Do not wash the ATV outside during freezing weather. Apply appropriate lubrication as described in the *Operator's Guide*.

Part of your responsibility towards safety is to respect the contents of the *Operator's Guide*. It provides valuable advise on how to properly take care of your ATV. If further assistance is required your ATV dealer is always willing to help.

Modification of the ATV to increase speed and performance may violate the terms and conditions of your ATV limited warranty. In addition, certain modifications including the removal of engine or exhaust components are illegal under most laws.

Changing the wheel and/or tire size may affect the stability of the ATV. Incorrect tire pressure may lead to blow outs or cause a tire to move around on its rim and become lost or damaged. Wheels or tires which are damaged should always be replaced.



**BOMBARDIER**  
*RECREATIONAL PRODUCTS*

 **WARNING**

Indicates a potential hazard that could result in serious injury or death.



**BOMBARDIER**  
RECREATIONAL PRODUCTS



## WARNING

**THIS VEHICLE CAN BE HAZARDOUS TO OPERATE.**

A collision or rollover can occur quickly, even during routine manoeuvres such as turning and driving on hills or over obstacles, if you fail to take proper precautions.

**SEVERE INJURY OR DEATH** can result if you do not follow these instructions:

- **BEFORE YOU OPERATE THIS ATV, READ THE OPERATOR'S GUIDE, THE SAFETY HANDBOOK AND ALL LABELS.**
- **NEVER OPERATE THIS ATV, WITHOUT PROPER INSTRUCTION.** Beginners should complete a certified training course.
- **NEVER CARRY A PASSENGER.** You increase your risk of losing control if you carry a passenger.
- **NEVER OPERATE THIS ATV ON A PAVED SURFACE.** You increase your risk of losing control if you operate this ATV on pavement.
- **NEVER OPERATE THIS ATV ON PUBLIC ROADS.** You can collide with another vehicle if you operate this ATV on a public road.
- **ALWAYS WEAR AN APPROVED HELMET,** eye protection, and protective clothing.
- **NEVER CONSUME ALCOHOL OR DRUGS** before or while operating this vehicle.
- **NEVER OPERATE THIS ATV AT EXCESSIVE SPEEDS.** You increase your risk of losing control if you operate this ATV at speeds too fast for the terrain, visibility conditions, or your experience.
- **NEVER ATTEMPT WHEELIES, JUMPS, OR OTHER STUNTS.**

