



SEA-DOO®



Operator's Guide
Includes
Safety, Vehicle and
Maintenance Information

2006

3D RFI™



WARNING

Read this guide thoroughly. It contains important safety information.

Do not remove this Operator's Guide from the vehicle.

2 1 9 0 0 0 4 0 7

This *OPERATOR'S GUIDE* utilizes the following symbols to emphasize particular information:

 The Safety Alert Symbol indicates a potential personal injury hazard.

 **WARNING** Indicates a potentially hazardous situation which, if not avoided, could result in serious injury or death.

CAUTION: Denotes an instruction which, if not followed, could severely damage vehicle components.

NOTE: Indicates supplementary information needed to fully complete an instruction.

 **WARNING**

For your safety, understand and follow all the safety precautions and instructions contained in this Operator's Guide, the Safety Videocassette and the on-product labels. Failure to do so can result in SEVERE INJURY OR DEATH.

Keep this *OPERATOR'S GUIDE* in a waterproof bag with the vehicle at all times. This *OPERATOR'S GUIDE* and the *SAFETY VIDEOCASSETTE* should remain with the vehicle at the time of sale.



Knight's Spray-Nine[†] is a trademark of Korkay System Ltd

GTX[†] is a trademark of Castrol Ltd. used under license

The following is a non-exhaustive list of trademarks that are the property of Bombardier Recreational Products Inc. or its affiliates:

XP-STM Mineral Injection Oil

GTITM

Sea-Doo LKTM

XP-STM Synthetic 2-stroke Oil

O.P.A.S.TM

XP[®]

Sea-Doo Synthetic Grease

RotaxTM

4-TECTM

DESSTM

RFITM

3DTM

Sea-Doo[®]

O.T.A.S.TM

FOREWORD

The *OPERATOR'S GUIDE* has been prepared to acquaint the owner/operator with this personal watercraft and its various controls, maintenance and safe riding instructions. It is indispensable for the proper use of the product and should be kept in a waterproof bag with the watercraft at all times.

Make sure you read and understand the content of the *OPERATOR'S GUIDE*.

For any questions pertaining to the warranty and its application, consult the *WARRANTY* section in this guide, and/or an authorized Sea-Doo dealer.

In USA, products are distributed by BRP US Inc. In Canada, products are distributed by Bombardier Recreational Products Inc. (collectively "BRP").

The information and components/system descriptions contained in this guide are correct at the time of writing. BRP however, maintains a policy of continuous improvement of its products without imposing upon itself any obligation to install them on products previously manufactured.

Because of its ongoing commitment to product quality and innovation, BRP reserves the right at any time to discontinue or change specifications, designs, features, models or equipment without incurring obligation.

The illustrations in this document show the typical construction of the different assemblies and may not represent the full detail or exact shape of the parts. However, they represent parts that have the same or similar function.

It is understood that this guide may be translated into another language. In the event of any discrepancy, the English version shall prevail.

Specifications are given in the SI metric system with the SAE U.S. equivalent in parenthesis. Where precise accuracy is not required, some conversions are rounded off for easier use.

A Shop Manual can be obtained for complete service, maintenance and more repair information.

The use of **LEFT** (port) and **RIGHT** (starboard) indications in the text, always refers to driving position (when sitting on watercraft).

Furthermore, in the marine industry, **FRONT** is referred to **BOW** and **REAR** as **STERN**.

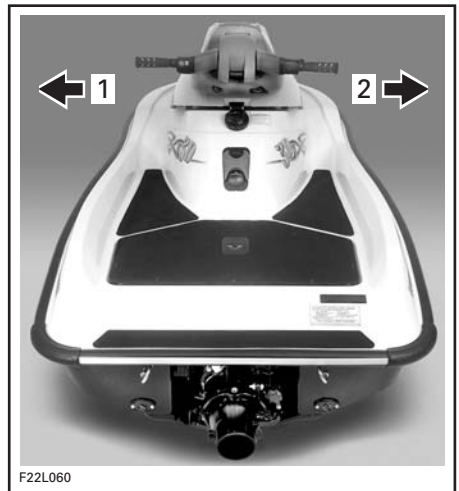

1. Left (port)
2. Right (starboard)

TABLE OF CONTENTS

SAFETY INFORMATION

INTRODUCTION	8
SAFETY CHECK LIST	9
General.....	9
GETTING UNDERWAY	10
To Wear	10
Helmets	12
To Bring	12
To Do	13
OPERATION	14
Collision Avoidance	14
Safe Riding	14
Operator/Passenger Awareness	15
Maneuverability of the Watercraft	15
OPERATING RULES	16
Remember these Rules of the Road	16
WEB SITES	17
LOCATION OF THE IMPORTANT LABELS	19

VEHICLE INFORMATION

REGISTRATION NUMBER LOCATION	26
IDENTIFICATION NUMBERS	27
Hull	27
Engine.....	27
CONTROLS/INSTRUMENTS/EQUIPMENTS	28
CONTROLS/INSTRUMENTS/EQUIPMENTS FUNCTIONS	30
1) Safety Lanyard (engine cut-off cord)	30
2) Handlebar	31
3) Handlebar Adjuster	31
4) Throttle Lever	32
5) Engine Start/Stop Button.....	33
6) Indicator Light Cluster	33
7) Steering Pole	34
8) Fuel Tank Cap	34
9) Engine Cover Latch	35
10) Oil Injection Reservoir Cap	37
11) Air Intake Opening	37
12) Bow and Stern Eyelets	37
13) Boarding Pads	38
14) Rear Platform	38

15) Cooling System Bleed Outlet	38
16) Flushing Connector.....	38
17) Bilge Drain Plugs	38
18) Jet Pump Nozzle	39
19) VTS Adjuster (if so equipped)	39
20) Jet Pump Water Intake	39
21) Fuses	40
22) Battery.....	40
23) Rear Access Cover	40
24) Automatic Bilge Pump.....	40
25) "Moto" Seat Release Button	40
26) "Moto" Seat Post Receiver	44
27) "Moto" Seat Post Release Lever	44
28) Kart Seat Lever (if so equipped)	44
29) Steering Pole Retainer (if so equipped)	45
LIQUIDS.....	47
Fueling Procedure	47
Recommended Fuel.....	47
Recommended Oil.....	47
Oil Injection System	48
BREAK-IN PERIOD.....	49
10-Hour Inspection	49
PRE-OPERATION CHECKS	50
Hull	51
Jet Pump Water Intake.....	51
Bilge	51
Water Flow in Cooling System (only when temperature is below or close to freezing point)	51
Battery	52
Fuel Tank and Oil Reservoir.....	52
Engine Compartment.....	52
Steering System	52
Steering Pole	52
Throttle System.....	52
VTS (Variable Trim System) (if so equipped)	52
Safety Lanyard and Engine Start/Stop Button	52
Optional Configurations	53
OPERATING INSTRUCTIONS.....	54
Principle of Operation	54
Boarding the Watercraft.....	57
Engine Starting Procedure	59
Riding	60
Rough Water or Poor Visibility Operation	61
Crossing Waves.....	61
Stopping/Docking	62
Beaching.....	62
Shutting Off the Engine	62

POST-OPERATION CARE.....	63
General Care	63
Additional Care for Foul Water or Salt Water	63
Cooling System Flushing and Engine Internal Lubrication.....	63
Anticorrosion Treatment	65
SPECIAL PROCEDURES	66
Limp Home Mode	66
Engine Overheating.....	66
Jet Pump Water Intake and Impeller Cleaning	66
Capsized Watercraft	67
Submerged Watercraft.....	67
Water-Flooded Engine.....	68
Fuel-Flooded Engine.....	68
Out of Fuel.....	69
Towing the Watercraft on the Water	69
Low-Charge Battery Condition	69
<i>MAINTENANCE INFORMATION</i>	
Engine Emissions Information.....	72
General.....	73
MAINTENANCE CHART	74
Periodic Inspection	74
MAINTENANCE.....	77
Lubrication.....	77
Throttle Cable Inspection	78
Fuel Injection System	78
Fuel and Oil Filters.....	78
Steering Alignment	78
Steering Pole	78
Handlebar and Adjuster Operation	79
“Moto” Seat	79
Kart Seat (if so equipped)	80
O.T.A.S.™ System.....	80
VTS Adjustment.....	80
Bilge Drain Plugs.....	80
Fuses.....	80
General Inspection and Cleaning.....	82
TRAILERING, STORAGE AND PRESEASON PREPARATION	84
Trailering	84
Storage.....	85
Preseason Preparation	89
Preseason Preparation Chart	90

TROUBLESHOOTING..... 92

SPECIFICATIONS 97

ABBREVIATIONS USED IN THIS MANUAL 100

WARRANTY

**BRP NORTH AMERICA LIMITED WARRANTY: 2006 SEA-DOO® 3D™ DI
PERSONAL WATERCRAFT 103**

**CALIFORNIA AND NEW YORK EMISSION CONTROL WARRANTY
STATEMENT FOR MODEL-YEAR 2006 SEA-DOO® 3D™ DI PERSONAL
WATERCRAFT. 107**

**BRP INTERNATIONAL LIMITED WARRANTY: 2006 SEA-DOO® 3D™ DI
PERSONAL WATERCRAFT 111**

PRIVACY INFORMATION..... 114

SAFETY INFORMATION

INTRODUCTION

Congratulations, you are now the proud owner of a Sea-Doo personal watercraft. You have selected one of the most popular watercraft on water. Your Sea-Doo® personal watercraft (PWC) can provide you and your family or friends the opportunity to fully enjoy the natural beauty and excitement of the world's waterways. Welcome to fun on water!

With this new enjoyment and freedom however comes the responsibility of safety for yourself, the people you lend your watercraft to, and other water users. Please follow all safety instructions and operate your watercraft with care. Be sure every operator of your watercraft fully understands the controls and operation of it and the importance of courteous, responsible riding. Each operator has a responsibility to ensure the safety of other water users.

Some of the information contained in this safety section may be new to you while other information may be common sense or obvious. Irrespective, we want you to have a safe, pleasurable riding experience, so please take a few minutes of your time to completely read this short safety section. Although the mere reading of such information does not eliminate the hazard, the understanding and application of the information will promote the correct use of the watercraft.

Failure to follow the instructions of this safety section may result in severe injury or death.

This safety section is for initial reference and its content is therefore limited. It should be read in conjunction with the rest of this *OPERATOR'S GUIDE*, the *SAFETY VIDEO* and the on-product warning/caution labels. It is also strongly recommended that operators obtain further information concerning "Boating Rules" from a local Coast Guard Auxiliary, Powerboat Squadron or other local boating authorities.

Many states or provinces have requirements regarding boating safety and competence certificates. BRP strongly recommends that any watercraft operator completes a safety and competence boating course. Check with your local Coast Guard or Power Sail Squadron in your area for course availability.

Some boating safety information can be obtained from the Boating Safety/Regulation Web sites listed at the end of this safety section.

Regulations concerning boating are modified from time to time. It is advisable to periodically check the local regulations wherever you plan to operate your watercraft.

We encourage you to have an Annual Safety Inspection of your personal watercraft. Please contact your dealer for further details.

Finally, we urge you to visit your dealer regularly for regular and safety maintenance and for any accessories you may require.

Have fun and...Bon Voyage.

SAFETY CHECK LIST

To fully appreciate the pleasures, enjoyment and excitement of boating there are some basic rules that should be observed and followed by any boater. Failure to follow this safety information and safe boating rules could result in injury, including the possibility of death to you, the people you lend your watercraft to, or other water users.

General

BRP recommends a minimum operator age of 16 years old.

A boating safety course is recommended and may be required in your province or state.

The performance of this watercraft may significantly exceed that of other craft you may have operated. Make sure to become completely familiar with the controls and operation of the watercraft before embarking on your first trip. If you have not had the opportunity to do so, practice driving solo in a suitable traffic free area and feel the response of each control. Be fully familiar with all controls before accelerating above idle speed. Do not assume that all PWCs handle identically. Each model differs, often substantially.

The operator of the watercraft controls, and is responsible for the watercraft's safe operation. He/she also has the responsibility to require that people, to whom he/she lends the watercraft to, read and understand this safety section Operator's Guide, the *SAFETY VIDEO* and the on-product warning/caution labels.

Ensure that all operators know how to swim and how to reboard the watercraft from the water.

Boarding in deep water can be strenuous. Practice in chest-deep water before operating or embarking your watercraft in deep water.

A PWC will not self-right if capsized. The operator must know the proper righting procedure as explained in the *OPERATOR'S GUIDE*. Make sure engine is off before rolling over the watercraft.

Your local Power Squadron or state/provincial authorities will be pleased to conduct a complementary safety examination of your watercraft and help you define your needs.

Never ride after consuming drugs or alcohol or if you feel tired or ill.

When fueling, follow the safe boating fueling instructions explicitly, as provided in your *OPERATOR'S GUIDE* and those given to you at the marina. Always verify fuel level before use and during the ride. Apply the principle of 1/3 fuel to destination, 1/3 back and 1/3 reserve fuel supply. Do not carry spare fuel or flammable liquids in any of the storage or engine compartments.

Always stop the engine before fueling and never allow anyone to remain on the watercraft while fueling. Always remember that fuel is flammable and explosive under certain conditions. Do not smoke or allow open flames or sparks in the vicinity.

Respect no wake zones, the rights of other water users and the environment. As the "skipper" and owner of a watercraft you are responsible for damage to other crafts caused by the wake of your watercraft. Allow no one to throw refuse overboard.

Don't forget that all persons must assist other boaters in an emergency.

GETTING UNDERWAY

To Wear

The operator must wear a Coast Guard approved Personal Flotation Device (PFD) that is suitable for PWC use.

An operator should have ready access to shatterproof glasses should riding conditions or personal preference warrant. Wind, water spray and speed may cause a person's eyes to water and create blurred vision.

The operator of PWCs must wear protective clothing, including:

- a wet suit bottom or thick, tightly woven, snug fitting clothing that provides equivalent protection. Thin bike shorts for example would not be appropriate. Severe internal injuries can occur if water is forced into body cavities as a result of falling into water or being near jet thrust nozzle. Normal swimwear does not adequately protect against forceful water entry into the lower body opening(s) of males or females.
- footwear, gloves and goggles/glasses are also recommended. Some type of lightweight, flexible foot protection is recommended. This will help reduce possible injury, should you step on sharp underwater objects.

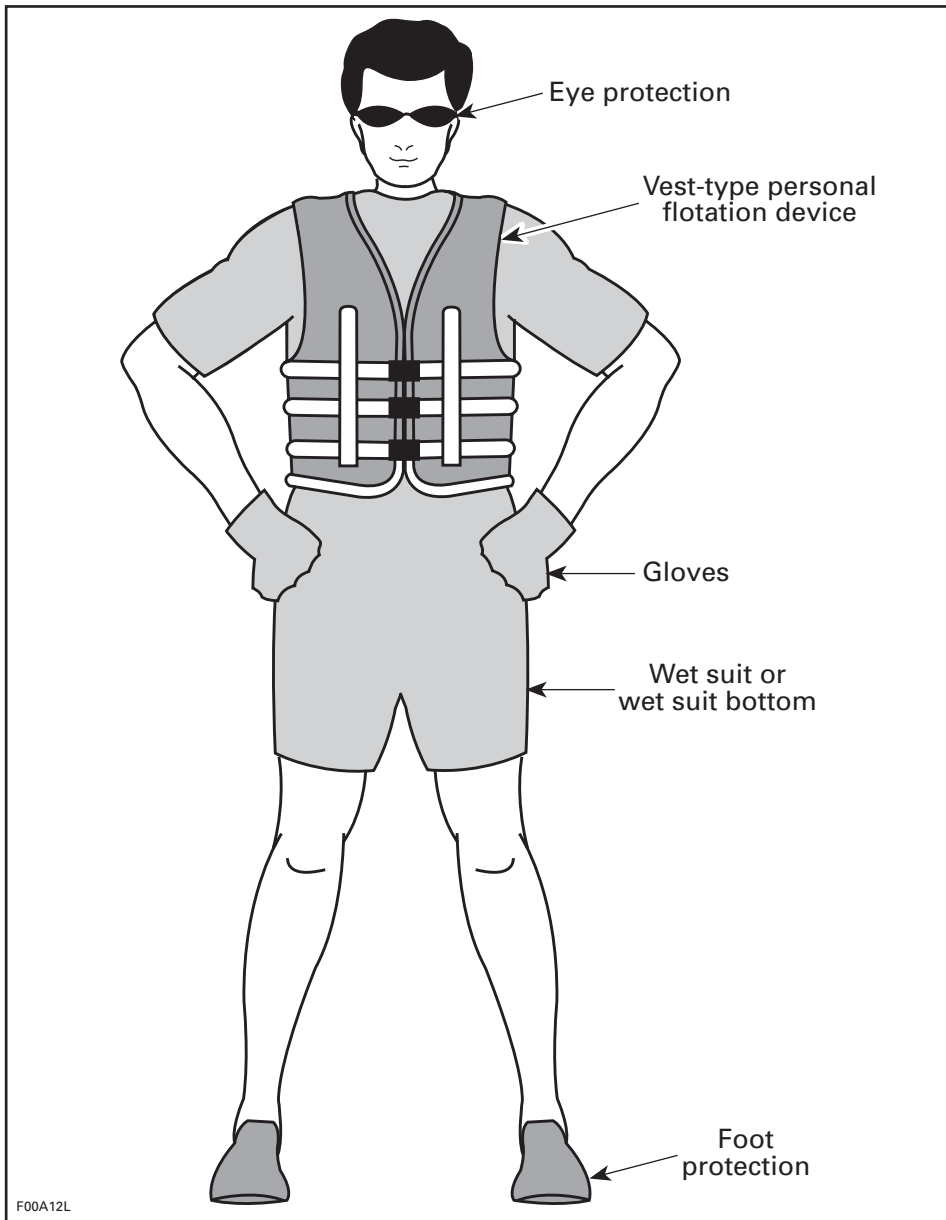

Helmets

Some Important Considerations

Helmets are designed to offer some degree of protection in case of impact to the head. In most motorized sports, the benefits of wearing a helmet clearly outweigh the drawbacks. However, in the case of motorized watersports such as riding personal watercraft, this is not necessarily true as there are some particular risks associated with the water.

Benefits

A helmet helps to reduce the risk of injury in case of a head impact against a hard surface such as another craft, for example, in the case of a collision. Similarly, a helmet with a chinguard might help prevent injuries to the face, jaw, or teeth.

Risks

On the other hand, in some situations when falling off the watercraft, helmets have a tendency to catch the water, like a "bucket", and put severe stresses on the neck or spine. This could result in choking, severe or permanent neck or spine injury, or death.

Helmets may also interfere with peripheral vision and hearing, or increase fatigue, which could contribute to increase the risk of a collision.

Weighing the Risks vs Benefits

In order to decide whether or not you should wear a helmet, it is best to consider the particular environment you will be riding in, as well as other factors such as personal experience. Will there be a lot of traffic on the water? What is your riding style?

The Bottom Line

Since each option minimizes some risks, but increases others, before each ride you must decide whether to wear a helmet or not based on your particular situation.

If you decide to wear a helmet, you must then decide what type is the most appropriate for the circumstances. Look for helmets that meet DOT or Snell standards, and if possible, choose one designed for motorized watersports.

Racing

Due to the nature of competition and the proximity of other crafts, BRP recommends wearing a helmet in close quarter PWC racing activities. Always follow the helmet requirements of the sanctioning organization.

To Bring

Always carry the regulatory safety items and have them conveniently on board available for use. Check the local regulations or consult your authorized Sea-Doo dealer. Such required safety items usually include, without limitation, a sound signaling device such as a whistle, a watertight flashlight or approved flares, a buoyant heaving line, an anchor and rope*, a bailer*, and an appropriate fire extinguisher*. The items marked with a "*" are not required in Canada if all persons on board a PWC are wearing a PFD.

A cellular telephone in a waterproof bag or container has also been found to be beneficial to boaters when in distress or just for contacting someone on shore.

To Do

Read and understand all warning/caution labels on your Sea-Doo PWC, your *OPERATOR'S GUIDE*, all other safety documents, and watch properly your *SAFETY VIDEO*, before operating. Always keep in mind that the "⚠" symbol, the Warning symbol, identifies an instruction which, if not followed, may cause serious personal injuries including the possibility of death.

Check local and federal boating laws applicable to the waterways where you intend to use your watercraft. Learn the local rules of the road. Know and understand the applicable navigation system (such as buoys and signs).

Know the waters in which the watercraft is to be operated. Current, tides, rapids, hidden obstacles, wakes and waves etc. can affect safe operation. It is not advisable to operate the watercraft in rough or inclement weather.

For safety reasons and proper care, always perform "Daily Pre-Operation Checks" as specified in your *OPERATOR'S GUIDE* before operating your watercraft.

Keep the engine shut-off cord (safety lanyard) attached to the operator's PFD at all times and keep it free from handlebars so that engine stops if operator falls off. After riding, remove cord from PWC to avoid unauthorized use by children or others. If operator falls off the watercraft and safety lanyard is unattached, the watercraft will not stop.

OPERATION

Collision Avoidance

Do not release throttle when trying to steer away from objects. You need throttle to steer.

Always keep a constant lookout for other water users, other boats or objects, especially when turning. Be alert for conditions that may limit your visibility or block your vision of others.

Respect the rights of other recreationists and/or bystanders and always keep a safe distance from all other craft, people and objects.

Do not wake or wave jump, ride the surf line or attempt to spray or splash others with your watercraft. You may misjudge the ability of the watercraft or your own riding skills and strike a boat or person.

This watercraft has the capability of turning more sharply than other boats, however, unless in an emergency, do not negotiate sharp, high speed turns. Such maneuvers make it hard for others to avoid you or understand where you are going. Also, you could be thrown from the watercraft.

Like any other craft, this PWC has no brake. Stopping distance will vary depending on initial speed, load, wind, and water conditions. Practice stopping and docking in a safe, traffic free area to have an idea of how long it will take to stop the watercraft under varying conditions.

Maintaining or increasing speed may be necessary to avoid a collision.

Safe Riding

Always keep in mind that as the throttle lever is released to idle position, less directional control is available, and as the engine is off, directional control is lost. You need throttle to steer.

Ride within your limits and level of riding ability. Avoid aggressive maneuvers to reduce the risk of loss of control, ejection and collision. Understand and respect the performance of your watercraft.

Always ride responsibly and safely. Use common sense and courtesy.

While your watercraft has the capacity of operating at high speeds, it is strongly recommended that high speed operation only be applied when ideal conditions exist and are permitted. Higher speed operation requires a higher degree of skill and increases the risk of severe injuries.

The forces generated on the body of riders while turning, negotiating waves or wakes, operating in choppy waters, or falling off the watercraft, especially at higher speeds, may cause injury including the possibility of broken legs and other bones or more serious injuries. Remain flexible and avoid sharp turns.

Do not engage in stunts or jumps as they could lead to serious injuries or even death. For example, you could hurt your back in landing from a jump or you could lose control of the watercraft while attempting to perform a stunt, and collide with your own watercraft or another obstacle. This watercraft offers many riding configurations, and it is important that, for your safety, you strictly follow the instructions on proper use of the watercraft in each configuration as they ensure that your riding position allows you to remain in control of the watercraft at all times. Any riding position that is not explicitly recommended by the manufacturer could lead to a loss of control and potentially serious injuries or death.

In shallow water, proceed with caution and at very low speeds. Grounding or abrupt stops may result in injury. Debris may also be picked up and be thrown rearward by the jet pump onto people or property.

PWCs are not designed for night-time operation.

Operator/Passenger Awareness

Never turn handlebar while someone is nearby rear of watercraft. Keep away from steering moving parts (nozzle, linkage, etc.).

Never operate this watercraft with a passenger onboard. This watercraft is for one (1) operator only. No passenger. There is no seat to accommodate a passenger and he could lack stability and be thrown off, leading to possible severe injuries.

Do not start or operate the watercraft if anyone is seated on the deck or swim platform, or is nearby in the water. Water and/or debris exiting jet thrust nozzle can cause severe injury.

The operator should be properly standing or seated before starting or moving the watercraft, and at all times when watercraft is in motion.

Keep away from intake grate while engine is on. Items such as long hair, loose clothing, or PFD straps can become entangled in moving parts resulting in severe injury or drowning.

To prevent accidental starting, always detach the safety lanyard from the watercraft during removal of any weeds or debris from the intake grate.

It should be remembered that sun, wind, alcohol, drugs, fatigue and illness, may impair your judgement and reaction time.

On a PWC, never place your feet and legs in the water to aid turning.

Maneuverability of the Watercraft

Do not overload the watercraft or take on a passenger. Overloading can affect maneuverability, stability and performance.

Avoid adding on accessories, or equipment which may alter your control of the watercraft.

Around or near docks or piers, maneuver with great caution. When you want to ride under a pier, only proceed at very low speed and make sure you have an adequate clearance.

Don't forget: Ride smart from the start and we all win!

OPERATING RULES

Operating a watercraft can be compared with driving unmarked highways and roads. To prevent collisions or avoid other boaters, a system of operating rules must be followed. It's not only common sense... it's the law!

Remember these Rules of the Road

Know the Right of Way Rules

Generally keep to your right and safely avoid other craft by keeping a safe distance from other craft, people and objects.

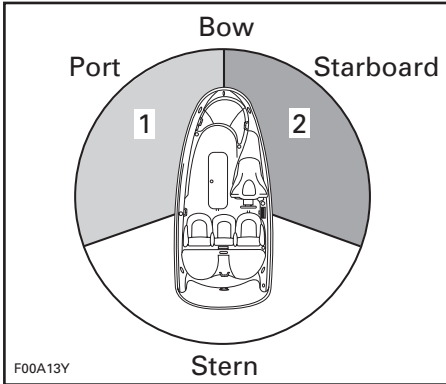

1. RED light
2. GREEN light (yield zone)

Crossing

Give right of way to craft ahead and to your right. Never cross in front of a boat.

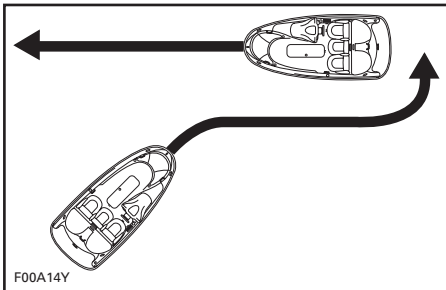

Meeting Head-On

Keep right.

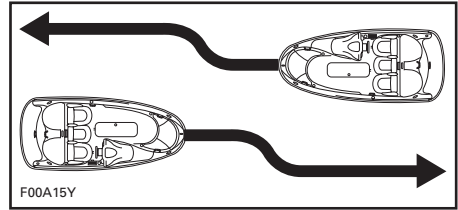

Passing

Give right of way to other craft and keep clear.

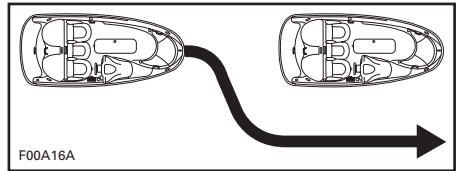

Navigation System

Navigational aids, such as signs or buoys, can assist you identify safe waters. Buoys will indicate whether you should keep to the right (starboard) or to the left (port) of the buoy or to which channel you can continue. They may also indicate whether you are entering a restricted or controlled area such as a no wake or speed zone. They may also indicate hazards or pertinent boating information. Markers maybe located on shore or on the water. They can also indicate speed limits, no power craft or boating, anchorage and other useful information. (The shape of each type of marker will provide assistance).

Make sure you know and understand the navigation system applicable to the waterways where you intend to use the watercraft.

WEB SITES

Sea-Doo website: www.sea-doo.com

Canadian Coast Guard (Office of Boating Safety)	www.ccg-gcc.gc.ca/obs-bsn/sbg-gsn/main_e.htm
United States Coast Guard	www.uscgboating.org/regulations/boating_laws.htm
Alabama	www.dcnr.state.al.us/mp/menu.htm
Alaska	www.dnr.state.ak.us/parks/boating
Arizona	www.azgfd.com
Arkansas	www.agfc.state.ar.us/
California	www.dbw.ca.gov
Colorado	http://parks.state.co.us/boating/
Connecticut	http://dep.state.ct.us/rec/prgactiv.htm
Delaware	www.dnrec.state.de.us/fw/index.htm
Florida (freshwater)	http://floridaconservation.org/law
Florida (saltwater)	www.dep.state.fl.us/law
Georgia	www.boat-ed.com
Hawaii	www.hawaii.gov/dlnr/dbor/dbor
Idaho	www.idahoparks.org/rec/boating.html
Indiana	www.state.in.us/dnr/regulations
Iowa	www.iowadnr.com/
Kansas	www.kdwp.state.ks.us/boating/boating.html
Kentucky	www.state.ky.us/agencies/fw/boating.htm
Louisiana	www.wlf.state.la.us
Maine	www.state.me.us/ifw/rv/boatinglaws2003.htm
Maryland	www.dnr.state.md.us/boating
Massachusetts	www.state.ma.us/dfwele/dle/boatrvsafe.htm
Michigan	www.boat-ed.com/mi/handbook
Minnesota	www.dnr.state.mn.us/safety/boatwater
Mississippi	www.dmr.state.ms.us
Missouri	www.mswp.state.mo.us
Montana	www.fwp.state.mt.us/education/outdoorskills.asp
Nebraska	www.ngpc.state.ne.us/boating
Nevada	http://www.boatnevada.org/

New Hampshire	www.state.nh.us/safety/ss/links.html
New Jersey	www.state.nj.us/mvs/boats.htm
New Mexico	www.emnrd.state.nm.us/nmparks/pages/question/regulate/rules/nmac172.pdf
North Carolina	www.ncwildlife.org/fs_index_02_regulations.htm
North Dakota	http://www.state.nd.us/gnf/boating/
Ohio	www.dnr.state.oh.us/odnr/watercraft
Oregon	www.osmb.state.or.us
Pennsylvania	www.fish.state.pa.us
Rhode Island	www.state.ri.us/dem/topics/boating.htm
South Carolina	www.dnr.state.sc.us/etc/boating.html
South Dakota	www.state.sd.us/gfp/divisionwildlife/boating/index.htm
Tennessee	www.state.tn.us/twra/boatmain.html
Texas	www.tpwd.state.tx.us/boat/boat.htm
Utah	www.stateparks.utah.gov/parks/safety.htm
Virginia	www.dgif.state.va.us/boating
Washington	www.parks.wa.gov/boating.asp
West Virginia	www.dnr.state.wv.us/law/boating.htm
Wisconsin	http://www.dnr.state.wi.us/org/caer/cs/Registrations/Boats.htm
Wyoming	http://gf.state.wy.us

NOTE: State websites not listed are under development. BRP makes no representation of endorsement of any of the products or services contain within any website listed.

LOCATION OF THE IMPORTANT LABELS

The following labels are on your watercraft. If missing or damaged, they can be replaced free of charge. See an authorized Sea-Doo dealer.

Please read the following labels carefully before operating this watercraft.

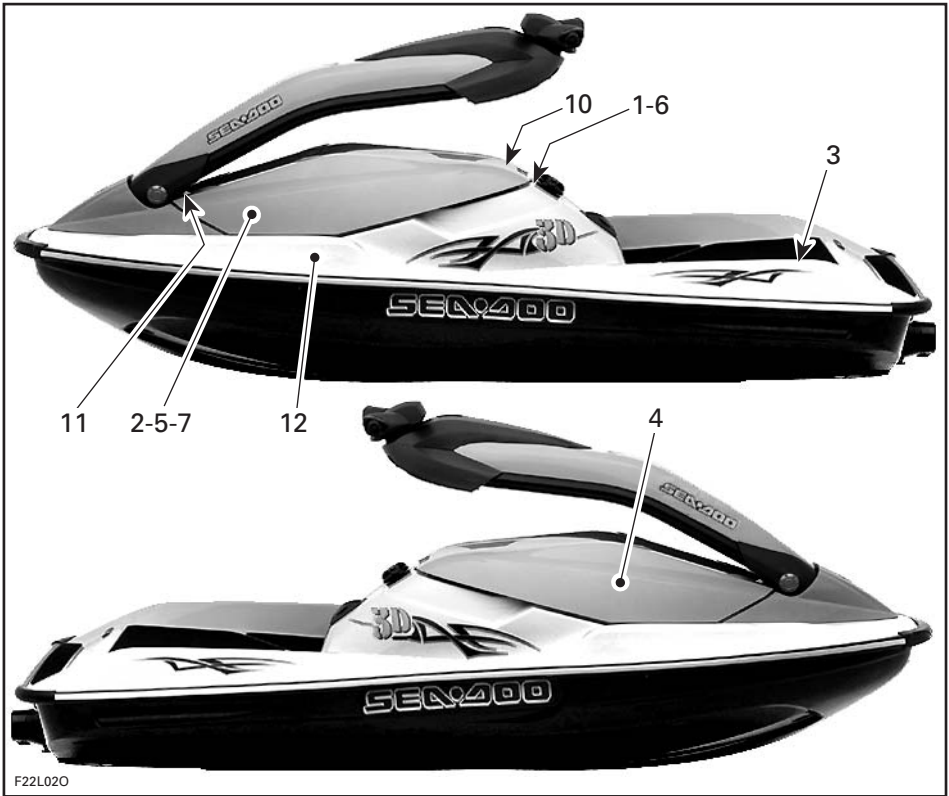

F22L020



"MOTO" CONFIGURATION



KART SEAT CONFIGURATION (IF SO EQUIPPED)

Label 1

⚠ WARNING
To reduce the risk of **SEVERE INJURY** or **DEATH**:

WEAR A PERSONAL FLOTATION DEVICE (PFD). All riders must wear a Coast Guard approved PFD that is suitable for personal watercraft (PWC) use.

WEAR PROTECTIVE CLOTHING. Severe internal injuries can occur if water is forced into body cavities as a result of falling into water or being near jet thrust nozzle. Normal swimwear does not adequately protect against forceful water entry into lower body opening(s) of males or females. All riders must wear a wet suit bottom or clothing that provides equivalent protection (see Operator's Guide). Footwear, gloves and goggles/glasses are recommended.

KNOW BOATING LAWS. Bombardier recommends a minimum operator age of 16 years old. Know the operator age and training requirement for your province/state. A boating safety course is recommended and may be required in your province/state.

ATTACH ENGINE SHUT-OFF CORD (LANYARD) to PFD and keep it free from handlebars so that engine stops if operator falls off. After riding, remove cord from PWC to avoid unauthorized use by children or others. **RIDE WITHIN YOUR LIMITS AND AVOID AGGRESSIVE MANEUVERS** to reduce the risk of loss of control, ejection, and collision. This is a high performance boat – not a toy. Sharp turns or jumping wakes or waves can increase the risk of back/ spinal injury (paralysis), facial injuries, and broken legs, ankles, and other bones. **Do not jump wakes or waves.**

DO NOT APPLY THROTTLE WHEN ANYONE IS AT REAR OF PWC – turn engine off or keep engine at idle. Water and/or debris exiting jet thrust nozzle can cause severe injury.



KEEP AWAY FROM INTAKE GRATE while engine is on. Items such as long hair, loose clothing, or PFD straps can become entangled in moving parts resulting in severe injury or drowning.

NEVER RIDE AFTER CONSUMING DRUGS OR ALCOHOL.
READ AND FOLLOW OPERATOR'S GUIDE.

⚠ WARNING
Collision result in more **INJURIES AND DEATHS** than any other type of accident for personal watercraft (PWC). **TO AVOID COLLISIONS: SCAN CONSTANTLY** for people, objects, and other watercraft. Be alert for conditions that limit your visibility or block your vision of others.

OPERATE DEFENSIVELY at safe speeds and keep a safe distance away from people, objects, and other watercraft.

- Do not follow directly behind PWCs or other boats.
- Do not go near others to spray or splash them with water.
- Avoid sharp turns or other maneuvers that make it hard for others to avoid you or understand where you are going.
- Avoid areas with submerged objects or shallow water.

TAKE EARLY ACTION to avoid collisions. Remember, PWCs and other boats do not have brakes.

DO NOT RELEASE THROTTLE WHEN TRYING TO STEER away from objects – you need throttle to steer. Always check throttle and steering controls for proper operation before starting PWC. Follow navigation rules and province / state and local laws that apply to PWCs. See Operator's Guide for more information. Seating is limited to one operator only. (XXX lbs / XXX kg).



F22A01L

Label 2

CAUTION/ATTENTION

Use XP-S synthetic 2-stroke oil only.
See Operator's guide.

Utiliser seulement l'huile synthétique 2-temps
XP-S. Voir le guide du conducteur.

F00A32Y

Label 3

THIS BOAT IS NOT REQUIRED TO COMPLY WITH THE FOLLOWING U.S. COAST GUARD SAFETY STANDARDS IN EFFECT ON THE DATE OF CERTIFICATION:

- FUEL SYSTEM
- DISPLAY OF CAPACITY INFORMATION
- SAFE LOADING
- FLOTATION
- POWERED VENTILATION

AS AUTHORIZED BY U.S. COAST GUARD GRANT OF EXEMPTION (CGB 88-001).

**BOMBARDIER RECREATIONAL PRODUCTS INC.
565 DE LA MONTAGNE STREET VALCOURT, QUÉBEC CANADA J0E 2L0**

219902640

MADE IN MEXICO

smo2006-003-017_aen

Label 4

BOMBARDIER RECREATIONAL PRODUCTS INC.

EMISSION CONTROL INFORMATION
THIS ENGINE IS CERTIFIED TO OPERATE ON UNLEADED GASOLINE AND CONFORMS TO 2006 U.S. EPA & CALIFORNIA EMISSION REGULATIONS FOR MARINE SI ENGINES.

BOMBARDIER PRODUITS RÉCRÉATIFS INC.
RENSEIGNEMENTS SUR LE DISPOSITIF ANTIPOLLUTION

CE MOTEUR EST CERTIFIÉ POUR FONCTIONNER À L'ESSENCE SANS PLOMB ET IL REPOUND AUX NORMES 2006 DE L'EPA DES É.-U. & RÉGLEMENTATIONS CALIFORNIENNES POUR LES MOTEURS MARINS À ALLUMAGE COMMANDÉ.

ENGINE FAMILY

6 BCXM7823CR

FAMILLE DE MOTEUR

FEL

80 g/kW-hr HC+NOx

LIMITE DES ÉMISSIONS DE LA FAMILLE

ENGINE DISPLACEMENT

781.6 cc

CYLINDRÉE

EXHAUST EMISSION CONTROL SYSTEM

IFI

SYSTÈME DE CONTRÔLE DES ÉMISSIONS

SPARK PLUG TYPE

NGK BR8ES

TYPE DE BOUCHE

SPARK PLUG GAP

0,027in/0,6-0,8 mm

ÉCARTEMENT DES ÉLECTRODES

POWER

82 kW

PUISSANCE

SEE OPERATORS GUIDE FOR MAINTENANCE SPECIFICATIONS.

VOIR MANUEL DE L'OPÉRATEUR POUR LES SPÉCIFICATIONS DE MAINTENANCE.

21990290A

smo2006-003-018_a

Label 5

▲ WARNING / AVERTISSEMENT

DO NOT CHARGE OR BOOST THE BATTERY WHILE INSTALLED ON THE WATERCRAFT

219902201

NE PAS CHARGER OU SURVOLTER LA BATTERIE LORSQU'ELLE EST INSTALLÉE DANS LA MOTOMARINE

F00A23Y

Label 6

<p>⚠ WARNING / AVERTISSEMENT</p> <ul style="list-style-type: none"> Gasoline vapors may cause fires or explosions. Do not overfill fuel tank. Keep the craft away from open flames and sparks. Do not start watercraft if liquid gasoline or vapors are present. Always replace engine cover before starting. <hr/> <ul style="list-style-type: none"> Les émanations d'essence peuvent provoquer des incendies ou des explosions. Éviter de trop remplir le réservoir de carburant. Garder la motomarine à l'écart des flammes et des étincelles. Ne pas démarrer la motomarine en présence d'essence liquide ou d'émanation d'essence. Toujours remettre le couvercle du compartiment-moteur en place avant de démarrer la motomarine. 	<p>⚠ WARNING / AVERTISSEMENT</p> <p>Avoid loss of control and collisions! BEFORE INSTALLING OR STOWING SEATS OR ACCESSORIES :</p> <ol style="list-style-type: none"> STOP THE CRAFT IN A SAFE AREA away from traffic or obstacles. TURN OFF ENGINE. BE ON THE LOOK-OUT for other crafts or obstacles. Your craft may drift while changing configuration. <hr/> <p>Évitez les pertes de contrôle et les collisions ! AVANT D'INSTALLER OU DE RANGER SIÈGES OU ACCESSOIRES:</p> <ol style="list-style-type: none"> ARRÊTEZ LA MOTOMARINE DANS UN ENDROIT SÉCURITAIRE, loin de tout trafic ou obstacles. ÉTEIGNEZ LE MOTEUR. SURVEILLEZ LES AUTRES EMBARCATIONS ET OBSTACLES. Vous pourriez dériver lors de l'opération.
---	--



F22A03L

Label 7

<p>⚠ WARNING</p> <p>Certain components in the engine compartment may be very hot. Direct contact may result in skin burn.</p>	<p>⚠ AVERTISSEMENT</p> <p>Certaines composantes dans l'habitacle du moteur peuvent être très chaudes. Le contact direct sur la peau peut causer des brûlures.</p>
--	--

F00A1AY

Label 8

	<p>⚠ WARNING</p> <p>To avoid loss of control or ejection: ALWAYS INSERT KNUCKLE FULLY INTO SOCKET AND LOCK-IN</p>
	<p>⚠ AVERTISSEMENT</p> <p>Pour éviter toute perte de contrôle ou éjection: TOUJOURS INSÉRER LA ROTULE COMPLÈTEMENT ET BIEN BARRER</p>

219 903 460
F22A0BY

Label 9

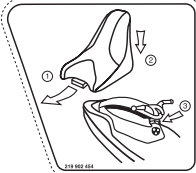
	<p>⚠ WARNING</p> <p>WHEN INSTALLING KART SEAT :</p> <ol style="list-style-type: none"> INSERT FRONT TAB properly in receptacle. LOCK IN REAR LATCH. LOCK IN HANDLEBAR POLE LATCH. <p>⚠ AVERTISSEMENT</p> <p>QUAND VOUS INSTALLEZ LE SIÈGE KART :</p> <ol style="list-style-type: none"> INSÉREZ BIEN LA LANGUETTE AVANT dans le réceptacle. ENCLENCHEZ BIEN LE LOQUET ARRIÈRE. ENCLENCHEZ BIEN LE LOQUET SOUS LA POLE DU GUIDON.
--	--

F22A0CY

IF SO EQUIPPED

Label 10

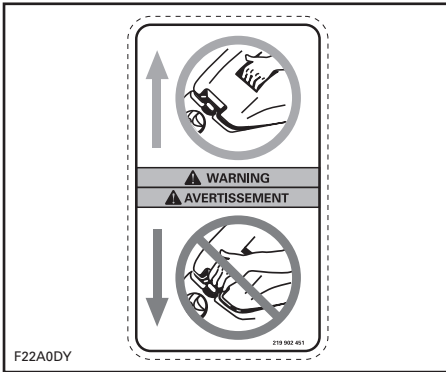

Label 11



Label 12



VEHICLE INFORMATION

REGISTRATION NUMBER LOCATION

All personal watercraft are required by federal law to be registered and legally numbered.

Due to space availability for proper display of registration number, refer to following illustration for location. The registration number should appear on each side of the watercraft.



1. Registration number location

NOTE: The registration number must be above the water line. Ensure also that the numbers are of the correct size and color. Check with local applicable regulations.

IDENTIFICATION NUMBERS

The main components of the watercraft (engine and hull) are identified by different serial numbers. It may sometimes become necessary to locate these numbers for warranty purposes or to trace the watercraft in the event of theft.

Hull

The Hull Identification Number (H.I.N.) is located on platform at the rear of watercraft.

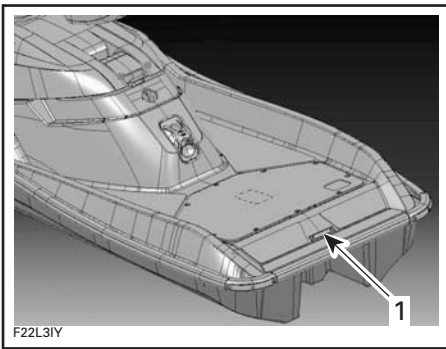

1. Hull Identification Number

It is composed of 12 digits:

YDV 12345 L 4 95
Model year
Year of production
Month of production
Serial number (a letter may also be used as a digit)
Manufacturer

Engine

The Engine Identification Number (E.I.N.) is located on the upper crankcase on PTO (Power Take-Off) side.

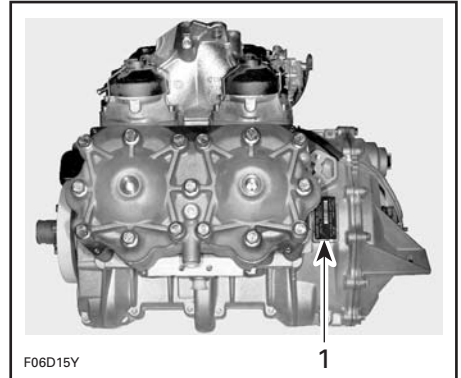

1. Engine Identification Number (E.I.N.)

CONTROLS/INSTRUMENTS/EQUIPMENTS

NOTE: Some components do not apply or are optional on some models.



F22L07M

"VERT" CONFIGURATION



F22L03P

"MOTO" CONFIGURATION



F22L04M

KART CONFIGURATION (IF SO EQUIPPED)

- | | |
|---|------------------------------------|
| 1. Safety Lanyard (engine cut-off cord) | 16. Flushing Connector |
| 2. Handlebar | 17. Bilge Drain Plugs |
| 3. Handlebar Adjuster | 18. Jet Pump Nozzle |
| 4. Throttle Lever | 19. VTS Adjuster |
| 5. Engine Start/Stop Button | 20. Jet Pump Water Intake |
| 6. Indicator Light Cluster | 21. Fuses |
| 7. Steering Pole | 22. Battery |
| 8. Fuel Tank Cap | 23. Rear Access Cover |
| 9. Engine Cover Latch | 24. Automatic Bilge Pump |
| 10. Oil Injection Reservoir Cap | 25. "Moto" Seat Release Button |
| 11. Air Intake Opening | 26. "Moto" Seat Post Receiver |
| 12. Bow and Stern Eyelets | 27. "Moto" Seat Post Release Lever |
| 13. Boarding Pad | 28. Kart Seat Latch |
| 14. Rear Platform | 29. Steering Pole Retainer |
| 15. Cooling System Bleed Outlet | |

CONTROLS/INSTRUMENTS/EQUIPMENTS FUNCTIONS

1) Safety Lanyard (engine cut-off cord)

The safety lanyard cap should be securely snapped onto its post to be fully operational.

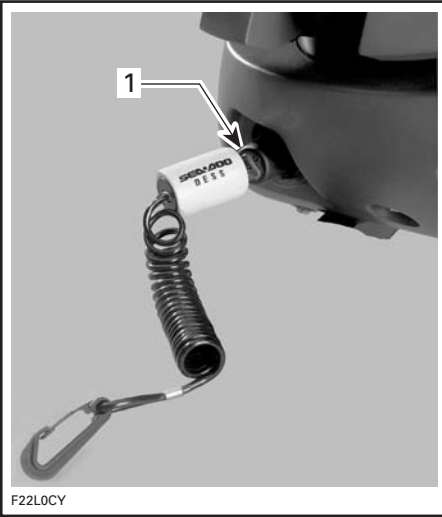

1. Safety lanyard on its post

Pulling the safety lanyard cap from its post stops the engine operation.

⚠ WARNING

While engine can be stopped using the engine start/stop button, good habits recommend that the safety lanyard also be disconnected when stopping.

Attach the safety lanyard to the operator's Personal Flotation Device (PFD) and snap the cap to the post to be able to start the engine.

Two short beeps indicates the system is ready to allow engine starting. Otherwise, refer to the *TROUBLESHOOTING* section for the coded signals chart.

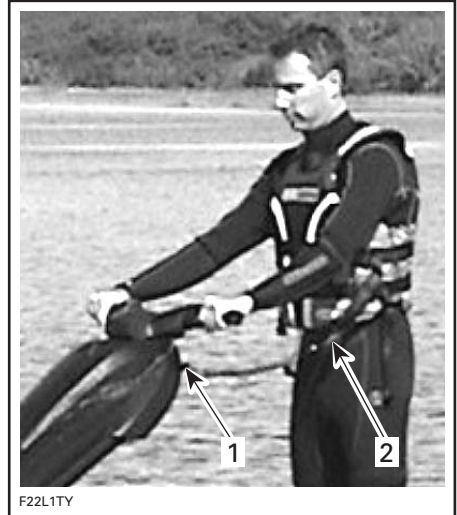

1. Safety lanyard cap on the post
2. Safety lanyard secured on operator's PFD



1. Safety lanyard cap on the post
2. Safety lanyard secured on operator's PFD

⚠ WARNING

Should the engine be stopped, watercraft directional control is lost. Always disconnect safety lanyard in order to prevent accidental engine starting or to avoid unauthorized use by children or others or theft.

If engine is not started within 5 seconds after installing the safety lanyard on its post, 4 very short beeps every 3 second interval will sound for approximately 2 hours to remind you to start the engine or to remove safety lanyard. Afterwards, the beeps will stop. The same will occur when safety lanyard is left on its post 5 seconds after engine is stopped.

Always ensure safety lanyard is not left on its post after engine is stopped.

IMPORTANT: Leaving the safety lanyard on its post when engine is not running will slowly discharge the battery.

Digitally Encoded Security System (DESS™)

The safety lanyard cap specifically contains an electronic circuit that gives it a unique electronic serial number. This is the equivalent of a conventional key.

This safety lanyard cannot be used on another watercraft and conversely, the one from another watercraft cannot be used on your watercraft.

However, the DESS brings a great flexibility. You can buy an additional safety lanyard and have it programmed for your watercraft.

To have additional safety lanyard, refer to an authorized Sea-Doo dealer.

Limited-Speed Operation

This model is also equipped with special safety lanyard.

The SEA-DOO Learning Key™ electronically limits the speed of the watercraft, therefore enabling first time users and less experienced operators to learn how to operate the watercraft while gaining the necessary confidence and control.

SEA-DOO Learning Key

With the SEA-DOO Learning Key™, the watercraft speed is limited to approximately 55 km/h (35 MPH).



2) Handlebar

The handlebar controls the direction of the watercraft. Turning the handlebar to the right steers the watercraft to the right and inversely.

⚠ WARNING

Check handlebar and corresponding steering nozzle operation before starting. Never turn handlebar while someone is nearby rear of watercraft. Keep away from steering moving parts (nozzle, linkage etc.).

This watercraft features the O.T.A.S. system. Refer to *THROTTLE LEVER* for more information.

3) Handlebar Adjuster

⚠ WARNING

Always stop engine and bring watercraft to a complete stop before adjusting handlebar.

The handlebar is adjustable to suit driver's preferences when driving watercraft depending on the configuration installed and used.

Lift the adjuster and hold while moving handlebar to the desired position. When handlebar is in position, release adjuster.

There are 3 positions. Notice that in the rearward position it is appropriate to use your index finger to activate the throttle. In the forward position, the thumb is more appropriate.

Notice there are 2 start/stop buttons. Use the button that is the most appropriate to you. Practice its use before riding the watercraft.

WARNING

Prior to using the watercraft:

- Ensure handlebar is properly adjusted and locked.
- Locate and practice using start/stop button.

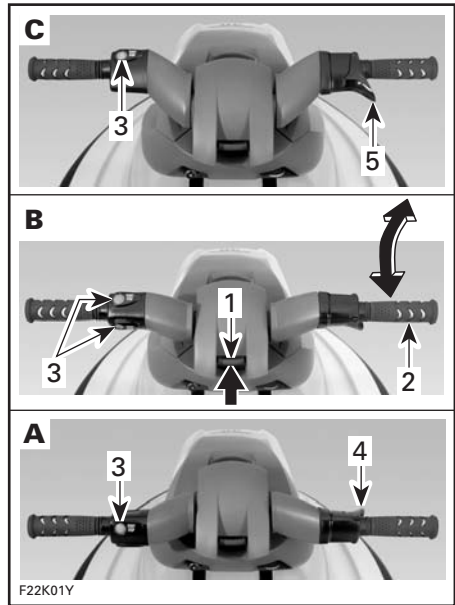

1. Handlebar adjuster
 2. Handlebar
 3. Start/stop buttons
 4. Index finger position
 5. Thumb position
- A. Rearward position
B. Middle position
C. Forward position

4) Throttle Lever

When the throttle lever is squeezed, the watercraft accelerates. When fully released, engine automatically slows down to idle speed and watercraft is gradually stopped by water drag.

Adjusting handlebar height changes the throttle lever position. Refer to *HANDLEBAR ADJUSTER* above.

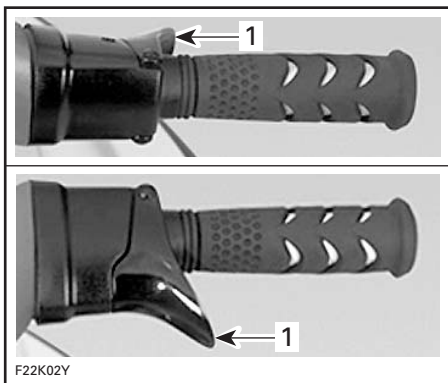

1. Throttle lever

O.T.A.S.[™] System (Off-Throttle Assisted Steering)

The O.T.A.S. (Off-Throttle Assisted Steering) system provides additional maneuverability in off-throttle situations. The O.T.A.S. system is electronically activated and slightly increases engine speed under a pre-programmed RPM when the driver initiates a full turn. When handlebar is brought back to its center position, the throttle reverts to idle.

5) Engine Start/Stop Button

To start engine, depress and hold the start/stop button. Release immediately after engine is started.

To stop engine, fully release throttle lever then depress the start/stop button.

Remember to disconnect safety lanyard from its post.

WARNING

Directional control is reduced when the throttle is released and lost when engine is off.

Adjusting handlebar height changes the start/stop button position. Refer to *HANDLEBAR ADJUSTER* above.

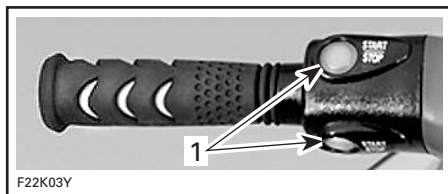

1. Engine start/stop buttons

6) Indicator Light Cluster

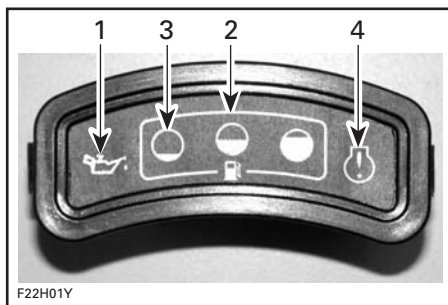

1. Low oil warning light
2. Fuel level lights
3. Low fuel level light
4. Warning light

When installing safety lanyard, all lights will turn on for a brief moment. This confirms their operation.

The low oil warning light will turn on whenever oil level is low in reservoir.

CAUTION: Always replenish oil reservoir as soon as possible to avoid serious engine damage.

When safety lanyard is installed and fuel tank is full, all fuel level lights are continuously turned on. As fuel level goes down, the fuel level lights will turn off one at a time to indicate remaining fuel.

As a reserve indicator, the beeper will turn on and the low level light will continuously blink when roughly 5 L (1.3 U.S. gal.) is left. When roughly 3 L (.8 U.S. gal.) is left, the light will turn off. The beeper will remain on until tank is refilled. Refer to the *TROUBLESHOOTING* section for the coded signals.

The warning light will turn on whenever there is a problem with the engine management system. It will blink when there is a problem with the O.T.A.S.™ system or the electric bilge pump.

NOTE: When engine is not running and safety lanyard is on its post, the warning light will remain turned on until safety lanyard is removed.

7) Steering Pole

In “vert” configuration, the steering pole can be moved up and down while driving to suit various riding position.

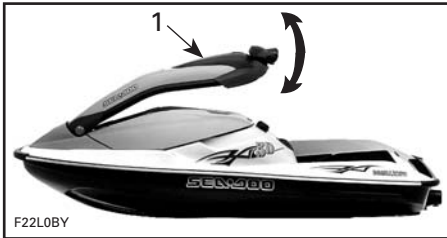

1. Steering pole

Steering pole weight is reduced at the handlebar by the action of a return spring. You may want to change the weight feeling at the handlebar, there is an adjustment for that purpose. If you install or remove the “moto” seat, you may want to readjust the spring tension.

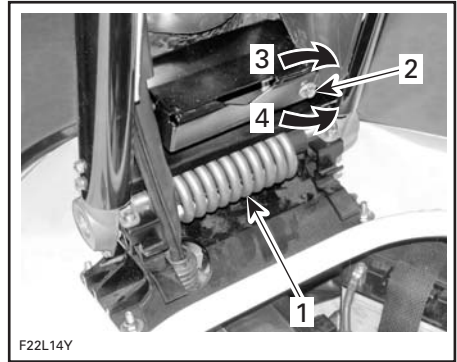

1. Return spring
2. Adjustment
3. To reduce weight at handlebar
4. To add weight at handlebar

Ensure to adjust handlebar to the desired position before use. Refer to *HANDLEBAR ADJUSTER*.

8) Fuel Tank Cap

Unscrew the cap counterclockwise. After fueling, reinstall cap and fully tighten.

WARNING

Always stop the engine before refueling. Fuel is flammable and explosive under certain conditions. Always work in a well ventilated area. Do not smoke or allow open flames or sparks in the vicinity. Fuel tank may be pressurized, turn cap slowly when opening. Never use an open flame to check fuel level. When fueling, keep watercraft level. Do not overfill or top off the fuel tank and leave watercraft in the sun. As temperature increases, fuel expands and might overflow. Always wipe off any fuel spillage from the watercraft. Periodically verify fuel system.

9) Engine Cover Latch

CAUTION: Removing engine cover should be done only when the watercraft is out of the water. Removing engine cover while on water might allow water to enter and to fill the bilge. If you need to reach the storage area or the fire extinguisher while on water, first turn off engine. Ensure to be on calm water and adopt a stable stance. Partially open engine cover just enough to reach the storage area. Close and relatch engine cover as quickly as possible.

Removing the engine cover gives access to the fire extinguisher storage area, storage tray, tool kit and the engine compartment.

First, stop the engine then raise and stabilize the steering pole at its highest position.

Pull the latch lever upward to unlock the engine cover.

Lift up the rear portion of engine cover, and pull rearward to remove.

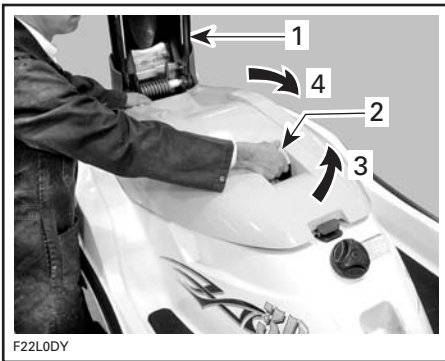

1. Steering pole at its highest position
2. Engine cover latch
3. Pull upward
4. Lift cover

Install steering pole holder to prevent pole from falling down.

WARNING

Always install steering pole holder immediately after engine cover removal to support the pole securely while working in the engine compartment. Otherwise, the steering pole may fall unexpectedly and hit any person underneath.

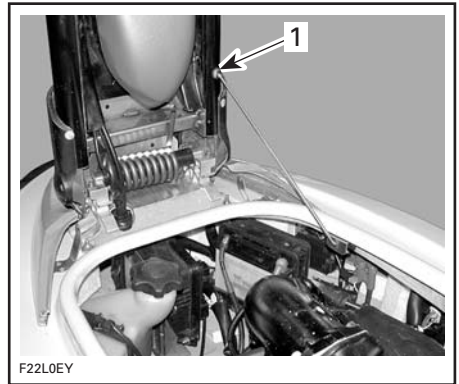

1. Insert holder here

WARNING

Components inside engine compartment may be hot. When starting or operating the engine, do not touch any electrical part. Never leave any object, rag, tool, etc., in the engine compartment or in the bilge.

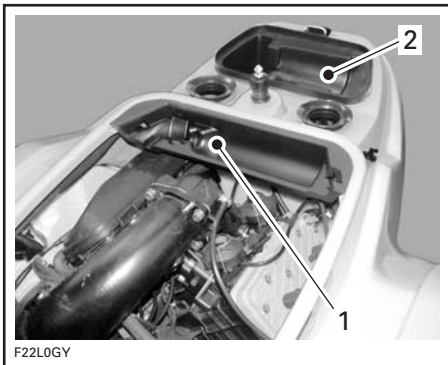

1. Fire extinguisher storage area
2. Storage tray

When done, unhook the steering pole holder and place the end in its receptacle as shown.

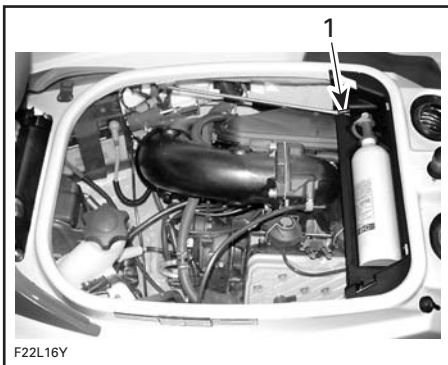

1. Holder end here

Ensure fire extinguisher is properly positioned in its location prior to reinstalling engine cover.

When reinstalling engine cover, properly insert engine cover tab into C-hook of body.

A distinctive snap will be felt when engaging the engine cover latch. Make sure the engine cover is secure by giving it a tug. If the engine cover cannot be latched easily, check to make sure the fire extinguisher is positioned properly and no object in the storage tray is interfering with the engine cover.

⚠ WARNING

To prevent pinching your fingers in the latch when installing the engine cover, always hold it by putting your hand in the recess designed for that purpose and identified by a pictogram.

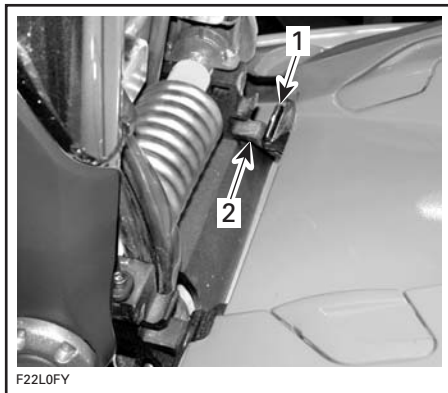

1. Tab
2. C-hook

Ensure to relatch engine cover. If engine cover cannot be latched, check position of fire extinguisher and if objects on storage tray prevent engine cover to latch.

NOTE: Verify periodically the lock pin tightness of engine cover. Tighten if needed and make sure engine cover latches properly.

Fire Extinguisher Storage Area

Referring to the above illustration in *ENGINE COVER LATCH*, that area includes an area to store an approved fire extinguisher (sold separately). Ensure to properly position fire extinguisher prior to installing engine cover.

CAUTION: Ensure to properly position fire extinguisher.

Storage Tray

Referring to the above illustration, that area is a convenient tray to store personal articles. The tray is designed to receive the "Safety equipment for small vessel kit" (sold separately).

Tool Kit

Tool kit is located in storage tray. It includes tools needed to perform basic watercraft maintenance.

10) Oil Injection Reservoir Cap

Remove engine cover to expose oil reservoir cap. Lock steering pole with the holder.

WARNING

Always install steering pole holder immediately after engine cover removal to support the pole securely while working in the engine compartment.

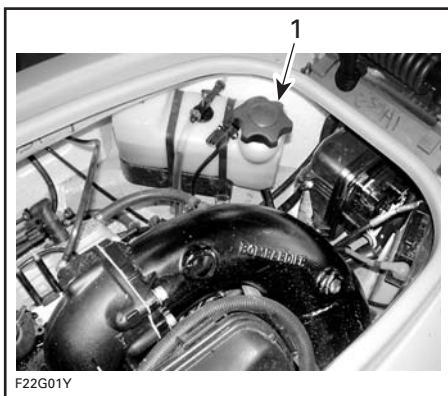

1. Oil injection reservoir cap

To add injection oil in the reservoir, unscrew the cap counterclockwise. Do not overfill.

Reinstall cap and fully tighten.

WARNING

Do not overfill. Reinstall cap and fully tighten. Oil is flammable. Always wipe off any oil spillage from the bilge.

Unlock steering pole and secure its holder.

Reinstall engine cover and relatch.

11) Air Intake Opening

Allows air into the bilge for ventilation purposes and engine supply. If the air intake opening is kept under water, water will get inside the bilge under certain circumstances.

CAUTION: If the air intake opening is kept under water, such as when turning constantly in tight circles, water will get inside the bilge, which may cause severe damage to internal parts of the engine.

12) Bow and Stern Eyelets

Eyelets can be used for mooring or as a tie-down points during trailering.

Bow Eyelet



1. Bow eyelet

Stern Eyelet

These eyelets can be used for tie-down purposes.

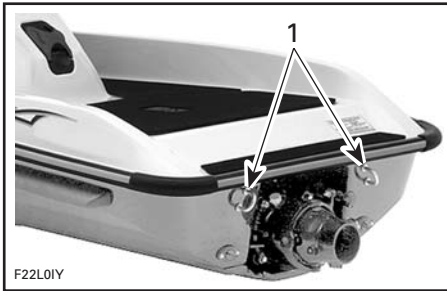

F22L01Y

1. Stern eyelets

13) Boarding Pads

Provide a cushioned surface for the knees when boarding.

14) Rear Platform

Provides a large surface to position your feet in the "vert" configuration. It also provides a convenient surface for easy boarding.

15) Cooling System Bleed Outlet



F22L0HZ

1. Bleed outlet

When engine is running, water should flow out of the outlet. This allows air in engine cooling system to escape. It also confirms that water is circulating in the cooling system.

NOTE: It may be required to increase slightly the engine RPM to see the water flowing out.

CAUTION: Should water not flow from outlet a few seconds after engine starts, immediately stop engine and refer to *POST-OPERATION CARE* and look for *COOLING SYSTEM FLUSHING* or refer to an authorized Sea-Doo dealer for servicing.

16) Flushing Connector

A convenient connector is provided to allow easy installation of a garden hose to flush the cooling system.

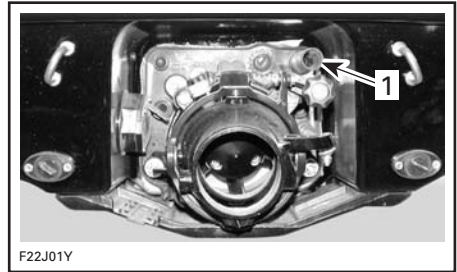

F22J01Y

1. Flushing connector

Refer to *POST-OPERATION CARE* section for proper use.

17) Bilge Drain Plugs

Should water be found in the bilge, it can be easily drained by unscrewing the drain plugs when engine is off and watercraft is out of the water.

CAUTION: Always take the watercraft out of the water prior to unscrewing drain plugs.

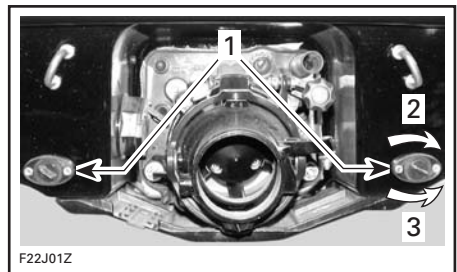

F22J01Z

1. Drain plugs
2. Tighten
3. Unscrew

Tilt the watercraft slightly to the rear so that the water can flow out of the bilge completely.

It is suggested to drain bilge when the watercraft is on a ramp.

CAUTION: Make sure the drain plugs are properly secured prior to launching the watercraft in the water.

18) Jet Pump Nozzle

Jet pump nozzle turns side to side via rider input at the handlebar. This provides directional control when engine is running.

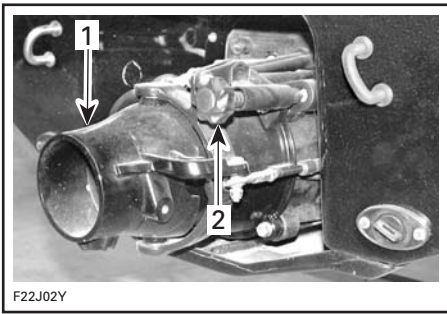

F22J02Y

1. Jet pump nozzle
2. VTS adjuster

19) VTS Adjuster (if so equipped)

A trim knob is used to change the jet pump nozzle trim angle manually and to adjust the ride to suit water conditions and driver preferences. Refer to illustration above.

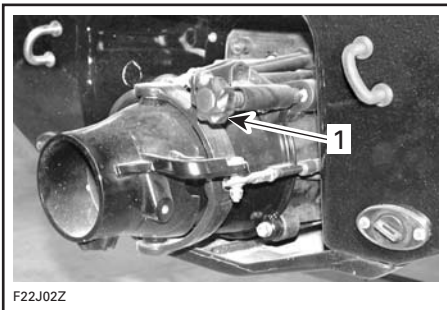

F22J02Z

1. Trim knob

There are reference numbers to indicate nozzle position and to facilitate fine tuning.

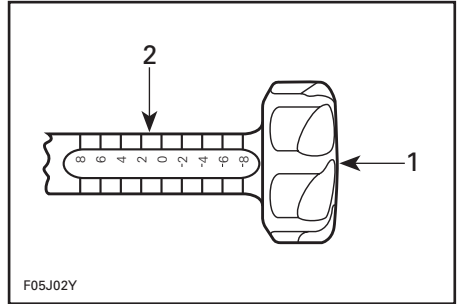

F05J02Y

1. Trim knob
2. Reference numbers

20) Jet Pump Water Intake

The water is drawn in by the impeller through this opening. The water intake grate minimizes the entry of foreign objects into the propulsion system.

⚠ WARNING

Keep away from intake grate while engine is on. Items such as long hair, loose clothing or personal flotation device straps could potentially become entangled in moving parts resulting in severe injury or drowning.

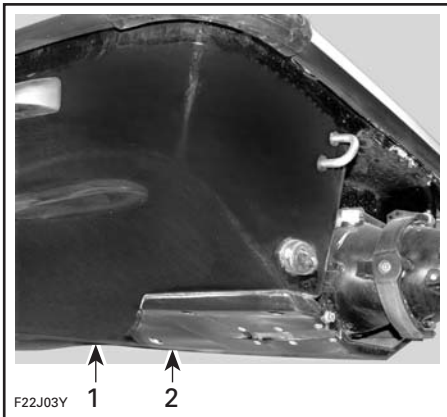

1. Water intake
2. Ride plate

21) Fuses

The fuses are located in the engine compartment. Refer to *MAINTENANCE* for more details.

22) Battery

The battery is located in the engine compartment. Refer to *SPECIAL PROCEDURES*.

23) Rear Access Cover

NOTE: If the “moto” seat is installed, stow it into steering pole. Refer to *“MOTO” SEAT INSTALLATION/STOWAGE*. If the kart seat is installed, remove it. Refer to *KART SEAT INSTALLATION/REMOVAL*.

The cover gives access to the drive system, exhaust system, bilge pump and bailer pick-ups.



1. Rear access cover

To remove cover, use a small screwdriver to pry caps off.

Use the small socket supplied in toolkit to remove screws then pull cover out.

At installation, tighten screws in a criss-cross pattern then reinstall caps.

24) Automatic Bilge Pump

The bilge pump evacuates water from the bilge.

When safety lanyard cap is installed on its post, the bilge pump is automatically turned on. It will remain on until all water is evacuated, then it will shut down automatically.

When engine is running, the bilge pump will automatically start periodically to evacuate water.

25) “Moto” Seat Release Button

This button is used to unlatch the “moto” seat stowed into the steering pole.

CAUTION: Prior to using this button, ensure that the steering pole is raised to its highest position and is held there firmly.

NOTE: It is suggested to deploy or stow the “moto” seat when the watercraft is out of the water or when securely docked. If this is not possible, it should be done on calm water.

"Moto" Seat Installation

WARNING

Before installing or stowing the "moto" seat.

- Stop the watercraft in a safe area away from traffic or obstacles.
- Turn off engine.
- Be on the look out for other crafts or obstacles. Your watercraft could drift while changing configuration.

Raise the steering pole to its highest position and firmly hold there.

With the other hand, pull the release button.



1. Release button

Pull the "moto" seat out of the steering pole.

CAUTION: Pay attention so that the "moto" seat does not rub against the engine cover.

Rotate the seat out, raise and pull rearwards. Hold in this position.



Keep the seat high enough to pull the seat post out.

CAUTION: Ensure to maintain the seat high enough so as to have room to pull the seat post out without touching the body.

Pull the red locking lever rearward and pull the post out of the seat.

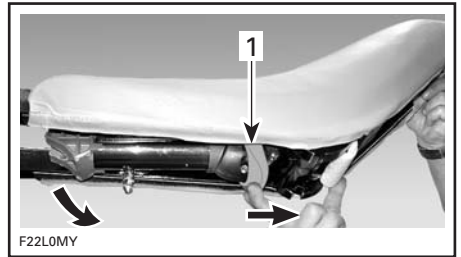

1. Lock lever



Rotate the post to a vertical position and move the seat to line up the post with its receiver.

NOTE: Notice that when rotating post, it will lock at an intermediate position. Push the red lever again to release the lock and continue to rotate post until it becomes vertical.

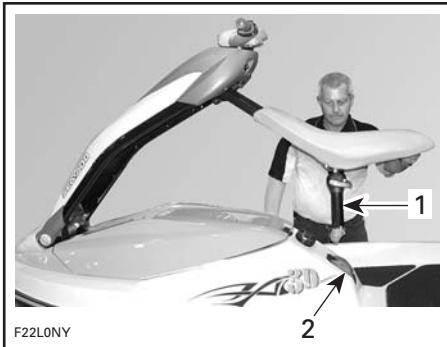

1. Post vertical
2. Receiver

Lift the receiver cap and hold open while inserting the seat post in receiver. Ensure post knuckle is fully inserted into the receiver.



1. Lift receiver cap

To lock post in position:

- Slide seat rearward.
- Firmly push seat down. You should hear a “clunk”.

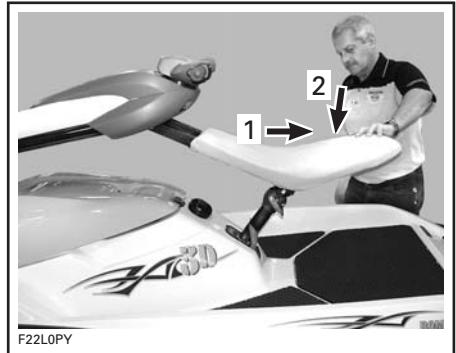

1. Slide seat rearward
2. Firmly push seat down

Ensure the seat is properly locked by pulling up on it.

⚠ WARNING

To avoid loss of control, always ensure that the seat is properly locked in prior to operating the watercraft.

Adjust steering to the desired position before use. Refer to *HANDLE-BAR ADJUSTER*.

CAUTION: Never ride with the “mo-to” seat resting directly on the deck as the seat could damage the deck.



"Moto" Seat Stowage

Unlock the seat post by lifting the red locking lever while firmly holding the steering pole by the handlebar.

NOTE: Pushing down on handlebar can ease to unlock seat.



1. Hold steering pole

Push the seat forward so that the seat post becomes vertical. Lift the seat to release the post from its receiver.



1. Seat post vertical

Keep the seat high enough and rotate the post into seat.



Firmly push the post in the seat until you hear a "clunk".

CAUTION: Make sure to maintain the seat high enough so that the post clears the body when rotated forward into the seat. Make sure that the post is latched properly.

Keep steering pole high enough and rotate seat in steering pole. Firmly push seat in steering pole until you hear a "clunk".



CAUTION: Make sure to maintain the steering pole high enough so that the "moto" seat clears the engine cover when rotated forward into the pole.

26) "Moto" Seat Post Receiver

The receiver locks the seat post into position on the deck. For instructions, refer to "MOTO" SEAT INSTALLATION/STOWAGE above.

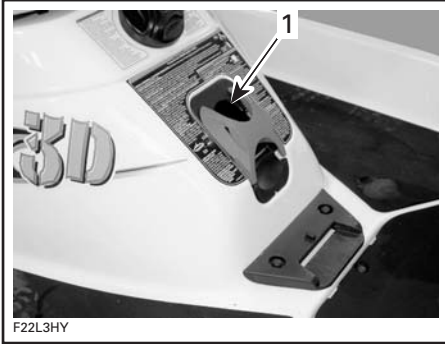

1. Receiver

27) "Moto" Seat Post Release Lever

The lever releases the seat post from within the seat. It is used also to release the post from its receiver on the deck. For instructions, refer to "MOTO" SEAT INSTALLATION/STOWAGE above.

28) Kart Seat Lever (if so equipped)

The lever releases the latch locking the seat on the deck.

WARNING

Only remove or install the kart seat when the watercraft is out of the water or docked securely on calm water.

Seat Installation

WARNING

Before installing or removing kart seat:

Only install or remove the kart seat when the watercraft is out of the water or docked securely on calm water.

With the seat slightly angled forward, insert the seat front tab into the anchor plate on the deck.

Line up the pin located underneath the seat with the hole in the deck, then push down to latch the seat.

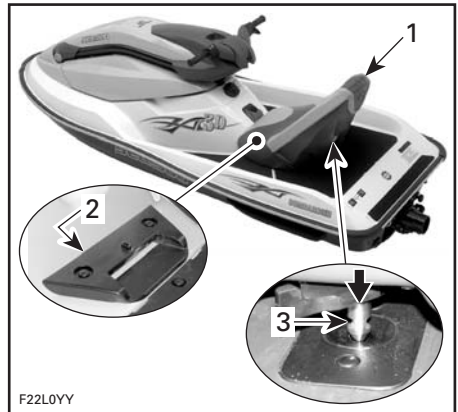

1. Kart seat
2. Anchor plate
3. Insert pin in hole

WARNING

Always make sure that the seat is installed properly and securely locked in place before operating the watercraft.

If you cannot rest your feet comfortably on the footrests, install the footrest spacers (refer to your authorized Sea-Doo dealer for more information). This will help achieve a more stable riding position.

The spacers have 2 steps to accommodate different rider heights. Use the one that best suits your leg size. Make sure to latch the spacers securely in the footwells of the watercraft.

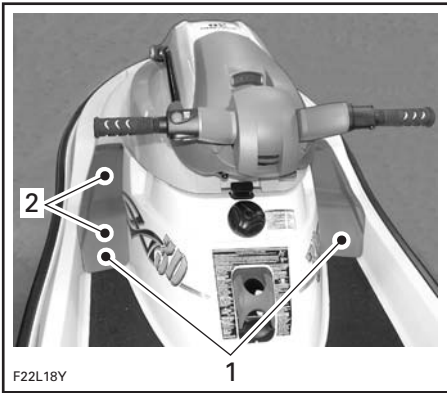

1. Footrest spacers
2. Two available steps

⚠ WARNING

Never operate the watercraft with the kart seat installed unless the steering pole is securely locked down. Never sit on the kart seat backrest for riding. This position does not allow sufficient control of the watercraft which can lead to serious injuries.

Seat Removal

Push and hold the lever as shown to release the latch, then lift the rear of seat up. Pull up the seat out of the anchor plate.

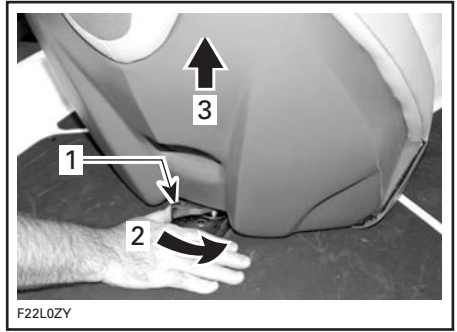

1. Lever
2. Push and hold
3. Lift seat

CAUTION: To prevent permanent deformation of the foam shape, always store the seat right side up and never leave any object on it.

29) Steering Pole Retainer (if so equipped)

NOTE: Only lock or unlock the steering pole when the watercraft is out of the water or docked securely on calm water.

When using the kart seat, it is necessary to lock the steering pole down with this retainer to prevent any vertical movement.

Pull the retainer out of the steering pole and hold while lowering the pole into position.

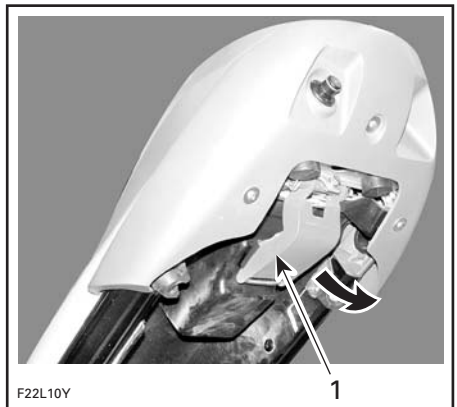

1. Pull retainer out

Continue lowering the steering pole down until the retainer can be inserted into the body hook. Then, push retainer to lock in position.

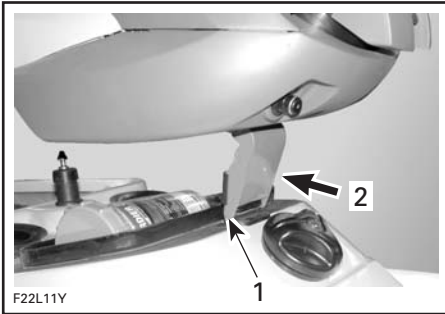

1. Position retainer in body hook
2. Push to lock

LIQUIDS

CAUTION: Scrupulously follow the instructions of this section. Failure to do so may reduce the engine's life and/or performance.

Fueling Procedure

WARNING

Follow these safe boating fueling instructions explicitly.

Turn off engine.

Do not allow anyone to remain on the watercraft.

Tie watercraft securely to the fueling pier.

Have a fire extinguisher close at hand.

Do not insert the spout too far in filler neck.

Pour fuel slowly so that air can escape from the tank and prevent fuel flow-back. Be careful not to spill fuel.

Stop filling when the fuel reaches the bottom of filler neck. Do not fill into the filler tube to prevent fuel spill out. Do not overfill. Fully tighten fuel tank cap.

WARNING

Always stop the engine before refueling. Fuel is flammable and explosive under certain conditions. Always work in a well ventilated area. Do not smoke or allow open flames or sparks in the vicinity. Fuel tank may be pressurized, turn cap slowly when opening. Never use an open flame to check fuel level. When fueling, keep watercraft level. Do not overfill or top off the fuel tank and leave watercraft in the sun. As temperature increases, fuel expands and might overflow. Always wipe off any fuel spillage from the watercraft. Periodically verify fuel system.

Recommended Fuel

Use unleaded regular gasoline with the following recommended minimum octane number.

LOCATION	OCTANE NUMBER
Inside North America	87 octane (RON + MON)/2
Outside North America	91 RON

NOTE: Do not mix oil with fuel. Always check injection oil reservoir level when refueling.

CAUTION: Never experiment with other fuels or fuel ratios. Never use fuel containing more than 10% alcohol, (ethanol or methanol). The use of non-recommended fuel can result in watercraft performance deterioration and damage to critical parts in the fuel system and engine components.

CAUTION: On DI models, never use injector cleaning products. They may contain additive that could damage injector components.

Recommended Oil

WARNING

Do not overfill. Reinstall cap and fully tighten. Oil is flammable. Always wipe off any oil spillage from the bilge.

Use only two-stroke engine injection oil sold by authorized Sea-Doo dealers.

MODELS	OIL TYPE
3D™ DI (1)	XP-S synthetic 2-stroke oil

CAUTION: (1) The XP-S synthetic 2-stroke oil is specially formulated and tested for the severe requirements of the 947 DI engines. Use of any other brand two-stroke oil may void the limited warranty. Use only XP-S synthetic 2-stroke oil. There is no known equivalent on the market for the moment. If a high quality equivalent were available, it could be used.

The XP-S synthetic 2-stroke oil provides superior lubrication, reduced engine component wear and oil deposit, thus maintaining maximum-level performance and anti-friction properties. This synthetic injection oil meets the latest ASTM and JASO standards by ensuring high biodegradability and low exhaust smoke.

CAUTION: Never use four-stroke petroleum or synthetic motor oil and never mix these with outboard motor oil. Do not use NMMA TC-W, TC-W2 or TC-W3 outboard two-stroke engine oils or ashless two-stroke engine oils. Avoid mixing different brands of API TC oil as resulting chemical reactions may cause severe engine damage.

CAUTION: DO NOT allow any four-stroke oil to be used, or put two-stroke oil into a used four-stroke oil container. If any four-stroke oil enters the system, the entire oil system (pump, reservoir, lines, valves etc) must be thoroughly cleaned out.

Oil Injection System

This watercraft features an oil injection system which does not require manual fuel/oil mixing.

A sufficient amount of injection oil should be maintained in the reservoir.

The use of a funnel is recommended to pour the oil into the reservoir. Stop filling as soon as oil appears at approximately 13 mm (1/2 in) from top of reservoir. Do not overfill.

CAUTION: Always maintain a sufficient amount of injection oil in the oil reservoir. Check and refill every time you refuel if necessary. Do not overfill. If the engine runs out of oil, severe engine damage will occur. If the oil reservoir is found almost empty, air can enter in the system and it should be bled. Immediately refer to an authorized Sea-Doo dealer to have the oil injection system inspected.

BREAK-IN PERIOD

CAUTION: Scrupulously follow the instructions of this section. Failure to do so may reduce the engine's life and/or performance.

With Sea-Doo watercraft powered by Rotax® engines, a break-in period of 10 hours is required before continuous operation at full throttle.

To achieve a good break-in, vary the engine speed every few minutes with brief wide open throttle accelerations of up to 15 seconds.

NOTE: DO NOT add injection oil in the fuel tank for the break-in.

CAUTION: Continued wide open throttle runs and prolonged cruising without speed variations should be avoided, this can cause engine damage during the break-in period.

10-Hour Inspection

NOTE: The 10-hour inspection is at the expense of the watercraft owner.

It is highly recommended that after the first 10 hours of operation, the watercraft be checked by an authorized Sea-Doo dealer. This inspection will also provide the opportunity to discuss the unanswered questions you may have encountered during the first hours of operation.

PRE-OPERATION CHECKS

WARNING

The pre-operation check is very important prior to operating the watercraft. Always check the proper operation of critical controls, safety features and mechanical components, before starting as listed hereinafter. If not done as specified here, severe injury or death might occur. Bring all safety equipment required by local laws.

Some of the following items may not have been previously covered in this guide, however they will be described in the *MAINTENANCE* or *SPECIAL PROCEDURES* section. Please refer to these sections to have more detailed information.

WARNING

Engine should be off and the safety lanyard should always be removed from its post prior to verifying any of the following points. Only start watercraft once all items have been checked and operate properly.

ITEM	OPERATION	✓
Hull	Inspect.	
Jet pump water intake	Inspect/clean.	
Bilge	Drain. Ensure plugs are secured.	
Water flow in cooling system (only when temperature is below or close to freezing point)	Check if water properly flows out at jet pump.	
Battery	Inspect tightness of cables and retaining bracket(s)	
Fuel tank and oil reservoir	Refill.	
Engine compartment	Check fuel line connections for tightness. Check for any fuel leak/odor.	
Steering system	Check operation and proper handlebar position.	
Steering pole	Check operation.	
Throttle system	Check operation.	
VTS (if so equipped)	Check position and adjustment.	
Safety lanyard and engine start/stop button	Check operation.	
Optional configurations	Check installation and settings.	

NOTE: See the detailed instructions hereinafter.

Hull

Inspect hull for cracks or damage.

Jet Pump Water Intake

Remove weeds, shells, debris or anything else that could restrict the flow of water and damage cooling system or propulsion unit. Clean as necessary. If any obstruction can not be removed, refer to an authorized Sea-Doo dealer for servicing.

Inspect leading edges of the impeller, if they have nicks or bends performance will be greatly reduced.

Bilge

Should water be present in the bilge, install safety lanyard on its post to start the electric bilge pump. If some water remains in bilge, tilt the watercraft to the rear and unscrew drain plugs to completely empty the bilge.

Secure bilge drain plugs.

WARNING

Make sure drain plugs are properly secured prior to launching the watercraft in water.

Water Flow in Cooling System (only when temperature is below or close to freezing point)

In Northern areas, if watercraft is to be used when temperature is below or close to freezing point (0°C (32°F)) or if watercraft was left unused while temperature was below or close to freezing point, water may be frozen in cooling system hoses. This could cause cooling system overheating. To ensure it is properly working, do the following prior to using the watercraft:

- The procedure is to be performed with watercraft out of water.
- Connect a garden hose to the flushing connector at jet pump.

- Perform the flushing operation as explained in *POST-OPERATION CARE*.
- Ensure water flows out of jet pump. Otherwise, water is frozen in cooling system and restricts water flow. Do not operate the watercraft in this condition.

NOTE: Pay attention that some water will also flow out of exhaust outlet. Make sure water is effectively flowing out of jet pump.

CAUTION: Operating watercraft with frozen water in cooling system might lead to engine components damage.

NOTE: When water freezes, damage to engine components should not occur because of water expansion, but because it prevents full flow of cooling water.

- Either wait until ice melts or pour some hot water to cooling system components and to engine. Then, perform the flushing operation again to make sure water properly flows out of jet pump. If you need assistance, refer to an authorized Sea-Doo dealer.

WARNING

Do not use any electrical heating device to heat the cooling system. Electrical devices may generate sparks that would ignite fuel vapors that might be present in the bilge causing a fire or an explosion.

- Ensure to drain bilge if water is present.

Battery

WARNING

Verify tightness of battery cables to their posts and condition of battery retaining bracket(s)/fasteners. Do not charge or boost battery while installed.

Fuel Tank and Oil Reservoir

With the watercraft horizontal, fill the fuel tank.

Check the oil level and refill reservoir as necessary.

Check fuel tank and oil reservoir retaining straps/fasteners.

Engine Compartment

WARNING

Should any leak or gasoline odor be present, do not start the engine. Refer to an authorized Sea-Doo dealer before use.

Steering System

With the assistance of another person, check the steering system for free operation. When the handlebar is horizontal, the jet pump nozzle should be in the straight ahead position. Make sure the handlebar is adjusted to suit your preference and to allow proper use the throttle lever.

WARNING

Check handlebar and corresponding steering nozzle operation before starting. Never turn handlebar while someone is close to the rear of watercraft. Keep away from steering moving parts (nozzle, linkage etc.).

Steering Pole

Check steering pole up and down movement for free and smooth operation. Pay attention to the weight feeling of the pole. It can be adjusted. Refer to *CONTROLS/INSTRUMENTS/EQUIPMENTS*.

Throttle System

Check throttle lever for free and smooth operation. It should return to its initial position immediately after it is released.

WARNING

Check throttle lever operation before starting the engine.

VTS (Variable Trim System) (if so equipped)

Make sure VTS is adjusted to suit your preference in accordance with the water conditions.

Safety Lanyard and Engine Start/Stop Button

Make sure that both switches operate properly. Start engine and stop it using each switch individually.

WARNING

Should the safety lanyard cap be loose or fail to remain on its post, replace it immediately in order to avoid unsafe use.

Optional Configurations

Refer to *CONTROLS/INSTRUMENTS/EQUIPMENTS*.

WARNING

To make sure you are in a riding position that allows you to be in control of the watercraft, always check that any optional seat or accessory that you are using are properly latched and stable before turning on the watercraft engine.

OPERATING INSTRUCTIONS

⚠ WARNING

Always perform the *PRE-OPERATION CHECKS* before operating the watercraft. Become thoroughly familiar with all controls and the function of each. Should any control or instruction not be fully understood, refer to an authorized Sea-Doo dealer.

This watercraft is designed for one person only.

⚠ WARNING

- Never allow a passenger on-board. This watercraft is for an operator only.
- Passenger does not have a stable seat and could lack stability and be thrown off, which could lead to severe injuries.

Principle of Operation

Propulsion

The engine is directly coupled to a drive shaft which, in turn, rotates an impeller. This impeller is accurately adjusted in a housing where the water is drawn up from underneath the watercraft. Then the water flows through the impeller to a venturi. The venturi accelerates the water and produces thrust to move the watercraft. Depressing the throttle lever increases engine speed and therefore watercraft speed.



⚠ WARNING

Whenever the engine is to be started, the operator should always be properly standing or sitting on the watercraft and be wearing protective clothing including a Coast Guard approved PFD and a wet suit bottom.

⚠ WARNING

Keep away from intake grate while engine is on. Items such as long hair, loose clothing or personal flotation device straps can become entangled in moving parts resulting in severe injury or drowning.

Variable Trim System (if so equipped)

The variable trim system (VTS) changes the angle of the jet pump nozzle to provide the operator with a fast, effective system to compensate for load, thrust, riding position and water conditions. Correctly adjusted, it can improve handling, reduce porpoising, and position the watercraft at its best riding angle to attain maximum performance.

When first using the watercraft, the operator should become familiar with the use of the variable trim system (VTS) at varying speeds and water conditions. A mid-range trim is generally used when cruising. Experience alone will dictate the best trim for the conditions. During the watercraft break-in period, when lower speeds are recommended, it is an excellent opportunity to gain familiarity of trim adjustment and its effects.

When the nozzle is positioned in an upward angle, the water thrust directs the bow of the watercraft upward. This position is used to optimize high speed.

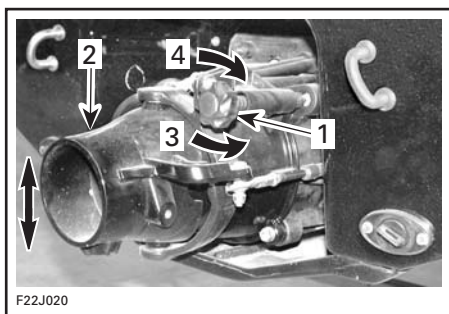

1. Adjuster
2. Nozzle up or down
3. To raise nozzle
4. To lower nozzle

When the nozzle is directed downward, the bow is forced downward and enhances the watercraft turning capabilities. As with any watercraft, speed and operator body position and movement (body English), will determine the degree and sharpness of the watercraft turn. Porpoising can be reduced or eliminated if the nozzle is downward and speed is adjusted proportionately.

Steering



LEFT TURN



RIGHT TURN



LEFT TURN



RIGHT TURN

Turning the handlebar pivots the jet pump nozzle which controls the watercraft direction. Turning the handlebar to the right will turn the watercraft to the right and inversely. The throttle should be applied to turn the watercraft.

In "vert" operation, the steering pole can be moved up and down while driving to suit various riding position.

NOTE: Moving steering pole up or down does not change the watercraft direction.

WARNING

Throttle should be applied and handlebar turned to change the direction of the watercraft. Steering efficiency will differ depending on load, water conditions and environmental factors such as the wind.

Unlike a car, a watercraft needs some throttle to turn. Practice in a safe area applying the throttle and turning away from an imaginary object. This is a good collision avoidance technique.

WARNING

Directional control is reduced when the throttle is released and lost when engine is off.

Keeping your feet spread apart and leaning in while turning may help to keep your balance when riding in "vert" configuration.

CAUTION: Combustion engine needs air to operate; consequently this watercraft cannot be totally watertight. Maneuvers such as figure eights etc., that cause the upper deck to be under water may cause severe engine problems due to water ingestion. Refer to *SPECIAL PROCEDURES* and *LIMITED WARRANTY* contained in this section.

O.T.A.S.™ System (Off-Throttle Assisted Steering)

The O.T.A.S. (Off-Throttle Assisted Steering) system provides additional maneuverability in off-throttle situations. The O.T.A.S. system is electronically activated and slightly increases engine speed when the driver initiates a full turn without throttle. When handlebar is brought back to its center position, the throttle reverts to idle.

We recommend that you familiarize yourself with this feature during your first ride.

Boarding the Watercraft

General

As with any watercraft, boarding should be done carefully and engine should not be running.

WARNING

- Engine should be OFF when boarding the watercraft. Keep limbs away from jet or intake grate.
- Inexperienced riders should practice how to get aboard (all methods explained here) close to shore first before venturing into deep water.
- Never use jet pump components as a supporting point to board the watercraft.

Boarding from a Dock or in Shallow Water

When boarding from a dock, hold the handlebar and carefully place one foot in the middle of the watercraft rear platform. Transfer your body weight to bring the other foot to the platform. Push the watercraft away from the dock.



NOTE: When boarding a watercraft with the “moto” or kart seat configuration, you can use the seat as an additional support point to keep your balance.

In shallow water, board the watercraft either from the side or the rear.

Ensure there is at least 90 cm (3 ft) of water underneath the lowest rear portion of the hull.

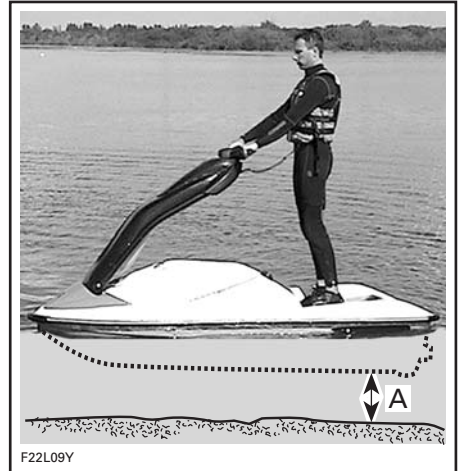

A. Maintain at least 90 cm (3 ft) underneath the lowest rear portion of the hull when you are aboard

Remember that the hull will ride deeper in the water when you are aboard.

CAUTION: Starting the engine or operating the watercraft in shallow water can draw sand, pebbles, or rocks through the jet pump, which might damage the impeller or other pump components.

Boarding in Deep Water

Swim to the rear of the watercraft.



Put your hands on the boarding platform and pull yourself up until your knee can reach the boarding platform, then get on.

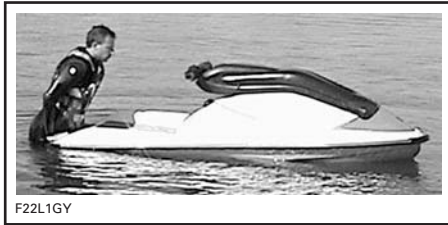

Bring your feet on the rear platform while maintaining balance using the handlebar.

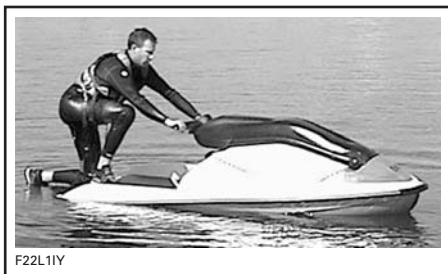

NOTE: When boarding a watercraft with the "moto" seat configuration, you can find helpful to use the seat strap.

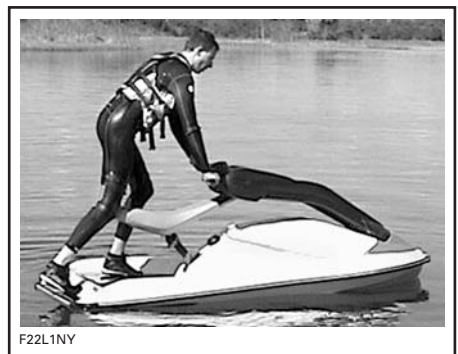
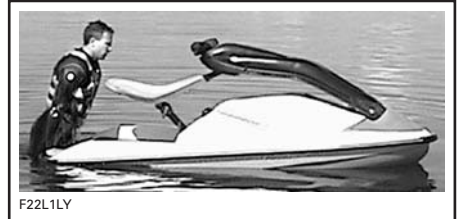

NOTE: When boarding a watercraft with the kart seat configuration (if so equipped), you can use the seat as an additional support point to keep your balance.



F22L10Y

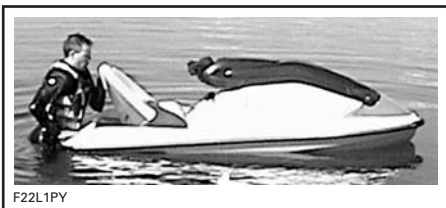

F22L1PY



F22L1QY



F22L1RY



F22L1SY

Once aboard, take the appropriate riding position.

Engine Starting Procedure

Preparation

Before unloading the watercraft from the trailer, it can be started for about 10 seconds to verify proper operation.

WARNING

Components inside the engine compartment may be hot. Keep away from electrical parts or jet pump area when engine is running.

Attach the safety lanyard to your PFD and snap the cap to its post before starting the engine.

NOTE: If you hear anything other than 2 short beeps from DESS system, it indicates a particular condition that should be corrected. Refer to the *TROUBLESHOOTING* section for the meaning of the coded signal.

WARNING

Before starting the engine, the operator should always be properly seated or have a stable stance in the "vert" configuration.

Firmly grip the handlebar with your hands and properly place both feet on the floorboard. In the "vert" configuration, keep both feet spread apart to achieve a stable stance.

CAUTION: Ensure there is at least 90 cm (3 ft) of water underneath the lowest rear portion of the hull when you are onboard prior to starting the engine. Otherwise damage to the impeller or other jet pump components might occur. Do not accelerate abruptly.

To start engine, depress and hold the engine start/stop button. Follow the procedure below for cold or warm engine starting.

NOTE: Never depress the throttle lever to start engine whether it is warm or cold.

Release the engine start/stop button immediately once the engine is started.

If engine fails to start after 10 seconds, wait a few seconds then repeat procedure.

CAUTION: Do not hold the start/stop button more than 30 seconds to avoid starter overheating. A rest period should be observed between the cranking cycles to let the starter cool down. Be careful not to discharge battery.

Riding

Slowly accelerate to reach deeper water. Do not apply full throttle until the engine is warm.

CAUTION: Avoid operating the watercraft in weeded areas. If unavoidable, continuously vary the watercraft speed.

WARNING

- Never attempt to perform jumps or stunts as they could lead to serious injuries or death.
- To make sure your riding position allows you to remain in control and locate any upcoming craft or obstacle, only adopt riding positions that are recommended by the manufacturer.

"Vert" Configuration



When operating the watercraft in the "vert" position, always keep both feet on the platform. Raising a foot increases the possibility of losing your balance and fall.

WARNING

In the event of a fall, do not hold on to the handlebar. Attempting to do so could result in an injury.

CAUTION: Hanging to handlebar while falling might damage the steering pole or other components. The steering pole length multiplies the effect of your weight and this creates an important stress on the watercraft components.

WARNING

In the "vert" configuration, the proper riding position is for the operator to be on the rear platform of the deck, behind the handlebar. Other riding positions may not allow to remain in control of the watercraft or may not offer enough visibility of your surrounding, which could lead to accidents, collisions and possible serious injuries.

"Moto" Configuration

It is recommended to deploy and stow the "moto" seat when the watercraft is out of the water or securely docked. If not possible, it should be done on calm water. Refer to the "MOTO" SEAT RELEASE BUTTON for detailed installation procedure.

WARNING

To avoid loss of control and collisions before deploying or stowing the "moto" seat:

- Stop the watercraft in a safe area, away from traffic or obstacles.
- Turn off the engine.
- Be on the look out for other crafts or obstacles. Your watercraft could drift while changing configuration.

WARNING

To avoid loss of control, always make sure that seat is properly locked in prior to operating the watercraft.

WARNING

In the "moto" configuration, the proper riding position is to sit straddled on the "moto" seat with both feet resting firmly on the deck. Other riding positions may not allow to remain in control of the watercraft or may not offer enough visibility of your surrounding, which could lead to accidents, collisions and possible serious injuries.

Kart Configuration (if so equipped)

Refer to the *KART SEAT LEVER* section for detailed installation procedure.

WARNING

- Only install or remove the kart seat when the watercraft is out of the water or docked securely on calm water.
- To avoid loss of control, always make sure that seat is properly locked in and that the steering pole is locked down, prior to operating the watercraft.

WARNING

- In the kart configuration, the proper riding position is to sit on the kart seat. It is not advisable to ride in the "vert" position (i.e. in a stand-up position) when the kart seat is installed, but if this is unavoidable, proceed at low speed with extra caution. Other riding positions may not allow to remain in control of the watercraft or may not offer enough visibility of your surrounding, which could lead to accidents, collisions and possible serious injuries.
- Never sit on the kart seat backrest for riding. This position does not allow sufficient control of the watercraft and could lead to serious injuries.

Rough Water or Poor Visibility Operation

Avoid operation in these conditions. If you must do so, proceed with caution and prudence using minimum speed.

Crossing Waves

Reduce speed.

Always be prepared to steer and balance as necessary.

When crossing wakes, always keep a safe distance from watercraft ahead.

WARNING

When crossing wakes, slow down. Operator can brace himself by posting. Do not jump waves or wakes.

Stopping/Docking

The watercraft is slowed down by water drag. The stopping distance will vary depending on the watercraft size, weight, speed, water surface condition, presence and direction of wind and current.



The rider should become familiarized with the stopping distance under different conditions.

Release the throttle at a sufficient distance before the expected landing or docking area.

When riding in "vert" configuration, moving a foot slightly forward or rearward may help to keep your balance and compensate for the watercraft deceleration.



Reduce speed to idle.

WARNING

Directional control is reduced when the throttle is released and lost when engine is off.

Beaching

CAUTION: It is not recommended to run the watercraft to the beach.

Come slowly to the beach and shut off the engine using the safety lanyard before water depth is less than 90 cm (3 ft) under the lowest rear portion of the hull, then pull the watercraft to the beach.

CAUTION: Riding the watercraft in shallower water might damage the impeller or other jet pump components.

Shutting Off the Engine

To keep watercraft directional control, the engine should be running until the watercraft is at idle.

To shut off the engine, completely release throttle lever and press the engine start/stop button. Remove safety lanyard from watercraft.

WARNING

Should the engine be shut off, watercraft directional control is lost. Never leave the safety lanyard on its post when watercraft is not in operation in order to prevent accidental engine starting or to avoid unauthorized use by children or others or theft.

POST-OPERATION CARE

WARNING

Allow engine to cool before performing any maintenance.

General Care

Take the watercraft out of the water every day to prevent marine organism growth.

Should any water be present in the bilge, install safety lanyard on its post to start the electric bilge pump. If some water remains, unscrew the drain plugs and tilt the watercraft rearward in order to allow water to flow out.

Wipe off any remaining fluid in the engine compartment (bilge, engine, battery, etc.) with clean dry rags (this is particularly important in salt water operation).

Additional Care for Foul Water or Salt Water

When the watercraft is operated in foul water and particularly in salt water, additional care should be taken to protect the watercraft and its components.

Rinse watercraft bilge area with fresh water.

Never use a high pressure washer to clean the bilge. **USE LOW PRESSURE ONLY** (like a garden hose).

High pressure can cause electrical or mechanical damages.

CAUTION: Failure to perform proper care such as: watercraft rinsing, cooling system flushing or anticorrosion treatment, when watercraft is used in salt water, will result in damage to the watercraft and its components. Never leave the watercraft stowed in direct sunlight.

Cooling System Flushing and Engine Internal Lubrication

General

Flushing the cooling system with fresh water is essential to neutralize corroding effects of salt or other chemical products present in water. It will help to remove sand, salt, shells or other particles in water jackets (engine, exhaust manifold, tuned pipe) and/or hoses.

Engine lubrication and flushing should be performed when the watercraft is not expected to be used further the same day or when the watercraft is stowed for any extended time.

WARNING

Perform this operation in a well ventilated area.

Proceed as follows:

Clean jet pump by spraying water in its inlet and outlet and then apply a coating of XP-S LUBE lubricant or equivalent.

Connect a garden hose to the fitting located at the rear of watercraft on jet pump support.

NOTE: If desired, a quick connect adapter can be used (P/N 295 500 473). No hose pincher is required to flush engine.

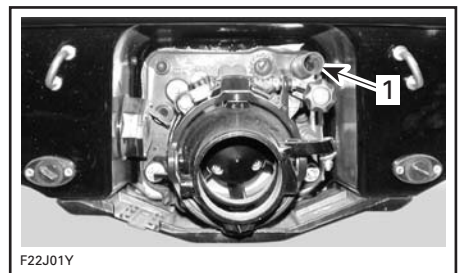

1. Flushing connector

NOTE: The quick connect adapter has to be removed once the procedure is completed.

Flushing and Lubrication

To flush cooling system, start the engine **then** immediately open the water tap.

WARNING

Components inside the engine compartment may be hot. Keep away from electrical parts or jet pump area when engine is running.

CAUTION: Never flush a hot engine. Always start the engine before opening the water tap. Open the water tap immediately after engine is started to prevent overheating.

Run the engine for about 3 minutes at a fast idle around 3500 RPM.

Ensure water flows out of drain lines (engine crankcase and engine cylinder while flushing. Otherwise, clean the lines.

CAUTION: Never run engine longer than 5 minutes. The drive line seal has no cooling when watercraft is out of water.

Spray XP-S LUBE or an equivalent lubricant, through the hole in the air intake silencer while keeping engine at fast idle during one minute.

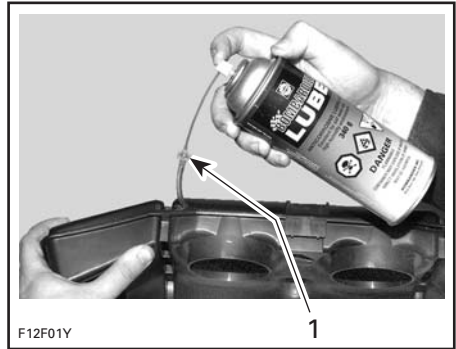

1. Partially pull tube out of air box to inject XP-S LUBE lubricant or equivalent. Push tube in when finished.

Lubrication of engine should be done for at least 1 minute.

CAUTION: When engine begins to run irregularly because of fuel starvation, immediately stop water flow before engine dies.

Close the water tap then stop the engine.

CAUTION: Always close the water tap before stopping the engine.

Final Steps

Disconnect the garden hose.

Pull out spark plug cables and connect them on the grounding device.

WARNING

Always use spark plug cable grounding device when removing spark plugs.

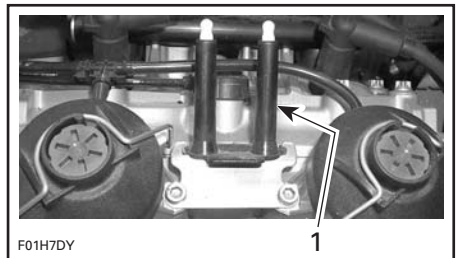

1. Grounding device

Remove both spark plugs and spray XP-S LUBE or an equivalent lubricant into each cylinder.

To prevent fuel to be injected and also to cut the ignition at the engine starting, proceed as follows.

While engine is stopped, fully depress throttle lever and HOLD for cranking.

NOTE: A 1 second beep every second indicates the drowned mode is active.

Crank the engine a few turns to distribute the oil on cylinder wall.

Apply anti-seize lubricant on spark plug threads then reinstall them.

Properly reconnect spark plug cables to spark plugs.

 WARNING
Always reconnect spark plug cables at the same spark plugs where they come from.

Wipe off any residual water from the engine.

Anticorrosion Treatment

To prevent corrosion, spray a corrosion inhibitor (salt water resistant) such as XP-S LUBE or an equivalent lubricant over metallic components in engine compartment.

Apply dielectric grease (salt water resistant) on battery posts and cable connectors.

CAUTION: Never leave rags or tools in the engine compartment or in the bilge.

SPECIAL PROCEDURES

Limp Home Mode

Monitoring System

To assist you when using the watercraft, a system monitors the electronic components of the fuel injection system and some components of the electrical system. When a fault occurs, the cluster warning light will blink with an audible signal to inform you of a particular condition. Refer to the *TROUBLESHOOTING* section for the beeper coded signals chart.

Limp Home Modes

Besides the signals as seen above, the system may automatically set default parameters to the MPEM to ensure the adequate operation of the watercraft if a component of the fuel injection system is not operating properly.

Depending on the severity of the malfunction, the watercraft speed may be reduced and not allowed to reach its top speed as usual. In this case, letting the engine returning at idle speed may allow normal operation to come back.

The engine RPM may be limited to idle if some critical components fail. In this case, removing and reinstalling the safety lanyard on its post may allow normal operation to come back.

These performance-reduced modes allow the rider to go back home which would not be possible without this advanced system. If this occurs, see an authorized SEA-DOO dealer as soon as possible for inspection.

Engine Overheating

CAUTION: If the monitoring beeper continuously sounds, stop engine immediately.

Perform *JET PUMP WATER INTAKE AND IMPELLER CLEANING* procedure described in this section.

When back on shore, flush cooling system, refer to *POST-OPERATION CARE*.

If engine still overheats, refer to an authorized Sea-Doo dealer for servicing.

Jet Pump Water Intake and Impeller Cleaning

WARNING

Keep away from intake grate while engine is on. Items such as long hair, loose clothing or personal flotation device straps could potentially become entangled in moving parts resulting in severe injury or drowning.

Weeds, shells or debris can get caught in the intake grate, drive shaft and/or impeller. A clogged water intake may cause troubles such as:

- Cavitation: Engine speed is high but watercraft moves slowly due to reduced jet thrust, jet pump components may be damaged.
- Overheating: Since the jet pump operation controls the flow of water to cool the engine, a clogged intake will cause the engine to overheat and cause damage to internal components.

A weed clogging area can be cleaned as follows:

In-Water Cleaning

Rock the watercraft several times while repeatedly pressing engine start/stop button for short period without starting engine. Most of the time, this will remove the blockage. Start engine and make sure water flows out from bleed outlet and that watercraft operates properly.

If the system is still blocked, take the watercraft out of the water and remove blockage manually.

On-Beach Water Cleaning

WARNING

Always remove safety lanyard cap from its post to prevent accidental engine start up before cleaning the jet pump area.

Place a cardboard or a carpet beside the watercraft to prevent scratches when turning the watercraft for cleaning purposes.

Rotate the watercraft on any side for cleaning.



Clean the water intake area. If the system is still clogged, refer to an authorized Sea-Doo dealer for servicing.

CAUTION: Inspect water intake grate for damage. Refer to an authorized Sea-Doo dealer for repair as necessary.

Capsized Watercraft

The watercraft is designed so that it should not turn over easily. Furthermore, two sponsons mounted on the side of the hull assist watercraft stability. However, if it does turn over, it will remain capsized.

WARNING

When watercraft is capsized, never attempt to restart the engine. The rider should always wear an approved personal flotation device.

“Vert” Configuration

To return the watercraft upright, make sure the engine is off. Lift steering pole up or step on bumper rail and use your weight to rotate the watercraft.

“Moto” Seat and Kart Configuration (if so equipped)

To return the watercraft upright, ensure the engine is off, grab the inlet grate, step on bumper rail and use your weight to rotate the watercraft.

The watercraft can be rotated on either side.

Submerged Watercraft

To limit damage to the engine, perform the following procedure as soon as possible.

Drain bilge.

If the watercraft was submerged in salt water, rinse off the bilge and all components with fresh water using a garden hose to stop the corroding effect of salt.

CAUTION: Never try to crank or start the engine of a watercraft that has been submerged. Water trapped in engine would cause severe damage to the engine components.

Bring the watercraft to be serviced by an authorized Sea-Doo dealer as soon as possible.

CAUTION: The longer the delay before you have the engine serviced, the greater will be the risk and severity of the damage will be to the engine.

Water-Flooded Engine

In the event the engine cannot be serviced within a few hours, remove spark plug cables and connect them on the grounding device.

WARNING

Never crank engine with spark plugs removed unless spark plug cables are connected to the grounding device. Be careful when cranking engine, water will spray out from spark plug holes.

Remove the spark plugs and wipe them dry using a clean and dry cloth.

Cover spark plug holes with a rag.

To prevent fuel to be injected and also to cut the ignition at the engine starting, proceed as follows.

While engine is stopped, fully depress throttle lever and HOLD for cranking.

NOTE: A 1 second beep every second indicates the drowned mode is active.

Crank engine several times to allow water to escape from spark plug openings.

Release throttle lever.

If water does not completely go out, it may be necessary to remove the air intake silencer then to lean the vehicle so that water can flow out from throttle bodies.

Spray XP-S LUBE or an equivalent lubricant into spark plug holes.

Crank engine again.

Reinstall spark plugs. Install clean dry spark plugs if possible. Reconnect cables.

WARNING

Always reconnect spark plug cables at the same spark plugs where they come from.

Start engine normally.

Fuel-Flooded Engine

When the engine does not start after several attempts, the engine may be fuel-flooded.

To prevent fuel to be injected and also to cut the ignition at the engine starting, proceed as follows.

While engine is stopped, fully depress throttle lever and HOLD for cranking.

Crank engine approximately 5 seconds.

NOTE: A 1 second beep every second indicates the drowned mode is active.

Release throttle lever and crank again to start engine.

If this does not work:

Remove spark plug cables and connect them on the grounding device.

WARNING

Always use spark plug cable grounding device whenever removing spark plugs. Never crank engine with spark plugs removed unless spark plug cables are connected to the grounding device.

Remove spark plugs and wipe them dry using a rag.

Cover spark plug holes with a rag.

Crank engine several times.

Reinstall spark plugs. Install clean dry spark plugs if possible. Reconnect cables.

WARNING

Always reconnect spark plug cables at the same spark plugs where they come from.

Start engine as explained above. If engine remains flooded, see an authorized Sea-Doo dealer.

Out of Fuel

DI Models

When running the engine out of fuel, it may be necessary to remove and install the safety lanyard 2 - 3 times to initially feed the fuel system after fuel tank refill.

Towing the Watercraft on the Water

Special precautions should be taken when towing a Sea-Doo watercraft on the water.

The maximum recommended towing speed is 24 km/h (15 MPH).

When towing your watercraft on the water, pinch the water supply hose to the engine with a large hose pincher to the engine with a large hose pincher (P/N 529 032 500).

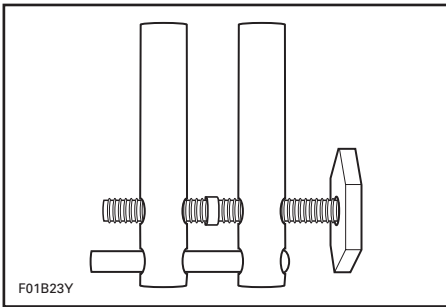

This will prevent the cooling system from filling up which may lead to water flooding the exhaust system pushing water back into the cylinders. When the engine is not running there isn't any exhaust pressure to push the water out the exhaust outlet.

CAUTION: Failure to do this may result in damage to the engine. If you must tow a stranded watercraft on the water and do not have a hose pincher, be sure to stay well below the maximum towing speed of 24 km/h (15 MPH).

Clamp down the hose pincher on the water supply hose as shown.

NOTE: A red tape on the water supply hose indicates which hose to pinch.



1. Water supply hose
2. Install hose pincher here
3. T-fitting

CAUTION: When finished towing the watercraft, the hose pincher must be removed before operation. Failure to do so will result in severe damage to the engine.

Low-Charge Battery Condition

See an authorized Sea-Doo dealer to recharge or replace the battery.

WARNING

Do not charge or boost the battery while installed in the watercraft. Electrolyte is poisonous and dangerous. Avoid contact with eyes, skin or clothing.

MAINTENANCE INFORMATION

Maintenance, replacement, or repair of the emission control devices and systems may be performed by any marine SI (spark ignition) engine repair establishments or individual.

Engine Emissions Information

Manufacturer's Responsibility

Beginning with 1999 model year engines, PWC manufacturers of marine engines must determine the exhaust emission levels for each engine horsepower family and certify these engines with the United States of America Environmental Protection Agency (EPA). An emissions control information label, showing emission levels and engine specifications, must be placed on each vehicle at the time of manufacture.

Dealer's Responsibility

When performing service on all 1999 and more recent Sea-Doo watercrafts that carry an emissions control information label, adjustments must be kept within published factory specifications.

Replacement or repair of any emission related component must be executed in a manner that maintains emission levels within the prescribed certification standards.

Dealers are not to modify the engine in any manner that would alter the horsepower or allow emission levels to exceed their predetermined factory specifications.

Exceptions include manufacturer's prescribed changes, such as altitude adjustments for example.

Owner Responsibility

The owner/operator is required to have engine maintenance performed to maintain emission levels within prescribed certification standards.

The owner/operator is not to, and should not allow anyone to modify the engine in any manner that would alter the horsepower or allow emissions levels to exceed their predetermined factory specifications.

EPA Emission Regulations

All new 1999 and more recent Sea-Doo watercraft manufactured by Bombardier Recreational Products Inc. (BRP) are certified to the EPA as conforming to the requirements of the regulations for the control of air pollution from new watercraft engines. This certification is contingent on certain adjustments being set to factory standards. For this reason, the factory procedure for servicing the product must be strictly followed and, whenever practicable, returned to the original intent of the design.

The responsibilities listed above are general and in no way a complete listing of the rules and regulations pertaining to the EPA requirements on exhaust emissions for marine products. For more detailed information on this subject, you may contact the following locations:

For all courier services:

U.S. Environmental Protection Agency
Office of Transportation and Air Quality
1310 L Street NW
Washington, DC 20005

Regular US Postal Mail:

1200 Pennsylvania Ave. NW
Mail code 6403J
Washington, DC 20460

EPA INTERNET WEB SITE:

<http://www.epa.gov/otaq>

EPA E-MAIL:

otaqpublicweb@epa.gov

General

Only perform servicing procedures which are detailed in this safety section. Further assistance or information can be obtained from your authorized Sea-Doo dealer. In many instances proper tools and training is required for certain servicing or repair procedures.

Maintain the watercraft and equipment in top condition at all times. Adhere to the prescribed maintenance schedules. An annual inspection of the watercraft is always a good recommendation that should be followed.

Always use spark plug cable grounding device when removing spark plugs.

The bilge should be kept clean of oil, water or other foreign materials.

Do not attempt to lift the watercraft without special equipment and training.

The engine and the corresponding components identified in this guide should not be utilized on product(s) other than for which they were designed. Maintenance procedures and specified tightening torque should be strictly adhered to. Never attempt repairs unless the appropriate tools are available. These watercrafts are designed with parts dimensioned in both the metric and the imperial systems. When replacing fasteners, make sure to use only those recommended by BRP. If required, contact your authorized Sea-Doo dealer for further servicing information.

MAINTENANCE CHART

Periodic Inspection

Routine maintenance is necessary for all mechanical products. A periodic inspection contributes to the product's life span.

The following maintenance chart gives guidelines for regular watercraft servicing scheduled to be performed by you and/or by an authorized Sea-Doo dealer. The schedule should be adjusted according to operating conditions and use.

IMPORTANT: Schedule for watercraft rental operations or higher number of hour use, will require greater frequency of inspection and maintenance.

The maintenance is very important, if you are not familiar with safe service practices and adjustment procedures, see your authorized Sea-Doo dealer.

NOTE: Some items are included in the *PRE-OPERATION CHECKS* and not necessarily repeated in this chart.

PERIODIC MAINTENANCE CHART						
PART/TASK	FIRST 10 HOURS					
	25 HOURS OR 3 MONTHS					
PART/TASK	50 HOURS OR 6 MONTHS					
	100 HOURS OR 1 YEAR					
PART/TASK	TO BE PERFORMED BY					
LEGEND						
GENERAL						
Lubrication/corrosion protection	T (1)		T		Operator	(1) Every 10 hours in salt water use.
ENGINE						
Support and rubber mount	I		I		Dealer	(5) Emission-related component. (4) Check at 350 hours or 5 years.
Seals and fasteners	I		I		Dealer	
Exhaust system fasteners (5)	I		I		Dealer	
RAVE valve(5)			C	C	Dealer	
Top end (leak test, piston and ring clearance)(5)	T (4)				Dealer	
Counterbalance shaft oil level			I	I	Dealer	
Spark plug (5)	I		R		Dealer	
Ignition timing (5)	T (4)				Dealer	
COOLING SYSTEM						
Flushing		T (3)			Operator	(1) Every 10 hours in salt water use.
Hose and fasteners	I		I		Dealer	(3) Daily flushing in salt water or foul water use.
Engine drain tubes		I (1)			Operator	
Air intake silencer fit/tightness	I			I	Dealer	

PERIODIC MAINTENANCE CHART

A: ADJUST
 C: CLEAN
 I: INSPECT
 L: LUBRICATE
 R: REPLACE
 T: PROCEED WITH TASK

FIRST 10 HOURS

25 HOURS OR 3 MONTHS

50 HOURS OR 6 MONTHS

100 HOURS OR 1 YEAR

TO BE PERFORMED BY

PART/TASK

LEGEND

FUEL SYSTEM

Throttle cable	I, A, L ⁽¹⁾			I, A, L	Dealer	(1) Every 10 hours in salt water use. (5) Emission-related component. (8) Replace at 250 hours. (6) In salt water use.
In-line fuel filter	I ⁽⁸⁾	I			Dealer	
Oil leakage between cylinder head and injector ⁽⁵⁾	I		I		Dealer	
Engine management system sensors (except TPS) and fuel injectors ⁽⁵⁾	I			I	Dealer	
Throttle body and TPS ⁽⁵⁾	I		I ⁽⁶⁾		Dealer	
Fuel lines, connections, check-valve, relief valve and fuel system pressurization ⁽⁵⁾	I	I			Dealer	
Air/fuel rail and fittings ⁽⁵⁾	I		I		Dealer	
Fuel tank straps	I			I	Dealer	

LUBRICATION SYSTEM

Oil injection pump ⁽⁵⁾	I			I	Dealer	(5) Emission-related component.
Oil lines	I	I			Dealer	
Oil filter	I	I		R	Dealer	
Oil reservoir straps	I				Operator	

ELECTRICAL SYSTEM

Electrical connections and fastening, ignition system, electrical box, starting system	I			I	Dealer	—
MPEM mounting brackets/fasteners				I	Dealer	
Digitally Encoded Security System and safety lanyard/post	I			I	Dealer	
Monitoring beeper	I			I	Dealer	
Battery, brackets and fasteners	I			I	Dealer	

STEERING SYSTEM

Steering cable	I			I	Dealer	—
Steering pole	I			I	Dealer	
Handlebar and adjuster operation	I			I	Dealer	
"Moto" seat	I			I	Dealer	

PERIODIC MAINTENANCE CHART

A: ADJUST
 C: CLEAN
 I: INSPECT
 L: LUBRICATE
 R: REPLACE
 T: PROCEED WITH TASK

FIRST 10 HOURS

25 HOURS OR 3 MONTHS

50 HOURS OR 6 MONTHS

100 HOURS OR 1 YEAR

TO BE PERFORMED BY

PART/TASK

LEGEND

O.T.A.S. SYSTEM

O.T.A.S. system operation	I		I		Dealer	
---------------------------	---	--	---	--	--------	--

PROPULSION SYSTEM

Drive shaft protection bellows			I ⁽²⁾		Dealer	(2) These items have to be initially checked after 25 hours. Thereafter, servicing to be made as specified in this chart. (11) Replace at 150 hours.
Seal carrier	L	L			Operator	
Drive shaft impeller splines			L		Dealer	
VTS (Variable Trim System)	I		I		Dealer	
Jet pump reservoir oil	R	I	R		Dealer	
Jet pump cover pusher			I		Dealer	
Impeller shaft seal				R ⁽¹¹⁾	Dealer	
Impeller and impeller/wear ring clearance			R ⁽²⁾		Dealer	
Water intake grate	I		I ⁽²⁾	I	Operator	

HULL AND BODY

Drain plugs (inside bilge), check for obstructions	I			I	Operator	—
Kart seat (if so equipped)	I		I		Operator	
Hull	I			I	Operator	

MAINTENANCE

WARNING

Only perform procedures as detailed in this guide. It is recommended that the assistance of an authorized Sea-Doo dealer be periodically obtained on other components/systems not covered in this guide. Unless otherwise specified, engine must not be running and the safety lanyard must be removed from its post for all maintenance procedures. Components inside engine compartment may be hot. Never use jet pump components or steering pole to lift the watercraft.

Lubrication

Seal Carrier

Use Sea-Doo synthetic grease or equivalent.

Remove rear access cover to gain access to seal carrier.



1. Rear access cover

Using a grease gun, carefully lubricate seal carrier of mid bearing until grease is just coming out of the seal.

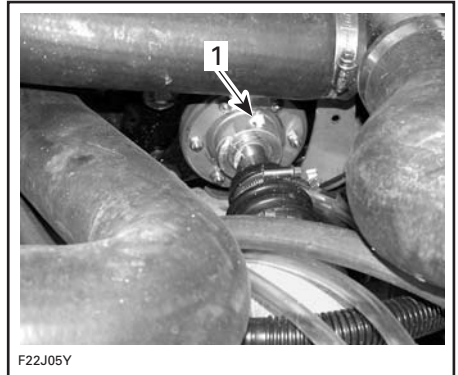

1. Grease seal carrier of mid bearing

Reinstall properly all removed parts.

Anticorrosion Protection

Throttle Cable

Lubricate the throttle cable with XP-S LUBE or an equivalent lubricant.

Electrical Connections

As necessary, apply anticorrosion product such as dielectric grease on battery posts and all exposed cable connectors.

CAUTION: Never lubricate connectors of the electronic modules.

Additional Lubrication

XP-S LUBE or an equivalent lubricant will help prevent corrosion of metallic parts and maintain proper operation of mechanisms and moving parts.

WARNING

Never lubricate the safety lanyard post.

Throttle Body and Oil Injection Pump

Lubricate springs, shafts and exposed portion of cables.

Throttle Cable Inspection

Throttle Cable

Depress and release the throttle lever. It should operate smoothly and return to its initial position without any hesitation. Repeat the test for each adjustable handlebar position. Refer to an authorized Sea-Doo dealer if necessary.

WARNING

Never alter or tamper with throttle cable adjustment or routing.

WARNING

If throttle lever does not automatically return to its initial position, do not operate watercraft and see your authorized Sea-Doo dealer.

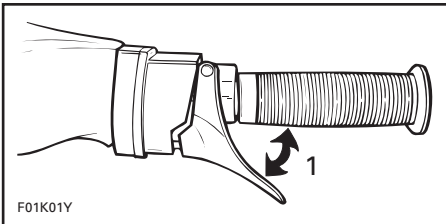

1. Should move freely

Fuel Injection System

The fuel injection system inspection should be performed by an authorized Sea-Doo dealer.

CAUTION: Never use injector cleaning products. They may contain additives that could damage injector components.

Idle Speed

Idle speed is controlled by the MPEM and is not adjustable.

CAUTION: Never attempt to adjust the idle speed screw as it is factory calibrated.

Fuel and Oil Filters

The in-line fuel filter and the oil filter should be replaced by an authorized Sea-Doo dealer. Fuel system pressurization should be performed at the same time.

CAUTION: An obstructed oil filter will cause oil starvation resulting in serious engine damage.

Steering Alignment

When the handlebar is positioned in the straight ahead position, the jet pump nozzle should be in the same direction allowing the watercraft to run in a straight line.

Refer to an authorized Sea-Doo dealer if an adjustment is necessary.

WARNING

Ensure the handlebar and jet pump nozzle operate freely from side to side and are not putting stress on the steering cable or brackets. Never turn handlebar while someone is close to the rear of the watercraft. Keep away from steering system parts (nozzle, linkage etc.).

Steering Pole

First make sure to retract the "moto" seat.

Move steering pole up and down. It should move freely and smoothly without resistance. Otherwise, rinse steering pole pivot with fresh water then lubricate with XP-S LUBE. If it is still stiff, refer to an authorized Sea-Doo dealer. If steering pole feels too heavy, it can be adjusted with the return spring. Refer to *CONTROLS/INSTRUMENTS/EQUIPMENTS*. If it does not help, it means that the spring could be broken.

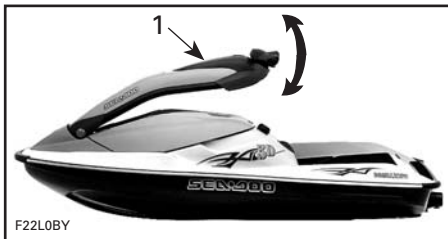

1. Steering pole

Lower steering pole to the lowest position and try moving it from side to side to detect any excessive play.



⚠ WARNING
If any of the above tests fail, do not operate the watercraft and refer to an authorized Sea-Doo dealer.

Handlebar and Adjuster Operation

Move handlebar to each position. It should move easily and lock in each position. If handlebar is hard to move (up/down), remove plastic cap and rinse mechanism with fresh water then lubricate with XP-S LUBE. If it is still stiff, refer to an authorized Sea-Doo dealer. Make sure there is no excessive play in the handlebar.

⚠ WARNING
If any of the above tests fail, do not operate the watercraft and refer to an authorized Sea-Doo dealer.

"Moto" Seat

Check that the seat properly latches into the steering pole. Inspect the latch mechanism for wear.

Deploy the seat. Ensure that the seat moves freely while rotating. Check for excessive lateral play.

Also check for excessive play of seat post in seat.

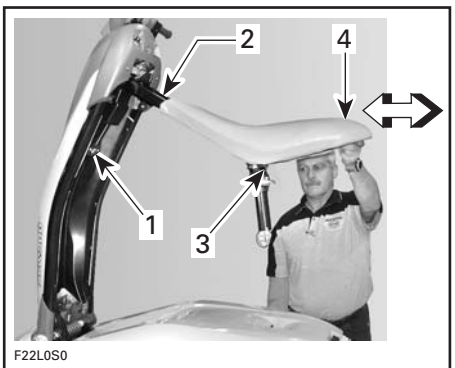

1. Latch mechanism
2. Seat structure
3. Check play of seat post
4. Check lateral play of seat structure

Inspect the seat post receiver in the deck. Check for dirt, sand or other debris. Check for excessive wear. Ensure that the cover moves freely.

Install the seat post in its receiver and ensure it latches properly. Inspect latch mechanism for wear. Try pulling out the post without releasing the latch.

⚠ WARNING
If any of the above tests fail, do not use the "moto" seat and refer to an authorized Sea-Doo dealer.

Kart Seat (if so equipped)

Check seat tab and anchor plate for wear or damage. Check latch mechanism for wear. Try pulling out the seat without releasing the latch.



1. Check seat tab and anchor plate
2. Check latch mechanism

⚠ WARNING

If any of the above tests fail, do not use the kart seat and refer to an authorized Sea-Doo dealer.

O.T.A.S.™ System

This test is to be performed with the watercraft in the water.

Make sure the path ahead is clear. Run the watercraft and bring it to a planing speed (above 4000 RPM) then release throttle lever. Turn handlebar all the way on one side within 3 seconds. Engine speed should increase. Otherwise, repeat the test and turn handlebar earlier after throttle release. If the RPM still does not increase, refer to an authorized Sea-Doo dealer.

VTS Adjustment

Turn the adjuster knob so that the nozzle reaches its highest position. Turn the adjuster knob in the opposite direction to reach the lowest position.

The nozzle should be move up and down without interfering with the venturi.

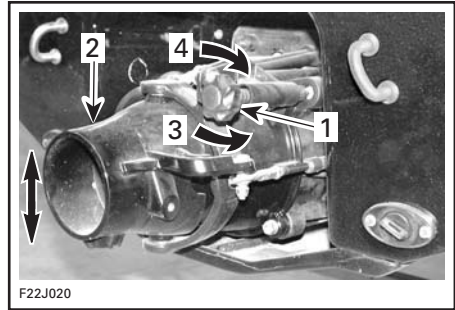

1. Adjuster knob
2. Nozzle up or down
3. To raise nozzle
4. To lower nozzle

CAUTION: Trim ring and/or nozzle should be free of interference in any position.

If any interference is found, refer to an authorized Sea-Doo dealer.

Bilge Drain Plugs

Drain plugs use a low pressure area in the jet pump to siphon the water out of the bilge when the engine is operating. Inspect each pick-up screen for obstructions, clean as necessary.

Fuses

If an electrical problem occurs, check the fuses. If a fuse is burnt, replace by one of the same rating. Follow procedures below.

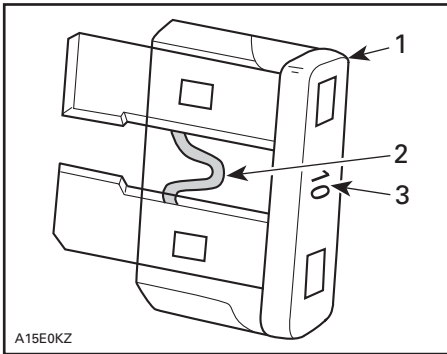

1. Fuse
2. Check if melted
3. Ampere rating

⚠ WARNING

Never use a higher rated fuse as this can cause severe damage. If a fuse has burnt out, the source of the malfunction must be determined and corrected before restarting. See an authorized Sea-Doo dealer for servicing.

Fuses can be found on the MPEM in engine compartment.

To access fuses, remove engine cover and lock the steering pole with the holder in the upright position.

⚠ WARNING

Always install steering pole holder immediately after engine cover removal to support the pole securely while working in the engine compartment.

MPEM

Locate the MPEM in front of engine.

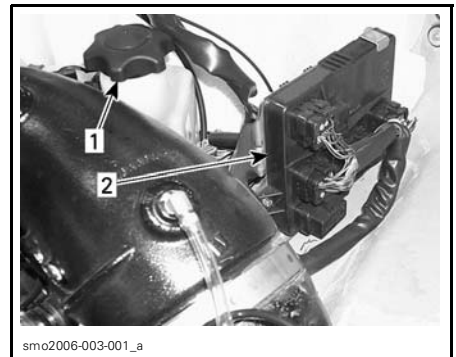

1. Oil tank
2. MPEM

Remove fuse cover from MPEM.

Use the tabs of the fuse cover to remove and reinstall fuses.

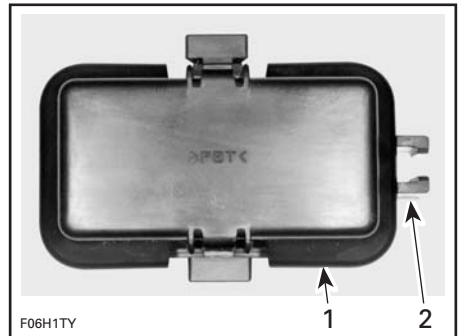

1. Fuse cover
2. Fuse tabs

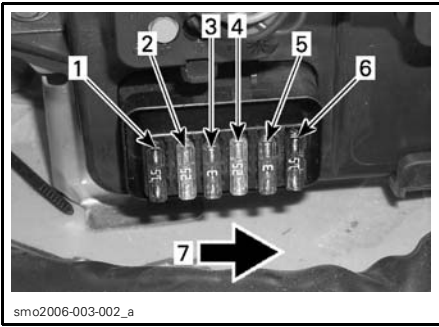

smo2006-003-002_a

FUSE IDENTIFICATION

1. 15 A, injection system
2. 25 A, battery
3. 3 A, spare (not used)
4. 25 A, regulator (charging system)
5. 3 A, bilge pump
6. 15 A, fuel pump
7. Front of vehicle

Other Fuse

The main fuse is located in the power supply cut-off relay.



smo2006-003-020_a

1. Starter relay
2. 30 A, main fuse

General Inspection and Cleaning

Inspection

Remove engine cover and lock the steering pole with the holder in the up-right position.

WARNING

Always install steering pole holder immediately after engine cover removal to support the pole securely while working in the engine compartment.

Check engine cover tabs and C-hooks as well as latch condition.

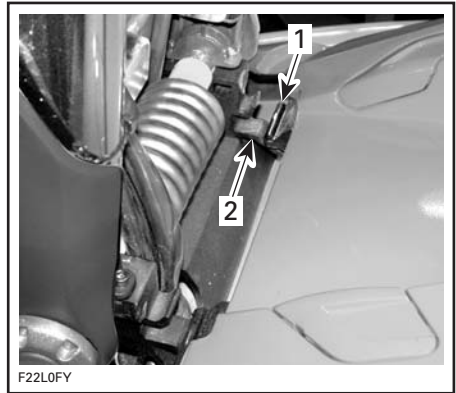

F22L0FY

1. Tab
2. C-hook

NOTE: Verify periodically that the latch pin for the engine cover is tight in the body. Tighten if needed and make sure engine cover latches properly.

Check engine compartment for any damage or leaks from the fuel/oil injection systems. Ensure all hose clamps are secure and no hose is cracked, kinked or shows any other damage.

WARNING

If any gasoline leak and/or odor are present, do not start the engine. Have the watercraft serviced by an authorized Sea-Doo dealer.

Inspect muffler, battery, fuel tank and oil reservoir fastening devices. Visually check electrical connections for corrosion and tightness.

Inspect hull and jet pump water intake grate for damage. Replace or have damaged parts repaired.

Reinstall engine cover and relatch properly.

Cleaning

The bilge should be cleaned by an authorized Sea-Doo dealer to remove any fuel/oil/electrolyte deposits and mildew.

Occasionally, wash the body with water and soap (only use mild detergent). Remove any marine organisms from engine and/or hull. Apply non-abrasive wax such as silicone wax.

CAUTION: Never clean fiberglass and plastic parts with strong detergent, degreasing agent, paint thinner, acetone, etc.

To clean the engine cover and the steering pole nose and top pieces, use only flannel cloths or an equivalent.



1. Engine cover, steering pole nose and top pieces

CAUTION: It is necessary to use flannel cloths or an equivalent on engine cover, steering pole nose and top to avoid further damaging the surfaces to clean.

To remove scratches on engine cover, steering pole nose or top pieces, use BOMBARDIER* Scratch Remover Kit (P/N 861 774 800).

NOTE: Be aware that when using any scratch remover product, the part finish will turn to a dull appearance.

CAUTION: Never clean plastic parts or engine cover with strong detergent, degreasing agent, paint thinner, acetone, products containing chlorine, etc.

To clean the carpets, use 3M™ Citrus Base Cleaner (24 oz spray can) or the equivalent.

Stains may be removed from seat and fiberglass with Knight's Spray-Nine[†] from Korkay System Ltd or the equivalent.

Respect the environment by ensuring fuel, oil or cleaning solutions do not drain into the waterways.

TRAILERING, STORAGE AND PRESEASON PREPARATION

Trailerling

Make sure that the oil reservoir and fuel tank caps are installed and tight.

WARNING

Never tip this vehicle on its end for transportation. We recommend that you carry the vehicle in its normal operating position.

Check the laws and regulations in your area that apply, especially the rules pertaining to:

- brake system
- tow vehicle weight
- mirrors.

Take the following precautions when trailerling the watercraft:

Secure the watercraft on the trailer by using tie-downs through the two stern eyelets (rear) in addition to the bow eyelet (front). Use additional tie-downs if necessary.

CAUTION: Do not route ropes or tie-downs over the kart seat (if so equipped) or “moto” seat as they could produce permanent damage. Wrap ropes or tie-downs with rags or similar protectors over the body of the watercraft only.

Make sure that the engine cover, the kart seat (if so equipped) or “moto” seat are properly latched.

WARNING

Make sure the kart seat (if so equipped) or “moto” seat is securely latched prior to trailerling.

A Sea-Doo cover will help to protect the watercraft, particularly when driving on dirt roads. This will prevent dirt entry through the air intake opening(s). In addition, the cover will properly retain steering pole to prevent movement.

Kart Seat Configuration (if so equipped)

If a Sea-Doo cover is not used, the steering pole must be locked down to prevent any movement during transportation. Use the steering pole retainer for that purpose.

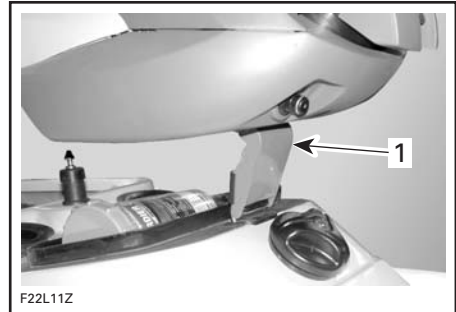

1. Steering pole retainer locked

CAUTION: Trailerling the watercraft without steering pole properly locked down might lead to damage to some components of the watercraft.

“Vert” Configuration

If a Sea-Doo cover is not used, the steering pole must be tied down to prevent any vertical movement during transportation.

Models Equipped with a Post Retainer

Pull the retainer out of the steering pole and hold while lowering the pole into position.

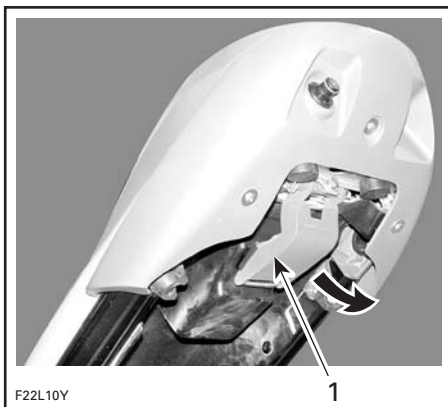

1. Pull post retainer out

Continue lowering the steering pole down until the retainer can be inserted into the body hook. Then, push retainer to lock in position.

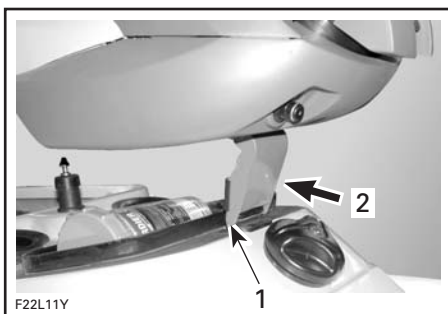

1. Position retainer in body hook
2. Push to lock

Models not Equipped with a Post Retainer

Use a bungee cord, wrapped with rags, where shown.

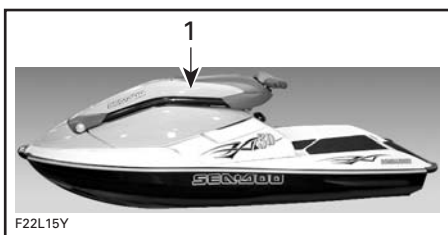

1. Tie down steering pole here

CAUTION: Trailering the watercraft without properly tying down steering pole might result in damage to the watercraft.

Always observe all trailering safety precautions.

Launching/Loading

CAUTION: Before launching the watercraft, make sure the bilge plugs are installed and screwed in tight. After loading the watercraft, make sure to remove them to drain bilge.

Storage

⚠ WARNING

Since fuel and oil are flammable, have an authorized Sea-Doo dealer inspect the fuel and oil systems integrity as specified in the periodic inspection chart.

It is strongly recommended that the watercraft be serviced by an authorized Sea-Doo dealer for storage but the following operations can be performed by you with a minimum of tools.

CAUTION: Do not run the engine during the storage period.

Body Rinsing/Repair

Wash the body with soap and water solution (only use mild detergent). Rinse thoroughly with fresh water. Remove marine organisms from the hull.

CAUTION: Never clean fiberglass and plastic parts with strong detergent, degreasing agent, paint thinner, acetone, etc.

For small gelcoat repairs, refer to an authorized Sea-Doo dealer. Replace damaged labels/decals.

Propulsion System

Lubricant in jet pump reservoir should be drained and reservoir cleaned. Refer to an authorized Sea-Doo dealer for this operation.

Grease lubrication point(s) of propulsion system as explained in *MAINTENANCE* section.

Fuel System

Sea-Doo fuel stabilizer (or equivalent), can be added in fuel tank to prevent fuel deterioration and gumming. Follow manufacturer's instructions for proper use.

CAUTION: Fuel stabilizer should be added prior to engine lubrication to ensure fuel system components protection against varnish deposits.

WARNING

Always stop the engine before refueling. Fuel is flammable and explosive under certain conditions. Always work in a well ventilated area. Do not smoke or allow open flames or sparks in the vicinity. Fuel tank may be pressurized, turn cap slowly when opening. Never use an open flame to check fuel level. When fueling, keep watercraft level. Do not overfill or top off the fuel tank and leave watercraft in the sun. As temperature increases, fuel expands and might overflow. Always wipe off any fuel spillage from the watercraft. Periodically verify fuel system.

Cooling System Flushing and Engine Internal Lubrication

Refer to procedure in *POST-OPERATION CARE*.

Battery

Contact your authorized Sea-Doo dealer.

Antifreezing Protection

In cool regions where freezing point may be encountered, cooling system should be filled with antifreeze or recreational vehicle antifreeze.

CAUTION: Antifreeze must be fed in cooling system. Otherwise remaining water will freeze. This operation requires a good technical knowledge of the cooling system path. If antifreezing is not performed adequately, any water left in the engine/exhaust system could freeze and cause severe damage. We strongly recommend this operation to be performed by an authorized Sea-Doo dealer.

NOTE: This procedure will require a minimum of 4 L (4.2 U.S. qt) of antifreeze.

Preparation

Some hoses have to be plugged to prevent draining, before filling cooling system jackets with the antifreeze. Install hose pinchers at the following location:

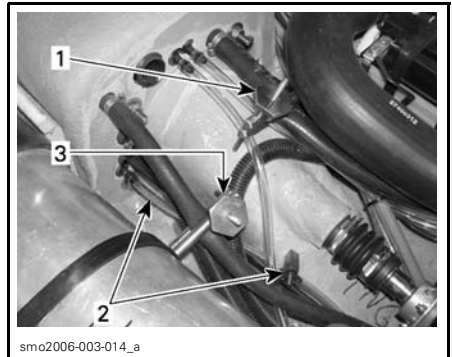

1. Water inlet hose
2. Engine cylinder drain hose (coming from underneath engine)
3. Water outlet hose underneath tuned pipe

Hose Disconnection

Disconnect the water supply hose (identified with a red tape) from T-fitting.

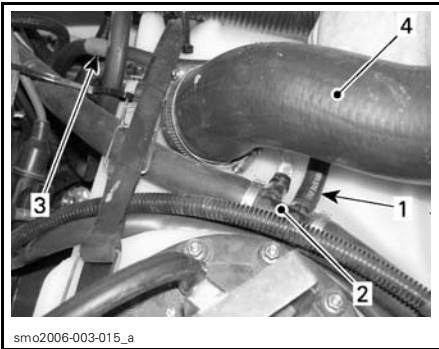

1. Disconnect the water supply hose (identified with a red tape)
2. T-fitting
3. Red tape
4. Fuel tank fill hose

Temporarily install a hose of approximately 61 cm (2 ft) in length with a 12.7 mm (1/2 in) internal diameter on the T-fitting (same location as previously disconnected hose).

Engine Bleeding

Insert a funnel into the temporary hose. Ensure to hold the funnel approximately 61 cm (2 ft) above the deck when pouring the antifreeze to create enough pressure so that it flows properly.

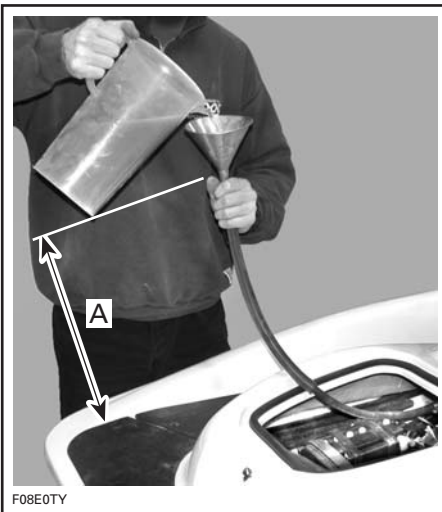

- TYPICAL**
 A. 61 cm (2 ft) to ease antifreeze flow

Pour antifreeze mix in engine until the colored solution mix appears at cooling system bleed outlet. At this point, install a hose pincher on bleed outlet hose.

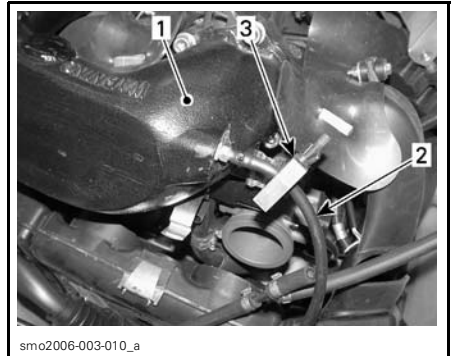

1. Head pipe
2. Bleed outlet hose
3. Hose pincher

Magneto Bleeding

Continue to pour until antifreeze appears at the engine magneto drain hose. Then, install a hose pincher on this hose.

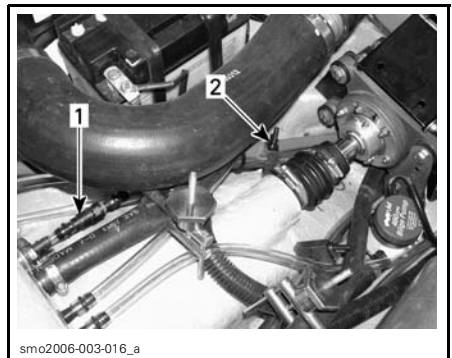

1. Engine magneto drain hose
2. Hose pincher

Engine Compressor Bleeding

Continue to pour until antifreeze flows in air compressor water outlet hose.

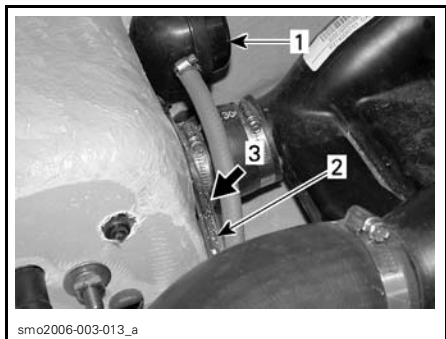

- smo2006-003-013_a
1. Noise Reducer
 2. Air compressor water outlet hose
 3. Look here for antifreeze color

Cone Pipe Bleeding

Remove temporary hose previously installed from T-fitting.

Disconnect cone pipe water outlet hose.

Connect a temporary hose to cone pipe water outlet fitting.

Insert the other end of hose into a small container located in bilge.

Install a funnel into the factory water supply hose (identified with a red tape).

Pour antifreeze until it comes out from the cone pipe outlet temporary hose.

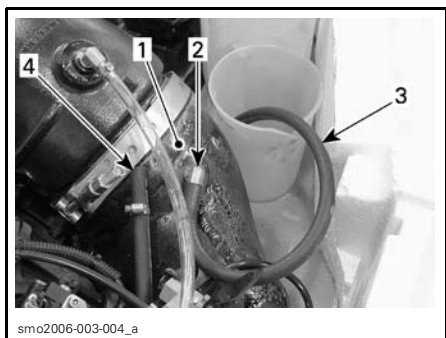

- smo2006-003-004_a
1. Tuned pipe cone
 2. Water outlet
 3. Temporary hose
 4. Disconnected hose

Stop pouring.

Remove temporary hose from cone pipe fitting and reconnect factory hose.

Remove pinchers in this order to allow proper flow of antifreeze.

NOTE: Most of the antifreeze will drain out when removing the hose pinchers. Use a container to recover it. **DISPOSE ANTIFREEZE AS PER YOUR LOCAL LAWS AND REGULATIONS.**

1. Bleed outlet hose.
2. Engine magneto drain hose.
3. Engine cylinder drain hose.
4. Water outlet hose.
5. Water inlet hose.

NOTE: Although most of the antifreeze drained out, it still has mixed with any water remaining in the water jackets. This will prevent freezing problems.

At preseason preparation, flush out the remaining antifreeze from cooling system prior to using the watercraft.

The following steps should be performed to provide the watercraft enhanced protection.

Clean the bilge with hot water and detergent or with bilge cleaner. Rinse thoroughly. Lift front end of watercraft to completely drain bilge. If any repairs are needed to body or to the hull contact your authorized Sea-Doo dealer. For paint touch up to mechanical parts use BOMBARDIER spray paint.

Anticorrosion Treatment

Wipe off any residual water in the engine compartment.

Spray XP-S LUBE lubricant or equivalent over metallic components in engine compartment.

WARNING

Do not lubricate the safety lanyard post.

Lubricate the throttle cable with XP-S LUBE lubricant or equivalent.

Reinstall engine cover and rear access cover.

Final Steps

Apply a good quality marine wax to the body.

The engine cover should be left partially opened during storage. This will prevent engine compartment condensation and potential corrosion.

CAUTION: To prevent permanent deformation of the kart seat foam, never leave any object on it during storage.

If the watercraft is to be stored outside, cover it with an opaque tarpaulin to prevent sun rays and grime from affecting the plastic components, watercraft finish as well as preventing dust accumulation.

CAUTION: The watercraft should never be left in water for storage. Never leave the watercraft stored in direct sunlight. Never completely seal watercraft in a plastic wrap. Ventilation must be provided to avoid condensation and potential corrosion.

Preseason Preparation

Use the following chart.

Since technical skills and special tools are required, some operations should be performed by an authorized Sea-Doo dealer.

WARNING

Only perform procedures as detailed in this guide. It is recommended that the assistance of an authorized Sea-Doo dealer be periodically obtained on other components/systems not covered in this guide. Unless otherwise specified, engine must not be running and the safety lanyard must be removed from its post for all maintenance procedures. Components inside engine compartment may be hot. When components condition seems less than satisfactory, replace with genuine BRP parts or approved equivalents.

Preseason Preparation Chart

NOTE: It is highly recommended that an authorized Sea-Doo dealer perform the annual safety inspection and factory campaigns in addition to the preseason preparation all at the same time.

OPERATIONS		TO BE PERFORMED BY
GENERAL	Lubrication/corrosion protection	Operator
	Spark plug replacement ⁽¹⁾	Dealer
ENGINE	Exhaust system condition (fasteners, hoses, etc.)	Dealer
	RAVE valve cleaning	Dealer
	Counterbalance shaft oil level	Dealer
	TDC setting	Dealer
	Air compressor, visual condition of hoses. Check for leaks CAUTION: Main hose between compressor and fuel rail may be hot.	Dealer
COOLING SYSTEM	Inspection of cooling system hoses and components	Dealer
FUEL SYSTEM	Throttle ⁽²⁾ cable inspection/adjustment	Dealer
	In-line fuel filter replacement	Dealer
	Fuel injection sensors verification	Dealer
	Fuel system; check valves, lines, fasteners, pressurization ⁽²⁾	Dealer
	Direct injector, check for leakage	Dealer
	Filler neck, fuel tank and fuel cap condition ⁽²⁾	Dealer
	Flame arrester inspection	Dealer
	Fuel tank straps	Dealer
Refill fuel tank	Operator	
LUBRICATION SYSTEM	Oil injection pump adjustment and bleeding	Dealer
	Oil filter replacement	Dealer
	Oil injection reservoir straps	Operator
	Oil injection reservoir filling	Operator
ELECTRICAL SYSTEM	Battery condition/charging and reinstallation	Dealer
	Battery, starter connections and routing ⁽²⁾	Dealer
	Monitoring beeper	Dealer
	Digitally encoded security system	Dealer

OPERATIONS		TO BE PERFORMED BY
STEERING SYSTEM	Steering system adjustment/inspection ⁽²⁾	Dealer
	Steering pole condition	Dealer
	Handlebar and adjuster condition	Dealer
	"Moto" seat condition	Dealer
O.T.A.S.™ SYSTEM	Check O.T.A.S. system operation	Dealer
PROPULSION SYSTEM	VTS (Variable Trim System) (if so equipped)	Dealer
	Propulsion system inspection	Dealer
	Jet pump oil replacement	Dealer
HULL AND BODY	Inspection of bailer pick-ups	Dealer
	Kart seat (if so equipped)	Dealer

⁽¹⁾ Before installing new spark plugs, it is suggested to burn the excess XP-S LUBE or equivalent by starting the engine using the old spark plugs.

⁽²⁾ Safety item covered in the annual safety inspection.

TROUBLESHOOTING

The following chart is provided to help in diagnosing the probable source of simple troubles. You may be able to solve many of these problems rather quickly, but others may require the skills of a mechanical technician. In such cases, consult an authorized Sea-Doo dealer for servicing.

Monitoring Beeper Coded Signals

CODED SIGNALS	POSSIBLE CAUSE	REMEDY
2 short beeps (while installing safety lanyard on post).	Confirms safety lanyard signal operation.	Engine can be started.
1 long beep (while installing safety lanyard on watercraft post).	Bad DESS system connection.	Reinstall safety lanyard cap correctly over post.
	Wrong safety lanyard.	Use a safety lanyard that has been programmed for the watercraft.
	Defective safety lanyard.	Use another programmed safety lanyard.
	Dried salt water in safety lanyard cap.	Clean safety lanyard cap to remove salt water.
	Defective DESS post.	Refer to an authorized Sea-Doo dealer.
	Improper operation of MPEM or defective wiring harness.	
1 second beep every second intervals.	Engine drowned mode is active.	Release throttle to cancel this mode.
A 2 seconds beep every minute intervals.	Very low battery voltage.	Refer to an authorized SEA-DOO dealer.
	Coolant and exhaust gas temperature sensors or TPS (throttle position sensor) or CPS (crankshaft position sensor) malfunction.	Refer to an authorized SEA-DOO dealer.
	MPEM malfunction.	Refer to an authorized SEA-DOO dealer.
A 2 seconds beep every 15 minutes intervals.	Oil injection reservoir level is low.	Refill.
A 2 seconds beep every 5 minutes intervals.	Fuel tank level is low or open circuit.	Refill. If problem persists, refer to an authorized Sea-Doo dealer.
4 short beeps every 3 seconds interval for 2 hours.	Safety lanyard has been left on its post without starting engine or after engine was stopped.	To prevent battery discharge, remove the safety lanyard from its post.
Continuously beeps.	Engine overheats.	See engine <i>OVERHEATING</i> .

Engine Will Not Start

OTHER OBSERVATION	POSSIBLE CAUSE	REMEDY
Engine does not turn over.	Safety lanyard removed.	Install cap over post.
	Burnt fuse on MPEM.	Check wiring then replace fuse(s).
	Discharged battery.	Refer to an authorized Sea-Doo dealer.
	Battery connections, corroded or loose. Bad ground.	Refer to an authorized Sea-Doo dealer.
	Water-flooded engine.	Refer to <i>WATER-FLOODED ENGINE</i> in <i>SPECIAL PROCEDURES</i> .
	Faulty sensor or MPEM.	Refer to an authorized Sea-Doo dealer.
	Seized engine.	
	Seized jet pump.	Try to clean. Otherwise, refer to an authorized Sea-Doo dealer.
Engine turns slowly.	Loose battery cable connections.	Check/clean/tighten.
	Discharged or weak battery.	Refer to an authorized Sea-Doo dealer.
	Worn starter.	
Engine turns normally.	Fuel tank empty or water-contaminated.	Refill. Siphon and fill with fresh fuel.
	Fuel filter clogged.	Refer to an authorized Sea-Doo dealer.
	Fouled/defective spark plugs.	Replace.
	Fuel-flooded engine.	Refer to <i>FUEL-FLOODED ENGINE</i> in <i>SPECIAL PROCEDURES</i> .
	Faulty component in the fuel injection system.	Refer to an authorized Sea-Doo dealer.
	Burnt fuel pump fuse.	Check wiring then replace fuse.
	Electrical problem.	Refer to an authorized Sea-Doo dealer.

Engine Misfires, Misinjects, Runs Irregularly

OTHER OBSERVATION	POSSIBLE CAUSE	REMEDY
Weak spark.	Fouled/defective/worn spark plugs.	Replace.
	Faulty MPEM.	Refer to an authorized Sea-Doo dealer.
	Too much oil supplied to engine.	Improper oil pump adjustment, refer to an authorized Sea-Doo dealer.

OTHER OBSERVATION	POSSIBLE CAUSE	REMEDY
Lean fuel mixture.	Fuel: Level too low, stale or water-contaminated.	Siphon and/or refill.
	Fuel filter clogged.	Refer to an authorized Sea-Doo dealer.
	Clogged injectors.	
	Defective sensor or MPEM.	
Rich fuel mixture (high fuel consumption).	Flame arrester dirty/clogged.	Clean or replace.
	Defective sensor or MPEM.	Refer to an authorized Sea-Doo dealer.

Engine Overheats

OTHER OBSERVATION	POSSIBLE CAUSE	REMEDY
Monitoring beeper sounds continuously.	Clogged jet pump water intake.	Clean.
	Clogged coolant system.	Flush cooling system.

Engine Continually Backfires

OTHER OBSERVATION	POSSIBLE CAUSE	REMEDY
Weak spark.	Fouled/defective/worn spark plugs.	Replace.
Overheated engine.	See engine <i>OVERHEATS</i> .	Refer to an authorized SEA-DOO dealer.
	Spark plug leads or wiring reversed.	Connect spark plug cables at their proper location. Otherwise, refer to an authorized Sea-Doo dealer.

Engine Pinging or Knocking

OTHER OBSERVATION	POSSIBLE CAUSE	REMEDY
	Poor quality gasoline/low octane.	Use well known quality and recommended gasoline.
	Spark plug heat range too high.	Use recommended spark plugs.
	TDC setting.	Refer to an authorized Sea-Doo dealer.

Engine Lacks Acceleration or Power

OTHER OBSERVATION	POSSIBLE CAUSE	REMEDY
	Weak spark.	Refer to engine <i>MISFIRES, RUNS IRREGULARLY</i> .
	Water in fuel or injection oil.	Siphon and replace.

Watercraft Engine Cannot Run Above Idle Speed

OTHER OBSERVATION	POSSIBLE CAUSE	REMEDY
	The monitoring system put the watercraft in limp home mode due to a component malfunction.	Try removing and reinstalling the safety lanyard on its post. Refer to an authorized SEA-DOO dealer.

Watercraft Can Not Reach Top Speed

OTHER OBSERVATION	POSSIBLE CAUSE	REMEDY
	VTS (if so equipped) is adjusted to suit other riding conditions.	Readjust to try another setting.
	Exhaust gases leak in bilge.	Refer to an authorized Sea-Doo dealer.
Cavitation.	Jet pump water intake clogged.	Clean.
	Damaged impeller.	Replace. Refer to an authorized Sea-Doo dealer.
	Damaged wear ring.	Replace. Refer to an authorized Sea-Doo dealer.
	The safety lanyard used purposely does not allow watercraft top speed.	Use a safety lanyard that allows to reach the top speed.
	The monitoring system put the watercraft in limp home mode due to a component malfunction.	Release throttle so that engine returns to idle speed. Refer to an authorized SEA-DOO dealer.

O.T.A.S. System Faults

OTHER OBSERVATION	POSSIBLE CAUSE	REMEDY
Engine RPM does not increase when throttle lever is released and steering is turned.	Improper sequence or timing of events when trying it.	Refer to <i>MAINTENANCE</i> . If it still does not work, refer to an authorized Sea-Doo dealer.

Abnormal Noise from Propulsion System

OTHER OBSERVATION	POSSIBLE CAUSE	REMEDY
Cavitation.	Weeds or debris jammed around impeller.	Clean and check for damage.
	Damaged impeller shaft or drive shaft.	Refer to an authorized Sea-Doo dealer.

Steering Pole is Heavier than Usual

OTHER OBSERVATION	POSSIBLE CAUSE	REMEDY
	Steering pole return spring adjustment.	Set the adjuster to reduce the weight at the handlebar. Refer to <i>STEERING POLE</i> .
	Steering pole return spring is broken.	Refer to an authorized Sea-Doo dealer.

Steering Pole is Stiffer than Usual

OTHER OBSERVATION	POSSIBLE CAUSE	REMEDY
	Dirty/damaged parts	Clean. If parts are damaged, refer to an authorized Sea-Doo dealer.

SPECIFICATIONS

VEHICLES		3D™ DI
ENGINE		
Type		Rotax® 947 DI, 2-stroke
Induction type		Reed valve
Exhaust system		Water cooled
Exhaust valve		Rotax Adjustable Variable Exhaust (RAVE)
Lubrication	Type	Oil injection
	Oil type	XP-S synthetic 2-stroke oil
Number of cylinders		2
Displacement		951.2 cc (58 cu. in)
Bore		88 mm (3.465 in)
Stroke		78.20 mm (3.079 in)
Compression ratio (corrected)		6.0:1
Rev limiter setting		7300 ± 50 RPM
COOLING SYSTEM		
Type		Water cooled, total loss type. Direct flow from propulsion unit
ELECTRICAL SYSTEM		
Magneto generator output		270 W @ 6000 RPM
Ignition system type		Digital inductive
TDC setting (BTDC)	mm (in)	5.39 ± 0.30 (.212 ± .011) (direct) measure through direct injection hole 7.87 ± 0.30 (.310 ± .011) (indirect) measure through spark plug hole
	Degrees	27 ± 1.5 @ 1450 RPM
Spark plug	Make and type	NGK, ZFR4F
	Gap	1.1 mm (.043 in)
Starting system		Electric starter
Battery		12 V, 19 A•h. Electrolyte type

VEHICLES		3D™ DI
Fuse	Battery	25A
	Regulator (charging system)	25A
	Fuel pump	15A
	Injection system	15A
	Bilge pump	3A
	Spare (not used)	3A
	Main	30A
FUEL SYSTEM		
Fuel	Type	Regular unleaded gasoline
	Minimum octane number	Inside North America: 87 (R + M) / 2 Outside North America: 91 RON
Fuel injection		Orbital direct fuel injection, twin throttle body (46 mm (1.81 in))
Idle speed		Not adjustable
PROPULSION		
Propulsion system		Bombardier Formula pump
Jet pump type		Axial flow, single stage, needle bearing
Transmission		Direct drive
Reverse system		No
O.T.A.S.™ system		Yes
VTS		Adjuster on jet pump unit
Pivoting angle of direction (nozzle)		~ 20°
Minimum required water level for jet pump		90 cm (3 ft) underneath the lowest rear portion of hull
DIMENSIONS		
Number of passenger (refer to load limit)		1
Overall length		272 cm (107 in)
Overall width		112 cm (44 in)
Overall height		VERT: 92 cm (36.25 in) MOTO: 112 cm (44.25 in) KART: 96 cm (37.75 in)
Weight		VERT/MOTO: 277 kg (609 lb) KART: 284 kg (624 lb)
Load limit (passenger + luggage)		114 kg (250 lb)

VEHICLES		3D™ DI
CAPACITIES		
Fuel tank (including reserve)		35 L (9.2 U.S. gal)
Fuel tank reserve (from low level signal)		Roughly 5 L (1.3 U.S. gal)
Oil injection reservoir		4 L (1 U.S. gal)
Impeller shaft reservoir	Capacity	100 mL (3.4 U.S. gal)
	Oil level	Up to plug

Bombardier Recreational Products Inc. reserves the right to make changes in design and specifications and/or to make additions to, or improvements in its products without imposing any obligation upon itself to install them on its products previously manufactured.

ABBREVIATIONS USED IN THIS MANUAL

ABBREVIATION	DESCRIPTION
AC	Alternate current
API	American petroleum institute
CARB	California air resource board
DC	Direct current
DESS	Digitally encoded security system
E.I.N.	Engine identification number
EPA	Environmental protection agency
LED	Light-emitting diode
MAG	Magneto
MPEM	Multi-purpose electronic module
MPH	Mile per hour
N.A.	Not applicable
NA engine	Naturally-aspirated engine
O.T.A.S.	Off-throttle assisted steering
OPT	Optional
PFD	Personal flotation device
P/N	Part number
PTO	Power take off
STD	Standard
TBD	To be determined
TDC	Top dead center
T.O.P.S.	Tip-over protection system
VTS	Variable trim system

WARRANTY

NORTH AMERICA

USA (Except Puerto Rico)	BRP US Inc. 7575 Bombardier Court Wausau, WI. 54401 Phone: (715) 848-4957 Fax: (715) 847-6879 www.brp.com
CANADA	BOMBARDIER RECREATIONAL PRODUCTS INC. 75 J.A. Bombardier Sherbrooke, QC J1L 1W3 Phone: (819) 566-3366 Fax: (819) 566-3062 www.brp.com

If your Sea-Doo watercraft requires warranty service, you should take it to any authorized Sea-Doo dealer. Be sure to bring your warranty registration card or other valid proof of the original date of purchase. If a question or problem arises regarding warranty, first contact the service manager or owner of the Sea-Doo dealership.

To find the nearest authorized Sea-Doo dealer, dial: 1 800 882-2900.

NOTE: If outside Canada or USA, consult your local authorized Sea-Doo distributor.

BRP NORTH AMERICA LIMITED WARRANTY: 2006 SEA-DOO® 3D™ DI PERSONAL WATERCRAFT

1. SCOPE

Bombardier Recreational Products Inc. ("BRP")* warrants its model-year 2006 Sea-Doo 3D DI personal watercraft from defects in material or workmanship for the period and under the conditions described below.

All genuine BRP parts and accessories, installed by an authorized BRP dealer (as hereinafter defined) at the time of delivery of the Sea-Doo personal watercraft, carry the same warranty as that of the personal watercraft.

Use of the product for racing or any other competitive activity, at any point, even by a prior owner, will render this warranty null and void.

2. WARRANTY COVERAGE DURATION

This warranty will be in effect from the date of delivery to the first retail consumer or the date the product is first put into use, whichever occurs first and for a period of:

- a) TWELVE (12) CONSECUTIVE MONTHS for private use owners.
- b) FOUR (4) CONSECUTIVE MONTHS for commercial use owners. A personal watercraft is used commercially when it is used in connection with generating income or any work or employment during any part of the warranty period. A personal watercraft is also used commercially when, at any point during the warranty period, it has commercial tags or is licensed for commercial use.
- c) In addition to the above, the emission related components providing input to emission control (see list below) are covered for TWENTY-FOUR (24) CONSECUTIVE MONTHS OR 200 HOURS OF ENGINE USE whichever occurs first.

Emission Related Components:

Throttle Position Sensor (TPS)
Air Temperature Sensor (ATS)
Air Pressure Sensor (APS)

The repair or replacement of parts or the performance of service under this warranty does not extend the life of this warranty beyond its original expiration date.

For Sea-Doo personal watercraft produced for sale in the states of California or New York, that are originally sold to a resident or subsequently warranty registered to a resident in the state of California or New York, please also refer to the applicable California and New York Emissions Control Warranty Statement.

3. CONDITIONS TO HAVE WARRANTY COVERAGE

This warranty coverage is available only on Sea-Doo personal watercraft purchased as new and unused by its first owner from a BRP dealer authorized to distribute Sea-Doo products in the country in which the sale occurred ("BRP dealer"), and then only after the BRP specified predelivery inspection process is completed and documented. Warranty coverage only becomes available upon proper registration of the product by an authorized BRP dealer. Moreover, this warranty coverage is only available if the personal watercraft is purchased in the country in which the purchaser resides. BRP will not honor this limited warranty to any private use owner or commercial use owner if the preceding conditions have not been met. Such limitations are necessary in order to allow BRP to preserve the safety of its products, consumers and the general public.

Routine maintenance outlined in the Operator's Guide must be timely performed in order to maintain warranty coverage. BRP reserves the right to make warranty coverage contingent upon proof of proper maintenance.

4. WHAT TO DO TO OBTAIN WARRANTY COVERAGE

The customer must notify an authorized servicing BRP dealer within two (2) days of the appearance of a defect, and provide it with reasonable access to the product and reasonable opportunity to repair it. The customer must also present to the authorized BRP dealer, proof of purchase of the product and must sign the repair/work order prior to the start of the repair in order to validate the warranty repair. All parts replaced under this limited warranty become the property of BRP.

5. WHAT BRP WILL DO

BRP's obligations under this warranty are limited to, at its sole discretion, repairing parts found defective under normal use, maintenance and service, or replacing such parts with new genuine BRP parts without charge for parts and labor, at any authorized BRP dealer.

BRP reserves the right to improve or modify products from time to time without assuming any obligation to modify products previously manufactured.

6. EXCLUSIONS

The following are not warranted under any circumstances:

- Normal wear and tear;
- Routine maintenance items, tune ups, adjustments;
- Damage caused by failure to provide proper maintenance and/or storage, as described in the *OPERATOR'S GUIDE*;
- Damage resulting from removal of parts, improper repairs, service, maintenance, modifications or use of parts not manufactured or approved by BRP or resulting from repairs done by a person that is not an authorized servicing BRP dealer;
- Damage caused by abuse, abnormal use, neglect, or operation of the product in a manner inconsistent with the recommended operation described in the *OPERATOR'S GUIDE*;
- Damage resulting from accident, submersion, fire, theft, vandalism or any act of God;
- Operation with fuels, oils or lubricants which are not suitable for use with the product (see the *OPERATOR'S GUIDE*);
- Water damages caused by water ingestion;
- Damages related to gel coat finish including but not limited to cosmetic gel coat finish, blisters or fiberglass delamination caused by blisters, crazing, spider of hairline cracks; and
- Incidental or consequential damages, or damages of any kind including without limitation towing, storage, telephone, rental, taxi, inconvenience, insurance coverage, loan payments, loss of time, loss of income.

7. LIMITATIONS OF LIABILITY

THIS WARRANTY IS EXPRESSLY GIVEN AND ACCEPTED IN LIEU OF ANY AND ALL OTHER WARRANTIES, EXPRESSED OR IMPLIED, INCLUDING WITHOUT LIMITATION ANY WARRANTY OF MERCHANTABILITY OR FITNESS FOR A PARTICULAR PURPOSE. TO THE EXTENT THAT THEY CANNOT BE DISCLAIMED, THE IMPLIED WARRANTIES ARE LIMITED IN DURATION TO THE LIFE OF THE EXPRESS WARRANTY. INCIDENTAL AND CONSEQUENTIAL DAMAGES ARE EXCLUDED FROM COVERAGE UNDER THIS WARRANTY. SOME STATES/PROVINCES DO NOT ALLOW FOR THE DISCLAIMERS, LIMITATIONS AND EXCLUSIONS IDENTIFIED ABOVE, AS A RESULT, THEY MAY NOT APPLY TO YOU. THIS WARRANTY GIVES YOU SPECIFIC RIGHTS, AND YOU MAY ALSO HAVE OTHER LEGAL RIGHTS WHICH MAY VARY FROM STATE TO STATE, OR PROVINCE TO PROVINCE.

Neither the distributor, any BRP dealer nor any other person has been authorized to make any affirmation, representation or warranty regarding the product, other than those contained in this limited warranty, and if made, shall not be enforceable against BRP. BRP reserves the right to modify this warranty at any time, being understood that such modification will not alter the warranty conditions applicable to the products sold while this warranty is in effect.

8. TRANSFER

If the ownership of a product is transferred during the warranty coverage period, this warranty shall also be transferred and be valid for the remaining coverage period provided that BRP is notified of such transfer of ownership in the following way:

- a) The former owner contacts BRP (at the phone number provided below) or an authorized BRP dealer and gives the coordinates of the new owner; or
- b) BRP or an authorized BRP dealer receives a proof that the former owner agreed to the transfer of ownership, in addition to the coordinates of the new owner.

9. CONSUMER ASSISTANCE

In the event of a controversy or a dispute in connection with this BRP limited warranty, BRP suggests that you try to resolve the issue at the dealership level. We recommend discussing the issue with the authorized dealer's service manager or owner.

If the issue has not yet been resolved, please submit your complaint in writing or call the appropriate number below:

IN CANADA:

BOMBARDIER RECREATIONAL
PRODUCTS INC.

CONSUMER SERVICES GROUP
VALCOURT QC J0E 2L0
TEL: (819) 566-3366

IN USA:

BRP US INC.

CONSUMER SERVICES GROUP
7575 BOMBARDIER COURT
WAUSAU WI 54401
TEL: (715) 848-4957

*In the USA, products are distributed and serviced by BRP US Inc.

©2005 Bombardier Recreational Products Inc. All rights reserved.

®Registered trademark and TM trademark of Bombardier Recreational Products Inc. or its affiliates.

CALIFORNIA AND NEW YORK EMISSION CONTROL WARRANTY STATEMENT FOR MODEL-YEAR 2006 SEA-DOO® 3D™ DI PERSONAL WATERCRAFT.

For California, your Sea-Doo 3D DI personal watercraft has a special environmental label required by the California Air Resources Board. The label has 1, 2, 3 or 4 stars. A hangtag, provided with your personal watercraft, describes the meaning of the star rating system.

The Star Label means Cleaner Marine Engines



F18L3CQ



The Symbol for Cleaner Marine Engines:

CLEANER AIR AND WATER

For a healthier lifestyle and environment.

Better Fuel Economy

Burns up to 30 - 40 percent less gas and oil than conventional carbureted two-stroke engines, saving money and resources.

Longer Emission Warranty

Protects consumer for worry free operation.

One Star - Low-Emission

The one-star label identifies personal watercraft , outboard, sterndrive and in-board engines that meet the Air Resources Board's Personal Watercraft and Outboard marine engine 2001 exhaust emission standards. Engines meeting these standards have 75% lower emissions than conventional carbureted two-stroke engines. These engines are equivalent to the U.S. EPA's 2006 standards for marine engines.

Two Stars - Very Low Emission

The two-star label identifies personal watercraft , outboard, sterndrive and in-board engines that meet the Air Resources Board's Personal Watercraft and Outboard marine engine 2004 exhaust emission standards. Engines meeting these standards have 20% lower emissions than One Star - Low-Emission engines.

Three Stars - Ultra Low Emission

The three-star label identifies engines that meet the Air Resources Board's Personal Watercraft and Outboard marine engine 2008 exhaust emission standards or the Sterndrive and Inboard marine engine 2003 exhaust emission standards. Engines meeting these standards have 65% lower emissions than One Star - Low Emission engines.

Four Stars - Super Ultra Low Emission

The four-star label identifies engines that meet the Air Resources Board's Sterndrive and Inboard marine engine 2009 exhaust emission standards. Personal Watercraft and Outboard marine engines may also comply with these standards. Engines meeting these standards have 90% lower emissions than One Star - Low Emission engines.

For more information:

Cleaner Watercraft – Get the Facts

1 800 END-SMOG

www.arb.ca.gov

YOUR EMISSION CONTROL WARRANTY RIGHTS AND OBLIGATIONS

The California Air Resources Board, the New York State Department of Environmental Conservation, and BRP US Inc. ("BRP")* on behalf of Bombardier Recreational Products Inc. are pleased to explain the emission control system warranty on your model-year 2006 Sea-Doo personal watercraft. In the states of California and New York, new personal watercraft engines must be designed, built and equipped to meet the States's stringent anti-smog standards. BRP must warrant the emission control system on your personal watercraft engine for the periods of time listed below provided there has been no abuse, neglect or improper maintenance of your personal watercraft engine.

Your emission control system may include parts such as the carburetor or fuel injection system, the ignition system and catalytic converter. Also included may be hoses, belts, connectors and other emission-related assemblies.

Where a warrantable condition exists, BRP will repair your personal watercraft engine at no cost to you including diagnosis, parts and labor provided that such work is performed by an authorized BRP dealer.

Manufacturer's Limited Warranty Coverage

This emission warranty covers model year 2006 Sea-Doo personal watercraft certified and produced by BRP for sale in the states of California or New York, that are originally sold to a resident or subsequently warranty registered to a resident in the state of California or New York. The BRP limited warranty conditions for Sea-Doo personal watercraft are still applicable to these models with the necessary modifications.

Select emission control parts of your 2006 Sea-Doo 3D DI personal watercraft are warranted from the date of delivery to the first retail consumer for a period of 4 years, or for 250 hours of use, whichever occurs first. However, warranty coverage based on the hourly period is only permitted for personal watercraft equipped with the appropriate hour meters or their equivalent. If any emission-related part on your engine is defective under warranty, the part will be repaired or replaced by BRP.

Parts covered for 2006 Sea-Doo 3D DI personal watercraft:

Fuel Rail	Fuel Lines	Water Temperature Sensor (WTS)
Rave Valve	Air Pressure Regulator	Fuel Pressure Regulator
Reed Valve	Fuel Pump	Fuel Injectors
Tuned Pipe	Cylinder Head	Multi Purpose Electronic Module (MPEM)
High-Tension Ignition Wires	Throttle Position Sensor (TPS)	Air Lines
Electrical Harness	Ignition Coil	Exhaust Manifold
Throttle Body	Air Temperature Sensor (ATS)	Airbox and Flame Arrester
Exhaust Hoses	Air Pressure Sensor (APS)	All Emission Component Related Gaskets; Head, Base, Exhaust
Spark Plugs	Crankshaft Position Sensor (CPS)	Air injector
Air compressor		

The emission warranty covers damage to other engine components that is caused by the failure of a warranted part.

The BRP Operator’s Guide provided contains written instructions for the proper maintenance and use of your personal watercraft. All emission warranty parts are warranted by BRP for the entire warranty period of the personal watercraft, unless the part is scheduled for replacement as required maintenance in the Operator’s Guide.

Emission warranty parts that are scheduled for replacement, as required maintenance, are warranted by BRP for the period of time before the first scheduled replacement date for that part. Emission warranty parts that are scheduled for regular inspection, but not regular replacement, are warranted by BRP for the entire warranty period of the personal watercraft. Any emission warranty part repaired or replaced under the terms of this warranty statement is warranted by BRP for the remainder of the warranty period of the original part. All parts replaced under this limited warranty become the property of BRP.

Maintenance receipts and records should be transferred to each subsequent owner of the personal watercraft.

Owner's Warranty Responsibilities

As the personal watercraft owner, you are responsible for the performance of the required maintenance listed in your Operator's Guide. BRP recommends that you retain all receipts covering maintenance on your personal watercraft engine, but BRP cannot deny warranty solely for the lack of receipts or your failure to ensure the performance of all scheduled maintenance.

As the personal watercraft owner, you should however be aware that BRP may deny you warranty coverage if your personal watercraft engine or a part has failed due to abuse, neglect, improper maintenance or unapproved modifications.

You are responsible for presenting your personal watercraft engine to an authorized BRP dealer as soon as a problem exists. The warranty repairs will be completed in a reasonable amount of time, not to exceed 30 days.

If you have any questions regarding your warranty rights and responsibilities or for the name and location of the nearest authorized BRP dealer you should contact the Customer Services Group at 1 (715) 848-4957.

* In the USA, products are distributed and serviced by BRP US Inc.

©2005 Bombardier Recreational Products Inc. All rights reserved.

®Registered trademark and ™ trademark of Bombardier Recreational Products Inc. or its affiliates.

BRP INTERNATIONAL LIMITED WARRANTY: 2006 SEA-DOO® 3D™ DI PERSONAL WATERCRAFT

1. SCOPE

Bombardier Recreational Products Inc. ("BRP") warrants its model-year 2006 Sea-Doo 3D DI personal watercraft from defects in material or workmanship for the period described below.

All genuine BRP parts and accessories, installed by an authorized BRP distributor/dealer (as hereinafter defined) at the time of delivery of the Sea-Doo personal watercraft, carry the same warranty as that of the personal watercraft.

Use of the product for racing or any other competitive activity, at any point, even by a prior owner will render this warranty null and void.

2. WARRANTY COVERAGE DURATION

This warranty will be in effect from the date of delivery to the first retail consumer or the date the product is first put into use, whichever occurs first and for a period of:

- a) TWELVE (12) CONSECUTIVE MONTHS, for private, recreational use.
- b) FOUR (4) CONSECUTIVE MONTHS, for commercial use. A personal watercraft is used commercially when it is used in connection with generating income or any work or employment during any part of the warranty period. A personal watercraft is also used commercially when, at any point during the warranty period, it has commercial tags or is licensed for commercial use.

The repair or replacement of parts or the performance of service under this warranty does not extend the life of this warranty beyond its original expiration date.

3. CONDITIONS TO HAVE WARRANTY COVERAGE

This warranty coverage is available only on Sea-Doo personal watercraft purchased as new and unused by its first owner from a BRP distributor/dealer authorized to distribute Sea-Doo products in the country in which the sale occurred ("BRP distributor/dealer"), and then only after the BRP specified pre-delivery inspection process is completed and documented.

Warranty coverage only becomes available upon proper registration of the product by a BRP distributor/dealer. Such limitations are necessary in order to allow BRP to preserve the safety of its products, consumers and the general public.

Routine maintenance outlined in the Operator's Guide must be timely performed in order to maintain warranty coverage. BRP reserves the right to make warranty coverage contingent upon proof of proper maintenance.

4. WHAT TO DO TO OBTAIN WARRANTY COVERAGE

The customer must notify a servicing BRP distributor/dealer within two (2) days of the appearance of a defect, and provide it with reasonable access to the product and reasonable opportunity to repair it. The customer must also present to the BRP distributor/dealer, proof of purchase of the product and must sign the repair/work order prior to the start of the repair in order to validate the warranty repair. All parts replaced under this limited warranty become the property of BRP.

5. WHAT BRP WILL DO

BRP's obligations under this warranty are limited to, at its sole discretion, repairing parts found defective under normal use, maintenance and service, or replacing such parts with new genuine BRP parts without charge for parts and labor, at any authorized BRP distributor/dealer.

BRP reserves the right to improve or modify products from time to time without assuming any obligation to modify products previously manufactured.

6. EXCLUSIONS

The following are not warranted under any circumstances:

- Normal wear and tear;
- Routine maintenance items, tune ups, adjustments;
- Damage caused by failure to provide proper maintenance and/or storage, as described in the *OPERATOR'S GUIDE*;
- Damage resulting from removal of parts, improper repairs, service, maintenance, modifications or use of parts not manufactured or approved by BRP or resulting from repairs done by a person that is not an authorized servicing BRP distributor/dealer;
- Damage caused by abuse, abnormal use, neglect or operation of the product in a manner inconsistent with the recommended operation described in the *OPERATOR'S GUIDE*;
- Damage resulting from accident, submersion, fire, theft, vandalism or any act of God;
- Operation with fuels, oils or lubricants which are not suitable for use with the product (see the *OPERATOR'S GUIDE*);
- Water damages caused by water ingestion;
- Damages related to gel coat finish including but not limited to cosmetic gel coat finish, blisters or fiberglass delamination caused by blisters, crazing, spider or hairline cracks; and
- Incidental or consequential damages, or damages of any kind including without limitation towing, storage, telephone, rental, taxi, inconvenience, insurance coverage, loan payments, loss of time, loss of income.

7. LIMITATIONS OF LIABILITY

THIS WARRANTY IS EXPRESSLY GIVEN AND ACCEPTED IN LIEU OF ANY AND ALL OTHER WARRANTIES, EXPRESSED OR IMPLIED, INCLUDING WITHOUT LIMITATION ANY WARRANTY OF MERCHANTABILITY OR FITNESS FOR A PARTICULAR PURPOSE. TO THE EXTENT THAT THEY CANNOT BE DISCLAIMED, THE IMPLIED WARRANTIES ARE LIMITED IN DURATION TO THE LIFE OF THE EXPRESS WARRANTY. INCIDENTAL AND CONSEQUENTIAL DAMAGES ARE EXCLUDED FROM COVERAGE UNDER THIS WARRANTY. SOME JURISDICTIONS DO NOT ALLOW FOR THE DISCLAIMERS, LIMITATIONS AND EXCLUSIONS IDENTIFIED ABOVE, AS A RESULT, THEY MAY NOT APPLY TO YOU. THIS WARRANTY GIVES YOU SPECIFIC RIGHTS, AND YOU MAY ALSO HAVE OTHER LEGAL RIGHTS WHICH MAY VARY FROM COUNTRY TO COUNTRY.

Neither the BRP distributor nor any other person has been authorized to make any affirmation, representation or warranty regarding the product, other than those contained in this limited warranty, and if made, shall not be enforceable against BRP.

BRP reserves the right to modify this warranty at any time, being understood that such modification will not alter the warranty conditions applicable to the products sold while this warranty is in effect.

8. TRANSFER

If the ownership of a product is transferred during the warranty coverage period, this warranty shall also be transferred and be valid for the remaining coverage period provided BRP is notified of such transfer of ownership in the following way:

BRP or an authorized BRP distributor/dealer receives a proof that the former owner agreed to the transfer of ownership, in addition to the coordinates of the new owner. The distributor will then forward this information directly to BRP.

9. CONSUMER ASSISTANCE

- a) In the event of a controversy or a dispute in connection with this BRP limited warranty, BRP suggests that you try to resolve the issue at the dealership level. We recommend discussing the issue with the authorized dealer's service manager or owner.
- b) If further assistance is required, the distributor's service department should be contacted in order to resolve the matter.
- c) If the matter still remains unresolved then contact BRP at the address listed below.

BOMBARDIER RECREATIONAL PRODUCTS INC.

CUSTOMER SERVICES GROUP
VALCOURT QC J0E 2L0
Tel.: 1 (819) 566-3366

© 2005 Bombardier Recreational Products Inc. All rights reserved.

® Registered trademark and ™ trademark of Bombardier Recreational Products Inc. or its affiliates.

PRIVACY INFORMATION

We wish to inform you that your coordinates will be used for safety and warranty purposes. Sometimes, we also use the coordinates of our clients to inform them about our products and to present them offers. Should you prefer not to receive information on our products, services and offers, please let us know by writing to the address below.

Also note that, from time to time, carefully selected and trustworthy organizations may be permitted to use the coordinates of our clients to promote quality products and services. If you prefer not to have your name and address released, please let us know by writing to the address below:

Bombardier Recreational Products Inc.
Warranty Department
75 J.A. Bombardier Street
Sherbrooke, Québec
Canada
J1L 1W3
Fax Number (819) 566-3590

AFFIX
PROPER
POSTAGE

**Bombardier
Recreational Products Inc.**

WARRANTY DEPARTMENT
75, J.A. Bombardier
Sherbrooke, QC
Canada
J1L 1W3

V00A2G

WATERCRAFT MODEL No. _____

HULL IDENTIFICATION NUMBER (H.I.N.) _____

ENGINE IDENTIFICATION NUMBER (E.I.N.) _____

Owner: _____
NAME

No. STREET APT

CITY STATE/PROVINCE ZIP/POSTAL CODE

Purchase Date _____
YEAR MONTH DAY

Warranty Expiry Date _____
YEAR MONTH DAY

To be completed by the authorized Sea-Doo dealer at the time of the sale.

DEALER IMPRINT AREA

F00A30L

Please verify with your selling dealer to ensure your SEA-DOO watercraft has been registered with BRP.

219 000 407

CA

OPERATOR'S GUIDE, 3D RFI / ENGLISH
GUIDE DU CONDUCTEUR, 3D RFI / ANGLAIS

FAIT AU / MADE IN CANADA

U/M.P.C.

©™ TRADEMARKS OF BOMBARDIER RECREATIONAL PRODUCTS INC. OR ITS AFFILIATES.

*TRADEMARK OF BOMBARDIER INC. USED UNDER LICENSE.

†TRADEMARK OF CASTROL LIMITED USED UNDER LICENSE.

©2005 BOMBARDIER RECREATIONAL PRODUCTS INC. ALL RIGHTS RESERVED. PRINTED IN CANADA.