

BOMBARDIER
RECREATIONAL PRODUCTS



OPERATOR'S GUIDE
TRAXTER
AUTOSHIFT/XL/XT/FOOTSHIFT
2002

704 000 014



WARNING

Read this guide thoroughly.
It contains important safety information.
Minimum recommended operator age:
16 years old.

Particularly important information in this *Operator's Guide* is designated by the following:



The Safety Alert Symbol means ATTENTION!



WARNING

Identifies an instruction which if not followed, may cause injuries including the possibility of death.

CAUTION: Denotes an instruction which if not followed, may damage the ATV and/or components.



WARNING

YOUR ATV CAN BE HAZARDOUS TO OPERATE. A collision or rollover can occur quickly, even during routine maneuvers such as turning and driving on hills or over obstacles, if you fail to take proper precautions.

For your safety, understand and follow all the warnings contained in the *Operator's Guide*, the *Safety Handbook* and the labels on your vehicle. **Failure to follow these warnings can result in SEVERE INJURY OR DEATH.**

Keep this *Operator's Guide* and the *Safety Handbook* with the vehicle at all times.

In USA, products are distributed by Bombardier Motor Corporation of America. In Canada, products are distributed by Bombardier Inc.

The following are trademarks of Bombardier Inc. or its subsidiaries:

BOMBARDIER®

TRAXTER®

ROTAX®

† Simple Green is a registered trademark of Sunshine Markers Inc.

BOMBARDIER
RECREATIONAL PRODUCTS



FOREWORD

Congratulations on your purchase of a new Bombardier® all-terrain vehicle (ATV). It is backed by the Bombardier warranty and a network of authorized Bombardier ATV dealers ready to provide the parts, service or accessories you may require.

Your dealer is committed to your satisfaction. He has taken training to perform the initial set-up and inspection of your vehicle as well as completed the final adjustment before you took possession. At delivery, your dealer would have explained the vehicle for the operation, maintenance and safety features. We trust you have taken full advantage of this! If you need more complete servicing information, please ask your dealer about the proper model-year ATV *Shop Manual*.

At delivery, you were also informed of the warranty coverage and completed the Warranty Registration Form which is to be sent to us for processing. In the near future you should be receiving a warranty card which will confirm our receipt of the registration as well as be used for warranty or recall purposes.

You are invited to contact our customer assistance center should you experience problems which cannot be resolved by an authorized Bombardier ATV dealer.

It is understood that this guide may be translated into another language. In the event of any discrepancy, the English version shall prevail.

The information and components/system descriptions contained in this document are correct at the time of publication. Bombardier Inc. however, maintains a policy of continuous improvement of its products without imposing upon itself any obligation to install them on products previously manufactured. Due to late changes, it may have some differences between the manufactured product and the descriptions and/or specifications in this guide. Bombardier Inc. reserves the right at any time to discontinue or change specifications, designs, features, models or equipment without incurring any obligation upon itself.

The illustrations in this document show the typical construction of the different assemblies and may not reproduce the full detail or exact shape of the parts. However, they represent parts that have the same or similar function.

Specifications are given in the SI metric system with the SAE U.S. equivalent in parenthesis. Where precise accuracy is not required, some conversions are rounded off for easier use.

We recommend genuine Bombardier products for replacement parts and accessories. They've been especially designed for your vehicle and manufactured to meet Bombardier's demanding standards.

A *Shop Manual* can be obtained for complete service, maintenance and more repair information.

TABLE OF CONTENTS

NOTICE	4
SPECIAL SAFETY MESSAGES	5
OPERATION WARNINGS	7
BOMBARDIER LIMITED WARRANTY NORTH AMERICA: 2002 BOMBARDIER® ATV	34
BOMBARDIER LIMITED WARRANTY INTERNATIONAL: 2002 BOMBARDIER® ATV	37
FREQUENTLY ASKED QUESTIONS	40
EMISSION REQUIREMENTS	41
LOCATION OF THE IMPORTANT LABELS	42
HOW TO IDENTIFY YOUR ATV	48
Engine and Vehicle Identification Number Location	48
CONTROLS/INSTRUMENTS/EQUIPMENTS	49
1) Throttle Lever	51
2) Front Brake Lever	51
3) Rear Brake Lever	51
4) Brake Lever Lock	52
5) Transmission Lever	52
6) Electric Gear Shift Button	53
7) Gearshift Pedal	54
8) Start/Stop Switch	54
9) Headlight Dimmer Switch	55
10) Headlight Switch	55
11) Engine Stop Switch	55
12) Start Button	56
13) Indicator Lights Cluster	56
14) Speedometer	57
15) Hourmeter	58
16) Ignition Switch	58
17) Choke Knob Lever	59
18) Fuel Tank Cap	59
19) Fuel Gauge	60
20) Fuel Valve	60
21) Rear Brake Pedal	60
22) Rewind Starter Handle	61
23) Footpeg	61
24) Storage Compartment	61
25) Seat Latch	62
26) Front/Rear Cargo Racks	63
27) Air Duct	63
28) Trailer Hitch	63
29) Radiator Cap	64
30) 12-Volt Power Outlet	64
31) Fuses	65
32) Winch	65
33) Winch Control Switch	65
34) Fairlead	65
35) Rear Cargo Box	66
36) Release Lever	66
37) Rear Cargo Box Gate	66
38) Lateral Compartment	67

LIQUIDS	68
Fuel	68
Engine/Transmission Oil	68
Engine Coolant	70
Brake Fluid	71
Battery Electrolyte	72
BREAK-IN PERIOD	74
Engine	74
10-Hour Inspection	74
PRE-OPERATION CHECK	75
OPERATING INSTRUCTIONS	76
General	76
Initial Cold Starting	76
Warm Engine Starting	77
Emergency Manual Starting	77
Stopping the Engine	77
Shifting the Transmission	77
Winch Operation	78
Dumping the Rear Cargo Box	79
SPECIAL PROCEDURES	80
Flooded Engine	80
Engine Overheat	80
Flipped Over	80
ATV Immersion	80
Post-Operation Care	81
Emergency Shifter	81
Storage and Preseason Preparation	82
MAINTENANCE CHART	83
MAINTENANCE	85
Engine/Transmission	85
Air Intake System	89
Electrical	91
Drive Train	94
Steering/Control Systems	96
Suspension	97
Brake	98
Body/Frame	98
CARGO AND TRANSPORTATION	100
Cargo	100
Transportation	101
TROUBLESHOOTING	103
SPECIFICATIONS	106
SI METRIC INFORMATION GUIDE	118
CHANGE OF ADDRESS/OWNERSHIP	119

NOTICE

The *Operator's Guide* and *Safety Handbook* have been prepared to acquaint the owner/operator of a new vehicle with the various vehicle controls, maintenance and safe operating instructions. They are indispensable for the proper use of the product.

This guide uses the following symbols.

**WARNING**

Identifies an instruction which, if not followed, could cause serious personal injuries including the possibility of death.

CAUTION: Denotes an instruction which, if not followed, could severely damage vehicle components.

NOTE: Indicates supplementary information needed to fully complete an instruction.

Although the mere reading of such information does not eliminate the hazard, the understanding and application of the information will promote the correct use of the all-terrain vehicle (ATV).

To fully appreciate the pleasures, enjoyment and excitement of using an ATV, there are some basic rules that **MUST** be observed and followed by any four-wheeler.

SPECIAL SAFETY MESSAGES

AN ATV IS NOT A TOY AND CAN BE HAZARDOUS TO OPERATE.

An ATV handles differently from other vehicles including motorcycles and cars. A collision or rollover can occur quickly, even during routine maneuvers such as turning and driving on hills or over obstacles, if you fail to take proper precautions.

SEVERE INJURY OR DEATH can result if you do not follow these instructions:

- ⚠ Read the *Operator's Guide*, the *Safety Handbook* and all labels carefully and follow the operating procedures described.
- ⚠ Never operate an ATV without proper instruction. **Take a training course.** Beginners should receive training from a certified instructor. Contact an authorized ATV dealer to find out about the training courses nearest you or call the Specialty Vehicle Institute of America (SVIA) at 1-800-887-2887 or in Canada, the Canada Safety Council (CSC) at 1-613-739-1535 ext. 227.
- ⚠ Always follow this age recommendation: A child under 16 years old should never operate this ATV.
- ⚠ Never carry a passenger on an ATV.
- ⚠ Never operate an ATV on any paved surfaces, including sidewalks, driveways, parking lots and streets.
- ⚠ Never operate an ATV on any public street, road or highway, even a dirt or gravel one.
- ⚠ Never operate an ATV without wearing an approved helmet that fits properly. You should also wear eye protection (goggles or face shield), gloves, boots, long sleeved shirt or jacket, and long pants.

- ⚠ Never consume alcohol or drugs before or while operating this ATV.
- ⚠ Never operate at excessive speeds. Always go at a speed that is proper for the terrain, visibility, and operating conditions, and your experience.
- ⚠ Never attempt wheelies, jumps, or other stunts.
- ⚠ Always inspect your ATV each time you use it to make sure it is in safe operating condition. Always follow the inspection and maintenance procedures and schedules described in the *Operator's Guide* and the *Safety Handbook*.
- ⚠ Always keep both hands on the handlebars and both feet on the footpegs of the ATV during operation.
- ⚠ Always go slowly and be extra careful when operating on unfamiliar terrain. Always be alert to changing terrain conditions when operating the ATV.
- ⚠ Never operate on excessively rough, slippery or loose terrain until you have learned and practiced the skills necessary to control the ATV on such terrain. Always be especially cautious on these kinds of terrain.
- ⚠ Always follow proper procedures for turning as described in the *Operator's Guide* and the *Safety Handbook*. Practice turning at low speeds before attempting to turn at faster speeds. Do not turn at excessive speed.
- ⚠ Never operate the ATV on hills too steep for the ATV or for your abilities. Practice on smaller hills before attempting larger hills.

- ⚠ Always follow proper procedures for climbing hills as described in the *Operator's Guide* and the *Safety Handbook*. Check the terrain carefully before you start up any hill. Never climb hills with excessively slippery or loose surfaces. Shift your weight forward. Never open the throttle suddenly or make sudden gear changes. Never go over the top of any hill at high speed.
- ⚠ Always follow proper procedures for going down hills and for braking on hills as described in the *Operator's Guide* and the *Safety Handbook*. Check the terrain carefully before you start down any hill. Shift your weight backward. Never go down a hill at high speed. Avoid going down a hill at an angle that would cause the vehicle to lean sharply to one side. Go straight down the hill where possible.
- ⚠ Always follow proper procedures for crossing the side of a hill as described in the *Operator's Guide* and the *Safety Handbook*. Avoid hills with excessively slippery or loose surfaces. Shift your weight to the uphill side of the ATV. Never attempt to turn the ATV around on any hill until you have mastered the turning technique described in the *Operator's Guide* and the *Safety Handbook* on level ground. Avoid crossing the side of a steep hill if possible.
- ⚠ Always use proper procedures if you stall or roll backwards when climbing a hill. To avoid stalling, use proper gear and maintain a steady speed when climbing a hill. If you stall or roll backwards, follow the special procedure for braking described in the *Operator's Guide* and the *Safety Handbook*. Dismount on the uphill side or to a side if pointed straight uphill. Turn the ATV around and remount, following the procedure described in the *Operator's Guide* and the *Safety Handbook*.
- ⚠ Always check for obstacles before operating in a new area. Never attempt to operate over large obstacles, such as large rocks or fallen trees. Always follow proper procedures when operating over obstacles as described in the *Operator's Guide* and the *Safety Handbook*.
- ⚠ Always be careful when skidding or sliding. Learn to safely control skidding or sliding by practicing at low speeds and on level, smooth terrain. On extremely slippery surfaces, such as ice, go slowly and be very cautious in order to reduce the chance of skidding out of control.
- ⚠ Never operate an ATV in fast flowing water or in water deeper than that specified in the *Operator's Guide* and the *Safety Handbook*. Remember that wet brakes may have reduced stopping ability. Test your brakes after leaving water. If necessary, apply them several times to let friction dry out the pads.
- ⚠ Always be sure there are no obstacles or people behind you when you operate in reverse. When it is safe to proceed in reverse, go slowly.
- ⚠ Always use the size and type tires specified in the *Operator's Guide*. Always maintain proper tire pressure as described in this guide.
- ⚠ Never modify an ATV through improper installation or use of accessories.
- ⚠ Never exceed the stated load limits for an ATV. Cargo should be properly distributed and securely attached. Reduce speed and follow instructions in the *Operator's Guide* and the *Safety Handbook* for carrying cargo or pulling a trailer. Allow greater distance for braking.
- ⚠ **FOR MORE INFORMATION ABOUT ATV SAFETY**, call the Specialty Vehicle Institute of America (SVIA) at 1-800-887-2887 or in Canada, the Canada Safety Council (CSC) at 1-613-739-1535 ext. 227.

OPERATION WARNINGS

While reading this *Operator's Guide*, remember that:

WARNING

Indicates a potential hazard that could result in serious injury or death.

The following warnings and their format have been requested by the United States Consumer Product Safety Commission and are required to be in the *Operator's Guide* and *Safety Handbook* for all ATV's.

NOTE: The following illustrations are general representations only. Your model may differ.

WARNING



V00A0AQ

POTENTIAL HAZARD

Operating this ATV without proper instruction.

WHAT CAN HAPPEN

The risk of an accident is greatly increased if the operator does not know how to operate the ATV properly in different situations and on different types of terrain.

HOW TO AVOID THE HAZARD

Beginning and inexperienced operators should complete the certified training course offered by Bombardier Inc. They should then regularly practice the skills learned in the course and the operating techniques described in the *Operator's Guide* and the *Safety Handbook*.

For more information about the training course, contact an authorized ATV dealer or call Bombardier Inc. at 1-819-566-3366.



V00A01Q

POTENTIAL HAZARD

Failure to follow the age recommendations for this ATV.

WHAT CAN HAPPEN

Use by children of ATVs that are not recommended for their age can lead to severe injury or death of the child.

Even though a child may be within the age group for which an ATV is recommended, he or she may not have the skills, abilities, or judgment needed to operate the ATV safely and may be involved in a serious accident.

HOW TO AVOID THE HAZARD

No one under 16 should operate a Bombardier ATV.

 **WARNING**



V00A02Q

POTENTIAL HAZARD

Carrying a passenger on this ATV or in the rear cargo box.

WHAT CAN HAPPEN

Greatly reduces your ability to balance and control this ATV.

Could cause an accident, resulting in harm to you and/or your passenger.

HOW TO AVOID THE HAZARD

Never carry a passenger. The long seat is to allow the operator to shift position as needed during operation. The rear cargo box is used to transport material only. They are not for carrying passengers.

WARNING

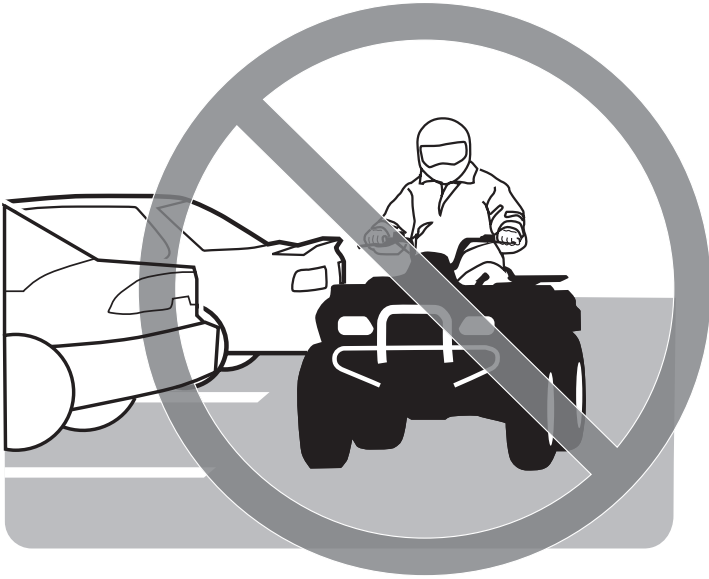

V00A03Q

POTENTIAL HAZARD

Operating this ATV on paved surfaces.

WHAT CAN HAPPEN

The ATV's tires are designed for off-road use only, not for use on pavement. Paved surfaces may seriously affect handling and control of the ATV, and may cause the vehicle to go out of control.

HOW TO AVOID THE HAZARD

Never operate the ATV on any paved surfaces, including sidewalks, driveways, parking lots and streets.

⚠ WARNING



V00A04Q

POTENTIAL HAZARD

Operating this ATV on public streets, roads or highways.

WHAT CAN HAPPEN

You can collide with another vehicle.

HOW TO AVOID THE HAZARD

Never operate this ATV on any public street, road or highway, even a dirt or gravel one. In many states it is illegal to operate ATVs on public streets, roads and highways.

WARNING



V00A06Q

POTENTIAL HAZARD

Operating this ATV without wearing an approved motorcycle helmet, eye protection and protective clothing.

WHAT CAN HAPPEN

Operating without an approved motorcycle helmet increases your chances of a severe head injury or death in the event of an accident.

Operating without eye protection can result in an accident and increases your chances of a severe injury in the event of an accident.

Operating without protective clothing increases your chances of severe injury in the event of an accident.

HOW TO AVOID THE HAZARD

Always wear an approved motorcycle helmet that fits properly. You should also wear:

- eye protection (goggles or face shield)
- gloves
- boots
- long sleeved shirt or jacket
- long pants.

⚠ WARNING



V00A07Q

POTENTIAL HAZARD

Operating this ATV after consuming alcohol or drugs.

WHAT CAN HAPPEN

- Could seriously affect your judgment.
- Could cause you to react more slowly.
- Could affect your balance and perception.
- Could result in an accident.

HOW TO AVOID THE HAZARD

Never consume alcohol or drugs before or while driving this ATV.

⚠ WARNING

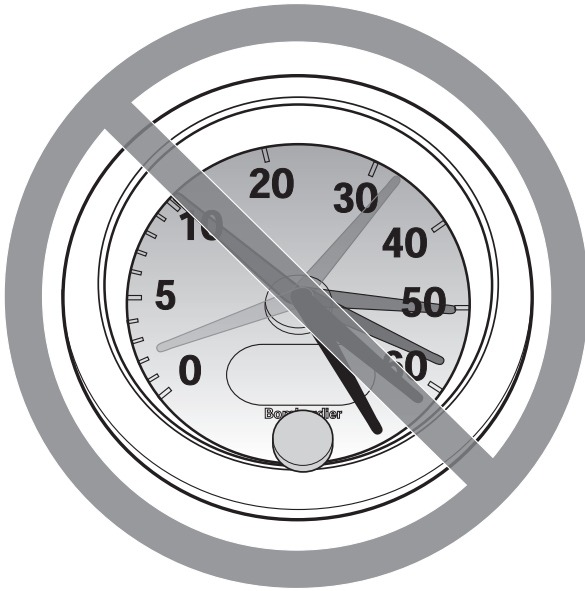

V00A08Q

POTENTIAL HAZARD

Operating this ATV at excessive speeds.

WHAT CAN HAPPEN

Increases your chances of losing control of the ATV, which can result in an accident.

HOW TO AVOID THE HAZARD

Always travel at a speed which is proper for the terrain, visibility and operating conditions, and your experience.

⚠ WARNING

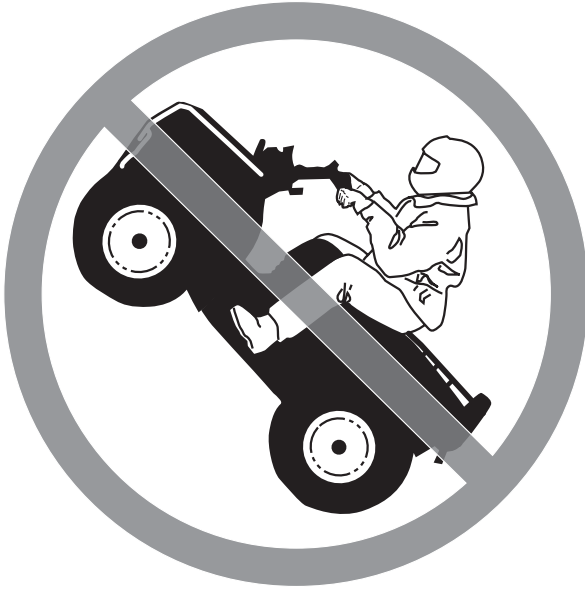

V00A09Q

POTENTIAL HAZARD

Attempting wheelies, jumps and other stunts.

WHAT CAN HAPPEN

Increases the chance of an accident, including an overturn.

HOW TO AVOID THE HAZARD

Never attempt stunts, such as wheelies or jumps. Don't try to show off.

WARNING

POTENTIAL HAZARD

Failure to inspect the ATV before operating.
Failure to properly maintain the ATV.

WHAT CAN HAPPEN

Increases the possibility of an accident or equipment damage.

HOW TO AVOID THE HAZARD

Always inspect your ATV each time you use it to make sure the ATV is in safe operating condition.

Always make sure that the rear cargo box is properly latched before operating.

Always follow the inspection and maintenance procedures and schedules described in the *Operator's Guide* and the *Safety Handbook*.

⚠ WARNING



V00A0B0

POTENTIAL HAZARD

Removing hands from handlebars or feet from footpegs during operation.

WHAT CAN HAPPEN

Removing even one hand or foot can reduce your ability to control the ATV or could cause you to lose your balance and fall off the ATV. If you remove a foot from the footpegs, your foot or leg may come into contact with the rear wheels, which could injure you or cause an accident.

HOW TO AVOID THE HAZARD

Always keep both hands on the handlebars and both feet on the footpegs of your ATV during operation.

⚠ WARNING

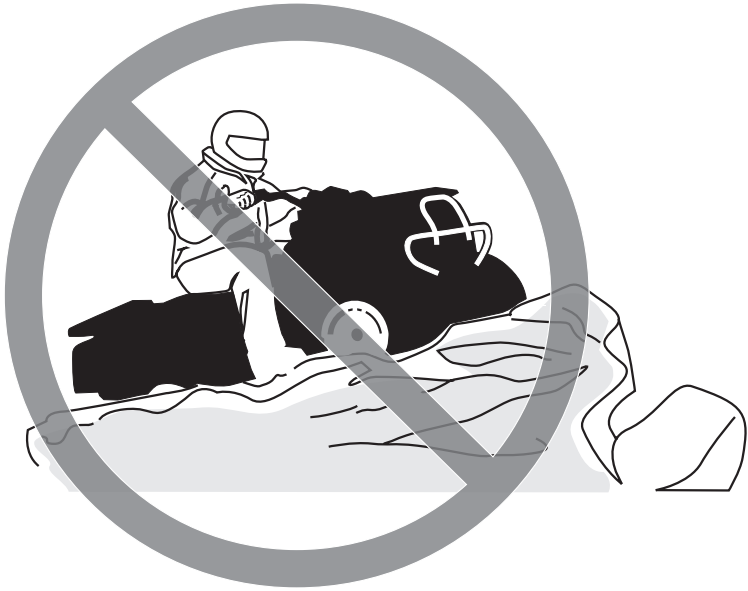

V00A0CQ

POTENTIAL HAZARD

Failure to use extra care when operating this ATV on unfamiliar terrain.

WHAT CAN HAPPEN

You can come upon hidden rocks, bumps, or holes, without enough time to react.

Could result in the ATV overturning or going out of control.

HOW TO AVOID THE HAZARD

Go slowly and be extra careful when operating on unfamiliar terrain.

Always be alert to changing terrain conditions when operating the ATV.

WARNING



V00A0DQ

POTENTIAL HAZARD

Failure to use extra care when operating on excessively rough, slippery or loose terrain.

WHAT CAN HAPPEN

Could cause loss of traction or vehicle control, which could result in an accident, including an overturn.

HOW TO AVOID THE HAZARD

Do not operate on excessively rough, slippery or loose terrain until you have learned and practiced the skills necessary to control the ATV on such terrain.

Always be especially cautious on these kinds of terrain.

⚠ WARNING



V00A0EQ

POTENTIAL HAZARD

Turning improperly.

WHAT CAN HAPPEN

ATV could go out of control, causing a collision or overturn.

HOW TO AVOID THE HAZARD

Always follow proper procedures for turning as described in the *Operator's Guide* and the *Safety Handbook*. Practice turning at low speeds before attempting to turn at faster speeds.

Do not turn at excessive speed.

⚠ WARNING



V00A00Q

POTENTIAL HAZARD

Operating on excessively steep hills.

WHAT CAN HAPPEN

The vehicle can overturn more easily on extremely steep hills than on level surfaces or small hills.

HOW TO AVOID THE HAZARD

Never operate the ATV on hills too steep for the ATV or for your abilities. Practice on smaller hills before attempting larger hills.

WARNING



V00A0FQ

POTENTIAL HAZARD

Climbing hills improperly.

WHAT CAN HAPPEN

Could cause loss of control or cause ATV to overturn.

HOW TO AVOID THE HAZARD

Always follow proper procedures for climbing hills as described in the *Operator's Guide* and the *Safety Handbook*.

Always check the terrain carefully before you start up any hill.

Never climb hills with excessively slippery or loose surfaces.

Shift your weight forward.

Never open the throttle suddenly or make sudden gear changes. The ATV could flip over backwards.

Never go over the top of any hill at high speed. An obstacle, a sharp drop, or another vehicle or person could be on the other side of the hill.

⚠ WARNING



V00A0GG

POTENTIAL HAZARD

Going down a hill improperly.

WHAT CAN HAPPEN

Could cause loss of control or cause ATV to overturn.

HOW TO AVOID THE HAZARD

Always follow proper procedures for going down hills as described in the *Operator's Guide* and the *Safety Handbook*.

NOTE: A special technique is required when braking as you go down a hill.

Always check the terrain carefully before you start down any hill.

Shift your weight backward.

Never go down a hill at high speed.

Avoid going down a hill at an angle which would cause the vehicle to lean sharply to one side. Go straight down the hill where possible.

WARNING



V00A0HQ

POTENTIAL HAZARD

Improperly crossing hills or turning on hills.

WHAT CAN HAPPEN

Could cause loss of control or cause ATV to overturn.

HOW TO AVOID THE HAZARD

Never attempt to turn the ATV around on any hill until you have mastered the turning technique as described in the *Operator's Guide* and the *Safety Handbook* on level ground. Be very careful when turning on any hill.

Avoid crossing the side of a steep hill if possible.

When crossing the side of a hill:

Always follow proper procedures as described in the *Operator's Guide* and the *Safety Handbook*.

Avoid hills with excessively slippery or loose surfaces.

Shift your weight to the uphill side of the ATV.

⚠ WARNING



V00A01Q

POTENTIAL HAZARD

Stalling, rolling backwards or improperly dismounting while climbing a hill.

WHAT CAN HAPPEN

Could result in ATV overturning.

HOW TO AVOID THE HAZARD

Use proper gear and maintain steady speed when climbing a hill.

If you lose all forward speed:

Keep weight uphill.

Apply the brakes.

Lock parking brake after you are stopped.

If you begin rolling backwards:

Keep weight uphill.

Never apply the rear brake while rolling backwards.

Apply the front brake gradually.

When fully stopped, apply rear brake as well and lock parking brake.

Dismount on uphill side, or to a side if pointed straight uphill.

Turn the ATV around and remount, following the procedure described in the *Operator's Guide* and the *Safety Handbook*.

WARNING



V00A0JQ

POTENTIAL HAZARD

Improperly operating over obstacles.

WHAT CAN HAPPEN

Could cause loss of control or a collision. Could cause the ATV to overturn.

HOW TO AVOID THE HAZARD

Before operating in a new area, check for obstacles.

Never attempt to ride over large obstacles, such as large rocks or fallen trees.

When you go over obstacles, always follow proper procedures as described in the *Operator's Guide* and the *Safety Handbook*.

⚠ WARNING



V00A0KQ

POTENTIAL HAZARD

Skidding or sliding improperly.

WHAT CAN HAPPEN

You may lose control of this ATV.

You may also regain traction unexpectedly, which may cause the ATV to overturn.

HOW TO AVOID THE HAZARD

Learn to safely control skidding or sliding by practicing at low speeds and on level, smooth terrain.

On extremely slippery surfaces, such as ice, go slowly and be very cautious in order to reduce the chance of skidding or sliding out of control.

⚠ WARNING



V00A0LQ

POTENTIAL HAZARD

Operating this ATV through deep or fast flowing water.

WHAT CAN HAPPEN

Tires may float, causing loss of traction and loss of control, which could lead to an accident.

HOW TO AVOID THE HAZARD

Never operate this ATV in fast flowing water or in water deeper than that specified in the *Operator's Guide* and the *Safety Handbook*.

Remember that wet brakes may have reduced stopping ability. Test your brakes after leaving water. If necessary, apply them several times to let friction dry out the pads.

⚠ WARNING



V00A0MQ

POTENTIAL HAZARD

Improperly operating in reverse.

WHAT CAN HAPPEN

You could hit an obstacle or person behind you, resulting in serious injury.

HOW TO AVOID THE HAZARD

When you select reverse gear, make sure there are no obstacles or people behind you. When it is safe to proceed, go slowly.

⚠ WARNING



V00A00Q

POTENTIAL HAZARD

Operating this ATV with improper tires, or with improper or uneven tire pressure.

WHAT CAN HAPPEN

Use of improper tires on this ATV, or operation of this ATV with improper or uneven tire pressure, may cause loss of control, and increases the risk of an accident.

HOW TO AVOID THE HAZARD

Always use the size and type, tires specified in the *Operator's Guide* for this vehicle.

Always maintain proper tire pressure as described in the *Operator's Guide* and the *Safety Handbook*.

⚠ WARNING



V00A0NQ

POTENTIAL HAZARD

Operating this ATV with improper modifications.

WHAT CAN HAPPEN

Improper installation of accessories or modification of this vehicle may cause changes in handling which in some situations could lead to an accident.

HOW TO AVOID THE HAZARD

Never modify this ATV through improper installation or use of accessories. All parts and accessories added to this vehicle should be genuine Bombardier or equivalent components designed for use on this ATV and should be installed and used according to instructions. If you have questions, consult an authorized Bombardier ATV dealer.

⚠ WARNING



V00A0PQ

POTENTIAL HAZARD

Overloading this ATV or carrying or towing cargo improperly.

WHAT CAN HAPPEN

Could cause changes in vehicle handling which could lead to an accident.

HOW TO AVOID THE HAZARD

Never exceed the stated load capacity for this ATV.

Cargo should be properly distributed and securely attached.

Reduce speed when carrying cargo or pulling a trailer. Allow greater distance for braking.

Always follow the instructions in the *Operator's Guide* and the *Safety Handbook* for carrying cargo or pulling a trailer.

 **WARNING**



V03M01Q

POTENTIAL HAZARD

Transporting inflammable or dangerous material can lead to explosions.

WHAT CAN HAPPEN

This can cause serious injury or death.

HOW TO AVOID THE HAZARD

Never transport inflammable or dangerous material.

While reading this *Operator's Guide*, remember that:

 **WARNING**

Indicates a potential hazard that could result in serious injury or death.

BOMBARDIER LIMITED WARRANTY NORTH AMERICA: 2002 BOMBARDIER® ATV

1. SCOPE OF THE LIMITED WARRANTY

BOMBARDIER INC. (hereinafter "BOMBARDIER") warrants its 2002 Bombardier ATV from defects in material or workmanship for the period described below.

All genuine BOMBARDIER parts and accessories, installed by an authorized BOMBARDIER dealer (as hereinafter defined) at the time of delivery of the 2002 Bombardier ATV, carry the same warranty as that of the ATV.

Tires and winches supplied as original equipment on your ATV are warranted separately by the individual tire or winch manufacturer as identified below. If an original tire or winch on your Bombardier ATV has a defect in material or workmanship, please contact these manufacturers or ask your authorized BOMBARDIER dealer for assistance.

Carlisle Tire & Wheel Company
(Traxters and QUEST tires)
23 Windham Boulevard
Aiken, SC 29805

Warranty Information:

in USA 1-800-260-7959

in Canada 1-800-265-6155

in Quebec 1-877-997-4999

Warn Industries Inc. (Winch)
12900 SE Capps Road
Clackamas, Oregon 97015-8903
Customer service:

in USA 1-800-543-9276

in Canada 1-800-668-6012

in Quebec 1-800-361-9291

Kenda USA (DS 650 tires)
7095 Americana Parkway
Reynoldsburg, OH 43068
1-614-866-9803

Use of the product for racing or any other competitive activity, at any point, even by a prior owner, will render this warranty null and void.

2. WARRANTY COVERAGE PERIOD

This warranty will be in effect FROM THE DATE OF DELIVERY TO THE FIRST RETAIL CONSUMER or the date the product is first put into use, whichever occurs first and for a period of:

SIX (6) CONSECUTIVE MONTHS, for private use or commercial owners.

The repair or replacement of parts or the performance of service under this warranty does not extend the life of this warranty beyond its original expiration date.

3. CONDITIONS TO HAVE WARRANTY COVERAGE

This warranty coverage is available only on 2002 Bombardier ATV purchased as new and unused by its first owner from a BOMBARDIER dealer authorized to distribute Bombardier ATV products in the country in which the sale occurred (hereinafter "BOMBARDIER dealer"), and then only after the BOMBARDIER specified pre-delivery inspection process is completed and documented. Warranty coverage only becomes available upon proper registration of the product by a BOMBARDIER dealer. Such limitations are necessary in order to allow BOMBARDIER to preserve both the safety of its products, and also that of its consumers and the public.

Routine maintenance outlined in the *Operator's Guide* must be timely performed in order to maintain warranty coverage. BOMBARDIER reserves the right to make warranty coverage contingent upon proof of proper maintenance.

4. WHAT TO DO TO OBTAIN WARRANTY COVERAGE

The customer must notify a servicing BOMBARDIER dealer within two (2) days of the appearance of a defect, and provide it with reasonable access to the product and reasonable opportunity to repair it. The customer must also present to the BOMBARDIER dealer, proof of purchase of the product and must sign the repair/work order prior to the start of the repair in order to validate the warranty repair. All parts replaced under this limited warranty become the property of BOMBARDIER.

5. WHAT BOMBARDIER WILL DO

BOMBARDIER's obligations under this warranty are limited to, at its sole discretion, repairing parts found defective under normal use, maintenance and service, or replacing such parts with new genuine BOMBARDIER parts without charge for parts and labor, at any authorized BOMBARDIER dealer.

BOMBARDIER reserves the right to improve or modify products from time to time without assuming any obligation to modify products previously manufactured.

6. EXCLUSIONS - ARE NOT WARRANTED

- Normal wear and tear;
- Routine maintenance items, tune ups, adjustments;
- Damage caused by failure to provide proper maintenance and/or storage, as described in the *Operator's Guide*;
- Damage resulting from removal of parts, improper repairs, service, maintenance, modifications or use of parts not manufactured or approved by BOMBARDIER or resulting from repairs done by a person that is not an authorized servicing BOMBARDIER dealer;
- Damage caused by abuse, abnormal use, neglect or operation of the product in a manner inconsistent with the recommended operation described in the *Operator's Guide*;
- Damage resulting from accident, submersion, fire, theft, vandalism or any act of God;
- Operation with fuels, oils or lubricants which are not suitable for use with the product (see the *Operator's Guide*);
- Water or snow ingestion;
- Incidental or consequential damages, or damages of any kind including without limitation towing, storage, telephone, rental, taxi, inconvenience, insurance coverage, loan payments, loss of time, loss of income.

7. LIMITATIONS OF LIABILITY

THIS WARRANTY IS EXPRESSLY GIVEN AND ACCEPTED IN LIEU OF ANY AND ALL OTHER WARRANTIES, EXPRESSED OR IMPLIED, INCLUDING WITHOUT LIMITATION ANY WARRANTY OF MERCHANTABILITY OR FITNESS FOR A PARTICULAR PURPOSE. TO THE EXTENT THAT THEY CANNOT BE DISCLAIMED, THE IMPLIED WARRANTIES ARE LIMITED IN DURATION TO THE LIFE OF THE EXPRESS WARRANTY. INCIDENTAL AND CONSEQUENTIAL DAMAGES ARE EXCLUDED FROM COVERAGE UNDER THIS WARRANTY. SOME STATES/PROVINCES DO NOT ALLOW FOR THE DISCLAIMERS, LIMITATIONS AND EXCLUSIONS IDENTIFIED ABOVE, AS A RESULT, THEY MAY NOT APPLY TO YOU. THIS WARRANTY GIVES YOU SPECIFIC RIGHTS, AND YOU MAY ALSO HAVE OTHER LEGAL RIGHTS WHICH MAY VARY FROM STATE TO STATE, OR PROVINCE TO PROVINCE.

Neither the distributor, any BOMBARDIER dealer nor any other person has been authorized to make any affirmation, representation or warranty regarding the product, other than those contained in this limited warranty, and if made, shall not be enforceable against BOMBARDIER.

BOMBARDIER reserves the right to modify this warranty at any time, being understood that such modification will not alter the warranty conditions applicable to the products sold while this warranty is in effect.

8. TRANSFER

If the ownership of a product is transferred during the warranty coverage period, this warranty shall also be transferred and be valid for the remaining coverage period provided that BOMBARDIER is notified of such transfer of ownership in the following way:

- a) The former owner contacts BOMBARDIER (at the phone number provided below) or an authorized BOMBARDIER dealer and gives the coordinates of the new owner;
or
- b) BOMBARDIER or an authorized BOMBARDIER dealer receives a proof that the former owner agreed to the transfer of ownership, in addition to the coordinates of the new owner.

9. CONSUMER ASSISTANCE

- a) In the event of a controversy or a dispute in connection with this BOMBARDIER LIMITED WARRANTY, BOMBARDIER suggests that you try to resolve the issue at the dealership level. We recommend discussing the issue with the authorized dealer's service manager or owner.
- b) If the issue has not yet been resolved, please submit your complaint in writing or call the appropriate number below:

In Canada:

BOMBARDIER INC.
RECREATIONAL PRODUCTS
BOMBARDIER ATV
CUSTOMER ASSISTANCE CENTER
VALCOURT, QUEBEC
JOE 2LO
Tel: (819) 566-3366

in USA:

BOMBARDIER MOTOR
CORPORATION OF AMERICA
RECREATIONAL PRODUCTS
CUSTOMER ASSISTANCE CENTER
P.O. BOX 8035
7575 BOMBARDIER COURT
WAUSAU WI 54402-8035
Tel: (715) 848-4957
Fax: (715) 847-6879

© 2001 Bombardier Inc. All rights reserved

® Registered trademark of Bombardier Inc.

BOMBARDIER LIMITED WARRANTY INTERNATIONAL: 2002 BOMBARDIER® ATV

1. SCOPE OF THE LIMITED WARRANTY

BOMBARDIER INC. (hereinafter "BOMBARDIER") warrants its 2002 BOMBARDIER ATV from defects in material or workmanship for the period described below.

All genuine BOMBARDIER parts and accessories, installed by an authorized BOMBARDIER distributor/dealer (as hereinafter defined) at the time of delivery of the 2002 BOMBARDIER ATV, carry the same warranty as that of the ATV.

Tires and winches supplied as original equipment on your ATV are warranted separately by the individual tire or winch manufacturer as identified below. If an original tire or winch on your BOMBARDIER ATV has a defect in material or workmanship, please contact these manufacturers or ask your authorized BOMBARDIER distributor/dealer for assistance.

Carlisle Tire & Wheel Company
(Traxters and QUEST tires)
23 Windham Boulevard
Aiken, SC 29805
Warranty Information:
International: 1-803-643-2900

Warn Industries Inc. (Winch)
12900 SE Capps Road
Clackamas, Oregon 97015-8903
Customer service:
International: 1-503-722-1200

Kenda USA (DS 650 tires)
7095 Americana Parkway
Reynoldsburg, OH 43068
1-614-866-9803

Use of the product for racing or any other competitive activity, at any point, even by a prior owner will render this warranty null and void.

2. WARRANTY COVERAGE PERIOD

This warranty will be in effect FROM THE DATE OF DELIVERY TO THE FIRST RETAIL CONSUMER or the date the product is first put into use, whichever occurs first and for a period of:

SIX (6) CONSECUTIVE MONTHS for private use or commercial owners.

The repair or replacement of parts or the performance of service under this warranty does not extend the life of this warranty beyond its original expiration date.

3. CONDITIONS TO HAVE WARRANTY COVERAGE

This warranty coverage is available only on 2002 BOMBARDIER ATV purchased as new and unused by its first owner from a BOMBARDIER distributor/dealer authorized to distribute BOMBARDIER ATV products in the country in which the sale occurred (hereinafter "BOMBARDIER distributor/dealer"), and then only after the BOMBARDIER specified pre-delivery inspection process is completed and documented. Warranty coverage only becomes available upon proper registration of the product by a BOMBARDIER distributor/dealer. Such limitations are necessary in order to allow BOMBARDIER to preserve both the safety of its products, and also that of its consumers and the public.

Routine maintenance outlined in the *Operator's Guide* must be timely performed in order to maintain warranty coverage. BOMBARDIER reserves the right to make warranty coverage contingent upon proof of proper maintenance.

4. WHAT TO DO TO OBTAIN WARRANTY COVERAGE

The customer must notify a servicing BOMBARDIER distributor/dealer within two (2) days of the appearance of a defect, and provide it with reasonable access to the product and reasonable opportunity to repair it. The customer must also present to the BOMBARDIER distributor/dealer, proof of purchase of the product and must sign the repair/work order prior to the start of the repair in order to validate the warranty repair. All parts replaced under this limited warranty become the property of BOMBARDIER.

5. WHAT BOMBARDIER WILL DO

BOMBARDIER's obligations under this warranty are limited to, at its sole discretion, repairing parts found defective under normal use, maintenance and service, or replacing such parts with new genuine BOMBARDIER parts without charge for parts and labor, at any authorized BOMBARDIER distributor/dealer.

BOMBARDIER reserves the right to improve or modify products from time to time without assuming any obligation to modify products previously manufactured.

6. EXCLUSIONS - ARE NOT WARRANTED

- Normal wear and tear;
- Routine maintenance items, tune ups, adjustments;
- Damage caused by failure to provide proper maintenance and/or storage, as described in the *Operator's Guide*;
- Damage resulting from removal of parts, improper repairs, service, maintenance, modifications or use of parts not manufactured or approved by BOMBARDIER or resulting from repairs done by a person that is not an authorized servicing BOMBARDIER distributor/dealer;
- Damage caused by abuse, abnormal use, neglect, use of the product on surfaces other than snow, or operation of the product in a manner inconsistent with the recommended operation described in the *Operator's Guide*;
- Damage resulting from accident, submersion, fire, theft, vandalism or any act of God;
- Operation with fuels, oils or lubricants which are not suitable for use with the product (see the *Operator's Guide*);
- Water or snow ingestion;
- Incidental or consequential damages, or damages of any kind including without limitation towing, storage, telephone, rental, taxi, inconvenience, insurance coverage, loan payments, loss of time, loss of income.

7. LIMITATIONS OF LIABILITY

THIS WARRANTY IS EXPRESSLY GIVEN AND ACCEPTED IN LIEU OF ANY AND ALL OTHER WARRANTIES, EXPRESSED OR IMPLIED, INCLUDING WITHOUT LIMITATION ANY WARRANTY OF MERCHANTABILITY OR FITNESS FOR A PARTICULAR PURPOSE. TO THE EXTENT THAT THEY CANNOT BE DISCLAIMED, THE IMPLIED WARRANTIES ARE LIMITED IN DURATION TO THE LIFE OF THE EXPRESS WARRANTY. INCIDENTAL AND CONSEQUENTIAL DAMAGES ARE EXCLUDED FROM COVERAGE UNDER THIS WARRANTY. SOME STATES/ PROVINCES DO NOT ALLOW FOR THE DISCLAIMERS, LIMITATIONS AND EXCLUSIONS IDENTIFIED ABOVE, AS A RESULT, THEY MAY NOT APPLY TO YOU. THIS WARRANTY GIVES YOU SPECIFIC RIGHTS, AND YOU MAY ALSO HAVE OTHER LEGAL RIGHTS WHICH MAY VARY FROM STATE TO STATE, OR PROVINCE TO PROVINCE.

Neither the distributor, any BOMBARDIER dealer nor any other person has been authorized to make any affirmation, representation or warranty regarding the product, other than those contained in this limited warranty, and if made, shall not be enforceable against BOMBARDIER.

BOMBARDIER reserves the right to modify this warranty at any time, being understood that such modification will not alter the warranty conditions applicable to the products sold while this warranty is in effect.

8. TRANSFER

If the ownership of a product is transferred during the warranty coverage period, this warranty shall also be transferred and be valid for the remaining coverage period provided that BOMBARDIER is notified of such transfer of ownership in the following way:

- a) The former owner contacts BOMBARDIER or an authorized BOMBARDIER distributor/dealer and gives the coordinates of the new owner; or
- b) BOMBARDIER or an authorized BOMBARDIER distributor/dealer receives a proof that the former owner agreed to the transfer of ownership, in addition to the coordinates of the new owner.

9. CONSUMER ASSISTANCE

- a) In the event of a controversy or a dispute in connection with this BOMBARDIER LIMITED WARRANTY, BOMBARDIER suggests that you try to resolve the issue at the distributorship/dealership level. We recommend discussing the issue with the authorized dealer's service manager or owner.
- b) If further assistance is required, the distributor's service department should be contacted in order to resolve the matter.

© 2001 Bombardier Inc. All rights reserved

® Registered trademark of Bombardier Inc.

FREQUENTLY ASKED QUESTIONS

Q: Why must my vehicle be registered with the factory? After all, I do have my original invoice as proof of when I purchased my vehicle.

A: *Registration is very important and an authorized Bombardier ATV dealer must register your vehicle with Bombardier Inc. Make sure the card has been sent. All of this will allow you to:*

- a) *Have warranty work performed at any authorized Bombardier ATV dealer in North America. Your registration card will provide the dealer with all the necessary data to complete warranty claim forms.*
- b) *Be advised by Bombardier Inc. should there be a safety recall or a particular warranty campaign.*
- c) *Be contacted much faster by the police, in the event that they find your vehicle subsequent to a theft.*

Q: Why must my vehicle be registered with the governing body having jurisdiction over vehicle use?

A: *Vehicle registration has two purposes: In many provinces or States, it is mandatory to register a vehicle in the same way as for a car. It allows the State or province to maintain records of existing vehicles. In some jurisdictions, governmental agencies use part of the registration fees for establishing and maintaining trails.*

Q: Where can I find information on the lubrication and maintenance of my vehicle?

A: *In the Operator's Guide provided with the vehicle at the time of delivery.*

Q: Will the entire warranty be voided or cancelled, if I do not operate or maintain my new vehicle exactly as specified in the *Operator's Guide*?

A: *The warranty of the new vehicle cannot be "Voided" or "Cancelled" if predelivered by an authorized Bombardier ATV dealer. However, if a particular failure is caused by operation or maintenance other than is shown in the Operator's Guide, THAT failure may not be covered under warranty. This includes service work performed by the customer, oil and filter change and especially the critical adjustments such as the carburetor.*

Q: Would you give some examples of abnormal use or strain, neglect or abuse which may affect the limited warranty coverage?

A: *These terms are general and overlap each other in some cases. Some specific examples may include: running the engine out of oil, operating the vehicle with a broken or damaged part which causes another part to fail, and so on. If you have any specific questions on operation or maintenance, please contact an authorized Bombardier ATV dealer for advice.*

Q: What costs are my responsibility during the warranty period?

A: *The customer's responsibility includes all costs of normal maintenance services, non-warranty repairs, accidents and collision damage, as well as oils, and spark plugs, and incidental or consequential damages costs as explained in the warranty.*

Q: Are "Genuine" Bombardier replacement parts used in warranty repairs also covered by the limited warranty coverage?

A: *Yes. When installed by an authorized Bombardier ATV dealer, any "Genuine" Bombardier part used in warranty repairs assumes the remaining warranty that exists on the vehicle.*

Q: If I sell my vehicle within the warranty period, will the new owner qualify for the balance of the limited warranty coverage?

A: *Yes, provided the re-sale has been registered with the manufacturer.*

Q: How can I receive the best owner assistance?

A: *The satisfaction, safety and goodwill of the owners of Bombardier products are of primary concern to your ATV dealer and Bombardier Inc. Normally, any problems that arise in connection with the sales transaction or the operation of your vehicle will be handled by your Dealer's Sales or Service Departments. It is recognized, however, that despite the best intentions of everyone concerned, misunderstandings will sometimes occur. Frequently, complaints are the result of a breakdown in communications and can quickly be resolved by a member of the dealership management. If the problem already has been reviewed with the Sales Manager or Service Manager, contact the Dealer Principal himself or the General Manager.*

We are always pleased to receive your comments on the Bombardier ATV.

EMISSION REQUIREMENTS

The California Air Resources Board (CARB) requires that your ATV observe with applicable exhaust emissions standards during its useful life, when operated and maintained according to the instructions supplied.

A non-compliance Red Label (as well as a Green Label) is obtained annually during California Vehicle registration. The appropriate label is denoted by the vehicle identification number (in the 8th character detailed herein).

VEHICLE CATEGORY	VIN 8th CHARACTER
Non-complying Red Label	Must denote a C or 3
Complying Green Label	Any alphanumeric designation other than a C or 3

LOCATION OF THE IMPORTANT LABELS

The following labels are on your ATV. If missing or damaged, they can be replaced free of charge. See an authorized Bombardier ATV dealer.

NOTE: The following illustrations used in this *Operator's Guide* are a general representation only. Your model may differ.

All Models except XL

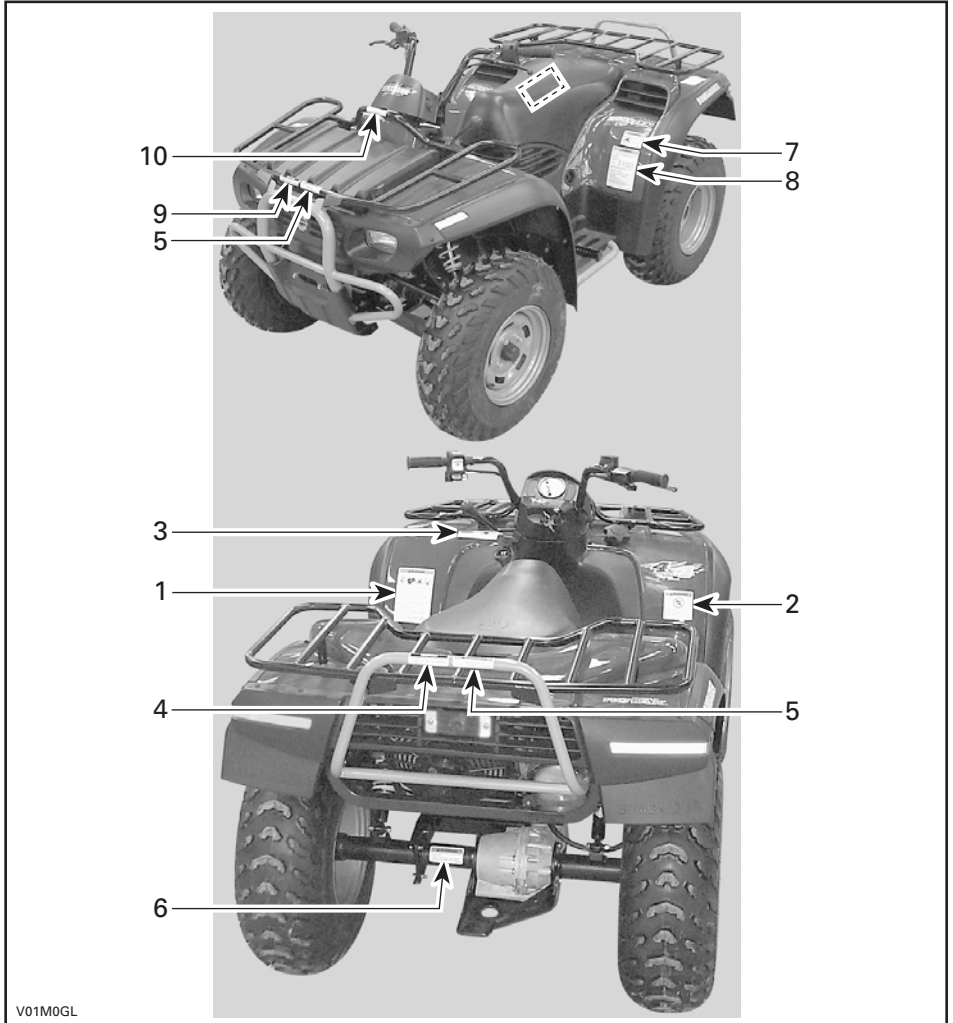

XL Models

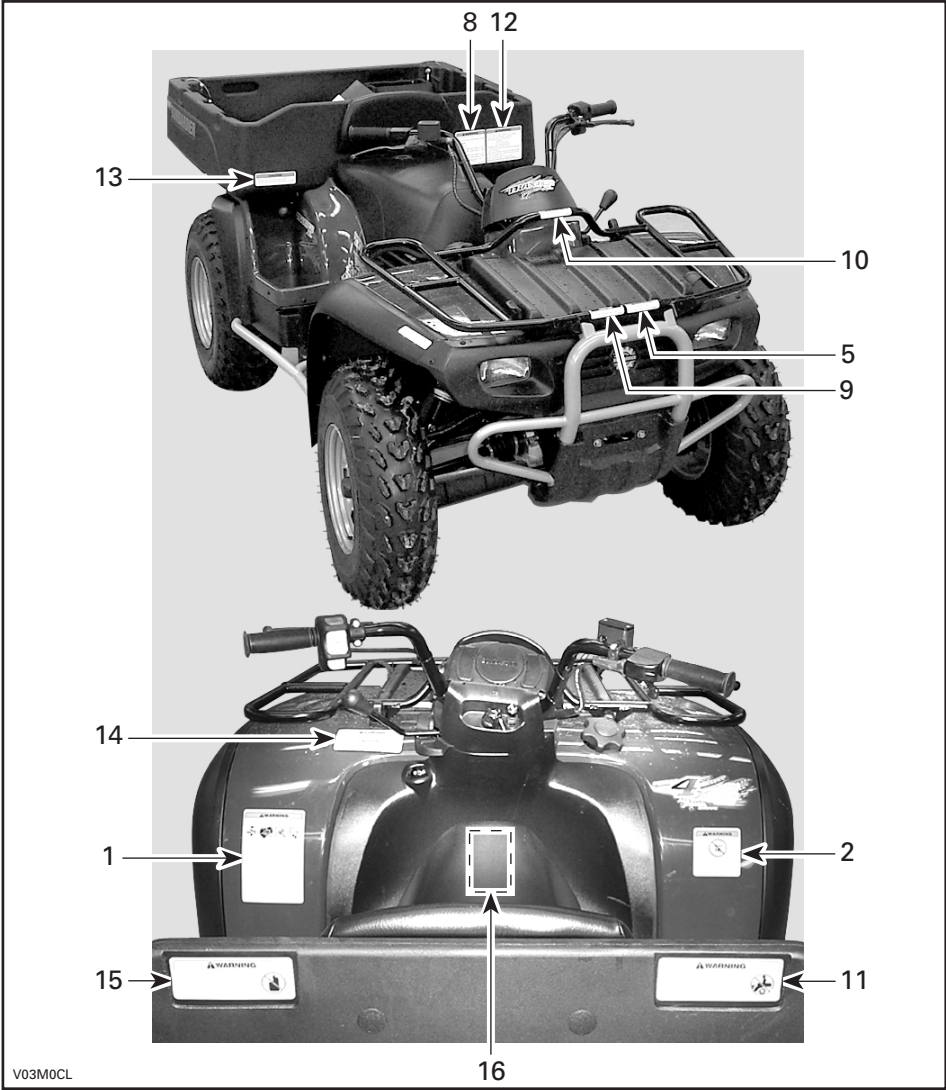

Label 1

⚠ WARNING

Improper ATV use can result in SEVERE INJURY or DEATH.



ALWAYS USE AN APPROVED HELMET AND PROTECTIVE GEAR.

NEVER USE ON PUBLIC ROADS.

NEVER CARRY PASSENGERS.

NEVER USE WITH DRUGS OR ALCOHOL.

NEVER operate:

- without proper training or instructions.
- at speeds too fast for your skills or the conditions.
- on public roads - a collision can occur with another vehicle.
- with a passenger - passengers affect balance and steering and increase risk of losing control.

ALWAYS:

- use proper riding techniques to avoid vehicle overturns on hills and rough terrain and in turns.
- avoid paved surfaces - pavement may seriously affect handling and control.

LOCATE AND READ OPERATOR'S GUIDE.
FOLLOW ALL INSTRUCTIONS & WARNINGS.

704 900 001

V01M01Z

Label 2

⚠ WARNING



Operating this ATV if you are under the age of 16 increases your chance of SEVERE INJURY or DEATH.

NEVER operate this ATV if you are under age 16.

704 900 011

V01M02Z

Label 3

CAUTION

- ATV MUST be stopped before shifting transmission lever.
- Always apply foot brake to shift from PARK (P).

704 900 001

V01M03Z

Label 4

CAUTION

MAXIMUM REAR LOAD : 175 lb (80 kg)
(Includes trailer tongue weight if applicable)

704 900 013

V01M04Z

ALL MODELS EXCEPT XL

Label 5

⚠ WARNING

NEVER sit here.

704 900 017

V01M050

Label 6

⚠ WARNING

Improper loading of a trailer may cause loss of vehicle control.

- Maximum towing weight: **1100 lb (500 kg)**.
- Maximum tongue weight: **30 lb (14 kg)**.

704 900 009

V01M06Z

Label 7

⚠ WARNING



NEVER ride as a passenger. Passengers can cause a loss of control, resulting in SEVERE INJURY or DEATH.

704 900 005

V01M07Z

Label 8

WARNING

Improper tire pressure or overloading can cause loss of control.
Loss of control can result in SEVERE INJURY or DEATH.

TIRE PRESSURE

- Set with tires cold:

- Recommended: FRONT: 37,9 kPa, (0,39 kgf/cm²), 5,5 psi.
 REAR: 34,5 kPa, (0,35 kgf/cm²), 5,0 psi.
- Minimum: FRONT: 34,5 kPa, (0,35 kgf/cm²), 5,0 psi.
 REAR: 31,0 kPa, (0,32 kgf/cm²), 4,5 psi.

- Never set tire pressure below minimum. It could cause the tire to dislodge from the rim.

LOADING / TRAILER TOWING

- Cargo or trailer can affect stability and handling.
- When loading with cargo or towing a trailer:
 - Reduce speed.
 - Allow more room to stop.
 - Avoid hills and rough terrain.
- Maximum Vehicle Load: 485 lb, (220 kg).
Includes weight of operator, cargo and accessories
(and if applicable, trailer tongue weight).

V01M0CY

ALL MODELS EXCEPT XL AND XT

WARNING

Improper tire pressure or overloading can cause loss of control.
Loss of control can result in SEVERE INJURY or DEATH.

TIRE PRESSURE

- Set with tires cold:

- Recommended: FRONT: 34,5 kPa, (0,35 kgf/cm²), 5,0 psi.
 REAR: 31,0 kPa, (0,32 kgf/cm²), 5,5 psi.
- Minimum: FRONT: 31,0 kPa, (0,32 kgf/cm²), 4,5 psi.
 REAR: 27,6 kPa, (0,28 kgf/cm²), 5,0 psi.

- Never set tire pressure below minimum. It could cause the tire to dislodge from the rim.

LOADING / TRAILER TOWING

- Cargo or trailer can affect stability and handling.
- When loading with cargo or towing a trailer:
 - Reduce speed.
 - Allow more room to stop.
 - Avoid hills and rough terrain.
- Maximum Vehicle Load: 485 lb, (220 kg).
Includes weight of operator, cargo and accessories
(and if applicable, trailer tongue weight).

V01M0DY

XT MODELS

WARNING

Improper tire pressure can cause loss of control.
Loss of control can result in SEVERE INJURY or DEATH.

TIRE PRESSURE

- Set with tires cold:

- Recommended: FRONT: 48,3 kPa, 0,49 kgf / cm², 7,0 psi.
 REAR: 48,3 kPa, 0,49 kgf / cm², 7,0 psi.
- Minimum FRONT: 41,4 kPa, 0,42 kgf / cm², 6,5 psi.
 REAR: 41,4 kPa, 0,42 kgf / cm², 6,5 psi.

- Never set tire pressure below minimum. It could cause the tire to dislodge from the rim.

V03M04Y

704 900 133

XL MODELS

Label 9

CAUTION

MAXIMUM FRONT LOAD : 90 lb (40 kg)
(Includes front storage tray load : 22 lb (10 kg))

704 900 015

V01M09Z

Label 10

WARNING

Always latch storage cover.

704 900 038

V01M0BZ

Label 11

⚠ WARNING

- Passengers can be thrown off.
- This can cause **SERIOUS INJURY** or **DEATH**.
- **NEVER** carry passengers.



V03M05Y 704 900 134

Label 12

⚠ WARNING

- Overloading can cause loss of control.
- Loss of control can result in **SEVERE INJURY** or **DEATH**.
- Cargo or trailer can affect stability and handling.
- When loading with cargo or loading a trailer:
 - reduce speed
 - allow more room to stop
 - avoid hills and rough terrain
- **MAXIMUM VEHICLE LOAD: 800 lb. (363 kg).**
(Includes weight of operator, cargo and accessories and if applicable, trailer tongue weight).
- Never transport inflammable products or other dangerous material.
- Distribute the cargo evenly and latch the rear cargo box and the lateral compartments properly.
- Never ride with a passenger in the rear cargo box.
- Never ride the vehicle with the rear cargo box unlatched.

V03M06Y 704 900 132

Label 13

CAUTION

- Maximum rear cargo box loading capacity: 600 lb.
- Maximum lateral compartments loading capacity: 15 lb (each).

V03M07Y 704 900 134

Label 14

⚠ WARNING

- Make sure the rear cargo box is closed and properly latched when shifting out of **PARK (P)**.

CAUTION

- ATV must be stopped before shifting transmission lever.
- Always apply foot brake to shift from **PARK (P)**.

V03M08Y 704 900 135

Label 15

⚠ WARNING

- Transporting inflammable products or other dangerous material can lead to explosions.
- This can cause serious injury or death.
- **NEVER** transport inflammable or dangerous material.



V03M09Y 704 900 131

Label 16

VEHICLE EMISSION CONTROL INFORMATION	ENGINE FAMILY CODE: IBCXX.4982GC MODEL(S): 7444/46/50/51/52/53/54/55/56/75/76 EXHAUST EMISSION CONTROL SYSTEM: EM DISPLACEMENT: 497.70cc TUNE-UP SPECIFICATIONS:		 BOMBARDIER <i>RECREATIONAL PRODUCTS</i>
	IDLE SPEED:	1100 RPM ± 100 RPM	
	IDLE AIR/FUEL MIXTURE SETTING:	FROM POSITION OF PILOT SCREW FOR MAXIMUM SPEED AT IDLE, UNSCREW 3/8 OF TURN	
	SPARK PLUG: FUEL: (RON + MON) /2 ENGINE OIL:	NGK DR8EA ELECTRODE GAP → 0.6 mm - 0.7 mm UNLEADED 87 OCTANE SAE 10W40	
THIS VEHICLE CONFORMS TO CARB REGULATIONS APPLICABLE TO 2002 MODEL YEAR NEW OFF-ROAD MOTORCYCLES AND ALL TERRAIN VEHICLES AND IS CERTIFIED TO 10 g/bhp-hr HC+Nox ENGINE FAMILY EXHAUST EMISSION STANDARD IN CALIFORNIA.			
			704 900 202

V01M0HL

NORTH AMERICA

VEHICLE EMISSION CONTROL INFORMATION	ENGINE FAMILY CODE: IBCXX.4982GC MODEL(S): 7467/68/69/70/71 EXHAUST EMISSION CONTROL SYSTEM: EM DISPLACEMENT: 497.70cc TUNE-UP SPECIFICATIONS:		 BOMBARDIER <i>RECREATIONAL PRODUCTS</i>
	IDLE SPEED:	1100 RPM ± 100 RPM	
	IDLE AIR/FUEL MIXTURE SETTING:	FROM POSITION OF PILOT SCREW FOR MAXIMUM SPEED AT IDLE, UNSCREW 3/8 OF TURN	
	SPARK PLUG: FUEL: (RON + MON) /2 ENGINE OIL:	NGK DR8EA ELECTRODE GAP → 0.6 mm - 0.7 mm UNLEADED 87 OCTANE SAE 10W40	
THIS VEHICLE CONFORMS TO CARB REGULATIONS APPLICABLE TO 2001 MODEL YEAR NEW OFF-ROAD MOTORCYCLES AND ALL TERRAIN VEHICLES AND IS CERTIFIED TO 10 g/bhp-hr HC+Nox ENGINE FAMILY EXHAUST EMISSION STANDARD IN CALIFORNIA.			
			704 900 252

V01M0IL

INTERNATIONAL

HOW TO IDENTIFY YOUR ATV

The main components of your vehicle (engine and frame) are identified by different serial numbers. It may sometimes become necessary to locate these numbers for warranty purposes or to trace your vehicle in the event of loss. These numbers are required by the authorized Bombardier ATV dealer to complete warranty claims properly. No warranty will be allowed by Bombardier Inc. if the engine identification number (EIN) or vehicle identification number (VIN) is removed or mutilated in any way. We strongly recommend that you take note of all the serial numbers on your vehicle and supply them to your insurance company.

Engine and Vehicle Identification Number Location

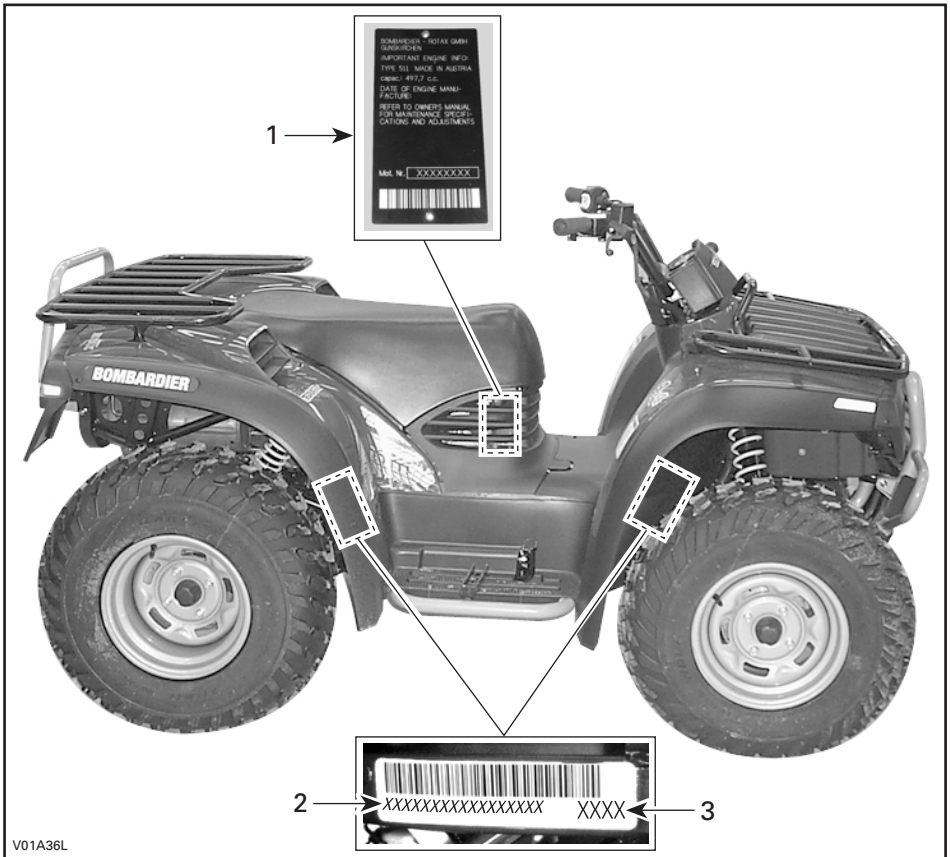

TYPICAL

1. EIN (Engine Identification Number)
2. VIN (Vehicle Identification Number)
3. Model

CONTROLS/INSTRUMENTS/EQUIPMENTS

NOTE: Some controls/instruments/equipments do not apply to some models. In these cases their reference numbers are deliberately missing in the illustrations. Some controls/instruments/equipments are optional on some models.

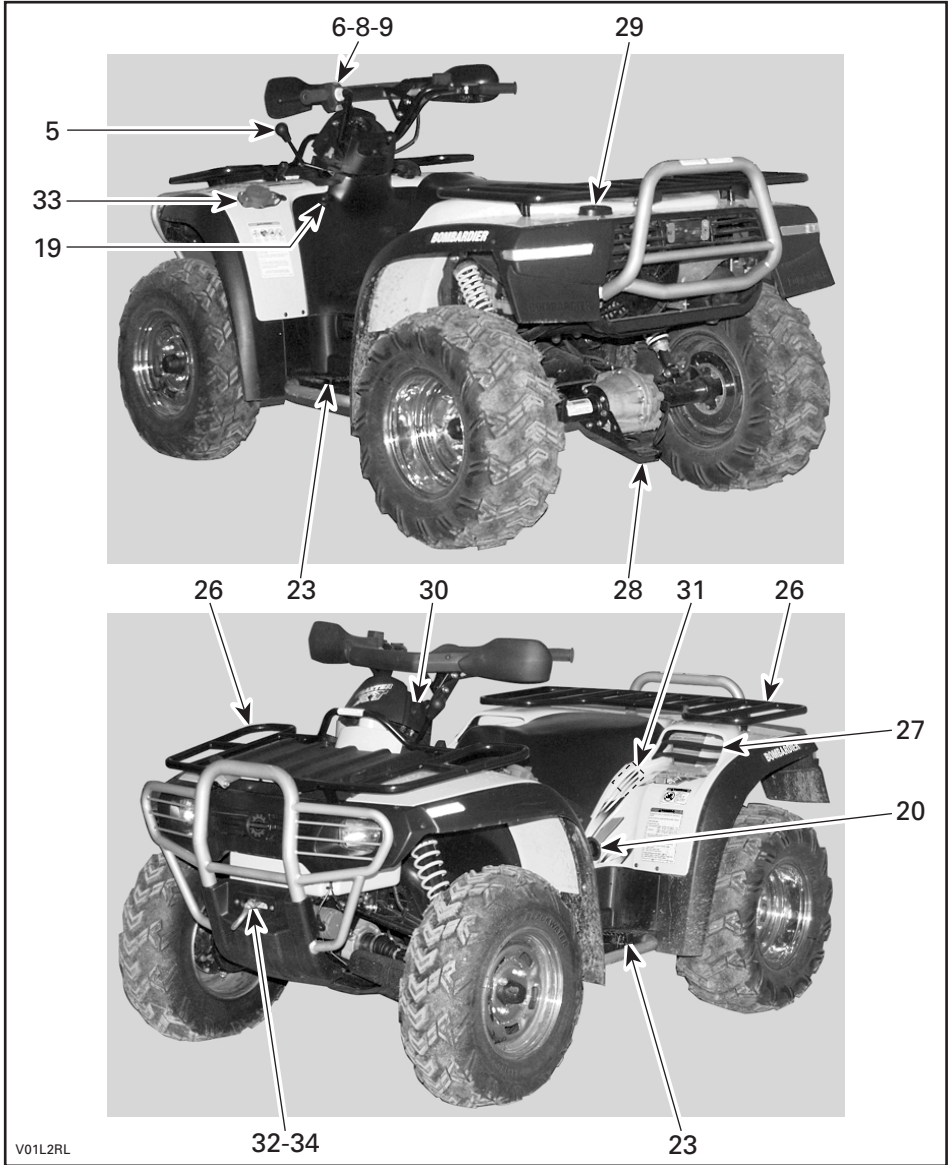

V01L2RL

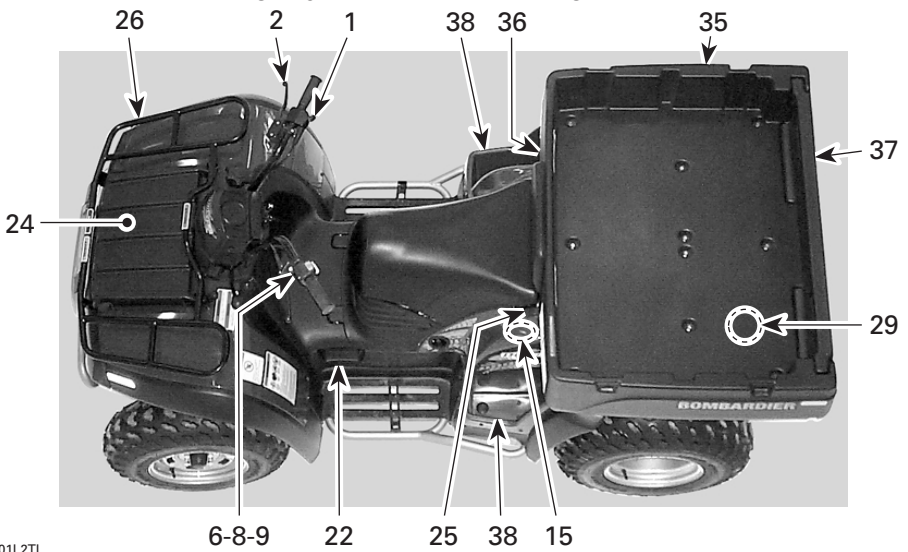
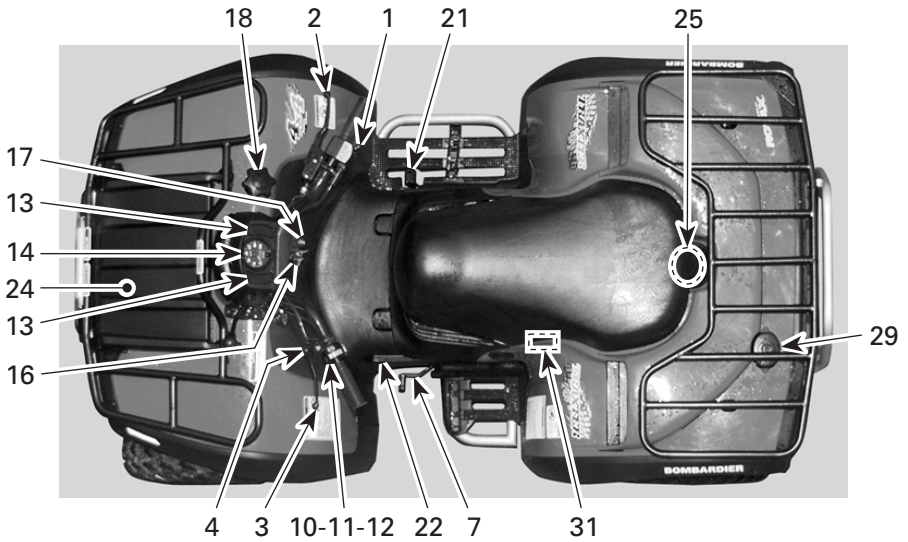

V01L2TL

While reading this *Operator's Guide*, remember that:

WARNING

Indicates a potential hazard that could result in serious injury or death.

NOTE: This section gives basic functions of the various controls of your ATV. For more details of how to operate one control in conjunction with some others, refer to OPERATING INSTRUCTIONS in this *Operator's Guide* and *Safety Handbook*.

1) Throttle Lever

Located on the right side of handlebar. When pushed, it increases the engine speed that allows the engagement of the transmission on the selected gear. When released, the engine speed should return automatically to idle and the vehicle will gradually slow down.

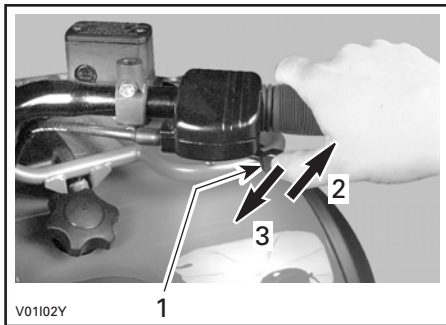

1. *Throttle lever*
2. *To accelerate*
3. *To decelerate*

2) Front Brake Lever

Located on the right side of handlebar. When compressed, the brake is applied. When released, it should automatically return to its original position. Braking effect is proportional to the force applied on the lever and to the type and condition of the terrain. The front brake will have also an effect on rear wheels through the drive train.

See the note at **Rear Brake Lever** below for additional information.

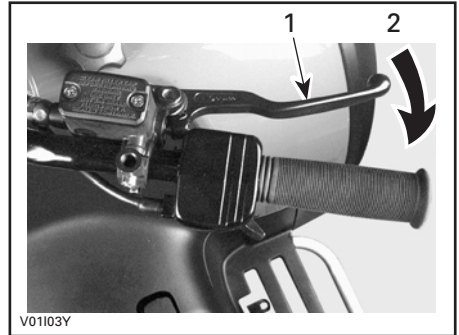

1. *Brake lever*
2. *To apply brake*

3) Rear Brake Lever

Located on the left side of handlebar. When compressed, the brake is applied. When released, it should automatically return to its original position. Braking effect is proportional to the force applied on the lever and to the type and condition of the terrain.

NOTE: Using the rear brake will have also an effect on front wheels because they are interconnected through the drive train. As on other wheeled vehicles, the vehicle weight is transferred to the front wheels when braking. To obtain greater stopping efficiency, the brake system distributes more braking force to the front wheels. This will affect vehicle handling and steering control when braking vigorously. Take it into account when braking.

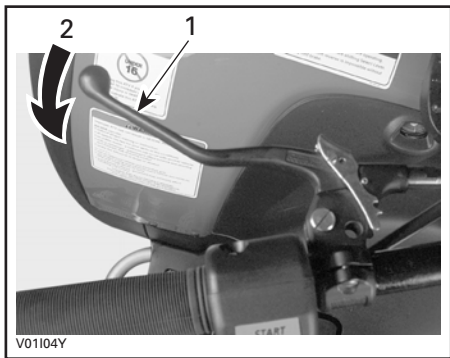

1. Brake lever
2. To apply brake

4) Brake Lever Lock

Located on left side of handlebar on rear brake lever. When applied, it prevents the vehicle from moving. Useful when the brake needs to be locked for example such as doing a K-turn.

WARNING

Always use the brake lever lock **and** engage the PARK position on the transmission lever when the vehicle is not in operation.

WARNING

Make sure brake lever lock is fully disengaged before operating the ATV.

When you ride the vehicle, the prolonged use of brakes may cause damage to the brake system and cause loss of braking capacity and/or fire.

To engage mechanism: Squeeze brake lever and maintain while moving lever lock with a finger. Brake lever is now compressed and applying rear brake.

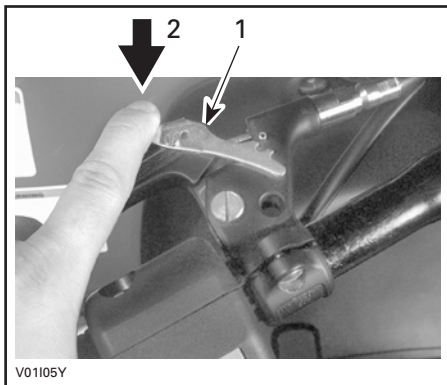

1. Brake lever lock
2. To apply parking brake

To release mechanism: Squeeze brake lever. Lever lock should automatically return to its original position. Brake lever should return to rest position. Always release brake lever lock before riding.

5) Transmission Lever

Located on the left side of steering column. A 5-position lever: P, R, N, H and L.

To change the transmission position, completely stop vehicle then move lever to the desired position while pulling lever upward. Do not force lever. If unable to shift, gently apply throttle to move ATV and try again.

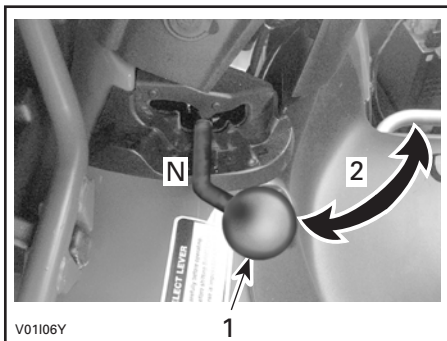

1. Transmission lever
2. To change position

CAUTION: Always completely stop the vehicle and apply the brake prior to moving the transmission lever.

P: Park

This position locks the transmission to help prevent vehicle movement. Always use when the vehicle is not in operation. In some circumstances, it may be necessary to rock the vehicle back and forth to move the gears in the transmission to allow the park to be engaged.

R: Reverse

This allows the vehicle to go backward. The vehicle speed is limited.

WARNING

Before moving vehicle in reverse, ensure the path behind is clear of obstacles or bystanders. Remain seated.

N: Neutral

This position disengages the transmission to allow manual vehicle movement or towing.

H: High gear

This selects the high speed range of the transmission in the gear box. It is the normal riding position. It allows the vehicle to reach its maximum speed.

L: Low gear

This selects the low speed range of transmission in the gear box. It is the working position. It allows the vehicle to move slowly with the maximum traction and power.

Refer to **Electric Gear Shift Button** below for gear shifting.

The gear position is displayed with indicator lights. Refer to **Electric Gear Shift Button** below.

6) Electric Gear Shift Button

All Models except FOOTSHIFT

Located on left side of handlebar. When pressing on the upper face, it shifts the transmission to the next higher gear. When pressing on the lower face, it shifts the transmission to the next lower gear.

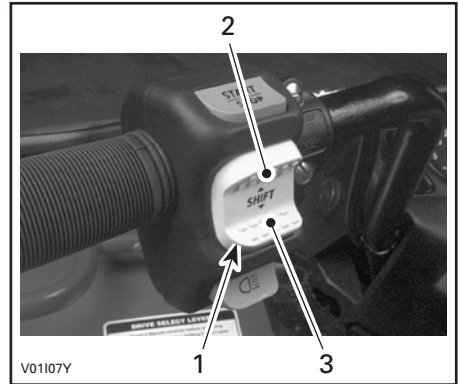

1. Gear shift button
2. Press here to upshift
3. Press here to downshift

The lower the gear, the slower the vehicle speed and the higher the gear, the higher the vehicle speed.

Vehicle must be running to allow gear change.

The button must be released then pressed again to perform another gear shift.

There are 5 gears in each reverse, high and low gear positions.

AUTOSHIFT Models

The AUTOSHIFT models feature a manual/automatic selector located on the RH side of the multi-function switch. It is possible to change the mode at any time, even when vehicle is running.

The automatic mode activates a change of gear in accordance with the engine RPM and throttle opening. When automatic mode is selected, just press or release throttle lever.

On some occasion, it may be useful or necessary to manually change the gear selection. The electronic module will allow the rider to override the automatic mode by pressing the shift button to a lower gear or a higher gear. The automatic mode will be kept and the shifting sequence will resume after shift is performed.

NOTE: However, if the vehicle is used in severe conditions, it is highly recommended to use the manual mode.

7) Gearshift Pedal

FOOTSHIFT Models

Located in front of left footpeg.

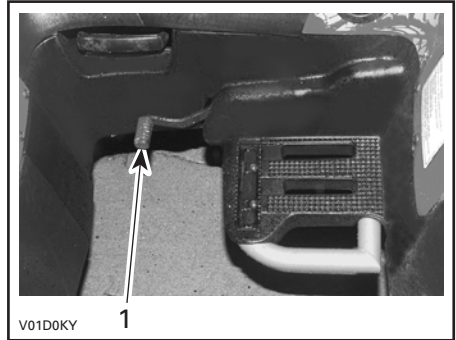

1. Gearshift pedal

8) Start/Stop Switch

All Models except FOOTSHIFT

Located on left side of handlebar. Dual function switch.

To start engine, press and hold the switch. Release immediately after engine is started.

To stop engine, fully release throttle lever then press the switch. It is not necessary to hold the switch.

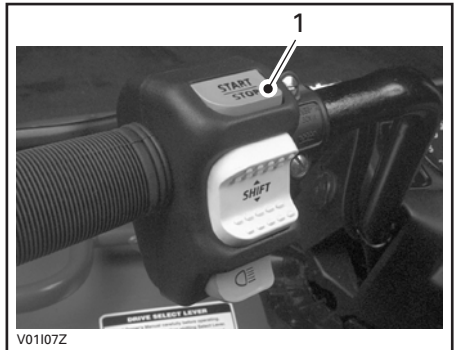

1. Start/stop switch

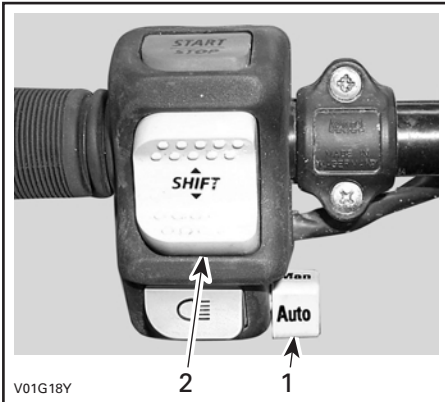

AUTOSHIFT MODELS ONLY

1. Manual/automatic selector
2. Gear shift button

NOTE: While engine can be stopped by turning ignition key OFF, we recommend the engine be stopped by pressing the start/stop switch.

9) Headlight Dimmer Switch

All Models except FOOTSHIFT

Located on left side of handlebar. Toggle type switch. It allows selection of headlight intensity.

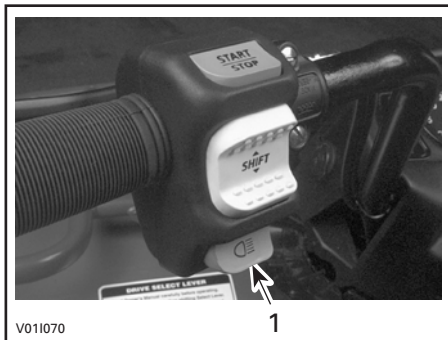

1. Headlight dimmer switch

10) Headlight Switch

FOOTSHIFT Models

Located on left side of handlebar. Place switch to LO for the low beam and taillight. Place switch to HI for the high beam and taillight.

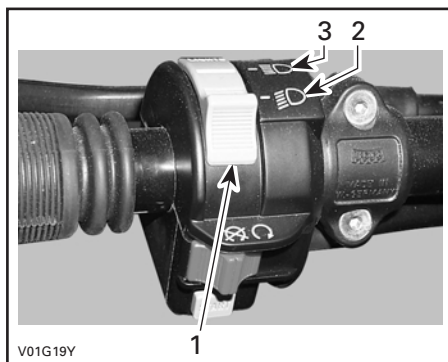

1. Headlight switch
2. Low beam position
3. High beam position

NOTE: Place ignition switch to ON "without light" position to close the headlight.



ON POSITION "WITHOUT LIGHT"

11) Engine Stop Switch

FOOTSHIFT Models

Located on left side of handlebar. The engine will turn over but will not start if the engine stop switch is turned to OFF position.

This switch can be used to stop engine and as an emergency control.

NOTE: While engine can be stopped by turning ignition key OFF, we recommend the engine be stopped by the engine stop switch.

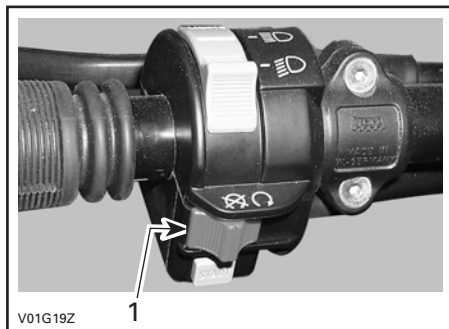

1. Engine stop switch

12) Start Button

FOOTSHIFT Models

Located on left side of handlebar.

To start engine, place the engine stop switch to RUN.

Press and hold the start button. Release immediately after engine is started.

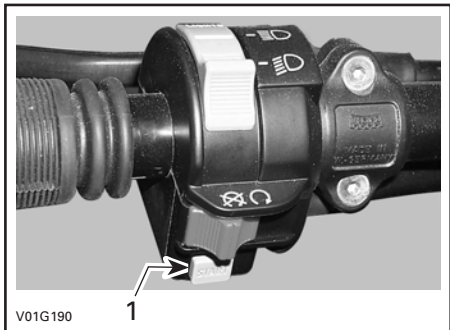

1. Start button

To stop engine, fully release throttle lever then use the engine stop switch.

13) Indicator Lights Cluster

NOTE: When first turning switch to ON (either position), all indicator lights will turn on for a brief moment. This validates their operation. Thereafter, only the lights that are activated will remain on (Reverse, Neutral or Auto (**on AUTOSHIFT models only**), gear position (**except FOOTSHIFT**) and engine indicator lights).

If all lights flash, it indicates a particular malfunction of the transmission or the electrical system. See an authorized Bombardier ATV dealer as soon as possible.

Gear Position Display

All Models except FOOTSHIFT

Located on left side of cluster. It lights up to indicate the gear position whenever the ignition switch is turned on when the transmission lever is NOT in PARK or in NEUTRAL position (either engine running or not).

If all lights flash **while shifting gear**, it indicates the shifting is not completed yet. Simply wait until the shifting completes or retry the shift with the gear shift button.

If all lights flash **continuously**, it indicates a damaged sensor (gearbox). Although the vehicle can still be operated in this condition, downshifting may increase engine "braking". Drive slowly. See an authorized Bombardier ATV dealer as soon as possible.

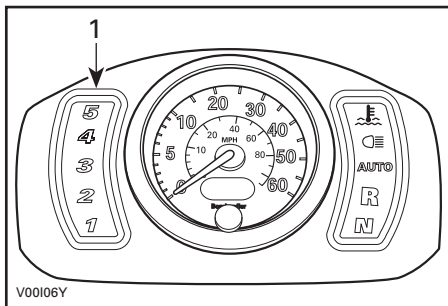

1. Gear position display

Other Indicator Lights

All Models

Located on right side of cluster. They light up to monitor different functions.

If REVERSE and NEUTRAL lights flash **continuously**, it indicates a damaged sensor (sub-transmission). Although the vehicle can still be operated in this condition, downshifting may increase engine "braking". Drive slowly. See an authorized Bombardier ATV dealer as soon as possible.

IF AUTO light flash, it indicates a possible problem with the TPS sensor. The manual mode is immediately selected. See an authorized Bombardier ATV dealer as soon as possible.

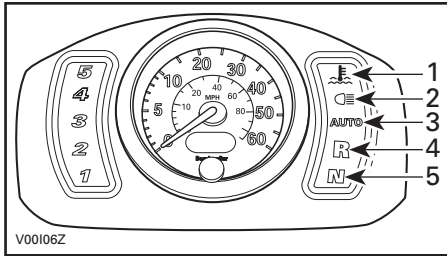

1. Engine
2. High intensity
3. Auto (AUTOSHIFT models only)
4. Reverse
5. Neutral

Engine

Dual function light. When indicator light is ON, it indicates a low oil pressure condition of the engine. When flashing, it indicates the engine is overheating.

This light turns on when the ignition switch is turned on and remains on until engine is running.

CAUTION: If the light does not turn off right after engine starting, stop engine. See an authorized Bombardier ATV dealer. Do not use the vehicle until repaired.

If engine overheats, refer to **Engine Overheat** in SPECIAL PROCEDURES.

High Intensity

When the indicator light is ON, it indicates the high intensity is selected on the headlights.

Auto

When lit, it indicates the vehicle is operating in automatic mode.

Reverse

When lit, it indicates the transmission is engaged in reverse.

Neutral

When lit, it indicates the transmission is in neutral position.

14) Speedometer

All Models except XL

Located in center of cluster. It indicates the speed of the vehicle in MPH and km/h. The speedometer is backlit when the ignition switch is turned on (either position).

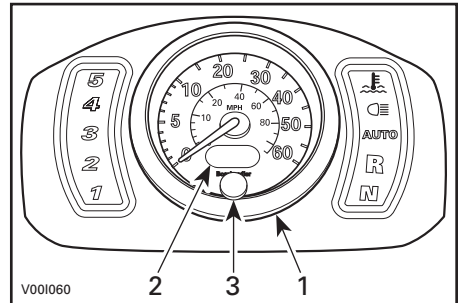

1. Speedometer
2. Odometer/trip meter
3. Display selection button

Odometer/Trip Meter

Combined LCD (Liquid Crystal Display) display. Odometer records the total distance traveled in miles. The trip meter records the distance traveled in miles until it is reset. The last right digit indicates the tenth of a mile. It can be used to approximately monitor the fuel tank range or distance between two locations for instance.

Display Selection Button

The odometer always appears when turning the ignition switch ON (either position). To change the display to the trip meter, momentarily press the button on the speedometer.

To reset the trip meter, push and HOLD button until all numbers read zero (while in trip meter selection).

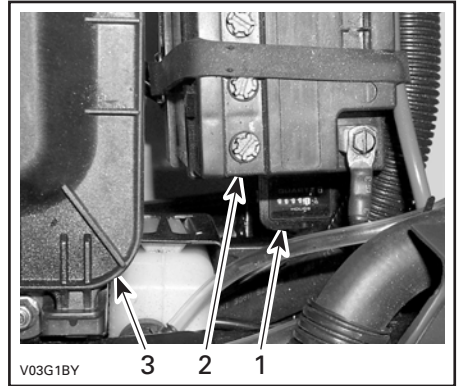

UNDER SEAT

1. Hourmeter
2. Battery
3. Air box

16) Ignition Switch

Located at bottom of cluster.

Key-operated, 3-position switch: OFF, ON with lights and ON without lights.



1. Ignition switch

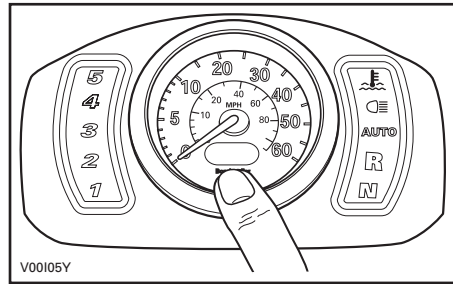

Press once to switch from odometer to tripmeter or vice versa. Press and hold to reset while in trip meter selection.

15) Hourmeter

XL Models Only

Located on battery rack under left rear fender.

The hourmeter indicates the engine working time.

The ON with lights position, turns on all lights with either the engine running or not. The headlights automatically dim to low intensity. Remember that having the lights on without the engine running discharges the battery. Always turn ignition to OFF after engine has been stopped.

NOTE: While engine can be stopped by turning ignition key OFF, we recommend the engine be stopped by pressing the start/stop switch or pushing the engine stop switch (**FOOTSHIFT only**).

Auto Shut-Down

If for some reason, the engine is not started within 3 minutes approximately, the MPEM (Multi-Purpose Electronic Module) will shut down to cut all electrical system functions. Simply turn the key to OFF then to ON to regain normal use.

17) Choke Knob Lever

Located at bottom of cluster. This device features a variable lever to ease cold start.

Position OFF is for normal use with a warm engine (pushed in).



V01117Z

CHOKE KNOB LEVER IN THE OFF POSITION

The full choke position is used for lower temperature (fully extended).



V01118Y

CHOKE LEVER IN THE FULL CHOKE POSITION

The other positions between OFF and FULL position, will be use depending on the temperature.

18) Fuel Tank Cap

Unscrew counterclockwise and remove cap to allow fuel tank filling then fully tighten clockwise.

WARNING

Never use an open flame to check fuel level.

19) Fuel Gauge

Located under cluster, the gauge shows an approximate amount of the fuel in tank.

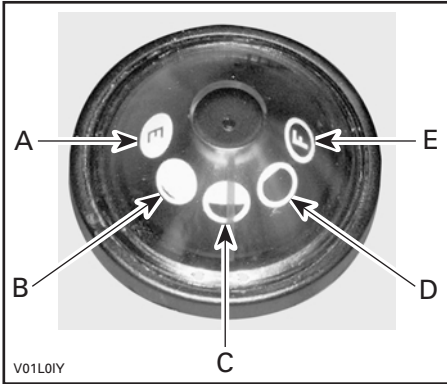

- A. Empty
- B. 1/4
- C. 1/2
- D. 3/4
- E. Full

20) Fuel Valve

Located on left side panel under front part of seat. 3-position rotary valve: OFF, ON, RES. Rotate the knob to align its pointer with ON, OFF or RES.

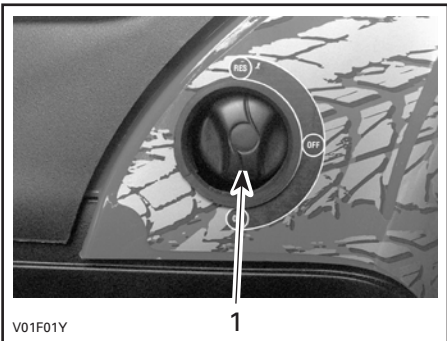

1. Align this pointer toward the desired position

OFF

Stops fuel supply to carburetor.

CAUTION: Turn valve to OFF position when ATV is not being operated or when transporting.

ON

Allows fuel to flow to carburetor. This is the normal position for operation of the vehicle.

RES (RESERVE)

When fuel is exhausted in the fuel tank when in the ON position, an emergency supply of fuel is available by turning the knob to RES. The reserve contains approximately 30% of the fuel tank capacity. Use only this position when the ON supply is empty.

When down to the reserve, refuel as soon as possible. Ensure to turn the valve back to the ON position after refuelling.

CAUTION: Improper opening of fuel valve will restrict the flow of fuel. Make sure valve is fully opened while running.

21) Rear Brake Pedal

Located on the right footpeg. When pressed down, the brake is applied. When released, it should return to its original position. Braking effect is proportional to the force applied on the lever and to the type and condition of the terrain.

NOTE: The brake will have also an effect on front wheels through the drive train.

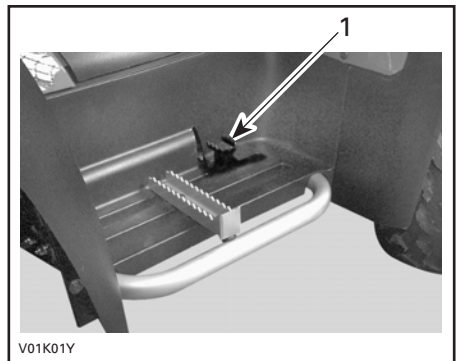

TYPICAL

1. Rear brake pedal

22) Rewind Starter Handle

The rewind starter handle is provided as an emergency starting device.

Follow the usual starting procedure; but use the rewind starter instead of the electric starter.

Located on left side panel under front part of seat. Auto-rewind type. To engage mechanism, pull handle slowly until a resistance is felt then continue to slowly pull the handle until the compression stroke **peak** (strong rotating resistance) is overpassed then, pull vigorously. Slowly release handle.

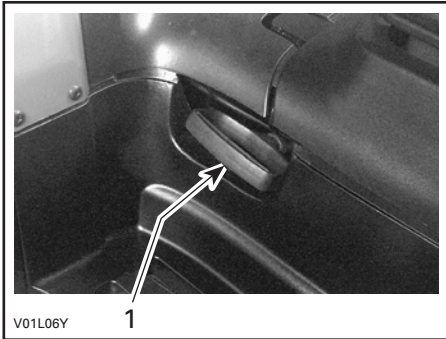

TYPICAL

1. Rewind starter handle

23) Footpeg

Located on footrest. Use this area to maintain your feet stable.

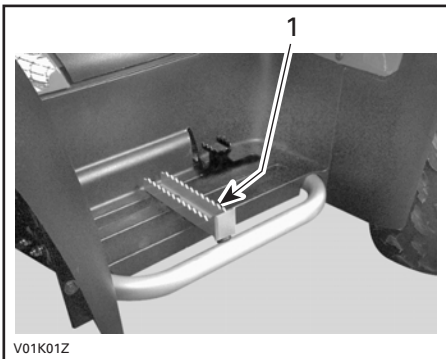

TYPICAL

1. Footpeg

24) Storage Compartment

Located in front of vehicle. Convenient location to carry personal articles such as a helmet, spare spark plugs, first aid kit, etc. Unlatch cover, gently lift then remove cover.

The compartment is equipped with a drain plug under the tool box. Remove plug to allow draining when necessary. Reinstall plug when finished.

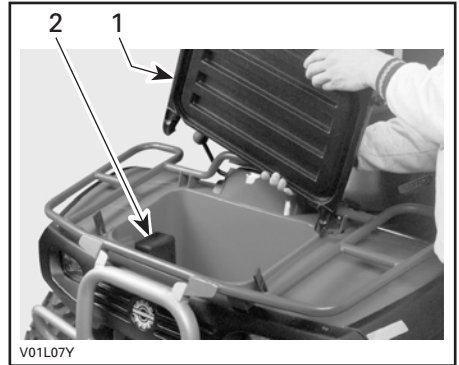

TYPICAL

1. Removing cover
2. Tool box

It also contains the *Operator's Guide* and *Safety Handbook* that should be kept in a waterproof bag and remain with the vehicle at all times.

⚠ WARNING

Never leave any heavy or loose breakable objects in the storage basket. Always latch cover before riding. If storage cover is removed to provide greater carrying area, ensure that cargo is secured and will not "fly out" when riding at speed on rough terrain. Slow down.

Tool Box

Located in storage compartment. The tool box contains tools for basic maintenance, the *Operator's Guide* and the *Safety Handbook*.

25) Seat Latch

Located underneath rear end of seat. It allows the removal of seat to give access to engine compartment.

All Models except XL

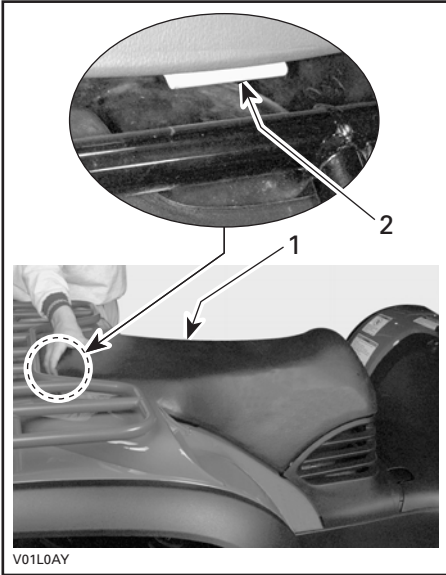

TYPICAL

1. Seat
2. Seat latch

Seat Removal

Pull latch upward while gently lifting rear of seat. Continue lifting movement until you can release the front retaining devices then completely remove seat.

Seat Installation

Place seat to allow the insertion of the U-shaped bracket over the rollers. Gently slide the brackets over rollers then lower seat. When seat rests in its position, firmly push seat down to latch.



TYPICAL

1. U-shaped bracket
2. Rollers

⚠ WARNING

Periodically verify the seat lock pin and tighten if needed. Make sure seat is securely latched before riding.

XL Models

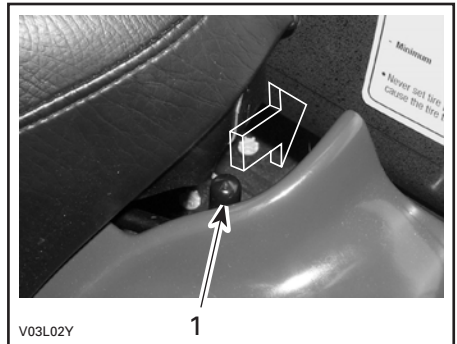

1. Seat latch

Seat Removal

Push latch backwards while gently lifting rear of seat. Continue lifting movement until you can release the front retaining devices then completely remove seat.

Seat Installation

Place seat to allow the insertion of the U-shaped bracket over the rollers. Gently slide the brackets over rollers then lower seat. When seat rests in its position, firmly push seat down to latch.

WARNING

Periodically verify the seat lock pin and tighten if needed. Make sure seat is securely latched before riding.

26) Front/Rear Cargo Racks

Located on top of chassis at front and rear. Convenient racks to carry gear.

WARNING

Ensure to properly secure material to rack. Do not overload. Ensure load does not interfere with visibility and/or steering. Do not carry passenger(s).

Refer to SPECIFICATIONS for carrying loads and cargo weight distribution recommendations.

NOTE: On XL models, there is a front cargo rack only.

27) Air Duct

Located on rear fenders. They force the flow of air to cool radiator.

CAUTION: Do not place anything over air intake ducts.

28) Trailer Hitch

Located on rear axle. Convenient hitch to install a ball to tow a trailer or other equipment. Install the proper ball size as per trailer manufacturer recommendations. Refer to SPECIFICATIONS for carrying loads and towing recommendations.

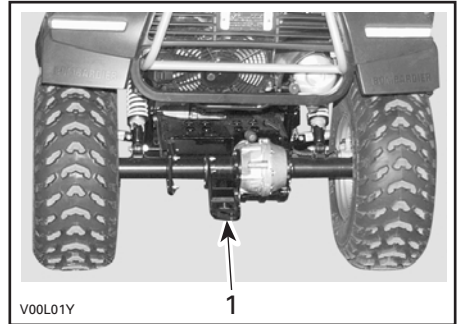

TYPICAL

1. Trailer hitch

WARNING

Ensure to install the proper ball size that matches the equipment you will tow.

Follow manufacturer instructions for proper attachment.

29) Radiator Cap

All Models except XL

Located at rear of rear panel. It provides access to the radiator filling neck.

Pull the protector cap to give access to the radiator cap. When finished, properly reinstall radiator cap then protector cap.

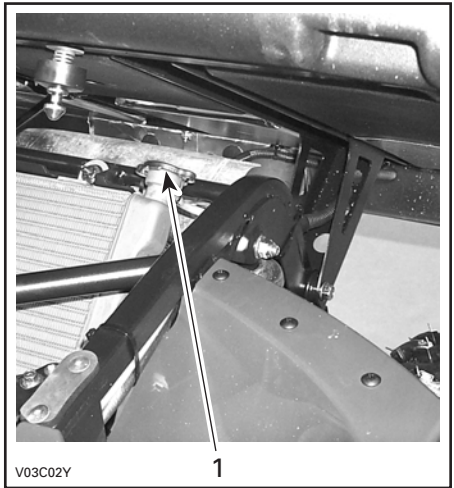

1. Radiator cap

30) 12-Volt Power Outlet

It is located on left side of cluster.

Convenient for handheld spotlight or other portable equipment.

Remove cap to use. Always reinstall protective cap after use to protect against weather.

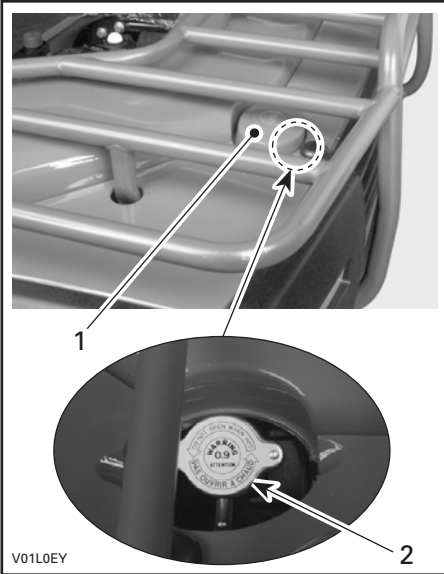

1. Protector cap
2. Radiator cap

XL Models

Located under rear cargo box.

Lift rear cargo box to gain access to the radiator cap. Then, properly reinstall radiator cap and close the rear cargo box properly.

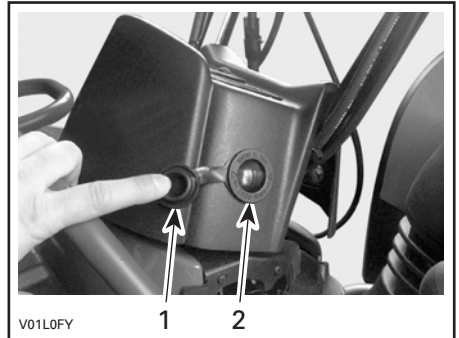

1. Protective cap
2. Power outlet

Do not exceed the rating capacity. See SPECIFICATIONS.

An auxiliary supply is available to connect additional accessories through a connector at the rear of vehicle. See an authorized Bombardier ATV dealer for more details.

31) Fuses

The electrical system is protected with fuses. Refer to MAINTENANCE for details.

32) Winch

XT Models

Located behind front skid plate.

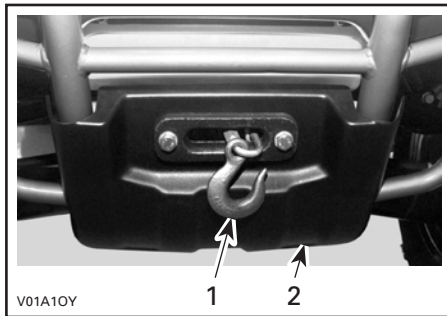

1. Winch
2. Front skid plate

33) Winch Control Switch

XT Models

Located on the LH side of the front fender.

To take out wire rope from winch, turn switch button counterclockwise.

To get wire rope into the winch, turn the switch button clockwise.

Refer to ATV Winch Operator's Manual for more informations.

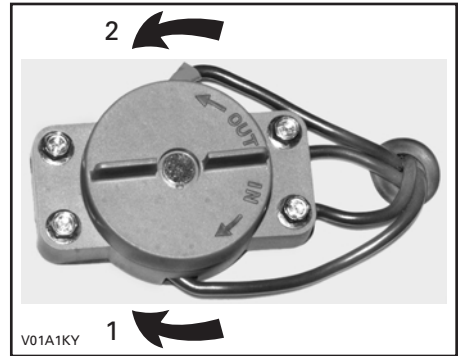

1. In
2. Out

34) Fairlead

XT Models

Located on the front skid plate.

The fairlead is used to prevent the damages to the vehicle and guide the wire rope into the winch.

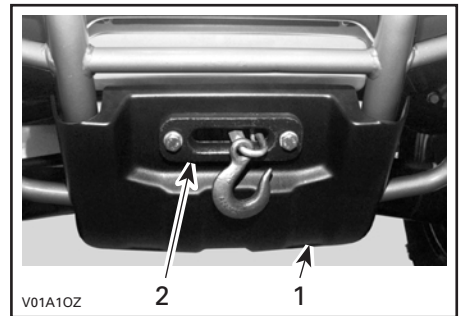

1. Front skid plate
2. Fairlead

35) Rear Cargo Box

XL Models

Located at the rear of vehicle. The rear cargo box is designed to receive varied materials.

WARNING

Never transport inflammable or dangerous material.

36) Release Lever

XL Models

Located under rear cargo box on the right side of seat.

It allows the dumping of rear cargo box.

To dump rear cargo box, move release lever toward the right side.

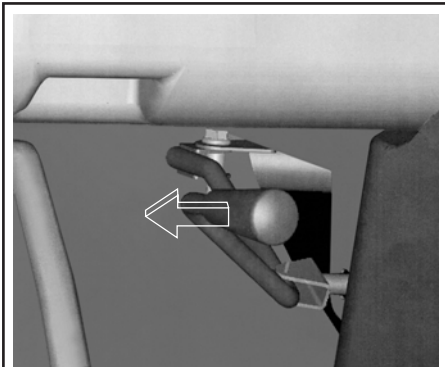

V03L03Y

37) Rear Cargo Box Gate

XL Models

Located at the rear end of the rear cargo box.

To open gate, unlatch and lift up gate about 50 mm (2 in) then slowly pivot gate downwards, toward rear. Two cables located on each side of rear cargo box will hold gate in place.

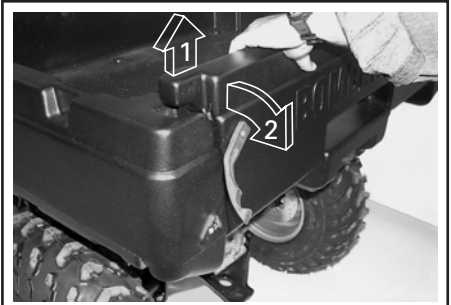

V03L04Y

OPENING PROCEDURE

Step **1**: Lift up

Step **2**: Lower gate

To close gate, raise and lift up gate. Then insert gate locks into lock grooves. Install latches.

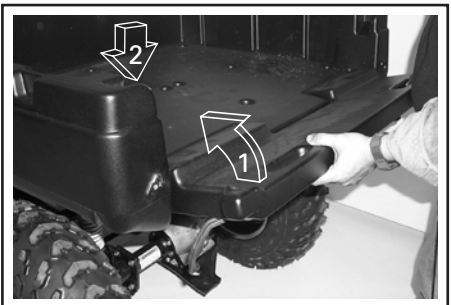

V03L05Y

CLOSING PROCEDURE

Step **1**: Raise gate

Step **2**: Lower gate

38) Lateral Compartment

XL Models

Located on both side of vehicle. The compartments are equipped with a drain plug. Remove plug to allow draining when necessary. Reinstall plug when finished.

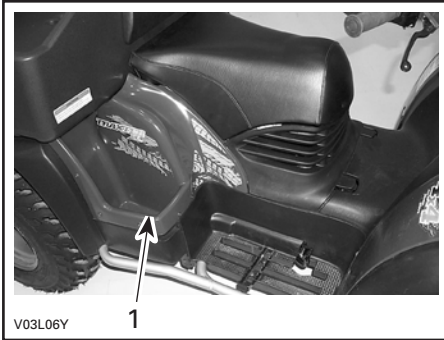

1. Lateral compartment

LIQUIDS

While reading this *Operator's Guide*, remember that:

WARNING

Indicates a potential hazard that could result in serious injury or death.

This section specifies the recommended liquids and procedures to check their levels. Refer to MAINTENANCE for procedures to replace the liquids.

Fuel

Recommended Fuel

Use regular unleaded gasoline or gasoline containing less than 10% of ethanol or methanol, available from most service stations. The gasoline used must have an octane number of 87 ((R + M)/2) or higher.

NOTE: In most service station, pump octane number corresponds to (R + M)/2 octane number. Usually a sticker can be found on the pump.

CAUTION: Never experiment with other fuels. The use of unrecommended fuel can result in vehicle performance deterioration and damage to critical parts in the fuel system and engine components.

CAUTION: Never mix oil with fuel. This ATV has a 4-stroke engine. Oil must be added to engine base only.

Fuel Level

WARNING

Never top up the fuel tank before placing the vehicle in a warm area. As temperature increases, fuel expands and may overflow. Fuel is flammable and explosive under certain conditions. Always wipe off any fuel or oil spillage from the vehicle.

Engine/Transmission Oil

Recommended Oil

Use 4-stroke **mineral-based** engine oil that meets or exceeds the requirements for API service classification SG, SH or SJ. Always check the API service label on the oil container to be sure it includes the letters SG, SH or SJ. Only use high-quality high-detergent oil.

NOTE: The same oil lubricates both engine and transmission. For improved overall performance and wear protection use **Bombardier synthetic oil (P/N 293 600 040)**. This is a special synthetic oil formulated for clutch type gear box.

CAUTION: Use of synthetic or synthetic blend oil, other than Bombardier synthetic oil 5W40 (P/N 293 600 040), may cause clutch slippage.

Oil Viscosity

SAE 10W40 is recommended for summer time.

SAE 5W30 is recommended for winter time.

Other viscosity should be used if the average temperature is outside the range of the recommended oil. See chart below.

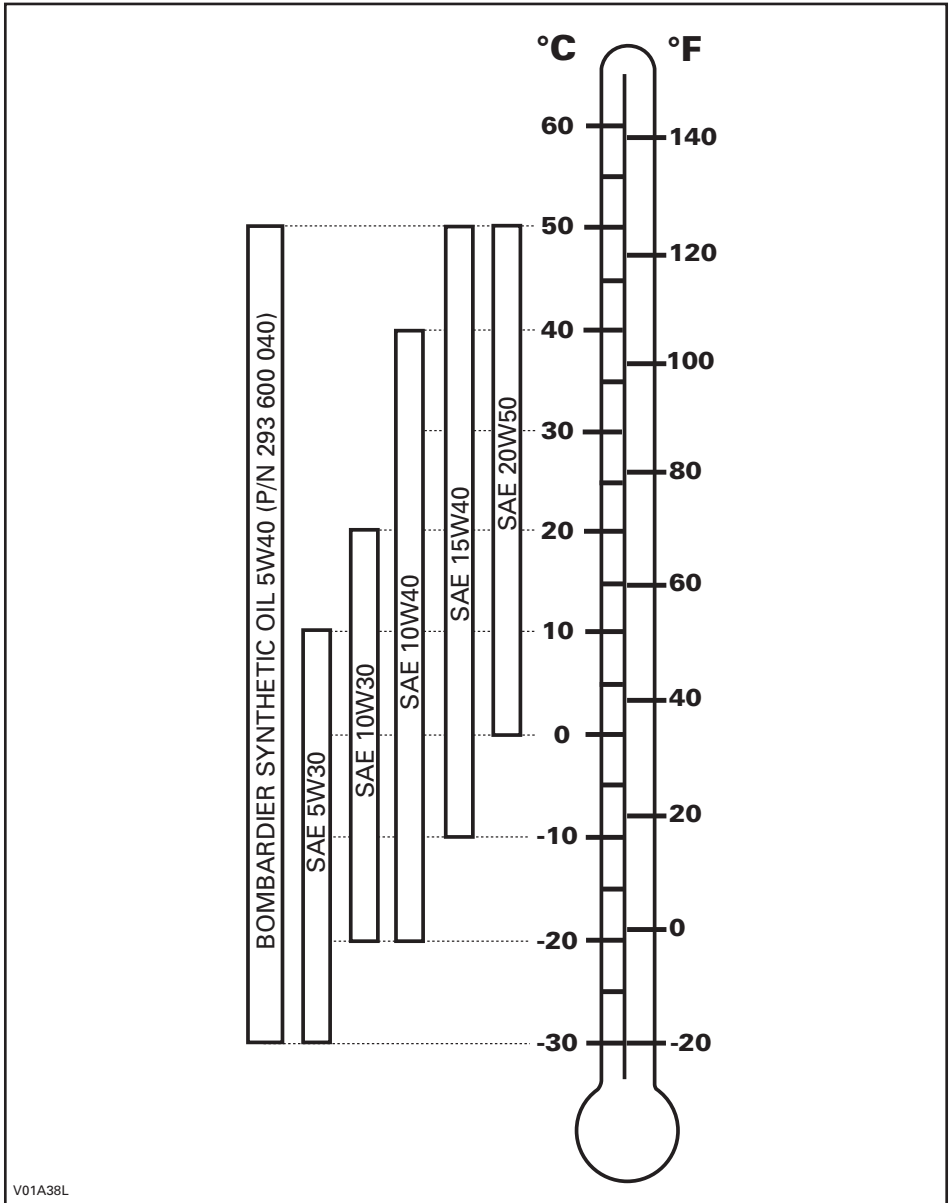

Oil Level

CAUTION: Check level frequently and refill if necessary. Do not overfill. Operating the engine/transmission with an improper level may severely damage engine/transmission. Wipe off any spillage.

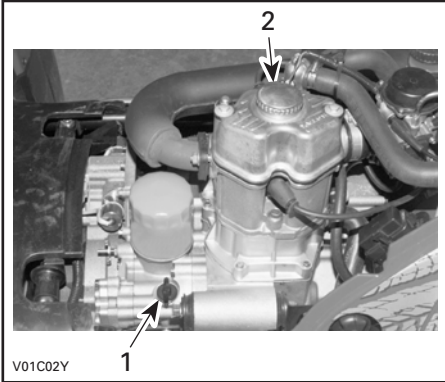

LH SIDE OF ENGINE

1. Dipstick
2. Filler cap

With vehicle on a level surface and engine cold, not running, check the oil level as follows:

1. Pull dipstick out and wipe clean.

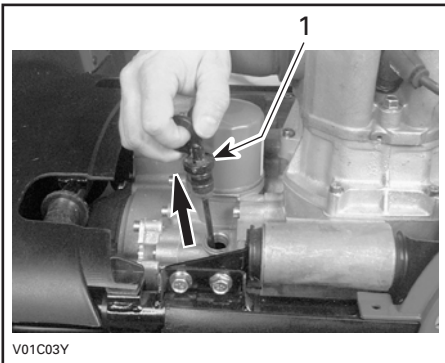

1. Pull out dipstick

2. Reinstall dipstick until it bottoms.
3. Remove and check oil level. It should be near or equal with the upper mark.

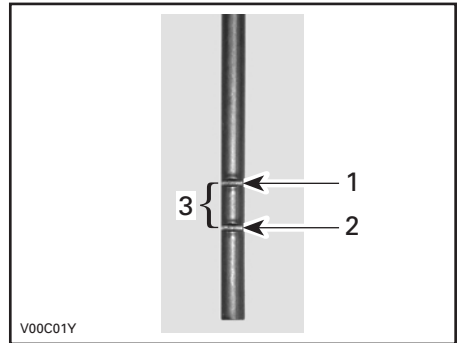

1. Full
2. Add
3. Operating range

4. Add oil up to upper mark if required.
5. To add oil, remove seat then unscrew filler cap. Use a funnel to avoid spillage. Do not overfill.
6. Properly reseal dipstick, reinstall and tighten filler cap then reinstall seat.

Engine Coolant

Recommended Coolant

Always use ethylene-glycol antifreeze containing corrosion inhibitors specifically for internal combustion aluminum engines.

Cooling system must be filled with water and antifreeze solution (40% water, 60% antifreeze).

Coolant Level

WARNING

Check coolant level with engine cold. Never add coolant in cooling system when engine is hot.

Remove seat.

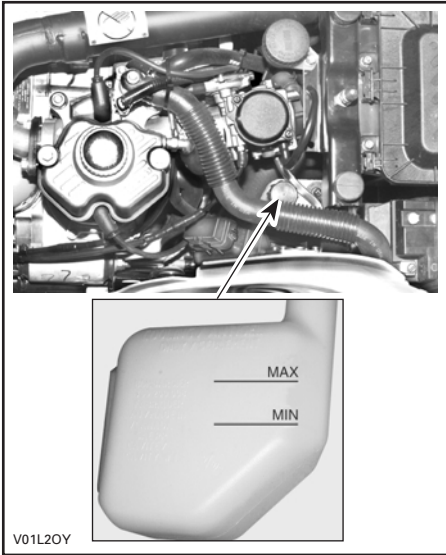

With vehicle on a level surface, liquid should be between MIN. and MAX. level marks of coolant reservoir.

NOTE: When checking level at temperature lower than 20°C (69°F), it may be slightly lower than MIN. mark.

Add coolant up to MAX. mark if required. Use a funnel to avoid spillage. **Do not overfill.**

Properly reinstall and tighten filler cap and reinstall seat.

If the coolant is added in the coolant reservoir, check the level in the radiator too. Add coolant if necessary.

NOTE: A cooling system that frequently requires coolant is the indication of leaks or engine problems. See an authorized Bombardier ATV dealer.

Coolant Replacement

Refer to MAINTENANCE section.

Brake Fluid

Recommended Fluid

Always use brake fluid meeting the specification DOT 4 only.

CAUTION: Never use other type of oil such as mineral-based or synthetic oil.

Fluid Level

With vehicle on a level surface, check brake fluid in reservoir for proper level. It should be above MIN. mark.

Add fluid as required. **Do not overfill.**

Clean filler cap before removing.

CAUTION: Use only DOT 4 brake fluid from a sealed container.

NOTE: A low level may indicate leaks or worn brake pads. See an authorized Bombardier ATV dealer.

Front Brake Fluid Reservoir

Turn steering in the straight-ahead position to ensure reservoir is level.

Check the brake fluid level, the reservoir is full when the fluid reaches of the top of window.

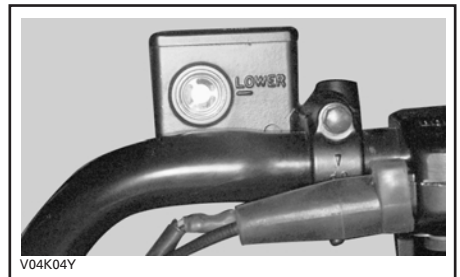

Visually inspect lever boot condition. Check for cracks, tears etc. Replace if damaged.

Rear Brake Fluid Reservoir

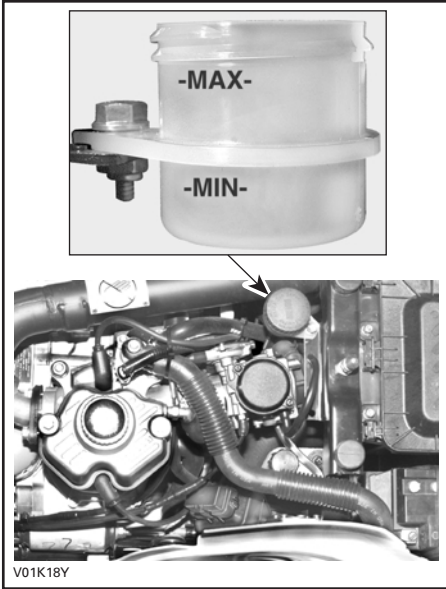

Battery Electrolyte Recommended Liquid

It is recommended to use distilled water.

Electrolyte Level

Place the vehicle on a level surface.

Check electrolyte level by the rear left inner fender. Use a flashlight if necessary. Do not use an open flame.

The electrolyte should be between lower and upper marks. If level is low, remove battery from vehicle to add distilled water.

Battery

Removal

Disconnect negative BLACK cable first then positive cable.

WARNING

Always respect this order for disassembly; disconnect BLACK negative cable first. Electrolyte or fuel vapors can be present in engine compartment and a spark may ignite them and possibly cause personal injuries.

Remove the holding straps.

Pull out vent tube from frame.

Remove battery from vehicle being careful not to tilt it so that electrolyte flows out of vent tube.

WARNING

Electrolyte is poisonous and dangerous. Avoid contact with eyes, skin and clothing. Wear protective eyeglasses and a suitable pair of non-absorbent gloves when removing the battery by hand.

CAUTION: Should any electrolyte spillage occur, immediately wash off with a solution of baking soda and water.

Refilling

Place battery on a level surface.

Unscrew caps and add distilled water up to upper mark as required. Do not overfill.

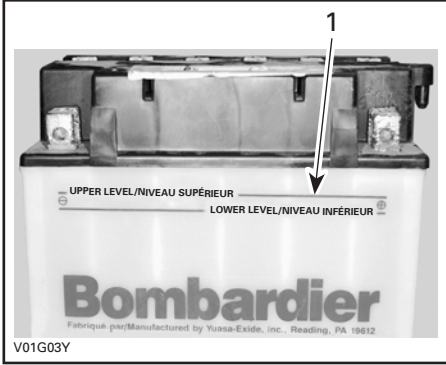

1. Upper mark

Properly retighten caps.

Installation

Reinstall battery in vehicle. Fasten battery and make sure to reinstall the vent tube.

WARNING

Connect positive RED cable first then negative cable. Always connect RED positive cable first.

NOTE: Place the positive RED cable between holding straps and battery.

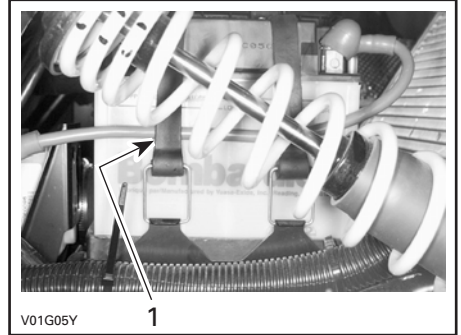

1. Cable between battery and strap

BREAK-IN PERIOD

Engine

A break-in period of 10 operating hours is required before running the vehicle at sustained full throttle.

CAUTION: Never mix oil with fuel. This vehicle has a 4-stroke engine. Oil must be added to engine base only.

During this period, maximum throttle should not exceed 3/4. **However, brief full acceleration and speed variations contribute to a good break-in.** Continued wide open throttle accelerations, prolonged cruising speeds and engine overheating are detrimental during the break-in period.

10-Hour Inspection

As with any precision piece of mechanical equipment, we suggest that after the first 10 hours or 30 days after the purchase, whichever comes first, your vehicle be inspected by an authorized Bombardier ATV dealer. This inspection will give you the opportunity to discuss the unanswered questions you may have encountered during the first hours of operation.

The 10-hour inspection is at the expense of the vehicle owner.

While reading this *Operator's Guide*, remember that:

WARNING

Indicates a potential hazard that could result in serious injury or death.

PRE-OPERATION CHECK

WARNING

The pre-operation check is very important prior to operating the vehicle. Always check the proper operation of critical controls, safety features and mechanical components before starting. If not done as specified here, severe injury or death might occur.

- Check tire pressure and condition.
- Check wheels and bearings for wear and damage.
- Check location of controls and ensure they work properly.
- Verify steering operates freely.
- Activate throttle control lever several times to ensure it operates freely. It must return to idle position when released.
- Activate the brake levers and foot pedal to make sure the brakes fully apply. Levers and pedal must fully return when released.
- Ensure transmission lever is working then reset in PARK position.
- Check fuel, oil and coolant levels.
- Check for oil leaks on the engine/transmission and drive train components.
- Ensure fuel valve is in fully open position (ON).
- Clean headlights and taillight.
- Ensure front storage cover compartment is properly latched.
- Ensure seat is properly latched.
- If you transport cargo, respect load capacity. Ensure cargo is properly secured to the racks.
- If you are pulling a trailer or other equipment, ensure it respects the tongue capacity and towing capacity. Ensure trailer is properly secured to hitch.
- Look and feel for loose parts while engine is off. Check fasteners.
- Ensure the path of travel is free of persons and obstacles.
- Check operation of ignition and start/stop switches, headlights, dimmer switch, taillight and indicator lights.
- Start engine and drive forward slowly a few feet and apply all brakes individually to test them.

Correct any problem you may have found. See an authorized Bombardier ATV dealer as necessary.

OPERATING INSTRUCTIONS

General

Engine can be started in any gear (from 1 to 5).

Transmission lever must be on PARK or NEUTRAL to allow engine starting.

For your convenience, an override mode allows to start the engine with the transmission lever in any position. Press and hold the front brake lever while pressing the start button.

NOTE: On FOOTSHIFT models, place the engine stop switch to RUN position then press start button.

Initial Cold Starting

Insert key in ignition switch and turn to ON.

NOTE: On FOOTSHIFT, place the engine stop switch to RUN position.

In cold weather, colder than 0°C (32°F), fully pull up the choke lever.

NOTE: When the temperature is below -15°C (5°F), the primer kit installation is recommended. See an authorized Bombardier ATV dealer.

Press start/stop button and hold until engine starts.

CAUTION: Do not hold start/stop switch or start button more than 30 seconds. A rest period should be observed between the cranking cycles to let starter cool down. Pay attention not to discharge battery.

NOTE: Throttle assist may be used to help engine starting faster. Press the throttle lever slightly. If too much throttle is used the choke system will not be activated.

Release start/stop switch or start button immediately when engine has started.

After a few minutes, release the choke lever until a best engine RPM.

NOTE: Overusing choke may flood engine and make it hard to start. Refer to SPECIAL PROCEDURES if it occurs.

When the engine is warm, push the choke lever to OFF and release brakes.



1. Full choke position

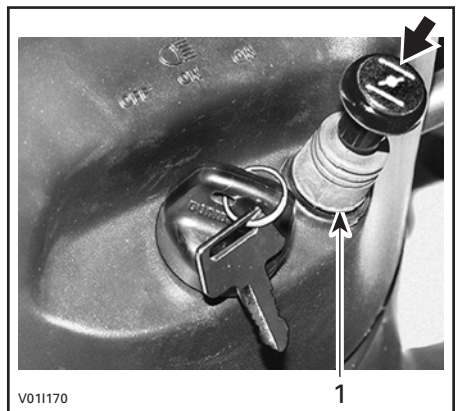

1. OFF position

Warm Engine Starting

Start the engine as explained above but without any choke. If the engine will not start after two 5-second attempts with the electric starter, pull the choke lever and place it half way position. Start the engine without activating the throttle lever. After few times, push the choke lever to OFF.

Emergency Manual Starting

WARNING

Always place transmission lever on PARK or NEUTRAL before starting engine manually.

Manual start is provided in the event electric start does not work.

If the engine indicator light is turned off, it indicates the electrical system is in the auto shut-down mode. Turn the ignition key OFF then ON to reactivate it.

Follow the same procedure as starting procedures above except use the re-wind starter to start instead.

Grasp manual starter handle firmly and, slowly, crank engine until a resistance appears.

Pass this resistance and release the handle.

Take again the handle firmly and crank engine.

Repeat this procedure completely if necessary.

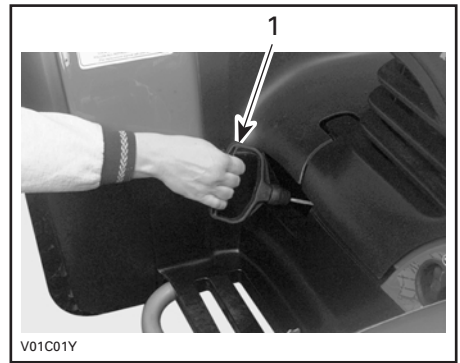

1. Grasp manual starter handle firmly and crank engine

Stopping the Engine

WARNING

Avoid parking on an incline land.

Release throttle and completely stop the vehicle.

Apply the parking brake.

Shift to 1st gear.

Set transmission lever in PARK position.

Press the start/stop switch or push the engine stop switch in OFF position.

Turn key in ignition switch to OFF.

Remove key from ignition switch.

Shifting the Transmission

Let engine idle to warm up.

Apply brakes and select the desired gear range H/L.

NOTE: The brake must be applied when the transmission lever is engaged in the park position. Shift to 1st gear.

Release brakes.

CAUTION: Make sure parking brake is fully disengaged before operating the ATV.

Gradually press the throttle lever to increase engine speed and thus engaging the centrifugal clutch.

All Models except AUTOSHIFT and FOOTSHIFT

When vehicle speed increases, slightly release throttle lever while pressing the electric gear shift button to upshift one gear then release button and press throttle lever again to continue the acceleration. Repeat until the last gear if desired or until vehicle speed you want is attained.

NOTE: While any throttle position can be used during shifting, it is recommended to slightly release the throttle position during upshifting.

Reverse the sequence to downshift.

AUTOSHIFT Models

When selector is in automatic mode, the transmission upshift automatically when the vehicle speed increases. Inversely, when vehicle speed decreases, the transmission downshifts automatically.

FOOTSHIFT Models

To shift the transmission, release throttle lever, then operate gearshift pedal as follow.

⚠ WARNING

Always release the throttle when shifting gears. Shifting gears without releasing the throttle, could cause loss of control or cause the ATV to overturn.

One full stroke of the pedal shifts the transmission to the next higher or lower gear in the shifting sequence. The pedal should automatically return to its original position.

To upshift to a higher gear, put the end of your boot under gearshift lever and lift up the pedal one full stroke. To downshift, step on the gearshift pedal and depress pedal one full stroke.



NOTE: While shifting, the clutch is operated hydraulically. The system requires the engine oil pressure. If the engine is shut off, there is no oil pressure for clutch operation.

Using the Reverse

All Models

CAUTION: When changing from forward to reverse, or vice-versa, always completely stop the vehicle and apply the brake prior to moving the transmission lever.

The same procedures as **Shifting the Transmission** above apply except for the following.

Set the transmission lever in REVERSE position.

Winch Operation

XT Models

See the ATV Winch Operator's Manual. This manual should be kept in the tool box and remain in the vehicle at all time.

Dumping the Rear Cargo Box

XL Models

Select a level ground to dump the load of rear cargo box.

WARNING

Do not attempt to dump or unload the vehicle on an inclined land.

Set the parking device.

Dismount from the vehicle.

Open rear cargo box gate.

Move the release lever toward right side and lift the front end of the rear cargo box to dump.

WARNING

Never operate the release lever without checking the position of the load. If weight distribution on the rear cargo box is located towards the back of the box and the release lever is activated, the box will want to dump on its own.

Adequately distributed cargo will prevent unexpected dumping of rear cargo box.

SPECIAL PROCEDURES

Flooded Engine

When the engine does not start after several attempts, the engine may be fuel flooded. Proceed as follows.

Turn ignition switch to ON and ensure choke is not applied.

Ensure the transmission lever is on PARK.

Fully press throttle lever and hold while starting the engine.

As soon as the engine starts, release throttle lever. Do not race engine.

If it does not work:

Disconnect spark plug cables.

Clean the spark plug area then remove spark plugs (tools are supplied in tool box).

Crank engine several times. Add a small quantity of engine oil in cylinder (equivalent to a cap of oil quart). Install new spark plugs if possible or clean and dry spark plugs.

Start engine as explained above. If engine continues to flood, see an authorized Bombardier ATV dealer.

Engine Overheat

If engine overheats and indicator light turns on, try the following:

Ensure air ducts are not obstructed.

Check and clean radiator fins. See MAINTENANCE section.

WARNING

The radiator can be very hot, wear gloves before touching radiator.

Reduce vehicle speed but try to keep vehicle moving to supply air to radiator. If engine is still overheating after approximately one minute, stop vehicle and set transmission to PARK. Stop engine.

Place the ignition switch to ON position (**Do not restart engine yet**). The radiator fan will allow to cool the radiator.

Let engine cool down. Check coolant level and refill if possible.

WARNING

Never refill cooling system when engine is hot.

See an authorized Bombardier ATV dealer as soon as possible.

Flipped Over

When vehicle is flipped over or stays tilted on the side, wait 3 to 5 minutes before starting engine. If the oil pressure light stays ON after starting engine, stop engine and see an authorized Bombardier ATV dealer as soon as possible.

ATV Immersion

Should the ATV become immersed, it will be necessary to take it to an authorized Bombardier ATV dealer as soon as possible. **DO NOT START THE ENGINE!**

CAUTION: Immersion of the ATV can cause serious damage if not correctly repaired.

Post-Operation Care

When vehicle is used in salt-water environment (beach area, launching/loading boats etc.), rinsing the vehicle with fresh water is necessary to preserve vehicle and its components. Metallic parts lubrication is highly recommended. Use BOMBARDIER LUBE. This must be performed at the end of each operating day.

When vehicle is operated in muddy conditions, rinsing the vehicle is recommended to preserve vehicle and its components and to keep lights clean.

Emergency Shifter

All Models except FOOTSHIFT

If the shifting system is not operational, you may use the emergency shifter. It allows to change the transmission gear when the vehicle is not in motion. You set the desired gear once then go back home while the transmission remains in this gear. No gear change can take place since the shifting system is not operational. The shifter shaft end is located on rear side of engine.

Place transmission on PARK position.

Remove seat.

- Use the special key in the tool box to rotate the emergency shifter. Open the tab of the tool approximately at a right angle (90°). Insert the screwdriver included in the tool box at the end of the special tool so that it can be used as a handgrip.

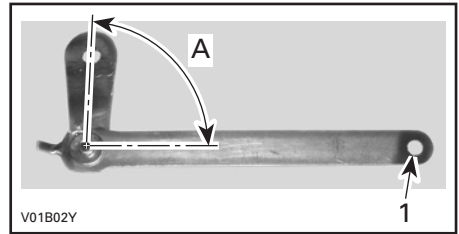

1. Insert the screwdriver here as a handgrip
A. Open tab at a right angle (90°)

WARNING

The exhaust pipe can be very hot. Wear gloves and/or allow exhaust pipe to cool.

Insert the tool to the end of the shifter shaft.

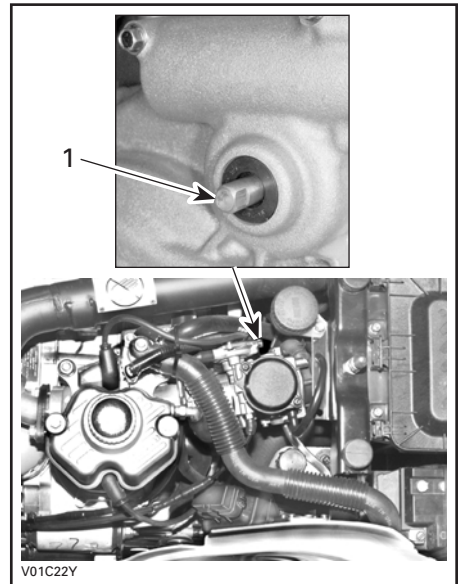

1. Emergency shifter shaft. Insert special tool here

Pull special tool upward to downshift and push downward to upshift. Place the gear in the desired position.

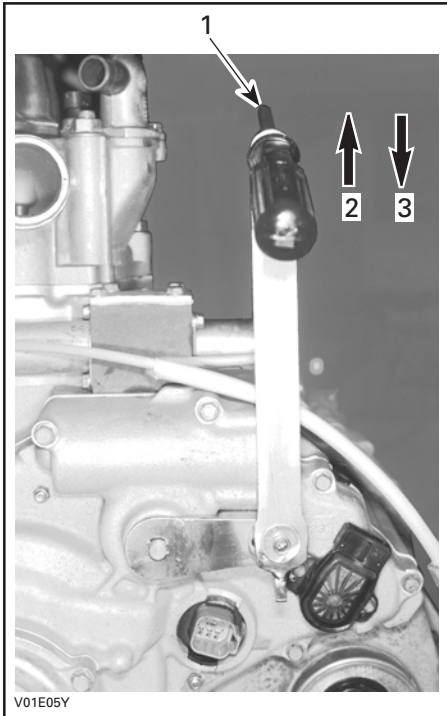

1. Use screwdriver as a handgrip
2. Pull to downshift
3. Push to upshift

NOTE: The 2nd or 3rd gear is recommended.

Remove the special tool. Close the tab of the tool. Replace tool and screwdriver in tool box.

Replace seat.

Storage and Preseason Preparation

WARNING

Have an authorized Bombardier ATV dealer inspect fuel system integrity as specified in MAINTENANCE CHART.

When a vehicle is not in use for more than one month, proper storage is a necessity.

See an authorized Bombardier ATV dealer for proper procedures.

When using your ATV after storage, a preparation is required. See an authorized Bombardier ATV dealer for proper procedures.

MAINTENANCE CHART

The maintenance is very important, if you are not familiar with safe service practices and adjustment procedures, see your authorized Bombardier ATV dealer.

LUBRICATION AND MAINTENANCE CHART I: Inspect, verify, clean, adjust, lubricate, replace if necessary C: Clean L: Lubricate R: Replace	INITIAL 10 h INSPECTION OR 150 mi (250 km) ①	EVERY				TO BE PERFORMED BY
		25 h OR 388 mi (625 km)	50 h OR 777 mi (1250 km)	100 h OR 1 YEAR OR 1553 mi (2500 km) ①	200 h OR 2 YEARS OR 3107 mi (5000 km)	
ENGINE/TRANSMISSION						
Engine/transmission oil and filter ④	R	R				CUSTOMER
Transmission oil strainer cleaning ②			C			CUSTOMER
Engine mount fasteners	I			I		DEALER
Exhaust system	I			I		DEALER
Spark arrester				C		CUSTOMER
Condition of seals	I			I		DEALER
Coolant ④	I		⑥		R	CUSTOMER
Radiator cap/cooling system pressure test	I				I	DEALER
Radiator condition/cleanliness (air ducts and radiator fins) ③	I		I			CUSTOMER
Rewind starter rope condition				I		DEALER
Clutch and transmission operation				I		DEALER
Footshift mechanism adjustment				I		CUSTOMER
PCV valve (if so equipped)					I	DEALER
FUEL SYSTEM						
Air filter ④		C ③	R ③			CUSTOMER
Fuel lines and connections	I			I		DEALER
Fuel tank strainer					R	DEALER
Carburetor adjustment	I			I		DEALER
ELECTRICAL SYSTEM						
Spark plugs ⑤	I			R		DEALER
Battery electrolyte level/connections/vent condition	I		I			CUSTOMER
Wiring harnesses, cables and lines	I			I		DEALER
Condition of ignition switch and start/stop switch (start button and engine stop switch on FOOTSHIFT) ②	I			I		CUSTOMER
Condition of lighting system (HI/LO intensity, brake light, headlight aiming, etc.) ④	I			I		CUSTOMER
Winch connections	Refer to ATV Winch Operator's Manual					CUSTOMER
DRIVE TRAIN						
Drive shaft boot and protector ④	I	I				CUSTOMER
Drive shaft joint			I			DEALER
Front/rear propeller shaft joint	I		L			DEALER
Wheel bearings condition				I		DEALER
Front differential and rear axle oil, seals and vent	I		I		R	DEALER

LUBRICATION AND MAINTENANCE CHART I: Inspect, verify, clean, adjust, lubricate, replace if necessary C: Clean L: Lubricate R: Replace	INITIAL 10 h INSPECTION OR 150 mi (250 km) ①	EVERY				TO BE PERFORMED BY
		25 h OR 388 mi (625 km)	50 h OR 777 mi (1250 km)	100 h OR 1 YEAR OR 1553 mi (2500 km) ①	200 h OR 2 YEARS OR 3107 mi (5000 km)	
		STEERING/CONTROL SYSTEMS				
Handlebar fasteners				I		DEALER
Throttle/housing/cable ④	I		I			CUSTOMER
Choke condition ④	I		I			CUSTOMER
Steering system	I			I		DEALER
Tie rod ends			I			DEALER
Wheel nuts/studs	I		I			CUSTOMER
Wear/Pressure of tires ④	I	I				CUSTOMER
Front wheel alignment	I			I		DEALER
SUSPENSION						
Swing arm ④				I		DEALER
Shock absorber ④			I			DEALER
A-arm lubrication			I			CUSTOMER
BRAKE						
Brake fluid front/rear ④	I	I			R	DEALER
Brake cable	I		I			DEALER
Brake pad		I				DEALER
Brake system (discs, hoses etc.)				I		DEALER
BODY/FRAME						
Engine compartment	C		C			CUSTOMER
Skid plate	I		I			CUSTOMER
Frame				I		DEALER
Hitch/trailer ball condition (if installed)	I		I			CUSTOMER
Chassis fasteners			I			CUSTOMER
Front storage compartment cover/seat latches ④			I			CUSTOMER
Rear cargo box release lever			I			CUSTOMER
Rear cargo box gate latches ②			I			CUSTOMER
Vehicle cleaning and protection			C			CUSTOMER

① To be performed by an authorized Bombardier ATV dealer. The initial maintenance is very important and must not be neglected.

② Clean at the same time that the engine/transmission oil is changed.

③ More often under severe use such dusty area, sand, snow, wet or muddy conditions.

④ Pre-ride inspection item.

⑤ Make sure that the spark plug gap is correct.

⑥ Every 50 hours, check coolant strength.

Refer to MAINTENANCE AND LUBRICATION section of *Shop Manual* for more details.

MAINTENANCE

While reading this *Operator's Guide*, remember that:

WARNING

Indicates a potential hazard that could result in serious injury or death.

WARNING

Unless otherwise specified, engine should not be running for all maintenance procedures.

WARNING

Should removal of a locking device (e.g. lock tabs, self-locking fasteners, etc.) be required when undergoing disassembly/assembly, always replace with a new one.

The following covers the maintenance items that can be performed by the customer if desired. Other items found in maintenance chart must be performed by an authorized Bombardier ATV dealer.

NOTE: Among other things, this section gives the procedures to replace the liquids. Refer to LIQUIDS for procedures to check levels and refill.

Engine/Transmission

Oil Change and Oil Filter Replacement

Oil and filter are to be replaced at the same time. Oil change should be done with a warm engine.

WARNING

The engine oil can be very hot. Wait until engine oil is warm.

- Ensure vehicle is on a level surface.
- Clean the drain plug area.
- Remove dipstick.
- Place a drain pan under the engine drain plug area.
- Unscrew drain plug.

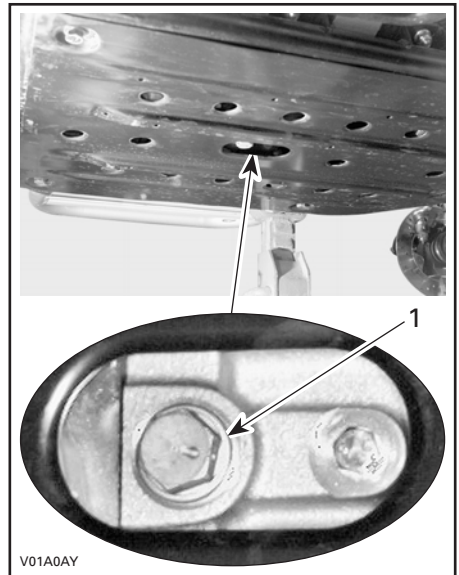

1. Oil drain plug

Wait enough time to allow oil to flow out of oil filter.

Carefully unscrew oil filter and as soon as it can be removed from the engine, turn it upright. Discard filter.

NOTE: Be sure that the old filter O-ring is removed.

CAUTION: Only use Bombardier high pressure filter or suitable equivalent. The Bombardier filter is specifically designed for this engine. This filter does not operate at the same pressure as other brands. Using a non-recommended filter may cause serious engine/transmission damage. See an authorized Bombardier ATV dealer.

Lubricate the O-ring on the filter with engine oil. Install the new filter then screw one full turn after O-ring contact.

Wipe out any oil spillage on engine.

Remove skid plate.

Remove oil strainer cover and oil collector, located near drain plug, then clean oil strainer.

Change gasket on drain plug. Clean gasket area on engine and drain plug then reinstall plug. Refill engine at the proper level with the recommended oil. Refer to SPECIFICATIONS for capacity.

Start engine and let idle for a few minutes. Ensure oil filter area and drain plug areas are not leaking.

Stop engine. Wait a while to allow oil to flow down to crankcase then check oil level. Refill as necessary.

Dispose of oil as per your local environmental regulations.

Coolant Replacement

WARNING

To prevent burning yourself, do not remove the radiator cap or loosen the engine drain plug if the engine is hot.

Turn the radiator cap counterclockwise and remove it.

Remove the drain plug under engine and drain the coolant into a suitable container.

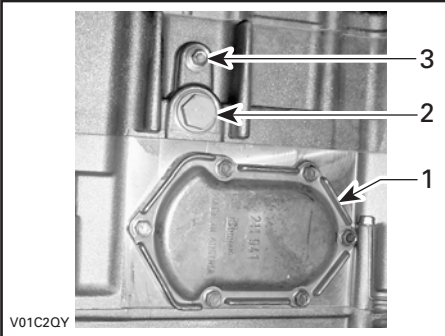

1. Oil strainer cover
2. Oil plug
3. Coolant plug

To clean oil strainer, use a solvent then dry with compressed air.

WARNING

Always wear eye protection and gloves.

Reinstall oil strainer, oil collector and oil strainer cover.

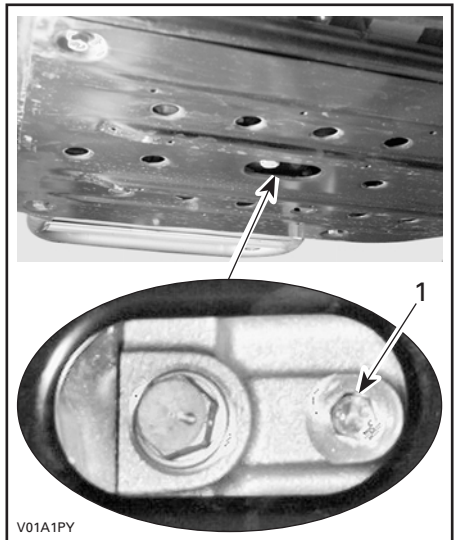

1. Cooling drain plug

Lift the rear of vehicle, about 2 or 3 inches, then remove the screw on the top of thermostat housing.

Drain the system completely and reinstall the drain plug.

Pinch hose between radiator and thermostat housing with a large hose pincher (P/N 529 032 500).



V03C03Y

Fill the radiator until the coolant comes out by the thermostat housing hole. Install the bleeding screw then remove the hose pincher.

Complete the radiator filling.

Check the level in the coolant reservoir and refill if necessary.

Run engine at idle with the radiator cap off. Slowly add additional coolant if necessary.

At this point, wait until engine reaches normal operating temperature. Depress the throttle lever two or three times; then add coolant if required.

Install radiator cap. Inspect all connections for leaks and check coolant level in the reservoir.

Valve Adjustment

Valve adjustment is not required on this engine.

Spark Arrester

The muffler must be periodically purged of accumulated carbon.

WARNING

Never run engine in an enclosed area. Never perform this operation immediately after the engine has been run because exhaust system is very hot. Make sure that there are no combustible materials in the area. Wear eye protection and gloves. Never stand behind the vehicle while purging exhaust system. Respect all applicable laws and regulations.

Select a well-ventilated area and make sure the muffler is cool.

Place transmission on PARK position.

Remove the clean-out plug from muffler.

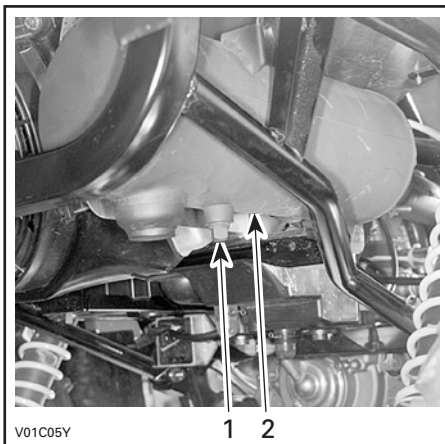

V01C05Y

TYPICAL

1. Clean-out plug
2. Muffler

Block the end of muffler with a shop rag and start engine.

Momentarily increase engine RPM several times to purge accumulated carbon out of the muffler.

Stop engine and allow muffler to cool.

Reinstall the clean-out plug.

Radiator

All Models except XL

Periodically check the radiator area and the air ducts for cleanliness. Ensure air ducts are unobstructed to allow air flow going to the radiator.

An access hole is available to inspect the radiator condition and to give access for cleaning.

Remove seat.

Pull on the circumference of the access plug and remove plug.

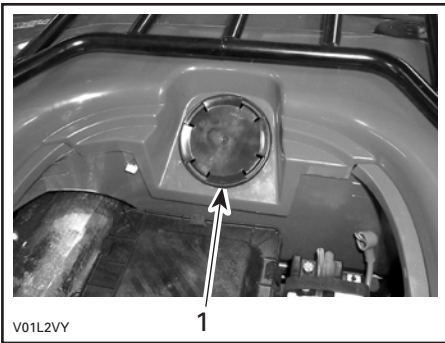

1. Access plug

Inspect radiator fins. They must be clean, free of mud, dirt, leaves and any other deposit that would prevent the radiator to cool properly.

Remove the deposits as much as you can with your hands. If water is available in proximity, try rinsing the radiator fins.

If available, use a garden hose to rinse the radiator fins.

WARNING

Never clean radiator with your hands when it is hot. Let the radiator cool down before cleaning.

CAUTION: Be careful not to damage the radiator fins when cleaning. Do not use any object/tool that could damage the fins. The fins are purposely thin parts to allow efficient cooling. When hosing, use low pressure only.

Properly reinstall access plug and seat.

Footshift Mechanism

Adjustment

To adjust gearshift mechanism, it is necessary to remove the LH side panel, use the following procedure.

Remove footpeg.

Remove screws retaining side panel and fenders.

Remove screws retaining side panel to the rear mudguards, then remove LH side panel.

To adjust gearshift pedal, unscrew tie-rod end to lower pedal and screw to raise. Adjust gearshift pedal at your preference.

If the adjustment is not sufficient, change the tie-rod end location. Unscrew the nut retaining the tie-rod end to pedal then move the tie-rod end in the other adjustment hole.

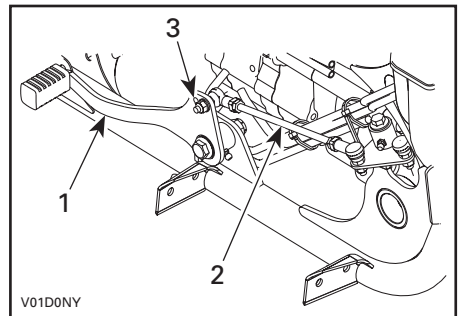

1. Gearshift pedal
2. Front tie-rod
3. Adjusting hole

The rear tie-rod must be adjust to 300 mm (11-13/16 in).

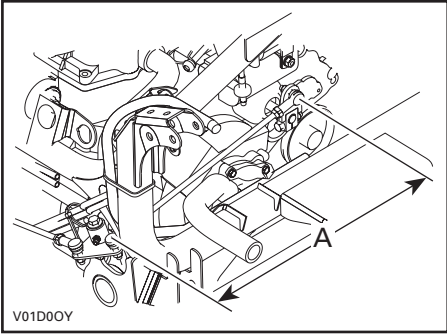

REAR VIEW OF ENGINE
A. 300 mm (11-13/16 in)

Air Intake System

Air Filter Cleaning/Draining

Periodically inspect air filter box drain tube for water or deposits.

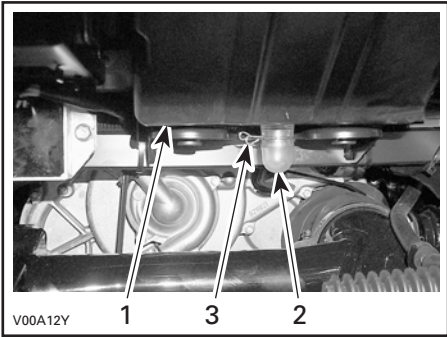

TYPICAL

1. Air filter box
2. Drain tube
3. Clamp

NOTE: If vehicle is used in dusty area, inspect more frequently than specified in MAINTENANCE CHART.

If water/deposits are found, squeeze and remove the clamp. Pull drain tube out.

CAUTION: Do not start engine when water is found in the drain tube.

When water/deposits are found, the air filter must be inspected/dried/replaced depending on its condition.

Remove air filter as explained below.

Air Filter Removal

CAUTION: Never remove or modify any component in the air box. The engine carburetion is calibrated to operate specifically with these components. Otherwise, engine performance degradation or damage can occur.

Remove seat.

NOTE: On the XL models, lift the rear cargo box to have access to the air filter box.

Release clamps and remove air filter box cover.

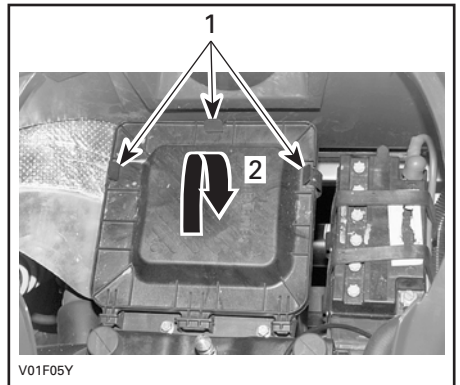

TYPICAL

1. Release clamps
2. Lift to remove

All Models except some XL Models

Loosen clamp and remove air filter.

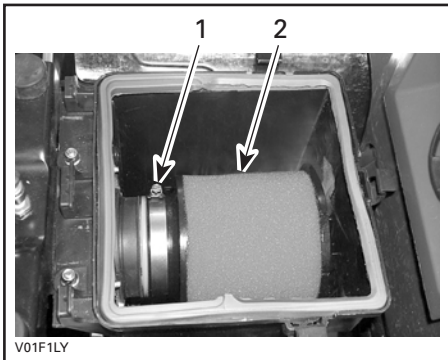

1. Clamp
2. Air filter

Pour cleaning solution into a bucket, dunk the filter multiple times until clean. Rinse with warm water.

NOTE: Products like Simple Green, dish soap or mild solvents can be used to clean the air filter. Simple Green® from Sunshine Makers Inc. is available at hardware stores or at automotive parts retailer.

While filter soaks, clean inside the air box.

Then, let the filter dry completely.

When the filter is dried, re-oil with air filter oil.

Some XL Models

Remove air baffles, air filter and foam.

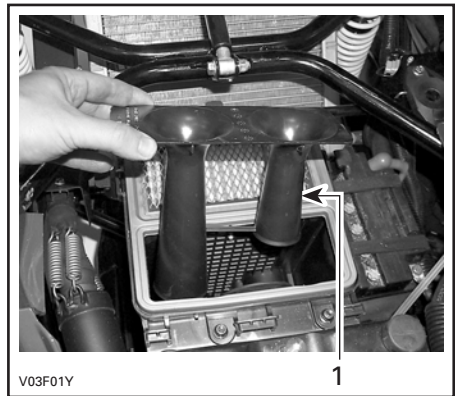

1. Air baffle

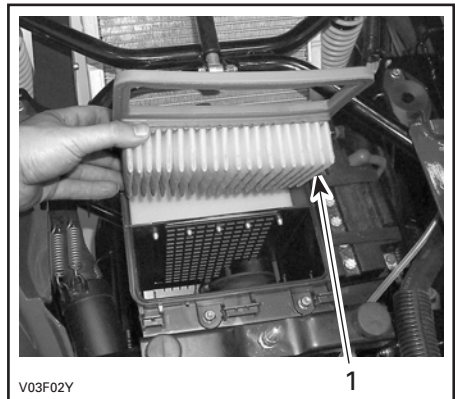

1. Air filter

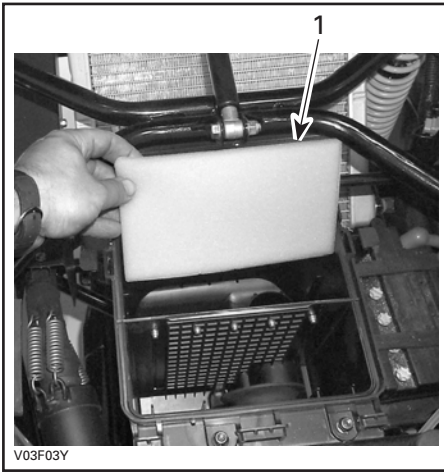

V03F03Y

1. Foam

Clean inside of air box.

Wash air filter and foam with warm water and mild detergent as necessary.

Squeeze foam to remove excess water. Let dry air filter and foam thoroughly.

If air filter element or foam is dirty, replace with a new one.

CAUTION: Never remove or modify any component in the air box. Always use genuine parts when replacing air filter and foam. The engine carburetion is calibrated to operate specifically with these components. Otherwise, engine performance degradation or damage can occur.

NOTE: Slight dust may be cleaned using a low-pressure airgun. Blow compressed air backward of operating air flow.

Air Filter Installation

Properly reinstall removed parts in the reverse order of their removal.

Electrical Battery

WARNING

Never charge a battery while installed in vehicle.

Clean battery post with a wire brush. Apply dielectric grease on post to protect against oxidation.

Fuses

If a fuse is damaged, replace it by one of the same rating.

CAUTION: Do not use a higher rated fuse as this can cause severe damage.

Fuses are located in engine compartment on LH side of battery.

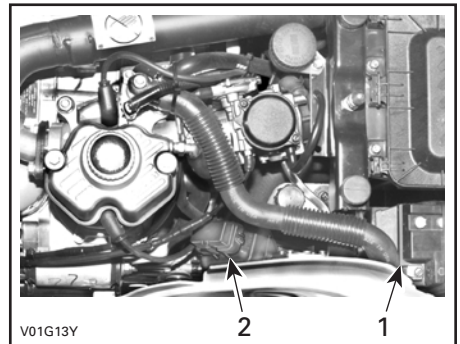

V01G13Y

1. Battery
2. Fuse holder

Fuses are identified by a number located beside the fuse.

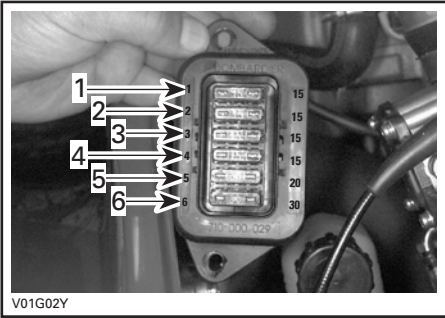

1. Ignition system
2. Accessories (power outlet and auxiliary supply)
3. Solenoids
4. Fan
5. MPEM (Multi-Purpose Electronic Module)
6. Charging system

To remove fuse from holder, pull fuse out. Check if filament is melted.

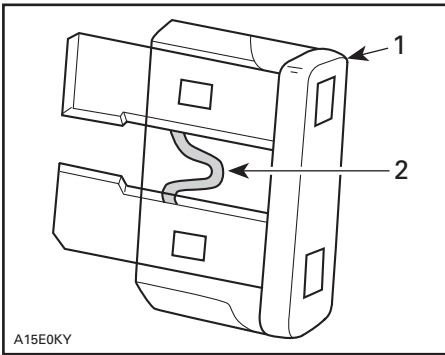

1. Fuse
2. Check if melted

Bulb Replacement

Always check light operation after replacement.

Headlights

All Models except FOOTSHIFT

Remove sealed beam.

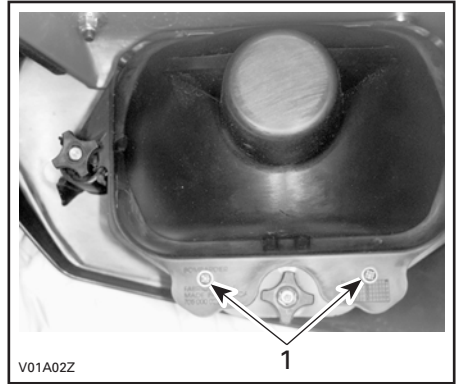

1. Remove screws and lift up the sealed beam cover

Properly reinstall removed parts in the reverse order of their removal.

Adjust beam aiming as follows:

Turn knobs to adjust beam height and side orientation to your convenience. Adjust both headlights evenly.

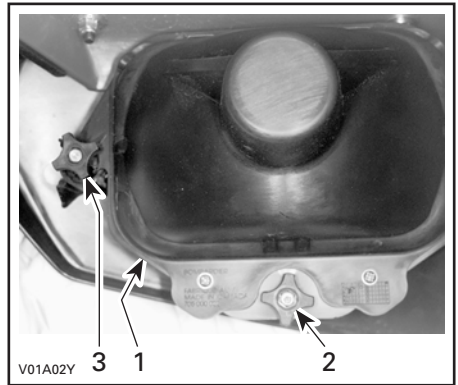

1. Headlight
2. Beam height adjustment
3. Beam side adjustment

FOOTSHIFT Models

CAUTION: Never touch glass portion of an halogen bulb with bare fingers, it shortens its operating life. If glass is touched, clean it with isopropyl alcohol which will not leave a film on the bulb.

Unplug connector from headlight.

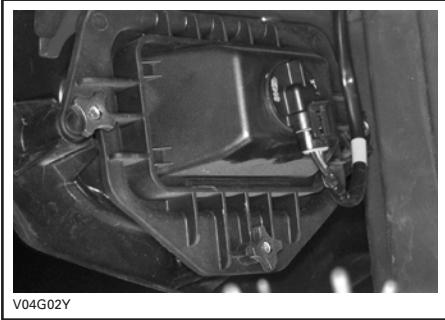

Rotate the bulb socket counterclockwise then remove headlight.

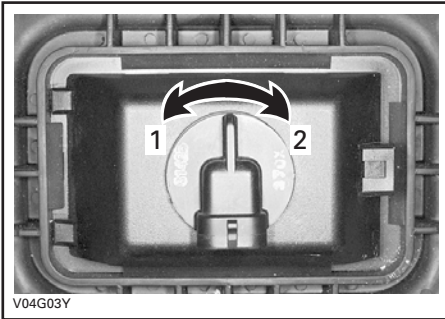

1. Unlock
2. Lock

Properly reinstall removed parts in the reverse order of their removal.

Adjust beam aiming as follows:

Turn knobs to adjust beam height and side orientation to your convenience. Adjust both headlights evenly.

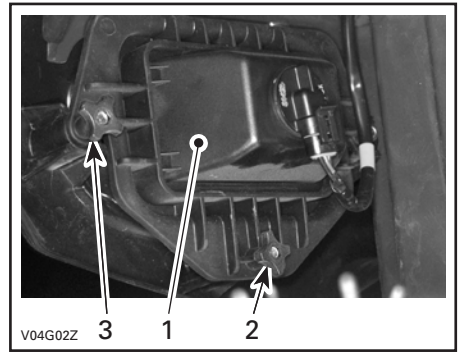

1. Headlight cover
2. Beam height adjustment
3. Beam side adjustment

Taillight Bulb Replacement

Unscrew lens screws to expose bulb. Push bulb in and hold while turning counterclockwise to release.

Install the new bulb by first pushing in while turning clockwise.

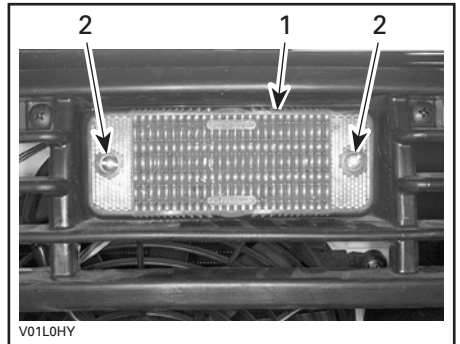

1. Lens
2. Screws

Indicator Light Replacement (if so equipped)

If one LED is burnt in the indicator light cluster, see an authorized Bombardier ATV dealer for replacement of the light cluster.

Speedometer Bulbs (if so equipped)

Each bulb can be replaced individually. Proceed as follows:

Remove the screw on each side of the steering cover.

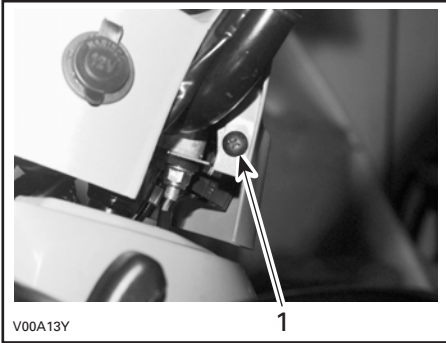

1. One screw on each side

Pull up the steering cover.

Remove the two nuts under speedometer and unplug the connector.

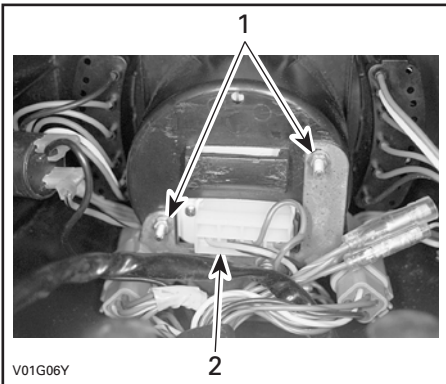

1. Remove the two nuts
2. Unplug the connector

Using a small screwdriver, pry cap out to expose bulb socket.

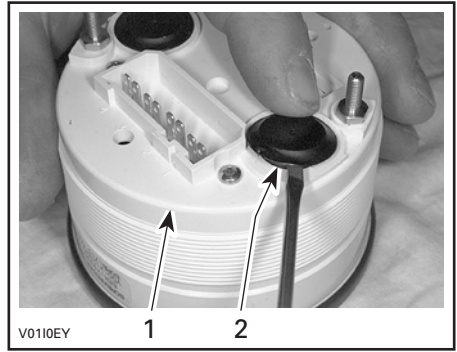

1. Speedometer
2. Pry cap out

Insert a small screwdriver in socket slot and turn counterclockwise until stopped.

Use small long nose pliers to pull bulb out or carefully pry out using a small screwdriver.

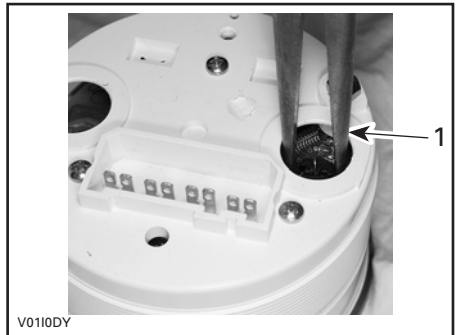

1. Pull bulb out

Reinstall new bulb using long nose pliers. Turn bulb socket clockwise to lock.

Drive Train

Drive Shaft Boot/Protector

Inspection

Visually inspect drive shaft protectors and boot conditions. Check protectors for damage or rubbing against shafts. Check boots for cracks, tears, leaking grease etc. Repair or replace damaged parts as necessary.

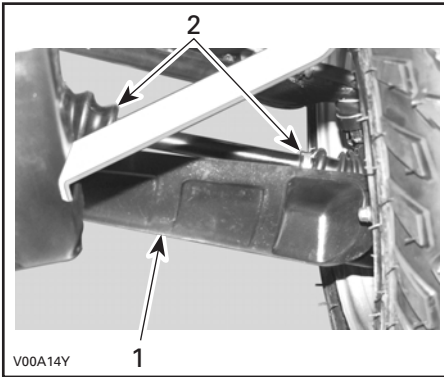

1. Drive shaft protector
2. Drive shaft boots

Wheel

Occasionally, wheel nuts should be removed to apply anti-seize lubricant on studs to ease further removal. This is particularly important when vehicle is used in salt-water environment or in mud. Remove one nut at a time, lubricate then retorquer.

Wheel Bearing Condition

Push and pull the wheels from the upper edge to feel the play. See an authorized Bombardier ATV dealer if there is any play.



Tires/Wheels

Tire Pressure

⚠ WARNING

Tire pressure greatly affects vehicle handling and stability. Under-pressure may cause tire to deflate and rotate on wheel. Overpressure may burst the tire. Always follow recommended pressure. Since tires are low-pressure types, a manual pump should be used.

Check pressure when tires are "cold" before using the vehicle. Tire pressure changes with temperature and altitude. Recheck pressure if one of these conditions has changed.

For your convenience, a pressure gauge is supplied in tool box.

TIRE PRESSURE		
ALL MODELS (except XL and XT)		
	FRONT	REAR
RECOMMENDED	38 kPa (5.5 PSI)	35 kPa (5 PSI)
MINIMUM	35 kPa (5 PSI)	31 kPa (4.5 PSI)
XL		
	FRONT	REAR
RECOMMENDED	48 kPa (7 PSI)	48 kPa (7 PSI)
MINIMUM	45 kPa (6.5 PSI)	45 kPa (6.5 PSI)
XT		
	FRONT	REAR
RECOMMENDED	35 kPa (5 PSI)	38 kPa (5.5 PSI)
MINIMUM	31 kPa (4.5 PSI)	35 kPa (5 PSI)

Although the tires are specifically designed for off-road use, a flat may still occur. Therefore, it is recommended to carry a tire pump and a repair kit.

Tire/Wheel Condition

Check tire for damage and wear. Replace if necessary.

Do not make a tire rotation. The front and rear tires have a different size. The tires are directional and their rotation must be kept in a specific direction for proper operation.

Wheel Removal

Loosen nuts then lift vehicle. Place a support under vehicle. Remove nuts then remove wheel.

At installation, it is recommended to apply anti-seize lubricant on threads. Gently tighten nuts in a criss-cross sequence then apply a final torque of 75 N•m (55 lbf•ft).

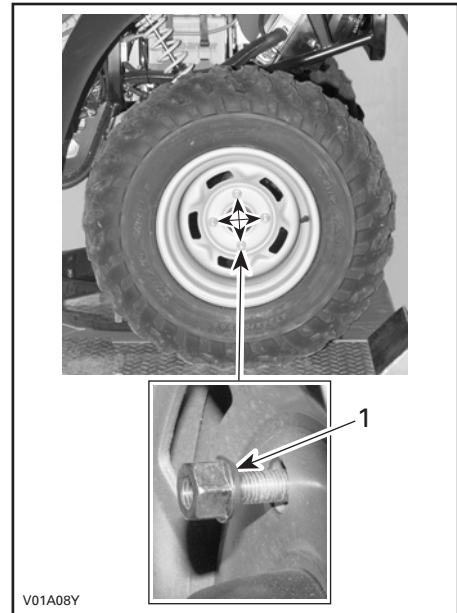

1. Taper side of nut

Steering/Control Systems

Throttle Cable Lubrication

The throttle cable must be lubricated with Bombardier cable lubricant (P/N 293 600 041) or an equivalent with the same characteristics.

Open the throttle lever housing.

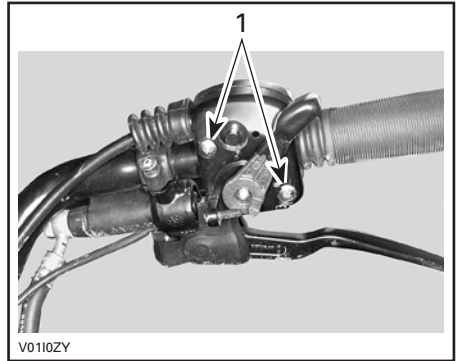

1. Remove screws

Remove:

- the cable from the throttle lever

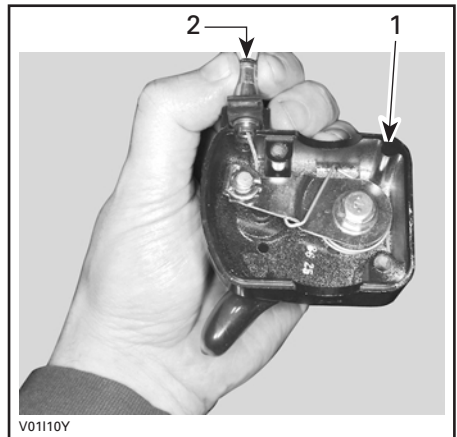

1. Throttle handle housing
2. Throttle cable

NOTE: Slide cable in clip slot and remove the end of cable from clip.

- the seal on the throttle cable.

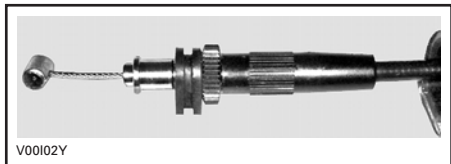

Remove the carburetor side cover.
Install the cable lube (P/N 529 035 738) on the cable.



Insert the needle of lubricant can on the cable lube hole.

⚠ WARNING
Always wear eye protection and gloves when you lubricate a cable.

NOTE: Place a rag around the cable lube to prevent the lubricant splash.

Put the lubricant until it passes through the cable.

Reinstall the cable and close the housing.

Suspension

A-Arms Lubrication

Lubricate front A-arms. Use synthetic grease (P/N 293 550 010). There is two grease fittings on the upper A-arm and two on the lower A-arm (underneath).

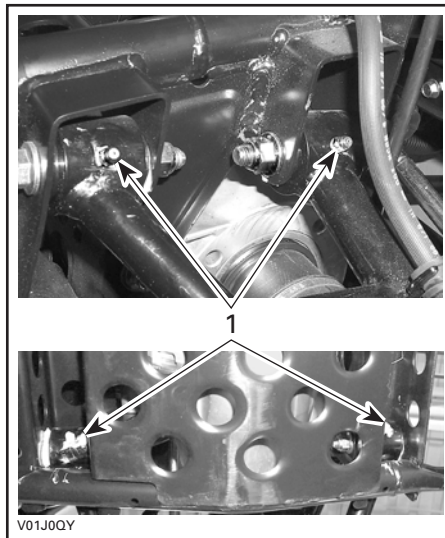

1. Grease fittings

Inspection

Inspect shock absorber for oil leaks and fasteners for tightness. See an authorized Bombardier ATV dealer as necessary.

Adjustment

Rear Shocks

⚠ WARNING
Left and right adjusting cams must always be set at the same position. Never adjust one adjusting cam only. Uneven adjustment can cause poor handling and loss of stability, which could lead to an accident.

Preload Adjustment

Adjust spring preload by turning adjusting cam accordingly with the adjusting wrench in vehicle tool box.

Turn the adjusting cams clockwise for a firmer ride and rough road condition or when carrying cargo or pulling a trailer.

Turn the adjusting cams counterclockwise for a light load and a smooth road condition.

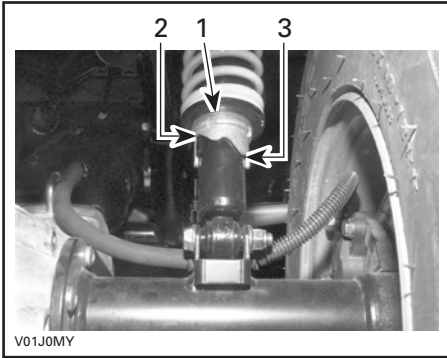

1. *Adjusting cams*
2. *Smooth adjustment*
3. *Hard adjustment*

Brake

Front Brake

The front brakes are hydraulic disc types. These brakes are self-adjusting and require no adjustment.

Rear Brake

The rear brake employs two systems. The first system used a cable, an adjustment is necessary, see an authorized Bombardier ATV dealer. The second system is hydraulic and require no adjustment. The systems are linked together for an higher efficiency.

Brake Cable Lubrication

Remove brake lever and lock (screw, nut and spring).

Remove cable from hand lever. To ease this operation, apply a force on the brake pedal to loosen the cable.

Put the cable luber (P/N 529 035 738) on the cable.

Insert the needle of the spray can in the hole.

Spray a small quantity of silicone lubricant (P/N 293 600 041) then press the brake pedal to move the brake cable. Repeat this procedure until the silicone lubricant exits the other end of the cable.

Body/Frame

Engine Compartment

Check engine compartment for any damage and leaks. Ensure all hose clamps are properly secured and no hose is cracked, kinked or otherwise damaged.

Inspect muffler, battery and reservoir fastening devices. Check electrical connections for corrosion and tightness.

Replace or have damaged parts repaired.

Skid Plate Condition

Check tightness of fasteners and condition of plate for cracks or other damage. Properly retighten fasteners as necessary and have skid plate replaced if damaged.

Hitch/Trailer Ball Condition

Check tightness of fasteners and tightness/condition of trailer ball. Properly retighten as necessary and replace ball if worn.

Fasteners

Check fastener condition and tightness on the vehicle. Retighten as required.

Seat Latch

Remove seat and check latch mechanism and pin for wear. See an authorized Bombardier ATV dealer for parts replacement if damaged.

Front Storage Compartment Latch

Check latch condition. See an authorized Bombardier ATV dealer for parts replacement if damaged.

Vehicle Cleaning and Protection

Painted parts which are damaged should be properly repainted to prevent rust.

When required, wash the body with hot water and soap (only use mild detergent). Apply non-abrasive wax.

CAUTION: Never clean plastic parts with strong detergent, degreasing agent, paint thinner, acetone, etc.

Winch

No lubrication is required for the life of the winch.

Check battery cables at 90 day intervals to be certain that they are clean and tight at all connections.

Inspect the wire rope before and after each winching operation. Replace winch rope when damaged.

For more details, see ATV Winch Operator's Manual.

NOTE: This manual should be kept in the tool box and remain with the vehicle at all time.

Rear Cargo Box

Check release lever and its mechanism for bend, cracks or other damages.

Lift up rear cargo box and check latches mechanism and pins for wear.

Check gate latches condition. See an authorized Bombardier ATV dealer for parts replacement if damaged.

CARGO AND TRANSPORTATION

While reading this *Operator's Guide*, remember that:

WARNING

Indicates a potential hazard that could result in serious injury or death.

Cargo

WARNING

The vehicle handling, stability and braking distance are affected when loading racks and using the vehicle. Correct loading and weight distribution are therefore important. Never overload, tow or carry cargo improperly. Always ensure the cargo is safely secured and properly distributed on the rack(s) or in the rear cargo box before operating the vehicle. Safely reduce speed when carrying cargo or pulling a trailer. Allow greater distance for braking. Always secure cargo as low as possible on the rack(s) or in the rear cargo box to reduce the effect of a higher center of gravity. Failure to follow the recommendations here could cause changes in vehicle handling which could lead to an accident resulting in severe injuries including the possibility of death. For more information, see the *Safety Handbook*.

When cargoing vehicle, respect these maximum loads.

All Models except XL

TOTAL LOAD ALLOWED:

220 kg (485 lb)

(includes driver, all other loads and added accessories)

80 kg (175 lb)

Includes rear rack and tongue load

40 kg (90 lb)

Includes front rack and storage compartment



V01L0VZ

XL Models

TOTAL LOAD ALLOWED:
364 kg (800 lb)
(includes driver, all other loads and added accessories)

40 kg (90 lb)
Includes front rack and storage compartment

273 kg (600 lb)
Includes rear cargo box and tongue load



13.6 kg (30 lb)
Includes both lateral compartments

V03L07Y

Secure Material in Rear Cargo Box

When carrying material in rear cargo box, it is highly recommended to secure the material properly. See the following illustration for the safety locations.

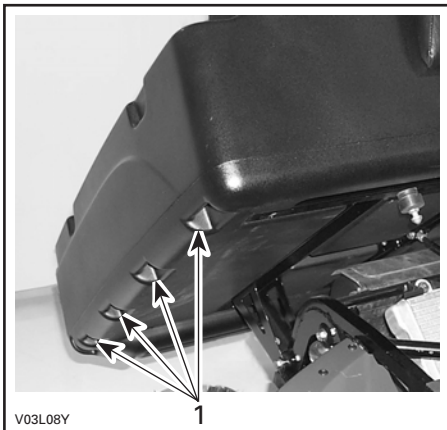

UNDER REAR CARGO BOX

1. Secure here

Transportation

When transporting a vehicle, secure vehicle to trailer with suitable tie-downs. Using ordinary ropes is not recommended.

WARNING

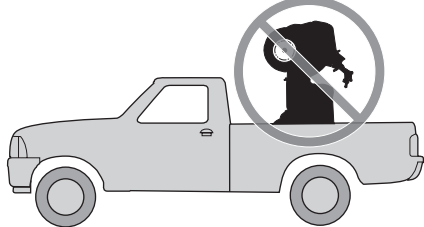

V00A174

Never tip this vehicle on end for transporting. We recommend that you carry the vehicle in its normal operating position (on all four wheels).

Place the fuel valve to OFF position.

Select the PARK position and set the parking brake.

Secure the vehicle to front by the front bumper and rear by the frame.

CAUTION: Attaching vehicle at other locations may damage the vehicle.

Front Location

All Models



TYPICAL

Rear Location

All Models except XL

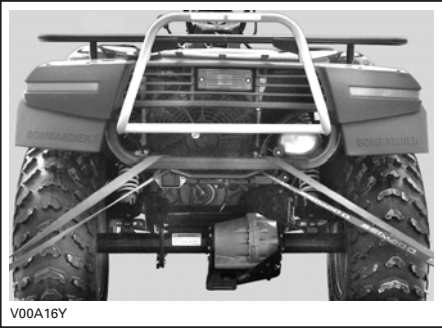

XL Models



V03L0GY

 **WARNING**

Do not tow this vehicle behind a car or other vehicle.

TROUBLESHOOTING

SYMPTOM: <i>Engine does not turn</i>	
POSSIBLE CAUSES	WHAT TO DO
1. Ignition switch is in the OFF position.	Place switch to ON position.
2. Transmission is not set on the PARK or NEUTRAL.	Set transmission either in PARK or in NEUTRAL or use the override mode.
3. Burnt fuse.	Check MPEM supply fuse and solenoids fuse.
4. Weak battery or loose connections.	Check charging system fuse. Check connections and terminals condition. Have the battery checked. Contact an authorized Bombardier ATV dealer.
5. Engine stop switch is in OFF position (FOOTSHIFT models only).	Place switch to ON position.

SYMPTOM: <i>Engine turns over but fails to start</i>	
POSSIBLE CAUSES	WHAT TO DO
1. Burnt fuse.	Check ignition fuse condition.
2. Mixture not rich enough to start cold engine.	Check fuel tank level and check starting procedure, particularly use of the choke. NOTE: Below - 15°C (5°F) the use of fuel primer (optional) is required. Also, it is recommended to add gas line antifreeze.
3. Flooded engine (spark plugs wet when removed).	Refer to SPECIAL PROCEDURES .
4. No fuel to the engine (spark plugs dry when removed).	Check fuel tank level; turn fuel valve to ON (also try on RES). A failure of the fuel pump or carburetor may have occurred. Contact an authorized Bombardier ATV dealer.
5. Spark plug/ignition (no spark).	Check ignition fuse condition. Remove spark plugs then reconnect to spark plug caps. Check that ignition switch and/or engine stop switch(es) is/are at the ON position. Start engine with spark plugs grounded to engine away from spark plug holes. If no spark appears, replace spark plugs. If trouble persists, contact an authorized Bombardier ATV dealer.
6. Engine compression.	As the engine is pulled over with the rewind starter, "cycles" of resistance should be felt as piston goes past top dead center. If no pulsating resistance is felt, it suggests a major loss of compression. Contact an authorized Bombardier ATV dealer.

SYMPTOM: <i>Engine lacks acceleration or power</i>	
POSSIBLE CAUSES	WHAT TO DO
1. Fouled or damaged spark plug.	Check item Engine turns over but fails to start.
2. Lack of fuel to engine.	Check item Engine turns over but fails to start.
3. Carburetor adjustments.	Contact an authorized Bombardier ATV dealer.
4. Engine is overheating.	Check Engine Overheat in SPECIAL PROCEDURES . If overheating persists, contact an authorized Bombardier ATV dealer.
5. Air box plugged or dirty.	Check air filter and clean if necessary. Check the position of the air intake tube, reinstall properly if necessary.

SYMPTOM: <i>Engine backfire</i>	
POSSIBLE CAUSES	WHAT TO DO
1. Exhaust system leakage.	Contact an authorized Bombardier ATV dealer.
2. Engine is running too hot.	See Engine lacks acceleration or power.
3. Ignition timing is incorrect or there is an ignition system failure.	Contact an authorized Bombardier ATV dealer.
4. Improper carburetor setting.	Contact an authorized Bombardier ATV dealer.

SYMPTOM: <i>Engine misfire</i>	
POSSIBLE CAUSES	WHAT TO DO
1. Fouled/damaged/worn spark plugs.	Clean/verify spark plugs and heat range. Replace as required.
2. Water in fuel.	Drain fuel system and refill with fresh fuel.

SYMPTOM: <i>Vehicle cannot reach full speed</i>	
POSSIBLE CAUSES	WHAT TO DO
1. Engine.	See Engine lacks acceleration or power.
2. Parking brake.	Ensure brake lever lock is completely removed.
3. Air box plugged or dirty.	Check air filter and clean if necessary. Check the position of the air intake tube, reinstall properly if necessary.

SYMPTOM: <i>Engine indicator light irregularly flashes at idle speed</i>	
POSSIBLE CAUSES	WHAT TO DO
1. Engine idle is set too low.	Contact an authorized Bombardier ATV dealer.

SYMPTOM: *Transmission does not shift smoothly*

POSSIBLE CAUSES	WHAT TO DO
1. Engine/transmission oil level is low.	Refill engine with recommended oil at the proper level.
2. Transmission shifting system.	Try depressing the throttle lever more while shifting.
3. Improper oil type.	Drain oil in engine and use recommended oil only.
4. Transmission.	See an authorized Bombardier ATV dealer.

SYMPTOM: *Transmission lever is hard to move*

POSSIBLE CAUSES	WHAT TO DO
1. Transmission gears are in a position that prevents the transmission lever to work.	Rock the vehicle back and forth to move the gears in the transmission and allow the transmission lever to be set.
2. Engine idle speed is set too high.	Adjust the idle speed. Refer to the specification.

SYMPTOM: *Automatic mode does not work*

POSSIBLE CAUSES	WHAT TO DO
1. Multi-function switch problem.	Contact an authorized Bombardier ATV dealer.
2. TPS sensor is defect.	Check TPS connector on carburetor. If the connection is good, contact an authorized Bombardier ATV dealer.
3. Engine.	Contact an authorized Bombardier ATV dealer.

SYMPTOM: *Rear cargo box does not latch properly*

POSSIBLE CAUSES	WHAT TO DO
1. Debris in locking mechanism.	Remove debris, clean locking mechanism and close rear cargo box.
2. Debris or object underneath rear cargo box.	Remove any object or debris underneath rear cargo box and close it properly.

SYMPTOM: *The RPM increases but the vehicle doesn't move*

POSSIBLE CAUSES	WHAT TO DO
1. Transmission is set on the PARK or NEUTRAL.	Move the transmission lever to R, H or L position.

SPECIFICATIONS

VEHICLE MODEL		TRAXTER	AUTOSHIFT
ENGINE			
Type		BOMBARDIER-ROTAX 511, 4 stroke. Longitudinal mount, liquid cooled, OHV	
Number of cylinder		Single cylinder	
Number of valve		2 valves with hydraulic lifters (no adjustment)	
Displacement		498 cc (30.3 cu. in)	
Bore	Standard	89 mm (3.5 in)	
Stroke		80 mm (3.15 in)	
Compression ratio		9:1	
Lubrication		Wet sump with replaceable oil filter (lubrication of engine and transmission simultaneously)	
Oil filter		BOMBARDIER-ROTAX	
Decompressor		Automatic	
Exhaust system		Nelson, stainless steel, USDA approved	
Air filter		2 stage foam filter	
TRANSMISSION			
Clutch		1 centrifugal and 1 multi-disc hydraulically controlled	
Transmission		Dual range (HI-LO) with park, neutral and reverse. 5 speeds. Electronically controlled hydraulic shift. Limited vehicle reverse speed	
COOLING			
Type		Liquid cooled	
Radiator		Rear mounted with thermostatic fan	
CARBURETION			
Carburetor make and type		Mikuni BSR33. Constant depression type with manual choke and ECS (Enricher Coating System)	
Choke plunger position		Variable	
Idle speed	± 100	1100 RPM	
Fuel pump make and type		Mikuni, external (vacuum-operated)	

VEHICLE MODEL		TRAXTER	AUTOSHIFT
ELECTRICAL			
Magneto generator make and type		Denso, 400 W @ 6000 RPM	
Ignition type		IDI (Inductive Discharge Ignition)	
Ignition timing		Not adjustable	
Engine RPM limiter		7600 RPM (any gear in forward)	
Vehicle speed limiter		15 km/h (9 MPH) in reverse	
Spark plug make and type		NGK DR8EA	
Number of spark plug		2	
Spark plug gap		0.6 to 0.7 mm (.024 to .027 in)	
Battery		12 V, 19 A (20 A, optional). Electrolyte type battery	
Starting system		Electric start and manual rewind starter. Start in any gear (with brake applied)	
Headlight		2 x 55 W, H4703	
Taillight		8/27 W, 1157	
Pilot lamp cluster		LEDS, 0.7 V approx.	
FUSES			
Ignition (no. 1)		15 A	
Accessories (no. 2)		15 A (power outlet and auxiliary supply)	
Solenoids (no. 3)		15 A	
Fan (no. 4)		15 A	
MPEM (Multi-Purpose Electronic Module) (no. 5)		20 A	
Charging system (no. 6)		30 A	
DRIVE TRAIN			
Front differential		Shaft driven/single auto-lock differential (shear pump)	
Rear axle		Shaft driven/solid axle	
SUSPENSION			
Front	Type	Independent suspension — double A-arm	
	Travel	178 mm (7 in)	
Rear	Type	Rigid swing-arm	
	Travel	190.5 mm (7.5 in)	
TIRES			
Pressure	Front	38 kPa (5.5 PSI) recommended, 35 kPa (5 PSI) minimum	
	Rear	35 kPa (5 PSI) recommended, 31 kPa (4.5 PSI) minimum	
Size	Front	635 OD x 203 W x 305 ID mm (25 x 8 x 12 in)	
	Rear	635 OD x 254 W x 305 ID mm (25 x 10 x 12 in)	

VEHICLE MODEL		TRAXTER	AUTOSHIFT
WHEELS			
Size	Front	305 dia. x 165 W mm (12 in x 6.5 in)	
	Rear	305 dia. x 203 W mm (12 in x 8 in)	
Wheel nut torque		75 N•m (55 lbf•ft)	
BRAKES			
Front		Hydraulic, 2 discs	
Rear		Hydraulic, 1 disc	
Parking		Park through transmission. LH brake lever includes a lock	
LOADING CAPACITY			
Front rack		40 kg (90 lb) includes front storage tray	
Rear rack		80 kg (175 lb) includes tongue load	
Total vehicle load allowed		220 kg (485 lb) includes driver, all other loads and added accessories	
GVWR (Gross Vehicle Weight Rating)		540 kg (1200 lb)	
Towing capacity		500 kg (1100 lb)	
Tongue capacity		14 kg (30 lb) included with rear rack	
Front storage tray		10 kg (22 lb) included with front rack	
DIMENSIONS			
Dry mass		343 kg (755 lb)	
Overall length		2071 mm (81.5 in)	
Overall width		1194 mm (47 in)	
Overall height		1143 mm (45 in)	
Wheel base		1296 mm (51 in)	
Wheel track	Front	992 mm (39 in)	
	Rear	940 mm (37 in)	
Turning radius		2133.6 mm (84 in)	
Toe-out adjustment		17 mm ± 4 mm (43/64 in ± 5/32 in)	
Ground clearance	Front and under engine	244 mm (9.6 in)	
	Rear axle	188 mm (7.4 in)	
Weight distribution (front/rear)		49/51%	

VEHICLE MODEL		TRAXTER	AUTOSHIFT
LIQUIDS			
Oil type (engine and transmission)		SAE, 4-stroke mineral-based engine oil. API classification SH or SJ or Bombardier synthetic oil. Do not use synthetic oil, other than Bombardier brand name or synthetic blend oil. Refer to OIL VISCOSITY CHART for proper grade.	
Coolant		Ethylene-glycol/water mix (60% coolant, 40% water). Use coolant specifically designed for aluminum engines	
Fuel	Type	Regular unleaded gasoline	
	Octane	87 (R + M)/2 or higher	
Differential	Front	Synthetic polyolester oil 75W90 (API GL-5)	
	Rear	Synthetic polyolester oil 75W90 (API GL-5)	
Hydraulic brake		Brake fluid, DOT 4	
Propeller shaft joint grease		Shell, Alvania EP-2 only	
CAPACITIES			
Vehicle range		Approximately 10 hours depending on many factors such as temperature, operating conditions and load	
Fuel tank		20 L (5.7 U.S. gal) including approximately 6 L (1.6 U.S. gal) reserve	
Engine/transmission oil		Oil change with filter: 2.5 L (2.65 quarts). Total: 3 L (3.17 quarts)	
Coolant		2.5 L (2.65 quarts)	
Differential	Front	650 mL (22 U.S. oz)	
	Rear	200 mL (10 U.S. oz)	

OD = outside diameter

ID = inside diameter

dia. = diameter

W = width

OHV = overhead valve

LEDS = light-emitting diodes

Because of our ongoing commitment to product quality and innovation, Bombardier reserves the right, at any time, to make changes in design and specifications and/or to make additions to, or improvements in its products without imposing any obligation upon itself to install them on its products previously manufactured.

VEHICLE MODEL		XT	XL
ENGINE			
Type		BOMBARDIER-ROTAX 511, 4 stroke. Longitudinal mount, liquid cooled, OHV	
Number of cylinder		Single cylinder	
Number of valve		2 valves with hydraulic lifters (no adjustment)	
Displacement		498 cc (30.3 cu. in)	
Bore	Standard	89 mm (3.5 in)	
Stroke		80 mm (3.15 in)	
Compression ratio		9:1	
Lubrication		Wet sump with replaceable oil filter (lubrication of engine and transmission simultaneously)	
Oil filter		BOMBARDIER-ROTAX	
Decompressor		Automatic	
Exhaust system		Nelson, stainless steel, USDA approved	
Air filter		2 stage foam filter	Cleanable synthetic panelette
TRANSMISSION			
Clutch		1 centrifugal and 1 multi-disc hydraulically controlled	
Transmission		Dual range (HI-LO) with park, neutral and reverse. 5 speeds. Electronically controlled hydraulic shift. Limited vehicle reverse speed	
COOLING			
Type		Liquid cooled	
Radiator		Rear mounted with thermostatic fan	
CARBURETION			
Carburetor make and type		Mikuni BSR33. Constant depression type with manual choke and ECS (Enricher Coating System)	
Choke plunger position		Variable	
Idle speed	± 100	1100 RPM	
Fuel pump make and type		Mikuni, external (vacuum-operated)	

VEHICLE MODEL		XT	XL
ELECTRICAL			
Magneto generator make and type	Denso, 400 W @ 6000 RPM		
Ignition type	IDI (Inductive Discharge Ignition)		
Ignition timing	Not adjustable		
Engine RPM limiter	7600 RPM (any gear in forward)		
Vehicle speed limiter	15 km/h (9 MPH) in reverse		
Spark plug make and type	NGK DR8EA		
Number of spark plug	2		
Spark plug gap	0.6 to 0.7 mm (.024 to .027 in)		
Battery	12 V, 19 A (20 A, optional). Electrolyte type battery		
Starting system	Electric start and manual rewind starter. Start in any gear (with brake applied)		
Headlight	2 x 55 W, H4703		
Taillight	8/27 W, 1157		
Pilot lamp cluster	LEDS, 0.7 V approx.		
FUSES			
Ignition (no. 1)	15 A		
Accessories (no. 2)	15 A (power outlet and auxiliary supply)		
Solenoids (no. 3)	15 A		
Fan (no. 4)	15 A		
MPEM (Multi-Purpose Electronic Module) (no. 5)	20 A		
Charging system (no. 6)	30 A		
DRIVE TRAIN			
Front differential	Shaft driven/single auto-lock differential (shear pump)		
Rear axle	Shaft driven/solid axle		
SUSPENSION			
Front	Type	Independent suspension — double A-arm	
	Travel	178 mm (7 in)	
Rear	Type	Rigid swing-arm	
	Travel	190.5 mm (7.5 in)	101.6 mm (4 in)

VEHICLE MODEL		XT	XL
TIRES			
Pressure	Front	35 kPa (5 PSI) recommended, 31 kPa (4.5 PSI) minimum	48 kPa (7 PSI) recommended, 45 kPa (6.5 PSI) minimum
	Rear	38 kPa (5.5 PSI) recommended, 35 kPa (5 PSI) minimum	48 kPa (7 PSI) recommended, 45 kPa (6.5 PSI) minimum
Size	Front	660 OD x 203 W x 305 ID mm (26 x 8 x 12 in)	635 OD x 203 W x 305 ID mm (25 x 8 x 12 in)
	Rear	660 OD x 254 W x 305 ID mm (26 x 10 x 12 in)	635 OD x 254 W x 305 ID mm (25 x 10 x 12 in)
WHEELS			
Size	Front	305 dia. x 165 W mm (12 in x 6.5 in)	
	Rear	305 dia. x 203 W mm (12 in x 8 in)	
Wheel nut torque		75 N•m (55 lbf•ft)	
BRAKES			
Front		Hydraulic, 2 discs	
Rear		Hydraulic, 1 disc	
Parking		Park through transmission. LH brake lever includes a lock	
LOADING CAPACITY			
Front rack		40 kg (90 lb) includes front storage tray	
Rear rack		80 kg (175 lb) includes tongue load	Not applicable
Rear cargo box		Not applicable	272 kg (600 lb) includes tongue load
Lateral compartment		Not applicable	6.8 kg (15 lb), each compartment
Total vehicle load allowed		220 kg (485 lb) includes driver, all other loads and added accessories	363 kg (800 lb) includes driver, all other loads and added accessories
GVWR (Gross Vehicle Weight Rating)		540 kg (1200 lb)	750 kg (1650 lb)
Towing capacity		500 kg (1100 lb)	
Tongue capacity		14 kg (30 lb) included with rear rack	14 kg (30 lb) included with rear cargo box
Front storage tray		10 kg (22 lb) included with front rack	

VEHICLE MODEL		XT	XL
DIMENSIONS			
Dry mass		361 kg (795 lb)	386 kg (850 lb)
Overall length		2116 mm (83.3 in)	2490 mm (98 in)
Overall width		1270 mm (50 in)	1207 mm (47-1/2 in)
Overall height		1143 mm (45 in)	1175 mm (46-1/4 in)
Wheel base		1296 mm (51 in)	1553 mm (61 in)
Wheel track	Front	992 mm (39 in)	
	Rear	940 mm (37 in)	
Turning radius		2209.8 mm (87 in)	2514.6 mm (99 in)
Toe-out adjustment		17 mm ± 4 mm (43/64 in ± 5/32 in)	
Ground clearance	Front and under engine	244 mm (9.6 in)	
	Rear axle	188 mm (7.4 in)	
Weight distribution (front/rear)		49/51 %	50/50 %
LIQUIDS			
Oil type (engine and transmission)		SAE, 4-stroke mineral-based engine oil. API classification SH or SJ or Bombardier synthetic oil. Do not use synthetic oil, other than Bombardier brand name or synthetic blend oil. Refer to OIL VISCOSITY CHART for proper grade.	
Coolant		Ethylene-glycol/water mix (60% coolant, 40% water). Use coolant specifically designed for aluminum engines	
Fuel	Type	Regular unleaded gasoline	
	Octane	87 (R + M)/2 or higher	
Differential	Front	Synthetic polyolester oil 75W90 (API GL-5)	
	Rear	Synthetic polyolester oil 75W90 (API GL-5)	
Hydraulic brake		Brake fluid, DOT 4	
Propeller shaft joint grease		Shell, Alvania EP-2 only	
CAPACITIES			
Vehicle range		Approximately 10 hours depending on many factors such as temperature, operating conditions and load	
Fuel tank		20 L (5.7 U.S. gal) including approximately 6 L (1.6 U.S. gal) reserve	
Engine/transmission oil		Oil change with filter: 2.5 L (2.65 quarts). Total: 3 L (3.17 quarts)	
Coolant		2.5 L (2.65 quarts)	
Differential	Front	650 mL (22 U.S. oz)	
	Rear	200 mL (10 U.S. oz)	

OD = outside diameter
ID = inside diameter
dia. = diameter

W = width
OHV = overhead valve
LEDS = light-emitting diodes

Because of our ongoing commitment to product quality and innovation, Bombardier reserves the right, at any time, to make changes in design and specifications and/or to make additions to, or improvements in its products without imposing any obligation upon itself to install them on its products previously manufactured.

VEHICLE MODEL		FOOTSHIFT	
ENGINE			
Type		BOMBARDIER-ROTAX 511, 4 stroke. Longitudinal mount, liquid cooled, OHV	
Number of cylinder		Single cylinder	
Number of valve		2 valves with hydraulic lifters (no adjustment)	
Displacement		498 cc (30.3 cu. in)	
Bore	Standard	89 mm (3.5 in)	
Stroke		80 mm (3.15 in)	
Compression ratio		9:1	
Lubrication		Wet sump with replaceable oil filter (lubrication of engine and transmission simultaneously)	
Oil filter		BOMBARDIER-ROTAX	
Decompressor		Automatic	
Exhaust system		Nelson, stainless steel, USDA approved	
Air filter		2 stage foam filter	
TRANSMISSION			
Clutch		1 centrifugal and 1 multi-disc hydraulically controlled	
Transmission		Dual range (HI-LO) with park, neutral and reverse. 5 speeds. Limited vehicle reverse speed	
COOLING			
Type		Liquid cooled	
Radiator		Rear mounted with thermostatic fan	
CARBURETION			
Carburetor make and type		Mikuni BSR33. Constant depression type with manual choke and ECS (Enricher Coating System)	
Choke plunger position		Variable	
Idle speed	± 100	1100 RPM	
Fuel pump make and type		Mikuni, external (vacuum-operated)	

VEHICLE MODEL		FOOTSHIFT
ELECTRICAL		
Magneto generator make and type	Denso, 400 W @ 6000 RPM	
Ignition type	IDI (Inductive Discharge Ignition)	
Ignition timing	Not adjustable	
Engine RPM limiter	7600 RPM (any gear in forward)	
Vehicle speed limiter	15 km/h (9 MPH) in reverse	
Spark plug make and type	NGK DR8EA	
Number of spark plug	2	
Spark plug gap	0.6 to 0.7 mm (.024 to .027 in)	
Battery	12 V, 19 A (20 A, optional). Electrolyte type battery	
Starting system	Electric start and manual rewind starter. Start in any gear (with brake applied)	
Headlight	2 x 55 W, H4703	
Taillight	8/27 W, 1157	
Pilot lamp cluster	LEDS, 0.7 V approx.	
FUSES		
Ignition (no. 1)	15 A	
Accessories (no. 2)	15 A (power outlet and auxiliary supply)	
Clutch solenoid (no. 3)	15 A	
Fan (no. 4)	15 A	
MPEM (Multi-Purpose Electronic Module) (no. 5)	20 A	
Charging system (no. 6)	30 A	
DRIVE TRAIN		
Front differential	Shaft driven/single auto-lock differential (shear pump)	
Rear axle	Shaft driven/solid axle	
SUSPENSION		
Front	Type	Independent suspension — double A-arm
	Travel	178 mm (7 in)
Rear	Type	Rigid swing-arm
	Travel	190.5 mm (7.5 in)
TIRES		
Pressure	Front	38 kPa (5.5 PSI) recommended, 35 kPa (5 PSI) minimum
	Rear	35 kPa (5 PSI) recommended, 31 kPa (4.5 PSI) minimum
Size	Front	635 OD x 203 W x 305 ID mm (25 x 8 x 12 in)
	Rear	635 OD x 254 W x 305 ID mm (25 x 10 x 12 in)

VEHICLE MODEL		FOOTSHIFT
WHEELS		
Size	Front	305 dia. x 165 W mm (12 in x 6.5 in)
	Rear	305 dia. x 203 W mm (12 in x 8 in)
Wheel nut torque		75 N•m (55 lbf•ft)
BRAKES		
Front		Hydraulic, 2 discs
Rear		Hydraulic, 1 disc
Parking		Park through transmission. LH brake lever includes a lock
LOADING CAPACITY		
Front rack		40 kg (90 lb) includes front storage tray
Rear rack		80 kg (175 lb) includes tongue load
Total vehicle load allowed		220 kg (485 lb) includes driver, all other loads and added accessories
GVWR (Gross Vehicle Weight Rating)		540 kg (1200 lb)
Towing capacity		500 kg (1100 lb)
Tongue capacity		14 kg (30 lb) included with rear rack
Front storage tray		10 kg (22 lb) included with front rack
DIMENSIONS		
Dry mass		343 kg (755 lb)
Overall length		2071 mm (81.5 in)
Overall width		1194 mm (47 in)
Overall height		1143 mm (45 in)
Wheel base		1296 mm (51 in)
Wheel track	Front	992 mm (39 in)
	Rear	940 mm (37 in)
Turning radius		2133.6 mm (84 in)
Toe-out adjustment		17 mm ± 4 mm (43/64 in ± 5/32 in)
Ground clearance	Front and under engine	244 mm (9.6 in)
	Rear axle	188 mm (7.4 in)
Weight distribution (front/rear)		49/51%

VEHICLE MODEL		FOOTSHIFT
LIQUIDS		
Oil type (engine and transmission)		SAE, 4-stroke mineral-based engine oil. API classification SH or SJ or Bombardier synthetic oil. Do not use synthetic oil, other than Bombardier brand name or synthetic blend oil. Refer to OIL VISCOSITY CHART for proper grade
Coolant		Ethylene-glycol/water mix (60% coolant, 40% water). Use coolant specifically designed for aluminum engines
Fuel	Type	Regular unleaded gasoline
	Octane	87 (R + M)/2 or higher
Differential	Front	Synthetic polyolester oil 75W90 (API GL-5)
	Rear	Synthetic polyolester oil 75W90 (API GL-5)
Hydraulic brake		Brake fluid, DOT 4
Propeller shaft joint grease		Shell, Alvania EP-2 only
CAPACITIES		
Vehicle range		Approximately 10 hours depending on many factors such as temperature, operating conditions and load
Fuel tank		20 L (5.7 U.S. gal) including approximately 6 L (1.6 U.S. gal) reserve
Engine/transmission oil		Oil change with filter: 2.5 L (2.65 quarts). Total: 3 L (3.17 quarts)
Coolant		2.5 L (2.65 quarts)
Differential	Front	650 mL (22 U.S. oz)
	Rear	200 mL (10 U.S. oz)

OD = outside diameter

ID = inside diameter

dia. = diameter

W = width

OHV = overhead valve

LEDS = light-emitting diodes

Because of our ongoing commitment to product quality and innovation, Bombardier reserves the right, at any time, to make changes in design and specifications and/or to make additions to, or improvements in its products without imposing any obligation upon itself to install them on its products previously manufactured.

SI* METRIC INFORMATION GUIDE

BASE UNITS

DESCRIPTION	UNIT	SYMBOL
length	meter	m
mass	kilogram	kg
force	newton	N
liquid	liter	L
temperature	Celsius	°C
pressure	kilo pascal	kPa
torque	newton-meter	N•m
land velocity	kilometer per hour	km/h

PREFIXES

PREFIX	SYMBOL	MEANING	VALUE
kilo	k	one thousand	1000
centi	c	one hundredth of	0.01
milli	m	one thousandth of	0.001
micro	μ	one millionth of	0.000001

CONVERSION FACTORS

TO CONVERT	TO ①	MULTIPLY BY
in	mm	25.4
in	cm	2.54
in ²	cm ²	6.45
in ³	cm ³	16.39
ft	m	0.3
oz	g	28.35
lb	kg	0.45
lbf	N	4.4
lbf•in	N•m	0.11
lbf•ft	N•m	1.36
lbf•ft	lbf•in	12
PSI	kPa	6.89
imp. oz	U.S. oz	0.96
imp. oz	mL	28.41
imp. gal	U.S. gal	1.2
imp. gal	L	4.55
U.S. oz	mL	29.57
U.S. gal	L	3.79
MPH	km/h	1.61
Fahrenheit	Celsius	(°F - 32) ÷ 1.8
Celsius	Fahrenheit	(°C x 1.8) + 32
hp	kW75

* The international system of units abbreviates SI in all languages.

① To obtain the reverse sequence, divide by the given factor. To convert **milli-meters to inches**, divide by 25.4.

NOTE: Conversion factors are rounded off to 2 decimals for easier use.

CHANGE OF ADDRESS/OWNERSHIP

If your address has changed, be sure to fill out and mail the card provided on this page.

Such notification is likewise necessary for your own safety even after expiration of the original warranty, since Bombardier Inc. will be in a position to contact you if correction to your ATV becomes necessary.

NOTE: This card is strictly for change of address only.



CHANGE OF ADDRESS CHANGE OF OWNERSHIP

VEHICLE IDENTIFICATION NUMBER

Model Number	Vehicle Identification Number (V.I.N.)

OLD ADDRESS:

NAME

NO. STREET APT

CITY STATE/PROVINCE ZIP/POSTAL CODE

COUNTRY

NEW ADDRESS:

NAME

NO. STREET APT

CITY STATE/PROVINCE ZIP/POSTAL CODE

COUNTRY

STOLEN UNITS

In the event that your ATV is stolen, you should notify your area's distributor warranty department of such.

Please provide your name, address, phone number, vehicle identification number and date it was stolen.

Bombardier will provide a list of stolen units to all ATV dealers on a monthly basis to aid in recovery of such units to their owners.



AFFIX
PROPER
POSTAGE

BOMBARDIER
RECREATIONAL PRODUCTS

WARRANTY DEPARTMENT
75, J.A. BOMBARDIER ST.
SHERBROOKE (QUEBEC)
CANADA J1L 1W3

ATV MODEL No. _____

VEHICLE IDENTIFICATION NUMBER (V.I.N.) _____

ENGINE IDENTIFICATION NUMBER (E.I.N.) _____

Owner: _____
NAME

No. STREET APT

CITY STATE/PROVINCE ZIP/POSTAL CODE

Purchase Date _____
YEAR MONTH DAY

Warranty Expiry Date _____
YEAR MONTH DAY

To be completed by the dealer at the time of the sale.

DEALER IMPRINT AREA

Please verify with your selling dealer to ensure your ATV has been registered with Bombardier.

 **WARNING**

Indicates a potential hazard that could result in serious injury or death.



BOMBARDIER
RECREATIONAL PRODUCTS

 **WARNING**

THIS VEHICLE CAN BE HAZARDOUS TO OPERATE.

A collision or rollover can occur quickly, even during routine manoeuvres such as turning and driving on hills or over obstacles, if you fail to take proper precautions.

SEVERE INJURY OR DEATH can result if you do not follow these instructions:

- **BEFORE YOU OPERATE THIS ATV, READ THE OPERATOR'S GUIDE, THE SAFETY HANDBOOK AND ALL LABELS.**
- **NEVER OPERATE THIS ATV, WITHOUT PROPER INSTRUCTION.** Beginners should complete a certified training course.
- **NEVER CARRY A PASSENGER.** You increase your risk of losing control if you carry a passenger.
- **NEVER OPERATE THIS ATV ON A PAVED SURFACE.** You increase your risk of losing control if you operate this ATV on pavement.
- **NEVER OPERATE THIS ATV ON PUBLIC ROADS.** You can collide with another vehicle if you operate this ATV on a public road.
- **ALWAYS WEAR AN APPROVED HELMET,** eye protection, and protective clothing.
- **NEVER CONSUME ALCOHOL OR DRUGS** before or while operating this vehicle.
- **NEVER OPERATE THIS ATV AT EXCESSIVE SPEEDS.** You increase your risk of losing control if you operate this ATV at speeds too fast for the terrain, visibility conditions, or your experience.
- **NEVER ATTEMPT WHEELIES, JUMPS, OR OTHER STUNTS.**

