



# SEA-DOO® 2003

Operator's **LRV**  
Guide



## WARNING

Read this guide thoroughly.  
It contains important safety information.



2 1 9 0 0 0 2 5 6

## **SAFETY WARNING**

Disregarding any of the safety precautions and instructions contained in this *Operator's Guide*, the *Safety Handbook*, the *Safety Videocassette* and on the on-product Warning Labels could cause injury, including the possibility of death. The operator has the responsibility to inform passenger(s) of safety precautions.

This *Operator's Guide*, the *Safety Handbook* and *Safety Videocassette* should remain with the craft at the time of resale.

**BOMBARDIER**  
*RECREATIONAL PRODUCTS*



Knight's Spray-Nine<sup>†</sup> is a trademark of Korkay System Ltd  
GTX<sup>†</sup> is a trademark of Castrol Ltd. Used under license

**The following trademarks are the property of Bombardier Inc. or its subsidiaries:**

SEA-DOO®

BOMBARDIER-ROTAX®

BOMBARDIER LUBE®

BOMBARDIER-ROTAX Formula XP-S Synthetic Injection Oil

BOMBARDIER Formula XP-S DI Synthetic Injection Oil

BOMBARDIER-ROTAX Injection Oil

Sea-Doo Synthetic Grease

Sea-Doo LK™

Rotax®

## **Doin'it on your new Sea-Doo watercraft**

Congratulations, you are now the proud owner of a Sea-Doo personal watercraft. Whether you are an experienced boater or are new to the sport of boating, we ask you to take the time to view the *Safety Videocassette* provided with the watercraft, to read this *Operator's Guide*, the *Safety Handbook* and on-product warning/caution labels and familiarize yourself with the contents. These manuals contain pertinent information which, if followed, will provide you with the necessary knowledge to help you fully enjoy the pleasures of this watercraft.

We strongly recommend that all watercraft operators complete a safety boating course. Check with your local Coast Guard or Power and Sail Squadron in your area for course availability. More serious boaters may want to obtain *Chapman Piloting* by Elbert S. Maloney, available at most book stores.

When introducing your family or friends to the sport, be sure they fully understand the controls and operation of the watercraft and the importance of courteous, responsible riding.

Each operator has a responsibility to ensure the safety of his/her passenger(s) and of other water users. Please follow all safety instructions and operate your craft with care.

We encourage you to have an Annual Safety Inspection of your watercraft. Please contact your dealer for further details.

Finally, we urge you to visit your dealer regularly for regular and safety maintenance as well as any watercraft accessories you may require.

Have fun and... Bon Voyage.

**Please keep this guide and *Safety Handbook* on board at all times. These manuals along with the *Safety Videocassette* should remain with the watercraft at time of resale.**

---

# TABLE OF CONTENTS

<b>FOREWORD .....</b>	<b>5</b>
<b>▲ SAFETY MEASURES .....</b>	<b>6</b>
General .....	6
Operation .....	6
Maintenance .....	8
<b>LIST OF DISTRIBUTORS .....</b>	<b>9</b>
<b>BOMBARDIER LIMITED WARRANTY NORTH AMERICA .....</b>	<b>10</b>
<b>BOMBARDIER LIMITED WARRANTY SOLD AND REGISTERED IN CALIFORNIA .....</b>	<b>13</b>
<b>BOMBARDIER LIMITED WARRANTY INTERNATIONAL.....</b>	<b>16</b>
<b>REGISTRATION NUMBER LOCATION .....</b>	<b>19</b>
<b>LOCATION OF THE IMPORTANT LABELS .....</b>	<b>20</b>
<b>IDENTIFICATION NUMBERS .....</b>	<b>23</b>
Hull .....	23
Engine.....	23
<b>CONTROLS, COMPONENTS AND INSTRUMENTS LOCATION .....</b>	<b>24</b>
<b>CONTROLS, COMPONENTS AND INSTRUMENTS FUNCTIONS.....</b>	<b>26</b>
1) Safety Lanyard (engine cut-off cord) .....	26
2) Handlebar .....	27
3) Throttle Lever.....	27
4) Engine Start/Stop Button .....	27
5) Shift Lever.....	27
6) Speedometer .....	28
7) Information Center Gauge/Buttons (if so equipped) .....	28
8) Glove Box.....	32
9) Fuel Tank Cap .....	32
10) Oil Injection Reservoir Cap.....	32
11) Front Storage Compartment Cover.....	32
12) Front Storage Compartment Cover Latch .....	33
13) Side Storage Compartments.....	33
14) Underseat Storage Compartments .....	33
15) Tool Kit .....	33
16) Air Intake Opening .....	33
17) Seat Strap .....	33
18) Seat Latch .....	33
19) Seat Extension Latch .....	34
20) Rear Storage Basket (if so equipped).....	34
21) Sun Deck.....	34
22) Bow and Stern Eyelets .....	35
23) Fender Cleats.....	35
24) Footboard.....	35

25) Boarding Platform .....	35
26) Boarding Step .....	35
27) Cooling System Bleed Outlet.....	36
28) Deck Drains.....	36
29) Flushing Connector.....	36
30) Bilge Drain Plugs.....	36
31) Automatic Bilge Pump .....	37
32) Jet Pump Nozzle.....	37
33) Reverse Gate .....	37
34) Jet Pump Water Intake .....	37
35) Fuses .....	37
36) Battery .....	37
<b>FUEL AND LUBRICATION .....</b>	<b>38</b>
Fueling Procedure .....	38
Recommended Fuel.....	38
Recommended Oil .....	38
Oil Injection System .....	39
<b>BREAK-IN PERIOD .....</b>	<b>40</b>
10-Hour Inspection .....	40
<b>PRE-OPERATION CHECKS .....</b>	<b>41</b>
Hull .....	42
Jet Pump Water Intake .....	42
Bilge .....	42
Battery.....	42
Fuel Tank and Oil Reservoir .....	42
Engine Compartment .....	42
Steering System.....	42
Throttle System.....	43
Shifter System.....	43
Storage Compartment Covers and Seat.....	43
Safety Lanyard and Engine Start/Stop Button .....	43
<b>OPERATING INSTRUCTIONS .....</b>	<b>44</b>
Principle of Operation.....	44
Boarding the Watercraft.....	46
Starting .....	48
Rough Water or Poor Visibility Operation.....	49
Crossing Waves .....	49
Stopping/Docking .....	49
Beaching.....	49
Shutting Off the Engine.....	49
<b>POST-OPERATION CARE.....</b>	<b>50</b>
General Care.....	50
Additional Care for Foul Water or Salt Water .....	50
Cooling System Flushing and Engine Internal Lubrication .....	50
Anticorrosion Treatment.....	52

<b>SPECIAL PROCEDURES.....</b>	<b>53</b>
Limp Home Mode .....	53
Engine Overheating .....	53
Jet Pump Water Intake and Impeller Cleaning .....	53
Capsized Watercraft .....	54
Submerged Watercraft .....	54
Water-Flooded Engine .....	55
Out of Fuel.....	55
Towing the Watercraft in Water .....	55
Low-Charge Battery Condition .....	56
<b>MAINTENANCE .....</b>	<b>57</b>
Engine Emissions Information .....	57
Lubrication .....	58
Periodic Inspection .....	59
Periodic Inspection Chart.....	60
Throttle Cable Inspection.....	62
Fuel Injection System .....	62
Fuel and Oil Filters.....	62
Steering Alignment.....	62
Vacuum Bailer Pick-Ups.....	62
Fuses.....	63
General Inspection and Cleaning .....	64
<b>TRAILERING, STORAGE AND PRE-SEASON PREPARATION.....</b>	<b>65</b>
Trailing .....	65
Storage .....	65
Pre-Season Preparation .....	69
<b>TROUBLESHOOTING .....</b>	<b>71</b>
<b>SPECIFICATIONS.....</b>	<b>75</b>
<b>SI METRIC INFORMATION .....</b>	<b>77</b>
<b>ABBREVIATIONS USED IN THIS MANUAL .....</b>	<b>78</b>
<b>PRIVACY INFORMATION .....</b>	<b>79</b>
<b>CHANGE OF ADDRESS.....</b>	<b>81</b>

---

# FOREWORD

The *Operator's Guide* and *Safety Handbook* have been prepared to acquaint the owner/operator or passenger with this personal watercraft and its various controls, maintenance and safe riding instructions. Each is indispensable for the proper use of the product, and should be kept in a waterproof bag with the watercraft at all times.

Make sure you read and understand the content of the *Operator's Guide* and *Safety Handbook*.

For any questions pertaining to the warranty and its application, consult the WARRANTY section in this guide, and/or an authorized SEA-DOO dealer.

This guide uses the following safety alert symbol in conjunction with signal words to indicate a potential personal injury hazard.

## **WARNING**

Indicates a potentially hazardous situation which, if not avoided, could result in death or serious injury.

## **CAUTION**

Indicates a potentially hazardous situation which, if not avoided, may result in minor or moderate injury. When used without the safety alert symbol , potential hazard exists for property damage only.

**NOTE:** Indicates supplementary information needed to fully complete an instruction.

Although the mere reading of such information does not eliminate the hazard, the understanding and application of the information will promote the correct use of the watercraft.

The information and components/system descriptions contained in this guide are correct at the time of writing. Bombardier Motor Corporation of America (B.M.C.A.) however, maintains a policy of continuous improvement of its products without imposing upon itself any obligation to install them on products previously manufactured.

Because of its ongoing commitment to product quality and innovation, B.M.C.A. reserves the right at any time to discontinue or change specifications, designs, features, models or equipment without incurring obligation.

The illustrations in this document show the typical construction of the different assemblies and may not represent the full detail or exact shape of the parts. However, they represent parts that have the same or similar function.

It is understood that this guide may be translated into another language. In the event of any discrepancy, the English version shall prevail.

Specifications are given in the SI metric system with the SAE U.S. equivalent in parenthesis. Where precise accuracy is not required, some conversions are rounded off for easier use.

A *Shop Manual* can be obtained for complete service, maintenance and more repair information.

---

## ⚠ SAFETY MEASURES

### General

- ⚠ To fully appreciate the pleasures, enjoyment and excitement of boating there are some basic rules that should be observed and followed by any rider. Some rules may be new to you or covered in the *Sea-Doo Safety Handbook* or *Safety Video-cassette*, others may be common sense or obvious... irrespective, we ask that you please take a few minutes of your time to read these safety instructions completely together with your safety handbook and any supplement applicable to your model before you operate your watercraft. **Failure to follow this safety information and safe boating rules could result in injury, including the possibility of death to you, your passenger(s), or other water users.**
- ⚠ Bombardier recommends not to operate a watercraft under 16 years of age.
- ⚠ Become completely familiar with the controls and operation of the watercraft before embarking on your first trip or taking on a passenger(s). If you have not had the opportunity to do so with your authorized Sea-Doo dealer, practice driving solo in a suitable area and feel the response of each control. Be fully familiar with all controls before applying throttle above idle speed. As its operator, you control and are responsible for the watercraft's safe operation.
- ⚠ Always carry the regulatory required safety items on board. Check the local regulations or consult your authorized Sea-Doo dealer.
- ⚠ Make sure that all users of the watercraft read and understand all on-product warnings.

### Operation

- ⚠ Always perform the pre-operation checks as specified in this guide.
- ⚠ Operator and passenger(s) should at all times wear a coast guard approved personal flotation device (PFD) that is suitable for personal watercraft.
- ⚠ Operator and passenger(s) should wear protective clothing. Severe internal injuries can occur if water is forced into body cavities of males or females as a result of falling into water or being near jet thrust nozzle. Wet suit bottom (or thick, tightly woven, snug fitting clothing that provides equivalent protection. Thin bike shorts for example would not be appropriate), footwear, gloves and goggles/glasses are recommended.
- ⚠ Always keep in mind that as the throttle lever is released to idle position, less directional control is available. **To turn the watercraft, both steering and throttle are necessary.**
- ⚠ Like any other craft, this watercraft has no brake. Stopping distance will vary depending on initial speed, load, wind, and water conditions. Practice stopping and docking in a safe, traffic free area to have an idea of how long it will take to stop the watercraft under varying conditions. Do not release throttle when trying to steer away from objects. You need throttle to steer. Do not use the watercraft's reverse, if so equipped, to stop.
- ⚠ Ensure that all passengers know how to swim and how to reboard the watercraft from the water.
- ⚠ The operator and passenger(s) should be properly seated and wearing an approved PFD before starting or moving the watercraft, and at all times when watercraft is in motion.



- ⚠ Do not start or operate the watercraft if someone is seated on the sun deck or swim platform, or is nearby in the water. The watercraft's jet thrust can cause injury. Always accelerate slowly.
- ⚠ To prevent accidental starting or unauthorized use, always detach the safety lanyard from the watercraft especially when swimmers are boarding or nearby, or during removal of any weeds or debris from the intake grate.
- ⚠ Never turn handlebar while someone is nearby rear of watercraft. Keep away from steering moving parts (nozzle, rudders, linkage, etc.)
- ⚠ Keep away from intake grate while engine is on. Items such as long hair, loose clothing, or PFD straps can become entangled in moving parts resulting in severe injury or drowning.
- ⚠ Ride within your limits and avoid aggressive maneuvers to reduce the risk of loss of control, ejection and collision.
- ⚠ Riding with a passenger(s) or pulling other crafts, tubes, skies or wakeboards makes the watercraft handle differently and requires greater skill. Do not overload the watercraft or take on more passengers than designated for the particular watercraft. Overloading can affect maneuverability, stability and performance.
- ⚠ Avoid adding on accessories, or equipment which may alter the configuration, balance or control of the watercraft. The watercraft may be fitted with tow eyelets which can be used to attach a ski rope. However, do not use these eyelets or the watercraft's cleats to tow a parasail. Severe injury or watercraft damage may occur.
- ⚠ In shallow water, proceed with caution and at very low speeds. Grounding or abrupt stops may result in injury. Debris may also be picked up and be thrown rearward by the jet pump onto people or property.
- ⚠ Respect no wake zones, the rights of other water users and the environment. As the "skipper" and owner of a watercraft you are responsible for damage to other crafts caused by the wake of your watercraft. Allow no one to throw refuse overboard.
- ⚠ Remember that a watercraft is not designed for night time operation.
- ⚠ Remember, gasoline fumes are inflammable and explosive. Always adhere to the fueling procedure contained in this guide and those given to you by the marina. Always verify fuel level before use and during the ride. Apply the principle of 1/3 fuel to destination, 1/3 back and 1/3 reserve fuel supply. Do not carry spare fuel or inflammable liquids in any of the storage or engine compartments.
- ⚠ Combustion engine needs air to operate; consequently this watercraft can not be totally watertight. Any maneuvers such as figure eights etc., that cause the upper deck to be under water may cause severe engine problems due to water ingestion. Refer to **SPECIAL PROCEDURES** and **Limited Warranty** contained in this guide.
- ⚠ Due to the close proximity of other racers, it is recommended that an approved personal watercraft helmet be used during racing events. Read and follow all instructions and warnings provided with the helmet.
- ⚠ Never ride after consuming drugs or alcohol or if you feel tired or ill. Operate your watercraft prudently and have fun.
- ⚠ Don't forget that all persons must assist other boaters in an emergency.



## Maintenance

- ⚠ Only perform servicing procedures which are detailed in this guide. Further assistance or information can be obtained from your authorized Sea-Doo dealer. In many instances proper tools and training is required for certain servicing or repair procedures.
- ⚠ Maintain the watercraft and equipment in top condition at all times. Adhere to the prescribed maintenance schedules. An annual inspection of the watercraft is always a good recommendation that should be followed.
- ⚠ Always use spark plug cable grounding device when removing spark plugs. Never check for engine ignition spark from an open cable and/or spark plug in the engine compartment as spark may cause fuel vapor to ignite.
- ⚠ The bilge should be kept clean of oil, water or other foreign materials.
- ⚠ Do not attempt to lift the watercraft without special equipment and training.
- ⚠ The engine and the corresponding components identified in this guide should not be utilized on product(s) other than for those they were designed. Maintenance procedures and specified tightening torque should be strictly adhered to. Never attempt repairs unless the appropriate tools are available. These watercrafts are designed with parts dimensioned in both the metric and the imperial systems. When replacing fasteners, make sure to use only those recommended by Bombardier. If required, contact your authorized Sea-Doo dealer for further servicing information.

---

# LIST OF DISTRIBUTORS

## NORTH AMERICA

<p><b>USA</b></p>  <p>(Except Puerto Rico)</p>	<p><b>BOMBARDIER MOTOR CORPORATION OF AMERICA</b> 7575 Bombardier Court WAUSAU, WI. 54401 Phone: (715) 848-4957 Fax: (715) 847-6879 www.bombardier.com</p>
<p><b>CANADA</b></p> 	<p><b>BOMBARDIER INC.</b> RECREATIONAL PRODUCTS 75 J. A. BOMBARDIER ST. SHERBROOKE, QC J1L 1W3 Phone: (819) 566-3366 Fax: (819) 566-3062 www.bombardier.com</p>

If your Sea-Doo watercraft requires warranty service, you should take it to any authorized Sea-Doo dealer. Be sure to bring your warranty registration card or other valid proof of the original date of purchase. If a question or problem arises regarding warranty, first contact the service manager or owner of the Sea-Doo dealership.

To find the nearest authorized Sea-Doo dealer, dial: 1-800-882-2900.

**NOTE:** If outside Canada or USA, consult your local authorized Sea-Doo distributor.

---

# **BOMBARDIER LIMITED WARRANTY NORTH AMERICA: SEA-DOO® WATERCRAFT**

## **1. SCOPE OF THE LIMITED WARRANTY**

In Canada, BOMBARDIER INC. (hereinafter “BOMBARDIER”), and in the USA, Bombardier on behalf of BOMBARDIER MOTOR CORPORATION OF AMERICA (BMCA) warrants its SEA-DOO watercraft from defects in material or workmanship for the period described below.

All genuine BOMBARDIER parts and accessories, installed by an authorized BOMBARDIER dealer (as hereinafter defined) at the time of delivery of the SEA-DOO watercraft, carry the same warranty as that of the watercraft.

Use of the product for racing or any other competitive activity, at any point, even by a previous owner, will render this warranty null and void.

## **2. WARRANTY COVERAGE PERIOD**

This warranty will be in effect FROM THE DATE OF DELIVERY TO THE FIRST RETAIL CONSUMER or the date the product is first put into use, whichever occurs first and for a period of:

### **a) For private use owners:**

- TWELVE (12) CONSECUTIVE MONTHS.

In the USA: SEA-DOO RX™ DI, SEA-DOO GTX† DI and SEA-DOO LRV™ DI

- TWELVE (12) CONSECUTIVE MONTHS for the emission related components providing input to emission control. (e.g. sensors).

### **b) For commercial use owners:**

- FOUR (4) CONSECUTIVE MONTHS.

In the USA: SEA-DOO RX™ DI, SEA-DOO GTX† DI and SEA-DOO LRV™ DI

- TWELVE (12) CONSECUTIVE MONTHS for the emission related components providing input to emission control. (e.g. sensors).

The repair or replacement of parts or the performance of service under this warranty does not extend the life of this warranty beyond its original expiration date.

CALIFORNIA RESIDENTS purchasing a SEA-DOO RX™ DI, a SEA-DOO GTX† DI, or a SEA-DOO LRV™ DI personal watercraft in California please also refer to the California Emissions Control Limited Warranty Statement.

## **3. CONDITIONS TO HAVE WARRANTY COVERAGE**

This warranty coverage is available only on SEA-DOO watercraft purchased as new and unused by its first owner from a BOMBARDIER dealer authorized to distribute SEA-DOO products in the country in which the sale occurred (hereinafter “BOMBARDIER dealer”), and then only after the BOMBARDIER specified pre-delivery inspection process is completed and documented. Warranty coverage only becomes available upon proper registration of the product by an authorized BOMBARDIER dealer. Such limitations are necessary in order to allow BOMBARDIER to preserve both the safety of its products, and also that of its consumers and the public.

Routine maintenance outlined in the *Operator's Guide* must be timely performed in order to maintain warranty coverage. BOMBARDIER reserves the right to make warranty coverage contingent upon proof of proper maintenance.

## **4. WHAT TO DO TO OBTAIN WARRANTY COVERAGE**

The customer must notify an authorized servicing BOMBARDIER dealer within two (2) days of the appearance of a defect, and provide it with reasonable access to the product and reasonable opportunity to repair it. The customer must also present to the authorized BOMBARDIER dealer, proof of purchase of the product and must sign the repair/work order prior to starting the repair in order to validate the warranty repair. All parts replaced under this limited warranty become the property of BOMBARDIER.

## **5. WHAT BOMBARDIER WILL DO**

BOMBARDIER's obligations under this warranty are limited to, at its sole discretion, repairing parts found defective under normal use, maintenance and service, or replacing such parts with new genuine BOMBARDIER parts without charge for parts and labor, at any authorized BOMBARDIER dealer.

BOMBARDIER reserves the right to improve or modify products from time to time without assuming any obligation to modify products previously manufactured.

## **6. EXCLUSIONS - ARE NOT WARRANTED**

- Normal wear and tear;
- Routine maintenance items, tune ups, adjustments;
- Damage caused by failure to provide proper maintenance and/or storage, as described in the *Operator's Guide*;
- Damage resulting from removal of parts, improper repairs, service, maintenance, modifications or use of parts not manufactured or approved by BOMBARDIER or resulting from repairs done by a person that is not an authorized servicing BOMBARDIER SEA-DOO dealer;
- Damage caused by abuse, abnormal use, neglect, or operation of the product in a manner inconsistent with the recommended operation described in the *Operator's Guide*;
- Damage resulting from accident, submersion, fire, theft, vandalism or any act of God;
- Operation with fuels, oils or lubricants which are not suitable for use with the product (see the *Operator's Guide*);
- Water damages caused by water ingestion;
- Damages related to gel coat finish including but not limited to cosmetic gel coat finish, blisters or fiberglass delamination caused by blisters, crazing, spyder or hairline cracks; and
- Incidental or consequential damages, or damages of any kind including without limitation towing, storage, telephone, rental, taxi, inconvenience, insurance coverage, loan payments, loss of time, loss of income.

## **7. LIMITATIONS OF LIABILITY**

THIS WARRANTY IS EXPRESSLY GIVEN AND ACCEPTED IN LIEU OF ANY AND ALL OTHER WARRANTIES, EXPRESSED OR IMPLIED, INCLUDING WITHOUT LIMITATION ANY WARRANTY OF MERCHANTABILITY OR FITNESS FOR A PARTICULAR PURPOSE. TO THE EXTENT THAT THEY CANNOT BE DISCLAIMED, THE IMPLIED WARRANTIES ARE LIMITED IN DURATION TO THE LIFE OF THE EXPRESS WARRANTY. INCIDENTAL AND CONSEQUENTIAL DAMAGES ARE EXCLUDED FROM COVERAGE UNDER THIS WARRANTY. SOME STATES/PROVINCES DO NOT ALLOW FOR THE DISCLAIMERS, LIMITATIONS AND EXCLUSIONS IDENTIFIED ABOVE, AS A RESULT, THEY MAY NOT APPLY TO YOU. THIS WARRANTY GIVES YOU SPECIFIC RIGHTS, AND YOU MAY ALSO HAVE OTHER LEGAL RIGHTS WHICH MAY VARY FROM STATE TO STATE, OR PROVINCE TO PROVINCE.

Neither the distributor, any BOMBARDIER dealer nor any other person has been authorized to make any affirmation, representation or warranty regarding the product, other than those contained in this limited warranty, and if made, shall not be enforceable against BOMBARDIER.

BOMBARDIER reserves the right to modify this warranty at any time, being understood that such modification will not alter the warranty conditions applicable to the products sold while this warranty is in effect.

## **8. TRANSFER**

If the ownership of a product is transferred during the warranty coverage period, this warranty shall also be transferred and be valid for the remaining coverage period provided that BOMBARDIER is notified of such transfer of ownership in the following way:

- a) The former owner contacts BOMBARDIER (at the phone number provided below) or an authorized BOMBARDIER dealer and gives the coordinates of the new owner; or
- b) BOMBARDIER or an authorized BOMBARDIER dealer receives a proof that the former owner agreed to the transfer of ownership, in addition to the coordinates of the new owner.

## **9. CONSUMER ASSISTANCE**

- a) In the event of a controversy or a dispute in connection with this BOMBARDIER LIMITED WARRANTY, BOMBARDIER suggests that you try to resolve the issue at the dealership level. We recommend discussing the issue with the authorized dealer's service manager or owner.
- b) If the issue has not yet been resolved, please submit your complaint in writing or call the appropriate number below:

**In Canada:**

**BOMBARDIER INC.  
RECREATIONAL PRODUCTS  
CUSTOMER ASSISTANCE CENTER  
VALCOURT QC J0E 2L0  
Tel: (819) 566-3366**

**In USA:**

**BOMBARDIER MOTOR  
CORPORATION OF AMERICA  
CUSTOMER ASSISTANCE CENTER  
7575 BOMBARDIER COURT  
WAUSAU WI 54401  
Tel: (715) 848-4957**

© 2002 Bombardier Inc. All rights reserved

® <sup>TM</sup> Registered trademarks of Bombardier Inc. or its subsidiaries.

† Trademark of Castrol Ltd, used under license.

---

# ONLY FOR 2002 SEA-DOO® RX™ DI, SEA-DOO GTX† DI AND SEA-DOO LRV™ DI SOLD AND REGISTERED IN CALIFORNIA

## CALIFORNIA EMISSION CONTROL WARRANTY STATEMENT

Your SEA-DOO watercraft has a special environmental label required by the California Air Resources Board (CARB). The label has 1, 2, or 3 stars. A hangtag, provided with your personal watercraft, describes the meaning of the star rating system.

The Star Label Means Cleaner Marine Engines



F00L2ZQ

The Symbol for Cleaner Marine Engines:

### Cleaner Air and Water

For a healthier lifestyle and environment.

### Better Fuel Economy

Burns up to 30 - 40 percent less gas and oil than conventional carbureted two-stroke engines, saving money and resources.

### Longer Emission Warranty

Protects consumer for worry free operation.

## One Star - Low-Emission

The one-star label identifies engines that meet the Air Resources Board's 2001 exhaust emission standards. Engines meeting these standards have 75% lower emissions than conventional carbureted two-stroke engines. These engines are equivalent to the U.S. EPA's 2006 standards for marine engines.

## Two Stars - Very Low Emission

The two-star label identifies engines that meet the Air Resources Board's 2004 exhaust emission standards. Engines meeting these standards have 20% lower emissions than One Star - Low - Emission engines.

## Three Stars - Ultra Low Emission

The three-star label identifies engines that meet the Air Resources Board's 2008 exhaust emission standards. Engines meeting these standards have 65% lower emissions than One Star - Low Emission engines.

For more information: Cleaner Watercraft – Get the Facts  
1 800 END-SMOG  
[www.arb.ca.gov](http://www.arb.ca.gov)

## **YOUR EMISSION CONTROL WARRANTY RIGHTS AND OBLIGATION**

The California Air Resources Board and BOMBARDIER on behalf of BOMBARDIER MOTOR CORPORATION OF AMERICA (BMCA) are pleased to explain the emission control system warranty on your 2002 SEA-DOO RX™ DI, SEA-DOO GTX† DI and SEA-DOO LRV™ DI personal watercraft engine. In California, new personal watercraft engines must be designed, built and equipped to meet the State's stringent anti-smog standards. BOMBARDIER must warrant the emission control system on your personal watercraft engine for the periods of time listed below provided there has been no abuse, neglect or improper maintenance of your personal watercraft engine.

Your emission control system may include parts such as the fuel injection system or the ignition system. Also included may be hoses, connectors and other emission-related assemblies.

Where a warrantable condition exists, BOMBARDIER will repair your personal watercraft engine at no cost to you including diagnosis, parts and labor provided that such work is performed by an authorized BOMBARDIER dealer.

### **Manufacturer's Limited Warranty Coverage**

This emission limited warranty covers model year 2002 SEA-DOO RX™ DI, SEA-DOO GTX† DI and SEA-DOO LRV™ DI personal watercraft engine certified and produced by BOMBARDIER for sale in California, that are originally sold in California to a California resident. The BOMBARDIER North America Limited warranty conditions for Sea-DoD watercraft are still applicable to these models with the necessary modifications.

Select emission control parts of your 2002 SEA-DOO RX™ DI, SEA-DOO GTX† DI and SEA-DOO LRV™ DI personal watercraft engine are warranted from the date of delivery to the first retail consumer for a period of 4 years, or for 250 hours of use, whichever occurs first. However, warranty coverage based on the hourly period is only permitted for personal watercraft equipped with the appropriate hour meters or their equivalent. If any emission-related part on your engine is defective under warranty, the part will be repaired or replaced by BOMBARDIER.

Parts covered are:

Air lines	Coolant temperature sensor
Fuel rail	Throttle position sensors
Rave valve	Ignition coil
Reed valve	Manifold temperature sensor
Tuned pipe	Manifold air pressure sensor
High-tension ignition wires	Crankshaft position sensor
Electrical harness	Air pressure regulator
Throttle bodies	Fuel pressure regulator
Exhaust hoses	Fuel injectors
Fuel lines	Electronic control module
Water regulator	Exhaust manifold
Air compressor	Fuel pump
Cylinder head	Air injector
Detonation/ knock sensor	All emission component related gaskets; head, base and exhaust



The emission warranty covers damage to other engine components that is caused by the failure of a warranted part.

The Bombardier Operator's Guide provided contains written instructions for the proper maintenance and use of your personal watercraft. All emission warranty parts are warranted by Bombardier for the entire warranty period of the watercraft, unless the part is scheduled for replacement as required maintenance in the Operator's Guide.

Emission warranty parts that are scheduled for replacement, as required maintenance, are warranted by Bombardier for the period of time before the first scheduled replacement date for that part. Emission warranty parts that are scheduled for regular inspection, but not regular replacement, are warranted by Bombardier for the entire warranty period of the watercraft. Any emission warranty part repaired or replaced under the terms of this warranty statement is warranted by BOMBARDIER for the remainder of the warranty period of the original part. All parts replaced under this limited warranty become the property of BOMBARDIER.

Maintenance receipts and records should be transferred to each subsequent owner of the watercraft.

### **Owner's Warranty Responsibilities**

As the personal watercraft engine owner, you are responsible for the performance of the required maintenance listed in your Operator's Guide. BOMBARDIER recommends that you retain all receipts covering maintenance on your personal watercraft engine, but BOMBARDIER cannot deny warranty solely for the lack of receipts or your failure to ensure the performance of all scheduled maintenance.

As the personal watercraft engine owner, you should however be aware that BOMBARDIER may deny you warranty coverage if your personal watercraft engine or a part has failed due to abuse, neglect, improper maintenance or unapproved modifications.

You are responsible for presenting your personal watercraft engine to an authorized BOMBARDIER dealer as soon as a problem exists. The warranty repairs will be completed in a reasonable amount of time, not to exceed 30 days.

If you have any questions regarding your warranty rights and responsibilities or for the name and location of the nearest authorized BOMBARDIER dealer you should contact the Customer Assistance Center at 1-715-848-4957.

---

# **BOMBARDIER LIMITED WARRANTY INTERNATIONAL: SEA-DOO® WATERCRAFT**

## **1. SCOPE OF THE LIMITED WARRANTY**

BOMBARDIER INC. (hereinafter "BOMBARDIER") warrants its SEA-DOO personal watercraft from defects in material or workmanship for the period described below.

All genuine BOMBARDIER parts and accessories, installed by an authorized BOMBARDIER distributor/dealer (as hereinafter defined) at the time of delivery of the SEA-DOO personal watercraft, carry the same warranty as that of the personal watercraft.

Use of the product for racing or any other competitive activity, at any point, even by a prior owner will render this warranty null and void.

## **2. WARRANTY COVERAGE PERIOD**

This warranty will be in effect FROM THE DATE OF DELIVERY TO THE FIRST RETAIL CONSUMER or the date the product is first put into use, whichever occurs first and for a period of:

a) TWELVE (12) CONSECUTIVE MONTHS, for private use owners.

b) FOUR (4) CONSECUTIVE MONTHS, for commercial use owners.

The repair or replacement of parts or the performance of service under this warranty does not extend the life of this warranty beyond its original expiration date.

## **3. CONDITIONS TO HAVE WARRANTY COVERAGE**

This warranty coverage is available only on SEA-DOO personal watercraft purchased as new and unused by its first owner from a BOMBARDIER distributor/dealer authorized to distribute SEA-DOO products in the country in which the sale occurred (hereinafter "BOMBARDIER distributor/dealer"), and then only after the BOMBARDIER specified pre-delivery inspection process is completed and documented. Warranty coverage only becomes available upon proper registration of the product by a BOMBARDIER dealer. Such limitations are necessary in order to allow BOMBARDIER to preserve both the safety of its products, and also that of its consumers and the public.

Routine maintenance outlined in the Operator's Guide must be timely performed in order to maintain warranty coverage. BOMBARDIER reserves the right to make warranty coverage contingent upon proof of proper maintenance.

## **4. WHAT TO DO TO OBTAIN WARRANTY COVERAGE**

The customer must notify a servicing BOMBARDIER distributor/dealer within two (2) days of the appearance of a defect, and provide it with reasonable access to the product and reasonable opportunity to repair it. The customer must also present to the BOMBARDIER distributor/dealer, proof of purchase of the product and must sign the repair/work order prior to the start of the repair in order to validate the warranty repair. All parts replaced under this limited warranty become the property of BOMBARDIER.

## **5. WHAT BOMBARDIER WILL DO**

BOMBARDIER's obligations under this warranty are limited to, at its sole discretion, repairing parts found defective under normal use, maintenance and service, or replacing such parts with new genuine BOMBARDIER parts without charge for parts and labor, at any authorized BOMBARDIER distributor/dealer.

BOMBARDIER reserves the right to improve or modify products from time to time without assuming any obligation to modify products previously manufactured.

## **6. EXCLUSIONS - ARE NOT WARRANTED**

- Normal wear and tear;
- Routine maintenance items, tune ups, adjustments;
- Damage caused by failure to provide proper maintenance and/or storage, as described in the *Operator's Guide*;
- Damage resulting from removal of parts, improper repairs, service, maintenance, modifications or use of parts not manufactured or approved by BOMBARDIER or resulting from repairs done by a person that is not an authorized servicing BOMBARDIER distributor/dealer;
- Damage caused by abuse, abnormal use, neglect or operation of the product in a manner inconsistent with the recommended operation described in the *Operator's Guide*;
- Damage resulting from accident, submersion, fire, theft, vandalism or any act of God;
- Operation with fuels, oils or lubricants which are not suitable for use with the product (see the *Operator's Guide*);
- Water ingestion;
- Damages related to gel coat finish including but not limited to cosmetic gel coat finish, blisters or fiberglass delamination caused by blisters, crazing, spider or hairline cracks; and
- Incidental or consequential damages, or damages of any kind including without limitation towing, storage, telephone, rental, taxi, inconvenience, insurance coverage, loan payments, loss of time, loss of income.

## **7. LIMITATIONS OF LIABILITY**

THIS WARRANTY IS EXPRESSLY GIVEN AND ACCEPTED IN LIEU OF ANY AND ALL OTHER WARRANTIES, EXPRESSED OR IMPLIED, INCLUDING WITHOUT LIMITATION ANY WARRANTY OF MERCHANTABILITY OR FITNESS FOR A PARTICULAR PURPOSE. TO THE EXTENT THAT THEY CANNOT BE DISCLAIMED, THE IMPLIED WARRANTIES ARE LIMITED IN DURATION TO THE LIFE OF THE EXPRESS WARRANTY. INCIDENTAL AND CONSEQUENTIAL DAMAGES ARE EXCLUDED FROM COVERAGE UNDER THIS WARRANTY. SOME COUNTRIES DO NOT ALLOW FOR THE DISCLAIMERS, LIMITATIONS AND EXCLUSIONS IDENTIFIED ABOVE, AS A RESULT, THEY MAY NOT APPLY TO YOU. THIS WARRANTY GIVES YOU SPECIFIC RIGHTS, AND YOU MAY ALSO HAVE OTHER LEGAL RIGHTS WHICH MAY VARY FROM COUNTRY TO COUNTRY.

Neither the BOMBARDIER distributor nor any other person has been authorized to make any affirmation, representation or warranty regarding the product, other than those contained in this limited warranty, and if made, shall not be enforceable against BOMBARDIER. BOMBARDIER reserves the right to modify this warranty at any time, being understood that such modification will not alter the warranty conditions applicable to the products sold while this warranty is in effect.

## **8. TRANSFER**

If the ownership of a product is transferred during the warranty coverage period, this warranty shall also be transferred and be valid for the remaining coverage period provided that BOMBARDIER is notified of such transfer of ownership in the following way:

- a) The former owner contacts BOMBARDIER or an authorized BOMBARDIER distributor/dealer and gives the coordinates of the new owner; or
- b) BOMBARDIER or an authorized BOMBARDIER distributor/dealer receives a proof that the former owner agreed to the transfer of ownership, in addition to the coordinates of the new owner.

## **9. CONSUMER ASSISTANCE**

- a) In the event of a controversy or a dispute in connection with this BOMBARDIER LIMITED WARRANTY, BOMBARDIER suggests that you try to resolve the issue at the distributorship/ dealership level. We recommend discussing the issue with the authorized dealer's service manager or owner.
- b) If further assistance is required, the distributor's service department should be contacted in order to resolve the matter.

---

## REGISTRATION NUMBER LOCATION

All personal watercraft are required by federal law to be registered and legally numbered.

Due to space availability for proper display of registration number, refer to following illustration for location. The registration number should appear on each side of the watercraft. On applicable models, install registration number to the left of the star label.

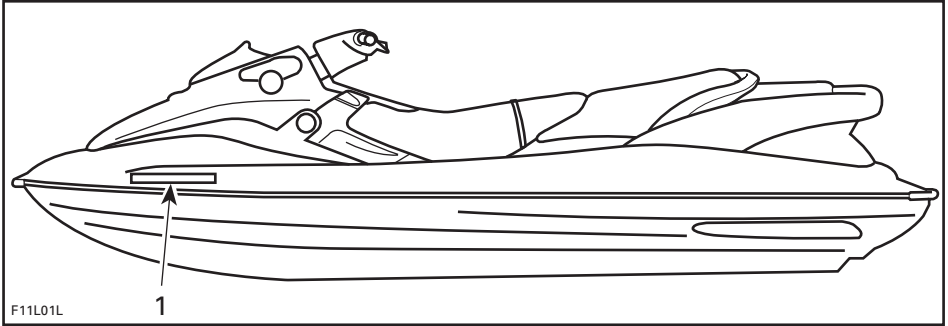

1. Registration number location

**NOTE:** The registration number must be above the water line. Ensure also that the numbers are of the correct size and color. Check with local applicable regulations.

# LOCATION OF THE IMPORTANT LABELS

The following labels are on your watercraft. If missing or damaged, they can be replaced free of charge. See an authorized Sea-Doo dealer.

Please read the following labels carefully before operating this watercraft.

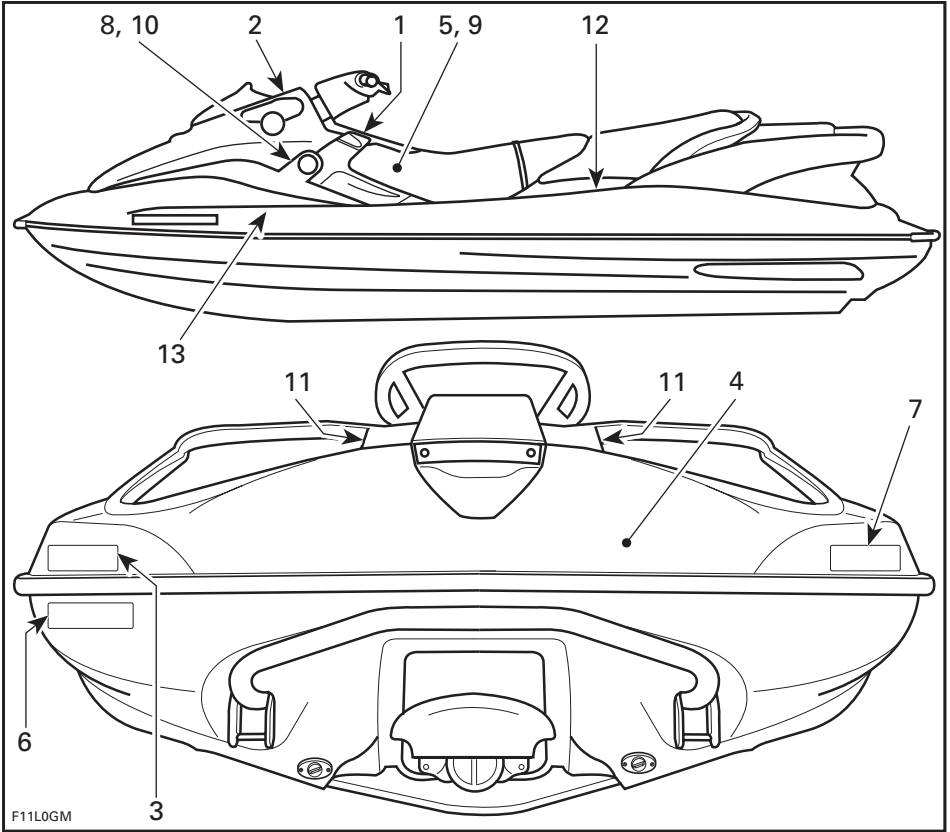

F11LOGM  
TYPICAL

## Label 1

### ⚠ WARNING

To reduce the risk of SEVERE INJURY or DEATH:

**WEAR A PERSONAL FLOTATION DEVICE (PFD).** All riders must wear a Coast Guard approved PFD that is suitable for personal watercraft (PWC) use.

**WEAR PROTECTIVE CLOTHING.** Severe internal injuries can occur if water is forced into body cavities as a result of falling into water or being near jet thrust nozzle. Normal swimwear does not adequately protect against forceful water entry into lower body opening(s) of males or females. All riders must wear a wet suit bottom or clothing that provides equivalent protection (see Operator's Guide). Footwear, gloves and goggles/glasses are recommended.

**KNOW BOATING LAWS.** Bombardier recommends a minimum operator age of 16 years old. Know the operator age and training requirements for your province/state. A boating safety course is recommended and may be required in your province/state.

**ATTACH ENGINE SHUT-OFF CORD (LANYARD)** to PFD and keep it free from handlebars so that engine stops if operator falls off. After riding, remove cord from PWC to avoid unauthorized use by children or others.

**STAY WITHIN YOUR LIMITS AND AVOID AGGRESSIVE MANEUVERS** to reduce the risk of loss of control, ejection and collision. This is a high performance boat - not a toy. Sharp turns or jumping wakes or waves can increase the risk of back/spinal injury (paralysis), facial injuries, and broken legs, ankles, and other bones. Do not jump wakes or waves.

**DO NOT APPLY THROTTLE WHEN ANYONE IS AT REAR OF PWC** - turn engine off or keep engine at idle. Water and/or debris exiting jet thrust nozzle can cause severe injury.

**KEEP AWAY FROM INTAKE GRATE** while engine is on. Items such as long hair, loose clothing, or PFD straps can become entangled in moving parts resulting in severe injury or drowning.

**NEVER RIDE AFTER CONSUMING DRUGS OR ALCOHOL**

**READ AND FOLLOW OPERATOR'S GUIDE**

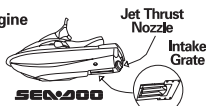

### ⚠ WARNING

Collisions result in more INJURIES AND DEATHS than any other type of accident for personal watercraft (PWC).

**TO AVOID COLLISIONS:**

**SCAN CONSTANTLY** for people, objects, and other watercraft. Be alert for conditions that limit your visibility or block your vision of others.

**OPERATE DEFENSIVELY** at safe speeds and keep a safe distance away from people, objects, and other watercraft.

- Do not follow directly behind PWCs or other boats.
- Do not go near others to spray or splash them with water.
- Avoid sharp turns or other maneuvers that make it hard for others to avoid you or understand where you are going.
- Avoid areas with submerged objects or shallow water.

**TAKE EARLY ACTION** to avoid collisions. Remember, PWCs and other boats do not have brakes.

**DO NOT RELEASE THROTTLE WHEN TRYING TO STEER** away from objects - you need throttle to steer. Always check throttle and steering controls for proper operation before starting PWC.

Follow navigation rules and province/state and local laws that apply to PWCs. See Operator's Guide for more information. Seating is limited to XX operator and XX passengers (XXX lbs./XXX kg.).



219 901 713

F12LOFL

## Label 2

### ▼ CAUTION

**USE BOMBARDIER-ROTAX FORMULA XP-S II SYNTHETIC OIL ONLY.**

Use of any other oil during the warranty coverage period will void the limited warranty.

F12LOIY

## Label 3

"THIS BOAT IS NOT REQUIRED TO COMPLY WITH THE FOLLOWING U.S. COAST GUARD SAFETY STANDARDS IN EFFECT ON THE DATE OF CERTIFICATION:

- Fuel System
- Safe Loading
- Display of Capacity Information
- Flotation
- Powered Ventilation

AS AUTHORIZED BY U.S. COAST GUARD GRANT OF EXEMPTION (CGB 88-001)."

Bombardier Corp.

7575 Bombardier Court, Wausau, WI 54401

Made in USA/Fabriqu  aux  tats-Unis

Bombardier Inc. Rd./Enr.,1988

F00L2D1

## Label 4

### EMISSION CONTROL INFORMATION

This engine is certified to operate on unleaded gasoline and conforms to 2002 U.S. EPA and California emission regulations for Marine SI Engines.



Engine Family: ..... XBCXM,XXXCR  
 FEL: ..... XXX gm/kW-hr HC + NO<sub>x</sub>  
 Engine Displacement: ..... XXX cc  
 Exhaust Emission Control System: ..... XXX

Spark Plug Type: ..... XXX  
 Spark Plug Gap: ..... XXX in./XXX mm  
 Power: ..... XXXX kW

See Operator's Guide for maintenance specifications

F11LOKY

TYPICAL

## Label 5

### • WARNING

**DO NOT BOOST BATTERY WHILE INSTALLED.**

F00L050

### Label 6

**CAUTION**

TO AVOID POSSIBLE ENGINE FLOODING WHEN ROLLED OVER:



- MAKE SURE ENGINE IS OFF
- GRAB INLET GRATE AND STEP ON BUMPER RAIL
- ROLL BOAT COUNTERCLOCKWISE

F06L0DZ

### Label 7

**WARNING**

- ENGINE MUST BE OFF WHEN USING BOARDING STEP.
- KEEP AWAY FROM JET OR INTAKE GRATE.
- STAY ON CENTER OF THE STEP.
- ONLY ONE PERSON AT THE TIME ON THE STEP.
- NEVER USE THE STEP FOR PULLING, TOWING,
- DIVING OR JUMPING, BOARDING A PWC THAT IS OUT
- OF WATER OR ANY OTHER PURPOSE FOR WHICH IT
- WAS NOT DESIGNED.

F07L24Y

SOME MODELS

### Label 8

**WARNING**

- Gasoline vapors may cause fires or explosions.
- Do not over fill fuel tank.
- Keep the craft away from open flames and sparks.
- Do not start craft if liquid gasoline or vapors are present.
- Always replace engine cover (or seat) before starting.

F00L2MY

### Label 9

**WARNING**

COMPONENTS INSIDE  
WATERCRAFT MAY BE HOT.

F00L2FY

SOME MODELS

### Label 10

**WARNING / AVERTISSEMENT**



**FUEL / ESSENCE**

F00A18Y

SOME MODELS

### Label 11

**WARNING**

- DO NOT STORE FUEL OR FLAMMABLE LIQUIDS IN THE STORAGE COMPARTMENTS.

F11L0EY

### Label 12

**WARNING**

- DO NOT ALLOW RIDERS ON THE REAR/PLATFORM WHEN THE ENGINE IS RUNNING.

F11L0FY

### Label 13



F00L2YY

SOME MODELS



# IDENTIFICATION NUMBERS

The main components of the watercraft (engine and hull) are identified by different serial numbers. It may sometimes become necessary to locate these numbers for warranty purposes or to trace the watercraft in the event of theft.

## Hull

The Hull Identification Number (H.I.N.) is located on footboard at the rear of watercraft.

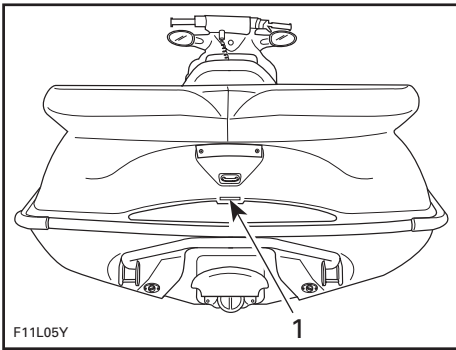

1. Hull Identification Number

It is composed of 12 digits:

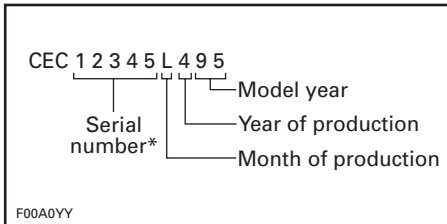

\*A letter may also be used as a digit.

## Engine

The Engine Identification Number (E.I.N.) is located on the upper crankcase on MAGNETO side.

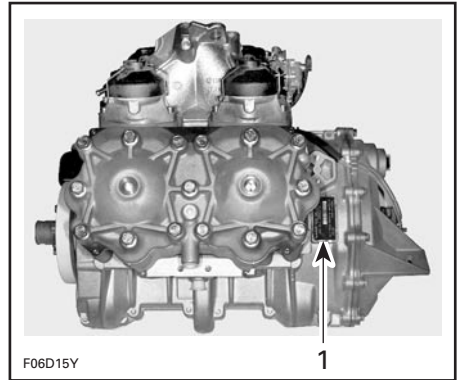

1. Engine Identification Number (E.I.N.)

# CONTROLS, COMPONENTS AND INSTRUMENTS LOCATION

NOTE: Some components do not apply or are optional on some models.

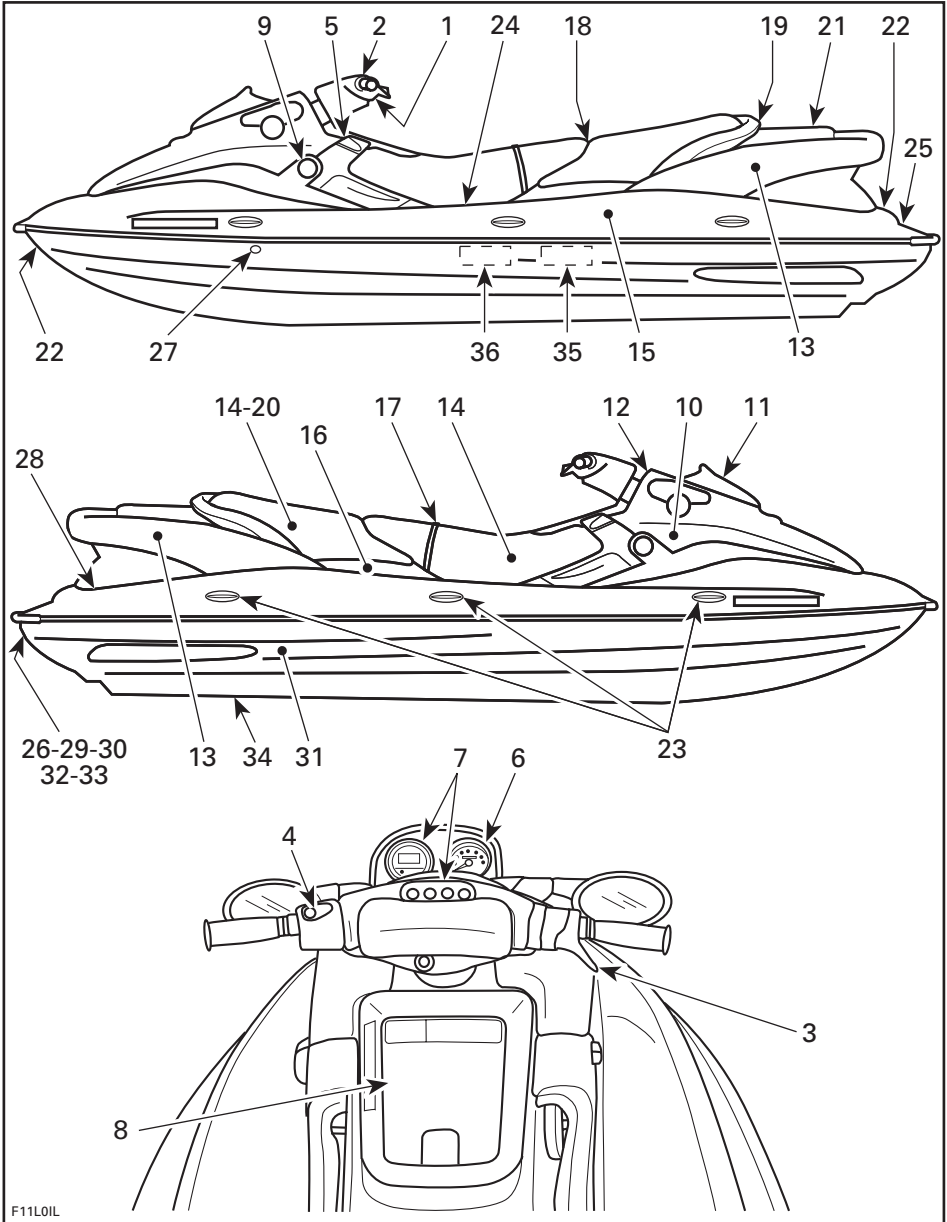

1. Safety Lanyard
2. Handlebar
3. Throttle Lever
4. Engine Start/Stop Button
5. Shift Lever
6. Speedometer
7. Information Center Gauge/Buttons
8. Glove Box
9. Fuel Tank Cap
10. Oil Injection Reservoir Cap
11. Front Storage Compartment Cover
12. Front Storage Compartment Cover Latch
13. Side Storage Compartments
14. Underseat Storage Compartments
15. Tool Kit
16. Air Intake Opening
17. Seat Strap
18. Seat Latch
19. Seat Extension Latch
20. Rear Storage Basket
21. Sun Deck
22. Bow and Stern Eyelets
23. Fender Cleats
24. Footboard
25. Boarding Platform
26. Boarding Step
27. Cooling System Bleed Outlet
28. Deck Drains
29. Flushing Connector
30. Bilge Drain Plugs
31. Automatic Bilge Pump
32. Jet Pump Nozzle
33. Reverse Gate
34. Jet Pump Water Intake
35. Fuses
36. Battery

# CONTROLS, COMPONENTS AND INSTRUMENTS FUNCTIONS

## 1) Safety Lanyard (engine cut-off cord)

The safety lanyard cap should be securely snapped onto its post to be fully operational.

Pulling the safety lanyard cap from its post stops the engine operation. Attach the safety lanyard to the operator's Personal Flotation Device (PFD) and snap the cap to the post to be able to start the engine.

Two short beeps indicates the system is ready to allow engine starting. Otherwise, refer to the TROUBLESHOOTING section for the coded signals chart.

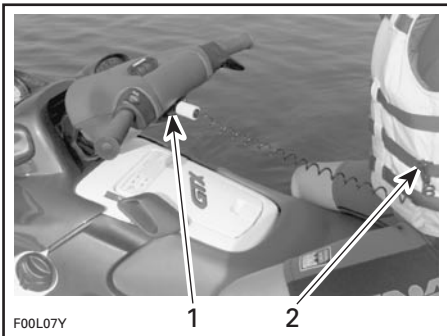

### TYPICAL

1. Safety lanyard cap on the post
2. Safety lanyard secured on operator's PFD

## WARNING

Should the engine be stopped, watercraft directional control is lost. Always disconnect safety lanyard when watercraft is not in operation in order to prevent accidental engine starting or to avoid unauthorized use by children or others or theft.

## WARNING

Should the safety lanyard cap become loose or fails to remain on its post, replace it immediately.

## Digitally Encoded Security System (DESS)

The safety lanyard cap specifically contains an electronic circuit that gives it a unique electronic serial number. This is the equivalent of a conventional key.

This safety lanyard cannot be used on another watercraft and conversely, the one from another watercraft cannot be used on your watercraft.

However, the DESS brings a great flexibility. You can buy an additional safety lanyard and have it programmed for your watercraft.

The **DI Model** also offers a special safety lanyard — the SEA-DOO LK™ (SEA-DOO Learning Key™) — which electronically limits the speed of the watercraft to approximately 55 km/h (35 MPH) therefore enabling first time users and less experienced operators to learn how to operate the watercraft while gaining the necessary confidence and control.



To have an additional safety lanyard, refer to an authorized SEA-DOO dealer. If the engine is stopped with the start/stop button while the safety lanyard remains on the post, it can be restarted within approximately 10 minutes by pressing the engine start/stop button. After this delay, it is necessary to apply a slight pressure or to remove and re-install the safety lanyard on the post to allow engine starting.

**⚠ WARNING**

While engine can be stopped using the engine start/stop button, good habits recommend that the safety lanyard also be disconnected when stopping.

## 2) Handlebar

The handlebar controls the direction of the watercraft. Turning the handlebar to the right steers the watercraft to the right and inversely.

**⚠ WARNING**

Check handlebar and corresponding steering nozzle operation before starting.

## 3) Throttle Lever

When the throttle lever is squeezed, the watercraft accelerates. When fully released, engine automatically slows down to idle speed and watercraft is gradually stopped by water drag.

## 4) Engine Start/Stop Button

To start engine, depress and hold the start/stop button. Release immediately after engine is started.

To stop engine, fully release throttle lever then depress the start/stop button and disconnect safety lanyard from the post.

**⚠ WARNING**

Directional control is reduced when the throttle is released and lost when engine is off.

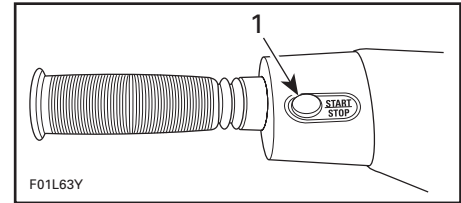

1. Engine start/stop button

With the Digitally Encoded Security System, leaving the safety lanyard for more than 10 minutes after stopping the engine will require a slight pressure or the removal and reinstallation of the safety lanyard on the post to allow engine starting.

## 5) Shift Lever

A push-pull lever:

- forward
- neutral
- reverse.

**⚠ WARNING**

Shift lever should only be used when the engine is idling and craft is completely stopped. Do not use as a grab handle.

**⚠ WARNING**

Only use reverse at slow speed and for the shortest time possible. Always ensure the path behind is clear of objects and persons including children playing in shallow water.

**CAUTION:** Never rev the engine at high RPM in reverse.

From the forward position, pull the lever to reverse. Push back to go to forward. Always set in forward when finished. To find the neutral, set in reverse then push back until the watercraft stops moving backwards.



F17L0AY

TYPICAL — FORWARD POSITION



F17L0BY

TYPICAL — NEUTRAL POSITION



F17L0CY

TYPICAL — REVERSE POSITION

## 6) Speedometer

Analog speedometer indicates the speed of watercraft in miles per hour (MPH) and kilometers per hour (km/h).

The speed sensor mounted on the ride plate sends the signal to the speedometer and information center.

## 7) Information Center Gauge/Buttons (if so equipped)

NOTE: With the safety lanyard disconnected, information center can be activated for approximately 33 seconds by depressing the engine start/stop button. This is convenient to see the fuel level or view some other functions when the safety lanyard is not at hand.

This is a LCD multifunction gauge. Different displays and functions can be activated using 2 buttons — MODE and SET — following specific sequences as described below.

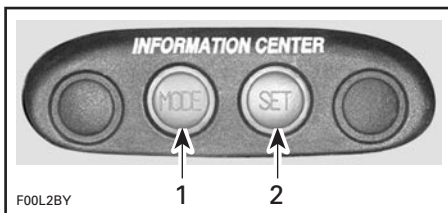

F00L2BY

1. To change display mode
2. To set or reset a function

### Resetting a Function

To reset a function (such as the chronometer, distance, etc.) press and hold the SET button for 2 seconds while in the appropriate mode.

The information center includes the following display areas.

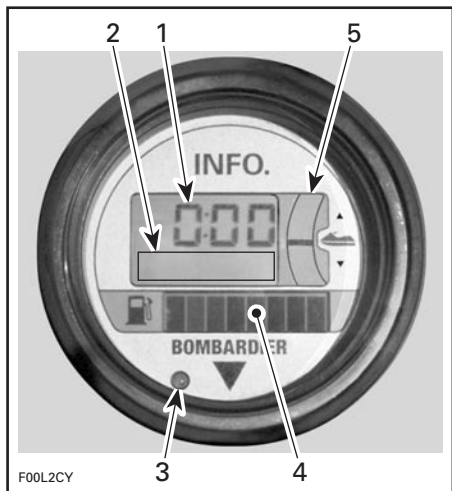

1. General display
2. Message/units display
3. Warning light
4. Fuel level display
5. VTS position indicator (if so equipped)

## General Display

The default display is the clock (or clock/compass if so equipped) unless another mode has been selected. See **Display Priorities** below.

Repeatedly pressing the MODE button scrolls the following displays: Tachometer, speedometer, average speed, trip meter, hourmeter, water temperature, exterior temperature (if so equipped) and chronometer.

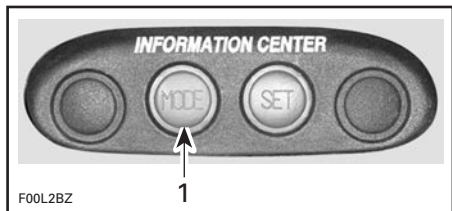

1. Press to change display mode

When you are satisfied with your choice, stop pressing the button.

**Clock:** Indicates the actual time in hours and minutes (hh:mm).

**Clock/Compass (if so equipped):** Displays the cardinal points to indicate the orientation of the watercraft.

## WARNING

Use the compass as a guide only. Not to be used for navigation purposes.

**Tachometer:** Indicates the revolutions per minute (RPM) of the engine.

**Speedometer:** Indicates the speed of watercraft in kilometers per hour (KPH) or miles per hour (MPH).

**Average Speed:** The information center approximately calculates and displays the average speed (AV KPH or AV MPH) of the watercraft since the last engine start.

**Trip Meter:** The information center approximately calculates the distance based on the operation time and the watercraft speed and displays the result in kilometers (KM) or miles (MILES).

**Hourmeter:** Displays the time in hours of the watercraft usage.

**Water Temperature:** Displays the water temperature (L TEMP) in degrees Celsius (°C) or Fahrenheit (°F).

**Exterior Temperature (if so equipped):** Displays the exterior air temperature (E TEMP) in degrees Celsius (°C) or Fahrenheit (°F).

**Chronometer:** Allows to measure an interval of time in hours and minutes (hh:mm).

## Message Display

The information center features a display area that blinks a message whenever one of the following circumstances occurs:

- fuel injection system sensors and major components (MAINT).
- compass error (COMPAS)
- maintenance (MAINT)
- engine overheating (H-TEMP)
- low fuel (FUEL-LO)
- low oil (OIL LOW)
- low voltage (12 V LOW)

A message will sound when one of the four last circumstances occurs.

Except for low fuel and low oil, which can be corrected by refilling, it is recommended to see an authorized SEA-DOO dealer when other messages occur.

The warning light will blink at the same time.

## Warning Light

The red warning LED (Light-Emitting Diode) blinks along with the message display to catch your attention.

## Fuel Level Display

Bar gauge continuously indicates the amount of fuel in the fuel tank while riding. A low-fuel condition is also indicated when it occurs. See **Message Display** above.

## Display Priorities

The clock, (clock/compass, if so equipped) is the default display mode. The default display is the one that appears when the information center is first activated or displayed back after an alternate display was chosen.

The tachometer, speedometer and chronometer, are the only other modes that may be chosen to replace the default display. When one of these is selected, it will become the default display until it is changed again.

When another display mode is chosen, the default display will be displayed back after 4 seconds.

As a self test, all LCD segments and the LED will turn on for 3 seconds each time the information center is activated.

In the event of a warning message, the message will blink and override the units display.

If more than one warning message occurs, the blinking messages will scroll every 4 seconds.

## Other Functions

The following describes how to select other available functions.

### Language Option

While in the clock/compass mode:

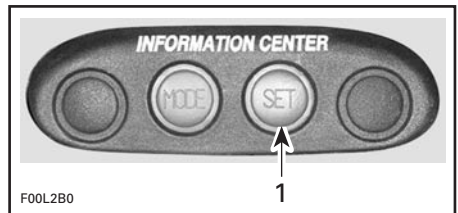

1. Press and hold for 2 seconds

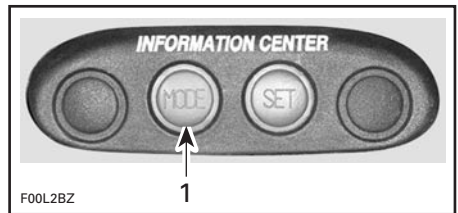

1. Repeatedly press

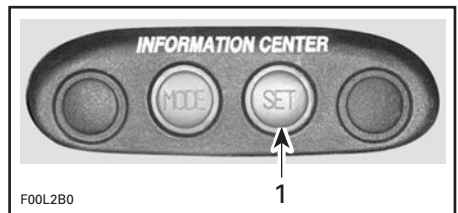

1. Press to end



## English/Metric System

Allows to display the units in the metric system or in the SAE English system.

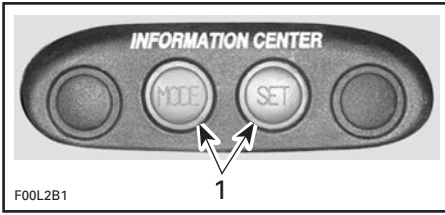

1. Press **TOGETHER** and hold for 2 seconds

## Clock Adjustment

While in the clock/compass mode:

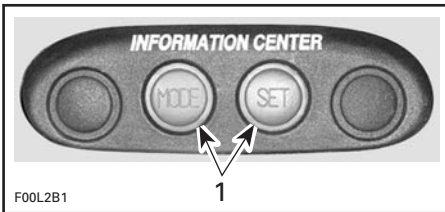

1. Press **TOGETHER** and hold for 2 seconds

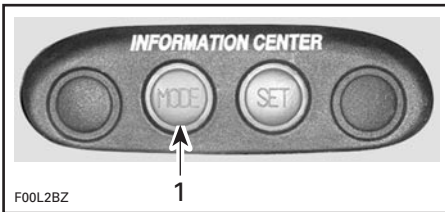

1. Repeatedly press to adjust **HOURS**

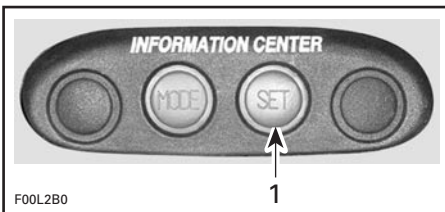

1. Repeatedly press to adjust **MINUTES**

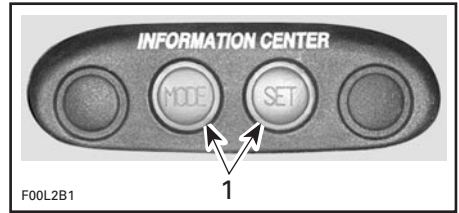

1. Press **TOGETHER** to end

**NOTE:** If **MODE** and **SET** buttons are not pressed at the end, the default display will come back after 10 seconds and the time entered will remain.

## Chronometer

While in the chronometer mode:

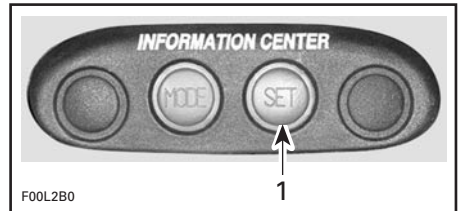

1. Press to start or stop chronometer

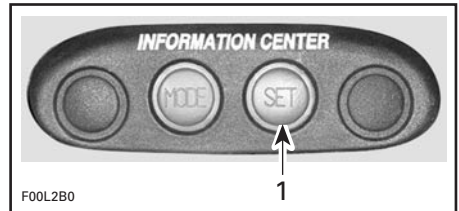

1. Press and hold for 2 seconds to reset

Chronometer is reset every time engine is turned off.

## Maintenance Information

When the watercraft is due for a maintenance inspection, the message MAINT will blink.

To clear the warning message while it is blinking:

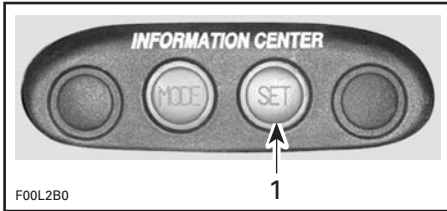

1. Press and hold for 2 seconds to reset

**NOTE:** If maintenance message (MAINT) continues to blink, it indicates a fault with the fuel injection system. Refer to an authorized SEA-DOO dealer for servicing.

## 8) Glove Box

A small, convenient storage compartment for personal articles.

## 9) Fuel Tank Cap

Refer to the vehicle illustration for fuel tank cap location.

Unscrew the cap counterclockwise. After fueling, reinstall cap and fully tighten.

### **WARNING**

Always stop the engine before refueling. Fuel is inflammable and explosive under certain conditions. Always work in a well ventilated area. Do not smoke or allow open flames or sparks in the vicinity. Fuel tank may be pressurized, slowly turn cap when opening. Never use an open flame to check fuel level. When fueling, keep watercraft level. Do not overfill or top off the fuel tank and leave watercraft in the sun. As temperature increases, fuel expands and might overflow. Always wipe off any fuel spillage from the watercraft. Periodically verify fuel system.

## 10) Oil Injection Reservoir Cap

Refer to the vehicle illustration for oil injection reservoir cap location.

To add injection oil in the reservoir, unscrew the cap counterclockwise. Do not overfill. Reinstall cap and fully tighten it.

### **WARNING**

Do not overfill. Reinstall cap and fully tighten. Oil is inflammable. Always wipe off any oil spillage from the bilge.

Open the front storage compartment cover to expose reservoir cap.

## 11) Front Storage Compartment Cover

It gives access to the front storage compartment. Always relatch cover after closing.

### Front Storage Compartment

A convenient watertight area, to carry personal articles. Ideal location for spare spark plugs, towrope, first aid kit, etc.

### **WARNING**

Never leave any heavy or breakable objects loose in the storage area/basket. Never store or carry anything below basket (if so equipped). Never operate the watercraft with any storage compartment cover open.

Fire extinguisher (sold separately) should not be loose in the front storage compartment.

## 12) Front Storage Compartment Cover Latch

Pull the latch lever upward in order to open the front storage compartment cover. Always relatch.

**NOTE:** Verify periodically the lock pin tightness of storage cover. Tighten if needed and make sure storage cover latches properly.

## 13) Side Storage Compartments

Two convenient watertight compartments to carry personal articles. Ideal location for water skis or wakeboards.

Left side storage compartment is also provided with a holder. Tool kit is inserted in that holder.

### **WARNING**

Never leave any heavy or breakable objects loose in the storage compartment. Never operate the craft with the storage compartment cover open.

## 14) Underseat Storage Compartments

Convenient watertight, removable basket to carry personal articles. Remove seat to gain access to underseat storage compartments.

### **WARNING**

Never leave any heavy or breakable objects loose in the storage compartment. Never operate the craft with the storage compartment cover open.

## 15) Tool Kit

Contains tools needed to perform basic watercraft maintenance.

## 16) Air Intake Opening

This is where air enters to supply the engine and to ventilate the engine compartment. If the air intake opening is kept under water, water will get inside bilge.

**CAUTION:** If the air intake opening is kept under water, such as turning constantly in tight circles, water will get inside bilge, which may cause severe damage to internal parts of the engine.

## 17) Seat Strap

The seat strap provides a handhold to assist boarding and is used as a handhold for the passenger.

## 18) Seat Latch

Removing the seat allows access to the engine compartment.

The seat latch is located at the rear end and underneath the seat.

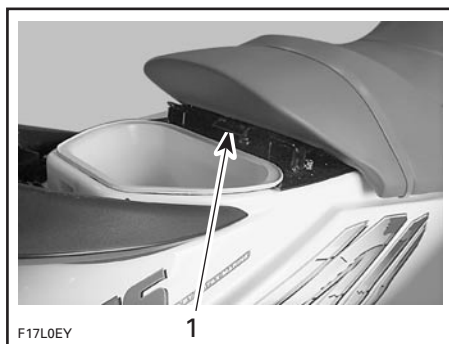

*TYPICAL*

1. Seat latch

To remove seat, pull the latch lever upward and hold. Lift and pull the seat rearward.

**NOTE:** It is necessary to remove the seat extension first and repeat the same procedure to remove the seat.

## Engine Compartment

This is where the mechanical, electrical and fuel/oil systems are located.

### **WARNING**

Components inside engine compartment may be hot. When starting or operating the engine, do not touch any electrical part. Never leave any object, rag, tool, etc., in the engine compartment or in the bilge.

When reinstalling the seat, insert seat hook into body front tab for each portion of the seat.

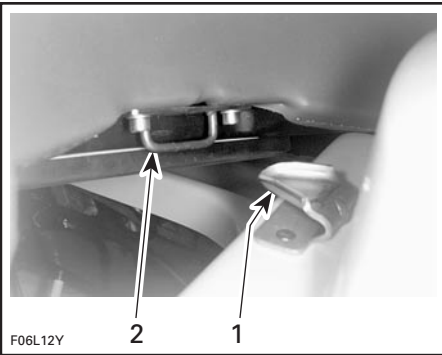

1. Insert this tab in hook
2. Hook

To latch seat, align latch hole with pin then, firmly push downward on rear of the seat.

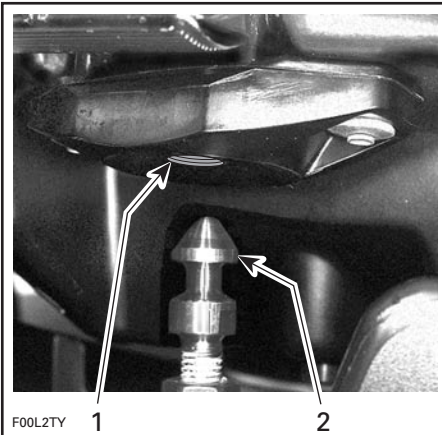

1. Latch hole
2. Pin

## 19) Seat Extension Latch

Removing the seat extension allows access to the rear storage basket. It also gives access to the seat latch.



1. Seat extension latch
2. Rear grab handle

## 20) Rear Storage Basket (if so equipped)

A convenient watertight, removable basket to carry personal articles.



TYPICAL

## 21) Sun Deck

A convenient space to rest or take some sun while anchored.

### **WARNING**

Do not start or operate the craft if a person is seated on the sun deck.

## 22) Bow and Stern Eyelets

### Bow Eyelet

Eyelets can be used for mooring, towing and as a tie-down point during trailering.

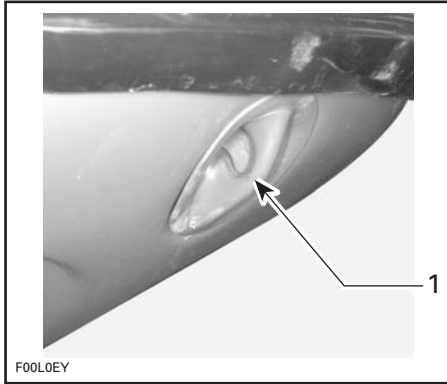

1. Bow eyelet

### Stern Eyelet

This eyelet allows a rope with a hook, a closed end or an open end to be attached.

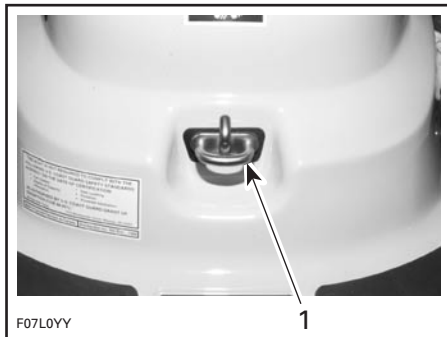

TYPICAL

1. Stern eyelet

## 23) Fender Cleats

These cleats can be temporarily used for docking, while refueling for fender installation.

**CAUTION:** Do not use the cleats for securing baggage or as a tie-down point for trailering or mooring. Never use mooring cleats to pull or lift the watercraft.



TYPICAL

1. Fender cleats (each side)

## 24) Footboard

User's feet should rest on the footboard when riding.

## 25) Boarding Platform

Provides a large surface for easier boarding from rear of watercraft.

## 26) Boarding Step

A convenient step to help reboarding the watercraft.

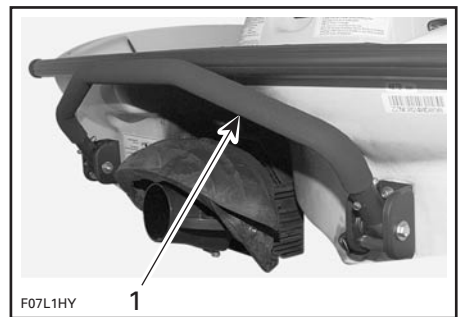

TYPICAL

1. Boarding step

Pull down the step with your hand and hold until a foot is put on the step.

## **⚠ WARNING**

Engine should be OFF when using boarding step. Keep limbs away from jet or intake grate. Stay on center of the step. Only one person at the time on the step. Never use the step for pulling, towing, diving or jumping, boarding a PWC that is out of water or any other purpose other than a boarding step.

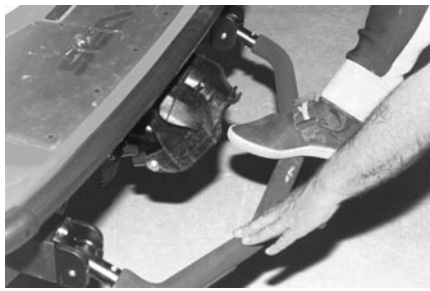

F00L2UY

## **27) Cooling System Bleed Outlet**

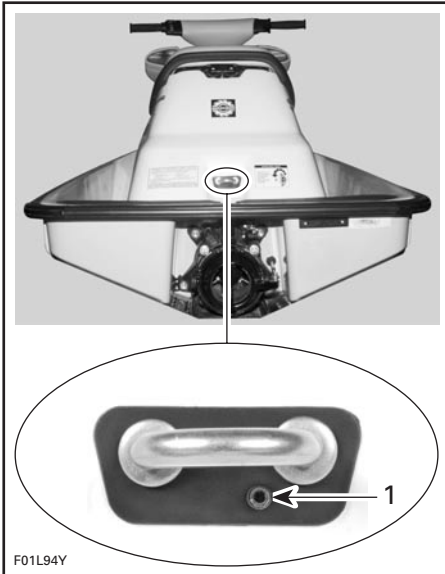

F01L94Y

**TYPICAL**

1. Bleed outlet

When engine is running, water should flow from the outlet. This allows air in engine cooling system to escape. It also indicates that water is circulating in the cooling system.

**NOTE:** It may be required to increase slightly the engine RPM to see the water flowing out.

**CAUTION:** Should water not flow from outlet a few seconds after engine starts, immediately stop engine and refer to POST-OPERATION CARE and look for Cooling System Flushing or refer to an authorized SEA-DOO dealer for servicing.

## **28) Deck Drains**

They provide drainage of water from rain, deck washing, water splashing, etc. Keep clean to avoid clogging.

## **29) Flushing Connector**

A convenient connector is provided to allow easy installation of a garden hose to flush the cooling system.

Refer to POST-OPERATION CARE section for proper use.

## **30) Bilge Drain Plugs**

Should water be found in the bilge, it can be easily drained by unscrewing the drain plugs when engine is off and watercraft is out of water.

**CAUTION:** Remove boat from water prior to unscrewing drain plugs.

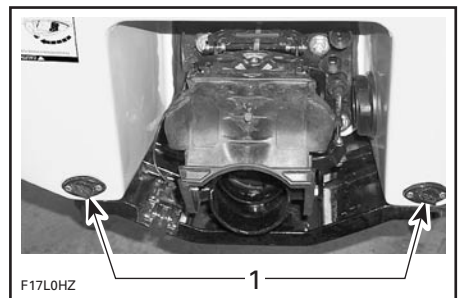

F17L0HZ

**TYPICAL**

1. Drain plugs

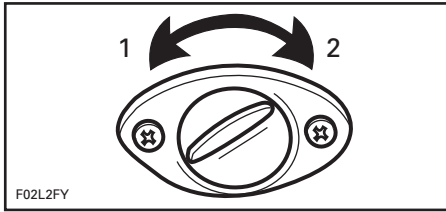

F02L2FY

1. *Unscrew*
2. *Tighten*

Tilt the watercraft slightly to the rear so that the water can completely flow out of the bilge.

It is suggested to drain bilge on a ramp.

**CAUTION:** Make sure drain plugs are properly secured prior to launching the watercraft in water.

### 31) Automatic Bilge Pump

Bilge pump evacuates water from the bilge.

When safety lanyard cap is plugged to the switch, bilge pump automatically turns on. It will stay on for 30 seconds.

When engine is started bilge pump remains on and stays on until engine is stopped. When engine is stopped pump remains on for 30 seconds and then automatically shuts-off.

### 32) Jet Pump Nozzle

Jet pump nozzle turns side to side via rider input at the handlebar. This provides directional control when engine is running.

#### **⚠ WARNING**

Never use nozzle as a supporting point to board the craft or to lift it.

### 33) Reverse Gate

When selecting the neutral or reverse position with the shift lever, the reverse gate moves up or down to obtain the desired position.

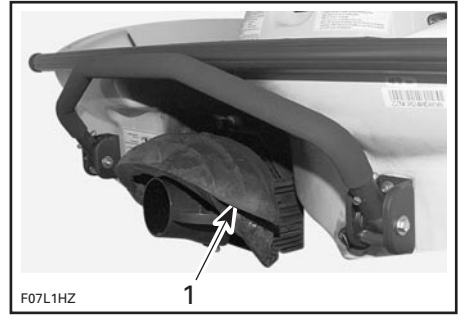

F07L1HZ

*TYPICAL*

1. *Reverse gate*

### 34) Jet Pump Water Intake

The water is drawn up by the impeller through this opening. The water intake grate minimizes the entry of foreign objects into the propulsion system.

#### **⚠ WARNING**

Keep away from intake grate while engine is on. Items such as long hair, loose clothing or personal flotation device straps can become entangled in moving parts resulting in severe injury or drowning.

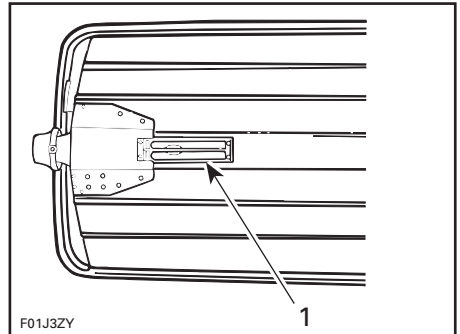

F01J3ZY

*TYPICAL*

1. *Water intake*

### 35) Fuses

Fuses are located in bilge. Refer to MAINTENANCE for more details.

### 36) Battery

Battery is located inside engine compartment. Refer to SPECIAL PROCEDURES.



# FUEL AND LUBRICATION

**CAUTION:** Scrupulously follow the instructions of this section. Failure to do so may reduce the engine's life and/or performance.

## Fueling Procedure

### WARNING

Follow these safe boating fueling instructions explicitly.

Turn off engine.

Do not allow anyone to remain on the watercraft.

Tie watercraft securely to the fueling pier.

Have a fire extinguisher close at hand.

Do not insert the spout too far in filler neck.

Pour fuel slowly so that air can escape from the tank and prevent fuel flow-back. Be careful not to spill fuel.

Stop filling when the fuel reaches the bottom of filler neck. Do not fill into the filler tube to prevent fuel spillage. Do not overfill. Fully tighten fuel tank cap.

### WARNING

Always stop the engine before refueling. Fuel is inflammable and explosive under certain conditions. Always work in a well ventilated area. Do not smoke or allow open flames or sparks in the vicinity. Fuel tank may be pressurized, turn cap slowly when opening. Never use an open flame to check fuel level. When fueling, keep watercraft level. Do not overfill or top off the fuel tank and leave watercraft in the sun. As temperature increases, fuel expands and might overflow. Always wipe off any fuel spillage from the watercraft. Periodically verify fuel system.

## Recommended Fuel

Use unleaded regular gasoline with 87 octane (Ron + Mon)/2 specification.

**NOTE:** Adding injection oil in the fuel tank for the break-in has no noticeable effects on a DI engine.

**CAUTION:** Never experiment with other fuels or fuel ratios. Never use fuel containing more than 10% alcohol, (ethanol or methanol). The use of non-recommended fuel can result in watercraft performance deterioration and damage to critical parts in the fuel system and engine components.

**CAUTION:** Never use injector cleaning products. They may contain additive that could damage injector components.

## Recommended Oil

### WARNING

Do not overfill. Reinstall cap and fully tighten. Oil is inflammable. Always wipe off any oil spillage from the bilge.

Use only two-stroke engine injection oil sold by authorized SEA-DOO dealers.

MODEL	OIL TYPE
LRV DI	BOMBARDIER Formula XP-S II synthetic injection oil (or equivalent)

**CAUTION:** BOMBARDIER Formula XP-S II oil is specially formulated and tested for use in our **947 DI** engines. Use of any other brand of two-stroke oil may void the limited warranty. Use only BOMBARDIER Formula XP-S II oil (or equivalent oil).



BOMBARDIER injection oil is a blend of basic oil and additives especially selected to ensure unequalled lubrication, engine cleanliness and minimum spark plug fouling.

The BOMBARDIER Formula XP-S II synthetic injection oil **provides superior lubrication**, reduced engine component wear and oil deposit, thus maintaining maximum-level performance and antifriction properties. This synthetic injection oil meets the latest ASTM and JASO standards by ensuring high biodegradability and low exhaust smoke.

**CAUTION:** Never use four-stroke petroleum or synthetic motor oil and never mix these with outboard motor oil. Do not use NMMA TC-W, TC-W2 or TC-W3 outboard two-stroke engine oils or ashless two-stroke engine oils. Avoid mixing different brands of API TC oil as resulting chemical reactions may cause severe engine damage.

## Oil Injection System

This watercraft features an oil injection system which does not require manual fuel/oil mixing.

A sufficient amount of injection oil should be maintained in the reservoir.

**NOTE:** It is recommended to carry a 1 L of spare injection oil.

The use of a funnel is recommended to pour the oil into the reservoir. Stop filling as soon as oil appears at approximately 13 mm (1/2 in) from top of reservoir. Do not overfill.

**CAUTION:** Always maintain a sufficient amount of injection oil in the oil reservoir. Check and refill every time you refuel if necessary. Do not overfill. If the engine runs out of oil, severe engine damage will occur. If the oil reservoir is found almost empty, air can enter in the system and it should be bled. Immediately refer to an authorized SEA-DOO dealer to have the oil injection system inspected.

---

## **BREAK-IN PERIOD**

**CAUTION:** Scrupulously follow the instructions of this section. Failure to do so may reduce the engine's life and/or performance.

With SEA-DOO watercraft powered by Rotax® engines, a break-in period of 10 hours is required before continuous operation at full throttle.

With the DI engine, in order to achieve a good break-in, vary the engine speed every few minutes with brief wide open throttle accelerations of up to 15 seconds.

**CAUTION:** Continued wide open throttle runs and prolonged cruising without speed variations should be avoided, this can cause engine damage during the break-in period.

**CAUTION:** Remove and clean spark plugs after engine break-in.

**NOTE:** Adding injection oil in the fuel tank for the break-in has no noticeable effects on a DI engine.

### **10-Hour Inspection**

It is highly recommended that after the first 10 hours of operation, the watercraft be checked by an authorized SEA-DOO dealer. This inspection will also provide the opportunity to discuss the unanswered questions you may have encountered during the first hours of operation.

---

The 10-hour inspection is at the expense of the watercraft owner.

---

---

# PRE-OPERATION CHECKS

## **WARNING**

The pre-operation check is very important prior to operating the watercraft. Always check the proper operation of critical controls, safety features and mechanical components, before starting as listed hereinafter. If not done as specified here, severe injury or death might occur. Bring all safety equipment required by local laws.

Some of the following items may not have been previously covered in this guide, however they will be described in the MAINTENANCE or SPECIAL PROCEDURES section. Please refer to these sections to have more detailed information.

## **WARNING**

Engine should be off and the safety lanyard should always be removed from its post prior to verifying any of the following points. Only start watercraft once all items have been checked and operate properly.

ITEM	OPERATION	✓
Hull	Inspect.	
Jet pump water intake	Inspect/clean.	
Bilge	Drain. Ensure plugs are secured.	
Battery	Inspect tightness of cables and retaining strap(s).	
Fuel tank and oil reservoir	Refill.	
Engine compartment	Check fuel line connections for tightness. Verify for any fuel leak/odor.	
Steering system	Check operation.	
Throttle system	Check operation.	
Shifter system	Check operation.	
Storage compartment covers and seat	Ensure they are closed and latched.	
Safety lanyard and engine start/stop button	Check operation.	

**NOTE:** See the detailed instructions hereinafter.

## Hull

Inspect hull for cracks or damage.

## Jet Pump Water Intake

Remove weeds, shells, debris or anything else that could restrict the flow of water and damage cooling system or propulsion unit. Clean as necessary. If any obstruction can not be removed, refer to an authorized SEA-DOO dealer for servicing.

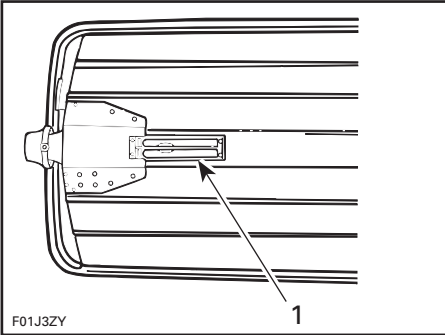

*TYPICAL*

1. Inspect this area

Inspect leading edges of the impeller, if they have nicks or bends performance will be greatly reduced.

## Bilge

Should water be present in the bilge, tilt the watercraft to the rear and unscrew drain plugs to completely empty the bilge.

Secure bilge drain plugs.

### **WARNING**

Make sure drain plugs are properly secured prior to launching the watercraft in water.

## Battery

### **WARNING**

Verify tightness of battery cables to their posts and condition of battery retaining strap(s)/fasteners. Do not charge or boost battery while installed.

## Fuel Tank and Oil Reservoir

With the watercraft horizontal, fill the fuel tank to specified level.

Check the oil level and refill reservoir as necessary.

Check fuel tank and oil reservoir retaining straps/fasteners.

## Engine Compartment

### **WARNING**

Should any leak or gasoline odor be present, do not start the engine. Refer to an authorized SEA-DOO dealer before use.

## Steering System

Assisted by another person, check steering operation for free movement. When the handlebar is horizontal, the jet pump nozzle should be in the straight ahead position. Ensure the jet pump nozzle pivots easily and in the same direction as the handlebar.

### **WARNING**

Check handlebar and corresponding steering nozzle operation before starting.

## Throttle System

Check throttle lever for free and smooth operation. It should return to its initial position immediately after it is released.

### **WARNING**

Check throttle lever operation before starting the engine.

## Shifter System

Check reverse gate operation for free movement. With shift lever in forward position, the gate should be in upward position. With the shift lever in neutral position, gate should be in middle position. With shift lever in reverse position, gate should be in downward position.

### **WARNING**

Verify the reverse gate operation before starting the engine.

## Storage Compartment Covers and Seat

Ensure they are closed and latched.

### **WARNING**

Make sure seat is securely latched.

## Safety Lanyard and Engine Start/Stop Button

Position shift lever in neutral. Ensure that both switches operate properly. Start engine and stop it using each switch individually.

### **WARNING**

Should the safety lanyard cap is loose or fail to remain on its post, replace it immediately in order to avoid unsafe use.

# OPERATING INSTRUCTIONS

## WARNING

Always perform the PRE-OPERATION CHECKS before operating the watercraft. Become thoroughly familiar with all controls and the function of each. Should any control or instruction not be fully understood, refer to an authorized SEA-DOO dealer.

## Principle of Operation

### Propulsion

The engine is directly coupled to a drive shaft which, in turn, rotates an impeller. This impeller is accurately adjusted in a housing where the water is drawn up from underneath the watercraft. Then the water flows through the impeller to a venturi. The venturi accelerates the water and produces thrust to move the watercraft. Depressing the throttle lever increases engine speed and therefore watercraft speed.



TYPICAL

## WARNING

Whenever the engine is to be started, the operator and passenger(s) should always be properly sitting on the watercraft and be wearing protective clothing including a Coast Guard approved PFD and a wet suit bottom.

## WARNING

Keep away from intake grate while engine is on. Items such as long hair, loose clothing or personal flotation device straps can become entangled in moving parts resulting in severe injury or drowning.

The shift lever should be in the forward position in order for the watercraft to advance.

### Neutral and Reverse

## WARNING

Never use jet pump components as a supporting point to board the watercraft. Shift lever should only be used when the engine is idling and watercraft is completely stopped. Never rev the engine at high RPM in reverse. Do not use reverse to stop the watercraft. Only use reverse at slow speed and for the shortest time possible. Always ensure the path behind is clear of objects and persons including children playing in shallow water.

To find the neutral, set in reverse then push back until the watercraft stops moving backwards.

The reverse gate will be in the middle position, directing half of the thrust toward the front of the watercraft to minimize watercraft movement.

## WARNING

When the watercraft is in neutral position, the drive shaft and impeller are still turning.

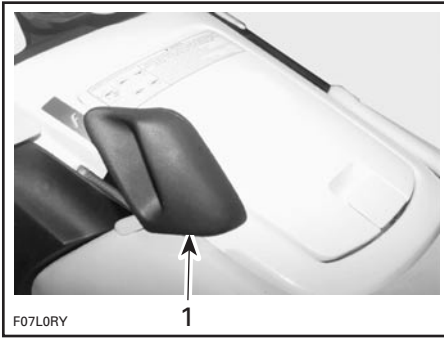

F07L0RY

1

**TYPICAL**

1. Shift lever in neutral position

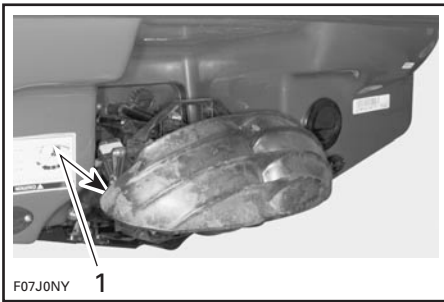

F07J0NY

1

**TYPICAL**

1. Reverse gate in middle neutral position

To obtain reverse, pull shift lever completely. The reverse gate will be in downward position, directing all the thrust toward the front of the watercraft.

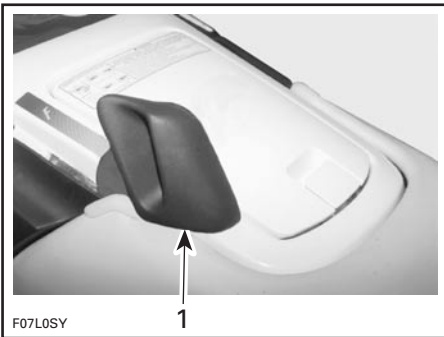

F07L0SY

1

**TYPICAL**

1. Shift lever in reverse position

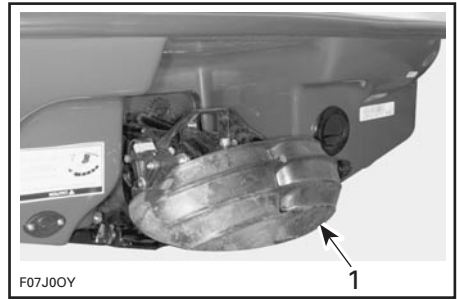

F07J00Y

1

**TYPICAL**

1. Reverse gate in downward reverse position

**NOTE:** To obtain maximum efficiency and control from the reverse, increase engine speed to slightly above idle. Too much RPM will create water turbulence and reduce reverse efficiency.

In reverse position, turn the handlebar in the opposite direction that you want to move the rear of the watercraft.

For example, to steer the rear of the watercraft to the left side, turn the handlebar to the right side.

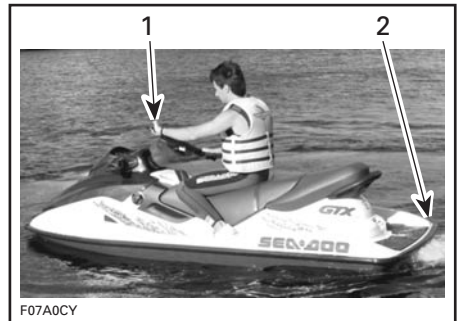

F07A0CY

**TYPICAL**

1. Handlebar turned to the right side
2. Rear of watercraft moving to the left side

**⚠ WARNING**

Shift lever should only be used when the engine is idling and watercraft is completely stopped. Do not use reverse to stop the watercraft.

## Steering



Turning the handlebar pivots the jet pump nozzle which controls the watercraft direction. Turning the handlebar to the right will turn the watercraft to the right and inversely. The throttle should be applied to turn the watercraft.

### **WARNING**

Throttle should be applied and handlebar turned to change the direction of the watercraft. Steering efficiency will differ depending on the number of passengers, load, water conditions and environmental factors such as the wind.

Unlike a car, a watercraft needs some throttle to turn. Practice in a safe area applying the throttle and turning away from an imaginary object. This is a good collision avoidance technique.

### **WARNING**

Directional control is reduced when the throttle is released and lost when engine is off.

The watercraft behaves differently with a passenger and requires greater skill. The passenger should always grip the seat strap or grab handle. Reduce speed and avoid sharp turns. Avoid choppy water conditions when carrying a passenger.

## Boarding the Watercraft

### General

As with any watercraft, boarding should be done carefully and engine should not be running.

### **WARNING**

Engine should be OFF when boarding the watercraft or when using boarding step (if so equipped). Keep limbs away from jet or intake grate. Stay on center of the step. Only one person at a time on the step. Never use the step for pulling, towing, diving or jumping, boarding a watercraft that is out of water or any other purpose other than a boarding step.

On some models, boarding is facilitated by using a step.

### **WARNING**

Inexperienced riders should practice how to get aboard (all methods explained here) close to shore first before venturing into deep water.

### **WARNING**

Never use jet pump components as a supporting point to board the watercraft.

### Boarding from a Dock or in Shallow Water

When boarding from a dock, slowly place one foot on the watercraft footboard nearest the dock and, at the same time, transfer the body weight to the other side in order to balance the watercraft while holding the handlebar. Then, bring the other foot over the seat and put it on the other footboard. Push the watercraft away from the dock.





F07A0BY

TYPICAL

Grip the grab handle and pull yourself upward until your knee can reach the boarding platform then grip the seat strap.

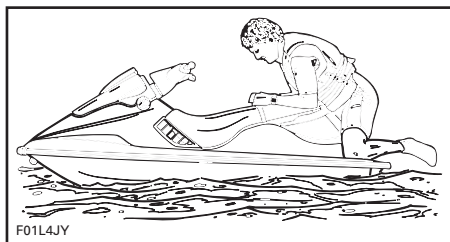

F01L4JY

Bring your feet on the footboard while maintaining balance.

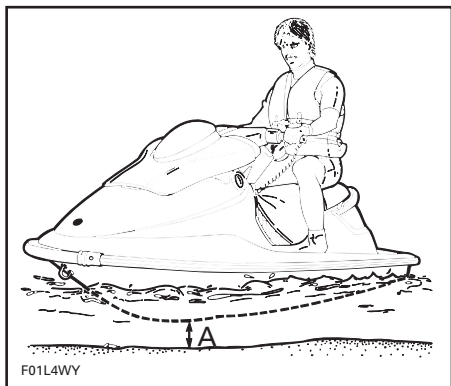

F01L4WY

A. 90 cm (3 ft)

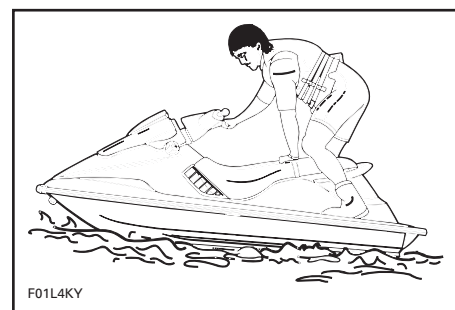

F01L4KY

Sit astride the seat.

In shallow water, board the watercraft either from the side or the rear.

## Boarding in Deep Water

### Operator Alone

Swim to the rear of the watercraft.

### Operator with a Passenger

The operator climbs on the watercraft the same way as explained previously.

In choppy water, the passenger, while in the water, may hold the watercraft to help the operator in climbing aboard.

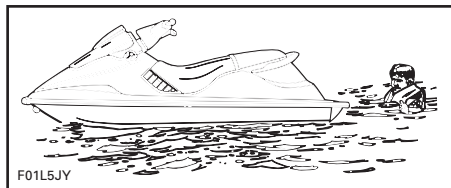

F01L5JY

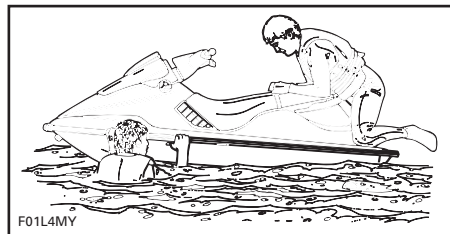

F01L4MY

The passenger then climbs on the watercraft while the operator maintains balance by sitting as close as possible to the console.

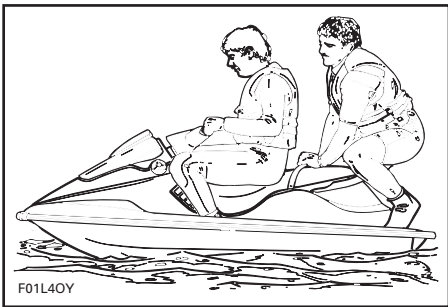
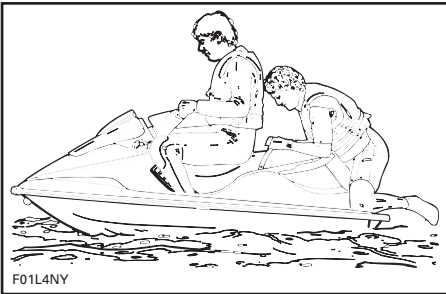

## Starting

### Preparation

Before unloading the watercraft from the trailer, it can be started for about 10 seconds to verify proper operation.

## WARNING

Components inside engine compartment may be hot. Do not touch electrical parts or jet pump area when engine is running.

Attach the safety lanyard to your PFD and snap the cap to its post before starting the engine.

**NOTE:** If you hear more than 2 short beeps from DESS system, it indicates a particular condition that should be corrected. Refer to the TROUBLESHOOTING section for the meaning of the coded signal.

## WARNING

Before starting the engine, the operator and passengers should always be properly seated.

Position shift lever to neutral.

Firmly grip handlebar with your left hand and place both feet on the footboard.

To start engine, depress and hold the engine start/stop button. Follow procedure below for cold or warm engine starting.

If engine fails to start after 10 seconds, wait a few seconds then repeat procedure.

**CAUTION:** Do not hold start/stop button more than 30 seconds to avoid starter overheating. A rest period should be observed between the cranking cycles to let starter cool down. Pay attention not to discharge battery. The engine should be started only after boarding, when there is at least 90 cm (3 ft) of water below the hull. Do not accelerate fast.

Release engine start/stop button immediately after engine is started.

### Cold or Warm Engine

Do not depress the throttle lever to start either a cold or warm engine.

### Riding

Slowly accelerate to reach deeper water. Do not apply full throttle until the engine is warm.



TYPICAL

**CAUTION:** Avoid watercraft operation in weeded areas. If unavoidable, vary watercraft speed.

## Rough Water or Poor Visibility Operation

Avoid operation in these conditions. If you must do so, proceed with caution and prudence using minimum speed.

## Crossing Waves

Reduce speed.

Always be prepared to steer and balance as necessary.

When crossing wakes, always keep a safe distance from **watercraft** ahead.

### **WARNING**

When crossing wakes, slow down. Operator and passenger(s) can brace themselves by posting. Do not jump waves or wakes.

## Stopping/Docking

The watercraft is slowed by water drag. The stopping distance will vary depending on the watercraft size, weight, speed, water surface condition, presence and direction of wind and current.

The operator should become familiarized with the stopping distance under different conditions.

Release the throttle at a sufficient distance before the expected landing area.

Reduce speed to idle.

On models equipped with shifter system, shift to neutral, reverse or forward, as required.

### **WARNING**

Directional control is reduced when the throttle is released and lost when engine is off.

## Beaching

**CAUTION:** It is not recommended to run the watercraft to the beach.

Come slowly to the beach and shut off the watercraft using the safety lanyard when water depth is 90 cm (3 ft) under the hull, then pull the watercraft to the beach.



## Shutting Off the Engine

To keep watercraft directional control, the engine should be running until the watercraft is at idle.

To shut off the engine, completely release throttle lever and press the engine start/stop button. Remove safety lanyard from watercraft.

### **WARNING**

Should the engine be shut off, watercraft directional control is lost. Never leave the safety lanyard on its post when watercraft is not in operation in order to prevent accidental engine starting or to avoid unauthorized use by children or others or theft.

# POST-OPERATION CARE

## WARNING

Allow engine to cool before performing any maintenance.

## General Care

Remove the watercraft from the water every day to prevent marine organisms growth.

Should any water be present in the hull, unscrew the drain plugs and tilt the watercraft to the rear in order to allow water to flow out.

Wipe up any remaining fluid in the engine compartment (bilge, engine, battery, etc.) with clean dry rags (this is particularly important in salt water use).

## Additional Care for Foul Water or Salt Water

When the watercraft is operated in foul water and particularly in salt water, additional care should be taken to protect the watercraft and its components. Rinse trailer and watercraft's bilge area with fresh water.

**CAUTION:** Failure to perform proper care such as: watercraft rinsing, cooling system flushing and anticorrosion treatment, when watercraft is used in salt water, will result in damage to the watercraft and its components. Never leave the watercraft stored in direct sunlight.

## Cooling System Flushing and Engine Internal Lubrication

### General

Flushing the cooling system with fresh water is essential to neutralize corroding effects of salt or other chemical products present in water. It will help to remove sand, salt, shells or other particles in water jackets (engine, exhaust manifold, tuned pipe) and/or hoses.

Engine lubrication and flushing should be performed when the watercraft is not expected to be used further the same day or when the watercraft is stored for any extended time.

## WARNING

Perform this operation in a well ventilated area.

Proceed as follows:

Clean jet pump by spraying water in its inlet and outlet and then apply a coating of BOMBARDIER LUBE lubricant or equivalent.

Connect a garden hose to connector located at the rear of watercraft on jet pump support.

**NOTE:** A quick connect adapter can be used (P/N 295 500 473). No hose pincher is required to flush engine.

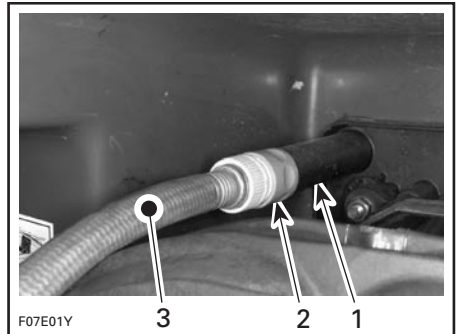

### TYPICAL

1. Hose adapter
2. Quick connect adapter (not mandatory)
3. Garden hose

**NOTE:** The quick connect adapter may be supplied with some models. It has to be removed if you do not use a quick connect adapter on your garden hose.

## Flushing

To flush cooling system, start the engine then immediately open the water tap.

### WARNING

Components inside engine compartment may be hot. Do not touch any electrical parts or jet pump area when engine is running.

**CAUTION:** Never flush a hot engine. Always start the engine before opening the water tap. Open water tap immediately after engine is started to prevent overheating.

Run the engine about 3 minutes at a fast idle around 3500 RPM.

Ensure water flows out of drain lines (engine crankcase, engine cylinder and air compressor while flushing. Otherwise, clean the lines.

**CAUTION:** Never run engine longer than 5 minutes. Drive line seal has no cooling when watercraft is out of water.

## Lubrication

Spray BOMBARDIER LUBE lubricant or equivalent, through hole of air intake silencer keeping engine at fast idle during one minute.

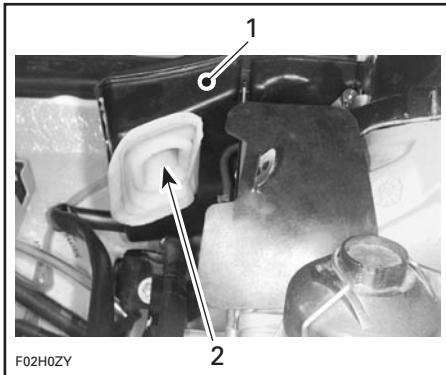

1. Air intake silencer
2. Spray BOMBARDIER LUBE here

Close the water tap then stop the engine.

**CAUTION:** Always close the water tap before stopping the engine.

## Final Steps

Disconnect the garden hose.

Remove spark plug cables and connect them on the grounding device.

### WARNING

Always use spark plug cable grounding device when removing spark plugs.

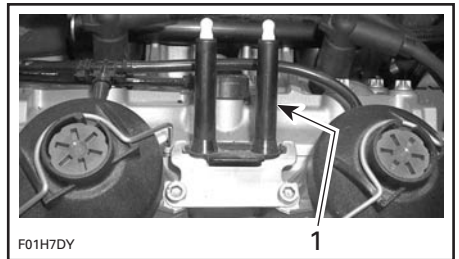

1. Grounding device

Remove both spark plugs and spray BOMBARDIER LUBE lubricant or equivalent into each cylinder.

To prevent fuel to be injected and also to cut the ignition at the engine starting, proceed as follows.

While engine is stopped, fully depress throttle lever and HOLD for cranking.

**NOTE:** A 1 second beep every second indicates the drowned mode is active.

Crank the engine a few turns to distribute the oil on cylinder wall.

Apply anti-seize lubricant on spark plug threads then reinstall them.

Properly reconnect spark plug cables to spark plugs.

 **WARNING**

Always reconnect spark plug cables at the same spark plugs where they come from. The cable coming out the edge of the electrical box must be connected to the MAG side spark plug.

Wipe up any residual water from the engine.

### **Anticorrosion Treatment**

To prevent corrosion, spray a corrosion inhibitor (salt water resistant) such as BOMBARDIER LUBE lubricant or equivalent over metallic components in engine compartment.

Apply dielectric grease (salt water resistant) on battery posts and cable connectors.

**CAUTION:** Never leave rags or tools in the engine compartment or in the bilge.

---

# SPECIAL PROCEDURES

## Limp Home Mode Monitoring System

To assist you when using the watercraft, a system monitors the electronic components of the fuel injection system and some components of the electrical system. When a fault occurs, it sends visual messages through the information center and/or audible signals through a beeper to inform you of a particular condition. Refer to the INFORMATION CENTER for the displayed messages and the TROUBLESHOOTING section for the beeper coded signals chart.

## Limp Home Modes

Besides the signals as seen above, the system may automatically set default parameters to the MPEM to ensure the adequate operation of the watercraft if a component of the fuel injection system is not operating properly.

Depending on the severity of the malfunction, the watercraft speed may be reduced and not allowed to reach its top speed as usual. In this case, letting the engine returning at idle speed may allow normal operation to come back.

The engine RPM may be limited to idle if some critical components fail. In this case, removing and reinstalling the safety lanyard on its post may allow normal operation to come back.

These performance-reduced modes allow the rider to go back home which would not be possible without this advanced system. If this occurs, see an authorized SEA-DOO dealer as soon as possible for inspection.

## Engine Overheating

**CAUTION:** If the monitoring beeper continuously sounds, **stop engine immediately.**

Perform **Jet Pump Water Intake and Impeller Cleaning** procedure described in this section.

When back to shore, flush cooling system, refer to POST-OPERATION CARE.

If engine still overheats, refer to an authorized SEA-DOO dealer for servicing.

## Jet Pump Water Intake and Impeller Cleaning

### **WARNING**

Keep away from intake grate while engine is on. Items such as long hair, loose clothing or personal flotation device straps can become entangled in moving parts resulting in severe injury or drowning.

Weeds, shells or debris can get caught on the intake grate, drive shaft and/or impeller. A clogged water intake may cause troubles such as:

1. **Cavitation:** Engine speed is high but watercraft moves slowly due to reduced jet thrust, jet pump components may be damaged.
2. **Overheating:** Since the jet pump operation controls the flow of water to cool the engine, a clogged intake will cause the engine to overheat and damage engine internal components.

A weed clogged area can be cleaned as follows:

### **In-Water Cleaning**

Rock the watercraft several times while repeatedly pressing engine start/stop button for short period without starting engine. Most of the time, this will remove the blockage. Start engine and make sure water flows out from bleed outlet and watercraft operates properly.

If system is still blocked, move the **watercraft** out of the water and remove blockage manually.

If the aforementioned method does not work, the following can be performed:

- With engine running and before applying throttle, put shift lever in reverse position and vary throttle quickly several times.
- Repeat procedure if necessary.

## On-Beach Water Cleaning

### **WARNING**

Always remove safety lanyard cap from its post to prevent accidental engine starting before cleaning the jet pump area.

Place a cardboard or a carpet beside the watercraft to prevent scratching when turning the watercraft for cleaning.

Rotating watercraft in the proper direction eliminates the possibility of residual water in the tuned pipe entering the engine and causing engine damage.

Rotate the watercraft **clockwise** (seen from rear) to its **right** side for cleaning.

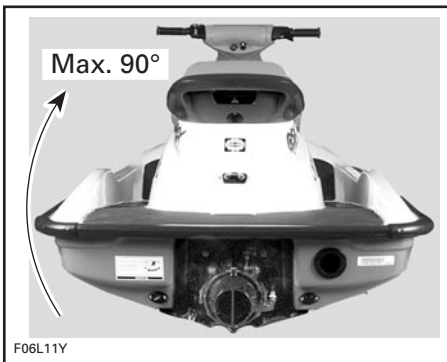

Clean the water intake area. If the system is still clogged, refer to an authorized SEA-DOO dealer for servicing.

**CAUTION:** Inspect water intake grate for damage. Refer to an authorized SEA-DOO dealer for repair as necessary.

## Capsized Watercraft

The watercraft is designed so that it should not turn over easily. Also two sponsons mounted on the side of the hull assist watercraft stability. If it turns over, it will remain capsized.

### **WARNING**

When watercraft is capsized, do not attempt to restart the engine. Operator and passengers should always wear approved personal flotation devices.

**CAUTION:** Always refer to decal located on stern of watercraft.

To return the watercraft upright, ensure the engine is off, grab the inlet grate, step on bumper rail and use your weight to rotate the watercraft.

Rotate the watercraft **counterclockwise** (seen from rear).

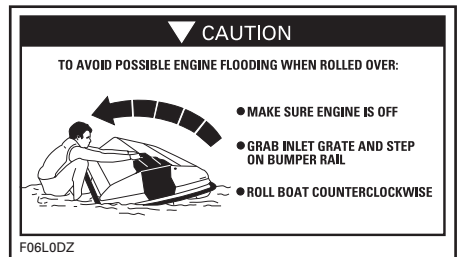

## Submerged Watercraft

If the watercraft is submerged and engine is water-flooded, it is strongly recommended that the watercraft be serviced by an authorized SEA-DOO dealer.



## Water-Flooded Engine

In the event the engine cannot be serviced within a few hours, remove spark plug cables and connect them on the grounding device.

### **WARNING**

Never crank engine with spark plugs removed unless spark plug cables are connected to the grounding device. Be careful when cranking engine, water will spray out from spark plug holes.

Remove spark plugs and dry them with a clean and dry cloth.

Cover spark plug holes with a rag.

To prevent fuel to be injected and also to cut the ignition at the engine starting, proceed as follows.

While engine is stopped, fully depress throttle lever and HOLD for cranking.

**NOTE:** A 1 second beep every second indicates the drowned mode is active.

Crank engine several times to allow water to escape from spark plug openings.

Release throttle lever.

If water does not completely go out, it may be necessary to remove the air intake silencer then to lean the vehicle so that water can flow out from throttle bodies.

Spray BOMBARDIER LUBE lubricant or equivalent into spark plug holes.

Crank engine again.

Reinstall spark plugs. Install clean dry spark plugs if possible. Reconnect cables.

### **WARNING**

Always reconnect spark plug cables at the same spark plugs where they come from. The cable coming out the edge of the electrical box must be connected to the MAG side spark plug.

Start engine normally.

## Out of Fuel

When running the engine out of fuel, it may be necessary to remove and install the safety lanyard 2 - 3 times to initially feed the fuel system after fuel tank refill.

## Towing the Watercraft in Water

Special precautions should be taken when towing a SEA-DOO watercraft in water.

Maximum recommended towing speed is 24 km/h (15 MPH).

When towing your watercraft in water, pinch the water supply hose from the impeller housing to the engine with a large hose pincher (P/N 529 032 500).

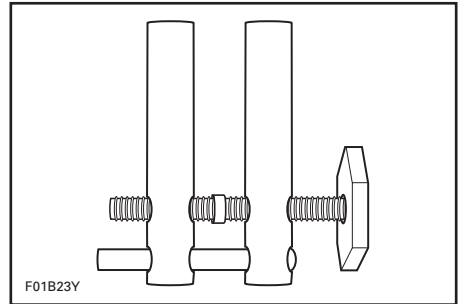

This will prevent the cooling system from filling which may lead to water being injected into and filling the exhaust system. Without the engine running there isn't any exhaust pressure to carry the water out the exhaust outlet.

**CAUTION:** Failure to do this may result in damage to the engine. If you must tow a stranded watercraft in water and do not have a hose pincher, be sure to stay well below the maximum towing speed of 24 km/h (15 MPH).

Snugly install the hose pincher on the water supply hose as shown.

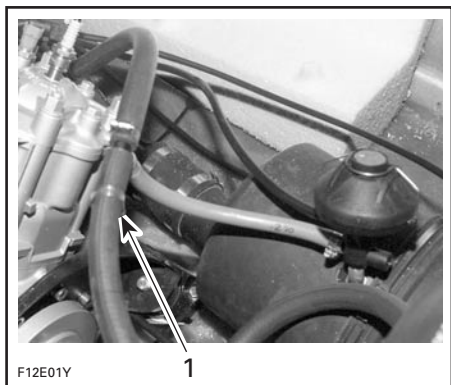

TYPICAL

1. Hose pincher on water supply hose on this side of the T-fitting

**CAUTION:** When finished towing the watercraft, hose pincher should be removed before operating it. Failure to do so will result in damage to the engine.

## Low-Charge Battery Condition

See an authorized SEA-DOO dealer to have it charged or replaced.

### **WARNING**

Do not charge or boost the battery while installed on the watercraft. Electrolyte is poisonous and dangerous. Avoid contact with eyes, skin and clothing.

---

# MAINTENANCE

Maintenance, replacement, or repair of the emission control devices and systems may be performed by any marine SI (spark ignition) engine repair establishments or individual.

## Engine Emissions Information

### Manufacturer's Responsibility

Beginning with 1999 model year engines, PWC manufacturers of marine engines must determine the exhaust emission levels for each engine horsepower family and certify these engines with the United States of America Environmental Protection Agency (EPA). An emissions control information label, showing emission levels and engine specifications, must be placed on each vehicle at the time of manufacture.

### Dealer's Responsibility

When performing service on all 1999 and more recent SEA-DOO watercrafts that carry an emissions control information label, adjustments must be kept within published factory specifications.

Replacement or repair of any emission related component must be executed in a manner that maintains emission levels within the prescribed certification standards.

Dealers are not to modify the engine in any manner that would alter the horsepower or allow emission levels to exceed their predetermined factory specifications.

Exceptions include manufacturer's prescribed changes, such as altitude adjustments for example.

### Owner Responsibility

The owner/operator is required to have engine maintenance performed to maintain emission levels within prescribed certification standards.

The owner/operator is not to, and should not allow anyone to modify the engine in any manner that would alter the horsepower or allow emissions levels to exceed their predetermined factory specifications.

### EPA Emission Regulations

All new 1999 and more recent SEA-DOO watercraft manufactured by Bombardier are certified to the EPA as conforming to the requirements of the regulations for the control of air pollution from new watercraft engines. This certification is contingent on certain adjustments being set to factory standards. For this reason, the factory procedure for servicing the product must be strictly followed and, whenever practicable, returned to the original intent of the design.

The responsibilities listed above are general and in no way a complete listing of the rules and regulations pertaining to the EPA requirements on exhaust emissions for marine products. For more detailed information on this subject, you may contact the following locations:

### VIA U.S. POSTAL SERVICE:

Office of Mobile Sources  
Engine Programs  
and Compliance Division  
Engine Compliance Programs  
Group (6403J)  
401 M St. NW  
Washington, DC 20460

### VIA EXPRESS or COURIER MAIL:

Office of Mobile Sources  
Engine Programs  
and Compliance Division  
Engine Compliance Programs  
Group (6403J)  
501 3<sup>rd</sup> St. NW  
Washington, DC 20001

EPA INTERNET WEB SITE:  
[www.epa.gov](http://www.epa.gov)

## WARNING

Only perform procedures as detailed in this guide. It is recommended that the assistance of an authorized SEA-DOO dealer be periodically obtained on other components/systems not covered in this guide. Unless otherwise specified, engine must not be running and the safety lanyard must be removed from its post for all maintenance procedures. Components inside engine compartment may be hot. Never use jet pump components to lift the watercraft.

## Lubrication

Use SEA-DOO synthetic grease or equivalent and lubricate PTO flywheel.

Proceed as follows:

Remove seat to expose engine compartment.

Remove vent tube support (if so equipped).

### PTO Flywheel

Remove the fasteners and pull out PTO flywheel guard.

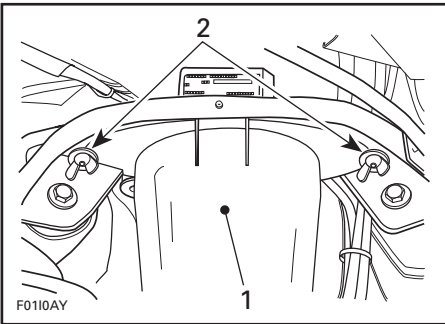

TYPICAL

1. Flywheel guard
2. Fasteners

Using a grease gun, carefully lubricate PTO flywheel at grease fitting until PTO flywheel boot **begins** to expand.

**CAUTION:** Immediately stop lubricating as soon as PTO flywheel boot begins to expand to prevent damage or slipping.

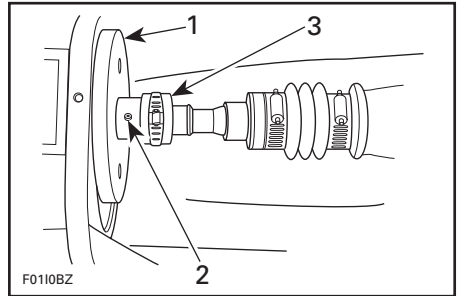

1. PTO flywheel
2. Grease fitting
3. PTO flywheel boot

Reinstall and secure PTO flywheel guard.

## Anticorrosion Protection

### Throttle Cable

Lubricate the throttle cable with BOMBARDIER LUBE lubricant or equivalent.

### Electrical Connections

As necessary, apply anticorrosion product such as dielectric grease on battery posts and all exposed cable connectors.

**CAUTION:** Do not lubricate connectors of the Multi-Purpose Electronic Module.

### Additional Lubrication

BOMBARDIER LUBE lubricant or equivalent will help prevent corrosion of metallic parts and maintain proper operation of moving mechanisms.

## WARNING

Do not lubricate the safety lanyard post.

## Seat Opening Mechanism, Tab, Hook and Lock Pin

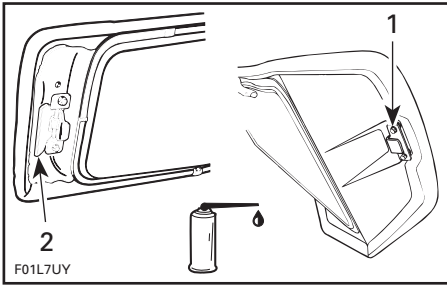

1. Front tab
2. Rear mechanism

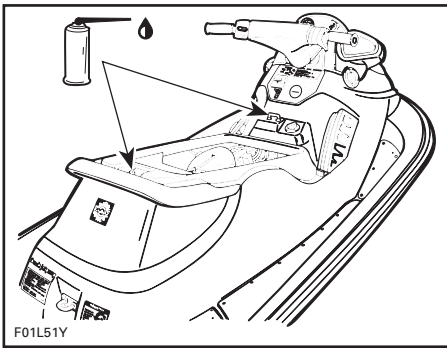

*TYPICAL*

### Reverse Gate

Lubricate pivoting points and mechanism.

## Periodic Inspection

Routine maintenance is necessary for all mechanized products. A periodic inspection contributes to the product's life span.

The following maintenance chart gives guidelines for regular watercraft servicing scheduled to be performed by you and/or by an authorized SEA-DOO dealer. The schedule should be adjusted according to operating conditions and use.

**IMPORTANT:** Schedule for watercraft rental operations or higher number of hour use, will require greater frequency of inspection and maintenance.

# Periodic Inspection Chart

DESCRIPTION		FREQUENCY				
		FIRST 10 HOURS	EVERY 25 HOURS OR 3 MONTHS	EVERY 50 HOURS OR 6 MONTHS	EVERY 100 HOURS OR 1 YEAR	TO BE PERFORMED BY
<b>GENERAL</b>	Lubrication/corrosion protection	①		✓		O
<b>ENGINE</b>	Support and rubber mount condition/tightness	✓		✓		D
	Exhaust system fasteners ④	✓		✓		D
	RAVE valve cleaning ④			✓	✓	D
	Top end inspection (leak test, piston and ring clearance) ④				⑧	D
	Counterbalance shaft oil level			✓	✓	D
	Spark plug inspection, cleaning and gap adjustment ⑤	✓				D
	Spark plug replacement ①			✓		D
TDC setting ④				⑧	D	
<b>COOLING SYSTEM</b>	Flushing		✓ ③			O
	Hose condition and fasteners	✓		✓		D
	Inspect/clean engine drain tubes		✓ ①			O
	Water flow regulator valve inspection				✓	D
<b>FUEL SYSTEM</b>	Throttle cable, inspection/lubrication	①	✓			O
	Fuel filter and lines inspection	✓	✓			D
	Fuel filter replacement				⑦	D
	Visually check for oil leakage between cylinder head and injector ④	✓		✓		D
	Fuel injection system sensors (except throttle body), visual inspection ④	✓			✓	D
	Throttle body cleaning and their sensors ④ ⑤	✓		✓		D
	Fuel vent line pressure relief valve inspection		✓			D
	Fuel lines, connections, check-valve and fuel system pressurization ④	✓	✓			D
	Visual inspection: throttle bodies, sensors, fuel lines, fuel rail and fittings ④	✓		✓		D
	Air intake silencer fit/tightness	✓			✓	D
	Fuel tank straps visual inspection	✓			✓	O
<b>LUBRICATION SYSTEM</b>	Oil injection pump adjustment ④	✓			✓	D
	Oil filter and lines inspection	✓	✓			D
	Oil filter replacement				✓	D
	Oil reservoir straps	✓				O

DESCRIPTION		FREQUENCY				
		FIRST 10 HOURS	EVERY 25 HOURS OR 3 MONTHS	EVERY 50 HOURS OR 6 MONTHS	EVERY 100 HOURS OR 1 YEAR	TO BE PERFORMED BY
ELECTRICAL SYSTEM	Electrical connections condition and fastening (ignition system, electrical box(es), starting system, fuel injectors, etc.)	✓		✓		D
	MPEM mounting brackets/fasteners			✓		D
	Digitally Encoded Security System	✓			✓	D
	Monitoring beeper	✓		✓		D
	Battery condition and strap(s)	✓		✓		D
STEERING SYSTEM	Inspection and cable adjustment	✓		✓		D
PROPULSION SYSTEM	Drive shaft boot and spline condition			✓ <sup>②</sup>		D
	Drive shaft protection hose inspection			✓ <sup>②</sup>		D
	PTO flywheel and seal carrier lubrication (if so equipped)	✓	✓			O
	Shifter system/cable adjustment	✓			✓	D
	Jet pump reservoir oil level/oil condition	Replace	✓	Replace		D
	Jet pump cover pusher inspection				✓	D
	Impeller shaft seal replacement				⑥	D
	Impeller condition and impeller/wear ring clearance			✓ <sup>②</sup>		D
Water intake grate condition			✓ <sup>②</sup>		O	
HULL AND BODY	Bailer pick-ups, check for obstructions	✓			✓	O
	Hull condition	✓			✓	O

**NOTE:** Some items are included in the PRE-OPERATION CHECKS and not necessarily repeated in this chart.

D: Dealer

O: Operator

① Every 10 hours in salt water use.

② These items have to be initially checked after 25 hours. Thereafter, servicing to be made as specified in this chart.

③ Daily flushing in salt water or foul water use.

④ Emission-related component.

⑤ In salt water use.

⑥ Replace at 150 hours.

⑦ Replace at 250 hours.

⑧ Check at 350 hours or 5 years.

## Throttle Cable Inspection

Depress and release the throttle lever. It should operate smoothly and return to its initial position without any hesitation. Refer to an authorized SEA-DOO dealer if necessary.

### **WARNING**

Do not alter or tamper with throttle cable adjustment or routing.

### **WARNING**

If throttle lever does not automatically return, do not operate watercraft and see your authorized SEA-DOO dealer.

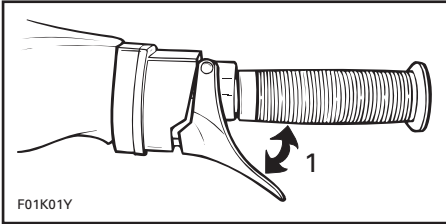

1. *Should move freely*

## Fuel Injection System

The fuel injection system inspection should be performed by an authorized SEA-DOO dealer.

**CAUTION:** Never use injector cleaning products. They may contain additives that could damage injector components.

## Fuel and Oil Filters

The fuel filter and the oil filter should be replaced by an authorized SEA-DOO dealer. Fuel system pressurization should be conducted at the same time.

**CAUTION:** An obstructed oil filter will cause oil starvation resulting in serious engine damage.

## Steering Alignment

When the handlebar is directed in straight ahead position, the jet pump nozzle should be in the same direction allowing the watercraft to run in a straight line.

Refer to an authorized SEA-DOO dealer if an adjustment is necessary.

### **WARNING**

Ensure the handlebar and jet pump nozzle operate freely from side to side and are not stressing the steering cable or brackets.

## Vacuum Bailer Pick-Ups

They are located each side of the drive shaft tunnel.

Two pick-ups use a low pressure area in the jet pump to siphon the water out of the bilge when the engine is operating.

Inspect each pick-up screen for obstructions, clean as necessary.

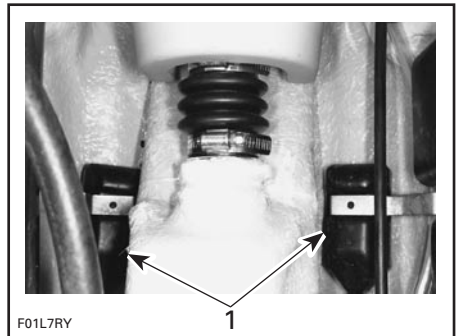

TYPICAL

1. *Vacuum bailer pick-ups*



## Fuses

If an electrical problem occurs, check the fuses. If a fuse is burnt, replace by one of the same rating. Follow procedures below.

### **WARNING**

Do not use a higher rated fuse as this can cause severe damage. If a fuse has burnt out, source of malfunction should be determined and corrected before restarting. See an authorized SEA-DOO dealer for servicing.

Fuses can be found at 2 locations; on the MPEM and in the rear electrical box.

### **MPEM**

To access fuses on the MPEM, open front storage compartment cover and remove storage basket.

Locate MPEM on the left side of watercraft.

Remove fuse cover from the MPEM.

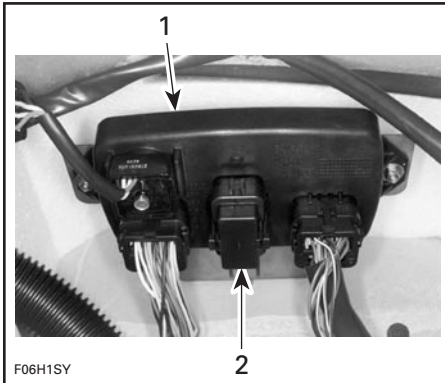

#### **TYPICAL**

1. MPEM
2. Fuse cover

Use the tabs of the fuse cover to remove and reinstall fuses.

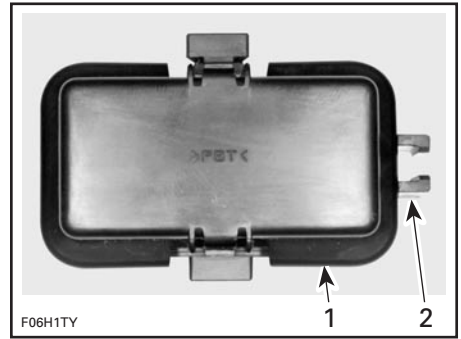

1. Fuse cover
2. Fuse tabs

### **Rear Electrical Box**

Remove seat.

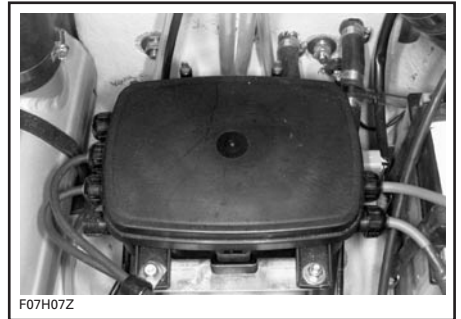

#### **TYPICAL**

Unclip and remove cover of the electrical box.

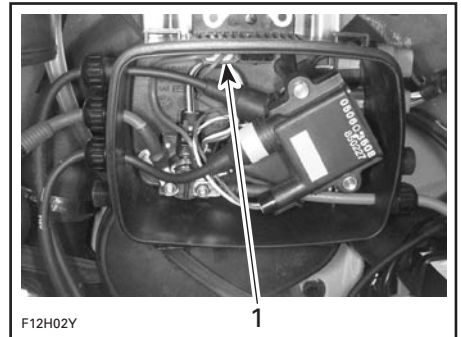

#### **TYPICAL**

1. Fuse holder

Properly reinstall removed components.

## General Inspection and Cleaning

### Inspection

Check engine compartment for any damage and fuel/oil injection systems for leaks. Ensure all hose clamps are properly secured and no hose is cracked, kinked or presenting any other damage.

#### **WARNING**

If any gasoline leak and/or odor are present, do not start the engine. Have the watercraft serviced by an authorized SEA-DOO dealer.

Inspect muffler, battery, fuel tank and oil reservoir fastening devices. Visually check electrical connections for corrosion and tightness.

Inspect hull and jet pump water intake grate for damage. Replace or have damaged parts repaired.

#### **WARNING**

Periodically verify the seat lock pin and tighten if needed. Make sure seat securely latches.

### Cleaning

The bilge should be cleaned by an authorized SEA-DO dealer to remove any fuel/oil/electrolyte deposits and mildew.

Occasionally, wash the body with water and soap (only use mild detergent). Remove any marine organisms from engine and/or hull. Apply non-abrasive wax such as silicone wax.

**CAUTION:** Never clean fiberglass and plastic parts with strong detergent, degreasing agent, paint thinner, acetone, etc.

Stains may be removed from seat and fiberglass with Knight's Spray-Nine from Korkay System Ltd or the equivalent.

Respect the environment by ensuring fuel, oil or cleaning solutions do not drain into the waterways.

---

# TRAILERING, STORAGE AND PRE-SEASON PREPARATION

## Trailering

Make sure that oil reservoir and fuel tank caps are properly installed.

### **WARNING**

Never tip this vehicle on end for transporting. We recommend that you carry the vehicle in its normal operating position.

Check the applicable laws and regulations in your area concerning towing a trailer, especially the following rules:

- brake system
- tow vehicle weight
- mirrors.

Take the following precautions when towing the watercraft:

Tie the watercraft to both bow and stern (front/rear) eyelets so that it is firmly retained on the trailer. Use additional tie-downs if necessary.

**CAUTION:** Do not route ropes or tie-downs over the seat as they could produce permanent damage. Wrap ropes or tie-downs with rags or similar protectors where they can touch the watercraft body.

Ensure all storage compartment covers and seat are properly latched.

### **WARNING**

Make sure seat is securely latched before prior to trailering.

A SEA-DOO cover can protect the watercraft, particularly before driving on dirt roads, to prevent dirt entry through the air intake opening(s).

Observe trailering safety precautions.

## Launching/Loading

**CAUTION:** Before launching the watercraft, ensure the bilge plugs are fully screwed. After loading the watercraft, ensure they are removed to drain bilge.

## Storage

### **WARNING**

Because fuel and oil are inflammable, have an authorized SEA-DOO dealer inspect the fuel and oil systems integrity as specified in the periodic inspection chart.

It is recommended that the watercraft be serviced by an authorized SEA-DOO dealer for storage but the following operations can be performed by you with a minimum of tools.

**CAUTION:** Do not run the engine during the storage period.

## Engine Draining

Check engine drain hose (lowest hose of engine). Make sure there is no sand or other particles in it and that it is not obstructed so that water can exit the engine. Clean hose and fitting as necessary.

**CAUTION:** Water in engine drain hose should be free to flow out, otherwise water could be trapped in engine. Should water freeze in engine, severe damage will occur. Check engine drain hose for obstructions.

Disconnect the quick connect fitting. Press both tabs and pull fitting.

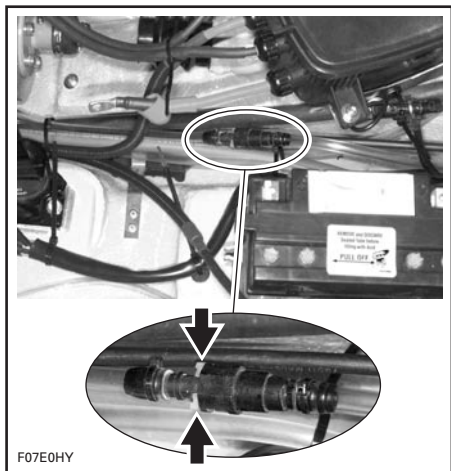

**DISCONNECT THIS HOSE**

Lower hose as necessary so that draining can take place.

Reconnect fitting when done.

Also ensure air compressor drain line is not obstructed. Clean as necessary.

**Body Rinsing/Repair**

Wash the body with soap and water solution (only use mild detergent). Rinse thoroughly with **fresh water**. Remove marine organisms from the hull.

**CAUTION:** Never clean fiberglass and plastic parts with strong detergent, degreasing agent, paint thinner, acetone, etc.

For small gelcoat repairs, refer to an authorized SEA-DOO dealer. Replace damaged labels/decals.

**Propulsion System**

Lubricant in jet pump reservoir should be drained and reservoir cleaned. Refer to an authorized SEA-DOO dealer for this operation.

Grease lubrication point(s) of propulsion system as explained in MAINTENANCE section.

**Fuel System**

SEA-DOO fuel stabilizer (or equivalent), can be added in fuel tank to prevent fuel deterioration. Follow manufacturer's instructions for proper use.

**CAUTION:** Fuel stabilizer should be added prior to engine lubrication to ensure fuel system components protection against varnish deposits.

**⚠ WARNING**

Fuel is flammable and explosive under certain conditions. Always work in a well ventilated area. Do not smoke or allow open flames or sparks in the vicinity. Fuel tank may be pressurized, slowly turn cap when opening. Never use an open flame to check fuel level. When fueling, keep watercraft level. Do not overfill or top off the fuel tank and leave watercraft in the sun. As temperature increases, fuel expands and might overflow. Always wipe any fuel spillage from the watercraft.

**Cooling System Flushing and Engine Internal Lubrication**

Refer to procedure in POST-OPERATION CARE.

**Battery**

Contact your authorized SEA-DOO dealer.

**Antifreezing Protection**

**NOTE:** This procedure requires approximately 2.5 L (2.6 U.S. qt.) of antifreeze.

In cool regions where freezing point may be encountered, cooling system should be filled with an equal part of water and antifreeze solution.

**CAUTION:** Antifreeze mix must be fed in cooling system. Otherwise remaining water will freeze. This operation requires a good technical knowledge of the cooling system path. If antifreezing is not performed adequately engine/exhaust system may freeze and cause severe engine damage. We strongly recommend this operation be performed by an authorized SEA-DOO dealer.

**CAUTION:** Always use ethylene glycol antifreeze containing corrosion inhibitors specifically recommended for aluminum engines.

**NOTE:** When available, it is recommended to use biodegradable antifreeze compatible with internal combustion aluminum engines. This will contribute to protect the environment.

**NOTE:** The engine will not have to run during this operation but should have been ran before, to exhaust as much water as possible, from cooling system components.

**NOTE:** On some models, it may be easier to reach hoses when you remove the seat opening bridge.

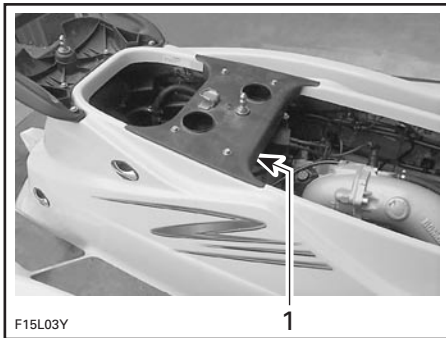

1. Seat opening bridge

### Hose Pinchers Installation

Some hoses have to be plugged to prevent draining, before filling cooling system jackets with the antifreeze.

Install hose pinchers at the following location:

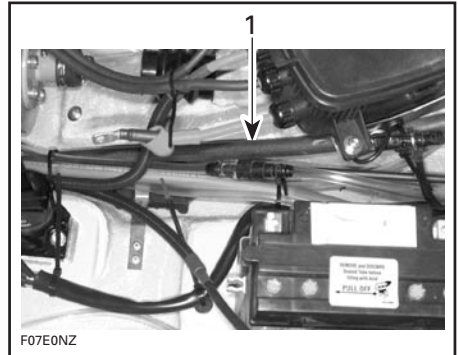

#### TYPICAL

1. Water outlet hose

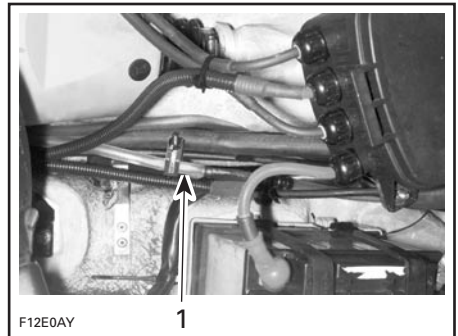

1. Crankcase cooling cover outlet hose

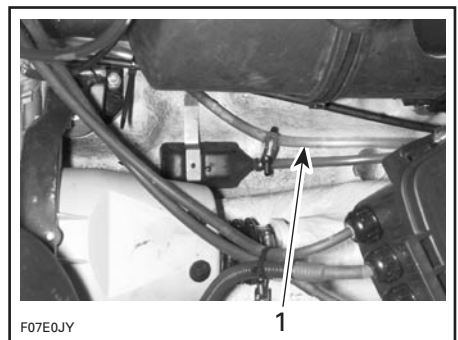

1. Engine cylinder drain hose

## Hose Disconnection

Disconnect water INLET hose at engine between T-fitting and cylinder head fitting.

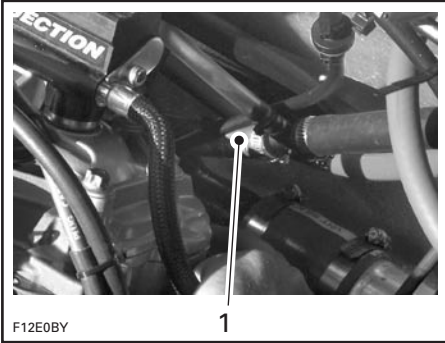

1. Disconnect this side of the T-fitting

Temporarily install a short piece of hose to replace the one removed.

## Antifreeze

Insert a funnel into the temporary hose and pour antifreeze mix in engine until the colored solution appears at cooling system bleed outlet.



At this point, install a hose pincher on bleed outlet hose.

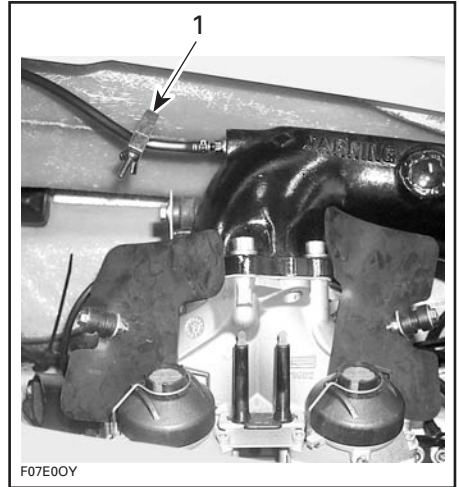

1. Bleed outlet hose

Continue to pour until antifreeze flows in air compressor water outlet hose.

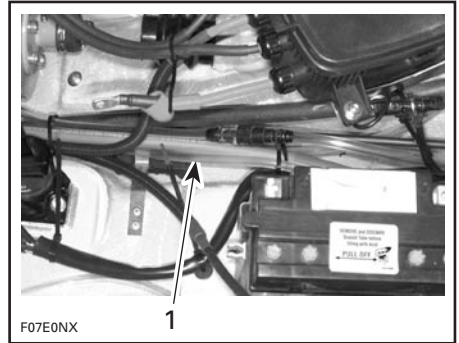

1. Air compressor water outlet hose

Remove pinchers in this order to allow proper flow of antifreeze.

1. Bleed outlet hose.
2. Crankcase cooling cover outlet hose.
3. Engine cylinder drain hose.
4. Water outlet hose.

Pour approximately 200 mL (7 oz) of antifreeze in the water regulator valve supply hose to allow antifreeze flowing through the valve and into muffler to protect it.

Remove temporary hose and reconnect engine water outlet hose.

Most of the antifreeze will drain out when removing the hose pinchers. Use a container to recover it. **DISPOSE ANTIFREEZE AS PER YOUR LOCAL LAWS AND REGULATIONS.**

**NOTE:** Although antifreeze will mainly drain out, the antifreeze has mixed with the water that was possibly trapped in the water jackets and thus preventing freezing problems.

At pre-season preparation, drain the remaining antifreeze from cooling system prior to using the watercraft.

The following steps should be performed to provide the watercraft enhanced protection.

Clean the bilge with hot water and detergent or with bilge cleaner. Rinse thoroughly. Lift front end of watercraft to completely drain bilge. If any repairs are needed to body or to the hull contact your authorized SEA-DOO dealer. For paint touch up to mechanical parts use Bombardier spray paint.

Reinstall vent tube support (if applicable).

### Anticorrosion Treatment

Wipe off any residual water in the engine compartment.

Spray BOMBARDIER LUBE lubricant or equivalent over metallic components in engine compartment.

#### **WARNING**

Do not lubricate the safety lanyard post.

Lubricate the throttle cable with BOMBARDIER LUBE lubricant or equivalent.

### Final Steps

Apply a good quality marine wax to the body.

The seat and the seat extension (if so equipped) should be partially left opened, the rear access cover and storage baskets (if so equipped) should be removed during storage. This will avoid engine compartment condensation and possible corrosion.

If the watercraft is to be stored outside, cover it with an opaque tarpaulin to prevent sun rays and grime from affecting the plastic components, watercraft finish as well as preventing dust accumulation.

**CAUTION:** The watercraft should never be left in water for storage. Never leave the watercraft stored in direct sunlight.

### Pre-Season Preparation

Use the following chart.

Since technical skills and special tools are required, some operations should be performed by an authorized SEA-DOO dealer.

#### **WARNING**

Only perform procedures as detailed in this guide. It is recommended that the assistance of an authorized SEA-DOO dealer be periodically obtained on other components/systems not covered in this guide. Unless otherwise specified, engine must not be running and the safety lanyard must be removed from its post for all maintenance procedures. Components inside engine compartment may be hot. When component conditions seem less than satisfactory, replace with genuine BOMBARDIER parts or approved equivalents.

## Pre-Season Preparation Chart

NOTE: It is highly recommended that an authorized SEA-DOO dealer perform the annual safety inspection and factory campaigns in addition to the pre-season preparation all at the same time.

	OPERATIONS	TO BE PERFORMED BY
<b>GENERAL</b>	Lubrication/corrosion protection	Operator
	Spark plug replacement ①	Dealer
<b>ENGINE</b>	Exhaust system condition (fasteners, hoses etc.)	Dealer
	RAVE valve cleaning	Dealer
	Counterbalance shaft oil level	Dealer
	TDC setting	Dealer
	Air compressor, visual condition of hoses. Check for leaks <b>CAUTION: Main hose between compressor and fuel rail may be hot.</b>	Dealer
<b>COOLING SYSTEM</b>	Inspection of cooling system hoses and components	Dealer
<b>FUEL SYSTEM</b>	Throttle ② cable inspection/adjustment	Dealer
	Fuel filter replacement	Dealer
	Fuel injection sensors verification	Dealer
	Fuel system; check valves, lines, fasteners, pressurization ②	Dealer
	Direct injector, check for leakage	Dealer
	Filler neck, fuel tank and fuel cap condition ②	Dealer
	Fuel tank straps	Operator
	Refill fuel tank	
<b>LUBRICATION SYSTEM</b>	Oil injection pump adjustment and bleeding	Dealer
	Oil filter replacement	Dealer
	Oil injection reservoir straps	Operator
	Oil injection reservoir filling	Operator
<b>ELECTRICAL SYSTEM</b>	Battery condition/charging and reinstallation	Dealer
	Battery, starter connections and routing ②	Dealer
	Monitoring beeper	Dealer
	Digitally encoded security system	Dealer
<b>STEERING SYSTEM</b>	Steering system adjustment/inspection ②	Dealer
<b>PROPULSION SYSTEM</b>	Shifter system condition and cable adjustment	Dealer
	Propulsion system inspection	Dealer
	Jet pump oil replacement	Dealer
<b>HULL AND BODY</b>	Inspection of bailer pick-ups	Dealer

① Before installing new spark plugs, it is suggested to burn the excess BOMBARDIER LUBE lubricant or equivalent by starting the engine using the old spark plugs.

② Safety item covered in the annual safety inspection.



# TROUBLESHOOTING

The following chart is provided to help in diagnosing the probable source of simple troubles. You may be able to solve many of these problems rather quickly, but others may require the skills of a mechanical technician. In such cases, consult an authorized SEA-DOO dealer for servicing.

## Monitoring Beeper Coded Signals

CODED SIGNALS	POSSIBLE CAUSE	REMEDY
2 short beeps (while installing safety lanyard on post).	<ul style="list-style-type: none"> <li>• Confirms safety lanyard signal operation.</li> </ul>	Engine can be started.
1 long beep (while installing safety lanyard on watercraft post or when pressing engine start/stop button).	<ul style="list-style-type: none"> <li>• Safety lanyard on post for more than 10 minutes without starting engine.</li> <li>• Bad connection.</li> <li>• Wrong safety lanyard.</li> <li>• Defective safety lanyard.</li> <li>• Dried salt water in safety lanyard cap.</li> <li>• Improper operation of MPEM or defective wiring harness.</li> </ul>	<p>Apply a slight pressure or remove and reinstall safety lanyard on post.</p> <p>Reinstall safety lanyard cap correctly over post.</p> <p>Use a safety lanyard that has been programmed for the watercraft.</p> <p>Use another programmed safety lanyard.</p> <p>Clean safety lanyard cap to remove salt water.</p> <p>Refer to an authorized SEA-DOO dealer.</p>
1 second beep every second intervals.	<ul style="list-style-type: none"> <li>• Engine drowned mode is active.</li> </ul>	Release throttle to cancel this mode.
A 2 seconds beep every 2 seconds intervals.	<ul style="list-style-type: none"> <li>• Exhaust system overheat.</li> </ul>	See engine OVERHEATING.
A 2 seconds beep every minute intervals.	<ul style="list-style-type: none"> <li>• Fuel tank level is low.</li> <li>• Very low battery voltage.</li> <li>• Coolant and exhaust gas temperature sensors or TPS (throttle position sensor) or CPS (crankshaft position sensor) malfunction.</li> <li>• MPEM malfunction.</li> </ul>	<p>Refill as soon as possible.</p> <p>Refer to an authorized SEA-DOO dealer.</p> <p>Refer to an authorized SEA-DOO dealer.</p> <p>Refer to an authorized SEA-DOO dealer.</p>
A 2 seconds beep every 15 minutes intervals.	<ul style="list-style-type: none"> <li>• Oil injection reservoir level is low.</li> </ul>	Refill.
Continuously beeps.	<ul style="list-style-type: none"> <li>• Engine overheats.</li> </ul>	See engine OVERHEATING.

## Engine Will Not Start

OTHER OBSERVATION	POSSIBLE CAUSE	REMEDY
Engine does not turn over.	<ul style="list-style-type: none"> <li>• Safety lanyard removed.</li> <li>• Burnt fuse on MPEM or in rear electrical box: battery, starting system, fuel pump.</li> <li>• Discharged battery.</li> <li>• Battery connections, corroded or loose.</li> <li>• Water-flooded engine.</li> <li>• Faulty sensor or MPEM.</li> <li>• Seized engine.</li> <li>• Seized jet pump.</li> </ul>	<p>Install cap over post.</p> <p>Check wiring then replace fuse(s).</p> <p>Refer to an authorized SEA-DOO dealer.</p> <p>Refer to an authorized SEA-DOO dealer.</p> <p>Refer to WATER-FLOODED ENGINE in SPECIAL PROCEDURES.</p> <p>Refer to an authorized SEA-DOO dealer.</p> <p>Refer to an authorized SEA-DOO dealer.</p> <p>Try to clean. Otherwise, refer to an authorized SEA-DOO dealer.</p>
Engine turns slowly.	<ul style="list-style-type: none"> <li>• Loose battery cable connections.</li> <li>• Discharged or weak battery.</li> <li>• Worn starter.</li> </ul>	<p>Check/clean/tighten.</p> <p>Refer to an authorized SEA-DOO dealer.</p> <p>Refer to an authorized SEA-DOO dealer.</p>
Engine turns normally.	<ul style="list-style-type: none"> <li>• Fuel tank empty or water-contaminated.</li> <li>• Fouled/defective spark plugs.</li> <li>• Faulty component in the fuel injection system.</li> <li>• Burnt fuel pump fuse.</li> <li>• Electrical problem.</li> </ul>	<p>Refill. Siphon and fill with fresh fuel.</p> <p>Replace.</p> <p>Refer to an authorized SEA-DOO dealer.</p> <p>Check wiring then replace fuse.</p> <p>Refer to an authorized SEA-DOO dealer.</p>

## Engine Misfires, Runs Irregularly

OTHER OBSERVATION	POSSIBLE CAUSE	REMEDY
Weak spark.	<ul style="list-style-type: none"> <li>• Fouled/defective/worn spark plugs.</li> <li>• Faulty MPEM.</li> <li>• Too much oil supplied to engine.</li> </ul>	<p>Replace.</p> <p>Refer to an authorized SEA-DOO dealer.</p> <p>Improper oil pump adjustment, refer to an authorized SEA-DOO dealer.</p>
Lean fuel mixture.	<ul style="list-style-type: none"> <li>• Fuel: Level too low, stale or water-contaminated.</li> <li>• Clogged injectors.</li> <li>• Defective sensor or MPEM.</li> </ul>	<p>Siphon and/or refill.</p> <p>Refer to an authorized SEA-DOO dealer.</p> <p>Refer to an authorized SEA-DOO dealer.</p>
Rich fuel mixture (high fuel consumption).	<ul style="list-style-type: none"> <li>• Flame arrester dirty/clogged (if so equipped).</li> <li>• Defective sensor or MPEM.</li> </ul>	<p>Clean or replace.</p> <p>Refer to an authorized SEA-DOO dealer.</p>

## Engine Overheats

OTHER OBSERVATION	POSSIBLE CAUSE	REMEDY
Monitoring beeper sounds continuously.	<ul style="list-style-type: none"> <li>• Clogged jet pump water intake.</li> <li>• Clogged coolant system.</li> </ul>	Clean. Flush cooling system.

## Engine Continually Backfires

OTHER OBSERVATION	POSSIBLE CAUSE	REMEDY
Weak spark.	<ul style="list-style-type: none"> <li>• Fouled/defective/worn spark plugs.</li> </ul>	Replace.
Overheated engine.	<ul style="list-style-type: none"> <li>• See engine OVERHEATS.</li> <li>• Spark plug leads or wiring reversed.</li> </ul>	Refer to an authorized SEA-DOO dealer. Connect spark plug cables at their proper location. Otherwise, refer to an authorized SEA-DOO dealer.

## Engine Pinging or Knocking

OTHER OBSERVATION	POSSIBLE CAUSE	REMEDY
	<ul style="list-style-type: none"> <li>• Poor quality gasoline/low octane.</li> <li>• Spark plug heat range too high.</li> <li>• Ignition timing or TDC setting.</li> </ul>	Use well known quality and recommended gasoline. Use recommended spark plugs. Refer to an authorized SEA-DOO dealer.

## Engine Lacks Acceleration or Power

OTHER OBSERVATION	POSSIBLE CAUSE	REMEDY
	<ul style="list-style-type: none"> <li>• Weak spark.</li> <li>• Water in fuel or injection oil.</li> </ul>	Refer to engine MISFIRES, RUNS IRREGULARLY. Siphon and replace.
Overheated engine.	<ul style="list-style-type: none"> <li>• Clogged injectors.</li> <li>• Low fuel pressure.</li> <li>• Stuck RAVE valves.</li> </ul>	See engine OVERHEATS. Refer to an authorized SEA-DOO dealer. Refer to an authorized SEA-DOO dealer. Refer to an authorized SEA-DOO dealer.

## Watercraft Engine Cannot Run Above Idle Speed

OTHER OBSERVATION	POSSIBLE CAUSE	REMEDY
	<ul style="list-style-type: none"> <li>• The monitoring system put the watercraft in limp home mode due to a component malfunction.</li> </ul>	Try removing and reinstalling the safety lanyard on its post. Refer to an authorized SEA-DOO dealer.

## Watercraft Can Not Reach Top Speed

OTHER OBSERVATION	POSSIBLE CAUSE	REMEDY
Cavitation.	<ul style="list-style-type: none"><li>• Jet pump water intake clogged.</li><li>• Damaged impeller.</li><li>• The safety lanyard used purposely does not allow watercraft top speed.</li><li>• The monitoring system put the watercraft in limp home mode due to a component malfunction.</li></ul>	<p>Clean.</p> <p>Replace. Refer to an authorized SEA-DOO dealer.</p> <p>Use a safety lanyard that allows to reach the top speed.</p> <p>Release throttle so that engine returns to idle speed. Refer to an authorized SEA-DOO dealer.</p>

## Abnormal Noise From Propulsion System

OTHER OBSERVATION	POSSIBLE CAUSE	REMEDY
Cavitation.	<ul style="list-style-type: none"><li>• Weeds or debris jammed around impeller.</li><li>• Damaged impeller shaft or drive shaft.</li></ul>	<p>Clean and check for damage.</p> <p>Refer to an authorized SEA-DOO dealer.</p>

# SPECIFICATIONS

ENGINE		LRV DI
Engine type		Rotax 947, 2-stroke
Induction type		Reed valve
Exhaust system		Water cooled/water injected with regulator
Exhaust valve		Rotax Adjustable Variable Exhaust (RAVE)
Lubrication	Type	Oil injection
	Oil type	BOMBARDIER Formula XP-S synthetic injection oil (or equivalent)
Number of cylinders		2
Displacement		951.2 cm <sup>3</sup> (58 in <sup>3</sup> )
Rev limiter setting		7200 ± 50 RPM
COOLING		
Type		Open circuit. Direct flow from propulsion unit
ELECTRICAL		
Magneto generator output		270 W @ 6000 RPM
Ignition system type		Digital inductive type
Spark plug	Make and type	NGK, ZFR4F
	Gap	1.1 mm (.043 in)
Starting system		Electric starter with reduction gear
Battery		12 V, 19 A•h
Fuse	Battery	25 A
	Main	30 A
	MPEM	N.A.
	Charging system (REG)	25 A
	Information center	N.A.
	Injection system (INJ)	N.A.
	Fuel pump (FP)	N.A.
CARBURETION		
Fuel type		Unleaded regular gasoline with 87 minimum octane (R+M)/2
Fuel injection		Orbital direct fuel injection, twin throttle body (46 mm (1.81 in))

N.A.: Not Applicable.

<b>PROPULSION</b>		<b>LRV DI</b>
Propulsion system		Bombardier Formula pump
Jet pump type		Axial flow, single stage
Transmission		Direct drive
Reverse system		Yes
Jet pump oil type		SEA-DOO synthetic polyolester oil SAE 75W90 GL5
Pivoting angle of direction (nozzle)		~ 23°
Minimum required water level for jet pump		90 cm (3 ft)
<b>DIMENSIONS</b>		
Number of passengers ①		4
Overall length		396 cm (156 in)
Overall width		155 cm (61 in)
Overall height		108 cm (42.5 in)
Weight		432 kg (952 lb)
Load limit (passengers + luggage)		338 kg (745 lb)
<b>CAPACITIES</b>		
Fuel tank		95 L (25 U.S. gal)
Oil injection tank		6 L (1.6 U.S. gal)
Impeller shaft reservoir	Capacity	115 mL (3.9 U.S. oz)
	Oil level	Up to plug

① Refer to load limit.

BOMBARDIER INC. reserves the right to make changes in design and specifications and/or to make additions to, or improvements in its products without imposing any obligation upon itself to install them on its products previously manufactured.

# SI\* METRIC INFORMATION

BASE UNITS			
DESCRIPTION	UNIT	SYMBOL	
length .....	meter .....	m	
mass .....	kilogram .....	kg	
force .....	newton .....	N	
liquid .....	liter .....	L	
temperature .....	Celsius .....	°C	
pressure .....	kilopascal .....	kPa	
torque .....	newton-meter .....	N•m	
land velocity .....	kilometer per hour .....	km/h	
navigation velocity .....	knot .....	kn	
PREFIXES			
PREFIX	SYMBOL	MEANING	VALUE
kilo .....	k .....	one thousand .....	1000
centi .....	c .....	one hundredth of .....	0.01
milli .....	m .....	one thousandth of .....	0.001
micro .....	μ .....	one millionth of .....	0.000001
CONVERSION FACTORS			
TO CONVERT	TO ①	MULTIPLY BY	
in .....	mm .....	25.4	
in .....	cm .....	2.54	
in <sup>2</sup> .....	cm <sup>2</sup> .....	6.45	
in <sup>3</sup> .....	cm <sup>3</sup> .....	16.39	
ft .....	m .....	0.3	
oz .....	g .....	28.35	
lb .....	kg .....	0.45	
lbf .....	N .....	4.4	
lbf•in .....	N•m .....	0.11	
lbf•ft .....	N•m .....	1.36	
lbf•ft .....	lbf•in .....	12	
PSI .....	kPa .....	6.89	
imp. oz .....	U.S. oz .....	0.96	
imp. oz .....	mL .....	28.41	
imp. gal .....	U.S. gal .....	1.2	
imp. gal .....	L .....	4.55	
U.S. oz .....	mL .....	29.57	
U.S. gal .....	L .....	3.79	
knot .....	MPH .....	1.15	
MPH .....	km/h .....	1.61	
Fahrenheit .....	Celsius .....	(°F - 32) ÷ 1.8	
Celsius .....	Fahrenheit .....	(°C x 1.8) + 32	
hp .....	kW .....	.75	

\* The international system of units abbreviates SI in all languages.

① To obtain the reverse sequence, divide by the given factor. Example: to convert millimeters to inches, divide by 25.4.

NOTE: Conversion factors are rounded off to 2 decimals for easier use.

---

## ABBREVIATIONS USED IN THIS MANUAL

	DESCRIPTION
AC	Alternate current
CDI	Capacitor discharge ignition
DC	Direct current
DESS	Digitally encoded security system
DI	Direct injection
ECU	Electronic control unit
E.I.N.	Engine identification number
EPA	Environmental protection agency
HP	Horse power
LCD	Liquid crystal display
LED	Light-emitting diode
MAG	Magneto
MPEM	Multi-purpose electronic module
MPH	Mile per hour
N.A.	Not applicable
OPT	Optional
PFD	Personal flotation device
P/N	Part number
PTO	Power take off
RAVE	Rotax adjustable variable exhaust
STD	Standard
TBD	To be determined
TDC	Top dead center
VROI	Variable rate oil injection



---

# **PRIVACY INFORMATION**

We wish to inform you that your coordinates will be used for safety and warranty purposes. Sometimes, we also use the coordinates of our clients to inform them about our products and to present them offers. Should you prefer not to receive information on our products, services and offers, please let us know by writing to the address below.

Also note that, from time to time, carefully selected and trustworthy organizations may be permitted to use the coordinates of our clients to promote quality products and services. If you prefer not to have your name and address released, please let us know by writing to the address below:

**BOMBARDIER INC.  
RECREATIONAL PRODUCTS**

**WARRANTY DEPARTMENT  
75, J.A. BOMBARDIER STREET  
SHÉRBROOKE, QUÉBEC  
CANADA J1L 1W3**

**FAX NUMBER (819) 566-3590**

**BOMBARDIER**  
*RECREATIONAL PRODUCTS*



# CHANGE OF ADDRESS

If your address has changed, be sure to fill out and mail the card provided on this page.

Such notification is likewise necessary for your own safety even after expiration of the original warranty, since Bombardier will be in a position to contact you if correction to your watercraft becomes necessary.

**NOTE:** This card is strictly for change of address only.

## CHANGE OF ADDRESS



CHANGE OF ADDRESS

### WATERCRAFT IDENTIFICATION NUMBERS

--	--	--	--	--	--	--	--	--	--	--	--	--	--	--	--	--

Model Number

Hull Identification Number (H.I.N.)

OLD ADDRESS:

\_\_\_\_\_

NAME

NO.

STREET

APT

CITY

STATE/PROVINCE

ZIP/POSTAL CODE

NEW ADDRESS:

\_\_\_\_\_

NAME

NO.

STREET

APT

CITY

STATE/PROVINCE

ZIP/POSTAL CODE

### STOLEN UNITS

In the event that your watercraft is stolen, you should notify your area's distributor warranty department of such.

Please provide your name, address, phone number, Hull Identification Number and date it was stolen.

Bombardier will provide a list of stolen units to all authorized Sea-Doo dealers on a monthly basis to aid in recovery of such units to their owners.



AFFIX  
PROPER  
POSTAGE

**BOMBARDIER**  
RECREATIONAL PRODUCTS  
WARRANTY DEPARTMENT  
75, J.A. BOMBARDIER ST.  
SHERBROOKE (QUEBEC)  
CANADA J1L 1W3

# CHANGE OF ADDRESS

If your address has changed, be sure to fill out and mail the card provided on this page.

Such notification is likewise necessary for your own safety even after expiration of the original warranty, since Bombardier will be in a position to contact you if correction to your watercraft becomes necessary.

**NOTE:** This card is strictly for change of address only.

## CHANGE OF ADDRESS



---

**CHANGE OF ADDRESS**

---

**WATERCRAFT IDENTIFICATION NUMBERS**

--	--	--	--	--	--	--	--	--	--	--	--	--	--	--	--	--	--	--	--	--	--	--	--

Model Number	Hull Identification Number (H.I.N.)
--------------	-------------------------------------

**OLD ADDRESS:** \_\_\_\_\_

NAME		
NO.	STREET	APT
CITY	STATE/PROVINCE	ZIP/POSTAL CODE

**NEW ADDRESS:** \_\_\_\_\_

NAME		
NO.	STREET	APT
CITY	STATE/PROVINCE	ZIP/POSTAL CODE

## STOLEN UNITS

In the event that your watercraft is stolen, you should notify your area's distributor warranty department of such.

Please provide your name, address, phone number, Hull Identification Number and date it was stolen.

Bombardier will provide a list of stolen units to all authorized Sea-Doo dealers on a monthly basis to aid in recovery of such units to their owners.



AFFIX  
PROPER  
POSTAGE

**BOMBARDIER**  
RECREATIONAL PRODUCTS  
WARRANTY DEPARTMENT  
75, J.A. BOMBARDIER ST.  
SHERBROOKE (QUEBEC)  
CANADA J1L 1W3

**WATERCRAFT MODEL No.** \_\_\_\_\_

**HULL**

IDENTIFICATION NUMBER (H.I.N.) \_\_\_\_\_

**ENGINE**

IDENTIFICATION NUMBER (E.I.N.) \_\_\_\_\_

**Owner:** \_\_\_\_\_  
NAME

\_\_\_\_\_  
No. STREET APT

\_\_\_\_\_  
CITY STATE/PROVINCE ZIP/POSTAL CODE

**Purchase Date** \_\_\_\_\_  
YEAR MONTH DAY

**Warranty Expiry Date** \_\_\_\_\_  
YEAR MONTH DAY

To be completed by the authorized Sea-Doo dealer at the time of the sale.

DEALER IMPRINT AREA

**Please verify with your selling dealer to ensure your SEA-DOO watercraft has been registered with Bombardier.**



®™ TRADEMARKS OF BOMBARDIER INC. OR ITS SUBSIDIARIES.  
©2002 BOMBARDIER INC. ALL RIGHTS RESERVED  
PRINTED IN CANADA