

# can-am™



## 2014 ROADSTER OPERATOR'S GUIDE

Includes Safety, Vehicle  
and Maintenance Information

# SPYDER™ ST

### WARNING

**Learn how the Spyder roadster is different.**

**Read** this operator's guide and watch the safety DVD.

**Complete** a training course (if available), practice and become proficient with the controls.

**Consult** local laws - license requirements vary by location.

**Keep** this guide in the front storage compartment.

2 1 9 0 0 1 2 2 1

Original Instructions





In Canada, products are distributed by Bombardier Recreational Products Inc.

In USA, products are distributed by BRP US Inc.

This is a non-exhaustive list of trademarks that are the property of Bombardier Recreational Products Inc. or its affiliates:

Rotax®

Spyder™

XPS™



iPhone, iPod, iPod nano and iPod touch are trademarks of Apple Inc. registered in U.S.A. and other countries.

"Made for iPod" and "Made for iPhone" mean that an electronic accessory has been designed to connect specifically to iPod or iPhone, respectively, and has been certified by the developer to meet Apple performance standards. Apple is not responsible for the operation of this device or its compliance with safety and regulatory standards. Please note that the use of this accessory with iPod or iPhone may affect wireless performance.

# FOREWORD

Deutsch	Dieses Handbuch ist möglicherweise in Ihrer Landessprache verfügbar. Bitte wenden Sie sich an Ihren Händler oder besuchen Sie: <a href="http://www.operatorsguide.brp.com">www.operatorsguide.brp.com</a> .
English	This guide may be available in your language. Check with your dealer or go to: <a href="http://www.operatorsguide.brp.com">www.operatorsguide.brp.com</a> .
Español	Es posible que este manual esté disponible en su idioma. Consulte a su distribuidor o visite: <a href="http://www.operatorsguide.brp.com">www.operatorsguide.brp.com</a> .
Français	Ce guide peut être disponible dans votre langue. Vérifier avec votre concessionnaire ou aller à: <a href="http://www.operatorsguide.brp.com">www.operatorsguide.brp.com</a> .
日本語	このガイドは、言語によって翻訳版が用意されています。ディーラーに問い合わせるか、次のアドレスでご確認ください： <a href="http://www.operatorsguide.brp.com">www.operatorsguide.brp.com</a> .
Nederlands	Deze handleiding kan beschikbaar zijn in uw taal. Vraag het aan uw dealer of ga naar: <a href="http://www.operatorsguide.brp.com">www.operatorsguide.brp.com</a> .
Norsk	Denne boken kan finnes tilgjengelig på ditt eget språk. Kontakt din forhandler eller gå til: <a href="http://www.operatorsguide.brp.com">www.operatorsguide.brp.com</a> .
Português	Este manual pode estar disponível em seu idioma. Fale com sua concessionária ou visite o site: <a href="http://www.operatorsguide.brp.com">www.operatorsguide.brp.com</a> .
Suomi	Käyttöohjekirja voi olla saatavissa omalla kielelläsi. Tarkista jälleenmyyjältä tai käy osoitteessa: <a href="http://www.operatorsguide.brp.com">www.operatorsguide.brp.com</a>
Svenska	Denna bok kan finnas tillgänglig på ditt språk. Kontakta din återförsäljare eller gå till: <a href="http://www.operatorsguide.brp.com">www.operatorsguide.brp.com</a> .

Congratulations on your purchase of a new CAN-AM™ Roadster. It is backed by the Bombardier Recreational Products Inc. (BRP) warranty and a network of authorized dealers ready to provide the parts, service or accessories you may require.

Your dealer is committed to your satisfaction. He has taken training to perform the initial set-up and inspection of your roadster before you took possession.

At delivery, you were informed of the warranty coverage and signed the *PREDELIVERY CHECK LIST* to ensure your new vehicle was prepared to your entire satisfaction.

## Know Before you Go

For your safety and the safety of passengers and bystanders, read the following sections before you operate the Spyder roadster:

- *GENERAL PRECAUTIONS*
- *VEHICLE INFORMATION*
- *SAFE OPERATING INSTRUCTIONS*
- *PRE-RIDE INSPECTION.*

Experienced motorcyclists should pay special attention to the *WHAT'S DIFFERENT ABOUT THE SPYDER ROADSTER* subsection.

## Safety Messages

The types of safety messages, what they look like and how they are used in this guide are explained as follows:

The safety alert symbol  indicates a potential injury hazard.

 **WARNING**

Indicates a potential hazard, if not avoided, could result in serious injury or death.

 **CAUTION** Indicates a hazard situation which, if not avoided, could result in minor or moderate injury.

**NOTICE** Indicates an instruction which, if not followed, could severely damage vehicle components or other property.

## About this Operator's Guide

This Operator's Guide was written in North America in a right-lane driving environment. Please adapt your application of these maneuvers to your jurisdiction and rules of the road.

In this Operator's Guide, the word motorcycle typically refers to a two-wheeled motorcycle.

This Operator's Guide is for both the SM5 (manual transmission) and the SE5 (semi-automatic transmission) Spyder roadster models. All text applies to both except for those items specified as "SM5 model" or "SE5 model".

Keep this Operator's Guide in the front storage compartment so that you can refer to it for things such as maintenance, troubleshooting and instructing others.

If you want to view and/or print an extra copy of your Operator's Guide, simply visit the following website [www.operatorsguide.brp.com](http://www.operatorsguide.brp.com).

The informations contained in this document are correct at the time of publication. BRP, however, maintains a policy of continuous improvement of its

products without imposing upon itself any obligation to install them on products previously manufactured. Due to late changes, some differences between the manufactured product and the descriptions and/or specifications in this guide may occur. BRP reserves the right at any time to discontinue or change specifications, designs, features, models or equipment without incurring any obligation upon itself.

This Operator's Guide and the *SAFETY DVD* video should remain with the vehicle when it is sold.

## Refer to Other Sources of Information

In addition to reading this Operator's Guide, you should read the Safety Card on the vehicle and watch the *SAFETY DVD* video.

If possible, take a training course that is specifically designed for the Spyder roadster. Check our website at [www.can-am.brp.com](http://www.can-am.brp.com) for more information about upcoming training course availability. If you cannot take a training course specifically designed for the Spyder roadster, it is a good idea to take a motorcycle training course, since some of the skills required are similar and information about managing risk on the road is taught and similarly applies to riding your Spyder roadster.

## Acknowledgment

BRP wishes to thank the Motorcycle Safety Foundation (MSF) for giving permission to BRP to use their material related to street motorcycle safety found in this Operator's Guide.

The MSF is an internationally recognized not for profit foundation and is supported by motorcycle manufacturers. It provides training, tools and partnerships to the motorcycle safety community. Visit its website at [www.msf-usa.org](http://www.msf-usa.org).

---

# TABLE OF CONTENTS

<b>FOREWORD</b> .....	<b>1</b>
Know Before you Go .....	1
Safety Messages .....	1
About this Operator's Guide .....	2
Refer to Other Sources of Information .....	2
Acknowledgment .....	2
<b>GENERAL PRECAUTIONS</b> .....	<b>8</b>
Avoid Carbon Monoxide Poisoning .....	8
Avoid Gasoline Fires and Other Hazards .....	8
Avoid Burns from Hot Parts .....	8
Accessories and Modifications .....	8
<b>VEHICLE INFORMATION</b>	
<b>PRIMARY CONTROLS</b> .....	<b>10</b>
1) Handlebar .....	11
2) Throttle .....	11
3) Clutch Lever (SM5 Model) .....	12
4) Gearshift Lever (SM5 Model) .....	12
5) Gearshift Selector (SE5 Model) .....	13
6) Brake Pedal .....	13
7) Parking Brake Switch .....	14
Applying Parking Brake .....	14
Releasing Parking Brake .....	15
<b>SECONDARY CONTROLS</b> .....	<b>16</b>
1) Ignition Switch .....	17
2) Engine Start Button .....	17
3) Engine Stop Switch .....	18
4) Hazard Warning Switch .....	18
5) Cruise Control Switch (ST-S and ST LTD Models) .....	18
6) Headlights Switch .....	20
7) Turn Signal Button .....	20
8) Horn Button .....	21
9) RECC (Roadster Electronic Command Center) .....	21
10) Reverse Button .....	21
11) Switch Cluster .....	22
<b>MULTIFUNCTION GAUGE</b> .....	<b>24</b>
Multifunction Gauge Description .....	24
Multifunction Gauge Startup Information .....	25
Digital Display Description .....	26
Navigating in the Digital Display .....	27
Category Icon Screen Description .....	29
<b>AUDIO CONTROLS</b> .....	<b>33</b>
Audio System Power .....	33
Audio Volume Control .....	33
Self-Adjusting Audio Volume .....	33

<b>AUDIO CONTROLS</b> (cont'd)	
Audio Mute .....	33
Radio Band .....	33
AUX (Auxiliary) .....	34
<b>GPS (OPTION PACKAGE)</b> .....	<b>36</b>
GPS Receiver Installation .....	36
GPS Receiver Removal .....	36
<b>EQUIPMENT</b> .....	<b>38</b>
Mirrors .....	38
Front Storage Compartment .....	38
Tool Kit .....	38
Operator's Guide .....	39
Seat .....	39
Body Panels .....	39
<b>BASIC PROCEDURES</b> .....	<b>43</b>
Adjusting the Windshield .....	43
Adjusting the Passenger Footrest .....	43
Starting and Stopping the Engine .....	43
Operating in Reverse .....	45
Operating During Break-In .....	46
Fueling .....	46
Using the 12 V Power Outlet (Option Package) .....	48
 <b>SAFE OPERATING INSTRUCTIONS</b> 	
<b>WHAT'S DIFFERENT ABOUT THE SPYDER ROADSTER</b> .....	<b>50</b>
Stability .....	50
Response to Road Conditions .....	50
Brake Pedal .....	50
Parking Brake .....	50
Steering .....	50
Width .....	51
Reverse .....	51
Driver's License and Local Laws .....	51
<b>DRIVING AID TECHNOLOGIES</b> .....	<b>52</b>
Vehicle Stability System (VSS) .....	52
Dynamic Power Steering (DPS) .....	53
<b>UNDERSTANDING RISK ON THE ROAD</b> .....	<b>54</b>
Type of Vehicle .....	54
Operator Skills and Judgment .....	54
Rider Condition .....	54
Vehicle Condition .....	55
Road and Weather Conditions .....	55
<b>RIDING GEAR</b> .....	<b>56</b>
Helmets .....	56
Other Riding Gear .....	56

<b>REQUIRED RIDING SKILLS AND PRACTICE EXERCISES .....</b>	<b>59</b>
Choosing a Practice Area .....	59
Preparing to Ride .....	60
Riding Posture .....	60
Practice Exercises (SM5 Model) .....	60
Practice Exercises (SE5 Model) .....	68
Developing Advanced Riding Skills .....	75
<b>STREET STRATEGIES .....</b>	<b>77</b>
Plan your Trip .....	77
Defensive Riding .....	77
Being Visible .....	78
Lane Position .....	79
Common Riding Situations .....	79
Road Conditions and Hazards .....	82
On-Road Emergencies .....	83
Tire Failure .....	83
<b>CARRYING A PASSENGER, CARGO OR TOWING A TRAILER .....</b>	<b>85</b>
Weight Limits .....	85
Operating with Extra Weight .....	85
Carrying a Passenger .....	85
Where to Store Cargo .....	86
Towing a Trailer .....	86
<b>KNOWLEDGE SELF-TEST .....</b>	<b>91</b>
Questionnaire .....	91
Answers .....	93
<b>SAFETY INFORMATION ON THE VEHICLE .....</b>	<b>94</b>
Hang Tag .....	94
Safety Card .....	95
Safety Labels .....	96

***PRE-RIDE INSPECTION***

<b>PRE-RIDE CHECKLIST .....</b>	<b>100</b>
---------------------------------	------------

***MAINTENANCE***

<b>MAINTENANCE SCHEDULE .....</b>	<b>102</b>
<b>BREAK-IN INSPECTION .....</b>	<b>107</b>
<b>MAINTENANCE PROCEDURES .....</b>	<b>108</b>
Engine Oil .....	108
Engine Oil Filter .....	111
HCM Oil Filter (SE5 Model) .....	111
Engine Coolant .....	112
Clutch Fluid (SM5 Model) .....	113
Battery .....	114

<b>MAINTENANCE PROCEDURES (cont'd)</b>	
Drive Belt .....	115
Wheels and Tires .....	117
Brakes .....	118
Headlights .....	120
<b>VEHICLE CARE .....</b>	<b>122</b>
Vehicle Cleaning .....	122
Vehicle Protection .....	122
<b>STORAGE AND PRESEASON PREPARATION .....</b>	<b>123</b>
Storage .....	123

***ROAD SIDE REPAIRS***

<b>DIAGNOSTIC GUIDELINES .....</b>	<b>126</b>
Will not Shift into First Gear (SM5 Model) .....	126
Will not Shift into Neutral (SE5 Model) .....	126
Will not Shift (SE5 Model) .....	126
Engine will not Start .....	126
<b>MESSAGES IN MULTIFUNCTION GAUGE .....</b>	<b>128</b>
<b>WHAT TO DO IN THE FOLLOWING CIRCUMSTANCES .....</b>	<b>131</b>
Lost Keys .....	131
Flat Tire .....	131
Dead Battery .....	131
<b>HOW TO REPLACE FUSES AND LIGHTS .....</b>	<b>133</b>
Fuses .....	133
Lights .....	135
<b>TRANSPORTING THE VEHICLE .....</b>	<b>141</b>

***TECHNICAL INFORMATION***

<b>VEHICLE IDENTIFICATION .....</b>	<b>144</b>
Vehicle Identification Number .....	144
Engine Identification Number .....	144
<b>SPECIFICATIONS .....</b>	<b>145</b>

***WARRANTY***

<b>BRP LIMITED WARRANTY — USA AND CANADA: 2014 Can-Am® SPYDER® ROADSTER .....</b>	<b>152</b>
<b>BRP LIMITED WARRANTY OUTSIDE USA AND CANADA: 2014 Can-Am™ SPYDER™ ROADSTER .....</b>	<b>157</b>



**CUSTOMER INFORMATION**

**PRIVACY INFORMATION..... 164**  
**CHANGE OF ADDRESS/OWNERSHIP..... 165**

---

# GENERAL PRECAUTIONS

## Avoid Carbon Monoxide Poisoning

All engine exhaust contains carbon monoxide, a deadly gas. Breathing carbon monoxide can cause headaches, dizziness, drowsiness, nausea, confusion and eventually death.

Carbon monoxide is a colorless, odorless, tasteless gas that may be present even if you do not see or smell any engine exhaust. Deadly levels of carbon monoxide can collect rapidly, and you can quickly be overcome and unable to save yourself. Also, deadly levels of carbon monoxide can linger for hours or days in enclosed or poorly ventilated areas. If you experience any symptoms of carbon monoxide poisoning, leave the area immediately, get fresh air and seek medical treatment.

To prevent serious injury or death from carbon monoxide:

- Never run the vehicle in poorly ventilated or partially enclosed areas such as garages, carports or barns. Even if you try to ventilate engine exhaust with fans or open windows and doors, carbon monoxide can rapidly reach dangerous levels.
- Never run the vehicle outdoors where engine exhaust can be drawn into a building through openings such as windows and doors.

## Avoid Gasoline Fires and Other Hazards

Gasoline is extremely flammable and highly explosive. Fuel vapors can spread and be ignited by a spark or flame many meters away from the engine. To reduce the risk of fire or explosion, follow these instructions:

- Refuel outdoors in a well ventilated area away from flames, sparks, lit cigarettes and other sources of ignition.
- Never add fuel with engine running.

- Never top off the fuel tank. Leave some room for the fuel to expand with temperature changes.
- Wipe up any spilled fuel.
- Never start or operate the engine with the fuel cap removed.
- Use only an approved red gasoline container to store fuel.
- Do not carry gasoline containers in the front storage compartment or anywhere else on the vehicle.

Gasoline is poisonous and can cause injury or death.

- Never siphon gasoline by mouth.
- If you swallow gasoline, get any in your eye or inhale gasoline vapor, see your doctor immediately.

If gasoline spills on you, wash with soap and water and change your clothes.

## Avoid Burns from Hot Parts

The exhaust, oil and cooling systems, and engine become hot during operation. Avoid contact during and shortly after operation to avoid burns.

## Accessories and Modifications

Do not make unauthorized modifications, or use attachments or accessories that are not approved by BRP. Since these changes have not been tested by BRP, they may increase the risk of crashes on the road or injuries, and they can make the vehicle illegal for use on the road.

Unlike most motorcycles, the Spyder roadster is equipped with a Vehicle Stability System (VSS), which is calibrated for the vehicle normal configuration. VSS may not function properly if the vehicle is modified, such as changing weight distribution, wheelbase, tires, suspension, brakes or steering.

See your authorized Can-Am roadster dealer for available accessories for your vehicle.

# ***VEHICLE INFORMATION***

# PRIMARY CONTROLS

It is important to know the location and operation of all controls, and to develop and practice smooth and coordinated use of them.

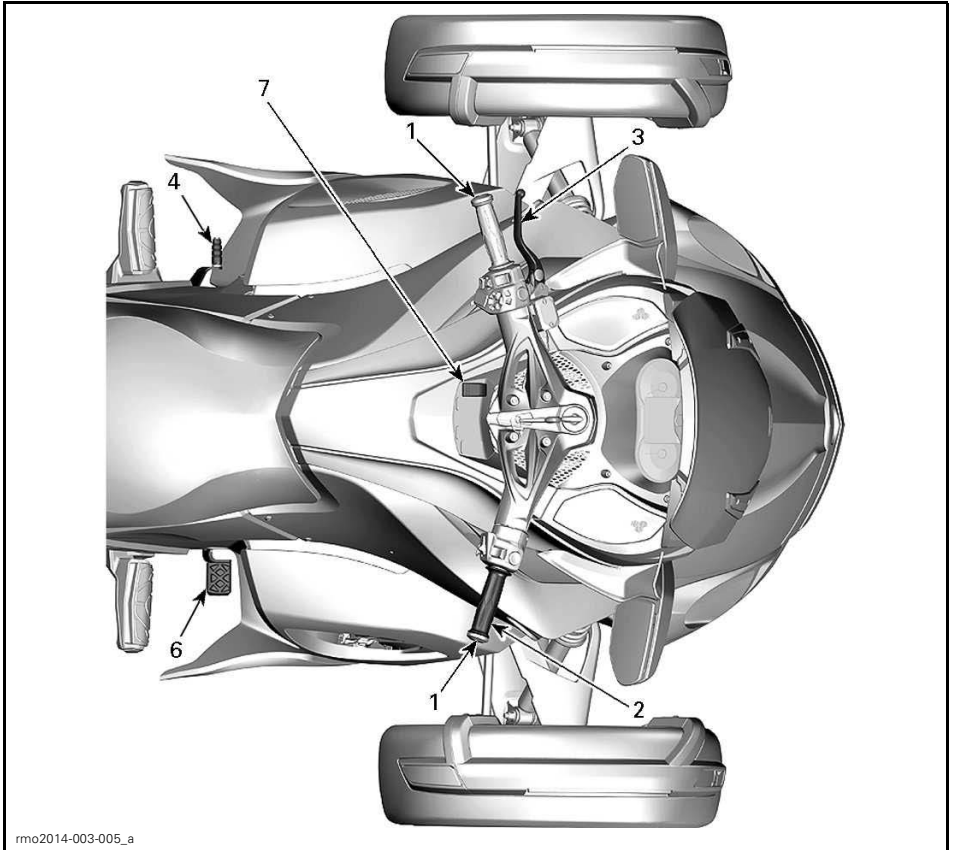

rmo2014-003-005\_a

**TYPICAL - SM5 MODEL**

1	Handlebar
2	Throttle
3	Clutch Lever
4	Gearshift Lever
6	Brake Pedal
7	Parking Brake Switch

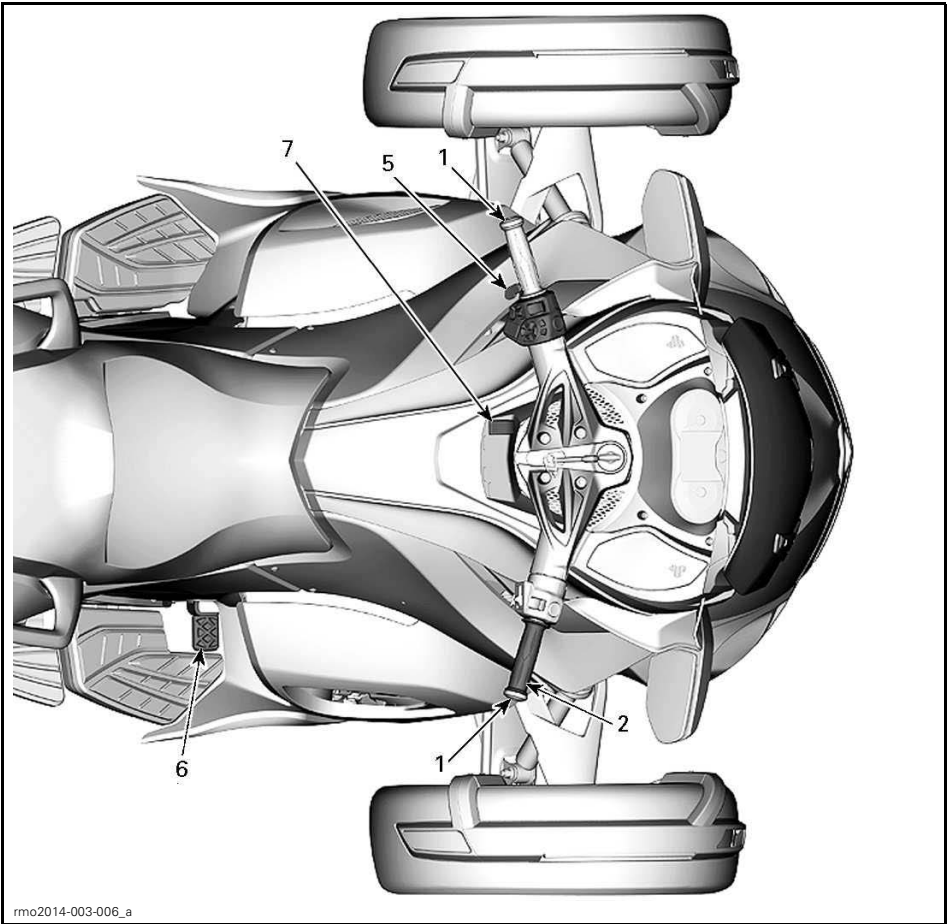

rmo2014-003-006\_e

TYPICAL - SE5 MODEL

1	Handlebar
2	Throttle
5	Gearshift Selector
6	Brake Pedal
7	Parking Brake Switch

## 1) Handlebar

Grip the handlebar with both hands. Steer the handlebar in the direction you want to go.

## 2) Throttle

The throttle is the right handgrip, and it controls engine speed. To increase engine speed, roll the throttle as shown (lower your wrist).

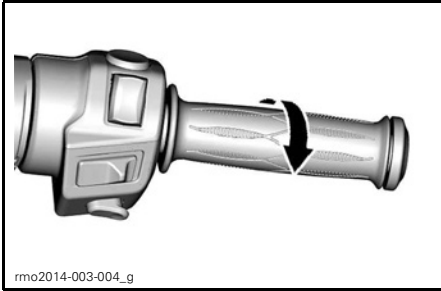

rmo2014-003-004\_g

**TO INCREASE SPEED**

To decrease engine speed, roll the throttle as shown (raise your wrist).

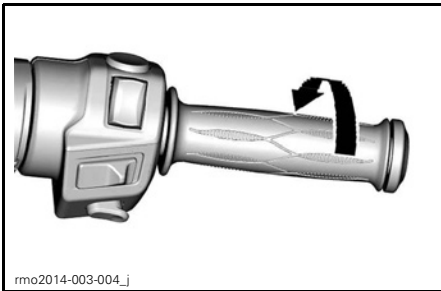

rmo2014-003-004\_j

**TO DECREASE SPEED**

The throttle is spring loaded and should return to idle when you release your grip.

**NOTE:** This vehicle is equipped with an ETC (Electronic Throttle Control). The throttle plates in the throttle body are controlled electronically and can be opened or closed irrespective of the throttle twist grip position when necessary. It may happen that when you accelerate, the VSS (Vehicle Stability System) prevents engine acceleration in order to maintain vehicle stability. Then, when the vehicle is stabilized, the engine RPM would increase as requested if the throttle was maintained. This would be felt as a "delayed" acceleration.

### 3) Clutch Lever (SM5 Model)

The clutch lever is in front of the left handgrip. The clutch controls the transmission of power from the engine to the rear wheel. The lever is squeezed in to disengage power and eased out to engage power.

#### Clutch Lever Position Adjustment

The distance between the clutch lever and handgrip can be adjusted from position 1 (greatest distance) to position 4 (smallest distance).

1. Push the clutch lever forward to release the adjuster dial. Hold in position.
2. Turn the adjuster dial to the desired position aligning the dial number with the dot on the lever.
3. Release the clutch lever.

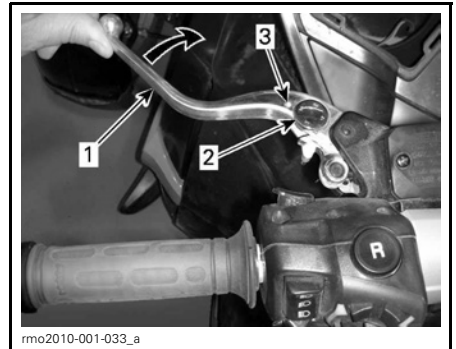

rmo2010-001-033\_a

#### CLUTCH LEVER ADJUSTMENT

1. Clutch lever
2. Adjuster dial
3. Dot

### 4) Gearshift Lever (SM5 Model)

The gearshift lever is in front of the left footrest.

The gear pattern is:  
Reverse-1-Neutral-2-3-4-5.

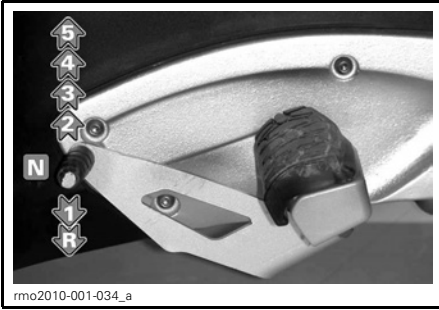

rmo2010-001-034\_a

**TYPICAL**

Lift up or press down fully to move sequentially from one gear to the next. When the lever is released, it returns to center where the mechanism resets for the next shift up or down. Neutral (N) is selected by either a half lift from first gear or a half press from second gear.

**NOTE:** To shift from neutral to first gear, press the brake and shift up.

To shift into reverse, refer to the *OPERATING IN REVERSE* in *BASIC PROCEDURES* subsection for detailed instructions.

## 5) Gearshift Selector (SE5 Model)

The gearshift selector is below the left handgrip.

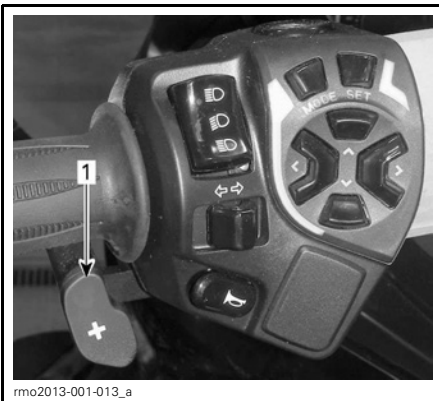

rmo2013-001-013\_a

## 1. Gearshift selector

Press selector forward to upshift. Pull selector toward you to downshift.

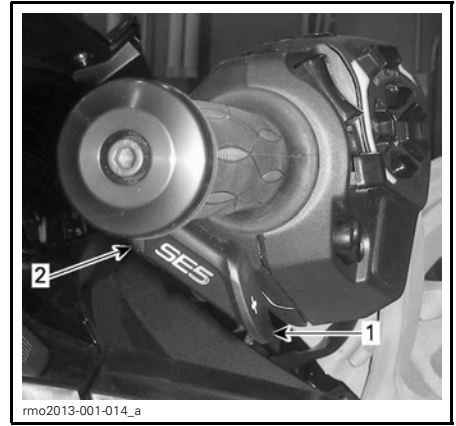

1. Upshift
2. Downshift

This shifts sequentially from one gear to the next. Release the selector after shifting.

To shift through multiple gears, use the selector multiple times.

To shift into neutral from first gear or reverse, briefly press or pull the gear selector. A longer activation will shift over neutral.

When the gearshift selector is released, the mechanism resets for the next shift up or down.

If operator does not downshift when slowing down and engine RPM drops below a threshold value, the gearbox will automatically downshift to the next available gear.

If the engine is started with the gearbox in gear, it will automatically shift to neutral position.

## 6) Brake Pedal

The brake pedal is in front of the right footrest. Press it down to operate. This pedal brakes all three wheels.

**SM5 Models and SE5 Base Model**

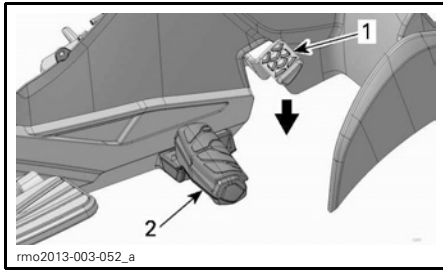

1. Brake pedal
2. Footrest

**ST-S and ST LTD SE5 Models**

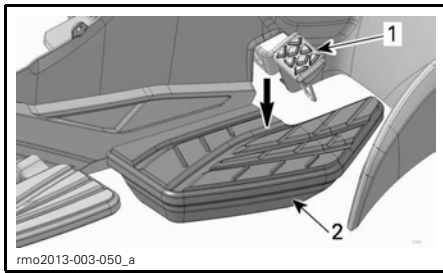

**NORMAL CONDITION**

1. Brake pedal
2. Floorboard

A mechanism allows the floorboard to lower if the pedal needs to be pressed more than normal. If that occurs, push on the rear portion of the floorboard until it clicks and test the braking system.

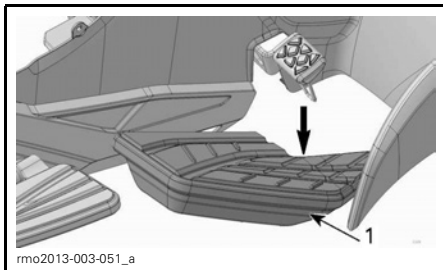

**LOWERED FLOORBOARD**

1. Floorboard

If this condition persists or if you find any braking system problems, refer to an authorized Can-Am roadster dealer.

**7) Parking Brake Switch**



The parking brake switch is located on the switch cluster. It allows to engage or release the electric parking brake.

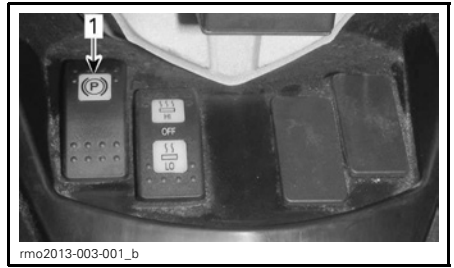

**TYPICAL**

1. Parking brake switch

**NOTE:** To apply or release the parking brake, the ignition key must be turned ON.

**NOTE:** The battery voltage must be at 10.5 V minimum to activate the parking brake. If voltage is below 10.5 V, the parking brake indicator lamp will turn ON.

**Applying Parking Brake**

With the vehicle stopped, press switch to apply the parking brake. The brake indicator lamp will flash.

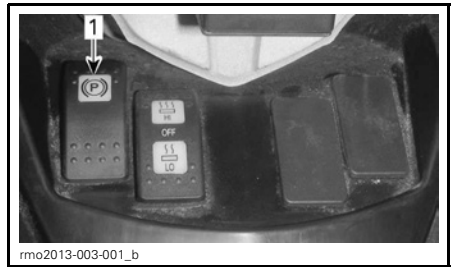

**TYPICAL**

1. Parking brake switch



**NOTE:** The parking brake cannot be activated when the vehicle is above 10 km/h.

Check that the parking brake is fully engaged. Hold the clutch (on SM5 models) and rock the vehicle back and forth.

## Releasing Parking Brake

To release parking brake, press and release switch and make sure brake indicator lamp turns OFF.

**NOTE:** A beeping sound will be heard if torque is applied and the parking brake is not released.

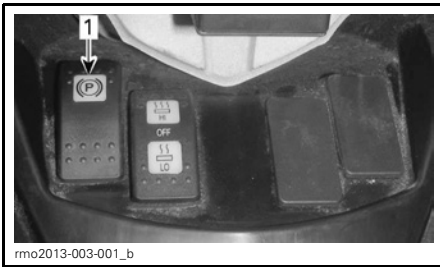

**TYPICAL**

1. Parking brake switch

# SECONDARY CONTROLS

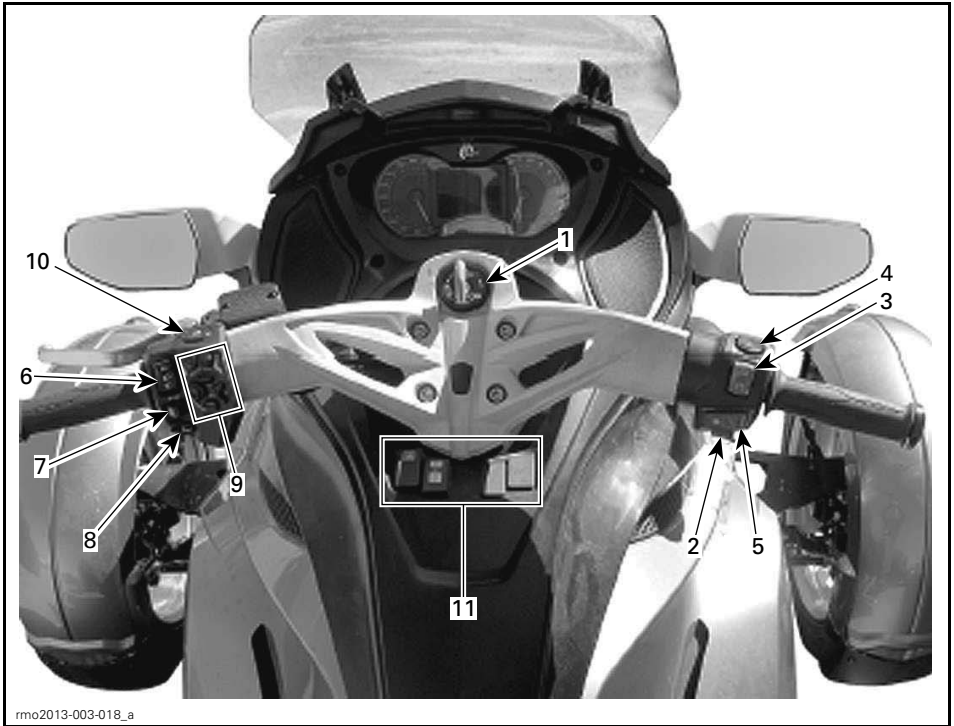

1	Ignition switch	7	Turn signal button
2	Engine start button	8	Horn button
3	Engine stop switch	9	RECC (Roadster Electronic Command Center)
4	Hazard warning switch	10	Reverse button
5	Cruise control switch	11	Switch cluster
6	Headlights switch		

## 1) Ignition Switch

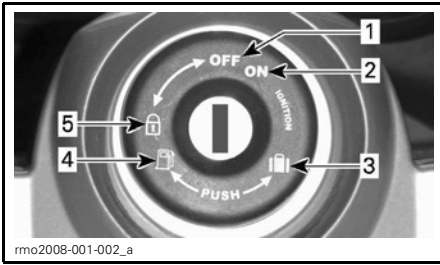

### IGNITION SWITCH

1. OFF
2. ON
3. Front storage compartment opening
4. Seat opening/fuel tank access
5. Steering lock position

The ignition switch is located in the center of the handlebar. It controls:

- Engine ignition
- Seat opening mechanism to access:
  - Fuel tank cap
  - Brake fluid reservoirs
- Front storage compartment opening mechanism to access:
  - Fuses
  - Battery terminals.
- Steering-lock mechanism.

**NOTICE** If the key does not turn easily, do not force it. Pull it out and reinsert.

### **⚠ WARNING**

If you turn the ignition switch to OFF, it shuts off the engine and all the electrical systems including the VSS and DPS. If you do this while the vehicle is moving, you could lose control and crash.

**NOTE:** You should receive two keys with your vehicle. Each key contains a computer chip specifically pre-programmed to allow starting the engine. Store the spare key in a safe place. You **must** have your spare key to have another one made by an authorized Can-Am roadster dealer.

## Ignition Function

### OFF

The key can be inserted or removed in this position.

In the OFF position, the electrical system of the vehicle is disabled.

The engine is shut down by turning the ignition switch to the OFF position.

### ON

When the key is turned to this position, the electrical system of the vehicle is activated.

The gauge should wake-up.

The vehicle lights are turned on.

The engine can be started.

## Handlebar Locking Function

To lock the steering mechanism:

1. Insert key in ignition switch.
2. Rotate the handlebar all the way to the right or to the left.
3. Turn the key 1/4 turn counterclockwise to the steering lock position then remove key.

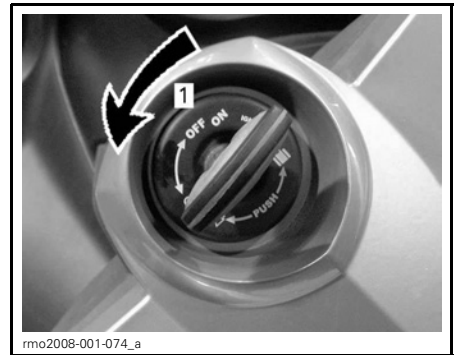

### KEY POSITION TO LOCK HANDLEBAR

1. Turn key 1/4 turn

## 2) Engine Start Button

The engine start button is near the right handgrip. When depressed and held, it starts the engine.

### 3) Engine Stop Switch

The engine stop switch is near the right handgrip. It has two positions and must be set to the run position before you can start the engine. It allows you to stop the engine anytime without removing your hand from the handlebar.

### 4) Hazard Warning Switch

The hazard warning switch is near the right handgrip. Push the button to turn on the hazard warning lights.

### 5) Cruise Control Switch (ST-S and ST LTD Models)

The cruise control switch is near the right handgrip.

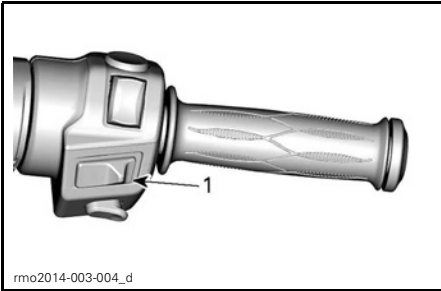

1. Cruise control switch

The switch is a multifunction switch. It allows to activate, set and stop the function of the cruise control.

**⚠ WARNING**

It is not recommended to use the cruise control when towing a trailer.

When set, the cruise control allows to maintain a steady speed while riding the vehicle. It will increase or reduce engine speed as necessary.

**NOTE:** The vehicle torque may vary slightly depending on the road conditions such as the wind, going downhill or uphill.

The cruise control is designed to be used for prolonged drives on low traffic highways. Never ride the vehicle with the cruise control activated in city streets, winding roads, in adverse weather or in any circumstances when you need the throttle control.

### Cruise Control Limitations

The cruise control is not an automatic pilot, it will not drive the vehicle.

The cruise control is not aware of what is going on the road and it does not steer or apply the brakes for you.

**⚠ WARNING**

Improper use of the cruise control can lead the vehicle to a loss of control.

### Setting the Cruise Control

To use the cruise control, the vehicle speed must be above approximately 40 km/h.

Turn the cruise control to ON by sliding the cruise control button to the right.

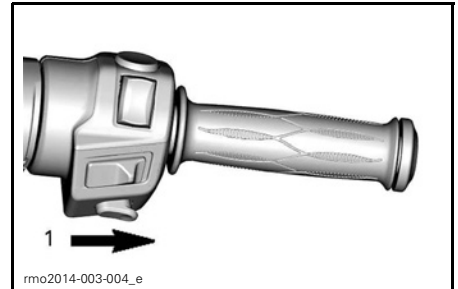

1. Slide button to the right

**NOTE:** The cruise control status will show CRUISE ON in the digital display.

Bring the vehicle at the speed you want to maintain then press the cruise button downward to SET the speed.

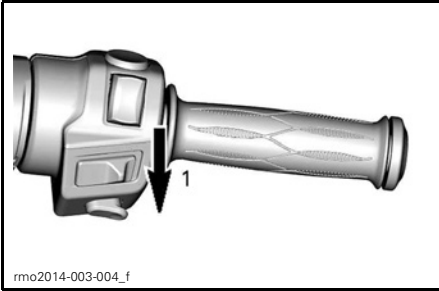

1. Push button downward to SET

**NOTE:** The cruise control status will show CRUISE SET in the digital display.

You can now release the throttle.

### **⚠ WARNING**

Always keep both hands on the handlebar while riding. Otherwise, this could cause a vehicle loss of control.

**NOTE:** You can increase engine speed using the throttle grip if you need to go faster than the set speed. Releasing the throttle will allow the cruise control to recover the set speed.

Once the cruise control has been set, the speed setting may be increased or reduced by pushing the button UP or DOWN. Each press of the button will change the speed setting by increments of 1.6 km/h. Holding the button will change the speed setting until released or the operating limit has been reached.

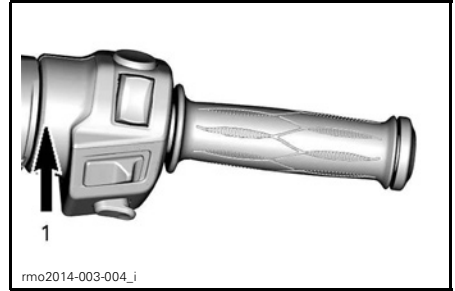

#### **CRUISE CONTROL PREVIOUSLY SET**

1. Push up button to increase the speed setting

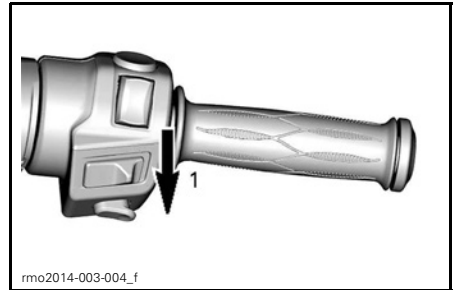

#### **CRUISE CONTROL PREVIOUSLY SET**

1. Push down button to reduce the speed setting

### **Stopping the Cruise Control**

To completely stop the cruise control operation, slide the cruise control button to the left.

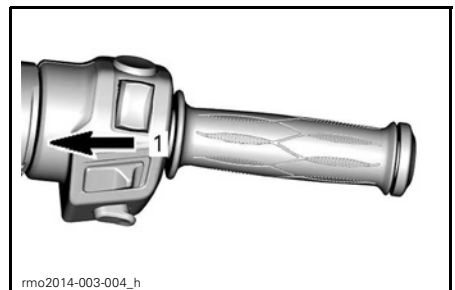

1. Slide button to OFF

**NOTE:** The CRUISE ON status will disappear in the digital display.

## Cancelling the Cruise Control

Any of the following event will cancel the cruise control and give you back the throttle control. It then can be re-summed if desired.

- Pressing the brake pedal.
- Squeezing the clutch lever or if clutch slippage occurs (SE5 models).
- Gear change (SE5 model).
- Any vehicle stability system intervention.

**NOTE:** When cancelling the cruise control, you may activate the throttle lever up to the desired position to make the transition smoother.

## Resuming the Cruise Control

If the cruise control was cancelled and the cruise control switch is still at the ON position, the cruise control operation can be resumed by pushing the cruise control button up. The cruise control will then recover the previous set speed.

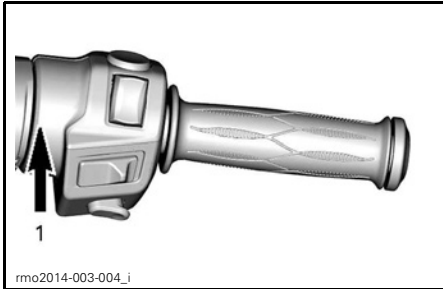

### CRUISE CONTROL PREVIOUSLY CANCELLED

1. Push up button to RESUME

**NOTE:** The cruise control status will show CRUISE SET in the digital display.

## 6) Headlights Switch

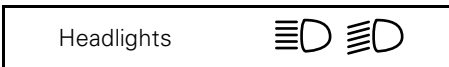

The switch is near the left handgrip, and is used to select high or low beam for the headlight. The headlights automatically turn on when the engine reaches 800 RPM.

To select high beams, push the switch to the front position. To select low beams, push the switch to the back position.

To flash the high beams, push the switch down, then release it. The high beams will stay on as long as you hold down the switch.

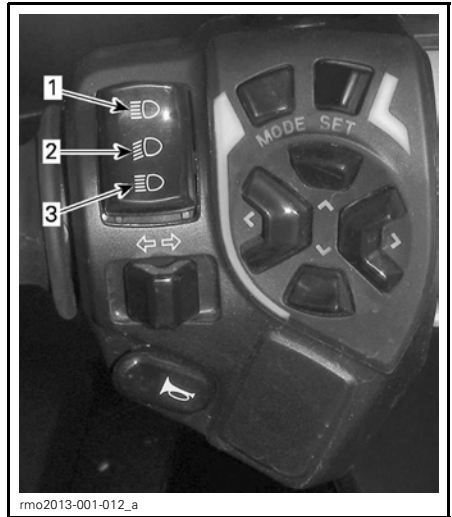

1. High beams
2. Low beams
3. Flash high beams

## 7) Turn Signal Button

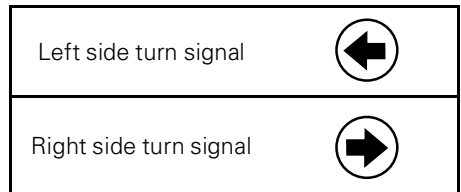

The turn signal button is located near the left handgrip. It turns off automatically after a normal turn, but you may have to turn it off manually after a shallow turn or lane change.

To turn the signal off, press the button in.

Turn signals will automatically turn off after 30 seconds while the vehicle is moving.

## 8) Horn Button

The horn button is located near the left handgrip.

## 9) RECC (Roadster Electronic Command Center)

The RECC is located near the left handgrip.

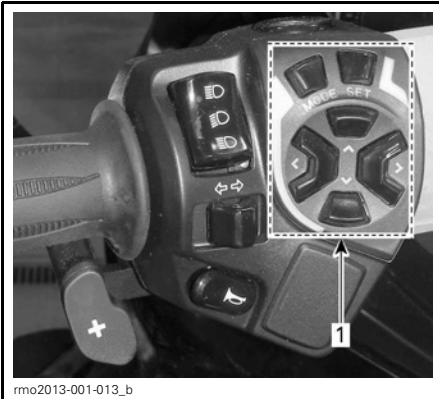

1. RECC

The RECC is a multifunction switch.

The RECC allows the control of numerous functions of the multifunction gauge.

**NOTE:** Inputs given to the RECC may be halted for a short delay as the vehicle electronic modules prioritize vehicle main functions. This should not be considered a malfunction.

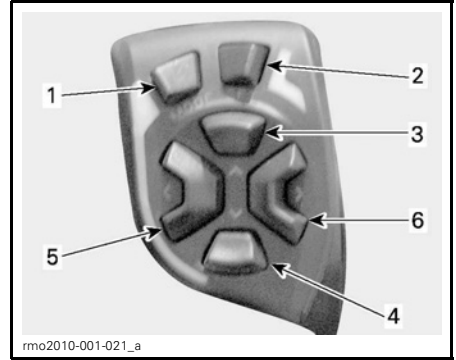

### RECC BUTTONS

1. **MODE button:** *Navigate through the screens*
2. **SET button:**  
**Quick press then release:** *Navigates through the secondary screens*  
**Holding button more than 1 second:** *Sets a value in the current function or navigate to a setup screen*
3. **UP button:** *Increase the volume (audio) or a value*
4. **DOWN button:** *Decrease the volume (audio) or a value*
5. **LEFT button:** *Move the screen arrows to the left to select a secondary menu or a setting*
6. **RIGHT button:** *Move the screen arrows to the right to select a secondary menu or a setting*

### **⚠ WARNING**

Using the RECC while driving can distract the driver from operating the vehicle. Always use buttons with caution and always keep your eyes on the road.

## 10) Reverse Button



The reverse button is located near the left handgrip.

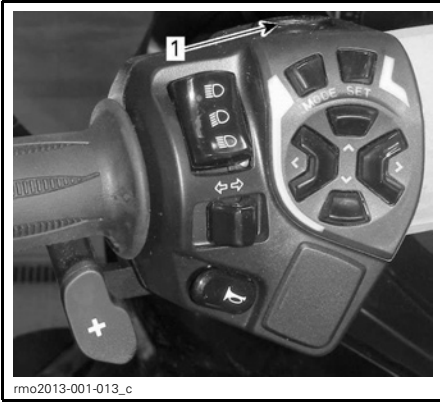

1. Reverse button

Push and hold the reverse button to allow shifting into reverse. Refer *OPERATING IN REVERSE* in *BASIC PROCEDURES* subsection for detailed instructions.

The hazard warning lights flash when the vehicle is in reverse.

## 11) Switch Cluster

The switch cluster is located above the seat. It gives control of numerous electrical accessories.

**NOTE:** The switch cluster is operational only when the engine is running and the battery voltage is over 11 Vdc.

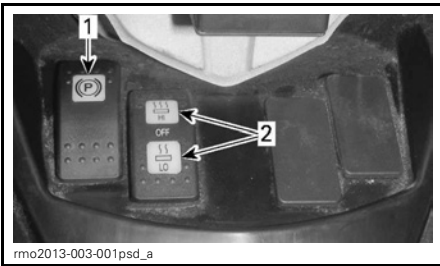

1. Parking brake switch  
2. Driver's heated grip switch (option package)

## Parking Brake Switch

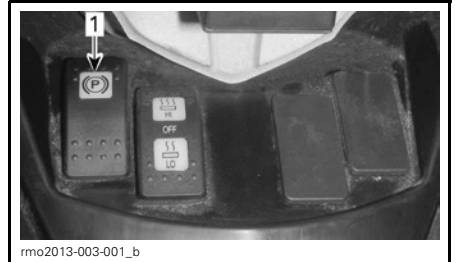

1. Parking brake switch

Refer to the *PRIMARY CONTROLS* subsection for detailed instructions.

## Driver's Heated Grip Switch (Option Package)

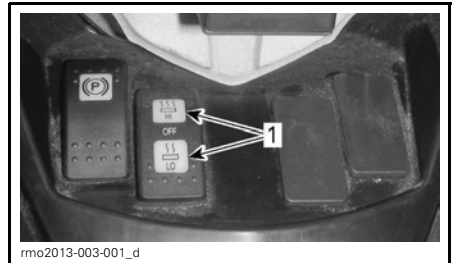

1. Heated grip switch

The heated grip switch allows to turn on and off the heated grips and to control the heating intensity.

For minimum heat, press the LO intensity side of the switch.

For maximum heat, press the HI intensity side of the switch.

To select the OFF position, set the switch to the middle position.



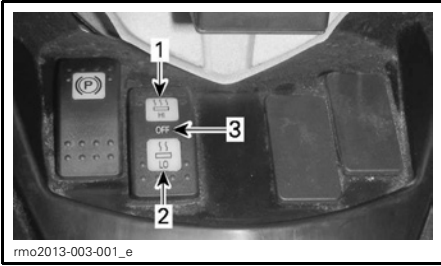

1. *HI intensity*
2. *LO intensity*
3. *OFF (middle position)*

**NOTE:** The heated grips will automatically turn off when ignition key is turned to OFF.

# MULTIFUNCTION GAUGE

## WARNING

Watching or using the multifunction gauge or the infotainment center can distract the driver from the operation of the vehicle. Always keep on observing the traffic and make sure the surrounding is clear and safe before doing so.

The multifunction gauge includes analog gauges (speedometer and tachometer), indicator lamps and an infotainment center with a digital screen.

## Multifunction Gauge Description

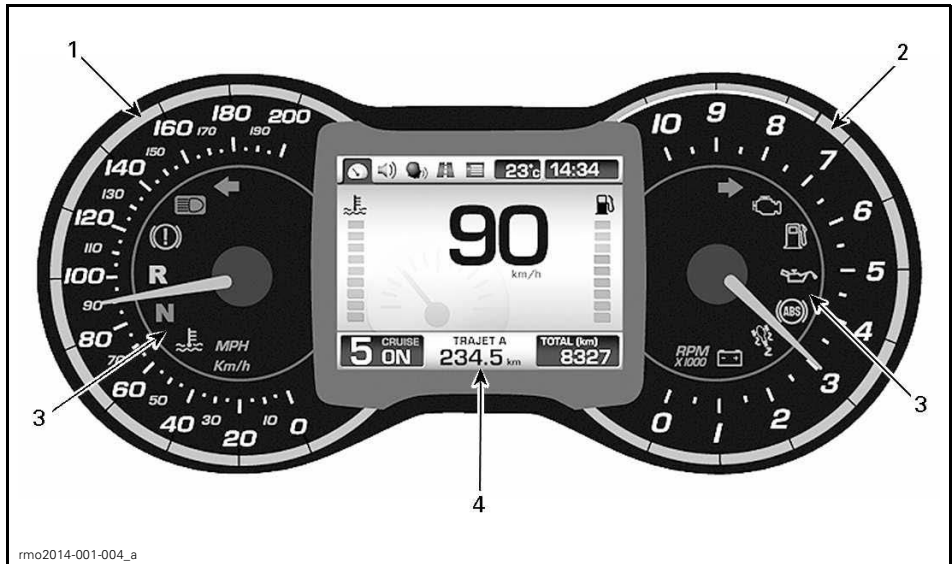

### 1) Analog Speedometer









Displays vehicle speed in kilometers (km/h) or miles per hour (MPH). To change units, refer to *PREFERENCES SCREEN*.

### 2) Analog Tachometer (RPM)

Displays engine revolutions per minute (RPM). Multiply by 1000 to obtain actual revolutions.

### 3) Indicator Lamps

Indicator lamps will inform you of various conditions or problems (see *MESSAGES IN MULTIFUNCTION GAUGE* in *ROAD SIDE REPAIRS* section).

INDICATOR LAMPS (NORMAL OPERATION)			
INDICATOR LAMP(S)		MAIN SCREEN	DESCRIPTION
All indicator lamps	On	None	Temporarily all 'indicator lamps are activated when ignition switch is ON and the engine is not started
	Flashing	None	Parking brake engaged
	Flashing + Beeper	None	SE5 model: The ignition switch is OFF and the parking brake is not engaged. Always engage the parking brake when parking the vehicle
	On	None	Gearbox in neutral position
	Flashing	None	Gearbox in reverse position
	On	None	Headlights in the HIGH beam position
	On	None	Low fuel level
	Flashing	None	VSS intervention occurs
	Flashing	None	Left side turn signal. Left and right side indicator lights flash at the same time: hazard warning lights
	Flashing	None	Right side turn signal. Left and right side indicator lights flash at the same time: hazard warning lights

#### 4) Digital Display

Displays useful real-time information to the rider and is used as an interface for the infotainment center.

The display will use a light color when the ambient light is bright and will automatically change to a darker color when the ambient light is dusky.

For a complete description of the digital display, refer to *DIGITAL DISPLAY DESCRIPTION*.

#### Multifunction Gauge Startup Information

A self test is initiated every time the ignition key is turned ON. The default riding screen will turn on and indicator lights will turn on for a moment. This allows the operator to validate that all indicators are working properly.

Any time the ignition switch is turned ON after having been in the OFF position for 5 minutes or more, the digital display will show the following message:

- BEFORE OPERATING READ THE SAFETY CARD ABOVE THEN PRESS MODE BUTTON.

Press the MODE button to acknowledge this message to allow engine starting.

## Digital Display Description

The display is divided in several areas as follows.

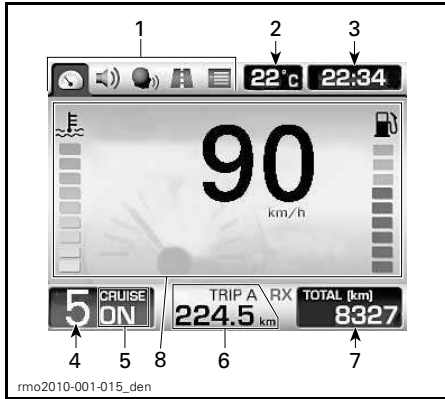

1. Category icons
2. Ambient temperature
3. Clock
4. Gearbox position
5. Cruise control status
6. Trip meter
7. Odometer
8. Main screen

### 1) Category Icons

There are 4 selectable category icons. Each icon is linked to a different screen. See table below.

CATEGORY ICON	CATEGORY ICON SCREEN
	Default riding
	Audio (option package)
	Trip meter
	Preferences (only available when vehicle is stopped, except for the trailer mode)

For a complete description, refer to *CATEGORY ICON SCREEN DESCRIPTION*.

You can navigate through the category icons to select several functions and to change certain settings using the RECC (Roadster Electronic Command Center). Refer to *RECC (ROADSTER ELECTRONIC COMMAND CENTER)* in *SECONDARY CONTROLS* subsection.

### 2) Ambient Temperature

The ambient air temperature is displayed in °C or °F. To change units, refer to *PREFERENCES SCREEN*.

### 3) Clock

The current time is displayed in 24h or AM/PM format. To change the format, refer to *PREFERENCES SCREEN*.

### 4) Gearbox Position

Displays the selected gearbox position.

### 5) Cruise Control Status

Displays ON when the cruise control is turned on but not set to any speed.

Displays SET when the cruise control is in operation and a speed has been set.

## 6) Trip Meter

Distance travelled in kilometers or miles since the last reset. Two trip meters are available and they are identified as "A" and "B". To change units, refer to *PREFERENCES SCREEN*.

As a second function, the trip meter may display an icon to inform the driver of a malfunction. Refer to *MESSAGES IN MULTIFUNCTION GAUGE* in the *ROAD SIDE REPAIRS* section.

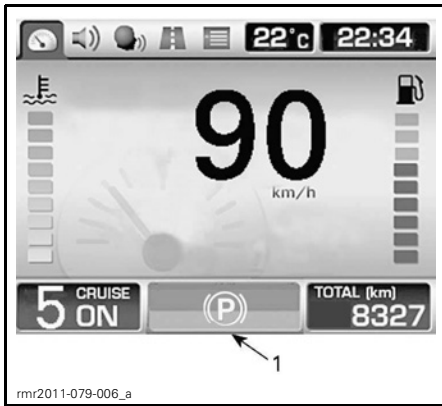

1. Icon

## 7) Odometer

Total distance travelled in kilometers or miles since the delivery from the factory. To change units, refer to *PREFERENCES SCREEN*.

## 8) Main Screen

The main screen is the area where the most information is displayed. The display will change when navigating through the available gauge functions.

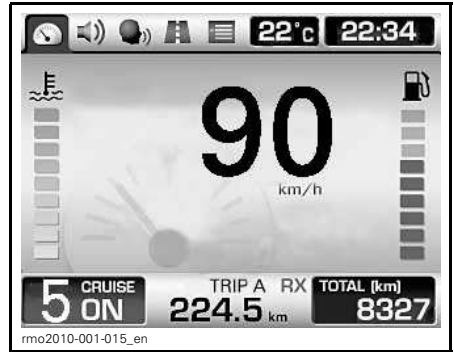

TYPICAL – DEFAULT RIDING SCREEN SHOWN

For a complete description of the screens, refer to *CATEGORY ICON SCREEN DESCRIPTION*.

## Navigating in the Digital Display

We recommend you practice selecting some functions on the infotainment center before getting on the road. You will get used to them and they will be easier to use on the road.

Use the RECC (Roadster Electronic Command Center) to control the display functions. Refer to *RECC (ROADSTER ELECTRONIC COMMAND CENTER)* in *SECONDARY CONTROLS* sub-section.



1. RECC

Pressing the MODE button will move a selection through the category icons, located at the top left area of the screen, in this order: Default riding screen, Audio, Trip meter and Preferences. Each press of the button will move the selection to the next available icon. When an icon is selected, its related screen will appear.

**NOTE:** The Audio icon is skipped when the vehicle is not equipped with this feature. The Preferences Screen is skipped when vehicle is above 5 km/h, except for the SE5 model for the towing mode.

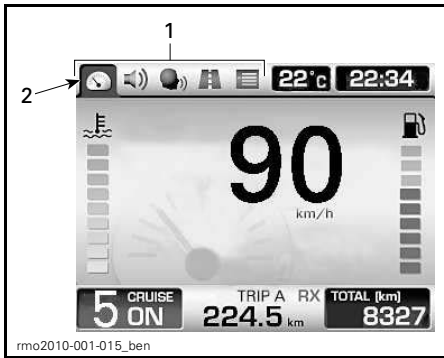

1. Category icons
2. Default riding icon selected

When the selection is on the last icon, it will then move to the first icon when the MODE button will be pressed.

In some screens, vertical or horizontal arrows are visible. This indicates that you have to use the LEFT/RIGHT button to change the setting enclosed by the horizontal arrows and to use the UP/DOWN button to change the setting enclosed by the vertical arrows.

When a double arrow is visible, it indicates the following depending on the displayed screen:

- Holding the DOWN button when the volume bar is displayed will mute the audio system. From the mute condition, pressing the UP button will reset the audio volume to its last setting.

- Holding the related arrow button will scroll the values to the end or to the beginning.
- Using the related arrow button will scroll the list to reveal the remaining items.

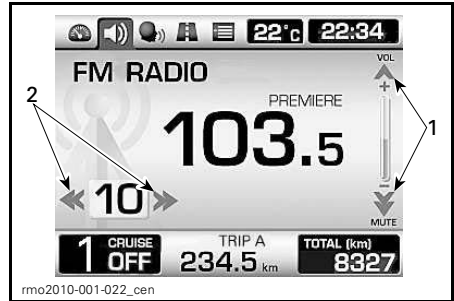

**TYPICAL**

1. Use the UP/DOWN button to select the vertical arrows
2. Use the LEFT/RIGHT button to select the horizontal arrows

When an item is selected, this sets the item to the current value.

After acknowledging the initial safety message at gauge startup, or after a few seconds elapsed in any other screen without pressing any RECC button, the display will automatically return to the default riding screen.

## Category Icon Screen Description

### Default Riding Screen

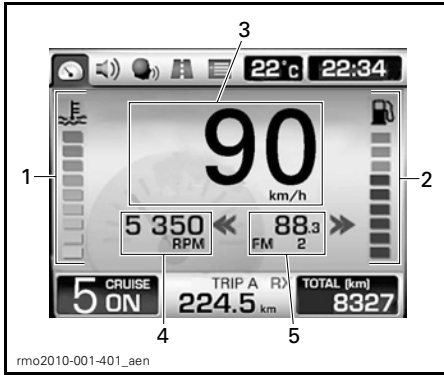

#### DEFAULT RIDING SCREEN

1. Engine coolant temperature (option package)
2. Fuel level (option package)
3. Digital speedometer
4. Engine speed (not factory set)
5. Radio preset or radio frequency (not factory set)

### 1) Engine Coolant Temperature

Bar gauge that continuously indicates the engine coolant temperature.

### 2) Fuel Level

Bar gauge that continuously indicates the amount of fuel left in the fuel tank.

### 3) Digital Speedometer

Displays vehicle speed in kilometers (km/h) or miles per hour (MPH). To change units, refer to *PREFERENCES SCREEN*.

### 4) Engine Speed

Displays engine speed in revolutions per minute (RPM).

**NOTE:** This is not a default setting. To activate this function, refer to *PREFERENCES SCREEN*.

### 5) Radio Preset or Radio Frequency

Displays the selected radio preset or radio frequency.

**NOTE:** This is not a default function. To activate this function, refer to *PREFERENCES SCREEN*.

### Audio Screen (Option Package)

This screen is only available when an audio system is installed.

The audio screen will appear with its last configuration.



#### TYPICAL

1. Current selected audio device

For additional information on audio functions, refer to *AUDIO CONTROLS*.

### Trip Meter Screen

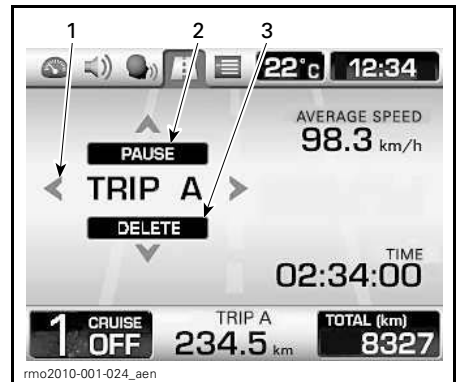

#### TYPICAL

1. Display selection: Trip A or Trip B
2. Pause or resume the selected trip meter
3. Reset the selected trip meter

Press the LEFT/RIGHT button to select the desired trip meter.

Press the UP button to pause or resume the selected trip meter.

Press the DOWN button to reset the selected trip meter.

### Preferences Screen

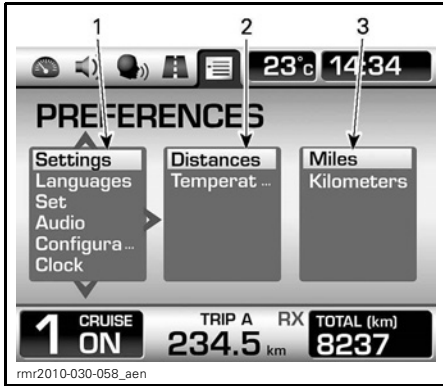

1. 1st column: Main category
2. 2nd column: Secondary category or item
3. 3rd column: Unit or setting

This screen is only available when vehicle is stopped.

**NOTE:** On SE5 model, the Trailer Mode in the Preferences Screen is available while riding.

Use the LEFT/RIGHT button to select the desired column.

Within a column, use the UP/DOWN button to select the desired item. If more items are available to the next right column, use the RIGHT button to select the column then use again the UP/DOWN button to select the desired item. Continue using this pattern to reach the desired item.

When an item is selected, this sets the item to the current value. You may then go to any screen, the value will be kept.

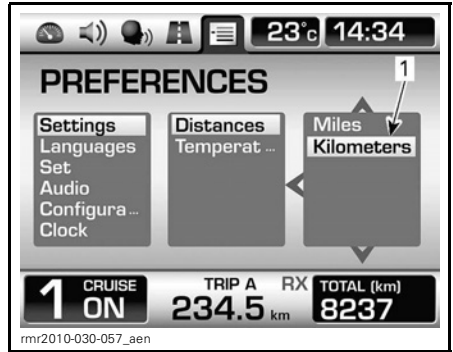

1. The selected value will be set

**NOTE:** When in the 2nd or 3rd column, you can go back to the column at the left using the LEFT button.

**NOTE:** When the units are changed they will be changed on both the analog and the digital displays. The units will be used for the odometer and both trip meters.

### Setting the Time

To set the hours:

Select CLOCK in main category of Preferences Screen.

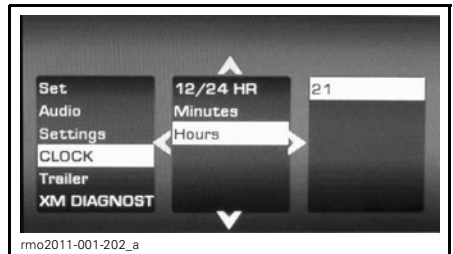

Select HOURS in secondary category. Adjust the unit value using the UP and DOWN arrow.

To set the minutes:

Select CLOCK in main category of Preferences Screen.



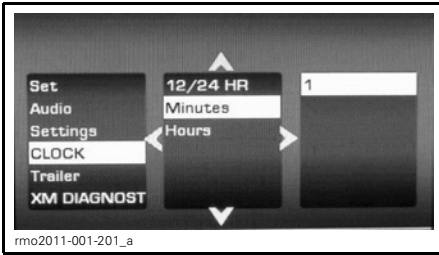

Select MINUTES in secondary category.

Adjust the unit value using the UP and DOWN arrow.

### Selecting the Hour Mode

To select the 12/24 hour mode:

Select CLOCK in main category of Preferences Screen.

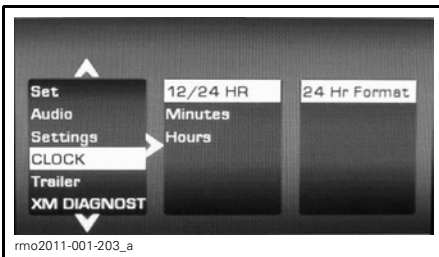

Select 12/24 HOUR in secondary category.

Select the appropriate value in main unit or setting.

### Selecting the Region Setting (Audio)

To select the region setting:

Select AUDIO in main category of Preferences Screen.

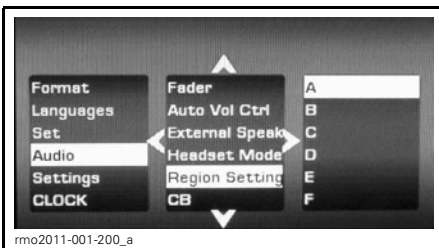

Select REGION SETTING in secondary category.

Select the appropriate region according to the table below in main unit or setting.

**NOTE:** If your country is not listed in the table below, select a region with an identical frequency range.

Restart the vehicle in order for changes to take effect.

REGION	COUNTRIES	LW	AM / MW	FM
A	- USA - Canada - South Africa	—	520 to 1720 kHz	87.9 to 107.9 MHz
B	- Austria - Bulgaria - Denmark - France - Iceland - Israel - Kuwait - Norway - Romania - Slovakia - Slovenia - Spain - Switzerland - Turkey - UAE - UK/Ireland - Ukraine	153 to 279 kHz	531 to 1602 kHz	87.5 to 108 MHz
C	- Benelux - Germany - Greece - Italy - Poland - Portugal - Russia	153 to 279 kHz	531 to 1602 kHz	87.5 to 108 MHz
D	- Japan	—	522 to 1629 kHz	76.1 to 89.9 MHz
E	- Australia - China - Malaysia - New Zealand	—	531 to 1701 kHz	87.5 to 108 MHz
F	- Taiwan	—	531 to 1701 kHz	87.5 to 108 MHz
G	- Argentina - Brazil - Cayman - Chile - Columbia - Costa Rica - Curacao - Dominican Rep. - Guadeloupe - Mexico - Puerto Rico - Venezuela	—	520 to 1720 kHz	87.9 to 107.9 MHz

# AUDIO CONTROLS

## Audio System Power

Follow one of the following steps below to turn the audio system ON:

- Turn ignition switch to ON
- Press MODE button for 3 seconds immediately after ignition switch is turned OFF.

Follow one of the following steps below to turn the audio system OFF:

- Turn ignition switch to OFF
- If the audio was ON with the ignition switch to OFF, press MODE button for 10 seconds.

## Audio Volume Control

When in the default riding screen, pressing the UP or DOWN button will increase or decrease the audio volume.

## Self-Adjusting Audio Volume

The audio volume level can be automatically adjusted based on the vehicle speed. This is controlled by the automatic volume control setting in the Preferences Screen.

## Audio Mute

Press the DOWN button and hold it more than one second. The audio volume will mute.

From the mute setting, pressing the UP button will reset the audio volume to its last setting.

## Radio Band

When in the audio screen, repeatedly pressing the SET button will display the available audio devices in this order:

- FM
- AM
- WX (NOAA weather radio)
- AUX (iPod device or MP3 player)
- XM.

NOTE: XM is displayed only if so equipped.

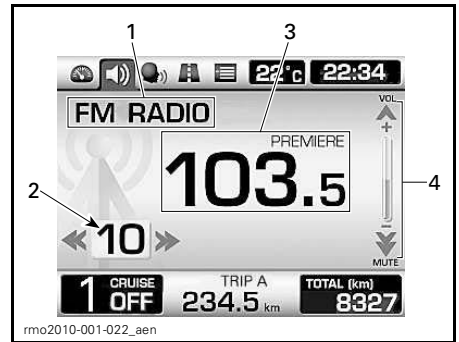

TYPICAL - FM RADIO SHOWN

1. Current selected band
2. Station number preset
3. Current station
4. Volume level

While riding, the available radio functions are:

- Audio volume
- Mute, seek and slew (XM radio) functions
- Radio preset functions (selection and storing).

NOTE: The radio is always ON. Use the MUTE function to cancel the volume.

To listen to the radio while ignition switch is set to OFF, hold the MODE button for 3 seconds immediately after the switch is set to OFF to power up the digital display.

NOTE: To preserve battery charge, radio may shut off automatically after a certain period.

## Selecting a Radio Preset Station

Press the LEFT/RIGHT button to decrease or increase the preset number.

Press and hold the LEFT/RIGHT button for more than one second to SEEK the next available radio station. The radio will remain tuned to that station.

Press the SET button and hold for more than one second to enter the setup screen.

In the setup screen, press the LEFT/RIGHT button to tune the radio frequency.

### Recording a Radio Preset Station

To record up to 15 preset stations:

Press the DOWN button to record the actual frequency to the preset number displayed.

**NOTE:** While riding, the radio station will be automatically recorded to the next available preset number. If all preset numbers are used, the preset number 15 will be overwritten.

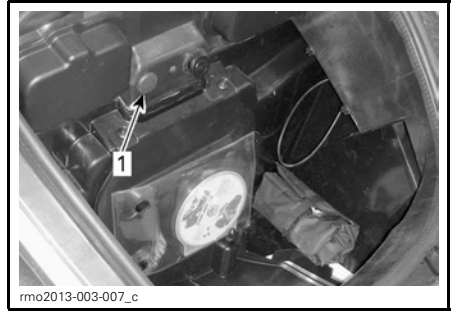

1. Audio in jack

An audio device can be connected in this jack to be played through the audio system.

**NOTE:** An adapter (optional on some models) is required to connect the audio device to the vehicle audio jack.

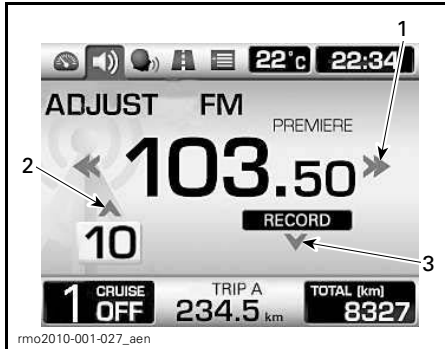

**TYPICAL**

1. LEFT/RIGHT button to select the frequency
2. UP button to select the preset number
3. DOWN button to record the radio station

### AUX (Auxiliary)

An audio input jack is provided in the front storage compartment.

### MP3 Player

When an MP3 player is connected to the vehicle audio connector (option package), it will play as set at the time of the connection. Only the volume control will be available.

### iPod Device

When an iPod device is connected, "iPod" is displayed instead of AUX.

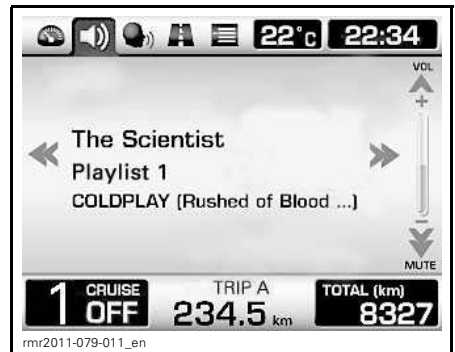

TYPICAL - iPod DEVICE SCREEN

Press the LEFT/RIGHT button to change the song in the current folder.

Press and hold the LEFT/RIGHT button for more than one second to change the playlist if the playlist item is se-

lected, to change the artist if the artist item is selected and to change the album if the album item is selected.

While riding, the available functions are:

- Audio volume and mute
- Previous or next song selection
- Artist, album or playlist selection.

### **Compatible iPod Device**

Made for:

- iPod touch  
(2<sup>nd</sup>, 3<sup>rd</sup> and 4<sup>th</sup> generation)
- iPod nano (5<sup>th</sup> and 6<sup>th</sup> generation)
- iPad
- iPad 2
- iPhone 4
- iPhone 3GS
- iPhone 3G.

## GPS (OPTION PACKAGE)

For GPS operation, refer to GPS manual.

### **⚠ WARNING**

Reading the GPS receiver can distract from the operation of the vehicle, particularly from constantly scanning the environment. Before reading the GPS receiver, ensure your environment is clear and free from obstacle, and bring the vehicle to a low speed. Additionally, make sure to often double-check for obstacles.

### **⚠ WARNING**

Remember, the data provided by the GPS receiver is for reference only. NEVER rely solely on this information for your safety.

## GPS Receiver Installation

To remove the cover plate from the GPS base, press on the push button to release it.

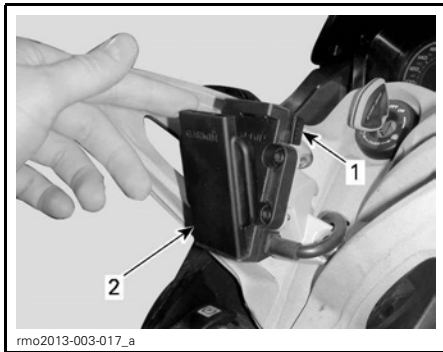

1. Push button
2. Cover plate

To attach the GPS receiver to its base; insert the lower part of the GPS receiver first into the tab, then push the GPS receiver towards the top of the base.

Push into place until it locks in.

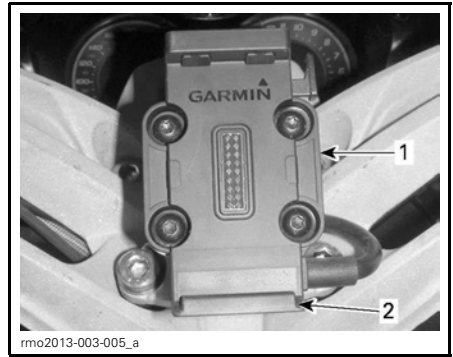

1. Base
2. Tab



1. GPS receiver

## GPS Receiver Removal

Press the push button

Gently pull the top of GPS receiver from the base until it unlocks.

Reposition the cover plate on the base and push into place

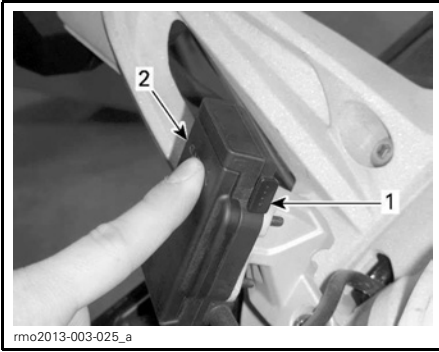

1. Push button
2. Cover

**⚠ CAUTION** The plastic cover must be installed at all times except when the GPS is installed onto the vehicle.

# EQUIPMENT

## Mirrors

### Adjusting Mirrors

Press the mirror at the points shown below to adjust its position in the four directions.

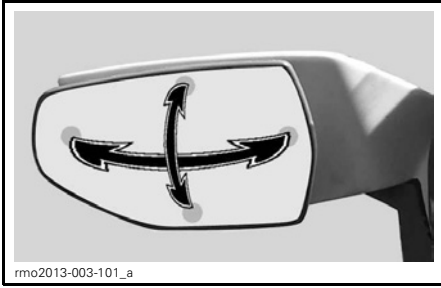

rmo2013-003-101\_a

MIRROR ADJUSTMENT POINTS

## Front Storage Compartment

Convenient compartment to store personal objects. When closed, the compartment is locked.

### Opening the Front Storage Compartment

1. Insert key in ignition switch.
2. **Push** and turn the key 1/4 turn counterclockwise to the front storage compartment position and hold while lifting cover.

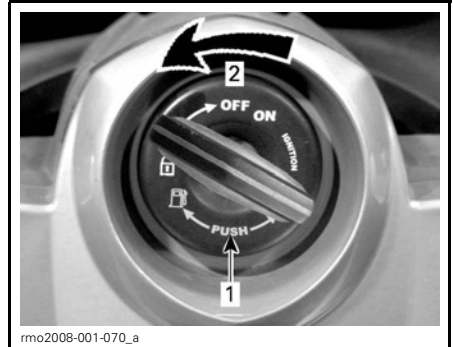

rmo2008-001-070\_a

### KEY POSITION TO OPEN FRONT STORAGE COMPARTMENT

1. Push key
2. Turn key 1/4 turn



rmo2013-003-002

FRONT STORAGE COMPARTMENT OPENED

**NOTE:** It is possible to open the front storage compartment with the engine running.

## Tool Kit

### Tool Kit Location

The tool kit is located inside the front storage compartment.



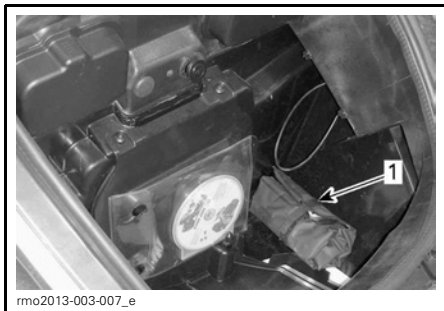

rmo2013-003-007\_e

**TYPICAL**

1. Tool kit

**Operator's Guide**

The operator's guide is located with the *SAFETY DVD* video inside the front storage compartment.

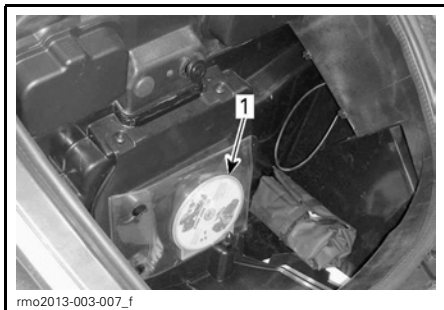

rmo2013-003-007\_f

**TYPICAL**

1. Operator's guide

**Seat****Opening the Seat**

1. Insert key in ignition switch.
2. Push and turn the key 1/4 turn clockwise to the seat opening position and hold while lifting seat.

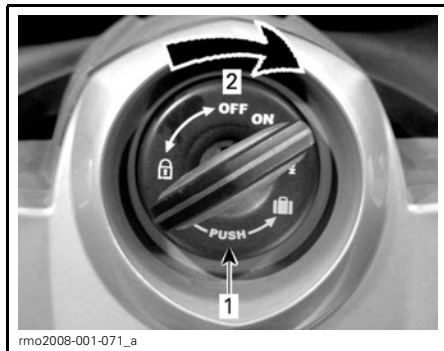

rmo2008-001-071\_a

**KEY POSITION TO OPEN SEAT**

1. Push key
2. Turn key 1/4 turn

**NOTICE** Do not force the seat past the maximum opening angle or it may break.



rmo2013-003-034\_a

1. Maximum opening of seat

**Body Panels**

The body panels on the vehicle can be removed for maintenance.

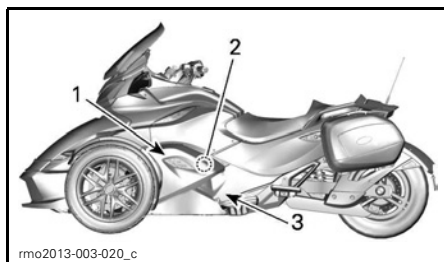

rmo2013-003-020\_c

**TYPICAL - LEFT HAND SIDE PANELS**

1. Middle side panel
2. Inner side panel
3. Bottom side panel

### 1) Middle Side Panel

The middle side panel can be removed to service vehicle.

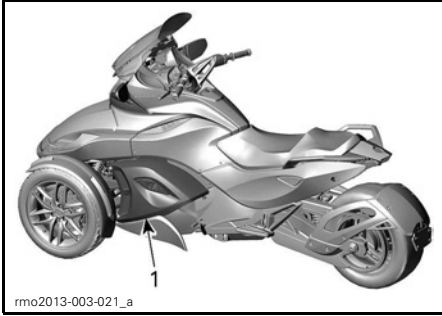

TYPICAL

1. Middle side panel

### Middle Side Panel Removal

1. Unscrew 3 clips.



TYPICAL

1. Middle side panel clips

2. Press down panel top edge with both hands and pull out.

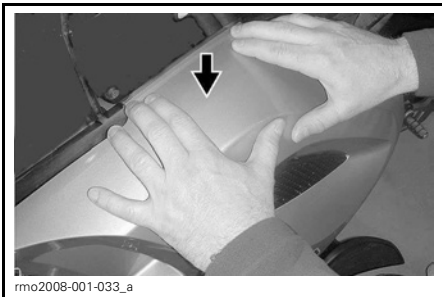

TYPICAL

3. Lift panel.

### Middle Side Panel Installation

1. Insert the middle side panel tabs into the bottom side panel slots.

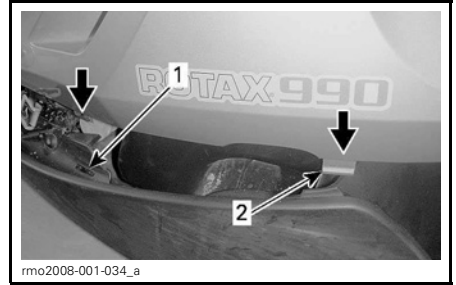

1. Bottom side panel slot
2. Middle side panel tab

2. Press down panel top edge with both hands and push in. While pressing, ensure that the lower tabs remain in the slots.

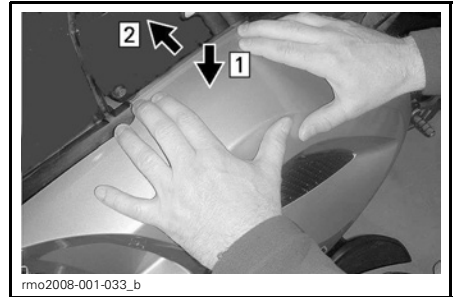

TYPICAL

Step 1: Press down top edge

Step 2: Push top edge under top side panel edge

3. Secure panel by pushing and turning each clip clockwise (1/4 turn) to its maximum rotation. Clip is properly fixed when a small amount of force is required while turning clip. Clip is not properly fixed when clip is loose while turning.



## 2) Inner Side Panel

### Inner Side Panel Removal

1. Remove middle side panel.
2. Unscrew Torx screw.

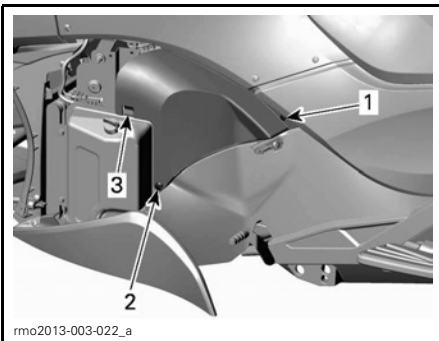

#### TYPICAL

1. Torx screw
2. Plastic rivet
3. Clip

3. Remove plastic rivet.
4. Slide the panel to release the clip.

### Inner Side Panel Installation

1. Slide panel back in position.
2. Install plastic rivet and screw in Torx screw.

**NOTICE** Do not overtorque. Any deformation on the panel around the screw is an indication that it is too tight. You may damage the panel.

## 3) Bottom Rear Side Panel

### Bottom Rear Side Panel Removal

1. Remove the inner side panel.

2. Unscrew the two screws from the bottom rear side panel.

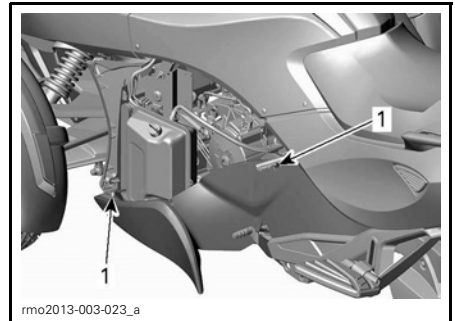

#### TYPICAL

1. Bottom panel Torx screws

3. Carefully slide the panel forward to disengage the tabs from the brackets.

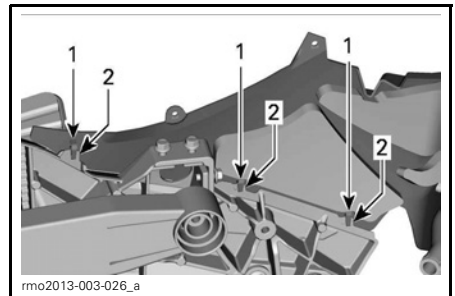

#### INNER SIDE OF PANEL

1. Tabs
2. Brackets

4. Once the panel is disengaged, tilt the bottom part towards you and lower the panel to release the top.
5. Remove the bottom rear side panel.

### Bottom Rear Side Panel Installation

1. Place the top part of the panel into position.
2. Tilt the bottom of the panel and insert it until it engages with the top panel.
3. Carefully slide the panel back until the tabs are just in front of the brackets.

4. Screw the 2 Torx screws.

**NOTICE** Do not overtorque. Any deformation on the panel around the screw is an indication that it is too tight. You may damage the panel.

5. Install the middle side panel.

# BASIC PROCEDURES

## Adjusting the Windshield

### **⚠ WARNING**

Adjusting the windshield can distract the driver from the operation of the vehicle. Always keep on observing the traffic and make sure the surrounding is clear and safe before doing so. Adjust windshield only when vehicle is stopped.

You can manually adjust the windshield to 5 different positions for your convenience.

Carefully slide the windshield along its tracks in a straight line.

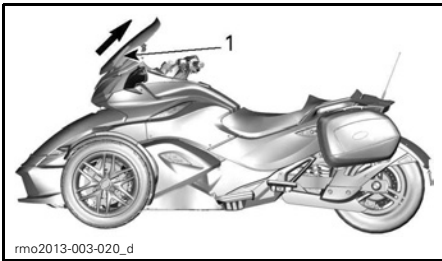

TYPICAL  
1. Track

## Adjusting the Passenger Footrest

For the passenger's comfort, its height can be adjusted.

Flip the footrest upward.

Turn the retaining screw counterclockwise with a wrench (stored in the tool kit) to loosen the screw.

**NOTE:** Do not completely unscrew the retaining screw to adjust the footrest. Unscrew only until you can disengage the footrest from the slots.

Raise or lower the footrest to your convenience.

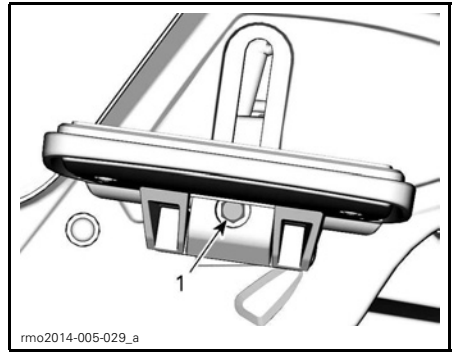

TYPICAL  
1. Retaining screw

**NOTE:** Make sure knob is properly inserted in slots before tightening.

When finished, tighten retaining screw clockwise.

Flip the footrest downward.

## Starting and Stopping the Engine

### Starting the Engine

### **⚠ WARNING**

Exhaust gas contains poisonous carbon monoxide that can rapidly accumulate in an enclosed or poorly ventilated area. If inhaled, it can cause serious injury or death.

Only run the engine in an unenclosed, well ventilated area. See **AVOID CARBON MONOXIDE POISONING**.

### SM5 Model

1. Push down and hold the brake pedal.
2. Turn the key to ON.

**NOTICE** Do not apply throttle while electrical system is initializing.

3. Refer to the Safety Card as needed to prepare yourself, your passenger and the vehicle, then press the MODE (M) button to enable the starter.
4. Set the engine stop switch to the RUN/ON position.
5. Pull in and hold the clutch lever.
6. Shift into NEUTRAL. Check the multifunction gauge cluster to be sure you are in neutral.
7. Press and hold the engine start button until the engine starts. Do not hold the start button for more than 15 seconds. If it does not start, release the button and wait 30 seconds to let the starter cool down before trying again.

**NOTICE** Do not apply throttle while starting the engine.

8. Check the display for problems and to ensure that the oil light turns off.
9. Release the parking brake. Make sure the parking brake indicator on the multifunction gauge cluster is off.

**NOTICE** If the parking brake is not fully released before operating the vehicle, brake pads will drag while you are moving. This can damage the brake system.

### *SE5 Model*

**NOTE:** The SE5 model can be started in any gear with the brake pedal depressed. The transmission automatically shifts to neutral when the engine started.

1. Push down and hold the brake pedal.
2. Turn the key to ON.

**NOTICE** Do not apply throttle while electrical system is initializing.

3. Refer to the Safety Card as needed to prepare yourself, your passenger and the vehicle, then press the MODE (M) button to enable the starter.
4. Set the engine stop switch to the RUN/ON position.
5. Press and hold the engine start button until the engine starts. Do not hold the start button for more than 15 seconds. If it does not start, release the button and wait 30 seconds to let the starter cool down before trying again.

**NOTICE** Do not apply throttle while starting the engine.

6. Check the display for problems and to ensure that the oil light turns off.
7. Release the parking brake. Make sure the parking brake indicator on the multifunction gauge cluster is off.

**NOTICE** If the parking brake is not fully released before operating the vehicle, brake pads will drag while you are moving. This can damage the brake system.

### **Stopping the Engine**

#### *SM5 Model*

1. Shift into first gear.
2. Set the engine stop switch to OFF.
3. Engage the parking brake. The brake indicator lamp will flash.
4. Turn the key to OFF.
5. Before dismounting, check that the parking brake is fully engaged. Hold the clutch and rock the vehicle back and forth.

**NOTE:** As the brake pads wear, you may need to push the parking brake lever farther to engage the brake.

**⚠ WARNING**

Always fully engage the parking brake. The vehicle can roll if the parking brake is not fully engaged and the transmission is in neutral.

**SE5 Model**

1. Shift into neutral.
2. Set the engine stop switch to OFF.
3. Engage the parking brake. The brake indicator lamp will flash.
4. Turn the key to OFF.

**NOTE:** If the parking brake is not engaged while the key is OFF, the park brake indicator light will flash and a beeper will sound.

5. Before dismounting, check that the parking brake is fully engaged. Rock the vehicle back and forth.

**⚠ WARNING**

Always fully engage the parking brake. The vehicle can roll if the parking brake is not fully engaged, regardless of what gear it is in. The centrifugal clutch is always disengaged when the vehicle is stopped, so the transmission will not hold the vehicle in place.

**All Models**

This vehicle is equipped with an Electronic Throttle Control (ETC).

Each time the ignition switch is turned OFF, the ETC motor stays energized for 40 minutes.

The ETC motor will emit a high frequency sound during this period of time that can be heard in a quiet environment.

This is a normal characteristic of the vehicle.

**Pushing the Vehicle**

**⚠ CAUTION** Avoid pushing the vehicle on a slope. If you must push the vehicle on a slope, take extra care to stay within reach of the brake pedal in case the vehicle starts to roll.

To move the vehicle a short distance without starting the engine:

1. While seated on the vehicle, push down and hold the brake pedal.
2. Shift the transmission into NEUTRAL (SM5 model).
3. Disengage the parking brake.
4. Dismount on the right side of the vehicle, keeping your foot on the brake pedal.
5. Push the vehicle, using the brake as needed.

**⚠ CAUTION** Only push from the right side, so you can reach the brake pedal. Stay clear of the hot exhaust pipe.

When pulling the vehicle backward, be careful that the front wheel does not roll over your feet.

6. Remount the vehicle and park as specified above.

**Operating in Reverse**

For safe operation in reverse, refer to *SAFE OPERATING INSTRUCTIONS* section.

**Shifting Into Reverse (SM5 Model)**

1. With engine running, shift into first gear.
2. Hold in the clutch lever.
3. Press and hold the reverse button.
4. Step down on the shift lever one stroke.

5. Release the reverse button and check that the letter "R" flashes on the multifunction gauge cluster and the hazard warning lights flash.

### Shifting Into Reverse (SE5 Model)

1. With engine running, the roadster stopped, and the brake depressed, shift into first gear or neutral.
2. Press and hold the reverse button.
3. Pull the gearshift selector toward you to downshift to reverse.

### Driving in Reverse

Check that the area behind you is clear and continue to look backwards while you operate in reverse. Keep your speed low and do not back up for long distances.

### Shifting Out of Reverse

#### *SM5 Model*

To shift out of reverse, hold in the clutch and lift the shift lever once to shift into first. You do not need to use the reverse button — it resets automatically.

#### *SE5 Model*

To shift out of reverse, stop vehicle and push on upshift selector quickly to shift into neutral and longer to shift in first gear.

### Operating During Break-In

A break-in period of 1 000 km is required for the vehicle.

During the first 300 km, avoid hard braking.

## **WARNING**

New brakes and tires do not operate at their maximum efficiency until their break-in is completed. Braking, steering and VSS performance may be reduced, so use extra caution.

Brakes and tires take about 300 km of riding with frequent braking and steering to break-in. For riding with infrequent braking and steering, allow extra time to break-in the brakes and tires.

During the first 1 000 km:

- Avoid full throttle acceleration.
- Avoid prolonged riding.
- If the cooling fan operates continuously during stop and go traffic, pull over and shut off the engine to let it cool off or speed up to let air cool off the engine.

After the break-in period, your vehicle should be inspected by an authorized Can-Am roadster dealer as per the *MAINTENANCE SCHEDULE*.

## **Fueling**

### **Fuel Requirements**

**NOTICE** Always use fresh gasoline. Gasoline will oxidize; the result is loss of octane, volatile compounds, and the production of gum and varnish deposits which can damage the fuel system.



Alcohol fuel blending varies by country and region. Your vehicle has been designed to operate using the recommended fuels, however, be aware of the following:

- Use of fuel containing alcohol above the percentage specified by government regulations is not recommended and can result in the following problems in the fuel system components:
  - Starting and operating difficulties.
  - Deterioration of rubber or plastic parts.
  - Corrosion of metal parts.
  - Damage to internal engine parts.
- Inspect frequently for the presence of fuel leaks or other fuel system abnormalities if you suspect the presence of alcohol in gasoline exceeds the current government regulations.
- Alcohol blended fuels attract and hold moisture which may lead to fuel phase separation and can result in engine performance problems or engine damage.

### Recommended Fuel

Use premium unleaded gasoline with an AKI (RON+MON)/2 octane rating of 91, or an RON octane rating of 95.

**NOTICE** Never experiment with other fuels. Engine or fuel system damages may occur with the use of an inadequate fuel.

### Refueling Procedure

#### **⚠ WARNING**

Gasoline is extremely flammable and highly explosive. Follow the refueling procedure to reduce the risk of fire or explosion. See **AVOID GASOLINE FIRES AND OTHER HAZARDS.**

To refuel the vehicle:

1. Park outdoors in a well ventilated area away from flames, sparks, anyone smoking and other sources of ignition.
2. Stop the engine.
3. Unlatch and lift seat (see the *EQUIPMENT* subsection). The fuel cap is located on the left side.
4. Slowly rotate cap counterclockwise and remove it.



**FUEL CAP ON LEFT SIDE UNDERNEATH SEAT**

5. Fill the tank until the fuel level reaches the higher point of the filler tube.

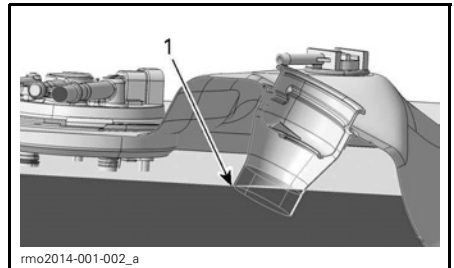

1. Higher point of the filler tube

**NOTE:** Do not try to top off the fuel tank. Leave some room for the fuel to expand with temperature changes.

6. Wipe up any spilled fuel. If fuel spills on you, wash with soap and water and change your clothes.
7. Put cap on and fully tighten clockwise until you hear a click. Never start or operate the engine with the fuel cap removed.

8. Close seat.

## Using the 12 V Power Outlet (Option Package)

A 12 V power outlet is available on the vehicle. It is located in the front storage compartment.

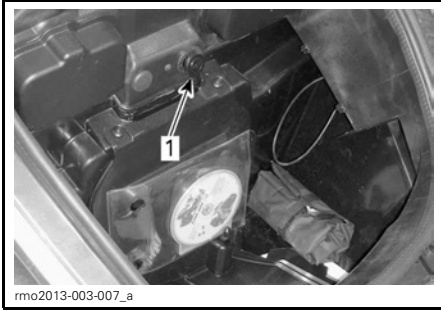

1. Power outlet

A 12-volt electric appliance may be connected to the jack connector. Electric current is supplied all the time.

**NOTICE** The 12-volt power outlet is not designed to supply current of more than 3 amperes.

**NOTE:** Leaving an appliance connected while the engine is not running will gradually discharge the battery.

**NOTE:** When fuse 6 is installed in the right fuse box, 12 V power outlet is only operational when ignition switch is at ON position. When fuse 7 is installed, 12 V power outlet is always operational.

# ***SAFE OPERATING INSTRUCTIONS***

---

# WHAT'S DIFFERENT ABOUT THE SPYDER ROADSTER

The Spyder roadster is a different type of road vehicle. This section will help you understand some of the vehicle distinctive features and operating characteristics.

## Stability

The three-wheeled “Y” configuration provides greater low-speed stability than a motorcycle. However, it is not as stable as a four-wheeled vehicle such as an automobile. Driving aid technologies, like the electronic Vehicle Stability System (VSS), help maintain stability during maneuvers, but you can still lose control, tip or roll the vehicle due to extreme maneuvers (such as hard turns at high speeds) or striking uneven surfaces or objects. In addition, the operator or passenger can fall off due to hard turns, acceleration, braking or impacts.

## Response to Road Conditions

The Spyder roadster responds differently than other vehicles to certain road conditions.

- Do not ride off-road or on ice or snow.
- Avoid puddles and running water. The vehicle hydroplanes more easily than a car. If you must go through water, slow down.
- Slow down on gravel, dirt or sand covered roads.

Refer to *STREET STRATEGIES* subsection for detailed instructions.

## Brake Pedal

One pedal brakes all three wheels. There is no hand-operated brake, and there is no way to brake front and rear wheels separately. The Spyder roadster is better able to brake and steer at the same time than a motorcycle. The

vehicle can stop quickly — be aware of vehicles behind you that may not be able to stop as quickly.

## Anti-Lock Braking System (ABS)

The vehicle is equipped with an Anti-lock Braking System (ABS) as part of the Vehicle Stability System (VSS). For hard braking, press and hold the brake pedal. ABS will prevent wheels from locking.

## Parking Brake

The parking brake mechanically brakes the rear wheel only, and it locks in place when engaged. It is not controlled by driving aid technologies (e.g., ABS, Electronic Brake Distribution).

## Steering

### Direct Steering

To steer your Spyder roadster, always steer in the direction of the turn.

Motorcyclists — Do not countersteer as it is done on a motorcycle. Unlike a motorcycle, your Spyder roadster cannot lean while turning. If you are a motorcyclist, you must relearn how to turn. Practice steering in the direction of the turn at all speeds until you are proficient.

### Sideways Forces in Turns

Unlike a motorcycle, the Spyder roadster does not lean in turns. You will feel sideways forces pushing you to the outside of the turn. To maintain balance, the operator and passenger must hold on with both hands and keep both feet firmly planted on the footrests. In hard turns, it may help to lean your upper body forward and toward the inside of the turn.

## Width

Because the Spyder roadster is wider than a typical motorcycle:

- Keep the front wheels in your lane during turns. Be particularly aware of where your front wheels are in curves and when passing. If you take a path that would put a motorcycle front wheel near the edge of the lane, the Spyder roadster front wheel may be out of the lane.
- Do not share lanes or split lanes (ride between two lanes of traffic). Group riding should proceed in a single file, even with motorcycles.
- Be prepared to swerve farther to avoid obstacles.

## Reverse

The Spyder roadster operates in reverse like a car. However, there are some important differences:

- The hazard warning lights flash when it is in reverse, but there are no backup lights. Be aware that other motorists might not know that you are about to back up.
- If necessary, have the passenger dismount if your visibility is limited.
- Remember that the front is wider than the rear. Do not back up too close to objects or you may hit them with the front tires.
- Keep your speed low and do not back up for long distances.
- When possible, park so that you do not have to back out of the parking space.
- **SM5 model:** Shift back into first gear before shutting off the engine.

**⚠ CAUTION** Always keep both feet on the pegs while operating in reverse. Never put your feet on the ground while backing-up.

## Driver's License and Local Laws

Driver's license requirements for operating the Spyder roadster vary by location. Depending on local laws, you may need a motorcycle endorsement, three-wheeled vehicle endorsement, or just a standard automobile driver's license.

Check with local authorities to make sure you have the proper license before operating the vehicle on public roads.

---

# DRIVING AID TECHNOLOGIES

## Vehicle Stability System (VSS)

The Spyder roadster is equipped with a Vehicle Stability System (VSS). VSS can help you control the direction of the vehicle and reduce the risk of tipping or rolling over in some situations. VSS consists of:

- An **Antilock Braking System (ABS)** that helps maintain steering control during hard braking by preventing the wheels from locking.
- An **Electronic Brake Distribution (EBD)** system that automatically adjusts the brake balance between all three wheels. With the ABS, EBD helps maintain directional control and maximize the braking force depending on the traction available.
- A **Traction Control System (TCS)** that helps prevent the rear wheel from slipping. The TCS will limit rear wheel spin only if you turn the handlebar (steer out of straight line) or if vehicle speed exceeds 50 km/h.
- A **Stability Control System (SCS)** is designed to limit the power driving the rear tire and to brake individual wheels, which reduces the risk of losing control of the vehicle or rolling over.

### Limitations

VSS cannot help you maintain control in all situations.

### Surfaces with Poor Traction

The grip of tires on the road surface limits the maximum braking. Even with ABS and EBD, your stopping distance will be longer on surfaces with poor traction or if you do not maintain tire pressure and tread condition.

If your tires lose traction with the road surface you may lose control of the vehicle, even with VSS.

If the paved road surface is covered or partially covered with ice, snow or slush, there is not enough traction

available to maintain control of the vehicle, even with VSS. Do not operate on snow, ice or slush.

Like other on-road vehicles, this vehicle can hydroplane on water (lose traction on a layer of water). If you ride too fast into a layer of water, such as a large puddle or flowing water on the road, the vehicle can lose traction and spin out, and the VSS cannot keep you in control. Avoid large water puddles or water streams, and slow down or pull off the road during heavy rains. If you must pass through water, slow down as much as possible before you reach it.

Reduce speed on surfaces with poor traction, like mud, sand, gravel or wet pavement. The Spyder roadster is not for off-road operation. Always operate the vehicle on maintained roadways. Do not use the vehicle on any other terrain.

### Tires

The VSS on the vehicle has been calibrated to perform best with a tire of a specific size, material and tread pattern. Replacing your tires with ones not approved by BRP can cause the VSS to be ineffective.

Use only BRP recommended tires, which can be ordered only from an authorized Can-Am roadster dealer.

Proper tire inflation pressure and tread condition are important for maintaining traction, especially on loose or wet surfaces.

### Hard Turns

The VSS does not control or limit steering input — it cannot keep you from turning too sharply. Large and rapid steering handlebar movements can cause the vehicle to go out of control, spin, tip or roll over.

## **Excess Speed**

The VSS does not control the vehicle speed, except when SCS intervenes during a turn. VSS does not prevent the vehicle from entering a turn too fast. If you drive too fast for conditions, you can lose control, even with VSS.

## **Dynamic Power Steering (DPS)**

The DPS (Dynamic Power Steering) provides a computer controlled, variable power assist, achieved by an electric motor to optimize the amount of steering effort required by the rider.

The steering assist level is dependent of the handlebar effort, the steering angle and the vehicle speed.

When vehicle is in the reverse gear, power steering assist will decrease as vehicle speed increases.

---

# UNDERSTANDING RISK ON THE ROAD

Before you operate the Spyder roadster, consider your risk of being hurt or killed in a crash, how you can reduce the risk and whether you are willing to take the risk. There are many factors that contribute to the risk that you face. You can control some of these factors, but others, like the behavior of other drivers, are beyond your control. Here are some of the factors that affect your risk:

## Type of Vehicle

Different types of vehicles vary in terms of size, visibility and maneuverability and provide different degrees of protection.

The Spyder roadster is small and maneuverable. Maneuverability can help avoid crashes. However, smaller vehicles are harder to see, which increases the chance that other motorists will cause a crash. In some situations, the Spyder roadster is less likely to be in a crash than a motorcycle. For example, you are less likely to tip over at low speeds while operating the vehicle. However, in other situations, the vehicle is more likely to be in a crash. For example, because the vehicle is wider, it will not fit through as small an opening as many motorcycles.

In cars and trucks, the structure of the vehicle provides protection in crashes and from other road hazards. In addition, passengers can protect themselves by wearing seat belts. You should expect that riding the Spyder roadster is riskier than riding in a car and that the risk of injury is more like riding a motorcycle.

As when riding a motorcycle, you can reduce the risk of injuries by wearing a helmet and riding gear.

## Operator Skills and Judgment

Every driver has some control over their own risk on the road. Drivers who develop good skills will have better control of their vehicle. Do not rely on your experience with motorcycles, automobiles, ATVs, snowmobiles or any other kind of vehicle to prepare you to operate the Spyder roadster. Learn how this vehicle is different. Read this Operator's Guide, watch the *SAFETY DVD* video, and if available, take a training course. Become proficient with the controls and be able to do the practice exercises accurately and with confidence before going on the road.

When you begin riding on the road, start with less challenging situations (e.g., light traffic, lower speeds, good weather, no passenger) and gradually move on to more challenging riding situations as you develop your skills. Plan ahead to avoid situations that are too difficult for your skill level, or that present more risk than you want to take on.

Even skilled drivers cause crashes. For example, if you use your skills to do extreme maneuvers or stunts, you increase your risk. The smart driver uses good judgment along with skills to increase the margin of safety and minimize risk. Learn the defensive driving techniques in the *STREET STRATEGIES* subsection.

## Rider Condition

A driver needs to be alert, sober, and physically ready to ride. Never use this vehicle with drugs or alcohol. Riding when intoxicated, tired or otherwise impaired increases the risk of a crash.

Alcohol, drugs, medications, fatigue, drowsiness and emotions can all inhibit your ability to ride safely. Like riding a motorcycle, riding the Spyder roadster is a challenging activity — being in good physical and mental con-



dition is even more important than for a car. The safest policy is to never operate the vehicle unless you are alert and completely sober. Even if your blood alcohol level is not over the legal limit, your judgment and skills are impaired by any alcohol consumption.

You must be physically able to operate all controls, turn the handlebar through the full range of steering, mount and dismount, and monitor your surroundings to operate the vehicle.

Passengers also need to be alert, sober and physically able to maintain their posture, hold on and react appropriately to curves, bumps, acceleration and stops.

## **Vehicle Condition**

Keep your vehicle in good condition.

Do pre-operation checks and perform regular maintenance. Watch for any messages on the multifunction gauge cluster when you start the vehicle, and address any problems before you ride.

## **Road and Weather Conditions**

Roads with heavy traffic, poor visibility or poor traction surfaces increase your risk. Choose routes that are appropriate for your skill level and the level of risk you are willing to accept.

# RIDING GEAR

Riding three-wheeled, open-air vehicles like the Spyder roadster requires the same protective gear as motorcycling. Even though the vehicle is more stable at low speeds than a motorcycle, you can still be thrown off.

This section is based on guidance for motorcyclists given by the Motorcycle Safety Foundation (MSF).

In the event of a crash, protective gear may prevent or reduce injuries. Protective gear also helps you stay comfortable and can help provide protection against the elements.

Recommended basic protective gear for riders and passenger includes sturdy over-the-ankle footwear with non-slip soles, long pants, a jacket, full-fingered gloves and, above all, an approved helmet with proper eye protection.

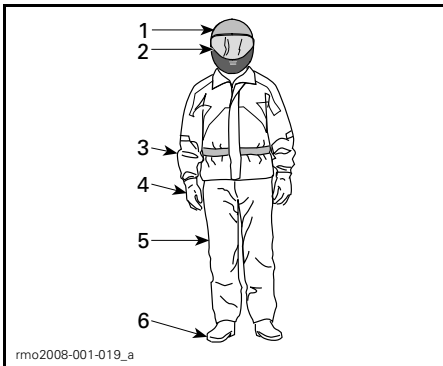

## RIDING GEAR

1. Approved helmet
2. Eye and face protection
3. Jacket with long sleeves
4. Gloves
5. Long pants
6. Over-the-ankle footwear

Proper apparel can reduce the severity of injury in case of a crash for both operators and passengers.

## Helmets

Helmets protect the head and brain from injury. A helmet can also protect the passenger's face from impact

with the back of the operator's helmet. Even the best helmet is no guarantee against injury, but statistics indicate that helmet use significantly reduces the risk of brain injury. So, be safe and always wear a helmet while riding.

## Choosing a Helmet

Helmets should be manufactured to meet the appropriate standard in your state, province or country.

A full-face helmet gives the most protection against impacts since it covers all of the head and face. It can also protect against debris, stones, insects, etc.

A three-quarter or open-face helmet can also offer protection. It is constructed with the same basic components but does not offer the face and chin protection of full-face helmets. If you wear an open-face helmet, you should use a snap-on face shield or a pair of goggles.

**NOTE:** Ordinary glasses or sunglasses are not sufficient eye protection for a motorcyclist. They can shatter or fly off, and they allow wind and airborne objects to reach the eyes.

Use tinted face shields, goggles or glasses in the daytime only; do not use them at night or in poor illumination. Do not use them if they impair your ability to discern color.

## Other Riding Gear

### Footwear

Always wear closed toe footwear. Sturdy over-the-ankle boots protect against a variety of riding hazards, such as stones that get thrown up from the roadway and burns from the hot exhaust pipe.

Avoid long shoelaces that can be tangled in the gearshift lever, brake pedal or other parts. Rubber soles and low heels are a good idea to help keep feet on the footrests.

## Gloves

Full-fingered gloves protect hands from the wind, sun, heat, cold and flying objects. Gloves that fit snugly will improve grip on the handlebar and help reduce hand fatigue. Sturdy, reinforced motorcycle gloves help protect hands in the event of a fall. Gloves made specifically for motorcyclists have seams on the outside to prevent irritation, and are curved to provide a natural grip when curled around the handgrips. If gloves are too bulky, it may be difficult to operate the controls. Gauntlets keep cold air from going up sleeves and protect the wrists.

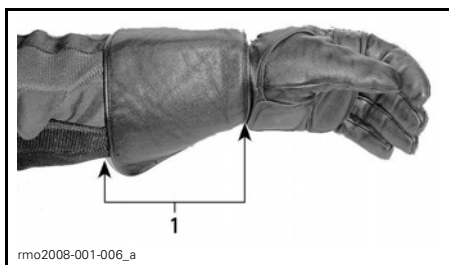

1. Glove gauntlet

## Jackets, Pants and Riding Suits

Wear a jacket and long pants, or a full riding suit. Quality motorcycle-type protective gear will provide comfort, and it can help you avoid being distracted by adverse environmental elements. In case of a crash, good quality protective gear made of sturdy material may prevent or reduce injury. Some gear includes padding or hard armor that may further reduce the risk of injury in a crash. Pants also help protect against burns from hot parts.

Protective gear sold for motorcycling will often provide the best combination of fit and protection. These garments are designed to fit while sitting in a riding position. They are cut longer in the sleeves and legs and are fuller across the shoulders. Riding suits are available in both one-piece and two-piece sets.

Leather is a good choice because it is durable and wind-resistant and provides protection against injury. Other abrasive-resistant protective gear made of synthetic fabrics are good choices, too. Do not wear loose or long clothing or scarves that can become tangled in the moving parts.

Flaps and fasteners seal out the wind. A jacket with a zippered front will be more wind resistant than a jacket with buttons or snaps. A flap of material over the zipper of a jacket gives additional protection against the wind. Jackets with snug cuffs and waist are recommended to keep wind from blowing in. A large, loose collar can flap when riding and may irritate skin or be a distraction.

In cool-weather riding, protect yourself against hypothermia. Hypothermia, a condition of low body temperature, can cause loss of concentration, slowed reactions and loss of smooth, precise muscle movement. In cool conditions, proper protective gear like a windproof jacket and insulated layers of clothing are essential. Even at moderate temperatures, you can feel very cold due to the wind while riding.

Protective gear that is appropriate for cold-weather riding may be too hot when stopped. Dress in layers so that clothing can be removed as desired. Topping the protective gear with a windproof outer layer can prevent cold air from reaching the skin.

Riding gear can also help a rider be more visible. Wearing bright colors is a wise choice. If a dark jacket is worn, an inexpensive reflective vest can be worn over it. It is a good idea to put extra reflective tape on garments worn regularly while riding.

## Rain Gear

If you must ride in wet weather, a rain suit or a waterproof riding suit is recommended. On long rides, it is a good

idea to carry rain gear. A dry rider will be much more comfortable and alert than a rider who is wet and cold.

One or two-piece styles are available, and those designed specifically for motorcycling are best. High-visibility orange or yellow colors are good choices. A feature to look for is elastic in the waist, pant legs and sleeves. The jacket should have a high collar and zip up with wide flaps across the opening. When purchasing a rain suit, consider adding waterproof gloves and footwear.

Remember, if the weather is wet, it is best to avoid riding. If you do ride in wet weather, you may need to stop if water starts to accumulate on the road.

### **Hearing Protection**

Long-term exposure to wind and motor noise when riding can cause permanent hearing loss. Properly worn hearing protective devices such as earplugs can help prevent hearing loss. Check local laws before using any hearing protective devices.

---

# REQUIRED RIDING SKILLS AND PRACTICE EXERCISES

Before you take the Spyder roadster on the road, you need to develop riding skills and strategies for managing risk on the road. The following exercises will familiarize you with the basic operation of the vehicle. If you have experience with motorcycles or other motor vehicles, pay particular attention to how the Spyder roadster operation and performance are different from vehicles you are used to. Practice each exercise until you can perform it proficiently before moving on to the next. This section includes the following exercises:

## ***SM5 Model***

1. Revving the engine and using the engine stop switch
2. Learning the friction zone and basic handling
3. Engine stop while in motion
4. Using the throttle and clutch
5. Basic turns
6. Quick stops
7. Weaves
8. Shifting
9. Swerve
10. Operating in reverse.

## ***SE5 Model***

1. Revving the engine and using the engine stop switch
2. Starting, stopping, and basic handling
3. Engine stop while in motion
4. Basic turns
5. Quick stops
6. Weaves
7. Shifting
8. Swerve
9. Operating in reverse.

## **Choosing a Practice Area**

Perform these exercises in a paved area at least 76 m - 30 m that is not open to traffic. A closed, well marked parking lot without obstacles (light poles, curbs, etc.) makes a good practice area. Be aware of oil left by parked cars. Look for parking lots that are empty during off hours, such as schools, churches, community centers or shopping centers. Do not trespass on private property.

Once you have selected a suitable location, get permission to use it from the owner. If there are obstructions, such as light poles or islands, be sure that they do not interfere with the required open paths shown in the diagram below.

Keep this basic parking lot diagram in mind when setting up the exercises. 3 m wide parking lot spaces are indicated in the diagrams for convenience, but the size of the spaces in the lot you use may be different. If the parking lot you choose does not have lines or if the parking spaces are sized much larger or smaller than the ones in the diagrams, use the dimensions shown below. Mark them using a tape measure and chalk or markers such as cones or milk containers weighted with water or sand.

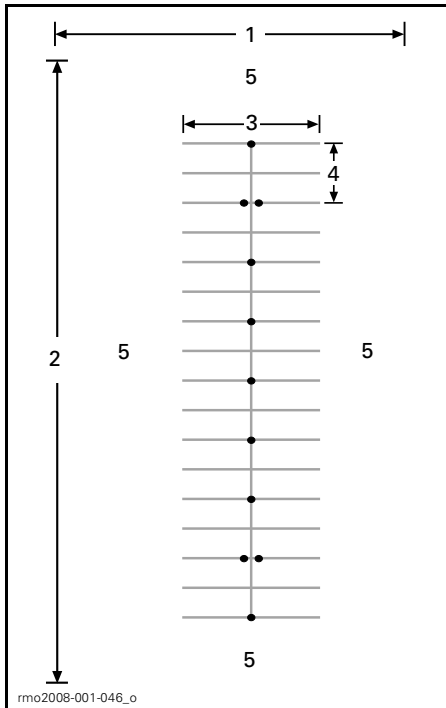

**TYPICAL PARKING LOT**

1. At least 30 m
2. At least 75 m
3. 12 m
4. 6 m
5. Open area

Even in a closed lot, be aware of potential traffic. Check to the front, sides and rear before doing an exercise. Also, watch out for children and animals.

**Preparing to Ride**

Know the location and operation of all the vehicle controls. Refer to *VEHICLE INFORMATION* section.

Perform the pre-ride inspection. Refer to *PRE-RIDE INSPECTION* section.

Always start and stop the engine according to the instructions in *STARTING AND STOPPING THE ENGINE* in the *BASIC PROCEDURES* subsection.

**Riding Posture**

Good posture helps you maneuver the vehicle more easily. Always keep both hands and both feet in position so that you can operate the controls easily. The wrist should typically be aligned straight with the arm (this position helps you apply the amount of throttle you want). Arms should be relaxed and bent. Keep your back straight and your head and eyes up. Keep both feet on the pegs near the controls.

Never operate the vehicle, even for a short distance, unless you are in the proper riding posture.



TYPICAL - RIDING POSTURE

**Practice Exercises (SM5 Model)**

**1) Revving the Engine and Using the Engine Stop Switch**

**Purpose**

- Become familiar with the sound of the engine revving so you will not be surprised during the exercises.
- Become familiar with using the engine stop switch.

### Directions

- With the vehicle in NEUTRAL, the parking brake engaged, and your right foot pressing the brake pedal, pull in and hold the clutch lever. Watch the tachometer and apply throttle (twist lowering your wrist) a few times to raise the RPM to no more than 4 000. As long as the clutch is fully pulled in the power will not transfer to the rear wheel.
- Use the engine stop switch to cut all power to the vehicle. Press the switch with your right thumb while keeping your hand on the handgrip.

### Tips for Additional Practice

- Practice pressing the engine stop switch without looking at it.

## 2) Learning the Friction Zone and Basic Handling

Pulling in the clutch disengages power to the rear wheel — if you feel like you are losing control while doing these exercises, you can pull in the clutch to stop accelerating and apply the brake as needed to slow down. You can also use the engine stop switch to cut power entirely.

The friction zone is the area in the travel of the clutch lever that begins where the clutch starts to transmit power to the rear wheel and ends just before the clutch becomes fully engaged. While the clutch is partially engaged, it allows you to precisely control engine power transmitted to the rear wheel. Proper use of the friction zone helps you get moving smoothly from a stop.

### Purpose

- Become familiar with the clutch and operating within the friction zone.
- Become familiar with low speed deceleration and braking.

### Directions

For this exercise, do **NOT** use any throttle. You will be controlling your movement using only the clutch in the friction zone and brake.

Begin by stopping every 6 m (every marker/every second line).

- Start the engine and release the parking brake.
- With the brake pedal depressed and the clutch lever pulled in, shift the transmission into first gear by firmly pushing down on the shift lever.
- Release the foot brake.
- **Slowly** let out the clutch lever until the vehicle starts to creep forward. Hold the clutch lever at this point. This is the friction zone. If you release the clutch too quickly, the engine may stall or the vehicle may jump forward. **If the vehicle stalls**, restart the engine and try again, releasing the clutch more gradually.
- As you approach the stopping point, pull the clutch lever all the way in and press the brake pedal to stop. Pulling the clutch in does not have to be gradual — you can do this quickly.
- When you reach the end of the straightaway, stop, turn the handlebar all the way to the right, and turn around. Be careful not to apply throttle as you turn. Stop when you are in line with the straightaway in the opposite direction.
- Repeat this exercise until you feel comfortable.

### Tips for Additional Practice

- As you become more comfortable with the friction zone, try stopping every 12 m (every other cone) so that you can fully release the clutch.

### 3) Engine Stop while in Motion

#### Purpose

- Become familiar with using the engine stop switch when in motion so you know how the vehicle will react if you need to use it later.

#### Directions

- Partway down the straightaway, while operating in the friction zone, turn the engine stop switch to OFF and coast to a stop.
- Restart the engine and repeat the exercise. Try releasing the clutch farther and moving a little faster before using the engine stop switch.

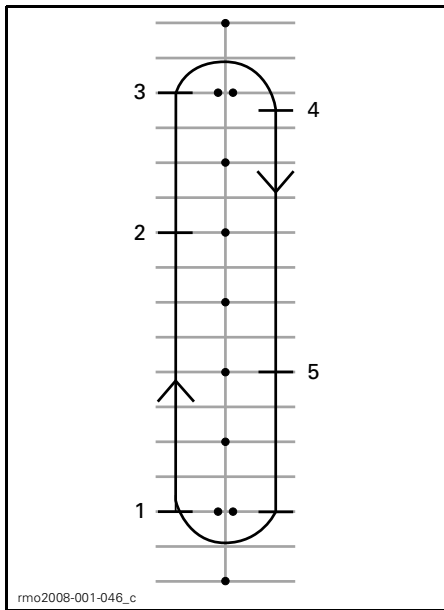

1. Start
2. Press engine stop switch
3. Proceed to end of straightaway, stop and turn as before
4. Stop
5. Press engine stop switch

Restart the engine and proceed to the next exercise.

### 4) Using the Throttle and Clutch

#### Purpose

- Become familiar with operating the throttle.
- Learn to balance throttle and clutch.

#### Directions

This exercise is similar to the friction zone exercise, except this time you will be using some throttle. You will use the entire straightaway, stopping only at the ends.

- Start this exercise stopped in first gear at the beginning of a straightaway.
- With the clutch lever pulled in, gently apply throttle until the tachometer reads between 1 500 and 2 000 RPM. Practice holding it within this range.
- Hold the throttle at this position while gently releasing the clutch lever as before. Try not to let the RPMs exceed 2 500.
- The more quickly you release the clutch lever, the more quickly you will accelerate. If you release the clutch too quickly, the engine may stall or the vehicle may jump forward.
- Applying too much throttle can cause the rear wheel to spin and can result in rapid acceleration.
- When the clutch lever is fully released, the throttle controls your speed.
- As you approach the end of the straightaway, release the throttle, pull in the clutch lever and apply the brakes to come to a stop.
- Without using throttle, turn around and head down the opposite straightaway.



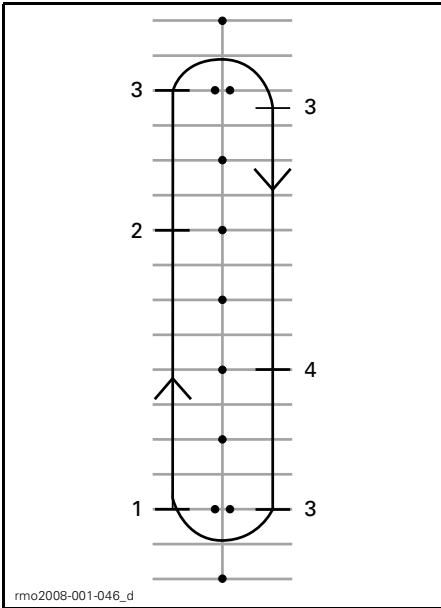

- As you approach the curve, slow down to no more than 8 km/h by pulling in the clutch lever and applying brake if needed.
- Hold the clutch lever in the friction zone to maintain your low speed.
- Look in the direction of the curve.
- Turn the handlebar in the direction of the curve, pulling on the inside hand-grip and pushing on the outside. Be careful not to change your hand position on the throttle.
- Leaning forward and into the curve may help you turn the handlebar more easily.
- Straighten your handlebar after the turn and proceed down the straight-away.

1. Start
2. Release throttle
3. Stop
4. Release throttle

**Tips for Additional Practice**

- Coordinate releasing the clutch lever and applying the throttle to start smoothly and to control your acceleration.

**5) Basic Turns**

**Purpose**

- Get comfortable turning in a controlled manner.

**Directions**

This exercise is similar to what you did before, except that now instead of stopping for each turn, you will make the turn in the friction zone.

- Proceed down the straight away in first gear. Ride a little farther from the cones so you can make a wide arcing turn at the end of the straight-away.



TYPICAL - RIDING POSTURE WHEN TURNING

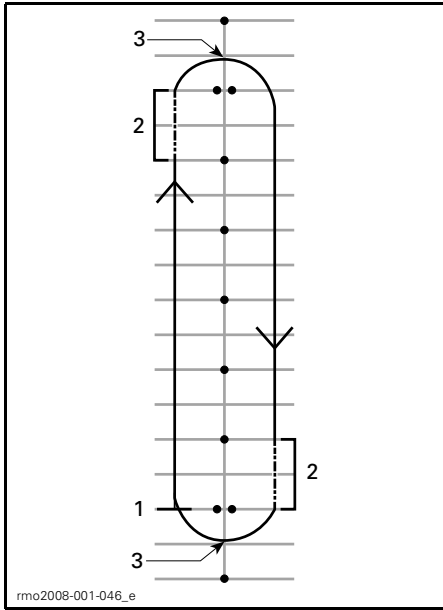

1. Start
2. Friction zone
3. Apex

**NOTE:** Motorcyclists - Riding through turns and curves with your Spyder roadster is different than on a motorcycle. The vehicle does not lean during a turn, so you may need to shift your body weight towards the inside of the turn to keep a comfortable posture on the vehicle. You will need to exert more force to turn the handlebar of your vehicle than is needed to turn a motorcycle. However, it is easier to stop while turning than with a motorcycle.

**Tips for Additional Practice**

- After you are comfortable turning in one direction, try going around the course the other way. Be careful not to apply more throttle than you intend when turning left.
- Stop at the apex of the turn to see what it is like to use your brakes in a curve or turn.

**6) Quick Stops**

**Purpose**

- Become familiar with the vehicle's braking ability.
- Learn to apply brakes with maximum force.

**Directions**

This exercise is similar to what you did before, except you'll be applying the brake more firmly, working up to braking as hard as possible.

- Start at one end of the straight away and accelerate to 8 km/h.
- Partway down the straightaway, release the throttle completely and brake quickly and firmly.
- Keep head and eyes up and keep handlebar straight.
- Repeat, increasing your speed and braking harder.

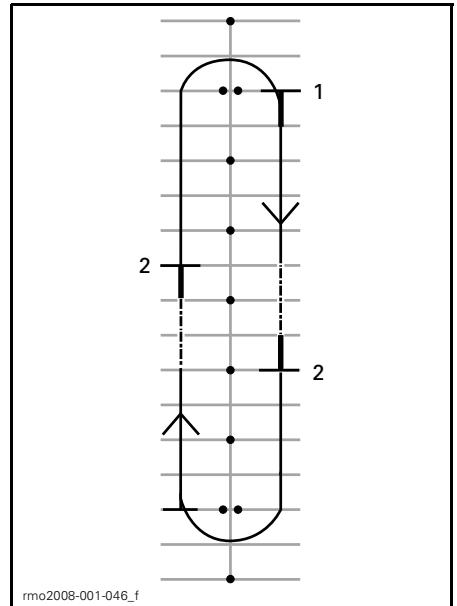

1. Start
2. Stop

**Tips for Additional Practice**

- Practice checking your mirrors before braking hard.

**7) Weaves**

**Purpose**

- Get more experience with the vehicle handling and rider position.

**Directions**

**6 m Weave**

1. Weave between every marker/intersection of every other parking spot. Do not use throttle — stay in the friction zone.
2. Lean into each turn and turn the handlebar in the direction you want to go by pulling and pushing the grips.

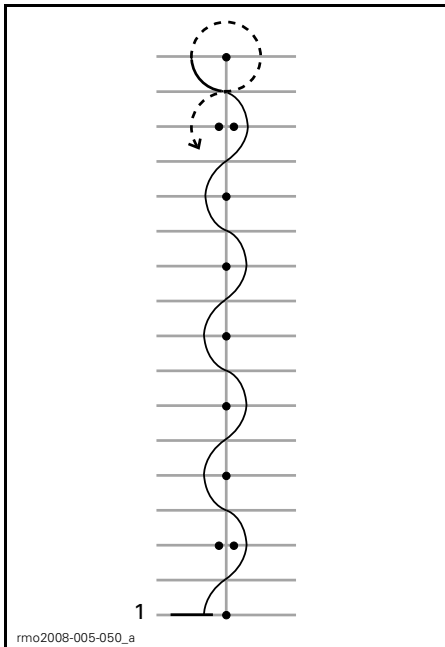

1. Start

**12 m Weave**

Once you're comfortable, try doing 12 m weaves between every other cone/every fourth parking space.

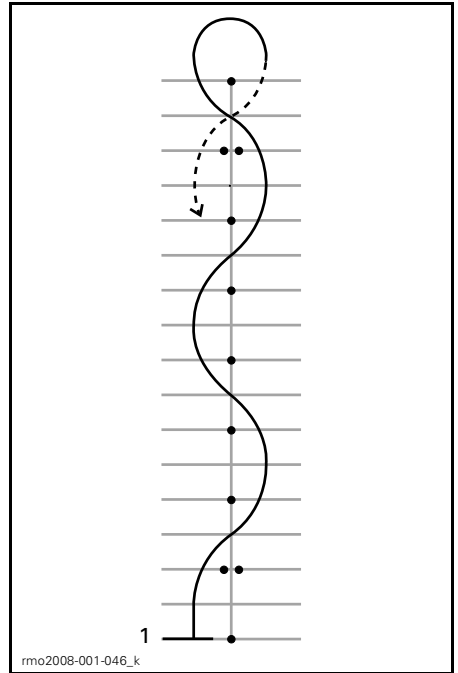

1. Start

**Tips for Additional Practice**

- You can gradually increase speed as you get comfortable to 16 km/h - 19 km/h for the weaves, but slow down for the U-turns at the ends.

**8) Shifting**

When riding, you must change gears to match the engine speed with road speed.

**Purpose**

- Become familiar with the foot motions needed to shift gears.
- Learn to upshift and downshift.

**Directions**

This exercise is similar to what you did before, except now you will be upshifting on the straightaways, then coming to a stop at the end of each straightaway. You may want to use the parking lot aisles for this exercise rather than riding in the spaces.

### 8a) Practice Using the Shift Lever at a Stop

First, while stopped, practice the left foot motion for shifting between first and second gears.

- At a stop in first gear, pull in the clutch lever.
- Slide the tip of your left foot under the shift lever and lift it as far as it will go, one firm stroke up to shift into second gear.
- Step on the shift lever and press it as far as it will go, one firm stroke down to shift into first gear.
- Repeat until you are comfortable with the foot motions required.

### 8b) Upshifting from First into Second Gear

In the straightaway, accelerate to approximately 16 km/h in first gear.

To upshift:

- Release the throttle.
- Pull in the clutch lever. (If you pull in the clutch before releasing throttle, the engine may rev — just release the throttle if this happens.)
- Slide the tip of your left foot under the shift lever and lift it as far as it will go, one firm stroke up to shift into second gear.
- Smoothly ease out the clutch.
- You do not need to apply throttle, but once you are comfortable, if space allows, you can apply the throttle to increase speed in second gear.

As you approach the end of the straightaway, come to a stop:

- Release the throttle.
- Pull the clutch lever all the way in.
- Apply brake.
- After stopping, downshift into first gear by stepping on the shift lever and pressing it as far as it will go, one firm stroke down. Once you are more comfortable, downshift into first as you come to a stop.

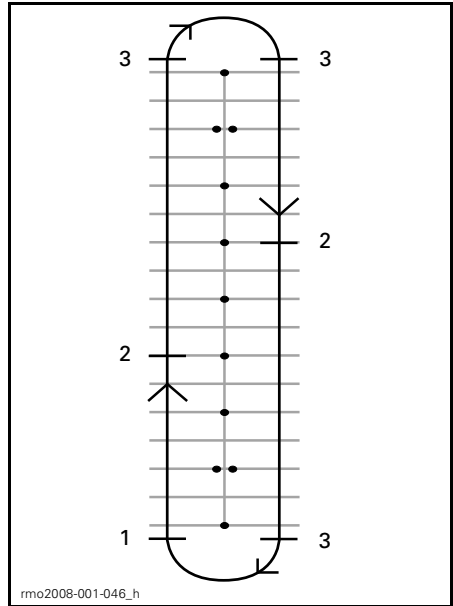

1. Start
2. Shift into second at 16 km/h
3. Stop

### 8c) Downshifting from Second to First Gear

If space allows, practice downshifting into from second to first gear.

In the straightaway, slow to approximately 16 km/h.

- Release the throttle and pull in the clutch lever.
- Step on the shift lever to shift into first gear.
- Smoothly ease out the clutch.
- Put your foot back on the peg.

### 8d) Other Gears

If space allows, you can try shifting into and out of higher gears as well. Follow the same process and shift up or down one gear at a time.

### Tips for Additional Practice

As you gain more experience, you can refine your shifting skills and use them to better control the vehicle.

- When downshifting, rolling on the throttle slightly while smoothly easing out the clutch can help the engine rev up to match vehicle speed more quickly and make the downshift smoother, preventing skidding of the rear wheel.
- Shifting to a lower gear slows the vehicle if you do not apply throttle. This is known as engine braking. To use engine braking, shift down one gear at a time and ease out the clutch between each downshift. Keep the clutch in the friction zone until the engine speed stabilizes, then ease out the lever fully until ready for the next downshift.
- Usually you shift gears one at a time, but it is possible to shift through more than one gear while the clutch is squeezed by repeating the up or down stroke as many times as you want gear changes.

Remember that VSS does not control engine braking. If you shift into too low a gear when you are at high speed, the rear tire can skid and you can lose control, spin out, tip or roll over, particularly in a curve.

### 9) Swerve

#### Purpose

- Become familiar with the vehicle's handling for quick maneuvers.
- Try different variations of braking and swerving.

#### Directions

Set up your markers as shown in the diagram below. Do not use any fixed or hard, heavy objects as markers for this exercise.

- Enter between the double cones at about 8 km/h and maintain that speed throughout.

- Steer around the line of cones.
- Exit through the second set of double cones.
- Repeat the exercise multiple times, swerving in both directions.

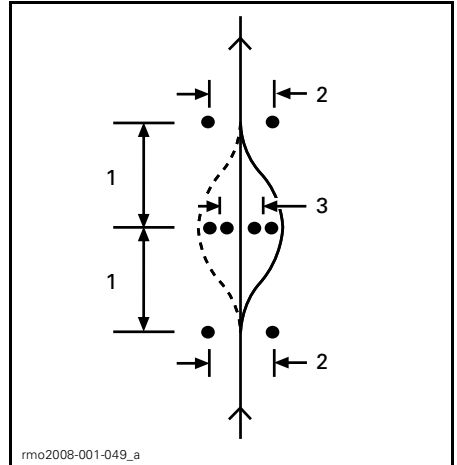

1. 6m
2. 3m
3. 2.5m

### Tips for Additional Practice

- You can gradually increase your entry speed (to no more than 13 km/h to 19 km/h and try some variations. For example, approach faster and slow before entering the exercise, pull in the clutch and apply brakes during the swerve, etc.
- A helper can add an element of surprise to the exercise by deciding which direction you should swerve, or if you should come to a stop instead. Have your helper stand at a safe distance (e.g., beyond the end of your practice area). As you reach the first set of cones, the helper can use hand signals to indicate which direction to swerve or for you to stop.
- Practice checking your mirrors and blind spot before you swerve.

## 10) Operating in Reverse

### Purpose

- Become familiar with the vehicle's handling and turning radius in reverse.

### Directions

Shift into reverse. See *OPERATING IN REVERSE* in *BASIC PROCEDURES* subsection.

Check that the area behind you is clear and continue to look backwards while you ease out the clutch. Be careful not to strike anything with your front wheels as you back up. Slow and stop using clutch and brake, just like when operating normally.

Back for a few feet at a time, stopping in between.

Keep your speed low and do not back up for long distances.

After you are comfortable with reverse, back into a parking space as shown in the diagram below.

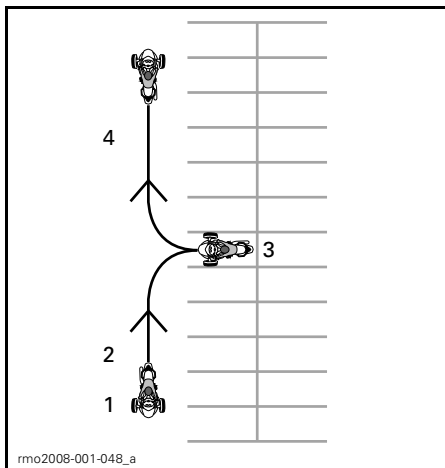

1. Start
2. Reverse
3. Stop
4. Forward

## Additional Practice in Controlled Environments

Once you are comfortable with all of the above exercises, you can try a few other things as space and conditions allow. This might be in the parking lot or at a later time in a place where you have the opportunity without putting yourself at risk.

- **Quick starts:** Try quickly getting up to speed and upshifting through the gears.
- **Quick stop from higher speed:** Similar to the quick stop exercise, but performed from higher speeds to get a feel for emergency stops.
- **Starting up an incline:** To do this, keep holding the brake pedal as you release the clutch lever until you are in the friction zone. This will keep you from rolling backwards.

## Practice Exercises (SE5 Model)

### 1) Revving the Engine and Using the Engine Stop Switch

#### Purpose

- Become familiar with the operation of the twist throttle.
- Become familiar with the sound of the engine at different RPMs. This will help you to know when to upshift and downshift based on the engine sound.
- Become familiar with using the engine stop switch.

#### Directions

- Start with the vehicle in NEUTRAL, the parking brake engaged, and your right foot on the brake pedal. Check the multifunction gauge cluster to be sure you are in NEUTRAL — if you are in first gear, the roadster will try to start moving when you apply the throttle.

- Watch the tachometer and apply throttle (twist by lowering your wrist) a few times to raise the RPM to no more than 4 000. Practice applying the throttle gently and smoothly, holding it steady at about 3 000 RPM, and releasing it. As long as the transmission is in neutral the power will not transfer to the rear wheel.
- Use the engine stop switch to cut all power to the vehicle. Press the switch with your right thumb while keeping your hand on the handgrip.

### Tips for Additional Practice

- Practice pressing the engine stop switch without looking at it.

## 2) Starting, Stopping and Basic Handling

### Purpose

- Learn throttle control and how to get the vehicle moving.
- Become familiar with low speed deceleration and braking.

### Directions

If you feel like you are losing control while doing these exercises, release the throttle to stop accelerating and apply the brake as needed to slow down. You can also use the engine stop switch to cut power entirely.

### 2a) Apply and Immediately Release Throttle

At first, you will only use the throttle for a moment at a time, then release it and coast.

- Start the engine and release the parking brake.
- With the brake pedal depressed, shift the transmission into first gear by pressing the gear selector forward.
- Release the brake.

- Slowly apply throttle until the vehicle starts to creep forward. As soon as you start moving release the throttle and coast, then press the brake to stop. Repeat to the end of the straightaway.
- To turn around at the end of the straightaway, stop, turn the handlebar all the way to the right, then briefly apply and release the throttle, and coast through the turn. You may need to briefly apply the throttle more than once to complete the turn. Stop when you are in line with the straightaway in the opposite direction.
- Continue with this part of the exercise until you are comfortable with applying and releasing the throttle.

### 2b) Hold Throttle, Release and Stop every 12 m

Next, you will be holding the throttle a little longer, then stopping every 12 m (every other marker/every fourth line).

- Again, slowly apply throttle until the vehicle starts to creep forward. This time, hold the throttle at this point.
- As you approach the stopping point, release the throttle and press the brake to stop.
- Turn around at the end of the straightaway as before, except now you do not need to release the throttle during the turn. Pay attention to maintaining a steady throttle position as you turn. Stop when you are in line with the straightaway in the opposite direction.

### 2c) Hold Throttle, Release and Stop at Ends

Next, use the entire straightaway, stopping only at the ends. Keep the throttle moderate.

### 3) Engine Stop while in Motion

#### Purpose

- Become familiar with using the engine stop switch when in motion so you know how the vehicle will react if you need to use it later.

#### Directions

- Partway down the straightaway, while operating at 8 km/h, turn the engine stop switch to OFF and coast to a stop.
- Restart the engine and repeat the exercise. Try increasing your speed (to a maximum of 20 km/h) before using the engine stop switch.

**NOTE: SE5 model** will not start in gear without brake pedal depressed.

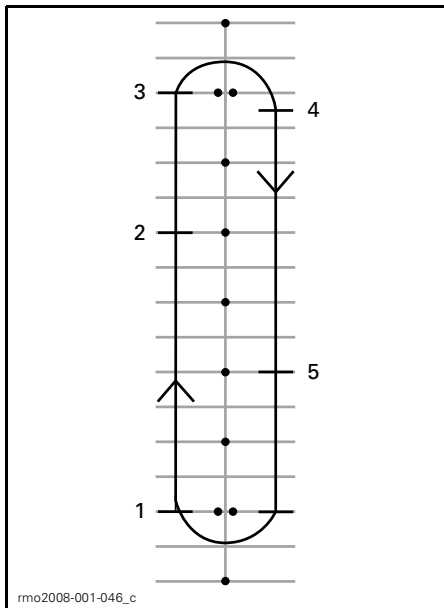

1. Start
2. Press engine stop switch
3. Proceed to end of straightaway, stop and turn as before
4. Stop
5. Press engine stop switch

Restart the engine and proceed to the next exercise.

### 4) Basic Turns

#### Purpose

- Get comfortable turning in a controlled manner.

#### Directions

This exercise is similar to what you did before, except that now instead of stopping for each turn, you will make the turn at low speed.

- Proceed down the straight away in first gear. Ride a little farther from the cones so you can make a wide arcing turn at the end of the straight-away.
- As you approach the curve, slow down to no more than 8 km/h by releasing the throttle and apply brake if needed.
- Hold the throttle to maintain your low speed.
- Look in the direction of the curve.
- Turn the handlebar in the direction of the curve, pulling on the inside hand-grip and pushing on the outside, being careful not to apply throttle.
- Leaning forward and into the curve may help you turn the handlebar more easily.
- Straighten your handlebar after the turn and proceed down the straight-away.





rmo2008-001-064

**TYPICAL - RIDING POSTURE WHEN TURNING**

**NOTE:** Motorcyclists - Riding through turns and curves with your Spyder roadster is different than on a motorcycle. The vehicle does not lean during a turn, so you may need to shift your body weight towards the inside of the turn to keep a comfortable posture on the vehicle. You will need to exert more force to turn the handlebar of your vehicle than is needed to turn a motorcycle. However, it is easier to stop while turning than with a motorcycle.

**Tips for Additional Practice**

- After you are comfortable turning in one direction, try going around the course the other way. Be careful not to apply more throttle than you intend when turning left.
- Stop at the apex of the turn to see what it is like to use your brakes in a curve or turn.

**5) Quick Stops**

**Purpose**

- Become familiar with the vehicle braking ability.
- Learn to apply brakes with maximum force.

**Directions**

This exercise is similar to what you did before, except you'll be applying the brake more firmly, working up to braking as hard as possible. The Anti-lock Braking System (ABS) will prevent the wheels from locking and help you maintain steering control while applying maximum braking force. Always release the throttle completely for

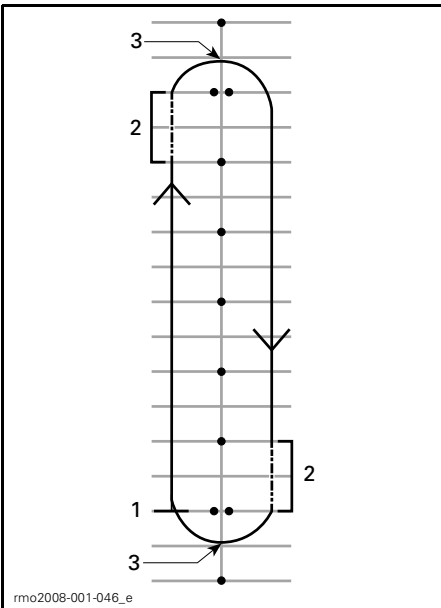

rmo2008-001-046\_e

1. Start
2. Friction zone
3. Apex

quick stops with the SE5. If you apply throttle and brake at the same time, your stopping distance will be longer.

- Start at one end of the straightaway and accelerate to 8 km/h. Partway down the straightaway, release the throttle completely and brake quickly. Never pump the brake as the ABS will prevent wheel lock.
- Keep head and eyes up, keep handlebar straight, and do not release the brake until fully stopped.
- Repeat, increasing your speed and braking harder.

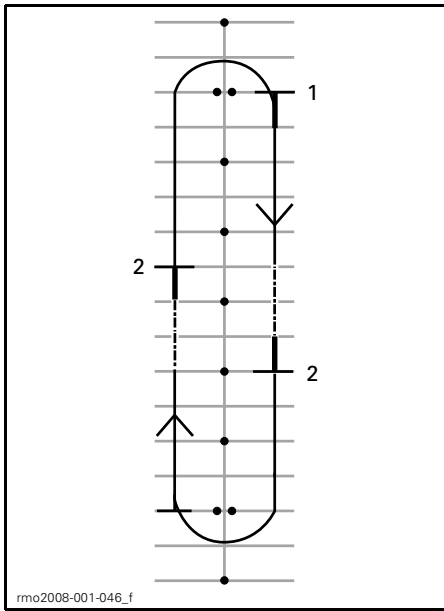

1. Start
2. Stop

**Tips for Additional Practice**

- Practice checking your mirrors before braking hard.

**6) Weaves**

**Purpose**

- Get more experience with the vehicle handling and rider position.

**Directions**

**6 m Weave**

1. Weave between every marker/ intersection of every other parking spot. Keep your speed low initially as you get used to making the changes of direction.
2. Lean into each turn and turn the handlebar in the direction you want to go by pulling and pushing the grips.

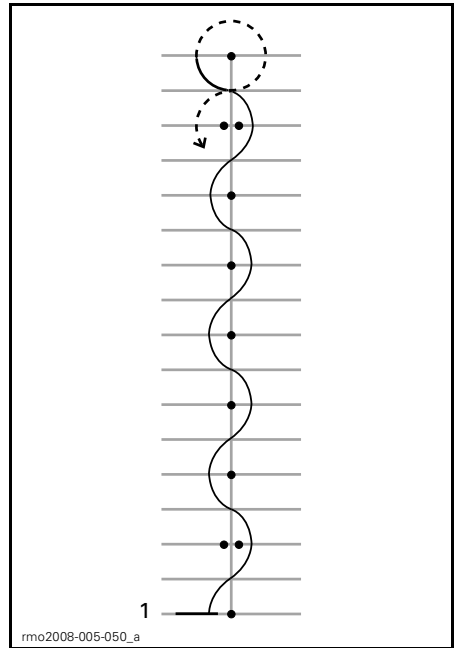

1. Start

**12 m Weave**

Once you're comfortable, try doing 12 m weaves between every other cone/every fourth parking space.

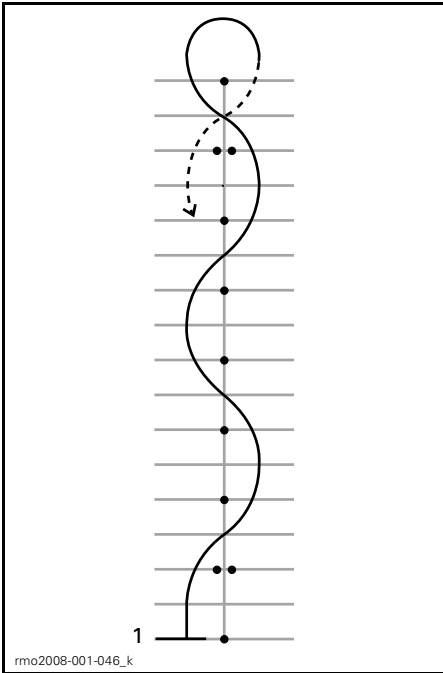

1. Start

**Tips for Additional Practice**

- You can gradually increase speed as you get comfortable to 16 km/h - 19 km/h for the weaves, but slow down for the U-turns at the ends.

**7) Shifting**

When riding, you must change gears to match the engine speed with road speed. Lower gears are used for lower speeds and higher gears are used for higher speeds, just like on a manual transmission car or truck.

The SE5 will not allow you to upshift if the engine speed is too low. The SE5 will automatically downshift if the engine speed drops under 1800 RPM.

**Purpose**

- Learn to upshift and downshift.

**Directions**

This exercise is similar to what you did before, except now you will be upshifting on the straightaways, then coming to a stop at the end of each straightaway. You may want to use the parking lot aisles for this exercise rather than riding in the spaces.

**7a) Practice Using the Gear Selector at a Stop**

First, while stopped, practice to single shift between reverse, neutral and first gear. Then practice to:

- Double shift from reverse to first gear
- Double shift from first to reverse gear
- Repeat until you are comfortable.

**7b) Upshifting from First into Second Gear**

- In the straightaway, accelerate until the engine speed reaches 3 000 RPM.
- Press the gear selector forward to shift into second gear. You do not have to release the throttle while shifting with the SE5.
- Once you are comfortable, if space allows, you can adjust the throttle to increase speed in second gear.

As you approach the end of the straightaway, come to a stop:

- Release the throttle.
- Apply brake.
- The SE5 will downshift automatically as the roadster slows. You can also manually downshift by pulling the gear selector towards you.

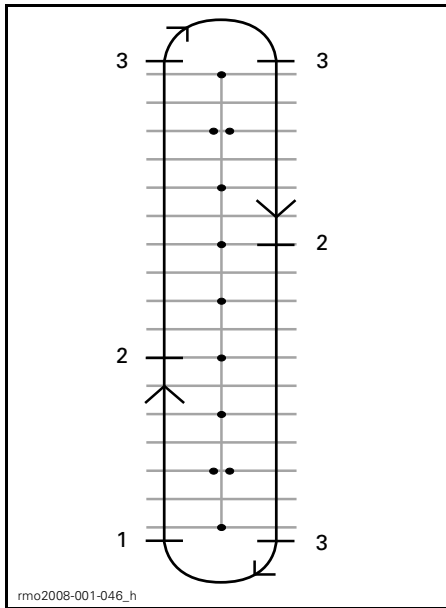

1. Start
2. Shift into second at 25 km/h
3. Stop

### 7c) If Space Allows, Practice Downshifting into First While Moving

In the straightaway:

- Pull the gear selector toward you without releasing throttle.
- You will feel more engine braking when you downshift without throttle.

### 7d) Other Gears

If space allows, you can try shifting into and out of higher gears as well. Follow the same process and shift up or down one gear at a time.

**NOTE:** Applying slightly more throttle while downshifting can help the engine rev up to match vehicle speed more quickly and make the downshift smoother. When you do not apply throttle while downshifting, engine braking will slow the vehicle. This can help you decrease speed, but remember that VSS does not control engine braking. If you shift into too low a gear when you are at high speed, the rear tire can skid and you can lose control, spin out, tip or roll over, particularly in a curve.

## 8) Swerve

### Purpose

- Become familiar with the vehicle's handling for quick maneuvers.
- Try different variations of braking and swerving.

### Directions

At this point you will need to change your course. Set up your markers as shown in the diagram below. Do not use any fixed or hard, heavy objects as markers for this exercise.

- Enter between the double cones at about 8 km/h and maintain that speed throughout.
- Steer around the line of cones.
- Exit through the second set of double cones.
- Repeat the exercise multiple times, swerving in both directions.

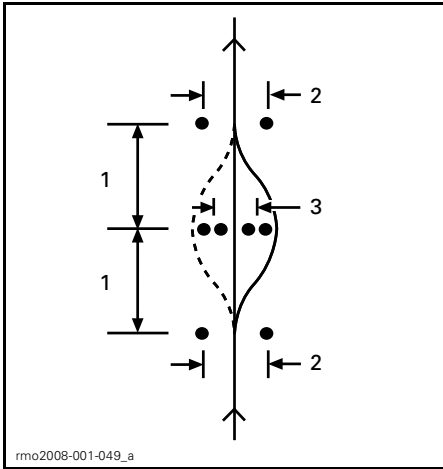

1. 6 m
2. 3 m
3. 2.5 m

### Tips for Additional Practice

- You can gradually increase your entry speed (to no more than 13 km/h to 19 km/h and try some variations. For example, approach faster and slow before entering the exercise, apply brakes during the swerve, etc.
- A helper can add an element of surprise to the exercise by deciding which direction you should swerve, or if you should come to a stop instead. Have your helper stand at a safe distance away (e.g., beyond the end of your practice area). As you reach the first set of cones, the helper can use hand signals to indicate which direction to swerve or for you to stop.
- Practice checking your mirrors and blind spot before you swerve.

## 9) Operating in Reverse

### Purpose

- Become familiar with the vehicle handling and turning radius in reverse.

### Directions

- Shift into reverse. See *OPERATING IN REVERSE* in *BASIC PROCEDURES* subsection.
- Check that the area behind you is clear. Continue to look backwards. Be careful not to strike anything with your front wheels as you back up. Slow and stop by releasing throttle and using brake, just like when operating normally.
- Back for a few feet at time, stopping in between.
- Keep your speed low and do not back up for long distances.
- After you are comfortable with reverse, back into a parking space as shown in the diagram below.

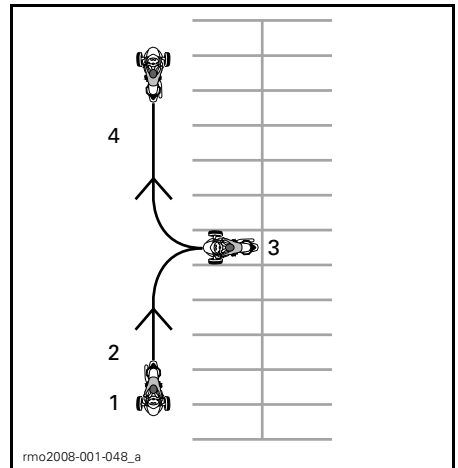

1. Start
2. Reverse
3. Stop
4. Forward

## Developing Advanced Riding Skills

Once you have mastered basic riding skills, you can begin developing more advanced skills. First, learn the "Street Strategies" covered in the next section. Then you can take the vehicle on the road in relatively low-risk situations.

Start by riding in less challenging situations:

- Short distances
- Good weather
- Low traffic
- Daytime
- Lower speeds
- No passenger.

You can gradually move on to more challenging riding situations as you develop your skills.

# STREET STRATEGIES

This section provides some strategies to reduce your risk on the road. Many of these strategies are similar to those used for motorcycles.

This section is based on guidance for motorcyclists given by the Motorcycle Safety Foundation (MSF). However, even experienced motorcyclists should read this section, as some strategies are different for the Spyder roadster.

## Plan your Trip

Always check weather conditions before riding the vehicle. Take appropriate gear for any weather you might encounter.

Plan a route and ride in conditions that are appropriate for your skill level.

The vehicle has a 25 L fuel tank. When the low fuel indicator light flashes, fill fuel tank as soon as possible. Plan your refueling stops, particularly in unpopulated areas.

## Defensive Riding

As with a motorcycle, defensive riding can help you avoid crashes. You need to stay alert at all times. Never stop watching your surroundings, including the area behind you. Always scan for potential hazards, plan ahead, and leave space and time to avoid trouble. Do not assume other motorists will see you or follow the rules of the road.

## Following Distance

Always leave at least a two-second following distance between you and the vehicle in front of you when operating under ideal riding conditions. This means that you should pass any fixed point on the road at least two full seconds after the vehicle in front of you.

When conditions make braking distance longer, or visibility is limited, use a longer following distance for a greater margin of safety. For example, braking distance is longer on slippery

road surfaces, down hills, or when carrying more weight, and visibility may be limited in fog, in curves or at night.

## Scanning Ahead

In addition to leaving adequate following distance to the next vehicle, scan ahead and plan your path even farther in advance.

Plan your immediate path at least four seconds ahead. Watch this path for hazards, such as anything in the road or anything entering the road.

Scan ahead 12 seconds along your anticipated path to identify potential hazardous situations before they happen. For example, look for intersections where other vehicles may appear or places where pedestrians might enter the road. Be prepared to respond if a hazardous situation develops.

## Watch Behind and to the Sides

Vehicles and other hazards can approach from all directions. Constantly be aware of your surroundings. Check your mirrors frequently to see directly behind you. Also do frequent head checks (turn your head to look) to monitor your blind spot.

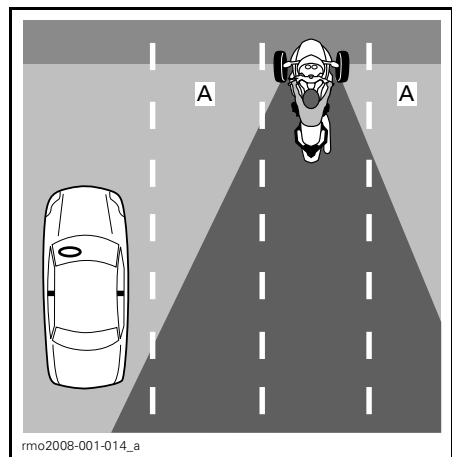

A. Operator's blind spots

When braking, be particularly aware of vehicles behind you that may not be able to stop as quickly as the Spyder roadster.

### Keep your Eyes Moving

To stay aware of your surroundings, do not fixate on any one thing. Move your eyes constantly to monitor the road, traffic control markings and devices and other vehicles. Look near and far, in all directions.

### Anticipate Trouble

Whenever you notice a potential hazard, plan a way to avoid it. This might mean adjusting your speed or lane position, or changing lanes. You should be ready for evasive maneuvers such as swerving and/or braking if something enters your path. Always leave time and space to react to trouble.

### Being Visible

Motorists tend not to see smaller vehicles like motorcycles. Therefore you should use strategies to become more visible.

### To Be More Visible to Other Motorists

#### Lighting and Reflectors

Make sure that the headlights, running lights and taillights on your vehicle work properly. Your vehicle is equipped with reflectors on the fenders, sides, and back. Make sure that all reflectors are clean and not broken or missing.

Use your high beams whenever possible, both day and night. Use low beams to avoid blinding other motorists at night or when too much light reflects back, such as in fog.

#### Signals

Use your turn signals to inform others of your intentions. The Spyder roadster has automatic canceling turn

signals, but they may not cancel after shallow turns. Make sure turn signals are off after you have completed your maneuver; leaving them on may confuse other motorists.

When possible, flash your brake lights before slowing and when waiting at intersections, to alert motorists behind you.

Use your emergency flashers to make yourself visible when needed.

You can also use your horn to attempt to alert other motorists of your presence.

Do not assume that other motorists will notice your lights, signals or horn.

### Blind Spots

Avoid riding in the blind spots of other vehicles. Position yourself so that drivers ahead can see you in their mirrors. In some cases, such as when you are following a truck or a bus, you must be farther behind the vehicle in front of you.

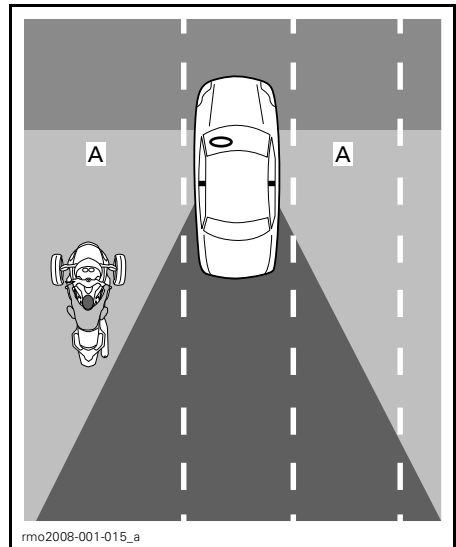

A. Blind spots of other vehicles



## Time of Day and Weather

In dim light, such as at night, at dawn or dusk, or in poor weather such as rain or fog, you may be harder to see. Glare at dawn and dusk or very bright sunlight can also make it harder for other motorists to see you.

## Clothing

Bright colors or reflective clothing can increase your visibility.

## Be Careful Even When Motorists See You

Even when motorists seem to notice you, they may still drive in a way that puts you at risk of a crash. Drive defensively, and do not rely on other motorists to operate their vehicles safely.

## Lane Position

Normally, position the Spyder roadster in the center of the lane. This position keeps the front tires in the lane. It also provides distance from vehicles in other lanes, reducing wind from large vehicles and reducing the risk of being struck by vehicles that leave their lane. This position also keeps your front wheels out of the slippery area in the middle of the lane, helping maintain braking and steering ability. If you are used to driving a car, remember that you are centered on the Spyder roadster, rather than seated to the side, so your perspective is different.

You can move to the left or right part of the lane, to avoid hazards, keep distance from other vehicles, or handle curves. You can also move to the left or right part of the lane to get a better view or to be seen by other vehicles. Because of the Spyder roadster center seat position and width, it may be harder to see around traffic, even when you are near the edge of the lane. You may need a greater following distance behind wide or tall vehicles. Avoid putting your wheel outside of the lane to see around traffic. In order

for drivers ahead to see you, you must be able to see their mirrors. When you are being followed by a large vehicle, passing vehicles may not be able to see you easily if you are not in the left part of the lane.

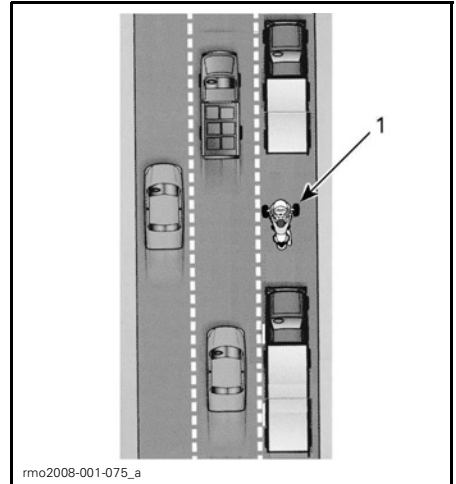

1. Vehicle in left portion of lane

Because the Spyder roadster is wider than a motorcycle, the range of lane positions is smaller. When riding in the left or right part of the lane be sure that the front wheels stay in the lane.

On multilane roads, choose a lane that is appropriate for your speed in the flow of traffic, and also consider your ability to see and be seen, and possible paths for evasive maneuvers (such as swerving into other lanes or onto the shoulder).

## Common Riding Situations

### Intersections

Intersections, including small intersections with alleys and driveways, present an additional risk due to the cross traffic. Always watch for traffic in all directions: behind, in front and to the left and right.

When stopping at an intersection, stop in the middle of the lane, even if you are preparing to turn. This can make you more visible and discourage other motorists from trying to drive around you. Watch for vehicles approaching from behind. Flash your brake lights as they approach. Be in first gear and be prepared to move if necessary to avoid a collision.

### Lane Changes and Passing

Remember that the Spyder roadster is wider than a motorcycle and needs more lateral space to pass another vehicle. Also remember that the vehicle is less visible than a car, so it is particularly important to signal your lane change well in advance and check your mirrors and blind spots. Be sure to turn off your turn signal after changing lanes; a lane change will not turn the handlebar far enough to automatically cancel the signal.

Never drive on the line between two lanes of traffic (split lanes). The vehicle is too wide.

Never drive on the shoulder to pass vehicles. If you put one wheel off the road, you can lose control.

### Turns

Remember to slow, look, and steer through turns.

- **Slow:** Reduce speed as needed before entering a turn by rolling off the throttle, using the brakes, and/or downshifting to a lower gear. Enter the turn at a speed that you can maintain throughout the turn.

Although the Spyder roadster is better able to brake while turning than a motorcycle, it is still important to slow down before you enter a turn or curve rather than braking in the turn. Braking and turning both require traction. The more traction you use for braking, the less there is available for turning at the same time.

When you take a turn or curve too fast, you may notice the inside front wheel lifting off the pavement and feel and hear VSS cutting back engine power. While VSS can help you maintain control, it is still possible to spin or roll over if you turn too hard and fast.

- **Look:** Search through the entire turn and keep your eyes moving. Evaluate the entire turn as soon as possible — surface characteristics, sharpness of the turn, and overall traffic conditions — so you have time to make decisions about speed and position. Sometimes turning your head in the direction of the turn helps to keep a good visual picture.
- **Steer:** Turn the handlebar to steer the vehicle in the direction of the turn. The Spyder roadster is not like a motorcycle, so it does not countersteer, and the vehicle does not lean. Remember, you will experience the lateral force generated by turning, so you may need to shift your body weight to the inside of the turn to keep a comfortable posture on the vehicle. You will need to exert more force to turn the handlebar of your vehicle than is needed to turn a motorcycle.

## SM5 Model

When shifting gears while turning, be careful not to release the clutch lever too fast. Adjust throttle as you release the clutch lever to match engine and vehicle speed in a smooth shift. Releasing the clutch too quickly or using too much throttle may cause the rear wheel to lose traction and start skidding, potentially causing loss of control. The Traction Control System (TCS) will detect the onset of wheel spin and reduce the power transmitted to the rear wheel. This intervention is intended to allow the rear wheel to regain traction and allow you to correct the unwanted oversteering to keep your vehicle on the intended turning radius.

## Curves

Because the Spyder roadster is narrower than a car, you can move from side to side in the lane in curves to straighten your path of travel. But the Spyder roadster is wider than a motorcycle, so less lateral movement is possible, and it is important to make sure that your front tires do not leave the lane.

For typical curves, an outside, inside, outside path is best.

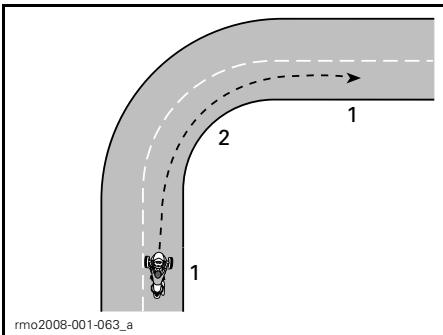

### PATH FOR TYPICAL CURVES

1. Outside
2. Inside (at the apex)

## Hills

Select an appropriate gear for the incline. Going up hills, a lower gear can help maintain enough power. Going down hills, a lower gear can provide engine braking to control your speed.

### SM5 Model

To start while on an incline, hold the vehicle in place with the brake until you move the clutch lever into the friction zone. Then smoothly release the brake as you release the clutch lever and apply throttle.

### SE5 Model

When stopped, the SE5 model can roll regardless of what gear it is in. The SE5 model centrifugal clutch is always disengaged when the vehicle is stopped, so the transmission will not hold the vehicle in place. Hold the brake pedal when stopped on an incline. To start while on an incline, hold the brake pedal as you increase throttle. Release the brake pedal as you feel the clutch engage (at about 1 800 RPM).

## Night Riding

In addition to using your lights and signals to be seen by other motorists, consider your own ability to see at night. Use high beams when appropriate. Avoid overriding your headlight (riding so fast that you can't see as far as your stopping distance). You can also use other vehicles headlights to see the road ahead.

Do not use tinted or colored visors or lenses at night, and be particularly careful that your visor does not have scratches or smudges.

## Group Riding

Ride single file only. Never share lanes, even with a motorcycle.

When riding with motorcycles, maintain proper following distance from the motorcycle in front of you, even

if they are riding to one side of the lane. In curves, do not try to follow the path of motorcycles. Motorcycles can move farther to the edges of the lane in curves — if you follow them exactly, your front wheel can leave the lane. Motorcycles may be able to take curves faster than the Spyder roadster. Do not try to match their speed.

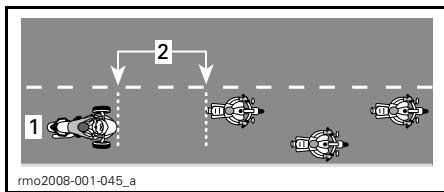

#### GROUP RIDING POSITION

1. Center of lane
2. Distance of 2 seconds

Particularly on curvy roads, Spyder roadster riders might become tired sooner than motorcyclists. Do not push yourself to keep up with motorcycles; stop if you are tired.

## Road Conditions and Hazards

### Ice, Snow and Slush

Do not ride on ice, snow or slush. Even with VSS, there will not be enough traction to maintain control on these slippery surfaces. The Spyder roadster is more likely than a car to spin out of control in slippery surfaces.

### Gravel, Dirt and Sand

On gravel, dirt, or sand-covered roads, use extra caution and reduce your speed, particularly for curves. These surfaces do not provide as much traction as paved surfaces and you can lose control, even with VSS.

### Wet Pavement and Puddles

There is normally enough traction to maintain control on pavement that is moist or wet, as long as there is not a layer of water on top of the pave-

ment (like a puddle or flowing water on the road). As with other vehicles, the Spyder roadster can hydroplane if you drive too fast over water that has accumulated on the road, but hydroplaning occurs at lower speeds than with most cars or motorcycles. You are more likely to hydroplane in deeper water. Watch for splashing or spraying when other vehicles go through water as an indicator of depth.

When hydroplaning occurs, one or more wheels rise up on a layer of water, losing contact with the road. If this happens to the rear wheel, you may feel it slide sideways. Hydroplaning wheels do not have the traction necessary to control the vehicle. You can lose control and spin out, and the VSS cannot keep you in control.

Avoid large water puddles or water streams, and slow down or pull off the road during heavy rains. If you must pass through water, slow down as much as possible before you reach it.

After passing through water, test your brakes. Apply them several times if necessary to let friction dry the brake pads.

Properly maintained tires reduce the risk of hydroplaning. Always maintain recommended tire pressure:

COLD TIRE PRESSURE	
Front tires	103 kPa ± 14 kPa
Rear tires	193 kPa ± 14 kPa

**NOTE:** The pressure difference between the left and right side tire should not exceed 3.4 kPa.

Immediately replace any tire that shows the maximum tread wear indicator to minimize risk of hydroplaning.

The middle of a lane can be particularly slick in the first few minutes of rain, as oil and dirt combine with the water. After more rain, water can accumulate in ruts in worn pavement. Avoid both of

these low traction areas. When possible, keep your front tires in areas with the best traction.

### Off-Road Use

Do not use the Spyder roadster off road. The vehicle cannot handle the rough, low-traction, uneven surfaces that you may encounter in off-road riding. You could easily get stuck, lose control or roll over. Also, it may be illegal for off-road use in certain areas.

### Obstacles, Holes and Bumps

Whenever possible, avoid riding over obstacles, holes and bumps. If you must ride over them, slow down as much as possible before you get there, then release the brake as you go over. For wide obstacles or bumps, approach straight on if possible, so that both front tires go over at the same time. When going over an obstacle, bump or hole with both front wheels, riders should stand up slightly on the pegs and use legs to absorb the shock. Be prepared for the rear wheel to strike the obstacle. For narrower obstacles, bumps or holes, it is better to ride over it with the rear tire. If you ride over them with a front tire, maintain a firm grip on the handlebar, take care not to accidentally applying the throttle and be prepared to correct your trajectory if necessary.

If you strike a large enough obstacle, bump or hole, the impact can make the vehicle jump and strike you, eject riders, make you lose control, spin or roll over.

If you can't come to a complete stop in time to avoid an obstacle, you can swerve to avoid it. You can swerve and brake at the same time if necessary.

If you encounter a large animal in the road, like a deer, it is best to stop before reaching it and wait until the animal leaves, or go past slowly. If a dog chases you, a good strategy is to slow

down and downshift as the dog approaches, then accelerate away as you get closer to where the dog would intercept you.

### On-Road Emergencies

A vehicle malfunction or an unexpected situation can occur any time during a ride. A well-maintained vehicle can help reduce the risk of malfunction, but you should still be prepared for an emergency.

- Always have the Operator's Guide and tool kit in the vehicle.
- When stopping on the road, follow these precautions:
  - If the road has paved shoulders, signal your intention to pull off the highway, pull off at near traffic speed, then slow down to a complete stop.
  - If the shoulder is unpaved, signal a right turn and slow down to a safe speed before pulling off the paved roadway.
  - To increase your visibility, turn on the hazard warning lights.
- If you have cellular phone or other communication device, fully charge it before long rides.
- If you are involved in an accident, BRP strongly recommends that you have your vehicle transported (see *TRANSPORTING THE VEHICLE* subsection) to the nearest Can-Am roadster dealer to have it thoroughly inspected for safety before riding again.
- Fill in the BRP accident/incident report.

### Tire Failure

If a tire failure or a blowout suddenly occurs, firmly grip the handlebar, gradually slow down and carefully steer to a safe place to stop. Avoid hard braking, downshifting, or sharp steering. If a front tire fails, the vehicle may tend to pull in the direction of the failed tire, so

you will need to maintain a firm grip on the handlebar to control your direction. Refer to *ROAD SIDE REPAIRS* section for instructions on tire repair.

# CARRYING A PASSENGER, CARGO OR TOWING A TRAILER

## Weight Limits

Do not exceed the weight limits for riders and cargo.

WEIGHT LIMITS	
Vehicle load limit (including operator, passenger, cargo and added accessories)	208 kg
Front storage compartment	16 kg

Excess weight will:

- Reduce your ability to accelerate, brake and turn.
- Reduce the effectiveness of the VSS.
- Increase the risk of rolling over if the weight is high or toward the rear.
- Reduce ground clearance, increasing the risk of striking low obstacles or uneven road surfaces.
- Increase the risk of tire failure.

## Operating with Extra Weight

Carrying a passenger or heavy cargo affects the way the vehicle handles because of the greater weight, and because the weight distribution will be different.

1. You will not be able to accelerate as quickly. Allow more time and space for passing.
2. You will not be able to stop as quickly. Use a longer following distance from the vehicle in front of you, at least three seconds. Use an even longer distance if riding conditions are not ideal (e.g., low visibility, poor road surface).

3. You will not be able to turn as sharply or at as high a speed. Slow down more than usual before turning and avoid sharp turns.
4. The Spyder roadster may be less stable. There is a greater risk of tipping or rolling during extreme maneuvers with weight that is higher or farther to the rear (like a passenger).

## Carrying a Passenger

The Spyder roadster is designed for only one passenger, seated behind the operator. Never carry multiple passengers.

Do not carry a passenger until you have experience riding alone in a variety of conditions and can proficiently handle the vehicle.

The passenger must be sober, alert, able to reach the passenger footrests and handholds, maintain balance and hold on in sudden maneuvers, and not distract the operator.

Be sure the passenger is wearing appropriate protective gear. The passenger should wear all of the protective gear recommended for the operator, particularly a helmet. A full-face helmet is recommended; in a sudden stop, the passenger's face can strike the back of the operator's helmet.

Keep the brakes applied and the transmission in neutral until the passenger is in riding position.

Instruct the passenger on how to ride before starting out. Have the passenger follow these rules:

1. Maintain proper riding position. Hold the passenger handholds and keep feet on the passenger footrests at all times, even with the accessory backrest. The passenger footrest height is adjustable. Refer to *ADJUSTING THE PASSENGER FOOTREST*. The passenger should

not hold on to the operator as the operator may not be able to withstand the lateral force generated by both.

Different gripping positions on the handholds may be more comfortable for different maneuvers. (e.g., one hand at the front corner of and one hand at the opposite back corner for turns, both hands further forward or back for other situations).

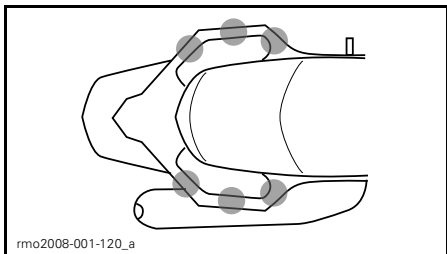

**DIFFERENT GRIPPING POSITIONS ON THE HANDHOLDS**

2. Engaging the parking brake while the vehicle is moving can cause a crash.
3. Stay clear of the exhaust pipe, the rear wheel and the drive belt.
4. Avoid turning around or leaning except to keep balance in a turn. In an unexpected maneuver, a passenger who is not in the normal riding position is more likely to fall off.
5. Watch the road and respond to upcoming road conditions. Lean into curves as needed to resist any sideways force. When crossing an obstacle, hole or bump, rise slightly off the seat without locking your elbows.

Avoid abrupt acceleration, braking and turns, especially with inexperienced passengers. Sudden, unexpected maneuvers can make the passenger fall off.

## Where to Store Cargo

You can carry cargo in the front storage compartment. Do not carry cargo in any other location unless the vehicle is equipped with approved BRP accessories.

### Front Storage Compartment

The front storage compartment has room to store light objects, such as two helmets. Do not put more than 16 kg in the front storage compartment, even if the items fit. Never store flammable items, such as fuel, in the front storage compartment. A front storage compartment liner is available. The front storage compartment includes a designated space for this Operator's Guide and a tool kit.

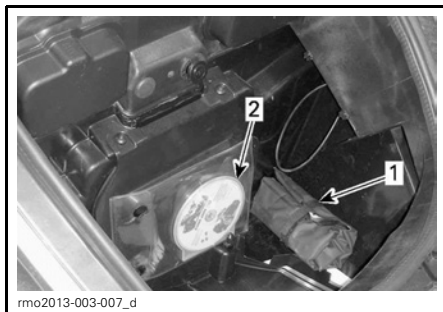

**TYPICAL**  
1. Tool kit  
2. Operator's guide

Make sure the front storage compartment latch is secure before riding.

## Towing a Trailer

The ST series has been designed to be able to tow a BRP optional trailer (with the optional BRP hitch).

The VSS (vehicle stability system) on the roadster ST series incorporates a program that allows to tow a BRP trailer while maintaining appropriate vehicle stability control.

Use only a BRP trailer designed specifically for the Roadster ST series or a BRP approved equivalent. This is im-



portant to ensure the trailer and the roadster remain stable during normal operation and it does not interfere with the vehicle stability system.

**NOTICE** The use of a non-recommended wiring harness may lead to vehicle electrical system failure.

## **⚠ WARNING**

The use of any other trailer could damage the vehicle or interfere with the proper operation of the vehicle stability system. It is not recommended to use the cruise control when towing a trailer.

Towing a trailer affects the way the vehicle handles due to the greater weight and the different weight distribution.

- Allow more time and space for passing.
- Allow a greater distance for braking.
- Use a longer following distance from the vehicle in front of you.
- Reduce your speed and slow down more than usual before turning and avoid sharp turns.
- There is a greater risk of tipping or rolling during extreme maneuvers.

Crosswinds and air turbulence caused when crossing or being passed by others can disrupt the steering and make the trailer to sway. To minimize the effect, keep a constant speed and do not make quick steering or braking corrections.

Reduce your speed before entering in a curve.

When cornering, achieve the turn on a larger radius. It takes more space to turn with a trailer.

Try to anticipate the riding ahead to avoid having to backup with a trailer.

Always move slowly when backing up. Ask someone to guide you when possible. Practice in an open area at the first opportunity. Refer to *REQUIRED RIDING SKILLS AND PRACTICE EXERCISES*.

When possible, avoid swerving, twist and turns, sharp and abrupt turns as well as sudden braking. This could cause the trailer to jackknife or to turn over. It is easier to unstabilize an empty trailer. When accelerating, it is normal to shift at a higher RPM to avoid loading excessively the engine.

**NOTICE** Avoid spinning the rear wheel. Rocks or pebbles could be projected on the trailer and damage it.

### **Trailer Mode (SE-5 Model Only)**

When a trailer is towed, the trailer mode must be activated to adapt gear changes.

**NOTICE** If the trailer mode is not activated when towing a trailer, engine components might be damaged.

The trailer mode can be set using one of the following methods.

### **Trailer Mode Activation When the Vehicle is Stopped**

Repeatedly press the MODE button on the RECC (Roadster Electronic Command Center) to select the Preferences Screen. Refer to *RECC (ROADSTER ELECTRONIC COMMAND CENTER)* in *SECONDARY CONTROLS* sub-section.

Select the TRAILER option then choose W/TRAILER.

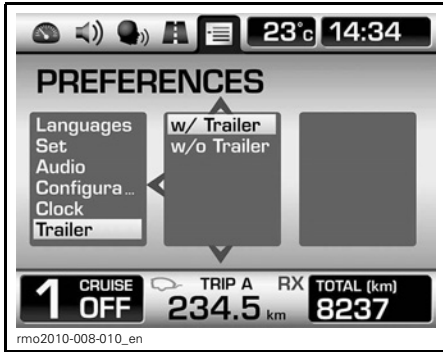

TYPICAL

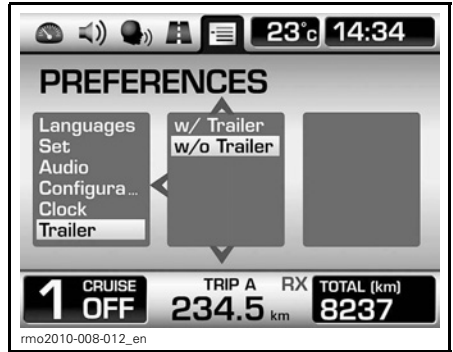

TYPICAL - WHEN VEHICLE IS STOPPED

### Trailer Mode Activation When the Vehicle is Moving more than 5 km/h

Repeatedly press the MODE button on the RECC (Roadster electronic command center) to select the Preferences Screen. Refer to *RECC (ROADSTER ELECTRONIC COMMAND CENTER)* in *SECONDARY CONTROLS* subsection.

Choose the icon shown by moving the selection rectangle over the icon.

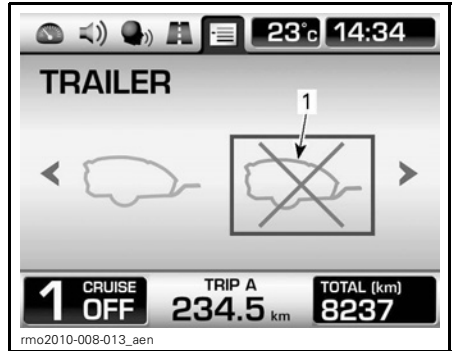

TYPICAL - WHEN VEHICLE IS MOVING

1. Icon to cancel the trailer mode

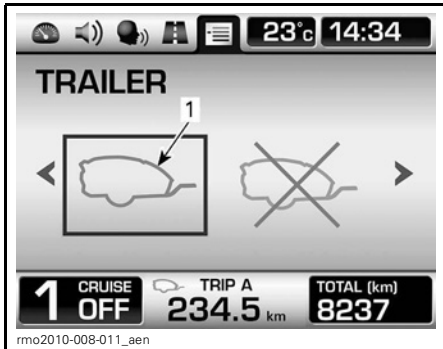

TYPICAL

1. Icon to select the trailer mode

### Canceling the Trailer Mode

When a trailer is not towed, cancel the trailer mode to get the optimum gear shifting. Proceed as per the *RECC (ROADSTER ELECTRONIC COMMAND CENTER)* in *SECONDARY CONTROLS* subsection but use the following options.

### Hill Particularities

When possible, avoid stopping uphill.

When starting uphill from a stop, more clutch slippage is needed to prevent engine stalling.

When riding uphill, more frequent downshift will be required so that engine has enough power to minimize speed variations.

When riding downhill, downshift one or more gears to use engine braking to slow down vehicle instead of continuously applying the brake. It will take longer to slow down or to stop.

## Load Limits

### **⚠ WARNING**

Never add cargo on the trailer cover as it will increase the risk of tipping over. All cargo must be stored and secured inside the trailer.

Load limits must be observed with the appropriate towing equipment.

TOWING SPECIFICATIONS	
Maximum weight on trailer tongue	18 kg
Maximum towed weight (trailer and cargo)	180 kg

**NOTE:** For information about the maximum cargo that can be loaded in trailer, refer to the *ROADSTER TRAILER RT-622 OPERATOR'S GUIDE*.

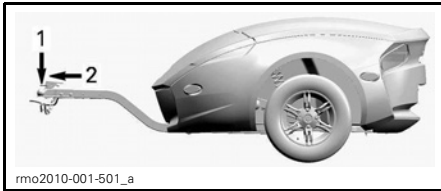

1. 18 kg
2. 180 kg

The weight at the tongue applies when the trailer is loaded. A scale can be used to measure the weight at the tongue when it is not latched to the vehicle. If the trailer is not fully loaded, place cargo in the front part of the trailer then, if the weight at the tongue is reached, place the remaining cargo at the rear in the trailer. The weight distribution in the trailer affects the weight at the tongue. Redistribute the weight in the trailer to meet the weight at the tongue specification. Too much weight at the tongue reduces steer-

ing control. Too little weight at the tongue can render the trailer unstable and make it sway.

### **⚠ WARNING**

Exceeding the maximum towed weight can seriously affect handling and performance of the vehicle. The vehicle handling, stability, acceleration and braking distance are affected when towing a trailer. Correct loading and weight distribution are important. Never overload, tow or carry cargo improperly. Always ensure the cargo is safely secured and properly distributed in the trailer before operating the vehicle. Always secure cargo as low as possible in the trailer to reduce the effect of a higher center of gravity. Failure to follow the recommendations here could cause affect the vehicle handling which could lead to the vehicle loss of control.

**NOTICE** Exceeding the maximum towed weight can damage vehicle or trailer. Avoid transporting heavy parts with sharp edges that could damage the trailer. Place the cargo so that it does not shift while the trailer is being towed.

### Hitch

Use only a BRP hitch or a BRP approved equivalent. The BRP hitch properly fits the vehicle swing arm and is securely bolted to the wheel axle.

**NOTICE** The use of a non-approved hitch may lead to rear swing arm failure.

### **⚠ WARNING**

If the hitch is removed from vehicle, always install a new cotter pin to lock the wheel axle nut.

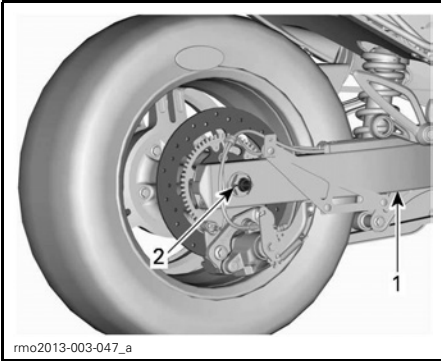

**WHEEL AXLE CAP AND MUFFLER REMOVED FOR CLARITY PURPOSE**

1. Swing arm
2. New cotter pin here

### **Safety Cables**

Always use safety cables when towing a trailer. Ensure they are secured to the trailer and to the hitch, and that they cross under the tongue. Leave enough slack in cables to allow the trailer to turn corners. When trailer is in straight line with the vehicle, ensure chains will not drag on the ground.

---

# KNOWLEDGE SELF-TEST

The following provides a sample of information that you should have learned by reading this guide. It does not include all of the important information, but should give you an idea of whether you have a general understanding of the vehicle and its operation.

See the *ANSWERS* on the page following the questionnaire.

## Questionnaire

1. If you need to stop quickly, press the brake pedal and activate the parking brake.  
True                      False
2. A pre-ride inspection should be performed once a week.  
True                      False
3. VSS allows you to use the vehicle in any kind of weather.  
True                      False
4. You should only replace the tires with those approved by BRP obtained from an authorized Can-Am roadster dealer.  
True                      False
5. It is important for the passenger to be alert and sober.  
True                      False
6. Name six items of protective gear that can reduce your risk of injury.  
1) \_\_\_\_\_  
2) \_\_\_\_\_  
3) \_\_\_\_\_  
4) \_\_\_\_\_  
5) \_\_\_\_\_  
6) \_\_\_\_\_
7. Protective gear is important for preventing and reducing injuries, keeping you comfortable, and providing protection against the elements.  
True                      False
8. Which of the following is not one of the vehicle driving controls?
  - a. Handlebar
  - b. Twist throttle
  - c. Front brake lever
9. You should leave your low beam lights on during the day for added visibility.  
True                      False
10. You should normally position the vehicle in the center of the lane.  
True                      False
11. Unlike a typical motorcycle, you should make it common practice to brake and turn at the same time.  
True                      False

12. Under normal conditions, following distance should be at least \_\_\_\_\_.

- a. 1 second
- b. 2 seconds
- c. 3 seconds

13. You should not store flammable liquids such as gasoline in the front storage compartment, even if they are in approved containers.

True                      False

14. List 5 ways of being more noticeable to other drivers.

- 1) \_\_\_\_\_
- 2) \_\_\_\_\_
- 3) \_\_\_\_\_
- 4) \_\_\_\_\_
- 5) \_\_\_\_\_

15. When braking on surfaces with less than ideal traction, you should pump the brakes to help maintain control of the vehicle.

True                      False

16. The vehicle's maximum load including riders, cargo and accessories is 208 kg.

True                      False

17. The vehicle can safely tow a trailer as long as the total towed weight does not exceed 208 kg.

True                      False

18. A passenger should hold onto the operator.

True                      False

19. Riding the Spyder roadster is as safe as riding in a car.

True                      False

20. ABS allows you to press the brake pedal hard without locking the brakes.

True                      False

## Answers

1. **False**  
To stop quickly, press the brake pedal only.
2. **False**  
You should do a pre-ride inspection every time you ride.
3. **False**  
If there is ice, snow, slush or enough water on the road to cause hydroplaning, VSS can not help you maintain control.
4. **True**
5. **True**
6.
  - 1) Helmet
  - 2) Eye and face protection
  - 3) Jacket with long sleeves
  - 4) Gloves
  - 5) Long pants
  - 6) Closed-toe footwear, preferably over the ankle.
7. **True**
8. **c. Front brake lever**  
The vehicle does not have a front brake lever.
9. **False**  
You should use your high beams during the day.
10. **True**
11. **False**  
You can brake and turn at the same time if you need to, but generally it is better to brake before the turn.
12. **b. 2 seconds**  
Under normal conditions, following distance should be at least two seconds.
13. **True**
14.
  - 1) Make sure your lights and reflectors are clean.
  - 2) Use your high beams whenever possible.
  - 3) Use your turn signals.
  - 4) Flash your brake lights before slowing.
  - 5) Use your emergency flashers as needed.
  - 6) Use your horn to alert others of your presence.
  - 7) Avoid riding in blind spots.
  - 8) Wear bright colors and reflective clothing.
15. **False**  
You should press and hold the brake pedal, not pump. The vehicle is equipped with ABS, which keeps the wheels from locking.
16. **True**
17. **True**  
You can tow a trailer with the vehicle as long as all the recommendations are strictly followed.
18. **False**  
The passenger should always hold on to the handholds.
19. **False**  
In cars and trucks, the structure of the vehicle provides protection. In addition, passengers can protect themselves by wearing seat belts. You should expect that riding the Spyder roadster is much riskier than riding in a car and that the risk of injury is more like the risk of injury when riding a motorcycle.
20. **True**

---

# SAFETY INFORMATION ON THE VEHICLE

This vehicle comes with a hang tag and labels containing important safety information.

Any person who rides this vehicle should read and understand this information on the vehicle before riding.

## Hang Tag

 **WARNING**

**The Spyder roadster is a different type of vehicle -  
it requires special skills and knowledge.  
Learn how the Spyder roadster is different.**

**Read** the operator's guide (in the front storage compartment) and watch the safety video.

**Complete** a training course (if available), **practice**, become proficient with the controls, and get a proper license.

**Refer** to the Safety Card before riding.

**Always wear a helmet and riding gear.**

With this type of vehicle, riders are exposed to more road risks than in a car. Even skilled operators can be struck by other vehicles or lose control. This vehicle will not protect you in a crash.

**Handling limits and road conditions**

The Vehicle Stability System (VSS) cannot stop you from losing control, flipping over, or falling off if you exceed this vehicle's limits. Know the limits for different road conditions. Do not ride on ice, snow, or off road. Avoid puddles and running water. This type of vehicle can hydroplane on water and slip on gravel, dirt and sand covered roads. If you must go through these road conditions, slow down.

This hangtag may only be removed by the customer.

704904124

704904124



## Safety Card

The Safety Card is found at the top of the multifunction gauge cluster. Pull it out to read it, and be sure to securely put it back before riding.

Use the Safety Card to review key information and when you are teaching new operators and passengers how to ride the vehicle. It also includes frequently referenced information.

**NOTE:** The following illustration used in this Operator's Guide is a general representation only. Your model may differ.

**⚠ WARNING**

The Spyder roadster is a different type of vehicle - it requires special skills and knowledge.

**Learn how the Spyder roadster is different.** Read the operator's guide (in front storage compartment) and watch the safety video.

**Complete** a training course (if available), **practice**, become proficient with the controls, and get a proper license. **Do the following procedures before each ride.**

<p><b>Check road conditions.</b> The Vehicle Stability System (VSS) cannot stop you from losing control, flipping over, or falling off if you exceed this vehicle's limits. Know the limits for different road conditions. Do not ride on ice, snow, or off road. Avoid puddles and running water. This type of vehicle can hydroplane on water and slip on gravel, dirt and sand covered roads. If you must go through these road conditions, slow down.</p> <p><b>Wear a helmet and riding gear.</b> With this type of vehicle, riders are exposed to more road risks than in a car. Even skilled operators can be struck by other vehicles or lose control. This vehicle will not protect you in a crash.</p>	<p><b>Instruct the passenger.</b></p> <ul style="list-style-type: none"> <li>• Always hold handholds and keep feet on pegs.</li> <li>• Watch the road. Lean into curves. Brace for bumps.</li> </ul> <p><b>Always keep in mind:</b></p> <ul style="list-style-type: none"> <li>• Brake with the foot pedal.</li> <li>• Reduce your speed if you are towing a trailer.</li> <li>• Make sure the surrounding is clear and safe before looking at the digital screen.</li> <li>• Steer in the direction of a turn; do not countersteer.</li> <li>• Keep all wheels in your lane, always ride in a single lane, and do not split lanes.</li> </ul> <p><b>Perform Pre-ride Inspection</b></p>
--	--



704904045

704904045

### SAFETY CARD

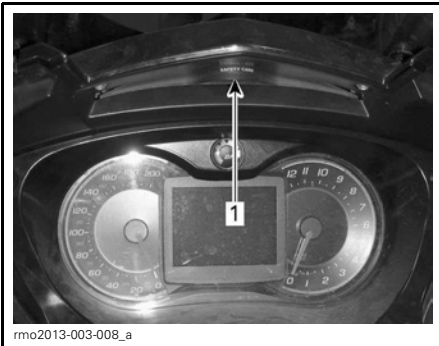

1. Safety card tab location



TYPICAL - SAFETY CARD PULLED OUT

## Safety Labels

These labels are affixed to the vehicle for the safety of the operator, passenger (2-UP) or bystanders

The following labels are on your vehicle, and they should be considered permanent parts of the vehicle. If missing or damaged, they can be replaced free of charge. See an authorized Can-Am roadster dealer.

**NOTE:** In the event of any discrepancy between this guide and the vehicle, the safety labels on the vehicle have precedence over the labels in this guide.

### Label 1

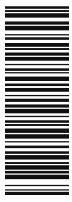
<b>TIRE INFORMATION</b>  <b>TIRE BRAND:</b> FRONT: KENDA KR31 REAR : KENDA KR21  <b>TIRE SIZE:</b> FRONT: MC165/55R15 55H REAR : MC225/50R15 76H  <b>RIM SIZE:</b> FRONT: 381 X 127mm REAR : 381 X 178mm	READ OPERATOR'S GUIDE THIS VEHICLE IS EQUIPPED WITH TUBELESS TIRES	704904243  
	<b>COLD TIRE PRESSURE</b>  <b>UP TO MAXIMUM WEIGHT CAPACITY</b> FRONT : 103± 14 kPa (1.03± 0.14 bar) REAR : 193± 14 kPa (1.93± 0.14 bar)  <b>UP TO 90 kg LOAD</b> FRONT : 103± 14 kPa (1.03± 0.14 bar) REAR : 193± 14 kPa (1.93± 0.14 bar)	CE  <b>MAXIMUM WEIGHT CAPACITY: 208kg</b>

704904243

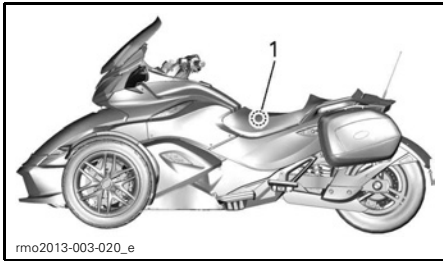

**TYPICAL**  
1. Label 1 location

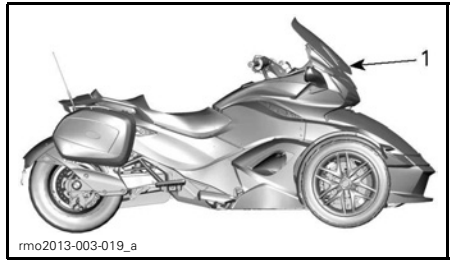

**TYPICAL**  
1. Label 2 location

### Label 2

<p><b>NOTICE</b></p> <p>Do not clean with alkaline or acid cleaner, gasoline or solvent to avoid windshield damage. See operator's guide.</p> <p>704903339</p>
--

704903339

### Label 3

<p><b>⚠ WARNING</b></p> <p><b>DO NOT OVERLOAD</b></p> <p><b>16 kg</b></p> <p><b>LOAD LIMIT</b> CE</p> <p>704903110</p>
--

704903110

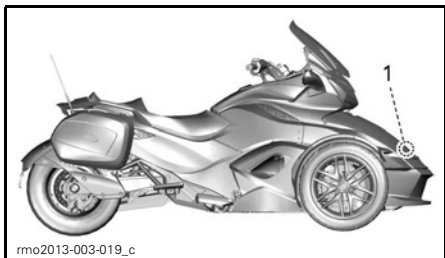

rmo2013-003-019\_c

**TYPICAL**

1. Label 3 located in the front storage compartment

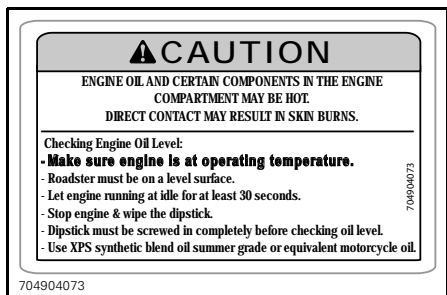
**Label 4**

704904073

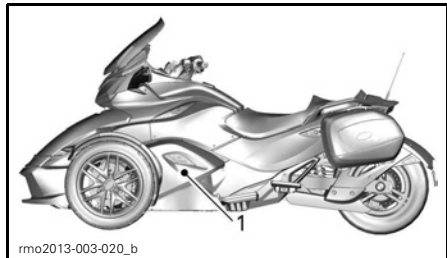

rmo2013-003-020\_b

**TYPICAL**

1. Label 4 located on the oil tank behind the left side panel

**Label 5**

rmo2008-003-003

**COOLANT RESERVOIR CAP**

rmo2013-003-027\_a

**TYPICAL**

1. Label 5 located underneath service cover

## Label 6

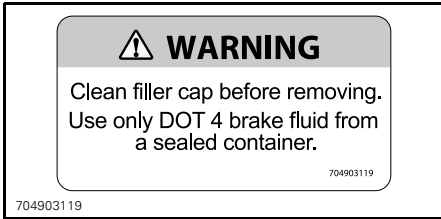

### TYPICAL

1. Label 6 located underneath seat

# ***PRE-RIDE INSPECTION***

# PRE-RIDE CHECKLIST

## WARNING

Perform a pre-ride inspection before each ride to detect potential problems during operation. The pre-ride inspection can help you monitor wear and deterioration before they become a problem. Correct any problems that you discover to reduce the risk of a breakdown or crash. See an authorized Can-Am roadster dealer as necessary.

There is a pre-ride inspection checklist on the Safety Card.

### Inspect:

- **Tires:** Look for damage, incorrect inflation and excessive tread wear. Refer to the *MAINTENANCE PROCEDURES* subsection.
- **Wheels and lugnuts:** Look for damage. Twist each front wheel lugnut by hand to be sure it is not loose. Be sure the rear wheel axle nut is in place.
- **Drive belt:** Look for fraying, cuts, punctures and missing teeth. Verify alignment. For additional information, refer to the *MAINTENANCE PROCEDURES* subsection
- **Leaks:** Look under the vehicle for any leaks.
- **Front storage compartment cover:** Pull to check that it is properly latched.
- Ensure seat is properly latched.
- **Mirrors:** Clean and adjust (see the *MIRRORS* in *EQUIPMENT* subsection).
- **Brake pedal:** Press and make sure you feel firm resistance. Pedal must fully return when released.
- **Throttle handle:** Twist several times. Be sure it operates freely and returns to idle position when released.

- **Clutch lever (SM5 model):** Adjust to your convenience (see the *PRIMARY CONTROLS* subsection). Squeeze to be sure it operates normally and fully returns when released.
- **Gearshift selector (SE5 model):** Be sure gearshift selector operates normally in both directions and returns to center when released.
- **Passenger footrest height adjustment:** Be sure the passenger is comfortable with the footrest height. Adjust as necessary.
- **Windshield:** Clean and adjust to your convenience.
- **Weight:** Ensure that total load on the vehicle (including operator, passenger, cargo and added accessories) does not exceed 208 kg.

### Turn Ignition Key to the ON Position:

- **Multifunction gauge cluster:** Check the gauges, indicators, messages and the fuel level.
- **Lights:** Check operation of headlights, taillight, brake light, turn signals and hazard warning lights.
- **Horn:** Check operation.
- **Steering:** Start engine and verify that steering operates freely.
- **Engine stop switch:** Check that the engine stop switch is working properly.
- **Parking brake:** Start engine, release parking brake and ensure brake indicator lamp is off on the multifunction gauger.
- **Brake:** Drive a short distance forward slowly then apply brake to test.

Always lock Safety Card back into position.

# ***MAINTENANCE***

# MAINTENANCE SCHEDULE

Maintenance is very important for keeping your vehicle in safe operating condition. Proper maintenance is the owner's responsibility. Perform periodic checks and follow the maintenance schedule. The maintenance schedule does not exempt the pre-ride inspection.

## WARNING

Failure to properly maintain the vehicle according to the maintenance schedule and procedures can make it unsafe to operate.

### BREAK-IN INSPECTION - 1 000 KM

Using BRP Utility and Diagnostic Software (B.U.D.S.), check fault codes and install required updates.

Replace engine oil and oil filter.

Inspect and clean the oil tank strainer.

Replace the Hydraulic Control Module (HCM) oil filter (**SE5 model only**).

Check engine coolant level.

Inspect throttle twist grip operation.

Check lighting system (brake light, hazard warning light, turn signal lights, position lights, license plate light).

Check backup light (**Australian model only**).

Check operation of control switches.

Inspect the drive belt condition and its tension. Adjust if required.

Check tightening torque of the rear wheel axle nut.

Check steering for abnormal play.

Check parking brake operation. Adjust as required.

Check body panels looseness.

Check operation of storage compartment latches, hinges and key barrels.



MINIMUM MAINTENANCE - (IF DRIVING LESS THAN 7 500 KM ANNUALLY)
Using BRP Utility and Diagnostic Software (B.U.D.S.), check fault codes and install required updates.
Using BRP Utility and Diagnostic Software (B.U.D.S.), check pillion rider switch operation.
Replace engine oil and oil filter.
Replace the Hydraulic Control Module (HCM) oil filter ( <b>SE5 model only</b> ).
Check clutch fluid level ( <b>SM5 model only</b> ) <sup>(1)</sup> .
Check radiator, hoses and water pump.
Check engine coolant level <sup>(1)</sup> .
Perform a pressure test of cooling system.
Check reverse mechanism operation. Adjust as required ( <b>SM5 model only</b> ).
Clean the rear wheel speed sensor. Check the sensor gap. Adjust as required <sup>(2)</sup>
Inspect throttle twist grip operation.
Check battery connection tightening. Clean them if necessary.
Check lighting system (brake light, hazard warning light, turn signal lights, position lights, license plate light).
Check backup light ( <b>Australian model only</b> ).
Check operation of control switches.
Inspect the drive belt condition and its tension. Adjust if required.
Check bearing condition of rear sprocket and rear wheel.
Check front wheel bearings condition.
Check tightening torque of front wheel lug nuts.
Check tightening torque of the rear wheel axle nut.
Check steering for abnormal play.
Check tie-rods condition.
Check shock absorbers for leak or other damages.
Check ball joint condition.
Check and/or replace brake fluid <sup>(1)</sup> .
Check brake pads and discs condition.
Check and adjust parking brake.
Check tightening of passenger handles.

**MINIMUM MAINTENANCE - (IF DRIVING LESS THAN 7 500 KM ANNUALLY)**

Lubricate footrest hinges.

Check body panels looseness.

Check operation of storage compartment latches, hinges and key barrels and/or lubricate.

Check operation of brake pedal and floorboard mechanism (**models with a floorboard**).

<sup>(1)</sup> Replace every 2 years.

<sup>(2)</sup> Check the gap each time the rear wheel is loosened.

**EVERY 500 KM**

Check engine oil level.

EVERY 7 500 KM
Using BRP Utility and Diagnostic Software (B.U.D.S.), check fault codes and install required updates.
Replace engine oil and oil filter.
Replace the Hydraulic Control Module (HCM) oil filter ( <b>SE5 model only</b> ).
Check clutch fluid level ( <b>SM5 model only</b> ).
Check engine coolant level.
Inspect throttle twist grip operation.
Check lighting system (brake light, hazard warning light, turn signal lights, position lights, license plate light).
Check backup light ( <b>Australian model only</b> ).
Check operation of control switches.
Inspect the drive belt condition and its tension. Adjust if required.
Check tightening torque of front wheel lug nuts.
Check tightening torque of the rear wheel axle nut.
Check steering for abnormal play.
Check tie-rods condition.
Check brake fluid level.
Check brake pads and discs condition.
Check parking brake operation. Adjust as required.
Check tightening of passenger handles.
Check body panels looseness.
Check operation of brake pedal and floorboard mechanism ( <b>models with a floorboard</b> ).

**EVERY 15 000 KM**

Using BRP Utility and Diagnostic Software (B.U.D.S.), check pillion rider switch operation.

Check reverse mechanism operation. Adjust as required (**SM5 model only**).

Clean the rear wheel speed sensor. Check the sensor gap. Adjust as required <sup>(1)</sup>.

Check battery connection tightening. Clean them if necessary.

Check shock absorbers for leak or other damages.

Check brake hoses for cracks or other damages.

Check operation of storage compartment latches, hinges and key barrels.

<sup>(1)</sup> Check the gap each time the rear wheel is loosened.

**EVERY 22 500 KM OR 2 YEARS (WHICHEVER COMES FIRST)**

Inspect and clean the oil tank strainer.

Check and adjust valves clearance <sup>(1)</sup>.

Replace air filter and clean air filter housing <sup>(2)</sup>.

Replace clutch fluid (**SM5 model only**).

Check radiator cap, hoses and water pump.

Perform a pressure test of cooling system.

Inspect and clean the throttle body.

Check condition of fuel hoses. Replace as required.

Spark plugs replacement.

Check front wheel bearings condition.

Perform steering alignment.

Check ball joint condition.

Replace brake fluid.

<sup>(1)</sup> Valve adjustment must be performed more frequently if driving often at high RPM.

<sup>(2)</sup> Inspection and replacement more frequent when using in dusty or wet areas.

**EVERY 30 000 KM OR 5 YEARS (WHICHEVER COMES FIRST)**

Replace the fuel filter.

**EVERY 45 000 KM**

Replace engine coolant (or every 5 years).

---

# BREAK-IN INSPECTION

We recommend that after the first 1 000 km of operation, your vehicle be inspected by an authorized Can-Am dealer. The initial maintenance is very important and must not be neglected.

**NOTE:** The break-in inspection is at the expense of the vehicle owner.

We recommend that this inspection be signed by an authorized Can-Am dealer.

---

Date of inspection

---

Authorized dealer signature

---

Dealer name

# MAINTENANCE PROCEDURES

This section includes instructions for basic maintenance procedures. If you have the necessary mechanical skills and the required tools, you can perform these procedures. If not, see your authorized Can-Am roadster dealer.

Other important items in the maintenance schedule that are more difficult and require special tools are best performed by your authorized Can-Am roadster dealer.

## **⚠ WARNING**

Turn off the engine and follow these maintenance procedures when performing maintenance. If you do not follow proper maintenance procedures you can be injured by hot parts, moving parts, electricity, chemicals or other hazards.

## Engine Oil

**NOTICE** The procedures for checking the Spyder roadster oil level and replacing oil are different from most of the motor vehicles today. Properly follow instructions provided in this section.

### Recommended Engine Oil

Use the XPS 4-STROKE SYNTH. BLEND OIL (SUMMER) (P/N 293 600 121).

If not available, use SAE 5W 40 semi-synthetic or synthetic motorcycle oil that meets the requirements for API service SL, SJ, SH or SG classification. Always check the API service label on the oil container.

**NOTE:** The same oil is used for the engine, gearbox, clutch, and the HCM (SE5 models).

**NOTICE** To avoid damaging the clutch, do not use a motor oil meeting the API service SM or ILSAC GF-4 classification. Clutch slippage will occur.

**NOTICE** Do not add any oil additives to the recommended oil. This may lead to gearbox and clutch malfunctions.

### Engine Oil Level Verification

**NOTICE** To obtain a precise reading of the engine oil level, follow this procedure and make sure engine is at normal operating temperature.

1. Park the vehicle on a level surface.
2. Remove the LH middle side panel. Refer to *BODY PANELS* in *EQUIPMENT* subsection.
3. With the engine already at **normal operating temperature**, start engine and let it run for at least 30 seconds.

**NOTE:** Running engine for at least 30 seconds allows the suction oil pump to drain the oil from the engine crankcase back into the oil tank. Not carrying out this step could result in overfilling the engine oil.

4. Stop engine.
5. Unscrew and remove the oil dipstick.

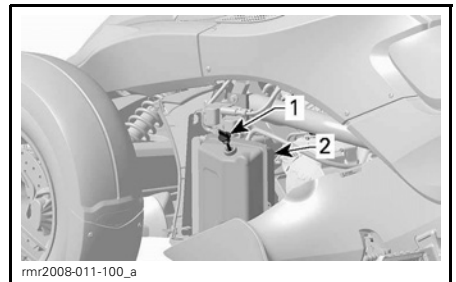

**TYPICAL**  
1. Oil dipstick  
2. Oil tank

6. Wipe off the dipstick.

7. Reinsert and **completely screw** in the dipstick to assure an accurate reading.
8. Unscrew and remove the dipstick again.
9. Check the oil level on the dipstick. It should be near or equal to the upper mark.

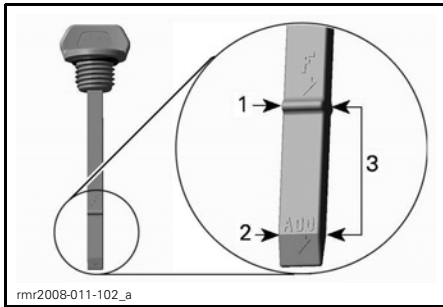

1. Upper mark (F)
2. Lower mark (add)
3. Operating range

### Oil Level is Near Upper Mark:

1. Do not add oil.
2. Properly insert and tighten dipstick.
3. Install the LH middle side panel. Refer to *BODY PANELS* in the *EQUIPMENT* subsection.

### Oil Level Adjustment:

1. Adjust oil level until it is in the operating range, close to the upper mark. **Do not overfill.**

**NOTE:** At the lower mark, add 500 ml of oil to reach upper mark (F).

2. Properly insert and tighten dipstick.
3. Install the LH middle side panel. Refer to *BODY PANELS* in the *EQUIPMENT* subsection.

### Engine Oil Change

Prior to changing the oil, ensure vehicle is on a level surface.

**NOTICE** The oil change should be carried out with a warm engine.

**! CAUTION** Engine oil can be very hot.

1. Remove the following LH body panels. Refer to *BODY PANELS* in the *EQUIPMENT* subsection:
  - Middle side panel
  - Inner side panel
  - Bottom side panel.
2. Remove the bottom plate under oil tank.

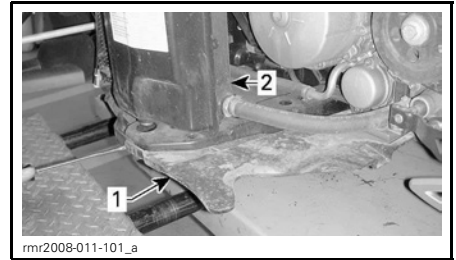

1. Bottom plate
2. Oil tank

3. Clean area around drain plug under oil tank.
4. Place an appropriate drain pan under oil tank.
5. Remove the tank drain plug and discard the sealing washer.

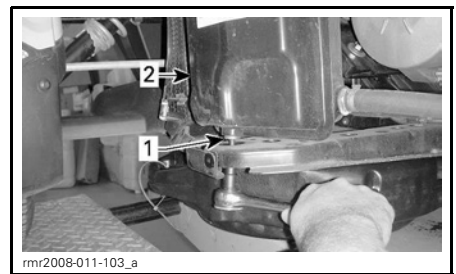

1. Reservoir drain plug
2. Oil tank

6. Remove the dipstick.
7. Allow sufficient time for oil to completely drain.
8. Clean area around engine drain plug.

9. Place an appropriate drain pan under the engine.
10. Remove the engine oil drain plug and discard the sealing washer.

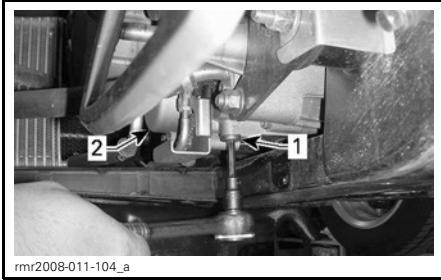

1. Engine oil drain plug
2. Oil filter cover

11. Allow sufficient time for oil to completely drain from crankcase.
12. Clean the magnet on the engine drain plug.
13. Using **NEW** sealing washers, install engine and oil tank drain plugs.

**NOTICE** Never reuse the drain plug sealing washer. Always replace it with a new one.

14. Torque drain plugs (engine and oil tank) to 20 N•m.
15. Replace engine oil filter. Refer to *ENGINE OIL FILTER REPLACEMENT* further in this subsection.

#### **SE5 Model**

16. Replace HCM oil filter. Refer to *HCM OIL FILTER* further in this subsection.

#### **All Models**

17. Pour 3 L of the recommended oil into oil tank.
18. Start engine and let idle for two minutes.

**NOTICE** Do not rev up engine during idling period as this may cause permanent engine damage.

**NOTICE** Ensure oil pressure warning lamp goes out within 5 seconds from engine start. If oil pressure warning lamp stays ON for more than 5 seconds, STOP ENGINE and recheck oil level.

Check for leaks at:

- Engine oil filter
- HCM oil filter
- Engine drain plug
- Oil tank drain plug.

19. Stop engine.

**NOTE:** The oil level dipstick is accurate when the oil temperature is at 80°C. If the oil level is checked when the oil is at room temperature 20°C, the proper oil level indication is half way between the lower (ADD) and upper (F) marks on the dipstick. This must be considered to prevent overfilling the oil tank.

#### **SM5 Models**

20. Add 0.9 L of the recommended oil in the oil tank (3.9 L).
21. Check oil level immediately and adjust if required.
22. Reinstall all removed body panels.
23. Dispose of used oil as per your local environmental regulations.

#### **SE5 Models**

24. Add 1.2 L of the recommended oil in the oil tank (4.2 L total quantity).
25. Check oil level immediately and adjust if required.

**NOTE:** When the engine oil filter and the HCM oil filter are replaced, the total oil quantity to add will be 4.3 L.

26. Reinstall all removed body panels.
27. Dispose of used oil as per your local environmental regulations.



## Engine Oil Filter

### Engine Oil Filter Removal

1. Refer to *ENGINE OIL CHANGE* for removal of the required body panels.
2. Remove oil filter cover screws.

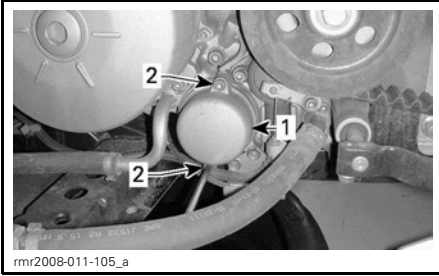

#### TYPICAL

1. Oil filter cover
2. Cover screws

3. Remove oil filter cover with O-ring. Discard O-ring.
4. Remove oil filter.
5. Dispose of filter as per your local environmental regulations.

### Engine Oil Filter Installation

Installation is the reverse of the removal procedure. However, pay attention to the following.

1. Check and clean oil inlet and outlet orifices in crankcase for dirt and contaminants.

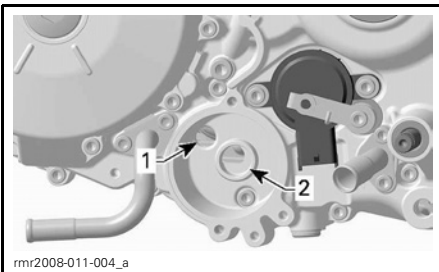

#### TYPICAL

1. Oil inlet orifice from oil pressure pump
2. Oil outlet orifice to engine lubrication system

2. Install a NEW O-ring on the oil filter cover.

To ease assembly and prevent displacement of the O-ring during installation, apply a light coat of oil on the oil filter and O-ring. Refer to following illustration.

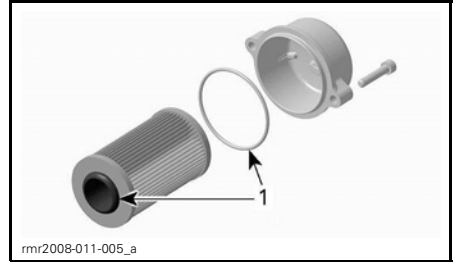

1. Apply oil here

### HCM Oil Filter (SE5 Model)

The HCM (Hydraulic Control Module) uses the same oil as the engine, but has its own oil filter.

**NOTICE** Replace HCM oil filter and engine oil filter at the same time.

### HCM Oil Filter Removal

1. Remove oil filter cover screws.

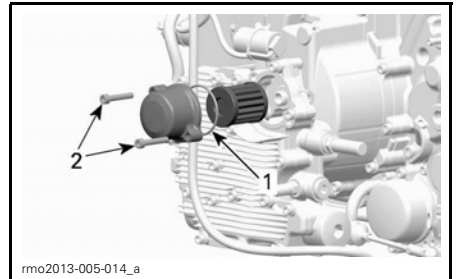

1. Oil filter cover
2. Cover screws

2. Remove oil filter cover with O-ring. Discard O-ring.
3. Remove oil filter.
4. Dispose filter as per your local environmental regulations.

## HCM Oil Filter Installation

The installation is the reverse of the removal procedure. Pay attention to the following.

1. Check and clean the oil inlet and outlet orifices in hydraulic control module for dirt and contaminations.

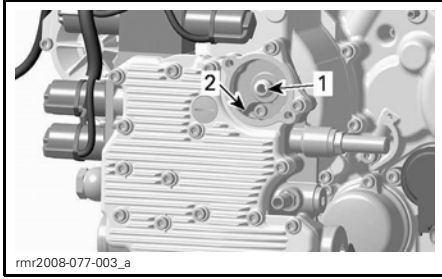

1. Oil outlet orifice to the hydraulic control module lubrication system
2. Oil inlet orifice to the oil pump

2. Install a **NEW** O-ring on oil filter cover.

To ease assembly and prevent displacement of the O-ring during installation, apply a light coat of oil on the oil filter and O-ring. Refer to following illustration.

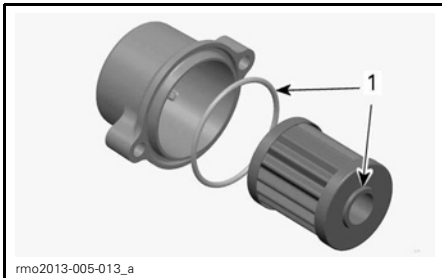

1. Apply oil here

## Engine Coolant

### Engine Coolant Level Verification

#### **⚠ WARNING**

When opening the reservoir, the coolant can be very hot and spray out if the engine is hot. In order to avoid getting burned, check the coolant level when the engine is cold.

The cooling system must be filled with distilled water and antifreeze solution (50% distilled water, 50% antifreeze).

For best performance, use LONG LIFE ANTIFREEZE (P/N 219 702 685).

With the engine cold, check the coolant level as follows:

1. Park the vehicle on a firm, level surface.
2. Open the front storage compartment.
3. Pull out the right-hand side service cover with both hands.
4. Check the coolant level on the right hand side. Coolant must be visible slightly above the COLD level mark.

**NOTE:** If engine is hot, coolant must be visible without exceeding the HOT level mark.

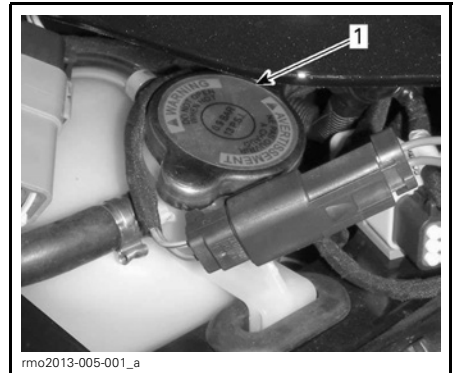

1. Coolant reservoir cap

- If required, add coolant until it is visible in the reservoir slightly above the COLD level mark. Use a funnel to avoid spillage. **Do not overfill.**
- Stop adding coolant once coolant starts to appear in the tube.

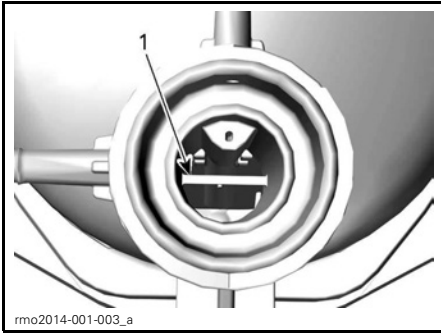

1. HOT coolant level reference line

- Reinstall the service cover.

**NOTE:** A coolant system that frequently requires coolant indicates leaks or engine problems. See an authorized Can-Am roadster dealer.

## Clutch Fluid (SM5 Model)

### Clutch Fluid Level Verification

Check the clutch fluid level when the clutch does not operate normally or when it is difficult to shift gears with the gearshift lever.

The clutch fluid reservoir is near the reverse interlock lever on the left handlebar.

Check the clutch fluid level as follows:

- Park the vehicle on a firm, level surface.
- Set the handlebar straight in order to position the top of clutch fluid reservoir horizontally.
- Wipe clean the cap area.
- Use the Phillips head screwdriver located in the toolkit.
- Unscrew cap retaining screws.



TYPICAL

- Carefully remove cap. Pay attention not to drop the cap seal.
- Look inside the reservoir to see the fluid level.

Check clutch fluid level inside the reservoir:

- The fluid must be flush to the fill level line (protuberance on the reservoir wall).

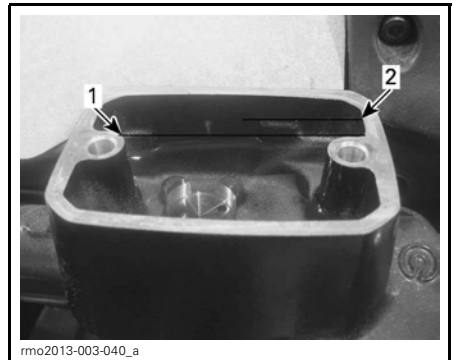

FLUID REMOVED FOR CLARITY PURPOSE

- Minimum
- Maximum

### Adding Clutch Fluid

- If the fluid level is lower than specified, add fluid to the reservoir up to the fill level line. Use only DOT 4 brake fluid.
- Add fluid as required. **Do not overfill.**

**NOTICE** Immediately wipe up any spills.

3. Push back the seal located inside the cap.
4. Reinstall the cap to the reservoir.
5. Tighten cap screws.

## Battery

### Battery Location

The battery is located in the front storage compartment. To access the battery, open the front storage compartment.



FRONT STORAGE COMPARTMENT

Loosen the screws and open the battery access panel.

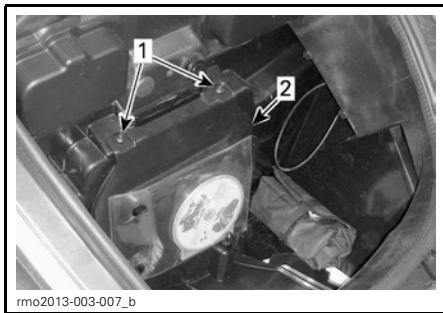

1. Screws
2. Battery access panel

### Battery Charging

The vehicle is equipped with a maintenance-free type battery and is completely sealed; there is no need to add water to adjust the electrolyte level. The battery may need to be charged if the vehicle has not been ridden for at least one month.

Always have the battery replaced by an authorized Can-Am roadster dealer.

### **⚠ WARNING**

Do not use conventional lead-acid type batteries. Acid may leak out through the battery vent of a conventional lead-acid type battery. Acid may also leak if the battery case is cracked or damaged, which can cause severe burns.

The battery can be charged while it is installed on the vehicle.

**NOTICE** Follow the instructions provided with your battery charger. Improper charging may damage the battery.

To charge the battery, proceed as follows:

1. Open the front storage compartment.
2. Remove the battery access panel.
3. First connect the POSITIVE (+) cable to the corresponding terminal.
4. Connect the NEGATIVE (-) cable to the corresponding terminal.

**NOTICE** Always connect the POSITIVE (+) cable first to avoid damaging the electrical system of the vehicle.

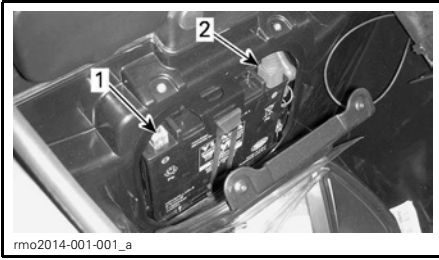

1. NEGATIVE (-) terminal
2. POSITIVE (+) terminal

5. Start the battery charger. Charging time will depend on the charging rate.

When the battery is charged:

6. First disconnect the NEGATIVE (-) cable.
7. Disconnect the POSITIVE (+) cable.

**NOTICE** Always disconnect the NEGATIVE (-) cable first to avoid damaging the electrical system of the vehicle.

8. Close the battery access panel and the front storage compartment.

A standard battery charger can be used. The recommended charge rate is 2 A. If the battery is dead, it can be jump started with a car battery (see the *ROAD SIDE REPAIRS* section).

For home charging, a "trickle" charger can be used to slow charge the battery. This type of charger can be left connected for a long period of time without damaging the battery. Always follow the charging time as recommended in the charger instructions.

## Drive Belt

Visually inspect belt alignment and condition before each ride.

Belt alignment and deflection adjustment should always be performed by an authorized Can-Am roadster dealer according to the *MAINTENANCE SCHEDULE*.

## Drive Belt Alignment

The gap between the belt and the sprocket internal flange should be sum of "X" + "Y" = 3.25 mm ± 2.75 mm. If belt goes beyond the outside edge of sprocket, have the belt properly aligned by an authorized Can-Am roadster dealer as soon as possible.

**NOTE:** Belt can be in contact with **ONLY ONE** flange from **ONLY ONE** of the sprockets.

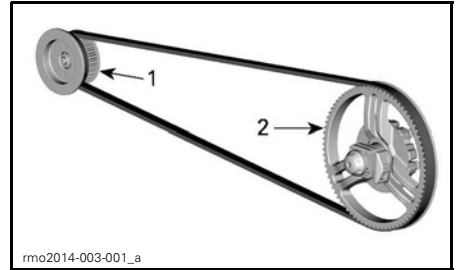

1. Front sprocket
2. Rear sprocket

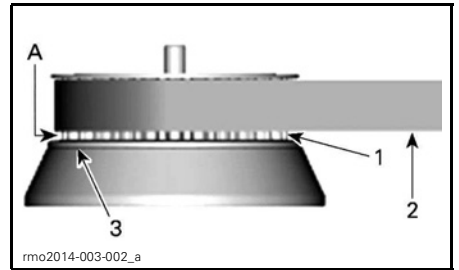

### FRONT SPROCKET

1. Front sprocket teeth
2. Belt
3. Sprocket internal flange
- A. GAP "X"

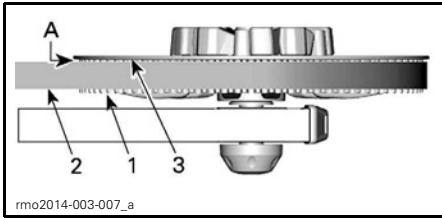

**REAR SPROCKET**

1. Rear sprocket teeth
  2. Belt
  3. Sprocket internal flange
- A. GAP "Y"

**Drive Belt Wear**

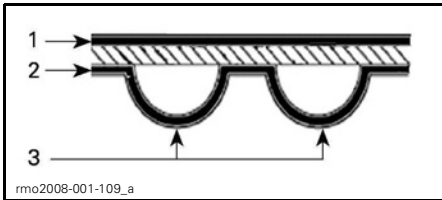

Inspect the drive belt with the vehicle in neutral, engine off, on a level surface with plenty of room — you will have to roll the vehicle forward or backward to see the full length of the belt.





**DRIVE BELT SURFACES**

1. Outer surface
2. Teeth side surface
3. Tooth

Inspect for the following conditions:

WEAR CONDITION	REQUIRED ACTION
Good condition 	None
Hairline cracks 	Monitor condition
Minor chipping 	Monitor condition

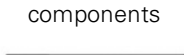
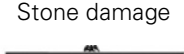
WEAR CONDITION	REQUIRED ACTION
Opened cracks 	Replace belt
Hook wear 	Replace belt
Missing teeth 	Replace belt
Belt fabric worn, exposing internal components 	Replace belt
Stone damage 	Replace belt

**NOTE:** Hairline cracks do not require the replacement of the belt, but must be monitored closely — they may lead to opened cracks or missing teeth, requiring belt replacement. Damage to the center of the belt will eventually require belt replacement, but when cracks extend to the edge of the belt, belt failure is imminent.

When a drive belt is replaced, also replace the sprockets to increase the longevity of the new drive belt.

**Drive Belt Tension**

While riding, if you feel vibrations in the belt or if the belt is skipping sprocket teeth, have the belt tension adjusted as soon as possible by an authorized Can-Am roadster dealer.

## Wheels and Tires

### WARNING

Tires that are not the recommended type, damaged, worn down below the minimum tread wear limit indicator or improperly inflated can cause loss of control. New tires will not operate at their maximum efficiency until their break-in is completed. Braking, steering and VSS performance may be reduced, so use extra caution. Tires take about 300 km of riding with frequent braking to break-in. For riding with infrequent braking, allow extra time to break-in the tires.

The tires have been specifically designed for the Spyder roadster. Use only the BRP recommended tires, which can be ordered only from an authorized Can-Am roadster dealer.

When the rear tire is removed or replaced, perform the following:

- Check and clean the rear sprocket bearing. Replace if damaged or broken.
- Check and clean the rear axle bearings. Replace if damaged or broken.
- Replace and lubricate the bearing seal of the rear axle.
- Replace and lubricate rear axle O-ring.
- Check and clean the rear axle wear sleeves. Replace if damaged or broken.

When the rear wheel is removed or replaced, perform the following:

- Replace rear wheel nut.
- Replace and lubricate the bearing seal of the rear axle.
- Replace and lubricate rear axle O-ring.
- Check rubber damper condition. Replace if damaged or broken.

## Tire Pressure

Check pressure when tires are cold before using the vehicle. Tire pressure changes with the air temperature. Recheck pressure if temperature has changed (e.g., significant weather change, driving in the mountains).

COLD TIRE PRESSURE	
Front tires	103 kPa ± 14 kPa
Rear tires	193 kPa ± 14 kPa

**NOTE:** The pressure difference between the left and right side tire should not exceed 3.4 kPa.

For your convenience, an electronic pressure gauge is supplied in the tool kit.

## Tire Damage

Check all tires for:

- Cuts, slits and cracks in the tires
- Bumps or bulges in the side of the tire or the tread
- Nails or other foreign objects in the side of the tire or tread
- Air leaks (hissing sound) caused by an ill-fitting rim or a faulty tire valve.

If any of the above occurs, have the tire repaired or replaced as soon as possible by an authorized Can-Am roadster dealer.

## Tire Tread Wear

Check minimum tread depth by using the tread-wear indicators (hard rubber bars molded at the base of the tread; 1 in figure bellow). Check in three locations across the tire tread:

- Outer edge
- Center
- Inside edge.

The tread-wear indicators will appear across the treads that have been worn down to the minimum tread depth. When at least one tread-wear indicator

appears across the tread, have the tire replaced as soon as possible by an authorized Can-Am roadster dealer.

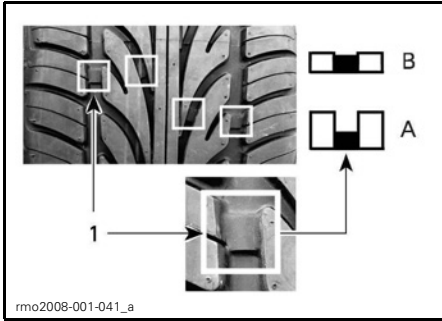

**TIRE TREAD WEAR**

1. Tread-wear limit indicator

A. Appropriate tread depth

B. Minimum tread depth, replace tire

It is normal to see uneven wear on tires depending on how the vehicle is driven and road conditions. The front tires external or internal edges and the rear tire center tread will wear unevenly depending on if the vehicle is driven smoothly or aggressively.

**⚠ WARNING**

The tires are designed to rotate only in one direction. Do not switch the left and right front wheels. If a tire is mounted on the incorrect side, you will have less traction and could lose control.

**⚠ WARNING**

Do not hold the front wheel spoke while attempting to spin the front wheel as your fingers may be caught between the wheel and the brake caliper.

**Tire Registration Form**

In the event of a tire recall, we can only contact you if we have your name and address. As a vehicle manufacturer, BRP keeps a record of the Tire Identification Number (TIN) associated with

the Vehicle Identification Number (VIN) (see the *VEHICLE IDENTIFICATION* subsection) and its current owner information.

If you replace any tire on your vehicle, a "Tire Registration Form" must be completed and sent to the tire manufacturer consumer service group. The "Tire Registration Form" is available at an authorized Can-Am roadster dealer.

**Brakes**

**⚠ WARNING**

New brakes will not operate at their maximum efficiency until their break-in is completed. Braking performance may be reduced, so use extra caution. Brakes take about 300 km of riding with frequent braking to break-in. For riding with infrequent braking, allow extra time to break-in the brakes.

**Brake Fluid Level Verification**

Use only DOT 4 brake fluid from a sealed container.

Check the brake fluid level as follows:

1. Park the vehicle on a firm, level surface.
2. Unlatch and lift the seat.



1. Brake fluid reservoir



3. Check the brake fluid level in both reservoirs, near the back of the seat. They should both be above the MIN. mark.

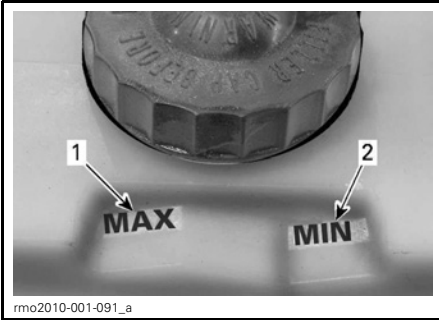

1. Brake fluid MAX. level mark
2. Brake fluid MIN. level mark

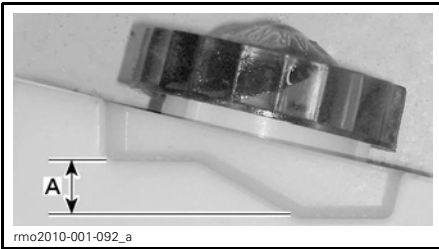

A. Operating range

4. Add fluid as required. Refer to *ADDING BRAKE FLUID* subsection.

**NOTE:** Low brake fluid may indicate leaks or worn brake pads. See an authorized Can-Am roadster dealer.

### Adding Brake Fluid

Remove the filler cap.

## ⚠ WARNING

Clean filler cap before removing. Use only DOT 4 brake fluid from a sealed container.

1. Add fluid to MAX level.

**NOTICE** Brake fluid can damage painted surfaces or plastic parts. Wipe up any spills.

2. Reinstall filler cap as follows:

- 2.1 Check that V slit is in good condition.
- 2.2 Ensure diaphragm are properly positioned.

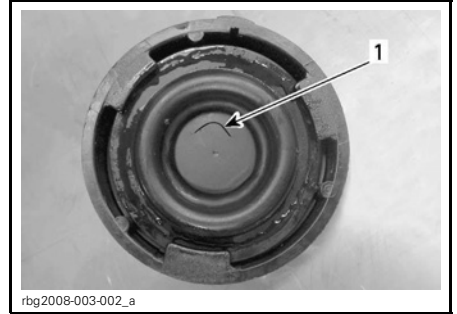

**TYPICAL**

1. V slit

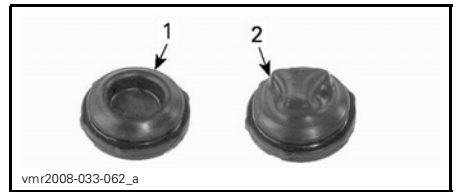

**TYPICAL**

1. Correct position
2. Wrong position

3. Close the seat and ensure it is fully latched.

### Brake System Verification

The front and rear brakes are hydraulic disc types. These brakes are self-adjusting and do not require adjustment.

The brake pedal also requires no adjustment.

To keep brakes in good condition, check the following as per the *MAINTENANCE SCHEDULE*:

1. Entire brake system for fluid leaks
2. Brake pedal for spongy feel
3. Brake discs for excessive wear and surface condition

4. Brake pads for wear, damage or looseness.

### ST-S and ST LTD SE5 Models

1. Release the latch underneath the floorboard.
2. Pivot the floorboard by manually pushing down its front part.
3. Flip back the floorboard until it latches. The mechanism must work freely.

See an authorized Can-Am roadster dealer if there are any problems with the brake system.

## Headlights

### Headlights Aiming

1. To access the headlights, see *LIGHTS* in *HOW TO REPLACE FUSES AND LIGHTS* subsection.
2. Position the vehicle 10 m in front of a test surface as shown.

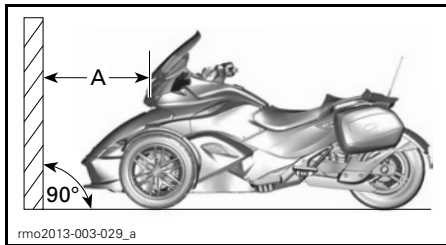

A. 10 m

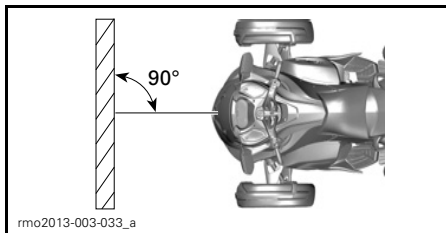

Trace 4 lines parallel to the ground on the test surface as follows:

LINES ON THE TEST SURFACE	
Line A	894 mm above ground
Line B	804 mm above ground
Line C	464 mm above ground
Line D	374 mm above ground

Have a person of at least 91 kg taking place on the driver's seat.

3. Select high beam.
4. Beam aiming is correct when the focus point (center point of ellipse) of the headlight reflection is between the upper marks.

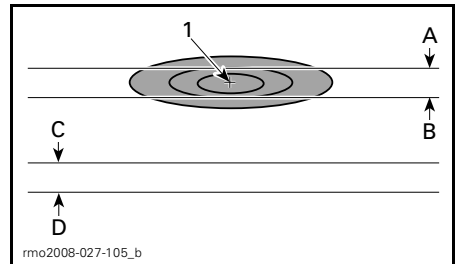

### HEADLIGHT REFLECTION ON TEST SURFACE — HIGH BEAM

1. Focus point
- A. 894 mm above ground
- B. 804 mm above ground
- C. 464 mm above ground
- D. 374 mm above ground

5. Select low beam.
6. Beam aiming is correct when the focus point (brightest point) of headlight reflection is between lower marks.

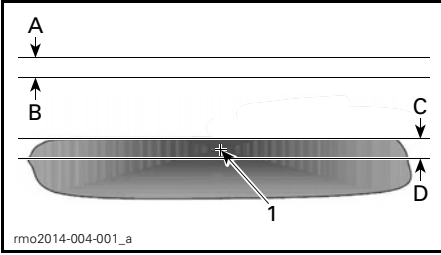

**HEADLIGHT REFLECTION ON TEST SURFACE — LOW BEAM**

1. Focus point
- A. 894 mm above ground  
 B. 804 mm above ground  
 C. 464 mm above ground  
 D. 374 mm above ground

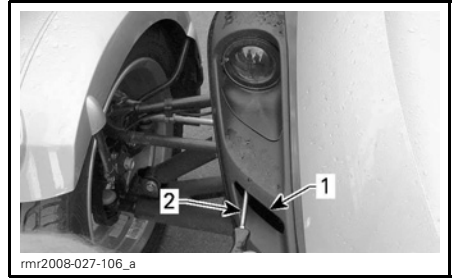

1. Air duct
2. Screwdriver

Turn adjustment screws to adjust beam height. Adjust both headlights evenly.

**Headlights Aiming Adjustment**

**High Beam**

Turn adjustment screws to adjust beam height. Adjust both headlights evenly.

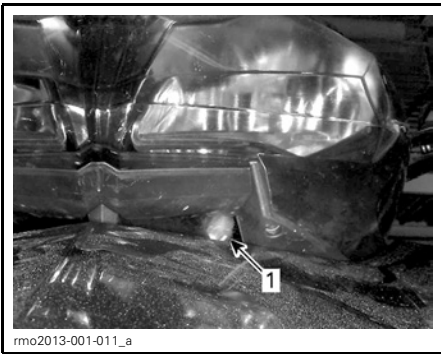

**ADJUSTMENT SCREW**

1. Adjustment screw

**Low Beam**

Insert a long Phillips screwdriver into air duct to reach the adjustment screws.

# VEHICLE CARE

## Vehicle Cleaning

To clean the vehicle, **do not use high-pressure washers** (like the ones found in car washes) as they may damage certain parts of the vehicle.

**NOTICE** Do not clean the windshield with alkaline or acid cleaner, gasoline or solvent to avoid windshield damage.

**NOTICE** For Matte finishes, do not use wax, detail spray, or other products used on regular paint. Do not wash with abrasive materials. Do not use mechanical cleaners or polishers, and do not rub the surfaces vigorously.

To clean the vehicle:

1. Rinse the vehicle thoroughly with water to remove loose dirt.
2. Using a soft, clean cloth, wash the vehicle with water mixed with a mild detergent, such as soap specially formulated for motorcycles or automobiles.

**NOTE:** Using warm water works well to remove bugs in the windshield and front panels.

**NOTE:** For **Matte finishes**, hand-wash with a soft wash mitt and a mild cleaning product safe for matte paint. To remove foreign substances such as insects, use a soft applicator and a mild solvent. Saturate and soak area before cleaning. Rub lightly.

3. While washing the vehicle, check for grease or oil. You can use XPS ROADSTER WASH (P/N 219 701 703) or a mild automotive degreaser. Thoroughly follow the manufacturer's instructions.
4. Dry the vehicle with a chamois or a soft towel.

**NOTE:** Vehicles with a matte paint finish may require more frequent cleaning.

## Vehicle Protection

Apply non-abrasive wax to plastic parts.

**NOTICE** Do not wax or polish matte surfaces (including matte paint finishes).

SURFACE	RECOMMENDATION
Glossy paint finishes	Apply only non-abrasive wax, safe for clear coat paints
Matte paint finishes	Do not apply wax
Matte finishes	

Windshield can be polished with a plastic cleaner/polisher.

**NOTICE** Do not use water repellent products on windshield.

### WARNING

Do not apply a vinyl or plastic protector on the seat as the surface will become slippery and the operator or the passenger may slip off the vehicle.

---

# STORAGE AND PRESEASON PREPARATION

## Storage

If the vehicle will not be ridden for at least four months, such as during the winter, proper storage is necessary to keep the vehicle in good condition.

BRP recommends you have your authorized Can-Am roadster dealer fully prepare your vehicle for storage. Or, at your convenience, you can follow the basic procedures below.

### To Prepare the Vehicle for Storage:

1. Inspect vehicle and have your authorized Can-Am roadster dealer repair any problems if necessary.
2. Change the engine oil and filter. Go to an authorized Can-Am roadster dealer if necessary.
3. Check engine coolant, brake fluid and clutch fluid levels.
4. Fill the fuel tank, add fuel stabilizer and run the engine to prevent the tank from rusting and the fuel from deteriorating. Strictly follow instructions on fuel stabilizer container.
5. Inflate all tires to their recommended pressure.
6. Clean the vehicle.
7. Lubricate all control cables and latches, pivoting points of all levers and lubrication points of front suspensions.
8. Close and latch all storage compartments.
9. Store the vehicle in a dry area, away from sunlight, with a small amount of daily temperature variation.
10. Cover the vehicle with a permeable materials (e.g., tarpaulin). Avoid using plastic or similar non-breathing, coated materials that restrict air flow and allow heat and moisture to accumulate.
11. Slow charge the battery once a month at the recommended charging rate of 2 A. It is not necessary to remove the battery.

## Preseason Preparation

### *All Models*

After a storage period, vehicle must be prepared and inspected.

### To Remove the Vehicle from Storage:

1. Uncover and clean the vehicle.
2. Charge the battery if needed.
3. Perform a pre-ride inspection, then test-ride the vehicle at low speed.

### *ST-S and ST LTD SE5 Models*

1. Release the latch underneath the floorboard.
2. Pivot the floorboard by manually pushing down its front part.
3. Flip back the floorboard until it latches. The mechanism must work freely.

***This page is  
intentionally blank***

# ***ROAD SIDE REPAIRS***

---

# DIAGNOSTIC GUIDELINES

**NOTICE** If the vehicle must be transported, do not have it towed — towing can seriously damage the vehicle. Refer to *TRANSPORTING THE VEHICLE* subsection for detailed instructions.

## Will not Shift into First Gear (SM5 Model)

If the gearbox cannot shift into first gear when vehicle is not moving:

1. Slowly release the clutch lever while maintaining a light pressure down on the shift lever.
2. When you feel the shift lever engaging into first gear, pull in the clutch lever.

## Will not Shift into Neutral (SE5 Model)

If the gearbox cannot shift into neutral when vehicle is not moving:

1. The engine speed will be automatically increased to approximately 1800 RPM then it will be brought back to idle speed.
2. Up to 3 attempts will be done.
3. If it does not work, retry pressing upshift or downshift button.

## Will not Shift (SE5 Model)

Have your vehicle transported to the nearest Can-Am roadster dealer.

## Engine will not Start

### ENGINE DOES NOT TURN OVER

---

1. Scrolling safety message on the multifunction gauge cluster not acknowledged.
  - Press the *MODE (M)* to acknowledge the safety message.
2. Engine stop switch in the OFF position.
  - Make sure that the engine stop switch is in the *ON* position.
3. Clutch lever not engaged (SM5 model).
  - Pull in and hold the clutch lever.
4. Ignition switch in the OFF position.
  - Turn the ignition to the *ON* position.
5. Battery dead or poor battery connections.
  - Check the battery charge. Recharge if necessary (see *MAINTENANCE PROCEDURES* subsection).
  - Check the battery connections in the front storage compartment (see *MAINTENANCE PROCEDURES* subsection).
6. Blown fuse.
  - Check fuse condition (see *HOW TO REPLACE FUSES AND LIGHTS* in this section).
7. Transmission is in gear (SE5 model).
  - Depress brake pedal if transmission is in gear.



---

**ENGINE TURNS OVER, BUT DOES NOT START**

---

**1. Low fuel.**

- *Fill the fuel tank (see BASIC PROCEDURES subsection).*

**2. Weak battery.**









- *Check battery charge. Recharge if necessary (see MAINTENANCE PROCEDURES subsection).*
- *Check the battery connections in the front storage compartment (see MAINTENANCE PROCEDURES subsection).*









**3. Engine management problem.**

- *Check to see whether the engine indicator lamp is ON while starting. See an authorized Can-Am roadster dealer.*

# MESSAGES IN MULTIFUNCTION GAUGE

Important information about vehicle condition is displayed on the multifunction gauge. When starting the engine, always look at the gauge for any indicator lamps or special messages.

INDICATOR LAMPS (MALFUNCTIONS)				
INDICATOR LAMP(S)	DIGITAL INDICATOR	DIGITAL WARNING	CAUSE	WHAT TO DO
 FLASHING	E displayed instead of selected gear	NONE	Gearbox position sensor malfunction	Stop vehicle and allow to reach neutral. Have the vehicle repaired by an authorized Can-Am roadster dealer.
NONE		KEY ERR	Wrong or defective key	Use the right key for the vehicle or contact an authorized Can-Am roadster dealer.
	NONE	NONE	Engine is overheating	<ul style="list-style-type: none"> <li>– Stop and wait for engine to cool off.</li> <li>– Check for leaks.</li> <li>– Check coolant level and adjust (see <i>MAINTENANCE PROCEDURES</i> subsection).</li> </ul>
	NONE	NONE	Low or high battery voltage	<ul style="list-style-type: none"> <li>– Recharge battery (see <i>MAINTENANCE PROCEDURES</i> subsection).</li> <li>– Check battery connections</li> </ul> Have the vehicle transported to the nearest authorized Can-Am roadster dealer.
	NONE	NONE	ABS malfunction. No ABS operation	Have the vehicle transported to the nearest authorized Can-Am roadster dealer.
	NONE	NONE	VSS malfunction	* Have the vehicle transported to the nearest authorized Can-Am roadster dealer.
	BRAKE FAILURE OR 	BRAKE FAILURE	EBD malfunction	Have the vehicle transported to the nearest authorized Can-Am roadster dealer.
	BRAKE FAILURE OR 	BRAKE FAILURE - LOW BRAKE FLUID	Low brake fluid level or faulty sensor	<ul style="list-style-type: none"> <li>– Check for brake fluid leaks.</li> <li>– Check brake fluid level and adjust (see <i>MAINTENANCE PROCEDURES</i> subsection).</li> </ul>

INDICATOR LAMPS (MALFUNCTIONS)				
INDICATOR LAMP(S)	DIGITAL INDICATOR	DIGITAL WARNING	CAUSE	WHAT TO DO
 ON+BEEPING AT KEY OFF	NONE	NONE	Faulty parking brake or component	– Make sure battery tension is at least at 10.5 V. – Check fuse no. 1 on the right fuse box (see <i>MAINTENANCE PROCEDURES</i> subsection).  Have the vehicle transported to the nearest authorized Can-Am roadster dealer.
 ON		NONE	Engine management component malfunction	Remove key, wait 20 seconds, and reinsert key.
		NONE	Dynamic power steering component	Have the vehicle repaired by an authorized Can-Am roadster dealer.
		NONE	Transmission Control Module component	– Remove key, wait 20 seconds, and reinsert key. – Have the vehicle repaired by an authorized Can-Am roadster dealer.
 FLASHING		LIMP HOME	Important engine management component or VSS malfunction	* Have the vehicle transported to the nearest authorized Can-Am roadster dealer.
 ON	NONE	NONE	Low oil pressure	– Check for oil leaks. – Check oil level and adjust (see <i>MAINTENANCE PROCEDURES</i> subsection).
A combination of two different warnings can occur.				

\* BRP recommends having the vehicle transported when in LIMP HOME. If you operate the vehicle in LIMP HOME, avoid abrupt maneuvers and immediately go to the nearest authorized Can-Am roadster dealer to have your vehicle serviced before riding again. In LIMP HOME, the engine RPM is limited and therefore the vehicle speed.

When a digital warning appears, it will show the warning for 6 seconds and then the warning will disappear for 60 seconds. During the 60 seconds, the small digital indicator will flash. This

sequence will be repeated three times and then will stop for 15 minutes. During the 15 minutes only the indicator lamps will be activated.

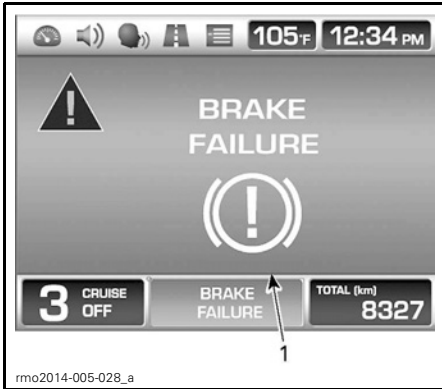

**TYPICAL**

1. Message

After a moment, the message disappears and is replaced by an icon in the trip odometer area.

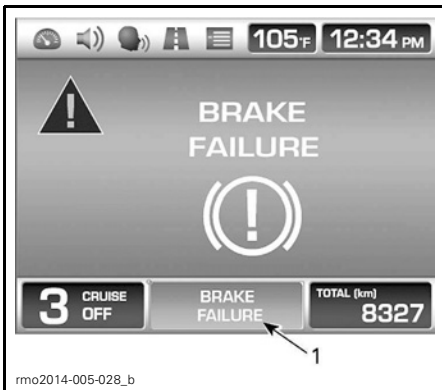

**TYPICAL**

1. Message/icon

**NOTE:** Skipped error messages will still be displayed in the lower section of the multifunction gauge and will be brought back to the main screen for a period of 60 seconds when the vehicle speed is below 3 km/h

If a problem persists, go to an authorized Can-Am roadster dealer.

# WHAT TO DO IN THE FOLLOWING CIRCUMSTANCES

## Lost Keys



Use your spare key to have another one made by an authorized Can-Am roadster dealer as soon as possible. **If both keys are lost**, the ignition switch will need to be replaced at the expense of the vehicle owner.

## Flat Tire

If a tire has a **major** puncture or cut in the tread and is completely deflated, have the vehicle transported to the nearest Can-Am Spyder dealer. Refer to *TRANSPORTING THE VEHICLE* subsection for transporting instructions.

If a tire has a **minor** nail or stone puncture and is not completely deflated, the tire can be temporarily repaired. To temporarily repair a tire, a self-inflating tire sealer or tire plug repair kit can be used. Follow the manufacturer's instructions that come with the tire sealer or repair kit and have the tire repaired or replaced by an authorized Can-Am roadster dealer **as soon as possible**.

When a tire is temporarily repaired, ride slowly and carefully, and frequently check tire pressure until it is replaced or permanently repaired.

## Dead Battery

If the battery is dead or too low to crank the engine, it can be jump started.

### WARNING

Connect the jumper cables as specified in the jump start procedure.

Batteries can emit explosive gas that can ignite if jumper cables are not properly connected.

To jump start the battery, proceed as follows:

1. Move the other vehicle as close as possible and preferably to the front of the Spyder roadster. Make sure the vehicles are not touching.
2. Shift the Spyder roadster into NEUTRAL (N) and engage the parking brake.
3. Turn off the engine of the other vehicle and all electrical accessories.
4. Open the hood of the other vehicle.
5. Open the front storage compartment of the Spyder roadster.
6. Make sure the ignition switch is set to OFF.
7. Remove the battery access panel.
8. Connect one end of the red POSITIVE (+) jumper cable to the POSITIVE (+) terminal of the Spyder roadster.
9. Connect the other end of the red POSITIVE (+) jumper cable to the POSITIVE (+) terminal of the booster battery.
10. Connect one end of the black NEGATIVE (-) jumper cable to the NEGATIVE (-) terminal of the booster battery.
11. Connect the other end of the black NEGATIVE (-) jumper cable to the NEGATIVE (-) terminal of the Spyder roadster.

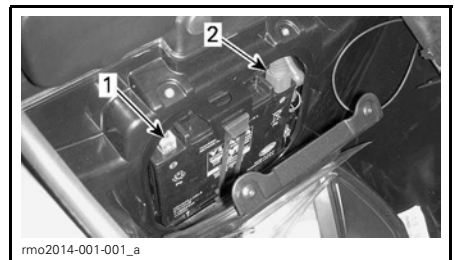

1. NEGATIVE (-) terminal
2. POSITIVE (+) terminal

12. Start the vehicle with the booster battery and run the engine at an idle of 1200 to 1500 RPM for a couple of minutes.
13. Stand on the right side of the Spyder roadster, apply brakes and start the engine. If it does not crank or it cranks slowly, wiggle the jumper cables to make sure they are making good contact and try again.  
If it still does not start, there might be a problem with the starting system. Have the vehicle transported (see *TRANSPORTING THE VEHICLE*) subsection and repaired by the nearest authorized Can-Am roadster dealer.
14. As soon the engine starts, disconnect both jumper cables in the reverse connection order, starting with the NEGATIVE (-) cable connected to the Spyder roadster.
15. Have the battery fully recharged with a battery charger (see *MAINTENANCE PROCEDURES* subsection) or by a qualified service station as soon as possible.

If the engine dies shortly after it has been jump started or when the jumper cables are disconnected, there might be a problem with the charging system. Have the vehicle transported (see *TRANSPORTING THE VEHICLE*) and repaired by the nearest authorized Can-Am roadster dealer.

After recharging battery, have the vehicle inspected by an authorized Can-Am roadster dealer.

# HOW TO REPLACE FUSES AND LIGHTS

## Fuses

If any electrical accessories stop working on the vehicle, check for blown fuses and replace if necessary.

If an electrical failure still occurs, have the vehicle serviced by an authorized Can-Am roadster dealer.

## Fuse Locations

Fuses are located inside the front storage compartment.

To access the fuse boxes, open the front storage compartment.



FRONT STORAGE COMPARTMENT

Push down on the fuse service covers and pull the covers off.

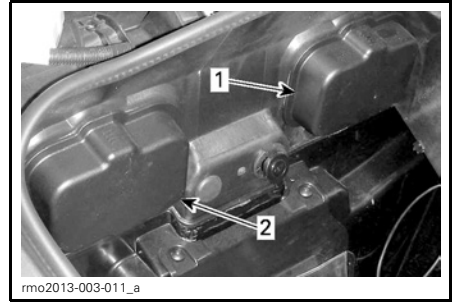

INSIDE FRONT STORAGE COMPARTMENT

1. Left fuse service cover
2. Right fuse service cover

Push down on the tabs and carefully remove the fuse box covers.

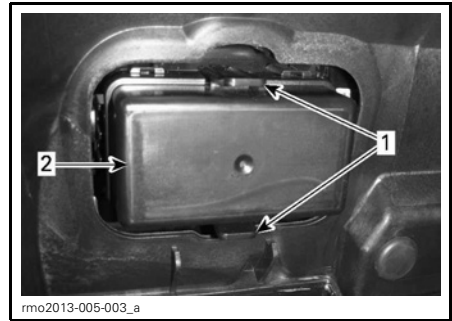

1. Tabs
2. Fuse box cover

## Fuse Description



FUSES - LEFT FUSE BOX

**NOTE:** Refer to decal located between both fuse boxes for correct identification

**NOTE:** Fuse boxes may differ between models.

**Left Fuse Box**

FUSE NO.	DESCRIPTION	RATING
1	Backup light/Cluster/ DLC	15 A
2	Wake-up ECM/VCM/MSR & D.E.S.S./SAS/YAS/PRS	10 A
3	NOT USED	
4	PBM	20 A
5	ECM	5 A
6	Injectors/Coils	15 A
7	Wake-up TCM, DPS/ Cluster	10 A
8	H02S/CAPS/Fuel pump/ EVAP/CSV	15 A



FUSES - RIGHT FUSE BOX

**Right Fuse Box**

FUSE NO.	DESCRIPTION	RATING
1	Days lights/Parking lamps/ Plate lights	15 A
2	Brake lights/Hazard	10 A
3	Radio	15 A
4	Trailer	10 A
5	Load shedding	25 A
6	DC plugs VKEY	5 A
7	Plugs VBAT	5 A
8	NOT USED	

**NOTE:** When fuse 6 is installed, 12 V power outlet is only operational when ignition switch is at ON position. When fuse 7 is installed, 12 V power outlet is always operational.



JCASE FUSES - LEFT FUSE BOX



**Left JCase Fuse Box**

JCASE FUSE NO.	DESCRIPTION	RATING
1	VCM pump	40 A
2	VCM pump	25 A
3	DPS	40 A
4	Main control	40 A
5	Cooling fan(s)	30 A

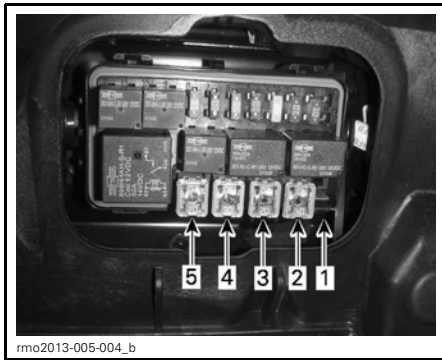

JCASE FUSES - RIGHT FUSE BOX

**Right JCase Fuse Box**

JCASE FUSE NO.	DESCRIPTION	RATING
1	Rectifier	60 A
2	Accessories	40 A
3	TCM solenoids	20 A
4	LO headlamps	30 A
5	HI headlamps	20 A

**Fuse Replacement**

1. To access the fuses, refer to fuse locations in *FUSES* in *HOW TO REPLACE FUSES AND LIGHTS* sub-section.
2. Set the ignition switch to OFF.

3. Pull the fuse out.
4. Check whether the filament is melted.

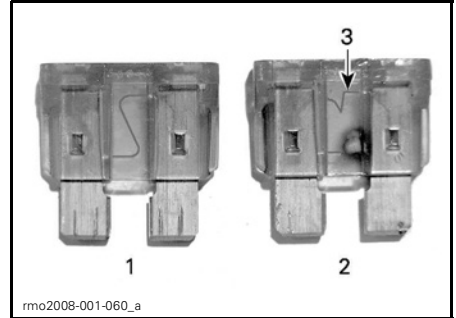

**FUSE**

1. Good fuse
2. Blown fuse
3. Melted filament

5. Replace the fuse with one with the same rating. Spare fuses are located in the fuse box cover.

**⚠ WARNING**

Using a higher-rated fuse can cause severe damage and may cause fires.

6. To close the fuse box covers, position covers over fuse boxes and carefully push down until they click.
7. To close the fuse service covers, position covers over fuse boxes and push down carefully until the fuse service covers engage.
8. Close the access cover and then the front storage compartment.

**Lights**

**NOTE:** The front turn signal lights are built with LEDs (light emitting diode) and this technology proved to be reliable. In the unlikely event they do not work, have them checked by an authorized Can-Am roadster dealer.

If any light stop working on the vehicle, replace bulb of defective light.

If the light failure still occurs, have the vehicle serviced by an authorized Can-Am roadster dealer.

**⚠ CAUTION** Always turn the ignition switch to the OFF position before replacing a bulb to avoid electric shock.

Always check light operation after replacement.

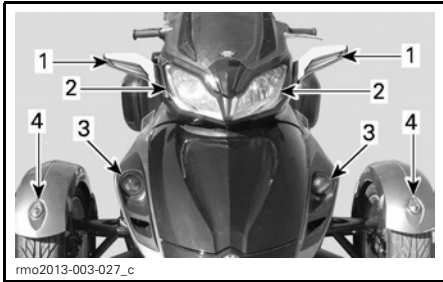

TYPICAL - LIGHTS LOCATION — FRONT OF VEHICLE

1. Turn signal light
2. Headlight - high beam
3. Headlight - low beam
4. Position light

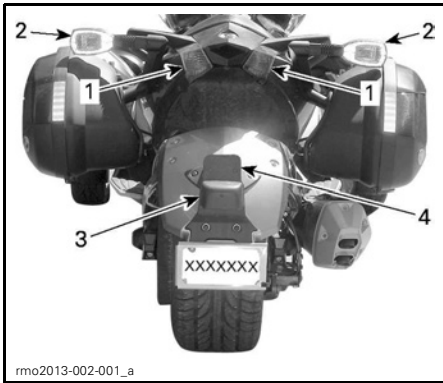

TYPICAL - LIGHTS LOCATION — REAR OF VEHICLE

1. Taillight/brake light
2. Turn signal light
3. License plate light
4. Backup light - Australian model only

### Headlight — Low Beam

1. Open front storage compartment.

2. Remove the appropriate top side panel (LH or RH).
3. Remove fasteners from front panel, then remove panel.

**NOTE:** Front panels are secured with one screw at the rear and three plastic rivets in the front (two on top, one on the bottom).

4. Release tabs then unplug bulb connector.

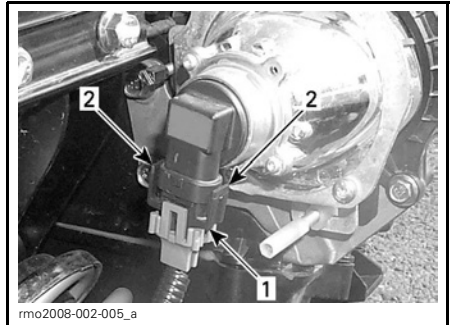

1. Bulb connector
2. Tabs

5. Turn bulb counterclockwise to release, then replace bulb.

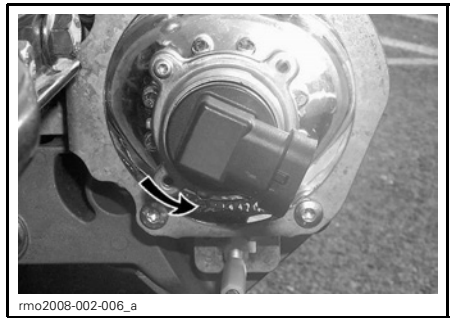

**NOTICE** Never touch glass portion of an halogen bulb with bare fingers, it shortens its operating life. If glass is touched, clean it with isopropyl alcohol which will not leave a film on the bulb.

6. Properly reinstall removed parts in the reverse order of their removal, pay attention to the following notice while reassembling.

**NOTICE** Do not overtighten panels screws. Any deformation on the panel around the screw is an indication that it is too tight. You may damage the panel.

### Headlight — High Beam

1. Remove the four screws and the upper panel.

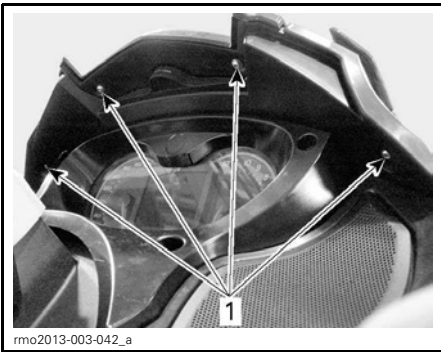

1. Screws

2. Remove the four screws and the gauge contour panel.

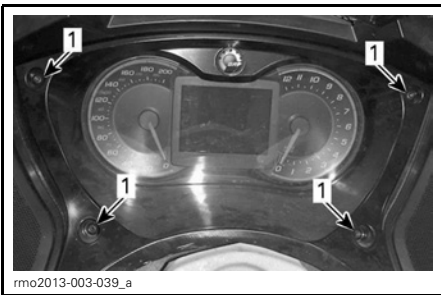

1. Screws

3. Manually disengage the gauge from the console by pushing down on the tabs.



rmo2013-003-016\_a

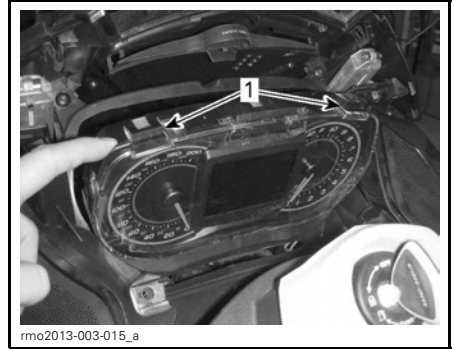

rmo2013-003-015\_a

1. Tabs

4. Disconnect electrical connector.
5. Remove the applicable rubber boot.

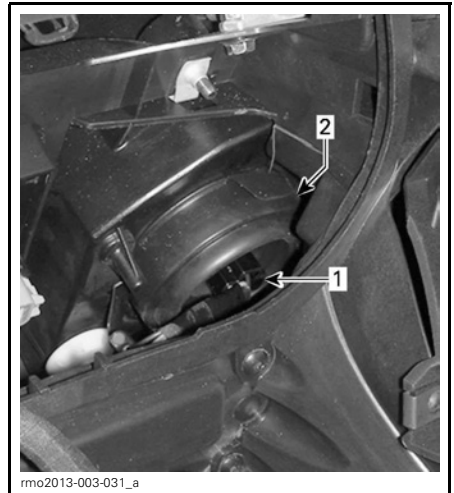

rmo2013-003-031\_a

1. Electrical connector  
2. Rubber boot

6. Press and pull both sides of the retaining clip at the same time to release it from bulb support.

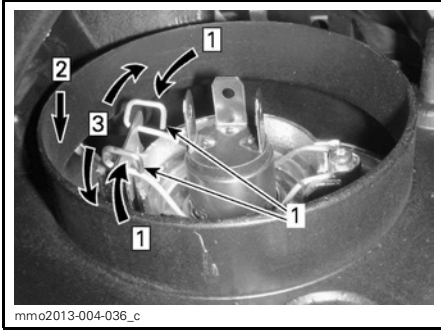

Step 1: Push both sides  
Step 2: Push down to release  
Step 3: Release both sides

1. Retaining clip

7. Pull bulb and replace. Properly reinstall parts.

**NOTICE** Never touch glass portion of halogen bulb with bare fingers, it shortens its operating life. If glass is touched, clean it with isopropyl alcohol and a clean cloth.

### Taillight/Brake Light

1. Remove the wheel well panel by unscrewing 7 Torx screws as indicated below.

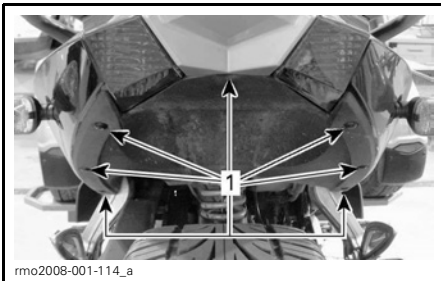

#### WHEEL WELL PANEL

1. 7 Torx screws location

2. Partially remove right rear side panel by removing the 2 plastic rivets under the seat as indicated below.

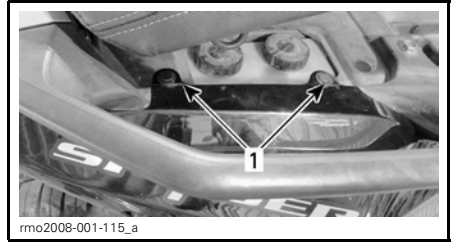

1. 2 plastic rivets under the seat

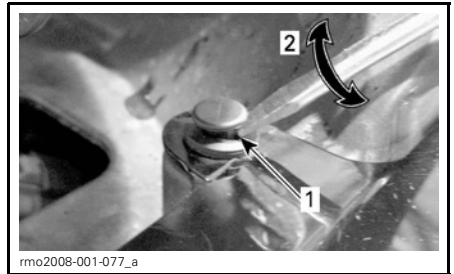

1. Flat head screwdriver under rivet head  
2. Turn screwdriver 1/4 turn

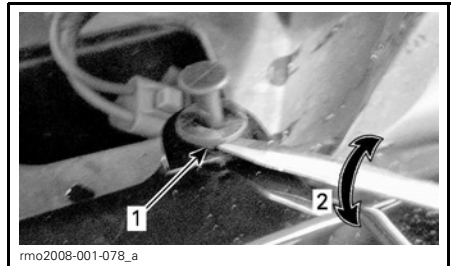

1. Flat head screwdriver under rivet  
2. Turn screwdriver 1/4 turn

3. Disconnect right turn signal housing connectors.
4. Remove the Torx screw behind the lens as indicated below.

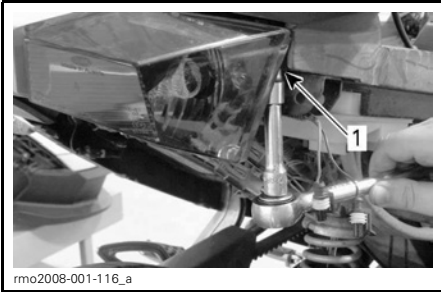

1. Removing Torx screw behind lens

- Remove the Torx screw beside the lens under the rear tip as indicated below.

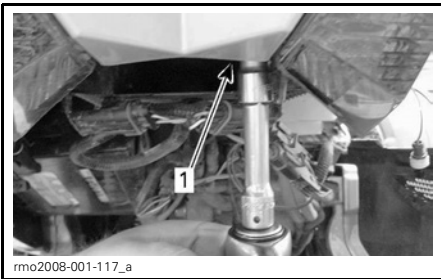

1. Removing Torx screw beside the lens

- Turn the connector counterclockwise and remove from the lens.

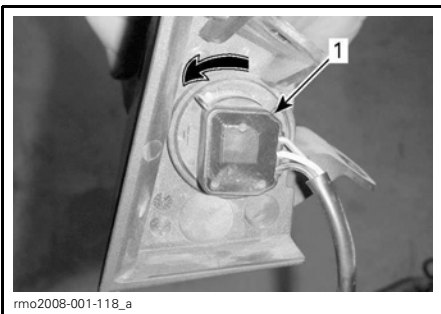

1. Connector

- Remove the bulb by pushing it in and turning counterclockwise.
- Install the new bulb by pushing it in and turning clockwise.
- Properly reinstall the parts in the reverse order of their removal.

**NOTE:** When installing right rear side panel, connect the turn signal housing connectors by matching the correct wire color and install plastic rivets.

## Position Light

### Base Model Only

- Push then hold lens towards rear of fender.



- Lift front portion of lens with your thumb or a small screwdriver to release.

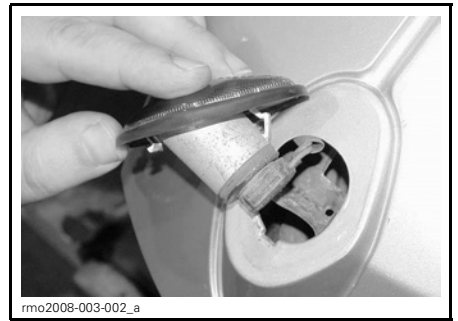

- Turn the bulb holder clockwise and remove it from the connector.

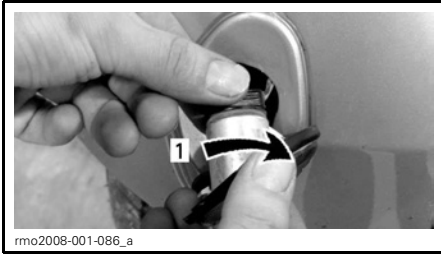

1. Turn clockwise

4. Pull bulb out of the holder as indicated below.

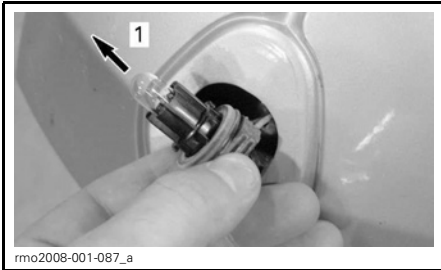

1. Pull out bulb

5. Insert a new bulb in the holder.
6. Properly reinstall the parts in the reverse order of their removal.

### ***ST-S and ST LTD Models***

The position lights are built with LEDs (light emitting diode) and this technology proved to be reliable. In the unlikely event they do not work, have them checked by an authorized Can-Am roadster dealer.

### **License Plate Light**

1. Remove the lens with a Phillips head screwdriver.

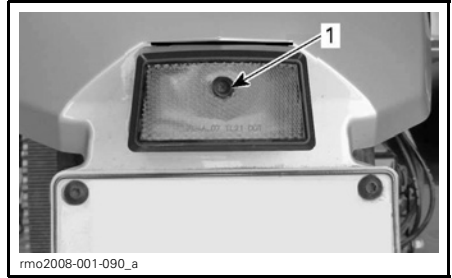

### **TYPICAL**

1. License plate lens screw

2. Remove the bulb by pushing it in and turning counterclockwise.
3. Install the new bulb by pushing and turning it clockwise.
4. Reinstall the lens.

### **Backup Light**

#### ***Australian Model Only***

1. Remove the lens with a Phillips head screwdriver.

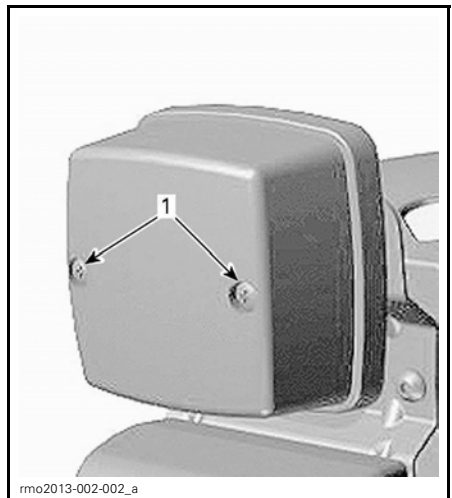

### **TYPICAL**

1. License plate lens screw

2. Remove the bulb by pushing in and turning counterclockwise.
3. Install the new bulb by pushing and turning it clockwise.
4. Reinstall the lens.

# TRANSPORTING THE VEHICLE

If your vehicle needs to be transported, it should be carried on a flatbed trailer of the proper size and capacity.

## **⚠ WARNING**

The windshield is designed to break away in the event of an impact. **NEVER** trailer this vehicle oriented backward as windshield could break away. **ALWAYS** trailer this vehicle facing forward.

**⚠ CAUTION** If you need to push the vehicle, do it from the right-hand side to be able to reach the brake pedal.

When pulling the vehicle backwards, be careful that the front wheel does not roll over your feet.

**NOTICE** Do not tow the Spyder roadster — towing can seriously damage the vehicle drive system.

When contacting a towing or transporting service, be sure to ask if they have a flatbed trailer, loading ramp or power ramp to safely lift the vehicle and tie-down straps. Ensure the vehicle is properly transported as specified in this section.

**NOTICE** Avoid using chains to tie the vehicle — they may damage the surface finish or plastic components.

To load the vehicle for transport, proceed as follows:

1. Shift the vehicle into NEUTRAL (N).
2. Remove the key from the ignition switch.

**NOTE:** For models with anti-theft tracking system, to disable the system turn the key in the ignition switch to ON for 1 second and then to OFF for 1 second, three times, all within 7 seconds. The anti-theft tracking system will remain disabled until the engine is started again.

3. Put a strap around the lower arm of each front suspension.

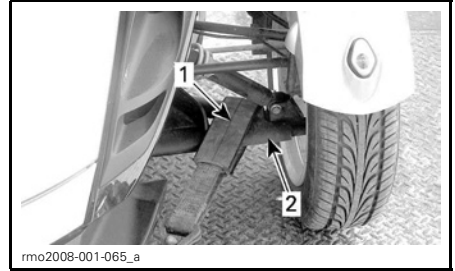

1. Strap
2. Lower suspension arm

4. Attach the straps to the winch cable. If possible, use chains or additional straps to attach the straps to the winch cable as indicated below to avoid damaging the bumper cover.

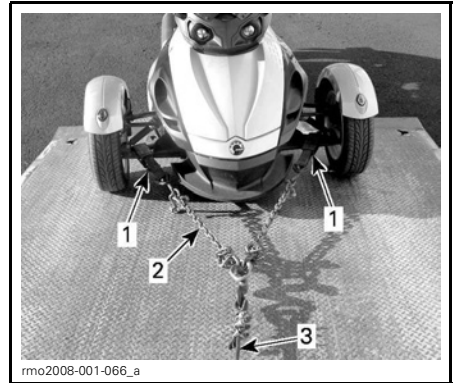

### TYPICAL

1. Strap around front suspension lower arms
2. Chains to avoid damaging the bumper cover
3. Winch cable
5. Ensure that the parking brake is released.
6. Pull the vehicle on the flatbed trailer with the winch.
7. Engage the parking brake.
8. Ensure that the vehicle is in NEUTRAL (N).
9. Strap the front tires by using one the following methods indicated below.

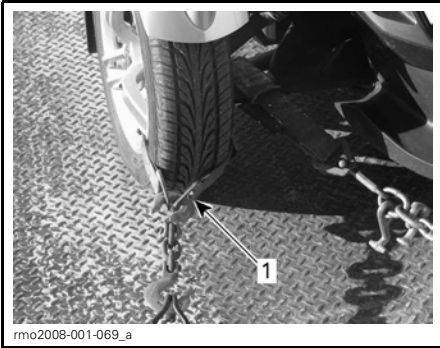

**FRONT WHEELS ATTACHMENT — METHOD 1**

1. Strap around the rim of each front wheel and attached to the front of trailer



**FRONT WHEELS ATTACHMENT — METHOD 2**

1. Strap around each wheel and fixed to the front and rear of trailer

10. Pass a tie-down strap inside the rear wheel rim only. Do not pass the tie-down strap inside the rear sprocket.

**NOTICE** Passing the tie-down strap inside the rear sprocket may seriously damage the drive system.

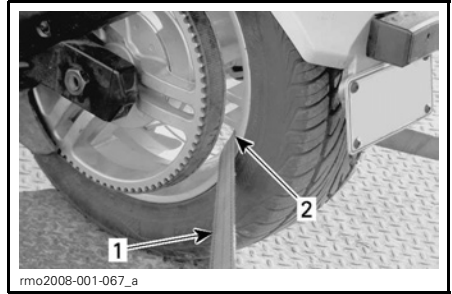

**REAR WHEEL ATTACHMENT**

1. Tie-down strap
2. Inside rear wheel rim ONLY

11. Firmly attach the rear wheel tie-down strap to the rear of the trailer with a ratchet.
12. Ensure that both the front and rear wheels are firmly attached to the trailer.

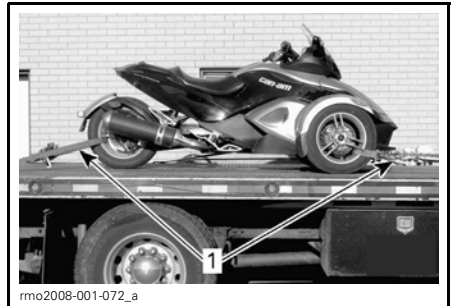

1. Front and rear wheel firmly attached to trailer



# ***TECHNICAL INFORMATION***

# VEHICLE IDENTIFICATION

The main components of your vehicle (engine and frame) are identified by different serial numbers. It may sometimes become necessary to locate these numbers for warranty purposes or to trace your vehicle in the event of loss. These numbers are required by the authorized Can-Am roadster dealer to complete warranty claims properly. No warranty will be allowed by Bombardier Recreational Products Inc. if the engine identification number (EIN) or vehicle identification number (VIN) is removed or mutilated in any way. We strongly recommend that you take note of all the serial numbers on your vehicle and supply them to your insurance company.

## Vehicle Identification Number

**NOTE:** VIN (Vehicle Identification Number) label may vary according to country.

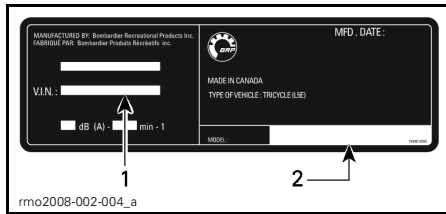

**TYPICAL - VEHICLE SERIAL NUMBER LABEL**

1. VIN (Vehicle Identification Number)
2. Model number

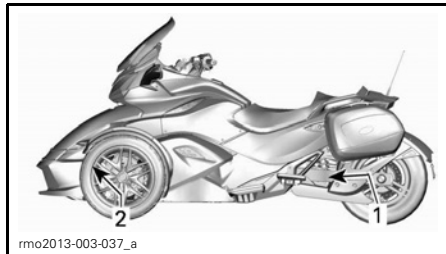

### LOCATION OF VIN

1. Swing arm (VIN label)
2. Lower frame (VIN stamped on the right side)

## Engine Identification Number

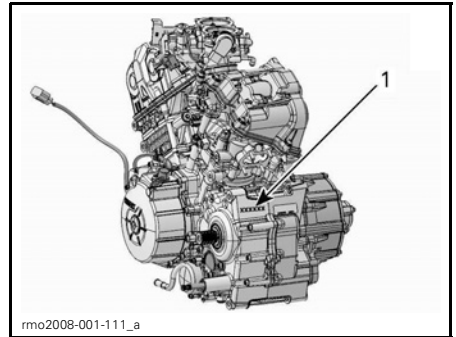

### TYPICAL

1. EIN (Engine Identification Number) location

# SPECIFICATIONS

MODEL			SPYDER ST	
<b>ENGINE</b>				
Engine type			ROTAX 991 60° V-Twin 4-stroke, Dual Over Head Camshaft (DOHC), liquid cooled	
Number of cylinders			2	
Number of valves			8 valves	
Bore			97 mm	
Stroke			67.5 mm	
Displacement			998 cm <sup>3</sup>	
Compression ratio			12.2:1	
Lubrication	Type		Dry sump with separate oil tank and oil cooler	
	Oil filter	Engine	BRP Rotax microglass fibre type, replaceable	
		Transmission (SE5)		
	Engine oil capacity	Oil change with new engine filter	SM5	3.9 L
		Oil change with new engine filter	SE5	4.2 L
		Oil change with new engine and HCM filters		4.3 L
Recommended engine oil		Use XPS 4-STROKE SYNTH. BLEND OIL (SUMMER) (P/N 293 600 121) or a 5W 40 semi-synthetic (minimum) or synthetic motorcycle oil meeting the requirements for API service SL, SJ, SH or SG classification.		
Clutch	SM5 model	Type	Wet, multi-plate, manual operation through a hydraulic piston, vacuum assist	
		Fluid	DOT 4	
	SE5 model	Type	Centrifugal clutch + wet multi-plate clutch automatically controlled by TCM	
		Engagement	2000 ± 200 RPM (centrifugal)	
		Stall	3200 ± 200 RPM (centrifugal)	
Exhaust system			2 into 1 with catalytic converter	
Air filter			Paper element	

**SPECIFICATIONS**

<b>MODEL</b>		<b>SPYDER ST</b>
<b>GEARBOX</b>		
Type	SM5	Sequential Manual 5-speed (SM5) with reverse interlock
	SE5	Sequential Semi-automatic 5-speed (SE5) with integrated reverse interlock
<b>COOLING SYSTEM</b>		
Type		Liquid cooled, single radiator with cooling fan
Coolant	Type	Ethyl glycol/water mix (50% coolant, 50% distilled water). Use premixed coolant sold by BRP LONG LIFE ANTIFREEZE (P/N 219 702 685) or coolant specifically designed for aluminum engines
	Capacity	3.15 L
<b>ELECTRICAL SYSTEM</b>		
Magneto generator output		650 W
Ignition system type		Electronic ignition with dual output coil
Ignition timing		Not adjustable
Spark plug	Quantity	2
	Make and type	NGK KR8Bi (apply heat-sink paste P12 (P/N 420 897 186) on spark plug threads)
	Gap	0.7 mm - 0.8 mm
Engine RPM limiter setting	Forward	9500 RPM
Battery	Type	Yuasa YTX24HL-BS
	Voltage	12 volts
	Nominal rating	21 A•h
	Recommended charging rate	2 A
Headlight		4 x 60/55 W (nominal)
Taillight/brake light		2 x 5/21 W
Backup light (Australian model only)		21 W
Turn signal lights	Front	2 x 21 W
	Rear	2 x 21 W
Position lights	Base model only	2 x 5 W

MODEL		SPYDER ST
<b>ELECTRICAL SYSTEM (cont'd)</b>		
License plate light		10 W
Fuses		Refer to <i>HOW TO REPLACE FUSES AND LIGHTS</i>
<b>FUEL SYSTEM</b>		
Fuel delivery	Type	Multi-point Electronic Fuel Injection (EFI) with ETC (Electronic Throttle Control) Dual throttle body (51 mm) with an actuator
Fuel pump	Type	Electrical module in fuel tank
Idle speed		1400 ± 100 RPM (not adjustable)
Fuel - Refer to <i>FUEL REQUIREMENTS</i>	Type	Premium unleaded gasoline
	Minimum octane	87 Pump Posted AKI (RON+MON)/2
		92 RON
	Recommended octane	91 Pump Posted AKI (RON+MON)2
95 RON		
Fuel tank capacity		23.5 L
<b>DRIVE SYSTEM</b>		
Final drive type		Carbon reinforced drive belt
Final drive ratio		28/79
<b>STEERING</b>		
Type		Dynamic Power Steering (DPS)
<b>FRONT SUSPENSION</b>		
Suspension type		Double A-arm with anti-roll bar
Suspension travel		151 mm
Shock absorber	Qty	2
	Type	SACHS twin-tube coil-over
Front preload adjustment		No adjustment
<b>REAR SUSPENSION</b>		
Suspension type		Swing arm with monoshock
Suspension travel		152 mm
Shock absorber	Qty	1
	Type	SACHS twin-tube coil-over
Rear preload adjustment		No adjustment

**SPECIFICATIONS**

<b>MODEL</b>		<b>SPYDER ST</b>
<b>BRAKES</b>		
Type		Brembo
Front brake		Dual 270 mm rigid discs, radially mounted Brembo monobloc calipers with 4 piston, 2-pad
Rear brake		Single disc 270 mm with 1 piston floating caliper with integrated parking brake
Brake fluid	Capacity	0.53 L
	Type	DOT 4
Parking brake		Mechanical, electrically actuated to the rear caliper
Minimum brake pad thickness		1 mm
Minimum brake disc thickness		6.4 mm
Maximum brake disc warpage		0.10 mm
<b>TIRES</b>		
Type (use only tires recommended by BRP)	Front	Kenda KR31 165/55/R15
	Rear	Kenda KR21A 225/50R15
Pressure	Front	Nominal.: 103 kPa Min.: 89 kPa Max.: 117 kPa <b>NOTE:</b> The pressure difference between the left and right side tire should not exceed 3.4 kPa.
	Rear	Nominal.: 193 kPa Min.: 179 kPa Max.: 207 kPa
Minimum tire tread depth	Front	2.5 mm
	Rear	4.0 mm
<b>WHEELS</b>		
Size (diameter X width)	Front	381 mm x 127 mm
	Rear	381 mm x 178 mm
Front wheel nuts torque		105 N•m to 113 N•m
Rear drive axle nut torque		210 N•m to 240 N•m

MODEL		SPYDER ST
<b>DIMENSIONS</b>		
Overall length		2 667 mm
Overall width		1 506 mm
Overall height		1 332 mm
Seat (top) height		737 mm
Wheel base		1 711 mm
Front wheel track		1 308 mm
Ground clearance, front and under engine		110 mm
<b>WEIGHT AND LOADING CAPACITY</b>		
Dry weight		392 kg
Front storage compartment	Capacity	55 L
	Maximum load	16 kg
Total vehicle load allowed (including operator, all other loads and added accessories)		208 kg
Gross vehicle weight rating (GVWR)		623 kg

Because of our ongoing commitment to product quality and innovation, BRP reserves the right, at any time, to make changes in design and specifications and/or to make additions to, or improvements in its products without imposing any obligation upon itself to install them on its previously manufactured products.

***This page is  
intentionally blank***



# ***WARRANTY***

---

# **BRP LIMITED WARRANTY — USA AND CANADA: 2014 Can-Am® SPYDER® ROADSTER**

## **1. SCOPE OF THE LIMITED WARRANTY**

Bombardier Recreational Products Inc. ("BRP")\* warrants its 2014 Can-Am Spyder Roadsters ("Roadster") sold by authorized Can-Am Roadster Dealers (as defined below) in the United States of America and in Canada from defects in material or workmanship for the period and under the conditions described below. This limited warranty will become null and void if: (1) Roadster was used for racing or any other competitive activity, at any point, even by a previous owner; (2) the odometer was removed or has been tempered with; (3) the Roadster was used off-road; or (4) the Roadster has been altered or modified in such a way so as to adversely affect its operation, performance or durability, or has been altered or modified to change its intended use.

Except if otherwise specified, all genuine Roadster parts and accessories installed on the Roadster by an authorized Dealer at the time of delivery of the Roadster carry the same warranty as that of the Roadster.

## **2. LIMITATIONS OF LIABILITY**

THIS WARRANTY IS EXPRESSLY GIVEN AND ACCEPTED IN LIEU OF ANY AND ALL OTHER WARRANTIES, EXPRESSED OR IMPLIED, INCLUDING WITHOUT LIMITATION ANY WARRANTY OF MERCHANTABILITY OR FITNESS FOR A PARTICULAR PURPOSE. TO THE EXTENT THAT THEY CANNOT BE DISCLAIMED, THE IMPLIED WARRANTIES ARE LIMITED IN DURATION TO THE LIFE OF THE EXPRESS WARRANTY. INCIDENTAL AND CONSEQUENTIAL DAMAGES ARE EXCLUDED FROM COVERAGE UNDER THIS WARRANTY. SOME STATES/PROVINCES DO NOT ALLOW FOR THE DISCLAIMERS, LIMITATIONS AND EXCLUSIONS IDENTIFIED ABOVE, AS A RESULT, THEY MAY NOT APPLY TO YOU. THIS WARRANTY GIVES YOU SPECIFIC RIGHTS, AND YOU MAY ALSO HAVE OTHER LEGAL RIGHTS WHICH MAY VARY FROM STATE TO STATE, OR PROVINCE TO PROVINCE.

Neither the distributor, any Dealer nor any other person has been authorized to make any affirmation, representation or warranty regarding the Roadster, other than those contained in this limited warranty, and if made, shall not be enforceable against BRP. BRP reserves the right to modify this warranty at any time, being understood that such modification will not alter the warranty conditions applicable to the Roadsters sold while this warranty is in effect.

## **3. EXCLUSIONS — ARE NOT WARRANTED**

The following are not warranted under any circumstances:

- Replacement of routine maintenance items such as, without limitation, oil, lubricants, fluids, filters and spark plugs.
- Normal wear and tear, such as, without limitation, wear and tear of the tires, battery, generator brushes, sealed beams and light bulbs, clutch plates and facings, drive belt, brake pads, brake linings and rotors and sprockets.
- Tune ups and adjustments including without limitation adjustments of belt, alignment and wheel balance.
- Damages related to the appearance of the Roadster, including without limitation scratches, dents, fading, flaking, peeling and damages to seat cover material.

- Damage caused by failure to provide proper maintenance or storage, as described in the *OPERATOR'S GUIDE*.
- Damage resulting from removal of parts, improper repairs, improper service or improper maintenance, modifications, alterations that are outside of the original specifications of the Roadster, or damage resulting from repairs done by a person that is not an authorized servicing Dealer.
- Damage resulting from the installation of parts with specifications that differ from the original Roadster parts, such as, without limitation, different tires, exhaust system, wheels or brakes.
- Damage resulting from abuse, abnormal use, neglect or operation of the Roadster in a manner inconsistent with the recommendations of the *OPERATOR'S GUIDE*.
- Damage resulting from water ingestion, accident, road hazards, submersion, fire, theft, vandalism or any act of God.
- Damage resulting from operation with fuels, oils or fluids with specifications different than as recommended in the *OPERATOR'S GUIDE*.
- Damage resulting from corrosion from road salts, battery acid, environmental influences or treatment contrary to the *OPERATOR'S GUIDE*.
- Incidental or consequential damages, including without limitation towing, storage, telephone, rental, taxi, inconvenience, insurance coverage, loan payments, loss of time or loss of income.

#### **4. WARRANTY COVERAGE PERIOD**

This warranty will be in effect from the date of delivery to the first retail consumer or the date the Roadster is first put into use, whichever occurs first and for the following periods:

1. For private, recreational use, **TWENTY FOUR (24) CONSECUTIVE MONTHS**, except for the items covered in points (2) to (5) below; and for commercial use **TWELVE (12) CONSECUTIVE MONTHS**, except for the items covered in points (2) to (5) below.  
A Roadster is used commercially when it is used in connection with any work or employment that generates income during any part of the warranty period. A Roadster is also used commercially when, at any point during the warranty period, it is licensed for commercial use.
2. For the battery, **SIX (6) CONSECUTIVE MONTHS**.
3. For the tires, **6 CONSECUTIVE MONTHS** or until tires are worn to the last three thirty-seconds of an inch (3/32 ") (2.38 millimeters) for the front tires and the last five thirty-seconds of an inch (5/32 ") (3.97 millimeters) for the rear tire, whichever occurs first.
4. For Roadsters sold to residents of the United States, **FIVE (5) YEARS or THIRTY THOUSAND (30 000) KILOMETERS (18,641 MILES)**, whichever occurs first, on the emission related components included in the chart below.

## WARRANTY EMISSION PART LIST

Oxygen sensor	Oil filler cap
Intake manifold	Catalytic converter
Ignition coil	Rear exhaust manifold
Spark plug wire (front cylinder)	Front exhaust manifold
Spark plug wire (rear cylinder)	Fuel return hose
Fuel tank	Evaporative emission control system (EVAP)
Fuel tank cap	Engine control module (ECM)

5. For Roadsters produced for sale in the state of California, that are originally sold to residents or subsequently warranty registered to residents in the state of California, please also refer to the applicable California Emissions Control Warranty Statement.

The repair or replacement of parts or the performance of service under this warranty does not extend the life of this warranty beyond its original expiration date.

## 5. CONDITIONS TO HAVE WARRANTY COVERAGE

This warranty coverage is available **only** if each of the following conditions has been fulfilled:

- The Roadster must be purchased as new and unused by its first owner from a Spyder Roadster dealer authorized to distribute Roadsters in the country in which the sale occurred (“Dealer”).
- The BRP-specified pre-delivery inspection process must be completed, documented and signed by the purchaser.
- The Roadster must have undergone proper warranty registration by an authorized Dealer.
- The Roadster must be purchased in the country in which the purchaser resides.
- Routine maintenance must be performed as indicated in the *OPERATOR'S GUIDE*. BRP reserves the right to make warranty coverage contingent upon proof of proper maintenance.

BRP will not honor this limited warranty to any private use owner or commercial use owner if the preceding conditions have not been met. Such limitations are necessary in order to allow BRP to preserve both the safety of its products, and also that of its consumers and the general public.

## 6. WHAT TO DO TO OBTAIN WARRANTY COVERAGE

The customer must cease using the Roadster upon the appearance of an anomaly. The customer must notify a servicing Dealer within three (3) days of the appearance of a defect, and provide it with reasonable access to the product and reasonable opportunity to repair it. The customer must also present to the authorized Dealer proof of purchase of the product and must sign the repair/work order prior to starting the repair in order to validate the warranty repair. All parts replaced under this limited warranty become the property of BRP.

## 7. WHAT BRP WILL DO

BRP's obligations under this warranty are limited to, at its sole discretion, repairing parts found defective under normal use, maintenance and service, or replacing such parts with new genuine Roadster parts without charge for parts and labor, at any authorized Dealer during the warranty coverage period. BRP's responsibility is limited to making the required repairs or replacements of parts. No claim of breach of warranty shall be cause for cancellation or rescission of the sale of the Roadster to the owner.

In the event that service is required outside of the country of original sale, the owner will bear responsibility for any additional charges due to local practices and conditions, such as, but not limited to, freight, insurance, taxes, license fees, import duties, and any and all other financial charges, including those levied by governments, states, territories and their respective agencies.

BRP reserves the right to improve or modify products from time to time without assuming any obligation to modify any products manufactured.

## 8. TRANSFER

If the ownership of a Roadster is transferred during the warranty coverage period, this warranty shall also be transferred and be valid for the remaining coverage period provided that BRP is notified of such transfer of ownership in the following way:

1. The former owner contacts BRP (at the phone number provided below) or an authorized Dealer and gives the coordinates of the new owner; or
2. BRP or an authorized Dealer receives a proof that the former owner agreed to the transfer of ownership, in addition to the coordinates of the new owner.

## 9. CONSUMER ASSISTANCE

In the event of a controversy or a dispute in connection with this limited warranty, BRP suggests that you try to resolve the issue at the dealership level. We recommend discussing the issue with the authorized Dealer's service manager or owner.

If the issue has not yet been resolved, please submit your complaint in writing or call the appropriate number below:

### In Canada:

**BOMBARDIER RECREATIONAL PRODUCTS INC.**  
SPYDER ROADSTER  
Customer Assistance Center  
75 J.-A. Bombardier Street  
Sherbrooke QC J1L 1W3  
Tel.: 819 566-3366

### In USA:

**BRP US INC.**  
SPYDER ROADSTER  
Customer Assistance Center  
7575 Bombardier Court  
Wausau WI 54401  
Tel.: 715 848-4957

# **CALIFORNIA EMISSION CONTROL WARRANTY STATEMENT**

## **YOUR WARRANTY RIGHTS AND OBLIGATIONS:**

The California Air Resources Board and BRP US Inc. ("BRP")\*, on behalf of Bombardier Recreational Products Inc., are pleased to explain the emission control system warranty on your 2014 Can-Am Spyder Roadster. In California, new motor vehicles must be designated, built and equipped to meet the State's stringent anti-smog standards. BRP must warrant the emission control system on your Roadster for the periods of time listed below provided there has been no abuse, neglect or improper maintenance of your Roadster.

Your emission control system may include parts such as the fuel-injection system, ignition system, catalytic converter and engine computer. Also included may be hoses, connectors and other emission-related assemblies. Where a warrantable condition exists, BRP will repair your Roadster at no cost to you including diagnosis, parts and labor.

## **MANUFACTURER'S WARRANTY COVERAGE**

– For 5 years or 30 000 kilometers (18,641 miles), whichever occurs first.

## **OWNER'S WARRANTY RESPONSIBILITIES:**

As the Roadster owner, you are responsible for the performance of the required maintenance listed in your *OPERATOR'S GUIDE*. BRP recommends that you retain all receipts covering maintenance on your Roadster, but BRP cannot deny warranty solely for the lack of receipts or for your failure to ensure the performance of all scheduled maintenance.

You are responsible for presenting your Roadster to a Dealer as soon as a problem exists. The warranty repairs should be completed in a reasonable amount of time, not to exceed 30 days.

As the Roadster owner, you should also be aware that BRP may deny you warranty coverage if your Roadster or a part has failed due to abuse, neglect, improper maintenance or unapproved modifications.

If you have any questions regarding your warranty rights and responsibilities, you should contact BRP's customer assistance center at 1 715 848-4957 or the California Air Resource Board at 9528 Telstar Avenue, El Monte, CA 91731.

\* In the USA, products are distributed and serviced by BRP US Inc.

© 2013 Bombardier Recreational Products Inc. All rights reserved.

™ Trademarks of Bombardier Recreational Products Inc. or its affiliates.

---

# **BRP LIMITED WARRANTY OUTSIDE USA AND CANADA: 2014 Can-Am™ SPYDER™ ROADSTER**

## **1. SCOPE OF THE LIMITED WARRANTY**

Bombardier Recreational Products Inc. ("BRP")\* warrants its 2014 Can-Am Spyder roadsters (the "Products") sold by authorized Can-Am Spyder roadster distributors or dealers located in the EEA (the "EEA" or "European Economic Area" shall mean the countries member of the European Union plus Norway, Iceland and Liechtenstein) or elsewhere, except in the USA and Canada\*\* (the "Distributors/Dealers") from defects in material or workmanship for the period and under the conditions described below. This limited warranty will become null and void if: (1) the Product was used for racing or any other competitive activity, at any point, even by a previous owner; or (2) the odometer was removed or has been tampered with; (3) the Product was used off-road; or (4) the Product has been altered or modified in such a way so as to adversely affect its operation, performance or durability, or has been altered or modified to change its intended use.

All genuine parts and accessories related to the Product and installed on the Product by an authorized Distributor/Dealer at the time of delivery of the Product carry the same warranty as that of the Product.

## **2. LIMITATIONS OF LIABILITY**

JURISDICTIONS TO THE EXTENT PERMITTED BY LAW. THIS WARRANTY IS EXPRESSLY GIVEN AND ACCEPTED IN LIEU OF ANY AND ALL OTHER WARRANTIES, EXPRESSED OR IMPLIED, INCLUDING WITHOUT LIMITATION ANY WARRANTY OF MERCHANTABILITY OR FITNESS FOR A PARTICULAR PURPOSE. TO THE EXTENT THAT THEY CANNOT BE DISCLAIMED, THE IMPLIED WARRANTIES ARE LIMITED IN DURATION TO THE LIFE OF THE EXPRESS WARRANTY. ALL INCIDENTAL, CONSEQUENTIAL, DIRECT, INDIRECT OR OTHER DAMAGES OF ANY KIND ARE EXCLUDED FROM COVERAGE UNDER THIS WARRANTY. SOME JURISDICTIONS DO NOT ALLOW FOR THE DISCLAIMERS, LIMITATIONS OF INCIDENTAL OR CONSEQUENTIAL DAMAGES OR OTHER EXCLUSIONS IDENTIFIED ABOVE. AS A RESULT, THEY MAY NOT APPLY TO YOU. THIS WARRANTY GIVES YOU SPECIFIC RIGHTS, AND YOU MAY ALSO HAVE OTHER LEGAL RIGHTS WHICH MAY VARY FROM COUNTRY TO COUNTRY, OR JURISDICTION TO JURISDICTION. (FOR PRODUCTS PURCHASED IN AUSTRALIA SEE CLAUSE 4 BELOW).

Neither the authorized Distributors/Dealers nor any other person has been authorized to make any affirmation, representation or warranty regarding the Product, other than those contained in this limited warranty, and if made, shall not be enforceable against BRP. BRP reserves the right to modify this warranty at any time, being understood that such modification will not alter the warranty conditions applicable to the Products sold while this warranty is in effect.

## **3. EXCLUSIONS — ARE NOT WARRANTED**

The following are not warranted under this limited policy under any circumstances:

- Replacement of routine maintenance items such as, without limitation, oil and lubricants, filters and spark plugs.
- Normal wear and tear, such as, without limitation, wear and tear of the tires, battery, generator brushes, sealed beams and light bulbs, clutch plates and facings, drive belt, brake pads, brake linings and rotors and sprockets.

- Tune ups and adjustments including without limitation adjustments of belt, alignment and wheel balance.
- Damages related to the appearance of the Product, including without limitation scratches, dents, fading, flaking, peeling and damages to seat cover material.
- Damage caused by negligence or failure to provide proper maintenance and/or storage, as described in the *OPERATOR'S GUIDE*.
- Damage resulting from removal of parts, improper repairs, improper service or improper maintenance, modifications, alterations that are outside of the original specifications of the Product, or damage resulting from use of parts or accessories not manufactured or approved by BRP which in its reasonable judgement are either incompatible with the product or adversely affect its operation, performance or durability or resulting from repairs done by a person that is not an authorized servicing Distributor/Dealer.
- Damage resulting from the installation of parts with specifications that differ from the original Product parts, such as, without limitation, different tires, exhaust system, wheels or brakes.
- Damage resulting from abuse, abnormal use, neglect, racing or operation of the Product in a manner inconsistent with the recommendations of the *OPERATOR'S GUIDE*.
- Damage resulting from water ingestion, accident, road hazards, submersion, fire, theft, vandalism or any act of God.
- Damage resulting from operation with fuels, oils or lubricants with specifications different than as recommended in the *OPERATOR'S GUIDE*.
- Damage resulting from corrosion from road salts, battery acid, environmental influences or treatment contrary to the *OPERATOR'S GUIDE*.
- Incidental or consequential damages, including without limitation, expense for gasoline, expense for transporting the Product to and from the authorized Distributor/Dealer, mechanic's travel time, trailering or towing, storage, telephone, cell phone, fax or telegram charges, rental of a like or replacement Product during warranty services or down time, taxi, travel, lodging, loss of or damage to personal property, inconvenience, cost of insurance coverage, loan payments, loss of time, loss of income, revenue or profits, or loss of enjoyment or use of Product.

#### **4. WARRANTY COVERAGE PERIOD**

This warranty will be in effect from the date of delivery to the first retail consumer or the date the Product is first put into use, whichever occurs first and for the following periods:

- a. For private, recreational use, **TWENTY-FOUR (24) CONSECUTIVE MONTHS**, except for the items covered in points (2) and 3) below; and for commercial use **TWELVE (12) CONSECUTIVE MONTHS**, except for the items covered in points (2) and (3) below.

The Product is used commercially when it is used in connection with any work or employment that generates income, during any part of the warranty period. The Product is also used commercially when, at any point during the warranty period, it is licensed for commercial use;



- b. For the battery, **SIX (6) CONSECUTIVE MONTHS**;
- c. For the tires, **6 CONSECUTIVE MONTHS** or until tires are worn to the last three thirty-second of an inch (3/32 ") (2.38 millimeters) for the front tires and the last five thirty-second of an inch (5/32 ") (3.97 millimeters) for the rear tire, whichever occurs first.

The repair or replacement of parts or the performance of service under this warranty does not extend the life of this warranty beyond its original expiration date.

Note that the duration and any other modalities of the warranty coverage are subject to the applicable national or local legislation in the customer's country.

## **FOR PRODUCTS SOLD IN AUSTRALIA ONLY**

Nothing in these Warranty terms and conditions should be taken to exclude, restrict or modify the application of any condition, warranty, guarantee, right or remedy conferred or implied under the Competition and Consumer Act 2010 (Cth), including the Australian Consumer Law or any other law, where to do so would contravene that law, or cause any part of these terms and conditions to be void. The benefits given to you under this limited warranty are in addition to other rights and remedies that you have under Australian law.

Our goods come with guarantees that cannot be excluded under the Australian Consumer Law. You are entitled to a replacement or refund for a major failure and for compensation for any other reasonably foreseeable loss or damage. You are also entitled to have the goods repaired or replaced if the goods fail to be of acceptable quality and the failure does not amount to a major failure.

## **5. CONDITIONS TO HAVE WARRANTY COVERAGE**

This warranty coverage is available only if each of the following conditions has been fulfilled:

- The Product must be purchased as new and unused by its first owner from a Distributor/Dealer authorized to distribute the Product in the country in which the sale occurred;
- The BRP specified pre-delivery inspection process has been completed and documented by the purchaser and the authorized Distributor/Dealer and signed by the purchaser;
- The Product must have undergone proper warranty registration by an authorized Distributor/Dealer;
- The Product must be purchased in the country in which the purchaser resides. However, for residents of the EEA, they must purchase the Products within the EEA, irrespective of which country within the EEA. For the residents of the Commonwealth of Independent States ("CIS"), they must purchase the Products within the CIS, irrespective of which country within the CIS.
- Routine maintenance as outlined in the *OPERATOR'S GUIDE* must be performed in a timely manner. BRP reserves the right to make warranty coverage contingent upon proof of proper maintenance.

BRP will not honour this limited warranty to any private use owner or commercial use owner if one of the preceding conditions has not been met. Such limitations are necessary in order to allow BRP to preserve both the safety of its products, and also that of its consumers and the general public.

## **6. WHAT TO DO TO OBTAIN WARRANTY COVERAGE**

The customer must cease using the Product upon the appearance of an anomaly. The customer must notify an authorized servicing Distributor/Dealer within two (2) months of the appearance of a defect, and provide it with reasonable access to the Product and reasonable opportunity to repair it. The customer must also present to the authorized Distributor/Dealer, proof of purchase of the Product and must sign the repair/work order prior to starting the repair in order to validate the warranty repair. All parts replaced under this limited warranty become the property of BRP. Note that the notification period is subject to the applicable national or local legislation in customer's country.

## **7. WHAT BRP WILL DO**

To the extent permitted by law, BRP's obligations under this warranty are limited to, at its sole discretion, repairing parts found defective under normal use, maintenance and service, or replacing such parts with new genuine Product parts without charge for parts and labour, at any authorized Distributor/Dealer during the warranty coverage period under the conditions described herein. BRP's responsibility is limited to making the required repairs or replacements of parts. No claim of breach of warranty shall be cause for cancellation or rescission of the sale of the Product to the owner. You may have other legal rights which may vary from country to country.

In the event that service is required outside of the country of original sale, or for EEA residents, if service is required outside of the EEA, the owner will bear responsibility for any additional charges due to local practices and conditions, such as, but not limited to, freight, insurance, taxes, license fees, import duties, and any and all other financial charges, including those levied by governments, states, territories and their respective agencies.

BRP reserves the right to improve or modify products from time to time without assuming any obligation to modify all products previously manufactured.

## **8. TRANSFER**

If the ownership of a Product is transferred during the warranty coverage period, this warranty shall also be transferred and be valid for the remaining coverage period provided that BRP is notified of such transfer of ownership in the following way:

- (a) The former owner contacts BRP (at the phone number provided below) or an authorized Distributor/Dealer and gives the coordinates of the new owner; or
- (b) BRP or an authorized Distributor/Dealer receives a proof that the former owner agreed to the transfer of ownership, in addition to the coordinates of the new owner.

## **9. CONSUMER ASSISTANCE**

1. In the event of a controversy or a dispute in connection with this limited warranty, BRP suggests that you try to resolve the issue at the Distributor/Dealer level. We recommend discussing the issue with the authorized Distributor/Dealer's service manager or owner.
2. If further assistance is required, the Distributor/Dealer service department should be contacted in order to resolve the matter.
3. If the matter still remains unresolved then contact BRP by writing at the address listed below.

### **For countries within Europe, Middle East, Africa, Russia and CIS, please contact our European office:**

BRP EUROPE N.V.  
Customer Assistance Center  
Skaldenstraat 125  
9042 Gent  
Belgium  
Tel.: +32-9-218-26-00

### **For Scandinavian countries, please contact our Finland office:**

BRP FINLAND OY  
Service Department  
Isoaavantie 7  
FIN-96320 Rovaniemi  
Finland  
Tel.: +358 16 3208 111

### **For all other countries, please contact your local Distributor/Dealer or contact our Canadian Office at:**

BOMBARDIER RECREATIONAL PRODUCTS INC.  
Customer Assistance Center  
75 J.-A. Bombardier Street  
Sherbrooke, QC J1L 1W3  
Tel.: +1 819 566-3366

You will find your Distributor's/Dealer, coordinates on [www.brp.com](http://www.brp.com).

## **ADDITIONAL TERMS AND CONDITIONS FOR FRANCE ONLY**

The following terms and conditions are applicable to products sold in France only:

The seller shall deliver goods that are complying with the contract and shall be responsible for defects existing upon delivery. The seller shall also be responsible for defects resulting from packaging, assembling instructions or the installation when it is its responsibility per the contract or if accomplished under its responsibility. To be compliant with the contract, the good shall:

1. Be fit for normal use for goods similar thereto and, if applicable:
  - 1.1 Correspond to the description provided by the seller and have the qualities presented to the buyer though sample or model;
  - 1.2 Have the qualities that a buyer may legitimately expect considering the public declarations of the seller, the manufacturer of its representative, including in advertising or labeling; or
2. Have the characteristics mutually agreed upon as between the parties or be fit for the specific use intended by the buyer and brought to the attention of the seller and which accepted.

The action for failure to comply is prescribed after two years after delivery of the goods. The seller is responsible for the warranty for hidden defects of the good sold if such hidden defects are rendering the good unfit for the intended use, or if they diminish its use in such a way that the buyer would not have acquired the good or would have given a lesser price, had he known. The action for such hidden defects shall be taken by the buyer within 2 years of the discovery of the defect.

\* In the European Economic Area and elsewhere, Products are distributed and serviced by BRP European Distribution S.A. and other subsidiaries of BRP.

\*\* The BRP limited warranty offered on Products sold in the USA and Canada is different than the one offered in the EEA and elsewhere.

© 2013 Bombardier Recreational Products Inc. All rights reserved.

™ Trademarks of Bombardier Recreational Products Inc. or its affiliates.

# ***CUSTOMER INFORMATION***

---

## PRIVACY INFORMATION

BRP wishes to inform you that your coordinates will be used for safety and warranty related purposes. Furthermore, BRP and its affiliates may use its customer list to distribute marketing and promotional information about BRP and related products.

To exercise your right to consult or correct your data, or to be removed from the addressee-list for direct marketing, please contact BRP.

By E-mail: [privacyofficer@brp.com](mailto:privacyofficer@brp.com)

By mail: BRP  
Senior Legal Counsel-Privacy Officer  
726 St-Joseph  
Valcourt QC  
Canada,  
J0E 2L0

---

## CHANGE OF ADDRESS/OWNERSHIP

If your address has changed or if you are the new owner of the vehicle, be sure to notify BRP by either:

- Mailing one of the following card below;
- **North America Only:** calling at 715 848-4957 (USA) or 819 566-3366 (Canada);
- Notifying an authorized Can-Am roadster dealer.

In case of change of ownership, please join a proof that the former owner agreed to the transfer.

Notifying BRP, even after the expiration of the limited warranty, is very important as it enables BRP to reach the vehicle owner if necessary, like when safety recalls are initiated. It is the owner's responsibility to notify BRP.

**STOLEN UNITS:** If your personal vehicle is stolen, you should notify BRP or an authorized Can-Am roadster dealer. We will ask you to provide your name, address, phone number, the vehicle identification number and the date it was stolen.

### In North America

BOMBARDIER RECREATIONAL PRODUCTS INC.  
Warranty Department  
75 J.-A. Bombardier Street  
Sherbrooke, QC J1L 1W3  
Canada

### In Other Countries in the World

BRP EUROPEAN DISTRIBUTION  
Warranty Department  
Chemin de Messidor 5-7  
1006 Lausanne  
Switzerland

### In Scandinavian Countries

BRP FINLAND OY  
Service Department  
Isoaavantie 7  
Fin-96320 Rovaniemi  
Finland  
Tel.: + 358 16 3208 111

***This page is  
intentionally blank***







**⚠ WARNING**

**The Spyder roadster is a different type of vehicle- it requires special skills and knowledge. Learn how the Spyder roadster is different.**

**Read** this operator's guide and watch the safety DVD.

**Complete** a training course (if available), **practice**, become proficient with the controls, and get a proper license.

**Refer** to the Safety Card before riding.

**Always wear a helmet and riding gear.**

With this type of vehicle, riders are exposed to more road risks than in a car. Even skilled operators can be struck by other vehicles or lose control. This vehicle will not protect you in a crash.

**Handling limits and road Conditions.**

The Vehicle Stability System (VSS) cannot stop you from losing control, flipping over, or falling off if you exceed this vehicle's limits. Know the limits for different road conditions. Do not ride on ice, snow, or off road. Avoid puddles and running water. This type of vehicle can hydroplane on water and slip on gravel, dirt and sand covered roads. If you must go through these road conditions, slow down.

219 001 221

CA

OPERATOR'S GUIDE, SPYDER ST CE / ENGLISH  
GUIDE DU CONDUCTEUR, SPYDER ST CE / ANGLAIS

FAIT AU / MADE IN CANADA

U/M:P.C.