

LYNX®



2019

OPERATOR'S GUIDE

Includes
Safety, Vehicle
and Maintenance Information



Radien

Trail / Crossover ACE™ Series

WARNING

Read this guide thoroughly. It contains important safety information. Minimum recommended operator's age: 16 years old. Keep this Operator's Guide in the vehicle.

6 1 9 9 0 0 9 5 2

Original Instructions

WARNING

Disregarding any of the safety precautions and instructions contained in this Operator's Guide, *SAFETY VIDEO* and on-product safety labels could cause injury including the possibility of death!

WARNING

This vehicle may exceed the performance of other vehicles you may have ridden. Take time to familiarize yourself with your new vehicle.

OPERATOR'S GUIDE 2019

TRAIL - CROSSOVER

49 Ranger PRO 900 ACE

49 Ranger PRO 900 ACE 39 mm

49 Ranger ST 900 ACE

49 Ranger ST 900 ACE 59 mm

Xtrim SC 900 ACE



Lynx products are manufactured by Bombardier Recreational Products Inc.

The following are trademarks of Bombardier Recreational Products Inc. or its subsidiaries.

ACE™

HPG™

ROTAX™

D.E.S.S.™

Lynx®

XPS™

The KYB Pro series is a registered mark of KYB America LLC.

FOREWORD

Deutsch	Dieses Handbuch ist möglicherweise in Ihrer Landessprache verfügbar. Bitte wenden Sie sich an Ihren Händler oder besuchen Sie: www.operatorsguides.brp.com
English	This guide may be available in your language. Check with your dealer or go to: www.operatorsguides.brp.com
Español	Es posible que este manual esté disponible en su idioma. Consulte a su distribuidor o visite: www.operatorsguides.brp.com
Français	Ce guide peut être disponible dans votre langue. Vérifier avec votre concessionnaire ou aller à: www.operatorsguides.brp.com
Italiano	Questa guida potrebbe essere disponibile nella propria lingua. Contattare il concessionario o consultare: www.operatorsguide.brp.com
中文	本手册可能有您的语种的翻译版本。请向经销商问询，或者登录 www.operatorsguides.brp.com 查询。
日本語	このガイドは、言語によって翻訳版が用意されています。ディーラーに問い合わせるか、次のアドレスでご確認ください： www.operatorsguides.brp.com
Nederlands	Deze handleiding kan beschikbaar zijn in uw taal. Vraag het aan uw dealer of ga naar: www.operatorsguides.brp.com
Norsk	Denne boken kan finnes tilgjengelig på ditt eget språk. Kontakt din forhandler eller gå til: www.operatorsguides.brp.com
Português	Este manual pode estar disponível em seu idioma. Fale com sua concessionária ou visite o site: www.operatorsguides.brp.com
Русский	Воспользуйтесь руководством на вашем языке. Узнайте о его наличии у дилера или на странице по адресу www.operatorsguide.brp.com
Suomi	Käyttöohjekirja voi olla saatavissa omalla kielelläsi. Tarkista jälleenmyyjältä tai käy osoitteessa: www.operatorsguides.brp.com
Svenska	Denna bok kan finnas tillgänglig på ditt språk. Kontakta din återförsäljare eller gå till: www.operatorsguides.brp.com

Congratulations on your purchase of a new Lynx® snowmobile. Whatever model you have chosen, it is backed by the Bombardier Recreational Products Inc. (BRP) warranty and a network of authorized Lynx snowmobile dealers ready to provide the parts, service or accessories you may require.

Your dealer is committed to your satisfaction. He has taken training to perform the initial set-up and inspection of your snowmobile as well as completed the final adjustment required to suit your specific weight and riding environment before you took possession.

At delivery, you were informed of the warranty coverage and signed the *PREDELIVERY CHECK LIST* to ensure your new vehicle was prepared to your entire satisfaction.

Know Before you Go

To learn how to reduce the risk for you, your passenger or bystanders being injured or killed, read the following sections before you operate the vehicle:

- SAFETY INFORMATION
- VEHICLE INFORMATION.

Also read all safety labels on your snowmobile and watch attentively your *SAFETY VIDEO* located at www.brplynx.com/en/owners/safety/safety-information.html.



We highly recommend that you take a safety riding course. Please check with your dealer or local authorities for availability in your area.

Failure to follow the warnings contained in this Operator's Guide can result in SERIOUS INJURY or DEATH.

The proper functioning of a snowmobile depends in part on the surface on which it is driven. Refer to *RIDING CONDITIONS AND YOUR SNOWMOBILE* for details.

Safety Messages

The types of safety messages, what they look like and how they are used in this guide are explained as follows:

The safety alert symbol  indicates a potential injury hazard.

WARNING

Indicates a potential hazard, if not avoided, could result in serious injury or death.

 **CAUTION** Indicates a hazard situation which, if not avoided, could result in minor or moderate injury.

NOTICE Indicates an instruction which, if not followed, could severely damage vehicle components or other property.

About this Operator's Guide

This Operator's Guide has been prepared to acquaint the owner/operator and passenger with this snowmobile and its various controls, safe riding and maintenance instructions.

The following terminology in regards to operator, passenger and vehicle configuration is used as follows throughout this guide:

- **Operator:** refers to the person being behind the controls and driving the snowmobile.
- **Passenger:** refers to a person sitting behind the operator.
- **1-UP:** refers to a model designed for an operator only.
- **2-UP:** refers to a model designed to accommodate **one** passenger.

Keep this Operator's Guide in the vehicle as you can refer to it for things such as maintenance, troubleshooting and instructing others.

Note that this guide is available in several languages. In the event of any discrepancy, the English version shall prevail.

If you want to view and/or print an extra copy of your Operator's Guide, simply visit the following website **www.operatorsguides.brp.com**.

The information contained in this document is correct at the time of publication. BRP, however, maintains a policy of continuous improvement of its products without imposing upon itself any obligation to install them on products previously manufactured. Due to late changes, some differences between the manufactured product and the descriptions and/or specifications in this guide may occur. BRP reserves the right at any time to discontinue or change specifications, designs, features, models or equipment without incurring any obligation upon itself.

This Operator's Guide should remain with the vehicle when it's sold.

TABLE OF CONTENTS

FOREWORD	1
Know Before you Go	2
Safety Messages	2
About this Operator's Guide	3

SAFETY INFORMATION

GENERAL PRECAUTIONS	10
Avoid Carbon Monoxide Poisoning	10
Avoid Gasoline Fires and Other Hazards	10
Avoid Burns from Hot Parts	11
Accessories and Modifications	11
SPECIAL SAFETY MESSAGES	12
ACTIVE TECHNOLOGIES (iTc) (900 ACE)	17
Introduction	17
iTc (intelligent Throttle Control)	17
RIDING THE VEHICLE	18
Pre-Ride Inspection	18
How to Ride	21
Carrying a Passenger	24
Terrain/Riding Variations	26
Environment	32
TRACTION ENHANCING PRODUCTS	36
Manoeuvrability	36
Acceleration	38
Braking	39
Important Safety Rules	39
Effects of Having a Studded Track on the Life of the Snowmobile	39
Installation of Studs on BRP Approved Tracks	40
Maintenance/Replacement	43
IMPORTANT ON-PRODUCT LABELS	44
Hang Tag(s)	44
Vehicle Safety Labels	45
Technical Information Labels	56

VEHICLE INFORMATION

CONTROLS, INSTRUMENTS AND EQUIPMENT	60
1) Handlebar	61

CONTROLS, INSTRUMENTS AND EQUIPMENT (cont'd)

2) Throttle Lever	61
3) Brake Lever	62
4) Parking Brake Lever	63
5) Engine Cut-off Switch	64
6) Emergency Engine Stop Switch	65
7) Multifunction Switch	67
8) Reverse (Mechanical)	71
9) Gauge	71
10) Storage Compartment	92
11) Operator's Guide	92
12) Seat	92
13) Front and Rear Bumpers	93
14) Drive Belt Guard	95
15) Tools	97
16) Spare Drive Belt Holder	98
17) Upper Body Module	99
18) Side Panels	103
19) Rear Rack	105
20) 2-up Seat (if equipped)	106
21) Adjustable Mirrors (On Applicable Models)	108
22) Electric Visor Jack Connector (On Applicable Models) ..	109
23) Eco/Standard/Sport Modes (On Applicable Models)	110
24) J-Hook	111
FUEL	113
Fuel Requirements	113
Vehicle Fueling Procedure	114
ENGINE OIL	116
Recommended Engine Oil	116
Oil Level Verification	117
BREAK-IN PERIOD	119
Operation During Break-In	119
OPERATING MODES	120
ECO Mode (Fuel Economy Mode)	120
Standard Mode	120
Sport Mode	120
Navigating Operating Modes	121

TABLE OF CONTENTS

BASIC PROCEDURES	123
Engine Starting Procedure	123
Emergency Starting	123
Vehicle Warm-Up	123
Shifting in Reverse	124
Shutting Off the Engine	125
RIDING CONDITIONS AND YOUR SNOWMOBILE	127
Altitude	127
Temperature	127
Hard Packed Snow	127
SPECIAL OPERATION	129
Towing an Accessory	129
Towing Another Snowmobile	129
TUNE YOUR RIDE	130
Rear Suspension Adjustments	131
Front Suspension Adjustments	135
Adjustment Tips According to Vehicle Behavior	138
Suspension Adjustment Table	139
VEHICLE TRANSPORTATION	142
MAINTENANCE	
MAINTENANCE SCHEDULE	144
MAINTENANCE PROCEDURES	147
Engine Coolant	147
Engine Oil	148
Engine Oil Filter	153
Exhaust System	155
Spark Plugs	156
Brake Fluid	156
Chaincase Oil	158
Drive Chain	160
Drive Belt	161
Track	165
Suspension	173
Skis	174
Fuses	174
Headlights	176
Removing Battery	180

MAINTENANCE PROCEDURES (cont'd)	
Installing Battery	182
VEHICLE CARE	183
Post-Operation Care.....	183
Vehicle Cleaning and Protection	183
STORAGE.....	184

TECHNICAL INFORMATION

VEHICLE IDENTIFICATION	186
Vehicle Description Decal	186
Identification Numbers.....	186
NOISE EMISSION AND VIBRATION VALUES	188
EC DECLARATION OF CONFORMITY	189
RADIO FREQUENCY DIGITALLY ENCODED SECURITY SYSTEM (RF D.E.S.S. KEY)	190
SPECIFICATIONS (ENGINE).....	191
SPECIFICATIONS (VEHICLE).....	193

TROUBLE-SHOOTING

TROUBLESHOOTING GUIDELINES	200
MONITORING SYSTEM	203
Pilot Lamps, Messages and Beeper Codes	203
Icons, Messages and Beeper Codes	207

WARRANTY

BRP FINLAND OY INTERNATIONAL LIMITED WARRANTY: 2019 LYNX® SNOWMOBILES.....	212
BRP FINLAND OY LIMITED WARRANTY FOR THE EUROPEAN AND THE COMMONWEALTH OF THE INDEPENDENT STATES (CIS) AREAS AND TURKEY : 2019 LYNX® SNOWMOBILES	217
MAINTENANCE RECORDS	223

CUSTOMER INFORMATION

CONTACT US	228
North America	228

TABLE OF CONTENTS

CONTACT US (cont'd)

Europe	228
Oceania	229
South America	229
Asia	229

CHANGE OF ADDRESS/OWNERSHIP	230
------------------------------------------	------------

SAFETY INFORMATION

GENERAL PRECAUTIONS

Avoid Carbon Monoxide Poisoning

All engine exhaust contains carbon monoxide, a deadly gas. Breathing carbon monoxide can cause headaches, dizziness, drowsiness, nausea, confusion and eventually death.

Carbon monoxide is a colorless, odorless, tasteless gas that may be present even if you do not see or smell any engine exhaust. Deadly levels of carbon monoxide can collect rapidly, and you can quickly be overcome and unable to save yourself. Also, deadly levels of carbon monoxide can linger for hours or days in enclosed or poorly ventilated areas. If you experience any symptoms of carbon monoxide poisoning, leave the area immediately, get fresh air and seek medical treatment.

To prevent serious injury or death from carbon monoxide:

- Never run the vehicle in poorly ventilated or partially enclosed areas such as garages, carports or barns. Even if you try to ventilate engine exhaust with fans or open windows and doors, carbon monoxide can rapidly reach dangerous levels.
- Never run the vehicle outdoors where engine exhaust can be drawn into a building through openings such as windows and doors.

Avoid Gasoline Fires and Other Hazards

Gasoline is extremely flammable and highly explosive. Fuel vapors can spread and be ignited by a spark or flame many feet away from the engine. To reduce the risk of fire or explosion, follow these instructions:

- Use only an approved gasoline container to store fuel.
- Strictly adhere to instructions in *VEHICLE FUELING PROCEDURE*.
- Never start or operate the engine if the fuel cap is not properly installed.

Gasoline is poisonous and can cause injury or death.

- Never siphon gasoline by mouth.
- If you swallow gasoline, get any in your eye or inhale gasoline vapor, see your doctor immediately.

If gasoline spills on you, wash with soap and water and change your clothes.

Avoid Burns from Hot Parts

The exhaust system and engine become hot during operation. Avoid contact during and shortly after operation to avoid burns.

Accessories and Modifications

Do not make unauthorized modifications, or use attachments or accessories that are not approved by BRP. Since these changes have not been tested by BRP, they may increase the risk of crashes or injuries, and they can make the vehicle illegal.

Tunnel accessories must be loaded onto vehicle as per instructions provided for each accessories.

Accessory passenger seats approved by BRP and conforming to SSCC standards may be available for certain models. If such a seat is used, you must follow the guidelines and recommendations in regards to a passenger in this guide.

WARNING

Passenger seat must have a strap or handholds and must meet SSCC standards.

See your authorized Lynx dealer for available accessories for your vehicle.

SPECIAL SAFETY MESSAGES

SEVERE INJURY OR DEATH can result if you do not follow these instructions:

- Always make a pre-ride inspection **BEFORE** you start the engine.
- Throttle mechanism should be checked for free movement and return to idle position before starting engine.
- Always attach tether cord eyelet to clothing before starting the engine.
- Never operate the engine without belt guard and brake disk guard securely installed or, with hood or side panels opened or removed. Never run the engine without drive belt installed. Running an unloaded engine such as without drive belt or with track raised, can be dangerous.
- Always engage parking brake before starting the engine.
- Everyone is a beginner the first time he sits behind the controls of a snowmobile regardless of previous experience in driving any other type of vehicle. The safe use of your snowmobile depends on many conditions such as visibility, speed, weather, environment, traffic, vehicle condition and the condition of the operator.
- Basic training is required for the safe operation of any snowmobile. Study your operator's guide paying particular attention to cautions and warnings. Join your local snowmobile club: its social activities and trail systems are planned for both fun and safety. Obtain basic instructions from your snowmobile dealer, friend, fellow club member or enroll in your state or provincial safety training program.
- Any new operator must read and understand all safety labels on the snowmobile, the Operator's Guide and watch the *SAFETY VIDEO* at www.brplynx.com/en/owners/safety/safety-information.html before operating the snowmobile. Only allow a new operator to operate the snowmobile in a restricted flat area, at least until he is completely familiar with its operation. If snowmobile operator's training course is offered in your area, have him enroll.
- The performance of some snowmobiles may significantly exceed that of other snowmobiles you have operated. Therefore, use by novice or inexperienced operators is not recommended.
- Snowmobiles are used in many areas and in many snow conditions. Not all models perform the same in similar conditions. Always consult your snowmobile dealer when selecting the snowmobile model for your particular needs and uses.

- Injury or death may result to the snowmobile operator, passenger or bystander if the snowmobile is used in risky conditions which are beyond the operator's, passenger's or snowmobile's capabilities or intended use.
- BRP recommends the operator has at least 16 years old of age. Verify also your local laws for age and training requirements.
- It is very important to inform any operator, regardless of his experience, of the handling characteristics of this snowmobile. The snowmobile configuration, such as ski stance, ski type, suspension type, track length, width and type vary from a model to another. The snowmobile handling is greatly influenced by these characteristics.
- The novice operator should become familiar with the snowmobile through practice on a level area at slow speeds before venturing far afield.
- Know your local laws. Federal, state, provincial and local government agencies have enacted laws and regulations pertaining to the safe use and operation of snowmobiles. It is your responsibility as a snowmobiler to learn and obey these laws and regulations. Respect and observance will result in safer snowmobiling for all. Be aware of the liability property damages and insurance laws regarding your equipment.
- Speeding can be fatal. In many cases, you cannot react or respond quickly enough to the unexpected. Always ride at a speed which is suitable to the trail, weather conditions and your own ability. Know your local rules. Speed limit may be in effect and meant to be observed.
- Always keep right hand side of the trail.
- Always keep a safe distance from other snowmobiles and bystanders.
- Remember, promotional material may show risky maneuvers performed by professional riders under ideal and/or controlled conditions. You should never attempt any such risky maneuvers if they are beyond your level of riding ability.
- Never use this vehicle with drugs or alcohol. They slow reaction time and impair judgement.
- Your snowmobile is not designed to be operated on public streets, roads or highways.

- Avoid road traveling. If you must do so, and it is permitted, reduce speed. The snowmobile is not designed to operate or turn on paving. When crossing a road, make a full stop, then look carefully in both directions before crossing at a 90° angle. Be wary of parked vehicles.
- Snowmobiling at night can be a delightful experience but because of reduced visibility, be extra cautious. Avoid unfamiliar terrain and be sure your lights are working. Always carry a flashlight and spare light bulbs.
- Never remove any original equipment from your snowmobile. Each vehicle has many built in safety features. Such features include various guards and consoles, plus reflective materials and safety labels.
- Nature is wonderful but don't let it distract your attention from driving. If you want to truly appreciate winter's scenery, stop your snowmobile on the side of the trail so that you don't become a hazard to others.
- Fences represent a very serious threat for both you and your snowmobile. Give a wide berth to telephone poles or posts.
- Hidden wires unseen from a distance can cause serious accidents.
- Always wear an approved safety helmet, eye protection and a face shield. This also applies to your passenger.
- Be aware of inherent risks associated with riding off trails, such as avalanche and other natural or man made hazards or obstacles.
- Tailgating another snowmobile should be avoided. If the snowmobile in front of you slows for any reason, its operator and passenger could be harmed through your neglect. Maintain a safe stopping distance between you and the snowmobile in front of you. Depending on the terrain condition, stopping may require a little more space than you think. Play it safe. Be prepared to use evasive driving.
- Venturing out alone with your snowmobile could also be hazardous. You could run out of fuel, have an accident, or damage your snowmobile. Remember, your snowmobile is capable of traveling further in half an hour than you may be able to walk in a day. Use the "buddy system". Always ride with a friend or member of your snowmobile club. Even then, tell someone where you are going and the approximate time you plan to return.

- Meadows sometimes have low areas where water accumulate and freezes over in winter. This ice is usually glare ice. Attempting to turn or brake on this surface could cause your vehicle to spin out of control. Never brake or attempt speeding or turning on glare ice. If you do happen to travel over such a condition, reduce speed by carefully releasing the throttle.
- Never "jump" with your snowmobile.
- While on safari, do not "gun" the throttle. Snow and ice can be thrown back into the path of a following snowmobile. In addition, when "gunning" the throttle, the vehicle digs into and leaves an irregular snow surface for others.
- Safaris are both fun and enjoyable but don't show off or overtake others in the group. A less experienced operator might try to do the same as you and fail. When riding with others, limit your abilities to the experience of others.
- In an emergency, the snowmobile engine can be stopped by pressing down on the emergency engine stop switch or by pulling the tether cord cap from the engine cut-off switch, while applying brake.
- Always engage parking brake when vehicle is not in use.
- Never run the engine in a non-ventilated area and/or if vehicle is left unattended.
- **Electric start models only:** Never charge or boost a battery while installed on snowmobile.
- Never attempt any fuel system or electrical system maintenance or repair. Any maintenance or repair of these systems must be performed by an authorized Lynx dealer.
- Ensure the path behind is clear of obstacles or bystanders before proceeding in reverse.
- Always remove the tether cord cap from engine cut-off switch when vehicle is not in operation in order to prevent accidental engine starting, to avoid unauthorized use by children or others or theft.
- NEVER stand behind or near a rotating track. Debris could be projected causing severe injuries. To remove packed snow or ice, stop engine, tilt and hold vehicle on its side and use wrench tool on the belt guard.
- Do not stud the track unless it has been approved for studs. At speed, a studded track that has not been approved for studs could tear and separate from vehicle. See an authorized Lynx dealer for current specific studding availability and applications.

SPECIAL SAFETY MESSAGES

- You may stud the track on this vehicle model. However, you **MUST** only use the BRP approved type stud for use on Lynx snowmobiles. **DO NOT EVER** use conventional studs because the track thickness is thinner than our standard tracks. The stud could tear off of track and separate from vehicle.
- Always wear an approved helmet and follow the same dressing guidelines as those recommended for the operator and described in this guide.
- Make sure that you are able to achieve a stable stance, both feet resting positively on the footboards of footrests with good grip, and that you are able to hold on firmly to the handholds.
- Do not forget, with 2-UP models, the operator is responsible for the safety of the passenger. Always remember that the snowmobile handling, stability and braking distance may be affected when riding with a passenger.
- Before riding the vehicle, ask your passenger to inform you to slowdown or stop immediately if he feels uncomfortable or insecure during the ride. Keep a watchful eye on your passenger while riding.

ACTIVE TECHNOLOGIES (iTC) (900 ACE)

Introduction

NOTE: Some functions or features described in this section may not apply to every model, or may be available as an option.

The throttle is electronic and provides a command signal to an electronic module whose function is to assure proper operation of its system within set parameters.

It is extremely important for operators to read all information contained in this operator's guide so as to become familiar with this snowmobile, its systems, controls, capabilities and limitations.

iTC (intelligent Throttle Control)

The system uses an electronic throttle control (ETC) that provides command signals to the ECM (Engine Control Module). With this system, there is no need for a traditional throttle cable.

The iTC allows the following operating modes:

- ECO mode
- Standard mode
- Sport mode.

ECO Mode

When ECO mode is selected (fuel economy mode), vehicle torque and speed are limited whereby an optimal cruising speed is maintained in order to reduce fuel consumption.

Refer to *OPERATING MODES* subsection for detailed instructions.

Standard Mode

In standard mode, acceleration is reduced when accelerating from a complete stop and when operating in the low vehicle speed range under certain conditions.

Sport Mode

In sport mode, maximum engine power is available throughout the engine operational range.

Refer to *OPERATING MODES* subsection for detailed instructions.

RIDING THE VEHICLE

Each operator has a responsibility to ensure the safety of other recreationists or bystanders.

You are responsible for proper operation of your vehicle as well as training those whom you allow to ride or drive. There may be noticeable handling and performance differences from one snowmobile to the other.

A snowmobile is relatively simple to operate but like any other vehicle or mechanical equipment, it can be hazardous if you or a passenger are reckless, thoughtless or inattentive. We encourage you to have an Annual Safety Inspection of your snowmobile. Please contact an authorized Lynx dealer for further details. Though not required, it is recommended that an authorized Lynx dealer performs the preseason preparation of your snowmobile. Each visit to your authorized Lynx dealer is a great opportunity for your dealer to verify if your snowmobile is included in any safety campaign. We also urge you to visit your authorized Lynx dealer in a timely manner if you become aware of any safety related campaigns.

See an authorized Lynx dealer for available accessories you may require.

Before venturing on the trails, operate the snowmobile in a restricted flat area until you are completely familiar with its operation and feel comfortable that you can safely tackle a more demanding task. Have an enjoyable and safe ride.

Pre-Ride Inspection

WARNING

The pre-operation check is very important prior to operating the vehicle. Always check the proper operation of critical controls, safety features and mechanical components before starting.

Before Starting the Engine

1. Remove snow and ice from body including lights, seat, footrests, controls and instruments.
2. Verify that air silencer prefilter is free of snow.
3. Verify that skis and steering operate freely. Check corresponding action of skis versus handlebar.

4. Check fuel and injection oil (if applicable) for levels and leaks. Replenish if necessary and in case of any leaks; you should seek service from an authorized Lynx dealer, repair shop, or person of your own choosing for maintenance, repair, or replacement.
5. All storage compartments must be properly latched and they must not contain any heavy or breakable objects. Hood and side panels must be also properly latched.
6. Activate the throttle control lever several times to check that it operates easily and smoothly. It must return to idle position when released.
7. Activate the brake lever and make sure the brake fully applies before the brake control lever touches the handlebar grip. It must fully return when released.
8. Apply parking brake and check if it operates properly. Leave parking brake applied.
9. Inspect drive belt condition and height, refer to *DRIVE BELT in MAINTENANCE PROCEDURES*.

After Engine is Started

For proper engine starting procedure, refer to the appropriate *ENGINE STARTING PROCEDURE*.

1. Check headlights high beam and low beam, taillight, stop light and pilot lamps operation.

NOTE: You may need to detach tether cord from your clothes to check lights. In such a case, attach cord as soon as you get back at the controls of the snowmobile.

2. Check the engine cut-off switch (by pulling tether cord cap) and emergency engine stop switch operation.
3. Release parking brake.
4. Refer to *VEHICLE WARM-UP* and follow instructions.

Pre-Ride Check List

ITEM	OPERATION	✓
BODY INCLUDING SEAT, FOOTRESTS, LIGHTS, AIR FILTER, CONTROLS AND INSTRUMENTS	Check condition and remove snow or ice.	
SKIS AND STEERING ACTION	Check for free movement and proper operation.	
FUEL AND INJECTION OIL (IF APPLICABLE)	Check for proper level and no leaks.	
COOLANT	Check for proper level and no leaks.	
BRAKE FLUID	Check for proper level and no leaks.	
STORAGE COMPARTMENT	Check for proper latching and no heavy or breakable objects.	
TRACK	Check condition and remove snow or ice. For studded tracks, refer to <i>TRACTION ENHANCING PRODUCTS</i> .	
THROTTLE LEVER	Check for proper operation.	
BRAKE LEVER	Check for proper operation.	
PARKING BRAKE, BRAKE	Check for proper operation.	
EMERGENCY ENGINE STOP SWITCH AND ENGINE CUT-OFF SWITCH (TETHER CORD CAP)	Check for proper action. Tether cord must be attached to operator clothing eyelet.	
LIGHTS	Check for proper operation.	
SKI RUNNERS	Check for proper operation.	
SLIDER SHOES	Check for proper operation.	
DRIVE BELT	Check for cracks, fraying or abnormal wear.	

How to Ride

Riding Gear

Proper snowmobile clothing should be worn. It should be comfortable and not too tight. Always check the weather forecast before going on a ride. Dress for the coldest weather expected. Thermal underwear next to the skin also provides a good insulation.

Wear an approved helmet at all times for safety and comfort. They provide both warmth and reduce injury. A stocking type cap, balaclava and face mask should always be carried or worn. Goggles or a face shield that attach to the helmet are indispensable.

Hands should be protected by a pair of snowmobile gloves or mitts which have sufficient insulation and allow use of thumbs and fingers for operation of controls.

Rubber bottom boots with either a nylon or a leather top, with removable felt liners are best suited for snowmobiling.

You should keep yourself as dry as possible when snowmobiling. When you come indoors, take your snowmobile suit and boots off and make certain they dry properly.

Do not wear a long scarf or loose apparels that could get caught in moving parts.

Carry colored lens goggles.

What to Bring

First aid kit	Provided tool kit
Mobile phone	Knife
Spare spark plugs	Flashlight
Friction tape	Trail map
Spare drive belt	Snack

Include other items depending on the length and time of your ride.

Rider Position (Forward Operation)

Your riding position and balance are the two basic principles of making your snowmobile go where you want it to. When turning on the side of a hill, you and your passenger must be ready to shift

body weight to help it turn in the desired direction. Operator and passenger must never attempt this maneuvering by placing feet outside of the vehicle. Experience will teach you how much lean to put into turns at different speeds and how much you will have to lean into a slope to maintain proper balance.

Generally, the riding position for best balance and control is sitting. However, the posting, kneeling or standing positions are also used under certain conditions.

! WARNING

Do not attempt any maneuvers if they are beyond your abilities.

Sitting

Feet on the running boards, body midway back on seat is an ideal position when operating the snowmobile over familiar, smooth terrain. Knees and hips should remain flexible to absorb shocks.



Posting

A semi-sitting position with the body off the seat and the feet under the body in a sort of squatting posture, thus allowing the legs to absorb the shocks when traveling over uneven terrain. Avoid abrupt stops.



Kneeling

This position is achieved by placing one foot firmly on the running board and the opposite knee on the seat. Avoid abrupt stops.



Standing

Place both feet on the running boards. Knees should be flexed to absorb the shock from surface bumps. This is an effective position to see better and to shift weight as conditions dictate. Avoid abrupt stop.



Rider Position (Reverse Operation)

We recommend sitting on your snowmobile when operating in reverse.

Avoid standing up. Your weight could shift forward against throttle lever while operating in reverse, causing an unexpected acceleration.

! WARNING

Unexpected acceleration when snowmobile operates in reverse can cause a loss of control.

Carrying a Passenger

Certain snowmobiles are designed for an operator only (1-UP), and others can allow one passenger (2-UP). Make sure to identify and respect the warnings according to your specific models.

Even when a passenger is allowed, this person must be physically fit for snowmobiling.

! WARNING

Any passenger must be able to firmly lay his feet on the footrests and keep his hands on the handholds or seat strap at all times when seated. Respecting those physical criteria is important to ensure that the passenger is stable and to reduce the risks of ejection.

The operator has a responsibility to ensure the safety of his passenger and should inform the passenger about snowmobiling basics.

WARNING

- Passenger must only sit on designated passenger seat. Never allow anyone to sit between the handlebar and the operator.
- Passenger and operator must always wear an approved helmet and warm clothing appropriate for snowmobiling. Make sure that no skin is exposed.
- If the passenger feels uncomfortable or insecure for any reason, he must right away inform the operator to slow-down or stop.

Riding with a passenger on board is different than riding alone. The operator has the benefit of knowing what will be the next maneuver and is able to prepare himself accordingly. The operator also benefits from the support of his grip on the handlebar. In contrast, the passenger has to rely on the operator's careful and safe operation of the vehicle. In addition, "body english" is limited with a passenger, and the operator can sometimes see more of the trail ahead than the passenger. Therefore, smooth starting and stopping are required with a passenger, and the operator must slow down. The operator must also warn the passenger about side hills, bumps, branches, etc. An unforeseen bump can leave you passenger-less. Remind your passenger to lean into the turn with you, without causing the vehicle to topple. Be extremely careful, go more slowly and check the passenger frequently.

WARNING

When riding with a passenger:

- Braking ability and steering control are reduced. Decrease speed and allow extra space to maneuver.
- Adjust suspension according to weight.

For complete information on how to adjust the suspension, please refer to *TUNE YOUR RIDE*.

Riding with a Child

On snowmobiles allowing two passengers (with optional seat), if you have an adult and a child for passenger, BRP recommends that the child sits in the center location. This allows an adult sitting in the rear

seat to keep a visual contact with the child and hold him if necessary. In addition, the child is best protected against the wind and cold temperature if seated in the center location.

Use extra caution and go even more slowly with a young passenger. Check frequently to make certain the child has a firm grip and is properly positioned with his feet on the running boards.

Terrain/Riding Variations

Groomed Trail

On a maintained trail, sitting is the most preferred riding position. Do not race and, above all, keep to the right hand side of the trail. Be prepared for the unexpected. Observe all trail signs. Do not zigzag from one side of the trail to the other.

Ungroomed Trail

Unless there has been a fresh snowfall you can expect "washboard" and snowdrift conditions. Taken at excessive speeds, such conditions can be physically harmful. Slow down. Hold on the handlebar and assume a posting position. Feet should be under the body assuming a crouched position to absorb any jarring effect. On longer stretches of "washboard" trails, the kneeling position of one knee on the seat can be adopted. This provides a certain amount of comfort, while at the same time keeps the body loose and capable of vehicle control. Beware of hidden rocks or tree stumps partially hidden by a recent snowfall.

Deep Snow

In deep "powder" snow, your vehicle could begin to "bog" down. If this occurs, turn in as wide an arc as possible and look for a firmer base. If you do get "bogged", and it happens to everyone, do not spin your track as this makes the vehicle sink deeper. Instead, turn the engine off, get off and move the back of the vehicle onto new snow. Then tramp a clear path ahead of the vehicle. A few feet will generally suffice. Restart the engine. Assume the standing position and rock the vehicle gently as you steadily and slowly apply the throttle. Depending on whether the front or rear end of the vehicle is sinking, your feet should be placed on the opposing end of the running boards. Never place foreign material beneath the track for support. Do not allow anyone to stand in front of, or to the rear of, the snowmobile with the engine running. Stay away from the track. Personal injury will result if contact is made with the revolving track.

Frozen Water

Traveling frozen lakes and rivers can be fatal. Avoid waterways. If you are in an unfamiliar area, ask the local authorities or residents about the ice condition, inlets, outlets, springs, fast moving currents or other hazards. Never attempt to operate your snowmobile on ice that may be too weak to support you and the vehicle. Operating a snowmobile on ice or icy surfaces can be very dangerous if you do not observe certain precautions. The very nature of ice is foreign to good control of a snowmobile or any vehicle. Traction for starting, turning or stopping is much less than that on snow. Thus, these distances can be multiplied manyfold. Steering is minimal, and uncontrolled spins are an ever present danger. When operating on ice, drive slowly with caution. Allow yourself plenty of room for stopping and turning. This is especially true at night.

Hard Packed Snow

Don't underestimate hard packed snow. It can be difficult to negotiate as both skis and track do not have as much traction. Best advice is to slow down and avoid rapid acceleration, turning or braking.

Uphill

There are two types of hills you can encounter — the open hill on which there are few trees, cliffs or other obstacles, and a hill that can only be climbed directly. On an open hill, the approach is to climb it by side hilling or slaloming. Approach at an angle. Adopt a kneeling position. Keep your weight on the uphill side at all times. Maintain a steady, safe speed. Continue as far as you can in this direction, then switch to an opposite hill angle and riding position.

A direct climb could present problems. Choose the standing position, accelerate before you start the climb and then reduce throttle pressure to prevent track slippage.

In either case, vehicle speed should be as fast as the incline demands. Always slow down as you reach the crest. If you cannot proceed further, don't spin your track. Turn the engine off, free the skis by pulling them out and downhill, place the rear of the snowmobile uphill restart the engine and ease it out with slow even throttle pressure. Position yourself to avoid tipping over, then descend.

Downhill

Downhill driving requires that you have full control of your vehicle at all times. On steeper hills, keep your center of gravity low and both hands on the handlebar. Maintain slight throttle pressure and allow the machine to run downhill with the engine operating. If a higher than safe speed is reached, slow down by braking but apply the brake with frequent light pressure. Never jam the brake and lock the track.

Side Hill

When crossing a side hill or traversing up or downhill, certain procedures must be followed. All riders should lean towards the slope as required for stability. The preferred operating positions are the kneeling position, with the knee of the down hill leg on the seat and the foot of the uphill leg on the running board, or the posting position. Be prepared to shift your weight quickly as needed. Side hills and steep slopes are not recommended for a beginner or a novice snowmobiler.

Avalanche Hazard

When riding on mountainous terrain, you should be aware of the risk of avalanches. Avalanches vary in size and shapes and generally occur in steep terrain and on unstable snow.

New snow, animals, people, wind and snowmobiles can all trigger an avalanche. Avoid high marking or traversing steep terrain when avalanche conditions are possible. When in unstable snow conditions, travel should be restricted to lower angle slopes. Wind formed cornices should be avoided. Staying off unstable conditions is the key to safe mountain riding. Probably most important is to be aware of the conditions and dangers on a daily basis when in the mountains. Check local avalanche forecasts and threats each day before heading out to ride and heed forecasters advice.

You should always carry a snow shovel, probe and avalanche beacon while riding on mountains. We recommend that all mountain riders take a local avalanche safety training course to become more familiar with snow conditions and learn how to properly use their equipment.

Here are some web sites that can help you finding important information:

- US: www.avalanche.org

- Europe: www.avalanches.org
- Canada: www.avalanche.ca

Slush

Slush should be avoided at all times. Always check for slush before starting across any lake or river. If dark spots appear in your tracks, get off the ice immediately. Ice and water can be thrown rearward into the path of a following snowmobile. Getting a vehicle out of a slush area is strenuous and in some cases, impossible.

Fog or Whiteout Conditions

On land or water, fog or visibility-limiting snow can form. If you have to proceed into the fog or heavy snow, do so slowly with your lights on and watch intently for hazards. If you are not sure of your way, do not proceed. Keep a safe distance behind other snowmobilers to improve visibility and reaction time.

Unfamiliar Territory

Whenever you enter an area that is new to you, drive with extreme caution. Go slow enough to recognize potential hazards such as fences or fence posts, brooks crossing your path, rocks, sudden dips, guy wires and countless other obstacles which could result in a termination of your snowmobile ride. Even when following existing tracks, be cautious. Travel at a speed so you can see what is around the next bend or over the top of the hill.

Bright Sunshine

Bright sunny days can considerably reduce your vision. The glare from sun and snow may blind you to the extent that you cannot easily distinguish ravines, ditches or other obstacles. Goggles with colored lenses should always be worn under these conditions.

Unseen Obstruction

There may be obstructions hidden beneath the snow. Driving off established trails and in the woods requires reduced speed and increased vigilance. Driving too fast in an area can make even minor obstacles very hazardous. Even hitting a small rock or stump could throw your snowmobile out of control and cause injury to its riders. Stay on established trails to reduce your exposure to hazards. Be safe, slow down and enjoy the scenery.

Hidden Wires

Always be on the lookout for hidden wires, especially in areas that may have been farmed at one time or another. Too many accidents have been caused by running into wires in the fields, guy wires next to poles and roads, and into chains and wires used as road closures. Slow speeds are a must.

Obstacles and Jumping

Unplanned jumps of snowdrifts, snowplow ridges, culverts or indistinguishable objects can be dangerous. You can avoid them by wearing the proper color lenses or face shields and by operating at a lower speed.

Jumping can be a hazardous situation. Be prepared before landing to absorb the shock and brace yourself for the impact. Knees must be flexed to act as shock absorbers. If the trail does suddenly drop away from you, crouch (stand) towards the rear of the vehicle and keep the skis up and straight ahead. Apply partial throttle and brace yourself for the impact. Knees must be flexed to act as shock absorbers.

Turning

Depending on terrain conditions, there are two preferred ways to turn or corner a snowmobile. For most snow surfaces, "body english" is the key to turning. Leaning towards the inside of the turn and positioning body weight on the inside foot will create a "banking" condition beneath the track. By adopting this position and positioning yourself as far forward as possible, weight will be transferred to the inside ski.

On occasion, you will find that the only way to turn the vehicle about in deep snow is to pull the snowmobile around. Do not over-exert yourself. Get assistance. Remember to always lift using your legs as opposed to your back.



Road Crossing

In some cases, you will be approaching the road from a ditch or snowbank. Choose a place where you know you can climb without difficulty. Use the standing position and proceed with only as much speed needed to crest the bank. Stop completely at the top of the bank and wait for all traffic to clear. Judge the drop to the roadway. Cross the road at a 90° angle. If you encounter another snowbank on the opposite side, position your feet near the rear of the vehicle. Remember, your snowmobile is not designed to operate on bare pavement and steering on this type of surface is more difficult.

Railroad Crossing

Never ride on railroad tracks. It is illegal. Railroad tracks and railroad rights-of-way are private property. A snowmobile is no match for a train. Before crossing a railroad track, stop, look and listen.

Night Rides

The amount of natural and artificial light at a given time can effect your ability to see or to be seen. Nighttime snowmobiling is delightful. It can be a unique experience if you acknowledge your reduced visibility. Before you start, make certain your lights are clean and work properly. Drive at speeds that will allow you to stop in time when you see an unknown or dangerous object ahead. Stay on established trails and never operate in unfamiliar territory. Avoid rivers and lakes. Guy wires, barbed wire fences, cabled road entrances and other objects such as tree limbs are difficult to see at night. Never drive alone. Always carry a flashlight. Keep away from residential areas and respect the right of others to sleep.

Riding in a Group

Before starting out, designate a “trail boss” to lead the party and another person to follow-up at the end of the party. Ensure that all members of the party are aware of the proposed route and destination. Make certain that you are carrying all necessary tools and equipment and that you have sufficient fuel to complete the trip. Never overtake the trail boss or, for that matter, any other snowmobile. Use down-the-line hand signals to indicate hazards or intent of direction change. Assist others whenever necessary.

It is always IMPORTANT to keep a safe distance between each snowmobile. Always maintain a safe interval and allow sufficient stopping distance. Don't be a tailgater. Know the position of the machine ahead.

Signals

If you intend to stop, raise either hand straight above your head. A left turn is indicated by extending your left hand straight out in the proper direction. For right turns, extend the left arm and raise the hand to a vertical position so it forms a right angle at the elbow. Every snowmobiler should relay any signal to the ones behind.

Trail Stops

Whenever possible, pull off the trail when you stop. This will reduce the hazard to other snowmobilers using the trail.

Trails and Signs

Trail signs are used to control, direct or regulate the use of snowmobiles on trails. Become familiar with all signs used in the area where you are snowmobiling.

Environment

Wildlife compliments your snowmobiling day. Snowmobile tracks provide firm ground over which animals can travel from area to area. Do not violate this privilege by chasing or harassing wildlife. Fatigue and exhaustion can lead to animal's death. Avoid areas posted for the protection or feeding of wildlife.

If you happen to be fortunate enough to see an animal, stop your snowmobile and observe quietly.

The guidelines that we support are not designed to limit your snowmobiling fun, but to preserve the beautiful freedom that you can experience only on a snowmobile! These guidelines will keep snowmobilers healthy, happy and able to introduce others to what they know and enjoy about their favorite winter pastime. So, the next time you hit the trails on a cool, crisp and clear winter day, we ask you to remember that you are paving the way for the future of our sport. Help us lead it down the right path! From all of us at BRP, thank you for doing your share.

There is nothing more exhilarating than snowmobiling. Venturing onto snowmobile trails that cross wild areas is an exciting and healthy winter sport. However, as the number of people using these recreational parks increases, so does the potential for damage to the environment. Abuse of land, facilities and resources inevitably leads to restrictions and closures of both private and public land.

In essence, the greatest threat to our sport, is all around us. Which leaves us with one logical choice. When we snowmobile, we must always ride responsibly.

The vast majority respect the law and the environment. Each of us must set an example for those who are new to the sport, young and old alike.

It is in every one's best interest to tread lightly into our recreational areas. Because, in the long run, to protect the sport we must preserve the environment.

Recognizing the importance of this issue and the need for snowmobilers to do their share in preserving areas that make it possible to enjoy our sport, BRP has developed the "Light Treading Is Smart Sledging" campaign for snowmobilers.

Light Treading refers to more than the thread of our tracks. It's a statement of concern, respect and willingness to take the lead and take action. It applies to the environment in general, its proper care and maintenance, its natural inhabitants and all enthusiasts and the public at large who enjoy the great outdoors. With this theme, we invite all snowmobilers to remember that respecting the environment is not only critical to the future of our industry but to future generations.

Light Treading in no way suggests you should curb your appetite for snowmobiling fun! It simply means tread with respect!

The fundamental objective of Light Treading is one of respect for where and how you ride a snowmobile. You're a light treader when you follow the principles below.

Become informed. Obtain maps, regulations and other information from the Forest Service or from other public land agencies. Learn the rules and follow them and that goes for speed limits, too!

Avoid running over young trees, shrubs, and grasses and don't cut wood. On flatlands or areas where trail riding is popular, it's important to ride only where authorized. Remember, there is a link between protecting your environment and your own safety.

Respect wildlife and be particularly sensitive of animals that are rearing young or suffering from food shortage. Stress can sap scarce energy reserves. Refrain from riding in areas where only animals are intended to tread!

Obey gate closures and regulatory signs and remember, light treaders don't litter!

Stay out of wilderness areas. They're closed to all vehicles. Know where the boundaries are.

Obtain permission to travel across private land. Respect the rights of landowners and other people's privacy. Remember, snowmobile technology has lowered the noise factor considerably, but you still shouldn't rev your engines where quiet "is the order of the day".

Snowmobilers know all too well the efforts that have been made throughout the sport's history to enjoy access to areas where people can snowmobile safely and responsibly. This effort continues today, as strong as ever.

Respecting the areas where we ride... wherever they may be... is the only way to ensure their future enjoyment. That's one major reason why we know you'll agree that Light Treading is smart sledding! And there are more.

Enjoying the opportunity to see winter and all its natural majestic wonders, is an experience cherished by snowmobilers. Light Treading will preserve this opportunity and will make it possible for us to expose others to the beauty of winter and the unique thrill of our sport! Light Treading will help our sport to grow!

Finally, Light Treading is the sign of a smart snowmobiler. You don't have to leave big tracks or careen through a virgin forest to show you can ride. So whether you're driving a high performance Lynx snow-

mobile or any other make or model, show you know what you're doing. Show you know how to send snow flying and make tracks with a light touch!

TRACTION ENHANCING PRODUCTS

NOTE: This section is applicable to snowmobiles equipped with a factory installed track that has been approved by BRP for special studs installation.

WARNING

Never stud a track that has not been approved for studs. Installing studs on an unapproved track could increase the risk of the track tearing or severing.

WARNING

You may stud the track on this vehicle model. However, you **MUST** only use the BRP approved type stud for use on these Lynx snowmobiles. **DO NOT EVER** use conventional studs as the track thickness is thinner than other standard tracks. The stud could tear off of track and separate from vehicle. See an authorized Lynx dealer for current specific studding availability and applications.

Using traction enhancing products such as, adjustable or more aggressive ski carbide runners and/or studs on your snowmobile will change its behavior, particularly in terms of manoeuvrability, acceleration, and braking.

Using traction enhancing products gives a better grip on packed snow and ice, but has no noticeable effect on soft snow. For this reason, driving a snowmobile equipped with traction enhancing products requires a certain adaptation period. If your snowmobile is equipped with traction enhancing products, be sure to take plenty of time to get used to the way it handles when turning, accelerating, and braking.

Also, always check local regulations concerning the use of traction enhancing products on snowmobiles. Always drive your snowmobile in a responsible manner, respecting the environment and other people's property.

Manoeuvrability

Using traction enhancing products such as, more aggressive ski carbide runners and/or studs makes the snowmobile grip the ground better at both the front and at the rear. The use of carbide runners is therefore required to give the skis a better grip, so that the front and rear of the snowmobile are in balance. While off-the-shelf carbide

ski runners are adequate, they don't necessarily give you optimal control, since that depends on your personal preferences, your riding style, and how your suspension is adjusted.

⚠ WARNING

If the front and rear of the snowmobile are out of balance due to an incorrect combination of traction enhancing products, the snowmobile may tend to oversteer or understeer, which could lead to a loss of control.

Oversteering

In certain conditions, using more aggressive ski carbide runners without studs on the rear track could make the snowmobile prone to oversteering, see illustration.

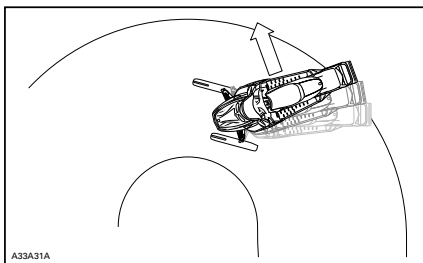

OVERSTEERING

Understeering

In certain conditions, the use of studs on the track could make the snowmobile prone to understeering if the skis are not equipped with more aggressive ski carbide runners, see illustration.

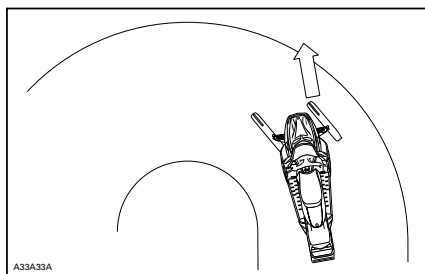

UNDERSTEERING

Controlled Driving

A balanced combination of carbide ski runners and studs on the track ensures adequate control and better handling, see illustration.

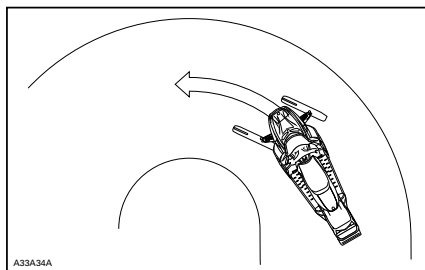

CONTROLLED DRIVING

Acceleration

Using studs on the track will allow your sled to accelerate better on packed snow and ice but will have no noticeable effect on soft snow. This can cause sudden variations in traction under certain conditions.

⚠ WARNING

To prevent surprises that could lead to a loss of control of the snowmobile:

- Always go easy on the throttle.
- NEVER try to spin the track to make the rear of the snowmobile skid.

This could cause debris or ice to be thrown violently backwards, possibly injuring others nearby or on snowmobiles behind you.

Braking

As in the case of acceleration, using studs on the track will give you better braking capacity on packed snow or ice but will have no noticeable effect on soft snow. Braking may thus vary suddenly under certain conditions. Be sure to use restraint in braking to keep from blocking the track in order to avoid surprises that could lead to a loss of control.

Important Safety Rules**⚠ WARNING**

To prevent serious injury to individuals near the snowmobile:

- NEVER stand behind or near a moving track.
- Always use a wide-base snowmobile stand with a rear deflector panel if it is necessary to rotate track.
- When the track is raised off the ground, only run it at the lowest possible speed.

Centrifugal force could cause debris, damaged or loose studs, pieces of torn track, or an entire severed track to be violently thrown backwards out of the tunnel with tremendous force.

Effects of Having a Studded Track on the Life of the Snowmobile

The use of traction enhancing products can increase the load and the stress on certain snowmobile components, as well as the vibration level. This can cause premature wear on parts such as belts, brake linings, bearings, chain, chaincase sprocket, and on approved

studded tracks, shorten track life. Always proceed with a visual inspection of your track before each use. For more information, refer to *TRACK* in *MAINTENANCE*.

Studs on the track can also cause serious damage to your snowmobile if it is not equipped with the tunnel protectors designed for your particular model. Damage to the electrical wiring or perforation of the heat exchangers are potential hazards, that could cause the engine to overheat and be severely damaged.

 **WARNING**

If tunnel protectors are excessively worn or not installed, the gas tank could be punctured, causing a fire.

NOTICE Ask your dealer for the appropriate tunnel protectors model and kit number required for your snowmobile.

NOTE: Consult the BRP limited warranty to find out what warranty limitations are related to the use of studs.

Installation of Studs on BRP Approved Tracks

 **WARNING**

Never stud a track that has not been approved for studs. Approved tracks can be identified by a stud symbol (see illustration below) molded into the track surface. Installing studs on an unapproved track could increase the risk of the track tearing or severing.

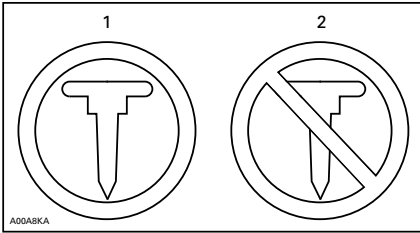

TRACK SYMBOLS

1. *Approved*
2. *NOT Approved*

To ensure safe and proper installation, BRP recommends to have the studs installed by your dealer.

- Use only the BRP approved special studs.
- Never use studs that exceed the height of your snowmobile's track profile by more than 9.5 mm (3/8 in).

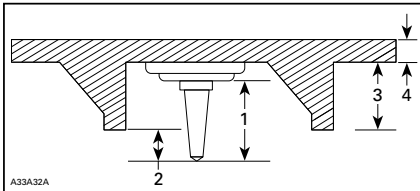

INSTALLATION OF STUDS

1. *Stud size*
2. *Penetration range 6.4 mm to 9.5 mm (1/4 in to 3/8 in)*
3. *Track lug height*
4. *Track belt thickness*

NOTE: All Radien MY19 models need to have stud protector installed on front and rear parts of the radiator, if studs are used.

 **WARNING**

- See an authorized Lynx dealer for current specific studding availability and applications.
- **DO NOT EVER** use conventional stud because, the track thickness is thinner than our standard tracks and the stud could tear off of track and separate from vehicle.
- Studs should only be installed in the locations indicated by molded bulges in the track surface. Some track models have two types of molded bulges; triangles and circles. See the warning molded into the track surface to know which one to use.
- Never stud a track with a profile of 35 mm (1-3/8 in) or more.
- The number of studs installed must always perfectly match the pattern of molded bulges in the track.
- Always consult the traction product manufacturer's installation instructions and recommendations before having your dealer install studs and runners. It is very important to follow the torque specifications for the stud bolts.

INSTALLING AN INCORRECT NUMBER OF STUDS OR AN IMPROPER INSTALLATION CAN INCREASE THE RISK OF THE TRACK TEARING OR SEVERING.

Maintenance/Replacement

PROCEED WITH A VISUAL INSPECTION OF YOUR TRACK BEFORE EACH USE.

Look for any defects, such as:

- Perforations in the track
- Tears in the track (particularly around traction holes on studded tracks)
- Lugs that are broken or torn off, exposing portions of rods
- Delamination of the rubber
- Broken rods
- Broken studs (studded tracks)
- Bent studs (studded tracks)
- Missing studs
- Studs that are torn off the track
- Missing track guide(s)
- Also, ensure that studs nut are tighten to the recommended torque.

On approved studded tracks, replace broken or damaged studs immediately. If your track shows signs of deterioration, it must be replaced immediately. When in doubt, ask your dealer. Always proceed with a visual inspection of your track before each use.

WARNING

Riding with a damaged track or studs could lead to loss of control.

IMPORTANT ON-PRODUCT LABELS

Hang Tag(s)

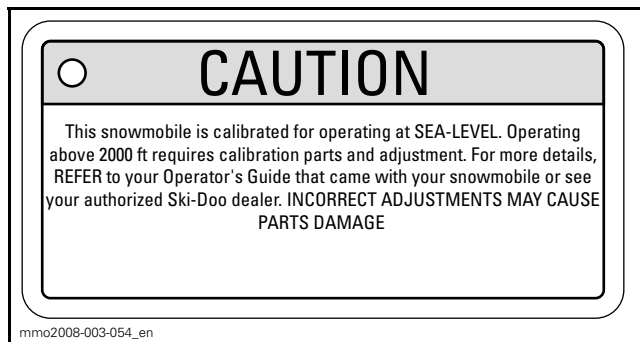

Vehicle Safety Labels

These labels are affixed to the vehicle for the safety of the operator, passenger or bystanders.

The following labels are on your vehicle and they should be considered permanent parts of the vehicle. If missing or damaged, the decals can be replaced free of charge. See an authorized Lynx dealer.

NOTE: In the event of any discrepancy between this guide and the vehicle, the safety labels on the vehicle have precedence over the labels in this guide.

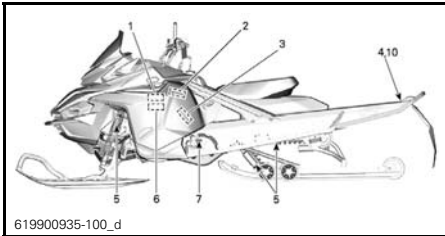

TYPICAL

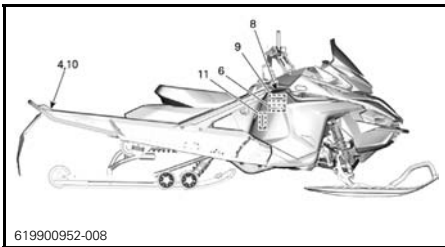

TYPICAL

Label 1

Toujours débrancher les connecteurs électriques des deux injecteurs d'essence avant de vérifier la production d'étincelles. Autrement, une étincelle pourrait allumer des vapeurs d'essence, ce qui représenterait un risque de feu.

AVERTISSEMENT 

WARNING 

Always electrically disconnect both fuel injectors prior to testing for ignition spark. Otherwise, fuel vapors may ignite in presence of a spark creating a fire hazard.

516007661

EN-516007661-DEC

LABEL 1

Label 2









 <p>WARNING</p> <p>This guard must ALWAYS be in place when engine is running beware of rotating parts they could cause injuries or catch your clothing.</p>	<p>NOTICE</p> <p>Drive pulley bolt recommended torque 85-92 lbf-ft / 115-125N-m</p> <p>Not applying the recommended torque may result in a major failure of the drive pulley and the engine. Refer to the shop manual for the complete assembly procedure.</p>
516007667	
EN-516007667-DEC	

LABEL 2

Label 3

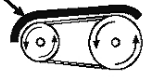
 **WARNING**

- Locate and read operator's guide. Follow all instructions and warnings.
- Beware of hot parts.
- Beware of hot vapors.
- Do not use without pulley guard.
- Beware of drive belt.
- Read instructions before service.

			
			
516003919			

516003919

LABEL 3

Label 4

 **WARNING**

Beware of rotating track



LABEL 4

Label 5

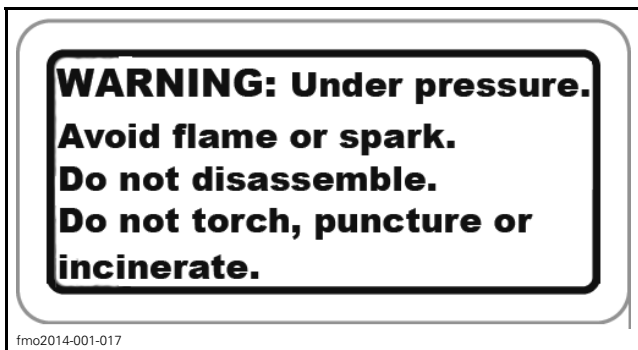

LABEL 5

Label 6



LABEL 6

Label 7



EN-516007652-DEC

LABEL 7

Label 8

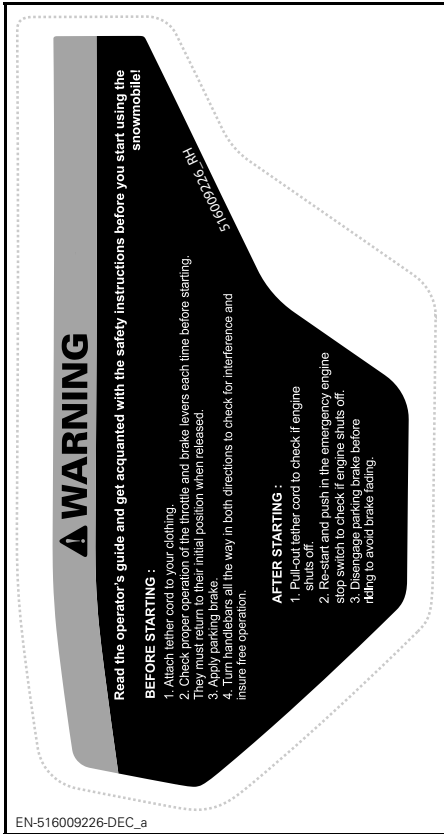

LABEL 8

Label 9



LABEL 9

Label 10

! WARNING

Exceeding maximum cargo load may affect steering control, braking ability and cause permanent damage.

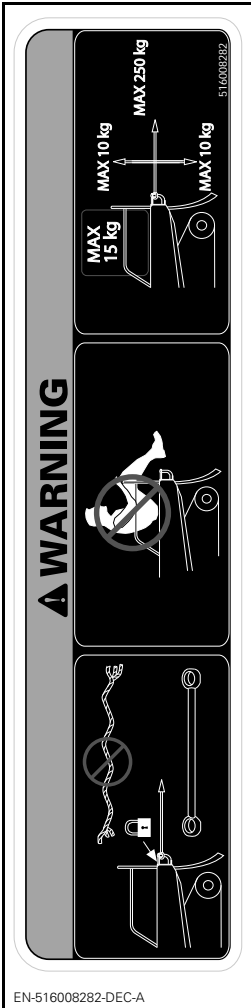

LABEL 10 - 49 RANGER MODELS

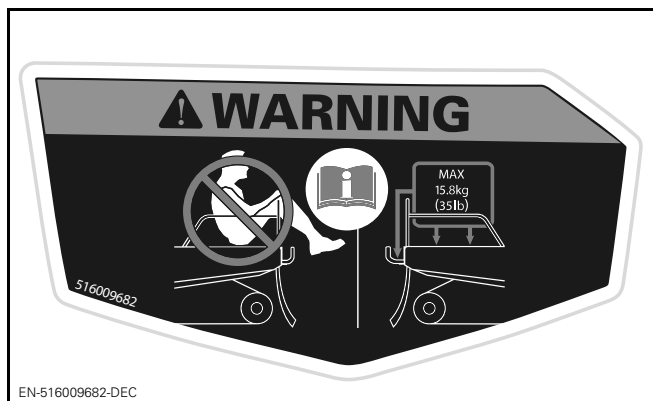

LABEL 10 - XTRIM SC MODELS

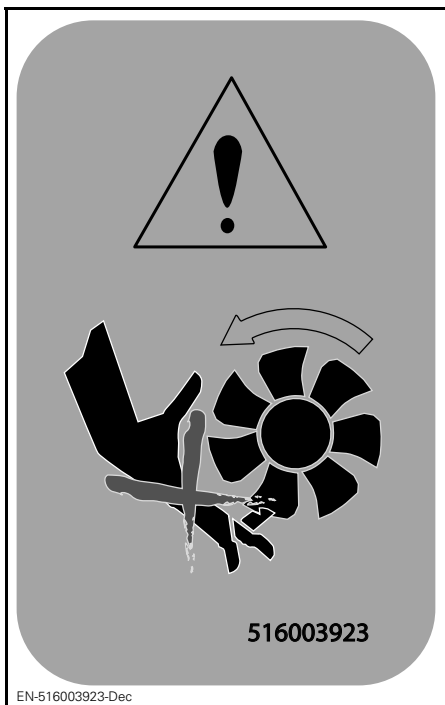

LABEL 11

Technical Information Labels

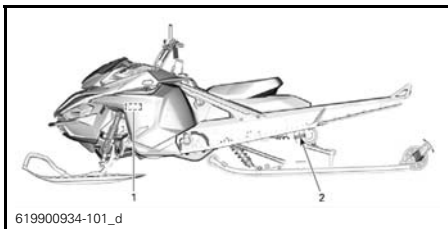

619900934-101_d

TYPICAL

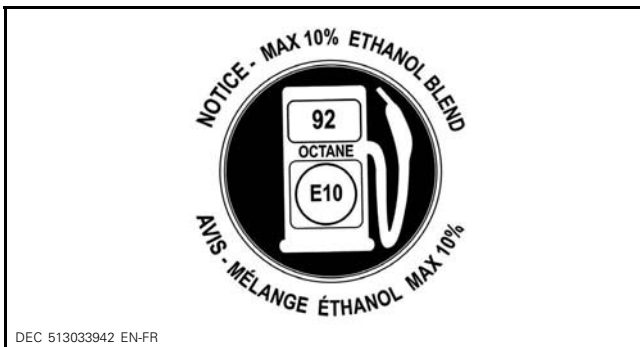

DEC 513033942 EN-FR

ON FUEL CAP - IN COUNTRIES USING RON OCTANE RATINGS

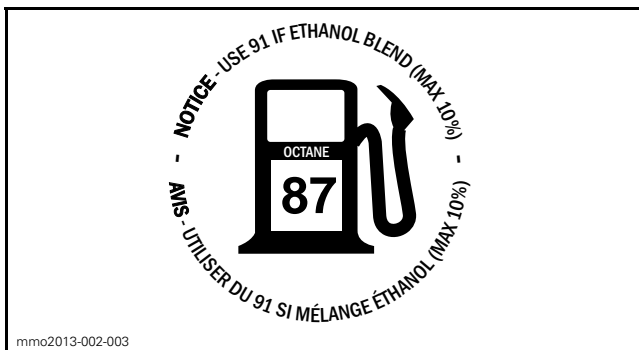

mmo2013-002-003

ON FUEL CAP - IN COUNTRIES USING PUMP POSTED AKI (RON+MON)/2 OCTANE RATINGS

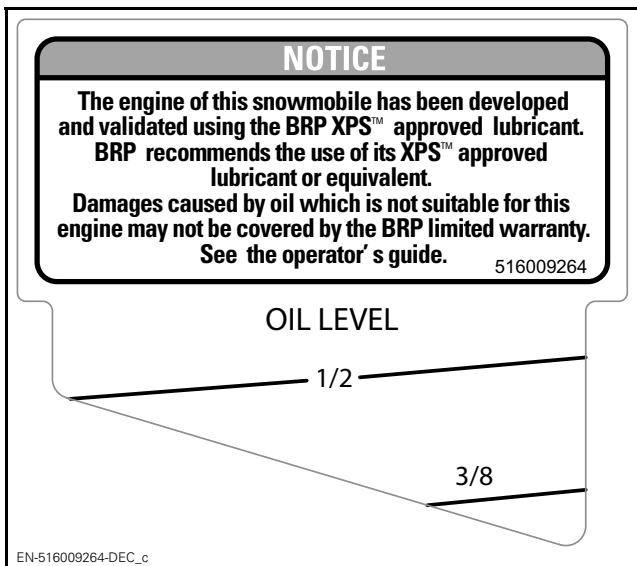

EN-516009264-DEC_c

LABEL 1

IMPORTANT ON-PRODUCT LABELS

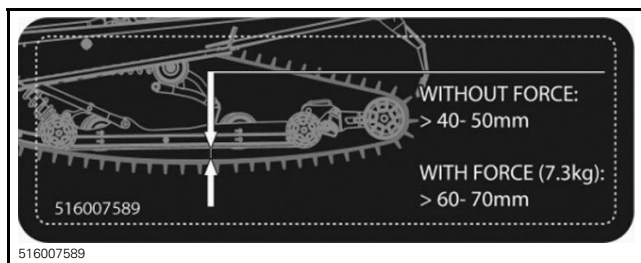

LABEL 2 - 49 RANGER PRO MODELS

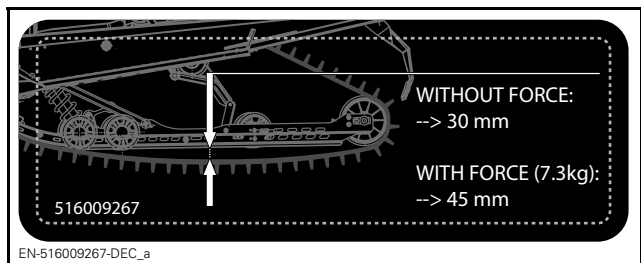

LABEL 2 - XTRIM SC MODELS

VEHICLE INFORMATION

CONTROLS, INSTRUMENTS AND EQUIPMENT

NOTE: Some features may not apply to your model or could be optional.

NOTE: Some vehicle safety labels are not shown on illustrations. For information on vehicle safety labels, refer to *IMPORTANT ON-PRODUCT LABELS*.

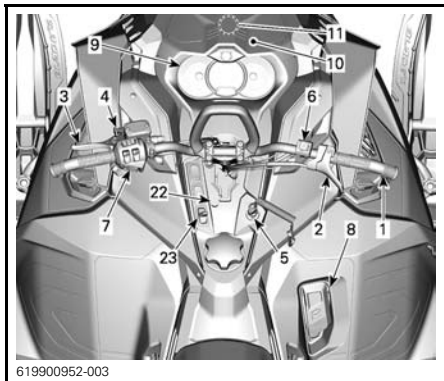

TYPICAL

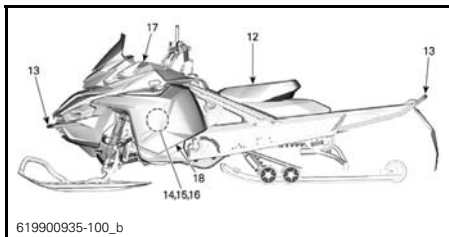

TYPICAL

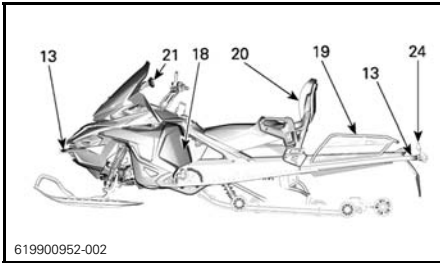

49 RANGER ST MODELS

1) Handlebar

The handlebar controls the steering of the snowmobile. As the handlebar is rotated to right or left, the skis are turned right or left to steer the snowmobile.

⚠ WARNING

Fast reverse while turning, could result in loss of stability and control.

2) Throttle Lever

Throttle lever is located on the RH side of handlebar.

Designed to be thumb activated. When squeezed, it increases the engine speed. When released, engine speed returns automatically to idle.

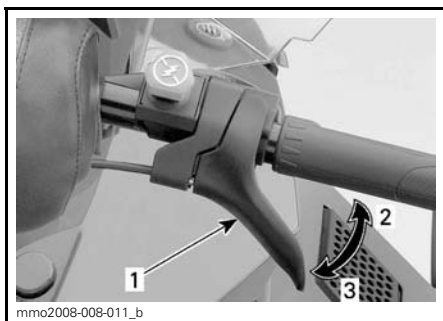

TYPICAL

1. *Throttle lever*
2. *To accelerate*
3. *To decelerate*

! WARNING

Test the throttle lever operation each time before starting the engine. The lever must return to the rest position once released. Otherwise, do not start engine.

3) Brake Lever

Brake lever is located on the LH side of handlebar.

When squeezed, brake is applied. When released, it automatically returns to the rest. Braking effect is proportional to the pressure applied on the lever and to the type of terrain and its snow coverage.

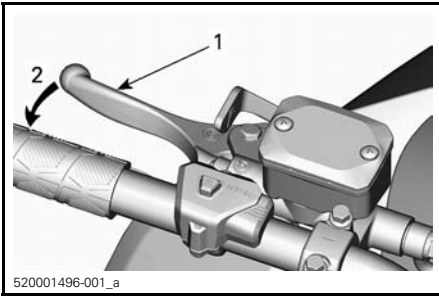

TYPICAL

1. Brake lever
2. Apply brake

4) Parking Brake Lever

Parking brake lever is located on the LH side of handlebar.

Parking brake should be used whenever snowmobile is parked.

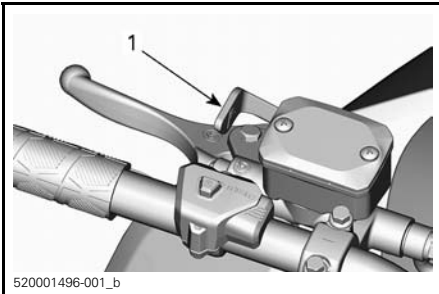

TYPICAL

1. Parking brake lever

WARNING

Make sure parking brake is fully disengaged before operating the snowmobile. When you ride the vehicle, brake pads that are caused to drag by a continuous pressure on the lever may cause damage to the brake system and cause loss of braking capacity and/or fire.

To Engage Parking Brake

Apply and hold brake, then lock brake lever using the parking brake lever as shown.

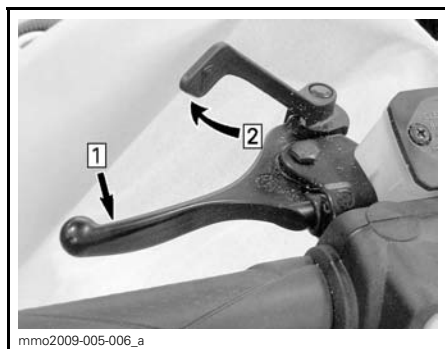

TYPICAL — ENGAGE MECHANISM

Step 1: Apply and hold brake

Step 2: Lock brake lever using parking brake lever

To Release Parking Brake

Squeeze brake lever. Parking brake lever will automatically return to its original position. Always release parking brake before riding.

WARNING

If release mechanism is covered by ice or snow, you should clean the mechanism and confirm mechanically that parking brake is released.

5) Engine Cut-off Switch

The engine cut-off switch (tether cord) is located on the console.

The tether cord cap must be securely snapped on the engine cut-off switch to allow vehicle operation.

NOTE: After engine starting, 2 short beeps should be heard if a programmed D.E.S.S. key (tether cord cap) is correctly snapped on engine cut-off switch. If another beep code is heard, refer to *MONITORING SYSTEM* for D.E.S.S. malfunction codes information.

Pulling the tether cord cap from the switch shuts the engine off.

 **WARNING**

Always attach the tether cord eyelet to clothing before starting the engine.

D.E.S.S. (Digitally Encoded Security System)

The tether cord cap has an integrated D.E.S.S. key to provide you and your snowmobile with the equivalent security of a conventional lock key.

The D.E.S.S. key contains an electronic chip which features a unique permanently memorized digital code.

Your authorized Lynx dealer has programmed the D.E.S.S. of your snowmobile to recognize the D.E.S.S. key in the tether cord cap to allow vehicle operation.

If another tether cord is used without programming the D.E.S.S., the engine will start but will not reach drive pulley engagement speed to move vehicle.

Make sure the tether cord cap is free of dirt or snow.

D.E.S.S. Flexibility

The D.E.S.S. of your snowmobile can be programmed by your authorized Lynx dealer to accept up to 8 different keys.

We recommend the purchase of additional tether cords from your authorized Lynx dealer. If you have more than one D.E.S.S. equipped Lynx snowmobile, each can be programmed by your authorized Lynx dealer to accept the other vehicles D.E.S.S. keys.

6) Emergency Engine Stop Switch

The emergency engine stop switch is located on the RH side of handlebar.

Push-pull type switch.

To stop the engine in an emergency, select OFF position (down) and simultaneously apply the brake. To restart, button must be at the ON position (up).



OFF POSITION

To allow engine starting, the switch must be in the ON position (UP).

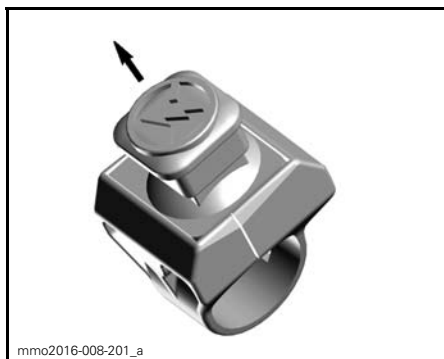

ON POSITION

All operators of the snowmobile should familiarize themselves with the function of the emergency engine stop switch by using it several times on first outing and whenever stopping the engine thereafter. This engine stopping procedure will become a reflex and will prepare operators for emergency situations requiring its use.

⚠ WARNING

If the switch has been used in an emergency caused by a suspected malfunction, the source of the malfunction should be determined and corrected before restarting engine. See an authorized Lynx dealer for servicing.

7) Multifunction Switch

Multifunction switch is located on the LH side of handlebar.

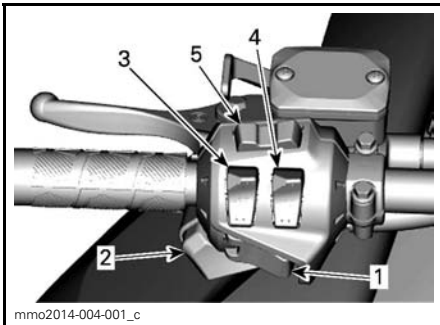
**TYPICAL**

1. Start button
2. Headlights dimmer switch
3. Heated grips switch
4. Heated throttle lever switch
5. Mode/set button

Start Button

On electric start models, press to start engine. Refer to *ENGINE STARTING PROCEDURE* in *BASIC PROCEDURES*.

Headlights Dimmer Switch

Press to select HI or LOW beam. Lights are automatically ON when the engine is running.

Heated Grips Switch

NOTE: Under 2000 RPM, heated grips will be limited at 50%.

Depress switch as required to select heating intensity to keep your hands at a comfortable temperature.

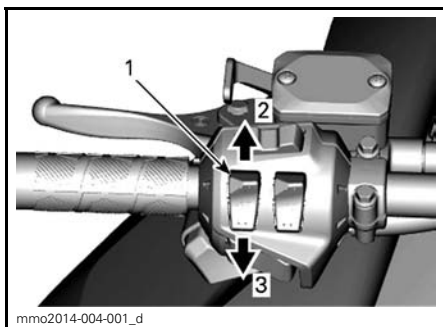

TYPICAL - VARIABLE INTENSITY

1. Heated grip switch
2. Increase heat
3. Decrease heat

The heating intensity is displayed via the digital display.

NOTE: There are nine intensity settings. When released, display will return to engine coolant temperature (if equipped).

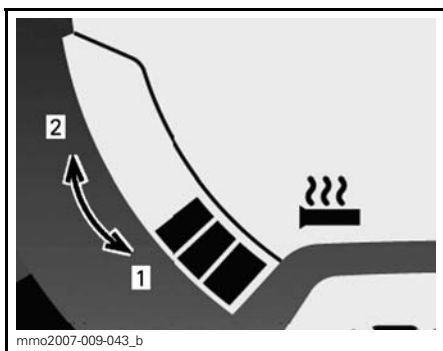

HEATING INTENSITY DISPLAY

1. Less heat
2. More heat

Heated grips will be in OFF position when there are no bars displayed on the gauge.

Heated Throttle Lever Switch

NOTE: Under 2000 RPM, heated throttle lever will be limited at 50%.
Depress switch as required to select heating intensity to keep your thumb at a comfortable temperature.

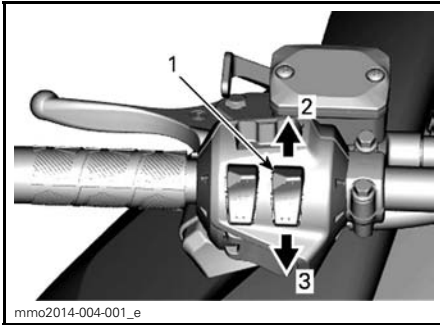

TYPICAL - VARIABLE INTENSITY

1. Heated throttle lever switch
2. Increase heat
3. Decrease heat

NOTE: The heating intensity is displayed via the multifunction display with the activation of the throttle lever switch. There are nine intensity settings. When released, display will return to fuel tank level.

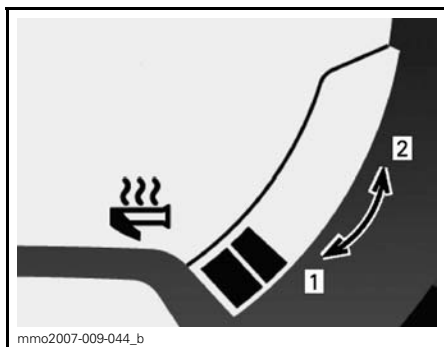

HEATING INTENSITY DISPLAY

1. Less heat
2. More heat

Heated throttle lever will be in OFF position when there are no bars displayed on the gauge.

Mode/Set Button

This button is used to manage the information displayed on the multifunction analog/digital gauge.

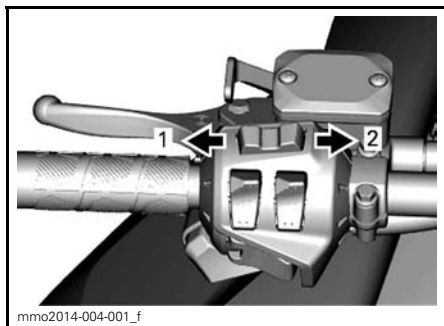

TYPICAL - MULTIFUNCTION GAUGE

1. MODE function
2. SET function

8) Reverse (Mechanical)

Reverse lever is located on right hand side of snowmobile. Refer to *REVERSE (MECHANICAL)* in *BASIC PROCEDURES* for procedure.

9) Gauge

Multifunction Analog/Digital Gauge

⚠ WARNING

Reading the gauge digital display can distract from the operation of the vehicle, particularly from constantly scanning the environment.

NOTE: The gauge is factory preset in Imperial units and in English. To change units or language, contact an authorized Lynx dealer.

Gauge Features

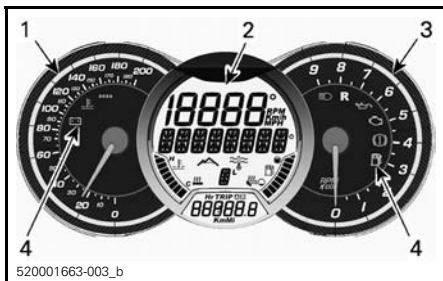

MULTIFUNCTION ANALOG/DIGITAL GAUGE

1. Analog speedometer
2. Multifunction digital display
3. Analog tachometer
4. Pilot lamps

1) Analog Speedometer

Indicates vehicle speed.



TYPICAL - LH PORTION OF GAUGE

2) Analog Tachometer

Indicates engine revolution per minute (RPM). Multiply by 1000 to obtain the actual revolutions.





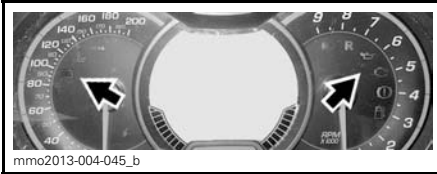

TYPICAL - RH PORTION OF GAUGE

3) Pilot Lamps and Messages



TYPICAL — PILOT LAMPS

See table below for usual pilot lamps information. Refer to *MONITORING SYSTEM* for details on malfunction pilot lamps and messages.

PILOT LAMP ON	BEEPER	MESSAGE DISPLAY	DESCRIPTION
	4 short beeps every 5 minutes	LOW OIL	Injection oil level is low. Stop vehicle in a safe place then, replenish injection oil reservoir.
	—	—	Low fuel level. One (1) bar left in fuel level display. Replenish fuel tank as soon as possible.
	Long beeps repeating slowly	REVERSE	Reverse is selected.
	3 short beeps	REV. FAIL	Reverse did not engage, try again.
	—	—	High beam headlights are selected.
—	—	WARM UP	Engine and/or injection oil need to warm-up before normal operation. The engine's RPM is limited until desired temperature is reached (up to 10 minutes when driving). Warm-up period may occur after a restart in very cold weather.

4) Multifunction Digital Display

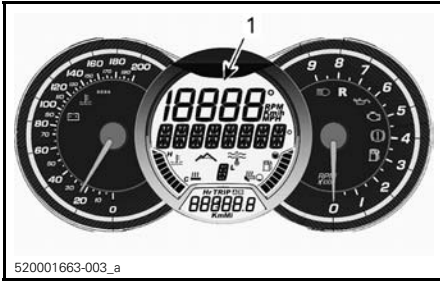

1. Multifunction display

The multifunction display is used to:

- Display the WELCOME message on power up
- Display the KEY recognition message
- Provide various indications as selected by the operator
- Display scrolling messages of function activation or system faults
- Display fault codes.

There are five digital displays where various information can be displayed.

- Upper display
- Center display
- Lower display
- LH side bar gauge
- RH side bar gauge

WARNING

Never adjust or set functions on the multifunction gauge while riding the vehicle.

Upper Display

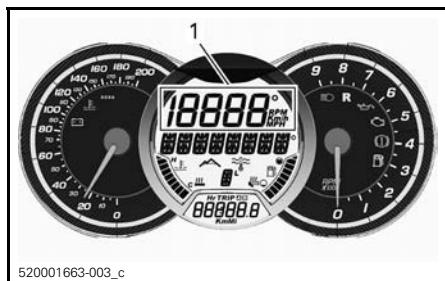

1. Upper Display

The following information can be selected on the upper display:

UPPER DISPLAY INFORMATION
Vehicle speed
Top speed (Since the last reset)
Average speed (Since the last reset)
Engine RPM
Top RPM (Since the last reset)
Instant fuel consumption
Total fuel consumption (Since the last reset)

To set the display to your preference, refer to *UPPER DISPLAY AND CENTER DISPLAY SET-UP*

Center Display

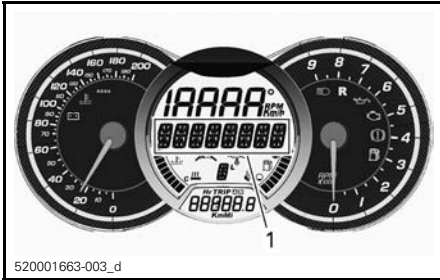

1. Center Display

The following information can be selected on the center display:

CENTER DISPLAY INFORMATION
Vehicle speed
Engine RPM
Engine coolant temperature
Altitude
System messages Refer to <i>PILOT LAMPS AND MESSAGES</i> and <i>MONITORING SYSTEM</i> for details

To set the display to your preference, refer to *UPPER DISPLAY AND CENTER DISPLAY SET-UP*

Lower display

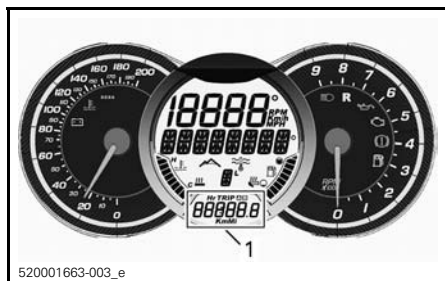

1. Lower display

The following information can be selected on the lower display:

LOWER DISPLAY INFORMATION
Odometer
Trip odometer
Trip hour
Clock

To set the display to your preference, refer to *LOWER DISPLAY SET-UP*

LH side Bar Gauge

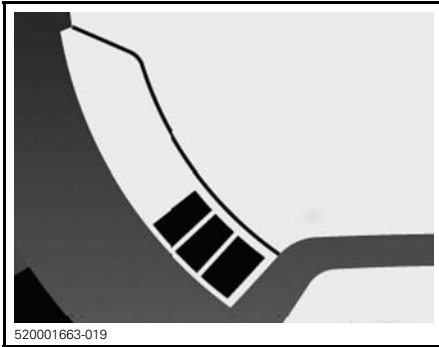

LH BAR GAUGE INFORMATION

Engine coolant temperature
Heated grips level

The LH side bar gauge displays the engine coolant temperature except while adjusting the heated grips.

NOTICE If engine overheats, stop vehicle in a safe place. Refer to TROUBLESHOOTING.

For details on heated grips operation, refer to *HEATED GRIPS SWITCH* in this section.

RH side Bar Gauge

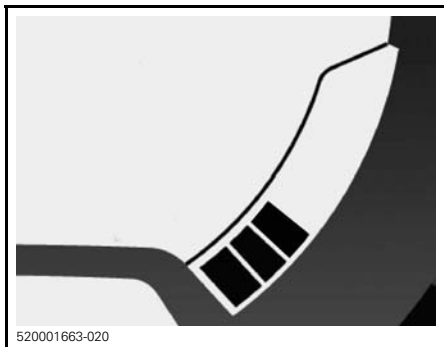

RH BAR GAUGE INFORMATION
Fuel level
Heated throttle lever level

The RH side bar gauge displays the fuel level except while adjusting the heated throttle lever.

For details on heated throttle lever operation, refer to *HEATED THROTTLE LEVER SWITCH* in this section.

Upper Display and Center Display Set-Up

1. Select the upper or center display by using the MODE (M) button on the multifunction switch.

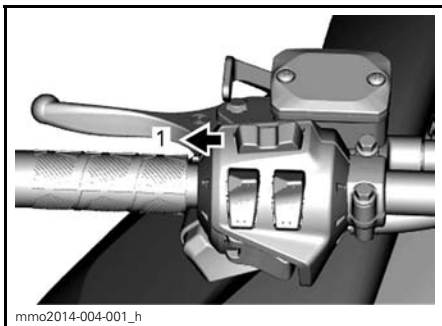

TYPICAL
1. MODE (M) button

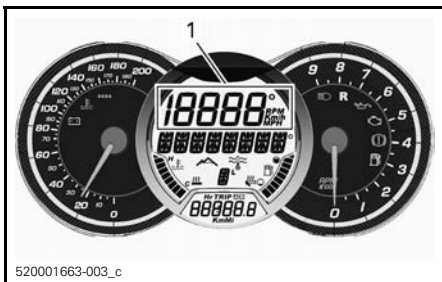

1. Upper display

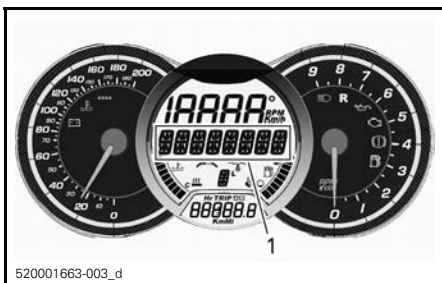

1. Center display

2. While the desired display is flashing, navigate through the display, by using the SET (S) button on the multifunction switch.

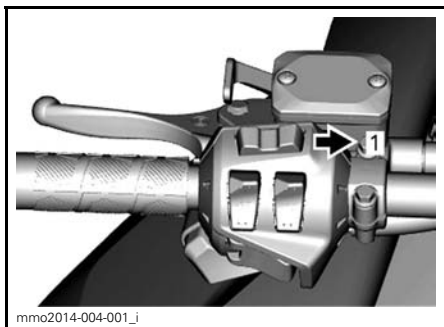

TYPICAL

1. SET (S) button

Once the desired information is displayed, press the MODE (M) button or wait 5 seconds to confirm.

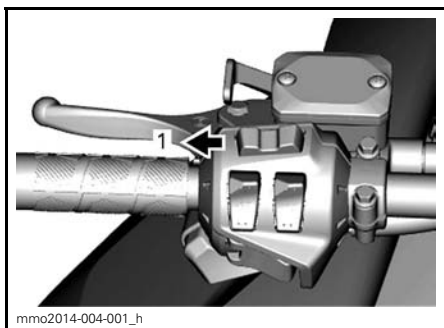

TYPICAL

1. MODE (M) button

To reset

- Average speed
- Top speed

- Total fuel consumption
- Top RPM

Press and hold the SET (S) button while display is flashing.

Lower Display Set-Up

Odometer and Hour Meter

Select the desired information by using the SET (S) button on the multifunction switch.

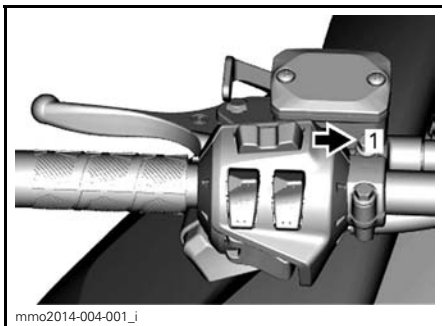

TYPICAL

1. SET (S) button



1. Lower display

To reset

- Trip odometer A or B
- Trip hour Meter

Press and hold the SET (S) button.

Clock

NOTE: This clock displays hour in the 24-hour format only.

Press the SET (S) button to select the clock mode on the lower display.

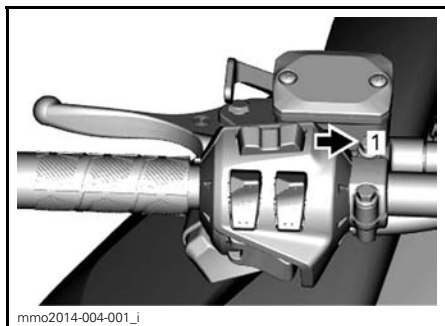

mmo2014-004-001_i

TYPICAL

1. SET (S) button

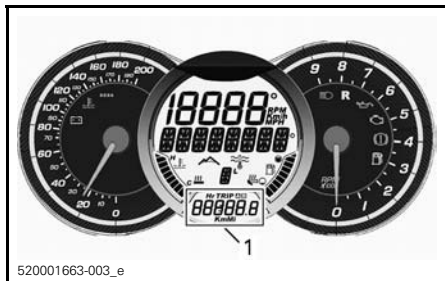

520001663-003_e

1. Lower display

To set time:

- Press and hold the SET (S) button
- While the hour digits are flashing, use the SET (S) button to set
- Use the MODE (M) button to switch to the minutes digits

- While the minutes digits are flashing, use the SET (S) button to set
- Press the MODE (M) button to save clock set-up and exit.

Gauge Features

Multifunction Digital Gauge

⚠ WARNING

Reading the gauge digital display can distract from the operation of the vehicle, particularly from constantly scanning the environment.

NOTE: The gauge is factory preset in Imperial units and in English. To change units or language, contact an authorized Lynx dealer.

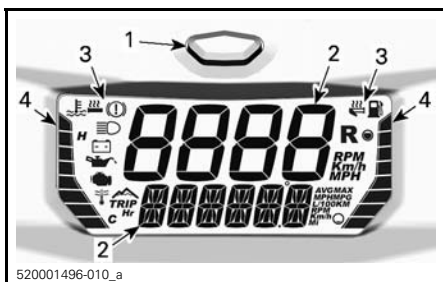

MULTIFUNCTION DIGITAL GAUGE

1. Mode button
2. Digital displays
3. Icons
4. Bar gauges

The gauge also has a built-in beeper.

Digital Display

⚠ WARNING

Never adjust or set functions on the multifunction gauge while riding the vehicle.

To set the displays to your preference, refer to *DISPLAY COMBINATION SELECTION*.

Upper Display

The upper display is used to display:

- Vehicle speed.
- Engine speed RPM.

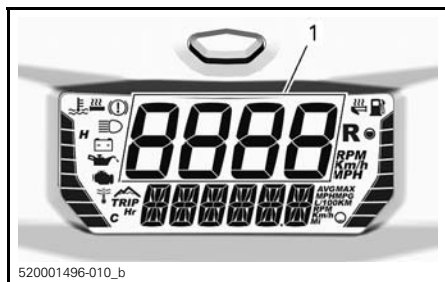

1. Upper Display

Lower Display

The lower display is used to display

- Various information (in combination with the upper display)
- Messages, refer to *ICONS AND MESSAGES* and *MONITORING SYSTEM* for details.
- Fault codes, refer to *MONITORING SYSTEM* for details.

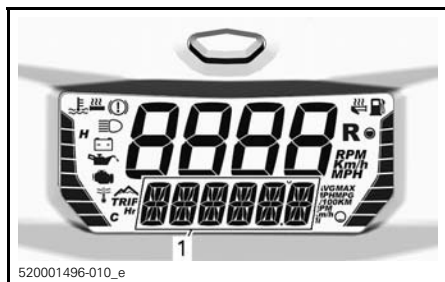

1. Lower display

LH side Bar Gauge



520001496-010_c

1. LH bar gauge

LH BAR GAUGE INFORMATION

Engine coolant temperature

Heated grips level

The LH side bar gauge displays the engine coolant temperature except while adjusting the heated grips.

NOTICE If engine overheats, stop vehicle in a safe place. Refer to TROUBLESHOOTING.

For details on heated grips operation, refer to *HEATED GRIPS AND THROTTLE LEVER SWITCH* in this section.

RH side Bar Gauge



1. RH bar gauge

LH BAR GAUGE INFORMATION

Fuel level

Heated throttle lever level

The RH side bar gauge displays the fuel level except while adjusting the heated throttle lever.

For details on heated throttle lever operation, refer to *HEATED AND THROTTLE LEVER SWITCH* in this section.

Display Combination Selection

To scroll through the information options, press and release the mode button repeatedly until the desired information is displayed.

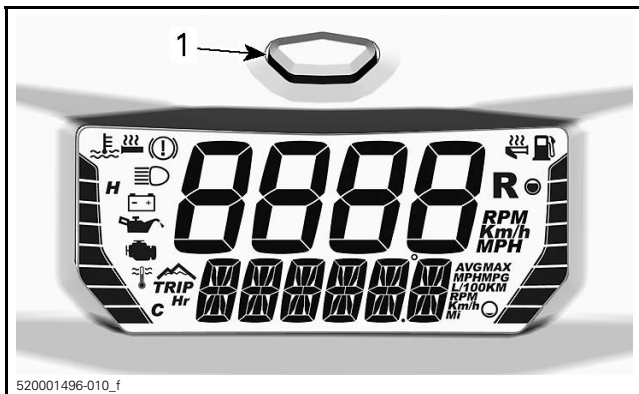

1. Gauge mode button

The upper and lower displays can be set as combinations only. They cannot be set separately.

See the following table for available combinations.

AVAILABLE DISPLAY COMBINATIONS			
	UPPER DISPLAY	LOWER DISPLAY	ICON/ SPECIFIC INFORMATION
1	Engine speed RPM	Vehicle speed	—
2	Vehicle speed	Engine speed (RPM)	—
3	Engine RPM	Altitude	





AVAILABLE DISPLAY COMBINATIONS				
	UPPER DISPLAY	LOWER DISPLAY	ICON/ SPECIFIC INFORMATION	
4	Vehicle speed	Altitude		
5		Odometer	—	
6		Trip odometer A (1)	TRIP	
7		Trip odometer B (1)	TRIP	
8		Trip hour (1)	TRIP Hr	
9		Top speed (1) (2)	MAX	
10		Average speed (1) (2)	AVG	
11		Top RPM (1)	MAX	
12		Average fuel consumption (4)	AVG	
13		Engine coolant temperature	—	
(1) Press and hold the mode button to reset (2) Resetting the trip odometer B also resets the average fuel consumption				

NOTE: Make sure to display the vehicle speed whenever this information is necessary.

Icons and Messages

See table below for usual icons and messages.

For details on malfunction pilot lamps and messages, refer to *MONITORING SYSTEM*.

ICON	BEEPER	MESSAGE LOWER DISPLAY	DESCRIPTION
—	2 short beeps	GOOD KEY	At power up, with a good key. Vehicle ready for use.
—	—	BREAK-IN	Displayed during break-in period. Refer to <i>BREAK-IN PERIOD</i>
	4 short beeps every 5 minutes	LOW OIL	Injection oil level is low. Stop vehicle in a safe place then, replenish injection oil reservoir.
	—	—	Low fuel level. One (1) bar left in fuel level display. Replenish fuel tank as soon as possible.
	Long beeps repeating slowly	REVERSE	Reverse is selected.
	3 short beeps	REV. FAIL	Reverse did not engage, try again.
	—	—	High beam headlights are selected.
—	—	WARM UP	Engine and/or injection oil need to warm-up before normal operation. The engine's RPM is limited until desired temperature is reached (up to 10 minutes when driving). Warm-up period may occur after a restart in very cold weather.

NOTE: Additional function may be available for your vehicle, see the appropriate Lynx accessory catalog.

10) Storage Compartment

A storage compartment is located at the front of the vehicle, above the gauge.

The Operator's Guide and the emergency starter rope are in the front storage compartment.

To open, push the button and lift the cover.

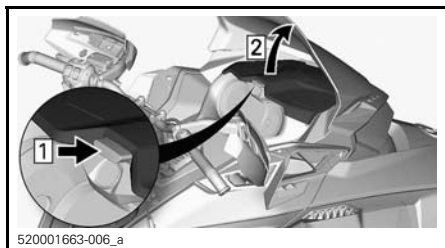

TYPICAL

NOTE: When closing, make sure cover is secured properly. You will hear a "clac".

11) Operator's Guide

The Operator's Guide should be stored in the *STORAGE COMPARTMENT*.

12) Seat

Seat Removal

Pull up on the front part of the seat.

Pull backwards while holding front part up.

Slide seat rearwards to remove it.

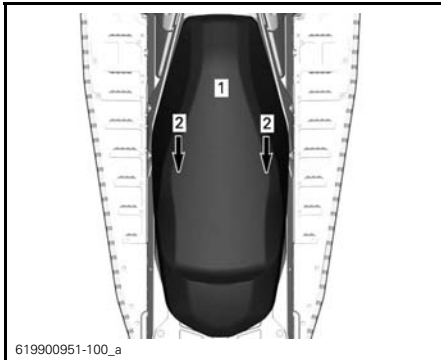

TYPICAL

Step 1: Pull up

Step 2: Pull backwards

Seat Installation

NOTICE Riding the vehicle with any objects between the seat and the fuel tank could damage the fuel tank. NEVER place any objects between seat and fuel tank.

Place seat over the hooks, then slide it forward.

⚠ WARNING

Make sure seat is securely latched before riding.

13) Front and Rear Bumpers

To be used whenever snowmobile requires manual lifting.

⚠ CAUTION Beware of injuries by using proper lifting techniques, notably using your legs force. Do not attempt to lift the rear of vehicle if it is above your limits. Use appropriate lifting device or have assistance to share lifting stress if possible.

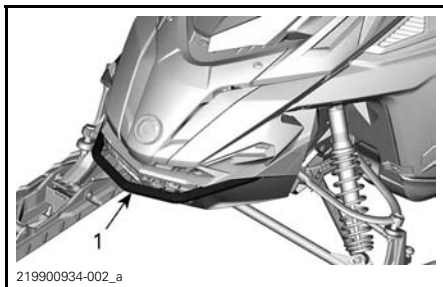

TYPICAL

1. Front bumper

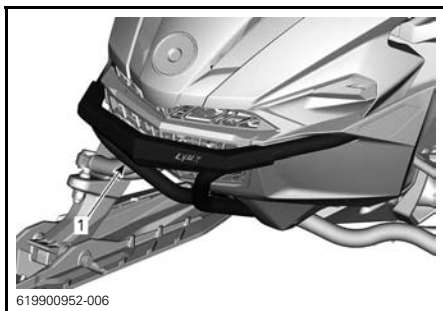

49 RANGER PRO MODELS

1. Front bumper

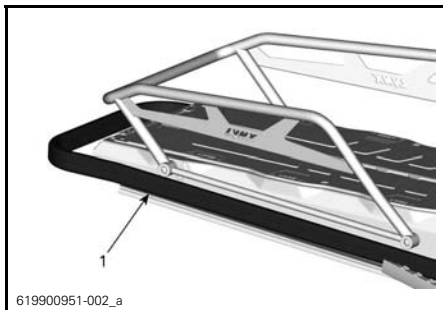

TYPICAL

1. Rear bumper

NOTICE Do not use skis to pull or lift snowmobile.

14) Drive Belt Guard

Drive Belt Guard Removal

WARNING

NEVER operate engine:

- Without shields and belt guard securely installed.
- With hood and/or side panels opened or removed.

NEVER attempt to make adjustments to moving parts while engine is running.

NOTE: Belt guard is purposely made slightly oversize to maintain tension on its pins and retainers preventing undue noise and vibration. It is important that this tension be maintained when reinstalling.

Remove tether cord cap from engine cut-off switch.

Open the LH side panel. See procedure in this section.

Remove retaining pin.

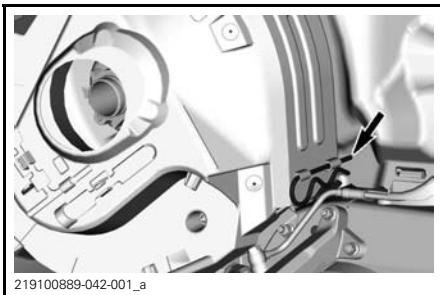

TYPICAL

Lift rear portion of guard then release from front tab.

Drive Belt Guard Installation

Insert the tab into the slot and push it into place

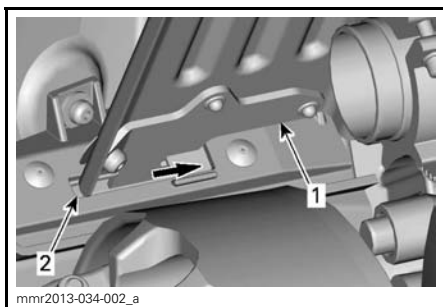

1. *Belt guard tab*
2. *Front support slot*

Push drive belt guard toward engine then toward front of vehicle.

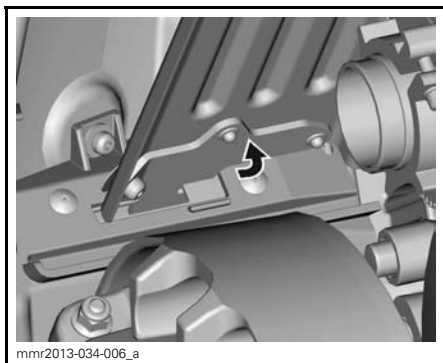

Position the rear portion of the belt guard over the retainer and secure it using the retaining pin.

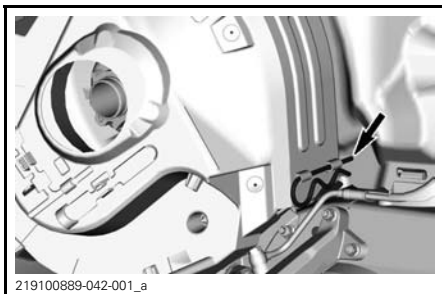

219100889-042-001_a

TYPICAL

15) Tools

A part of the drive belt guard is designed to hold the tools allowing for basic maintenance.

The tools are supplied with the vehicle.

NOTICE Make sure tools are secured properly.

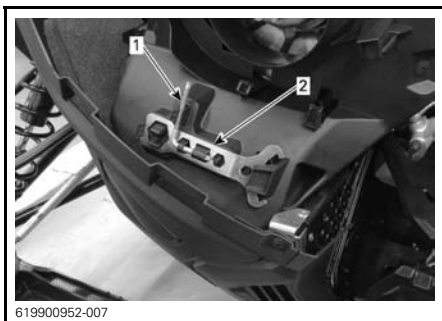

619900952-007

TYPICAL - DRIVE BELT GUARD

1. Pulley expander and headlight adjustment tool location
2. Suspension adjustment tool location

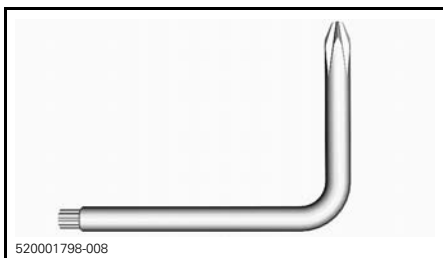

PULLEY EXPANDER AND HEADLIGHT ADJUSTMENT TOOL

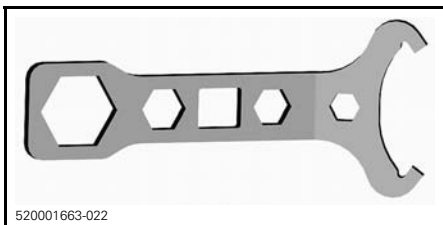

SUSPENSION ADJUSTMENT TOOL

16) Spare Drive Belt Holder

A spare drive belt can be stored in a holder located on the drive belt guard.

NOTE: The spare drive belt is not supplied with the snowmobile.

Position spare drive belt into drive belt guard slot.

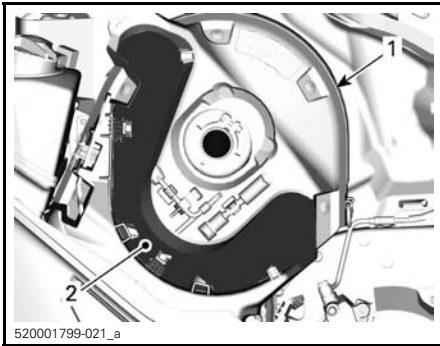

TYPICAL

1. Drive belt guard
2. Slot

Secure in place by sliding it behind the tabs.

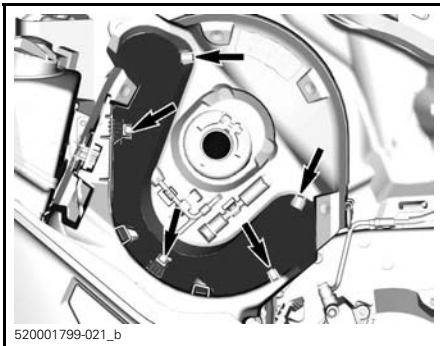

TYPICAL

17) Upper Body Module

Upper Body Module Removal

1. Open the storage compartment.

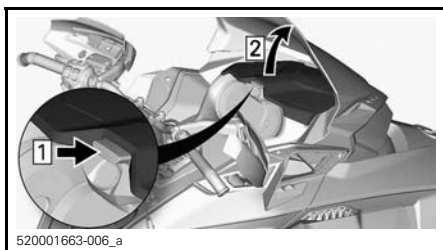

TYPICAL

2. Remove the gauge retaining screws.

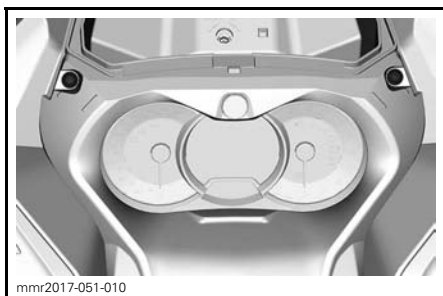

TYPICAL

3. Lift the front of the gauge, then slide it forward to remove it.

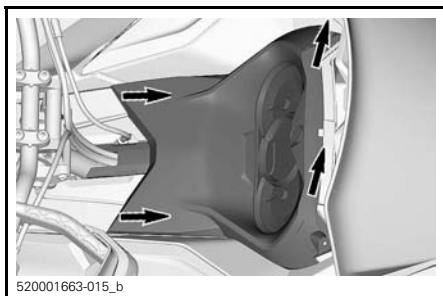

4. Disconnect gauge connector and set gauge aside.

5. Disconnect 12V post connectors before removing the storage compartment (if equipped).

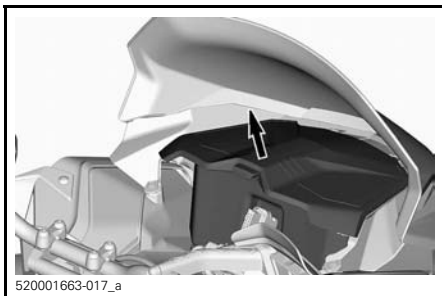

6. Disconnect the MAPTS and headlight connectors.

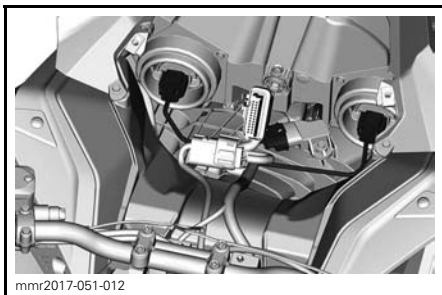

TYPICAL

7. Remove both side panels. Refer to *SIDE PANELS* in this section.
8. Loosen the air intake duct clamp.

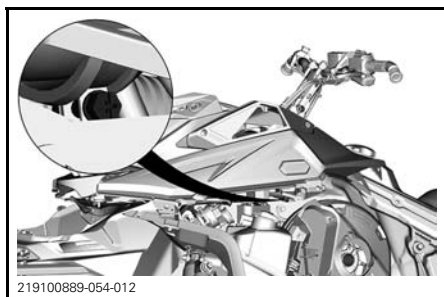

9. Remove the upper body module retaining screws on both sides.

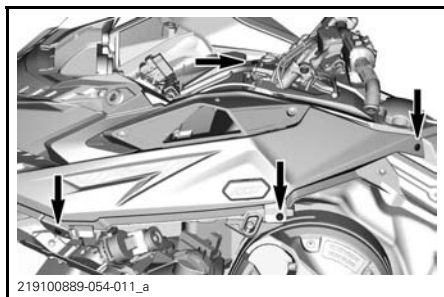

10. Remove the upper body module.
 - 10.1 Grab the upper body module in the gauge support section.
 - 10.2 Pull the module forward.
 - 10.3 Remove the module from the vehicle.

Upper Body Module Installation

1. At front, insert the upper body module tabs into the upper bottom pan openings.
 2. Lower the rear end of the upper body module.
- NOTE:** Make sure the air intake duct is positioned correctly in the boot.
3. Tighten air intake duct clamp.

4. On both sides, install the upper body module retaining screws.
5. Install the hood.

TIGHTENING TORQUE	
Upper body screws	2.3 N•m ± 0.2 N•m (20 lbf•in ± 2 lbf•in)
Hood screws	

6. Connect the manifold air pressure and temperature sensor (MAPTS) connector.
7. Connect the headlight connectors.
8. Install the storage compartment but leave the cover open.
9. Install gauge, secure with the screws.

TIGHTENING TORQUE	
Gauge screws	2.3 N•m ± 0.2 N•m (20 lbf•in ± 2 lbf•in)

10. Install the side panels.

18) Side Panels

WARNING

Never operate engine with side panels opened or removed from vehicle.

Side Panels Opening and Closing

Release all latches, then open panel.

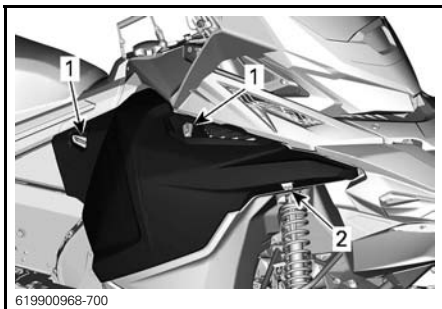

ALL MODELS EXCEPT 49 RANGER PRO

1. Turn
2. Push

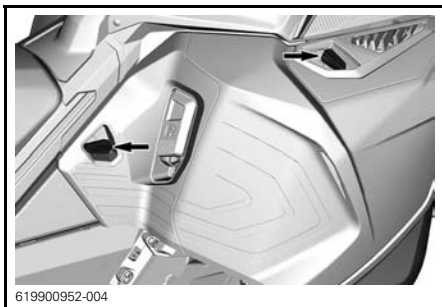

49 RANGER PRO

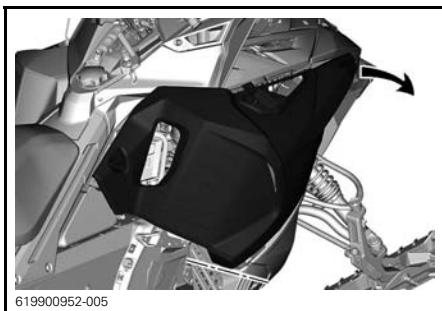

TYPICAL

When closing panel, make sure latches are locked securely.

Side Panels Removal

Open side panel.

Lift the side panel to disengage the tabs.

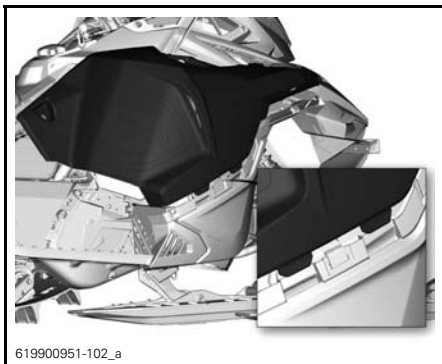

19) Rear Rack

WARNING

All objects in rear rack must be properly latched. Do not carry any breakable objects. Excessive weight in rack may reduce steering ability. Always readjust suspension according to the load. The capacity of this rack is limited, the **MAXIMUM** cargo load is 15.8 kg (35 lb). Ride at very low speed when loaded. Avoid speed over bumps.

49 Ranger Model

 **CAUTION** Always readjust suspension according to the load. The capacity of this rack is limited, the **MAXIMUM** cargo load is 25 kg (55.1 lb). Ride at very low speed when loaded. Avoid speed over bumps.

20) 2-up Seat (if equipped)

! WARNING

Any passenger must be able to firmly lay is feet on the footrests and keep his hands on the handholds at all times when seated. Respecting those physical criteria is important to ensures that the passenger is stable and to reduce the risks of ejection.

Passenger seat with backrest.

! WARNING

- Read operator's guide and get acquainted with the instructions before remove seat from the snowmobile.
- Make sure seat is securely latched before riding.

1. Pull up the rubber tabs.
2. Open The LINQ Attachments.
3. Lift the backrest.

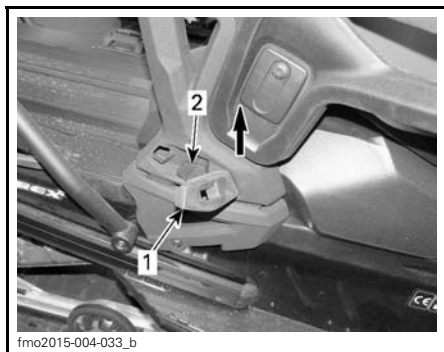

1. Rubber tab
2. LINQ Attachment

4. Refer to the decal located on the RH backrest bracket and locate backrest until it latches in position.

Backrest Installation

To install the backrest, proceed as follows:

1. Install backrest on vehicle.
2. Install screws on the backrest harms on both side.

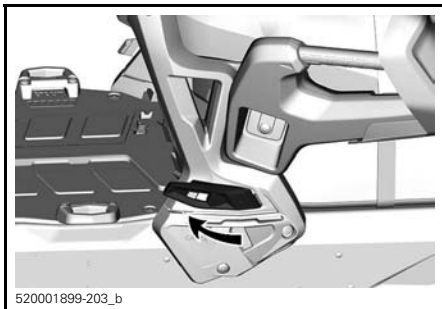

49 RANGER ST

Passenger Handhold (On Applicable Models)

To adjust the handhold height, proceed as follows:

1. Remove screws.

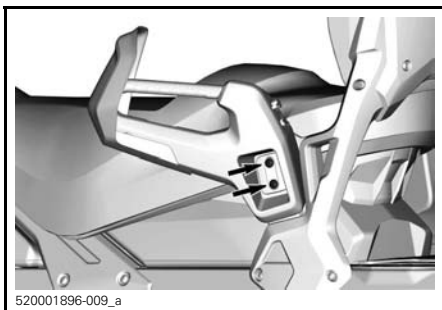

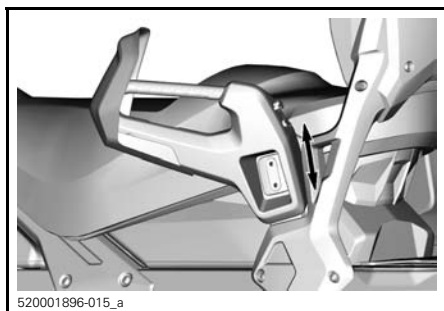

2. Raise or lower the handhold to suit passenger's comfort.
3. Reinstall screws. Tighten to specification.

TIGHTENING TORQUE	
Screws	24.5 N•m ± 3.5 N•m (18 lbf•ft ± 3 lbf•ft)

21) Adjustable Mirrors (On Applicable Models)

Each mirror can be adjusted to suit operator's preference.

WARNING

Adjust with vehicle at rest in a safe place.

When installing a cover, the mirrors can be tilted downward to ease installation.

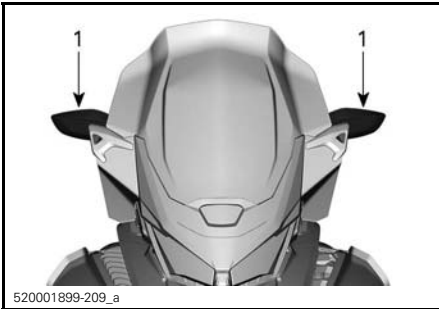

1. Mirrors

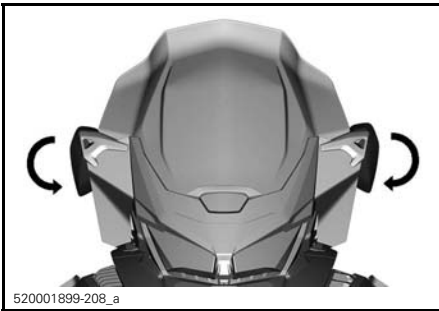

22) Electric Visor Jack Connector (On Applicable Models)

An electric visor can be connected to the jack connector. A stress relief extension is supplied with the vehicle.

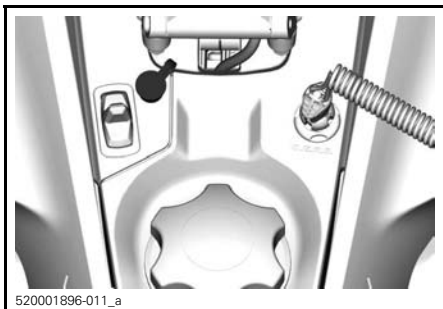

DRIVER - ELECTRIC VISOR JACK CONNECTOR LOCATION

23) Eco/Standard/Sport Modes (On Applicable Models)

The Eco/Standard/Sport switch is located on the console to the left of the steering column.

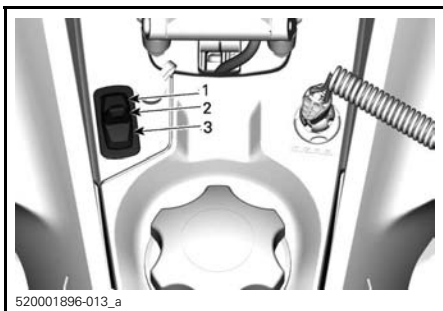

1. Sport mode
2. Standard mode
3. Eco mode

24) J-Hook

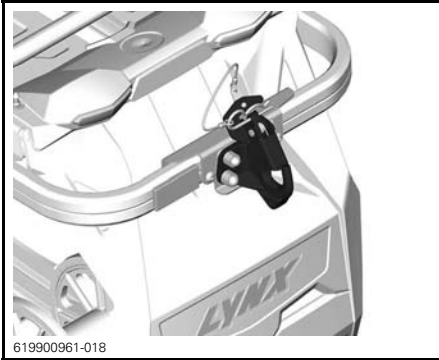

The J-Hook is located on the rear bumper. It can be used to tow. To use the hook, remove hairpin cotter to lower locking plate.

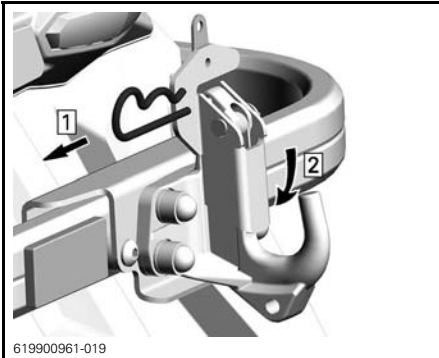

To lock, install hairpin cotter.

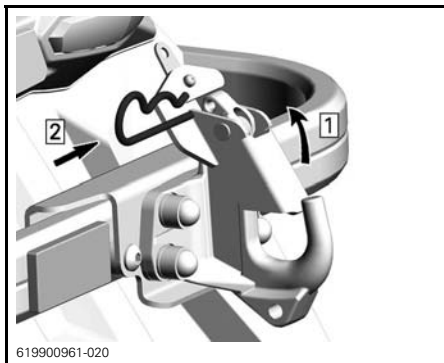

619900961-020

FUEL

Fuel Requirements

NOTICE Always use fresh gasoline. Gasoline will oxidize; the result is loss of octane, volatile compounds, and the production of gum and varnish deposits which can damage the fuel system.

Alcohol fuel blending varies by country and region. Your vehicle has been designed to operate using the recommended fuels, however, be aware of the following:

- Use of fuel containing alcohol above the percentage specified by government regulations is not recommended and can result in the following problems in the fuel system components:
 - Starting and operating difficulties.
 - Deterioration of rubber or plastic parts.
 - Corrosion of metal parts.
 - Damage to internal engine parts.
- Inspect frequently for the presence of fuel leaks or other fuel system abnormalities if you suspect the presence of alcohol in gasoline exceeds the current government regulations.
- Alcohol blended fuels attract and hold moisture which may lead to fuel phase separation and can result in engine performance problems or engine damage.

Recommended Fuel

Use unleaded gasoline containing MAXIMUM 10% ethanol. The gasoline must have the following minimum octane requirements.

FUEL TYPE	MIN. OCTANE RATING
Fuel with NO ethanol	87 AKI (RON+MON)/2 92 RON
Fuel which may contain up to 10% MAX ethanol	91 AKI (RON+MON)/2 95 RON 

NOTICE Never experiment with other fuels. Engine or fuel system damages may occur with the use of an inadequate fuel.

NOTICE Do NOT use fuel from fuel pumps labeled E85.

Use of fuel labeled E15 is prohibited by U.S. EPA Regulations.

Fuel Antifreeze Additives

When using oxygenated fuel, additional gas line antifreeze or water absorbing additives are not required and should be not used.

When using non-oxygenated fuel, isopropyl base gas line antifreeze can be used in a proportion of 150 ml (5 U.S. oz) of gas line antifreeze added to 40 L (10.6 U.S. gal.) of gas.

This precaution is in order to reduce the risk of frost buildup in fuel system components which may lead, in certain cases, to severe damage to engine.

NOTE: Use only methyl hydrate free gas line antifreeze.

Vehicle Fueling Procedure

WARNING

- Fuel is flammable and explosive under certain conditions.
- Never use an open flame to check fuel level.
- Never smoke or allow flame or spark in vicinity.
- Always work in a well-ventilated area.

1. Stop engine.

WARNING

Always stop engine before refueling.

2. Have operator and passenger get off vehicle.

WARNING

Do not allow anyone seated on the vehicle while fueling.

3. Unscrew slowly the fuel reservoir cap counterclockwise to remove it.

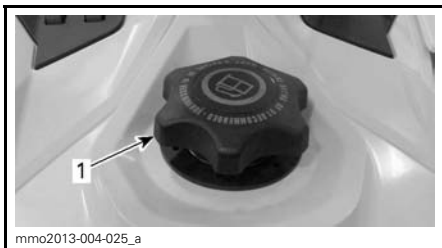
**TYPICAL**

1. Fuel tank cap

⚠ WARNING

If a differential pressure condition is noticed (whistling sound heard when loosening fuel reservoir cap) have vehicle inspected and/or repaired before further operation.

4. Insert the spout into the filler neck.
5. Pour fuel slowly so that air can escape from the tank and prevent fuel flow back. Be careful not to spill fuel.
6. Stop filling when the fuel reaches the bottom of filler neck. Do not overfill.

⚠ WARNING

Never top up the fuel tank before placing the vehicle in a warm area. As temperature increases, fuel expands and may overflow.

7. Fully tighten fuel reservoir cap clockwise.

⚠ WARNING

Always wipe off any fuel spillage from the vehicle.

NOTE: Do not sit or lean on seat when fuel tank cap is not properly installed.

ENGINE OIL

Recommended Engine Oil

Scandinavia Countries

XPS™ RECOMMENDED ENGINE OIL	
900ACE	4T 0W40 SYNTHETIC OIL (EUR) (P/N 779286)
IF THE RECOMMENDED XPS ENGINE OIL IS NOT AVAILABLE	
Use a 0W40 4-stroke SAE synthetic engine oil meeting or exceeding the following lubricant industry specifications: – API service classification SM or SN Always check the API service label certification on the oil container, it must contain at least the indicated standard.	

Rotax® engines were developed and validated using the XPS™ oil. BRP recommends the use of its XPS engine oil or an equivalent at all time. Do not add any oil additives to the recommended engine oil. Damages caused by the use of an oil not suitable for the engine or by adding of an oil additives may not be covered by the BRP Limited Warranty.

All Other Countries

XPS™ RECOMMENDED ENGINE OIL	
900ACE	4T 0W40 SYNTHETIC OIL (P/N 779139)
IF THE RECOMMENDED XPS ENGINE OIL IS NOT AVAILABLE	
<p>Use a 0W40 4-stroke SAE synthetic engine oil meeting or exceeding the following lubricant industry specifications:</p> <ul style="list-style-type: none"> – API service classification SM or SN <p>Always check the API service label certification on the oil container, it must contain at least the indicated standard.</p>	

Rotax® engines were developed and validated using the XPS™ oil. BRP recommends the use of its XPS engine oil or an equivalent at all time. Do not add any oil additives to the recommended engine oil. Damages caused by the use of an oil not suitable for the engine or by adding of an oil additives may not be covered by the BRP Limited Warranty.

Oil Level Verification

NOTICE Check level before each ride and refill if necessary. Do not overfill. Operating the engine with an improper level may severely damage engine. Wipe off any spillage.

Place vehicle on a level surface and proceed as follows to check oil level:

1. Start engine and let it reach its normal operating temperature. Engine is at normal temperature when rear radiator gets warm, indicating that the thermostat is open.
2. Let engine run at idle for 30 more seconds.
3. Stop engine.
4. Open the LH side panel, refer to *CONTROLS, INSTRUMENTS AND EQUIPMENT*.
5. Remove the drive belt guard, refer to *DRIVE BELT GUARD*.
6. Remove dipstick from the filler tube, then wipe it clean.
7. Completely insert dipstick in the filler tube.

8. Remove dipstick and check the oil level. Oil level should be between the MIN and MAX marks as shown, add if necessary.

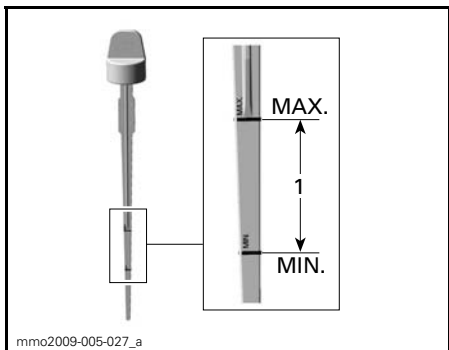

1. Oil level between MIN. and MAX.

⚠ CAUTION Engine oil can be very hot.

⚠ WARNING

Wipe off any oil spills. Oil is highly flammable when heated.

BREAK-IN PERIOD

Operation During Break-In

Engine

During the break-in period:

- Avoid prolonged full throttle operation.
- Avoid sustained accelerations.
- Avoid prolonged cruising speeds.
- Avoid engine overheating.

However, brief accelerations and speed variations contribute to a good break-in.

During a predetermined period, the engine management system controls some engine parameters.

The duration is based on fuel volume. It will take approximately two fuel tanks to complete the break-in.

During this period:

- The engine performance and behavior will not be optimal.
- The fuel and oil consumption will be higher.

Drive Belt

A new drive belt requires a break in period of 50 km (30 mi).

During the break-in period:

- Avoid strong acceleration and deceleration.
- Avoid pulling a load.
- Avoid high speed cruising.

If the vehicle creeps, lower the drive belt height from the preliminary setting. Refer to *DRIVE BELT* in *MAINTENANCE PROCEDURE*.

OPERATING MODES

WARNING

Whenever changing operating mode, make sure to maintain situational awareness while riding.

ECO Mode (Fuel Economy Mode)

When ECO mode is selected (fuel economy mode), vehicle torque and speed are limited whereby an optimal cruising speed is maintained in order to reduce fuel consumption.

Once activated, ECO mode will remain active until it is deactivated by the operator.

Standard Mode

When in Standard mode, no indicator is in the multifunction gauge.

Sport Mode

WARNING

Ensure passenger is advised to hold on tightly before activating Sport mode. Sport mode provides increased acceleration.

When selected, Sport mode provides for instant throttle response and more rapid accelerations than Standard or ECO mode.

Once activated, Sport mode will remain active until it is deactivated by the operator.

A message of the selected mode will be displayed at activation and deactivation as follow:

OPERATING MODE	MESSAGE AT ACTIVATION
Sport	SPORT MODE
Normal	NORMAL MODE
Eco	ECO MODE

Navigating Operating Modes

Use ECO/Standard/Sport Mode switch to navigate between power levels, from ECO (reduced power) to Standard (full power) to Sport (increased response).

To increase power, press the switch upwards. To decrease power, press the switch downwards.

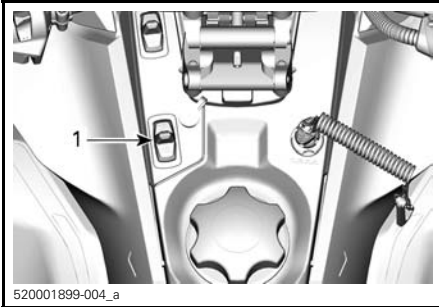

TYPICAL - LH SIDE OF FUEL TANK
1. Mode switch

To activate Standard mode when in Sport mode, press bottom end of switch once.

To activate ECO mode when in Sport mode, press bottom end of switch twice.

To activate ECO mode when in Standard mode, press bottom end of switch once.

WARNING

Ensure passenger is advised to hold on tightly before activating Sport mode. Sport mode provides increased acceleration.

To activate Sport mode when in Standard mode, press top end of switch once.

To activate Sport mode when in ECO mode, press top end of switch twice.

To activate Standard mode when in ECO mode, press top end of switch once.

 **WARNING**

When adjusting modes, be sure to maintain situational awareness of other snowmobiles, obstacles, or persons.

BASIC PROCEDURES

Engine Starting Procedure

Procedure

1. Apply parking brake.
2. Recheck throttle control lever operation.
3. Put your helmet on.
4. Ensure that the tether cord cap is installed on the engine cut-off switch and that the cord is attached to your clothing eyelet.
5. Ensure that the emergency engine stop switch is in the ON position (up).

WARNING

Never depress throttle while starting engine.

6. Release parking brake.

NOTE: For an initial cold start, do not release parking brake. Perform the *VEHICLE WARM-UP* procedure as explained below.

7. Depress the START button to engage the electric starter and start the engine. Release button immediately when engine has started.

NOTICE Do not engage electric starter for more than 10 seconds at a time. A rest period should be observed between the cranking cycles to allow electric starter to cool down.

Emergency Starting

Do not attempt any emergency starting procedure. Have the battery charged or replaced.

Vehicle Warm-Up

Before every ride, vehicle has to be warmed up as follows.

1. Start engine as explained in *ENGINE STARTING PROCEDURE* above.
2. Allow engine to warm up one or two minutes at idle speed.

NOTE: Engine will shut down after approximately 12 minutes of idling.

3. Disengage parking brake.

4. Apply throttle until drive pulley engages. Drive at low speed the first two or three minutes.

NOTICE If vehicle does not move when throttle is applied, stop engine, remove tether cord cap from the engine cut-off switch, then do the following.

- Check if skis are stuck on the ground. Lift one ski at a time by the handle, then put it down.
- Check if track is stuck on the ground. Lift rear of snowmobile enough to clear track from the ground, then drop.
- Check rear suspension for hard snow or ice accumulation that could interfere with track rotation. Clean the area.

CAUTION Beware of injuries by using proper lifting techniques, notably using your legs force. Do not attempt to lift the rear of vehicle if it is above your limits.

! WARNING

Make sure tether cord cap is removed before standing in front the vehicle, getting close to the track or rear suspension components.

NOTE: Warm-up is electronically controlled. During this period (up to 10 minutes depending on ambient temperature), engine RPM is limited.

Shifting in Reverse

1. Bring vehicle to a complete stop.
2. Apply and hold brake. Remain seated, refer to *RIDER POSITION (REVERSE OPERATION)* in *RIDING THE VEHICLE* for posture information.
3. With engine at idle speed, select reverse (R) gear using the reverse lever.

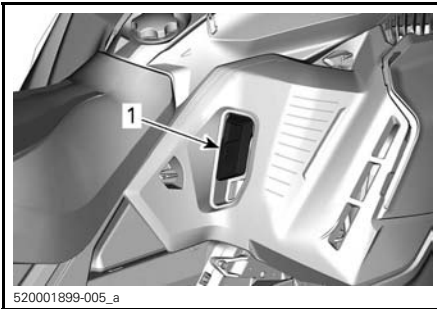

1. Reverse lever

⚠ WARNING

Engaging the reverse mode is done by pulling up reverse lever when the engine is running. Wait until the reverse alarm sounds and the reverse pilot lamp comes on in the analog/digital gauge before operating throttle to proceed in reverse. The reverse speed is not limited. Always proceed with caution as fast reverse could result in loss of vehicle stability. Come to complete stop before pulling up reverse lever. Always remain seated and apply the brake before shifting. Ensure the path behind is clear of obstacles or bystanders before proceeding.

Shifting in Forward

1. Bring vehicle to a complete stop.
2. Apply and hold brake.
3. Pull down the reverse lever.
4. Apply throttle slowly and evenly. Allow drive pulley to engage then accelerate carefully.

Shutting Off the Engine

Release throttle lever and wait until engine has returned to idle speed.

Shut off the engine using either the emergency engine stop switch or by pulling off the tether cord cap from the engine cut-off switch.

 **WARNING**

Always remove the tether cord cap from engine cut-off switch when vehicle is not in operation in order to prevent accidental engine starting or to avoid unauthorized use by children or others or theft.

RIDING CONDITIONS AND YOUR SNOWMOBILE

Altitude

At factory, your snowmobile was calibrated to be used within an altitude range (relative to sea level).

A new snowmobile has a tag attached to the handlebar indicating its calibration. Refer to *IMPORTANT ON-PRODUCT LABELS*.

If for any reason you don't know your snowmobile calibration, contact an authorized Lynx dealer.

If your snowmobile is to be used at an altitude outside the specified range, have it calibrated accordingly by an authorized Lynx dealer.

NOTICE An inappropriate altitude calibration would decrease performance and may cause serious damage to the snowmobile.

Temperature

The engine management of these engines provides the optimum air/fuel ratio for all temperatures.

Hard Packed Snow

Some models covered in this guide are built for deep snow conditions and should never be used during prolonged time in marginal or hard packed snow conditions.

All Models Equipped with Minimum Track Profile of 44.5mm (1.75 in)

BRP does **not recommend** to ride a snowmobile equipped with high lug profile track at **high speed** in a trail, on hard packed surfaces or ice for an extended period of time.

In the event that you have to, **reduce your speed**, then minimize the distance you ride on those surfaces.

NOTICE Running those tracks at high speed in a trail, on hard packed surfaces or ice put more stress on the lugs, which tend to heat up as a result. To avoid potential degradation or damage to the track, reduce your speed, then minimize the distance you ride on those surfaces.

Vehicles Equipped with Ice Scratchers

Ice scratchers are equipped on the vehicle to increase engine cooling efficiency, to lubricate and to cool track clips and sliders. They must be used whenever on ice, hard packed snow, or any conditions that do not lift enough snow particles into the rear suspension/tunnel.

NOTICE Although it is not recommended to ride the models in trail or hard snow conditions, it is highly suggested to combine idler wheels with ice scratchers if the vehicle is used in those conditions.

SPECIAL OPERATION

Towing an Accessory

Always use a rigid tow bar to tow an accessory. Any towed accessory should have reflectors on both sides and at the rear. Check local laws for brake light(s) requirements.

WARNING

Never tow an accessory with a rope. Always use a rigid tow bar. Using a rope would result in a collision between the object and the snowmobile and possibly in a tip over in case of a rapid deceleration or on a downward slope.

Towing Another Snowmobile

If a snowmobile is disabled and must be towed use a rigid tow bar. Remove the drive belt from disabled snowmobile, refer to *DRIVE BELT* in *MAINTENANCE PROCEDURES* and tow at moderate speed.

NOTICE Always remove the drive belt of the snowmobile that is to be towed to prevent damage to its belt and drive system.

In an emergency situation only, if a rigid tow bar is not available, a rope can be used. Proceed with extra caution. In some areas, it may be illegal to do so. Check with state or local authorities.

Remove the drive belt, attach the rope to the ski legs (spindles), have someone sit on the towed snowmobile to activate the brake, and tow at low speed.

NOTICE In order to prevent damage to the steering system, never attach the tow rope to the ski loops (handles).

WARNING

Never ride at high speed when towing a disabled snowmobile. Proceed slowly with extra caution.

TUNE YOUR RIDE

Snowmobile handling and comfort depend upon multiple adjustments.

WARNING

Suspension adjustment could affect vehicle handling. Always take time to familiarize yourself with the vehicle's behavior after any suspension adjustment have been made. Always adjust LH and RH suspension components to the same setting.

Choice of suspension adjustments vary with carrying load, operator's weight, personal preference, riding speed and field condition.

NOTE: Some adjustments may not apply to your snowmobile.

WARNING

Before proceeding with any suspension adjustment, remember:

- Park in a safe place.
- Remove the tether cord cap from the engine cut-off switch.
- Use appropriate lifting device or have assistance to share lifting stress. If a lifting device is not used, use proper lifting techniques, notably using your legs force.
- Do not attempt to lift the front or rear of vehicle if it is above your limits.
- Support front of vehicle off the ground with a suitable device before adjusting suspension.
- Support rear of vehicle off the ground with a wide-base snowmobile stand with a rear deflector panel.
- Make sure support device is stable and secure.

The best way to set up the suspension is to customize each adjustment one at a time. Various adjustments are interrelated. It may be necessary to readjust center spring after adjusting front springs for instance. Test run the snowmobile under the same conditions; trail, speed, snow, operator riding position, etc. Proceed methodically until you are satisfied.

Following are guidelines to fine-tune suspension. Use suspension adjustment tool provided in the tool kit.

Rear Suspension Adjustments

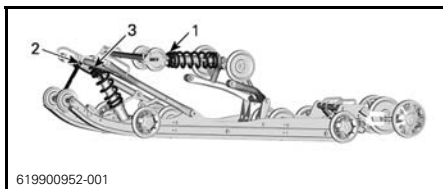

TYPICAL - ADJUSTABLE COMPONENTS

1. Rear spring
2. Stopper strap
3. Center spring

NOTICE Whenever adjusting rear suspension, check track tension and adjust if necessary.

Stopper Strap

Stopper strap length has an effect on the amount of weight the center spring has to carry especially during acceleration, therefore on the front end uplift.

Stopper strap length also has an effect on center spring travel.

NOTICE Whenever stopper strap length is changed, track tension must be checked.

NOTE: Stopper strap can be set to position 1, 2, 3 or 4. Smaller numbers correspond to a longer strap setting.

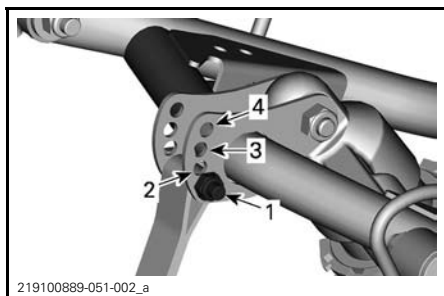

STOPPER STRAP POSITIONS

1. Position 1 (longest)
2. Position 2
3. Position 3
4. Position 4 (shortest)

When operating the snowmobile in deep snow or hill climbing, it may be necessary to vary stopper strap length and/or riding position, to change the angle at which the track rides on the snow. Operator's familiarity with the various adjustments as well as snow conditions will dictate the most efficient combination.

Generally, a longer stopper strap setting gives better performance on a flat landscape and a shorter setting will improve handling in steep hill climbing and deep snow conditions.

STOPPER STRAP SETTING	
POSITION	USE
1	Boon docking: <ul style="list-style-type: none">- Better bump absorption- Lighter and easier handling on flat landscape.

STOPPER STRAP SETTING	
POSITION	USE
2	Normal setting: Best overall setting (General use)
3	Hill climb: <ul style="list-style-type: none"> - Better track attack angle for hill climbing - Better maneuverability on deep snow and on sidehilling
4	Steep hill climb: <ul style="list-style-type: none"> - Better track attack angle for hill climbing - Less transfer - Lower ride height

Center Spring

Center spring preload has an effect on steering effort, handling and bump absorption.

Also, since center spring preload adjustment puts more or less pressure on the front of the track, it has an effect on the performance in deep snow.

ACTION	RESULT
Increasing preload	Lighter steering
	More bump absorption capability
Decreasing preload	Heavier steering
	Less bump absorption capability

To adjust, unscrew the locking ring, then turn the adjustment ring to set the spring preload.

When the desired preload is set, tighten the locking ring against the adjustment ring.

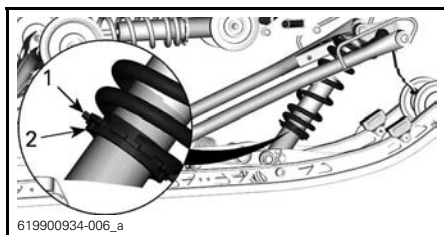

1. Adjustment ring
2. Locking ring

Rear Spring

Rear spring preload has an effect on comfort, ride height and load compensation.

Also, adjusting rear spring preload shifts more or less weight to the snowmobile front end. As a result, more or less weight is applied to the skis. This has an effect on performance in deep snow, steering effort and handling.

Slight suspension bottoming occurring under the worst riding conditions indicates a good choice of spring preload.

ACTION	RESULT
Increasing preload	Firmer rear suspension
	Higher rear end
	More bump absorption capability
	Heavier steering
Decreasing preload	Softer rear suspension
	Lower rear end
	Less bump absorption capability
	Lighter steering
	Better deep snow performance and handling

For normal setting, refer to *SUSPENSION ADJUSTMENT TABLE*.

To adjust, unscrew the locking ring, then turn the adjustment ring to set the spring preload.

When the desired preload is set, tighten the locking ring against the adjustment ring.

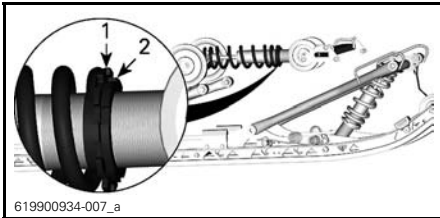

1. Adjustment ring
2. Locking ring

Front Suspension Adjustments

Ski Stance

Skis can be set to three different widths.

To obtain the different widths, place the spacers:

- Inside the skis leg (narrowest ski stance setting: easiest to initiate turn on sidehills), or
- Outside the skis leg (widest ski stance setting: most stable on corners), or
- On each side (central setting: best steering accuracy on deep snow).

NOTE: It is recommended to only use middle position.

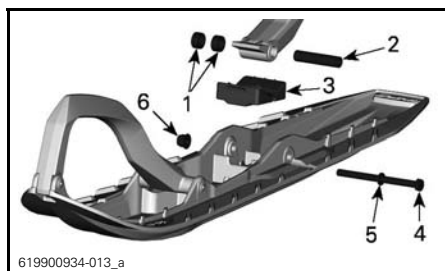

1. Spacers
2. Axle
3. Stopper
4. Screw
5. Washer
6. Nut

TIGHTENING TORQUE	
Ski bolt	48 N•m ± 6 N•m (35 lbf•ft ± 4 lbf•ft)

Front Springs

Front spring preload has an effect on front suspension firmness.

Front spring preload also has an effect on the steering behavior.

ACTION	RESULT
Increasing preload	Firmer front suspension
	Higher front end
	More precise steering
	More bump absorption capability
Decreasing preload	Softer front suspension
	Lower front end
	Lighter steering
	Less bump absorption capability

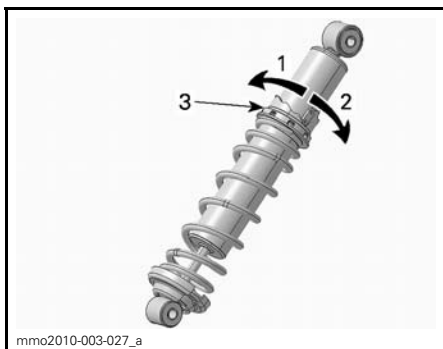

mmo2010-003-027_a

CAM TYPE - HPG SHOCK ABSORBER

1. *Decrease preload*
2. *Increase preload*
3. *Spring preload adjustment cam*

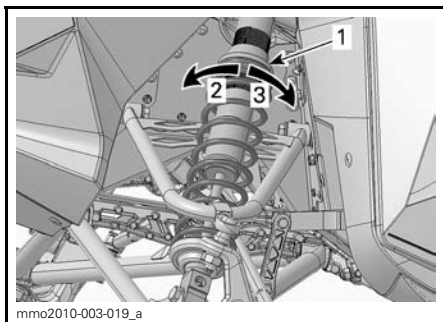

mmo2010-003-019_a

TYPICAL

1. *Spring preload adjustment ring*
2. *Increase preload*
3. *Decrease preload*

Adjustment Tips According to Vehicle Behavior

PROBLEM	CORRECTIVE MEASURES
Front suspension darting	Check ski alignment. <ul style="list-style-type: none"> – Reduce front suspension spring preload. – Increase center spring preload. – Reduce rear spring preload.
Steering feels too heavy at steady speeds	<ul style="list-style-type: none"> – Reduce front suspension spring preload. – Increase center spring preload.
Steering feels too heavy during acceleration	<ul style="list-style-type: none"> – Reduce rear spring preload. – Lengthen limiter strap.
Too much ski lift during cornering or acceleration	<ul style="list-style-type: none"> – Shorten limiter strap. – Increase rear spring preload.
Rear of snowmobile seems too stiff	<ul style="list-style-type: none"> – Reduce rear spring preload. – Reduce compression damping adjustment if equipped
Rear of snowmobile seems too soft	<ul style="list-style-type: none"> – Increase rear spring preload.
Rear suspension is frequently bottoming	<ul style="list-style-type: none"> – Increase compression damping adjustment if equipped. – Increase rear spring preload. – Increase center spring preload. – Lengthen limiter strap. – Increase compression damping adjustment if equipped.

PROBLEM	CORRECTIVE MEASURES
Snowmobile seems to pivot around its center	<ul style="list-style-type: none"> - Reduce center spring preload. - Increase rear spring preload. - Increase front suspension spring preload. - Shorten limiter strap.
Track spins too much at start	<ul style="list-style-type: none"> - Lengthen limiter strap.
Ski diving in deep snow	<ul style="list-style-type: none"> - Install ski tip enlarger.

Suspension Adjustment Table

NOTE: Clicks and turns counted from closed position.

FRONT SPRING / SHOCK ABSORBER SETTINGS			
SETTING	COMFORT	NORMAL (STANDARD)	SPORT
Low speed compression (Clicks)	20	15	5
High speed compression (Turns)	2.5	2	0.5
Rebound (All models except Xtrim SC) (Clicks)	14	14	12
Rebound (Xtrim SC) (Clicks)	-	4	-
Spring preload (mm) / (# Cam position) (All models except Xtrim SC)	5	5 / # 1	5
Spring preload (mm) / (# Cam position) (Xtrim SC)	-	10	-

CENTER SPRING / SHOCK ABSORBER STOPPER STRAP SETTINGS			
SETTING	COMFORT	NORMAL (STANDARD)	SPORT
Low speed compression (Clicks)	20	15	5
High speed compression (Turns)	2.5	2	0.5
Rebound (Clicks)	10	8	6
Spring preload (mm) / (# Cam position) (All models except Xtrim SC) (With stopper strap removed)	2	5 / # 2	2
Spring preload (mm) / (# Cam position) (Xtrim SC) (With stopper strap removed)	-	8	-

STOPPER STRAP POSITION (STANDARD SETTING)			
POSITION	XTRIM SC	49 RANGER	
		PRO	ST
1- Best comfort, Longest travel in center arm suspension	STD Position	Optional	Optional

STOPPER STRAP POSITION (STANDARD SETTING)			
POSITION	XTRIM SC	49 RANGER	
		PRO	ST
2-	Optional	STD Position	STD Position
3- Less ski lift, Short travel on center suspension	Optional	Optional	Optional
4-	-		

REAR SPRING / SHOCK ABSORBER SETTINGS			
SETTING	COMFORT	NORMAL (STANDARD)	SPORT
Low speed compression (Clicks)	20	15	5
High speed compression (Turns)	2.5	2	0.5
Rebound (Clicks)	10	8	6
Spring preload (mm) / (# Cam position) (All models except Xtrim SC) (With stopper strap removed)	7	5 / # 1	7
Spring preload (mm) / (# Cam position) (Xtrim SC) (With stopper strap removed)	-	8	-

NOTE: For E-Start models and/or on Link-Q, add 1 full turn preload (1.5 mm (.06 in)) on rear shock.

VEHICLE TRANSPORTATION

Make sure that oil reservoir and fuel tank caps are properly installed.

Tilt bed trailers can easily be equipped with a winch mechanism to afford maximum safety in loading. Simple as it may seem, never drive your snowmobile onto a tilt bed trailer or any other kind of trailer or vehicle. Many serious accidents have resulted from driving up and over a trailer. Anchor your vehicle securely, front and rear, even on short hauls. Be certain all equipment is securely fastened. Cover your snowmobile when trailering to prevent road grime from causing damage.

Be certain your trailer meets state or provincial requirements. Ensure the hitch and safety chains are secure and the brake, turn indicators and clearance lights all function.

WARNING

Do not tow the vehicle facing backwards. If the vehicle is towed facing backwards, the wind may cause damage to the windshield or even loss of the windshield.

MAINTENANCE

MAINTENANCE SCHEDULE

Maintenance is very important for keeping your vehicle in safe operating condition. A warranty claim may be denied if, among other things, the owner or operator caused the problem through improper maintenance or use. The vehicle should be serviced as per maintenance schedule.

NOTE: The maintenance schedule does not exempt the pre-ride inspection.

WARNING

Failure to properly maintain the vehicle according to the maintenance schedule and procedures can make it unsafe to operate.

FIRST INSPECTION AFTER THE FIRST 1 500 KM (1,000 MI)

Adjust drive chain

Check chaincase oil level

Adjust and align track

FIRST INSPECTION AFTER THE FIRST 3 000 KM (2,000 MI) OR 1 YEAR OF OPERATION (WHICHEVER COMES FIRST)

Change engine oil and filter

EVERY YEAR AT PRESEASON OR 3 000 KM (2,000 MI) (WHICHEVER COMES FIRST)

Perform pre-ride inspection

Check fault codes

Charge battery

Adjust drive chain

Inspect, adjust and align track

Inspect brake hose, pads and disk

Check coolant density

Inspect drive belt

**EVERY YEAR AT PRESEASON OR 3 000 KM (2,000 MI)
(WHICHEVER COMES FIRST)**

Visually inspect and clean drive pulley

Tighten drive pulley retaining screw to specified torque

Inspect and clean driven pulley

Inspect engine seals and gaskets for leaks

Lubricate rear suspension. Lubricate whenever the vehicle is used in wet conditions (rain, puddles)

Inspect exhaust system and check for leaks

Tighten exhaust manifold screws to specified torque

Inspect fuel lines and connections

Inspect front suspension

Inspect rear suspension (including stopper straps and slider shoes)

Inspect tie-rod ends and alignment

Adjust headlight beam aiming

EVERY 2 YEARS OR 6 000 KM (4,000 MI) (WHICHEVER COMES FIRST)

Replace brake fluid

Replace chaincase oil

Inspect engine rubber mounts

EVERY 3 YEARS OR 10 000 KM (6,000 MI) (WHICHEVER COMES FIRST)

Replace spark plugs

MAINTENANCE SCHEDULE

EVERY 5 YEARS
Replace engine coolant
Replace in-line fuel filter

MAINTENANCE PROCEDURES

This section includes instructions for basic maintenance procedures.

WARNING

Turn off the engine, remove tether cord cap and follow these maintenance procedures when performing maintenance. If you do not follow proper maintenance procedures you can be injured by hot parts, moving parts, electricity, chemicals or other hazards.

WARNING

Should removal of a locking device be required (e.g. lock tabs, self-locking fasteners, etc.) when undergoing disassembly/assembly, always replace with a new one.

Engine Coolant

WARNING

Never open coolant tank cap when engine is hot.

Engine Coolant level Verification

Open the RH side panel, refer to *CONTROLS, INSTRUMENTS AND EQUIPMENT*.

Check coolant level at room temperature with the cap removed. Liquid should be at cold level line of coolant tank.

NOTE: When checking level at low temperature it may be slightly lower than the mark.

If additional coolant is necessary or if entire system has to be refilled, refer to an authorized Lynx dealer, repair shop or person of your own choosing.

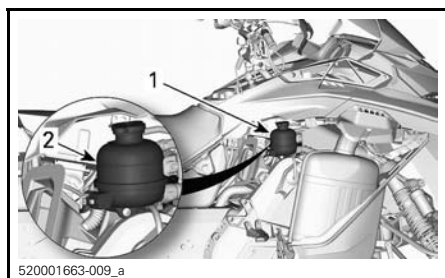

TYPICAL

1. Coolant reservoir
2. COLD line

Recommended Engine Coolant

COUNTRY	RECOMMENDED COOLANT
Scandinavia	EXTENDED LIFE PRE-MIXED COOLANT (EUR) (P/N 779223)
All other countries	EXTENDED LIFE PRE-MIXED COOLANT (P/N 779150)
Alternative, or if not available	Distilled water and antifreeze solution (50% distilled water, 50% antifreeze)

NOTICE Always use ethylene-glycol antifreeze containing corrosion inhibitors specifically for internal combustion aluminum engines.

Engine Oil

Engine Oil Level Verification

NOTICE Check level before each ride and refill if necessary. Do not overfill. Operating the engine with an improper level may severely damage engine. Wipe off any spillage.

Place vehicle on a level surface and proceed as follows to check oil level:

1. Start engine and let it reach its normal operating temperature. Engine is at normal temperature when rear radiator gets warm, indicating that the thermostat is open.
2. Let engine run at idle for 30 more seconds.
3. Stop engine.
4. Open the LH side panel, refer to *CONTROLS, INSTRUMENTS AND EQUIPMENT*.
5. Remove the drive belt guard, refer to *DRIVE BELT GUARD*.
6. Remove dipstick from the filler tube, then wipe it clean.
7. Completely insert dipstick in the filler tube.
8. Remove dipstick and check the oil level. Oil level should be between the MIN and MAX marks as shown, add if necessary.

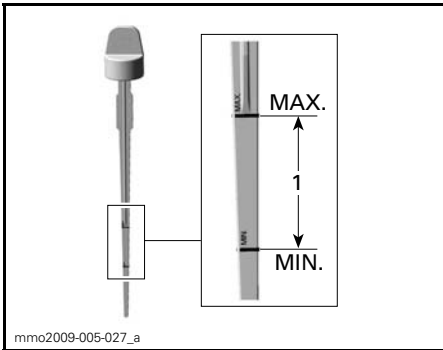

1. Oil level between MIN. and MAX.

⚠ CAUTION Engine oil can be very hot.

⚠ WARNING

Wipe off any oil spills. Oil is highly flammable when heated.

Engine Oil Replacement

⚠ CAUTION The engine oil can be very hot. Wait until engine oil is warm.

NOTICE Engine oil and oil filter must be replaced at the same time.

1. Bring engine to its normal operating temperature.
2. Place vehicle on a level surface.
3. Remove the LH side panel.
4. Remove dipstick.

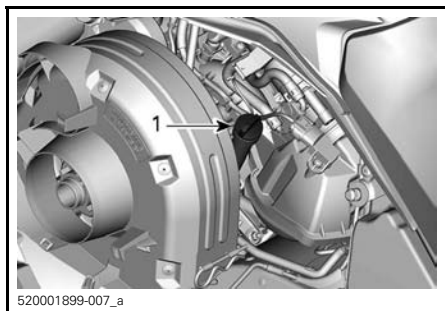

LH SIDE OF VEHICLE

1. Oil tank dipstick

5. Remove *OIL FILTER*, see procedure in this subsection.
6. From underneath the vehicle, access the drain plug:
 - 6.1 Remove one access cover retaining screw and loosen the other.
 - 6.2 Pivot the access cover to clear the bottom pan opening.

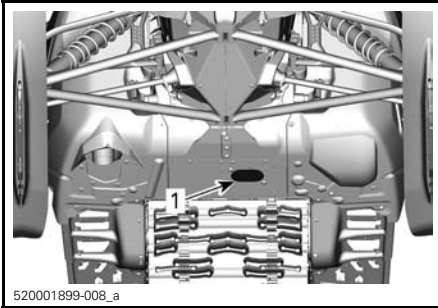

1. Drain plugs access cover

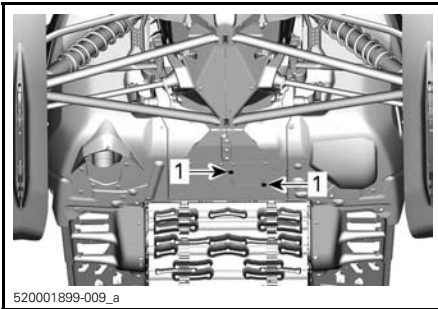

PIVOT THE ACCESS COVER

1. Retaining screws
7. Clean drain plug area.
8. Place a drain pan under the bottom pan opening.
9. Remove engine drain plugs in the following order.
 - 9.1 Main drain plug.
 - 9.2 Secondary drain plug.

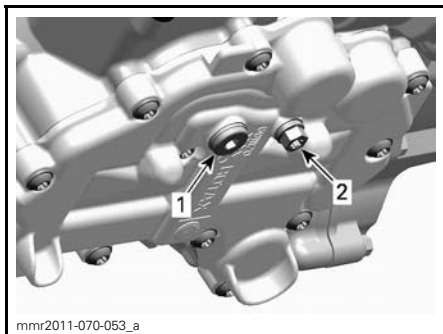

UNDERNEATH THE ENGINE

1. Main drain plug
2. Secondary drain plug

10. Allow oil to drain completely.

11. Install **NEW** sealing washers on oil drain plugs.

NOTICE Never use a sealing washer a second time. Always replace with a new one.

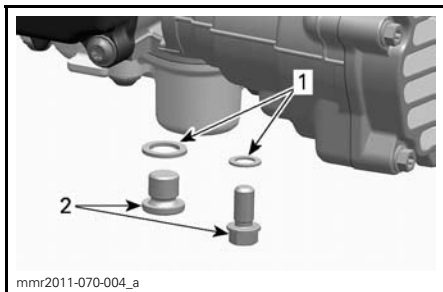

1. Sealing washer
2. Oil drain plug

12. Install drain plugs and tighten to specification.

TIGHTENING TORQUE

Drain plugs

20 N•m ± 2 N•m
(15 lbf•ft ± 1.5 lbf•ft)

13. Install a new *OIL FILTER*, see procedure in this subsection.
14. Refill oil tank at the proper level with the recommended oil.

APPROXIMATE ENGINE OIL CAPACITY (WITH FILTER)

3.3 L (3.5 qt (U.S. liq.))

15. Reinstall dipstick in oil tank and properly tighten it.
16. Start engine and let it idle for a few minutes.
17. Ensure there are no leaks.
18. Stop engine and check oil level as explained in this subsection. Refill if necessary.
19. Dispose oil and filter as per your local environmental regulations.

Engine Oil Filter

Engine Oil Filter Replacement

Oil Filter Removal

1. Remove the RH side panel.
2. Clean oil filter area.
3. Remove:
 - Oil filter cover screws
 - Oil filter cover with O-ring
 - Oil filter.

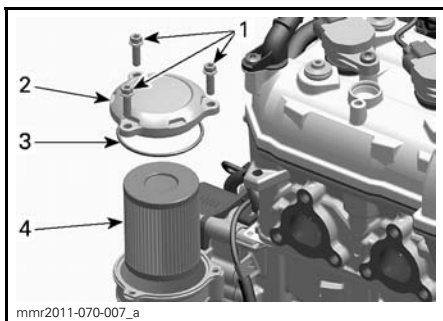

1. Oil filter cover screws
2. Oil filter cover
3. O-ring
4. Oil filter

4. Dispose filter as per your local environmental regulations.

Oil Filter Installation

1. Check the oil filter inlet and outlet orifices inside oil filter receptacle (integrated part of magneto cover) for dirt and contaminations.

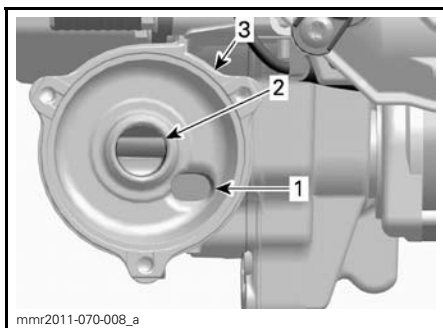

1. Oil inlet orifice from the oil pressure pump
2. Oil outlet orifice to the engine lubrication system
3. Oil filter receptacle

2. Install a **NEW** O-ring on oil filter cover.
3. Install the new filter into the cover.
4. Lubricate filter seal and cover O-ring with engine oil.

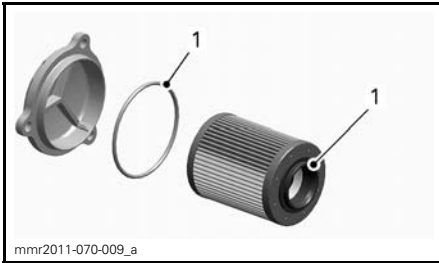

1. Lubricate with engine oil

NOTICE Pay attention to avoid pinching the O-ring during filter and cover installation.

5. Install the oil filter cover.
6. Tighten oil filter cover screws to specification.

TIGHTENING TORQUE	
Oil filter cover screws	10 N•m ± 1 N•m (89 lbf•in ± 9 lbf•in)

7. Wipe off any oil spillage on engine.

Exhaust System

Exhaust System Verification

The muffler tail pipe should be centered with the exit hole in the bottom pan. Exhaust system must be free of rust or leaks. Make sure that all parts are securely in place.

Check retaining springs condition and replace if necessary.

The exhaust system is designed to reduce noise and to improve the total performance of the engine. Modification may be in violation of local laws.

NOTICE If any exhaust system component is removed, modified or damaged, severe engine damage may result.

Spark Plugs

Spark plugs inspection or replacement may be performed by an authorized Lynx dealer, repair shop, or person of your own choosing. Spark plugs inspection or replacement requires an in-depth technical knowledge. Though not required, it is recommended that an authorized Lynx dealer performs spark plugs inspection or replacement.

Brake Fluid

Recommended Fluid

Use only DOT 4 brake fluid from a sealed container. An opened container may be contaminated or may have absorbed moisture from the air.

WARNING

Use only DOT 4 brake fluid from a sealed container. To avoid serious damage to the braking system, do not use fluids other than the recommended one, nor mix different fluids for topping up.

NOTICE Brake fluid can damage painted and plastic parts. Handle with care. Rinse thoroughly in case of spillage.

Brake Fluid Level Verification

NOTICE Vehicle must be on a level surface before checking any fluid levels.

Check brake fluid (DOT 4) in reservoir for proper level. Add fluid (DOT 4) as required.

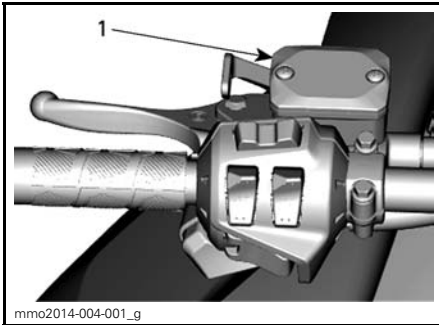

TYPICAL

1. Brake fluid reservoir

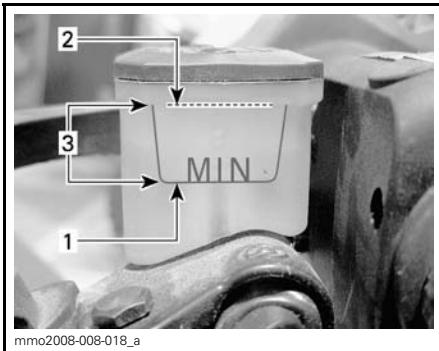

TYPICAL

1. Minimum
2. Maximum
3. Operating range

⚠ CAUTION Avoid getting brake fluid on skin or eyes - it may cause severe burns. In case of contact skin, wash thoroughly. In case of contact with the eyes, immediately rinse with plenty of water for at least 10 minutes and then consult a doctor immediately.

Chaincase Oil

Recommended Chaincase Oil

RECOMMENDED CHAINCASE OIL	
Scandinavia	SYNTHETIC CHAINCASE OIL (EUR) (P/N 779185)
All other countries	SYNTHETIC CHAINCASE OIL (P/N 779156)

NOTICE The chaincase of this snowmobile has been developed and validated using the XPS™ Synthetic chaincase oil. BRP strongly recommends the use of its XPS Synthetic chaincase oil at all times. Damages caused by oil which is not suitable for the chaincase will not be covered by the BRP limited warranty.

Access to Chaincase

Open RH side panel, refer to *CONTROLS, INSTRUMENTS AND EQUIPMENT*.

Chaincase Oil Level Verification

With the vehicle on a level surface, check the oil level by removing the check plug.

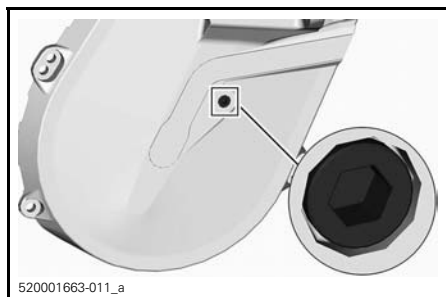

TYPICAL - CHECK PLUG

Oil level must reach the threaded hole.

If level is correct, reinstall check plug and tighten to the specified torque.

TIGHTENING TORQUE	
Check plug	6 N•m ± 1 N•m (53 lbf•in ± 9 lbf•in)

If level is insufficient, refer to *CHAINCASE FILLING PROCEDURE*.

Chaincase Filling Procedure

Remove the check plug.

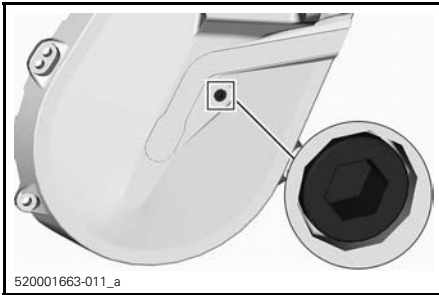

TYPICAL - CHECK PLUG

Remove the filler cap.

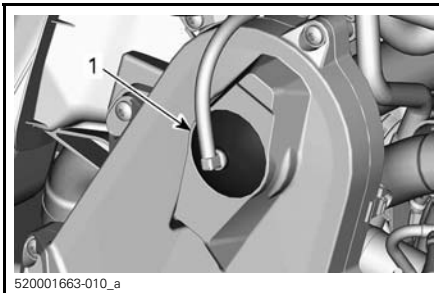

TYPICAL - TOP OF CHAINCASE

1. Filler cap

Pour recommended oil in the filler hole until oil comes out by the check plug hole.

Reinstall check plug and tighten to specification.

TIGHTENING TORQUE	
Check plug	$6 \text{ N}\cdot\text{m} \pm 1 \text{ N}\cdot\text{m}$ ($53 \text{ lbf}\cdot\text{in} \pm 9 \text{ lbf}\cdot\text{in}$)

Reinstall the filler cap.

Drive Chain

Access to Chaincase

Open RH side panel, refer to *CONTROLS, INSTRUMENTS AND EQUIPMENT*.

Drive Chain Adjustment

Using the Torx end of the driven pulley expander, GENTLY turn tensioner clockwise to eliminate the play.

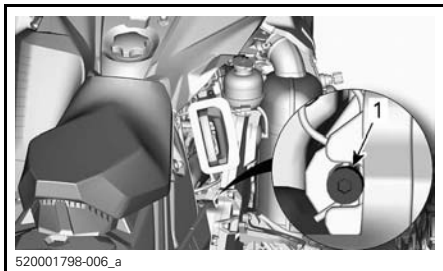

TYPICAL

Do not force the tensioner in.

NOTE: Do not remove the hair cotter pin.

NOTICE Overtightening the drive chain could result in severe damage to the chaincase components.

Drive Belt

Drive Belt Inspection

Inspect belt for cracks, fraying or abnormal wear (uneven wear, wear on one side, missing cogs, cracked fabric). If abnormal wear is noted, probable cause could be pulley misalignment, excessive RPM with frozen track, fast starts without warm-up period, burred or rusty sheave, oil on belt or distorted spare belt. Contact an authorized Lynx dealer.

Drive Belt Replacement

Drive Belt Removal

1. Remove tether cord cap from engine cut-off switch.
2. Remove drive belt guard, refer to *CONTROLS, INSTRUMENTS AND EQUIPMENT*.
3. Insert the driven pulley expander provided in the threaded hole on the adjuster hub as shown.



TYPICAL - PULLEY EXPANDER INSTALLED ON ADJUSTER HUB

4. Open the driven pulley by screwing the tool in.
5. Remove the drive belt by slipping it over the top of the driven pulley, then over the drive pulley.

Drive Belt Installation

1. If necessary, open the driven pulley, refer to *DRIVE BELT REMOVAL* above.

2. Slip the belt over the drive pulley, then over the driven pulley.

NOTICE Do not force or use tools to pry the belt into place, as this could cut or break the cords in the belt.

NOTE: The maximum drive belt life span is obtained when belt is installed with arrows in the direction of rotation.

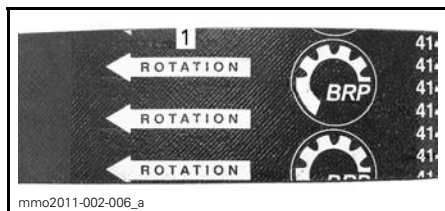

1. To be pointed in the direction of rotation

3. Unscrew and remove the driven pulley expander from the pulley.
4. Rotate the driven pulley several times to properly set the belt between the sheaves.
5. If a new belt was installed, an adjustment will be required for the proper belt height. Refer to *DRIVE BELT HEIGHT ADJUSTMENT* below.
6. Install belt guard, refer to *CONTROLS, INSTRUMENTS AND EQUIPMENT*.
7. Close side panel, refer to *CONTROLS, INSTRUMENTS AND EQUIPMENT*.

Drive Belt Height Adjustment

The drive belt height must be checked every time a new drive belt is installed and as part of the pre-ride inspection.

To adjust the drive belt height, proceed as follows:

1. Remove tether cord cap from engine cut-off switch.
2. Remove drive belt guard.
3. Loosen the clamping bolt.

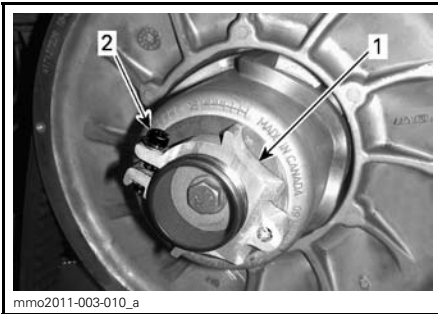

1. Adjuster hub
2. Clamping bolt

4. Using the suspension adjustment tool provided, turn the ring 1/4 turn at a time then rotate the driven pulley to properly set the drive belt between the pulley sheaves.



1. Suspension adjustment tool

NOTE: The adjustment ring has left hand treads.

Repeat step 4 until the lowest portion of the cogs on the external surface of drive belt is even with the driven pulley edge.

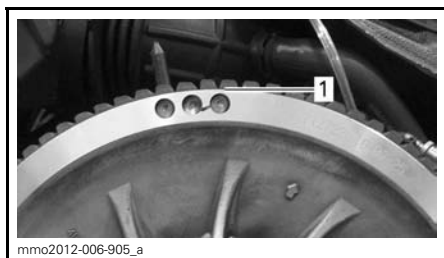

TYPICAL - PRELIMINARY SETTING

1. Lowest portion of cogs even with external surface of drive belt

NOTE: Turning the ring counterclockwise lowers the drive belt in the pulley. Turning the ring clockwise raises the drive belt in the pulley.

5. Firmly tighten the clamping bolt. If possible, tighten to specification using a torque wrench.

TIGHTENING TORQUE	
Clamping bolt	5.5 N•m ± 0.5 N•m (49 lbf•in ± 4 lbf•in)



TYPICAL

1. Clamping bolt

6. Install drive belt guard.
7. Install side panel.

NOTE: These settings are correct as a preliminary adjustment for most models. In some cases, when starting the engine, the vehicle could creep, indicating that the drive belt is too tight.

If the vehicle creeps, lower the drive belt height from the preliminary setting. Repeat procedure until creeping stops.

Reverse Activation

NOTE: The reverse may not activate if the belt is positioned too high in the driven pulley. If reverse activation does not work properly, ensure the drive belt is properly adjusted. Adjust the drive belt lower in the driven pulley if needed.

Track

Track Condition

WARNING

Remove tether cord cap from engine cut-off switch before performing any maintenance or adjustment, unless otherwise specified. Vehicle must be parked in a safe place, away from the trail.

Remove tether cord cap from engine cut-off switch.

Lift the rear of the snowmobile and support it with a wide-base snowmobile mechanical stand with a rear deflector panel. With the engine off, rotate the track by hand, and inspect condition. If worn or cut, or if track fibers are exposed, or if missing or defective inserts or guides are noted; contact an authorized Lynx dealer.

Snowmobiles Equipped with Traction Enhancing Products

If your snowmobile is equipped with a BRP approved studded track, **PROCEED WITH A VISUAL INSPECTION OF YOUR TRACK BEFORE EACH USE.**

Look for any defects, such as:

- Perforations in the track
- Tears in the track (particularly around traction holes on studded tracks)
- Lugs that are broken or torn off, exposing portions of rods
- Delamination of the rubber
- Broken rods
- Broken studs (studded tracks)

- Bent studs (studded tracks)
- Missing studs
- Studs that are torn off the track
- Missing track guide(s)
- Also, ensure that studs nut are tighten to the recommended torque.

On approved studded tracks, replace broken or damaged studs immediately. If your track shows signs of deterioration, it must be replaced immediately. When in doubt, ask your dealer.

WARNING

Riding with a damaged track or studs could lead to a loss of control.

For complete information on traction enhancing products, refer to *TRACTION ENHANCING PRODUCTS* in *SAFETY INFORMATION* at the beginning of this Operator's Guide.

Track Tension and Alignment

NOTE: Track tension and alignment are interrelated. Do not adjust one without the other.

WARNING

To prevent serious injury to individuals near the snowmobile:

- NEVER stand behind or near a moving track.
- Always use a wide-base snowmobile stand with a rear deflector panel if it is necessary to rotate track.
- When the track is raised off the ground, only run it at the lowest possible speed.

Centrifugal force could cause debris, damaged or loose studs, pieces of torn track, or an entire severed track to be violently thrown backwards out of the tunnel with tremendous force, possibly resulting in the loss of a leg or other serious injury.

Track Tension Verification

NOTE: Ride the snowmobile in snow about 15 to 20 minutes prior to adjusting track tension.

1. Remove tether cord cap from engine cut-off switch.

- Lift rear of vehicle and support it off the ground.

⚠ CAUTION Use proper lifting techniques, notably using your legs force. Do not attempt to lift the rear of vehicle if it is above your limits.

- Allow rear suspension to fully extend.
- Use the TENSIO METER (P/N 414 348 200).



- Set deflection between 50 mm to 60 mm (1-3/16 in to 1-3/8 in) using bottom O-ring.



TYPICAL - DEFLECTION SETTING

- Bottom O-ring set to specification*
- Place upper O-ring to 0 kgf (0 lbf).
- Position the tensiometer on track, halfway between front and rear idler wheels.
- Push the tensiometer downwards until bottom O-ring (deflection set earlier) be aligned with the bottom of slider shoe.

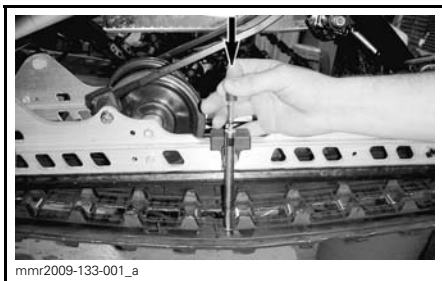

TYPICAL

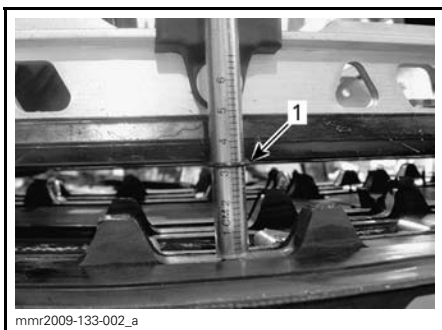

TYPICAL

1. Deflection O-ring aligned with slider shoe

9. Read load recorded by the upper O-ring on the tensiometer.



TYPICAL - LOAD READING

1. Upper O-ring

10. Load reading must be as per the following table.

Xtrim SC models

TRACK ADJUSTMENT SPECIFICATION	
Track tension without force	30 mm (1.18 in)
Track tension with 7.3 kgf (16.1 lbf)	45 mm (1.77 in)

49 Ranger models

TRACK ADJUSTMENT SPECIFICATION	
Track tension without force	40 mm to 50 mm (1.57 in to 1.97 in)
Track tension with 7.3 kgf (16.1 lbf)	60 mm to 70 mm (2.36 in to 2.76 in)

11. If load reading is not in accordance with the specification, adjust track tension. Refer to *TRACK TENSION ADJUSTMENT*.

Track Tension Adjustment

1. Remove tether cord cap from engine cut-off switch.
2. Lift rear of vehicle and support it off the ground.

⚠ CAUTION Use proper lifting techniques, notably using your legs force. Do not attempt to lift the rear of vehicle if it is above your limits.

3. Loosen the rear axle nut or screws.
4. Tighten or loosen both adjustment screws (equally) to increase or decrease track tension.

MAINTENANCE PROCEDURES

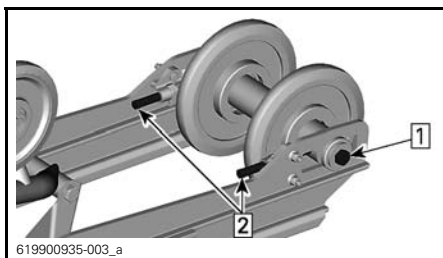

MODELS WITH TWO BOLTS

1. Loosen the axle screws (both sides)
2. Tighten or loosen the adjustment screws

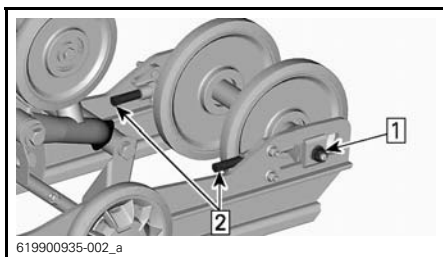

MODELS WITH LONG BOLT

- Step 1: Loosen the axle nut
Step 2: Tighten or loosen the adjustment screws

5. If correct tension is unattainable, contact an authorized Lynx dealer.
6. Retighten the rear axle nut to specification.

TIGHTENING TORQUE

Rear idler wheel retaining nut	24.5 N•m ± 3.5 N•m (18 lbf•ft ± 3 lbf•ft)
--------------------------------	----------------------------------------------

7. Check track alignment as described below.

Track Alignment

⚠ WARNING

Before checking track alignment, ensure that the track is free of all particles which could be thrown out while track is rotating. Keep hands, tools, feet and clothing clear of track. Always lift the snowmobile on a wide-base stand with a rear deflector panel. Ensure no one is standing in close proximity to the snowmobile, especially at the rear of the track. Never rotate track at high speed.

Centrifugal force could cause debris, damaged or loose studs, pieces of torn track, or an entire severed track to be violently thrown backwards out of the tunnel with tremendous force.

1. Lift rear of vehicle and support it off the ground.

⚠ CAUTION Use proper lifting techniques, notably using your legs force. Do not attempt to lift the rear of vehicle if it is above your limits.

2. Start engine and accelerate slightly so that track slowly turns. This must be done in a short period of time (15 to 20 seconds).
3. Check that the track is well centered; equal distance on both sides between edges of track guides and slider shoes.

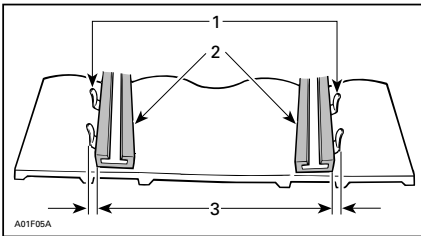

1. Guides
2. Slider shoes
3. Equal distance

4. To correct track alignment:

- 4.1 Stop engine.
- 4.2 Remove tether cord cap from engine cut-off switch.

! WARNING

Remove tether cord cap from engine cut-off switch before performing any maintenance or adjustment, unless otherwise specified. Vehicle must be parked in a safe place, away from the trail.

- 4.3 Loosen the rear axle nut.
- 4.4 Tighten adjustment screw on side where the slider shoe is the farthest from the track insert guides.

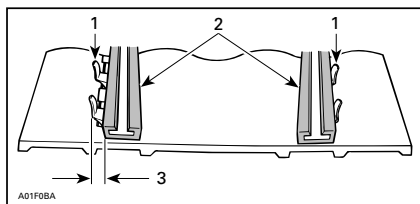

- 1. Guides
- 2. Slider shoes
- 3. Tighten on this side

- 5. Tighten the rear axle nut.

! WARNING

Properly tighten wheel retaining bolt, otherwise wheel may come off and cause track to "lock".

- 6. Restart engine and rotate track slowly to recheck alignment.
- 7. Tighten the rear axle nut to specification.

TIGHTENING TORQUE

Rear idler wheel retaining nut	24.5 N•m ± 3.5 N•m (18 lbf•ft ± 3 lbf•ft)
--------------------------------	----------------------------------------------

- 8. Reposition snowmobile on the ground.

Suspension

Rear Suspension Condition

Visually inspect all suspension components including slider shoes, springs, wheels, etc.

NOTE: During normal driving, snow will act as a lubricant and coolant for the slider shoes. Extensive riding on ice or sanded snow, will create excessive heat build-up and cause premature slider shoe wear.

Suspension Stopper Strap Condition

Inspect stopper strap for wear and cracks, bolt and nut for tightness. If loose inspect holes for deformation. Replace as required. Tighten nut to specification.

TIGHTENING TORQUE	
Stopper strap nut	10 N•m ± 1 N•m (89 lbf•in ± 9 lbf•in)

Suspension Lubrication

Lubricate the following suspension pivots at grease fittings. Refer to *MAINTENANCE SCHEDULE* for maintenance frequency.

SUSPENSION GREASE	
Scandinavia	SYNTHETIC GREASE SUSPENSION (EUR) (P/N 779226)
All other countries	SYNTHETIC SUSPENSION GREASE (P/N 779163)

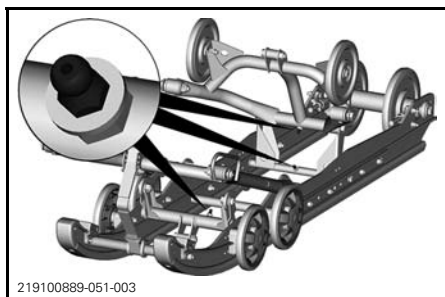

TYPICAL

Steering and Front Suspension Condition

Visually inspect steering and front suspension for tightness of components (steering arms, control arms and links, tie rods, ball joints, ski bolts, ski legs, etc.). If necessary, contact an authorized Lynx dealer.

Skis

Wear and Condition of Skis and Runners

Check the condition of the skis and ski runner carbides. If worn, contact an authorized Lynx dealer.

WARNING

Excessively worn skis and/or ski runners will adversely affect snowmobile control.

Fuses

Access to Fuse Block

Open RH side panel, refer to *CONTROLS, INSTRUMENTS AND EQUIPMENT*.

Fuses Location

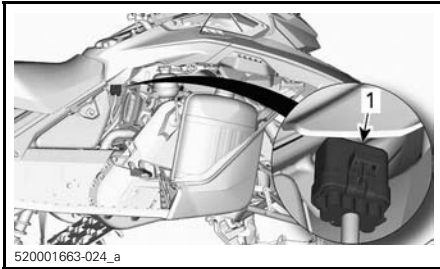

TYPICAL

1. Fuse block

Unlock fuse block from its cover.

FUSE IDENTIFICATION	AMPERAGE RATING
Main	40 A
Fan	15 A
Relay coils Start button	5 A
Accessories	7.5 A
Head lamp	20 A
Cluster	15 A
Tail light Brake	10 A
ECM RFID	10 A
Ignition coils Fuel injectors Fuel pump Starter solenoid	10 A

Fuse Inspection

Check fuse condition and replace it if necessary.

To remove fuse from holder, pull fuse out. Check if filament is melted.

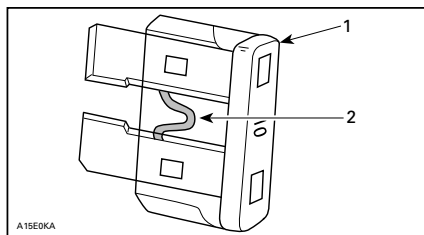

1. Fuse
2. Check if melted

! WARNING

Do not use a higher rated fuse.

! WARNING

If fuse has burnt out, source of malfunction should be determined and corrected before restarting. See an authorized Lynx dealer for servicing.

Headlights

Headlights Bulb Replacement

1. Open the storage compartment.

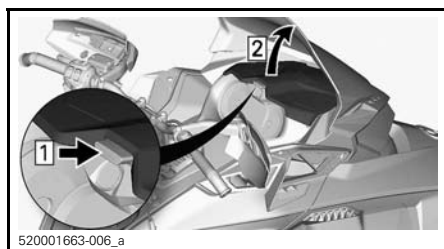

TYPICAL

2. Remove the gauge retaining screws.

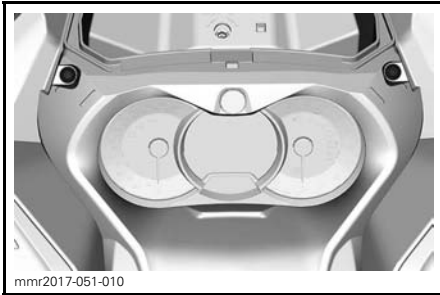

3. Lift the front of the gauge, then slide it forward to remove it.

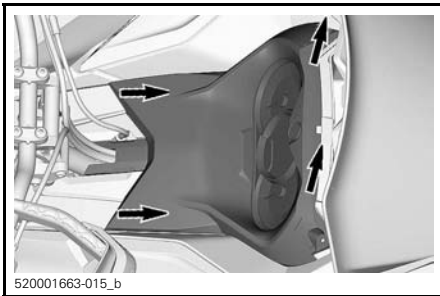

4. Set gauge aside.
5. Remove the storage compartment.

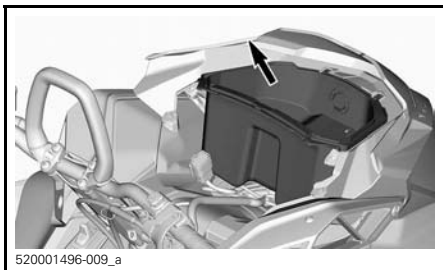

6. Disconnect 12V plug connectors and unscrew the 12V plug to remove (if equipped).

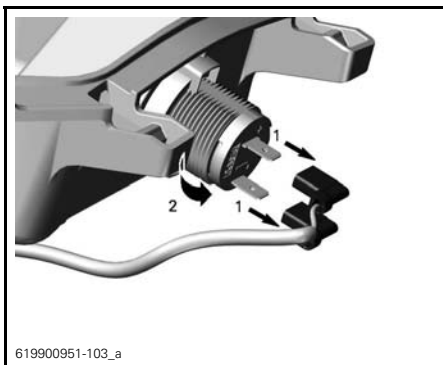

1. *Disconnect*
2. *Unscrew*

7. Disconnect bulb connector.

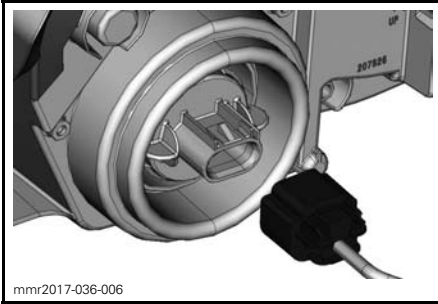

8. Unlock bulb by turning it counterclockwise.
9. Pull bulb out.

NOTE: Ensure bulb seal stays in place.

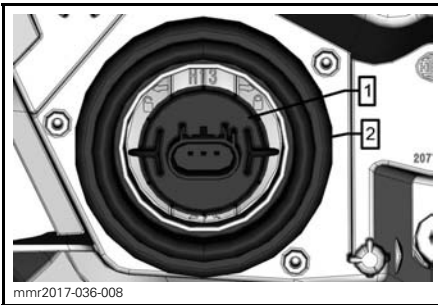

1. Bulb
2. Bulb seal

Install a new bulb using the reverse of the removal procedure.

NOTICE Never touch glass portion of an halogen bulb with bare fingers, it shortens its operating life. If glass is touched, clean it with isopropyl alcohol which will not leave a film on the bulb.

Check headlights operation.

Headlights Beam Aiming

Open the storage compartment, see *FRONT STORAGE COMPARTMENT*.

Turn the adjustment screw with appropriate screwdriver to reach desired beam height.

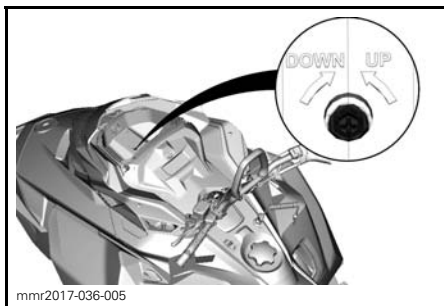

Removing Battery

1. Remove cargo box (if applicable).
2. Remove seat and backrest (if applicable).
3. Remove battery cover.

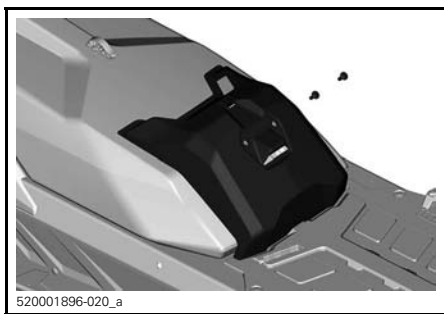

TYPICAL

4. Disconnect negative before positive terminal.

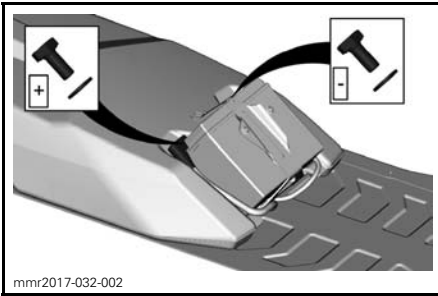

5. Remove battery hold down bracket.

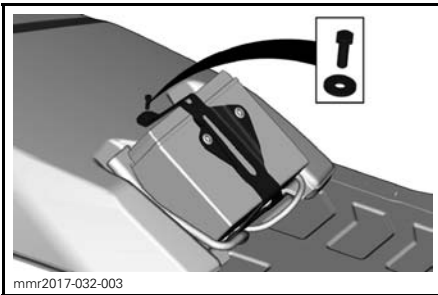

6. Remove battery.

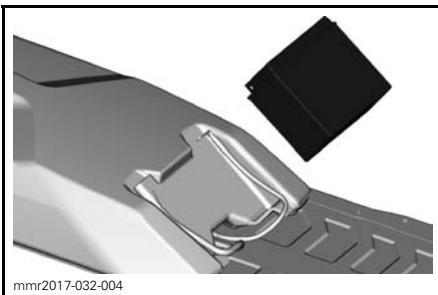

Installing Battery

The installation is the reverse of the removal procedure. However, pay attention to the following details.

TIGHTENING TORQUE	
Battery terminals (positive and negative)	10 N•m ± 2 N•m (89 lbf•in ± 18 lbf•in)
Battery hold down bracket	5 N•m ± 0.5 N•m (44 lbf•in ± 4 lbf•in)
Battery cover retaining screws	7 N•m ± 1 N•m (62 lbf•in ± 9 lbf•in)

Reinstall the seat, backrest and cargo box if applicable.

VEHICLE CARE

Post-Operation Care

Remove snow and ice from rear suspension, track, front suspension, steering mechanism and skis.

WARNING

Make sure tether cord cap is away from engine cut-off switch before standing in front the vehicle, getting close to the track or rear suspension components.

Always cover your snowmobile when leaving it outside overnight or during extended periods of inactivity. This will protect it from frost and snow as well as help retain its appearance.

Vehicle Cleaning and Protection

Wash snowmobile with water mixed with a mild detergent. Use only microfiber cloths or an equivalent.

NOTICE It is necessary to use microfiber cloths or equivalent on windshield and hood to avoid damaging further surfaces to clean.

To remove grease, oil and grime, use BRP HEAVY DUTY CLEANER (P/N 293 110 001).

NOTICE Do not use Heavy duty cleaner on decals or vinyl.

To remove stubborn dirt from all plastic and vinyl surfaces, use CLEANER AND DEGREASER PRO C1 (P/N 779262).

NOTICE Never clean plastic parts or hood with strong detergent, degreasing agent, paint thinner, acetone, products containing chlorine, etc.

Wax painted portion of the vehicle for better protection.

NOTE: Apply wax on glossy finish only.

STORAGE

During summer, or when a snowmobile is not in use for more than three months, proper storage is necessary.

STORAGE
Clean the vehicle
Add fuel stabilizer to fuel following the product manufacturer recommendations. Run the engine after adding the product to the fuel
Lubricate engine (
Lubricate brake lever pivot
Lubricate rear suspension
Charge battery monthly to keep it fully charged during storage
Block muffler outlet with rags
Lift rear of vehicle until track is clear of the ground. Do not release track tension

⚠ CAUTION Use appropriate lifting device or have assistance to share lifting stress. If a lifting device is not used, use proper lifting techniques, notably using your legs force. Do not attempt to lift the rear of vehicle if it is above your limits.

NOTICE The snowmobile has to be stored in a cool and dry place and covered with an opaque but ventilated tarpaulin. This will prevent sun rays and grime from affecting plastic components and vehicle finish.

NOTICE Fuel stabilizer should be added prior to engine lubrication to ensure protection against varnish deposits.

TECHNICAL INFORMATION

VEHICLE IDENTIFICATION

Vehicle Description Decal

Vehicle description decal is located on right hand side of tunnel.

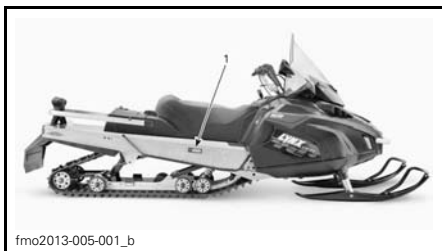

TYPICAL

1. Vehicle description decal

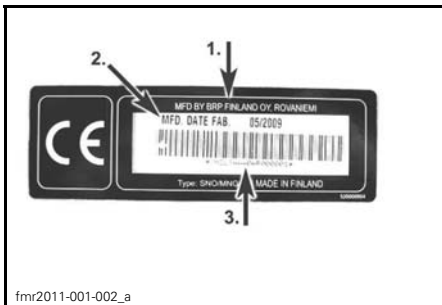

VEHICLE DESCRIPTION DECAL

1. Manufacturer name
2. Manufacturing date
3. Vehicle identification number (VIN)

Identification Numbers

The main components of your snowmobile (engine and frame) are identified by different identification numbers. It may sometimes become necessary to locate these numbers for warranty purposes or to trace your snowmobile in the event of loss. These numbers are required by the authorized Lynx dealer to complete warranty claims properly. We strongly recommend that you take note of all the identification numbers on your snowmobile and supply them to your insurance company.

Vehicle Identification Number (VIN)

VIN is scribed on vehicle description decal. See above. It is also engraved on tunnel near vehicle description decal.

Model number and model year are part of the information found in the VIN. See illustration.

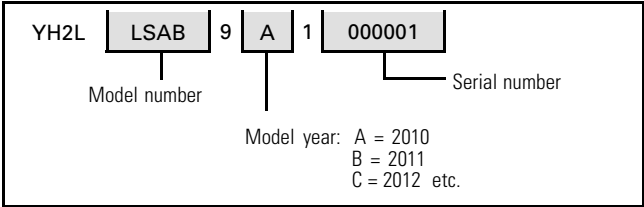

Engine Identification Number Location

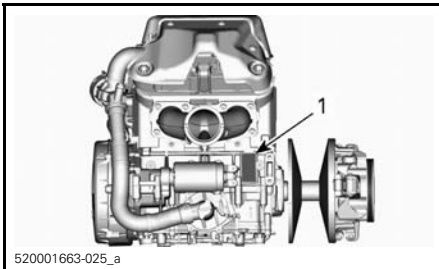

1. Engine identification number

NOISE EMISSION AND VIBRATION VALUES

MODEL		900 ACE
NOISE EMISSION AND VIBRATION VALUES ¹		
Noise	Sound power level (L_{WA})	91,2 dB @ 3625 RPM (Uncertainty (K_{wa}) 3 dB)
Vibration	Hand-arm system	3.15 m/s ² @ 3625 RPM
	Whole body at seat	<0.5 m/s ² @ 3625 RPM
¹ : Noise emission and Vibration values are measured in accordance with Standard ISMA 1: 2014 on a paved surface, at neutral or without belt.		

EC DECLARATION OF CONFORMITY

The EC-Declaration of Conformity does not appear in this version of the Operator's Guide.

Please refer to the printed version that was delivered with your vehicle.

RADIO FREQUENCY DIGITALLY ENCODED SECURITY SYSTEM (RF D.E.S.S. KEY)

This device complies with FCC Part 15 and Industry Canada license exempt RSS standard(s).

Operation is subject to the following two conditions: (1) this device may not cause interference, and (2) this device must accept any interference, including interference that may cause undesired operation of the device.

Changes or modifications not expressly approved by the party responsible for compliance could void the user's authority to operate the equipment.

IC Registration Number: 12006A-M01456

FCC ID: 2ACERM01456

We, the party responsible for compliance, declare under our sole responsibility that the device is in conformity with the provisions of the following Council Directive: 2014/53/EU. To which this declaration relates is in conformity with the essential requirements and other relevant requirements. The product is in conformity with the following directives, harmonized standards and regulations:

Radio Equipment Directive (RED) 2014/53/EU and Harmonized Standards:

EN 300 330-2, EN 60950-1

SPECIFICATIONS (ENGINE)

ENGINE	900 ACE
Engine type	Rotax 903, liquid cooled, 4-stroke, D.O.H.C., dry sump
Number of cylinder	3
Bore	74 mm (2.913 in)
Stroke	69.7 mm (2.744 in)
Displacement	899 cm ³ (54.86 in ³)
Maximum power engine speed	7250 ± 100 RPM

FUEL SYSTEM

Fuel delivery	Multi point EFI, 46 mm heated throttle body
Idle speed (not adjustable)	1200 ± 200 RPM

ELECTRICAL SYSTEM

Lighting system output	30 A @ 14.5 V 1340 W @ 6000 RPM	
Spark plug	Type	NGK ILKR8Q7 (engine and spark plug threads are indexed)
	Gap ⁽¹⁾	Not adjustable 0.6 mm to 0.7 mm (.024 in to .028 in)

SPECIFICATIONS (ENGINE)

LUBRICATION SYSTEM			
Engine oil	Type ⁽²⁾	Scandinavia	4T 0W40 SYNTHETIC OIL (EUR) (P/N 779286)
		All other countries	4T 0W40 SYNTHETIC OIL (P/N 779139)
	Quantity		Oil change with filter: 3.5 L (3.7 qt (U.S. liq.))

SPECIFICATIONS (VEHICLE)

COOLING SYSTEM		
Coolant type	Scandinavia	EXTENDED LIFE PRE-MIXED COOLANT (EUR) (P/N 779223)
	All other countries	EXTENDED LIFE PRE-MIXED COOLANT (P/N 779150)
	Alternative, or if not available	Ethyl glycol and distilled water (50%/50%) or coolant specifically formulated for aluminum engines
Coolant capacity	49 Ranger	7.4 L (7.8 qt (U.S. liq.))
	Xtrim SC	6.8 L (7.19 qt (U.S. liq.))

FUEL SYSTEM		
Fuel pump		In-tank electrical fuel pump
Fuel	Type	Premium unleaded Refer to <i>FUEL REQUIREMENTS</i>
	Octane rating	87 Pump Posted AKI (R+M)/2 92 (RON)
Fuel tank capacity		34 L (35.9 qt (U.S. liq.))

SPECIFICATIONS (VEHICLE)

ELECTRICAL SYSTEM	
Battery	12 V, 18 A•h
Headlamp	2 x 60/55 W (H-13)
Taillight and stoplight	0.14/2.6 W LED
Fuses	Refer to <i>FUSES</i> in <i>MAINTENANCE</i>

DRIVE SYSTEM		
Chaincase oil	Type	Scandinavia: SYNTHETIC CHAINCASE OIL (EUR) (P/N 779185) All other countries: SYNTHETIC CHAINCASE OIL (P/N 779156)
	Capacity	350 ml (12 U.S. oz)
Chain drive ratio	Xtrim SC 900 ACE	24 / 51 / 110
	49 Ranger PRO 900 ACE	21 / 51 / 116
	49 Ranger PRO 900 ACE 39 mm	21 / 49 / 114
	49 Ranger ST 900 ACE	21 / 49 / 114
	49 Ranger ST 900 ACE 59 mm	21 / 51 / 116
Drive pulley type		pDrive
Drive pulley engagement RPM		2200 ± 100 RPM
Driven pulley type		QRS
Drive sprocket number of teeth		8

DRIVE SYSTEM			
Track	Width	40.6 cm (16 in)	
	Length	49 Ranger	414.1 cm (163 in)
		Xtrim SC	370 cm (145.7 in)
	Profile height	49 Ranger PRO	59 mm (2.3 in)
		49 Ranger PRO 39mm	39 mm (1.5 in)
		49 Ranger ST	39 mm (1.5 in)
		49 Ranger ST 59mm	59 mm (2.3 in)
Xtrim SC	39 mm (1.5 in)		
Track adjustment ⁽³⁾	Deflection	Refer to <i>TRACK TENSION AND ALIGNMENT.</i>	
	Force		

BRAKE SYSTEM		
Brake fluid	Type	DOT 4
	Quantity	65 ml (2.2 U.S. oz)

FRONT SUSPENSION	
Suspension type	LFS
Suspension maximum travel	221 mm (8.7 in)

SPECIFICATIONS (VEHICLE)

FRONT SUSPENSION		
Shock absorber type	49 Ranger	HPG 36
	Xtrim SC	KYB 36 R
Stabilizer bar type		Link

REAR SUSPENSION			
Suspension type	49 Ranger		PPS2 4100-A
	Xtrim SC		PPS2 3700
Suspension maximum travel			390 mm (15.4 in)
Shock absorber type	Center	49 Ranger	HPG 36
		Xtrim SC	KYB 36
	Rear	49 Ranger	HPG 36
		Xtrim SC	KYB 46

WEIGHT AND DIMENSIONS		
Mass (dry)	49 Ranger PRO	273 kg (602 lb)
	49 Ranger ST	277 kg (611 lb)
	Xtrim SC	255 kg (562 lb)
Overall length	49 Ranger	354.0 cm (139.4 in)
	Xtrim SC	331 cm (130.3 in)
Overall width		118 cm (46.5 in)

WEIGHT AND DIMENSIONS		
Overall height (including windshield)	49 Ranger	138 cm (54.3 in)
	Xtrim SC	127 cm (50 in)
Ski stance	All models except 49 Ranger PRO	99.6 cm (39.2 in)
	49 Ranger PRO	92.1 cm (36.3 in)

⁽¹⁾ **NOTICE** DO NOT ATTEMPT TO ADJUST GAP ON THIS SPARK PLUG.

⁽²⁾ Refer to *ENGINE OIL* for detailed information.

⁽³⁾ Measure gap between slider shoe and bottom inside track when exerting a downward pull to the track.

***This page is
intentionally blank***

TROUBLE- SHOOTING

TROUBLESHOOTING GUIDELINES

ELECTRIC STARTER DOES NOT WORK

- 1. Emergency engine stop switch in OFF position or tether cord cap not installed on engine cut-off switch.**
 - *Place the emergency engine stop switch in the ON position and install tether cord cap (on engine cut-off switch).*
- 2. Throttle applied while attempting an engine start.**
 - *Release throttle while cranking.*

ENGINE IS CRANKED BUT FAILS TO START

- 1. No fuel to the engine.**
 - *Check fuel tank level, add fuel if necessary.*
- 2. System voltage too low.**
 - *Contact an authorized Lynx dealer.*

ENGINE RPM DOES NOT REACH CLUTCH ENGAGEMENT POINT

- 1. D.E.S.S. did not read D.E.S.S. key code in the tether cord cap. D.E.S.S. pilot lamp blinks (slow short beeps/repetitive).**
 - *Properly install tether cord cap.*
- 2. D.E.S.S. has read a different code than the one programmed. D.E.S.S. pilot lamp blinks rapidly (fast short beeps/repetitive).**
 - *Install a tether cord cap for which this snowmobile was programmed.*
- 3. ECM does not recognize the D.E.S.S. key.**
 - *Refer to an authorized Lynx dealer.*

ENGINE LACKS ACCELERATION OR POWER

- 1. Engine warm-up in progress.**
 - *Drive vehicle at low speeds for a few minutes.*
- 2. Engine break-in period not completed.**
 - *Complete break-in period.*
- 3. Drive and driven pulleys require servicing.**
 - *Contact an authorized Lynx dealer.*

ENGINE LACKS ACCELERATION OR POWER (cont'd)

4. Engine overheats.

- Check coolant level, refer to MAINTENANCE PROCEDURES.
- Check heat exchangers cleanliness. Clean if necessary.

5. Drive belt worn too thin.

- If the drive belt has lost more than 3 mm (1/8 in) of its original width, it will affect vehicle performance.
- Replace drive belt.

6. Incorrect track adjustment.

- Refer to MAINTENANCE and/or see an authorized Lynx dealer for proper alignment and tension adjustments.

7. Fuel pressure too low.

- Seek service from an authorized Lynx dealer, repair shop, or person of your own choosing for maintenance, repair, or replacement.

ENGINE BACKFIRES

1. Engine is running too hot.

- Refer to item 4 of ENGINE LACKS ACCELERATION OR POWER above.

2. Ignition timing is incorrect or there is an ignition system failure.

- Seek service from an authorized Lynx dealer, repair shop, or person of your own choosing for maintenance, repair, or replacement.

3. Exhaust system leak.

- Seek service from an authorized Lynx dealer, repair shop, or person of your own choosing for maintenance, repair, or replacement.

4. Fuel pressure too low.

- Seek service from an authorized Lynx dealer, repair shop, or person of your own choosing for maintenance, repair, or replacement.

ENGINE MISFIRES

1. Water in fuel.

- Drain fuel system and refill with fresh fuel.

HEATED GRIPS/THUMB WARMERS ARE NOT WORKING

1. Engine RPM is too low.

- *Make sure engine RPM is above 2000.*

ENGINE HAS SHUT DOWN

1. The engine shuts down after long periods of idling.

- *Do not let engine idle too long. Refer to VEHICLE WARM-UP in OPERATING INSTRUCTION.*

MONITORING SYSTEM

Pilot Lamps, Messages and Beeper Codes

Multifunction Analog/Digital Gauge

Gauge pilot lamp(s) will inform you if an anomaly occurs or to inform you of a particular condition.



TYPICAL — PILOT LAMPS

Pilot lamp can flash alone or in combination with another lamp.

On the multifunction analog/digital gauge, the center display is used as a complement of the pilot lamps to give you a brief description if an anomaly occurs or to inform you of a particular condition.

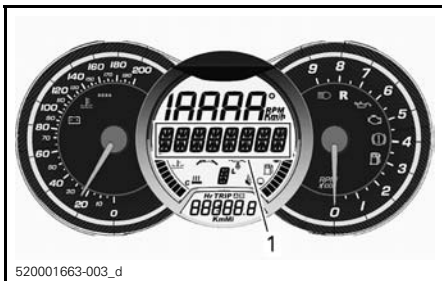



1. Center Display



Messages will be displayed with a beep code and pilot lamp(s).

Beeper codes will be heard and messages will be displayed to catch your attention.

See table below for details.

NOTE: Some of the listed pilot lamps and messages do not apply to all models. The message display is available only on the multifunction analog/digital gauge.

PILOT LAMP ON	BEEPER	MESSAGE DISPLAY	DESCRIPTION
	4 short beeps every 30 seconds	ENGINE OVERHEAT	Engine is overheating, reduce snowmobile speed and run in loose snow or stop engine immediately and let engine cool down. Check coolant level, refer to <i>MAINTENANCE</i> . If coolant level is correct and overheating persists, contact an authorized Lynx dealer. Do not run the engine if condition persists.
		MUFFLER	Reduce speed or stop engine. Let engine cool down and restart. If overheating persists, contact an authorized Lynx dealer. Do not run the engine if condition persists.
	Short beeps repeating rapidly	ENGINE OVERHEAT	Critical overheating. Stop engine immediately and let engine cool down. Check coolant level, refer to <i>MAINTENANCE</i> . If coolant level is correct and overheating persists, contact an authorized Lynx dealer. Do not run the engine if condition persists.
		MUFFLER OVERHEAT	Critical overheating. Stop engine immediately and let engine cool down. If overheating persists, contact an authorized Lynx dealer. Do not run the engine if condition persists.
		ECM OVERHEAT	

PILOT LAMP ON	BEEPER	MESSAGE DISPLAY	DESCRIPTION
	4 short beeps every 5 minutes	LOW BAT	Indicate a low or high battery voltage condition. See an authorized Lynx dealer as soon as possible.
		HIGH BAT	
	4 short beeps	CHECK ENGINE	Engine fault, see an authorized Lynx dealer, repair shop or person of your own choosing as soon as possible.
	—		Displayed when brake is applied for more than 15 seconds while throttle lever is squeezed and vehicle is moving at more than 5 km/h (3 MPH).
—	4 short beeps every 5 minutes	KNOCK	Engine detonation (RPM is limited when this condition occurs). <ul style="list-style-type: none"> – Ensure recommended fuel is used. – Check fuel quality, replace if necessary. – If fault still occurs, contact an authorized Lynx dealer, repair shop, or person of your own choosing.
—	4 short beeps every 5 minutes	REV LIMIT	Engine RPM limited for protection when certain faults occur.
—	—	OVER REV	Indicates that maximum engine RPM is reached. Check clutch calibration.

MONITORING SYSTEM

PILOT LAMP ON	BEEPER	MESSAGE DISPLAY	DESCRIPTION
—	Short beeps repeating rapidly	SHUTDOWN	Shutdown procedure in force due to engine overheating or fuel pump problem.
—	—	COMMUNICATION	Communication problem between ECM and gauge. Stop engine, remove tether cord cap. Wait a few minutes, then start engine. If problem persists, contact an authorized Lynx dealer.
DESS	2 short beeps	—	Good key, vehicle ready to operate.
	Short beeps, repeating slowly	CHECK KEY	Unable to read key (bad connection). Make sure the key is clean and correctly snapped on post.
	Short beeps repeating rapidly	BAD KEY	Invalid key or key not programmed. Use the proper key for the vehicle or have the programmed.
—	—	 (blinking)	Fuel level sensor problem.

Icons, Messages and Beeper Codes



The gauge icons inform you of an anomaly or a particular condition. Icons can come on or blink alone or in combination with others.





1. Lower display



In addition to the icons, messages are displayed along with a beep code.

See following table for details.

ICON ON	BEEPER	MESSAGE	DESCRIPTION
	4 short beeps every 30 seconds	ENGINE OVERHEAT	Engine is overheating, reduce snowmobile speed and run in loose snow or stop engine immediately and let engine cool down. Check coolant level, refer to <i>MAINTENANCE</i> . If coolant level is correct and overheating persists, contact an authorized Lynx dealer. Do not run the engine if condition persists.
		MUFFLER	Reduce speed or stop engine. Let engine cool down and restart. If overheating persists, contact an authorized Lynx dealer. Do not run the engine if condition persists.
		ECM	
	Short beeps repeating rapidly	OVERHEAT In combination with "ENGINE OVERHEAT" above	Critical overheat. Stop engine immediately and let engine cool down. Check coolant level, refer to <i>MAINTENANCE</i> . If coolant level is correct and overheating persists, contact an authorized Lynx dealer. Do not run the engine if condition persists.
		OVERHEAT In combination with "MUFFLER" OR "ECM"	Critical overheat. Stop engine immediately and let engine cool down. If overheating persists, contact an authorized Lynx dealer. Do not run the engine if condition persists.

ICON ON	BEEPER	MESSAGE	DESCRIPTION
	4 short beeps every 5 minutes	LOW BAT	Indicate a low or high battery voltage condition. See an authorized Lynx dealer as soon as possible.
		HIGH BAT	
	4 short beeps	CHECK ENGINE	Engine fault, see an authorized Lynx dealer, repair shop or person of your own choosing as soon as possible.
 (blinking)	4 short beeps		Displayed when brake is applied for more than 15 seconds while throttle lever is squeezed and vehicle is moving at more than 5 km/h (3 MPH).
—	4 short beeps every 8 seconds	KNOCK	Engine detonation (RPM is limited when this condition occurs). <ul style="list-style-type: none"> – Ensure recommended fuel is used. – Check fuel quality, replace if necessary. – If fault still occurs, contact an authorized Lynx dealer repair shop, or person of your own choosing.
—	4 short beeps every 5 minutes	REV LIMIT	Engine RPM limited for protection when certain faults occur.
—	—	OVER REV	Indicates that maximum engine RPM is reached. Check clutch calibration.

MONITORING SYSTEM

ICON ON	BEEPER	MESSAGE	DESCRIPTION
—	Short beeps repeating rapidly	SHUT DOWN	Shutdown procedure in force due to engine overheating or fuel pump problem.
—	—	COMMUNICATION	Communication problem between ECM and gauge. Stop engine, remove tether cord cap. Wait a few minutes, then start engine. If problem persists, contact an authorized Lynx dealer.
—	Short beeps, repeating slowly	CHECK KEY	Unable to read key (bad connection). Make sure the key is clean and correctly snapped on post.
	Short beeps repeating rapidly	BAD KEY	Invalid key or key not programmed. Use the proper key for the vehicle or have the programmed.
   (All blinking)	—	—	Fuel level sensor problem.

WARRANTY

BRP FINLAND OY INTERNATIONAL LIMITED WARRANTY: 2019 LYNX® SNOWMOBILES

1) SCOPE OF THE LIMITED WARRANTY

Bombardier Recreational Products Inc. ("BRP")* warrants its 2019 LYNX snowmobiles sold by distributors or dealers authorized by BRP to distribute LYNX snowmobiles ("LYNX Distributor/Dealer") outside of the fifty United States, Canada, members of the European Economic Area (which is comprised of the member states of the European Union plus Norway, Iceland and Liechtenstein) ("EEA"), members states of the Commonwealth of the Independent States (including Ukraine and Turkmenistan) ("CIS") and Turkey, from defects in material or workmanship for the period and under the conditions described below.

Non-factory installed parts and accessories are not covered under this limited warranty. Please refer to the applicable parts and accessories limited warranty text.

This limited warranty will become null and void if: (1) the snowmobile was used for racing or any other competitive activity, at any point, even by a previous owner; or (2) the snowmobile has been altered or modified in such a way so as to adversely affect its operation, performance or durability, or has been altered or modified to change its intended use.

2) LIMITATIONS OF LIABILITY

TO THE EXTENT PERMITTED BY LAW, THIS WARRANTY IS EXPRESSLY GIVEN AND ACCEPTED IN LIEU OF ANY AND ALL OTHER WARRANTIES, EXPRESSED OR IMPLIED, INCLUDING WITHOUT LIMITATION ANY WARRANTY OF MERCHANTABILITY OR FITNESS FOR A PARTICULAR PURPOSE. TO THE EXTENT THAT THEY CANNOT BE DISCLAIMED, THE IMPLIED WARRANTIES ARE LIMITED IN DURATION TO THE LIFE OF THE EXPRESS WARRANTY. INCIDENTAL AND CONSEQUENTIAL DAMAGES ARE EXCLUDED FROM COVERAGE UNDER THIS WARRANTY. SOME JURISDICTIONS DO NOT ALLOW FOR THE DISCLAIMERS, LIMITATIONS AND EXCLUSIONS IDENTIFIED ABOVE, AS A RESULT, THEY MAY NOT APPLY TO YOU. THIS WARRANTY GIVES YOU SPECIFIC RIGHTS, AND YOU MAY ALSO HAVE OTHER LEGAL RIGHTS WHICH MAY VARY FROM COUNTRY TO COUNTRY. (FOR PRODUCTS PURCHASED IN AUSTRALIA SEE CLAUSE 4 BELOW).

Neither the LYNX Distributor/Dealer nor any other person has been authorized to make any affirmation, representation or warranty regarding the product, other than those contained in this limited warranty, and if made, shall not be enforceable against BRP.

BRP reserves the right to modify this warranty at any time, being understood that such modification will not alter the warranty conditions applicable to the products sold while this warranty is in effect.

3) EXCLUSIONS – ARE NOT WARRANTED

The following are not warranted under this limited warranty under any circumstances:

- Normal wear and tear;
- Routine maintenance items, tune ups, adjustments;
- Damage caused by negligence or failure to provide proper maintenance and/or storage, as described in the Operator's Guide;
- Damage resulting from removal of parts, improper repairs, service, maintenance, modifications or use of parts or accessories not manufactured or approved by BRP which in its reasonable judgement are either incompatible with the product or adversely affect its operation, performance and durability, or resulting from repairs done by a person that is not an authorized servicing LYNX Distributor/Dealer;
- Damage caused by abuse, abnormal use, neglect, racing or operation of the product on surfaces other than snow, or operation of the product in a manner inconsistent with the recommended operation described in the Operator's Guide;
- Damage resulting from accident, submersion, fire, snow or water ingestion, theft, vandalism or any act of God;
- Operation with fuels, oils or lubricants which are not suitable for use with the product (see the Operator's Guide);
- Damage resulting from rust, corrosion or exposure to the elements;
- Incidental or consequential damages, or damages of any kind including without limitation towing, storage, transportation expenses, telephone, rental, taxi, inconvenience, insurance coverage, loan payments, loss of time, loss of income; or time missed for downtime experience due to service work.
- And damage resulting from studs installed on tracks if the installation does not conform to BRP's instructions.

4) WARRANTY COVERAGE PERIOD

This warranty will be in effect from (1) the date of delivery to the first retail consumer or (2) the date the product is first put into use, whichever occurs first and for a period of:

TWELVE (12) CONSECUTIVE MONTHS, for private or commercial use owners. However, the warranty coverage period on a snowmobile delivered between June 1st and December 1st of a given year will expire November 30th of the following year.

The repair or replacement of parts or the performance of service under this warranty does not extend the life of this warranty beyond its original expiration date.

Note that the duration and any other modalities of the warranty coverage are subject to the applicable national or local legislation in the customer's country.

FOR PRODUCTS SOLD IN AUSTRALIA ONLY

Nothing in these Warranty terms and conditions should be taken to exclude, restrict or modify the application of any condition, warranty, guarantee, right or remedy conferred or implied under the Competition and Consumer Act 2010 (Cth), including the Australian Consumer Law or any other law, where to do so would contravene that law, or cause any part of these terms and conditions to be void. The benefits given to you under this limited warranty are in addition to other rights and remedies that you have under Australian law.

Our goods come with guarantees that cannot be excluded under the Australian Consumer Law. You are entitled to a replacement or refund for a major failure and for compensation for any other reasonably foreseeable loss or damage. You are also entitled to have the goods repaired or replaced if the goods fail to be of acceptable quality and the failure does not amount to a major failure.

5) CONDITIONS TO HAVE WARRANTY COVERAGE

This warranty coverage is available **only** if each of the following conditions has been fulfilled:

- The 2019 LYNX snowmobile must be purchased as new and unused by its first owner from a LYNX Distributor/Dealer authorized to distribute LYNX snowmobiles in the country in which the sale occurred;

- The BRP specified pre-delivery inspection process must be completed and documented;
- The product must have undergone proper registration by an authorized LYNX Distributor/Dealer;
- The 2019 LYNX snowmobile must be purchased in the country or union of countries in which the purchaser resides.
- Routine maintenance outlined in the Operator's Guide must be timely performed in order to maintain warranty coverage. BRP reserves the right to make warranty coverage contingent upon proof of proper maintenance.

BRP will not honour this limited warranty to any private use owner or commercial use owner if one of the preceding conditions has not been met. Such limitations are necessary in order to allow BRP to preserve both the safety of its products, and also that of its consumers and the general public.

6) WHAT TO DO TO OBTAIN WARRANTY COVERAGE

The customer must cease using the snowmobile upon the appearance of an anomaly. The customer must notify a servicing LYNX Distributor/Dealer within two (2) days of the appearance of a defect, and provide it with reasonable access to the product and reasonable opportunity to repair it. The customer must also present to the authorized LYNX Distributor/Dealer, proof of purchase of the product and must sign the repair/work order prior to starting the repair in order to validate the warranty repair. All parts replaced under this limited warranty become the property of BRP.

Note that the notification period is subject to the applicable national or local legislation in customer's country.

7) WHAT BRP WILL DO

To the extent permitted by law, BRP's obligations under this warranty are limited to, at its sole discretion, repairing parts found defective under normal use, maintenance and service, or replacing such parts with new genuine LYNX parts without charge for parts and labour, at any authorized LYNX Distributor/Dealer during the warranty coverage period under the conditions described herein. BRP's responsibility is limited to making the required repairs or replacements of parts.

No claim of breach of warranty shall be cause for cancellation or rescission of the sale of the snowmobile to the owner. You may have other legal rights which may vary from country to country.

In the event that service is required outside of the country of original sale, the owner will bear responsibility for any additional charges due to local practices and conditions, such as, but not limited to, freight, insurance, taxes, license fees, import duties, and any and all other financial charges, including those levied by governments, states, territories and their respective agencies.

BRP reserves the right to improve or modify products from time to time without assuming any obligation to modify products previously manufactured.

8) TRANSFER

If the ownership of a product is transferred during the warranty coverage period, this limited warranty, subject to its terms and conditions, shall also be transferred and be valid for the remaining coverage period provided BRP or an authorized LYNX Distributor/Dealer receives a proof that the former owner agreed to the transfer of ownership, in addition to the co-ordinates of the new owner.

9) CONSUMER ASSISTANCE

In the event of a controversy or a dispute in connection with this limited warranty, BRP suggests that you try to resolve the issue at the LYNX Distributor/Dealer level. We recommend discussing the issue with the authorized LYNX Distributor/Dealer's service manager or owner.

If the matter still remains unresolved, contact BRP by filling out the customer contact form at www.brp.com or contact BRP by mail at one of the addresses listed under the *CONTACT US* section of this guide.

* For the territory covered by this limited warranty, products are distributed and serviced by Bombardier Recreational Products Inc. or its affiliates.

© 2018 Bombardier Recreational Products Inc. All rights reserved.

® Registered trademark of Bombardier Recreational Products Inc.

BRP FINLAND OY LIMITED WARRANTY FOR THE EUROPEAN AND THE COMMONWEALTH OF THE INDEPENDENT STATES (CIS) AREAS AND TURKEY : 2019 LYNX® SNOWMOBILES

1) SCOPE OF THE LIMITED WARRANTY

Bombardier Recreational Products Inc. ("BRP")* warrants its 2019 LYNX snowmobiles sold by distributors or dealers authorized by BRP to distribute LYNX snowmobiles ("LYNX Distributor/Dealer") in member states of the European Economic Area (which is comprised of the member states of the European Union plus Norway, Iceland and Liechtenstein) ("EEA"), in member states of the Commonwealth of the Independent States (including Ukraine and Turkmenistan) ("CIS") and Turkey from defects in material or workmanship for the period and under the conditions described below.

Non-factory installed parts and accessories are not covered under this limited warranty. Please refer to the applicable parts and accessories limited warranty text.

This limited warranty will become null and void if: (1) the snowmobile was used for racing or any other competitive activity, at any point, even by a previous owner; or (2) the snowmobile has been altered or modified in such a way so as to adversely affect its operation, performance or durability, or has been altered or modified to change its intended use.

2) LIMITATIONS OF LIABILITY

TO THE EXTENT PERMITTED BY LAW, THIS WARRANTY IS EXPRESSLY GIVEN AND ACCEPTED IN LIEU OF ANY AND ALL OTHER WARRANTIES, EXPRESSED OR IMPLIED, INCLUDING WITHOUT LIMITATION ANY WARRANTY OF MERCHANTABILITY OR FITNESS FOR A PARTICULAR PURPOSE. TO THE EXTENT THAT THEY CANNOT BE DISCLAIMED, THE IMPLIED WARRANTIES ARE LIMITED IN DURATION TO THE LIFE OF THE EXPRESS WARRANTIES. INCIDENTAL AND CONSEQUENTIAL DAMAGES ARE EXCLUDED FROM COVERAGE UNDER THIS WARRANTY. SOME JURISDICTIONS DO NOT ALLOW FOR THE DISCLAIMERS, LIMITATIONS AND EXCLUSIONS IDENTIFIED ABOVE, AS A RESULT, THEY MAY NOT APPLY TO YOU. THIS WARRANTY GIVES YOU SPECIFIC RIGHTS, AND YOU MAY ALSO HAVE OTHER LEGAL RIGHTS WHICH MAY VARY FROM COUNTRY TO COUNTRY.

Neither the LYNX Distributor/Dealer nor any other person has been authorized to make any affirmation, representation or warranty regarding the product, other than those contained in this limited warranty, and if made, shall not be enforceable against BRP.

BRP reserves the right to modify this warranty at any time, being understood that such modification will not alter the warranty conditions applicable to the products sold while this warranty is in effect.

3) EXCLUSIONS – ARE NOT WARRANTED

The following are not warranted under this limited warranty under any circumstances:

- Normal wear and tear;
- Routine maintenance items, tune ups, adjustments;
- Damage caused by negligence or failure to provide proper maintenance and/or storage, as described in the Operator's Guide;
- Damage resulting from removal of parts, improper repairs, service, maintenance, modifications or use of parts or accessories not manufactured or approved by BRP which in its reasonable judgement are either incompatible with the product or adversely affect its operation, performance and durability, or resulting from repairs done by a person that is not an authorized servicing LYNX Distributor/Dealer;
- Damage caused by abuse, abnormal use, neglect, racing or operation of the product on surfaces other than snow, or operation of the product in a manner inconsistent with the recommended operation described in the Operator's Guide;
- Damage resulting from accident, submersion, fire, snow or water ingestion, theft, vandalism or any act of God;
- Operation with fuels, oils or lubricants which are not suitable for use with the product (see the Operator's Guide);
- Damage resulting from rust, corrosion or exposure to the elements;
- Incidental or consequential damages, or damages of any kind including without limitation towing, transportation expenses, storage, telephone, rental, taxi, inconvenience, insurance coverage, loan payments, loss of time, loss of income or time missed for downtime experience due to service work;
- and damage resulting from studs installed on tracks if the installation does not conform to BRP's instructions.

4) WARRANTY COVERAGE PERIOD

This warranty will be in effect from (1) the date of delivery to the first retail consumer or (2) the date the product is first put into use, whichever occurs first and for a period of:

TWENTY-FOUR (24) CONSECUTIVE MONTHS, for private use owners and TWELVE (12) CONSECUTIVE MONTHS for commercial use owners. However, the warranty coverage period on a snowmobile delivered between June 1st and December 1st of a given year will expire November 30th of the applicable year. A snowmobile is used commercially when it is used in connection with generating income or any work or employment during any part of the warranty period. A snowmobile is also used commercially when, at any point during the warranty period, it has commercial tags or is licensed for commercial use.

The repair or replacement of parts or the performance of service under this warranty does not extend the life of this warranty beyond its original expiration date.

Note that the duration and any other modalities of the warranty coverage are subject to the applicable national or local legislation in the customer's country.

5) CONDITIONS TO HAVE WARRANTY COVERAGE

This warranty coverage is available **only** if each of the following conditions has been fulfilled:

- The 2019 LYNX snowmobile must be purchased as new and unused by its first owner from a LYNX Distributor/Dealer authorized to distribute LYNX products in the country in which the sale occurred;
- The BRP specified pre-delivery inspection process must be completed and documented;
- The product must have undergone proper registration by an authorized LYNX Distributor/Dealer;
- The 2019 LYNX snowmobile must be purchased within the EEA by an EEA resident, in the CIS for residents of the countries comprised in such area and in Turkey for residents of Turkey; and
- Routine maintenance outlined in the Operator's Guide must be timely performed in order to maintain warranty coverage. BRP reserves the right to make warranty coverage contingent upon proof of proper maintenance.

BRP will not honour this limited warranty to any private use owner or commercial use owner if one of the preceding conditions has not been met. Such limitations are necessary in order to allow BRP to preserve both the safety of its products, and also that of its consumers and the general public.

6) WHAT TO DO TO OBTAIN WARRANTY COVERAGE

The customer must cease using the snowmobile upon the appearance of an anomaly. The customer must notify a servicing LYNX Distributor/Dealer within two (2) months of the appearance of a defect, and provide it with reasonable access to the product and reasonable opportunity to repair it. The customer must also present to the authorized LYNX Distributor/Dealer, proof of purchase of the product and must sign the repair/work order prior to starting the repair in order to validate the warranty repair. All parts replaced under this limited warranty become the property of BRP.

Note that the notification period is subject to the applicable national or local legislation in customer's country.

7) WHAT BRP WILL DO

To the extent permitted by law, BRP's obligations under this warranty are limited to, at its sole discretion, repairing parts found defective under normal use, maintenance and service, or replacing such parts with new genuine LYNX parts without charge for parts and labour, at any authorized LYNX Distributor/Dealer during the warranty coverage period under the conditions described herein. BRP's responsibility is limited to making the required repairs or replacements of parts. No claim of breach of warranty shall be cause for cancellation or rescission of the sale of the snowmobile to the owner. You may have other legal rights which may vary from country to country.

In the event that service is required outside of the EEA, CIS or Turkey, the owner will bear responsibility for any additional charges due to local practices and conditions, such as, but not limited to, freight, insurance, taxes, license fees, import duties, and any and all other financial charges, including those levied by governments, states, territories and their respective agencies.

BRP reserves the right to improve or modify products from time to time without assuming any obligation to modify products previously manufactured.

8) TRANSFER

If the ownership of a product is transferred during the warranty coverage period, this limited warranty, subject to its terms and conditions, shall also be transferred and be valid for the remaining coverage period provided BRP or an authorized LYNX Distributor/Dealer receives a proof that the former owner agreed to the transfer of ownership, in addition to the co-ordinates of the new owner.

9) CONSUMER ASSISTANCE

In the event of a controversy or a dispute in connection with this limited warranty, BRP suggests that you try to resolve the issue at the LYNX Distributor/Dealer level. We recommend discussing the issue with the authorized LYNX Distributor/Dealer's service manager or owner.

If the matter still remains unresolved, contact BRP by filling out the customer contact form at www.brp.com or contact BRP by mail at one of the addresses listed under the *CONTACT US* section of this guide.

* In the EEA, products are distributed and serviced by BRP European Distribution S.A. and other affiliates or subsidiaries of BRP.

© 2018 Bombardier Recreational Products Inc. All rights reserved.

® Registered trademark of Bombardier Recreational Products Inc.

ADDITIONAL TERMS AND CONDITIONS FOR FRANCE ONLY

The following terms and conditions are applicable to products sold in France only:

The seller shall deliver goods that are complying with the contract and shall be responsible for defects existing upon delivery. The seller shall also be responsible for defects resulting from packaging, assembling instructions or the installation when it is its responsibility per the contract or if accomplished under its responsibility. To be compliant with the contract, the good shall:

1. Be fit for normal use for goods similar thereto and, if applicable:
 - Correspond to the description provided by the seller and have the qualities presented to the buyer though sample or model;
 - Have the qualities that a buyer may legitimately expect considering the public declarations of the seller, the manufacturer of its representative, including in advertising or labeling; or
2. Have the characteristics mutually agreed upon as between the parties or be fit for the specific use intended by the buyer and brought to the attention of the seller and which accepted

The action for failure to comply is prescribed after two years after delivery of the goods. The seller is responsible for the warranty for hidden defects of the good sold if such hidden defects are rendering the good unfit for the intended use, or if they diminish its use in such a way that the buyer would not have acquired the good or would have given a lesser price, had he known. The action for such hidden defects shall be taken by the buyer within 2 years of the discovery of the defect.

MAINTENANCE RECORDS

Send photocopy of maintenance record to BRP if needed.

PREDELIVERY	
Serial number: _____ Mileage / km: _____ Hours: _____ Date: _____ Dealer no: _____ Notes: _____	Signature/Print: _____
Refer to vehicle Pre-Delivery Bulletin for detailed installation procedures	

FIRST INSPECTION	
Mileage / km: _____ Hours: _____ Date: _____ Dealer no: _____ Notes: _____	Signature/Print: _____
For maintenance schedule refer to Maintenance Information section of this operator's guide	

SERVICE

Mileage /
km:

Hours:

Date:

Dealer
no:

Notes:

Signature/Print:

For maintenance schedule refer to Maintenance Information
section of this operator's guide

SERVICE

Mileage /
km:

Hours:

Date:

Dealer
no:

Notes:

Signature/Print:

For maintenance schedule refer to Maintenance Information
section of this operator's guide

SERVICE

Mileage /
km:

Hours:

Date:

Dealer
no:

Notes:

Signature/Print:

For maintenance schedule refer to Maintenance Information
section of this operator's guide

SERVICE

Mileage /
km:

Hours:

Date:

Dealer
no:

Notes:

Signature/Print:

For maintenance schedule refer to Maintenance Information
section of this operator's guide

SERVICE

Mileage /
km:

Hours:

Date:

Dealer
no:

Notes:

Signature/Print:

For maintenance schedule refer to Maintenance Information
section of this operator's guide

SERVICE

Mileage /
km:

Hours:

Date:

Dealer
no:

Notes:

Signature/Print:

For maintenance schedule refer to Maintenance Information
section of this operator's guide

CUSTOMER INFORMATION

CONTACT US

www.brp.com

North America

565 de la Montagne Street
Valcourt (Québec) J0E 2L0
Canada

Sturtevant, Wisconsin, U.S.A.
10101 Science Drive
Sturtevant, Wisconsin
53177
U.S.A.

Sa De Cv, Av. Ferrocarril 202
Parque Ind. Querétaro, Lote2-B
76220
Santa Rosa Jáuregui, Oro., Mexico

Europe

Skaldenstraat 125
B-9042 Gent
Belgium

Itterpark 11
D-40724 Hilden
Germany

ARTEPARC Bâtiment B
Route de la côte d'Azur, Le Canet
13590 Meyreuil
France

Ingvald Ystgaardsvei 15
N-7484 Trondheim
Norway

Isoaavantie 7
PL 8040
96101 Rovaniemi

Formvägen 16
S-906 21 Umeå
Sweden

Avenue d'Ouchy 4-6
1006 Lausanne
Switzerland

Oceania

6 Lord Street
Lakes Business Park
Botany, NSW 2019
Australia

South America

Rua James Clerck Maxwell, 230
TechnoPark Campinas SP 13069-380 Brazil

Asia

15/F Parale Mitsui Building,8
Higashida-Cho, Kawasaki-ku
Kawasaki 210-0005
Japan

Room Dubai, level 12, Platinum Tower
233 Tai Cang Road
Xintiandi, Lu Wan District
Shanghai 200020
PR China

CHANGE OF ADDRESS/OWNERSHIP

If your address has changed or if you are the new owner of the snowmobile, be sure to notify BRP by either:

- Notifying an authorized Lynx dealer.
- Mailing one of the change of address cards on the following pages at one of the BRP addresses indicated in the *CONTACT US* section of this guide.

In case of change of ownership, please join a proof that the former owner agreed to the transfer.

Notifying BRP, even after the expiration of the limited warranty, is very important as it enables BRP to reach the snowmobile owner if necessary, like when safety recalls are initiated. It is the owner's responsibility to notify BRP.

STOLEN UNITS: If your personal snowmobile is stolen, you should notify BRP or an authorized Lynx dealer. We will ask you to provide your name, address, phone number, the vehicle identification number and the date it was stolen.

VEHICLE MODEL No. _____

VEHICLE IDENTIFICATION NUMBER (V.I.N.) _____

ENGINE IDENTIFICATION NUMBER (E.I.N.) _____

Owner: _____
NAME

No. STREET APT

CITY STATE/PROVINCE ZIP/POSTAL CODE

Purchase Date _____
YEAR MONTH DAY

Warranty Expiry Date _____
YEAR MONTH DAY

To be completed by the dealer at the time of the sale.

DEALER IMPRINT AREA

⚠ WARNING

BEFORE YOU OPERATE THIS VEHICLE, READ THIS OPERATOR'S GUIDE, ALL ON-PRODUCT SAFETY LABELS AND WATCH THE SAFETY VIDEO.



619 900 952

OPERATOR'S GUIDE, RADIEN Trail / Crossover ACE Series / ENGLISH
GUIDE DU CONDUCTEUR, Série RADIEN Trail / Crossover ACE
Series / ANGLAIS

FAIT AU / MADE IN CANADA

U/M:P.C.