

BOMBARDIER* ATV



OPERATOR'S GUIDE

INCLUDES
SAFETY, VEHICLE AND MAINTENANCE
INFORMATION



2006
OUTLANDER™
MAX
400



WARNING

Read this guide thoroughly.
It contains important safety information.
Minimum recommended operator age: 16 years.
Passenger: 12 years.
Do not remove this *Operator's Guide* from the vehicle.

This Operator's Guide utilizes the following symbols to emphasize particular information:



The Safety Alert Symbol indicates a potential personal injury hazard.



Indicates a potential hazard that, if not avoided, could result in serious injury or death.

CAUTION: Denotes an instruction which, if not followed, could severely damage vehicle components.

WARNING

YOUR VEHICLE CAN BE HAZARDOUS TO OPERATE. A collision or rollover can occur quickly, even during routine maneuvers such as turning and driving on hills or over obstacles, if you fail to take proper precautions.

For your safety, understand and follow all the warnings contained in this Operator's Guide and the labels on your vehicle. **Failure to follow these warnings can result in SEVERE INJURY OR DEATH.**

Keep this Operator's Guide with the vehicle at all times.

WARNING

Disregarding any of the safety precautions and instructions contained in this Operator's Guide, Safety Videocassette and on-product labels could cause injury including the possibility of death!

All safety documentation should remain with the vehicle at the time of sale.

All content of the Safety Information section should be interpreted by the reader as a warning which, if not followed, may result in injury including the possibility of death.

The following trademarks are property of Bombardier Recreational Products Inc.:

Outlander™

ROTAX®

XP-S™

TTI™

Printed in the E.U. (Outlander Max EN 2006.fm)

®™ Trademarks of Bombardier Recreational Products Inc. or its affiliates.

© 2006 Bombardier Recreational Products Inc. and BRP US Inc. All rights reserved.

* Trademark of Bombardier Inc., used under license.

FOREWORD

Congratulations on your purchase of a new Bombardier* recreational vehicle. It is backed by the BRP warranty and a network of authorized Bombardier ATV dealers ready to provide the parts, service or accessories you may require.

Your dealer is committed to your satisfaction. He has taken training to perform the initial set-up and inspection of your vehicle as well as completed the final adjustment before you took possession. At delivery, your dealer would have explained the operation, maintenance and safety features of the vehicle. We trust you have taken full advantage of this! If you need more complete servicing information, please ask your dealer.

At delivery, you were also informed of the warranty coverage and completed the Warranty Registration Form which is to be sent to us for processing. In the near future you should be receiving a warranty card which will confirm our receipt of the registration as well as be used for warranty or recall purposes.

You are invited to contact our customer assistance center should you experience problems which cannot be resolved by an authorized Bombardier ATV dealer.

It is understood that this Operator's Guide may be translated into another language. In the event of any discrepancy, the English version shall prevail. Throughout this document the masculine is used to denote the masculine or feminine.

The information and components/system descriptions contained in this document are correct at the time of publication. Bombardier Recreational Products Inc. (BRP), however, maintains a policy of continuous improvement of its products without imposing upon itself any obligation to install them on products previously manufactured. Due to late changes, some differences between the manufactured product and the descriptions and/or specifications in this guide may occur. BRP reserves the right at any time to discontinue or change specifications, designs, features, models or equipment without incurring any obligation upon itself.

The illustrations in this document show the typical construction of the different assemblies and may not reproduce the full detail or exact shape of the parts. However, they represent parts that have the same or similar function.

The use of RIGHT and LEFT indications in the text always refers to driving position (when sitting on vehicle).

Specifications are given in the international metric system with the SAE U.S. equivalent in parenthesis. Where precise accuracy is not required, some conversions are rounded off for easier use.

We recommend genuine Bombardier products for replacement parts and accessories. They've been especially designed for your vehicle and manufactured to meet BRP's demanding standards.

A Shop Manual can be obtained for complete service and maintenance information and more repair information.

TABLE OF CONTENTS

WHILE READING THIS OPERATOR'S GUIDE, REMEMBER THAT:

WARNING

Indicates a potential hazard that, if not avoided, could result in serious injury or death.

FOREWORD	1
NOTICE	7
INTRODUCTION	8

SAFETY INFORMATION

SPECIAL SAFETY MESSAGES	11
OPERATION WARNINGS	14
SAFETY WARNING	43
Pre-operation Check.....	44
Clothing	45
Carrying Loads/Passenger	46
Hauling a Trailer	46
Working with Your Vehicle.....	46
Recreational Riding	47
Environment	47
Design Limitation	48
Off-Highway Operation	48
General Operating and Safety Precautions.....	48
Uphill Driving	49
Downhill Driving.....	49
Side Hilling.....	49
Drop-Offs	49
Riding Techniques.....	50
HANG TAG	58
LOCATION OF THE IMPORTANT LABELS	59

SAFETY TRAINING

INTRODUCTION	66
Objective.....	66
Sections Covered	66
Time Required	66
SECTION I - GENERAL SAFETY INFORMATION	67
Objective.....	67
Outline	67
Expected Results.....	68
SECTION II - BOMBARDIER 2-UP VEHICLE SAFETY VIDEOCASSETTE	69
Objective.....	69

Outline	69
SECTION III - OPERATOR'S GUIDE REVIEW	70
Objective.....	70
Outline	70
Expected Results.....	70
SECTION IV - HANDS-ON RIDING.....	71
Objective.....	71
Outline	71
Expected Results.....	71
DRIVING MANEUVER LIST	72
INSTRUCTOR'S CHECK LIST	76
Introduction:.....	76
Section I: General Safety Information.....	76
Section II: Bombardier 2-Up Vehicle Safety Videocassette.....	76
Section III: Operator's Guide Review.....	77
Section IV: Hands-On Riding.....	77
Trainee's Scoring Chart.....	79

VEHICLE INFORMATION

HOW TO IDENTIFY YOUR ATV	82
Engine and Vehicle Identification Number Location	82
Compliance Label	83
EMISSION REQUIREMENTS.....	84
CONTROLS/INSTRUMENTS/EQUIPMENT.....	85
1) Throttle Lever	87
2) 2WD/4WD Selector	87
3) Brake Lever	87
4) Brake Lever Lock	88
5) Transmission Lever.....	88
6) Multi-Function Switch	89
7) Speedometer.....	92
8) 12-Volt Power Outlet	94
9) Ignition Switch.....	95
10) Fuel Tank Cap.....	95
11) Fuel Gauge	96
12) Fuel Valve	96
13) Brake Pedal.....	97
14) Footpeg	97
15) Grab Handles	97
16) Passenger's Seat/Storage Box	98
17) Operator's Seat.....	99
18) Access Panel	100
19) Rear Storage Compartment.....	101
20) Cargo Racks	101

21) Trailer Hitch.....	101
22) Radiator Cap.....	102
23) Fuses	102
24) Tool Box.....	102
25) Rewind Starter Handle	103
26) Dipstick	103
27) Winch	103
28) Winch Control Switch	104
29) Fairlead	104
LIQUIDS	105
Fuel.....	105
Engine/Transmission Oil.....	105
Engine Coolant	107
Brake Fluid	108
Battery	108
BREAK-IN PERIOD	109
Engine	109
Belt	109
10-Hour Inspection	109
OPERATING INSTRUCTIONS.....	110
General.....	110
Pre-operation check	110
Initial Cold Starting	111
Warm Engine Starting	111
Emergency Manual Starting	112
Stopping the Engine	112
Shifting the Transmission	112
2WD/4WD Selector	113
Winch Operation.....	113
SPECIAL PROCEDURES.....	114
Flooded Engine	114
Engine Overheat.....	114
Post-Operation Care.....	114
Turn Over	115
ATV Immersion.....	115
Storage and Preseason Preparation	115
CARGO AND TRANSPORTATION	116
Cargo.....	116
Transportation	117

TROUBLESHOOTING	118
SPECIFICATIONS	121
<i>MAINTENANCE INFORMATION</i>	
MAINTENANCE CHART	128
GENERAL	131
ENGINE/TRANSMISSION	132
Oil Change and Oil Filter Replacement	132
Oil Strainer Cleaning	133
Coolant Replacement	133
Radiator	135
CARBURETOR	136
AIR INTAKE SYSTEM	137
Air Filter box Draining	137
Air Filter Removal	137
Air Filter cleaning	138
Air Filter Installation	138
ELECTRICAL	139
Spark Plug	139
Battery	139
Bulb Replacement	141
DRIVE TRAIN	143
Drive Shaft Boot/Protector	143
Wheel	143
Wheel Bearing Condition	143
Tires/Wheels	144
STEERING SYSTEM	145
Throttle Cable Lubrication	145
Throttle Lever Adjustment	146
SUSPENSION	148
Lubrication	148
Inspection	148
Adjustment	148
BRAKE	149
Front and Rear Brakes	149
Brake Fluid Replacement	149
BODY/FRAME	150
Engine Area	150
Hitch/Trailer Ball Condition	150
Chassis Fasteners	150
Seat Fasteners	150
Vehicle Cleaning and Protection	150

WARRANTY

BRP INTERNATIONAL LIMITED WARRANTY: 2006 BOMBARDIER	
ATV PRODUCTS.....	152
PRIVACY OBLIGATIONS/DISCLAIMER.....	155
CHANGE OF ADDRESS/OWNERSHIP	157

NOTICE

This Operator's Guide has been prepared to acquaint the owner/operator of a new vehicle with the various vehicle controls, maintenance and safe operating instructions. It is indispensable for the proper use of the product.

This Operator's Guide uses the following symbols.



WARNING

Indicates a potential hazard that, if not avoided, could result in serious injury or death.

CAUTION: Denotes an instruction which, if not followed, could severely damage vehicle components.

NOTE: Indicates supplementary information needed to fully complete an instruction.

Although the mere reading of such information does not eliminate the hazard, the understanding and application of the information will promote the correct use of this vehicle.

To fully appreciate the pleasures, enjoyment and excitement of using this vehicle, there are some basic rules that **MUST** be observed and followed by any user.

INTRODUCTION

Your dealer should have provided you with some basic information on the particular controls and features of your new vehicle. Please take the time to study this Operator's Guide and all on-product warning labels as well as the Safety Videocassette that came with this vehicle. They more completely describe what you should know about this vehicle before riding it.

Whether you are a new user or an experienced rider, it is important for your personal safety as well as passenger safety that you know the controls and features of this vehicle. Equally important is knowing how to properly ride.

Irrespective of your age, experience or state regulations, it is always prudent for you or any other person who may ride your vehicle, to take an approved safe riding course. Please check with your dealer or local authorities for availability in your area. If you are a completely new rider, this should be done before your first ride. Your instructor should be able to provide advice on local conditions and safe riding practices particular to the area.

Riding conditions vary from place to place. Each is subject to weather conditions which may radically change from time to time and from season to season. Riding on sand is different than riding on snow or through forests or marshes. Each location may require a greater degree of awareness and skill may not be suitable with a passenger. Show good judgement. Always proceed with caution. Please do not take any unnecessary risks that could leave you or your passenger stranded or possibly injured.

The vehicle handling, stability and braking distance may be affected when riding with a passenger. Safely reduce speed when riding with a passenger. Allow greater distance for braking.

The contents of this Operator's Guide provide riding information which has been proven reliable by other users. They are not intended as a definitive means of avoiding accidents. How you apply this information, coupled with your mental and physical condition, the particular terrain hazard and your risk acceptance level will have an effect on your riding experience. Have fun... and ride responsibly.

This Operator's Guide has been prepared to acquaint the owner/operator of a new vehicle with the various vehicle controls, maintenance and safe operating instructions. They are indispensable for the proper use of the product.

We would be pleased to receive any comments on the content and format of this Operator's Guide, the Safety Videocassette or on-product warnings labels.

SAFETY INFORMATION

WARNING

Operator:

- A person under 16 years old should never operate this vehicle.
- Never carry more than one passenger on this vehicle.
- Passenger must be seated on the designated passenger seat and hold on to the grab handles at all times.
- The operator is responsible for the safety of the passenger. In doubt, disembark him before executing any maneuver.
- The vehicle handling, stability and braking distance may be affected when riding with a passenger. Safely reduce speed when riding with a passenger.
- Allow greater distance for braking.
- Always practice the maneuvers described in this Operator's Guide without and with passenger.
- Inform the passenger concerning the basic rules for a safe ride.
- Never carry passenger when the storage box is installed (in place of rear seat).

Passenger:

- The passenger should be 12 years old or more and must be capable of keeping his feet on footrests and his hands on grab handles at all times when he is seated on this vehicle.
- Passenger should always hold on to rear passenger grab handles. Never hold on to the operator.
- Passenger should pay attention to vehicle and operator movements.
- Passenger should always wear the appropriate protective gear, including an approved helmet with a rigid chin guard.
- Passenger should always keep hands and feet in the proper place during operation.
- Never get up during vehicle operation. An excessive movement could cause loss of control.

Failure to follow the recommendations here could cause changes in vehicle handling which could lead to an accident resulting in severe injuries including the possibility of death for the passenger and/or the operator.

While reading this Operator's Guide, remember that:

WARNING

Indicates a potential hazard that, if not avoided, could result in serious injury or death.

SPECIAL SAFETY MESSAGES

THIS VEHICLE IS NOT A TOY AND CAN BE HAZARDOUS TO OPERATE.

This vehicle handles differently from other vehicles including motorcycles and cars. A collision or rollover can occur quickly, even during routine maneuvers such as turning and driving on hills or over obstacles, if you fail to take proper precautions.

SEVERE INJURY OR DEATH can result if you do not follow these instructions:

- △ Read this Operator's Guide and all on-product warning labels carefully and follow the operating procedures described. Watch and pay attention to the Safety Videocassette before operation.
- △ Never operate this vehicle without proper instruction. Take a training course offered by BRP. All operator should receive training from a certified instructor. See your authorized Bombardier ATV dealer for more informations.
- △ Always follow this age recommendation: A person under 16 years old should never operate this vehicle.
- △ Never carry more than one passenger on this vehicle. This passenger should be 12 years old or more and must be capable of keeping his feet on the footrests and his hands on grab handles at all times when seated.
- △ Passenger must be seated on the designated passenger's seat and hold on to the grab handles at all times. Do not allow passenger to sit anywhere else.
- △ Never operate the vehicle without the passenger's seat or the storage box properly installed.
- △ Never carry passenger on this vehicle if the storage box is installed (in place of rear seat).
- △ The vehicle handling, stability and braking distance may be affected when riding with a passenger. Safely reduce speed when riding with a passenger. Allow greater distance for braking.
- △ Never operate this vehicle on any paved surfaces, including sidewalks, driveways, parking lots and streets.
- △ Never operate this vehicle on any public street, road or highway, even a dirt or gravel one.
- △ Never take place on this vehicle without wearing an approved helmet that fits properly. The operator and the passenger should also wear eye protection (goggles or face shield), gloves, boots, long sleeved shirt or jacket, and long pants. The passenger should have an approved helmet including a rigid chin guard.
- △ Never consume alcohol or drugs before or while riding this vehicle.
- △ Never operate at excessive speeds. Always go at a speed that is proper for the terrain, visibility, and operating conditions, and your experience.
- △ Never attempt wheelies, jumps, or other stunts.
- △ Always inspect your vehicle each time you use it to make sure it is in safe operating condition. Always follow the inspection and maintenance procedures and schedules described in this Operator's Guide.
- △ The operator and the passenger must always keep both hands on the handlebars or grab handles and both feet on the footpegs of the vehicle during operation.

- ⚠ Always go slowly and be extra careful when operating on unfamiliar terrain. Always be alert to changing terrain conditions when operating this vehicle. Always keep in mind that you are carrying a passenger.
- ⚠ Never operate on excessively rough, slippery or loose terrain until you have learned and practiced the skills necessary to control this vehicle on such terrain. Always be especially cautious on these kinds of terrain. Always keep in mind that you are carrying a passenger.
- ⚠ Always follow proper procedures for turning as described further in this Operator's Guide. Practice turning at low speeds before attempting to turn at faster speeds. Do not turn at excessive speed. Carrying a passenger may affect the stability and the handling of the vehicle.
- ⚠ Never operate this vehicle on hills too steep for the vehicle or for your abilities. Do not forget, the operator is responsible for the safety of the passenger. In doubt, disembark him before climbing hill. Always remember that the vehicle handling, stability and braking distance may be affected when riding with a passenger.
- ⚠ Always follow proper procedures for climbing hills as described further in this Operator's Guide. Check the terrain carefully before you start up any hill. Never climb hills with excessively slippery or loose surfaces. Shift operator and passenger weight forward. Never open the throttle suddenly or make sudden gear changes. Never go over the top of any hill at high speed. Always keep in mind that you are carrying a passenger.
- ⚠ Always follow proper procedures for going down hills and for braking on hills as described further in this Operator's Guide. Check the terrain carefully before you start down any hill. Shift operator and passenger weight backward. Never go down a hill at high speed. Avoid going down a hill at an angle that would cause the vehicle to lean sharply to one side. Go straight down the hill where possible. Always keep in mind that you are carrying a passenger.
- ⚠ Always follow proper procedures for crossing the side of a hill as described further in this Operator's Guide. Avoid hills with excessively slippery or loose surfaces. Shift operator and passenger weight to the uphill side of the vehicle. Never attempt to turn the vehicle around on any hill until you have mastered the turning technique described in this Operator's Guide on level ground. Avoid crossing the side of a steep hill if possible. Always keep in mind that you are carrying a passenger.
- ⚠ Always use proper procedures if you stall or roll backwards when climbing a hill. To avoid stalling, use proper gear and maintain a steady speed when climbing a hill. If you stall or roll backwards, follow the special procedure for braking described in this Operator's Guide. First, disembark the passenger then the operator. Dismount on the uphill side or to a side if pointed straight uphill. Turn the vehicle around and remount, following the procedure described further in this Operator's Guide.

- △ Always check for obstacles before operating in a new area. Never attempt to operate over large obstacles, such as large rocks or fallen trees. Always follow proper procedures when operating over obstacles as described further in this Operator's Guide. Do not forget, the operator is responsible for the safety of the passenger. In doubt, disembark him to get through the obstacles.
- △ Always be careful when skidding or sliding. Never attempt with a passenger; overturn or passenger ejection may occur. Learn to safely control skidding or sliding by practicing at low speeds and on level smooth terrain. On extremely slippery surfaces, such as ice, go slowly and be very cautious in order to reduce the chance of skidding out of control.
- △ Never operate this vehicle in fast flowing water or in water deeper than that specified in this Operator's Guide. Remember that wet brakes may have reduced stopping ability. Test your brakes after leaving water. If necessary, apply them several times to let friction dry out the pads. The vehicle braking distance may be affected when riding with a passenger. Safely reduce speed when riding with a passenger. Allow greater distance for braking.
- △ Always be sure there are no obstacles or people behind the vehicle when you operate in reverse. When it is safe to proceed in reverse, go slowly. Take account that the passenger can obstruct your view.
- △ Always use the size and type tires specified further in this Operator's Guide. Always maintain proper tire pressure as described further in this Operator's Guide.
- △ Never modify this vehicle through improper installation or use of accessories. Only use BRP's approved accessories. Do not install passenger seats or use the racks to carry more than one passenger.
- △ Never exceed the stated load limits for this vehicle including operator and passenger, all other loads and added accessories. Cargo should be properly distributed and securely attached. Reduce speed and follow instructions in this manual for carrying cargo or pulling a trailer. Allow greater distance for braking.
- △ Do not forget, the operator is responsible for the safety of the passenger. If in doubt, disembark him. Always practice the maneuvers described in this Operator's Guide without and with passenger. Always remember that the vehicle handling, stability and braking distance may be affected when riding with a passenger. Safely reduce speed when riding with a passenger. Allow greater distance for braking. In some situations, this vehicle can be used easily with the operator alone but not necessarily with a passenger. Use your common sense.

OPERATION WARNINGS

While reading this Operator's Guide, remember that:

WARNING

Indicates a potential hazard that, if not avoided, could result in serious injury or death.

NOTE: The following illustrations are general representations only. Your model may differ.

WARNING



V00A0AQ

POTENTIAL HAZARD

Operating this vehicle without proper instruction.

WHAT CAN HAPPEN

The risk of an accident is greatly increased if the operator does not know how to operate this vehicle properly in different situations and on different types of terrain with or without passenger.

HOW TO AVOID THE HAZARD

Beginning and inexperienced operators should complete the training course offered by BRP. They should then regularly practice the skills learned in the course and the operating techniques described in this Operator's Guide.



V00A1AQ

POTENTIAL HAZARD

Failure to follow the age recommendations for this vehicle.

WHAT CAN HAPPEN

A lack of respect for this age recommendation can lead to severe injury or death of the child. Even though a child may be within the age group for which this vehicle is recommended, he may not have the skills, abilities, or judgment needed to operate this vehicle safely and may be involved in a serious accident.

HOW TO AVOID THE HAZARD

No one under 16 should operate this vehicle.

⚠ WARNING



V00A1BQ

POTENTIAL HAZARD

Failure to follow the age recommendations for the passenger.

WHAT CAN HAPPEN

A child, under 12, may not have the ability needed to ride safely and may be involved in a serious accident.

HOW TO AVOID THE HAZARD

No one under 12 should be riding on this vehicle.

⚠ WARNING

POTENTIAL HAZARD

Failure to respect the physical limitations of the passenger.

WHAT CAN HAPPEN

A passenger that cannot completely lean his feet on footrests can be ejected when riding on uneven terrain.

HOW TO AVOID THE HAZARD

The passenger must be capable of keeping his feet on the footrests and his hands on grab handles at all times when he is seated on the vehicle.

WARNING



V00A1CQ

POTENTIAL HAZARD

Carrying more than one passenger on this vehicle.

WHAT CAN HAPPEN

Carrying more than one passenger reduces your ability to balance and control this vehicle. Could cause an accident, resulting in harm to you and/or your passengers.

HOW TO AVOID THE HAZARD

Never carry more than one passenger. Even with a long seat that provides unrestricted operator movement, it is not designed nor intended to carry more than one operator and one passenger. The passenger must use the designated passenger's seat when he is seated on the vehicle.

When the storage box is installed (in place of rear seat), the vehicle becomes a ONE-RIDER vehicle and NO PASSENGER must be allowed on it.

WARNING



V00A2DQ

POTENTIAL HAZARD

Allowing passenger to sit in a location other than the designated passenger's seat.

WHAT CAN HAPPEN

Passenger seated in a location other than the designated passenger's seat could:

- impair vehicle stability which could lead to a loss of control
- suffer injury from impact on hard surfaces.

Could cause an accident, resulting in harm to you and/or your passenger.

HOW TO AVOID THE HAZARD

Passenger must always remain seated on designated passenger's seat with feet firmly planted on footrests and always hold on to the grab handles.

⚠ WARNING

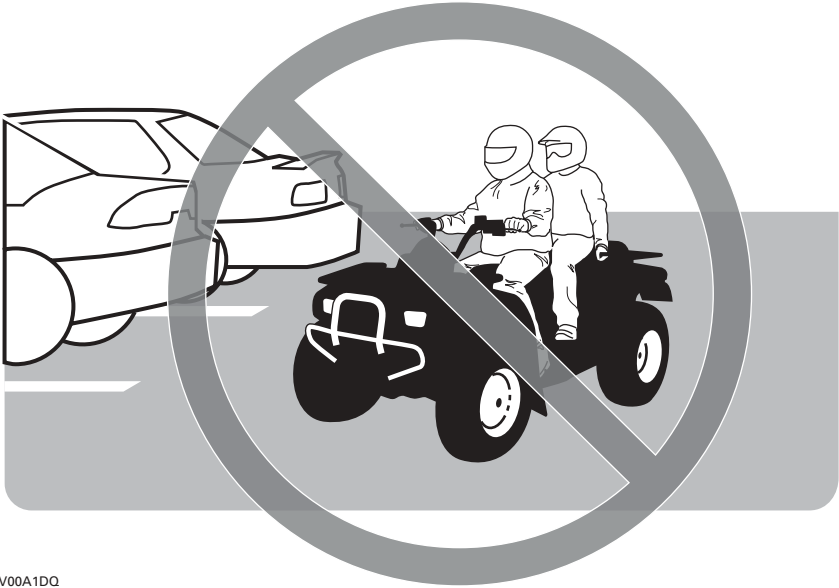

V00A1DQ

POTENTIAL HAZARD

Operating this vehicle on paved surfaces.

WHAT CAN HAPPEN

The tires are designed for off-road use only, not for use on pavement. Paved surfaces may seriously affect handling and control of the vehicle, and may cause the vehicle to go out of control.

HOW TO AVOID THE HAZARD

Never operate this vehicle on any paved surfaces, including sidewalks, driveways, parking lots and streets.

⚠ WARNING



V00A1EQ

POTENTIAL HAZARD

Operating this vehicle on public streets, roads or highways.

WHAT CAN HAPPEN

You can collide with another vehicle.

HOW TO AVOID THE HAZARD

Never operate this vehicle on any public street, road or highway, even a dirt or gravel one. In many states it is illegal to operate this vehicle on public streets, roads and highways.

WARNING



V00A1FQ

POTENTIAL HAZARD

Riding this vehicle without wearing an approved helmet, eye protection and protective clothing. Passenger should also have an approved helmet with a rigid chin guard.

WHAT CAN HAPPEN

The following items concern the operator and the passenger:

- riding without an approved helmet increases the chances of a severe head injury or death in the event of an accident
- riding without eye protection can result in an accident and increases the chances of a severe injury in the event of an accident
- riding without protective clothing increases the chances of severe injury in the event of an accident.

HOW TO AVOID THE HAZARD

Always wear an approved helmet that fits properly. You should also wear:

- eye protection (goggles or face shield),
- rigid chin guard (recommended for the passenger),
- gloves and boots,
- long sleeved shirt or jacket,
- long pants.

WARNING



V00A07Q

POTENTIAL HAZARD

Riding this vehicle after consuming alcohol or drugs.

WHAT CAN HAPPEN

- Could cause the passenger to fall off.
- Could seriously affect your judgment.
- Could cause you to react more slowly.
- Could affect your balance and perception.
- Could result in an accident or death of passenger and/or operator.

HOW TO AVOID THE HAZARD

The operator and the passenger should never consume alcohol or drugs before or while riding this vehicle.

WARNING

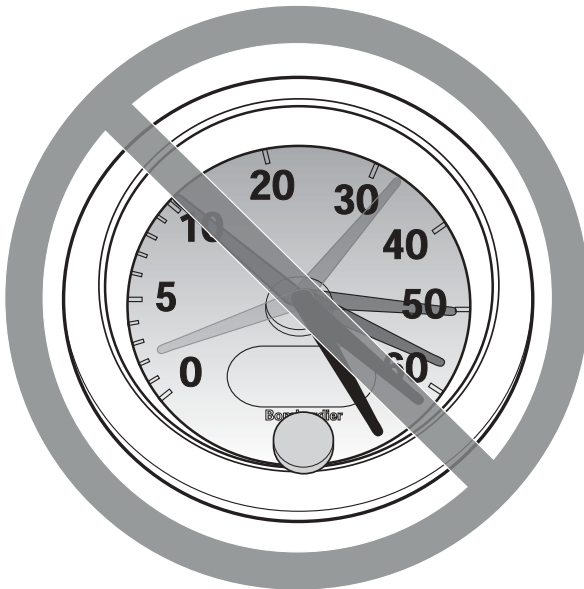

V00A08Q

POTENTIAL HAZARD

Operating this vehicle at excessive speeds.

WHAT CAN HAPPEN

Increases your chances of losing control of the vehicle, which can result in an accident.

HOW TO AVOID THE HAZARD

Always travel at a speed which is proper for the terrain, visibility and operating conditions, and your experience.

The vehicle handling, stability and braking distance may be affected when riding with a passenger. Safely reduce speed when riding with a passenger. Allow greater distance for braking.

⚠ WARNING



V00A1GQ

POTENTIAL HAZARD

Attempting wheelies, jumps and other stunts.

WHAT CAN HAPPEN

Increases the chance of an accident, for the operator and the passenger, including an over-turn.

HOW TO AVOID THE HAZARD

Never attempt stunts, such as wheelies or jumps. Do not try to show off.

 **WARNING**

POTENTIAL HAZARD

Failure to inspect the vehicle before operating.
Failure to properly maintain the vehicle.

WHAT CAN HAPPEN

Increases the possibility of an accident or equipment damage.

HOW TO AVOID THE HAZARD

Always inspect your vehicle each time you use it to make sure the vehicle is in safe operating condition.

Always follow the inspection and maintenance procedures and schedules described further in this Operator's Guide.

 **WARNING**

POTENTIAL HAZARD

Riding on frozen waterways.

WHAT CAN HAPPEN

Severe injury or death can result if the vehicle and/or operator and/or passenger break through the ice.

HOW TO AVOID THE HAZARD

Never ride this vehicle on a frozen surface before you are sure the ice is thick enough and sound enough to support the vehicle and its load, as well as the force that is created by a moving vehicle.

WARNING



V00A1HQ

POTENTIAL HAZARD

Removing hands from handlebars for the operator and from grab handles for the passenger, or feet from the footrests during operation.

WHAT CAN HAPPEN

Removing even one hand or foot can reduce your ability to control the vehicle or could cause you to lose your balance and fall off the vehicle. If you remove a foot from the footrests, your foot or leg may come into contact with the rear wheels, which could injure you or cause an accident.

HOW TO AVOID THE HAZARD

Operator and passenger must always keep both hands on the handlebars or on grab handles and both feet on the footrests during vehicle operation.

WARNING



V00A11Q

POTENTIAL HAZARD

Failure to use extra care when operating this vehicle on unfamiliar terrain.

WHAT CAN HAPPEN

You can come upon hidden rocks, bumps, or holes, without enough time to react.
Could result in the vehicle overturning, passenger ejection or loss of control.

HOW TO AVOID THE HAZARD

Go slowly and be extra careful when operating on unfamiliar terrain.

Always be alert to changing terrain conditions when operating the vehicle.

Do not forget, the operator is responsible for the safety of his passenger. Safely reduce speed when riding with a passenger.

WARNING



V00A1JQ

POTENTIAL HAZARD

Failure to use extra care when operating on excessively rough, slippery or loose terrain.

WHAT CAN HAPPEN

Could cause loss of traction or vehicle control, which could result in an accident, including an overturn or passenger ejection.

HOW TO AVOID THE HAZARD

Do not operate on excessively rough, slippery or loose terrain until you have learned and practiced the skills necessary to control this vehicle on such terrain.

Always be especially cautious on these kinds of terrain.

Do not forget, the operator is responsible for the safety of the passenger. In doubt, disembark the passenger before operating on these terrains.

⚠ WARNING



V00A1KQ

POTENTIAL HAZARD

Turning improperly.

WHAT CAN HAPPEN

Vehicle could go out of control, causing a collision, an overturn or a passenger ejection.

HOW TO AVOID THE HAZARD

Always follow proper procedures for turning as described further in this Operator's Guide. Practice turning at low speeds before attempting to turn at faster speeds.

Do not forget, the operator is responsible for the safety of the passenger. Never perform this maneuver with a passenger. Always remember that the vehicle handling, stability and braking distance may be affected when riding with a passenger.

Do not turn at excessive speed.

WARNING



V00A1LQ

POTENTIAL HAZARD

Operating on excessively steep hills.

WHAT CAN HAPPEN

The vehicle can overturn more easily on extremely steep hills than on level surfaces or small hills.

HOW TO AVOID THE HAZARD

Never operate this vehicle on hills too steep for the vehicle or for your abilities.

Practice, without and with passenger, on smaller hills before attempting larger hills.

Always remember that, even if this vehicle can climb some steep hills, it is not recommended to climb such hills with a passenger; always disembark him before attempting this maneuver. Show good judgement.

WARNING



V00A1MQ

POTENTIAL HAZARD

Climbing hills improperly.

WHAT CAN HAPPEN

Could cause loss of control, passenger ejection or cause vehicle to overturn.

HOW TO AVOID THE HAZARD

Always follow proper procedures for climbing hills as described further in this Operator's Guide.

Always check the terrain carefully before you start up any hill. Do not forget, the operator is responsible for the safety of the passenger. In doubt, disembark him before climbing hill. Always remember that the vehicle handling, stability and braking distance may be affected when riding with a passenger.

Never climb hills with excessively slippery or loose surfaces.

Shift operator and passenger weight forward.

Never open the throttle suddenly or make sudden gear changes. The vehicle could flip over backwards.

Never go over the top of any hill at high speed. An obstacle, a sharp drop, or another vehicle or person could be on the other side of the hill.

WARNING



V00A1N0

POTENTIAL HAZARD

Going down a hill improperly.

WHAT CAN HAPPEN

Could cause loss of control, passenger ejection or cause vehicle to overturn.

HOW TO AVOID THE HAZARD

Always follow proper procedures for going down hills as described further in this Operator's Guide. NOTE: A special technique is required when braking as you go down a hill.

Always check the terrain carefully before you start down any hill. Do not forget, the operator is responsible for the safety of the passenger. In doubt, disembark him before climbing hill. Always remember that the vehicle handling, stability and braking distance may be affected when riding with a passenger.

Shift operator and passenger weight backward. The passenger must hold the grab handles firmly.

Never go down a hill at high speed.

Avoid going down a hill at an angle which would cause the vehicle to lean sharply to one side. Go straight down the hill where possible.

WARNING



V00A10Q

POTENTIAL HAZARD

Improperly crossing hills or turning on hills.

WHAT CAN HAPPEN

Could cause loss of control, passenger ejection or cause vehicle to overturn.

HOW TO AVOID THE HAZARD

Never attempt this maneuver when the passenger is on board. Always disembark him before executing.

Never attempt to turn the vehicle around on any hill until you have mastered the turning technique as described further in this Operator's Guide on level ground. Be very careful when turning on any hill.

Avoid crossing the side of a steep hill if possible.

When crossing the side of a hill:

Always follow proper procedures as described further in this Operator's Guide.

Avoid hills with excessively slippery or loose surfaces.

Operator and passenger must shift their weight to the uphill side of the vehicle.

WARNING

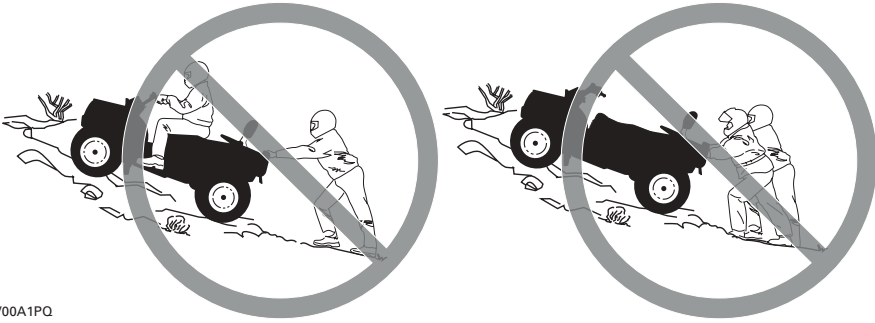

V00A1PQ

POTENTIAL HAZARD

Stalling, rolling backwards or improperly dismounting while climbing a hill.

WHAT CAN HAPPEN

Could result in vehicle overturning.

HOW TO AVOID THE HAZARD

Use proper gear and maintain steady speed when climbing a hill.

If you lose all forward speed:

Operator and passenger must keep their weight uphill. Never open the throttle suddenly or make sudden gear changes. The vehicle could flip over backwards.

Apply the brakes.

Lock parking brake after you are stopped.

First, disembark the passenger, then dismount on uphill side, or to a side if pointed straight uphill.

If you begin rolling backwards:

Operator and passenger must keep their weight uphill. Never open the throttle suddenly or make sudden gear changes. The vehicle could flip over backwards.

Never apply the rear brake while rolling backwards.

Apply the front brake gradually.

When fully stopped, apply rear brake as well and lock parking brake.

First, disembark the passenger, then dismount on uphill side, or to a side if pointed straight uphill.

Turn the vehicle around and remount, following the procedure described further in this Operator's Guide.

WARNING



V00A1QQ

POTENTIAL HAZARD

Improperly operating over obstacles.

WHAT CAN HAPPEN

Could cause loss of control, passenger ejection or a collision.

Could cause the vehicle to overturn.

HOW TO AVOID THE HAZARD

The operator is responsible for the safety of his passenger. In doubt, disembark him before riding over obstacles. Always remember that the vehicle handling and stability may be affected when riding with a passenger.

Before operating in a new area, check for obstacles.

Never attempt to ride over large obstacles, such as large rocks or fallen trees.

When you go over obstacles, always follow proper procedures as described further in this Operator's Guide.

WARNING



V00A1RQ

POTENTIAL HAZARD

Skidding or sliding improperly.

WHAT CAN HAPPEN

You may lose control of this vehicle.

You may also regain traction unexpectedly, which may cause the vehicle to overturn or passenger ejection.

HOW TO AVOID THE HAZARD

Never slide or skid with passenger. Always remember that the vehicle handling and stability may be affected when riding with a passenger.

Learn to safely control skidding or sliding by practicing at low speeds and on level smooth terrain.

On extremely slippery surfaces, such as ice, go slowly and be very cautious in order to reduce the chance of skidding or sliding out of control.

WARNING



V00A1SQ

POTENTIAL HAZARD

Operating this vehicle through deep or fast flowing water.

WHAT CAN HAPPEN

Tires may float, causing loss of traction and loss of control, which could lead to an accident.

HOW TO AVOID THE HAZARD

Never operate this vehicle in fast flowing water or in water deeper than that specified further in this Operator's Guide.

Check water depth and current before you attempt to cross any water. Water should not go above footrests.

Remember that wet brakes may have reduced stopping ability. Test your brakes after leaving water. If necessary, apply them several times to let friction dry out the pads. Do not forget, allow greater distance for braking when you ride with a passenger.

⚠ WARNING



V00A1TQ

POTENTIAL HAZARD

Improperly operating in reverse.

WHAT CAN HAPPEN

You could hit an obstacle or person behind the vehicle, resulting in serious injury.

HOW TO AVOID THE HAZARD

When you select reverse gear, make sure there are no obstacles or people behind the vehicle. When it is safe to proceed, go slowly. Take account that the passenger can obstruct your view.

 **WARNING**



V00A00Q

POTENTIAL HAZARD

Operating this vehicle with improper tires, or with improper or uneven tire pressure.

WHAT CAN HAPPEN

Use of improper tires on this vehicle, or operation of this vehicle with improper or uneven tire pressure, may cause loss of control, and increases the risk of an accident.

HOW TO AVOID THE HAZARD

Always use the size and type of tires specified further in this Operator's Guide for this vehicle. Always maintain proper tire pressure as described further in this Operator's Guide.

WARNING



V00A26Q

POTENTIAL HAZARD

Operating this vehicle with improper modifications.

WHAT CAN HAPPEN

Improper installation of accessories or modification of this vehicle may cause changes in handling which in some situations could lead to an accident.

HOW TO AVOID THE HAZARD

Never modify this vehicle through improper installation or use of accessories. All parts and accessories added to this vehicle should be approved by BRP and should be installed and used according to instructions. If you have questions, consult an authorized Bombardier ATV dealer.

Do not install passenger seat or use the racks to carry more than one passenger.

WARNING



V00A1UQ

POTENTIAL HAZARD

Overloading this vehicle or carrying or towing cargo improperly.

WHAT CAN HAPPEN

Could cause changes in vehicle handling which could lead to an accident.

HOW TO AVOID THE HAZARD

Never exceed the stated load capacity for this vehicle including operator and passenger, as well as other loads and added accessories.

Cargo should be properly distributed and securely attached.

Reduce speed when carrying cargo or pulling a trailer. Allow greater distance for braking.

Always follow the instructions in this Operator's Guide for carrying cargo or pulling a trailer.

 **WARNING**



V03M01Q

POTENTIAL HAZARD

Transporting inflammable or dangerous material can lead to explosions.

WHAT CAN HAPPEN

This can cause serious injury or death.

HOW TO AVOID THE HAZARD

Never transport inflammable or dangerous material.

While reading this Operator's Guide, remember that:

 **WARNING**

Indicates a potential hazard that, if not avoided, could result in serious injury or death.

SAFETY WARNING

To fully appreciate the pleasures and excitement of riding this vehicle, there are some basic rules and tips that you should follow. Some may be new to you while others may be common sense or obvious. Irrespective, we ask that you take a few minutes to read this Operator's Guide completely before you operate this vehicle.

BRP does not recommend that anyone under the age of 16 drive this vehicle. The passenger should be 12 years old or more and must be capable of keeping his feet on the footrests and his hands on the grab handles at all times when seated. For the child's safety, we strongly recommend you also follow and enforce this recommendation. You are the sole judge of a rider's capability to understand the risks and operate a vehicle safely.

Persons with cognitive or physical impairments or who are high risk takers have an increased exposure to overturns or collisions which may result in injury including death.

Become completely familiar with the operational controls and the general operation of the vehicle before venturing into off road conditions. Practice driving in a suitable area free of hazards and feel the response of each control. Drive at low speeds. Higher speeds require greater experience, knowledge and suitable riding conditions.

The vehicle handling, stability and braking distance will be affected when riding with a passenger. Safely reduce speed when riding with a passenger. Allow greater distance for braking.

Not all vehicles are the same. Each has its own unique performance characteristics, controls and features. Each will ride and handle differently.

Never assume that the vehicle will go everywhere safely. Sudden changes in terrain caused by holes, depressions, banks, softer or harder "ground" or other irregularities may cause the vehicle to topple or become unstable. To avoid this, slow down and always observe the terrain ahead. If the vehicle does begin to topple or tipover, it is usually the best advice to immediately get off... AWAY from the direction of the tipover!

Pre-operation Check

WARNING

The pre-operation check is very important prior to operating the vehicle. Always check the proper operation of critical controls, safety features and mechanical components before starting. If not done, severe injury or death might occur.

Before using this vehicle, the operator should always:

- Apply parking brake and check if it operates properly.
- Check tire pressure and condition.
- Check wheels and bearings for wear and damage.
- Check location of controls and ensure they work properly.
- Verify if steering operates freely.
- Activate throttle control lever several times to ensure it operates freely. It must return to idle position when released.
- Activate the brake lever and brake pedal to make sure the brakes fully apply. Lever and pedal must fully return when released.
- Ensure transmission lever is working then reset in PARK position.
- Check fuel, oil and coolant levels.
- Check for oil leaks on the engine/transmission and drive train components.
- Ensure fuel valve is in fully open position (ON).
- Clean headlamps and taillight.
- Ensure front access compartment cover and rear storage compartment cover are properly latched.

- Ensure that the operator's and either the passenger's seat or the storage box are in place and properly latched.
- If you transport cargo, respect load capacity. Ensure cargo is properly secured to the racks.
- If you are pulling a trailer or other equipment, ensure it respects the tongue capacity and towing capacity. Ensure trailer is properly secured to hitch.
- Look and feel for loose parts while engine is off. Check fasteners.
- Ensure the path of travel is free of persons and obstacles.
- Check operation of ignition switch, start button, engine stop switch, taillight and direction lights.
- Check passengers seat and backrest condition.
- Check the grab handles condition.
- Educate the passenger concerning the basic rules for a safe ride.
- Make sure that the passenger, if carrying one, is seated on the designated passenger's seat.
- When storage box is installed (in place of rear seat), check if it is latched properly.
- Start engine and drive forward slowly a few feet and apply all brakes individually to test them.
- Check operation of 2WD/4WD selector.

Correct any problem you may have found before riding. See an authorized Bombardier ATV dealer as necessary.

Clothing

Actual weather conditions should help you decide how to dress. However, it is important that the operator and the passenger always wear the appropriate protective clothing and apparel, including an approved helmet, eye protection, boots, gloves, long sleeved shirt and pants. The passenger should have an approved helmet including a rigid chin guard. This type of clothing will provide you protection from some of the minor hazards you may encounter en route. Operator and passenger must never wear loose clothing such as a scarf that may get entangled in the vehicle or on tree branches and shrubs. Depending on conditions, antifogging goggles or sun glasses may be required. Sun glasses should only be worn during the daytime. Different colored lenses available for goggles or glasses help you distinguish terrain variations.

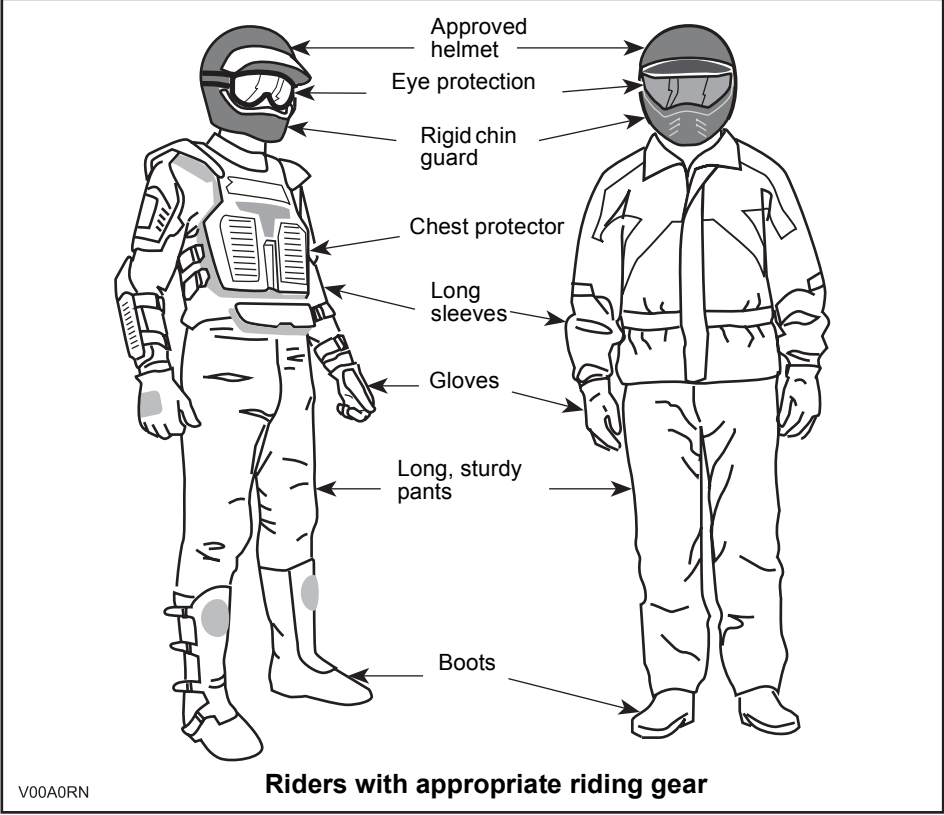

Carrying Loads/Passenger

Any load carried on the vehicle's carrying rack(s) will affect the stability and control of the vehicle. For this reason, do not exceed the load limits of the vehicle manufacturer. Always make sure the load is secured and cannot interfere with your proper control. Always be aware that the "load" may slide or fall off and create an accident. Avoid loads that may protrude sideways and get snagged or caught in brush or other obstacles. Avoid covering and obstructing the headlamp or brake lamp with the cargo. Always make sure any storage compartment latches are closed. If a removable compartment cover is removed to carry a load, make sure that the load is secure and that smaller objects cannot "fly out". Secure compartment covers.

This vehicle is designed specifically to carry an operator and ONE passenger only. The passenger must be seated on the designated passenger's seat and hold on to the grab handles at all times. Do not install other passenger's seat other than the one recommended by BRP. Do not use the racks or their location to carry passenger(s). Carrying more than one passenger may affect the stability and your control of the vehicle. When the storage box is installed (in place of a rear seat), the vehicle becomes a ONE-RIDER vehicle and NO PASSENGER must be allowed on it.

Hauling a Trailer

Riding this vehicle with a trailer substantially increases the risk of toppling, especially on inclined slopes. If a trailer is used behind the vehicle make sure that its hitch is compatible with the one on the vehicle. Make sure the trailer is horizontal with the vehicle. (In some instances a special extension may have to be installed on the vehicle hitch). Use security chains to secure the trailer with the vehicle. This vehicle may require additional stopping distance if hauling heavy loads, especially on inclined surfaces and when a passenger is on board. Be careful not to skid or slide. When stopped or parked, block the vehicle and trailer wheels from possible movement. Always make sure load is evenly distributed on the trailer. Use caution when disconnecting a loaded trailer; it or its load may topple on you or others. Do not turn at high speeds. Always use low gear range and slow down a lot.

Working with Your Vehicle

Your vehicle can help you perform a number of different LIGHT tasks ranging from snow removal to pulling wood or carrying cargo. A variety of accessories are available from your authorized Bombardier ATV dealer. However, always respect the load and capacities of the vehicle. Overloading of the vehicle can overstress the components and cause failure. To prevent possible injury, it is equally important to follow the instructions and warnings that accompany the accessory. Avoid any physical exertion through lifting or pulling of heavy loads or manpowering the vehicle. (Continue to read RECREATIONAL RIDING below).

Recreational Riding

Respect the rights and limitations of others. Stay away from areas designated for other types of off road use. This includes snowmobile trails, equestrian trails, cross country ski trails, mountain bike trails etc. Never assume there are no other users on the trail. Always stay to the complete right of the trail and do not zig zag to one side of the trail then the other. Be prepared to stop or pull off to the side if another trail user appears in front of you.

Join a local ATV club. They will provide you with a map and advice you or inform you where you can ride. If a club does not exist in your area, help start one. Group riding and activities provide a pleasurable, social experience.

Always keep a safe distance from other riders. Your judgment of speed, terrain conditions, weather, mechanical condition of your vehicle and the "trust in judgment" you have in others around you will help you make a better choice of appropriate safe distance. This vehicle, like any other motorized vehicle, cannot stop "on a dime". The vehicle handling, stability and braking distance may be affected when riding with a passenger. Safely reduce speed when riding with a passenger. Allow greater distance for braking.

Before you ride, tell someone where you are planning to travel and your expected time of return. Never consume alcohol or drugs before or while riding!

Depending on the length of your ride, carry additional tools or emergency equipment. Find out where you can get additional gasoline and oil. Be prepared for the possible conditions you may encounter. An emergency first aid kit should always be a consideration.

Environment

One of the benefits of this vehicle is that it can take you off the beaten path away from most communities. However, you should always respect nature and the rights of others to enjoy it. Do not ride in environmentally sensitive areas. Do not drive over forest crops or shrubs... nor cut down trees or take down fencing... nor spin your wheels and destroy the terrain. Tread Lightly.

Chasing wildlife is in many areas illegal. Wildlife can die of exhaustion after being chased by a motorized vehicle. If you encounter animals on the trail, stop and observe quietly and with caution. It will be one of the better memories of your life.

Observe the rule... what you take in, carry out. Do not litter. Do not start campfires unless you have permission to do so... and then only... away from dry areas. The hazards you may create on the trail may cause injury to others or yourself, even at a later date.

Respect farm lands. Always obtain the permission of the landowner before riding on private land. Respect crops, farm animals and property lines. If you come to a closed gate, close it again after yourself.

Finally, do not pollute streams, lakes or rivers and do not modify the engine or muffling system, or remove any of its components.

Design Limitation

Although the vehicle is exceptionally rugged for its class, it is still a light vehicle by definition and its operation must be restricted to its proper purpose.

The addition of weight to any part of the vehicle changes its gravitational stability and modifies its performance.

Off-Highway Operation

The very nature of off-highway operation is dangerous. Any terrain, which has not been specially prepared to carry vehicles, presents an inherent danger where angularity, terrain substance and exact steepness are unpredictable. The terrain itself presents a continual element of danger, which must be knowingly accepted by anyone venturing over it.

An operator who takes a vehicle off-road should always exercise the utmost care in selecting the safest path and keeping close watch on the terrain ahead of him. On no account should the vehicle be operated by anyone who is not completely familiar with the driving instructions applicable to the vehicle, nor should it be operated on steep or treacherous terrain.

General Operating and Safety Precautions

Care, caution, experience and driving skill are the best precautions against the hazards of vehicle operation.

Whenever there is the slightest doubt that the vehicle can safely negotiate an obstacle or a particular piece of terrain, always choose an alternate route.

In off-road operation, power and traction, not speed, are important. Never drive faster than visibility and your own ability to select a safe route permit.

Constantly watch the terrain ahead for sudden changes in slopes or obstacles, such as rocks or stumps, that may cause loss of stability, resulting in tipover or rollover.

The vehicle handling, stability and braking distance may be affected when riding with a passenger. Safely reduce speed when riding with a passenger. Allow greater distance for braking.

Never operate the vehicle if the controls do not function normally.

When operating in reverse, check that the path behind the vehicle is free of people or obstacles. Proceed slowly and avoid sharp turns. Take into account that the passenger can obstruct your view. Disembark your passenger if necessary.

When stopped or parked, always apply the parking brake. This is especially important when parking on a slope. On very steep inclines or if the vehicle is carrying cargo, the wheels should be blocked using rocks or bricks. Remember to turn the fuel valve to the closed position.

Uphill Driving

Due to configuration, this vehicle has excellent climbing ability, so much so that tipover is possible before traction is lost. For example, it is common to encounter terrain situations where the top of the hill has eroded to a point that the hill peak rises very sharply. The vehicle can readily negotiate such a condition, however, in doing so, when the front of the vehicle is driven to a point that the vehicle's balance changes rearward tipover can occur.

The same situation may apply if an embedded object causes the front of the vehicle to climb more than desired. If such a situation occurs take an alternate route. Be aware of side hilling dangers when doing so.

It is also wise to know the terrain condition on the other side of the hill or bank. All too often there exists a sharp drop-off that is impossible to negotiate or descend.

Downhill Driving

This vehicle can climb slopes that are steeper than it can safely descend. Therefore, it is essential to assure that a safe route exists to descend a slope before you climb it.

Decelerating while negotiating a slippery downhill slope could "toboggan" the vehicle. Maintain steady speed and/or accelerate slightly to regain control.

Side Hilling

Whenever possible, such operation should be avoided. If necessary, do so with extreme caution. Always disembark the passenger before performing this operation. Side hilling on steep inclines could result in rollover. In addition, slippery or unfirm surfaces could result in uncontrollable side sliding. Do not attempt to turn the vehicle downhill with the slide. Avoid all objects or depressions that will intensify the raising of one side of the vehicle higher than the other, thus causing rollover.

Drop-Offs

This vehicle will "bottom-out" and usually stop if either the front or rear wheels are driven over a drop-off. If the drop is sharp or deep, the vehicle will nose dive and tipover.

WARNING

Avoid negotiating drop-offs. Reverse and select an alternate route.

Riding Techniques

Riding your vehicle too fast for the conditions may result in injury. Apply only enough throttle to proceed safely. Statistics show that high speed turns usually result in mishaps and injury. Always remember that this vehicle is heavy! Its pure weight alone may entrap you should it fall and pin you down.

This vehicle is not designed for jumping nor can it, or you, absorb the energy of high impacts such as jumping. Performing "wheelies" can cause the vehicle to flip over onto you. Both practices have a high risk for you and your passenger and should be avoided at all times.

To maintain proper control it is strongly advised that you keep your hands on the handlebar and within easy reach of all controls. The same holds true for your feet. To minimize the possibility of any leg or foot injury, keep your feet on the footrests at all times. Do not direct your toes outwards nor place your foot out to assist turning as they can be hit or snagged by passing obstacles or may contact the wheels. Your passenger must keep his hands on grab handles and his feet on footrests at all times.

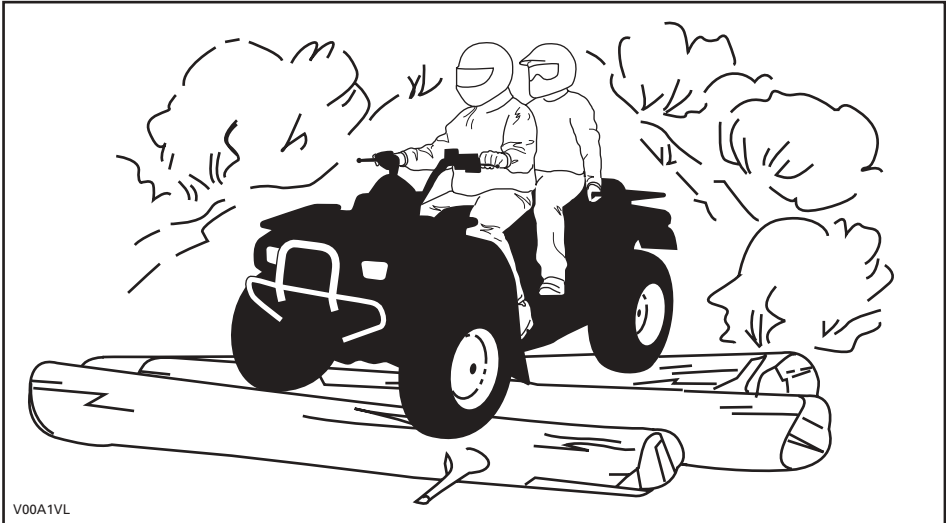

Even though there is an adequate suspensions system on this vehicle there are "washboard" or rough terrain conditions that will make you feel uncomfortable and even cause back injury. "Posting" or riding in a crouched position will often be required. Slow down and allow your flexed legs to absorb impact.

If a road usage is allowed in your area, operate your vehicle on paved surfaces only for short distance and for the only purpose of moving the vehicle from an off-road usage to another. Always operate your vehicle at low speed (never exceed 65 km/h (40 MPH)) and reduce the speed before making a turn. Always respect all road traffic laws when operating your vehicle on public roads or streets. If you have to cross a road, the lead driver should get off his vehicle then observe and give directions to the other riders. The last person after crossing then assists the lead driver to cross. Do not travel sidewalks. They are designated for pedestrian use.

Water can be a unique hazard. If it is too deep the vehicle may "float" and topple. Check the water depth and current before you attempt to cross any water. Water should not go above the footrest. Be wary of slippery surfaces such as rocks, grass, logs, etc., both in the water and on its banks. A loss of traction may occur. Do not attempt to enter the water at high speed. The water will act as a brake and could throw you.

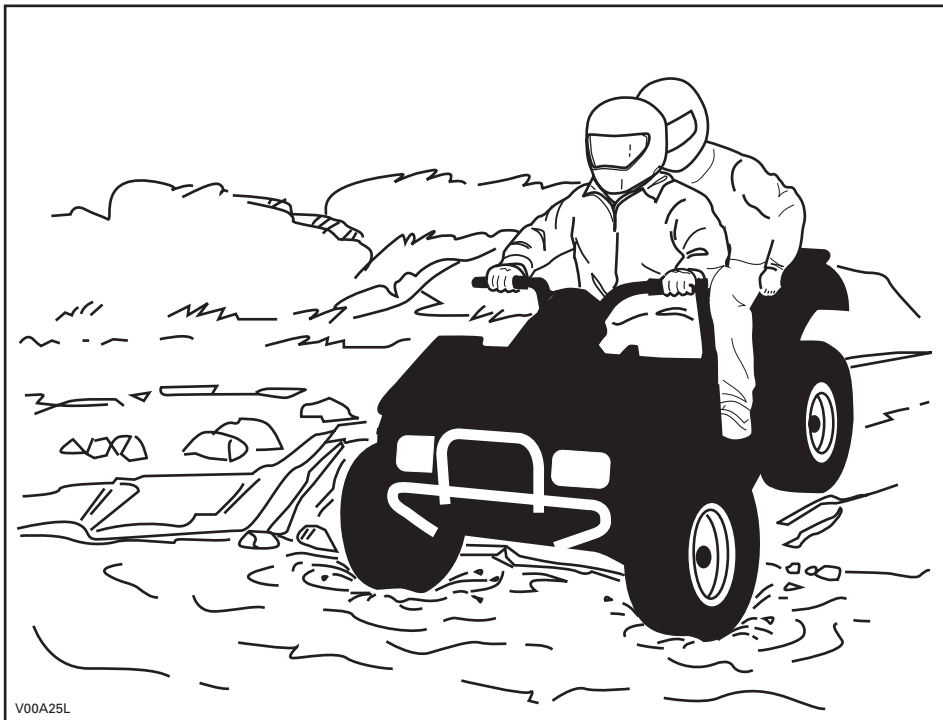

Water will affect the braking ability of your vehicle. Make sure you dry the brakes by applying them several times after the vehicle leaves the water. The vehicle braking distance may be affected when riding with a passenger. Safely reduce speed when riding with a passenger. Allow greater distance for braking.

Mud or marsh lands may be encountered near water. Be prepared for sudden "holes" or changes in depth. Similarly so, be watchful of hazards such as rocks, logs, etc., partially covered by vegetation.

If your trip crosses frozen waterways, make sure that the ice is thick enough and sound enough to support the total weight of yourself, your passenger, the vehicle and its load. Be ever watchful of open water... it is a sure indication that the ice thickness will vary. The operator is responsible for the safety of the passenger. If in doubt, do not attempt to cross.

Ice will also affect the control of vehicle. Slow down and do not "gun" the throttle. This will only result in spinning of the tires and possible tipover of the vehicle. Avoid rapid braking. This again will possibly result in an uncontrolled slide and tipover of the vehicle or passenger ejection. Slush should be avoided at all times since it could block the operation or controls of the vehicle. Never attempt this maneuver with a passenger. Always remember that the vehicle handling and stability may be affected when riding with a passenger.

Sand and riding on sand dunes or on snow is another unique experience but there are some basic precautions that should be observed. Wet, deep or fine sand/snow may create a loss of traction and cause the vehicle to slide, drop off or become "bogged" down. If this occurs look for a firmer base. Again, the best advice is to slow down and be watchful of the conditions. When you ride with a passenger, drive slowly.

When riding in sand dunes it is advisable to equip the vehicle with an antenna type safety flag. This will help make your location more visible to others over the next sand dune. Proceed carefully should you see another safety flag ahead. Since the antenna type safety flag can snag and rebound on your body if caught, do not use it in areas where there are low hanging branches or obstacles. Always remember that the vehicle handling and stability may be affected when riding with a passenger.

Riding on loose stones or gravel is very similar to riding on ice. They will affect the steering of vehicle... possibly causing it to slide or cause passenger ejection and tipover especially at high speeds. In addition, braking distance may be affected. Remember that "gunning" the throttle or sliding may cause loose stones to be ejected rearwards into the path of another rider's way. Never do it deliberately. Always remember that vehicle handling, stability and braking distance may be affected when riding with a passenger.

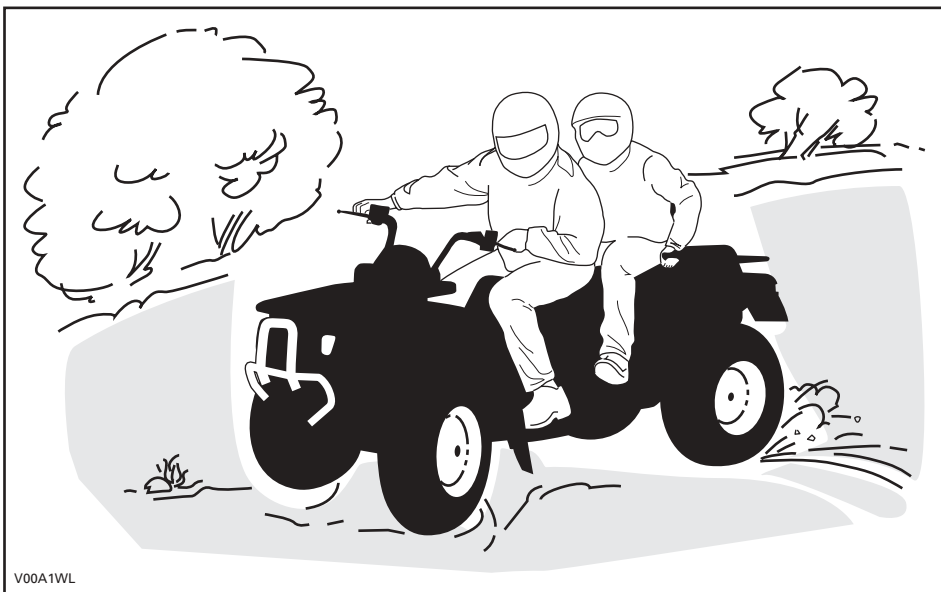

V00A1WL

If you do get into a slide or skid, it may help to turn the handlebar into the direction of the skid until you regain control. Never jam the brakes and lock the wheels.

Respect and follow all posted trail signs. They are there to help you and others.

Obstacles in the "trail" should be traversed with caution. This includes loose rocks, fallen trees, slippery surfaces, fences, posts, and embankments and depressions. You should avoid them whenever possible. Remember that some obstacles are too large or dangerous to cross and should be avoided. The operator is responsible for the safety of the passenger and in doubt, disembark him before getting through the obstacles. Small rocks or fallen trees may be safely crossed... approach at a 90° angle. Stand on the footrests while keeping your knees flexed. Adjust speed without losing momentum and do not "gun" the throttle. Hold handlebar or grab hands firmly. Place operator and passenger body weight rearwards and proceed. Do not try to lift the vehicle front wheels off the ground. Be aware that the object may be slippery or may move while crossing.

When driving on hills or slopes two things are highly important... be prepared for slippery surfaces or terrain variations and obstacles and... use proper body positioning. The operator is responsible for the safety of the passenger and in doubt, disembark him before getting through the obstacles.

Uphill

Do not forget, the operator is responsible for the safety of the passenger. In doubt, disembark him before climbing hill. Always remember that the vehicle handling, stability and braking distance may be affected when riding with a passenger.

If you decide to keep your passenger, he must synchronize his movements with yours.

Operator and passenger must keep their body weight forward, towards the top of the hill. Keep your feet on the footpegs and shift into low gear then accelerate and when necessary, change gear quickly as you climb. Do not over-speed since this may cause the front of the vehicle to lift from the ground and fall back on you. If the hill is too steep and you cannot proceed or the vehicle begins to roll backwards, apply the brake, being careful not to slide. Dismount, passenger first, then use the "U" turn or "K" turn (while walking back, next to the vehicle on the up hill side and with a hand on the brake lever, slowly back the rear of the vehicle toward the top of the hill then drive downhill). Always walk or dismount on the upside of the slope while keeping clear of the vehicle and its rotating wheels. Do not try to hold on to the vehicle if it begins to topple. Stay clear. Do not ride over the crest of the hill at high speed. Obstacles, including sharp drop-offs, may exist. The passenger should get on the vehicle only when the vehicle has returned to a safe location.

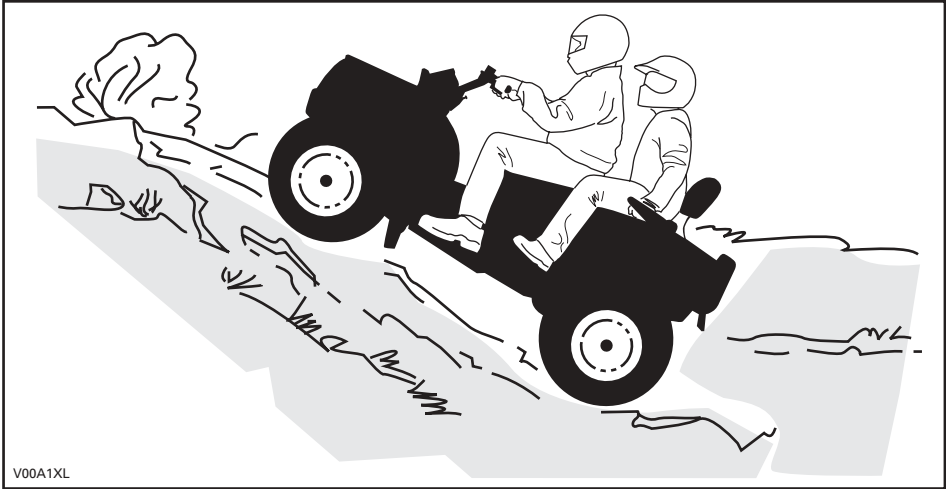

Downhill

Do not forget, the operator is responsible for the safety of the passenger. In doubt, disembark him before going down the hill. Always remember that the vehicle handling, stability and braking distance may be affected when riding with a passenger.

If you decide to keep your passenger, he must synchronize his movements with yours.

Operator and passenger must keep their body weight rearwards. Apply the brake gradually to prevent skidding. Do not "coast" down the slope using solely engine compression or in neutral gear.

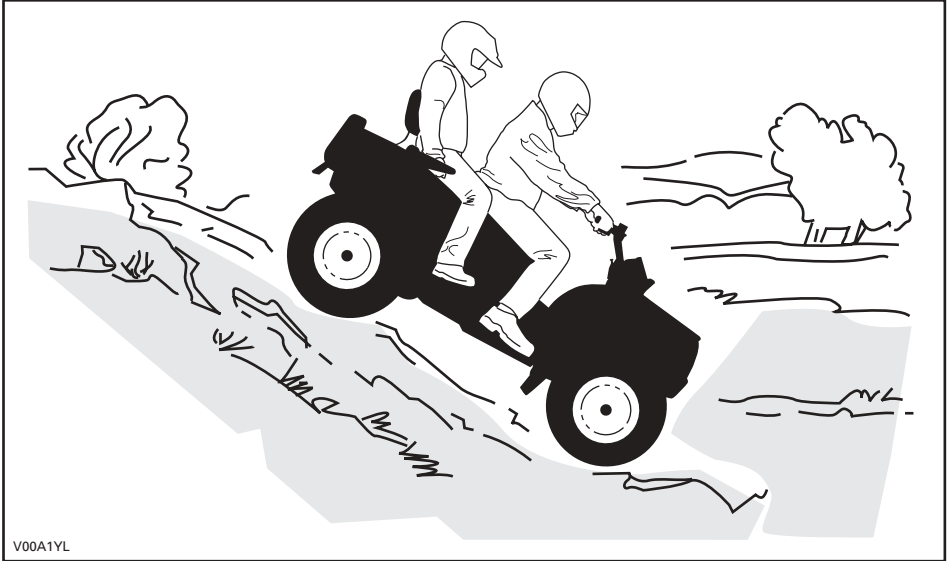

V00A1YL

Side hilling

Do not forget, the operator is responsible for the safety of the passenger. In doubt, disembark him before proceeding. Always remember that the vehicle handling, stability and braking distance may be affected when riding with a passenger.

If you decide to keep your passenger, he must synchronize his movements with yours.

This is one of the most risky types of riding since it may drastically change the balance of the vehicle. It should be avoided wherever possible. If it is necessary to do so however, it is important that you **ALWAYS** keep your body weight on the upside of the slope... and be prepared to dismount on that side should the vehicle begin to topple. Do not try to stop or save the vehicle from damage.

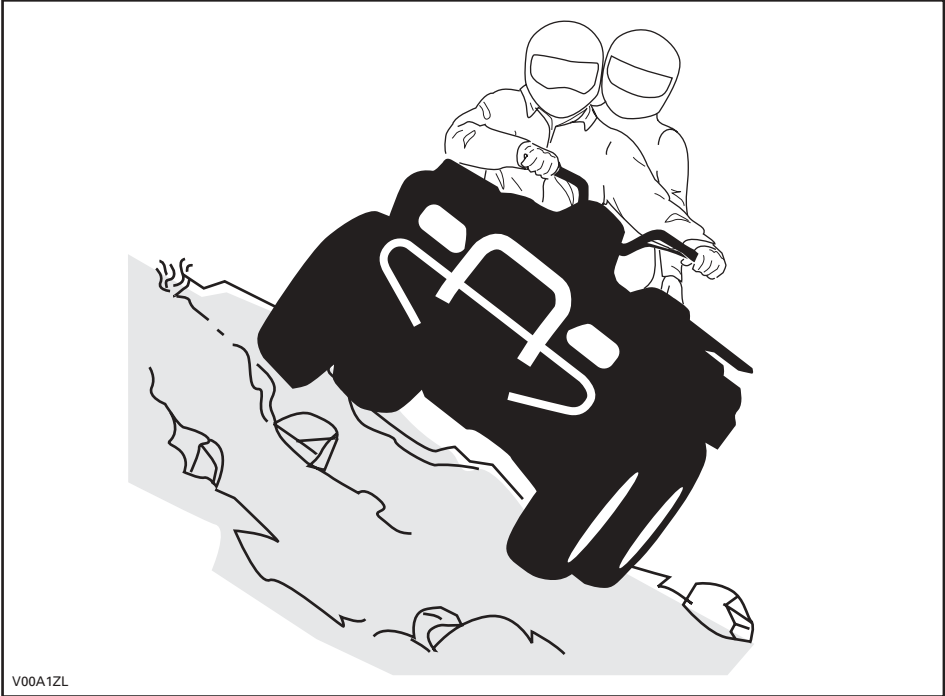

V00A1ZL

Routine Maintenance

Once your ride completed, it is wise to remove any build up of snow, ice, mud and grime. Not only will this help you keep your vehicle longer and in good condition for resale but will eliminate potential hazards the next time you use the vehicle. Wash your vehicle in warm soapy water then allow it to dry. (A towel may help). Do not wash your vehicle outside during freezing weather. Apply appropriate lubrication as described in the MAINTENANCE section.

Part of your responsibility towards safety is to respect the contents of this Operator's Guide. It provides valuable advice on how to properly take care of your vehicle. If further assistance is required your authorized Bombardier ATV dealer is always willing to help.

Modification of the vehicle to increase speed and performance may violate the terms and conditions of your vehicle limited warranty. In addition, certain modifications including the removal of engine or exhaust components are illegal under most laws.

Changing the wheel and/or tire size may affect the stability of the vehicle. Incorrect tire pressure may lead to blow outs or cause a tire to move around on its rim and become lost or damaged. Wheels or tires which are damaged should always be replaced.

The vehicle handling, stability and braking distance may be affected when riding with a passenger. Safely reduce speed when riding with a passenger. Allow greater distance for braking.

The operator is responsible for the safety of the passenger. In doubt, disembark him before executing the maneuver. Use your common sense.

While reading this Operator's Guide, remember that:

WARNING

Indicates a potential hazard that, if not avoided, could result in serious injury or death.

HANG TAG

This vehicle comes with a hang tag and labels containing important safety information. Any person who rides this vehicle should read and understand this information before riding.

2-UP VEHICLE

NO OPERATOR UNDER AGE 16

NO PASSENGER UNDER AGE 12

NEVER CARRY MORE THAN ONE PASSENGER

THIS VEHICLE IS FOR OFF ROAD USE ONLY.

BOMBARDIER 2-UP ATV SAFETY TRAINING IS MANDATORY. MAKE SURE TO WATCH THE SAFETY VIDEO. READ AND UNDERSTAND THE OPERATOR'S GUIDE AND ALL OF THE WARNING LABELS ON THIS VEHICLE BEFORE OPERATING.

CHECK WITH YOUR DEALER TO FIND OUT MORE ABOUT STATE OR LOCAL LAWS REGARDING VEHICLE OPERATION.

This hangtag is not to be removed before sale.

V00MOBL

WARNING

Improper vehicle use can result in SEVERE INJURY or DEATH.



ALWAYS USE AN APPROVED HELMET AND PROTECTIVE GEAR FOR DRIVER AND PASSENGER.



NEVER USE ON PUBLIC ROADS.



NEVER CARRY MORE THAN 1 PASSENGER.



NEVER RIDE AFTER USING DRUGS OR ALCOHOL.

NEVER operate:

- without proper 2-UP ATV training or instructions.
- at speeds too fast for your skills or the conditions.
- on public roads - a collision can occur with another vehicle.

THE OPERATOR MUST ALWAYS:

- use proper riding techniques to avoid overturns on hills and rough terrain and in turns.
- avoid paved surfaces - pavement may seriously affect handling and control.
- reduce speed and use extra caution at all times when carrying a passenger - dismount passenger when conditions require.
- make sure passenger reads and understands this label and passenger safety label.

LOCATE AND READ OPERATOR'S GUIDE. FOLLOW ALL INSTRUCTIONS & WARNINGS.

This hangtag is not to be removed before sale. 70490906

VEHICLE ENGINE DESCRIPTION:

XXXXX

EPA CERTIFIED

NER (NORMALIZED EMISSION RATE) =
ON A 0 TO 10 SCALE, 0 BEING THE CLEANEST

*** NOT TO BE REMOVED PRIOR TO SALE**



vmo2006-005-009_en

LOCATION OF THE IMPORTANT LABELS

The following labels are on your vehicle and they should be considered permanent parts of the vehicle. If missing or damaged, they can be replaced free of charge. See an authorized Bombardier ATV dealer.

NOTE: The following illustrations used in this Operator's Guide are a general representation only. Your model may differ.

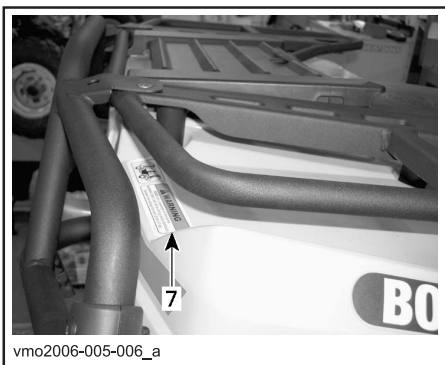
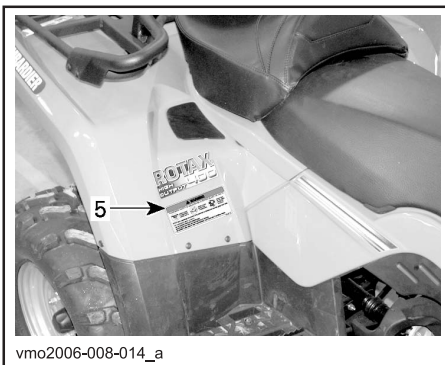
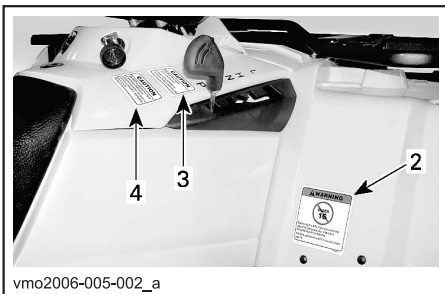
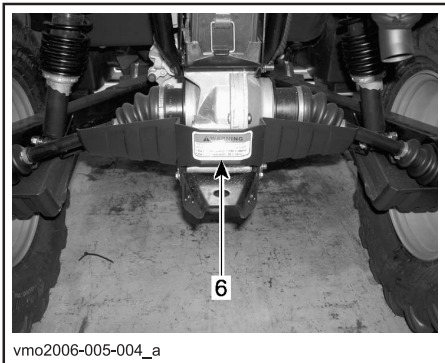

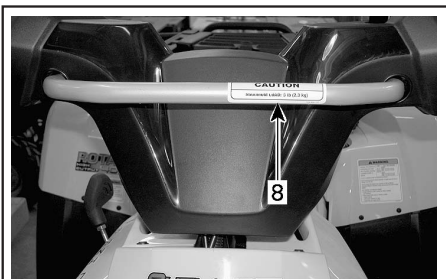

vmo2006-005-007_a

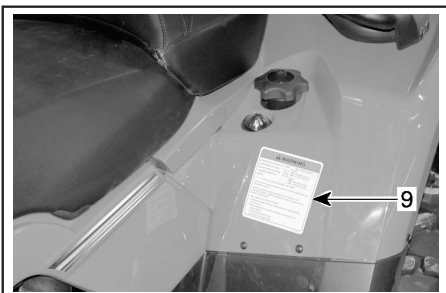

vmo2006-008-002_a

LABEL 1

WARNING

Improper vehicle use can result in SEVERE INJURY or DEATH.

ALWAYS USE AN APPROVED HELMET AND PROTECTIVE GEAR FOR DRIVER AND PASSENGER.

NEVER USE ON PUBLIC ROADS.

NEVER CARRY MORE THAN 1 PASSENGER.

NEVER RIDE AFTER USING DRUGS OR ALCOHOL.

NEVER operate:

- without proper 2-UP ATV training or instructions.
- at speeds too fast for your skills or the conditions.
- on public roads - a collision can occur with another vehicle.

THE OPERATOR MUST ALWAYS:

- use proper riding techniques to avoid vehicle overturns on hills and rough terrain and in turns.
- avoid paved surfaces - pavement may seriously affect handling and control.
- reduce speed and use extra caution at all times when carrying a passenger - dismount passenger when conditions require.

LOCATE AND READ OPERATOR'S GUIDE. FOLLOW ALL INSTRUCTIONS & WARNINGS.

70400004

V00M0CY

LABEL 2

WARNING

Operating this vehicle if you are under age of 16 increases the chance of SEVERE INJURY or DEATH to both rider and passenger.

NEVER operate this vehicle if you are under age 16.

NEVER carry more than one passenger.

704 900 515

V01M0RY

LABEL 3

CAUTION

- **ATV MUST be stopped before shifting lever.**
- **Always apply foot brake to shift from Park (P) and Neutral (N).**

704 900 470

V07M06Y

LABEL 4

CAUTION

ATV MUST be stopped to engage or disengage 4WD switch.

Mechanical damage may occur if switch is engaged or disengaged while driving.

704 900 471

V07M07Y

LABEL 5

WARNING

PASSENGER SAFETY to reduce the risk of SEVERE INJURY OR DEATH

NEVER CARRY A PASSENGER UNDER AGE 12

NEVER CARRY MORE THAN 1 PASSENGER

NEVER RIDE AFTER USING DRUGS OR ALCOHOL

NEVER carry a passenger too small to firmly plant feet on footrests and securely grasp hand holds.

THE PASSENGER MUST ALWAYS:

- use and approved helmet and protective gear.
- securely grasp hand holds and plant feet firmly on footrests.
- tell operator to slow down or stop if uncomfortable - get off and walk if conditions require.

704 801 913

vmo2006-008-003_aen

LABEL 6



WARNING

Improper loading of a trailer may cause loss of vehicle control, resulting in severe injury or death.

- **Maximum towing weight: 500 kg (1100 lb).**
- **Maximum tongue weight: 14 kg (30 lb).**

704900766

V00M05Y

LABEL 7





WARNING

- **NEVER carry a passenger on this carrier**
- **MAXIMUM FRONT LOAD:** X kg (X lb) evenly distributed.
- **MAXIMUM REAR LOAD:** X kg (X lb) evenly distributed. (Includes trailer tongue weight if applicable)

704 801 080

vmo2006-005-010_a

LABEL 8

CAUTION

MAXIMUM LOAD: 2.3 kg (5 lb).

704 900 717

V07M0YY

LABEL 9



WARNING

Improper tire pressure or overloading can cause loss of control, resulting in SEVERE INJURY or DEATH.

LOAD	COLD TIRE PRESSURE
UP TO XXX kg (XXX lb)	FRONT MAX: XX.X kPa (X.X psi) MIN: X.X kPa (X.X psi)
	REAR MAX: XX.X kPa (X.X psi) MIN: XX.X kPa (X.X psi)

ALWAYS maintain proper tire pressure as shown. Inflate at max pressure when loaded with cargo.

NEVER set tire pressure below minimum. It could cause the tire to dislodge from the rim.

NEVER exceed the vehicle load capacity of XXX kg (XXX lb) including weight of operator, cargo, accessories and trailer tongue weight.

ATV LOADING and TRAILER TOWING
Cargo/passenger loading or trailer towing can affect stability and handling. Load must be properly distributed on racks.

When loaded with cargo or passenger or towing a trailer:



- reduce speed.
- allow more distance to stop.
- avoid hills and rough terrain.

704801120

vmo2006-008-004_aen

LABEL 10



<p>DA FND OG LÆS BRUGERVEJLEDNINGEN, OVERHOLD ALLE INSTRUKTIONER OG ADVARSLER.</p> <p>NL ZOEK DE GEBRUIKERSHANDLENING OP EN LEES HEM. HOUD U AAN ALLE AANWIJZINGEN EN WAARSCHUWINGEN.</p> <p>FR LOCALISER ET LIRE LE GUIDE DE L'OPÉRATEUR. SUIVRE TOUS LES CONSIGNES ET AVERTISSEMENTS.</p> <p>FI PAKKANNA JA LUE KÄYTTÖOHJEITA JA VAROITUKSIA.</p>	<p>DE BETRIEBSANLEITUNG AUSFÜHREN MACHEN UND LESEN. ALLE ANWEISUNGEN UND WARNHINWEISE BEFOLGEN.</p> <p>EL ΒΡΕΤΕ ΚΑΙ ΔΙΑΒΑΣΤΕ ΤΟΝ ΟΔΗΓΟ ΧΡΗΣΗΣ. ΑΚΟΛΟΥΘΗΣΤΕ ΟΛΕΣ ΤΙΣ ΟΔΗΓΙΕΣ ΚΑΙ ΤΙΠΟΛΟΓΙΟΤΗΤΕΣ.</p> <p>IT LEGGERE IL MANUALE DELL'OPERATORE. SEGUIRE TUTTE LE ISTRUZIONI E AVVERTENZE.</p> <p>PT LOCALIZAR E LER O GUIA DE OPERAÇÃO. OBSERVAR TODAS AS INSTRUÇÕES E MENSAGENS DE AVISO.</p>	<p>ES UBICAR Y LEER LA GUIA DEL OPERADOR. ATENERSE A TODAS LAS INSTRUCCIONES Y MENSAJES DE ADVERTENCIA.</p> <p>SV TA REDA PÅ INSTRUKTIONSBOKEN OCH LÄS DEN. UPPMÄRKSAMMA ALLA ANVÄNINGAR OCH VARNINGAR.</p>	 
---	---	---	--

vmo2006-005-011 704 901 114

INTERNATIONAL MODELS ONLY

LABEL 11

<p>EMISSION CONTROL INFORMATION THIS VEHICLE MEETS U.S. ENVIRONMENTAL PROTECTION AGENCY AND CALIFORNIA REGULATIONS FOR MODEL YEAR 2006.</p>		<p>RENSEIGNEMENTS SUR LE DISPOSITIF ANTIPOLLUTION CE VÉHICULE SATISFAIT AUX NORMES 2006 DE L'E.P.A. & À LA RÉGLEMENTATION CALIFORNIENNE.</p>																											
<table style="width: 100%; border-collapse: collapse;"> <tr> <td style="width: 35%;">ENGINE FAMILY</td> <td style="width: 30%; text-align: center;">XXX</td> <td style="width: 35%;">FAMILLE DE MOTEUR</td> </tr> <tr> <td>FUEL</td> <td style="text-align: center;">XXX</td> <td>LEF</td> </tr> <tr> <td>ENGINE DISPLACEMENT</td> <td style="text-align: center;">XXX</td> <td>CYLINDRÉE</td> </tr> <tr> <td>EXHAUST EMISSION CONTROL SYSTEM</td> <td style="text-align: center;">XXX</td> <td>SYSTÈME DE CONTRÔLE DES ÉMISSIONS</td> </tr> <tr> <td>FUEL</td> <td style="text-align: center;">XXX</td> <td>ESSENCE</td> </tr> <tr> <td>ENGINE OIL</td> <td style="text-align: center;">XXX</td> <td>HUILE À MOTEUR</td> </tr> <tr> <td>IDLE SPEED</td> <td style="text-align: center;">XXX</td> <td>VITESSE DE RALENTI</td> </tr> <tr> <td>SPARK PLUG TYPE</td> <td style="text-align: center;">XXX</td> <td>TYPE DE BOUGIE</td> </tr> <tr> <td>SPARK PLUG GAP</td> <td style="text-align: center;">XXX</td> <td>ÉCARTEMENT DES ÉLECTRODES</td> </tr> </table>	ENGINE FAMILY	XXX	FAMILLE DE MOTEUR	FUEL	XXX	LEF	ENGINE DISPLACEMENT	XXX	CYLINDRÉE	EXHAUST EMISSION CONTROL SYSTEM	XXX	SYSTÈME DE CONTRÔLE DES ÉMISSIONS	FUEL	XXX	ESSENCE	ENGINE OIL	XXX	HUILE À MOTEUR	IDLE SPEED	XXX	VITESSE DE RALENTI	SPARK PLUG TYPE	XXX	TYPE DE BOUGIE	SPARK PLUG GAP	XXX	ÉCARTEMENT DES ÉLECTRODES		
ENGINE FAMILY	XXX	FAMILLE DE MOTEUR																											
FUEL	XXX	LEF																											
ENGINE DISPLACEMENT	XXX	CYLINDRÉE																											
EXHAUST EMISSION CONTROL SYSTEM	XXX	SYSTÈME DE CONTRÔLE DES ÉMISSIONS																											
FUEL	XXX	ESSENCE																											
ENGINE OIL	XXX	HUILE À MOTEUR																											
IDLE SPEED	XXX	VITESSE DE RALENTI																											
SPARK PLUG TYPE	XXX	TYPE DE BOUGIE																											
SPARK PLUG GAP	XXX	ÉCARTEMENT DES ÉLECTRODES																											
<p>SEE OPERATOR'S GUIDE FOR MAINTENANCE SPECIFICATIONS / VOIR GUIDE DU CONDUCTEUR POUR LES DONNÉES SPÉCIFICATIONS D'ENTRETIENS BOMBARDIER RECREATIONAL PRODUCTS INC</p>																													

vmo2006-005-0012

SAFETY TRAINING

INTRODUCTION

Objective

The objective of this course is to give the Bombardier 2-UP vehicle owner the information required to operate a 2-UP vehicle safely. The course will be offered to all 2-UP vehicle buyers, and members of their immediate families. Successful completion of the training course is required to complete the sale of the 2-UP vehicle.

The 2-UP vehicle allows you to ride with one passenger. Remember, you should never allow passengers on an ATV not specifically designed for such use.

Sections Covered

1. General Safety Information
2. Bombardier 2-UP vehicle Safety Video-cassette
3. Operator's Guide Review
4. Hands-on Riding

Time Required

As required, depending on trainee's experience and skills.

SECTION I - GENERAL SAFETY INFORMATION

Objective

The purpose of this section is to:

- a) Explain why this safety training is important.
- b) Discuss CPSC (Consumer Product Safety Commission) Injury and Death Statistics.
- c) Discuss Bombardier's age and size recommendation.
- d) Discuss what protective clothing should be worn by the operator and the passenger while riding the 2-UP vehicle.
- e) Discuss when an operator should begin to ride with a passenger.
- f) Discuss local, state and federal laws pertaining to ATV use.
- g) Discuss the areas where you can ride.

Outline

A) This Course is Provided:

- To make riding more enjoyable to you and your passenger.
 - To reduce the chance of injury and death to you and your passenger through safety and risk awareness.
1. What could happen when proper safety and risk precautions are not followed.
 2. Why you should not carry more than one passenger on your 2-UP vehicle.
 3. Why you and your passenger should keep your feet on your respective footrests at all times, and why your passenger should always hold the grab handles while riding.
 4. Why you and your passenger should not use alcohol or drugs prior to operating your vehicle.
 5. Why you should not ride on paved surfaces.

B) CPSC Statistics

- The CPSC has published statistics of injury and death suffered by riders of ATVs during the last 5 years (January 1997 - December 2001):
1. 417,200 ATV-related injuries
 2. 1,463 ATV-related deaths.

C) Age and Size Requirements for the 2-UP Vehicle

- No one under the age of 16 should operate a 2-UP vehicle.

- No passenger under 12 should be allowed on a 2-UP vehicle. Regardless of age, your passenger should also be able to firmly plant his/her feet on footrests and securely grasp the grab handles.
- Do not allow a person unfamiliar with your 2-UP vehicle to operate it.

D) Protective Clothing that Should be Worn by the Driver and the Passenger

- Approved helmet (ANSI, SNELL, CSA or DOT)
 1. full face
 2. 3/4 shell
 3. passenger's helmet should have a rigid chin guard
- Protective boots
- Riding gloves
- Eye protection (goggles or face shield)
- Long sleeve shirt
- Full length pants
- Elbow pads (optional)
- Knee pads (optional)
- Kidney belt (optional).

E) Riding with a Passenger

- Before riding with a passenger, the operator should first become highly familiar with the operation of the 2-UP vehicle.
- Once ready, the operator should begin riding with a passenger at very low speed and on familiar terrain.

F) ATV-Related Local, State and Federal Laws

- Discuss those laws.

G) Areas where you Cannot Ride your 2-UP Vehicle

Basic rules are:

- Do not ride on private land without the owner's permission.
- Do not ride in areas where your 2-UP vehicle might cause permanent damage.
- Do not attempt maneuvers that exceed your ability.
- Always know where you are and where you are going.

Expected Results

Upon completion of this section, you should:

- Know the current injury and death statistics as published by the CPSC.
- Know BRP's policy toward drivers under 16 years of age, and passengers under 12 years of age.
- Know what clothing and protective gear should be worn by you and your passenger while riding.
- Know the local, state and federal laws applying to ATV operation.
- Know basic rules of where and how not to ride.

SECTION II - BOMBARDIER 2-UP VEHICLE SAFETY VIDEOCASSETTE

Objective

The purpose of this section is to:

- a) Indicate guidelines prior to viewing the Bombardier 2-UP vehicle Safety Videocassette.
- b) Present safety-related information through the Bombardier 2-UP vehicle Safety Videocassette.
- c) Answer all questions that may remain at the end through a recap.

Outline

A) Guidelines

Ask to stop the video at any point if a question should arise. Repeat the video if necessary, if you are uncertain on any points.

B) Safety-Related Information

Clothing

Refer to section I.

Age Recommendation

No operator under 16 and no passenger under 12 or too small to reach the footrests or the grab handles.

Operator's Guide Usage

You must read and understand the Operator's Guide.

Pre-Operating Check

You must do a pre-operating check to assure the vehicle is in safe and proper working order every time you use it.

Body Posture

You and your passenger must position your body weight to lessen the hazard of tipping over. You and your passenger must keep your feet on your respective footrests at all times, and your passenger should always hold the grab handles.

Starting Procedure

The proper method for starting the vehicle.

Uphill and Downhill Riding

The proper method of travelling up and down hills with or without a passenger.

Backing Up

The proper method for backing up.

Side hilling

The proper method for traversing a hill with or without a passenger.

1. Avoid doing it.
2. Weight transfer.
3. Emergency dismount.

Riding with a Passenger or Load

Handling and braking ability changes when carrying a passenger or load.

Water Crossing

Use caution while crossing water.

Vehicle Transportation

Proper method for loading and preparing the 2-UP vehicle to be transported.

1. Apply parking brake.
2. Transmission lever on PARK position.
3. Turn off fuel valve.
4. Make sure fuel and oil caps are tight.
5. Secure front and rear of vehicle.

Law Observance

Refer to section I.

C) Recap

- Questions and answers.
- Review of the CPSC injury and death data.
- Review of safety messages, such as wearing protective head gear and clothing.

Expected Results

Upon completion of this section, you should:

- Know the content of the Bombardier 2-UP vehicle Safety Videocassette.

SECTION III - OPERATOR'S GUIDE REVIEW

Objective

The purpose of this section is to:

- a) Emphasize the importance of observing the warning and caution symbols.
- b) Review the Operator's Guide and be familiar with the important points of each section.

Outline

- A) Warning and Caution Symbols
 - Note the warning and caution symbols in each section and what they are warning about; know the consequences of not following these warnings.
- B) Operator's Guide Review
 - Note the important points of the Operator's Guide:
 1. Table of Contents
 2. Notice Page
 3. Special Safety Messages
 4. Operation Warnings
 5. Warning Labels
 6. Vehicle Identification Number
 7. Controls/Instruments/Equipment
 8. Break-In Period
 9. Pre-Operation Check
 10. Operating Instructions
 11. Special Procedures
 12. Post-Operating Care
 13. Cargo and Transportation
 14. Maintenance.

Expected Results

Upon completion of this section, you should:

- Be familiar with the need to review the Operator's Guide frequently.
- Know the meaning of the warning and caution symbols in the Operator's Guide and what they refer to.
- Know all sections in the Operator's Guide and what they refer to.

SECTION IV - HANDS-ON RIDING

Objective

The purpose of this section is to:

- a) Familiarize you with the pre-operation check.
- b) Remind you about the protective clothing that should be worn by you and your passenger while riding the 2-UP vehicle.
- c) Have you drive the 2-UP vehicle and perform all of the basic maneuvers.

Outline

A) Pre-Operation Checks

- Perform pre-operation check on the 2-UP vehicle, using the checklist from the Operator's Guide and identify all controls.

B) Protective Clothing

- Wear the proper clothing when riding the 2-UP vehicle:
 1. Approved helmet (with a rigid chin guard for the passenger)
 2. Riding boots
 3. Gloves
 4. Eye protection
 5. Long sleeve shirt
 6. Long Pants
 7. Elbow pads (optional)
 8. Knee pads (optional)
 9. Kidney belt (optional).

C) Basic Maneuvers

- Drive the course performing all of the basic maneuvers described in the attached DRIVING MANEUVER LIST, without a passenger.
 1. Dealer representative demonstrates each of the maneuvers first.
 2. You perform the maneuver without passenger, after being shown how.
 3. Dealer representative checks off the scoring chart when you have completed the maneuvers satisfactorily.
 4. Dealer representative and you continue with the maneuvers one at a time until all have been performed, and checked off.

Expected Results

Upon completion of this section, you should:

- Know how to do a pre-operation check.
- Know the proper clothing to be worn by you and the passenger while riding your 2-UP vehicle.
- Have performed all of the basic riding maneuvers on the riding course.

DRIVING MANEUVER LIST

Hands-on riding practice should incorporate the maneuvers described below.

Trainees are required to perform a minimum number of repetitions of each of the eight driving maneuvers. The person giving the training must demonstrate each maneuver and then have the trainee repeat the following minimum number of repetitions.

Maneuver # 1

Starting and stopping practice on a large oval course (minimum repetition: once counter-clockwise and once clockwise).

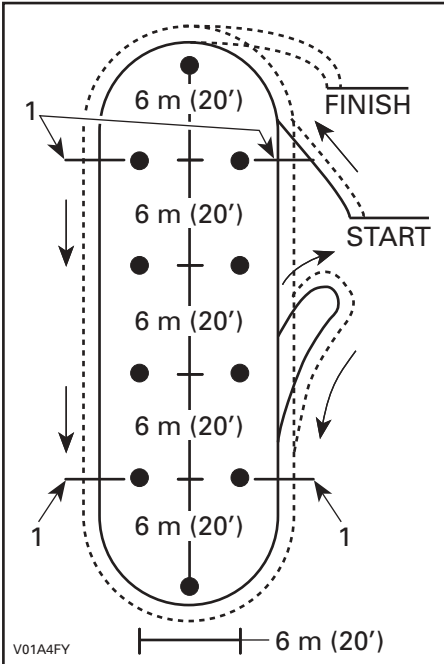

TYPICAL

1. Stop here

Maneuver # 2

Turning left and right - figure 8's (minimum repetition: three times).

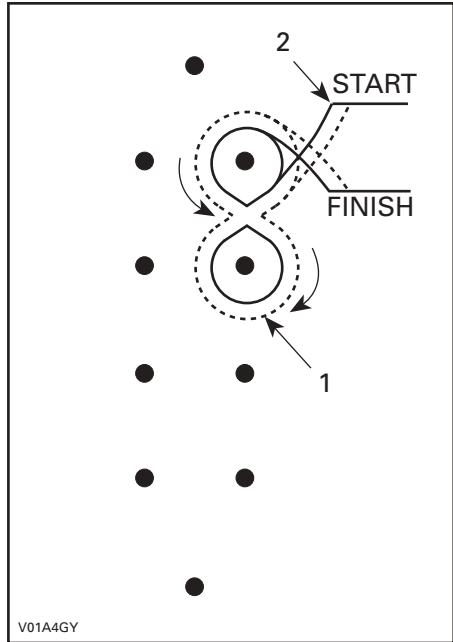

TYPICAL

1. 2 laps or more
2. Finish of 1st maneuver

Maneuver # 3

Sharp turns less than 90° - left and right. Corners 90 and less than 90 (minimum repetition: two clockwise and two counterclockwise).

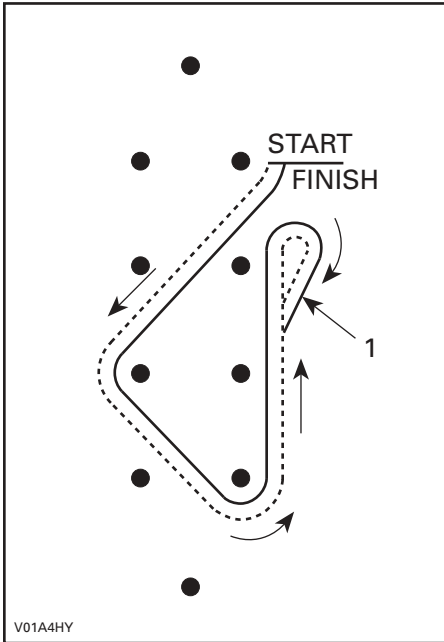

TYPICAL

1. Reverse range

Maneuver # 4

Slalom (minimum repetition: three times).

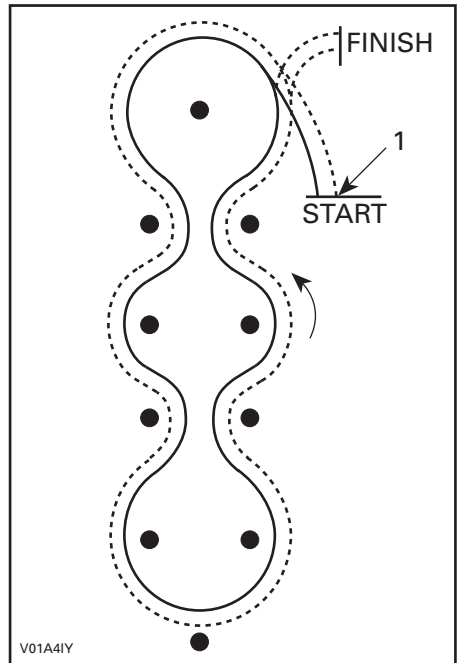

TYPICAL

1. Finish of last maneuver

While reading this Operator's Guide, remember that:

WARNING

Indicates a potential hazard that, if not avoided, could result in serious injury or death.

Maneuver # 5

Quick stop: large oval with panic maneuver (minimum repetition: two times).

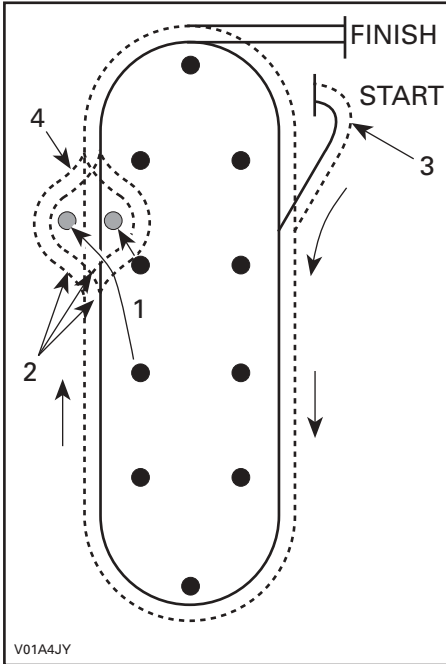

TYPICAL

1. Move 2 cones
2. Instructor specifies left, right or straight on command
3. Finish of last maneuver
4. Instructor signal panic turnout

Maneuver # 6

Riding over obstacle (minimum repetition: once with left wheels, once with right wheels, and once with both wheels).

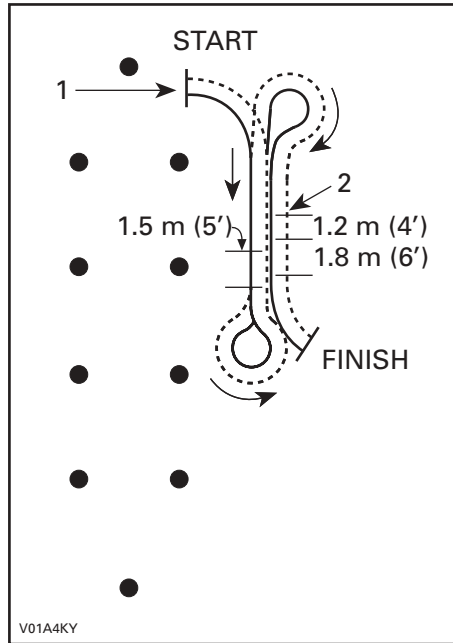

TYPICAL

1. Finish of last maneuver
2. Obstacle

Maneuver # 7

Traversing hills (minimum repetition: once each direction).

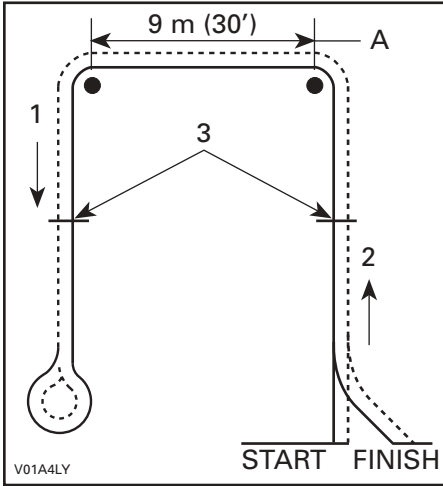

TYPICAL

- 1. Down
- 2. Uphill
- 3. Stop and start here
- A. Traverse

Maneuver # 8

U-turn and K- turn (minimum repetition: one time).

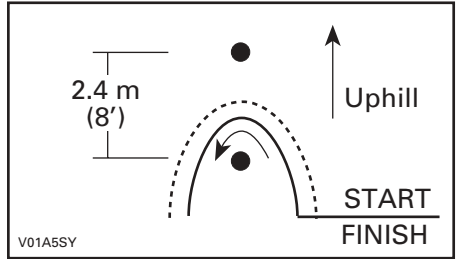

TYPICAL U- TURN

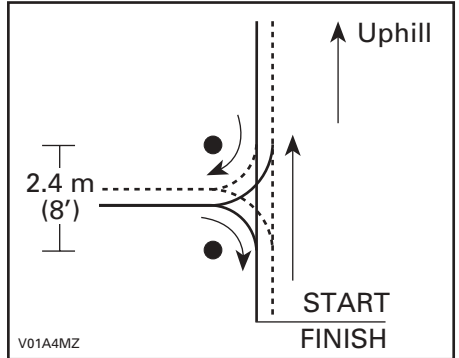

TYPICAL K- TURN

INSTRUCTOR'S CHECK LIST

Name of 2-UP vehicle purchaser: _____

Name of distributor/dealer representative: _____

Date: _____

IMPORTANT:

This 2-UP vehicle Safety Training Course is mandatory and must be completed for any new 2-UP vehicle purchaser.

Random checks will be performed by a third party agency to ensure the training is being performed.

Failure to perform the required training may constitute a violation of the Bombardier ATV distributor/dealer agreement.

If you would like further information on the 2-UP vehicle Safety Training course, please contact BRP.

Introduction:

- Each trainee must carefully read the content of the Customer Safety Training Guide.

Section I: General Safety Information

- Explain the reason for safety training.
- Discuss CPSC Injury and Death Statistics.
- Discuss BRP's age and size recommendations.
- Discuss what protective clothing should be worn by the operator and the passenger while riding the 2-UP vehicle.
- Discuss local, state and federal laws pertaining to ATV use.
- Discuss what areas are acceptable to ride in.

Section II: Bombardier 2-Up Vehicle Safety Videocassette

- Review the Bombardier 2-UP vehicle Safety Videocassette with your trainee. Make sure to answer any questions your trainee may have.

Section III: Operator's Guide Review

- Review the Operator's Guide with your trainee. Emphasize the need for periodic and frequent reviews of the guide.
- Draw trainee's attention to the warning and caution symbols, and explain their meaning.

Section IV: Hands-On Riding

- Perform the pre-operation check with your trainee.
- Remind your trainee about the protective clothing that should be worn by driver and passenger while riding the 2-UP vehicle.
- Demonstrate each of the maneuvers to the trainee.
- Have the trainee drive the 2-UP vehicle and perform all of the following basic maneuvers.

1) Starting and Stopping

Starting and stopping practice on a large oval course (minimum repetition: once counterclockwise and once clockwise).

- Should have a starting area long enough so the operator has enough time to think about the next maneuver before he has to execute it.
- Should incorporate a braking area at least 9 m (30 ft) long in which the trainee will have to negotiate a stop, in a straight line, from various speeds.

2) Turning

Turning left and right - figure 8's (minimum repetition: three times).

3) Sharp Turns

Sharp turns less than 90° – left and right. Corners: 90 degrees and less than 90 degrees (minimum repetition: two clockwise and two counterclockwise).

4) Slalom

Slalom at least 4 markers – each 6 m (20 ft) apart (minimum repetition: three times).

5) Quick Stop

Quick stop as used in article I above. Large oval with panic maneuver (minimum repetition: two times).

6) Riding Over Obstacles

Riding over obstacles – 4 x 4 pieces of wood should be placed in vehicle's path so rider can drive over them (minimum repetition: once with left wheels, once with right wheels, and once with both wheels).

7) Traversing Hills

First, remind the trainee that sidehilling should be avoided if possible.

Where there is a hill available of approximately 8% incline or less, the course should be set up to use the hill to practice traversing (minimum repetition: once each direction). If there is no hill available, make sure to review the description of the maneuver in the Operator's Guide with the trainee.

8) K-Turn and U-Turn

Where there is a hill available of approximately 8% incline or less, the course should be set up to use the hill to practice K-turns and U-turns (minimum repetition: one time). If there is no hill available, make sure to review the description of the maneuver in the Operator's Guide with the trainee.

- Complete checklist and score card. Purchaser and dealer representative must sign.**
- Copy checklist and score card for your records.**

Trainee's Scoring Chart

EXERCISE	PASS	FAIL
1. Starting and stopping		
2. Turning		
3. Sharp turns		
4. Slalom		
5. Quick stops		
6. Riding over obstacles		
7. Traversing hills (if there is no hill available, make sure to review the description of the maneuver in the Operator's Guide with the trainee)		
8. K-turn and U-turn (if there is no hill available, make sure to review the description of the maneuver in the Operator's Guide with the trainee)		
9. Instructor comments: _____ _____ _____ _____		

NOTE: The dealer must make a photocopy of this scoring card for his record.

Signature of 2-UP vehicle purchaser: _____

Signature of distributor/dealer representative: _____

Date: _____

VEHICLE INFORMATION

HOW TO IDENTIFY YOUR ATV

The main components of your vehicle (engine and frame) are identified by different serial numbers. It may sometimes become necessary to locate these numbers for warranty purposes or to trace your vehicle in the event of loss. These numbers are required by the authorized Bombardier ATV dealer to complete warranty claims properly. No warranty will be allowed by BRP if the engine identification number (EIN) or vehicle identification number (VIN) is removed or mutilated in any way. We strongly recommend that you take note of all the serial numbers on your vehicle and supply them to your insurance company.

Engine and Vehicle Identification Number Location

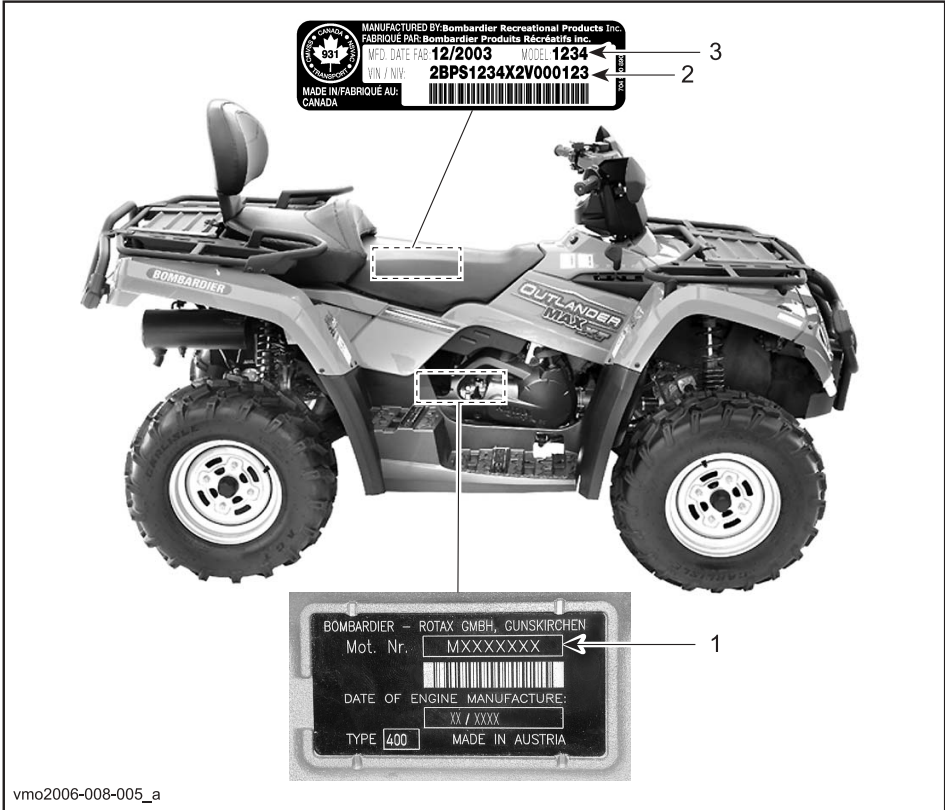

vmo2006-008-005_a

TYPICAL

1. EIN (Engine Identification Number)
2. VIN (Vehicle Identification Number)
3. Model

Compliance Label

This label indicates vehicle's compliance in many countries.

Label Location	
Outlander MAX	Under seat, on the upper bar of frame



U.S.A. AND CANADA

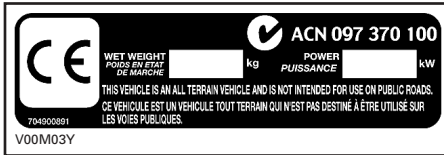

OTHER COUNTRIES IN THE WORLD

EMISSION REQUIREMENTS

The California Air Resources Board (CARB) requires that your ATV comply with applicable exhaust emissions standards during its useful life, when operated and maintained according to the instructions supplied.

A noncompliance Red Label (as well as a Green Label) is obtained annually during California Vehicle registration. The appropriate label is denoted by the vehicle identification number (in the 8th character detailed herein).

VEHICLE CATEGORY	VIN 8 th CHARACTER
Non-complying Red Label	Must denote a C or 3
Complying Green Label	Any alphanumeric designation other than a C or 3

CONTROLS/INSTRUMENTS/EQUIPMENT

NOTE: Some controls/instruments/equipment are optional.

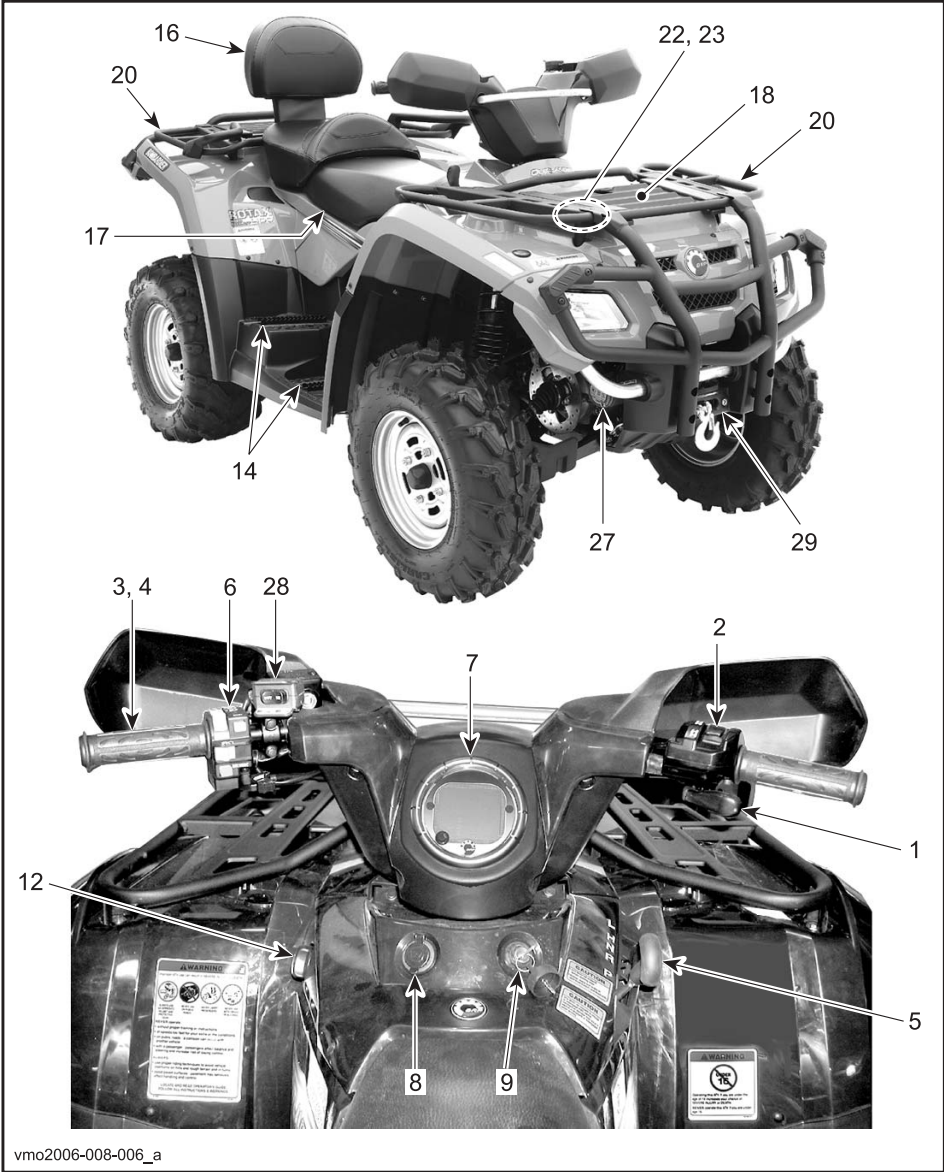

vmo2006-008-006_a

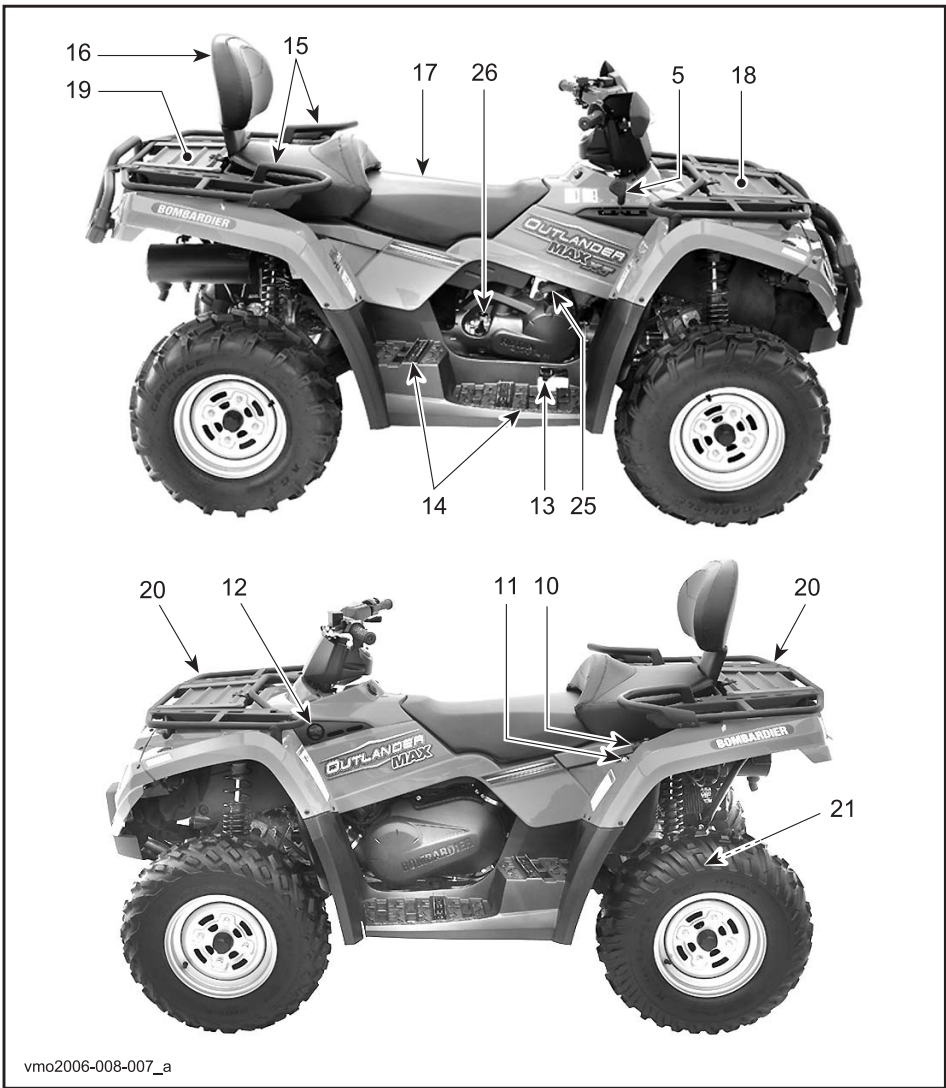

While reading this Operator's Guide, remember that:

⚠ WARNING

Indicates a potential hazard that, if not avoided, could result in serious injury or death.

NOTE: This section gives basic functions of the various controls of your ATV. For more details of how to operate one control in conjunction with some others, refer to OPERATING INSTRUCTIONS further in this section.

1) Throttle Lever

Located on the right side of handlebar. When pushed, it increases the engine speed that allows the engagement of the transmission on the selected gear.

When released, the engine speed should return automatically to idle and the vehicle will gradually slow down.

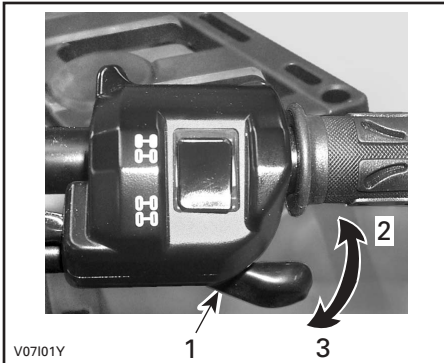

1. Throttle lever
2. To accelerate
3. To decelerate

2) 2WD/4WD Selector

Located on the top of throttle handle, this selector allows to choose between 2WD and 4WD.

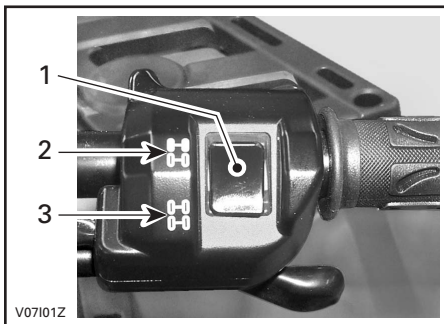

1. Selector
2. 2WD position
3. 4WD position

3) Brake Lever

Located on the left side of handlebar. When the brake lever is compressed, the front and rear brakes are applied. When released, the brake lever should automatically return to its original position. Braking effect is proportional to the force applied on the lever and to the type and condition of the terrain.

NOTE: As on other wheeled vehicles, the vehicle weight is transferred to the front wheels when braking. To obtain greater stopping efficiency, the brake system distributes more braking force to the front wheels. This will affect vehicle handling and steering control when braking vigorously. Take it into account when braking.

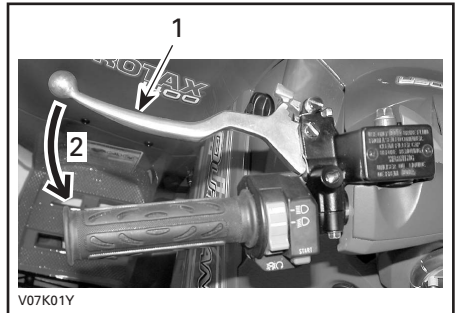

TYPICAL

1. Brake lever
2. To apply brakes

4) Brake Lever Lock

Located on left side of handlebar on the brake lever. When applied, it prevents the vehicle from moving. Useful when the brake needs to be locked for example when doing a K-turn, during transportation or when the vehicle is not in operation.

WARNING

Always use the brake lever lock and engage the PARK position on the transmission lever when the vehicle is not in operation.

WARNING

Make sure brake lever lock is fully disengaged before operating the ATV. When you ride the vehicle, brakes that are caused to drag by a continuous pressure on the lever may cause damage to the brake system and cause loss of braking capacity and/or fire.

To engage mechanism: Squeeze brake lever and maintain while moving lever lock. Brake lever is now compressed and applying all brakes.

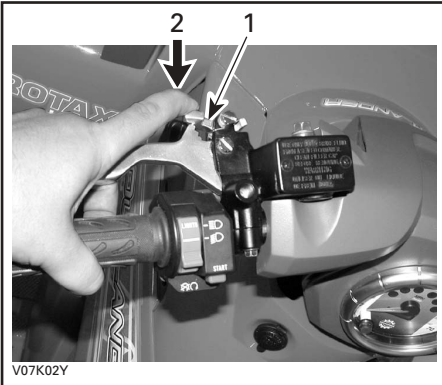

TYPICAL

1. Brake lever lock
2. Press to apply parking brakes

To release mechanism: Squeeze brake lever. Lever lock should automatically return to its original position. Brake lever should return to rest position. Always release brake lever lock before riding.

5) Transmission Lever

Located on the right side of vehicle. A 5-position lever: P, R, N, H and L.

To change the transmission position, completely stop vehicle then move lever to the desired position. Do not force lever. If unable to shift, rock the vehicle back and forth to move the gears in the transmission and try again.



TYPICAL – SHIFT PATTERN

CAUTION: Always completely stop the vehicle and apply the brake prior to moving the transmission lever.

P: Park

This position locks the transmission to help prevent vehicle movement. Always use when the vehicle is not in operation. In some circumstances, it may be necessary to rock the vehicle back and forth to move the gears in the transmission to allow the park to be engaged.

R: Reverse

This allows the vehicle to go backward. The vehicle speed is limited.

WARNING

Before moving vehicle in reverse, ensure the path behind is clear of obstacles or bystanders. Remain seated.

N: Neutral

This position disengages the transmission to allow manual vehicle movement.

H: High gear

This selects the high speed range of the transmission in the gear box. It is the normal driving speed range. It allows the vehicle to reach its maximum speed.

L: Low gear

This selects the low speed range of the transmission in the gear box. It is the working position. It allows the vehicle to move slowly with the maximum traction and power.

NOTE: Use the low speed range to pull any load or to climb a steep incline.

6) Multi-Function Switch

The multi-function switch is located on the left side of handlebar.

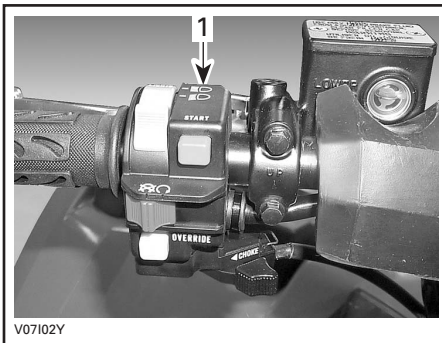

TYPICAL

1. Multi-function switch

The controls located on this multi-function switch are:

Headlamp Switch

Located on the top of multi-function switch. Place headlamp switch to LO for the low beam and brake lamp. Place headlamp switch to HI for the high beam and taillight.

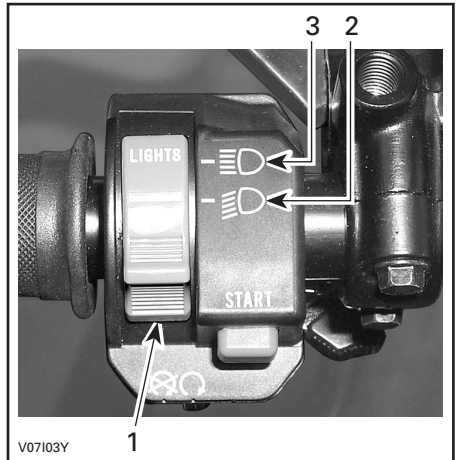

TYPICAL

1. Headlamp switch
2. Low beam position
3. High beam position

NOTE: Place ignition switch to ON "without light" position to close the headlamp.

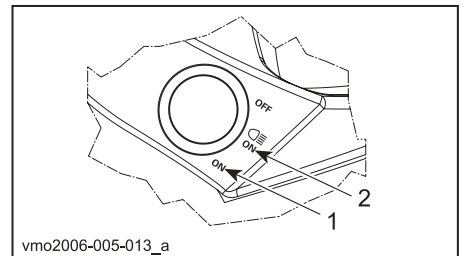

IGNITION SWITCH

1. ON "without light"
2. ON "with light"

Engine Stop Switch

Located at the middle of multi-function switch. The engine will turn over but will not start if the engine stop switch is turned to OFF position.

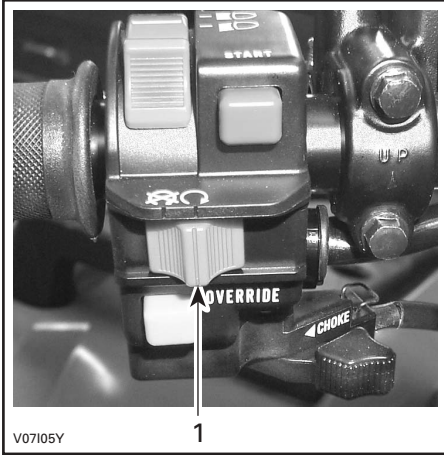

TYPICAL

1. Engine stop switch

This switch can be used to stop engine and as an emergency control.

NOTE: While engine can be stopped by turning ignition key OFF, we recommend the engine be stopped by the engine stop switch.

To stop engine, fully release throttle lever then use the engine stop switch.

Start Button

Located above engine stop switch.

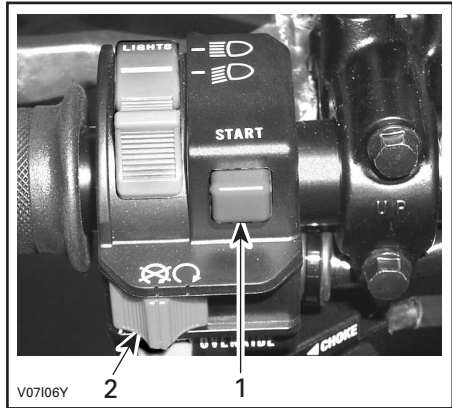

TYPICAL

1. Start button
2. Engine stop switch

To start engine, place the engine stop switch to RUN.

Press and hold the start button. Release immediately after engine is started.

Override Button

Located below engine stop switch.

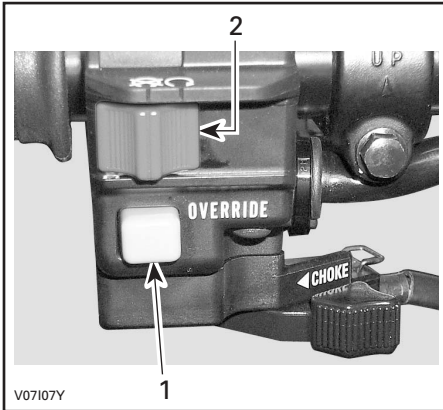

TYPICAL

1. *Override button*
2. *Engine stop switch*

This button is used to override the reverse speed limiter system and while power backing up. To do this, press the override button.

WARNING

Never activate the override button while throttle is open as loss of control may result, causing severe personal injury or death.

Choke Lever

Located at bottom of multi-function switch. This device features a variable lever to ease cold start.

Position OFF is for normal use with a warm engine.



CHOKE LEVER IN THE OFF POSITION

The full choke position is used for lower engine temperature.



CHOKE LEVER IN THE FULL CHOKE POSITION

The other positions between OFF and FULL position, will be use depending on the engine temperature.

7) Speedometer

This vehicle is equipped with an electronic speedometer. It indicates the speed of vehicle either in MPH or km/h.

The speedometer is located at the middle of cluster and it backlit every time the ignition switch is turned ON.

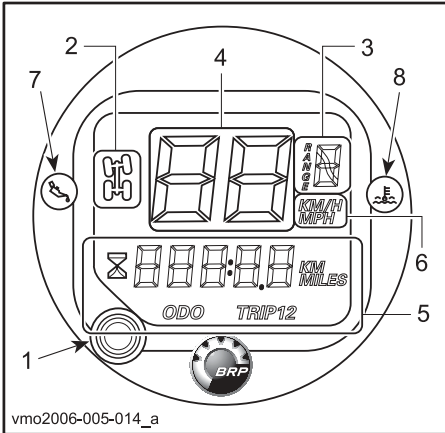

TYPICAL

1. Display selector button
2. 4WD system display
3. Transmission position display
4. Vehicle speed display
5. Multi-function display
6. Unit display
7. Oil pressure indicator lamp
8. Engine temperature indicator lamp

Change from One Unit to the Other

The speedometer is factory preset in miles but it is possible to change it to kilometer reading.

NOTE: The unit modification is applied to the speedometer, odometer and trip meter.

Turn ignition switch OFF position.

Slightly lift speedometer at the bottom using a small flat screwdriver until small locking tab is released from steering cover.

Turn speedometer clockwise until speedometer slightly pops-out from steering cover.

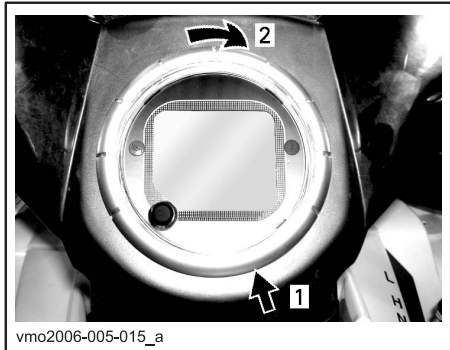

1. Lift to release locking tab
2. Turn clockwise to release speedometer

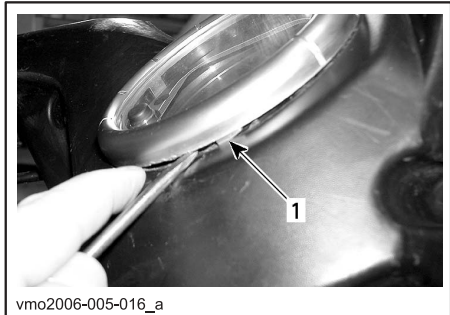

1. Locking tab

Plug connectors to change units from miles to kilometers. Unplug to return to miles reading. Fix the change wires to the harness with new locking tie.

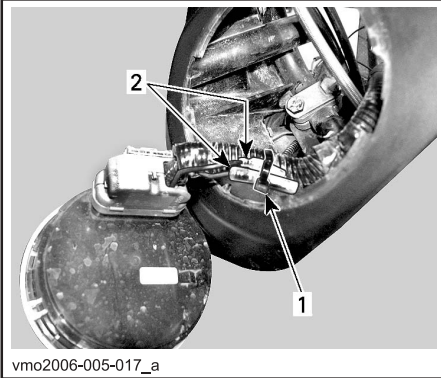

1. Locking tie
2. Connectors to change units

Speedometer Display Codes

Speedometer Reads FAIL

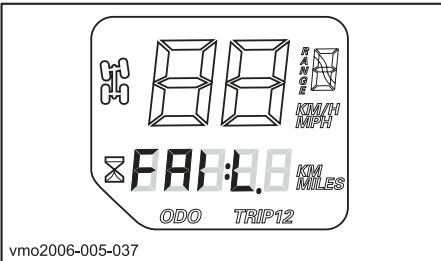

If your speedometer shows FAIL in the multi-function display, it means that the speedometer has sensed 18 volts in the electrical system, caused by a disconnected or defective voltage regulator.

Check voltage regulator connection or contact an authorized Bombardier ATV dealer for voltage regulator replacement.

Speedometer Reads SCALE

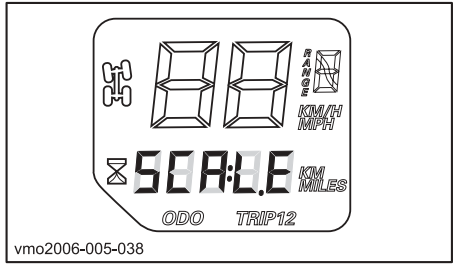

If your speedometer shows SCALE in the multi-function display, it means that the display selector button is stuck in the down position or depressed when the electrical system was activated.

Display Selector Button

Use selector button to change speedometer display to the desired mode:

- hourmeter
- odometer
- trip meter 1
- trip meter 2



1. Selector button

Multi-Function Display

Odometer (ODO)

Odometer records the total distance travelled either in miles or kilometers.

Trip Meter (TRIP 1/TRIP 2)

For your convenience, your speedometer is equipped with two separate trip meter.

The trip meter records distance travelled since it has been reset. Distance travelled is displayed either in miles or kilometers.

It can be used to establish a fuel tank range or distance between 2 way points for instance.

Push and HOLD display selection button for 2 seconds to reset the trip meter.

Hourmeter



The hourmeter records engine running time in hours and minutes.

Transmission Position (RANGE)



Indicates the transmission is in park position.



Indicates the transmission is in reverse position.



Indicates the transmission is in neutral position.

4-Wheel Drive System



When this indicator is ON, it indicates the 4WD system is activated.

Indicator Lamps

Oil Pressure (RED)



When this indicator light is ON, it indicates a low oil pressure condition of the engine.

CAUTION: If the light does not turn off right after engine starting, stop engine. Check engine oil level. Refill if necessary. If the oil level is good, see an authorized Bombardier ATV dealer. Do not use the vehicle until repaired.

Engine Temperature (RED)



When this indicator light is ON, it indicates the engine is overheating. If engine overheats, refer to ENGINE OVERHEAT in SPECIAL PROCEDURES.

CAUTION: If the light does not turn off right after engine starting, stop engine. See an authorized Bombardier ATV dealer. Do not use the vehicle until repaired.

8) 12-Volt Power Outlet

It is located on the console behind the ignition switch.

Convenient for handheld spotlight or other portable equipment.

Remove protective cap to use. Always reinstall it after use to protect against weather.

Do not exceed the rating capacity. See SPECIFICATIONS.

An auxiliary supply is available to connect additional accessories. Two wires are hidden in the wiring harness at the rear of vehicle. See an authorized Bombardier ATV dealer for more details.

9) Ignition Switch

Located on the console.

Key-operated, 3-position switch: OFF, ON with lights and ON without lights.

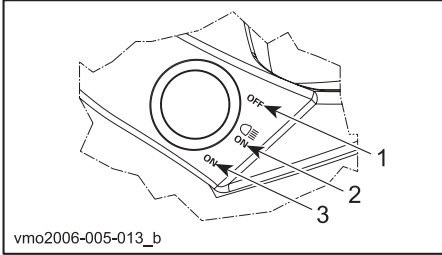

1. OFF
2. ON with lights
3. ON without lights

Insert key in switch and turn to the desired position. To remove key, turn key to OFF then pull it out.

The ON with lights position, turns on all lights with either the engine running or not. Remember that having the lights on without the engine running discharges the battery. Always turn ignition to OFF after engine has been stopped.

NOTE: While engine can be stopped by turning ignition key OFF, we recommend the engine be stopped by the engine stop switch.

10) Fuel Tank Cap

The fuel tank cap is located on the left side of the rear fender.

CAUTION: Never place anything over fuel tank cap because the vent hole on the top of fuel tank cap can be blocked and the engine could misfire.

Unscrew counterclockwise and remove cap to allow fuel tank filling then fully tighten clockwise.

WARNING

Always stop engine before refueling. Open cap slowly. If a differential pressure condition is noticed (whistling sound heard when loosening fuel tank cap) have vehicle inspected and/or repaired before further operation. Fuel is flammable and explosive under certain conditions. Never use an open flame to check fuel level. Never smoke or allow flame or spark in vicinity. Always work in a well-ventilated area. Never top up the fuel tank before placing the vehicle in a warm area. As temperature increases, fuel expands and may overflow. Always wipe off any fuel spillage from the vehicle.

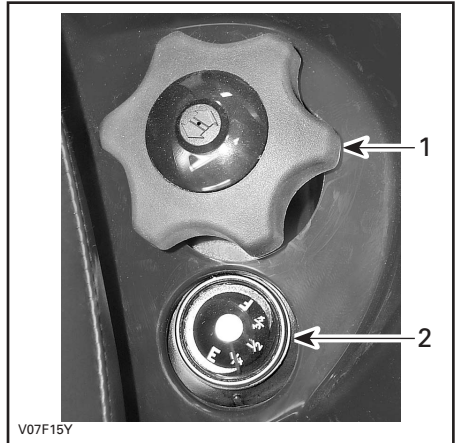

1. Fuel tank cap
2. Fuel gauge Seat

11) Fuel Gauge

Located on the left side of the rear fender near fuel tank cap, the gauge shows an approximate amount of the fuel in tank.



12) Fuel Valve

Located on left side panel under console. This is a 3-position rotary valve: OFF, ON, RES. Rotate the knob to align its pointer with ON, OFF or RES.

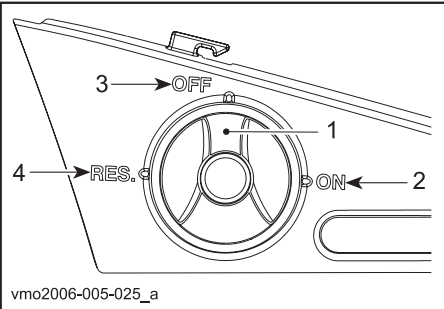

1. Align this pointer toward the desired position
2. ON
3. OFF
4. RES. (reserve)

OFF

Stops fuel supply to carburetor.

CAUTION: Turn valve to OFF position when vehicle is not being operated or when transporting.

ON

Allows fuel to flow to carburetor. This is the normal position for operation of the vehicle.

RES (reserve)

When fuel is exhausted in the fuel tank when in the ON position, an emergency supply of fuel is available by turning the knob to RES. The reserve contains approximately 12% of the fuel tank capacity. Use this position only when the ON supply is empty.

When down to the reserve, refuel as soon as possible. Ensure to turn the valve back to the ON position after refuelling.

CAUTION: Improper opening of fuel valve will restrict the flow of fuel. Make sure valve is fully opened while running.

13) Brake Pedal

Located on the right footrest. When pressed down, the rear brake is applied. When released, the brake pedal should return to its original position. Braking effect is proportional to the force applied on the pedal and to the type and condition of the terrain.

NOTE: The brake will have also an effect on front wheels through the drive train.

The brake pedal applies the rear brake only. Should the main brake system fail, the rear brake can be activated by depressing the brake pedal.

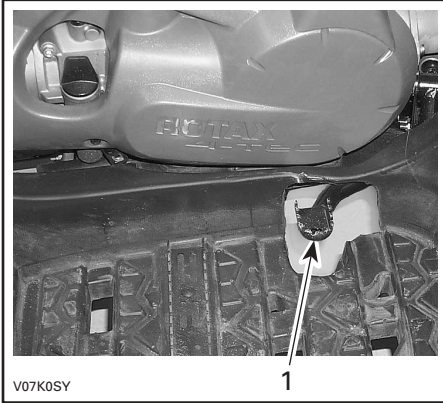

V07K0SY

1. Brake pedal

14) Footpeg

Located on footrest. Use this area to keep your feet and the passenger's feet stable.

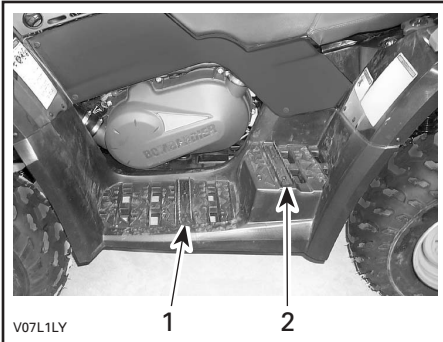

V07L1LY

1. Operator's footpeg
2. Passenger's footpeg

15) Grab Handles

The grab handles are located on each side of passenger's seat.

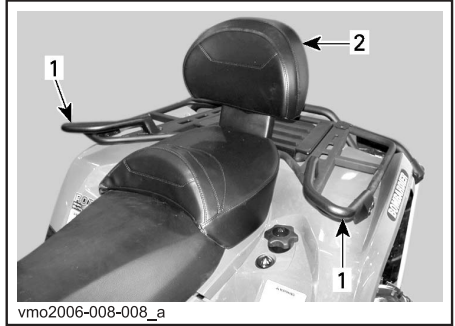

vmo2006-008-008_a

1. Grab handles
2. Passenger's seat

The grab handles must be used by the passenger to hold on firmly during vehicle operation.

⚠ WARNING

Never hold on to the operator. Always hold the grab handles firmly.

16) Passenger's Seat/Storage Box

WARNING

Never operate the vehicle without passenger's seat or storage box properly installed.

The passenger's seat is designed specially to allow a secure and pleasant ride at ONE (1) passenger. The integrated backrest supports his back during the ride.

The storage box is used to convert a two-rider vehicle to a one-rider vehicle with extra cargo capacity.

The conversion of the vehicle is easy, remove the passenger's seat then install the storage box or vice versa. Use the procedure described below to remove and install the features correctly.

WARNING

Without its passenger's seat, the vehicle becomes a ONE RIDER vehicle and NO PASSENGER must be allowed on vehicle. NEVER carry passenger on storage box.

Passenger's Seat Removal

- Pull one of the passenger's seat latch levers. Those levers are located underneath the RH or LH rear end of seat.

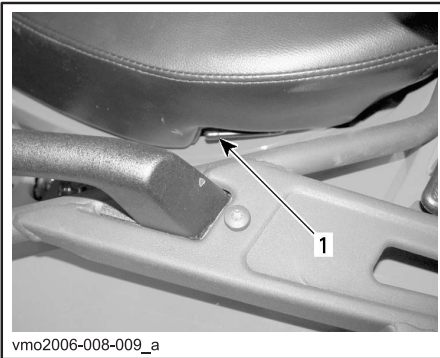

TYPICAL — LH SIDE

1. Seat latch

- Gently lift the rear of the seat.
- Pull seat rearwards.
- Continue lifting movement until you can release the front retaining device then completely remove passenger's seat.

Passenger's Seat Installation

- Insert passenger's seat positioning tubes into rear fender provided holes.

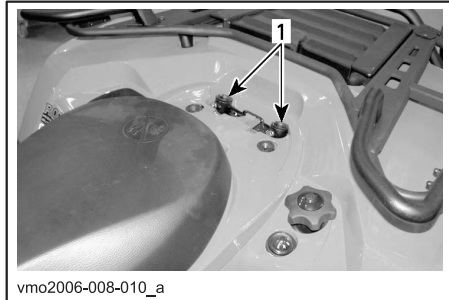

1. Holes for passenger's seat positioning tubes

- When seat rests in its position, firmly push seat down to latch.

NOTE: A distinctive snap will be felt. Double check that the seat is secure by giving it a tug to confirm proper latching.

WARNING

Make sure seat is securely latched before riding.

Storage Box Removal

- Pull storage box strap to release from vehicle.
- Remove storage box.

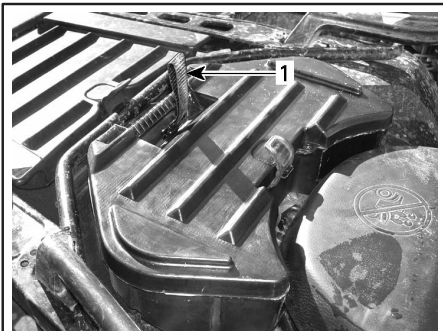

vmo2006-008-012_a

1. Strap

Storage Box Installation

- Position storage box onto rear fender.
- When storage box rests in its position, firmly push down to latch.
- To open storage box, unhook the rubber latch.

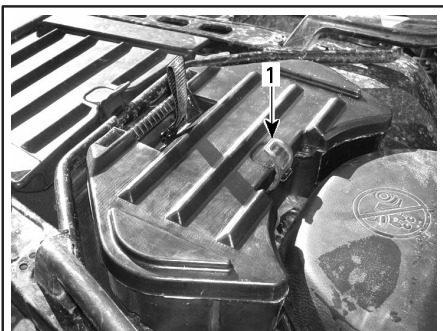

vmo2006-008-012_b

1. Rubber latch

17) Operator's Seat

NOTE: To remove the operator's seat, the passenger's seat or storage box removal is necessary.

Seat Removal

To remove the operator's seat, push its latch forward. This latch is located underneath the rear of seat.



vmo2006-008-011_a

1. Seat latch

Pull seat rearward. Continue lifting movement until you can release the front retaining device then completely remove seat.

Seat Installation

Insert front tabs of seat into frame hooks. When seat rests in its position, firmly push seat down to latch.

NOTE: A distinctive snap will be felt. Double check that the seat is secure by giving it a tug to confirm proper latching.

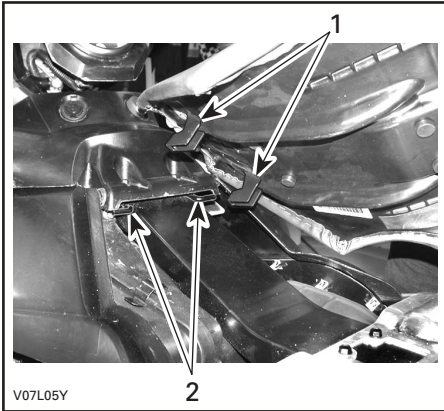

V07L05Y

1. Insert these tabs in hooks
2. Hooks



WARNING

Make sure seat is securely latched before riding.

18) Access Panel

The access panel is located on the front fender, between front racks. To open the panel, unlatch, lift then remove it completely.

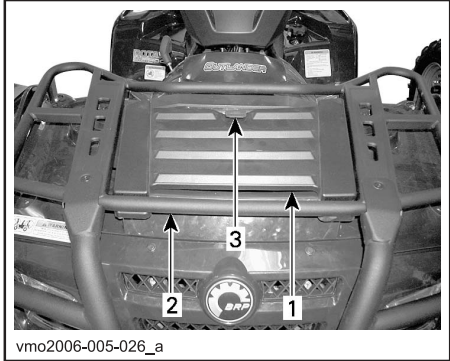

vmo2006-005-026_a

1. Access panel
2. Front rack
3. Latch

This panel allows an easier access to the service compartment. The service compartment contains different maintenance items like rear brake fluid reservoir, radiator cap, coolant reservoir and fuse holders.

19) Rear Storage Compartment

Located in rear of vehicle. Convenient location to carry personal articles such as a spare spark plugs, first aid kit, etc. Unlatch cover, gently lift then remove cover.

The compartment is equipped with a drain plug. Remove plug to allow draining when necessary. Reinstall plug when finished.

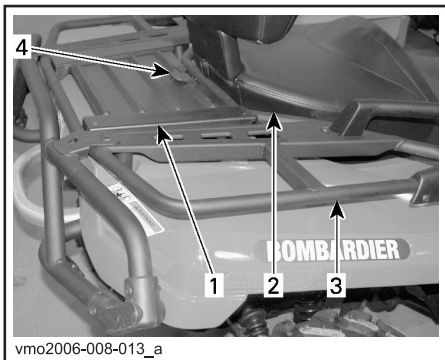

1. Rear storage compartment cover
2. Seat
3. Rear racks
4. Latch

WARNING

When engine is running, always engage the PARK position on the transmission lever before opening cover. Never leave any heavy or loose breakable objects in the storage basket. Always latch cover before riding. If storage cover is removed to provide greater carrying area, ensure that cargo is secured and will not "fly out" when riding at speed on rough terrain. Slow down.

20) Cargo Racks

Located on top of chassis at front and rear. Convenient racks to carry gear.

WARNING

Ensure to properly secure material to racks. Do not overload. Ensure load does not interfere with visibility and/or steering. Do not carry passenger(s).

NOTE: Refer to SPECIFICATIONS for carrying loads and cargo weight distribution recommendations.

21) Trailer Hitch

Located near rear axle. Convenient hitch to install a ball to tow a trailer or other equipment. Install the proper ball size as per trailer manufacturer recommendations. Refer to SPECIFICATIONS for carrying loads and towing recommendations.

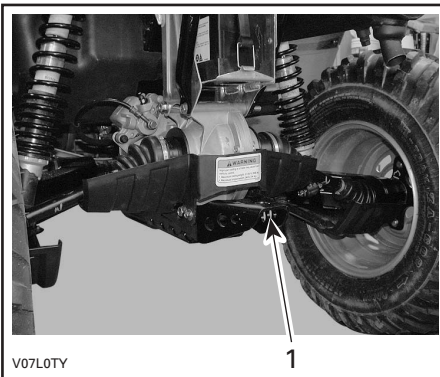

1. Trailer hitch

WARNING

Ensure to install the proper ball size that matches the equipment you will tow.

NOTE: Follow manufacturer's instructions for proper attachment.

22) Radiator Cap

Located in service compartment, under access panel.

WARNING

In order to avoid getting burned, do not remove the radiator cap when the engine is hot.

To remove the radiator cap, press and turn it counterclockwise. Reverse the removal procedure to install.

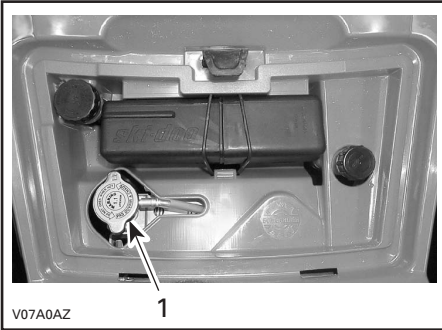

1. Radiator cap

23) Fuses

The electrical system is protected with fuses. Refer to MAINTENANCE for details.

The fuse holders are located in the service compartment.

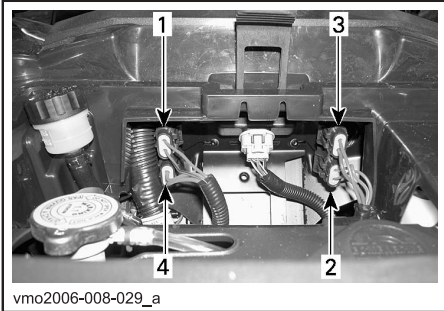

FUSES LOCATION

1. Accessories (15 A)
2. Fan (15 A)
3. Main (20 A)
4. Charging system (30 A)

24) Tool Box

The tool box is located in the rear storage compartment. It contains tools for basic maintenance, this Operator's Guide and the ATV Winch Operator's Manual with the XT models.

The tools included in the tool box are:

- pliers (1)
- screwdriver (1)
- open wrench 10/13 mm (1)
- open wrench 15/17 mm (1)
- socket wrench 10/13 mm (1)
- socket wrench 16/18 mm (1)
- tire pressure gauge (1)
- shock absorber key (1)
- fuse 30 A (1)
- fuse 20 A (1)
- fuse 15 A (1).

25) Rewind Starter Handle

The rewind starter handle is provided as an emergency starting device.

Follow the usual starting procedure; but use the rewind starter instead of the electric starter.

Located on right side of vehicle. Auto-rewind type. To engage mechanism, pull handle slowly until a resistance is felt then continue to slowly pull the handle until the compression stroke peak (strong rotating resistance) is overpassed then, pull vigorously. Slowly release handle.



1. Rewind starter handle

26) Dipstick

Located on the right side of engine. Allow to check the oil level in the engine.

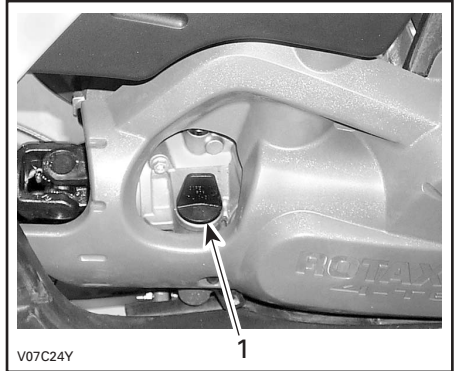

1. Dipstick

Refer to LIQUID to check the engine oil level correctly.

27) Winch

XT Models

Located behind front skid plate.

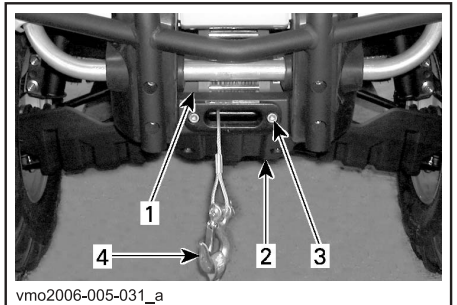

1. Winch
2. Front skid plate
3. Fairlead
4. Winch Hook

28) Winch Control Switch

XT Models

Located on the left side of the handlebar.

To take out wire rope from winch, press the left side of switch.

To get wire rope into the winch, press the right side of switch.

Refer to ATV Winch Operator's manual for more informations.

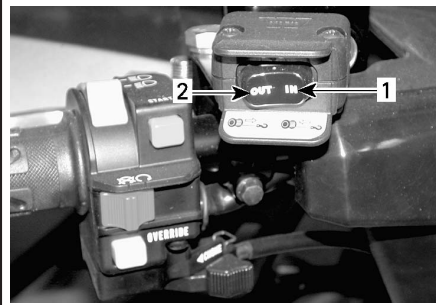

vmo2006-005-032_a

1. *In*
2. *Out*

29) Fairlead

XT Models

Located on the front of skid plate.

The fairlead is used to prevent the damages to the vehicle and guide the wire rope into the winch.

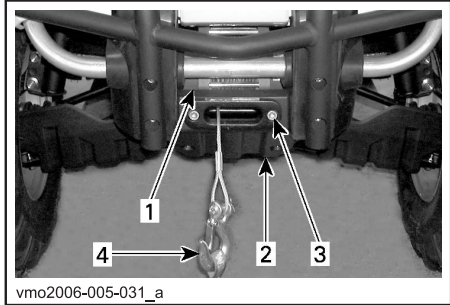

vmo2006-005-031_a

1. *Winch*
2. *Front skid plate*
3. *Fairlead*
4. *Winch hook*

LIQUIDS

While reading this Operator's Guide, remember that:

WARNING

Indicates a potential hazard that, if not avoided, could result in serious injury or death.

NOTE: This section specifies the recommended liquids and procedures to check their levels. Refer to MAINTENANCE for procedures to replace the liquids.

Fuel

Recommended Fuel

Use regular unleaded gasoline, available from most service stations or oxygenated fuel containing a maximum total of 10% of ethanol or methanol or both. The gasoline used must have the following recommended minimum octane number.

OCTANE NUMBER	
Inside North America	(87 (R + M)/2)
Outside North America	91 RON

CAUTION: Never experiment with other fuels. The use of unrecommended fuel can result in vehicle performance deterioration and damage to critical parts in the fuel system and engine components.

CAUTION: Never mix oil with fuel. This ATV has a 4-stroke engine. Oil must be added to engine base only.

Fuel Level

WARNING

Always stop engine before refueling. Open cap slowly. If a differential pressure condition is noticed (whistling sound heard when loosening fuel tank cap) have vehicle inspected and/or repaired before further operation. Fuel is flammable and explosive under certain conditions. Never use an open flame to check fuel level. Never smoke or allow flame or spark in vicinity. Always work in a well-ventilated area. Never top up the fuel tank before placing the vehicle in a warm area. As temperature increases, fuel expands and may overflow. Always wipe off any fuel or oil spillage from the vehicle.

Engine/Transmission Oil

Recommended Oil

Use 4-stroke engine oil that meets or exceeds the requirements for API service classification SG, SH or SJ. Always check the API service label on the oil container to be sure it includes the letters SG, SH or SJ. Only use high-quality high-detergent oil.

NOTE: The same oil lubricates both engine and transmission.

Oil Viscosity

SAE 5W30 is recommended for all seasons.

However, during the hottest days of the summer and bitter cold days of the winter, refer to the following chart to select the proper viscosity.

NOTE: For improved overall performance and wear protection use XP-S 5W40 synthetic 4-stroke oil (P/N 293 600 039).

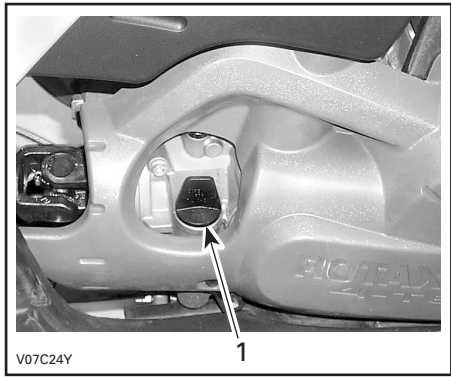
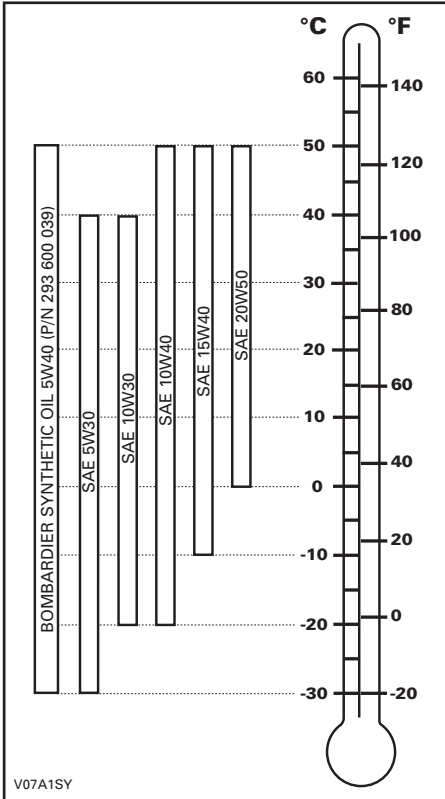

RH SIDE OF ENGINE

1. Dipstick

With vehicle on a level surface and engine cold, not running, check the oil level as follows:

1. Unscrew dipstick then remove it and wipe clean.
2. Reinstall dipstick, screw in it completely.
3. Remove and check oil level. It should be near or equal to the upper mark.

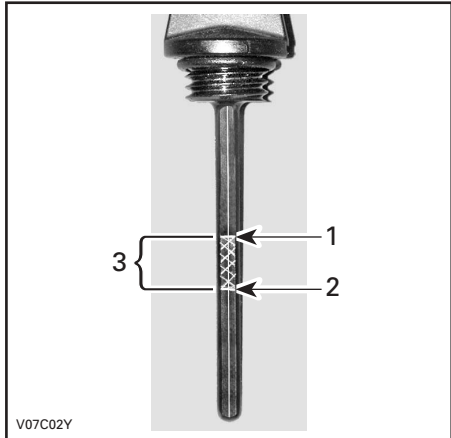

1. Full
2. Add
3. Operating range

Oil Level

CAUTION: Check level frequently and refill if necessary. Do not overfill. Operating the engine/transmission with an improper level may severely damage engine/transmission. Wipe off any spillage.

To add oil, remove dipstick. Place a funnel into the dipstick tube to avoid spillage.

Add a small amount of recommended oil and recheck oil level.

Repeat the above procedures until oil level reaches the dipstick's upper mark. Do not overfill.

Properly tighten dipstick.

Engine Coolant

Recommended Coolant

Always use ethylene-glycol antifreeze containing corrosion inhibitors specifically for internal combustion aluminum engines.

Cooling system must be filled with Bombardier premixed coolant (P/N 219 700 362) or with distilled water and antifreeze solution (50% distilled water, 50% antifreeze).

Coolant Level

WARNING

Check coolant level with engine cold. Never add coolant in cooling system when engine is hot.

Remove access panel.

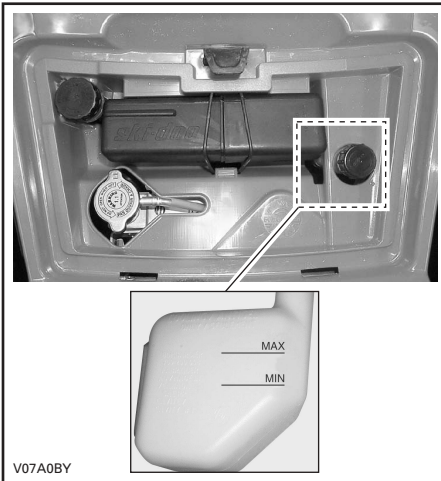

With vehicle on a level surface, liquid should be between MIN. and MAX. level marks of coolant reservoir.

NOTE: When checking level at temperature lower than 20°C (68°F), it may be slightly lower than MIN. mark.

Add coolant up to MAX. mark if required. Use a funnel to avoid spillage. Do not overfill.

Properly reinstall and tighten filler cap and reinstall access panel.

If the coolant is added in the coolant reservoir, check the level in the radiator too. Add coolant if necessary.

WARNING

In order to avoid getting burned, do not remove the radiator cap if the engine is hot.

NOTE: A cooling system that frequently requires coolant is the indication of leaks or engine problems. See an authorized Bombardier ATV dealer.

Coolant Replacement

Refer to MAINTENANCE section.

Brake Fluid

Recommended Fluid

Always use brake fluid meeting the specification DOT 4 only.

CAUTION: To avoid serious damage to the braking system, do not use fluids other than the recommended one, nor mix different fluids for topping up.

Fluid Level

With vehicle on a level surface, check brake fluid in reservoirs for proper level. They should be above MIN. mark.

Add fluid as required. Do not overfill.

Clean filler cap before removing.

CAUTION: Use only DOT 4 brake fluid from a sealed container. Do not use brake fluid taken from old or already opened containers.

NOTE: A low level may indicate leaks or worn brake pads. See an authorized Bombardier ATV dealer.

Brake Lever Fluid Reservoir

Turn steering in the straight-ahead position to ensure reservoir is level. Check the brake fluid level, the reservoir is full when the fluid reaches of the top of window.

Visually inspect lever boot condition. Check for cracks, tears, etc. Replace if damaged.

Brake Pedal Fluid Reservoir

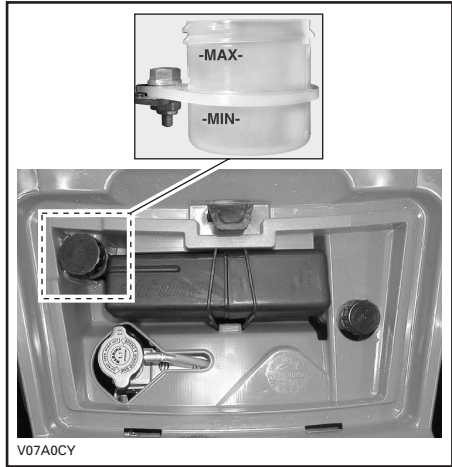

Battery

This vehicle is equipped with a dry type battery that requires no maintenance.

Refer to MAINTENANCE for removal/installation instructions.



BREAK-IN PERIOD

Engine

A break-in period of 10 operating hours is required before running the vehicle at sustained full throttle.

CAUTION: Never mix oil with fuel. This vehicle has a 4-stroke engine. Oil must be added to engine base only.

During this period, maximum throttle should not exceed 3/4. However, brief full acceleration and speed variations contribute to a good break-in. Continued wide open throttle accelerations, prolonged cruising speeds and engine overheating are detrimental during the break-in period.

Belt

A new belt requires a break-in period of 50 km (30 miles). Avoid strong acceleration/deceleration, pulling a load or high speed cruising.

10-Hour Inspection

NOTE: The 10-hour inspection is at the expense of the vehicle owner

As with any precision piece of mechanical equipment, we suggest that after the first 10 hours, 300 km (185 m) or 30 days after the purchase, whichever comes first, your vehicle be inspected by an authorized Bombardier ATV dealer. This inspection will give you the opportunity to discuss the unanswered questions you may have encountered during the first hours of operation.

While reading this Operator's Guide, remember that:

WARNING

Indicates a potential hazard that, if not avoided, could result in serious injury or death.

OPERATING INSTRUCTIONS

General

The transmission lever must be on PARK or NEUTRAL to allow engine to start.

NOTE: For your convenience, an override mode allows the engine to be started with the transmission lever in any position. Press and hold the brake lever or the brake pedal while pressing the start button.

To start the engine, place the engine stop switch to RUN, insert the key in the ignition switch and turn to ON, then press the start button.

Pre-operation check

WARNING

The pre-operation check is very important prior to operating the vehicle. Always check the proper operation of critical controls, safety features and mechanical components before starting. If not done, severe injury or death might occur.

Before using this vehicle, the operator should always:

- Apply parking brake and check if it operates properly.
- Check tire pressure and condition.
- Check wheels and bearings for wear and damage.
- Check location of controls and ensure they work properly.
- Verify if steering operates freely.
- Activate throttle control lever several times to ensure it operates freely. It must return to idle position when released.
- Activate the brake lever and brake pedal to make sure the brakes fully apply. Lever and pedal must fully return when released.
- Ensure transmission lever is working then reset in PARK position.
- Check fuel, oil and coolant levels.
- Check for oil leaks on the engine/transmission and drive train components.
- Ensure fuel valve is in fully open position (ON).
- Clean headlamps, and taillight.
- Ensure front access compartment cover and rear storage compartment cover are properly latched.

- Ensure that the operator's and either the passenger's seat or the storage box are in place and properly latched.
- If you transport cargo, respect load capacity. Ensure cargo is properly secured to the racks.
- If you are pulling a trailer or other equipment, ensure it respects the tongue capacity and towing capacity. Ensure trailer is properly secured to hitch.
- Look and feel for loose parts while engine is off. Check fasteners.
- Ensure the path of travel is free of persons and obstacles.
- Check operation of ignition switch, start button, engine stop switch, taillight and indicator lights.
- Check passenger's seat and backrest condition.
- Check the grab handles condition.
- Educate the passenger concerning the basic rules for a safe ride.
- Make sure that the passenger, if carrying one, is seated on the designated passenger's seat.
- When storage box is installed (in place of rear seat), check if it is latched properly.
- Start engine and drive forward slowly a few feet and apply all brakes individually to test them.
- Check operation of 2WD/4WD selector

Correct any problem you may have found before riding. See an authorized Bombardier ATV dealer as necessary.

Initial Cold Starting

Insert key in ignition switch and turn to ON.

Place the engine stop switch to RUN.

In cold weather, under 0°C (32°F), place the choke lever in full position.



TYPICAL

1. Full choke position

Press the start button and hold until the engine starts.

CAUTION: Do not hold the start button more than 30 seconds. A rest period should be observed between the cranking cycles to let the starter cool down. Pay attention not to discharge the battery.

NOTE: The throttle can be used to help starting the engine faster. Press the throttle lever slightly; if it is pressed too much, the choke system will not be activated.

Release the start button immediately when the engine has started.

After a few seconds, move the choke lever from full choke position to an intermediate position until the best engine RPM is achieved.

NOTE: Over using the choke may flood the engine and make it hard to start. Refer to SPECIAL PROCEDURES if it occurs.

When the engine is warm, push the choke lever to OFF, and release brakes.

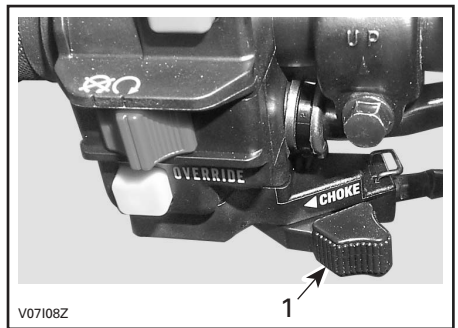

TYPICAL

1. OFF position

Warm Engine Starting

Start the engine as explained above but without the choke. If the engine does not start after two 5-second attempts with the electric starter, pull the choke lever and place it between the ON and the OFF position. Start the engine without activating the throttle lever. After a few seconds, push the choke lever to OFF.

Emergency Manual Starting

WARNING

Always place transmission lever on PARK or NEUTRAL before starting engine manually.

Manual start is provided in the event electric start does not work.

Follow the starting procedures above but instead use the rewind starter to start.

Hold manual starter handle firmly and, slowly, crank the engine until a resistance is felt.

Pass this resistance and release the handle.

Again take the handle firmly and crank engine.

Repeat this procedure completely if necessary.

Stopping the Engine

WARNING

Avoid parking on slope.

Release throttle and completely stop the vehicle.

Apply the parking brake by using brake lever lock on brake lever.

Set transmission lever in PARK position.

Push the engine stop switch in OFF position.

Turn key in ignition switch to OFF.

Remove key from ignition switch.

Shifting the Transmission

Let engine idle to warm up.

Apply brakes and select the desired gear range H or L.

NOTE: The brake must be applied when the transmission lever is engaged in the park position.

Release brakes.

CAUTION: Make sure parking brake is fully disengaged before operating the ATV.

Gradually press the throttle lever to increase engine speed and thus engaging the continuously variable transmission (CVT).

At the opposite, when the throttle lever is released, the engine speed decreases.

Using the Reverse

CAUTION: When changing from forward to reverse, or vice-versa, always completely stop the vehicle and apply the brake prior to moving the transmission lever.

The same procedures as SHIFTING THE TRANSMISSION above apply except for the following.

Set the transmission lever in REVERSE position.

2WD/4WD Selector

The 4WD mode may be selected or deselected when the vehicle is stopped.

CAUTION: The vehicle must be stopped to engage or disengage 2WD/4WD selector. Mechanical damage may occur if selector is engaged or disengaged while driving.

CAUTION: If the rear wheels are spinning, release the throttle and wait engine return to the idle before selecting the 4WD mode.

The 4WD mode is engaged when the selector is pushed downwards.

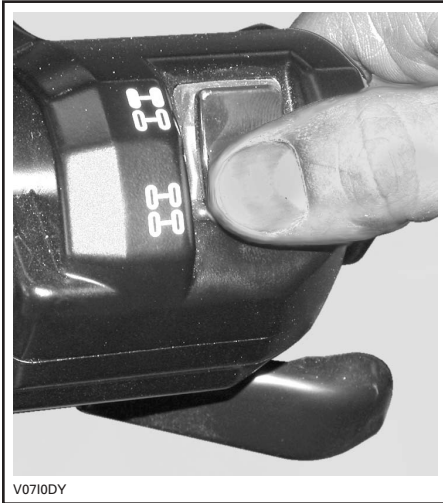

V0710DY

4WD MODE

To deselect the 4WD mode, press the selector on 2WD.



V0710EY

2WD MODE

When the selector is located on the 2WD, the vehicle is in 2 wheel drive at all time.

Winch Operation

XT Models

See the ATV Winch Operator's Manual. This manual should be kept in the tool box and remain in the vehicle at all times.

SPECIAL PROCEDURES

Flooded Engine

When the engine does not start after several attempts, the engine may be fuel flooded. Proceed as follows.

Turn ignition switch to ON and ensure choke is not applied.

Ensure the transmission lever is on PARK.

Fully press throttle lever and hold while starting the engine.

As soon as the engine starts, release throttle lever. Do not race engine.

If it does not work:

Clean the spark plug cap area then remove it. Remove the spark plug (tools are supplied in tool box).

WARNING

Always wear eye protector and gloves when cleaning the spark plug hole.

Crank engine several times. Add a small quantity of engine oil in cylinder (equivalent to a cap of oil quart). Install new spark plug if possible or clean and dry spark plug.

Start engine as explained above. If engine continues to flood, see an authorized Bombardier ATV dealer.

Engine Overheat

If engine overheats and indicator light turns on, try the following:

Check and clean radiator fins. See MAINTENANCE section.

WARNING

The radiator can be very hot, wear gloves before touching radiator.

Reduce vehicle speed but try to keep vehicle moving to supply air to radiator. If engine is still overheating after approximately one minute, stop vehicle and set transmission to PARK. Stop engine.

Place the ignition switch to ON position (**DO NOT RESTART ENGINE YET**). The radiator fan will cool the radiator.

Let engine cool down. Check coolant level and refill if possible.

WARNING

Never refill cooling system when engine is hot.

See an authorized Bombardier ATV dealer as soon as possible.

Post-Operation Care

When vehicle is used in salt-water environment (beach area, launching/loading boats etc.), rinsing the vehicle with fresh water is necessary to preserve vehicle and its components. Metallic parts lubrication is highly recommended. Use BOMBARDIER LUBE (P/N 293 600 016). This must be performed at the end of each operating day.

When vehicle is operated in muddy conditions, rinsing the vehicle is recommended to preserve vehicle and its components and to keep lights clean.

NOTE: Never use a high pressure washer to clean the vehicle. **USE LOW PRESSURE ONLY** (like a garden hose). High pressure can cause electrical or mechanical damages.

Turn Over

When vehicle is turned over or stays tilted on the side, replace the vehicle in its normal operating position (on all four wheels) and wait 3 to 5 minutes before starting engine.

Before starting engine, check engine oil level and refill if necessary. If the oil pressure light stays ON after starting engine, stop engine and see an authorized Bombardier ATV dealer as soon as possible.

ATV Immersion

Should the ATV become immersed, it will be necessary to take it to an authorized Bombardier ATV dealer as soon as possible. **DO NOT START THE ENGINE!** Immersion of the ATV can cause serious damage if the correct re-start procedure is not followed.

Storage and Preseason Preparation

WARNING

Have an authorized Bombardier ATV dealer inspect fuel system integrity as specified in MAINTENANCE CHART.

When a vehicle is not in use for more than one month, proper storage is a necessity.

See an authorized Bombardier ATV dealer for proper procedures.

When using your ATV after storage, a preparation is required. See an authorized Bombardier ATV dealer for proper procedures.

CARGO AND TRANSPORTATION

While reading this Operator's Guide, remember that:

WARNING

Indicates a potential hazard that, if not avoided, could result in serious injury or death.

Cargo

WARNING

The vehicle handling, stability and braking distance are affected when loading racks and using the vehicle. Correct loading and weight distribution are therefore important. Never overload, tow or carry cargo improperly. Always ensure the cargo is safely secured and properly distributed on the rack(s) before operating the vehicle. Safely reduce speed according to terrain conditions when carrying cargo or pulling a trailer. Allow greater distance for braking. Always secure cargo as low as possible on the rack(s) to reduce the effect of a higher center of gravity. Failure to follow the recommendations here could cause changes in vehicle handling which could lead to an accident resulting in severe injuries including the possibility of death.

When cargoing vehicle, respect these maximum loads.

MAXIMUM LOADS		
Total load allowed	235 kg (517 lb)	Includes driver, all other loads and added accessories.
Front load	45 kg (100 lb)	Evenly distributed.
Rear load	90 kg (200 lb)	Evenly distributed. Includes rear rack, rear storage box and tongue load.

Transportation

When transporting a vehicle, secure vehicle to trailer or in pickup box with suitable tie-downs. Using ordinary ropes is not recommended.



Place the fuel valve to OFF position.

Select the PARK position and set the parking brake.

Secure the vehicle by the front bumper and rear bumper.

CAUTION: Attaching vehicle at other locations may damage the vehicle.

Unload racks before transporting the vehicle.

Front Location

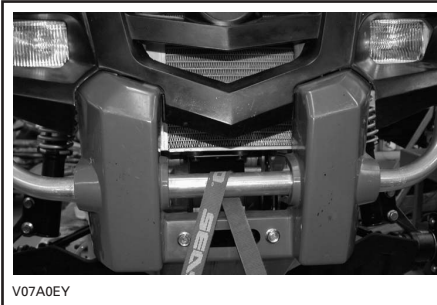

Rear Location



TYPICAL



TROUBLESHOOTING

Engine does not turn

1. Ignition switch is in the OFF position.
 - *Place switch to the ON position.*
2. Transmission is not set on PARK or NEUTRAL.
 - *Set transmission either in PARK or in NEUTRAL or press the brake lever.*
3. Burnt fuse.
 - *Check main fuse condition.*
4. Weak battery or loose connections.
 - *Check charging system fuse.*
 - *Check connections and terminals condition.*
 - *Have the battery checked.*
 - *Contact an authorized Bombardier ATV dealer*

Engine turns over but fails to start

1. Engine stop switch.
 - *Make sure that engine stop switch is in ON position.*
2. Mixture not rich enough to start cold engine.
 - *Check fuel tank level and check starting procedure, particularly use of the choke.*
3. Flooded engine (spark plugs wet when removed).
 - *Refer to SPECIAL PROCEDURES.*
4. No fuel to the engine (spark plugs dry when removed).
 - *Check fuel tank level; turn fuel valve to ON (also try on RES). A failure of the fuel pump or carburetor may have occurred.*
 - *Contact an authorized Bombardier ATV dealer.*
5. Spark plug/ignition (no spark).
 - *Check main fuse condition.*
 - *Remove spark plug then reconnect to ignition coil.*
 - *Check that ignition switch and/or engine stop switch is/are at the ON position.*
 - *Start engine with spark plug grounded to the engine away from spark plug hole. If no spark appears, replace spark plug.*
 - *If trouble persists, contact an authorized Bombardier ATV dealer.*
6. Engine compression.
 - *As the engine is pulled over with the rewind starter, “cycles” of resistance should be felt as piston goes past top dead center. If no pulsating resistance is felt, it suggests a major loss of compression.*
 - *Contact an authorized Bombardier ATV dealer.*

Engine lacks acceleration or power

1. Fouled or damaged spark plug.
 - *Check item ENGINE TURNS OVER BUT FAILS TO START.*
2. Lack of fuel to engine.
 - *Check item ENGINE TURNS OVER BUT FAILS TO START.*
3. Carburetor adjustments.
 - *Contact an authorized Bombardier ATV dealer.*
4. Engine is overheating.
 - *Check ENGINE OVERHEATING in SPECIAL PROCEDURES.*
 - *If overheating persists, contact an authorized Bombardier ATV dealer.*
5. Air filter/box plugged or dirty.
 - *Check air filter and clean if necessary.*
 - *Check deposits in air box drain.*
 - *Check the position of the air intake tube.*
6. CVT dirty or wear.
 - *Contact an authorized Bombardier ATV dealer.*

Engine backfire

1. Exhaust system leakage.
 - *Contact an authorized Bombardier ATV dealer.*
2. Engine is running too hot.
 - *See ENGINE LACKS ACCELERATION OR POWER.*
3. Ignition timing is incorrect or there is an ignition system failure.
 - *Contact an authorized Bombardier ATV dealer.*
4. Improper carburetor setting.
 - *Contact an authorized Bombardier ATV dealer.*

Engine misfire

1. Fouled/damaged/worn spark plug.
 - *Clean/verify spark plug and heat range. Replace as required.*
2. Water in fuel.
 - *Drain fuel system and refill with fresh fuel.*

Vehicle cannot reach full speed

1. Engine.
 - See *ENGINE LACKS ACCELERATION OR POWER.*
2. Parking brake.
 - *Ensure brake lever lock is completely removed.*
3. Air filter/box plugged or dirty.
 - *Check air filter and clean if necessary.*
 - *Check deposits in air box drain.*
 - *Check the position of the air intake tube.*
4. CVT dirty or wear.
 - *Contact an authorized Bombardier ATV dealer.*

Transmission lever is hard to move

1. Transmission gears are in a position that prevents the transmission lever to work.
 - *Rock the vehicle back and forth to move the gears in the transmission and allow the transmission lever to be set.*
2. Engine idle speed is set too high.
 - *Adjust the idle speed. Refer to SPECIFICATIONS.*
3. CVT dirty or wear.
 - *Contact an authorized Bombardier ATV dealer.*

The RPM increases but the vehicle does not move

1. The transmission is on PARK or NEUTRAL position.
 - *Select the Reverse, HI or LO position.*
2. CVT dirty or worn-out.
 - *Contact an authorized Bombardier ATV dealer.*
3. Water in the CVT housing.
 - *Contact an authorized Bombardier ATV dealer.*

SPECIFICATIONS

VEHICLE MODEL		OUTLANDER™ 400 H.O.	
		MAX	MAX XT
ENGINE			
Type		BOMBARDIER-ROTAX® 4-TEC, 4-stroke. Over Head Camshaft (OHC)	
Number of cylinder		Single cylinder	
Number of valves		4 valves with mechanical lifters (adjustable)	
Displacement		400 cc (24.4 cu. in)	
Bore	Standard	91 mm (3.58 in)	
Stroke		62 mm (2.5 in)	
Compression ratio		10:1	
Lubrication		Wet sump with replaceable oil filter (lubrication of engine and transmission simultaneously)	
Decompressor		Automatic	
Exhaust system		Spark arrester approved by USDA Forest Service	
Air filter		2 stage foam filter	
TRANSMISSION			
Transmission		Continuously Variable Transmission (CVT)	
COOLING			
Type		Liquid cooled	
Radiator		Front mounted with thermostatic fan	
CARBURETION			
Carburetor	Make	Mikuni BSR33	
	Type	Constant velocity with manual choke and ECS (Enricher Coasting System)	
Choke		Variable	
Idle speed		± 50	1300 RPM
Fuel pump	Make	Mikuni	
	Type	External (vacuum-operated)	

VEHICLE MODEL		OUTLANDER™ 400 H.O.	
		MAX	MAX XT
ELECTRICAL			
Magneto generator	Make	Denso	
	Type	400 W @ 6000 RPM	
Ignition type		CDI (Capacitor Discharge Ignition)	
Ignition timing		Not adjustable	
Engine RPM limiter		8000 RPM (any gear in forward)	
Vehicle speed limiter		15 km/h (9 MPH) in reverse	
Spark plug	Make	NGK	
	Type	DCPR8E	
	Gap	0.6 to 0.7 mm (0.024 to 0.027 in)	
Number of spark plug		1	
Battery	Type	Dry type battery	
	Volt	12 V, 18 Ah	
Starting system		Electric start and manual rewind starter. Start on P, R, N, H or L position (with brake applied)	
Headlamp bulb		2 x 35 W	
Taillight bulb		8/27 W	
Pilot lamp cluster		Not available	
Fuses	Accessories	15 A (power outlet and auxiliary supply)	
	Fan	20 A	
	Main	30 A	
	Charging system	20 A	
DRIVE TRAIN			
Front differential		Shaft driven/single auto-lock differential (shear pump)	
Rear axle		Shaft driven	
Turning radius		2 m (79 in)	

VEHICLE MODEL			OUTLANDER™ 400 H.O.	
			MAX	MAX XT
SUSPENSION				
Front	Type	Independent suspension — McPherson type		
	Travel	178 mm (7 in)		
Rear	Type	TTI independent™		
	Travel	203 mm (8 in)		
TIRES				
Make		Othsu	Carlisle ACT	
Type		Bias	Radial	
Pressure	Up to 235 kg (517 lb)	Front	34 kPa (5 PSI) maximum, 31 kPa (4.5 PSI) minimum	
		Rear	34 kPa (5 PSI) maximum, 31 kPa (4.5 PSI) minimum	
Size	Front	25 x 8 - 12		
	Rear	25 x 10 - 12	25 x 11 - 12	
WHEELS				
Size	Front	12 x 6		
	Rear	12 x 7.5		
Wheel nut torque		70 N·m (52 lbf-ft)		
BRAKES				
Front		Hydraulic, 2 discs		
Rear		Hydraulic, 1 disc		
Parking		Park through transmission. LH brake lever includes a lock		
LOADING CAPACITY				
Front racks		45 kg (100 lb)		
Rear racks		90 kg (200 lb) includes tongue load		
Rear storage box		10 kg (22 lb)		
Total vehicle load allowed		235 kg (517 lb) includes operator and passenger, all other loads and added accessories		
GVWR (Gross Vehicle Weight Rating)		554 kg (1219 lb)		
Towing capacity		500 kg (1100 lb)		
Tongue capacity		14 kg (30 lb) included with rear racks		

VEHICLE MODEL		OUTLANDER™ 400 H.O.	
		MAX	MAX XT
DIMENSIONS			
Dry mass		298 kg (657 lb)	
Overall length		2.39 m (94 in)	
Overall width		1.17 m (46 in)	
Overall height		1.14 m (45 in)	
Seat height		877 mm (35 in)	
Wheel base		1.45 m (57 in)	
Wheel track	Front	965 mm (38 in)	
	Rear	914 mm (36 in)	
Ground clearance		236 mm (9.3 in)	
Weight distribution (front/rear)		46/54%	
LIQUIDS and GREASES			
Engine oil type (engine and transmission)		SAE 5W30, 4-stroke mineral-based. API classification SG, SH or SJ or Bombardier synthetic oil 5W40. Refer to OIL VISCOSITY CHART for other grade	
Coolant		Ethylene-glycol/water mix (50% coolant, 50% distilled water). Use Bombardier premixed coolant or a coolant specifically designed for aluminum engines	
Fuel	Type	Regular unleaded gasoline	
	Octane	87 (R + M)/2 or higher	
Differential	Front	Bombardier differential oil 5W40 or Synthetic polyester oil 75W90 (API GL-5)	
	Rear		
Brake		Brake fluid, DOT 4	
Propeller shaft joint grease		Suspension synthetic grease (P/N 293 550 033)	

VEHICLE MODEL		OUTLANDER™ 400 H.O.	
		MAX	MAX XT
CAPACITIES			
Fuel tank		16 L (4.2 U.S. gal) including an approximate reserve of 2 L (0.5 U.S. gal)	
Engine/transmission oil		Oil change with filter: 3 L (3.17 U.S. quarts).	
Coolant		2.2 L (2.32 U.S. quarts)	
Differential	Front	500 ml (17 U.S. oz)	
	Rear	300 ml (10 U.S. oz)	
Brake fluid		250 ml (8.5 U.S. oz)	

A Ampere

RPM revolution per minute

V volt

Ah Ampere hour

USDA United States Department of Agriculture

W watt

Because of our ongoing commitment to product quality and innovation, BRP reserves the right, at any time, to make changes in design and specifications and/or to make additions to, or improvements in its products without imposing any obligation upon itself to install them on its products previously manufactured.

MAINTENANCE INFORMATION

MAINTENANCE CHART

The maintenance is very important; if you are not familiar with safe service practices and adjustment procedures, see your authorized Bombardier ATV dealer.

PERIODIC MAINTENANCE CHART							
A: ADJUST C: CLEAN I: INSPECT L: LUBRICATE R: REPLACE T: PROCEED WITH TASK	INITIAL INSPECTION 10 H OR 30 DAYS OR 300 KM (185 mi)						
	(To be performed by an authorized Bombardier BRP ATV dealer. The initial maintenance is very important and must not be neglected.)						
	25 H OR 750 KM (470 mi)						
	50 H OR 1500 KM (930 mi)						
	100 H OR 1 YEAR OR 3000 KM (1865 mi)						
200 H OR 2 YEARS OR 6000 KM (3730 mi)							
TO BE PERFORMED BY							
PART/TASK						LEGEND	
ENGINE/TRANSMISSION							
Engine/transmission oil level ②	EVERY RIDE				CUSTOMER	(2) Pre-ride inspection item. (3) Every 100 hours, check coolant. (4) More often under severe use such dusty area, sand, snow, wet or muddy conditions.	
Engine/transmission oil and filter	R		R		CUSTOMER		
Engine/transmission oil strainer				C	DEALER		
Valve adjustment	I, T			I, T	DEALER		
Engine mounting fasteners	I			I	DEALER		
Exhaust system	I			I	DEALER		
Spark arrester				C	CUSTOMER		
Condition of seals	I			I	DEALER		
Coolant ②	I			T, ③	R		CUSTOMER
Cooling system pressure test	T				T		DEALER
Radiator condition/cleanliness (radiator fins) ④	I		I				CUSTOMER
Drive belt				I			DEALER
Drive and driven pulleys condition/cleanliness				C			DEALER
CVT air inlet/outlet duct condition/cleanliness	I		I				DEALER
Rewind starter rope condition				I			DEALER
FUEL							
Air filter ②		C ④		R ④		CUSTOMER	
Fuel lines and connections	I			I		DEALER	
Fuel tank strainers					R	DEALER	
Carburetor	A			A		DEALER	
Carburetor valve piston				I		DEALER	

PERIODIC MAINTENANCE CHART

A: ADJUST C: CLEAN I: INSPECT L: LUBRICATE R: REPLACE T: PROCEED WITH TASK	INITIAL INSPECTION 10 H OR 30 DAYS OR 300 KM (185 mi) (To be performed by an authorized Bombardier BRP ATV dealer. The initial maintenance is very important and must not be neglected.)						
	25 H OR 750 KM (470 mi)						
	50 H OR 1500 KM (930 mi)						
	100 H OR 1 YEAR OR 3000 KM (1865 mi)						
	200 H OR 2 YEARS OR 6000 KM (3730 mi)						
	TO BE PERFORMED BY						
PART/TASK						LEGEND	
ELECTRICAL							
Spark plug ⑤	T			R		CUSTOMER	(2) Pre-ride inspection item. (5) Make sure the spark plug is correctly gapped.
Battery connections	I		I			CUSTOMER	
Wiring harnesses, cables and lines	I			I		DEALER	
Condition of ignition switch, start button and engine stop switch ②	I			I		CUSTOMER	
Condition of lighting system (Hi/Lo intensity, brake lamp, headlamp aiming, etc.) ②	I			I		CUSTOMER	
Winch	Refer to ATV Winch Operator's Manual					CUSTOMER	
DRIVE TRAIN							
Drive shaft boots and protector's ②	I	I				CUSTOMER	(2) Pre-ride inspection item. (4) More often under severe use such dusty area, sand, snow, wet or muddy conditions.
Drive shaft joints			I			DEALER	
Rear propeller shaft joint	I		L ④			DEALER	
Wheel bearing condition				I		CUSTOMER	
Front/rear differentials (oil level, seals and vents)	I		I		R	DEALER	
STEERING							
Handlebar fasteners				I		DEALER	(2) Pre-ride inspection item. (4) More often under severe use such dusty area, sand, snow, wet or muddy conditions.
Throttle/housing/cable condition ②	I		I			CUSTOMER	
Choke condition ②	I		I			CUSTOMER	
Steering system (column, bearing, etc.)	I			I ④		DEALER	
Tie rod ends			I			DEALER	
Wheel nuts/studs	I		I			CUSTOMER	
Tires pressure and wear ②	EVERY RIDE					CUSTOMER	
Front wheels alignment	I			I		DEALER	

PERIODIC MAINTENANCE CHART

INITIAL INSPECTION 10 H OR 30 DAYS OR 300 KM (185 mi)
(To be performed by an authorized Bombardier BRP ATV dealer. The initial maintenance is very important and must not be neglected.)

A: ADJUST
C: CLEAN
I: INSPECT
L: LUBRICATE
R: REPLACE
T: PROCEED WITH TASK

25 H OR 750 KM (470 mi)

50 H OR 1500 KM (930 mi)

100 H OR 1 YEAR OR 3000 KM (1865 mi)

200 H OR 2 YEARS OR 6000 KM (3730 mi)

TO BE PERFORMED
BY

PART/TASK

LEGEND

SUSPENSION

Trailing arms	I			I		DEALER	
McPherson struts	I		I			DEALER	
Rear shock absorbers	I		I			DEALER	
A-arms	I		I			CUSTOMER	
Ball joint	I	I				DEALER	

BRAKE

Brake fluid (front and rear) ②	I	I			R ⑥	CUSTOMER	(2) Pre-ride inspection item. (4) More often under severe use such dusty area, sand, snow, wet or muddy conditions. (6) Brake fluid replacement or any brake system repairs must be performed by an authorized BRP ATV dealer.
Brake pads		I ④				CUSTOMER	
Brake system (discs, hoses etc.)					I	CUSTOMER	

BODY/FRAME

Engine compartment	C		C			CUSTOMER	(4) More often under severe use such dusty area, sand, snow, wet or muddy conditions.
Frame				I		DEALER	
Hitch/trailer ball condition (if installed)	EVERY RIDE					CUSTOMER	
Chassis fasteners			I			CUSTOMER	
Grab handles	EVERY RIDE					CUSTOMER	
Passenger's seat or storage box and its fasteners	EVERY RIDE					CUSTOMER	
Operator's seat and its fasteners	EVERY RIDE					CUSTOMER	
Vehicle cleaning and protection			C ④			CUSTOMER	

GENERAL

While reading this Operator's Guide, remember that:

WARNING

Indicates a potential hazard that, if not avoided, could result in serious injury or death.

WARNING

Unless otherwise specified, engine should not be running for all maintenance procedures. Before performing any service or inspection operation on the vehicle, wait until the engine and exhaust have cooled down to avoid potential burns.

WARNING

Should removal of a locking device (e.g. lock tabs, self-locking fasteners, etc.) be required when undergoing disassembly/assembly, always replace with a new one.

The following covers the maintenance items that can be performed by the customer if desired. Other items found in maintenance chart must be performed by an authorized Bombardier ATV dealer.

NOTE: Among other things, this section gives the procedures to replace the liquids. Refer to LIQUIDS for procedures to check levels and refill.

ENGINE/TRANSMISSION

Oil Change and Oil Filter Replacement

Oil and filter are to be replaced at the same time. Oil change should be done with a warm engine.

WARNING

The engine oil can be very hot. In order to avoid getting burned, do not remove the engine drain plug or the filter cover if the engine is hot. Wait until engine oil is warm.

Ensure vehicle is on a level surface.

Remove dipstick.

Clean the oil drain plug area.

Place a drain pan under the oil drain plug area.

Unscrew oil drain plug.

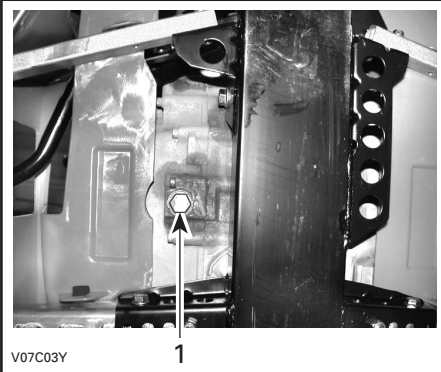

TYPICAL

1. Oil drain plug

Allow enough time for oil to flow out of oil filter.

Remove the right engine cover.

Unscrew the oil filter cover.

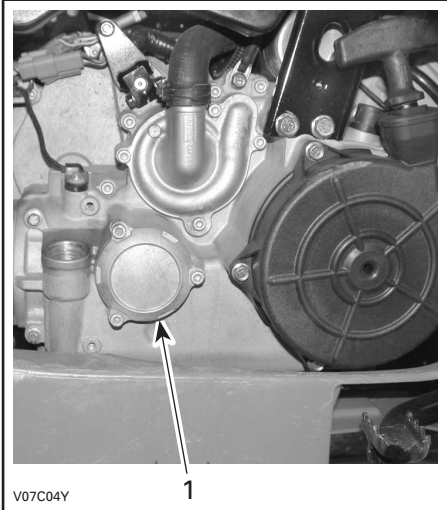

TYPICAL

1. Oil filter cover

Remove the oil filter and replace with a new filter.

NOTE: Check the cover O-ring and change it if necessary.

Wipe out any oil spillage on engine.

Change gasket on oil drain plug. Clean gasket area on engine and oil drain plug then re-install plug. Refill engine at the proper level with the recommended oil. Refer to SPECIFICATIONS for capacity.

Start engine and let idle for a few minutes. Ensure oil filter area and oil drain plug areas are not leaking.

Stop engine. Wait a while to allow oil to flow down to crankcase then check oil level. Refill as necessary.

Dispose of oil as per your local environmental regulations.

Oil Strainer Cleaning

The oil strainer must be cleaned every 200 hours or every 2 years or every 6000 km (3730 m).

Contact an authorized Bombardier ATV dealer.

Coolant Replacement

WARNING

In order to avoid potential burns, do not remove the radiator cap or loosen the coolant drain plug if the engine is hot.

Open the access panel and remove the radiator cap.

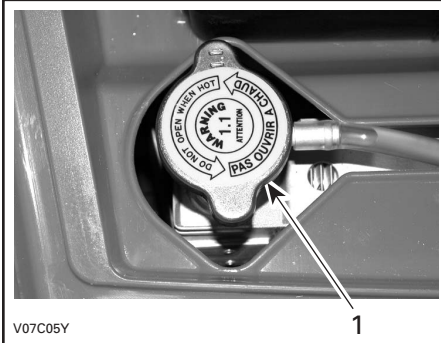

1. Radiator cap

On the right side of vehicle, remove the engine cover.

Unscrew the coolant drain plug and drain the coolant into a suitable container.

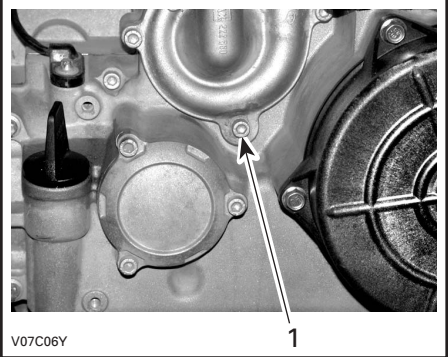

1. Coolant drain plug

NOTE: Do not unscrew the coolant drain plug completely.

Disconnect the engine temperature sensor connectors, then unscrew the bleeding screw on the top of thermostat housing.

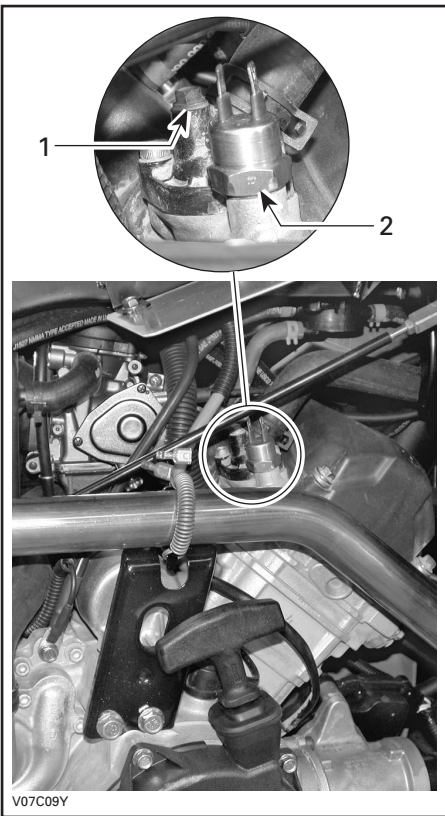

1. Bleeding screw
2. Engine temperature sensor

Drain the system completely and reinstall the coolant drain plug.

Pinch hose between radiator and thermostat housing with a large hose pincher (P/N 529 032 500) or an equivalent.

CAUTION: Do not use vise-grip pliers to pinch hose.

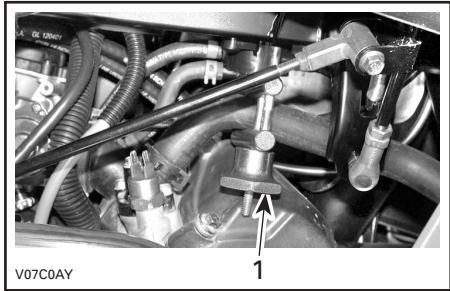

1. Hose pincher

Fill the radiator until the coolant comes out by the thermostat housing hole. Install the bleeding screw then remove the hose pincher.

Complete the radiator filling.

Check the level in the coolant reservoir and refill if necessary.

Run engine at idle with the radiator cap off. Slowly add coolant if necessary.

At this point, wait until engine reaches normal operating temperature. Depress the throttle lever two or three times; then add coolant if required.

Install radiator cap. Inspect all connections for leaks and check coolant level in the reservoir.

Drive Belt

See an authorized Bombardier ATV dealer to check the width and the condition of drive belt.

Valve Adjustment

See an authorized Bombardier ATV dealer for valves adjustment.

Insufficient clearance will cause loss of power and possibly damage the valves. Excessive clearance will cause noise.

Spark Arrester

The muffler must be periodically purged of accumulated carbon.

WARNING

Never run engine in an enclosed area. Never perform this operation immediately after the engine has been run because exhaust system is very hot. Make sure that there are no combustible materials in the area. Wear eye protection and gloves. Never stand behind the vehicle while purging exhaust system. Respect all applicable laws and regulations.

Select a well-ventilated area and make sure the muffler is cool.

Place transmission on PARK position.

Remove the clean-out plug of the muffler.

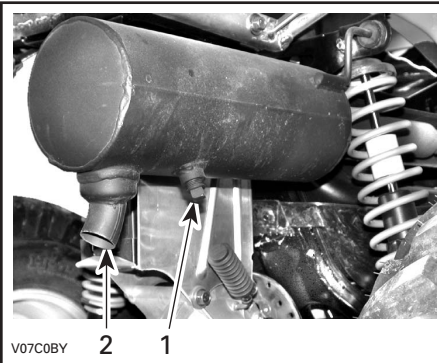

1. Clean-out plug
2. Muffler

Block the end of the muffler with a shop rag and start engine.

Momentarily increase engine RPM several times to purge accumulated carbon out of the muffler.

Stop engine and allow muffler to cool.

Reinstall the clean-out plug.

Radiator

Periodically check the radiator area for cleanliness.

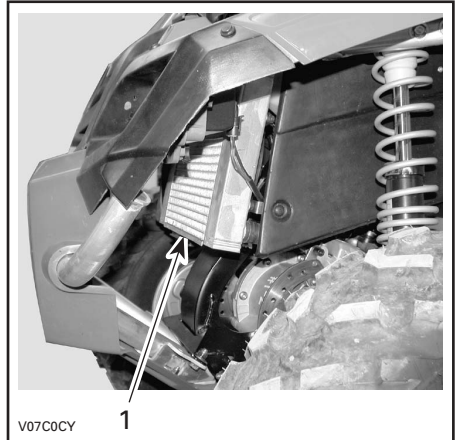

TYPICAL

1. Radiator

Inspect radiator fins. They must be clean, free of mud, dirt, leaves and any other deposit that would prevent the radiator to cool properly.

Remove as much deposits as you can with your hands. If water is available in proximity, try rinsing the radiator fins.

If available, use a garden hose to rinse the radiator fins.

WARNING

Never clean radiator with your hands when it is hot. Let the radiator cool down before cleaning.

CAUTION: Be careful not to damage the radiator fins when cleaning. Do not use any object/tool that could damage the fins. The fins are purposely thin parts to allow efficient cooling. WHEN HOSING, USE LOW PRESSURE ONLY, NEVER USE A HIGH PRESSURE WASHER.

See an authorized Bombardier ATV dealer to check the performance of the cooling system.

CARBURETOR

See an authorized Bombardier ATV dealer each year to verify and clean the fuel system.

AIR INTAKE SYSTEM

Air Filter box Draining

Periodically inspect air filter box drain tube for liquids water or deposits.

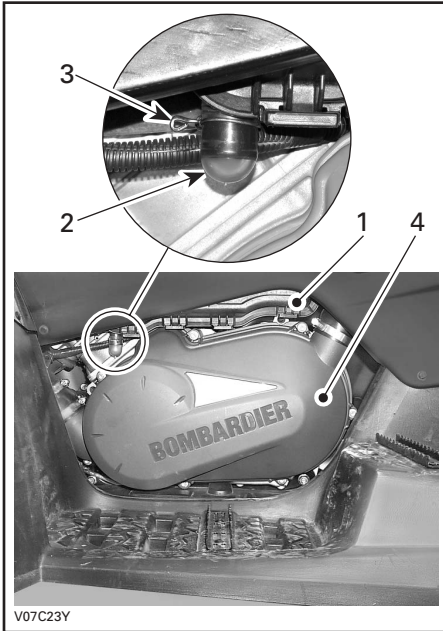

TYPICAL

1. Air filter box
2. Drain tube
3. Clamp
4. CVT cover

NOTE: If vehicle is used in dusty area, inspect more frequently than specified in MAINTENANCE CHART.

If liquids/deposits are found, squeeze and remove the clamp. Pull drain tube out and empty it.

CAUTION: Do not start engine when liquids/deposits are found in the drain tube.

When liquids/deposits are found, the air filter must be inspected, dried or replaced depending on its condition.

Remove air filter as explained below.

Air Filter Removal

CAUTION: Never remove or modify any component in the air box. Otherwise, engine performance degradation or damage can occur. The engine carburetion is calibrated to operate specifically with these components.

Remove seat.

Release clamps and remove air filter box cover.

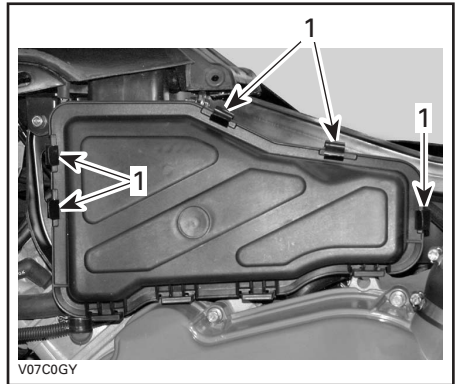

1. Release clamps

Loosen clamp and remove air filter.

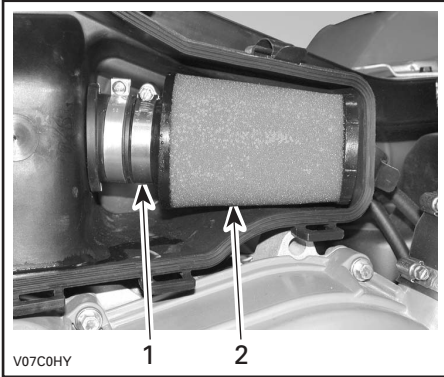

1. *Clamp*
2. *Air filter*

Air Filter cleaning

Pour cleaning solution (P/N 219 700 341) or an equivalent into a bucket. Put the filter in to soak.

While filter soaks, clean inside the air box.

Rinse the filter with warm water until all cleaning solution disappears.

Then, let the filter dry completely.

When the filter is dried, re-oil with air filter oil (P/N 219 700 340) or an equivalent.

Air Filter Installation

Properly reinstall removed parts in the reverse order of their removal.

ELECTRICAL

⚠ WARNING

Unless otherwise indicated, always turn ignition switch to the OFF position before performing any maintenance or repair on electrical system.

Spark Plug

Removal

Unplug the spark plug cable.

Unscrew the spark plug one turn.

Clean the spark plug and cylinder head with pressurized air if possible.

⚠ WARNING

Always wear safety goggles when using pressurized air.

Unscrew spark plug completely then remove it.

Installation

Prior to installation make sure that contact surfaces of cylinder head and spark plug are free of grime.

Using a feeler gauge, set the spark plug gap to 0.7 mm (0.27 in).

Apply anti-seize lubricant over spark plug threads to prevent a possible seizure.

Screw spark plug into cylinder head by hand and tighten with a torque wrench and a proper socket.

Torque spark plug to 20 N·m (15 lbf·ft).

Battery

⚠ WARNING

Never charge a battery while installed in the vehicle.

Removal

Disconnect BLACK (-) cable first then RED (+) cable.

⚠ WARNING

Always respect this order for disassembly; disconnect BLACK (-) cable first.

Remove the holding strap then pull the battery out of frame.

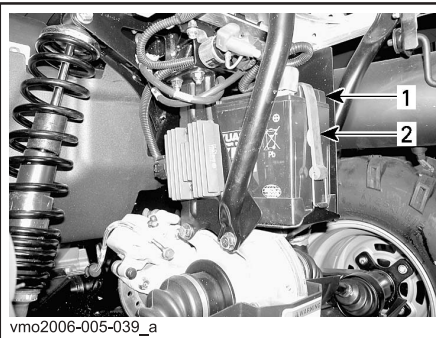

TYPICAL

1. Battery
2. Holding strap

Cleaning

Clean battery, battery casing and battery posts using a solution of baking soda and water.

Remove corrosion from battery cable terminals and battery posts using a firm wire brush. Battery casing should be cleaned by soft brush and baking soda solution.

Installation

Reinstall battery in vehicle.

WARNING

Connect RED (+) cable first then BLACK (-) cable. Always connect RED (+) cable first.

Fuses

WARNING

Always turn the ignition switch off before replacing a defective fuse.

If a fuse is damaged, replace it by one of the same rating.

CAUTION: Do not use a higher rated fuse as this can cause severe damage.

Fuses are located in the service compartment, behind tool box.

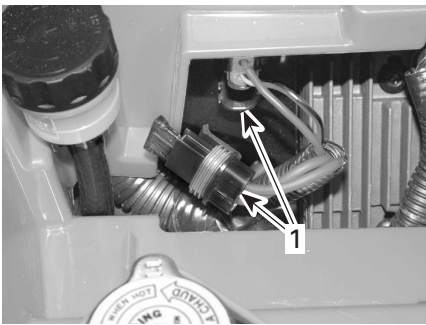

V07C01Y

TYPICAL

1. Fuse holders

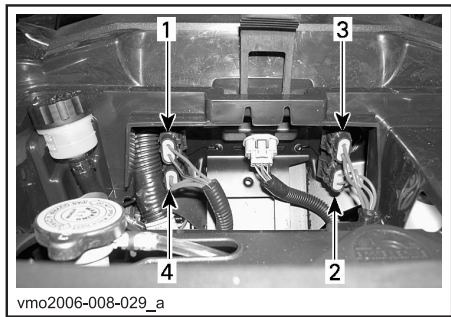

vmo2006-008-029_a

1. Accessories (15 A) (power outlet and auxiliary supply)
2. Fan (20 A)
3. Main (30 A)
4. Charging system (20 A)

To remove fuse from holder, remove the fuse holder cover then pull fuse out. Check if filament is melted.

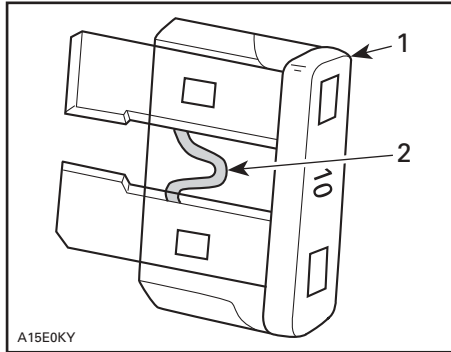

A15E0KY

TYPICAL

1. Fuse
2. Check if melted

Bulb Replacement

WARNING

Always turn the ignition switch OFF before replacing a defective bulb.

Always check light operation after replacement.

Headlamps

CAUTION: Never touch glass portion of an halogen bulb with bare fingers, it shortens its operating life. If glass is touched, clean it with isopropyl alcohol which will not leave a film on the bulb.

Remove holder screws.

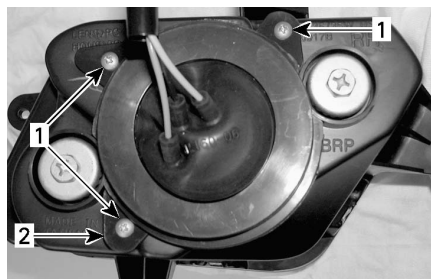

vmo2006-005-043_a

1. Screws
2. Holder

Remove rubber protector over headlamp housing.

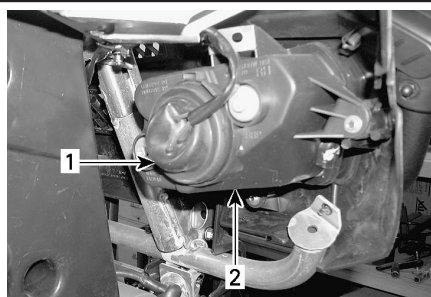

vmo2006-005-040_a

1. Rubber protector
2. Headlamp housing

Unplug connector from headlamp.

NOTE: Use small locking tab to unlock connector then pull on connector.

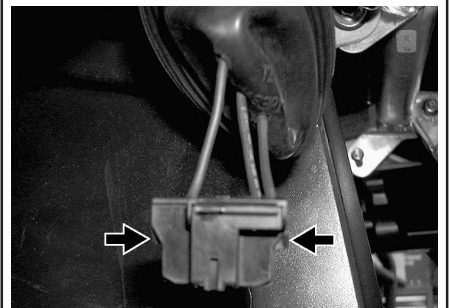

vmo2006-005-041_a

PUSH ON LOCKING TAB TO UNLOCK CONNECTOR

NOTE: Concerning the following illustrations, the front fascia has been removed from the vehicle for a better comprehension.

Press the spindle then push it on the side to unlock headlamp bulb.

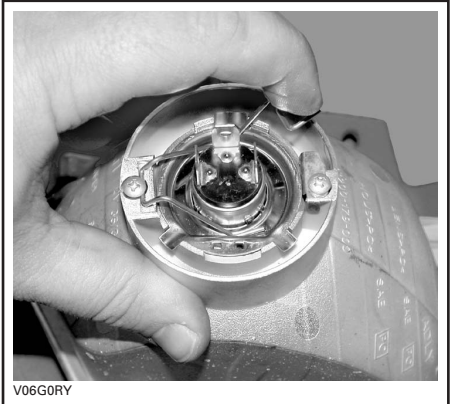

V06G0RY

TYPICAL

Lift and hold the spindle then remove the bulb.



TYPICAL

Properly reinstall removed parts in the reverse order of their removal.

Beam Aiming Adjustment

Adjust beam aiming as follows:

Turn adjustment screws to adjust beam height and side orientation to your convenience. Adjust both headlamps evenly.

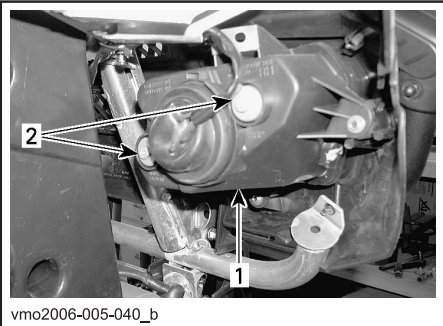

TYPICAL

1. Headlamp cover
2. Adjustment screws

Taillight

Unscrew lens screws to expose bulbs.

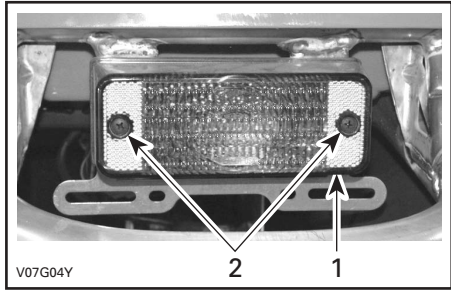

1. Lens
2. Screws

Push the bulb in and hold while turning counterclockwise to release.

Install the new bulb by first pushing in while turning clockwise.

Speedometer

The speedometer is lighted with LEDs. If one LED burnt, replace the speedometer. The LEDs are not available separately.

DRIVE TRAIN

Drive Shaft Boot/Protector

Inspection

Visually inspect drive shaft protectors and boots conditions. Check protectors for damage or rubbing against shafts. Check boots for cracks, tears, leaking grease etc. Repair or replace damaged parts as necessary.

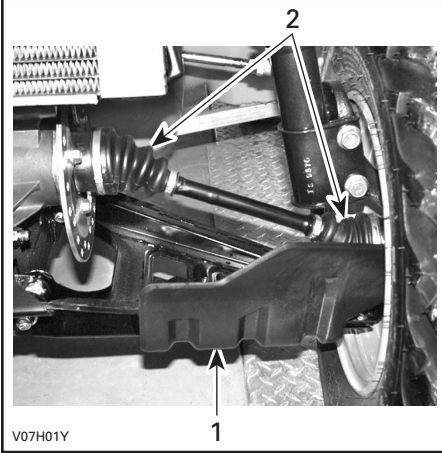

FRONT OF VEHICLE
1. Drive shaft protector
2. Drive shaft boots

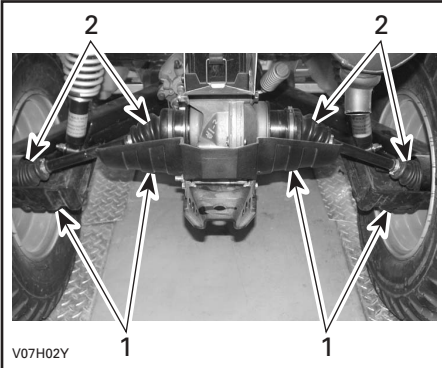

REAR OF VEHICLE
1. Drive shaft protector
2. Drive shaft boots

Wheel

Occasionally, wheel nuts should be removed to apply anti-seize lubricant on studs to ease future removal. This is particularly important when vehicle is used in salt-water environment or in mud. Remove one nut at a time, lubricate then retorque.

Wheel Bearing Condition

Push and pull the wheels from the upper edge to feel the play. See an authorized Bombardier ATV dealer if there is any play.

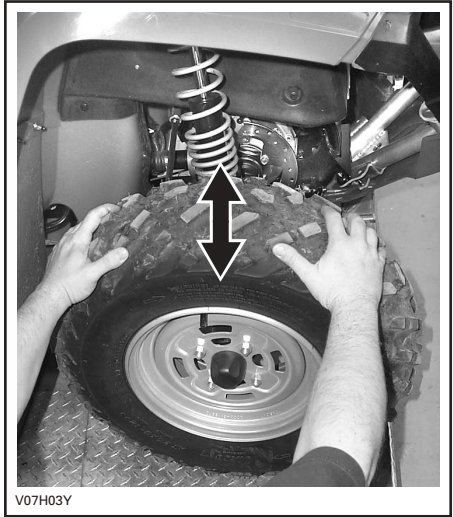

Tires/Wheels

WARNING

When the tires are replaced, never install a bias tire with a radial tire. Such a combination could create handling and/or stability problems.

Do not mix tires of different size and/or design to the same axle.

Front and rear tire pairs must be the identical model and manufacturer.

For unidirectional tread pattern, ensure that the tires are installed in the correct direction of rotation.

The radial tires must be installed as a complete set.

Severe injury or death can result if you do not follow these instructions.

Tire Pressure

WARNING

Tire pressure greatly affects vehicle handling and stability. Underpressure may cause tire to deflate and rotate on wheel. Overpressure may burst the tire. Always follow recommended pressure. Since tires are low-pressure types, a manual pump should be used.

Check pressure when tires are "cold" before using the vehicle. Tire pressure changes with temperature and altitude. Recheck pressure if one of these conditions has changed.

For your convenience, a pressure gauge is supplied in tool box.

TIRE PRESSURE			
UP to 235 kg (517 lb)	MAX.	FRONT	REAR
		34 kPa (5 PSI)	34 kPa (5 PSI)
MIN.	31 kPa (4.5 PSI) <th>31 kPa (4.5 PSI) </th>	31 kPa (4.5 PSI)	

Although the tires are specifically designed for off-road use, a flat may still occur. Therefore, it is recommended to carry a tire pump and a repair kit.

Tire/Wheel Condition

Check tire for damage and wear. Replace if necessary.

Do not rotate tires. The front and rear tires have a different size. The tires are directional and their rotation must be kept in a specific direction for proper operation.

Wheel Removal

Loosen nuts then lift vehicle. Place a support under vehicle. Remove nuts then remove wheel.

At installation, it is recommended to apply anti-seize lubricant on threads. Gently tighten nuts in a criss-cross sequence then apply a final torque of 70 N·m (52 lbf·ft).

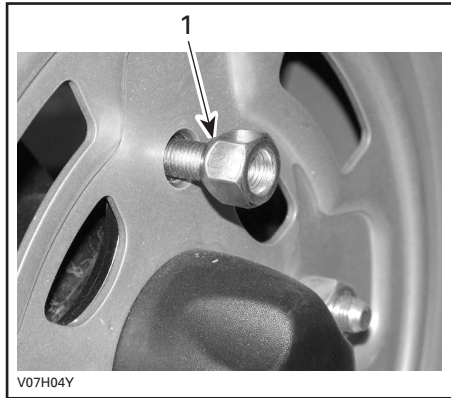

1. Taper side of nut

CAUTION: Always use the recommended wheel nuts (P/N 250 100 039). Using a different nut could cause damages to the rim.

STEERING SYSTEM

Throttle Cable Lubrication

Lubrication

The throttle cable must be lubricated with cable lubricant (P/N 293 600 041) or an equivalent.

WARNING

Always use a silicone-based lubricant. Using another lubricant (like a water-based lubricant) could cause the throttle lever/cable sticking or stiffness.

Open the throttle lever housing.

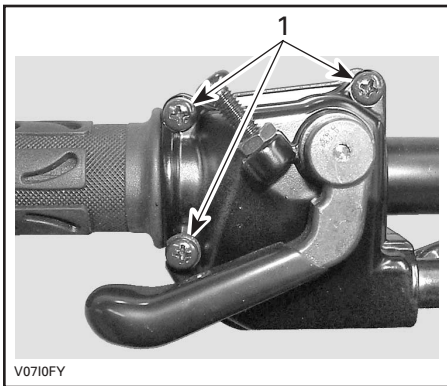

1. Remove these screws

Separate the housing. Slide rubber protector back to expose throttle cable adjuster.

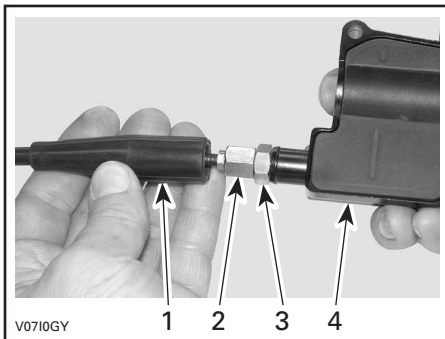

1. Cable protector
2. Throttle cable adjuster
3. Lock nut
4. Throttle lever housing

Screw in the throttle cable adjuster.

Remove:

- inner housing protector

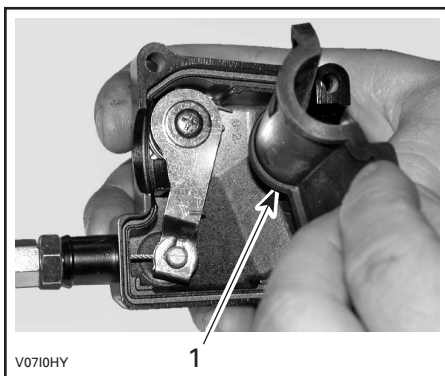

1. Inner housing protector

- the cable from the throttle lever housing.

NOTE: Slide cable in clip slot and remove the end of cable from clip.



Remove the carburetor side cover.

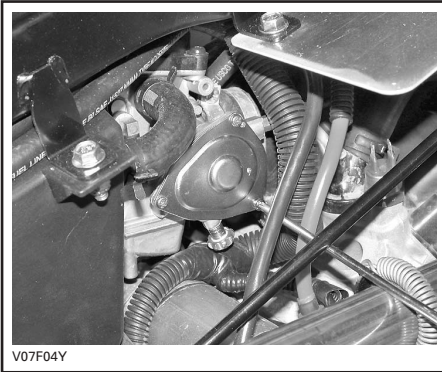

Insert the needle of lubricant can in the end of throttle cable adjuster.



NOTE: Place a rag around the throttle cable adjuster to prevent the lubricant from splashing.

Add lubricant until it runs out at carburetor end of the throttle cable.

Reinstall and adjust the cable.

Throttle Lever Adjustment

Slide rubber protector back to expose throttle cable adjuster.

Loosen lock nut then turn the adjuster to obtain correct throttle lever free play.

NOTE: Measure throttle free play at the tip of throttle lever.



WARNING

Always wear eye protection and gloves when you lubricate a cable.

Tighten lock nut and reinstall protector.

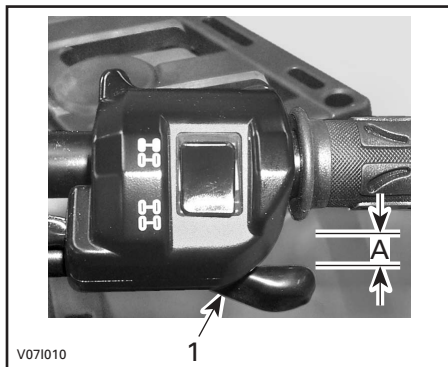

1. *Throttle lever*

A. *3 to 6 mm (1/8 to 7/32 in)*

With the transmission lever on PARK position, start the engine. Check if the throttle cable is adjusted correctly by turning handlebar fully right then fully left. If the engine RPM increases, readjust the throttle lever free play.

SUSPENSION

Lubrication

Lubricate front A-arms. Use suspension synthetic grease (P/N 293 550 033) or an equivalent. There is two grease fittings on each A-arm.

Inspection

Front Suspension

Inspect the McPherson struts for oil leaks or other damages. Check tightness of fasteners. See an authorized Bombardier ATV dealer as necessary.

Rear Suspension

Inspect shock absorber for oil leaks and fasteners for tightness. See an authorized Bombardier ATV dealer as necessary.

Trailing arms

Check trailing arms for distortion, cracks or bending. See an authorized Bombardier ATV dealer if any problem is detected.

A-arms

Check A-arms for cracks, bending or other damages. See an authorized Bombardier ATV dealer as necessary.

Adjustment

Rear Shocks

WARNING

Left and right adjustment cams must always be set to the same position. Never adjust one adjusting cam only. Uneven adjustment can cause poor handling and loss of stability, which could lead to an accident.

Preload Adjustment

Adjust spring preload by turning adjusting cam accordingly, with the adjusting wrench in vehicle tool box.

Turn the adjusting cams clockwise for a firmer ride and rough road condition or when carrying cargo or pulling a trailer.

Turn the adjusting cams counterclockwise for a light load and a smooth road condition.

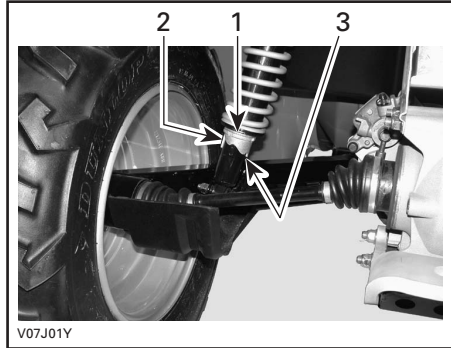

1. *Adjusting cams*
2. *Smooth adjustment*
3. *Hard adjustment*

BRAKE

Front and Rear Brakes

The front and rear brakes are hydraulic disc types. These brakes are self-adjusting and require no adjustment.

The brake lever and the brake pedal require no adjustment.

Check the following to keep the brakes in a good operating condition:

- brake system for fluid leaks
- brake for spongy feel
- brake discs for excessive wear and surface condition
- brake pads for wear, damage or looseness.

SERVICE LIMITS	
Brake pads thickness	1 mm (0.040 in)
Front discs thickness	3.5 mm (0.138 in)
Rear disc thickness	4.3 mm (0.170 in)
Maximum discs warpage	0.2 mm (0.010 in)

See your authorized Bombardier ATV dealer if a problem is detected concerning the brake system.

Brake Fluid Replacement

WARNING

The brake fluid replacement or any brake system repairs should be performed by an authorized Bombardier ATV dealer.

BODY/FRAME

Engine Area

Check engine area for any damage and leaks. Ensure all hose clamps are properly secured and no hose is cracked, kinked or otherwise damaged.

Inspect muffler, battery and reservoir fastening devices.

Check electrical connections for corrosion and tightness.

Replace or have damaged parts repaired.

Hitch/Trailer Ball Condition

Check tightness of fasteners and tightness/condition of trailer ball. Properly retighten as necessary and replace ball if worn.

Chassis Fasteners

Check fastener condition and tightness on the vehicle. Retighten as required.

Seat Fasteners

Remove seat(s) and/or storage box and check latch mechanisms and pins for wear. See an authorized Bombardier ATV dealer for parts replacement if damaged.

Vehicle Cleaning and Protection

Never use a high pressure washer to clean the vehicle. **USE LOW PRESSURE ONLY (like a garden hose)**. High pressure can cause electrical or mechanical damages.

Painted parts which are damaged should be properly repainted to prevent rust.

When required, wash the body with hot water and soap (only use mild detergent). Apply non-abrasive wax.

CAUTION: Never clean plastic parts with strong detergent, degreasing agent, paint thinner, acetone, etc.

While reading this Operator's Guide, remember that:

WARNING

Indicates a potential hazard that, if not avoided, could result in serious injury or death.

WARRANTY

BRP INTERNATIONAL LIMITED WARRANTY: 2006 BOMBARDIER* ATV PRODUCTS

1. SCOPE OF THE LIMITED WARRANTY

Bombardier Recreational Products INC. (hereinafter "BRP"), warrants its 2006 Bombardier ATV products from defects in material or workmanship for the period described below.

All genuine Bombardier parts and accessories, installed by an authorized Bombardier distributor/dealer (as hereinafter defined) at the time of delivery of the 2006 Bombardier ATV product, carry the same warranty as that of the ATV.

Use of the product for racing or any other competitive activity, at any point, even by a previous owner, will render this warranty null and void.

2. WARRANTY COVERAGE PERIOD

This warranty will be in effect FROM THE DATE OF DELIVERY TO THE FIRST RETAIL CONSUMER or the date the product is first put into use, whichever occurs first and for a period of: SIX (6) CONSECUTIVE MONTHS, for private use or commercial use owners ⁽¹⁾.

The repair or replacement of parts or the performance of service under this warranty does not extend the life of this warranty beyond its original expiration date.

3. CONDITIONS TO HAVE WARRANTY COVERAGE

This warranty coverage is available only on 2006 Bombardier ATV products purchased as new and unused by its first owner from a Bombardier distributor/dealer authorized to distribute Bombardier ATV products in the country in which the sale occurred (hereinafter "Bombardier ATV distributor/dealer"), and then only after the BRP specified pre-delivery inspection process is completed and documented. Warranty coverage only becomes available upon proper registration of the product by an authorized Bombardier ATV distributor/dealer. Such limitations are necessary in order to allow BRP to preserve both the safety of its products, and also that of its consumers and the public.

Routine maintenance outlined in the Operator's Guide must be timely performed in order to maintain warranty coverage. BRP reserves the right to make warranty coverage contingent upon proof of proper maintenance.

4. WHAT TO DO TO OBTAIN WARRANTY COVERAGE

The customer must notify a servicing Bombardier ATV distributor/dealer within two (2) days of the appearance of a defect, and provide it with reasonable access to the product and reasonable opportunity to repair it. The customer must also present to the authorized Bombardier distributor/dealer, proof of purchase of the product and must sign the repair/work order prior to starting the repair in order to validate the warranty repair. All parts replaced under this limited warranty become the property of BRP.

1.The warranty is TWENTY FOUR (24) consecutive months if the product was sold in any of the member states of the European Union (EC directive 1999/44/EC).

The warranty period, however, is SIX (6) consecutive months if the product is used for commercial purposes.

5. WHAT BRP WILL DO

BRP's obligations under this warranty are limited to, at its sole discretion, repairing parts found defective under normal use, maintenance and service, or replacing such parts with new genuine Bombardier parts without charge for parts and labor, at any authorized Bombardier distributor/dealer.

BRP reserves the right to improve or modify products from time to time without assuming any obligation to modify products previously manufactured.

6. EXCLUSIONS - ARE NOT WARRANTED

- Normal wear and tear;
- Routine maintenance items, tune ups, adjustments;
- Damage caused by failure to provide proper maintenance and/or storage, as described in the Operator's Guide;
- Damage resulting from removal of parts, improper repairs, service, maintenance, modifications or use of parts not manufactured or approved by BRP or resulting from repairs done by a person that is not an authorized servicing Bombardier distributor/dealer;
- Damage caused by abuse, abnormal use, neglect or operation of the product in a manner inconsistent with the recommended operation described in the Operator's Guide;
- Damage resulting from accident, submersion, fire, theft, vandalism or any act of God;
- Operation with fuels, oils or lubricants which are not suitable for use with the product (see the Operator's Guide);
- Water or snow ingestion;
- Incidental or consequential damages, or damages of any kind including without limitation towing, storage, telephone, rental, taxi, inconvenience, insurance coverage, loan payments, loss of time, loss of income.

7. LIMITATIONS OF LIABILITY

THIS WARRANTY IS EXPRESSLY GIVEN AND ACCEPTED IN LIEU OF ANY AND ALL OTHER WARRANTIES, EXPRESSED OR IMPLIED, INCLUDING WITHOUT LIMITATION ANY WARRANTY OF MERCHANTABILITY OR FITNESS FOR A PARTICULAR PURPOSE. TO THE EXTENT THAT THEY CANNOT BE DISCLAIMED, THE IMPLIED WARRANTIES ARE LIMITED IN DURATION TO THE LIFE OF THE EXPRESS WARRANTY. INCIDENTAL AND CONSEQUENTIAL DAMAGES ARE EXCLUDED FROM COVERAGE UNDER THIS WARRANTY. SOME STATES/PROVINCES DO NOT ALLOW FOR THE DISCLAIMERS, LIMITATIONS AND EXCLUSIONS IDENTIFIED ABOVE, AS A RESULT, THEY MAY NOT APPLY TO YOU. THIS WARRANTY GIVES YOU SPECIFIC RIGHTS, AND YOU MAY ALSO HAVE OTHER LEGAL RIGHTS WHICH MAY VARY FROM COUNTRY TO COUNTRY.

Neither the distributor, any Bombardier ATV dealer nor any other person has been authorized to make any affirmation, representation or warranty regarding the product, other than those contained in this limited warranty, and if made, shall not be enforceable against BRP.

BRP reserves the right to modify this warranty at any time, being understood that such modification will not alter the warranty conditions applicable to the products sold while this warranty is in effect.

8. TRANSFER

If the ownership of a product is transferred during the warranty coverage period, this warranty shall also be transferred and be valid for the remaining coverage period provided that BRP is notified of such transfer of ownership in the following way:

BRP or an authorized Bombardier ATV distributor/dealer receives a proof that the former owner agreed to the transfer of ownership, in addition to the coordinates of the new owner. The distributor will then forward this information directly to BRP.

9. CONSUMER ASSISTANCE

- a) In the event of a controversy or a dispute in connection with this BRP LIMITED WARRANTY, BRP suggests that you try to resolve the issue at the dealership level. We recommend discussing the issue with the authorized dealer's service manager or owner.
- b) If further assistance is required, the distributor's service department should be contacted in order to resolve the matter.
- c) If the matter still remains unresolved then contact BRP by writing to us at the address listed below.

BOMBARDIER RECREATIONAL PRODUCTS EUROPE N.V.
CUSTOMER SERVICE CENTER
BELGIUM
Tel: +32 (0)9 272 63 30

© 2006 Bombardier Recreational Products Inc. All rights reserved.

® Registered trademark of Bombardier Recreational Products Inc. or its subsidiaries.

* Trademark of Bombardier Inc., used under license.

PRIVACY OBLIGATIONS/DISCLAIMER

We wish to inform you that your coordinates will be used for safety and warranty purposes. Sometimes, we also use the coordinates of our clients to inform them about our products and to present them offers. Should you prefer not to receive information on our products, services and offers, please let us know by writing to the address below.

Also note that, from time to time, carefully selected and trustworthy organizations may be permitted to use the coordinates of our clients to promote quality products and services. If you prefer not to have your name and address released, please let us know by writing to the address below:

Bombardier Recreational Products Europe N.V.
Customer Service
Guldensporenpark 83, building I
B-9820 Merelbeke, Belgium
Fax Number +32 (0)9 272 63 49

CHANGE OF ADDRESS/OWNERSHIP

If your address has changed or if you are the new owner of the ATV, be sure to notify BRP by either:

- mailing the card below;
- notifying an authorized Bombardier ATV dealer.

In case of change of ownership, please join a proof that the former owner agreed to the transfer. Notifying BRP, even after the expiration of the limited warranty, is very important as it enables BRP to reach the ATV owner if necessary, like when safety recalls are initiated. It is the owner's responsibility to notify BRP.

STOLEN UNITS: If your personal ATV is stolen, you should notify BRP or an authorized Bombardier ATV dealer. We will ask you to provide your name, address, phone number, the vehicle identification number and the date it was stolen.

CHANGE OF ADDRESS

CHANGE OF OWNERSHIP

VEHICLE IDENTIFICATION NUMBER

Model Number

Vehicle Identification Number (V.I.N.)

OLD ADDRESS
OR PREVIOUS OWNER:

NAME

NO. STREET APT

CITY STATE/PROVINCE ZIP/POSTAL CODE

COUNTRY

NEW ADDRESS
OR NEW OWNER:

NAME

NO. STREET APT

CITY STATE/PROVINCE ZIP/POSTAL CODE

COUNTRY



AFFIX
PROPER
POSTAGE

Bombardier Recreational Products Europe N.V.
Customer Service
Guldensporenpark 83, building I
B-9820 Merelbeke, Belgium

CHANGE OF ADDRESS/OWNERSHIP

If your address has changed or if you are the new owner of the ATV, be sure to notify BRP by either:

- mailing the card below;
- notifying an authorized Bombardier ATV dealer.

In case of change of ownership, please join a proof that the former owner agreed to the transfer. Notifying BRP, even after the expiration of the limited warranty, is very important as it enables BRP to reach the ATV owner if necessary, like when safety recalls are initiated. It is the owner's responsibility to notify BRP.

STOLEN UNITS: If your personal ATV is stolen, you should notify BRP or an authorized Bombardier ATV dealer. We will ask you to provide your name, address, phone number, the vehicle identification number and the date it was stolen.

CHANGE OF ADDRESS

CHANGE OF OWNERSHIP

VEHICLE IDENTIFICATION NUMBER

Model Number

Vehicle Identification Number (V.I.N.)

OLD ADDRESS
OR PREVIOUS OWNER:

NAME

NO. STREET APT

CITY STATE/PROVINCE ZIP/POSTAL CODE

COUNTRY

NEW ADDRESS
OR NEW OWNER:

NAME

NO. STREET APT

CITY STATE/PROVINCE ZIP/POSTAL CODE

COUNTRY



AFFIX
PROPER
POSTAGE

Bombardier Recreational Products Europe N.V.
Customer Service
Guldensporenpark 83, building I
B-9820 Merelbeke, Belgium

ATV MODEL No. _____

VEHICLE
IDENTIFICATION NUMBER (V.I.N.) _____

ENGINE
IDENTIFICATION NUMBER (E.I.N.) _____

Owner:

_____ NAME

NO. _____ STREET _____ APT _____

CITY _____ STATE/PROVINCE _____ ZIP/POSTAL CODE _____

Purchase Date _____
YEAR MONTH DAY

Warranty Expiry Date _____
YEAR MONTH DAY

To be completed by the dealer at the time of the sale.

DEALER IMPRINT AREA

Please verify with your dealer to ensure your vehicle has been registered with BRP.

While reading this Operator's Guide, remember that:



Indicates a potential hazard that, if not avoided, could result in serious injury or death.

2006



WARNING

THIS VEHICLE CAN BE HAZARDOUS TO OPERATE. A collision or rollover can occur quickly, even during routine manoeuvres such as turning and driving on hills or over obstacles, if you fail to take proper precautions.

SEVERE INJURY OR DEATH can result if you do not follow these instructions:

- **BEFORE YOU OPERATE THIS VEHICLE, READ THIS OPERATOR'S GUIDE AND ALL ON-PRODUCT LABELS.**
- **NEVER OPERATE THIS ATV WITHOUT PROPER INSTRUCTIONS.** Beginners should complete a certified training course.
- **NEVER CARRY MORE THAN ONE PASSENGER.** You increase your risk of losing control if you carry more than one passenger.
- **NEVER OPERATE THIS ATV ON A PAVED SURFACE.** You increase your risk of losing control if you operate this ATV on pavement.
- **NEVER OPERATE THIS ATV ON PUBLIC ROADS.** You can collide with another vehicle if you operate this ATV on a public road.
- **OPERATOR AND PASSENGER SHOULD ALWAYS WEAR AN APPROVED HELMET,** eye protection and protective clothing.
- **NEVER CONSUME ALCOHOL OR DRUGS** before or while riding this vehicle.
- **NEVER OPERATE THIS ATV AT EXCESSIVE SPEEDS.** You increase your risk of losing control if you operate this ATV at speeds too fast for the terrain, visibility conditions, or your experience.
- **NEVER ATTEMPT WHEELIES, JUMPS, OR OTHER STUNTS.**

®™ TRADEMARKS OF BOMBARDIER RECREATIONAL PRODUCTS INC. OR ITS AFFILIATES.

* TRADEMARK OF BOMBARDIER INC. USED UNDER LICENSE.

© 2006 BOMBARDIER RECREATIONAL PRODUCTS INC. ALL RIGHTS RESERVED. PRINTED IN THE U.S.A.

OPERATOR'S GUIDE
OUTLANDER MAX 400
2006
219 000 386