

The Lynx logo is written in a bold, italicized, white sans-serif font with a registered trademark symbol.The year '2014' is displayed in a large, white, 3D-style font with a slight shadow, set against the snowy background.

OPERATOR'S GUIDE

XU

600/800R E-TEC®

1200 4-TEC®

⚠ WARNING

Read this guide thoroughly. It contains important safety information.

Minimum recommended operator's age: 16 years old.
Keep this Operator's Guide in the vehicle.

EN 619 900 454

"Original instructions"

OPERATOR'S GUIDE 2014

Adventure™ Grand Tourer 600 E-TEC
Adventure™ Grand Tourer 600 E-TEC Ice Speak
Xtrim™ Commander 600 E-TEC
Xtrim™ Commander Limited 600 E-TEC
Xtrim™ Commander 800R E-TEC
Adventure™ Grand Tourer 1200 4-TEC

WARNING

Disregarding any of the safety precautions and instructions contained in this Operator's Guide and on-product safety labels could cause injury including the possibility of death!

WARNING

This vehicle may exceed the performance of other vehicles you may have ridden in the past. Take time to familiarize yourself with your new vehicle.



Lynx products are manufactured by BRP.

The following are trademarks of Bombardier Recreational Products Inc. or its subsidiaries.

D.E.S.S.™

HPG™

XU™

Lynx®

ROTAX®

TRA™

PPST™

† Trademark of Castrol Limited used under license.

fmo2014-003 en

®™ and the BRP logo are trademarks of Bombardier Recreational Products Inc. or its affiliates.

©2013 Bombardier Recreational Products Inc. and BRP US Inc. All rights reserved.

FOREWORD

Deutsch	Dieses Handbuch ist möglicherweise in Ihrer Landessprache verfügbar. Bitte wenden Sie sich an Ihren Händler oder besuchen Sie: www.operatorsguide.brp.com .
English	This guide may be available in your language. Check with your dealer or go to: www.operatorsguide.brp.com .
Français	Ce guide peut être disponible dans votre langue. Vérifier avec votre concessionnaire ou aller à: www.operatorsguide.brp.com .
Italiano	Questa guida potrebbe essere disponibile nella propria lingua. Contattare il concessionario o consultare: www.operatorsguide.brp.com .
日本語	このガイドは、言語によって翻訳版が用意されています。ディーラーに問い合わせるか、次のアドレスでご確認ください： www.operatorsguide.brp.com .
Norsk	Denne boken kan finnes tilgjengelig på ditt eget språk. Kontakt din forhandler eller gå til: www.operatorsguide.brp.com .
Русский	Воспользуйтесь руководством на вашем языке. Узнайте о его наличии у дилера или на странице по адресу www.operatorsguide.brp.com .
Suomi	Käyttöohjekirja voi olla saatavissa omalla kielelläsi. Tarkista jälleenmyyjältä tai käy osoitteessa: www.operatorsguide.brp.com
Svenska	Denna bok kan finnas tillgänglig på ditt språk. Kontakta din återförsäljare eller gå till: www.operatorsguide.brp.com .

Congratulations on your purchase of a new Lynx® snowmobile. Whatever model you have chosen, it is backed by the Bombardier Recreational Products Inc. (BRP) warranty and a network of authorized Lynx snowmobile dealers ready to provide the parts, service or accessories you may require.

Your dealer is committed to your satisfaction. He has taken training to perform the initial set-up and inspection of your snowmobile as well as completed the final adjustment required to suit your specific weight and riding environment before you took possession.

At delivery, you were informed of the warranty coverage and signed the *PREDELIVERY CHECK LIST* to ensure your new vehicle was prepared to your entire satisfaction.

Know Before you Go

To learn how to reduce the risk for you, your passenger or bystanders being injured or killed, read the following sections before you operate the vehicle:

- SAFETY INFORMATION
- VEHICLE INFORMATION.

Also read all safety labels on your snowmobile.

We highly recommend that you take a safety riding course. Please check with your dealer or local authorities for availability in your area.

Failure to follow the warnings contained in this Operator's Guide can result in SERIOUS INJURY or DEATH.

Safety Messages

The types of safety messages, what they look like and how they are used in this guide are explained as follows:

The safety alert symbol  indicates a potential injury hazard.

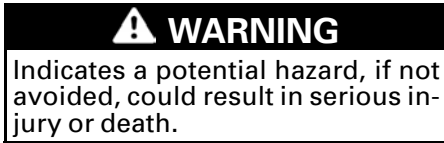

 **CAUTION** Indicates a hazard situation which, if not avoided, could result in minor or moderate injury.

NOTICE Indicates an instruction which, if not followed, could severely damage vehicle components or other property.

About this Operator's Guide

This Operator's Guide has been prepared to acquaint the owner/operator and passenger with this snowmobile and its various controls, safe riding and maintenance instructions.

Keep this Operator's Guide in the vehicle as you can refer to it for things such as maintenance, troubleshooting and instructing others.

Note that this guide is available in several languages. In the event of any discrepancy, the English version shall prevail.

If you want to view and/or print an extra copy of your Operator's Guide, simply visit the following website www.operatorsguide.brp.com.

The informations contained in this document are correct at the time of publication. BRP, however, maintains a policy of continuous improvement of its products without imposing upon itself any obligation to install them on products previously manufactured. Due to late changes, some differences between the manufactured product and the descriptions and/or specifications in this guide may occur. BRP reserves

the right at any time to discontinue or change specifications, designs, features, models or equipment without incurring any obligation upon itself.

This Operator's Guide should remain with the vehicle when it's sold.

TABLE OF CONTENTS

FOREWORD	1
Know Before you Go	1
Safety Messages	1
About this Operator's Guide	2

SAFETY INFORMATION

GENERAL PRECAUTIONS	8
Avoid Carbon Monoxide Poisoning	8
Avoid Gasoline Fires and Other Hazards	8
Avoid Burns from Hot Parts	8
Accessories and Modifications	8
SPECIAL SAFETY MESSAGES	9
RIDING THE VEHICLE	12
Pre-Ride Inspection	12
How to Ride	14
Carrying a Passenger	16
Terrain/Riding Variations	17
Environment	21
TRACTION ENHANCING PRODUCTS	23
Manoeuvrability	23
Acceleration	24
Braking	24
Important Safety Rules	25
Effects of Having a Studded Track on the Life of the Snowmobile	25
Installation of Studs on BRP Approved Tracks	25
Inspection of a Studded Track	26
IMPORTANT ON-PRODUCT LABELS	27
Hang Tag	27
Vehicle Safety Labels	27
Technical Information Labels	30

VEHICLE INFORMATION

CONTROLS, INSTRUMENTS AND EQUIPMENT	34
1) Handlebar	36
2) Throttle Lever	36
3) Brake Lever	36
4) Parking Brake Lever	36
5) Engine Cut-Off Switch	37
6) Emergency Engine Stop Switch	38
7) Multifunction Switch	38
8) Gearshift Lever	41
9) Adjustable Mirrors	41
10) Tool Kit	41

CONTROLS, INSTRUMENTS AND EQUIPMENT (cont'd)	
11) Front and Rear Bumpers	42
12) Gauge	42
13) Backrest	53
14) Passenger Seat (1+1)	53
15) Passengers Handholds	54
16) Mountain Strap (Commander Models)	55
17) Storage Compartment	56
18) Rear Rack	56
19) Passenger Heated Grip and Seat Switch	57
20) 12-Volt Power Outlet	57
21) Hitch	57
22) Tilt Steering (Grand Tourer models)	58
23) Track	58
24) Fuses	59
25) Anchor Points	60
26) Drive Belt Guard	60
27) Hood	61
28) Upper Side Panels	61
29) Lower Side Panels	62
30) Rewind Starter Handle	64
31) Spark Plug Storage	64
32) Fuel Tank Cap	64
33) Storage Box	64
34) Shovel	65
35) Battery display / Charging plug	65
36) Electronic Controlled Suspension (ECS)	65
37) Seat heater	65
FUEL AND OIL	66
Fuel Requirements	66
Recommended Fuel	66
Fueling Procedure	66
Recommended Oil	67
BREAK-IN PERIOD	69
Operation During Break-In	69
OPERATING INSTRUCTIONS	70
Engine Starting Procedure	70
Emergency Starting	70
Vehicle Warm-Up	71
Gearbox Operation	72
Shifter rod adjustment	72
Shutting Off the Engine	73
Towing an Accessory	73
Towing Another Snowmobile	73
TUNE YOUR RIDE	74
Rear Suspension Adjustment	74
Front Suspension Adjustment	78

TUNE YOUR RIDE (cont'd)	
Vehicle Behavior Related to Suspension Adjustment	79
VEHICLE TRANSPORTATION	80

MAINTENANCE

BREAK-IN INSPECTION	82
PERIODIC MAINTENANCE CHART	84
MAINTENANCE SCHEDULE (2-STROKE)	85
MAINTENANCE SCHEDULE (4-STROKE)	87
MAINTENANCE PROCEDURES	89
Air Intake Silencer Prefilter	89
Engine Coolant	89
Injection Oil (600 HO E-TEC, 800R E-TEC)	90
Engine Oil (1200 4-TEC)	90
Exhaust System	91
Spark Plugs	91
Engine Stopper (E-TEC models)	92
Brake Fluid	93
Gearbox Oil	94
Drive Belt	94
Drive Pulley	97
Track	98
Suspension	102
Skis	103
Fuses	103
Lights	104
VEHICLE CARE	107
Post-Operation Care	107
Vehicle Cleaning and Protection	107
STORAGE	108
Engine Storage Mode (E-TEC)	108
PRESEASON PREPARATION	110

TECHNICAL INFORMATION

VEHICLE IDENTIFICATION	114
Vehicle Description Decal	114
Identification Numbers	114
EC-DECLARATION OF CONFORMITY	116
SPECIFICATIONS	117

TROUBLESHOOTING

TROUBLESHOOTING GUIDELINES (E-TEC)..... 126
TROUBLESHOOTING GUIDELINES (1200 4-TEC) 128
MONITORING SYSTEM 130
 Pilot Lamps, Messages and Beeper Codes..... 130
 How to Read Fault Codes 133

WARRANTY

**BRP FINLAND OY INTERNATIONAL LIMITED WARRANTY: 2014 LYNX®
SNOWMOBILES 136**

CUSTOMER INFORMATION

CHANGE OF ADDRESS/OWNERSHIP..... 140

SAFETY INFORMATION

GENERAL PRECAUTIONS

Avoid Carbon Monoxide Poisoning

All engine exhaust contains carbon monoxide, a deadly gas. Breathing carbon monoxide can cause headaches, dizziness, drowsiness, nausea, confusion and eventually death.

Carbon monoxide is a colorless, odorless, tasteless gas that may be present even if you do not see or smell any engine exhaust. Deadly levels of carbon monoxide can collect rapidly, and you can quickly be overcome and unable to save yourself. Also, deadly levels of carbon monoxide can linger for hours or days in enclosed or poorly ventilated areas. If you experience any symptoms of carbon monoxide poisoning, leave the area immediately, get fresh air and seek medical treatment.

To prevent serious injury or death from carbon monoxide:

- Never run the vehicle in poorly ventilated or partially enclosed areas such as garages, carports or barns. Even if you try to ventilate engine exhaust with fans or open windows and doors, carbon monoxide can rapidly reach dangerous levels.
- Never run the vehicle outdoors where engine exhaust can be drawn into a building through openings such as windows and doors.

Avoid Gasoline Fires and Other Hazards

Gasoline is extremely flammable and highly explosive. Fuel vapors can spread and be ignited by a spark or flame many feet away from the engine. To reduce the risk of fire or explosion, follow these instructions:

- Use only an approved gasoline container to store fuel.
- Strictly adhere to instructions in *FUELING PROCEDURE*.
- Never start or operate the engine if the fuel cap is not properly installed.

Gasoline is poisonous and can cause injury or death.

- Never siphon gasoline by mouth.
- If you swallow gasoline, get any in your eye or inhale gasoline vapor, see your doctor immediately.

If gasoline spills on you, wash with soap and water and change your clothes.

Avoid Burns from Hot Parts

The exhaust system and engine become hot during operation. Avoid contact during and shortly after operation to avoid burns.

Accessories and Modifications

Do not make unauthorized modifications, or use attachments or accessories that are not approved by BRP. Since these changes have not been tested by BRP, they may increase the risk of crashes or injuries, and they can make the vehicle illegal.

See your authorized Lynx dealer for available accessories for your vehicle.

SPECIAL SAFETY MESSAGES

SEVERE INJURY OR DEATH can result if you do not follow these instructions:

- Always make a pre-ride inspection BEFORE you start the engine.
- Throttle mechanism should be checked for free movement and return to idle position before starting engine.
- Always attach tether cord eyelet to clothing before starting the engine.
- Never operate the engine without belt guard and brake disk guard securely installed or, with hood or side panels opened or removed. Never run the engine without drive belt installed. Running an unloaded engine such as without drive belt or with track raised, can be dangerous.
- Always engage parking brake before starting the engine.
- Everyone is a beginner the first time he sits behind the controls of a snowmobile regardless of previous experience in driving any other type of vehicle. The safe use of your snowmobile depends on many conditions such as visibility, speed, weather, environment, traffic, vehicle condition and the condition of the driver.
- Basic training is required for the safe operation of any snowmobile. Study your Operator's Guide paying particular attention to cautions and warnings. Join your local snowmobile club: its social activities and trail systems are planned for both fun and safety. Obtain basic instructions from your snowmobile dealer, friend, fellow club member or enroll in your state or provincial safety training program.
- Any new operator must read and understand all safety labels on the snowmobile and the Operator's Guide before operating the snowmobile. Only allow a new operator to operate the snowmobile in a restricted flat area — at least until he is completely familiar with its operation. If snowmobile operator training course is offered in your area, have him enroll.
- The performance of some snowmobiles may significantly exceed that of other snowmobiles you have operated. Therefore, use by novice or inexperienced operators is not recommended.
- Snowmobiles are used in many areas and in many snow conditions. Not all models perform the same in similar conditions. Always consult your snowmobile dealer when selecting the snowmobile model for your particular needs and uses.
- Injury or death may result to the snowmobile operator, passenger or bystander if the snowmobile is used in risky conditions which are beyond the driver's, passenger's or snowmobile's capabilities or intended use.
- BRP recommends the operator has at least 16 years old of age.
- It is very important to inform any operator, regardless of his experience, of the handling characteristics of this snowmobile. The snowmobile configuration, such as ski stance, ski type, suspension type, track length, width and type vary from a model to another. The snowmobile handling is greatly influenced by these characteristics.
- The novice driver should become familiar with the snowmobile through practice on a level area at slow speeds before venturing far afield.
- Know your local laws. Federal, state, provincial and local government agencies have enacted laws and regulations pertaining to the safe use and operation of snowmobiles. It is your responsibility as a snowmobiler to learn and obey these laws and regulations. Respect and observance will result in safer snowmobiling for all. Be aware of the liability property damages and insurance laws regarding your equipment.

- Speeding can be fatal. In many cases, you cannot react or respond quickly enough to the unexpected. Always ride at a speed which is suitable to the trail, weather conditions and your own ability. Know your local rules. Speed limit may be in effect and meant to be observed.
- Always keep right hand side of the trail.
- Always keep a safe distance from other snowmobiles and bystanders.
- Remember, promotional material may show risky maneuvers performed by professional riders under ideal and/or controlled conditions. You should never attempt any such risky maneuvers if they are beyond your level of riding ability.
- Never use this vehicle with alcohol or drugs. They slow reaction time and impair judgement.
- Your snowmobile is not designed to be operated on public streets, roads or highways.
- Avoid road traveling. If you must do so, and it is permitted, reduce speed. The snowmobile is not designed to operate or turn on paving. When crossing a road, make a full stop, then look carefully in both directions before crossing at a 90° angle. Be wary of parked vehicles.
- Snowmobiling at night can be a delightful experience but because of reduced visibility, be extra cautious. Avoid unfamiliar terrain and be sure your lights are working. Always carry a flashlight and spare light bulbs.
- Never remove any original equipment from your snowmobile. Each vehicle has many built in safety features. Such features include various guards and consoles, plus reflective materials and safety labels.
- Nature is wonderful but don't let it distract your attention from driving. If you want to truly appreciate winter's scenery, stop your snowmobile on the side of the trail so that **you** don't become a hazard to others.
- Fences represent a very serious threat for both you and your snowmobile. Give a wide berth to telephone poles or posts.
- Hidden wires unseen from a distance can cause serious accidents.
- Always wear an approved safety helmet, eye protection and a face shield. This also applies to your passenger.
- Be aware of inherent risks associated with riding off trails, such as avalanche and other natural or man made hazards or obstacles.
- Tailgating another snowmobile should be avoided. If the snowmobile in front of you slows for any reason, its driver and passenger could be harmed through your neglect. Maintain a safe stopping distance between you and the snowmobile in front of you. Depending on the terrain condition, stopping may require a little more space than you think. Play it safe. Be prepared to use evasive driving.
- Venturing out alone with your snowmobile could also be hazardous. You could run out of fuel, have an accident, or damage your snowmobile. Remember, your snowmobile is capable of traveling further in half an hour than you may be able to walk in a day. Use the "buddy system". Always ride with a friend or member of your snowmobile club. Even then, tell someone where you are going and the approximate time you plan to return.

- Meadows sometimes have low areas where water accumulate and freezes over in winter. This ice is usually glare ice. Attempting to turn or brake on this surface could cause your vehicle to spin out of control. Never brake or attempt speeding or turning on glare ice. If you do happen to travel over such a condition, reduce speed by carefully releasing the throttle.
- Never “jump” with your snowmobile.
- When riding in a group, do not “gun” the throttle. Snow and ice can be thrown back into the path of a following snowmobile. In addition, when “gunning” the throttle, the vehicle digs into and leaves an irregular snow surface for others.
- Riding in a group is both fun and enjoyable but don't show off or overtake others in the group. A less experienced operator might try to do the same as you and fail. When riding with others, limit your abilities to the experience of others.
- In case of an emergency, press down on the emergency engine stop switch, then apply brakes.
- Never run the engine in a non-ventilated area and/or if vehicle is left unattended.
- Always engage parking brake before starting the engine.
- Never charge or boost a battery while installed on snowmobile.
- Ensure the path behind is clear of obstacles or bystanders before proceeding in reverse.
- Always remove the tether cord cap from engine cut-off switch when vehicle is not in operation in order to prevent accidental engine starting, to avoid unauthorized use by children or others or theft.
- NEVER stand behind or near a rotating track. Debris could be projected causing severe injuries. To remove packed snow or ice, stop engine, tilt and hold vehicle on its side and use screwdriver from tool kit.
- You may stud the track on this vehicle model. However, you MUST only use the BRP approved type stud for use on Lynx snowmobiles. DO NOT EVER use conventional studs, the track thickness is thinner compared to some other tracks. The stud could tear off track and be projected.
- Never ride as a passenger unless the snowmobile is equipped with a passenger seat and passenger handholds or holding strap. Sit only on the designated passenger seat.
- Always wear an approved helmet and follow the same dressing guidelines as those recommended for the operator and described in this guide.
- Make sure that you are able to achieve a stable stance, both feet resting positively on the footboards of footrests with good grip, and that you are able to hold on firmly to the handholds.
- Once underway, if you feel uncomfortable or insecure for any reason, don't wait, tell the driver to slow down or stop.

RIDING THE VEHICLE

Each operator has a responsibility to ensure the safety of other recreationists or bystanders.

You are responsible for proper operation of your vehicle as well as training those whom you allow to ride or drive. There may be noticeable handling and performance differences from one snowmobile to the other.

A snowmobile is relatively simple to operate but like any other vehicle or mechanical equipment, it can be hazardous if you or a passenger are reckless, thoughtless or inattentive. We encourage you to have an Annual Safety Inspection of your snowmobile. Please contact an authorized Lynx dealer for further details. Finally, we urge you to visit an authorized Lynx dealer periodically for regular and safety maintenance, as well as snowmobile accessories you may require.

Before venturing on the trails, operate the snowmobile in a restricted flat area until you are completely familiar with its operation and feel comfortable that you can safely tackle a more demanding task. Have an enjoyable and safe ride.

Pre-Ride Inspection

WARNING

The pre-operation check is very important prior to operating the vehicle. Always check the proper operation of critical controls, safety features and mechanical components before starting.

Before Starting the Engine

If a malfunction or leak is detected, see and authorized Lynx dealer.

1. Remove snow and ice from body including lights, seat, footrests, controls and instruments.
2. Verify that air silencer prefilter is free of snow.

3. Verify that skis and steering operate freely. Check corresponding action of skis versus handlebar.
4. Check fuel and oil levels. Replenish if necessary.
5. All storage compartments must be properly latched and they must not contain any heavy or breakable objects. Hood and side panels must be also properly latched.
6. Activate the throttle control lever several times to check that it operates easily and smoothly. It must return to idle position when released.
7. Activate the brake lever and make sure the brake fully applies before the brake control lever touches the handlebar grip. It must fully return when released.
8. Apply parking brake and check if it operates properly. Leave parking brake applied.

After Engine is Started

For proper engine starting procedure, refer to *ENGINE STARTING PROCEDURE* in the *OPERATING INSTRUCTIONS* subsection.

1. Check headlights high beam and low beam, taillight, stop light and pilot lamps operation.

NOTE: You may need to detach tether cord your clothes to check lights. In such a case, attach cord as soon as you get back at the controls of the snowmobile.

2. Check the engine cut-off switch (by pulling tether cord cap) and emergency engine stop switch operation.
3. Release parking brake.
4. Refer to the *WARM UP* section and follow instructions.

Pre-Ride Check List

ITEM	OPERATION	✓
Body including seat, footrests, lights, air filter, controls and instruments	Check condition and remove snow or ice.	
Skis and steering	Check for free movement and proper action.	
Fuel and oil	Check for proper level.	
Coolant	Check for proper level.	
Storage compartment	Check for proper latching and no heavy or breakable objects.	
Throttle lever	Check for proper action.	
Track	Check condition and remove snow or ice.	
Brake lever	Check for proper action.	
Parking brake	Check for proper action.	
Emergency engine stop switch and engine cut-off switch (tether cord cap)	Check for proper action. Tether cord must be attached to driver clothing eyelet.	
Lights	Check for proper operation.	

How to Ride

Riding Gear

Proper snowmobile clothing should be worn. It should be comfortable and not too tight. Always check the weather forecast before going on a ride. Dress for the coldest weather expected. Thermal underwear next to the skin also provides a good insulation.

Wear an approved helmet at all times for safety and comfort. A stocking type cap, balaclava and face mask should always be carried or worn. Goggles or a face shield that attaches to the helmet are indispensable.

Hands should be protected by a pair of snowmobile gloves or mitts which have sufficient insulation and allow use of thumbs and fingers for operation of controls.

Rubber bottom boots with either a nylon or a leather top, with removable felt liners are best suited for snowmobiling.

You should keep yourself as dry as possible when snowmobiling. When you come indoors, take your snowmobile suit and boots off and make certain they dry properly.

Do not wear long scarfs and loose apparels that could get caught in moving parts.

Carry colored lens goggles.

What to Bring

Every snowmobiler should carry at least the following basic parts and tools that can help him and others in an emergency:

First aid kit	Provided tool kit
Mobile phone	Knife
Spare spark plugs	Flashlight
Friction tape	Trail map
Spare drive belt	Snack

Rider Position (Forward Operation)

Your riding position and balance are the two basic principles of making your snowmobile go where you want it to. When turning on the side of a hill, you and your passenger must be ready to shift body weight to help it turn in the desired direction. Driver and passenger(s) must never attempt this maneuvering by placing feet outside of the vehicle. Experience will teach you how much lean to put into turns at different speeds and how much you will have to lean into a slope to maintain proper balance.

Generally, the riding position for best balance and control is sitting. However, the posting, kneeling or standing positions are also used under certain conditions.

WARNING

Do not attempt any maneuvers if they are beyond your abilities.

Sitting

Feet on the running boards, body mid-way back on seat is an ideal position when operating the snowmobile over familiar, smooth terrain. Knees and hips should remain flexible to absorb shocks.



fmo2008-003-001



fmo2008-003-003

Standing

Place both feet on the running boards. Knees should be flexed to absorb the shock from surface bumps. This is an effective position to see better and to shift weight as conditions dictate. Avoid abrupt stop.



fmo2008-003-004

Posting

A semi-sitting position with the body off the seat and the feet under the body in a sort of squatting posture, thus allowing the legs to absorb the shocks when traveling over uneven terrain. Avoid abrupt stops.



fmo2008-003-002

Rider Position (Reverse Operation)

We recommend sitting on your snowmobile when operating in reverse.

Avoid standing up. Your weight could shift forward against throttle lever while operating in reverse, causing an unexpected acceleration.

⚠ WARNING

Unexpected acceleration when snowmobile operates in reverse can cause a loss of control.

Kneeling

This position is achieved by placing one foot firmly on the running board and the opposite knee on the seat. Avoid abrupt stops.

Carrying a Passenger

Certain snowmobiles are designed for an operator only, others can allow one passenger only, and others can allow up to two passengers. Refer to the indications on the vehicles to know if any particular snowmobile can accommodate passengers or not, and if so, how many. Always respect those indications. Overloading is dangerous because snowmobiles are not designed for it.

Even when passengers are allowed, you must make sure that the persons who would like to become passengers are physically fit for snowmobiling.

WARNING

Any passenger must be able to firmly lay his feet on the footrests and keep his hands on the handholds or seat strap at all times when seated. Respecting those physical criteria is important to ensure that the passenger is stable and to reduce the risks of ejection.

On snowmobiles allowing two passengers, if you have an adult and a child for passenger, BRP recommends that the child sits in the center location. This allows an adult sitting in the rear seat to keep a visual contact with the child and hold him if necessary. In addition, the child is best protected against the wind and cold temperature if seated in the center location.

Each operator has a responsibility to ensure the safety of his passengers and should inform them of snowmobiling basics.

WARNING

- Passengers must only sit on designated passenger seats. Never allow anyone to sit between the handlebar and the operator.
- Each passenger seat must have a strap or handholds and meet SCCC standards.
- Passengers and operators must always wear an approved helmets and warm clothing appropriate for snowmobiling. Make sure that no skin is exposed.
- Once underway, if a passenger feels uncomfortable or insecure for any reason, he must not wait, and tell the driver to slowdown or stop.

Riding with passengers on board is different than riding alone. The operator has the benefit of knowing what will be the next maneuver and is able to prepare himself accordingly. The operator also benefits from the support of his grip on the handlebar. In contrast, the passengers have to rely on the operator's careful and safe operation of the vehicle. In addition, "body english" is limited with passengers, and the operator can sometimes see more of the trail ahead than the passengers. Therefore, smooth starting and stopping are required with passengers, and the operator must slow down. The operator must also warn passengers of side hills, bumps, branches, etc. An unforeseen bump can leave you passenger-less. Remind your passengers to lean into the turn with you, without causing the vehicle to topple. Be extremely careful, go more slowly and check the passengers frequently.

WARNING

When riding with a passenger:

- Braking ability and steering control are reduced. Decrease speed and allow extra space to maneuver.
- Adjust suspension according to weight.

For complete information on how to adjust the suspension, please refer to the *TUNE YOUR RIDE* subsection.

Use extra caution and go even more slowly with young passengers. Check frequently to make certain the child has a firm grip and is properly positioned with his feet on the running boards.

Terrain/Riding Variations

Groomed Trail

On a maintained trail, sitting is the most preferred riding position. Do not race and, above all, keep to the right hand side of the trail. Be prepared for the unexpected. Observe all trail signs. Do not zigzag from one side of the trail to the other.

Ungroomed Trail

Unless there has been a fresh snowfall you can expect “washboard” and snowdrift conditions. Taken at excessive speeds, such conditions can be physically harmful. Slow down. Hold on the handlebar and assume a posting position. Feet should be under the body assuming a crouched position to absorb any jarring effect. On longer stretches of “washboard” trails, the kneeling position of one knee on the seat can be adopted. This provides a certain amount of comfort, while at the same time keeps the body loose and capable of vehicle control. Beware of hidden rocks or tree stumps partially hidden by a recent snowfall.

Deep Snow

In deep “powder” snow, your vehicle could begin to “bog” down. If this occurs, turn in as wide an arc as possible and look for a firmer base. If you do get “bogged”, and it happens to everyone, do not spin your track as this makes the vehicle sink deeper. Instead, turn the engine off, get off and move the back of the vehicle onto new snow. Then tramp a clear path ahead of the vehicle. A few feet will generally suffice. Restart the engine. Assume the standing position and rock the vehicle gently as you steadily and slowly apply the throttle. Depending on whether the front or rear end of the vehicle is sinking, your feet should be placed on the opposing end of the running boards. Never place foreign material beneath the track for support. Do not allow anyone to stand in front of, or to the rear of, the snowmobile with the engine running. Stay away from the track. Personal injury will result if contact is made with the revolving track.

Frozen Water

Traveling frozen lakes and rivers can be fatal. Avoid waterways. If you are in an unfamiliar area, ask the local authorities or residents about the ice condition, inlets, outlets, springs, fast moving currents or other hazards. Never attempt to operate your snowmobile on ice that may be too weak to support you and the vehicle. Operating a snowmobile on ice or icy surfaces can be very dangerous if you do not observe certain precautions. The very nature of ice is foreign to good control of a snowmobile or any vehicle. Traction for starting, turning or stopping is much less than that on snow. Thus, these distances can be multiplied manyfold. Steering is minimal, and uncontrolled spins are an ever present danger. When operating on ice, drive slowly with caution. Allow

yourself plenty of room for stopping and turning. This is especially true at night.

Hard Packed Snow

Don't underestimate hard packed snow. It can be difficult to negotiate as both skis and track do not have as much traction. Best advice is to slow down and avoid rapid acceleration, turning or braking.

Uphill

There are two types of hills you can encounter — the open hill on which there are few trees, cliffs or other obstacles, and a hill that can only be climbed directly. On an open hill, the approach is to climb it by side hilling or slaloming. Approach at an angle. Adopt a kneeling position. Keep your weight on the uphill side at all times. Maintain a steady, safe speed. Continue as far as you can in this direction, then switch to an opposite hill angle and riding position.

A direct climb could present problems. Choose the standing position, accelerate before you start the climb and then reduce throttle pressure to prevent track slippage.

In either case, vehicle speed should be as fast as the incline demands. Always slow down as you reach the crest. If you cannot proceed further, don't spin your track. Turn the engine off, free the skis by pulling them out and downhill, place the rear of the snowmobile uphill restart the engine and ease it out with slow even throttle pressure. Position yourself to avoid tipping over, then descend.

Downhill

Downhill driving requires that you have full control of your vehicle at all times. On steeper hills, keep your center of gravity low and both hands on the handlebar. Maintain slight throttle pressure and allow the machine to run downhill with the engine operating.

If a higher than safe speed is reached, slow down by braking but apply the brake with frequent light pressure. Never jam the brake and lock the track.

Side Hill

When crossing a side hill or traversing up or downhill, certain procedures must be followed. All riders should lean towards the slope as required for stability. The preferred operating positions are the kneeling position, with the knee of the down hill leg on the seat and the foot of the uphill leg on the running board, or the posting position. Be prepared to shift your weight quickly as needed. Side hills and steep slopes are not recommended for a beginner or a novice snowmobiler.

Avalanche Hazard

When riding on mountainous terrain, you should be aware of the risk of avalanches. Avalanches vary in size and shapes and generally occur in steep terrain and on unstable snow.

New snow, animals, people, wind and snowmobiles can all trigger an avalanche. Avoid high marking or traversing steep terrain when avalanche conditions are possible. When in unstable snow conditions, travel should be restricted to lower angle slopes. Wind formed cornices should be avoided. Staying off unstable conditions is the key to safe mountain riding. Probably most important is to be aware of the conditions and dangers on a daily basis when in the mountains. Check local avalanche forecasts and threats each day before heading out to ride and heed forecasters advice.

You should always carry a snow shovel, probe and avalanche beacon while riding on mountains. We recommend that all mountain riders take a local avalanche safety training course to become more familiar with snow conditions and learn how to properly use their equipment.

Here are some web sites that can help you finding important information:

– Europe: www.avalanches.org

Slush

Slush should be avoided at all times. Always check for slush before starting across any lake or river. If dark spots appear in your tracks, get off the ice immediately. Ice and water can be thrown rearward into the path of a following snowmobile. Getting a vehicle out of a slush area is strenuous and in some cases, impossible.

Fog or Whiteouts

On land or water, fog or visibility-limiting snow can form. If you have to proceed into the fog or heavy snow, do so slowly with your lights on and watch intently for hazards. If you are not sure of your way, do not proceed. Keep a safe distance behind other snowmobilers to improve visibility and reaction time.

Unfamiliar Territory

Whenever you enter an area that is new to you, drive with extreme caution. Go slow enough to recognize potential hazards such as fences or fence posts, brooks crossing your path, rocks, sudden dips, guy wires and countless other obstacles which could result in a termination of your snowmobile ride. Even when following existing tracks, be cautious. Travel at a speed so you can see what is around the next bend or over the top of the hill.

Bright Sunshine

Bright sunny days can considerably reduce your vision. The glare from sun and snow may blind you to the extent that you cannot easily distinguish ravines, ditches or other obstacles. Goggles with colored lenses should always be worn under these conditions.

Unseen Obstruction

There may be obstructions hidden beneath the snow. Driving off established trails and in the woods requires reduced speed and increased vigilance. Driving too fast in an area can make even minor obstacles very hazardous. Even hitting a small rock or stump could throw your snowmobile out of control and cause injury to its riders. Stay on established trails to reduce your exposure to hazards. Be safe, slow down and enjoy the scenery.

Hidden Wires

Always be on the lookout for hidden wires, especially in areas that may have been farmed at one time or another. Too many accidents have been caused by running into wires in the fields, guy wires next to poles and roads, and into chains and wires used as road closures. Slow speeds are a must.

Obstacles and Jumping

Unplanned jumps of snowdrifts, snowplow ridges, culverts or indistinguishable objects can be dangerous. You can avoid them by wearing the proper color lenses or face shields and by operating at a lower speed.

Jumping a snowmobile is an unsafe and dangerous practice. However, if the trail does suddenly drop away from you, crouch (stand) towards the rear of the vehicle and keep the skis up and straight ahead. Apply partial throttle and brace yourself for the impact. Knees must be flexed to act as shock absorbers.

Turning

Depending on terrain conditions, there are two preferred ways to turn or corner a snowmobile. For most snow surfaces, "body english" is the key to turning. Leaning towards the inside of the turn and positioning body weight

on the inside foot will create a “banking” condition beneath the track. By adopting this position and positioning yourself as far forward as possible, weight will be transferred to the inside ski.

On occasion, you will find that the only way to turn the vehicle about in deep snow is to pull the snowmobile around. Do not over-exert yourself. Get assistance. Remember to always lift using your legs as opposed to your back.



Road Crossing

In some cases, you will be approaching the road from a ditch or snowbank. Choose a place where you know you can climb without difficulty. Use the standing position and proceed with only as much speed needed to crest the bank. Stop completely at the top of the bank and wait for all traffic to clear. Judge the drop to the roadway. Cross the road at a 90° angle. If you encounter another snowbank on the opposite side, position your feet near the rear of the vehicle. Remember, your snowmobile is not designed to operate on bare pavement and steering on this type of surface is more difficult.

Railroad Crossing

Never ride on railroad tracks. It is illegal. Railroad tracks and railroad rights-of-way are private property. A snowmobile is no match for a train. Before crossing a railroad track, stop, look and listen.

Night Rides

The amount of natural and artificial light at a given time can effect your ability to see or to be seen. Nighttime snowmobiling is delightful. It can be a unique experience if you acknowledge your reduced visibility. Before you start, make certain your lights are clean and work properly. Drive at speeds that will allow you to stop in time when you see an unknown or dangerous object ahead. Stay on established trails and never operate in unfamiliar territory. Avoid rivers and lakes. Guy wires, barbed wire fences, cabled road entrances and other objects such as tree limbs are difficult to see at night. Never drive alone. Always carry a flashlight. Keep away from residential areas and respect the right of others to sleep.

Riding in a Group

Before starting out, designate a “trail boss” to lead the party and another person to follow-up at the end of the party. Ensure that all members of the party are aware of the proposed route and destination. Make certain that you are carrying all necessary tools and equipment and that you have sufficient fuel to complete the trip. Never overtake the trail boss or, for that matter, any other snowmobile. Use down-the-line hand signals to indicate hazards or intent of direction change. Assist others whenever necessary.

It is always IMPORTANT to keep a safe distance between each snowmobile. Always maintain a safe interval and allow sufficient stopping distance. Don't be a tailgater. Know the position of the machine ahead.

Signals

If you intend to stop, raise either hand straight above your head. A left turn is indicated by extending your left hand straight out in the proper direction. For right turns, extend the left arm and raise the hand to a vertical position so it

forms a right angle at the elbow. Every snowmobiler should relay any signal to the ones behind.

Trail Stops

Whenever possible, pull off the trail when you stop. This will reduce the hazard to other snowmobilers using the trail.

Trails and Signs

Trail signs are used to control, direct or regulate the use of snowmobiles on trails. Become familiar with all signs used in the area where you are snowmobiling.

Environment

Wildlife compliments your snowmobiling day. Snowmobile tracks provide firm ground over which animals can travel from area to area. Do not violate this privilege by chasing or harassing wildlife. Fatigue and exhaustion can lead to animal's death. Avoid areas posted for the protection or feeding of wildlife.

If you happen to be fortunate enough to see an animal, stop your snowmobile and observe quietly.

The guidelines that we support are not designed to limit your snowmobiling fun, but to preserve the beautiful freedom that you can experience only on a snowmobile! These guidelines will keep snowmobilers healthy, happy and able to introduce others to what they know and enjoy about their favorite winter pastime. So, the next time you hit the trails on a cool, crisp and clear winter day, we ask you to remember that you are paving the way for the future of our sport. Help us lead it down the right path! From all of us at BRP, thank you for doing your share.

There is nothing more exhilarating than snowmobiling. Venturing onto snowmobile trails that cross wild areas is an exciting and healthy winter sport. However, as the number of people us-

ing these recreational parks increases, so does the potential for damage to the environment. Abuse of land, facilities and resources inevitably leads to restrictions and closures of both private and public land.

In essence, the greatest threat to our sport, is all around us. Which leaves us with one logical choice. When we snowmobile, we must always ride responsibly.

The vast majority respect the law and the environment. Each of us must set an example for those who are new to the sport, young and old alike.

It is in every one's best interest to tread lightly into our recreational areas. Because, in the long run, to protect the sport we must preserve the environment.

Recognizing the importance of this issue and the need for snowmobilers to do their share in preserving areas that make it possible to enjoy our sport, BRP has developed the "Light Treading Is Smart Sledding" campaign for snowmobilers.

Light Treading refers to more than the thread of our tracks. It's a statement of concern, respect and willingness to take the lead and take action. It applies to the environment in general, its proper care and maintenance, its natural inhabitants and all enthusiasts and the public at large who enjoy the great outdoors. With this theme, we invite all snowmobilers to remember that respecting the environment is not only critical to the future of our industry but to future generations.

Light Treading in no way suggests you should curb your appetite for snowmobiling fun! It simply means tread with respect!

The fundamental objective of Light Treading is one of respect for where and how you ride a snowmobile. You're a light treader when you follow the principles below.

Become informed. Obtain maps, regulations and other information from the Forest Service or from other public land agencies. Learn the rules and follow them and that goes for speed limits, too!

Avoid running over young trees, shrubs, and grasses and don't cut wood. On flatlands or areas where trail riding is popular, it's important to ride only where authorized. Remember, there is a link between protecting your environment and your own safety.

Respect wildlife and be particularly sensitive of animals that are rearing young or suffering from food shortage. Stress can sap scarce energy reserves. Refrain from riding in areas where only animals are intended to tread!

Obey gate closures and regulatory signs and remember, light treaders don't litter!

Stay out of wilderness areas. They're closed to all vehicles. Know where the boundaries are.

Obtain permission to travel across private land. Respect the rights of landowners and other people's privacy. Remember, snowmobile technology has lowered the noise factor considerably, but you still shouldn't rev your engines where quiet "is the order of the day".

Snowmobilers know all too well the efforts that have been made throughout the sport's history to enjoy access to areas where people can snowmobile safely and responsibly. This effort continues today, as strong as ever.

Respecting the areas where we ride... wherever they may be... is the only way to ensure their future enjoyment. That's one major reason why we know you'll agree that Light Treading is smart sledding! And there are more.

Enjoying the opportunity to see winter and all its natural majestic wonders, is an experience cherished by snowmobilers. Light Treading will preserve

this opportunity and will make it possible for us to expose others to the beauty of winter and the unique thrill of our sport! Light Treading will help our sport to grow!

Finally, Light Treading is the sign of a smart snowmobiler. You don't have to leave big tracks or careen through a virgin forest to show you can ride. So whether you're driving a high performance Lynx, a sporty RS snowmobile or any other make or model, show you know what you're doing. Show you know how to send snow flying and make tracks with a light touch!

TRACTION ENHANCING PRODUCTS

NOTE: This section is applicable to snowmobiles equipped with a factory installed track that has been approved by BRP for special studs installation.

⚠ WARNING

Never stud a track that has not been approved for studs. Approved tracks can be identified by a stud symbol (see illustration below) molded into the track surface. Installing studs on an unapproved track could increase the risk of the track tearing or severing.

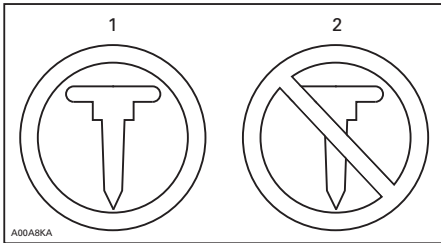

TRACK SYMBOLS

1. *Approved*
2. *NOT Approved*

⚠ WARNING

Use only the BRP approved type stud for these Lynx snowmobiles. **DO NOT EVER** use conventional studs as the track thickness is thinner than other standard tracks. The stud could tear off of track and separate from vehicle. See an authorized Lynx dealer for current specific studding availability and applications.

Using traction enhancing products such as, more aggressive ski carbide runners and/or studs on your snowmobile will change its behavior, particularly in terms of manoeuvrability, acceleration, and braking.

Using traction enhancing products gives a better grip on packed snow and ice, but has no noticeable effect

on soft snow. For this reason, driving a snowmobile equipped with traction enhancing products requires a certain adaptation period. If your snowmobile is equipped with traction enhancing products, be sure to take plenty of time to get used to the way it handles when turning, accelerating, and braking.

Also, always check local regulations concerning the use of traction enhancing products on snowmobiles. Always drive your snowmobile in a responsible manner, respecting the environment and other people's property.

Manoeuvrability

Using traction enhancing products such as, more aggressive ski carbide runners and/or studs makes the snowmobile grip the ground better at both the front and at the rear. The use of carbide runners is therefore required to give the skis a better grip, so that the front and rear of the snowmobile are in balance. While off-the-shelf carbide ski runners are adequate, they don't necessarily give you optimal control, since that depends on your personal preferences, your riding style, and how your suspension is adjusted.

⚠ WARNING

If the front and rear of the snowmobile are out of balance due to an incorrect combination of traction enhancing products, the snowmobile may tend to oversteer or understeer, which could lead to a loss of control.

Oversteering

In certain conditions, using more aggressive ski carbide runners without studs on the rear track could make the snowmobile prone to oversteering, see illustration.

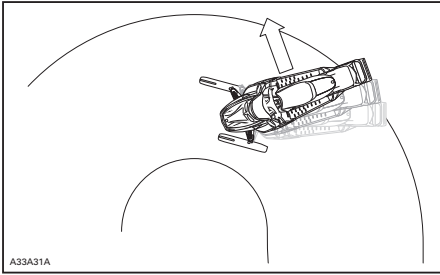

OVERSTEERING

Understeering

In certain conditions, the use of studs on the track could make the snowmobile prone to understeering if the skis are not equipped with more aggressive ski carbide runners, see illustration.

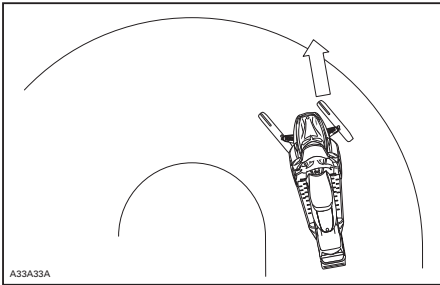

UNDERSTEERING

Controlled Driving

A balanced combination of carbide ski runners and studs on the track ensures adequate control and better handling, see illustration.

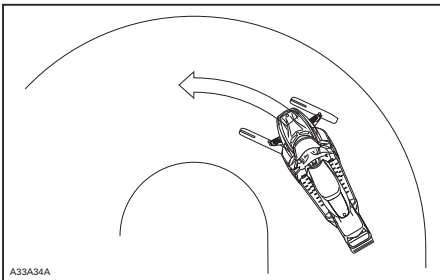

CONTROLLED DRIVING

Acceleration

Using studs on the track will allow your sled to accelerate better on packed snow and ice but will have no noticeable effect on soft snow. This can cause sudden variations in traction under certain conditions.

⚠ WARNING

To prevent surprises that could lead to a loss of control of the snowmobile:

- Always go easy on the throttle.
- NEVER try to spin the track to make the rear of the snowmobile skid.

This could cause debris or ice to be thrown violently backwards, possibly injuring others nearby or on snowmobiles behind you.

Braking

As in the case of acceleration, using studs on the track will give you better braking capacity on packed snow or ice but will have no noticeable effect on soft snow. Braking may thus vary suddenly under certain conditions. Be sure to use restraint in braking to keep from blocking the track in order to avoid surprises that could lead to a loss of control.

Important Safety Rules

⚠ WARNING

To prevent serious injury to individuals near the snowmobile:

- NEVER stand behind or near a moving track.
- Always use a wide-base snowmobile stand with a rear deflector panel if it is necessary to rotate track.
- When the track is raised off the ground, only run it at the lowest possible speed.

Centrifugal force could cause debris, damaged or loose studs, pieces of torn track, or an entire severed track to be violently thrown backwards out of the tunnel with tremendous force.

Effects of Having a Studded Track on the Life of the Snowmobile

The use of traction enhancing products can increase the load and the stress on certain snowmobile components, as well as the vibration level. This can cause premature wear on parts such as drive belts, brake linings, bearings, chain, chaincase sprocket, and on approved studded tracks, shorten track life. Always proceed with a visual inspection of your track before each use. For more information, refer to the *TRACK* in *MAINTENANCE PROCEDURES*.

Studs on the track can also cause serious damage to your snowmobile if it is not equipped with the tunnel protectors designed for your particular model. Damage to the electrical wiring or perforation of the heat exchangers are potential hazards, that could cause the engine to overheat and be severely damaged.

⚠ WARNING

If tunnel protectors are excessively worn or not installed, the gas tank could be punctured, causing a fire.

NOTICE Ask your dealer for the appropriate tunnel protectors model and kit number required for your snowmobile.

NOTE: Consult the BRP limited warranty to find out what warranty limitations are related to the use of studs.

Installation of Studs on BRP Approved Tracks

⚠ WARNING

Never stud a track that has not been approved for studs. Installing studs on an unapproved track could increase the risk of the track tearing or severing.

To ensure safe and proper installation, BRP recommends to have the studs installed by your dealer.

- Use only the BRP approved special studs.
- Never use studs that exceed the height of your snowmobile's track profile by more than 9.5 mm.

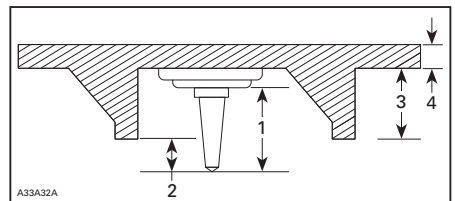

INSTALLATION OF STUDS

1. Stud size
2. Penetration range 6.4 mm to 9.5 mm
3. Track lug height
4. Track belt thickness

⚠ WARNING

- See an authorized Lynx dealer for current specific studding availability and applications.
- DO NOT EVER use conventional stud because, the track thickness is thinner than our standard tracks and the stud could tear off of track and separate from vehicle.
- Studs should only be installed in the locations indicated by molded bulges in the track surface.
- Never stud a track with a profile of 35 mm or more.
- The number of studs installed must always perfectly match the pattern of molded bulges in the track.
- Always consult the traction product manufacturer's installation instructions and recommendations before having your dealer install studs and runners. It is very important to follow the torque specifications for the stud bolts.

INSTALLING AN INCORRECT NUMBER OF STUDS OR AN IMPROPER INSTALLATION CAN INCREASE THE RISK OF THE TRACK TEARING OR SEVERING.

- Broken studs (studded tracks)
- Bent studs (studded tracks)
- Missing studs
- Studs that are torn off the track
- Missing track guide(s)
- Loose studs.

On approved studded tracks, replace broken or damaged studs immediately. If your track shows signs of deterioration, it must be replaced immediately. When in doubt, ask your dealer. Always proceed with a visual inspection of your track before each use.

⚠ WARNING

Riding with a damaged track or studs could lead to loss of control.

Inspection of a Studded Track

PROCEED WITH A VISUAL INSPECTION OF YOUR TRACK BEFORE EACH RIDE.

Look for any defects, such as:

- Perforations in the track
- Tears in the track (particularly around traction holes on studded tracks)
- Lugs that are broken or torn off, exposing portions of rods
- Delamination of the rubber
- Broken rods

IMPORTANT ON-PRODUCT LABELS

Hang Tag

VEHICLE ENGINE DESCRIPTION:
XXXXX

EPA CERTIFIED

NER (NORMALIZED EMISSION RATE) = X
ON A 0 TO 10 SCALE, 0 BEING THE CLEANEST

***NOT TO BE REMOVED PRIOR TO SALE**



704901107
vmo2006-005-009_en

CAUTION

This snowmobile is calibrated for operating at SEA-LEVEL. Operating above 2000 ft requires calibration parts and adjustment. For more details, REFER to your Operator's Guide that came with your snowmobile or see your authorized Ski-Doo dealer. **INCORRECT ADJUSTMENTS MAY CAUSE PARTS DAMAGE**

516004598

Vehicle Safety Labels

Read and understand all the safety labels on your vehicle. These labels are affixed to the vehicle for the safety of the operator, passenger or bystander.

The following labels are on your vehicle and they should be considered permanent parts of the vehicle. If missing or damaged, the decals can be replaced free of charge. See an authorized Lynx dealer.

NOTE: In the event of any discrepancy between this guide and the vehicle, the safety labels on the vehicle have precedence over the labels in this guide.

Dear consumer,

Your new E-TEC engine technology has an automatic computer-controlled break-in period that ensures you get the most performance, efficiency and reliability for life. During the break-in, it will consume more oil and fuel than normal. Also, you may feel the engine misfire. This is normal, the computer is protecting the engine components against premature wear and ensure optimal break-in. After this period, which lasts for about the first two tanks of fuel (22 gal./80 l), you'll be able to experience the unmatched performance, fuel and oil economy that only the E-TEC technology delivers.

Cher client,

Votre nouveau moteur à technologie E-TEC a une période de rodage contrôlée automatiquement qui assurera une performance, une efficacité et une fiabilité optimales à long terme. Durant la période de rodage, le moteur consommera plus d'huile et d'essence qu'à la normale. Ainsi, il se peut que le moteur ait des ratés. Cela est normal puisque le module de commande protège le moteur contre l'usure prématurée et assure un rodage optimal. Après cette période, qui dure environ 2 pleins d'essence (80 l), vous serez en mesure de profiter pleinement des performances, ainsi que de la faible consommation d'huile et d'essence, que seule la technologie E-TEC peut offrir.

516004621

XTRIM COMMANDER 800 E-TEC

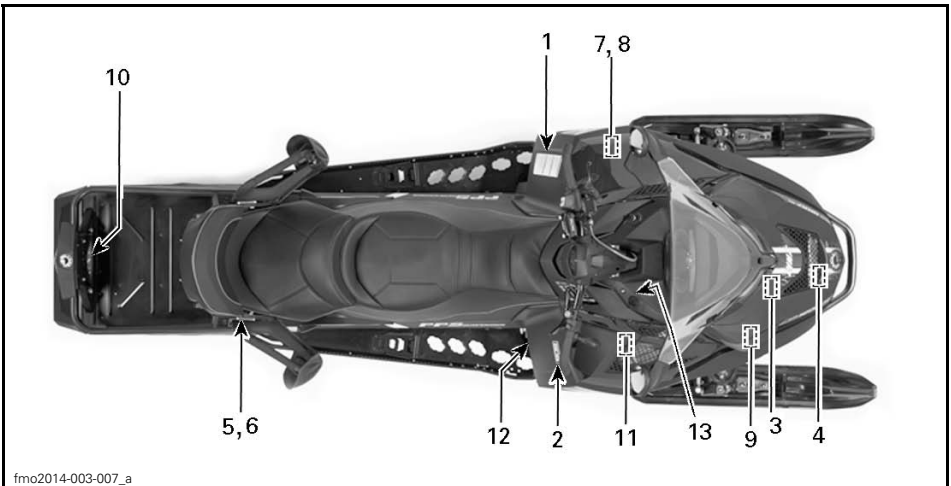

⚠ VAROITUS

Lue käyttöohjekirja ja tutustu turvallisuusohjeisiin ennen moottorikelkan käyttöönottoa !

Ennen moottorin käynnistämistä TARKISTA

- että kaasu ja jarrunhallintalaitteet ovat kunnossa
- että **KAIKKI** suojat ovat paikallaan
- että kaikki suojat on suljettu
- että hätäkatkaisijan naru on kiinnitetty

Kun moottori käy, TARKISTA

- että hätäkatkaisija ja pysäytysnappi toimivat
- mikä vaihde on päällä ennen liikkeelle lähtöä

⚠ WARNING

Läs ägarehandboken och bekanta dig med säkerhetsföreskrifterna före användandet av snöskoter !

Före motorn startas, KONTROLLERA

- att gas- och bromsreglage löper lätt och automatiskt återgår till neutralläge
- att **ALLA** skydd är på plats
- att nödstoppslinan är fäst runt ena handleden eller i kläderna

När motorn startat, KONTROLLERA

- att nödstopp och stoppknapp fungerar
- vilken växel som är ilagd före avfärd

⚠ WARNING

Read the operator's manual and get acquainted with the safety instructions before you start using the snowmobile.

Before starting the snowmobile, CHECK

- that acceleration and brake system are in order
- that **ALL** the protections are in place
- that all the protections are closed
- that the emergency cut out switch is fastened

When the engine is running, CHECK

- that the emergency cut out switch and the emergency switch function
- that which gear is on before start

516006403

516006403

LABEL 1

⚠ WARNING | ⚠ AVERTISSEMENT





516002703



LABEL 2

⚠ CAUTION

Beware of HOT parts!

516004651



LABEL 3

516003923

516003923

LABEL 4



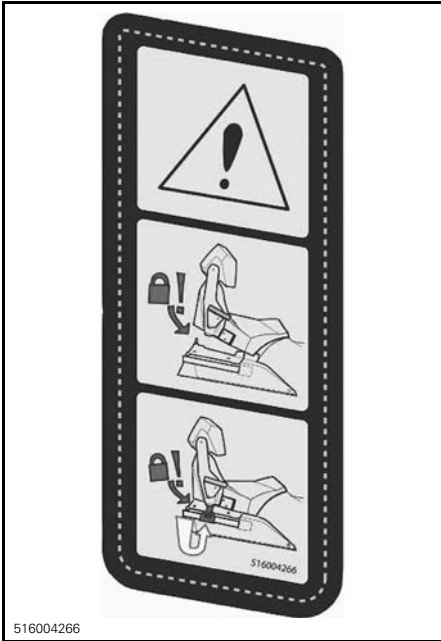

516005111

ADVENTURE GT - LABEL 5

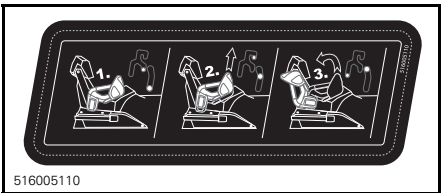

516004266
COMMANDER LTD- LABEL 5



516005110
ADVENTURE GT- MODELS- LABEL 6

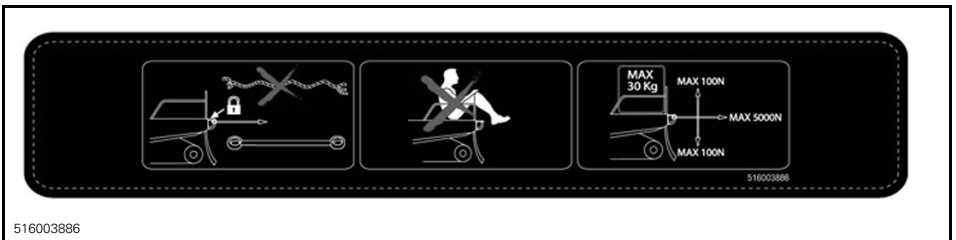

516003886
LABEL 10



516004649
ON PULLEY GUARD - LABEL 7

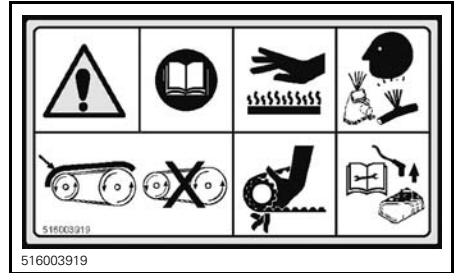

516003919
ON PULLEY GUARD - LABEL 8

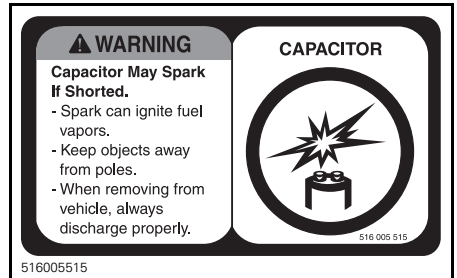

516005515
LABEL 9

⚠ CAUTION

ENGINE OIL AND CERTAIN COMPONENTS IN THE ENGINE COMPARTMENT MAY BE HOT. DIRECT CONTACT MAY RESULT IN SKIN BURN.

CHECKING ENGINE OIL LEVEL

- Make sure engine is at operating temperature.
- Vehicle must be level to perform verification.
- Let engine running at idle for at least 30 seconds.
- Stop engine and wait at least 30 seconds.
- Check oil level using the dipstick.
- The engine of this snowmobile has been developed and validated using the BRP XPS™ Synthetic 4-stroke oil (293 600 112). BRP strongly recommends the use of its XPS™ Synthetic 4-stroke oil at all times. Damages caused by oil which is not suitable for the engine will not be covered by the BRP limited warranty.

516005521

LABEL 11



516003925

ADVENTURE GT 1200 EU- MODELS - LABEL 12

**MAX
25W**

516003918

LABEL 13

⚠ WARNING

Always electrically disconnect both fuel injectors prior to testing for ignition spark. Otherwise, fuel vapors may ignite in presence of a spark creating a fire hazard.

5583A

516005583A

ON FUEL INJECTORS - E-TEC MODELS

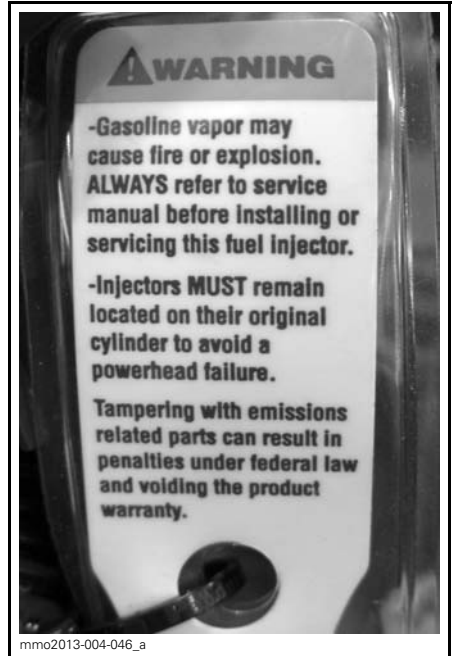

mno2013-004-046_a

ON FUEL INJECTORS - E-TEC ONLY

Technical Information Labels

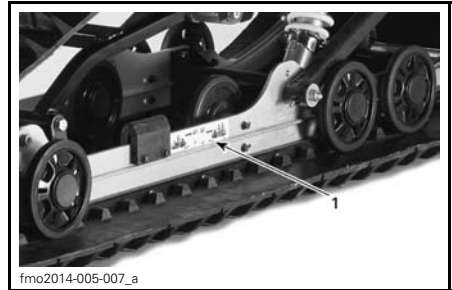

fmo2014-005-007_a

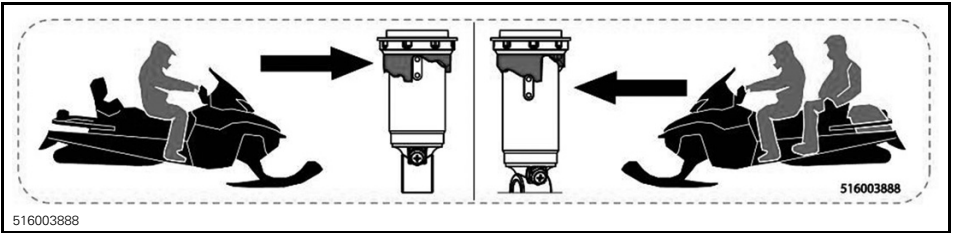

LABEL 1

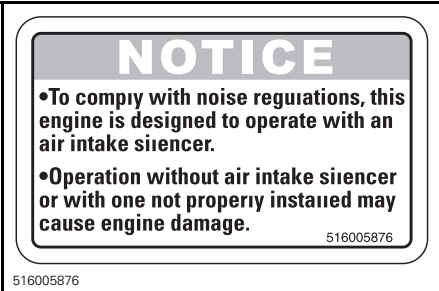

LABEL 2



ADVENTURE GT 1200 EU- MODELS - ON PASSENGER HANDHOLD



ON PULLEY GUARD - LABEL 3

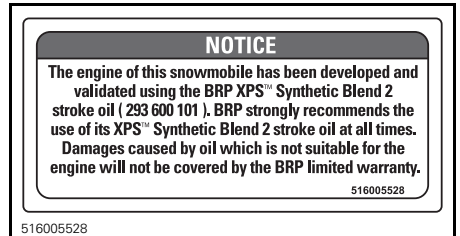

2-TEC- MODELS - ON ENGINE COMPARTMENT

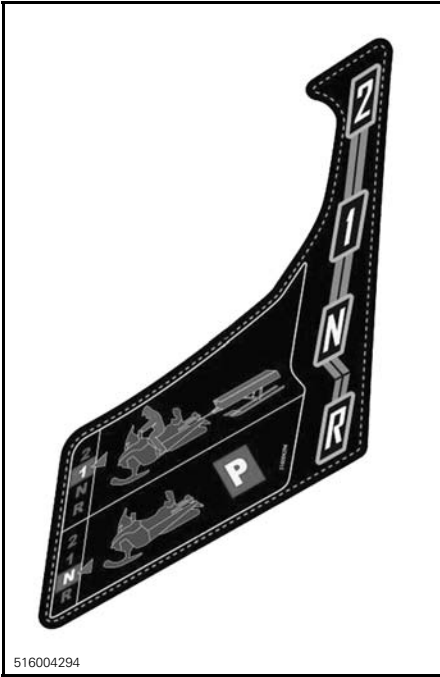

ON CONSOLE NEAR SHIFT LEVER

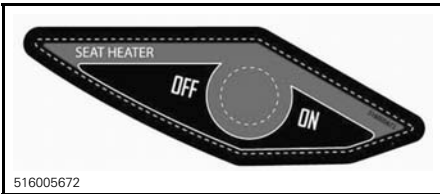

ON CONSOLE - ADVENTURE GT 1200 EU-MODELS

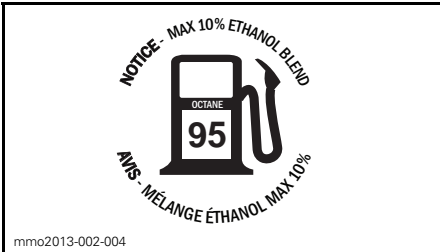

LOCATED ON FUEL CAP

VEHICLE INFORMATION

CONTROLS, INSTRUMENTS AND EQUIPMENT

NOTE: Some features may not apply to your model or could be optional.

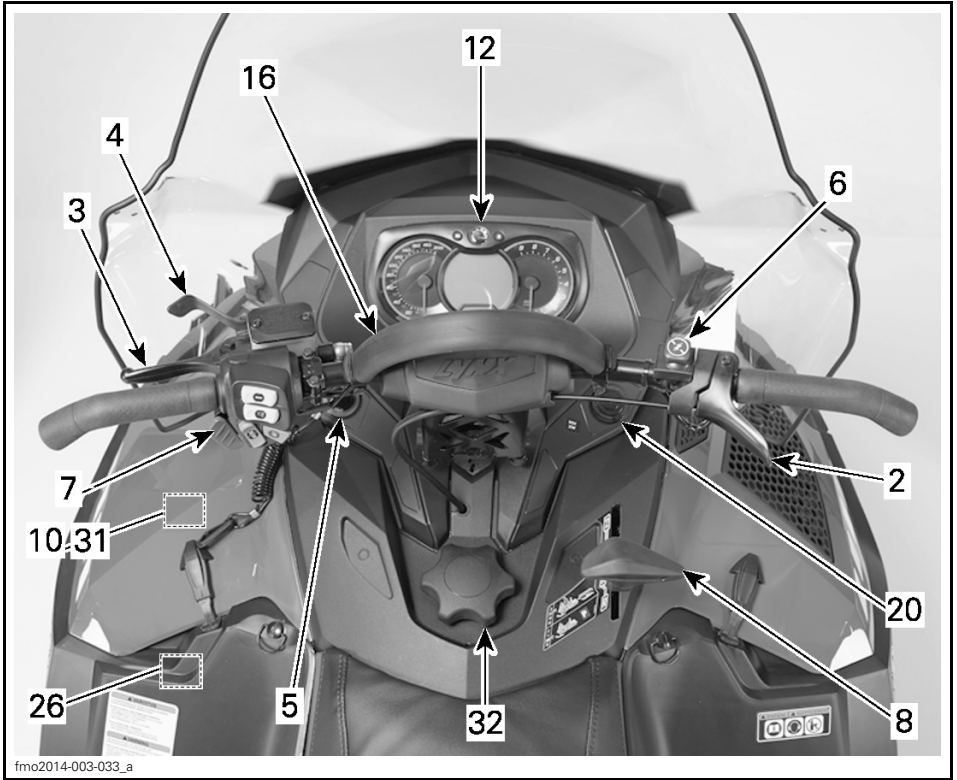

TYPICAL

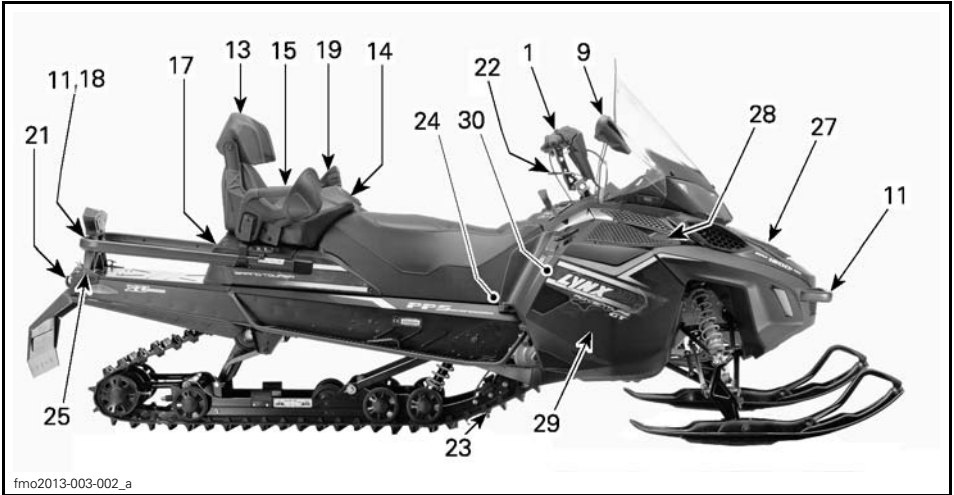

TYPICAL



XTRIM™ COMMANDER LIMITED 600 E-TEC



ADVENTURE™ GRAND TOURER 1200 4-TEC
ECS

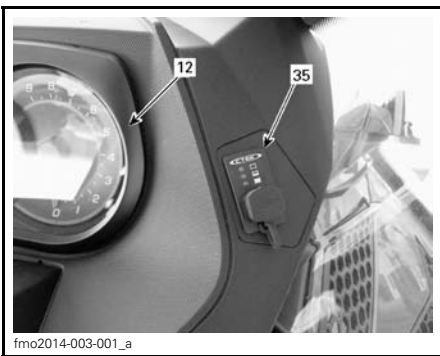

XTRIM™ COMMANDER LIMITED 600 E-TEC



ADVENTURE™ GRAND TOURER 1200 4-TEC

1) Handlebar

The handlebar controls the steering of the snowmobile. As the handlebar is rotated to right or left, the skis are turned right or left to steer the snowmobile.

⚠ WARNING

Fast reverse while turning, could result in loss of stability and control.

2) Throttle Lever

Throttle lever is located on the RH side of handlebar.

Designed to be thumb activated. When squeezed, it increases the engine speed. When released, engine speed returns automatically to idle.

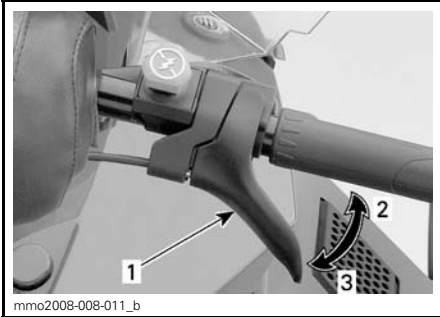

TYPICAL

1. Throttle lever
2. To accelerate
3. To decelerate

⚠ WARNING

Test the throttle lever operation each time before starting the engine. The lever must return to its rest position once released. Otherwise, do not start engine.

3) Brake Lever

Brake lever is located on the LH side of handlebar.

When squeezed, the brake is applied. When released, it automatically returns to its rest position. Braking effect is proportional to the pressure applied on the lever and to the type of terrain and its snow coverage.

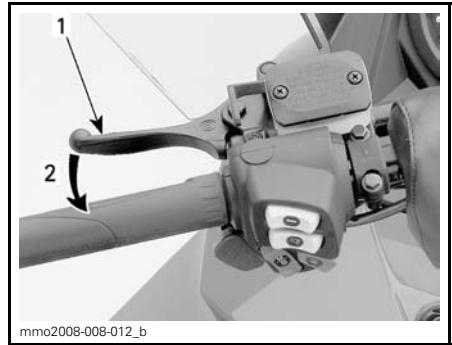

TYPICAL

1. Brake lever
2. To apply brake

4) Parking Brake Lever

Parking brake lever is located on the LH side of handlebar.

Parking brake should be used whenever snowmobile is parked.

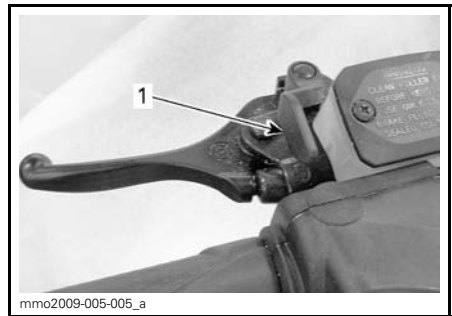

TYPICAL

1. Parking brake lever

⚠ WARNING

Make sure parking brake is fully disengaged before operating the snowmobile. When you ride the vehicle, brake pads that are caused to drag by a continuous pressure on the lever may cause damage to the brake system and cause loss of braking capacity and/or fire.

To Engage Parking Brake

Apply and hold brake, then lock brake lever using the parking brake lever as shown.

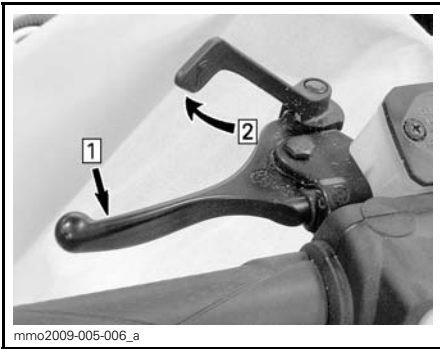
**TYPICAL — ENGAGE MECHANISM**

Step 1: Apply and hold regular brake
Step 2: Lock brake lever using parking brake lever

To Release Parking Brake

Squeeze brake lever. Parking brake lever will automatically return to its original position. Always release parking brake before riding.

5) Engine Cut-Off Switch

The engine cut-off switch is located to on the LH side of console.

The tether cord cap must be securely snapped to the engine cut-off switch to allow vehicle operation.

NOTE: After engine starting, 2 short beeps should be heard if a programmed D.E.S.S. key (tether cord cap) is correctly snapped on engine cut-off switch. If another beep code is heard, refer to *MONITORING SYSTEM* for D.E.S.S. malfunction codes information.

⚠ WARNING

Always attach the tether cord eyelet to clothing before starting the engine.

Pulling the tether cord cap from the engine cut-off switch shuts the engine off.

D.E.S.S. (Digitally Encoded Security System)

The tether cord cap has an integrated D.E.S.S. key to provide you and your snowmobile with the equivalent security of a conventional lock key.

The D.E.S.S. key contains an electronic chip which features a unique permanently memorized digital code.

Your authorized Lynx dealer has programmed the D.E.S.S. of your snowmobile to recognize the D.E.S.S. key in the tether cord cap to allow vehicle operation.

If another tether cord is used without programming the D.E.S.S., the engine will start but will not reach drive pulley engagement speed to move vehicle.

Make sure the tether cord cap is free of dirt or snow.

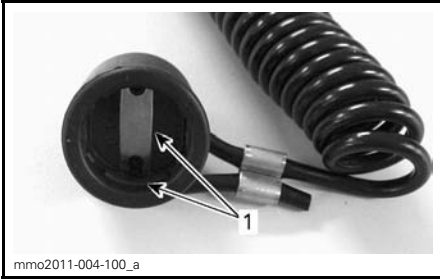

TETHER CORD CAP
1. Free of dirt or snow

D.E.S.S. Flexibility

The D.E.S.S. of your snowmobile can be programmed by your authorized Lynx dealer to accept up to 8 different keys.

We recommend the purchase of additional tether cords from your authorized Lynx dealer. If you have more than one D.E.S.S.-equipped Lynx snowmobile, each can be programmed by your authorized Lynx dealer to accept the other vehicles D.E.S.S. keys.

6) Emergency Engine Stop Switch

The emergency engine stop switch is located on the RH side of handlebar.

Push-pull type switch.

To stop the engine in an emergency, select OFF position (down) and simultaneously apply the brake. To restart, button must be at the ON position (up).

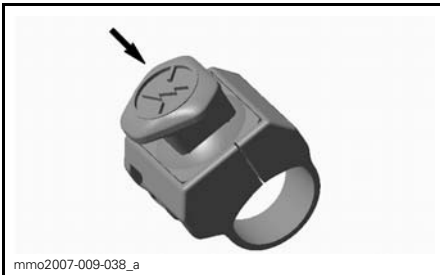

OFF POSITION

To allow engine starting, the switch must be in the ON position (UP).



ON POSITION

All operators of the snowmobile should familiarize themselves with the function of the emergency engine stop switch by using it several times on first outing and whenever stopping the engine thereafter. This engine stopping procedure will become a reflex and will prepare operators for emergency situations requiring its use.

⚠ WARNING

If the switch has been used in an emergency caused by a suspected malfunction, the source of the malfunction should be determined and corrected before restarting engine. See an authorized Lynx dealer for servicing.

7) Multifunction Switch

Multifunction switch is located on the LH side of handlebar.



TYPICAL

1. Start button
2. Headlights dimmer switch
3. Heated grips
4. Heated throttle lever
5. Mode/set button

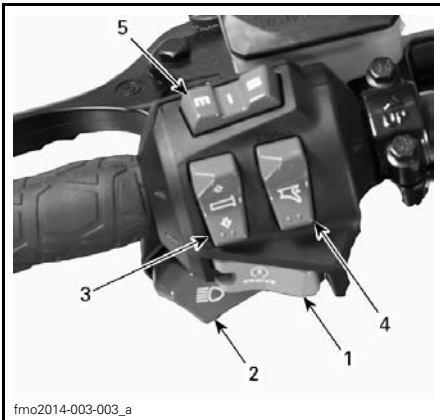

XTRIM COMMANDER 800R E-TEC

1. Start button
2. Headlights dimmer switch
3. Heated grips
4. Heated throttle lever
5. Mode/set button

Start Button

Press to start engine. Refer to *ENGINE STARTING PROCEDURE* in the *OPERATING INSTRUCTIONS* subsection.

Headlights Dimmer Switch

Press to select HI or LOW beam. Lights are automatically ON when the engine is running.

Heated Grips Switch

NOTE: Heated grips are enabled above 1900 engine RPM.

Depress switch as required to select heating intensity to keep your hands at a comfortable temperature.

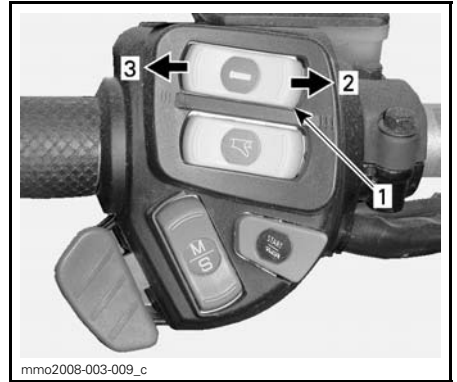

VARIABLE INTENSITY

1. Heated grips switch
2. Increase heat
3. Decrease heat



XTRIM COMMANDER 800R E-TEC - VARIABLE INTENSITY

1. Heated grips switch
2. Increase heat
3. Decrease heat

The heating intensity is displayed via the multifunction display.

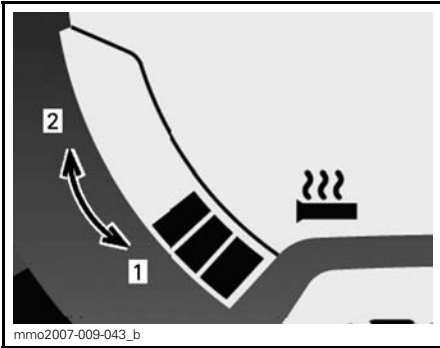

HEATING INTENSITY DISPLAY

1. Colder (Less heat)
2. Warmer (More heat)

Heated grips will be in OFF position when there are no bars displayed on the gauge.

Heated Throttle Lever Switch

NOTE: Heated throttle lever is enabled above 1900 engine RPM.

Depress switch as required to select heating intensity to keep your thumb at a comfortable temperature.

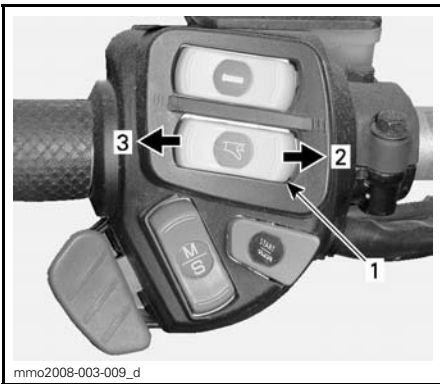

VARIABLE INTENSITY

1. Heated throttle lever switch
2. Increase heat (Warmer)
3. Decrease heat (Colder)



XTRIM COMMANDER 800R E-TEC - VARIABLE INTENSITY

1. Heated throttle lever switch
2. Increase heat (Warmer)
3. Decrease heat (Colder)

NOTE: The heating intensity is displayed via the multifunction display with the activation of the throttle lever switch. When released, display will return to fuel tank level.

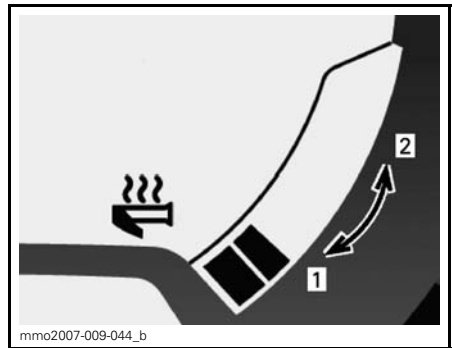

HEATING INTENSITY DISPLAY

1. Colder (Less heat)
2. Warmer (More heat)

Heated throttle lever will be in OFF position when there are no bars displayed on the gauge.

Mode/Set Button

This button can be used instead of the two buttons on top of the analog/digital gauge to facilitate gauge adjustments.

- When pressed upward, it has the same functions as the MODE (M) button.
- When pressed downward, it has the same functions as the SET (S) button.



mmo2008-003-009_b

MULTIFUNCTION GAUGE

1. MODE function
2. SET function



fmo2014-003-003_d

XTRIM COMMANDER 800R E-TEC -MULTIFUNCTION GAUGE

1. MODE function
2. SET function

8) Gearshift Lever

Use this lever to select gears. The gearbox has two forward gears, a reverse gear and a neutral.

Refer to *GEARBOX OPERATION* in *OPERATING INSTRUCTIONS* for details.

NOTE: It is necessary to push shift lever knob down to move it from neutral to reverse gear.

NOTE: Do not shift when vehicle is moving.

9) Adjustable Mirrors

Each mirror can be adjusted to suit driver's preference by gently rotating the mirror glass.

⚠ WARNING

Adjust with vehicle at rest in a safe place.

10) Tool Kit

A tool kit containing tools for basic maintenance is supplied with the vehicle.

The tool kit support is located in engine compartment on pulley guard.

NOTICE Make sure tool kit is properly secured to avoid contact with belt or pulley.

To remove the tool kit support from the pulley guard, unlock the tab from underneath the pulley guard and pull the tool kit support towards front to release it.



TYPICAL
1. Tool kit

11) Front and Rear Bumpers

To be used whenever snowmobile requires manual lifting.

CAUTION Use proper lifting techniques, notably using your legs force. Do not attempt to lift either end of the vehicle if it is above your limits. Use appropriate lifting device or have assistance to share lifting stress if possible.



TYPICAL
1. Front bumper



TYPICAL
1. Rear bumper

NOTICE Do not use skis to pull or lift snowmobile.

12) Gauge

WARNING
Never adjust or set functions on the multifunction gauge while riding the vehicle, you could lose control.

Gauge Description

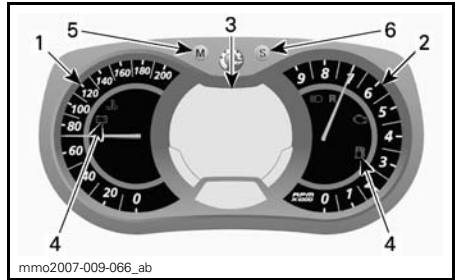

MULTIFUNCTION ANALOG/DIGITAL GAUGE

1. Speedometer
2. Tachometer
3. Multifunction digital display
4. Pilot lamps
5. Mode button
6. Set button

1) Speedometer

Measures vehicle speed.



LH PORTION OF GAUGE

3) Multifunction Digital Display

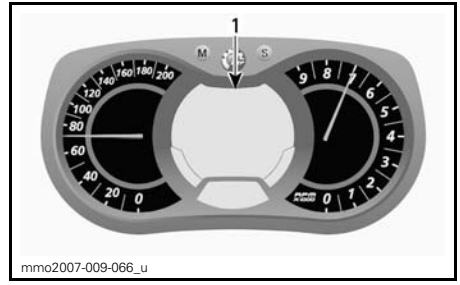

MULTIFUNCTION ANALOG/DIGITAL GAUGE
1. Multifunction display

2) Tachometer (RPM)

Measures engine revolution per minute (RPM). Multiply by 1000 to obtain the actual revolutions.



RH PORTION OF GAUGE

⚠ WARNING

Never adjust or set functions on the multifunction gauge while riding the vehicle, you could lose control.

The multifunction display is used to:





- Display the WELCOME message on power up
- Display the KEY recognition message
- Provide various indications as selected by the operator
- Activating or changing various functions or modes of operation
- Display scrolling messages of function activation or system faults
- Display fault codes.

4) Pilot Lamps and Messages



TYPICAL — PILOT LAMPS

See table below for usual pilot lamps information. Refer to *MONITORING SYSTEM* for details on malfunction pilot lamps.

PILOT LAMP(S) ON	BEEPER	MESSAGE DISPLAY	DESCRIPTION
	4 short beeps every 5 minutes	LOW OIL	Two stroke engine: Injection oil level is low. Stop vehicle in a safe place then, replenish injection oil reservoir. Four stroke engines: Refer to <i>MONITORING SYSTEM</i> .
	—	—	Low fuel level. One (1) bar left in fuel level display. Replenish fuel tank as soon as possible.
	Long beeps repeating slowly	REVERSE	Reverse is selected.
	3 short beeps	REV. FAIL	Reverse did not engage, try again.
	—	—	High beam headlights are selected.
—	—	WARM UP	Engine and/or injection oil need to warm-up before normal operation. The engine's RPM is limited until desired temperature is reached (up to 10 minutes when driving). Warm-up period may occur after a restart in very cold weather.

5) MODE (M) Button

Button use to navigate in gauge multifunction display.

NOTE: MODE (M) button on the multi- switch housing has the same functions and can also be used.

6) SET (S) Button

Button used to navigate, adjust or reset gauge multifunction display.

In order to memorize settings, engine must be running.

NOTE: SET (S) button on the multifunction switch has the same functions and can also be used.

Gauge Features

AVAILABLE INDICATIONS IN NUMERICAL DISPLAY					
FUNCTIONS	Adventure GT 600 E-TEC	Xtrim Commander 600 E-TEC	Xtrim Commander Ltd 600 E-TEC	Xtrim Commander 800R E-TEC	Adventure GT 1200 4-TEC
A) Speedometer	Indication by default				
B) Engine RPM	X	X	X	X	X
C) Odometer	X	X	X	X	X
D) Trip meter "A" or "B"	X	X	X	X	X
E) Trip hour meter	X	X	X	X	X
F) Clock	X	X	X	X	X
G) Fuel level	X	X	X	X	X
H) Altitude	X	X	X	X	N.A.
I) Heated grips heating intensity	X	X	X	X	X
J) Heated throttle lever heating intensity	X	X	X	X	X
K) Instant fuel consumption	X	X	X	X	X
L) Total fuel consumption	X	X	X	X	X
M) Message display	X	X	X	X	X
N) Coolant temperature	X	X	X	X	X
O) E-TEC engine storage mode	X	X	X	X	N.A.
P) Top Speed	X	X	X	X	X
Q) Average speed	X	X	X	X	X
X = An X indicates a standard feature, Opt = Feature available as an option, N.A. = Not available					

When the information center is first powered up, the numerical display defaults to the last selected indication.

A) Speedometer

In addition of the analog type speedometer, vehicle speed can also be displayed via the multifunction display.

Vehicle speed can be displayed on display 1 or display 2.

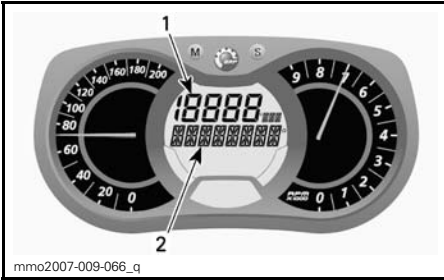

MULTIFUNCTION DISPLAY

1. Display 1
2. Display 2

Use MODE (M) button to select the desired display, then proceed as follows:

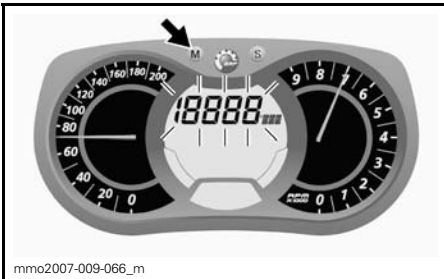

While display is flashing, press the SET (S) button to select speedometer mode.

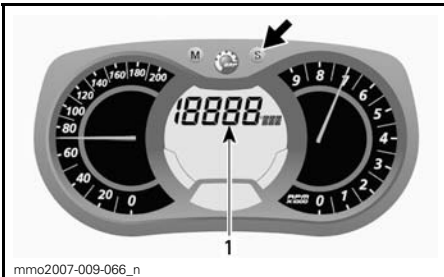

1. Speedometer mode

Press the MODE (M) button to confirm selection or wait 5 seconds.

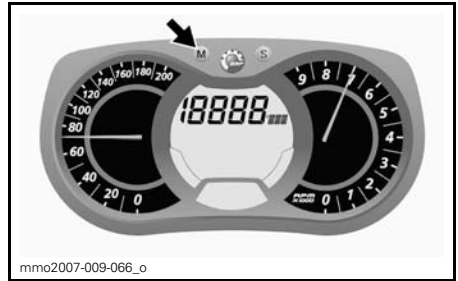

B) Tachometer (RPM)

In addition of the analog type tachometer, RPM can also be displayed via the multifunction display.

Engine RPM can be displayed on display 1 or display 2.

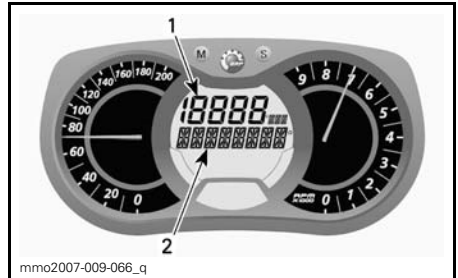

MULTIFUNCTION DISPLAY

1. Display 1
2. Display 2

Use MODE (M) button to select the desired display, then proceed as follows:

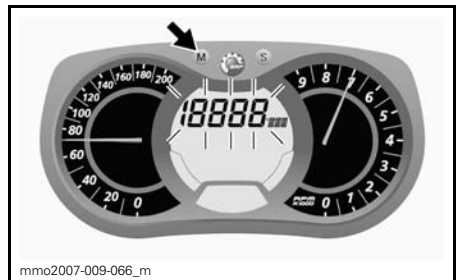

While display is flashing, press SET (S) button to select RPM mode.

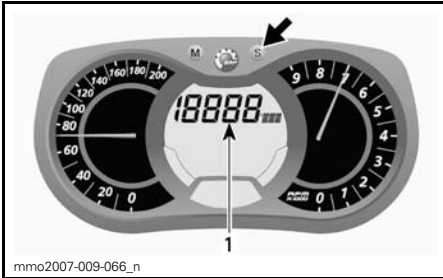

1. RPM mode

Press the MODE (M) button to confirm selection or wait 5 seconds.

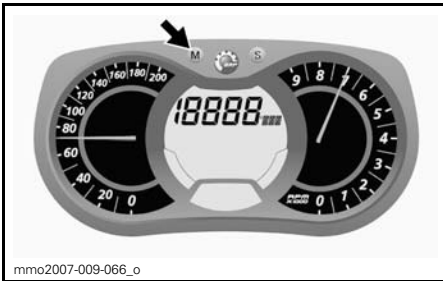

C) Odometer

Records the total distance travelled.

Press the SET (S) button to select odometer mode.

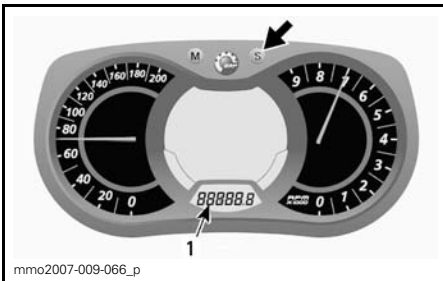

1. Odometer (km/mi) mode

D) Trip Meter "A" or "B"

Trip meters records distance travelled since it has been reset.

Press the SET (S) button to select trip meter (TRIP A/TRIP B) mode.

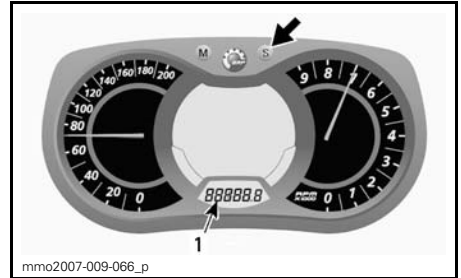

1. Trip meter (TRIP A/TRIP B) mode

Press and hold the SET (S) button to re-set.

NOTE: On E-TEC models, resetting TRIP B mode will also reset TOTAL FUEL CONSUMPTION.

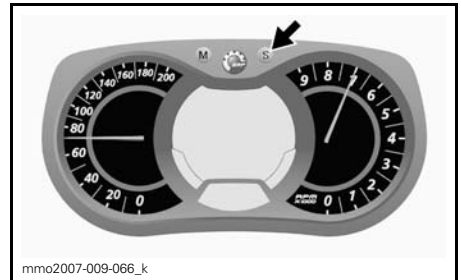

E) Trip Hour Meter

Records vehicle running time when the electrical system is activated since it has been reset.

Press the SET (S) button to select trip hour meter (HrTRIP) mode.

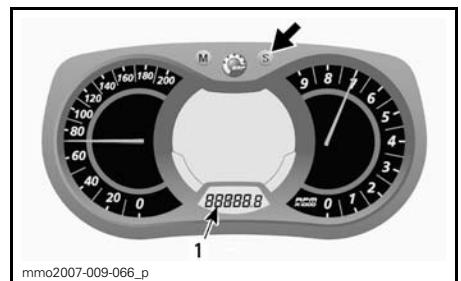

1. Trip hour meter (HrTRIP) mode

Press and hold the SET (S) button to re-set.

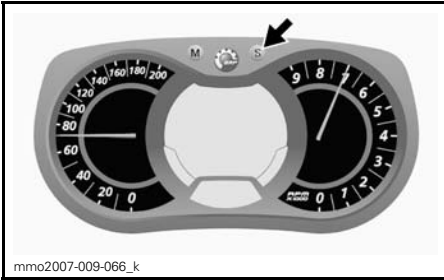

F) Clock

Electric Start Models

NOTE: This clock displays in the 24-hour format only.

Press the SET (S) button to select clock mode.

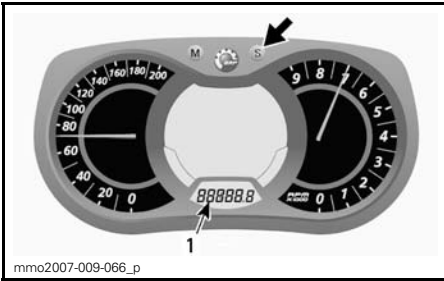

1. Clock mode

G) Fuel Level

Bar gauge that continuously indicates the amount of fuel left in the fuel tank.

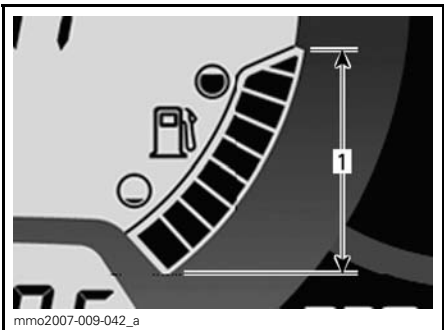

FUEL LEVEL

1. Operating range

H) Altitude

Displays vehicle **approximate** altitude above sea level calculated from the barometric pressure.

NOTE: Altitude displayed is rounded off every 100 meters (gauge set in metric) or 200 feet (gauge set in imperial units).

To display vehicle altitude, proceed as follows.

Press the MODE (M) button to select display 2.

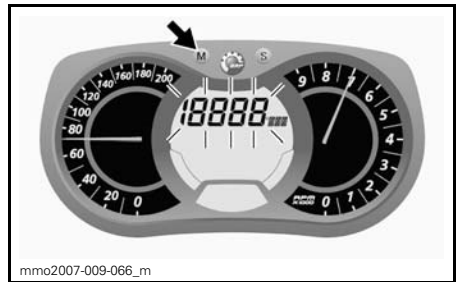

While display is flashing, press the SET (S) button to select altitude mode.

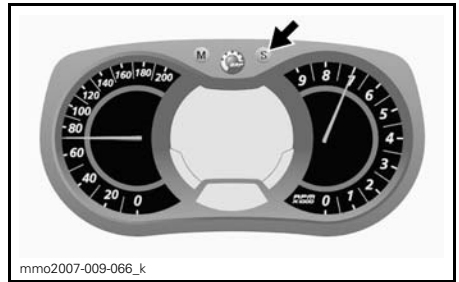

The following symbol appears when altitude mode is selected.



ALTITUDE MODE

Press the MODE (M) button to confirm selection or wait 5 seconds.



I) Heated Grips Heating Intensity

Bar gauge that indicates heating intensity.

Refer to *HEATED GRIPS SWITCH* for more details.

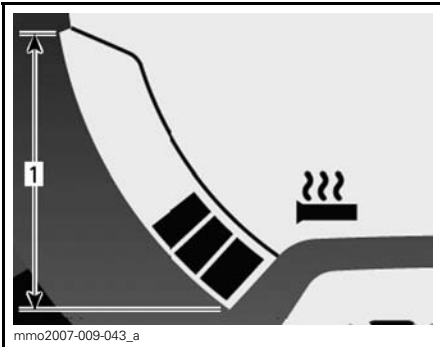

HEATED GRIPS

1. Operating range

J) Heated Throttle Lever Heating Intensity

Bar gauge that indicates heating intensity.

Bar gauge will be displayed instead of the fuel level with the activation of the heated throttle lever switch. When released, display will return to fuel level.

Refer to *HEATED THROTTLE LEVER SWITCH* for more details.

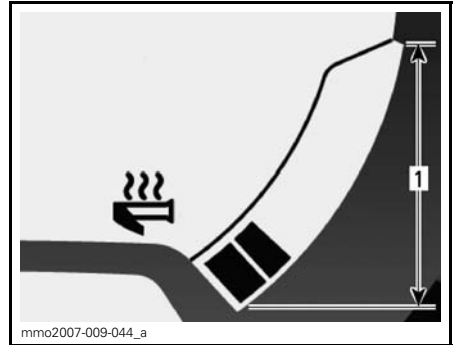

HEATED THROTTLE LEVER

1. Operating range

K) Instant Fuel Consumption

Calculates vehicle average fuel consumption while riding.

To display vehicle average fuel consumption, proceed as follows.

Press the MODE (M) button to select display 1.

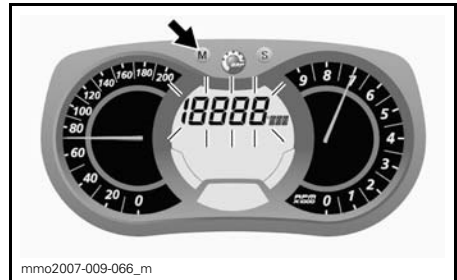

While display flashes, press SET (S) button to select instant fuel consumption mode.

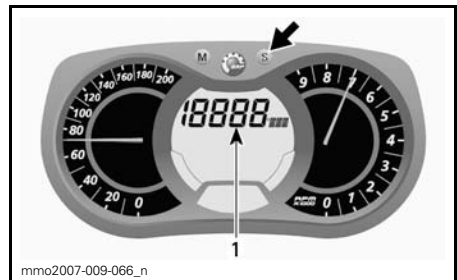

1. Instant fuel consumption mode

Press the MODE (M) button to confirm selection or wait 5 seconds.



L) Total Fuel Consumption

Records vehicle average fuel consumption since it has been reset.

To display vehicle total fuel consumption, proceed as follows.

Press the MODE (M) button to select display.



While display flashes, press the SET (S) button to select total fuel consumption (TC) mode.

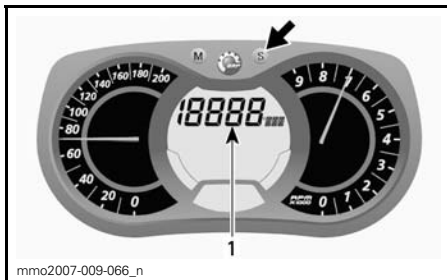

1. Total fuel consumption (TC) mode

TC appears when the mode is selected.

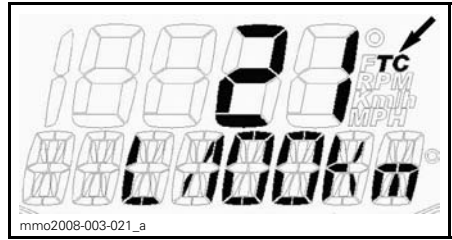

TYPICAL

Press the MODE (M) button to confirm selection or wait 5 seconds.

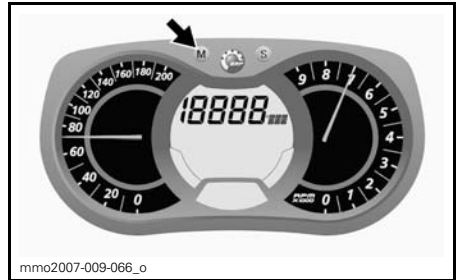

To reset, set the trip meter to TRIP B. Refer to *TRIP METER "A" OR "B"* for more details.

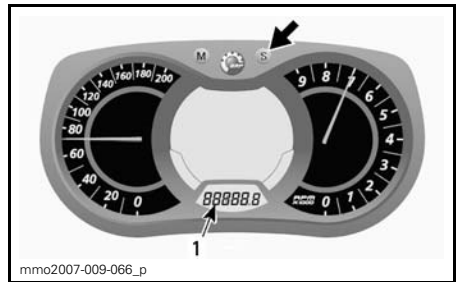

1. Trip meter (TRIP B) mode

Press and hold the SET (S) button to reset.

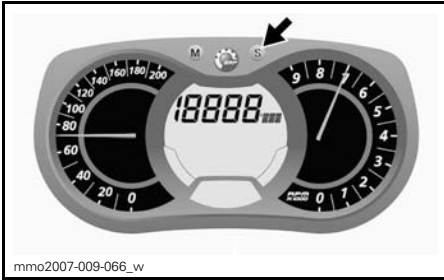

M) Message Display

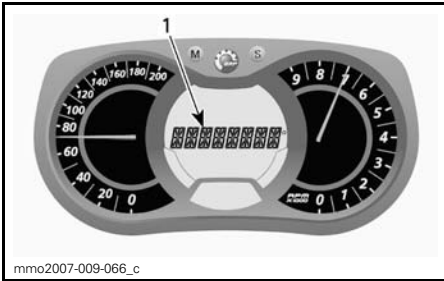

1. Message display

Refer to *PILOT LAMPS AND MESSAGES* in this subsection for details on usual messages.

Refer to *MONITORING SYSTEM* for details on malfunction and D.E.S.S. related messages.

N) Coolant Temperature

Bar gauge that continuously indicates the engine coolant temperature.

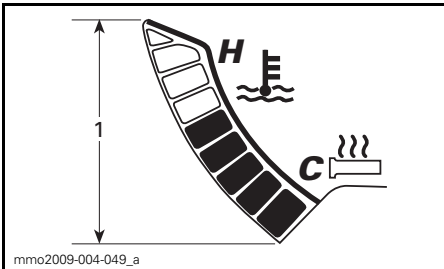

COOLANT TEMPERATURE

1. Range

O) E-TEC Engine Storage Mode

Displays OIL when the storage mode procedure is initiated.

P) Top Speed

Records vehicle top speed since it has been reset.

To display vehicle top speed, proceed as follow.

Push the MODE (M) button to select display.

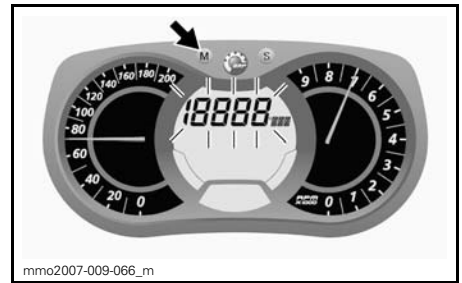

NOTE: Display will flash for approximately 5 seconds, then will return to the previously selected mode if display is not changed.

Push the SET (S) button to select top speed (TOP_SPD) mode.

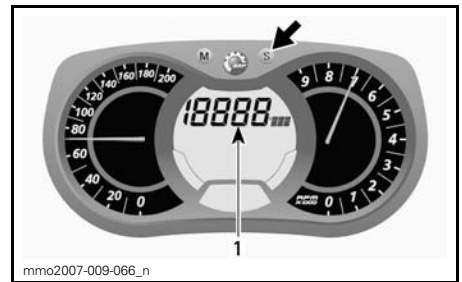

1. Top speed (TOP_SPD) mode

Push the MODE (M) button to confirm selection or wait 5 seconds.



To reset, push the MODE (M) to select mode.



NOTE: Display will flash for approximately 5 seconds, then will return to the previously selected mode if display is not changed.

Push SET (S) button to select vehicle average speed (AVR_SPD) mode.

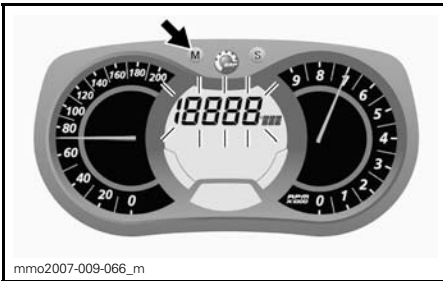

Push and hold the SET (S) button within 5 seconds to reset.

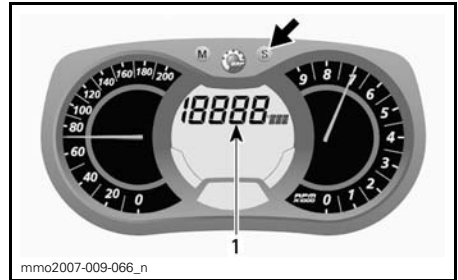

1. Vehicle average speed (AVR_SPD) mode

Push the MODE (M) button to confirm selection or wait 5 seconds.

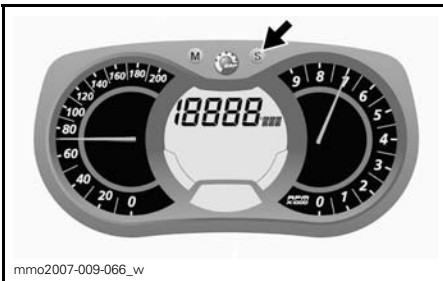

Q) Average Speed

Records vehicle average speed since it has been reset.

To display vehicle average speed, proceed as follow.

Push the MODE (M) button to select display.

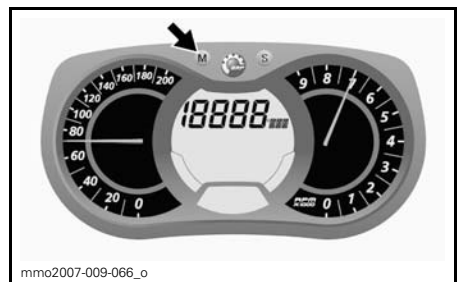

To reset, push the MODE (M) to select mode.



Push and hold the SET (S) button within 5 seconds to reset.

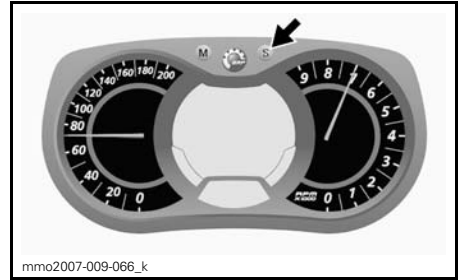

To change HOURS, while the value of HOURS is blinking, use the SET (S) button to change hours.

To change MINUTES, while the value of HOURS is blinking, press the MODE (M) button to switch to minutes. Use the SET (S) button to change minutes.

Press the MODE (M) button to save clock set-up and exit mode.

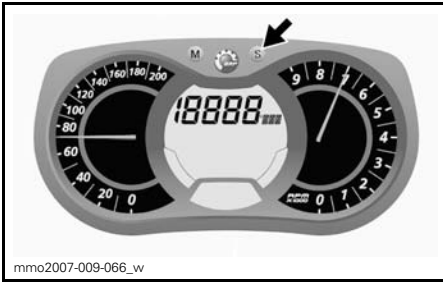

Unit Selection (KM/H vs MPH)

The units can be set in metric or imperial. Refer to an authorized Lynx dealer.

Gauge Setup

Clock Setting

NOTE: This clock displays in the 24-hour format only.

Press the SET (S) button to select clock mode.

Language Selection

The gauge display language can be changed. Refer to an authorized Lynx dealer for language availability and setup the gauge to your preference.

13) Backrest

A fixed backrest is installed on the passenger seat.

14) Passenger Seat (1+1)

Not in models Xtrim™ Commander 600 E-TEC and 800R E-TEC

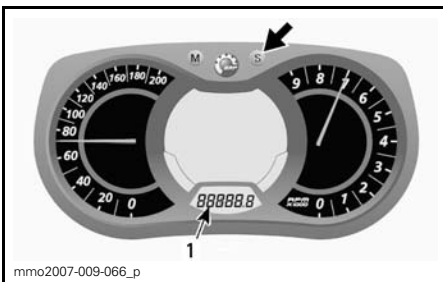

1. Clock mode

Press and hold the SET (S) button to activate clock set-up.

⚠ WARNING

Any passenger must be able to firmly lay his feet on the footrests and keep his hands on the grab handles at all times when seated. Respecting those physical criteria is important to ensure that the passenger is stable and to reduce the risks of ejection.

Passenger Seat Removal

To remove the passenger seat, proceed as follows:

1. Disconnect the accessories connector by pulling.

NOTE: The connector is located on the LH side of the storage box.



1. Accessories connector

2. Install the rubber plug on the connector.
3. Push the latch tab in and lift-up the rear of seat.

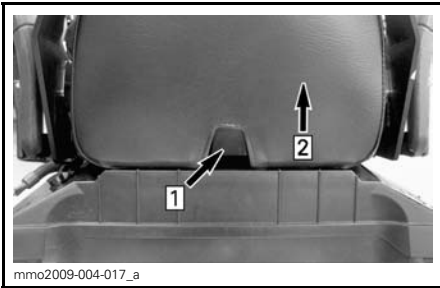

Step 1: Push tab
Step 2: Lift rear of seat

4. Slide seat rearward and set aside.

Passenger Seat Installation

To install the passenger seat, proceed as follows:

1. Place the passenger seat facing forward on the storage box lid.

2. Slightly incline the passenger seat towards front and engage both seat hooks in the storage box lid slots.

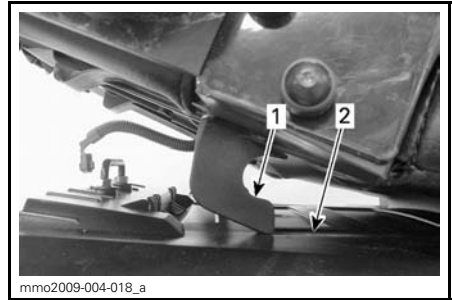

1. Seat hook
2. Slot

3. Push the passenger seat towards the driver's seat and firmly push the rear portion down to lock the passenger seat in position.

NOTE: A distinctive snap will be felt. Double check that the seat is secure by giving it a tug to confirm proper latching.

⚠ WARNING

Make sure seat is securely latched before riding.

4. Connect the accessories connector.

15) Passengers Handholds

Grand Tourer models

The handholds can be set at three different positions:



LOW



HIGH



UP

To set the handholds to the desired position, proceed as follows:

1. Pull up the knob and unscrew several turns until the handhold is free to move.

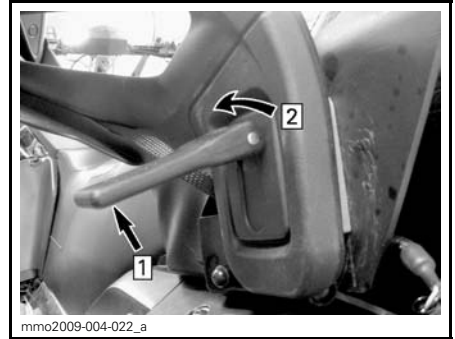

- Step 1: Pull up
- Step 2: Unscrew

2. Refer to the decal located on the RH backrest bracket and guide the handhold to the desired position.

NOTE: The decal can also be seen in the *IMPORTANT ON-PRODUCT LABELS* subsection of this guide.

3. Screw the knob enough to obtain a suitable tension.
4. Lower knob to lock the handhold in place.

Xtrim™ Commander 600 E-TEC Ltd

Fixed handholds on each side of the passenger seat.



1. Passenger handhold

16) Mountain Strap (Commander Models)

Mountain strap provides a grip for the driver when side-hilling.

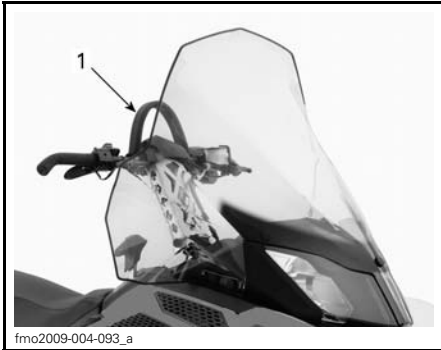

fmo2009-004-093_a

TYPICAL

1. Mountain strap

⚠ WARNING

This strap is not for towing, lifting or other purpose than temporary use as a grab handle when a leverage is needed at very low speeds.

17) Storage Compartment

The storage compartment is located behind the driver's seat.

⚠ WARNING

The storage compartment must be properly latched and must not contain any sharp or breakable objects.

To open the lid, pull and hold the rubber tab sideways, then lift the RH side of the lid or passenger seat if installed.



fmo2009-004-024_a

- Step 1: Pull rubber tab
- Step 2: Lift RH side

To close lid, simply push it down until it latches.

In addition, when passenger seat is installed, hook the retaining strap to the rear bumper as shown.



fmo2010-002-012_a

1. Retaining strap
2. Rear bumper

⚠ CAUTION When closing lid with the passenger seat installed, secure with the retaining strap.

18) Rear Rack

The rear rack can accommodate personal articles (luggage), a fuel caddy or the storage box.

⚠ WARNING

All objects in rear rack must be properly latched. Do not carry any breakable objects. Excessive weight in rack may reduce steering ability.

⚠ WARNING

Always readjust suspension according to the load. The capacity of this rack is limited, the MAXIMUM cargo load is 30 kg (66 lb). Ride at very low speed when loaded. Avoid speed over bumps.

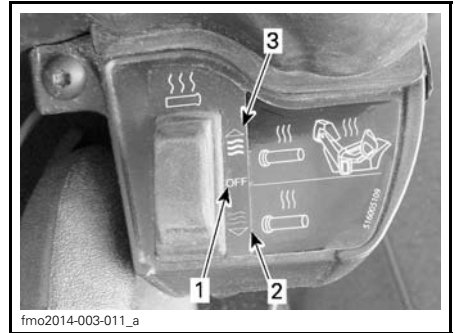
Adventure GT 1200

1. Off
2. Warm, Passenger Grip
3. Hot, Passenger Heated Grip and Seat

19) Passenger Heated Grip and Seat Switch**Adventure GT models**

The switch is located on the LH passenger handhold.

Adjust heating intensity as shown.



1. Off
2. Warm
3. Hot

20) 12-Volt Power Outlet

On all models, a 12-volt power outlet is installed at front, near steering column.

A 12-volt electric appliance may be connected to that jack connector.

E-TEC models

If you need continuous current contact an authorized Lynx dealer.

21) Hitch

Use the hitch in conjunction with a tow bar to tow an accessory.

When attaching any accessory, always refer to the manufacturer's recommendations.

NOTE: Refer to decal on vehicle for towing weight capacities.

⚠ WARNING

Never tow an accessory with a rope. Always use a rigid tow bar. Using a rope would result in a collision between the object and the snowmobile and possibly in a tip over in case of a rapid deceleration or on a downward slope.

J-Type Hitch

Attaching an Equipment

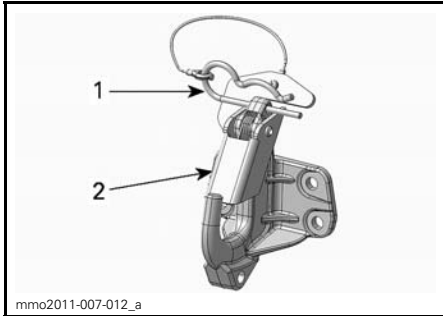

1. Hairpin clip
2. Safety tab

1. Remove the hairpin clip.
2. Align accessory attachment hole with the hitch hook.
3. Push the accessory attachment passed the safety tab.
4. Secure safety tab using the hairpin clip.

Detaching an Equipment

1. Remove the hairpin clip.
2. Push safety tab forward to free accessory attachment from the hitch.
3. Detach accessory attachment.
4. Install hairpin clip.

22) Tilt Steering (Grand Tourer models)

On the Grand Tourer model, the handlebar height is adjustable. To adjust, proceed as follows:

1. Pull up the lock lever.



2. Bring the handlebar to the desired position and release the lock lever.

NOTE: On the other models, the steering can be set to a desired fixed position, see your Lynx authorized dealer.

23) Track

⚠ WARNING

Never stud a track that has not been approved for studs. Installing studs on an unapproved track could increase the risk of the track tearing or severing, possibly resulting in serious injury or death.

Before proceeding with the installation of special studs on tracks you must contact your authorized LYNX snowmobile dealer for current specific studding availability and applications.

BRP does **not** recommend to ride a snowmobile equipped with high lug profile track at **high speed** in a trail, on hard packed surfaces or ice for an extended period of time.

In the event that you have to, **reduce your speed**, then minimize the distance you ride on those surfaces.

⚠ CAUTION Running those tracks at high speed in a trail, on hard packed surfaces or ice put more stress on the lugs, which tend to heat up as a result. To avoid potential degradation or damage to the track, reduce your speed, then minimize the distance you ride on those surfaces.

For general instructions on maintenance of tracks, refer to the sections *TRACK* and *TRACK TENSION AND ALIGNMENT* in the *MAINTENANCE* section of this guide.

24) Fuses

The electrical system is protected with fuses, refer to *ELECTRICAL SYSTEM* for details.

The fuse box is located in the left side of vehicle behind seat cover. To get access to fuse box open lower side panel and then remove seat cover lower left aside.

⚠ CAUTION Do not use a higher rated fuse as this can cause severe damage to electrical components and/or be a potential fire.

⚠ WARNING

If fuse has burnt out, source of malfunction should be determined and corrected before restarting. See an authorized LYNX dealer for servicing.



fmo2012-003-005



fmo2012-003-021

550 MODEL

Battery

Battery is located in storage box under passenger seat. To get access to battery push battery cover notches both sides of cover and remove it

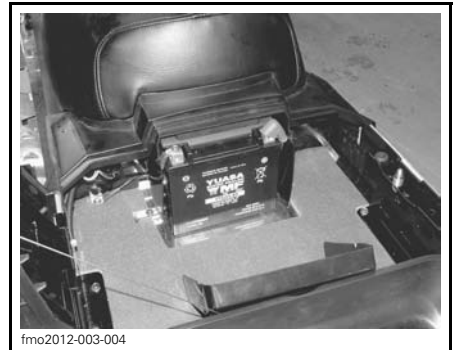

fmo2012-003-004

25) Anchor Points

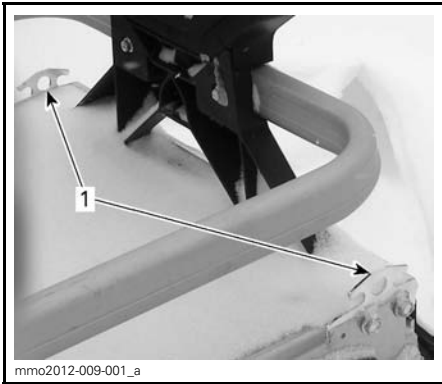

REAR OF VEHICLE

1. Anchor points

Two anchor points are provided to secure load in rear rack.

NOTICE Do not exceed maximum load capacity of rear rack. **MAXIMUM** cargo load is 30 kg (66 lb).

26) Drive Belt Guard

Drive Belt Guard Removal

⚠ WARNING

NEVER operate engine:

- Without shields and belt guard securely installed.
- With hood and/or side panels opened or removed.

NEVER attempt to make adjustments to moving parts while engine is running.

NOTE: Drive belt guard is purposely made slightly oversize to maintain tension on its pins and retainers preventing undue noise and vibration. It is important that this tension be maintained when reinstalling.

Remove the tether cord cap from engine cut-off switch.

Refer to *CONTROLS, INSTRUMENTS AND EQUIPMENT* and open engine compartment LH side panel.

Remove retaining pin.

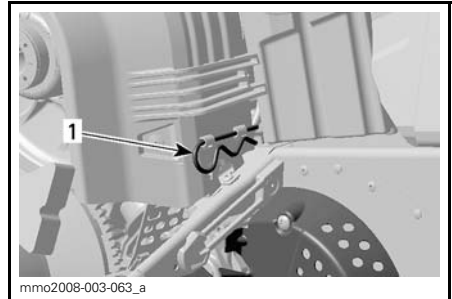

TYPICAL

1. Retaining pin

Lift rear portion of drive belt guard then release from front tabs.

Drive Belt Guard Installation

When reinstalling drive belt guard, position its cutaway toward front of snowmobile.

Place belt guard front openings over tabs.

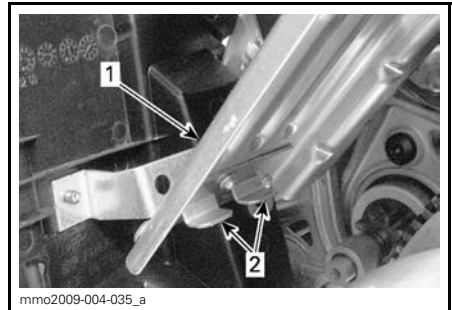

1. Belt guard
2. Tabs

Position the grommet over the retaining rod.

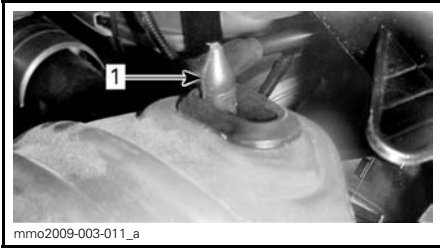

1. Retaining rod

Position rear portion of the belt guard over the retainer and secure it using the retaining pin.

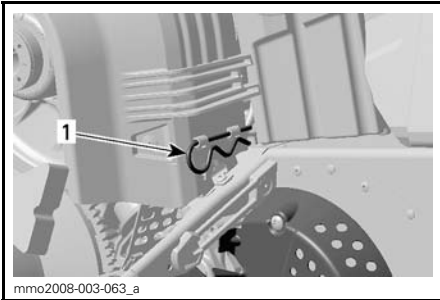

1. Retaining pin

27) Hood

⚠ WARNING

Never operate engine with hood removed from vehicle.

Hood Removal

1. Remove upper side panels as explained below.
2. Unhook the rubber ties on both sides.



1. Rubber tie

3. Slide hood towards front to free the tabs from their slots.

Hood Installation

1. Engage the tabs located at front and center of the hood into the bottom pan slots.

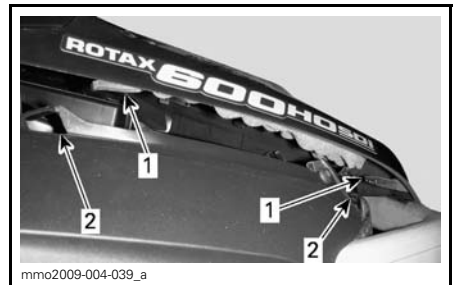

TYPICAL

1. Tabs
2. Slots

2. Slide hood towards headlights until it stops.

3. Hook the rubber ties.

28) Upper Side Panels

⚠ WARNING

Never operate engine with side panels opened or removed from vehicle.

Upper Side Panel Removal

1. Unhook the rubber tie.

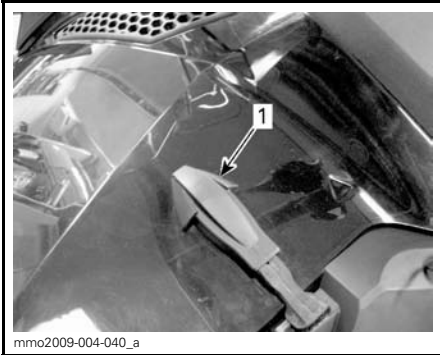

1. Rubber tie

2. Lift the rear portion of panel to free the plastic tab from the console.
3. Slide panel towards rear.

Upper Side Panel Installation

1. Insert the panel lower tabs into the bottom pan slots.

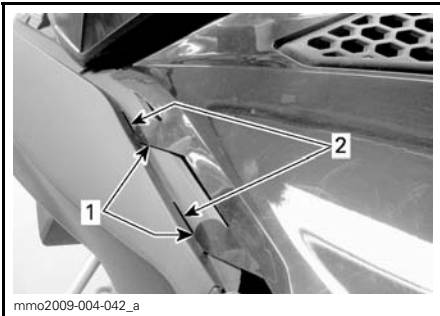

1. Panel lower tabs
2. Bottom pan slots

2. Hook the panel top center tabs to the console.

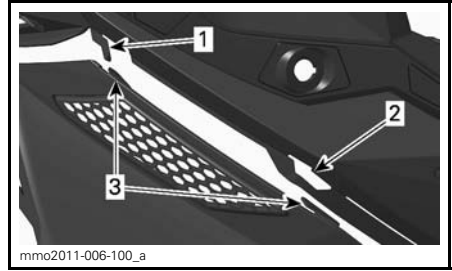

1. Console hook
2. Console slot
3. Panel center tabs

3. Insert the rear tab into the console slot.

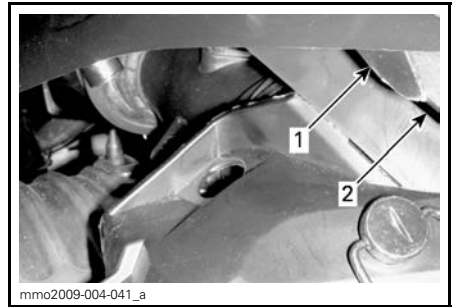

1. Rear tab
2. Console slot

4. Hook rubber tie.

29) Lower Side Panels

⚠ WARNING

Never operate engine with side panels opened or removed from vehicle.

Lower Side Panel Opening

1. Remove upper side panel as explained above.
2. Unhook the rubber tie.

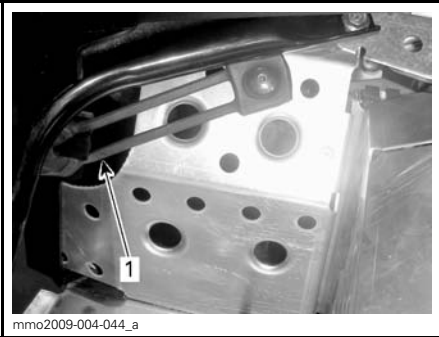

1. Rubber tie

3. Turn the clip 1/4 turn counterclockwise to unlock.

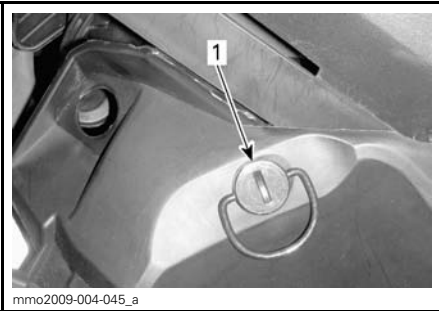

1. Clip

4. Slightly lift the rear of side panel, then open sideways.

Lower Side Panel Closing

1. Insert the panel tab into the bottom pan slot.

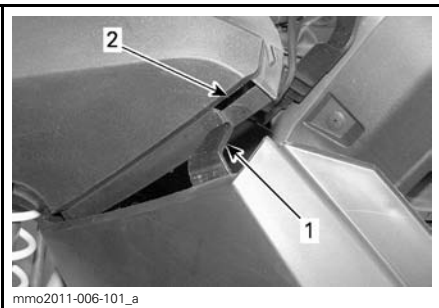

1. Lower side panel tab
2. Bottom pan slot

2. Insert the lower section of side panel over the aluminium chassis and the aluminium tab into the panel slot.

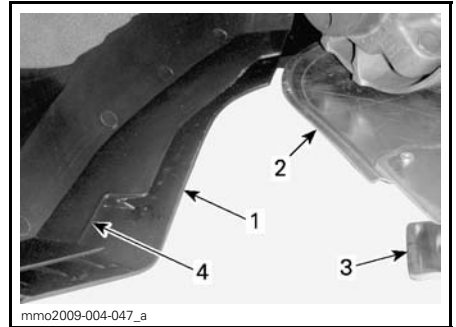

1. Lower section
2. Aluminium chassis
3. Aluminium tab
4. Panel slot

3. Insert the panel dowel into the tunnel hole.

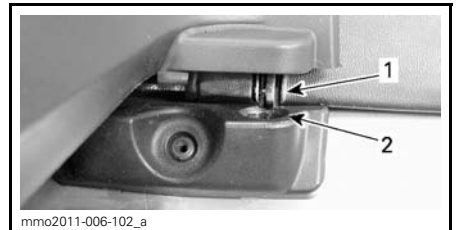

1. Dowel
2. Tunnel hole

4. Hook the rubber tie.
5. Lock the clip by turning it 1/4 turn clockwise.

Lower Side Panel Removal/Installation

1. Open lower side panel as explained above.
2. Lift the front of side panel and free the lower hinge from its slot.
3. Free the upper hinge by lowering the panel.

Reverse procedure for installation.

30) Rewind Starter Handle

Auto-rewind type located on right hand side of snowmobile behind side panel. To engage mechanism, pull handle slowly until a resistance is felt then pull vigorously. Slowly release handle.

31) Spark Plug Storage

A space is provided in the tool kit to keep spare spark plugs dry and prevent shocks that might affect the adjustment or break them.

NOTE: Spare spark plugs are not supplied with snowmobile.

NOTE: Check spare spark plug gap according to *SPECIFICATIONS* before installation.

⚠ CAUTION Do not attempt to adjust spark plug gap.

32) Fuel Tank Cap

Unscrew to fill up tank then fully tighten.

⚠ WARNING

Always stop the engine before refueling. Fuel is flammable and explosive under certain conditions. Always work in a well ventilated area. Do not smoke or allow open flames or sparks in the vicinity. Open cap slowly. If a differential pressure condition is noticed (whistling sound heard when loosening fuel tank cap) have vehicle inspected and/or repaired before further operation. Do not overfill or top off the fuel tank before placing the vehicle in a warm area. As temperature increases, fuel expands and might overflow. Always wipe off any fuel spillage from the vehicle. Periodically verify fuel system.

NOTE: Do not sit or lean on seat when fuel tank cap is not properly installed.

33) Storage Box

*Xtrim™ Commander Limited
600 E-TEC*

Storage Box Opening/Closing

To open storage box lid, release both rubber ties, then lift lid up.



1. Rubber tie

To close, push lid down in order to insert the lid pins into the box grommets. Attach the rubber ties.

Storage Box Removal/Installation

To remove storage box from vehicle, open lid and remove the four screws retaining storage box to the rear rack. Keep the screws for installation.

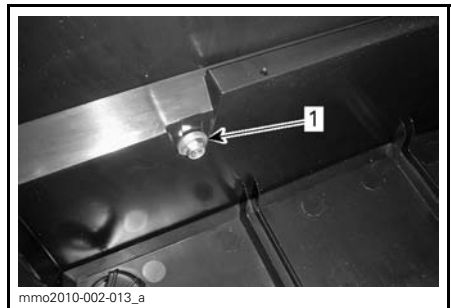

INSIDE THE STORAGE BOX

1. Retaining screw

To install storage box, make sure that the tunnel surface is clean. Put storage box within the rear rack rails.

Attach using the four screws. Tighten to $10\text{ N}\cdot\text{m} \pm 1\text{ N}\cdot\text{m}$.

34) Shovel

*Xtrim™ Commander Limited
600 E-TEC*

Shovel is located on RH side of vehicle.

35) Battery display / Charging plug

*Xtrim™ Commander Limited
600 E-TEC*

Battery display / Charging plug is located to the RH side of console.

The charging level is displayed with LEDs.



1. Battery Display/Charging plug

36) Electronic Controlled Suspension (ECS)

*Adventure™ Grand Tourer
1200 4-TEC ECS*

The operator can adjust the comfort and ride height by Electronic Controlled Suspension (ECS).



1. Min
2. Max

Refer to *REAR SUSPENSION ADJUSTMENT* in the *TUNE YOUR RIDE* section

37) Seat heater

*Adventure™ Grand Tourer
1200 4-TEC*

Seat heater switch is installed at front, near gearshift lever.

Seat heater can be switched ON or OFF.

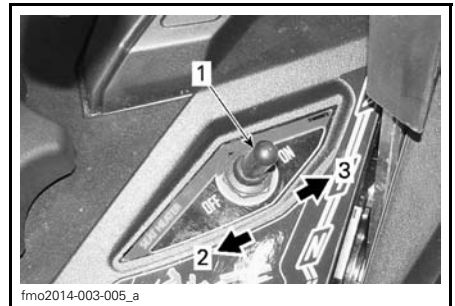

1. Seat heater switch
2. Heat OFF
3. Heat ON

FUEL AND OIL

Fuel Requirements

NOTICE Always use fresh gasoline. Gasoline will oxidize; the result is loss of octane, volatile compounds, and the production of gum and varnish deposits which can damage the fuel system.

Alcohol fuel blending varies by country and region. Your vehicle has been designed to operate using the recommended fuels, however, be aware of the following:

- Use of fuel containing alcohol above the percentage specified by government regulations is not recommended and can result in the following problems in the fuel system components:
 - Starting and operating difficulties.
 - Deterioration of rubber or plastic parts.
 - Corrosion of metal parts.
 - Damage to internal engine parts.
- Inspect frequently for the presence of fuel leaks or other fuel system abnormalities if you suspect the presence of alcohol in gasoline exceeds the current government regulations.
- Alcohol blended fuels attract and hold moisture which may lead to fuel phase separation and can result in engine performance problems or engine damage.

Recommended Fuel

Use unleaded gasoline containing MAXIMUM 10% ethanol. The gasoline must have the following minimum octane requirements:

ENGINE	MINIMUM OCTANE RATING
600 HO E-TEC	95 E10
800R E-TEC	
1200 4-TEC	

NOTICE Use octane rating according to fuel type. Never experiment with other fuels. Engine or fuel system damages may occur with the use of an inadequate fuel.

Fuel Antifreeze Additives

When using oxygenated fuel, additional gas line antifreeze or water absorbing additives are not required and should be not used.

When using non-oxygenated fuel, isopropyl base gas line antifreeze can be used in a proportion of 150 ml of gas line antifreeze added to 40 L of gas.

This precaution is in order to reduce the risk of frost buildup in carburetors or other fuel system components which may lead, in certain cases, to severe damage to engine.

NOTE: Use only methyl hydrate free gas line antifreeze.

Fueling Procedure

Unscrew to fill up tank then fully tighten.

WARNING

- Always stop engine before refueling. Open cap slowly.
- If a differential pressure condition is noticed (whistling sound heard when loosening fuel tank cap) have vehicle inspected and/or repaired before further operation.
- Fuel is flammable and explosive under certain conditions.
- Never use an open flame to check fuel level.
- Never smoke or allow flame or spark in vicinity.
- Always work in a well-ventilated area.
- Never top up the fuel tank before placing the vehicle in a warm area. As temperature increases, fuel expands and may overflow.
- Always wipe off any fuel spillage from the vehicle.

NOTE: Do not sit or lean on seat when fuel tank cap is not properly installed.

Recommended Oil

RECOMMENDED INJECTION OIL		
ENGINE	XPS SYNTHETIC BLEND 2-STROKE OIL (P/N 619 590 103)	XPS SYNTHETIC 2-STROKE OIL (P/N 619 590 106)
600 HO E-TEC	✓	✓
800R E-TEC	✓	✓ Preferred

NOTICE The engine of this snowmobile has been developed and validated using the recommended BRP XPS™ oil. BRP strongly recommends the use of its recommended XPS oil at all times. Damages caused by oil which is not suitable for the engine will not be covered by the BRP limited warranty.

1200 4-TEC

ENGINE	RECOMMENDED ENGINE OIL
1200 4-TEC	XPS 4-STROKE SYNTHETIC OIL (ALL CLIMATE) (P/N 619 590 114)

NOTICE The engine of this snowmobile has been developed and validated using the BRP XPS™ Synthetic 4-stroke oil. BRP strongly recommends the use of its XPS Synthetic 4-stroke oil at all times. Damages caused by oil which is not suitable for the engine will not be covered by the BRP limited warranty.

If the recommended oil is not available, use SAE 0W-40 synthetic-based oil that meets or exceeds the requirements for API service classification SM.

BREAK-IN PERIOD

Operation During Break-In

A break-in period of 10 operating hours or 500 km is required for the vehicle.

After the break-in period, the vehicle should be inspected by an authorized Lynx dealer. Refer to *MAINTENANCE* section.

Engine

During the break-in period:

- Avoid prolonged full throttle operation.
- Avoid sustained accelerations.
- Avoid prolonged cruising speeds.
- Avoid engine overheating.

However, brief accelerations and speed variations contribute to a good break-in.

During the first few hours of break-in, the engine management system controls some engine parameters which will slightly reduce the engine performance.

E-TEC Models

During a predetermined period, the engine management system controls some engine parameters.

The duration is based on fuel volume. It will take approximately two fuel tanks to complete the break-in.

During this period:

- The engine performance and behavior will not be optimal.
- The fuel and oil consumption will be higher.

Drive Belt

A new drive belt requires a break in period of 50 km.

During the break-in period:

- Avoid strong acceleration and deceleration.
- Avoid pulling a load.
- Avoid high speed cruising.

OPERATING INSTRUCTIONS

Engine Starting Procedure

Procedure

1. Apply parking brake.
2. Recheck throttle lever operation.
3. Put your helmet on.
4. Ensure that the tether cord cap is installed on the engine cut-off switch and that the cord is attached to your clothing eyelet.
5. Ensure that the emergency engine stop switch is in the ON position (up).
6. Depress the START button to engage the electric starter and start the engine. Release button immediately when engine has started.

WARNING

Never depress throttle while starting engine.

NOTICE Do not engage electric starter for more than 10 seconds at a time. A rest period of at least 30 seconds should be observed between the cranking cycles to allow electric starter to cool down.

7. Release parking brake.

NOTE: For an initial cold start, do not release parking brake. Perform the *VEHICLE WARM-UP* procedure as explained below.

Emergency Starting

1200 4-TEC Model

Do not attempt any emergency starting procedure. Have the battery charged or replaced.

E-TEC Model

If the starter does not operate and you have followed the steps in *ENGINE STARTING PROCEDURE*, start engine with the emergency cord as follows:

Starting Using an Emergency Starter Rope

The engine can be started with the emergency starter rope supplied with the tool kit. Proceed as follows:

1. Remove belt guard.

WARNING

Do not wind starting rope around your hand. Hold rope by the handle only. Do not start the snowmobile by the drive pulley unless it is a true emergency situation. Have the snowmobile repaired as soon as possible.



2. Attach one end of emergency rope to rewind handle.

NOTE: The spark plug socket can be used as an emergency handle.

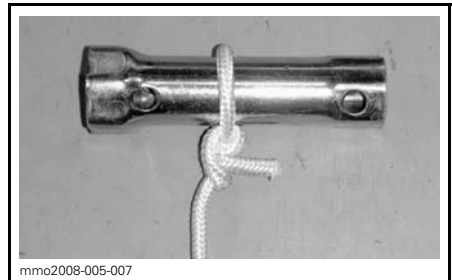

3. Attach the other end of emergency rope to the starter clip supplied in the tool kit.



mmo2008-005-009

- Hook up clip on drive pulley.

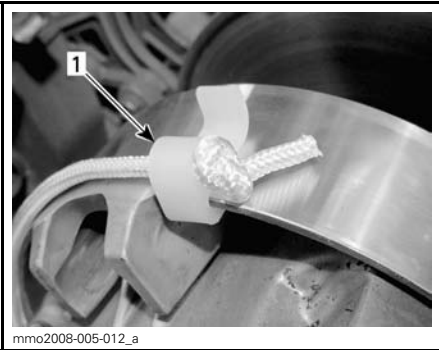

mmo2008-005-012_a

1. Clip installation location
- Wind the rope tightly around drive pulley. When pulled, rope must rotate counterclockwise.

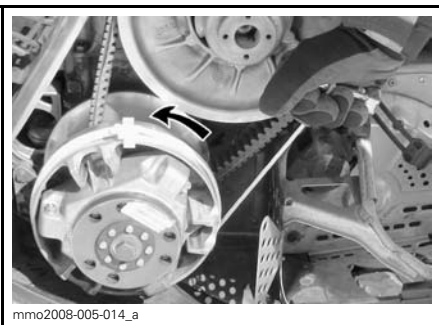

mmo2008-005-014_a

- Pull the rope using a sharp, crisp pull so the rope comes free of the drive pulley.

⚠ WARNING

When starting the snowmobile in an emergency situation, using drive pulley, do not reinstall the belt guard and return slowly to have snowmobile repaired.

Vehicle Warm-Up

Before every ride, vehicle has to be warmed up as follows:

- Start engine as explained in *ENGINE STARTING PROCEDURE* above.
- Allow engine to warm up one or two minutes at idle speed.

NOTE: It is not recommended to let engine running at idle speed for more than 10 minutes.

- Disengage parking brake.
- Apply throttle until drive pulley engages. Drive at low speed the first two or three minutes.

NOTICE If vehicle does not move when throttle is applied, stop engine, remove tether cord cap from the engine cut-off switch, then do the following.

- Check if skis are stuck on the ground. Lift one ski at a time by the handle, then put it down.
- Check if track is stuck on the ground. Lift rear of snowmobile enough to clear track from the ground, then drop.
- Check rear suspension for hard snow or ice accumulation that could interfere with track rotation. Clean the area.

⚠ CAUTION Use proper lifting techniques, notably using your legs force. Do not attempt to lift the rear of vehicle if it is above your limits.

⚠ WARNING

Make sure tether cord cap is removed before standing in front the vehicle, getting close to the track or rear suspension components.

NOTE: On E-TEC models, warm-up is electronically controlled. During this period (up to 10 minutes depending on ambient temperature), engine RPM is limited.

Gearbox Operation

NOTICE

- Always put gearbox in 1st gear when pulling a load.
- Always put gearbox in neutral (N) when parked.
- Come to a complete stop and hold brake before shifting to or from reverse. Wait until the reverse alarm sounds before operating throttle.

Neutral

When set in neutral (N), the gearbox disengages the pulleys from the track.

Shifting in Reverse

To engage reverse gear, proceed as follows:

1. Bring vehicle to a complete stop.
2. Apply and hold brake.
3. With engine at idle speed, select reverse (R) gear using the gearshift lever.

NOTE: It is necessary to push shift lever knob down to move it from neutral to reverse gear.

4. Gently depress throttle lever.

⚠ WARNING

The reverse speed is not limited. Always proceed with caution as fast reverse could result in loss of vehicle stability. Always remain seated. Ensure the path behind is clear of obstacles or bystanders before proceeding.

Shifting in Forward

There are two forward gears.

To engage a forward gear, proceed as follows:

1. Bring vehicle to a complete stop.
2. Apply and hold brake.
3. With engine at idle speed, select low (1) or high (2) gear using the gearshift lever.
4. Gently depress throttle lever.

NOTE: Do not shift when vehicle is moving: When you change gear from 1st to 2nd gear or opposite or to reverse gear vehicle must be stopped (vehicle is not moving and RPM must be at idle).

Shifter rod adjustment

1. Adjust shifter rod to initial length from end to end 258mm
2. Mount the rod to the vehicle
3. Put gear to the Reverse and check if lever touches edge of the slot in the console.
4. If yes, shorten the rod by turning the rod ½ turn and check again.
5. Put gear to 2nd gear and check if lever touches edge of the slot in the console.
6. If yes, lengthen the rod by turning the rod ½ turn and check again

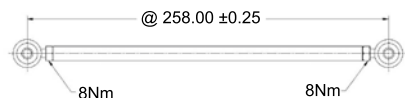

Shutting Off the Engine

Release throttle lever and wait until engine has returned to idle speed.

Shut off the engine using either the emergency engine stop switch or by pulling off the tether cord cap from the engine cut-off switch.

WARNING

Always remove the tether cord cap from engine cut-off switch when vehicle is not in operation in order to prevent accidental engine starting or to avoid unauthorized use by children or others or theft.

Towing an Accessory

Always use a rigid tow bar to tow an accessory. Any towed accessory should have reflectors on both sides and at the rear. Check local laws for brake light(s) requirements.

WARNING

Never tow an accessory with a rope. Always use a rigid tow bar. Using a rope would result in a collision between the object and the snowmobile and possibly in a tip over in case of a rapid deceleration or on a downward slope.

Towing Another Snowmobile

If a snowmobile is disabled and must be towed use a rigid tow bar. Remove the drive belt from disabled snowmobile, refer to *DRIVE BELT* in the *MAINTENANCE PROCEDURE* subsection and tow at moderate speed.

NOTICE Always remove the drive belt of the snowmobile that is to be towed to prevent damage to its belt and drive system.

In an emergency situation only, if a rigid tow bar is not available, a rope can be used. Proceed with extra caution. In some areas, it may be illegal to do so. Check with state or local authorities.

Remove the drive belt, attach the rope to the ski legs (spindles), have someone sit on the towed snowmobile to activate the brake, and tow at low speed.

NOTICE In order to prevent damage to the steering system, never attach the tow rope to the ski loops (handles).

WARNING

Never ride at high speed when towing a disabled snowmobile. Proceed slowly with extra caution.

TUNE YOUR RIDE

WARNING

Suspension adjustment could affect vehicle handling. Always take time to familiarize yourself with the vehicle's behavior after any suspension adjustment have been made.

Snowmobile handling and comfort depend upon suspension adjustments.

Choice of suspension adjustments vary with carrying load, driver's weight, personal preference, riding speed and field condition.

WARNING

Before proceeding with any suspension adjustment, remember:

- Park in a safe place.
- Remove the tether cord cap from the engine cut-off switch.
- Use appropriate lifting device or have assistance to share lifting stress. If a lifting device is not used, use proper lifting techniques, notably using your legs force.
- Do not attempt to lift the front or rear of vehicle if it is above your limits.
- Support front of vehicle off the ground with a suitable device before adjusting suspension.
- Support rear of vehicle off the ground with a wide-base snowmobile stand with a rear deflector panel.
- Make sure support device is stable and secure.

Customize each adjustment one at a time. It may be necessary to readjust center spring after adjusting front springs for instance. Test run the snowmobile under the same conditions; trail, speed, snow, driver riding position, etc. Change one adjustment and retest. Proceed methodically until you are satisfied.

Following are guidelines to fine-tune suspension.

REAR AND FRONT SUSPENSION SPRING PRELOAD FACTORY SETTINGS			
MODEL	SKI	FRONT ARM	REAR ARM
Xtrim Commander 600 E-TEC	7mm / cam position #2	13 mm / cam position #5	13mm / cam position #4
Xtrim Commander Ltd 600 E-TEC	7mm / cam position #2	13 mm / cam position #5	13mm / cam position #4
Grand tourer 600 HO E-TEC	14mm / cam position #4	13 mm / cam position #5	12mm / cam position #4
Grand Tourer 1200 4-TEC	10mm / cam position #3	15mm / cam position #6	12mm / cam position #4
Grand Tourer 1200 4-TEC ECS	10mm / cam position #4	15mm / cam position #3	10mm/ ECS #1
Xtrim Commander 800R E-TEC	11mm	10 mm	15 mm

Rear Suspension Adjustment

NOTICE Whenever adjusting rear suspension, check track tension and adjust as necessary.

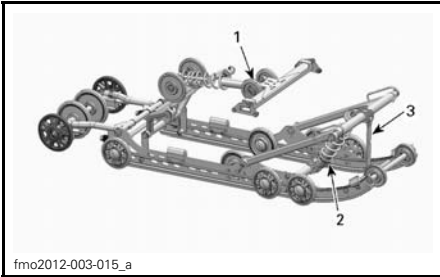

fmo2012-003-015_a

PPS-5900A REAR SUSPENSION

1. Rear spring adjustable for comfort and ride height
2. Center spring for steering behavior
3. Stopper strap for snowmobile weight transfer

Stopper Strap

Ride at low speed then fully accelerate. Note steering behavior.

Adjust stopper strap length accordingly.

NOTICE Whenever stopper strap length is changed, track tension must be readjusted.

REFERENCE TABLE	
WEIGHT TRANSFER (SKI PRESSURE)	WHAT TO DO
Comfortable: good weight transfer (light pressure)	No adjustment required
Light: too much weight transfer (lift off the ground)	Strap too long, reduce strap length
Heavy: not enough weight transfer (heavy pressure)	Strap too short, increase strap length

Increase or decrease strap length by bolting to a different hole.

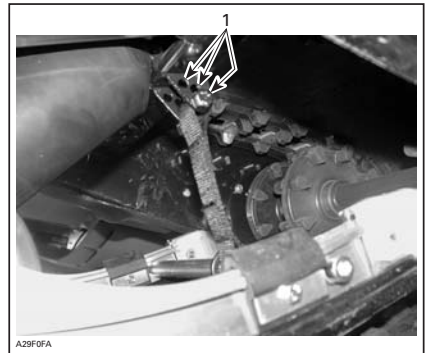

A29F0FA

TYPICAL

1. Adjustment holes (stopper strap)

NOTE: Decreasing the stopper strap length may reduce comfort. If too much weight transfer is felt, try to correct it by adjusting the coupling blocks first.

Rear Springs

Rear spring preload has an effect on comfort, ride height and load compensation.

Also, adjusting rear spring preload shifts more or less weight to the snowmobile front end. As a result, more or less weight is applied to the skis. This has an effect on performance in deep snow, steering effort and handling.

Slight suspension bottoming occurring under the worst riding conditions indicates a good choice of spring preload.

ACTION	RESULT
Increasing preload	Firmer rear suspension
	Higher rear end
	More bump absorption capability
	Heavier steering
Decreasing preload	Softer rear suspension
	Lower rear end
	Less bump absorption capability
	Lighter steering
	Better performance and handling in deep snow

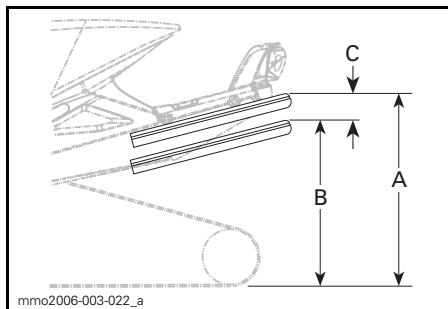

- A. Suspension fully extended
- B. Suspension has collapse with driver, passenger(s) and load added
- C. Distance between dimension "A" and "B", must not exceed 50 to 75 mm (3 to 4 in), see table

REFERENCE TABLE	
C	WHAT TO DO
50 to 75 mm (2 to 3 in)	No adjustment required
More than 75 mm (3 in)	Adjusted too soft, Increase preload (see preload adjustment)
Less than 50 mm (2 in)	Adjusted too hard, Decrease preload (see preload adjustment)

NOTE: If the specification is unattainable with the original springs, see an authorized Lynx dealer for other available springs.

NOTICE To increase spring preload, always turn the left side adjustment cam in a clockwise direction, and the right side cam in a counterclockwise direction.

Electronic Controlled Suspension (ECS)

Adventure™ Grand Tourer 1200 4-TEC ECS

To adjust, proceed as follows:

1. Start engine.

NOTE: When the LEDs are displaying a running light from left to right, it means the system is calibrating itself. No actions are needed in this case. Keep vehicle running as long the led's running stops.

2. Press left or right buttons to increase or decrease spring pre adjustment.

The led display shows the actual spring setting (1 to 9, 1 being the softest setting).



1. Min
2. Max

NOTE: When one of the LED's starts blinking the controller is reporting an error code. Contact an authorized Lynx dealer and report which LED is blinking.

Center Spring

Ride at moderate speed on a trail.

If handlebar seems too easy or too hard to turn, adjust center spring accordingly.

WARNING

Before proceeding with any suspension adjustment, remember:

- park in a safe place
- remove tether cord cap
- lift rear of vehicle off the ground with a wide-base snowmobile stand with a rear deflector panel
- make sure lifting device is stable and secure.

REFERENCE TABLE

STEERING BEHAVIOR	WHAT TO DO
Easy to turn (neutral)	No adjustment required
Harder to turn (oversteering)	Adjusted too soft, increase preload
Very easy to turn (understeering)	Adjusted too hard, decrease preload

Using the suspension adjustment key from toolbox, turn adjustment cam to set the desired preload.

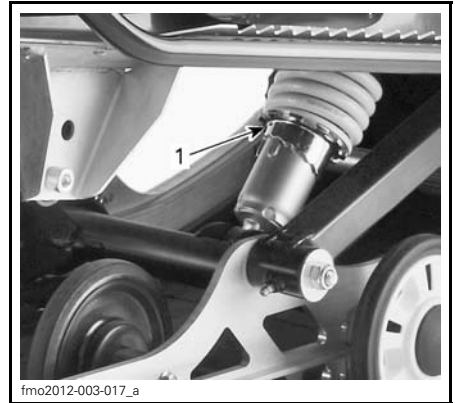

1. Adjustment cam

Center Arm has two positions. When operating the snowmobile on trail, utility or 2-UP, set Center arm on position 1.

When operating the snowmobile in deep snow, it may be necessary to set Center arm to position 2.

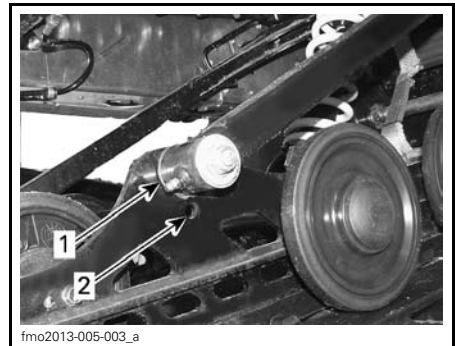

CENTER ARM

1. Position 1
2. Position 2

Deep Snow Riding

When operating the snowmobile in deep snow, it may be necessary to vary stopper strap length and/or riding position, to change the angle at which the track rides on the snow. Operator's familiarity with the various adjustments as well as snow conditions will dictate the most efficient combination.

Front Suspension Adjustment

Front Springs

Front spring preload has an effect on front suspension firmness.

Front spring preload also has an effect on the steering behavior.



TYPICAL - CAM TYPE PRELOAD

1. Adjustment cam



TYPICAL - FRONT SUSPENSION

1. Front springs for handling

WARNING

Always adjust both front springs to same position.

REFERENCE TABLE

HANDLING	WHAT TO DO
Good: steering comfortable to turn	No adjustment required
Bad: steering too easy to turn	Adjusted too soft, increase spring preload
Bad: steering too hard to turn	Adjusted too hard, decrease spring preload

Vehicle Behavior Related to Suspension Adjustment

PROBLEM	CORRECTIVE MEASURES
Front suspension wandering	Check ski alignment and camber angle adjustment. See an authorized Lynx dealer. Reduce ski ground pressure. <ul style="list-style-type: none"> – Reduce front suspension spring preload. – Increase center spring preload. – Reduce rear spring preload.
Snowmobile seems unstable and seems to pivot around its center	Reduce rear suspension front arm pressure. <ul style="list-style-type: none"> – Reduce center spring preload. – Increase rear spring preload. – Increase front suspension spring preload.
Steering feels too heavy	Reduce ski ground pressure. <ul style="list-style-type: none"> – Reduce front suspension spring preload. – Increase center spring preload.
Rear of snowmobile seems too stiff	Reduce rear spring preload.
Rear of snowmobile seems too soft	Increase rear spring preload.
Rear suspension front shock absorber is frequently bottoming	Lengthen stopper strap. Increase center spring preload.
Track spins too much at start	Lengthen stopper strap.

VEHICLE TRANSPORTATION

Make sure that oil reservoir and fuel tank caps are properly installed.

Tilt bed trailers can easily be equipped with a winch mechanism to afford maximum safety in loading. Simple as it may seem, never drive your snowmobile onto a tilt bed trailer or any other kind of trailer or vehicle. Many serious accidents have resulted from driving up and over a trailer. Anchor your vehicle securely, front and rear, even on short hauls. Be certain all equipment is securely fastened. Cover your snowmobile when trailering to prevent road grime from causing damage.

Be certain your trailer meets state or provincial requirements. Ensure the hitch and safety chains are secure and the brake, turn indicators and clearance lights all function.

MAINTENANCE

BREAK-IN INSPECTION

After the first 10 hours or 500 km of operation, whichever comes first, your vehicle have to be inspected by an authorized Lynx dealer. The break-in inspection is very important and must not be neglected.

NOTE: The break-in inspection is at the expense of the vehicle owner.

BREAK-IN INSPECTION (2-STROKE)	
ENGINE	Inspect engine motor mounts
	Inspect exhaust system and check for leaks
	Tighten exhaust manifold screws to specified torque
	Check coolant level
	Adjust oil injection pump (550 model)
	Inspect oil injection pump adjustment (All except E-TEC)
FUEL SYSTEM	Inspect fuel lines and connections
	Inspect throttle cable
DRIVE SYSTEM AND BRAKE	Inspect drive belt
	Visually inspect drive pulley
	Tighten drive pulley retaining screw to specified torque
	Inspect driven pulley
	Adjust and align track
	Change chaincase / gearbox oil
	Adjust drive chain (except models with gearbox)
	Check brake fluid level
Inspect brake hose, pads and disk	
STEERING SYSTEM	Inspect steering mechanism
	Inspect skis and runners
	Tighten frame pyramid rod screws to specified torque
SUSPENSION	Inspect front suspension
	Inspect rear suspension (including stopper straps and slider shoes)
	Lubricate front and rear suspension
	Retorque rear profile screws (6 pcs) to 25 N•m to 30 N•m (Only XU models)
ELECTRICAL SYSTEM	Inspect spark plugs (only 550)

BREAK-IN INSPECTION (4-STROKE)	
ENGINE	Inspect engine seals and gaskets for leaks
	Inspect exhaust system and check for leaks
	Check coolant level
	Change engine oil and filter
FUEL SYSTEM	Inspect fuel lines and connections
	Inspect throttle cable (except 900 ACE)
DRIVE SYSTEM AND BRAKE	Inspect drive belt
	Visually inspect drive pulley
	Tighten drive pulley retaining screw to specified torque
	Inspect driven pulley
	Check driven pulley preload
	Adjust and align track
	Change chaincase / gearbox oil
	Adjust drive chain (Not for models equipped with gearbox)
	Check brake fluid level
Inspect brake hose, pads and disk	
STEERING SYSTEM	Inspect steering mechanism
	Inspect skis and runners
	Tighten frame pyramid rod screws to specified torque
SUSPENSION	Inspect front suspension
	Inspect rear suspension (including stopper straps and slider shoes)
	Retorque rear profile screws (6 pcs) to 25 N•m to 30 N•m (Only XU models)

PERIODIC MAINTENANCE CHART

WARNING

It is recommended that the assistance of an authorized LYNX dealer be periodically obtained on other components/systems not covered in this guide. Unless otherwise specified, engine must be cold and not running. Remove the tether cord cap (DESS key) before performing any maintenance or adjustment, unless otherwise specified. Vehicle must be parked in a safe place, away from the trail.

WARNING

Observe WARNINGS and CAUTIONS mentioned throughout this guide which are relevant to the item being checked. When component conditions seem less than satisfactory, replace with genuine BRP parts or approved equivalents.

Some items may not apply to your particular model.

MAINTENANCE SCHEDULE (2-STROKE)

NOTE: The maintenance schedule does not exempt the pre-ride inspection.

EVERY 1 500 KM	
DRIVE SYSTEM	Models with chaincase: Adjust drive chain
	Models with chaincase: Check chaincase oil level
	Models with gearbox: Check oil level
EVERY 3 000 KM OR 1 YEAR (WHICHEVER COMES FIRST)	
ENGINE	Inspect heat shields
	Inspect engine rubber mounts
	Inspect exhaust system and check for leaks
	Inspect cooling system cap, hoses and clamps and check for leaks
	Adjust engine stopper
DRIVE SYSTEM AND BRAKE	Visually inspect and clean drive pulley
	Tighten drive pulley retaining screw to specified torque
	Clean driven pulley
	Adjust and align track
	Inspect brake hose, pads and disk
STEERING SYSTEM	Inspect steering mechanism
SUSPENSION	Inspect front suspension
	Inspect rear suspension and stopper strap.
	Lubricate front and rear suspension whenever the vehicle is used in wet conditions (wet snow, rain, puddles)
	All models with T/A shocks, oil change / service.
ELECTRICAL SYSTEM	Replace spark plugs (All except of E-TEC)

MAINTENANCE SCHEDULE (2-STROKE)

EVERY 6 000 KM OR 2 YEARS (WHICHEVER COMES FIRST)	
ENGINE	Clean and lubricate rewind starter
FUEL SYSTEM	Inspect fuel pump strainer and replace if necessary
	Inspect throttle cable
DRIVE SYSTEM	Replace brake fluid
	Lubricate the splines of joint between QRS axle and gearbox (XU models)
	Replace the following drive pulley wear parts: slider shoes, O-rings and sliding sheave bushing (800R E-TEC)

EVERY 10 000 KM OR 3 YEARS (WHICHEVER COMES FIRST)	
ENGINE	E-TEC: Inspect oil pump strainer and clean if needed
	Replace oil filter (550 only)
DRIVE SYSTEM	Replace the following drive pulley wear parts: spring cover bushing and ramps (800R E-TEC)
ELECTRICAL SYSTEM	E-TEC: Replace spark plugs (must be replaced by an authorized BRP dealer)

EVERY 5 YEARS	
ENGINE	Replace engine coolant
FUEL SYSTEM	Replace in-line fuel filter

MAINTENANCE SCHEDULE (4-STROKE)

NOTE: The maintenance schedule does not exempt the pre-ride inspection.

EVERY 1 500 KM	
DRIVE SYSTEM	Models with chaincase: Adjust drive chain
	Models with chaincase: Check chaincase oil level
	Models with gearbox: Check oil level

EVERY 3 000 KM OR 1 YEAR (WHICHEVER COMES FIRST)	
ENGINE	Inspect all heat shields
	Inspect exhaust system and check for leaks (1200 4-TEC and 900 ACE)
DRIVE SYSTEM AND BRAKE	Visually inspect and clean drive pulley
	Tighten drive pulley retaining screw to specified torque
	Check driven pulley preload
	Clean driven pulley
	Adjust and align track
	Inspect brake hose, pads and disk
STEERING SYSTEM	Inspect steering mechanism
SUSPENSION	Inspect front suspension
	Inspect rear suspension and stopper strap.
	Lubricate front and rear suspension whenever the vehicle is used in wet conditions (wet snow, rain, puddles)
	All models with T/A shocks, oil change / service

EVERY 6 000 KM OR AT PRE-SEASON (WHICHEVER COMES FIRST)	
ENGINE	Change engine oil and filter

MAINTENANCE SCHEDULE (4-STROKE)

EVERY 6 000 KM OR 2 YEARS (WHICHEVER COMES FIRST)	
FUEL SYSTEM	Replace fuel filter (1200 4-TEC)
	Replace fuel pump outlet filter (900 ACE)
DRIVE SYSTEM AND BRAKE	Replace drive pulley slider shoes, O-ring and rollers and inspect ramps (1200 4-TEC and 900 ACE only)
	Replace brake fluid
	Inspect throttle cable (except 900 ACE)
	Lubricate the splines of joint between QRS axle and gearbox (XU models)
EVERY 10 000 KM OR 3 YEARS (WHICHEVER COMES FIRST)	
ELECTRICAL SYSTEM	Replace spark plugs
EVERY 20 000 KM	
ENGINE	Check valve clearance and adjust if necessary. (1200 4-TEC and 900 ACE)
EVERY 5 YEARS	
ENGINE	Replace engine coolant

MAINTENANCE PROCEDURES

This subsection includes instructions for basic maintenance procedures. If you have the necessary mechanical skills and the required tools, you can perform these procedures. If not, see your authorized Lynx dealer.

Other important items in the maintenance schedule that are more difficult and require special tools are best performed by your authorized Lynx dealer.

⚠ WARNING

Turn off the engine, remove tether cord cap and follow these maintenance procedures when performing maintenance. If you do not follow proper maintenance procedures you can be injured by hot parts, moving parts, electricity, chemicals or other hazards.

⚠ WARNING

Should removal of a locking device be required (e.g. lock tabs, self-locking fasteners, etc.) when undergoing disassembly/assembly, always replace with a new one.

Air Intake Silencer Prefilter

Air Intake Silencer Prefilter Verification

Ensure that air intake silencer prefilter is properly installed, clean and in good condition.



1. Prefilter

To remove prefilter, simply pull it out.

To install prefilter, push it back in place making sure it is properly secured.

Engine Coolant

⚠ WARNING

Never open coolant tank cap when engine is hot.

Engine Coolant level

Remove the upper RH side panel. Refer to *SIDE PANELS* in *CONTROLS, INSTRUMENTS AND EQUIPMENT* subsection.

The cold level line is just above the retaining clamp.

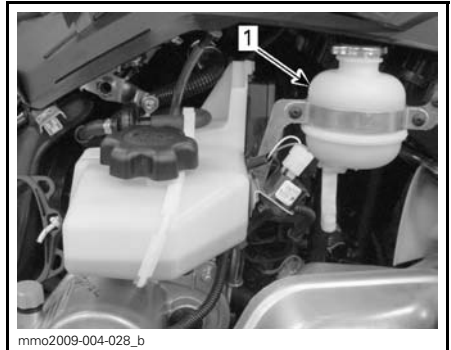

TYPICAL

1. Cold level line

Check coolant level at room temperature with the cap removed. Liquid should be at cold level line (engine cold) of coolant tank.

NOTE: When checking coolant level at low temperature it may be slightly below the cold level line.

To add coolant, remove front coolant tank fixation and slightly pull the tank outwards to make room for the cap.

If additional a large amount of coolant has to be added or if entire system has to be refilled, refer to an authorized Lynx dealer.

Recommended Engine Coolant

Always use ethylene-glycol antifreeze containing corrosion inhibitors specifically for internal combustion aluminum engines.

Cooling system must be filled with BRP PREMIXED COOLANT (P/N 219 700 362) or with distilled water and antifreeze solution (50% distilled water, 50% antifreeze).

Injection Oil (600HO E-TEC, 800RE-TEC)

Adding Injection Oil

Remove the upper RH side panel. Refer to *SIDE PANELS* in *CONTROLS, INSTRUMENTS AND EQUIPMENT* subsection.

Always maintain a sufficient amount of recommended injection oil in the injection oil reservoir.

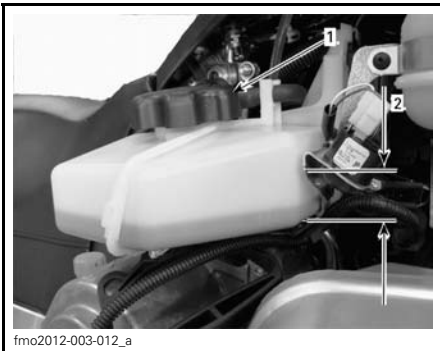

fmo2012-003-012_a

TYPICAL

1. Oil reservoir

Unscrew injection oil reservoir cap to fill up reservoir then fully tighten.

NOTICE Check level and refill every time you refuel.

⚠ WARNING

Do not overfill. Reinstall cap and fully tighten. Wipe off any oil spills. Oil is highly flammable when heated.

Engine Oil (1200 4-TEC)

Engine Oil Level

NOTICE Check level before each ride and refill if necessary. Do not overfill. Operating the engine with an improper level may severely damage engine. Wipe off any spillage.

Place vehicle on a level surface and proceed as follows to check oil level:

1. Start engine and let it reach its normal operating temperature. Engine is at normal temperature when rear radiator gets warm, indicating that the thermostat is open.
2. Let engine run at idle for 30 more seconds.
3. Stop engine.
4. Open the LH side panel, refer to *CONTROLS, INSTRUMENTS AND EQUIPMENT*.
5. Remove the drive belt guard, refer to *DRIVE BELT GUARD*.
6. Remove dipstick from the filler tube, then wipe it clean.
7. Completely insert dipstick in the filler tube.
8. Remove dipstick and check the oil level. Oil level should be between the MIN and MAX marks as shown, add if necessary.

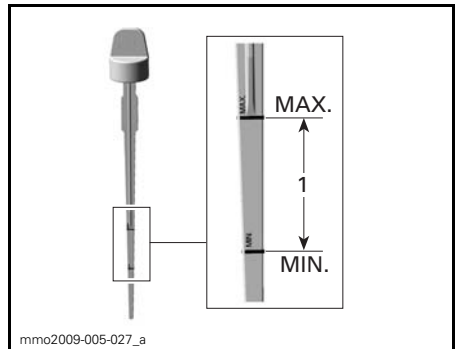

mmo2009-005-027_a

1. Oil level between MIN. and MAX.

⚠ CAUTION Engine oil can be very hot.

⚠ WARNING
Wipe off any oil spills. Oil is highly flammable when heated.

Exhaust System

Exhaust System Verification

The tail pipe of the muffler should be centered with the exit hole in the bottom pan. Exhaust system must be free of rust or leaks. Make sure that all parts are securely in place.

Check retaining springs condition and replace if necessary.

The exhaust system is designed to reduce noise and to improve the total performance of the engine. Modification may be in violation of local laws.

NOTICE If any exhaust system component is removed, modified or damaged, severe engine damage may result.

Spark Plugs

Spark plugs inspection or replacement must be done by an authorized Lynx dealer.

Recommended Spark Plug

⚠ CAUTION Use only spark plug mentioned list below. It must be installed to a specific torque, refer to *SPARK PLUG INSTALLATION* for proper installation procedure.

Spark Plug Removal/Installation

Removal

Open LH side panel.

Remove belt guard, refer to *BELT GUARD REMOVAL*.

Unplug spark plug cables.

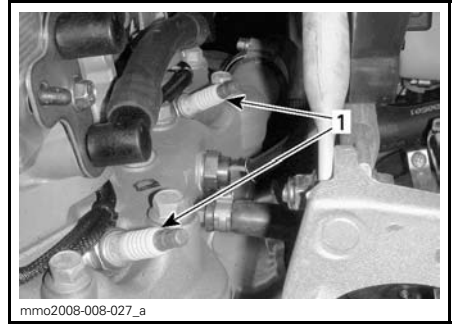

LH SIDE OF ENGINE COMPARTMENT

1. Spark plugs

Using tools from tool kit, unscrew spark plugs one turn.

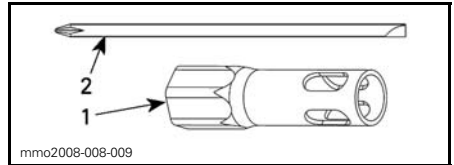

1. 16 mm socket
2. Screwdriver rod

Clean spark plugs and cylinder heads with pressurized air if possible.

⚠ WARNING
Always wear safety goggles when using pressurized air.

Unscrew spark plugs completely then remove them.

Installation

Prior to installation, make sure that contact surfaces of cylinder head and spark plugs are free of grime.

Using a feeler gauge, verify spark plug gap.

Replace spark plug if not within specifications.

CAUTION Do not attempt to adjust gap on these plugs.

Model	Spark plug type	Spark plug gap
600 HO E-TEC	NGK PZFR6F	Not adjustable. 0.75mm ± 0.05 mm
800R E-TEC	NGK PFR7AB	Not adjustable. 0.75 + 0.05 mm/- 0.05 mm
1200 4-TEC	NGK CR8EKB	Not adjustable

Screw spark plugs into cylinder head by hand until it bottoms.

Tighten plugs using tools from tool kit or with a torque wrench and a proper socket.

Using Tools from Tool Kit

Use the 16 mm socket and the screwdriver rod from the vehicle tool kit.

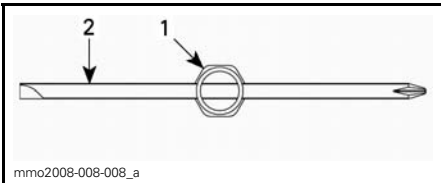

TOP VIEW

- 16 mm socket
- Screwdriver rod

Torque spark plugs as per the following illustrations.

NOTE: Ensure spark and washer sits properly on cylinder head.

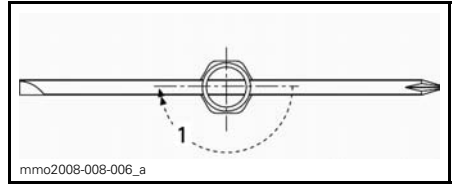

NEW SPARK PLUG

- Torque 1/2 of a turn

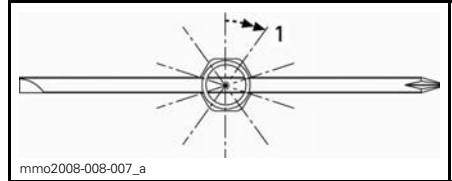

USED SPARK PLUG

- Torque 1/10 of a turn

Using a Torque Wrench.

Torque spark plugs to 27.5 N•m.

Engine Stopper (E-TEC models)

Engine Stopper Adjustment

The engine stopper is located on the LH front engine support, in front of the drive pulley.

- Remove tether cord cap from engine cut-off switch.
- Remove the LH lower side panel, refer to *CONTROLS, INSTRUMENTS AND EQUIPMENT*.
- Remove drive belt guard, refer to *DRIVE BELT GUARD REMOVAL* in this subsection.
- Loosen the three screws retaining the engine stopper to the engine support just enough to allow a vertical play (1/2 to one turn).

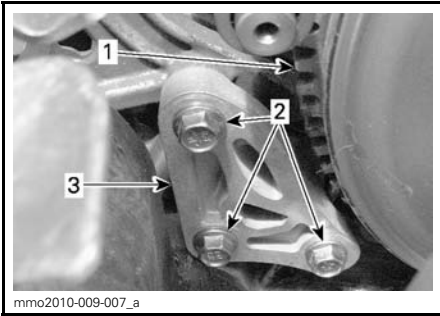

- 1. Drive pulley
- 2. Engine stopper screws
- 3. Engine stopper

- 5. Press engine stopper down vertical. Engine stopper and rubber stop block (on engine) should be on contact.
- 6. Tighten screws to the specified torque, following the illustrated sequence. Take care not to pinch the feeler gauge.

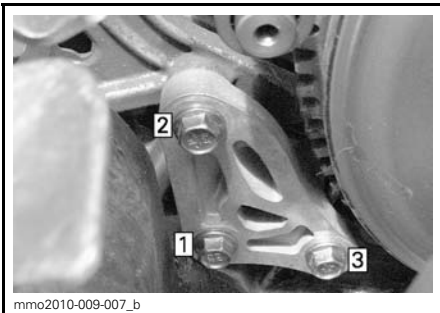

TIGHTENING SEQUENCE

STOPPER SCREW TIGHTENING TORQUE
10 N•m ± 2 N•m

NOTICE Serious pulley damage can occur if the engine stopper and its screws are not properly installed.

Brake Fluid

Recommended Fluid

Use only DOT 4 brake fluid from a sealed container. An opened container may be contaminated or may have absorbed moisture from the air.

⚠ WARNING

Use only DOT 4 brake fluid from a sealed container. To avoid serious damage to the braking system, do not use fluids other than the recommended one, nor mix different fluids for topping up.

NOTICE Brake fluid can damage painted and plastic parts. Handle with care. Rinse thoroughly in case of spillage.

Brake Fluid Level

Place vehicle on a level surface. Check brake fluid (DOT 4) in reservoir for proper level. Add fluid (DOT 4) as required.

⚠ WARNING

Use only DOT 4 brake fluid from a sealed container. To avoid serious damage to the braking system, do not use fluids other than the recommended one, nor mix different fluids for topping up.

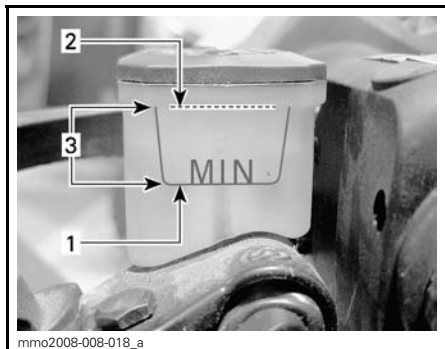

1. Minimum
2. Maximum
3. Operating range

NOTICE Brake fluid can damage painted and plastic parts. Handle with care. Rinse thoroughly in case of spillage.

Gearbox Oil

Recommended Gearbox Oil

RECOMMENDED GEARBOX OIL
XPS SYNTHETIC GEAR OIL (75W 140) (P/N 619 590 182)

NOTICE The gearbox oil have to meet requirements of API GL 5 class. The gearbox of this snowmobile has been developed and validated using the XPS™ Synthetic gear oil. BRP strongly recommends the use of its XPS Synthetic gear oil at all times. Damages caused by oil which is not suitable for the gearbox will not be covered by the BRP limited warranty.

Gearbox Oil Level

With the vehicle on a level surface, check the oil level by removing the check plug on the left side of gearbox.

Oil level must reach the threaded hole's lower edge.

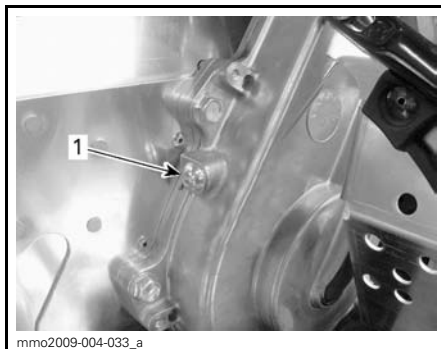

1. Check plug

To add oil, proceed as follows:

1. Remove the filler cap.



TYPICAL

1. Filler cap
2. Pour recommended oil in gearbox by the filler hole until oil comes out by the check plug hole.
3. Reinstall check plug and torque to specification.

CHECK PLUG TORQUE
$10\text{ N}\cdot\text{m} \pm 1\text{ N}\cdot\text{m}$

Drive Belt

Drive Belt Inspection

Inspect belt for cracks, fraying or abnormal wear (uneven wear, wear on one side, missing cogs, cracked fabric). If abnormal wear is noted, probable cause could be pulley misalign-

ment, excessive RPM with frozen track, fast starts without warm-up period, burred or rusty sheave, oil on belt or distorted spare belt. Contact an authorized Lynx dealer.

Spare Drive Belt

A spare drive belt can be stored in the storage box.

NOTE: Spare drive belt is not supplied with the snowmobile (Spare drive belt is supplied with Commander Limited).

CAUTION To avoid damages to the drive belt, ensure that things which are carried in storage box are not damaged the spare drive belt.

Drive Belt Replacement

Drive Belt Removal

1. Remove tether cord cap from engine cut-off switch.
2. Open LH side panel, refer to *CONTROLS, INSTRUMENTS AND EQUIPMENT* in this section.
3. Remove belt guard, refer to *BELT GUARD REMOVAL*.
4. Insert the driven pulley expander provided in the tool kit in the threaded hole on the adjuster hub as shown.



PULLEY EXPANDER ON ALUMINUM ADJUSTER HUB

5. Open the driven pulley by screwing the tool in.
6. Remove the belt by slipping it over the top of the driven pulley, then over the drive pulley.

Drive Belt Installation

1. If necessary, open the driven pulley, refer to *DRIVE BELT REMOVAL* above.
2. Slip the belt over the drive pulley, then over the driven pulley.

NOTICE Do not force or use tools to pry the belt into place, as this could cut or break the cords in the belt.

NOTE: The maximum drive belt life span is obtained when belt is installed with arrows in the direction of rotation.

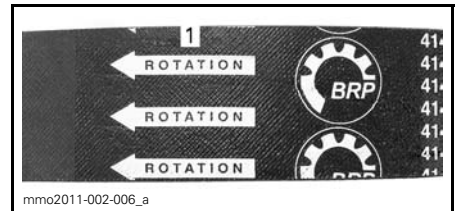

1. To be pointed in the direction of rotation
3. Unscrew and remove the driven pulley expander from the pulley.
4. Rotate the driven pulley several times to properly set the belt between the sheaves.
5. If a new belt was installed, adjust the belt height. Refer to *DRIVE BELT HEIGHT ADJUSTMENT* below.
6. Install belt guard, refer to *DRIVE BELT GUARD INSTALLATION*.
7. Close side panel, refer to *SIDE PANELS* in *CONTROLS, INSTRUMENTS AND EQUIPMENT* subsection.

Drive Belt Height Adjustment

The drive belt height must be checked every time a new belt is installed.

To adjust the drive belt height, proceed as follows:

1. Remove the tether cord cap from engine cut-off switch.
2. Open LH side panel, refer to *SIDE PANELS* in *CONTROLS, INSTRUMENTS AND EQUIPMENT* subsection.
3. Remove belt guard, refer to *DRIVE BELT GUARD REMOVAL*.
4. Loosen the clamping bolt.

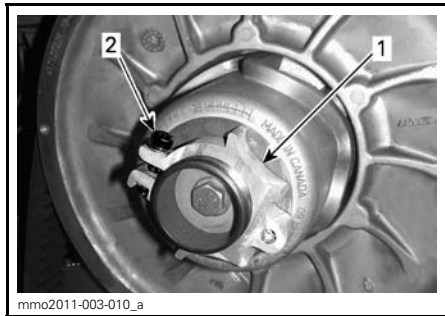

ALUMINUM ADJUSTER HUB

1. Adjuster hub
2. Clamping bolt

5. Using the suspension adjustment tool provided in the tool kit, turn the ring 1/4 turn at a time then rotate the driven pulley to properly set the belt between the pulley sheaves.



ALUMINUM ADJUSTER HUB

1. Suspension adjustment tool

NOTE: The adjustment ring has left hand treads.

Belt without External Cogs

Repeat step 5 until the external surface of drive belt exceeds driven pulley edge by 0mm.

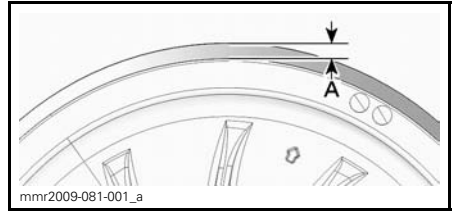

PRELIMINARY SETTING

- A. 0mm

Belt with External Cogs

Repeat step 5 until the bottom of grooves on the external side of drive belt are flush with the driven pulley edges.

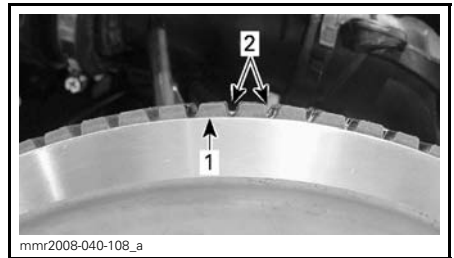

PRELIMINARY SETTING

1. Driven pulley edge
2. External drive belt grooves

All Drive Belt Types

NOTE: Turning the ring counterclockwise lowers the belt in the pulley. Turning the ring clockwise raises the belt in the pulley.

6. Tighten the clamping bolt to specification.

CLAMPING BOLT TORQUE

5.5 N•m ± 0.5 N•m

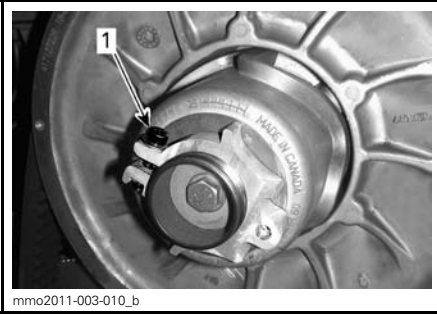

mmo2011-003-010_b

1. Clamping bolt

7. Install belt guard, refer to *DRIVE BELT GUARD INSTALLATION*.
8. Close side panel, refer to *SIDE PANELS* in *CONTROLS, INSTRUMENTS AND EQUIPMENT* subsection.

NOTE: This setting is correct as a preliminary adjustment for most models and belt types. In some cases, when starting the engine, the vehicle could creep, indicating that the belt is too tight.

If the vehicle creeps, lower the drive belt height from the preliminary setting. Repeat procedure until creeping stops.

Reverse Activation

NOTE: The reverse may not activate or may be harder to activate if the belt is positioned too high in the driven pulley. If reverse activation does not work properly, ensure the drive belt is properly adjusted. Adjust the drive belt lower in the driven pulley if needed.

Drive Pulley

Drive Pulley Adjustment (only TRA)

The drive pulley is factory calibrated for sea level operation.

⚠ WARNING

Remove the tether cord cap from engine cut-off switch before performing any adjustment. Vehicle must be parked in a safe place, away from the trail.

The drive pulley is factory calibrated to transmit maximum engine power at a predefined RPM. Factors such as ambient temperature, altitude or surface condition may vary this critical engine RPM thus affecting snowmobile efficiency.

This adjustable drive pulley allows setting maximum engine RPM to maintain maximum power.

Calibration screws should be adjusted so that actual maximum engine RPM matches the maximum horsepower RPM.

ENGINE	MAXIMUM HORSEPOWER RPM
600 HO E-TEC	8100 RPM (± 100)
800R E-TEC	7900 RPM (± 100)

NOTE: Use precision digital tachometer for engine RPM adjustment.

NOTE: The adjustment has an effect on high RPM only.

Calibration screw has a notch on top of its head.

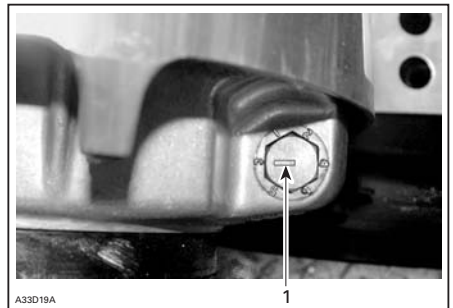

A33D19A

1. Notch

There are 6 positions numbered 1 to 6. Each position modifies maximum engine RPM by approximately 200 RPM. Lower position numbers decrease engine RPM in steps of 200 RPM and higher position numbers increase it in steps of 200 RPM.

Example:

Calibration screw is set at position 4 and is changed to position 6. So maximum engine RPM is increased by 400 RPM.

Procedure

Just loosen lock nut enough to pull calibration screw partially out and adjust to desired position. Do not completely remove the lock nut. Torque lock nuts to $10\text{ N}\cdot\text{m} \pm 2\text{ N}\cdot\text{m}$.

NOTICE Do not completely remove calibration screw otherwise internal washers will fall off. Always adjust all 3 calibration screws and make sure they are all set to the same position.

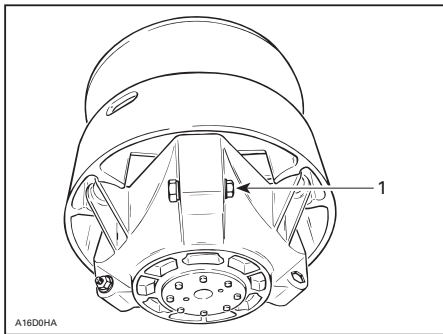

TYPICAL

1. Loosen just enough to permit rotating of calibrate screw

⚠ WARNING

NEVER disassemble or modify the drive pulley.

Improper assembly or modifications could cause the pulley to explode violently under the stress generated by the high rotational speed.

See your Lynx dealer to maintain or service the drive pulley. Improper servicing or maintenance may affect performance and reduce belt life. Always respect maintenance schedules.

⚠ WARNING

NEVER operate engine:

- Without shields and belt guard securely installed.
- With hood and/or side panels opened or removed.

NEVER attempt to make adjustments to moving parts while engine is running.

Track

Track Condition

⚠ WARNING

Remove the tether cord cap before performing any maintenance or adjustment, unless otherwise specified. Vehicle must be parked in a safe place, away from the trail.

Remove the tether cord cap.

Lift the rear of the snowmobile and support it with a wide-base snowmobile mechanical stand with a rear deflector panel. With the engine off, rotate the track by hand, and inspect condition. If worn or cut, or if track fibers are exposed, or if missing or defective inserts or guides are noted; contact an authorized Lynx dealer.

Snowmobiles Equipped with Traction Enhancing Products

If your snowmobile is equipped with a BRP approved studded track, PROCEED WITH A VISUAL INSPECTION OF YOUR TRACK BEFORE EACH USE.

Look for any defects, such as:

- Perforations in the track
- Tears in the track (particularly around traction holes on studded tracks)
- Lugs that are broken or torn off, exposing portions of rods
- Delamination of the rubber
- Broken rods
- Broken studs (studded tracks)
- Bent studs (studded tracks)
- Missing studs
- Studs that are torn off the track
- Missing track guide(s)
- Also, ensure that studs nut are tighten to the recommended torque.

On approved studded tracks, replace broken or damaged studs immediately. If your track shows signs of deterioration, it must be replaced immediately. When in doubt, ask your dealer.

⚠ WARNING

Riding with a damaged track or studs could lead to a loss of control, resulting in a risk of serious injury or death.

For complete information on traction enhancing products, refer to the section entitled *TRACTION ENHANCING PRODUCTS* in the *SAFETY INFORMATION* section at the beginning of this Operator's Guide.

Track Tension and Alignment

NOTE: Track tension and alignment are interrelated. Do not adjust one without the other.

⚠ WARNING

To prevent serious injury to individuals near the snowmobile:

- NEVER stand behind or near a moving track.
- Always use a wide-base snowmobile stand with a rear deflector panel if it is necessary to rotate track.
- When the track is raised off the ground, only run it at the lowest possible speed.

Centrifugal force could cause debris, pieces of torn track, or an entire severed track to be violently thrown backwards out of the tunnel with tremendous force.

Track Tension Verification

NOTE: Ride the snowmobile in snow about 15 to 20 minutes prior to adjusting track tension.

1. Remove tether cord cap from engine cut-off switch.
 2. Lift rear of vehicle and support it off the ground.
- ⚠ CAUTION** Use proper lifting techniques, notably using your legs force. Do not attempt to lift the rear of vehicle if it is above your limits.
3. Allow rear suspension to fully extend.
 4. Use the TENSIO METER (P/N 414 348 200).



DEFLECTION
40 mm to 50 mm

5. Set deflection using bottom O-ring.



mmr2009-133-003_b

DEFLECTION SETTING

1. Bottom O-ring set to specification
6. Place upper O-ring to 0 kgf.
7. Position the tensiometer on track, halfway between front and rear idler wheels.
8. Push the tensiometer downwards until bottom O-ring (deflection) be aligned with the bottom of slider shoe.



mmr2009-133-003_a

LOAD READING

1. Upper O-ring
10. Load reading must be as per the following table.

TRACK ADJUSTMENT SPECIFICATION	
TRACK DEFLECTION SETTING	40 mm to 50 mm
TRACK LOAD READING	7.3 kg

11. If load reading is not in accordance with the specification, adjust track tension. Refer to *TRACK TENSION ADJUSTMENT*.

NOTICE Too much tension will result in power loss and excessive stress on suspension components.

Track Tension Adjustment

1. Remove the tether cord cap from engine cut-off switch.
2. Remove rear wheel caps (if so equipped).

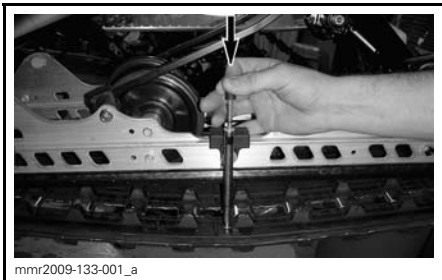

mmr2009-133-001_a

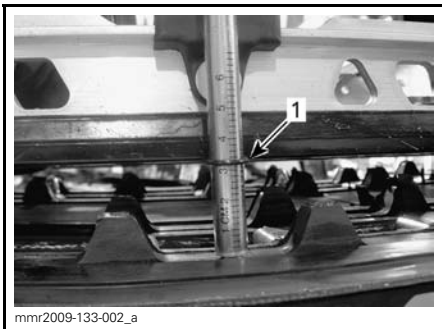

mmr2009-133-002_a

1. Deflection O-ring aligned with slider shoe
9. Read load recorded by the upper O-ring on the tensiometer.



fmr2008-048-007_a

1. RH rear idler wheel cap
3. Loosen the rear idler wheel retaining bolts.

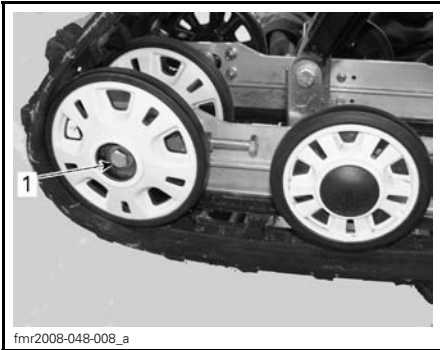

1. RH rear idler wheel bolt

4. Tighten or loosen both adjustment screws to increase or decrease track tension.

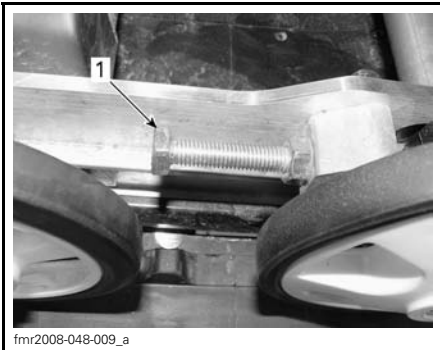

1. RH adjustment screw

5. If correct tension is unattainable, contact an authorized Lynx dealer.
6. Retighten retaining bolts.

TORQUE
48 N•m ± 6 N•m

7. Check track alignment as described below.

Track Alignment

⚠ WARNING

Before checking track alignment, ensure that the track is free of all particles which could be thrown out while track is rotating. Keep hands, tools, feet and clothing clear of track. Always lift the snowmobile on a wide-base stand with a rear deflector panel. Ensure no one is standing in close proximity to the snowmobile, especially at the rear of the track. Never rotate track at high speed. Centrifugal force could cause debris, damaged or loose studs, pieces of torn track, or an entire severed track to be violently thrown backwards out of the tunnel with tremendous force.

Start the engine and accelerate slightly so that track barely turns. This must be done in a short period of time (about 5 seconds).

Check that the track is well centered; equal distance on both sides between edges of track guides and slider shoes.

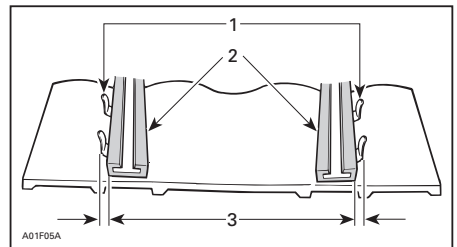

1. Guides
2. Slider shoes
3. Equal distance

If off center, perform alignment as follows:

⚠ WARNING

Remove the tether cord cap from engine cut-off switch before performing any maintenance or adjustment, unless otherwise specified. Vehicle must be parked in a safe place, away from the trail.

1. Remove the tether cord cap from engine cut-off switch.
2. Loosen rear idler wheel retaining bolts.
3. Tighten the adjustment bolt on side where the slider shoe is the farthest from the track insert guides.

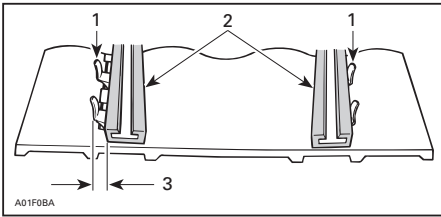

1. Guides
 2. Slider shoes
 3. Tighten on this side
4. Tighten lock nuts.
 5. Torque idler wheels retaining bolts to $48 \text{ N}\cdot\text{m} \pm 6 \text{ N}\cdot\text{m}$.

⚠ WARNING

Make sure all fasteners are properly tightened to avoid losing an idler wheel or causing the track to lock.

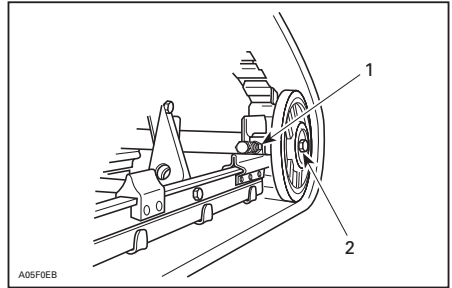

TYPICAL
 1. Locknut
 2. Retaining bolts

6. Start engine and rotate track slowly to recheck alignment.
7. Reposition snowmobile on ground.
8. Install rear wheel caps if so equipped.

Suspension

Rear Suspension Condition

Visually inspect all suspension components including slider shoes, springs, wheels, etc.

NOTE: During normal driving, snow will act as a lubricant and coolant for the slider shoes. Extensive riding on ice or sanded snow, will create excessive heat build-up and cause premature slider shoe wear.

Suspension Stopper Strap Condition

Inspect stopper strap for wear and cracks, bolt and nut for tightness. If loose inspect holes for deformation. Replace as required. Torque nut to $9 \text{ N}\cdot\text{m} \pm 1 \text{ N}\cdot\text{m}$.

Rear Suspension Lubrication

Lubricate rear suspension at grease fittings using SUSPENSION GREASE (P/N 293 550 033). Refer to *MAINTENANCE SCHEDULE* for maintenance frequency.

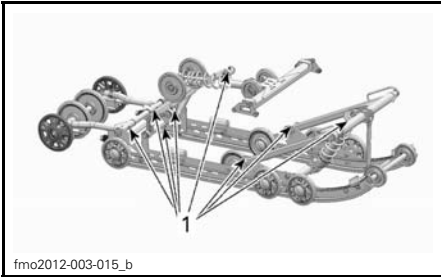

fmo2012-003-015_b

1. Grease fittings

Steering and Front Suspension Condition

Visually inspect steering and front suspension for tightness of components (steering arms, control arms and links, tie rods, ball joints, ski bolts, ski legs, etc.). If necessary, contact an authorized Lynx dealer.

Skis

Wear and Condition of Skis and Runners

Check the condition of the skis and ski runner carbides. If worn, contact an authorized Lynx dealer.

⚠ WARNING
Excessively worn skis and/or ski runners will adversely affect snowmobile control.

Blade Ski

Standard position for Ski is that Ski runner is installed on center holes.

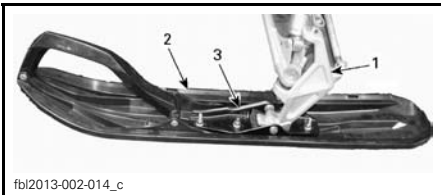

fbl2013-002-014_c

- TYPICAL**
1. Ski leg
2. Ski
3. Ski Runner

Ski stance can be adjusted by spacer location. It can be installed inside or outside of the ski leg

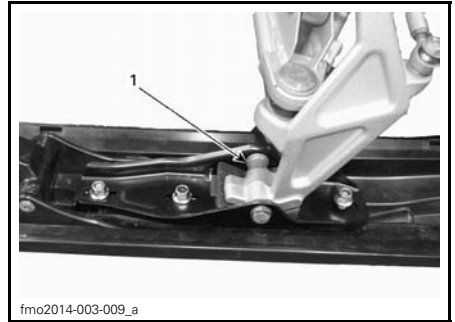

fmo2014-003-009_a

1. Spacer on inside of ski leg

Fuses

Fuse Inspection

The electrical system is protected with fuses.

Check fuse condition and replace it if necessary.

To remove fuse from holder, pull fuse out. Check if filament is melted.

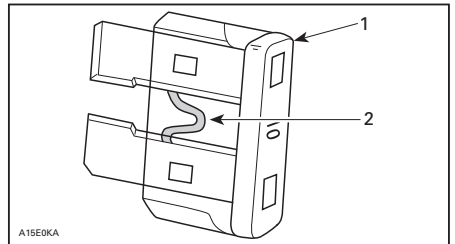

A15E0KA

1. Fuse
2. Check if melted

⚠ WARNING
Do not use a higher rated fuse.

⚠ WARNING
If fuse has burnt out, source of malfunction should be determined and corrected before restarting. See an authorized Lynx dealer for servicing.

Fuse Location

The fuse box is located behind the front seat upholstery at the LH front lower portion of seat.

Refer to the decal inside the fuse box cover or the *SPECIFICATIONS* subsection for fuse identification.

To access the fuse box, carefully pull seat upholstery out of the aluminum extrusion by pulling the plastic strip downwards and sideways at the same time.



TYPICAL - PULL STRIP



1. Fuse box

Close upholstery by pushing the strip back in the aluminium extrusion.

Lights

Always check light operation after bulb replacement.

Headlights Bulb Replacement

NOTICE Never touch glass portion of an halogen bulb with bare fingers, it shortens its operating life. If glass is touched, clean it with isopropyl alcohol which will not leave a film on the bulb.

1. By using a small screwdriver, release multifunction gauge locking tabs.

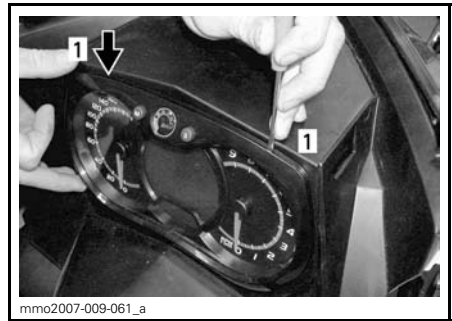

1. Locking tab

2. Gently pull on multifunction gauge and set aside.



3. Unplug burnt bulb connector. Remove the rubber boot.

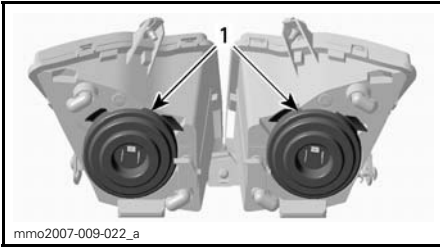

1. Rubber boots

4. Press and pull both sides of the retaining clip at the same time to release it from bulb support.

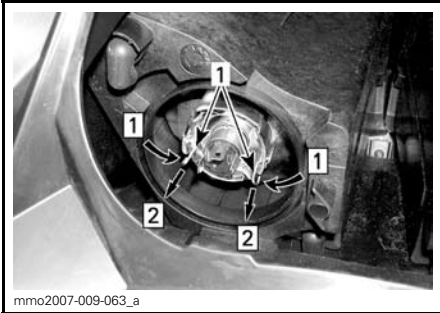

Step 1: Push both sides
Step 2: Pull to release

1. Retaining clip

5. Pull bulb and replace. Properly re-install parts.

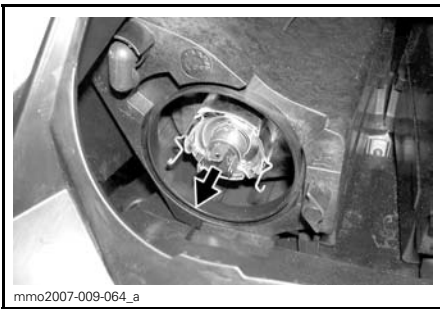

PULL BULB AND REPLACE

Headlights Beam Aiming

Remove multifunction gauge, refer to *HEADLIGHTS BULB REPLACEMENT*. Turn knob to adjust beam height.

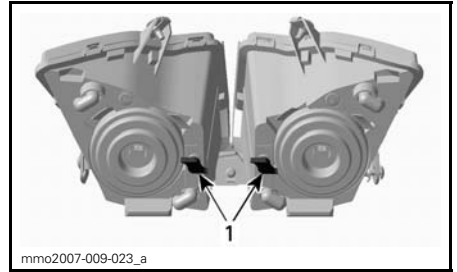

TYPICAL

1. Knobs

Taillight Bulb Replacement

1. Carefully pull taillight assembly by both ends at the same time.

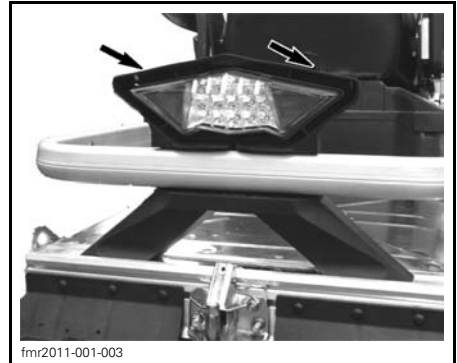

NOTICE Plastic retaining pins may break if taillight assembly is forced sideways. Avoid sideways movement when pulling taillight out.

NOTICE Do not pull taillight housing out too far to avoid damaging wiring.

2. Remove lamp socket from taillight assembly.
 - 2.1 Turn socket counterclockwise.
 - 2.2 Pull socket out.
3. Replace bulb.
4. Secure socket into taillight assembly.
5. Push taillight assembly back into place.

NOTE: Led taillight: leds cannot be replaced.

If led taillight is failed change taillight assembly. Fasten new taillight by screws.

VEHICLE CARE

Post-Operation Care

Remove snow and ice from rear suspension, track, front suspension, steering mechanism and skis.

WARNING

Make sure tether cord cap is away from engine cut-off switch before standing in front the vehicle, getting close to the track or rear suspension components.

Always cover your snowmobile when leaving it outside overnight or during extended periods of inactivity. This will protect it from frost and snow as well as help retain its appearance.

Vehicle Cleaning and Protection

Remove any dirt or rust.

To clean the entire vehicle, use only flannel cloths or equivalent.

NOTICE It is necessary to use flannel cloths or equivalent on windshield and hood to avoid scratching the surfaces.

To remove grease, oil and grime, use BRP HEAVY DUTY CLEANER (P/N 293 110 001).

NOTICE Do not use heavy duty cleaner on decals or vinyl.

To remove stubborn dirt from all plastic and vinyl surfaces, use XPS MULTI-PURPOSE CLEANER (P/N 219 701 709).

To remove scratches on windshield or hood use the SCRATCH REMOVER KIT (P/N 861 774 800).

NOTICE Never clean plastic parts or hood with strong detergent, degreasing agent, paint thinner, acetone, products containing chlorine, etc.

Wax painted portion of the vehicle for better protection.

NOTE: Apply wax on glossy finish only.

STORAGE

During summer, or when a snowmobile is not in use for more than three months, proper storage is necessary.

STORAGE	
VEHICLE	Clean the vehicle
ENGINE	2-Stroke models: Lubricate engine. See owners manual for instruction.
	Block muffler with rags
	Add fuel stabilizer to fuel following the product manufacturer recommendations Run the engine after adding the product to the fuel
DRIVE SYSTEM AND BRAKE	Lubricate brake lever pivot
	Lift rear of vehicle until track is clear of the ground. Do not release track tension
SUSPENSION	Inspect and lubricate rear suspension
	Lubricate front and rear suspension
ELECTRICAL SYSTEM	Charge battery monthly to keep it fully charge during storage

⚠ CAUTION Use appropriate lifting device or have assistance to share lifting stress. If a lifting device is not used, use proper lifting techniques, notably using your legs force. Do not attempt to lift the rear of vehicle if it is above your limits.

NOTICE The snowmobile has to be stored in a cool and dry place and covered with an opaque but ventilated tarpaulin. This will prevent sun rays and grime from affecting plastic components and vehicle finish.

Engine Storage Mode (E-TEC)

Like other engines, the 600 HO E-TEC has to be properly lubricated at storage for internal parts protection. The E-TEC system offers a built-in engine storage lubrication function (summerization) that can be initiated by the operator.

To engage procedure, do the following:

1. Place the vehicle in a well ventilated area.
2. Start the engine and let it run at idle speed until it reaches its operating temperature (watch the coolant

temperature on the display or verify the rear heat exchanger becomes warm).

3. Push the SET (S) button to select odometer mode.

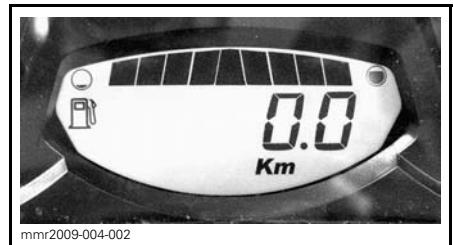

NOTE: The storage mode does not function in other modes (trip A, trip B and hr trip).

- Repeatedly depress the HI/LOW beam switch rapidly, then, **while doing this**, press and hold the **SET button** until **PUSH "S"** appears on the display.

NOTE: It is critical for this procedure to depress the HI/LOW beam switch repeatedly **before** holding down the SET button.



- Release all buttons when gauge displays **PUSH "S"** appears.
- Again, press and hold the SET (S) button for 2 - 3 seconds.

NOTE: The gauge will display **OIL** when the storage procedure is initiated.

- When gauge displays **OIL**, release button and wait for the lubrication function to end.

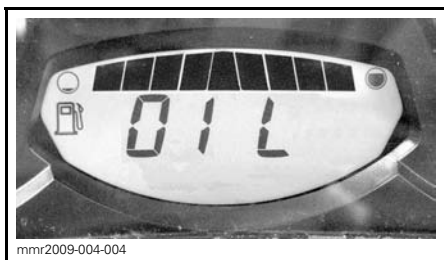

Do not touch anything during engine lubrication cycle.

The engine lubrication function takes approximately 1 minute. During this time engine RPM will increase slightly to approximately 1600 RPM and the oil pump will "oil flood" the engine.

At the end of engine lubrication function, the ECM will stop the engine.

Remove tether cord cap from engine cut-off switch.

NOTICE Do not start the engine during storage period.

PRESEASON PREPARATION

PRESEASON PREPARATION (2-STROKE)	
ENGINE	Inspect engine rubber mounts
	Check exhaust system condition and check for leaks
	Tighten exhaust manifold screws or nuts to specified torque
	Inspect engine fan belt (550 model)
	Adjust oil injection pump (550 model)
	Inspect cooling system cap, hoses and clamps and check for leaks
	Check coolant density
	Inspect crankshaft PTO seal
FUEL SYSTEM	Inspect fuel lines and connections
	Clean, inspect and adjust carburetors (550 model)
	Clean and inspect throttle body (except 550 model)
	Inspect throttle cable
DRIVE SYSTEM AND BRAKE	Inspect drive belt (adjust at every drive belt replacement)
	Clean and visually inspect drive pulley
	Clean and inspect driven pulley
	Inspect, adjust and align track
	Adjust drive chain (Not for models equipped with gearbox)
	Change chaincase / gearbox oil
	Check brake fluid level
	Inspect brake hose, pads and disk
STEERING SYSTEM	Inspect steering mechanism
	Inspect skis and runners
SUSPENSION	Inspect front suspension
	Inspect rear suspension (including stopper straps and slider shoes)
ELECTRICAL SYSTEM	Inspect spark plugs (All except E-TEC)
	Replace spark plugs after starting the engine with the old spark plugs to burn the excess of storage oil (550 model)
	Charge battery (if so equipped)
	Adjust headlight beam aiming

PRESEASON PREPARATION (4-STROKE)	
ENGINE	Visually inspect engine seals and gaskets and check for leaks
	Check exhaust system condition and check for leaks
	Change engine oil and filter
	Check coolant density
FUEL SYSTEM	Inspect fuel lines and connections
	Clean and inspect throttle body
	Inspect throttle cable (except 900 ACE)
DRIVE SYSTEM AND BRAKE	Inspect drive belt (adjust at every drive belt replacement)
	Clean and visually inspect drive pulley
	Clean and inspect driven pulley
	Inspect, adjust and align track
	Adjust drive chain (Not for models equipped with gearbox)
	Change chaincase / gearbox oil
	Check brake fluid level
	Inspect brake hose, pads and disk
STEERING SYSTEM	Inspect steering mechanism
	Inspect skis and runners
SUSPENSION	Inspect front suspension
	Inspect rear suspension and stopper strap.
ELECTRICAL SYSTEM	Charge battery (if so equipped)
	Adjust headlight beam aiming

TECHNICAL INFORMATION

VEHICLE IDENTIFICATION

Vehicle Description Decal

Vehicle description decal is located on right hand side of tunnel.



TYPICAL

1. Vehicle description decal

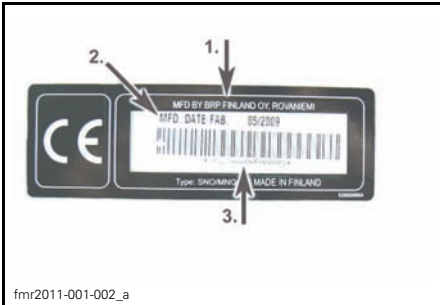

VEHICLE DESCRIPTION DECAL

1. Manufacturer name
2. Manufacturing date
3. Vehicle identification number (VIN)

Identification Numbers

The main components of your snowmobile (engine and frame) are identified by different identification numbers. It may sometimes become necessary to locate these numbers for warranty purposes or to trace your snowmobile in the event of loss. These numbers are required by the authorized Lynx dealer to complete warranty claims properly. No warranty will be allowed by BRP if the engine identification number or vehicle identification number (VIN) is removed or mutilated in any way. We strongly recommend that you take note of all the

identification numbers on your snowmobile and supply them to your insurance company.

Vehicle Identification Number (VIN)

VIN is scribed on vehicle description decal. See above. It is also engraved on tunnel near vehicle description decal.

Model number and model year are part of the information found in the VIN. See illustration.

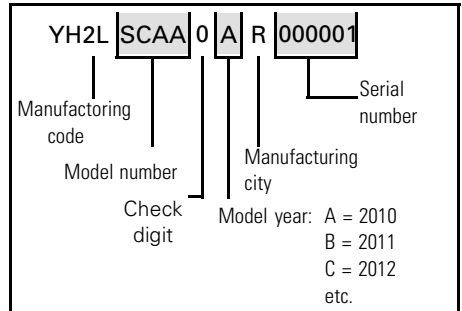

Engine Identification Number

Refer to the following illustrations to locate the engine identification number on the applicable engine.



TYPICAL - 600 HO E-TEC ENGINE

1. Engine serial number

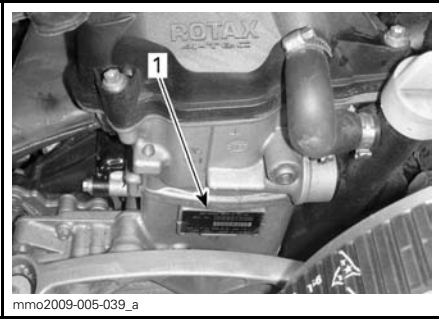

1200 4-TEC ENGINE
1. Engine serial number

EC-DECLARATION OF CONFORMITY

The EC-Declaration of Conformity does not appear in this version of the Operator's Guide.

Please refer to the printed version that was delivered with your vehicle.

Vibrations in the seat (EN 1032, ISO 5008), is less than 0,5 m/s².

Vibrations in the handle (EN 1032, ISO 5008), is less than 2,5 m/s².

SPECIFICATIONS

SYSTEM	MODELS
ENGINE	600HO E-TEC
Engine type	Rotax® 593, liquid cooled w/Reed valve, 3D-RAVE
Cylinders	2
Displacement	594.4 cm ³
Bore	72 mm
Stroke	73 mm
Maximum horsepower engine RPM	8100 RPM
Fuel injection system	E-TEC direct injection
Exhaust system	Single tuned pipe, baffle muffler
Engine oil	XPS SYNTHETIC BLEND 2-STROKE OIL (P/N 619 590 103)
Engine oil tank capacity	2.8 L
Coolant	Ethyl glycol/water mix (50% coolant, 50% distilled water). Use BRP premix coolant or coolant specifically designed for aluminum engines
Recommended fuel type	Premium unleaded
Minimum octane rating	95 (Fuel which may contain up to 10% ethanol)
Fuel tank capacity	45 L
ENGINE	800R E-TEC
Engine type	Rotax® 797, liquid cooled w/Reed valve, 3D-RAVE
Cylinders	2
Displacement	799.5 cm ³
Bore	82 mm
Stroke	76 mm
Maximum horsepower engine RPM	7900 RPM
Fuel injection system	E-TEC direct injection
Exhaust system	Single tuned pipe, baffle muffler
Engine oil	XPS SYNTHETIC BLEND 2-STROKE OIL (P/N 619 590 103)
Engine oil tank capacity	2.8 L
Coolant	Ethyl glycol/water mix (50% coolant, 50% distilled water). Use BRP premix coolant or coolant specifically designed for aluminum engines
Recommended fuel type	Premium unleaded
Minimum octane rating	95 (Fuel which may contain up to 10% ethanol)
Fuel tank capacity	45 L

SPECIFICATIONS

ENGINE	1200 4-TEC
Engine type	Rotax 1203, liquid cooled, 4-Stroke, D.O.H.C. with balancer shaft, dry sump
Cylinders	3
Displacement	1 170.7 cm ³
Bore	91 mm
Stroke	60 mm
Maximum horsepower engine RPM	7800 RPM
Fuel injection system	Multi point EFI, 52 mm heated throttle body
Exhaust system	Exhaust pipe, muffler
Engine oil	XPS 4-STROKE SYNTHETIC OIL (ALL CLIMATE) (P/N 619 590 114)
Engine oil tank capacity	Oil change with filter: 3.5 L
Coolant	Ethyl glycol/water mix (50% coolant, 50% distilled water). Use BRP premix coolant or coolant specifically designed for aluminum engines
Recommended fuel type	Regular unleaded (fuel containing maximum 10% ethanol)
Minimum octane	95 (fuel which may contain up to 10% MAX ethanol)
Fuel tank capacity	45 L

DRIVE SYSTEM			
Drive pulley	Type	600 HO E-TEC	TRA III™
		800 R E-TEC	TRA VII
		1200 4-TEC	eDrive 2
	Engagement	600 HO E-TEC	3000 RPM ± 100
		800 R E-TEC	3800 RPM ± 100
		1200 4-TEC	2200 RPM ± 100
Driven pulley type		800 R E-TEC	QRS-short
		600 HO E-TEC	QRS
		1200 4-TEC	
Drive sprocket number of teeth	Adventure GT		8
	Xtrim Commander, Adventure GT CE		7
Gearbox oil			XPS SYNTHETIC GEAR OIL (75W 140) (P/N 619 590 182)
Gearbox oil capacity			700 ml
Track nominal width			500mm
Track nominal length			392.3mm
Track profile height	Xtrim Commander		44 mm
	Adventure GT		32 mm
Track tension	Deflection		40 mm to 50 mm
	Force ⁽¹⁾		7.3 kg
Track alignment			Equal distance between edges of track guides and slider shoes
BRAKE SYSTEM			
Brake system			Hydraulic, REV-XP brake type
Brake fluid			DOT 4

SPECIFICATIONS

SUSPENSION		
Front suspension		A-LFS
Front shock	Xtrim Commander 600, Adventure GT	HPG 36
	Adventure GT ECS	HPG 36, long stroke
	Xtrim Commander 800 R	KYB 36 R
Front suspension max. travel	Xtrim	210 mm
	Adventure GT	225 mm
Rear suspension		PPS 5900 A
Front arm shock	Xtrim Commander, 600, Adventure GT	HPG 36
	Xtrim Commander 800R	KYB 36
	Adventure GT ECS	HPG 36 Long
Rear arm shock	Xtrim Commander 600, Adventure GT	HPG 36
	Xtrim Commander, 800R	KYB 46
	Adventure GT CE	2xMC25
	Adventure GT ECS	HPG 36 with Electronic preload adjust
Rear suspension max. travel		340 mm
ELECTRICAL SYSTEM		600 HO E-TEC
Magneto output		12V/1200 W
Headlights bulb HI/LOW beam		2 x 60/55 Watts (H-4)
Taillight bulb		Led
Spark plug	Type	NGK PZFR6F ⁽²⁾
	Gap	0.75 mm ± 0.05 mm (Not adjustable)
Fuses/ Relays/ Capacitor	F 1: Battery	30 A
	F 2: Start	5 A
	F 3: Horn (optional)	10 A
	F 4: Fan	15 A
	F5: Air suspension (opitonal)	15 A
	F6: GPS & Charger	10 A
	R 2:	Fan relay
	R 3:	Accessory relay

ELECTRICAL SYSTEM		800 R E-TEC
Magneto output		12V/1200 W
Headlights bulb HI/LOW beam		2 x 60/55 Watts (H-4)
Taillight bulb		Led
Spark plug	Type	NGK PFR7AB ⁽²⁾
	Gap	0.75 mm ± 0.05 mm (Not adjustable)
Fuses/ Relays/ Capacitor	F 1: Battery	30 A
	F 2: Start	5 A
	F 3: Horn (optional)	10 A
	F 4: Fan	15 A
	F5: Air Suspension (optional)	15 A
	F6: GPS & Charger	10 A
	R 1:	Accessory relay
	R 2:	Fan relay

SPECIFICATIONS

ELECTRICAL SYSTEM		1200 4-TEC
Magneto output		12V/490 W
Headlights bulb HI/LOW beam		2 x 60/55 Watts (H-4)
Taillight bulb		Led
Spark plug	Type	NGK CR8EKB ⁽²⁾
	Gap	Not adjustable
Fuses	F 1: HIC/CDI	5 A
	F 2: Fuel pump	10 A
	F 3: HIC	5 A
	F 4: HIC	5 A
	F 5: HIC	5 A
	F 6: Rear light / PW Hood	10 A
	F 7: Headlights	15 A
	F 8: Relay/Gauge	10 A
	F 9: Relay/Gauge	7.5 A
	F 10: Fan	15 A
	F 11: Rear power outlet	5 A (10 A with horn)
	F 12: Air Suspension	15 A
	F 13 :Charging	30 A
Relays	R 1:	Run relay
	R 2:	Fan relay
	R 3:	Load relay

WEIGHT AND DIMENSIONS		
Dry weight	Xtrim Commander 600 HO E-TEC	287 kg
	Xtrim Commander LTD 600 HO E-TEC	304 kg
	Xtrim Commander 800R E-TEC	292 kg
	Adventure GT 600 HO E-TEC	303 kg/306 kg
	Adventure GT 1200 4-TEC	325 kg
	Adventure GT CE 1200 4-TEC	336 kg
Vehicle overall length		323 cm
Vehicle overall width	Xtrim	112 cm to 116.2 cm
	Adventure GT	119.3 cm to 123.5 cm
Vehicle overall height		142.5 cm
Ski stance	Xtrim	975 adj. (+42mm)
	Adventure GT	1060, adj +42mm

(1)

Measure gap between slider shoe and bottom inside track when exerting a downward pull to the track.

NOTICE (2) Do not attempt to adjust gap on this spark plug.

TROUBLESHOOTING

TROUBLESHOOTING GUIDELINES (E-TEC)

ELECTRIC STARTER DOES NOT WORK

1. Emergency engine stop switch in OFF position or tether cord cap not installed on engine cut-off switch.
 - *Place the emergency engine stop switch in the ON position and install tether cord cap (on engine cut-off switch).*
2. Throttle applied while attempting an engine start.
 - *Release throttle while cranking.*

ENGINE IS CRANKED BUT FAILS TO START

1. No fuel to the engine.
 - *Check fuel tank level, add fuel if necessary.*
2. System voltage too low.
 - *Contact an authorized Lynx dealer.*

ENGINE RPM DOES NOT REACH CLUTCH ENGAGEMENT POINT

1. D.E.S.S. key not recognized. D.E.S.S. pilot lamp blinks (slow short beeps/repetitive).
 - *Properly install tether cord cap.*
 - *Install a tether cord cap with the D.E.S.S. key for which this snowmobile was programmed.*

ENGINE OVERHEATS

1. Insufficient snow or hard packed snow.
 - *Drive in loose snow. If there is no loose snow near, pull over, stop engine and let it cool down. Once engine has cooled down, reach loose snow as soon as possible.*
2. Low coolant level.
 - *Check coolant level, see MAINTENANCE PROCEDURES.*
3. Clogged heat exchangers.
 - *Clean heat exchangers.*
4. Rear suspension adjusted too high (too much distance between the snow guard and the ground)

ENGINE LACKS POWER

1. Engine warm-up in progress (E-TEC).
 - *Drive vehicle at low speeds for a few minutes.*
2. Engine break-in period not completed (E-TEC).
 - *Complete break-in period.*
3. Incorrect drive pulley adjustment.
 - *Adjust drive pulley, refer to MAINTENANCE PROCEDURES.*
4. Drive and driven pulleys require servicing.
 - *Contact an authorized Lynx dealer.*

ENGINE LACKS POWER (cont'd)

5. Drive belt worn too thin.

- *If the drive belt has lost more than 3 mm (1/8 in) of its original width, it will affect vehicle performance.*
- *Replace drive belt.*

6. Incorrect track adjustment.

- *See MAINTENANCE and/or an authorized Lynx dealer for proper alignment and tension adjustments.*

7. RAVE valves problem (E-TEC).

- *Contact an authorized Lynx dealer.*

8. Fuel pressure too low.

- *Contact an authorized Lynx dealer.*

ENGINE BACKFIRES

1. Engine is running too hot.

- *See ENGINE OVERHEATS.*

2. Ignition timing is incorrect or ignition system failure.

- *Contact an authorized Lynx dealer.*

3. Exhaust system leak.

- *Contact an authorized Lynx dealer.*

4. Fuel pressure too low.

- *Contact an authorized Lynx dealer.*

ENGINE MISFIRES

1. Water in fuel.

- *Drain fuel system and refill with fresh fuel.*

2. RAVE valves malfunction (E-TEC).

- *Have RAVE valves system inspected by an authorized Lynx dealer.*

HEATED GRIPS/THUMB WARMERS ARE NOT WORKING

1. Engine RPM is too low.

- *Make sure engine RPM is above 2000.*

ENGINE HAS SHUT DOWN

1. The engine shuts down after long periods of idling.

- *Do not let engine idle too long. Refer to VEHICLE WARM-UP in OPERATING INSTRUCTION.*

TROUBLESHOOTING GUIDELINES (1200 4-TEC)

STARTER DOES NOT WORK

1. Engine stop switch in OFF position or tether cord cap (D.E.S.S. key) away from post.
 - *Place engine stop switch in the ON position and install tether cord cap (D.E.S.S. key) on post.*
2. Throttle applied while attempting an engine start.
 - *Release throttle while cranking.*

ENGINE RPM DOES NOT REACH CLUTCH ENGAGEMENT POINT

1. D.E.S.S. did not read tether cord cap (D.E.S.S. key) code. D.E.S.S. pilot lamp blinks (slow short beeps/repetitive).
 - *Properly install tether cord cap (D.E.S.S. key).*
2. D.E.S.S. has read a different code than the one programmed. D.E.S.S. pilot lamp blinks rapidly (fast short beeps/repetitive).
 - *Install a tether cord cap (D.E.S.S. key) for which this snowmobile was programmed.*

ENGINE OVERHEATS

1. Insufficient snow or hard packed snow.
 - *Drive in loose snow. If there is no loose snow near, pull over, stop engine and let it cool down. Once engine has cooled down, reach loose snow as soon as possible.*
2. Low coolant level.
 - *Check coolant level, see MAINTENANCE PROCEDURES.*
3. Clogged heat exchangers.
 - *Clean heat exchangers.*
4. Rear suspension adjusted too high (too much distance between the snow guard and the ground)

ENGINE LACKS POWER

1. Drive and driven pulleys require servicing.
 - *Contact an authorized Lynx dealer.*
2. Drive belt worn too thin.
 - *If the drive belt has lost more than 3 mm (1/8 in) of its original width, it will affect vehicle performance.*
 - *Replace drive belt.*
3. Incorrect track adjustment.
 - *See MAINTENANCE INFORMATION and/or an authorized Lynx dealer for proper alignment and tension adjustments.*

ENGINE MISFIRES

1. Water in fuel.
 - *Drain fuel system and refill with fresh fuel.*

ENGINE HAS SHUT DOWN WHILE IDLING.

1. The engine shuts down after long periods of idling.

- *Do not let engine idle too long. Refer to VEHICLE WARM-UP in OPERATING INSTRUCTION.*

MONITORING SYSTEM

Pilot Lamps, Messages and Beeper Codes

Gauge pilot lamp(s) will inform you if an anomaly occurs or to inform you of a particular condition.

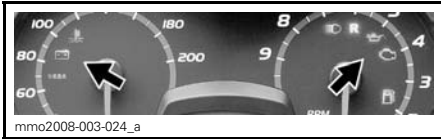

TYPICAL — PILOT LAMPS

Pilot lamp can flash alone or in combination with another lamp.

On the multifunction analog/digital gauge, the display is used as a complement of the pilot lamps to give you a brief description if an anomaly occurs or to inform you of a particular condition.

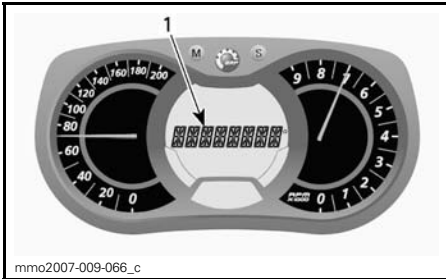





1. Message display

Messages will be displayed with a beep code and pilot lamp(s).

Beeper codes will be heard and messages (depending on gauge model) will be displayed to catch your attention.

See table below for details.

NOTE: Some of the listed pilot lamps and messages do not apply to all models.

PILOT LAMP(S) ON	BEEPER	MESSAGE DISPLAY	DESCRIPTION
	4 short beeps every 5 minutes	LOW OIL	Four stroke engines: Low engine oil pressure. Stop vehicle in a safe place then, check oil level. Fill to proper level. If oil level was correct, discontinue use and contact an authorized Lynx dealer.
	4 short beeps every 30 seconds	ENGINE OVERHEAT	Engine is overheating, reduce snowmobile speed and run in loose snow or stop engine immediately and let engine cool down. Check coolant level, refer to <i>MAINTENANCE</i> . If coolant level is correct and overheating persists, contact an authorized Lynx dealer. Do not run the engine if condition persists.
		MUFFLER	Reduce speed or stop engine. Let engine cool down and restart. If overheating persists, contact an authorized Lynx dealer. Do not run the engine if condition persists.
	Short beeps repeating rapidly	ENGINE OVERHEAT	Critical overheat. Stop engine immediately and let engine cool down. Check coolant level, refer to <i>MAINTENANCE</i> . If coolant level is correct and overheating persists, contact an authorized Lynx dealer. Do not run the engine if condition persists.
		MUFFLER OVERHEAT	Critical overheat. Stop engine immediately and let engine cool down. If overheating persists, contact an authorized Lynx dealer. Do not run the engine if condition persists.
		ECM OVERHEAT	Do not run the engine if condition persists.
	4 short beeps every 5 minutes	LOW BAT	Indicate a low or high battery voltage condition. See an authorized Lynx dealer as soon as possible.
		HIGH BAT	
	4 short beeps	CHECK ENGINE	Engine fault, see an authorized Lynx dealer as soon as possible.
—	4 short beeps every 5 minutes	KNOCK	Engine detonation (RPM is limited when this condition occurs). <ul style="list-style-type: none"> – Ensure recommended fuel is used. – Check fuel quality, replace if necessary. – If fault still occurs, contact an authorized Lynx dealer.

PILOT LAMP(S) ON	BEEPER	MESSAGE DISPLAY	DESCRIPTION
—	4 short beeps every 5 minutes	REV LIMIT	Engine RPM limited for protection when certain faults occur.
—	Short beeps repeating rapidly	SHUTDOWN	Shutdown procedure in force due to engine overheating or fuel pump problem, remove tether cord cap from engine cut-off switch and contact an authorized Lynx dealer.
—	—	COMMUNICATION	Communication problem between ECM and gauge. Stop engine, remove tether cord cap . Wait a few minutes, then start engine. If problem persists, contact an authorized Lynx dealer.
D.E.S.S.	2 short beeps	—	Good key, vehicle ready to operate.
	2 short beeps, repeating slowly	CHECK KEY	Unable to read key (bad connection). Make sure the key is clean and correctly snapped on post.
	Short beeps repeating rapidly	BAD KEY	Invalid key or key not programmed. Use the proper key for the vehicle or have the programmed.
—	—	 (blinking)	Fuel level sender problem.
—	—	THROTTLE OPEN	Throttle applied while attempting an engine start (engine cranks but won't run). Release throttle while starting.
—	—	DROWN MODE	Throttle wide open while attempting an engine start (engine cranks but won't run). Release throttle while starting.

How to Read Fault Codes

Multifunction Analog/Digital Display Only

To read any active fault code, press and hold MODE (M) Button and simultaneously depress the HI/LOW beam switch repeatedly several times.

If two or more codes are registered, use SET (S) or MODE (M) to scroll.

To exit the fault codes mode, press and hold MODE (M) Button.

Contact an authorized Lynx dealer for code signification.

WARRANTY

BRP FINLAND OY INTERNATIONAL LIMITED WARRANTY: 2014 LYNX® SNOWMOBILES

1) SCOPE OF THE LIMITED WARRANTY

BRP Finland Oy ("BRP") warrants its 2014 LYNX snowmobiles from defects in material or workmanship for the period and under the conditions described below.

All genuine LYNX parts and accessories, installed by an authorized BRP distributor/dealer (as hereinafter defined) at the time of delivery of the 2014 LYNX snowmobile, carry the same warranty as that of the snowmobile.

Use of the product for racing or any other competitive activity, at any point, even by a previous owner, will render this warranty null and void.

2) WARRANTY COVERAGE PERIOD

This warranty will be in effect from the date of delivery to the first retail consumer or the date the product is first put into use, whichever occurs first and for a period of:

A) TWELVE (12) CONSECUTIVE MONTHS, for private use owners

B) TWELVE (12) CONSECUTIVE MONTHS, for commercial use owners

C) TWENTY FOUR (24) CONSECUTIVE MONTHS, for private use owners when product was sold in a member state of the European Union and Russia. The repair or replacement of parts or the performance of service under this warranty does not extend the life of this warranty beyond its original expiration date.

3) CONDITIONS TO HAVE WARRANTY COVERAGE

This warranty coverage is available only on 2014 LYNX snowmobile purchased as new and unused by its first owner from a BRP distributor/dealer authorized to distribute LYNX products in the country in which the sale occurred ("BRP distributor/dealer"), and then only after the BRP specified pre-delivery inspection process is completed and documented. Warranty coverage only becomes available upon proper registration of the product by an authorized BRP distributor/dealer. Moreover, this warranty coverage is only available if the LYNX snowmobile is purchased in the country in which the purchaser resides. BRP will not honor this limited warranty to any private use owner or commercial use owner if the preceding conditions have not been met. Such limitations are necessary in order to allow BRP to preserve both the safety of its products, and also that of its consumers and the general public.

Routine maintenance outlined in the Operator's Guide must be timely performed in order to maintain warranty coverage. BRP reserves the right to make warranty coverage contingent upon proof of proper maintenance.

4) WHAT TO DO TO OBTAIN WARRANTY COVERAGE

The customer must notify a servicing BRP distributor/dealer within two (2) months of the appearance of a defect, and provide it with reasonable access to the product and reasonable opportunity to repair it. The customer must also present to the authorized BRP distributor/dealer, proof of purchase of the product and must sign the repair/work order prior to starting the repair in order to validate the warranty repair. All parts replaced under this limited warranty become the property of BRP.

5) WHAT BRP WILL DO

BRP's obligations under this warranty are limited to, at its sole discretion, repairing parts found defective under normal use, maintenance and service, or replacing such parts with new genuine LYNX parts without charge for parts and labor, at any authorized BRP distributor/dealer during the warranty coverage period.

BRP reserves the right to improve or modify products from time to time without assuming any obligation to modify products previously manufactured.

6) EXCLUSIONS

The following are not warranted under any circumstances:

- Normal wear and tear;
- Routine maintenance items, tune ups, adjustments;
- Damage caused by failure to provide proper maintenance and/or storage, as described in the Operator's Guide;
- Damage resulting from removal of parts, improper repairs, service, maintenance, modifications or use of parts not manufactured or approved by BRP or resulting from repairs done by a person that is not an authorized servicing BRP distributor/dealer;
- Damage caused by abuse, abnormal use, neglect, use of the product on surfaces other than snow, or operation of the product in a manner inconsistent with the recommended operation described in the Operator's Guide;
- Damage resulting from accident, submersion, fire, theft, vandalism or any act of God;
- Operation with fuels, oils or lubricants which are not suitable for use with the product (see the Operator's Guide);
- Snow or water ingestion;
- Incidental or consequential damages, or damages of any kind including without limitation towing, storage, telephone, rental, taxi, inconvenience, insurance coverage, loan payments, loss of time, loss of income; and
- Damage resulting from studs installed on tracks if the installation does not conform to BRP's instructions.

7) LIMITATIONS OF LIABILITY

THIS WARRANTY IS EXPRESSLY GIVEN AND ACCEPTED IN LIEU OF ANY AND ALL OTHER WARRANTIES, EXPRESSED OR IMPLIED, INCLUDING WITHOUT LIMITATION ANY WARRANTY OF MERCHANTABILITY OR FITNESS FOR A PARTICULAR PURPOSE. TO THE EXTENT THAT THEY CANNOT BE DISCLAIMED, THE IMPLIED WARRANTIES ARE LIMITED IN DURATION TO THE LIFE OF THE EXPRESS WARRANTY. INCIDENTAL AND CONSEQUENTIAL DAMAGES ARE EXCLUDED FROM COVERAGE UNDER THIS WARRANTY. SOME STATES/ PROVINCES DO NOT ALLOW FOR THE DISCLAIMERS, LIMITATIONS AND EXCLUSIONS IDENTIFIED ABOVE, AS A RESULT, THEY MAY NOT APPLY TO YOU. THIS WARRANTY GIVES YOU SPECIFIC RIGHTS, AND YOU MAY ALSO HAVE OTHER LEGAL RIGHTS WHICH MAY VARY FROM STATE TO STATE, OR PROVINCE TO PROVINCE.

Neither the distributor, any BRP distributor/dealer nor any other person has been authorized to make any affirmation, representation or warranty regarding the product, other than those contained in this limited warranty, and if made, shall not be enforceable against BRP.

BRP reserves the right to modify this warranty at any time, being understood that such modification will not alter the warranty conditions applicable to the products sold while this warranty is in effect.

8) TRANSFER

If the ownership of a product is transferred during the warranty coverage period, this warranty shall also be transferred and be valid for the remaining coverage period provided BRP or an authorized BRP distributor / dealer receives a proof that the former owner agreed to the transfer of ownership, in addition to the co-ordinates of the new owner.

9) CONSUMER ASSISTANCE

1. In the event of a controversy or a dispute in connection with this limited warranty, BRP suggests that you try to resolve the issue at the dealership level. We recommend discussing the issue with the authorized distributor/dealer's service manager or owner.
2. If further assistance is required, the distributor's service department should be contacted in order to resolve the matter.
3. If the matter still remains unresolved then contact BRP by writing to us at the address below.

ADDRESS:

BRP-FINLAND OY
SERVICE DEPARTMENT
P.O. BOX 8040
FIN-96101 ROVANIEMI
FINLAND

CUSTOMER INFORMATION

CHANGE OF ADDRESS/OWNERSHIP

If your address has changed or if you are the new owner of the snowmobile, be sure to notify BRP by either:

- Mailing one of the change of address cards on the following pages.
- Notifying an authorized Lynx dealer.

In case of change of ownership, please join a proof that the former owner agreed to the transfer.

Notifying BRP, even after the expiration of the limited warranty, is very important as it enables BRP to reach the snowmobile owner if necessary, like when safety recalls are initiated. It is the owner's responsibility to notify BRP.

STOLEN UNITS: If your personal snowmobile is stolen, you should notify BRP or an authorized Lynx dealer. We will ask you to provide your name, address, phone number, the vehicle identification number and the date it was stolen.

BRP FINLAND OY
Service Department
Isoaavantie 7
FIN-96320 Rovaniemi



CHANGE OF ADDRESS CHANGE OF OWNERSHIP

VEHICLE IDENTIFICATION NUMBER

--	--

Model Number Vehicle Identification Number (V.I.N.)

OLD ADDRESS OR PREVIOUS OWNER: _____

NAME

NO. STREET APT

CITY STATE/PROVINCE ZIP/POSTAL CODE

COUNTRY TELEPHONE

NEW ADDRESS OR NEW OWNER: _____

NAME

NO. STREET APT

CITY STATE/PROVINCE ZIP/POSTAL CODE

COUNTRY TELEPHONE

E-MAIL ADDRESS _____

V00A2F



CHANGE OF ADDRESS CHANGE OF OWNERSHIP

VEHICLE IDENTIFICATION NUMBER

--	--

Model Number Vehicle Identification Number (V.I.N.)

OLD ADDRESS OR PREVIOUS OWNER: _____

NAME

NO. STREET APT

CITY STATE/PROVINCE ZIP/POSTAL CODE

COUNTRY TELEPHONE

NEW ADDRESS OR NEW OWNER: _____

NAME

NO. STREET APT

CITY STATE/PROVINCE ZIP/POSTAL CODE

COUNTRY TELEPHONE

E-MAIL ADDRESS _____

V00A2F



brp.com

LYNX



® ™ and the BRP logo are trademarks of Bombardier Recreational Products Inc. or its affiliates.