

LYNX®



**OPERATOR'S GUIDE
XU SERIES • 2012**

EN 619 900 281

OPERATOR'S GUIDE 2012

Adventure™ Grand Tourer 600 E-TEC
Adventure™ Grand Tourer 1200 4-TEC
Xtrim™ Commander 600 E-TEC
59 Yeti® 600 ACE
69 Yeti® 600 ACE
59 Yeti® 550

SAFETY WARNING

Disregarding any of the safety precautions and instructions contained in this Operator's Guide, or on-product warnings may result in injury, including the possibility of death.

This Operator's Guide should remain with the snowmobile at time of resale.



Lynx products are manufactured by BRP.

The following are trademarks of Bombardier Recreational Products Inc. or its subsidiaries.

DESS™

3-D RAVE™

ROTAX™

LYNX®

HPG™

RERT™

E-TEC®

TRA™

600 ACE™

4-TEC™

eDrive™

FOREWORD

Congratulations on your purchase of a new Lynx snowmobile. Whatever model you have chosen, it is backed by the Bombardier Recreational Products inc. (BRP) warranty and a network of authorized Lynx snowmobile dealers ready to provide the parts, service or accessories you may require.

The Operator's Guide has been prepared to acquaint the owner/operator and passenger with this new snowmobile and its various controls, maintenance and safe riding instructions. This guide is indispensable for the proper use of the product and should be kept with this snowmobile at all times.

Make sure you read and understand the content of this Operator's Guide.

After reading, please keep this Operator's Guide with the snowmobile. If the snowmobile is resold, please give the guide to the new owner for his awareness. An extra copy of the Operator's Guide is available from your Lynx snowmobile dealer at no charge.



If you have any question regarding any topic whether or not it is covered in this Operator's Guide, please send a written letter to BRP to following address:

BRP Finland OY
Service Department
P.O. Box 8039
FIN-96101 ROVANIEMI
FINLAND
Tel +358 16 3208 111

This guide uses the following safety alert symbol in conjunction with signal words to indicate a potential personal injury hazard.

WARNING

Indicates a potentially hazardous situation which, if not avoided, could result in death or serious injury.

 **CAUTION** Indicates a potentially hazardous situation which, if not avoided, may result in minor or moderate injury. When used without the safety alert symbol , potential hazard exists for property damage only.

NOTE: Indicates supplementary information needed to fully complete an instruction.

Although the mere reading of such information does not eliminate the hazard, the understanding and application of the information will promote the correct use of the vehicle.

Your dealer is committed to your satisfaction. He has taken training to perform the initial set-up and inspection of your snowmobile as well as completed the final adjustment required to suit your specific weight and riding environment before you took possession. At delivery, your dealer would have explained the snowmobile controls and provided you with a brief explanation of the various suspension adjustments. We trust you have taken full advantage of this!

At delivery, you were also informed of the warranty coverage and have completed the Warranty Registration process.

The information and components/system descriptions contained in this guide are correct at time of publication. BRP, however maintains a policy of continuous improvement of its products without imposing upon itself any obligation to install them on products previously manufactured.

Because of its ongoing commitment to product quality and innovation, BRP reserves the right at any time to discontinue or change specifications, designs, features, models or equipment without incurring obligation.

The illustrations in this document show the typical construction of the different assemblies and, in all cases,

may not reproduce the full detail or exact shape of the parts shown, however, they represent parts which have the same or a similar function.

It is understood that this guide may be translated into another language. In the event of any discrepancy, the English version shall prevail.

Specifications are given in the SI metric system with the SAE U.S. equivalent in parentheses. Where precise accuracy is not required, some conversions are rounded off for easier use.

Most components of this snowmobile are built with parts dimensioned in the metric system. Most fasteners are metric and must not be replaced by customary fasteners or vice versa.

We recommend genuine BRP products for replacement parts and accessories. They've been specially designed for your vehicle and manufactured to meet BRP's demanding standards.

For any questions pertaining to the warranty and its application, consult the WARRANTY section in this guide, and/or an authorized Lynx dealer.

TABLE OF CONTENTS

FOREWORD	1
----------------	---

SAFETY INFORMATION

IMPORTANT BASIC SAFETY MEASURES	8
Training	8
Performance	8
Age	8
Speed	8
Riding	8
Operation	9
Maintenance	10
Fuel	10
Basics for Passenger	11
LAWS AND REGULATIONS	12
RIDING THE VEHICLE	13
Principle of Operation	13
How to Ride	13
Carrying a Passenger	15
Terrain/Riding Variations	16
Transporting and Towing	20

ENVIRONMENT INFORMATION

GENERAL	22
JUST WHAT IS LIGHT TREADING?	23
WHY IS LIGHT TREADING SMART	24

VEHICLE INFORMATION

HOW TO IDENTIFY YOUR SNOWMOBILE	26
Vehicle Description Decal	26
Serial Numbers	26
CONTROLS, INSTRUMENTS AND EQUIPMENT	28
1) Speedometer	30
2) Tachometer (RPM)	30
3) Gauge Digital Display	31
4) Gauge Multifunction Digital Display	32
5) Gauge Pilot Lamps	43
6) Gauge MODE (M) Button (not in YETI 600 ACE and 550 models)	46
7) Gauge SET (S) Button (not in YETI 600 ACE and 550 models)	46
8) Throttle Lever	46
9) Brake Lever	46
10) Parking Brake Lever	46
11) Multi-Switch Housing	47

CONTROLS, INSTRUMENTS AND EQUIPMENT (cont'd)	
12) Handlebar	50
13) Handle Bar Position adjuster (Grand Tourer models)	50
14) Mountain Strap (Commander Models)	50
15) Tether Cut-Out Switch	50
16) Engine Cut-Out Switch	52
17) Rewind Starter Handle	52
18) Gearshift Lever	52
19) Fuel Tank Cap	53
20) Hood and Side Panels	53
21) Fuses	57
22) Grab Handle/Bumper	58
23) Storage Compartment	58
24) Tool Kit	59
25) Spark Plug Storage	59
26) Spare Drive Belt	59
27) Shields and Guards	59
28) Track	60
29) Passenger Seat	60
30) Passengers Handholds	61
31) Rear Passenger Heating Grip Switch	62
32) Rear Rack	62
33) 12-Volt Power Outlet	62
34) Hook Type Hitch	62
35) Choke lever (59 YETI 550)	63
FUEL	64
Recommended Fuel	64
INJECTION OIL (550SK AND 600 HO E-TEC)	65
Recommended Injection Oil	65
BREAK-IN PERIOD	66
Break-In Period Duration	66
Operation During Break-In	66
OPERATING INSTRUCTIONS	67
Pre-Operation Check	67
Engine Starting Procedure	68
Carburetor Engine Starting Procedure (550 model)	69
Vehicle Warm-Up	69
Gearbox Operation	70
Shutting Off the Engine	71
Post-Operation Care	71
SPECIAL OPERATING INSTRUCTIONS	72
Riding at High Altitudes	72
Riding in Cold Weather	72
Emergency Starting	72
Towing an Accessory	73
Towing Another Snowmobile	73

SPECIAL OPERATING INSTRUCTIONS (cont'd)	
Transporting the Vehicle	73
TUNE YOUR RIDE	75
Rear Suspension Adjustment	75
Front Suspension Adjustment	78
TROUBLESHOOTING	79
Beeper Codes	79
General	79
SPECIFICATIONS	81
DECLARATION OF CONFORMITY	93

MAINTENANCE INFORMATION

BREAK-IN INSPECTION	96
PERIODIC MAINTENANCE CHART	98
MAINTENANCE SCHEDULE (2-STROKE)	99
MAINTENANCE SCHEDULE (4-STROKE)	101
PRESEASON PREPARATION	103
STORAGE	105
MAINTENANCE PROCEDURES	106
Air Intake Silencer Prefilter Verification	106
Cooling System	106
Engine Oil (1200 4-TEC and 600 ACE)	106
Recommended Engine Oil	106
Exhaust System	107
Drive belt Guard	107
Brake Fluid Level	108
Brake Condition	109
Brake Adjustment	109
Gearbox Oil	109
Drive Belt	109
Drive Pulley	111
Track	113
Track Tension and Alignment	113
Rear Suspension Condition	116
Suspension Stopper Strap Condition	116
Rear Suspension Lubrication	116
Steering and front suspension	116
Front Suspension Lubrication (LTS)	116
Skis	117
Recommended Spark Plug	117
Spark Plug Removal/Installation	117
Engine Stopper	118
Fuses	119

BODY/FRAME	121
Vehicle Cleaning and Protection	121
Bulb Replacement	121
Headlamp Beam Aiming.....	122
Taillight	122
STORAGE AND PRESEASON PREPARATION	124
Storage.....	124
Preseason Preparation	126

WARRANTY

BRP FINLAND OY INTERNATIONAL LIMITED WARRANTY: 2012 LYNX® SNOWMOBILES	128
PRIVACY OBLIGATIONS/DISCLAIMER	131
CHANGE OF ADDRESS/OWNERSHIP	132

SAFETY INFORMATION

IMPORTANT BASIC SAFETY MEASURES

Training

▲ Basic training is required for the safe operation of any snowmobile. Study your Operator's Guide paying particular attention to cautions and warnings. Join your local snowmobile club: its social activities and trail systems are planned for both fun and safety. Obtain basic instructions from your snowmobile dealer, friend, fellow club member or enroll in your local training program.

▲ Always show a new operator how to start and stop the vehicle. Indicate the correct riding positions and, above all else, only allow him to operate the snowmobile in a restricted flat area — at least until he is completely familiar with its operation. If there is a local snowmobile operator's training course existing, have him enroll.

Performance

▲ The performance of some snowmobiles may significantly exceed that of other snowmobiles you have operated. Therefore, use by novice or inexperienced operators is not recommended.

▲ Snowmobiles are used in many areas and in many snow conditions. Not all models perform the same in similar conditions. Always consult your snowmobile dealer when selecting the snowmobile model for your particular needs and uses.

▲ Injury or death may result to the snowmobile operator, passenger or bystander if the snowmobile is used in risky conditions which are beyond the driver's, passenger's or snowmobile's capabilities or intended use.

Age

▲ BRP recommends the operator has at least 16 years old of age. Follow your local legislation.

Speed

▲ Speeding can be fatal. In many cases, you cannot react or respond quickly enough to the unexpected. Always ride at a speed which is suitable to the trail, weather conditions and your own ability. Know your local rules. Speed limit may be in effect and meant to be observed.

Riding

▲ Always keep right hand side of the trail.

▲ Always keep a safe distance from other snowmobiles and bystanders.

▲ Remember, promotional material may show risky maneuvers performed by professional riders under ideal and/or controlled conditions. You should never attempt any such risky maneuvers if they are beyond your level of riding ability.

▲ Never ride after consuming drugs or alcohol or if you feel tired or ill. Operate your snowmobile prudently.

▲ Your snowmobile is not designed to be operated on public streets, roads or highways.

▲ Snowmobiling at night can be a delightful experience but because of reduced visibility, be extra cautious. Avoid unfamiliar terrain and be sure your lights are working. Always carry a flashlight and spare light bulbs.

▲ Nature is wonderful but don't let it distract your attention from driving. If you want to truly appreciate winter's scenery, stop your snowmobile on the side of the trail so that **you** don't become a hazard to others.

▲ Fences represent a very serious threat for both you and your snowmobile. Give a wide berth to telephone poles or posts.

▲ Hidden wires unseen from a distance can cause serious accidents.

- ▲ Always wear an approved safety helmet, eye protection and a face shield. This also applies to your passenger.
- ▲ Be aware of inherent risks associated with riding off trails, such as avalanche and other natural or man made hazards or obstacles.
- ▲ Avoid road traveling. If you must do so, and it is permitted, reduce speed. The snowmobile is not designed to operate or turn on paving. When crossing a road, make a full stop, then look carefully in both directions before crossing at a 90° angle. Be wary of parked vehicles.
- ▲ Tailgating another snowmobile should be avoided. If the snowmobile in front of you slows for any reason, its driver and passenger could be harmed through your neglect. Maintain a safe stopping distance between you and the snowmobile in front of you. Depending on the terrain condition, stopping may require a little more space than you think. Play it safe. Be prepared to use evasive driving.
- ▲ Venturing out alone with your snowmobile could also be hazardous. You could run out of fuel, have an accident, or damage your snowmobile. Remember, your snowmobile is capable of traveling further in half an hour than you may be able to walk in a day. Use the "buddy system". Always ride with a friend or member of your snowmobile club. Even then, tell someone where you are going and the approximate time you plan to return.
- ▲ Meadows sometimes have low areas where water accumulate and freezes over in winter. This ice is usually glare ice. Attempting to turn or brake on this surface could cause your vehicle to spin out of control. Never brake or attempt speeding or turning on glare ice. If you do happen to travel over such a condition, reduce speed by carefully releasing the throttle.
- ▲ Never "jump" with your snowmobile. This should be left to professional stunt men. Don't show off. Be responsible.
- ▲ While on safari, do not "gun" the throttle. Snow and ice can be thrown back into the path of a following snowmobile. In addition, when "gunning" the throttle, the vehicle digs into and leaves an irregular snow surface for others.
- ▲ Safaris are both fun and enjoyable but don't show off or overtake others in the group. A less experienced operator might try to do the same as you and fail. When riding with others, limit your abilities to the experience of others.

Operation

- ▲ Always make a pre-start inspection BEFORE you turn on the ignition.
- ▲ In an emergency, the snowmobile engine can be stopped by activating the engine cut-out switch, pulling the tether cord cap or turning off the key.
- ▲ Throttle mechanism should be checked for free movement and return to idle position before starting engine.
- ▲ Always engage parking brake when vehicle is not in use.
- ▲ Never run the engine in a non-ventilated area and/or if vehicle is left unattended.

- ▲ Never operate the engine without belt guard securely installed or, with hood or access/side panels open or removed. Never run the engine without drive belt installed. Running an unloaded engine such as without drive belt or with track raised, can be dangerous.
- ▲ **Electric start models only:** Never charge or boost a battery while installed on snowmobile.
- ▲ Ensure the path behind is clear of obstacles or bystanders before proceeding in reverse.
- ▲ Do not leave your keys in the ignition switch, it is an invitation to thieves and a danger to young children.
- ▲ Raising the rear of your snowmobile while the engine is running could cause snow, ice or debris to be thrown back at an observer. Never raise the rear of the vehicle while the engine is running. To clear or inspect the track, stop the engine, tilt the vehicle on its side and remove blockage with a piece of wood or branch. Never allow anyone near a rotating snowmobile track.

Maintenance

- ▲ Know your snowmobile and treat it with the respect and care due of any power driven machine. Common sense, proper handling and routine maintenance will result in safer and enjoyable use.
- ▲ Only perform procedures as detailed in this guide. Unless otherwise specified, engine should be turned OFF and cold for all lubrication, adjustment and maintenance procedures.
- ▲ Never have the engine running while the hood is open. Even at idle, a snowmobile engine is turning around 1,800 revolutions per minute. Always turn off the ignition before opening the hood for any reason.

- ▲ Never remove any original equipment from your snowmobile. Each vehicle has many built in safety features. Such features include various guards and consoles, plus reflective materials and warning labels.
- ▲ A poorly maintained snowmobile itself can be a potential hazard. Excessively worn components could render the vehicle completely inoperative. Keep the snowmobile in good working condition at all times. Follow your pre-operation check, weekly, monthly and annually routine maintenance and lubrication procedures as detailed in this guide. Consult a snowmobile dealer or acquire a shop manual and proper tools and equipment if other repairs or service is required.
- ▲ Do not stud the track unless it as been approved for studs. At speed, a studded track that as not been approved for studs could tear and separate from vehicle posing a risk of severe injury or death.

Fuel

- ▲ Always stop the engine before refueling. Fuel is flammable and explosive under certain conditions. Always work in a well-ventilated area. Do not smoke or allow open flames or sparks in the vicinity. Open cap slowly. If a differential pressure condition is noticed (whistling sound heard when loosening fuel tank cap) have vehicle inspected and/or repaired before further operation. Do not overfill or top off the fuel tank before placing the vehicle in a warm area. As temperature increases, fuel expands and might overflow. Always wipe off any fuel spillage from the vehicle. Periodically verify fuel system.

Basics for Passenger

- ▲ Never ride as a passenger unless the snowmobile is equipped with a passenger seat, and sit only on the designated passenger seat.
- ▲ Always wear a DOT approved helmet and follow the same dressing guidelines as those recommended for the operator and described in this guide.
- ▲ Make sure that you are able to achieve a stable stance, both feet resting positively on the footboards of footrests with good grip, and that you are able to hold on firmly to the handholds.
- ▲ Once underway, if you feel uncomfortable or insecure for any reason, don't wait, tell the driver to slow down or stop.

LAWS AND REGULATIONS

▲ Know your local laws.

State, provincial and local government agencies have enacted laws and regulations pertaining to the safe use and operation of snowmobiles. It is your responsibility as a snowmobiler to learn and obey these laws and regulations. Respect and observance will result in safer snowmobiling for all.

Be aware of the liability property damages and insurance laws regarding your equipment.

RIDING THE VEHICLE

Before venturing on the trails, operate the snowmobile in a restricted flat area until you are completely familiar with its operation and feel comfortable that you can safely tackle a more demanding task. Have an enjoyable and safe ride.

Principle of Operation

Propulsion

Depressing throttle lever increases engine RPM causing the drive pulley to engage. Depending on models, engine RPM must be between 2500 and 4200 before drive pulley engagement will occur.

Outer sheave of drive pulley moves toward inner sheave, forcing the drive belt to move upward on the drive pulley and simultaneously forcing the sheaves apart on the driven pulley.

The driven pulley senses the load on the track and limits the belt movement. The result is an optimized speed ratio between engine RPM and the speed of the vehicle at any time.

WARNING

Never operate engine without belt guard securely installed or, with hood or access/side panels open or removed.

Power is transferred to the track through the chaincase or gearbox and drive axle.

WARNING

Always use a wide-base snowmobile mechanical stand to properly support vehicle during any track verification. Slowly accelerate engine in order to rotate track at very low speed when it is not on ground.

Turning

Handlebar controls the steering of the vehicle. As the handlebar is rotated to right or left, the skis are turned right or left to steer the snowmobile.

Stopping

Before riding your snowmobile, you should understand how to stop it. This is done by releasing the throttle and gradually depressing the brake lever on the left side of the handlebar. In an emergency, you may stop your vehicle by pressing the engine cut-out switch located near the throttle control and applying the brake. Remember, a snowmobile cannot "stop on a dime". Braking characteristics vary with deep snow, packed snow or ice. If the track is locked during hard braking, skidding may result.

How to Ride

How to Dress

Proper snowmobile clothing should be worn. It should be comfortable and not too tight. Always check the weather forecast before going on a ride. Dress for the coldest weather expected. Thermal underwear next to the skin also provides a good insulation.

DOT approved helmets are recommended at all times. They provide both warmth and reduce injury. A stocking type cap, balaclava and face mask should always be carried or worn. Goggles or a face shield that attach to the helmet are indispensable.

Hands should be protected by a pair of snowmobile gloves or mitts which have sufficient insulation and allow use of thumbs and fingers for operation of controls.

Rubber bottom boots with either a nylon or a leather top, with removable felt liners are best suited for snowmobiling.

You should keep yourself as dry as possible when snowmobiling. When you come indoors, take your snowmobile suit and boots off and make certain they dry properly.

Do not wear long scarfs and loose apparels that could get caught in moving parts.

What to Bring

Every snowmobiler should carry at least the following basic parts and tools that can help him and others in an emergency:

- this Operator's Guide
- spare spark plugs and wrench
- friction tape
- spare drive belt
- spare starter rope
- spare light bulbs
- tool kit (including at least pliers, screwdriver, adjustable wrench)
- knife
- flashlight.

Include other items depending on the length and time of your ride.

Riding Position

Your riding position and balance are the two basic principles of making your snowmobile go where you want it to. When turning on the side of a hill, you and your passenger must be ready to shift body weight to help it turn in the desired direction. Driver and passenger(s) must never attempt this maneuvering by placing feet outside of the vehicle. Experience will teach you how much lean to put into turns at different speeds and how much you will have to lean into a slope to maintain proper balance.

Generally, the riding position for best balance and control is sitting. However, the posting, kneeling or standing positions are also used under certain conditions.

The novice driver should become familiar with the snowmobile through practice on a level area at slow speeds before venturing afield.

⚠ WARNING
Do not attempt any maneuvers if they are beyond your abilities.

Sitting

Feet on the running boards, body mid-way back on seat is an ideal position when operating the snowmobile over familiar, smooth terrain. Knees and hips should remain flexible to absorb shocks.



Posting

A semi-sitting position with the body off the seat and the feet under the body in a sort of squatting posture, thus allowing the legs to absorb the shocks when traveling over uneven terrain. Avoid abrupt stops.



Kneeling

This position is achieved by placing one foot firmly on the running board and the opposite knee on the seat. Avoid abrupt stops.



Standing

Place both feet on the running boards. Knees should be flexed to absorb the shock from surface bumps. This is an effective position to see better and to shift weight as conditions dictate. Avoid abrupt stop.



Carrying a Passenger

Certain snowmobiles are designed for an operator only, others can allow one passenger only, and others can allow up to two passengers. Refer to the indications on the vehicles to know if any particular snowmobile can accommodate passengers or not, and if so, how many. Always respect those indi-

cations. Overloading is dangerous because snowmobiles are not designed for it.

Even when passengers are allowed, you must make sure that the persons who would like to become passengers are physically fit for snowmobiling.

⚠ WARNING

Any passenger must be able to firmly lay his feet on the footrests and keep his hands on the grab handles or seat strap at all times when seated. Respecting those physical criteria is important to ensure that the passenger is stable and to reduce the risks of ejection.

Each operator has a responsibility to ensure the safety of his passengers and should inform them of snowmobiling basics.

⚠ WARNING

- Passengers must only sit on designated passenger seats. Never allow anyone to sit between the handlebar and the operator.
- Each passenger seat must have a strap or grab handles and meet SSCC standards.
- Passengers and operators must always wear DOT approved helmets and warm clothing appropriate for snowmobiling. Make sure that no skin is exposed.
- Once underway, if a passenger feels uncomfortable or unsecure for any reason, he must not wait, and tell the driver to slow-down or stop.

Riding with passengers on board is different than riding alone. The operator has the benefit of knowing what will be the next maneuver and is able to prepare himself accordingly. The operator also benefits from the support of

his grip on the handlebar. In contrast, the passengers have to rely on the operator's careful and safe operation of the vehicle. In addition, "body english" is limited with passengers, and the operator can sometimes see more of the trail ahead than the passengers. Therefore, smooth starting and stopping are required with passengers, and the operator must slow down. The operator must also warn passengers of side hills, bumps, branches, etc. An unforeseen bump can leave you passenger-less. Remind your passengers to lean into the turn with you, without causing the vehicle to topple. Be extremely careful, go more slowly and check the passengers frequently.

WARNING

When riding with a passenger:

- Braking ability and steering control are reduced. Decrease speed and allow extra space to maneuver.
- Adjust suspension according to weight.

For complete information on how to adjust the suspension, please refer to the section of this Operator's Guide entitled SUSPENSION ADJUSTMENTS under OPERATING INSTRUCTIONS and to the relevant label on the belt guard.

Use extra caution and go even more slowly with young passengers. Check frequently to make certain the child has a firm grip and is properly positioned with his feet on the running boards.

Terrain/Riding Variations

Groomed Trail

On a maintained trail, sitting is the most preferred riding position. Do not race and, above all, keep to the right hand side of the trail. Be prepared

for the unexpected. Observe all trail signs. Do not zigzag from one side of the trail to the other.

Ungroomed Trail

Unless there has been a fresh snowfall you can expect "washboard" and snowdrift conditions. Taken at excessive speeds, such conditions can be physically harmful. Slow down. Hold on the handlebar and assume a posting position. Feet should be under the body assuming a crouched position to absorb any jarring effect. On longer stretches of "washboard" trails, the kneeling position of one knee on the seat can be adopted. This provides a certain amount of comfort, while at the same time keeps the body loose and capable of vehicle control. Beware of hidden rocks or tree stumps partially hidden by a recent snowfall.

Deep Snow

In deep "powder" snow, your vehicle could begin to "bog" down. If this occurs, turn in as wide an arc as possible and look for a firmer base. If you do get "bogged", and it happens to everyone, do not spin your track as this makes the vehicle sink deeper. Instead, turn the engine off, get off and move the back of the vehicle onto new snow. Then tramp a clear path ahead of the vehicle. A few feet will generally suffice. Restart the engine. Assume the standing position and rock the vehicle gently as you steadily and slowly apply the throttle. Depending on whether the front or rear end of the vehicle is sinking, your feet should be placed on the opposing end of the running boards. Never place foreign material beneath the track for support. Do not allow anyone to stand in front of, or to the rear of, the snowmobile with the engine running. Stay away from the track. Personal injury will result if contact is made with the revolving track.

Frozen Water

Traveling frozen lakes and rivers can be fatal. Avoid waterways. If you are in an unfamiliar area, ask the local authorities or residents about the ice condition, inlets, outlets, springs, fast moving currents or other hazards. Never attempt to operate your snowmobile on ice that may be too weak to support you and the vehicle. Operating a snowmobile on ice or icy surfaces can be very dangerous if you do not observe certain precautions. The very nature of ice is foreign to good control of a snowmobile or any vehicle. Traction for starting, turning or stopping is much less than that on snow. Thus, these distances can be multiplied manyfold. Steering is minimal, and uncontrolled spins are an ever present danger. When operating on ice, drive slowly with caution. Allow yourself plenty of room for stopping and turning. This is especially true at night.

Hard Packed Snow

Don't underestimate hard packed snow. It can be difficult to negotiate as both skis and track do not have as much traction. Best advice is to slow down and avoid rapid acceleration, turning or braking.

Uphill

There are two types of hills you can encounter — the open hill on which there are few trees, cliffs or other obstacles, and a hill that can only be climbed directly. On an open hill, the approach is to climb it by side hilling or slaloming. Approach at an angle. Adopt a kneeling position. Keep your weight on the uphill side at all times. Maintain a steady, safe speed. Continue as far as you can in this direction, then switch to an opposite hill angle and riding position.

A direct climb could present problems. Choose the standing position, accelerate before you start the climb and then reduce throttle pressure to prevent track slippage.

In either case, vehicle speed should be as fast as the incline demands. Always slow down as you reach the crest. If you cannot proceed further, don't spin your track. Turn the engine off, free the skis by pulling them out and downhill, place the rear of the snowmobile uphill restart the engine and ease it out with slow even throttle pressure. Position yourself to avoid tipping over, then descend.

Downhill

Downhill driving requires that you have full control of your vehicle at all times. On steeper hills, keep your center of gravity low and both hands on the handlebar. Maintain slight throttle pressure and allow the machine to run downhill with the engine operating. If a higher than safe speed is reached, slow down by braking but apply the brake with frequent light pressure. Never jam the brake and lock the track.

Side Hill

When crossing a side hill or traversing up or downhill, certain procedures must be followed. All riders should lean towards the slope as required for stability. The preferred operating positions are the kneeling position, with the knee of the down hill leg on the seat and the foot of the uphill leg on the running board, or the posting position. Be prepared to shift your weight quickly as needed. Side hills and steep slopes are not recommended for a beginner or a novice snowmobiler.

Slush

Slush should be avoided at all times. Always check for slush before starting across any lake or river. If dark spots appear in your tracks, get off the ice immediately. Ice and water can be

thrown rearward into the path of a following snowmobile. Getting a vehicle out of a slush area is strenuous and in some cases, impossible.

Fog or Whiteouts

On land or water, fog or visibility-limiting snow can form. If you have to proceed into the fog or heavy snow, do so slowly with your lights on and watch intently for hazards. If you are not sure of your way, do not proceed. Keep a safe distance behind other snowmobilers to improve visibility and reaction time.

Unfamiliar Territory

Whenever you enter an area that is new to you, drive with extreme caution. Go slow enough to recognize potential hazards such as fences or fence posts, brooks crossing your path, rocks, sudden dips, guy wires and countless other obstacles which could result in a termination of your snowmobile ride. Even when following existing tracks, be cautious. Travel at a speed so you can see what is around the next bend or over the top of the hill.

Bright Sunshine

Bright sunny days can considerably reduce your vision. The glare from sun and snow may blind you to the extent that you cannot easily distinguish ravines, ditches or other obstacles. Goggles with colored lenses should always be worn under these conditions.

Unseen Obstruction

There may be obstructions hidden beneath the snow. Driving off established trails and in the woods requires reduced speed and increased vigilance. Driving too fast in an area can make even minor obstacles very hazardous. Even hitting a small rock or stump could throw your snowmobile out of control and cause injury to its riders. Stay on established trails

to reduce your exposure to hazards. Be safe, slow down and enjoy the scenery.

Hidden Wires

Always be on the lookout for hidden wires, especially in areas that may have been farmed at one time or any other. Too many accidents have been caused by running into wires in the fields, guy wires next to poles and roads, and into chains and wires used as road closures. Slow speeds are a must.

Obstacles and Jumping

Unplanned jumps of snowdrifts, snowplow ridges, culverts or indistinguishable objects can be dangerous. You can avoid them by wearing the proper color lenses or face shields and by operating at a lower speed.

Jumping a snowmobile is an unsafe and dangerous practice. However, if the trail does suddenly drop away from you, crouch (stand) towards the rear of the vehicle and keep the skis up and straight ahead. Apply partial throttle and brace yourself for the impact. Knees must be flexed to act as shock absorbers.

Turning

Depending on terrain conditions, there are two preferred ways to turn or corner a snowmobile. For most snow surfaces, "body english" is the key to turning. Leaning towards the inside of the turn and positioning body weight on the inside foot will create a "banking" condition beneath the track. By adopting this position and positioning yourself as far forward as possible, weight will be transferred to the inside ski.

On occasion, you will find that the only way to turn the vehicle about in deep snow is to pull the snowmobile around.

Do not over-exert yourself. Get assistance. Remember to always lift using your legs as opposed to your back.



fmo2008-003-005

Road Crossing

In some cases, you will be approaching the road from a ditch or snowbank. Choose a place where you know you can climb without difficulty. Use the standing position and proceed with only as much speed needed to crest the bank. Stop completely at the top of the bank and wait for all traffic to clear. Judge the drop to the roadway. Cross the road at a 90° angle. If you encounter another snowbank on the opposite side, position your feet near the rear of the vehicle. Remember, your snowmobile is not designed to operate on bare pavement and steering on this type of surface is more difficult.

Railroad Crossing

Never ride on railroad tracks. It is illegal. Railroad tracks and railroad rights-of-way are private property. A snowmobile is no match for a train. When crossing a railroad track, stop, look and listen.

Night Rides

The amount of natural and artificial light at a given time can effect your ability to see or to be seen. Nighttime snowmobiling is delightful. It can be a unique experience if you acknowledge your reduced visibility. Before you start, make certain your lights

are clean and work properly. Drive at speeds that will allow you to stop in time when you see an unknown or dangerous object ahead. Stay on established trails and never operate in unfamiliar territory. Avoid rivers and lakes. Guy wires, barbed wire fences, cabled road entrances and other objects such as tree limbs are difficult to see at night. Never drive alone. Always carry a flashlight. Keep away from residential areas and respect the right of others to sleep.

Safari Riding

Before starting out, designate a "trail boss" to lead the party and another person to follow-up at the end of the party. Ensure that all members of the party are aware of the proposed route and destination. Make certain that you are carrying all necessary tools and equipment and that you have sufficient fuel to complete the trip. Never overtake the trail boss or, for that matter, any other snowmobile. Use down-the-line hand signals to indicate hazards or intent of direction change. Assist others whenever necessary.

It is always IMPORTANT to keep a safe distance between each snowmobile. Always maintain a safe interval and allow sufficient stopping distance. Don't be a tailgater. Know the position of the machine ahead.

Signals

If you intend to stop, raise either hand straight above your head. A left turn is indicated by extending your left hand straight out in the proper direction. For right turns, extend the left arm and raise the hand to a vertical position so it forms a right angle at the elbow. Every snowmobiler should relay any signal to the ones behind.

Trail Stops

Whenever possible, pull off the trail when you stop. This will reduce the hazard to other snowmobilers using the trail.

Trails and Signs

Trail signs are used to control, direct or regulate the use of snowmobiles on trails. Become familiar with all signs used in the area where you are snowmobiling.

Transporting and Towing

Follow transporting and towing instructions explained further in this guide.

ENVIRONMENT INFORMATION

GENERAL

Wildlife compliments your snowmobiling day. Snowmobile tracks provide firm ground over which animals can travel from area to area. Do not violate this privilege by chasing or harassing wildlife. Fatigue and exhaustion can lead to animal's death. Avoid areas posted for the protection or feeding of wildlife.

If you happen to be fortunate enough to see an animal, stop your snowmobile and observe quietly.

The guidelines that we support are not designed to limit your snowmobiling fun, but to preserve the beautiful freedom that you can experience only on a snowmobile! These guidelines will keep snowmobilers healthy, happy and able to introduce others to what they know and enjoy about their favorite winter pastime. So, the next time you hit the trails on a cool, crisp and clear winter day, we ask you to remember that you are paving the way for the future of our sport. Help us lead it down the right path! From all of us at BRP, thank you for doing your share.

There is nothing more exhilarating than snowmobiling. Venturing onto snowmobile trails that criss-cross the wild areas of forests an exciting and healthy winter sport. However, as the number of people using these recreational parks increases, so does the potential for damage to the environment. Abuse of land, facilities and resources inevitably leads to restrictions and closures of both private and public land.

In essence, the greatest threat to our sport, is all around us. Which leaves us with one logical choice. When we snowmobile, we must always ride responsibly.

The vast majority respect the law and the environment. Each of us must set an example for those who are new to the sport, young and old alike.

It is in every one's best interest to tread lightly into our recreational areas. Because, in the long run, to protect the sport we must preserve the environment.

Recognizing the importance of this issue and the need for snowmobilers to do their share in preserving areas that make it possible to enjoy our sport, BRP has developed the "Light Treading Is Smart Sledding" campaign for snowmobilers.

Light Treading refers to more than the tread of our tracks. It's a statement of concern, respect and willingness to take the lead and take action. It applies to the environment in general, its proper care and maintenance, its natural inhabitants and all enthusiasts and the public at large who enjoy the great outdoors. With this theme, we invite all snowmobilers to remember that respecting the environment is not only critical to the future of our industry but to future generations.

Light Treading in no way suggests you should curb your appetite for snowmobiling fun! It simply means tread with respect!

JUST WHAT IS LIGHT TREADING?

The fundamental objective of Light Treading is one of respect for where and how you ride a snowmobile. You're a light treader when you follow the principles below.

Become informed. Obtain maps, regulations and other information from the Forest Service or from other public land agencies. Learn the rules and follow them and that goes for speed limits, too!

Avoid running over young trees, shrubs, and grasses and don't cut wood. On flatlands or areas where trail riding is popular, it's important to ride only where authorized. Remember, there is a link between protecting your environment and your own safety.

Respect wildlife and be particularly sensitive of animals that are rearing young or suffering from food shortage. Stress can sap scarce energy reserves. Refrain from riding in areas where only animals are intended to tread!

Obey gate closures and regulatory signs and remember, light treaders don't litter!

Stay out of wilderness areas. They're closed to all vehicles. Know where the boundaries are.

Obtain permission to travel across private land. Respect the rights of landowners and other people's privacy. Remember, snowmobile technology has lowered the noise factor considerably, but you still shouldn't rev your engines where quiet "is the order of the day".

WHY IS LIGHT TREADING SMART

Snowmobilers know all too well the efforts that have been made throughout the sport's history to enjoy access to areas where people can snowmobile safely and responsibly. This effort continues today, as strong as ever.

Respecting the areas where we ride... wherever they may be... is the only way to ensure their future enjoyment. That's one major reason why we know you'll agree that Light Treading is smart sledding! And there are more.

Enjoying the opportunity to see winter and all its natural majestic wonders, is an experience cherished by snowmobilers. Light Treading will preserve this opportunity and will make it possible for us to expose others to the beauty of winter and the unique thrill of our sport! Light Treading will help our sport to grow!

Finally, Light Treading is the sign of a smart snowmobiler. You don't have to leave big tracks or careen through a virgin forest to show you can ride. So whether you're driving a high performance Lynx, a sporty Lynx Xtrim Commander XU snowmobile or any other make or model, show you know what you're doing. Show you know how to send snow flying and make tracks with a light touch!

VEHICLE INFORMATION

HOW TO IDENTIFY YOUR SNOWMOBILE

Vehicle Description Decal

Vehicle description decal is located on right hand side of tunnel.



TYPICAL

1. Vehicle description decal

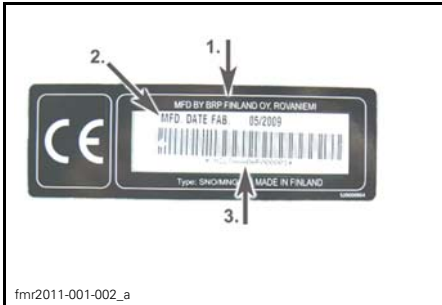

VEHICLE DESCRIPTION DECAL

1. Manufacturer name
2. Manufacturing date
3. Vehicle identification number (VIN)

Serial Numbers

The main components of your snowmobile (engine and frame) are identified by different serial numbers. It may sometimes become necessary to locate these numbers for warranty purposes or to trace your snowmobile in the event of loss. These numbers are required by the authorized Lynx dealer to complete warranty claims properly. No warranty will be allowed by BRP if the engine serial number or vehicle identification number (VIN) is removed or mutilated in any way. We strongly recommend that you take note of all

the serial numbers on your snowmobile and supply them to your insurance company.

Vehicle Identification Number (VIN) Location

VIN is scribed on vehicle description decal. See above. It is also engraved on tunnel near vehicle description decal.

Model Number Location

Model number is part of vehicle identification number (VIN).

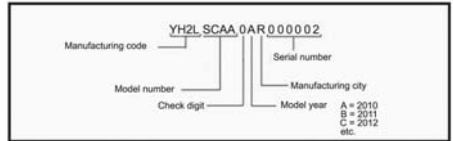

VIN DESCRIPTION

Engine Serial Number Location

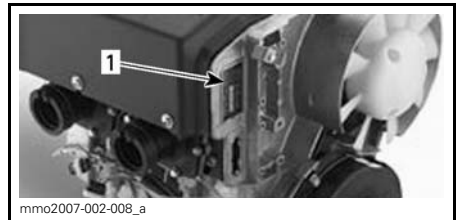

550 ENGINE

1. Engine serial number

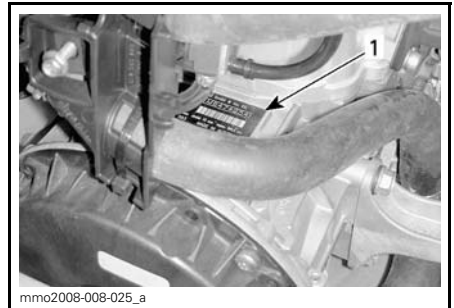

600 E-TEC

1. Engine serial number

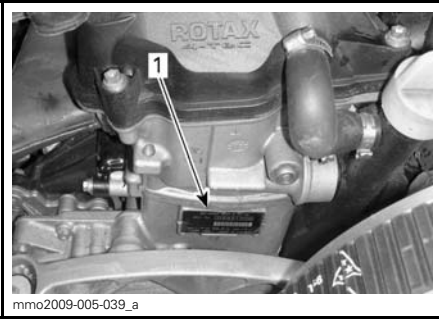

1200 4-TEC ENGINE
1. Engine serial number

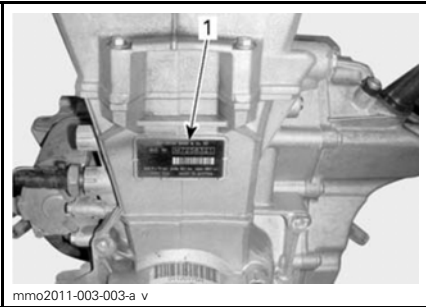

600 ACE ENGINE
1. Engine identification number

CONTROLS, INSTRUMENTS AND EQUIPMENT

NOTE: Some controls/instruments/equipment do not apply or are optional on some models. In these cases their reference numbers are deliberately missing in the illustrations.

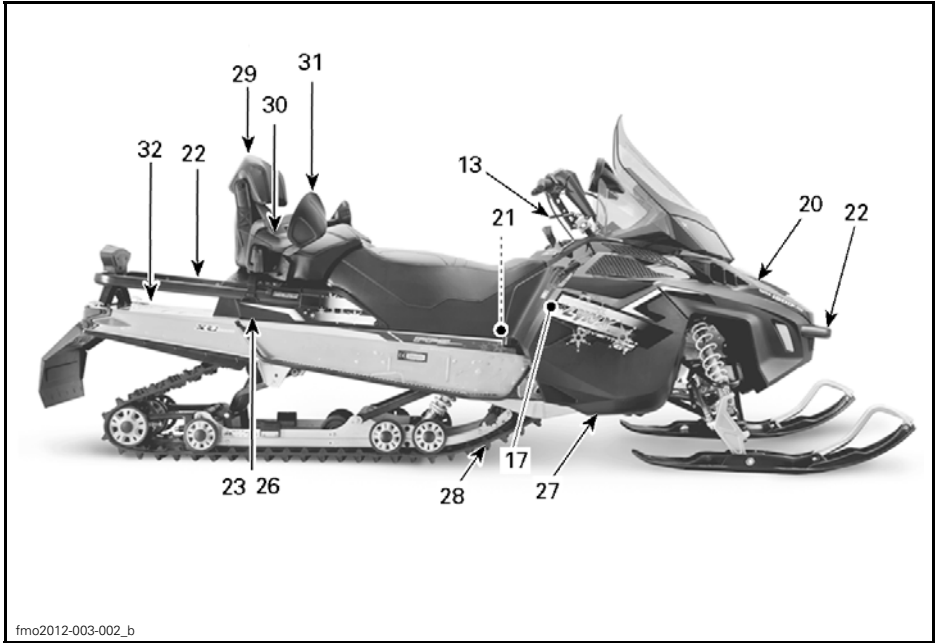

TYPICAL

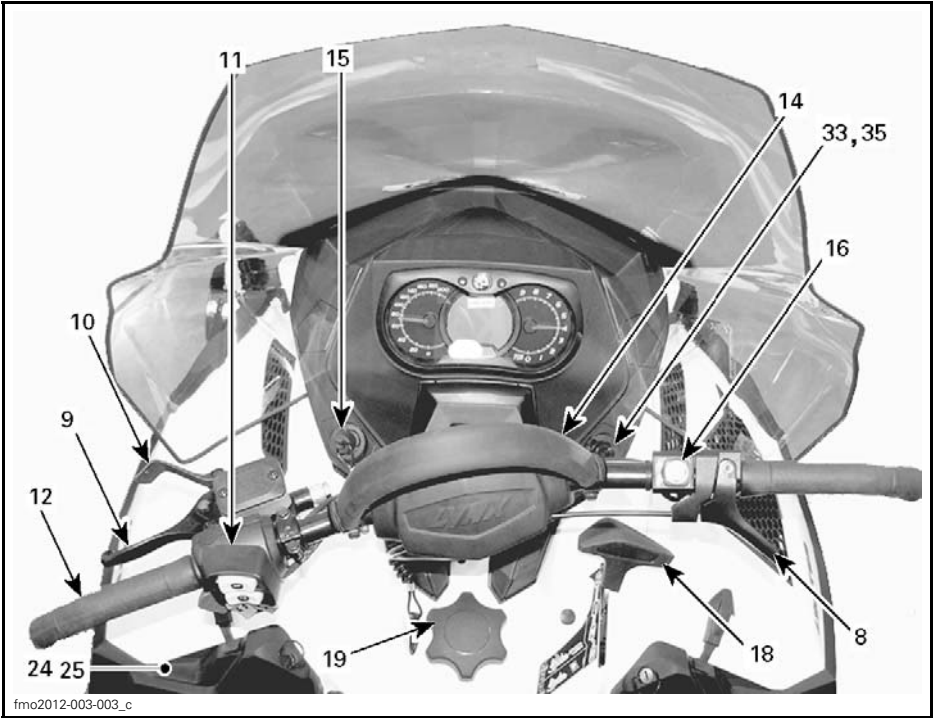

TYPICAL



34. HOOK TYPE HITCH

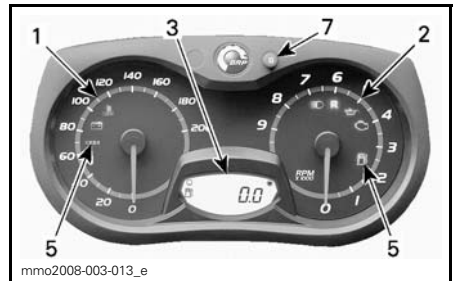

ANALOG/DIGITAL GAUGE

NOTE: Some features are not applicable to all models or may be available as an option.

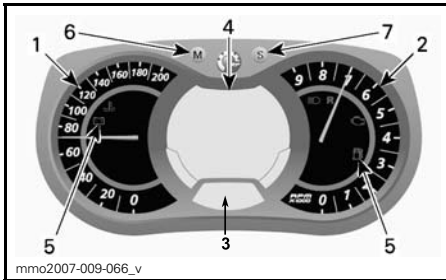

mmmo2007-009-066_v
MULTIFUNCTION ANALOG/DIGITAL GAUGE

1. Speedometer
2. Tachometer (RPM)
3. Gauge Digital Display
4. Gauge Multifunction Digital Display
5. Gauge Pilot Lamps
6. Gauge MODE (M) Button
7. Gauge SET (S) Button
8. Throttle Lever
9. Brake Lever
10. Parking Brake Lever
11. Multi-Switch Housing
12. Handlebar
13. Handle Bar Position adjuster (Grand Tourer model)
14. Mountain Strap (only in Commander)
15. Tether Cut-Out Switch
16. Engine Cut-Out Switch
17. Rewind Starter Handle (behind right side panel)
18. Gearshift Lever
19. Fuel Tank Cap
20. Hood and Side Panels
21. Fuses
22. Grab Handle/Bumper
23. Storage Compartment
24. Tool Kit
25. Spark Plug Storage
26. Spare Drive Belt
27. Shields and Guards
28. Track
29. Passenger seat
30. Passengers Handholds
31. Rear Passenger Heating Grip Switch

32. Rear Rack
33. 12-Volt Power Outlet
34. Hook Type Hitch
35. Choke lever (59 YETI 550)

1) Speedometer

Measures vehicle speed in miles or kilometers.

The speedometer is factory preset in Metric units but it is possible to change it to Imperial units, contact an authorized LYNX dealer for unit settings.

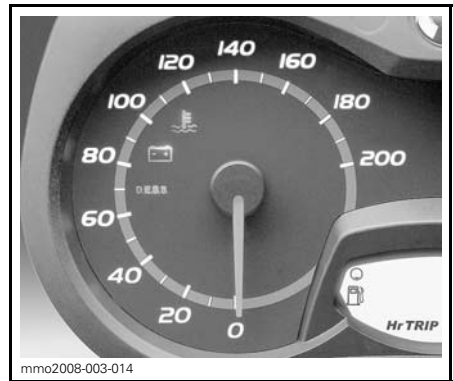

mmmo2008-003-014
LH PORTION OF GAUGE

2) Tachometer (RPM)

Measures engine revolution per minute (RPM). Multiply by 1000 to obtain the actual revolutions.



mmmo2008-003-019
RH PORTION OF GAUGE

3) Gauge Digital Display

Digital display that supplies several real time useful information to the driver.

⚠ WARNING

Reading the gauge digital display can distract from the operation of the vehicle, particularly from constantly scanning the environment. This could lead to a collision resulting in severe injuries or death. Before reading the gauge digital display, ensure your environment is clear and free from obstacle, and bring the vehicle to a low speed. Before proceeding with any adjustments, park vehicle in a safe place and away from the trail.

The digital display is factory preset in Metric units but it is possible to change it to Imperial units, contact an authorized LYNX dealer for unit settings.

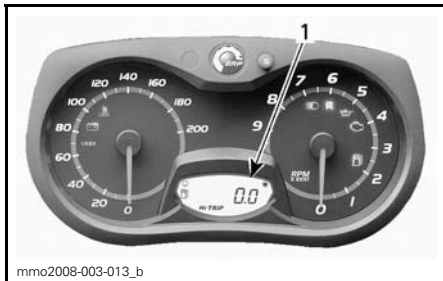

mmo2008-003-013_b

ANALOG/DIGITAL GAUGE

1. Digital display

DISPLAY FEATURES	
FUNCTIONS	REFER TO TOPICS
Odometer	A)
Trip meter "A" or "B"	B)
Trip hour meter	C)
Fuel level	D)

A) Odometer

Records the total distance travelled.

Push the SET (S) button to select odometer (Km/Mi) mode.

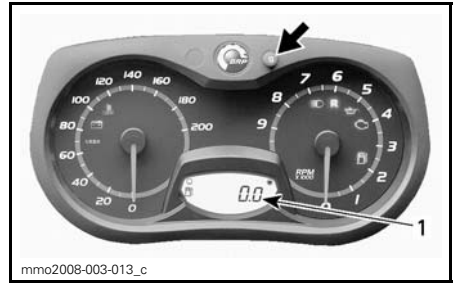

mmo2008-003-013_c

1. Odometer (Km/Mi) mode

B) Trip Meter "A" or "B" (not in YETI 600 ACE and 550 models)

Trip meters records distance travelled since it has been reset.

Push the SET (S) button to select trip meter (TRIP A/TRIP B) mode.

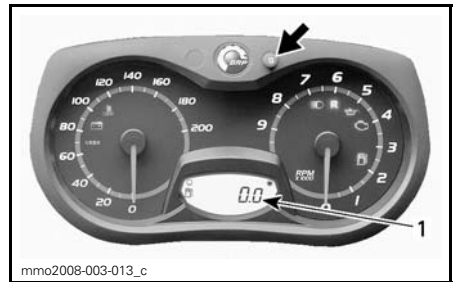

mmo2008-003-013_c

1. Trip meter (TRIP A/TRIP B) mode

Push and hold the SET (S) button to reset.

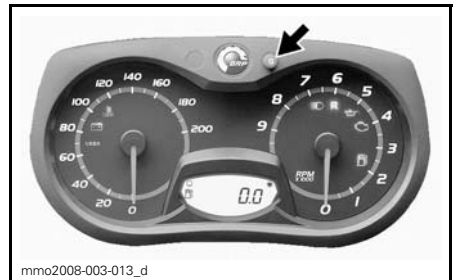

mmo2008-003-013_d

C) Trip Hour Meter (not in YETI 600 ACE and 550 models)

Records vehicle running time when the electrical system is activated since it has been reset.

Push the SET (S) button to select trip hour meter (HrTRIP) mode.

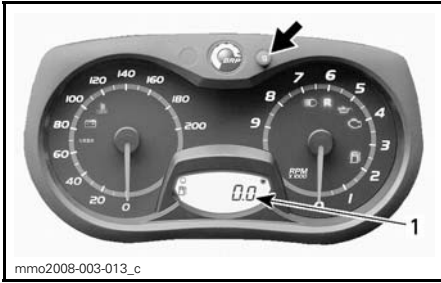

1. Trip hour meter (HrTRIP) mode

Push and hold the SET (S) button to re-set.

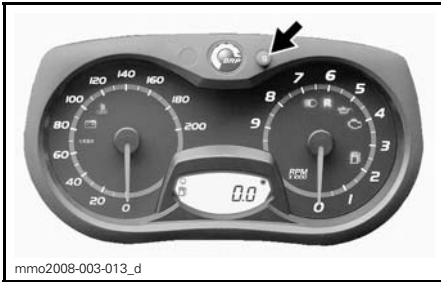

D) Fuel Level

Bar gauge that continuously indicates the amount of fuel left in the fuel tank.

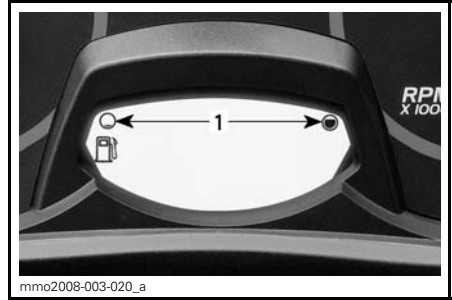

FUEL LEVEL

1. Operating range

4) Gauge Multifunction Digital Display

Multifunction digital display that supplies several real time useful information to the driver in English.

⚠ WARNING

Reading the gauge digital display can distract from the operation of the vehicle, particularly from constantly scanning the environment. This could lead to a collision resulting in severe injuries or death. Before reading the gauge digital display, ensure your environment is clear and free from obstacle, and bring the vehicle to a low speed. Before proceeding with any adjustments, park vehicle in a safe place and away from the trail.

Also, the multifunction digital display is factory preset in Metric units but it is possible to change it to Imperial units, contact an authorized LYNX dealer for unit settings.

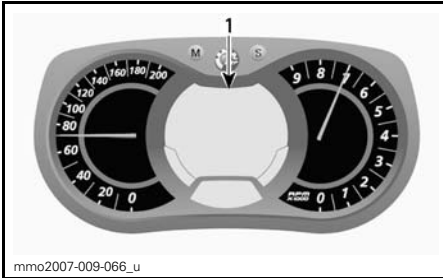

MULTIFUNCTION ANALOG/DIGITAL GAUGE
1. Multifunction display

A) Speedometer

In addition of the analog type speedometer, vehicle speed can also be displayed via the multifunction display.



1. Vehicle speed display

To display vehicle speed, proceed as follow.

Push the MODE (M) button to select display.



NOTE: Display will flash for approximately 5 seconds, then will return to the previously selected mode if display is not changed.

Push the SET (S) button to select speedometer (Km/h/MPH) mode.

DISPLAY FEATURES	
FUNCTIONS	REFER TO TOPICS
Speedometer	A)
Tachometer (RPM)	B)
Odometer	C)
Trip meter "A" or "B"	D)
Trip hour meter	E)
Clock (Only GT)	F)
Fuel level	G)
Altitude	H)
Top speed	I)
Average speed	J)
Heated grips heating intensity	K)
Heated throttle lever heating intensity	L)
Instant fuel consumption	M)
Total fuel consumption	N)
Message Display	O)
Coolant Temperature	P)
Lap Record Mode (Accessory)	Q)

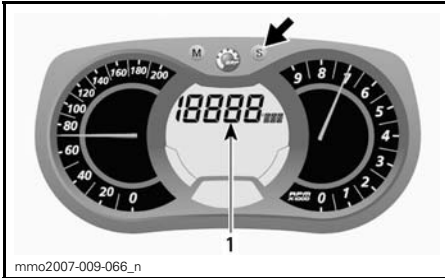

1. Speedometer (Km/h/MPH) mode

Push the MODE (M) button to confirm selection or wait 5 seconds.

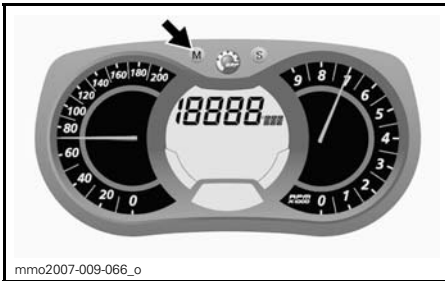

B) Tachometer (RPM)

In addition of the analog type tachometer, RPM can also be displayed via the multifunction display.

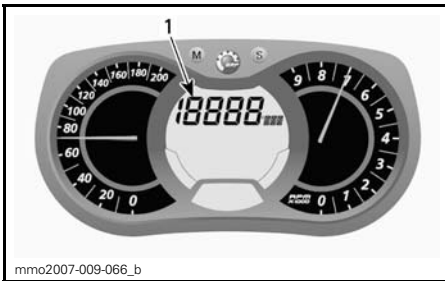

1. RPM display

To display RPM, proceed as follow.
Push the MODE (M) button to select display.



NOTE: Display will flash for approximately 5 seconds, then will return to the previously selected mode if display is not changed.

Push SET (S) button to select RPM mode.

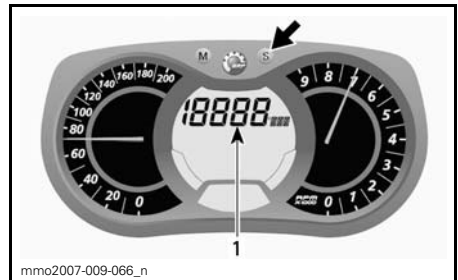

1. RPM mode

Push the MODE (M) button to confirm selection or wait 5 seconds.

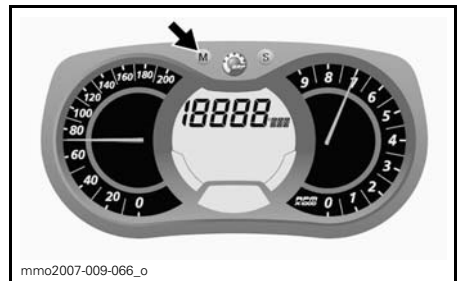

C) Odometer

Records the total distance travelled.

Push the SET (S) button to select odometer (Km/Mi) mode.

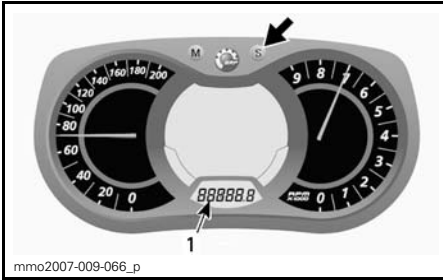

1. Odometer (Km/Mi) mode

D) Trip Meter "A" or "B"

Trip meters records distance travelled since it has been reset.

Push the SET (S) button to select trip meter (TRIP A/TRIP B) mode.

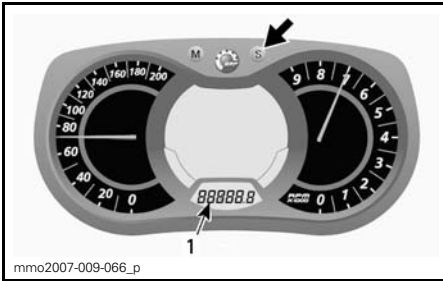

1. Trip meter (TRIP A/TRIP B) mode

Push and hold the SET (S) button to re-set.

NOTE: On E-TEC models, resetting TRIP B mode will also reset TOTAL FUEL CONSUMPTION.

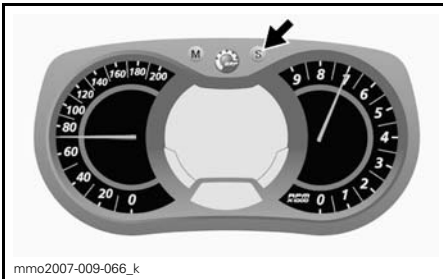

E) Trip Hour Meter

Records vehicle running time when the electrical system is activated since it has been reset.

Push the SET (S) button to select trip hour meter (HrTRIP) mode.

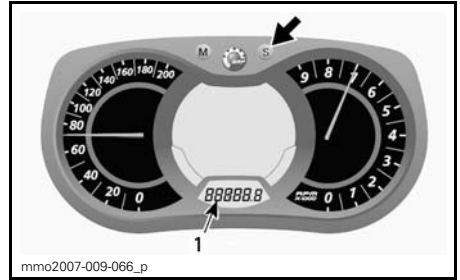

1. Trip hour meter (HrTRIP) mode

Push and hold the SET (S) button to re-set.

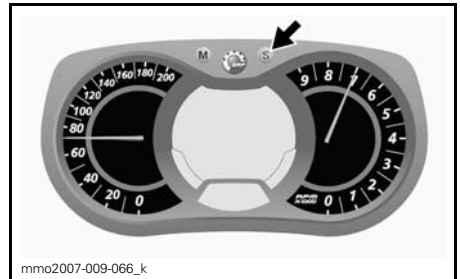

F) Clock (Only GT)

Electric Start Models

Push the SET (S) button to select clock mode.

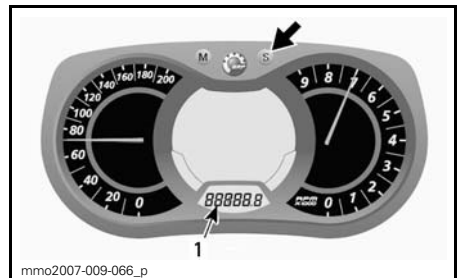

1. Clock mode

Push and hold the SET (S) button to activate clock set-up.

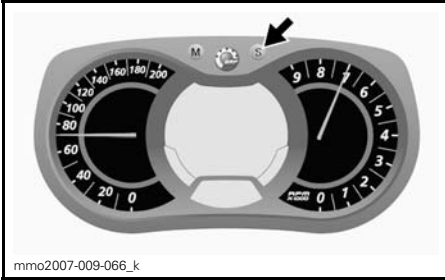

To change HOURS, while the value of HOURS is blinking, use the SET (S) button to change hours.

To change MINUTES, while the value of HOURS is blinking, press the MODE (M) button to switch to minutes. Use the SET (S) button to change minutes.

Push the MODE (M) button to save clock set-up and exit mode.

G) Fuel Level

Bar gauge that continuously indicates the amount of fuel left in the fuel tank.

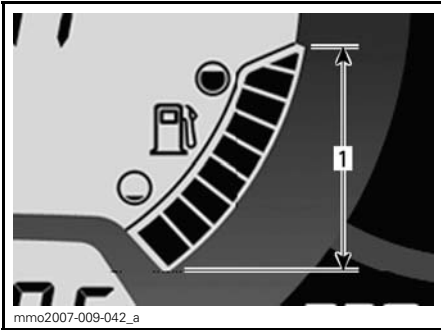

FUEL LEVEL

1. Operating range

H) Altitude

Displays vehicle altitude above sea level in meters or feet.

Vehicle altitude can be displayed via display 1 or display 2 of the multifunction display.

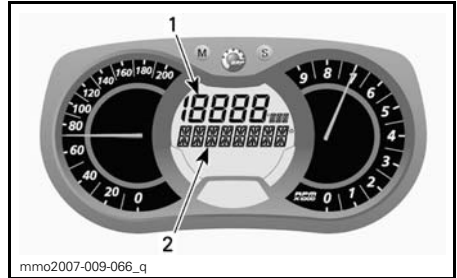

MULTIFUNCTION DISPLAY

1. Display 1
2. Display 2

Via Display 1

To display vehicle altitude via display 1, proceed as follow.

Push the MODE (M) button to select display.

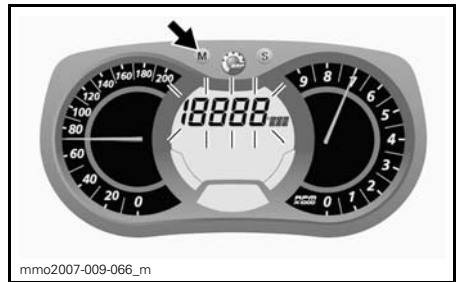

NOTE: Display will flash for approximately 5 seconds, then will return to the previously selected mode if display is not changed.

Push the SET (S) button to select altitude (M/FT) mode.

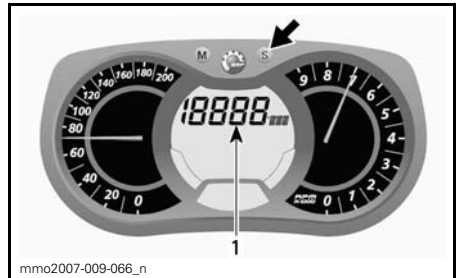

1. Altitude (M/FT) mode

Look for the following symbol to ensure proper mode.

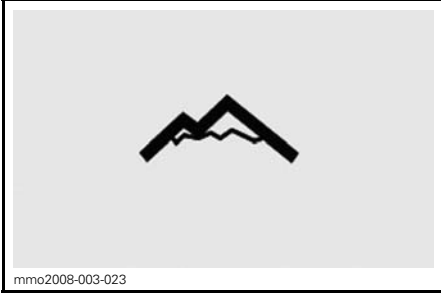

ALTITUDE MODE

Push the MODE (M) button to confirm selection or wait 5 seconds.

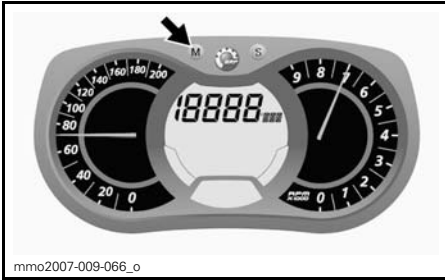

Via Display 2

To display vehicle altitude via **display 2**, proceed as follow.

Push the MODE (M) button 2 times within a second to select display.

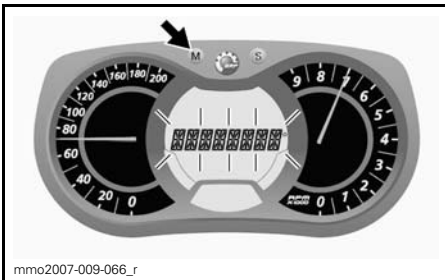

NOTE: Display will flash for approximately 5 seconds, then will return to the previously selected mode if display is not changed.

Push the SET (S) button to select altitude (M/FT) mode.

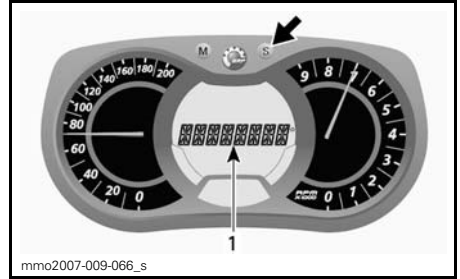

1. Altitude (M/FT) mode

Look for the following symbol to ensure proper mode.



ALTITUDE MODE

Push MODE (M) button to confirm selection or wait 5 seconds.

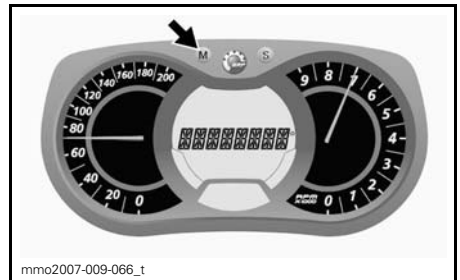

I) Top Speed

Records vehicle top speed since it has been reset.

To display vehicle top speed, proceed as follow.

Push the MODE (M) button to select display.



Push and hold the SET (S) button within 5 seconds to reset.

NOTE: Display will flash for approximately 5 seconds, then will return to the previously selected mode if display is not changed.

Push the SET (S) button to select top speed (TOP_SPD) mode.

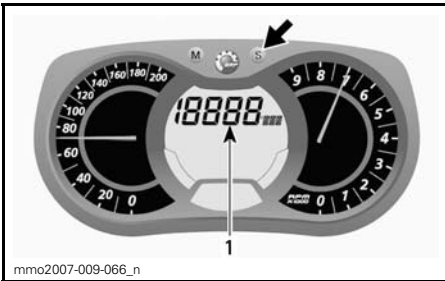
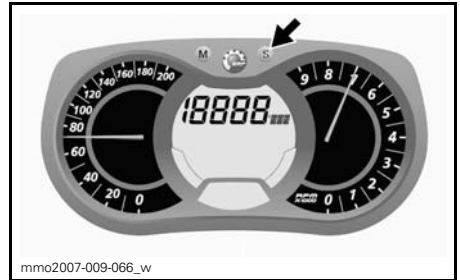

1. Top speed (TOP_SPD) mode

J) Average Speed

Records vehicle average speed since it has been reset.

To display vehicle average speed, proceed as follow.

Push the MODE (M) button to select display.

Push the MODE (M) button to confirm selection or wait 5 seconds.

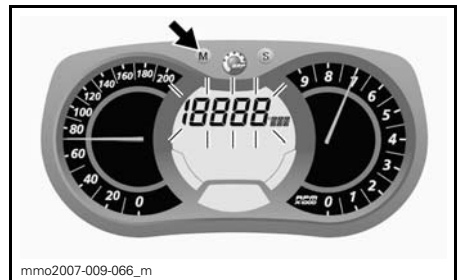
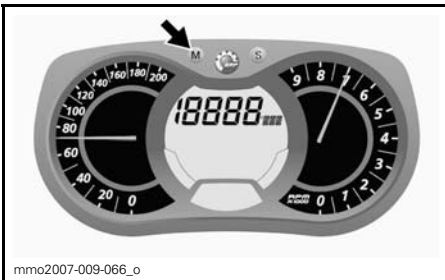

NOTE: Display will flash for approximately 5 seconds, then will return to the previously selected mode if display is not changed.

Push SET (S) button to select vehicle average speed (AVR_SPD) mode.

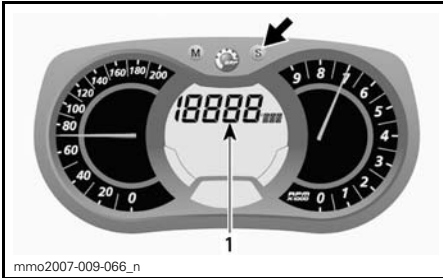

1. Vehicle average speed (AVR_SPD) mode

Push the MODE (M) button to confirm selection or wait 5 seconds.

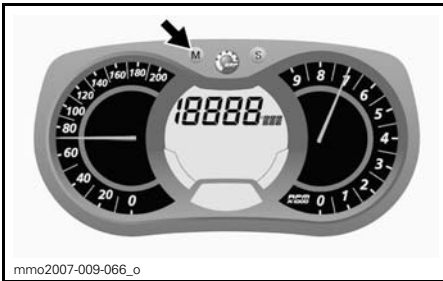

To reset, push the MODE (M) to select mode.



Push and hold the SET (S) button within 5 seconds to reset.

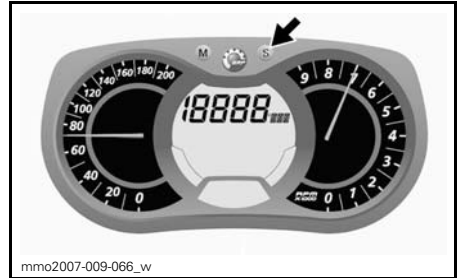

K) Heated Grips Heating Intensity

Bar gauge that indicates heating intensity.

Refer to *HEATING GRIPS SWITCH* for more details.

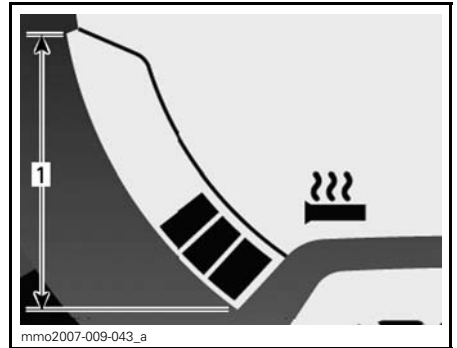

HEATING GRIPS

1. Operating range

L) Heated Throttle Lever Heating Intensity

Bar gauge that indicates heating intensity.

Bar gauge will be displayed instead of the fuel level with the activation of the heating throttle lever switch. When released, display will return to fuel level.

Refer to *HEATING THROTTLE LEVER SWITCH* for more details.

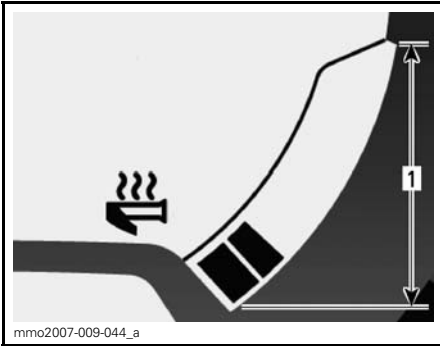

HEATING THROTTLE LEVEL

1. Operating range

M) Instant Fuel Consumption

Calculates vehicle average fuel consumption while riding.

To display vehicle average fuel consumption, proceed as follow.

Push the MODE (M) button to select display.



NOTE: Display will flash for approximately 5 seconds, then will return to the previously selected mode if display is not changed.

Push SET (S) button to select instant fuel consumption (L/100 km) mode.

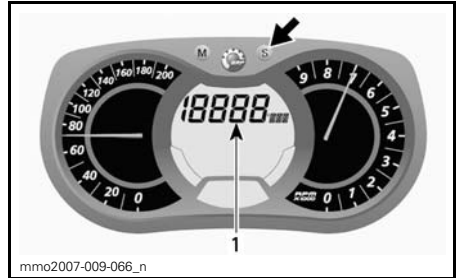

1. Instant fuel consumption (L/100 km) mode

Push the MODE (M) button to confirm selection or wait 5 seconds.

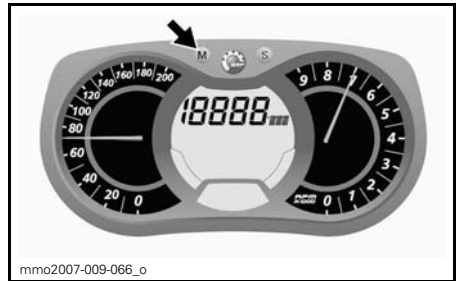

N) Total Fuel Consumption

Records vehicle average fuel consumption since it has been reset.

To display vehicle total fuel consumption, proceed as follow.

Push the MODE (M) button to select display.



NOTE: Display will flash for approximately 5 seconds, then will return to the previously selected mode if display is not changed.

Push the SET (S) button to select total fuel consumption (TC) mode.

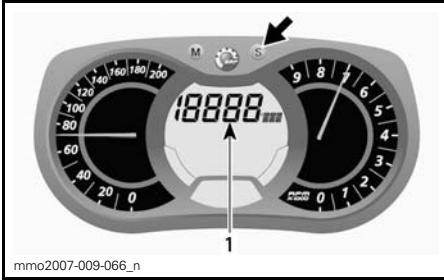

1. Total fuel consumption (TC) mode

Look for the abbreviation (TC) to ensure proper mode.

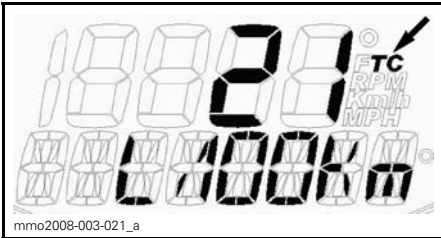

TYPICAL

Push the MODE (M) button to confirm selection or wait 5 seconds.

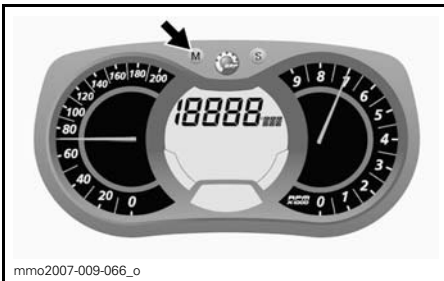

To reset, set the trip meter to TRIP B. Refer to *TRIP METER "A" OR "B"* for more details.

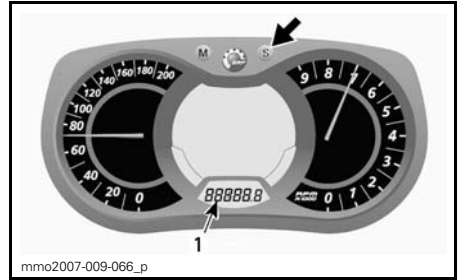

1. Trip meter (TRIP B) mode

Push and hold the SET (S) button to reset.

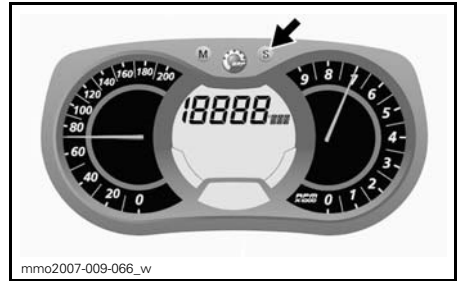

O) Message Display

This display is used as a complement of the pilot lamps to catch your attention and to give you a brief description if an anomaly occurs or to inform you of a particular condition.

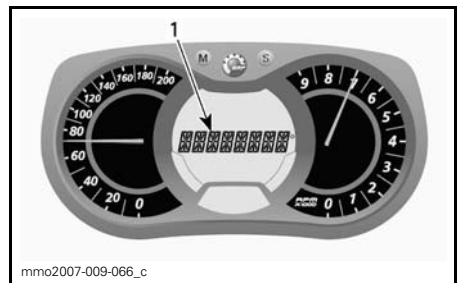

1. Message display

Message will be displayed with a beep code and pilot lamp(s).

Refer to *GAUGE PILOT LAMPS* for more details on beeper codes and what to do depending on the message.

P) Coolant Temperature

Bar gauge that continuously indicates the engine coolant temperature.

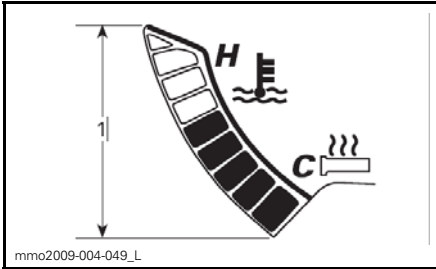

COOLANT TEMPERATURE

1. Range

Q) Lap Record Mode (Accessory)

With this mode, vehicle speed, engine revolutions per minute (RPM) and a preselected function in display 1 can be recorded at the same time during a period of time defined by the operator.

Also, a possibility of nine (9) different sessions (laps) can be recorded for a maximum total of 15 minutes.

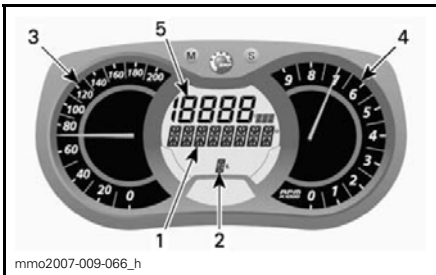

LAP RECORD MODE

1. Lap record mode display
2. Sessions (laps)
3. Vehicle speed
4. Engine revolution per minute (RPM)
5. Preselected function

To Activate Lap Record Mode:

1. Press the SET (S) button to select the odometer mode in display 3.
2. Press and hold SET (S) button for 2 seconds to activate mode, REC will be displayed to indicate that record mode has been selected.



1. Record mode
2. Odometer

3. Press the SET (S) button to scroll between modes.

Available modes are: STOP, REC (record) or PLAY.

To Record:

1. Select REC (record) mode.

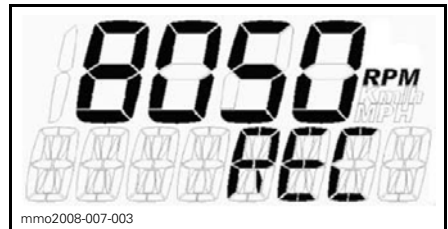

RECORD MODE

2. Press the MODE (M) button to start recording.
3. While recording, press the MODE (M) button again each time you want to record a new lap time (from 1 to 9 laps).

Press the SET (S) button to stop recording.



RECORD MODE

1. Recording time
2. Lap/session
3. Selected mode

To record another session, press the SET (S) button until REC (record) mode appears in display. Repeat same procedure previously described to record.

To Review Recorded Data:

1. Select PLAY mode.

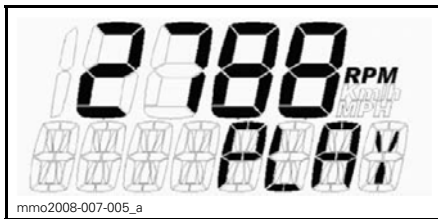

PLAY MODE

2. Press the MODE (M) button to play recorded data.

All recorded data (speedometer, tachometer and the preselected mode in display 1) will be displayed at the same time.

3. Press the SET (S) button to stop recorded lap OR press the MODE (M) button to switch to another recorded lap.

NOTE: Pressing the SET (S) button will stop time of the lap in progress, then the display will show the recorded time length of that lap and will switch automatically to the following recorded lap after 5 seconds.

At the end of all recorded laps, STOP will appear in display.

To review recorded data again, press the SET (S) button to return to PLAY mode. Repeat same procedure previously described to review.

To record other laps, press the SET (S) button to switch to REC (record) mode. Repeat same procedure previously described to record.

Press and hold SET (S) button for 5 seconds to exit the lap record mode, the previously selected mode will be displayed.

Analog display using procedure

Analog/digital gauge

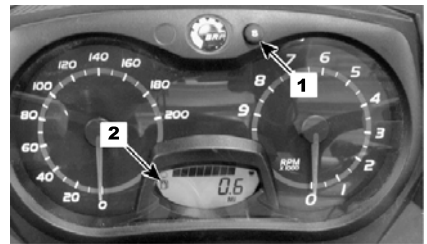

1. SET (S) Button
2. Fuel level gauge

Push the SET (S) button until display is on odometer mode.

Press and hold S button for 3 seconds and the multi functions display will show engine temperature.

Press and hold S button for 3 seconds to display back fuel gauge.

5) Gauge Pilot Lamps

Gauge pilot lamp(s) will inform you if an anomaly occurs or to inform you of a particular condition.











TYPICAL — PILOT LAMPS

Pilot lamp can flash alone or in combination with another lamp.

Beeper codes will be heard and messages (depending on gauge model) will be displayed to catch your attention.

Refer to the following table for more details.

NOTE: Message display is not available on all gauges.

PILOT LAMP(S) ON	BEEPER	DESCRIPTION
	Continuous fast short beeps	Engine, muffler or ECM is/are overheating, engine is limited to 5500 RPM. Stop engine as soon as possible and allow components to cool. Check cooling system.
	Continuous fast short beeps	<ul style="list-style-type: none"> - Critical low injection oil level. Stop vehicle in a safe place as soon as possible then, replenish injection oil reservoir before restarting engine. - If oil injection level is high, it then indicates a failure of the oil injection system, see an authorized LYNX dealer as soon as possible.
	4 short beeps	Engine, muffler or ECM is/are overheating, reduce snowmobile speed and run in loose snow or stop engine and allow components to cool. Check cooling system.
	4 short beeps	Engine management system fault that can change the normal operation of the engine, see an authorized LYNX dealer as soon as possible.
	4 short beeps every 2 minutes	<ul style="list-style-type: none"> - Engine under protection mode. - Ensure recommended fuel is used. - Check fuel quality, replace if necessary. - If fault still occurs, contact an authorized LYNX dealer.
	Continuously beeps	<ul style="list-style-type: none"> - Engine shutdown procedure in force due to an overheating during too long idle. - Fuel pump problem, contact an authorized LYNX dealer.
	4 short beeps every 2 minutes	Injection oil level is low. Replenish injection oil reservoir as soon as possible.
	—	Low fuel level. One (1) bar left in fuel level display. Replenish fuel tank as soon as possible.
	Slow long beeps	Electronic reverse is selected.
	3 short beeps	Engine rotation did not change after reverse try, try again.
	—	Headlamp is in HI beam position.
DESS	Refer to <i>DESS PILOT LAMP CODES</i> in <i>TETHER CUT-OUT SWITCH</i> .	

How to Read Fault Codes

Multifunction Analog/Digital Display Only

Press and hold MODE (M) Button and simultaneously depress the HI/LOW beam switch repeatedly several times.

If two or more codes are registered, use SET (S) or MODE (M) to scroll.

To exit the fault codes mode, press and hold MODE (M) Button.

Contact an authorized LYNX dealer for code signification.

6) Gauge MODE (M) Button (not in YETI 600 ACE and 550 models)

Multifunction Analog/Digital Gauge Only

Button use to navigate in gauge multi-function display.

NOTE: MODE (M) button on the multi-switch housing has the same functions and can also be used.

7) Gauge SET (S) Button (not in YETI 600 ACE and 550 models)

Button use to navigate, adjust or reset gauge multifunction display.

NOTE: SET (S) button on the multi-switch housing has the same functions and can also be used.

8) Throttle Lever

Designed to be thumb activated. When squeezed, it increases the engine speed and engages the transmission. When released, engine speed returns automatically to idle.

WARNING

Test the throttle lever operation each time before starting the engine. The lever must return to its original position once released. Otherwise, do not start engine.

9) Brake Lever

When squeezed, the brake is applied. When released, it automatically returns to its original position. Braking effect is proportional to the pressure applied on the lever and to the type of terrain and its snow coverage.

10) Parking Brake Lever

Parking brake should be used whenever snowmobile is parked.

WARNING

Make sure parking brake is fully disengaged before operating the snowmobile. When you ride the vehicle, brake pads that are caused to drag by a continuous pressure on the lever may cause damage to the brake system and cause loss of braking capacity and/or fire.

To Engage Mechanism

Squeeze brake lever and maintain while pulling locking lever with a finger. When brake lever is held at halfway the parking brake should be fully applied.

 CAUTION Parking brake position can vary depending on brake pads wear. Ensure when the parking brake is applied that the vehicle stays securely in place.

NOTE: Locking lever can be adjusted in two different positions.

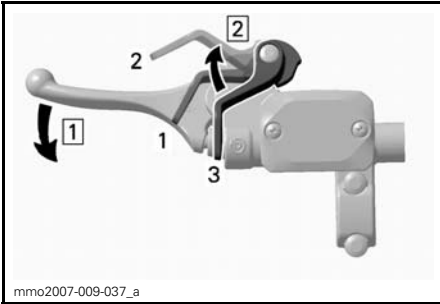

TYPICAL — ENGAGE MECHANISM

1. Position 1
2. Position 2
3. OFF

- Step 1: Squeeze and maintain brake lever
- Step 2: Adjust locking lever

To Release Mechanism

Squeeze brake lever. Locking lever will automatically return to its original position. Always release parking brake before riding.

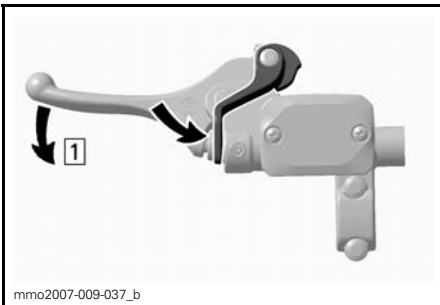

TYPICAL — RELEASE MECHANISM

- Step 1: Squeeze brake lever

11) Multi-Switch Housing

YETI 600 ACE and 550 models

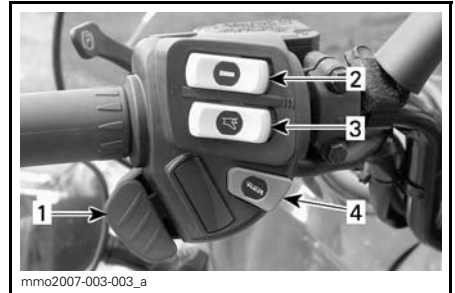

1. Headlights Dimmer Switch
2. Heated Grips Switch
3. Heated Throttle Lever Switch
4. Start Button

All models except YETI 600 ACE and 550 models

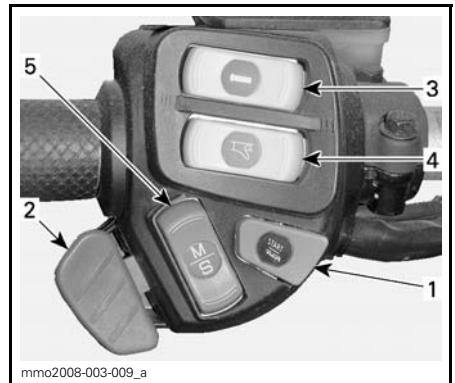

TYPICAL

1. Start button
2. Headlamp dimmer switch
3. Heating grips
4. Heating throttle lever
5. Mode/set button

Start Button

When pressed, it engine starts. in *OPERATING INSTRUCTIONS* section for procedure.

Headlamp Dimmer Switch

When pressed, it allows selection of headlamp HI or LOW beam. Lights are automatically ON whenever the engine is running.

Heating Grips Switch

Select the desired position to keep your hands at a comfortable temperature.

All models except YETI 600 ACE and 550 models

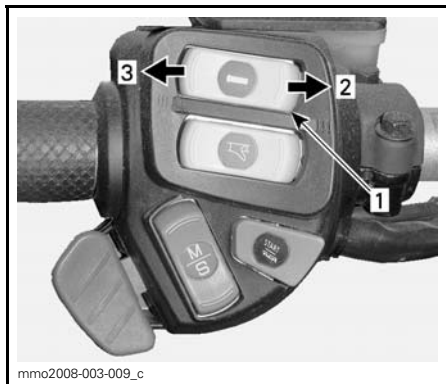

1. Heating grip switch
2. Warmer
3. Colder

On the above mentioned models, grips heating intensity will be displayed via the multifunction display

Heating grips will be in OFF position when there are no bars left in the display.

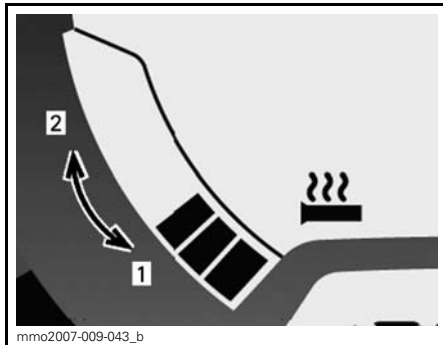

MULTIFUNCTION GAUGE — HEATING INTENSITY

1. Colder
2. Warmer

YETI 600 ACE and 550 models

NOTE: The heated grips are enabled above 2000 engine RPM.

Select the switch position according to the desired heating intensity to keep your hands at a comfortable temperature.

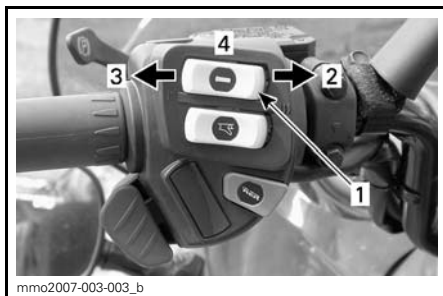

- TYPICAL**
1. Heated grip switch
 2. Hot
 3. Warm
 4. Off

Heating Throttle Lever Switch

Select the desired position to keep your thumb at a comfortable temperature.

All models except YETI 600 ACE and 550 models

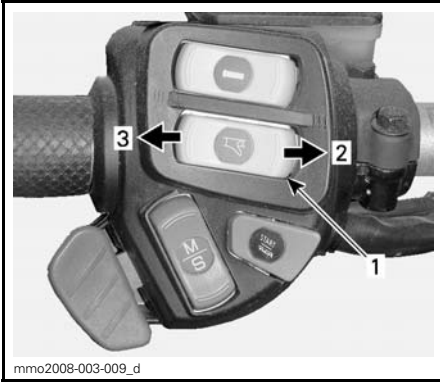

1. Heated throttle lever switch
2. Warmer
3. Colder

Heating throttle lever will be in OFF position when there are no bars left in the display.

NOTE: Bar gauge will be displayed with the activation of the throttle lever switch. When released, display will return to fuel tank level.

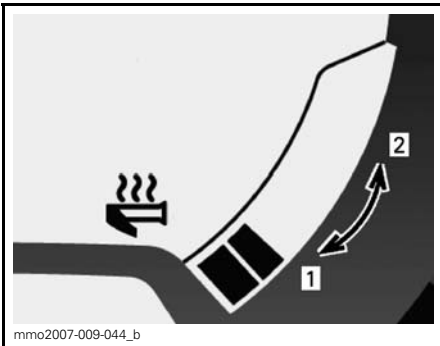

MULTIFUNCTION GAUGE — HEATING INTENSITY

1. Colder
2. Warmer

YETI 600 ACE and 550 models

NOTE: The heated grips are enabled above 2000 engine RPM.

Select the switch position according to the desired heating intensity to keep your thumb at a comfortable temperature.

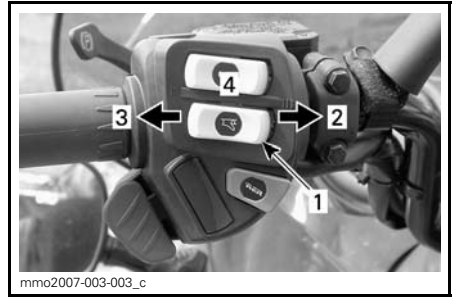

TYPICAL

1. Heated throttle lever switch
2. Hot
3. Warm
4. Off

Mode/Set Button

All except YETI 600 ACE and 550 models

This button can be used instead of the two buttons on top of the analog/digital gauge to facilitate gauge adjustments.

- When pushed upward, it has the same functions as the MODE (M) button.
- When pushed downward, it has the same functions as the SET (S) button.

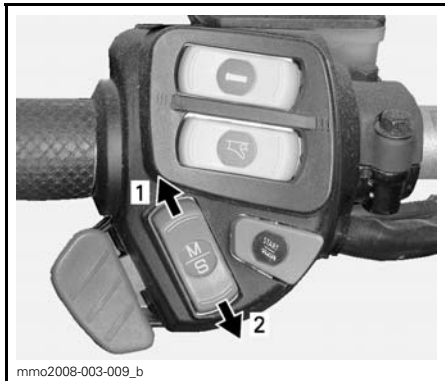

mmo2008-003-009_b
MULTIFUNCTION GAUGE

1. MODE function
2. SET function

12) Handlebar

The handlebar controls the steering of the snowmobile. As the handlebar is rotated to right or left, the skis are turned right or left to steer the snowmobile.

⚠ WARNING

Fast reverse while turning, could result in loss of stability and control.

13) Handle Bar Position adjuster (Grand Tourer models)

In Grand Tourer model is handlebar position quick adjuster. You can change handlebar to 4 different position.



fmo2009-004-092

14) Mountain Strap (Commander Models)

Commander Models

Mountain strap provides a grip for the driver when side-hilling.

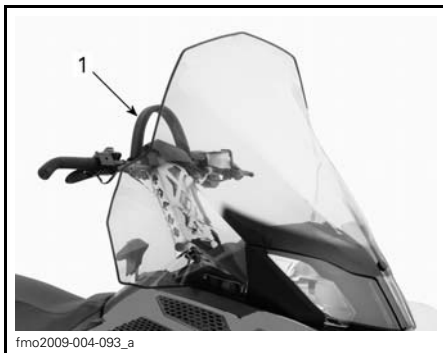

fmo2009-004-093_a

1. Mountain Strap

⚠ WARNING

This strap is not for towing, lifting or other purpose than temporary use as a grab handle during side-hilling. Always keep at least one hand on handlebar.

15) Tether Cut-Out Switch

General

When the tether cord cap (DESS key) is removed, it shuts the engine off preventing snowmobile to runaway if the operator falls off the vehicle accidentally.

⚠ WARNING

Always remove the tether cord cap (DESS key) when vehicle is not in operation in order to prevent accidental engine starting, to avoid unauthorized use by children or others or theft.

Operation

Attach tether cord eyelet to clothing, then snap cap (DESS key) over post before starting engine.

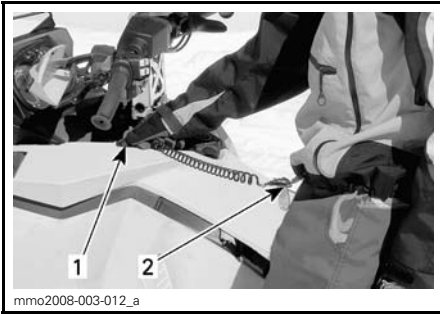
**TYPICAL**

1. Snap over post
2. Attach to clothing

If emergency engine shut off is required, pull tether cord cap (DESS key) from post completely.

DESS (Digitally Encoded Security System) Key/Cut-Out Switch

The tether cord cap (DESS key) is digitally encoded to provide you and your snowmobile with the equivalent security of a conventional lock key and it shuts off the engine preventing snowmobile to runaway if the operator falls off the vehicle accidentally.

The DESS key provided with your snowmobile contains an electronic chip which features a unique permanently memorized digital code. Your authorized LYNX dealer programs this key in the ECM (Engine Control Module) of your snowmobile to allow engine operation above 3000 RPM if and only if this unique code has been read after engine starting.

If another DESS key is installed, the engine will start but will not reach drive pulley engagement speed to move vehicle.

Make sure the DESS key is free of dirt or snow.

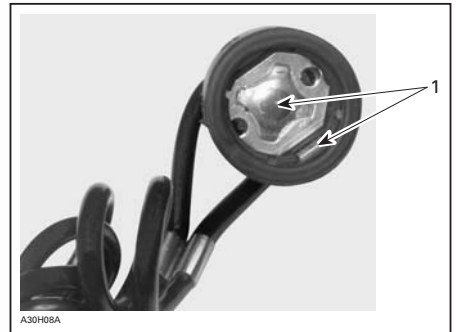
**DESS KEY**

1. Free of dirt or snow

Additional DESS Keys

The ECM of your snowmobile can be programmed by your authorized LYNX dealer to accept 8 different keys.

We recommend the purchase of additional keys from your authorized LYNX dealer. If you have more than one DESS-equipped LYNX snowmobile, each can be programmed by your authorized LYNX dealer to accept the other vehicles keys.

DESS Pilot Lamp Codes

NOTE: If any code still occurs, contact an authorized LYNX dealer.

WARNING SIGNALS		DESCRIPTION	
BEEPER	DISPLAY MESSAGE		
2 shorts	WELCOME...	Personalized welcome message, good key	
Slow short beeps/ repetitive	CHECK KEY	Unable to read key (bad connection)	Make sure the key is free of dirt or snow. Reinstall key and restart engine. Vehicle can not be driven.
Fast short beeps/ repetitive	BAD KEY	Invalid key or key not programmed	Use the proper key for this vehicle or have the key programmed. Vehicle can not be driven.

16) Engine Cut-Out Switch

Push-pull type switch. To stop the engine in an emergency, select OFF position (down) and simultaneously apply the brake. To restart, button must be at the ON position (up).



mmo2007-009-038_a

OFF POSITION



mmo2007-009-038_b

ON POSITION

All operators of the snowmobile should familiarize themselves with the function of this device by using it several times on first outing and whenever stopping the engine thereafter. This engine cut-out procedure will become a reflex and will prepare operators for emergency situations requiring its use.

⚠ WARNING

If the switch has been used in an emergency caused by a suspected malfunction, the source of the malfunction should be determined and corrected before restarting engine. See an authorized LYNX dealer for servicing.

17) Rewind Starter Handle

Auto-rewind type located on right hand side of snowmobile behind side panel. To engage mechanism, pull handle slowly until a resistance is felt then pull vigorously. Slowly release handle.

18) Gearshift Lever

Use this lever to select gears. The gearbox has two forward gears, a reverse gear and a neutral.

Refer to *GEARBOX OPERATION* in *OPERATING INSTRUCTIONS* for details.

NOTE: It is necessary to push shift lever knob down to move it from neutral to reverse.

Gear shifting

These models are equipped with 4-position gear shift lever. Two gears forward, reverse gear and neutral position between 1-gear and reverse gear.

NOTE: Gear shifting at movement is possible only between 1 and 2 gear when engine is running at idle and the speed is under 20 km/h.

19) Fuel Tank Cap

Unscrew to fill up tank then fully tighten.

! WARNING

Always stop the engine before refueling. Fuel is flammable and explosive under certain conditions. Always work in a well ventilated area. Do not smoke or allow open flames or sparks in the vicinity. Open cap slowly. If a differential pressure condition is noticed (whistling sound heard when loosening fuel tank cap) have vehicle inspected and/or repaired before further operation. Do not overfill or top off the fuel tank before placing the vehicle in a warm area. As temperature increases, fuel expands and might overflow. Always wipe off any fuel spillage from the vehicle. Periodically verify fuel system.

NOTE: Do not sit or lean on seat when fuel tank cap is not properly installed.

20) Hood and Side Panels

Hood

! WARNING

Never operate engine with hood removed from vehicle.

Hood Removal

1. Remove upper side panels as explained below.
2. Unhook the rubber straps on both sides.



1. Rubber strap

3. Slide hood towards front to free the tabs from their slots.

Hood Installation

1. Engage the tabs located at front and center of the hood into the bottom pan slots.

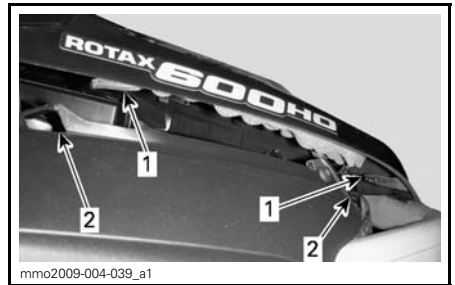

1. Tabs
2. Slots

2. Slide hood towards headlights until it stops.
3. Hook the rubber straps.

Upper Side Panels

⚠ WARNING

Never operate engine with side panels opened or removed from vehicle.

Upper Side Panel Removal

1. Unhook the rubber strap.

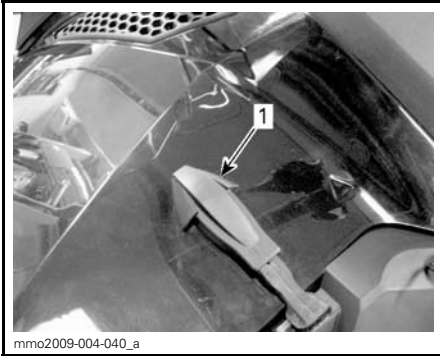

1. Rubber strap

2. Lift the rear portion of panel to free the plastic tab from the console.

3. Slide panel towards rear.

Upper Side Panel Installation

1. Insert front lower tabs into the upper bottom pan slots.

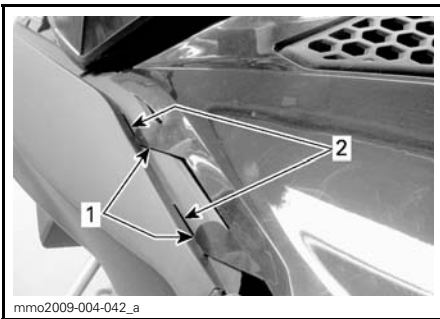

1. Tabs
2. Slots

2. Hook the panel top center tabs to the console.

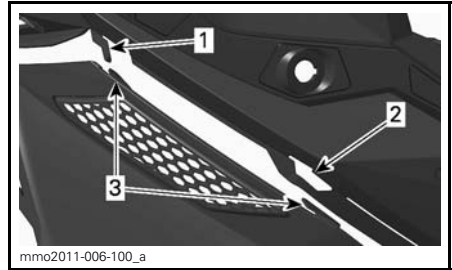

1. Console hook
2. Console slot
3. Panel center tabs

3. Insert the rear tab into the console slot.

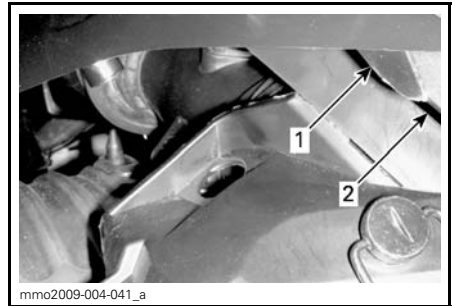

1. Rear Tab
2. Console Slot

4. Hook rubber strap.

Lower Side Panels

⚠ WARNING

Never operate engine with side panels opened or removed from vehicle.

Lower Side Panel Opening

1. Remove upper side panel as explained above.

Grand Tourer 600 E-TEC, Grand Tourer 1200 4-TEC, Commander 600 E-TEC

2. Unhook the rubber strap.

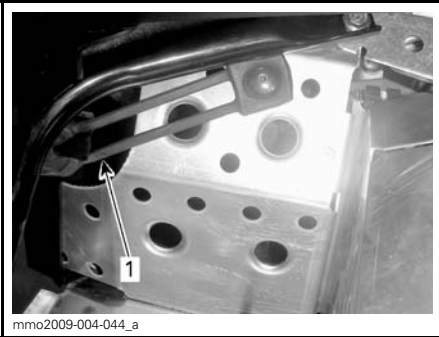

mmo2009-004-044_a

1. Rubber strap

All

3. Turn the clip 1/4 turn counterclockwise to unlock.

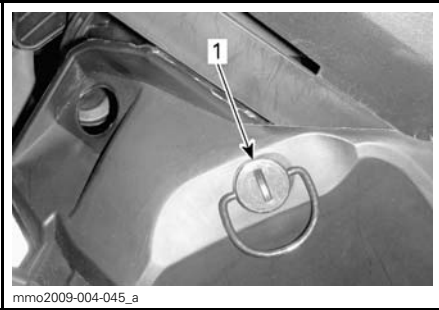

mmo2009-004-045_a

1. Clip

Grand Tourer 600 E-TEC, Grand Tourer 1200 4-TEC, Commander 600 E-TEC

4. Slightly lift the rear of side panel, then open sideways.

YETI 600 ACE and 550 models

5. Push and hold lock tab in, then pull panel up and rearward.



fmo2012-003-022_a

1. Lock tab

Lower Side Panel Closing

Grand Tourer 600 E-TEC, Grand Tourer 1200 4-TEC, Commander 600 E-TEC

1. Insert the front upper tab into the upper bottom pan slot.

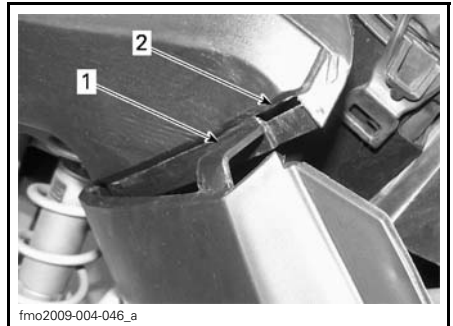

fmo2009-004-046_a

1. Tab
2. Slot
2. Insert the lower section of side panel over the aluminium chassis and the aluminium tab into the panel slot.

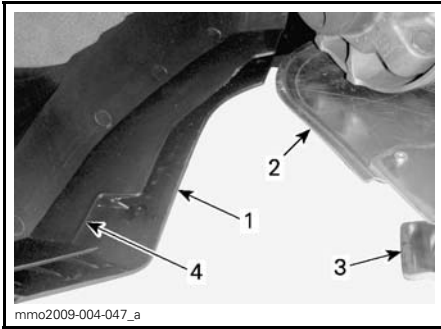

1. Lower section
2. Aluminium chassis
3. Aluminium tab
4. Panel slot

3. Insert the lower rear tab into the tunnel slot.

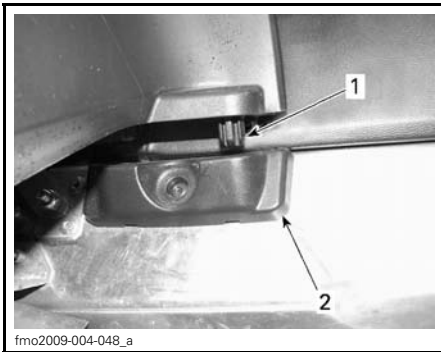

1. Tab
2. Slot

4. Hook the rubber strap.

YETI 600 ACE and 550 models

5. Insert the panel lower tabs into the pan slots.

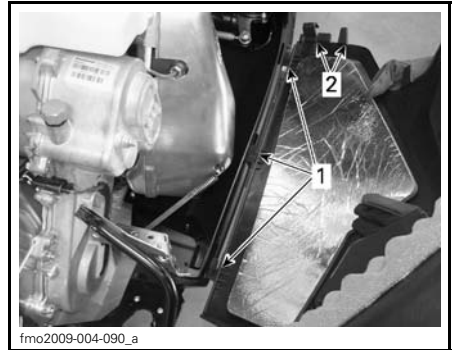

1. Lower tabs
2. Lower front tabs

6. Align panel front tabs in the bottom pan slots



1. Panel front tabs
2. Bottom pan slots

7. Push panel towards front.

8. Insert the lower rear tab into the tunnel slot.

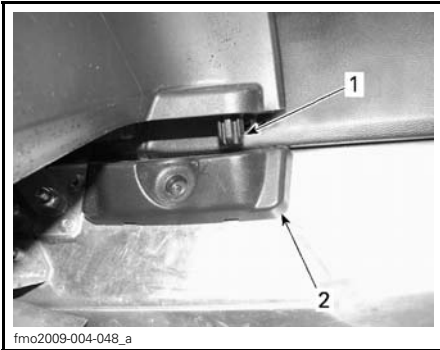

1. Tab
2. Tunnel slot

All

9. Lock the clip by turning it 1/4 turn clockwise

Lower Side Panel Removal/Installation

- Open lower side panel as explained above.
- Lift the front of side panel and free the lower hinge from its slot.
- Free the upper hinge by lowering the panel.

Reverse procedure for installation.

21) Fuses

The electrical system is protected with fuses, refer to *ELECTRICAL SYSTEM* for details.

The fuse box is located in the left side of vehicle behind seat cover. To get access to fuse box open lower side panel and then remove seat cover lower left aside.

⚠ CAUTION Do not use a higher rated fuse as this can cause severe damage to electrical components and/or be a potential fire.

⚠ WARNING

If fuse has burnt out, source of malfunction should be determined and corrected before restarting. See an authorized LYNX dealer for servicing.



550 MODEL

Battery

Battery is located in storage box under passenger seat. To get access to battery push battery cover notches both sides of cover and remove it



22) Grab Handle/Bumper

To be used whenever snowmobile requires manual lifting.

⚠ WARNING

Use proper lifting techniques, notably using your legs force. Do not attempt to lift the vehicle by hand alone. Use appropriate lifting device or have assistance to share lifting stress if possible.



FRONT

1. Grab handle/bumper



REAR

1. Grab handle/bumper

⚠ CAUTION Do not use skis to pull or lift snowmobile.

23) Storage Compartment

The storage compartment is located behind the driver's seat.

⚠ WARNING

The storage compartment must be properly latched and must not contain any sharp, heavy or breakable objects.

To open the lid, pull and hold the rubber tab sideways, then lift the RH side of the lid or passenger seat if installed.



1. Pull rubber tab
2. Lift RH side

24) Tool Kit

A tool kit containing tools for basic maintenance is supplied with the vehicle.

Tool bag is located in engine compartment on pulley guard.



1. Tool kit

25) Spark Plug Storage

A space is provided in the tool kit to keep spare spark plugs dry and prevent shocks that might affect the adjustment or break them.

NOTE: Spare spark plugs are not supplied with snowmobile.

NOTE: Check spare spark plug gap according to *SPECIFICATIONS* before installation.

⚠ CAUTION Do not attempt to adjust spark plug gap.

26) Spare Drive Belt

A spare drive belt can be stored in storage box under seat.

NOTE: Spare drive belt is not supplied with the snowmobile

⚠ CAUTION To avoid damages to the drive belt, ensure that things which are carried in storage box are not damaged the spare drive belt.



27) Shields and Guards

⚠ WARNING

Never operate engine without belt guard securely installed or, with hood, brake disk guard or side panels opened or removed.

Your snowmobile is provided with a number of shields and guards. Leave these in place on your vehicle as they are designed to keep clothing and hands out of moving parts and away from hot components. Never attempt to make adjustments to any moving part while the engine is running.

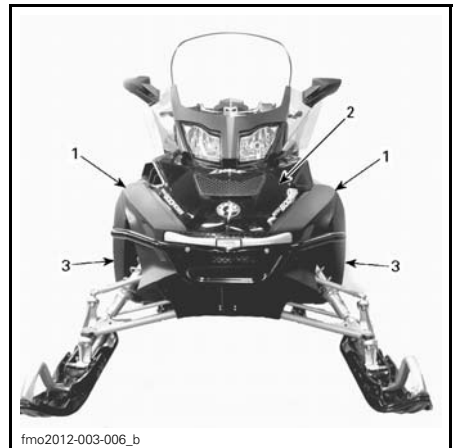

TYPICAL

1. Upper Side panels
2. Front hood
3. Side Panels



1. Belt guard
2. Brake disk guard

28) Track

⚠ WARNING

Never stud a track that has not been approved for studs. Installing studs on an unapproved track could increase the risk of the track tearing or severing, possibly resulting in serious injury or death.

Before proceeding with the installation of special studs on tracks you must contact your authorized LYNX snowmobile dealer for current specific studing availability and applications.

BRP does **not recommend** to ride a snowmobile equipped with high lug profile track at **high speed** in a trail, on hard packed surfaces or ice for an extended period of time.

In the event that you have to, **reduce your speed**, then minimize the distance you ride on those surfaces.

⚠ CAUTION Running those tracks at high speed in a trail, on hard packed surfaces or ice put more stress on the lugs, which tend to heat up as a result. To avoid potential degradation or damage to the track, reduce your speed, then minimize the distance you ride on those surfaces.

For general instructions on maintenance of tracks, refer to the sections *TRACK* and *TRACK TENSION AND ALIGNMENT* in the *MAINTENANCE* section of this guide.

29) Passenger Seat

Grand Tourer® Commander models only (as option).

⚠ WARNING

Any passenger must be able to firmly lay his feet on the footrests and keep his hands on the grab handles at all times when seated. Respecting those physical criteria is important to ensure that the passenger is stable and to reduce the risks of ejection.

Passenger Seat Removal

To remove the passenger seat, proceed as follows:

1. Disconnect the accessories connector by turning the plastic housing counterclockwise.

NOTE: The connector is located on the LH side of the storage compartment.

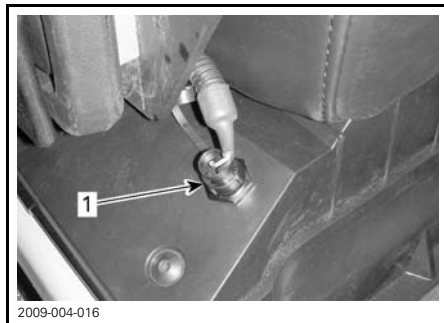

1. Accessories connector

2. Install the rubber plug on the connector.
3. Push the latch tab in and lift-up the rear of seat.

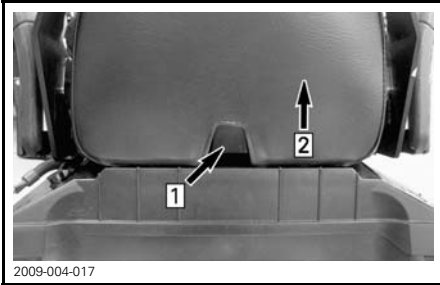

1. Push tab
2. Lift rear of seat

4. Slide seat rearward and set aside.

Passenger Seat Installation

To install the passenger seat, proceed as follows:

1. Place the passenger seat facing forward on the storage compartment lid.
2. Slightly incline the passenger seat towards front and engage both seat hooks in the storage compartment lid slots.

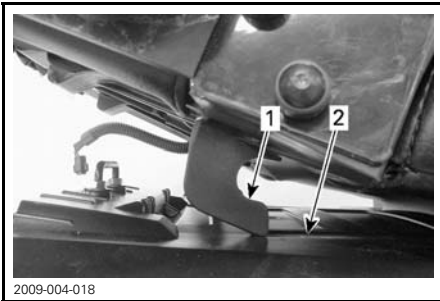

1. Seat hook
2. Slot

3. Push the the passenger seat towards the driver's seat and firmly push the rear portion down to lock the passenger seat in position.

NOTE: A distinctive snap will be felt. Double check that the seat is secure by giving it a tug to confirm proper latching.

WARNING

Make sure seat is securely latched before riding.

4. Connect the accessories connector

30) Passengers Handholds

The handholds can be set at three different positions:



LOW



HIGH

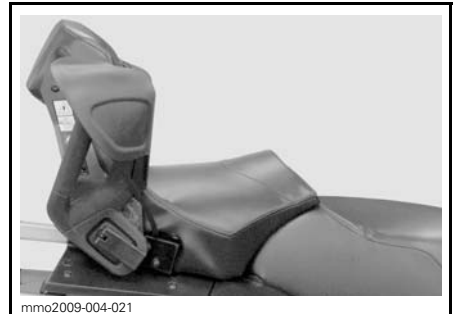

UP

To set the handholds to the desired position, proceed as follows:

1. Pull up the knob and unscrew several turns until the handhold is free to move.
2. Refer to the decal located on the RH backrest bracket and guide the handhold to the desired position.

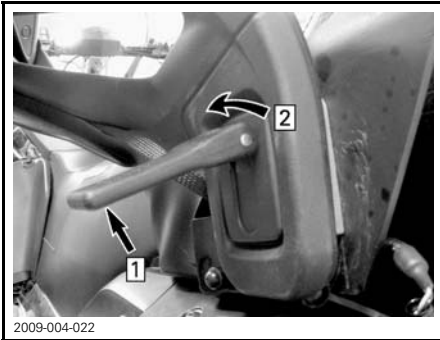

1. Pull up
2. Unscrew

3. Screw the knob enough to obtain a suitable tension.
4. Lower knob to lock the handhold in place.

31) Rear Passenger Heating Grip Switch

The switch is located on the LH passenger handhold.

Adjust heating intensity as shown.



1. Off
2. Warm
3. Hot

32) Rear Rack

⚠ WARNING

All objects in rear rack must be properly latched. Do not carry any breakable objects. Excessive weight in rack may reduce steering ability.

⚠ WARNING

Always readjust suspension according to the load. The capacity of this rack is limited, the MAXIMUM cargo load is 30 kg (66 lb). Ride at very low speed when loaded. Avoid speed over bumps.

33) 12-Volt Power Outlet

A 12-volt electric appliance may be connected to that jack connector. Electric current is supplied whenever engine is running.

34) Hook Type Hitch

Use the hitch in conjunction with a tow bar to tow an accessory.

When attaching any accessory, always refer to the manufacturer's recommendations.

NOTE: Refer to decal on vehicle for towing weight capacities.

⚠ WARNING

Never tow an accessory with a rope. Always use a rigid tow bar. Using a rope would result in a collision between the object and the snowmobile and possibly in a tip over in case of a rapid deceleration or on a downward slope.

J-Type Hitch*Attaching an Equipment*

fmo2012-003-013_a

1. Safety tab
2. Hairpin clip

1. Remove the hairpin clip.
2. Align accessory attachment hole with the hitch hook.
3. Push the accessory attachment passed the safety tab.
4. Secure safety tab using the hairpin clip.

Detaching an Equipment

1. Remove the hairpin clip.
2. Push safety tab forward to free accessory attachment from the hitch.
3. Detach accessory attachment.

4. Install hairpin clip.

35) Choke lever (59 YETI 550)

See proper usage instructions in *OPERATING INSTRUCTIONS* section.

This device features a 3-position lever to facilitate cold start.

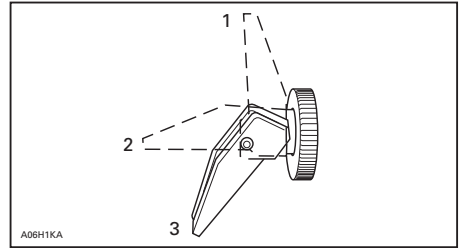

1. OFF
2. Position 2
3. Position 3

Initial Cold Starting

NOTE: Do not operate the throttle lever with the choke lever on.

Move the choke lever to position 3 and start the engine. As soon as the engine starts, move the lever to position 2. After a few seconds (10 seconds maximum) move the choke lever to OFF.

NOTE: In severe cold weather, colder than -20°C you may need to flip choke lever from OFF to position 1 a couple of times once engine is started.

Warm Engine Starting

Start the engine without any choke. If the engine will not start after two pulls of the rope or two 5 second attempts with the electric starter move choke lever to position 2. Start the engine without activating the throttle lever. As soon as the engine starts move the choke lever to OFF.

FUEL

Recommended Fuel

Use unleaded gasoline available from most service stations or oxygenated fuel containing a maximum total of 10% of ethanol or methanol or both. The gasoline used must have the following recommended minimum octane number.

OCTANE NUMBER		
98 E5		
95 E10	▼	▼
ENGINES	95 E10	98 E5
550SK	X	X
600 HO E-TEC	X	X
600 ACE	X	X
1200 4-TEC	X	X

⚠ CAUTION Never experiment with other fuels or fuel ratios. The use of unrecommended fuel can result in snowmobile performance deterioration and damage to critical parts in the fuel system and engine components. Do not mistake oil reservoir cap for fuel tank cap. Oil reservoir cap is identified OIL.

Fueling Procedure

Unscrew to fill up tank then fully tighten.

⚠ WARNING

- Always stop engine before refueling. Open cap slowly.
- If a differential pressure condition is noticed (whistling sound heard when loosening fuel tank cap) have vehicle inspected and/or repaired before further operation.
- Fuel is flammable and explosive under certain conditions.
- Never use an open flame to check fuel level.
- Never smoke or allow flame or spark in vicinity.
- Always work in a well-ventilated area.
- Never top up the fuel tank before placing the vehicle in a warm area. As temperature increases, fuel expands and may overflow.
- Always wipe off any fuel spillage from the vehicle.

NOTE: Do not sit or lean on seat when fuel tank cap is not properly installed.

Fuel System Antifreeze

When using oxygenated fuel, additional gas line antifreeze or water absorbing additives are not required and should be not used.

INJECTION OIL (550SK AND 600 HO E-TEC)

Recommended Injection Oil

RECOMMENDED INJECTION OIL			
XP-S synthetic oil (P/N 619590106) (2) (3)			
XP-S synthetic blend (P/N 619590103)(2) (3)			
XP-S mineral injection oil (P/N 619590101)(4)			
ENGINES	▼	▼	▼
550 SK	X	X	X
600 HO E-TEC	—	X (1)	X

NOTICE (1) These engines were specifically developed and validated using BRP XPS™ oil. BRP strongly recommends the use of its XPS oil at all times. Damages caused by oil which is not suitable for the engine will not be covered by the BRP limited warranty.

NOTICE Check level and refill every time you refuel.

Injection Oil Level Verification

The injection oil reservoir is located behind the RH side panel.

Always maintain a sufficient amount of recommended injection oil in the injection oil reservoir.

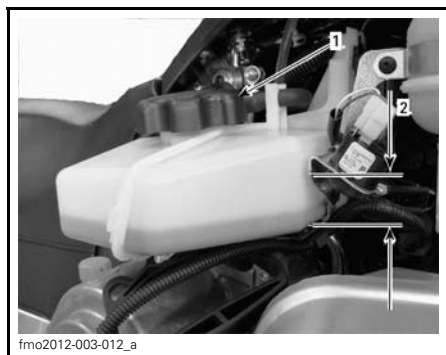

TYPICAL

1. Injection oil reservoir
2. Level marks (1/4, 1/2, 3/4)

NOTICE Check level and refill every time you refuel.

NOTICE Do not mismatch oil reservoir cap with fuel tank cap.

⚠ WARNING

Do not overfill. Reinstall cap and fully tighten. Wipe off any oil spills. Oil is highly flammable when heated.

BREAK-IN PERIOD

Break-In Period Duration

A break-in period of 10 operating hours or 500 km (300 mi) is required.

E-TEC Models

During a predetermined period, the engine management system controls some engine parameters.

The duration is based on fuel volume. It will take approximately two fuel tanks to complete the break-in.

During this period:

- The engine performance and behavior will not be optimal.
- The fuel and oil consumption will be higher.

550 Engine Only

To assure additional protection during the initial engine break-in, 500 mL of recommended injection oil should be added to fuel for the first full filling of fuel tank. Have spark plugs cleaned after engine break-in.

Operation During Break-In

Engine

During the break-in period:

- Avoid prolonged full throttle operation.
- Avoid sustained accelerations.
- Avoid prolonged cruising speeds.
- Avoid engine overheating.

However, brief accelerations and speed variations contribute to a good break-in.

Drive Belt

A new drive belt requires a break in period of 50 km (30 mi).

During the break-in period:

- Avoid strong acceleration and deceleration.
- Avoid pulling a load.
- Avoid high speed cruising.

Break-In Inspection

After the break-in period, the vehicle should be inspected by an authorized Lynx dealer. Refer to *MAINTENANCE* section.

OPERATING INSTRUCTIONS

Pre-Operation Check

WARNING

The pre-operation check is very important prior to operating the vehicle. Always check the proper operation of critical controls, safety features and mechanical components before starting. If not done as specified here, severe injury or death might occur.

- Remove snow and ice from body including seat, footrests, controls and instruments.
- Lights — The headlamp, the taillight and the brake light are standard equipment. Be sure lights are clear of dirt, slush or snow and are in good working order or condition.
- Verify that track and idler wheels are free to turn and not frozen.

WARNING

Always use a wide base snowmobile mechanical stand to properly support vehicle during any track verification. Slowly accelerate engine in order to rotate track at very low speed when it is not on ground.

- Activate the brake control lever and make sure the brake fully applies before the brake control lever touches the handlebar grip. It must fully return when released.
- Check the parking device. Apply parking brake and check if it operates properly.
- Activate the throttle control lever several times to check that it operates easily and smoothly.

WARNING

Throttle lever must operate easily and smoothly. It must return to idle position when released.

- Check operation of tether cord cap (DESS key), engine cut-out switches, headlamp switch (HI-LO), taillight, brake light and pilot lamps.
- Verify that skis and steering operate freely. Check corresponding action of skis versus handlebar.
- Check fuel and oil for levels and leaks. Replenish as necessary and see an authorized LYNX dealer in case of any leaks.
- Verify that air silencer prefilter is free of snow.
- All storage compartments must be properly latched and they must not contain any heavy or breakable objects. Hood and side panels must be also properly latched.

WARNING

All adjustable features should be positioned at optimal setting. Securely tighten all adjustment locks.

- Make certain your snowmobile is pointed away from people or objects before you start it. No one is to be standing in front of or in back of the snowmobile.
- Be warmly dressed with clothing designed for snowmobiling.

PRE-OPERATION CHECK LIST

ITEM	OPERATION	✓
Body including seat, footrests, lights, controls and instruments	Check that there is no snow or ice.	
Track and idler wheels	Check for free movement.	
Brake lever	Check proper action.	
Parking device	Check proper action.	
Throttle lever	Check proper action.	
Switches and lights	Check proper action. Tether cord must be attached to driver clothing eyelet.	
Skis and steering	Check for free movement and proper action.	
Fuel and oil	Check for proper level and leaks.	
Air silencer prefilter	Check that there is no snow or ice.	
Adjustable features	Check for optimal adjustment and securely tightened adjustment locks.	
Storage compartment	Check for proper latching and no heavy or breakable objects.	
Vehicle vicinity	Snowmobile must be pointed away from people or objects. No one is to be standing in front of or in back of the snowmobile.	
Clothing	Be warmly dressed with clothing designed for snowmobiling.	

Engine Starting Procedure**General****Procedure**

- Recheck throttle control lever operation.
- Ensure that the tether cord cap (DESS key) is in position and that the cord is attached to your clothing eyelet.
- Ensure that the engine cutout switch is in the ON position.

NOTE: For an initial cold start, do not release parking brake. Perform the *VEHICLE WARM-UP* procedure as explained below.

Electric Starting (if so equipped)

- Depressing the START/RER button will engage the electric starter and start the engine.
- Release button immediately when engine has started.

 WARNING

Never depress throttle while starting engine.

⚠ CAUTION Do not use electric starter for more than 10 seconds. A rest period should be observed between the cranking cycles to let electric starter cool down. Using electric starter when engine has started could damage electric starter mechanism.

NOTE: If for any reason, the engine cannot be cranked electrically, start engine manually using the rewind starter.

Carburetor Engine Starting Procedure (550 model)

Procedure

1. Recheck throttle control lever operation.
2. Ensure that the tether cord cap (DESS key) is in position and that the cord attached to your clothing eyelet.
3. Ensure that the engine cutout switch is in the ON position.
4. Activate the choke according to the temperature as explained below.

Choke Application

Initial Cold Starting When Temperature is Below - 10°C (+ 15°F)

NOTE: Do not operate the throttle lever with the choke lever on.

Set the choke lever to position 3.

NOTE: After the engine is started, let engine warm up at fast idle until engine speed drops. Then, close off choke to ensure proper air-fuel mixture.

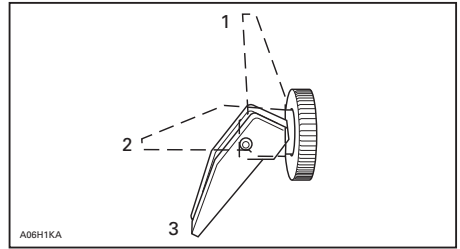

1. OFF
2. Position 2
3. Position 3

Initial Cold Starting When Temperature is Above - 10°C (above + 15°F)

Set the choke lever to position 2.

NOTE: After the engine is started, close off choke to ensure proper air-fuel mixture.

Warm Engine Starting

Start the engine without any choke. If the engine will not start after two pulls of the rope or two 5 second attempts with the electric starter move choke lever to position 2. Start the engine without activating the throttle lever. As soon as the engine starts move the choke lever to OFF.

Vehicle Warm-Up

Before every ride, vehicle has to be warmed up as follows.

Engage parking brake.

Snowmobile must be securely supported by the rear bumper using a wide-base snowmobile mechanical stand. Track must be 100 mm (4 in) off the ground.

Attach tether cord to operator's clothing eyelet.

Start engine and allow it to warm up two or three minutes at idle speed.

Disengage parking brake.

⚠ WARNING

Make sure wide-base snowmobile mechanical stand is stable. Stay clear of the front of vehicle and the track. Do not use too much throttle during warm-up or when track is free-hanging.

Apply throttle until drive pulley engages. Let track rotate at low speed for several turns. The lower the vehicle temperature, the longer vehicle warm-up should be.

Shut-off the engine and remove the wide-base snowmobile mechanical stand.

Skis may be frozen on the ground. Grab both skis one at a time by their loops and lift their front end slightly off the ground.

After restarting engine, the vehicle can be driven at low speed for the first 2 or 3 minutes of riding. After that, it may be driven up to the legal speed limit as per normal safety practices.

Gearbox Operation

Neutral

When set in Neutral (N), the gearbox disengages the pulleys from the track.

Shifting in Reverse

To engage reverse gear, proceed as follows:

1. Bring vehicle to a complete stop.
2. Apply and hold brake.
3. With engine at idle speed, select reverse (R) gear using the gearshift lever.

NOTE: It is necessary to push shift lever knob down to move it from neutral to reverse.

4. Gently depress throttle lever.

NOTICE Come to a complete stop before engaging reverse. Apply brake before shifting. Wait until the reverse alarm sounds before operating throttle.

⚠ WARNING

The reverse speed is not limited. Always proceed with caution as fast reverse could result in loss of vehicle stability. Always remain seated. Ensure the path behind is clear of obstacles or bystanders before proceeding.



fmo2012-003-011
GEARSHIFT LEVER

NOTICE Always put the transmission in neutral (N) when parked.

NOTICE Always put the transmission in the first (1) gear when pulling a load.

Shifting in Forward

There are two forward gears.

To engage a forward gear, proceed as follows:

1. Bring vehicle to a complete stop.
2. Apply and hold brake.

3. With engine at idle speed, select low (1) or high (2) gear using the gearshift lever.
4. Gently depress throttle lever.

NOTE: It is possible to shift from 1st to 2nd gear if vehicle speed is below 20 km/h (12MPH). Release throttle to shift.

Shifter rod adjustment

1. Adjust shifter rod to initial length from end to end 258mm
2. Mount the rod to the vehicle
3. Put gear to the Reverse and check if lever touches edge of the slot in the console.
4. If yes, shorten the rod by turning the rod ½ turn and check again.
5. Put gear to 2nd gear and check if lever touches edge of the slot in the console.
6. If yes, lengthen the rod by turning the rod ½ turn and check again

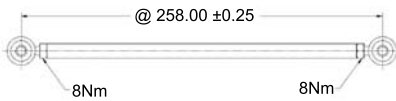

Shutting Off the Engine

Release throttle lever and wait until engine has returned to idle speed.

Shut off the engine using either engine cut-out switch or tether cord cap (DESS key) engine cut-out switch.

⚠ WARNING

Always remove the tether cord cap (DESS key) when vehicle is not in operation in order to prevent accidental engine starting or to avoid unauthorized use by children or others or theft.

Post-Operation Care

Shut off the engine. Install rear of vehicle on a wide-base snowmobile mechanical stand.

Remove snow and ice from rear suspension, track, front suspension, steering mechanism and skis.

Always cover your snowmobile when leaving it outside overnight or during extended periods of inactivity. This will protect it from frost and snow as well as help retain its appearance.

SPECIAL OPERATING INSTRUCTIONS

Riding at High Altitudes

⚠ CAUTION Failure to re-calibrate may cause serious engine damage.

Refer to an authorized LYNX dealer..

Riding in Cold Weather

Carburetor Equipped Models

All vehicles have been calibrated for - 20°C (- 4°F). They can be operated at warmer winter temperatures without risk of problems.

⚠ CAUTION For colder temperatures than - 20°C (- 4°F), carburetor(s) must be recalibrated to avoid engine damage. Refer to an authorized LYNX dealer.

Refer also to *RIDING AT HIGH ALTITUDES OR SEA LEVEL*.

Emergency Starting

1200 4-TEC and 600 ACE

Do not attempt an emergency starting procedure. Have the battery charged or replaced.

600 HO E-TEC and 550

The engine can be started with the emergency starter rope supplied with the tool kit.

Remove belt guard.

⚠ WARNING

Do not wind starting rope around your hand. Hold rope by the handle only. Do not start the snowmobile by the drive pulley unless it is a true emergency situation. Have the snowmobile repaired as soon as possible.

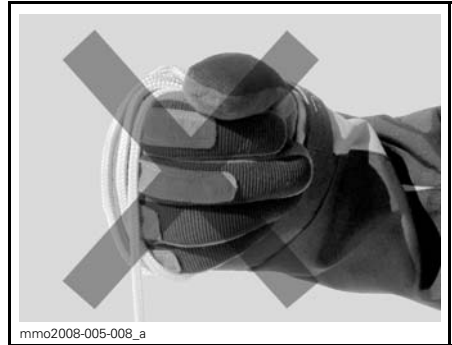

Attach one end of emergency rope to rewind handle.

NOTE: The spark plug socket can be used as an emergency handle.

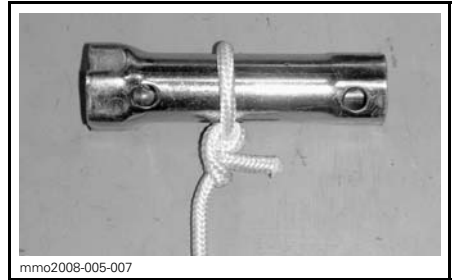

Attach the other end of emergency rope to the starter clip supplied in the tool kit.

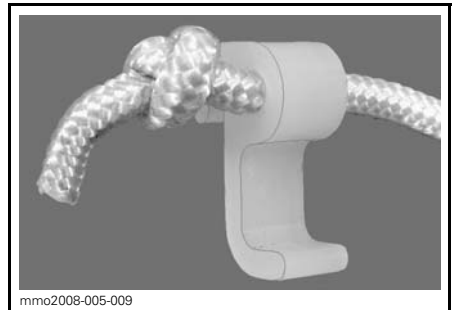

Hook up clip on drive pulley.

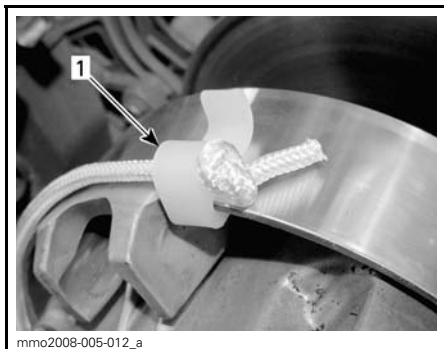

1. Clip installation location

Wind the rope tightly around drive pulley. When pulled, pulley must rotate counterclockwise.

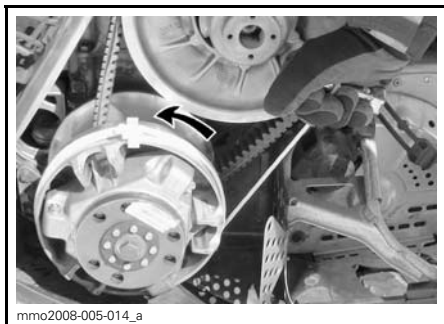

Pull the rope using a sharp, crisp pull so the rope comes free of the drive pulley. Start engine as per usual manual starting.

⚠ WARNING

When starting the snowmobile in an emergency situation, using drive pulley, do not reinstall the belt guard and return slowly to have snowmobile repaired.

Towing an Accessory

Always use a rigid tow bar to tow an accessory. Any towed accessory should have reflectors on both sides and at the rear. Check local laws for brake light(s) requirements.

⚠ WARNING

Never tow an accessory with a rope. Always use a rigid tow bar. Using a rope would result in a collision between the object and the snowmobile and possibly in a tip over in case of a rapid deceleration or on a downward slope.

Towing Another Snowmobile

If a snowmobile is disabled and must be towed use a rigid tow bar, remove the drive belt from disabled snowmobile and tow at moderate speed.

⚠ CAUTION Always remove the drive belt of the snowmobile that is to be towed to prevent damage to its belt and drive system.

In an emergency situation only, if a rigid tow bar is not available, a rope can be used provided you proceed with extra caution. In some areas, it may be illegal to do so. Check with state or local authorities.

Remove the drive belt, attach the rope to the ski legs (spindles), have someone sit on the towed snowmobile to activate the brake, and tow at low speed.

⚠ CAUTION In order to prevent damage to the steering system, never attach the tow rope to the ski loops (handles).

⚠ WARNING

Never ride at high speed when towing a disabled snowmobile. Proceed slowly with extra caution.

Transporting the Vehicle

Make sure that oil reservoir and fuel tank caps are properly installed.

Tilt bed trailers can easily be equipped with a winch mechanism to afford maximum safety in loading. Simple as it may seem, never drive your snowmobile onto a tilt bed trailer or any other kind of trailer or vehicle. Many serious accidents have resulted from driving up and over a trailer. Anchor your vehicle securely, front and rear, even on short hauls. Be certain all equipment is securely fastened. Cover your snowmobile when trailering to prevent road grime from causing damage.

Be certain your trailer meets state or provincial requirements. Ensure the hitch and safety chains are secure and the brake, turn indicators and clearance lights all function.

TUNE YOUR RIDE

WARNING

Suspension adjustment could affect vehicle handling. Always take time to familiarize yourself with the vehicle's behavior after any suspension adjustment have been made.

Snowmobile handling and comfort depend upon suspension adjustments.

Choice of suspension adjustments vary with carrying load, driver's weight, personal preference, riding speed and field condition.

WARNING

Before proceeding with any suspension adjustment, remember:

- Park in a safe place.
- Remove the tether cord cap (DESS key).
- If the front or rear of vehicle have to be lifted, make sure the lifting device is stable and secure.

 **CAUTION** Do not attempt to lift the vehicle by hand alone. Use appropriate lifting device to avoid risk of strain injuries.

Following are guidelines to fine-tune suspension.

The best way to set up the suspension, is to start from factory settings, then customize each adjustment one at a time. It may be necessary to readjust center spring after adjusting front springs for instance. Test run the snowmobile under the same conditions; trail, speed, snow, driver riding position, etc. Change one adjustment and retest. Proceed methodically until you are satisfied.

REAR AND FRONT SUSPENSION SPRING PRELOAD FACTORY SETTINGS			
MODEL	SKI	FRONT ARM	REAR ARM
Commander 600 E-TEC	6mm / cam position #2	15mm / cam position #6	13mm / cam position #4
Grand tourer 600 HO E-TEC	14mm / cam position #4	7mm / cam position #3	10mm / cam position #3
Grand Tourer 1200 4-TEC	10mm / cam position #3	15mm / cam position #6	12mm / cam position #4
59 YETI 600 ACE	-	5mm / cam position #2	12mm / cam position #4
69 YETI 600 ACE	-	5mm / cam position #2	5mm / cam position #1
59 YETI 550	-	5mm / cam position #2	7mm / cam position #2

Rear Suspension Adjustment

NOTICE Whenever adjusting rear suspension, check track tension and adjust as necessary.

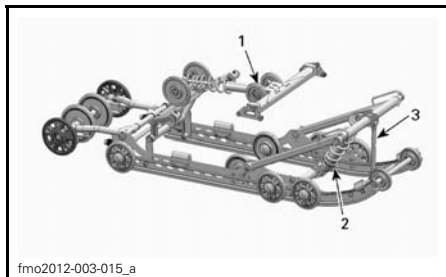

fmo2012-003-015_a

PPS-5900A REAR SUSPENSION

1. Rear spring adjustable for comfort and ride height
2. Center spring for steering behavior
3. Stopper strap for snowmobile weight transfer

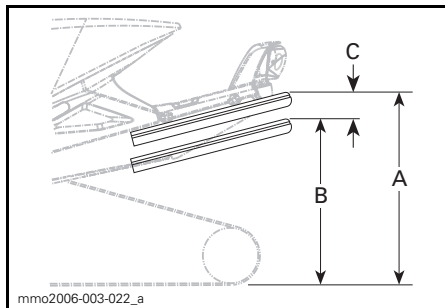

mmo2006-003-022_a

- A. Suspension fully extended
- B. Suspension has collapse with driver, passenger(s) and load added
- C. Distance between dimension "A" and "B", must not exceed 50 to 75 mm (3 to 4 in), see table

Rear Spring Preload (Comfort)

IMPORTANT: Make sure that all objects to be transported are in place in storage compartment and rear rack.

- Grab rear bumper and lift until suspension is fully extended.
- From this point, rear of snowmobile should collapse by 50 to 75 mm (2 to 3 in) when driver and passenger (if so applicable) take place. Measure at rear bumper as shown in next illustration.

⚠ WARNING

Do not attempt to lift the vehicle by hand alone. Use appropriate lifting device or have assistance to share lifting stress in order to avoid risk of strain injuries.

REFERENCE TABLE	
C	WHAT TO DO
50 to 75 mm (2 to 3 in)	No adjustment required
More than 75 mm (3 in)	Adjusted too soft, Increase preload (see preload adjustment)
Less than 50 mm (2 in)	Adjusted too hard, Decrease preload (see preload adjustment)

Slight suspension bottoming occurring under the worst riding conditions indicates a good choice of spring preload.

Center Spring Preload (Steering Behavior)

Ride at moderate speed on a trail.

If handlebar seems too easy or too hard to turn, adjust center spring accordingly.

⚠ WARNING

Before proceeding with any suspension adjustment, remember:

- park in a safe place
- remove tether cord cap
- lift rear of vehicle off the ground with a wide-base snowmobile stand with a rear deflector panel
- make sure lifting device is stable and secure.

REFERENCE TABLE

STEERING BEHAVIOR	WHAT TO DO
Easy to turn (neutral)	No adjustment required
Harder to turn (oversteering)	Adjusted too soft, increase preload
Very easy to turn (understeering)	Adjusted too hard, decrease preload

Using the suspension adjustment key from toolbox, turn adjustment cam to set the desired preload.

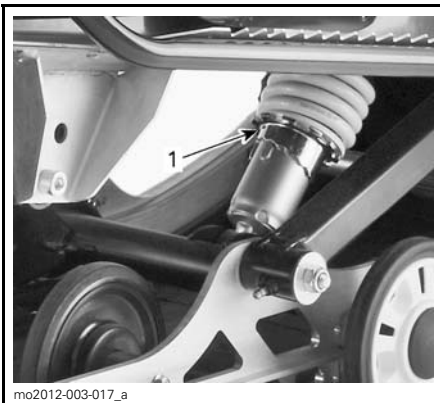

1. Adjustment cam

Stopper Strap Length (Weight Transfer)

Ride at low speed then fully accelerate.

Note steering behavior.

Adjust stopper strap length accordingly.

NOTICE Whenever stopper strap length is changed, track tension must be readjusted.

REFERENCE TABLE

WEIGHT TRANSFER (SKI PRESSURE)	WHAT TO DO
Comfortable: good weight transfer (light pressure)	No adjustment required
Light: too much weight transfer (lift off the ground)	Strap too long, reduce strap length
Heavy: not enough weight transfer (heavy pressure)	Strap too short, increase strap length

Increase or decrease strap length by bolting to a different hole.

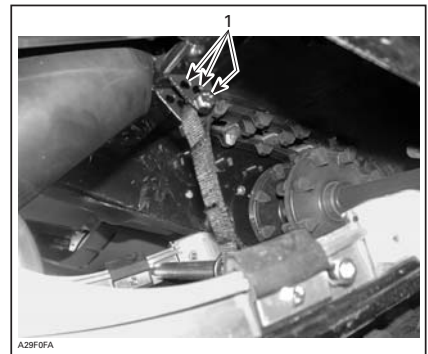
**TYPICAL**

1. Adjustment holes (stopper strap)

NOTE: Decreasing the stopper strap length may reduce comfort. If too much weight transfer is felt, try to correct it by adjusting the coupling blocks first.

Deep Snow Riding

When operating the snowmobile in deep snow, it may be necessary to vary stopper strap length and/or riding position, to change the angle at which the track rides on the snow. Operator's familiarity with the various adjustments as well as snow conditions will dictate the most efficient combination.

Front Suspension Adjustment

Front Springs Preload (Handling)

Ride at moderate speed and check for proper handling.

Adjust front springs accordingly.

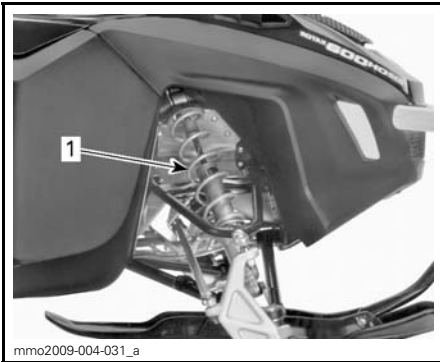

TYPICAL - FRONT SUSPENSION
1. Front springs for handling

REFERENCE TABLE	
HANDLING	WHAT TO DO
Good: steering comfortable to turn	No adjustment required
Bad: steering too easy to turn	Adjusted too soft, increase spring preload
Bad: steering too hard to turn	Adjusted too hard, decrease spring preload



TYPICAL - CAM TYPE PRELOAD
1. Adjustment cam

WARNING

Always adjust both front springs to same position.

TROUBLESHOOTING

Beeper Codes

Beeper codes are used to inform you on the DESS system operation and/or as a complement of the pilot lamps to catch your attention if an anomaly occurs or to inform you of a particular condition.

For more details on DESS system beeper codes, refer to *DESS PILOT LAMP CODES* in *TETHER CUT-OUT SWITCH*.

For more details on gauge pilot lamps, refer to *GAUGE PILOT LAMPS*.

For any beep code not listed in this Operator's Guide, refer to an authorized LYNX dealer.

General

ELECTRIC STARTER DOES NOT WORK.

1. Engine stop switch in OFF position or tether cord cap (DESS key) away from post.
 - Place engine stop switch in the ON position and install tether cord cap (DESS key) on post.
2. Throttle applied while attempting an engine start.
 - Release throttle while cranking.

ENGINE RPM DOES NOT REACH CLUTCH ENGAGEMENT POINT.

1. DESS did not read tether cord cap (DESS key) code. DESS pilot lamp blinks (slow short beeps/repetitive).
 - Properly install tether cord cap (DESS key).
2. DESS has read a different code than the one programmed. DESS pilot lamp blinks rapidly (fast short beeps/repetitive).
 - Install a tether cord cap (DESS key) for which this snowmobile was programmed.

ENGINE OVERHEATS

1. Insufficient snow or hard packed snow.
 - Drive in loose snow. If there is no loose snow near, pull over, stop engine and let it cool down. Once engine has cooled down, reach loose snow as soon as possible.
2. Low coolant level.
 - Check coolant level, see *MAINTENANCE PROCEDURES*.
3. Clogged heat exchangers.
 - Clean heat exchangers.

ENGINE LACKS OF POWER/VEHICLE DOES NOT REACH FULL SPEED.

1. Engine warm-up in progress (E-TEC).
 - Drive vehicle at low speeds for a few minutes.
2. Engine break-in period not completed (E-TEC).
 - Complete break-in period.

ENGINE LACKS OF POWER/VEHICLE DOES NOT REACH FULL SPEED. (cont'd)

3. Incorrect drive pulley adjustment.

- *Adjust drive pulley, refer to MAINTENANCE PROCEDURES.*

4. Drive and driven pulleys require servicing.

- *Contact an authorized Lynx dealer.*

5. Drive belt worn too thin.

- *If the drive belt has lost more than 3 mm (1/8 in) of its original width, it will affect vehicle performance.*
- *Replace drive belt.*

6. Incorrect track adjustment.

- *See MAINTENANCE INFORMATION and/or an authorized Lynx dealer for proper alignment and tension adjustments.*

7. RAVE valves problem (E-TEC).

- *Contact an authorized Lynx dealer.*

ENGINE BACKFIRES.

1. Engine is running too hot.

- *See ENGINE OVERHEATS..*

2. Ignition timing is incorrect or ignition system failure.

- *Contact an authorized Lynx dealer.*

3. Exhaust system leak.

- *Contact an authorized Lynx dealer.*

4. Fuel pressure too low.

- *Contact an authorized Lynx dealer.*

ENGINE MISFIRES.

1. Water in fuel.

- *Drain fuel system and refill with fresh fuel.*

2. RAVE valves malfunction (E-TEC).

- *Have RAVE valves system inspected by an authorized Lynx dealer.*

SPECIFICATIONS

NOTE: Because of its ongoing commitment to product quality and innovation, BRP reserves the right, at any time, to make changes in design and specifications and/or to make additions to, or improvements in its products without imposing any obligation upon itself to install them on its products previously manufactured.

MODEL		XTRIM COMMANDER 600 E-TEC/ ADVENTURE GRAND TOURER 600 E-TEC
ENGINE SYSTEM		
Engine type	Rotax™ 600 HO, liquid cooled w/Reed valve, 3D RAVE™	
Cylinders	2	
Displacement	cm ³	594.40
Bore	mm	72
Stroke	mm	73
Maximum horsepower RPM	8100 RPM	
Fuel system type	E-TEC direct injection	
Exhaust system	Single tuned pipe, baffle muffler	
DRIVE SYSTEM		
Drive pulley type	TRA™ III	
Driven pulley type	QRS	
Engagement	3000 RPM	
Gearbox oil capacity	700 ml	
Gear Ratio	1 st	3.23
	2 nd	1.98
	R	3.68
Drive sprocket number of teeth	8	
Brake system	Hydraulic, XU brake type	
Track nominal width	500 mm	
Track nominal length	3923 mm	
Track profile height	Commander	38 mm
	Grand tourer 600 E-TEC	32 mm

SPECIFICATIONS

MODEL		XTRIM COMMANDER 600 E-TEC/ ADVENTURE GRAND TOURER 600 E-TEC
DRIVE SYSTEM		
Track tension	Deflection	40-50 mm
	Force ⁽¹⁾	7.3 kg
Track alignment		Equal distance between edges of track guides and slider shoes
SUSPENSION		
Front suspension		A-LFS
Front shock		36mm HPG™
Front suspension max. travel	Commander	210 mm
	Grand tourer 600 E-TEC	225 mm
Rear suspension		PPS 5900 A
Rear shock		36mm HPG
Rear suspension max. travel		340 mm
ELECTRICAL		
Lightning system output		12V/1200W
Headlamp bulb HI/LOW beam		2 x 60/55 Watts (H-4)
Taillight		Led
Spark plug	Type	NGK PZFR6F ⁽²⁾
	Gap	Not adjustable (0.8 +0/-0.1mm)

MODEL		XTRIM COMMANDER 600 E-TEC/ ADVENTURE GRAND TOURER 600 E-TEC
ELECTRICAL		
Fuses /Relays	F 1: Battery	30 A
	F 2: Start	5 A
	F 3:Horn	10 A
	F 4: Fan	15 A
	R 1: Run relay	-
	R 2:Fan relay	-
DIMENSIONS		
Vehicle overall length		3230 mm
Vehicle overall width	Commander	1162 mm
	Grand tourer 600 E-TEC	1235 mm
Vehicle overall height	Commander	1280 mm
	Grand tourer 600 E-TEC	1330 mm
Official dry weight	Commander	287 kg
	Grand tourer 600 E-TEC	303 kg
Ski stance	Commander	975 mm adj +42mm
	Grand tourer 600 E-TEC	1080 mm adj.-42mm

SPECIFICATIONS

MODEL		XTRIM COMMANDER 600 E-TEC/ ADVENTURE GRAND TOURER 600 E-TEC
LIQUIDS		
Recommended fuel type		Regular unleaded
Minimum octane		95 E10
Recommended oil (engine)		Refer to <i>RECOMMENDED OIL</i> section
Brake system fluid		SRF (DOT 4) or GTLMA (DOT 4)
Gear box oil type		XP-S synthetic chain case oil
Coolant	Mixture	Ethyl glycol/water mix (50% coolant, 50% distilled water). Use coolant specifically designed for aluminum engines
	Premix	(P/N 219 700 362) 12 x 1 L
CAPACITIES		
Fuel tank	L	45
Oil tank	L	2.8
⁽¹⁾ Measure gap between slider shoe and bottom inside track when exerting a downward pull to the track. ⁽²⁾ CAUTION: Do not attempt to adjust gap on this plug. ⁽³⁾ Drive belt height must be adjusted every time a new drive belt is installed. Confirm drive belt part number application with an authorized LYNX dealer.		

MODEL		ADVENTURE GRAND TOURER 1200 4-TEC
ENGINE		
Engine type	Rotax 1203, liquid cooled, 4-Stroke, D.O.H.C. with balancer shaft, dry sump	
Cylinders	3	
Displacement	1170.7cm ³	
Bore	91 mm	
Stroke	60 mm	
Maximum horsepower engine RPM	7800 RPM	
Fuel injection system	Multi point EFI, 52 mm heated throttle body	
Exhaust system	Exhaust pipe, muffler	
Engine oil	XP-S™ 0W40 synthetic 4-stroke oil	
Engine oil tank capacity	Oil change with filter: 3.5 L	
Coolant	Ethyl glycol/water mix (50% coolant, 50% distilled water). Use BRP premix coolant or coolant specifically designed for aluminum engines	
Recommended fuel type	Regular unleaded	
Minimum octane	95 E10	
Fuel tank capacity	45 L	
DRIVE SYSTEM		
Drive pulley type	TRA IV	
Driven pulley type	QRS	
Engagement	2500 RPM	
Gearbox oil capacity	700ml	
Gear Ratio	1	3.23
	2	1.98
	R	3,68
Drive sprocket number of teeth	8	
Gearbox oil type	XP-S synthetic chain case oil	

SPECIFICATIONS

MODEL		ADVENTURE GRAND TOURER 1200 4-TEC
DRIVE SYSTEM (cont'd)		
Brake system		Hydraulic, XU brake type
Brake system fluid		DOT 4
Track nominal width		500 mm
Track nominal length		3923 mm
Track profile height		32 mm
Track tension	Deflection	30 - 40 mm
	Force	7.3 kg
SUSPENSION		
Front suspension		A-LFS
Front shock		36 HPG
Front suspension max. travel		225 mm
Rear suspension		PPS 5900 A
Front arm shock		36 HPG
Rear arm shock		36 HPG

MODEL		ADVENTURE GRAND TOURER 1200 4-TEC
ELECTRICAL SYSTEM		
Lightning system output		12V/500W
Headlights bulb HI/LOW beam		2 x 60/55 Watts (H-4)
Taillight bulb		Led
Spark plug		NGK CR8EKB
Fuses/Relays	F1 HIC/CDI	5 A
	F2 Fuel pump	10 A
	F3 HIC	5 A
	F4 HIC	5 A
	F5 HIC	5 A
	F6 Rear light/ PW HOOD	10 A
	F7 Headlight	15 A
	F8 Relay / Gauge	10 A
	F9 Relay / Gauge	7,5 A
	F10 Fan	15 A
	F11 Rear Power Outlet (with horn 10A)	5 A
	F13 Charging	30 A
	R1 Run Realy	-
	R2 Fan Relay	-
R3 Load Relay	-	
DIMENSIONS AND WEIGHT		
Vehicle overall length		3230 mm
Vehicle overall width		1193-1235 mm
Vehicle overall height		1330 mm
Dry weight		325kg
Ski type		CTRL II
Ski Stance		1080, adj -42mm

SPECIFICATIONS

MODEL		59 YETI 600 ACE, 69 YETI 600 ACE
ENGINE		
Engine type	Rotax 602, liquid cooled, 4-stroke, D.O.H.C., dry sump.	
Cylinders	2	
Displacement	600 cm ³	
Bore	74 mm	
Stroke	69.7 mm	
Maximum horsepower engine RPM	7250 RPM	
Fuel injection system	Multi point EFI, 46 mm throttle body	
Exhaust system	Double front pipe, baffle muffler	
Engine oil	XPS SYNTHETIC OIL (WINTER GRADE) or SAE 0W 40 API SM synthetic oil	
Engine oil tank capacity	Oil change, 2.2 L	
Coolant	Ethyl glycol/water mix (50% coolant, 50% distilled water). Use BRP premix coolant or coolant specifically designed for aluminum engines	
Recommended fuel type	Regular unleaded	
Minimum octane	95 E10	
Fuel tank capacity	45 L	
DRIVE SYSTEM		
Drive pulley type	eDrive	
Driven pulley type	QRS	
Engagement	2200 RPM	
Gearbox oil capacity	700ml	
Gear Ratio	1	3,86
	2	2,30
	R	3,68
Drive sprocket number of teeth	59 Yeti 600 ACE	7
	69 Yeti 600 ACE	8
Gearbox oil type	XP-S synthetic chain case oil	

MODEL		59 YETI 600 ACE, 69 YETI 600 ACE
DRIVE SYSTEM (cont'd)		
Brake system		Hydraulic, XU brake type
Brake system fluid		DOT 4
Track nominal width	59 Yeti 600 ACE	500 mm
	69 Yeti 600 ACE	600 mm
Track nominal length	59 Yeti 600 ACE	3923 mm
	69 Yeti 600 ACE	3968 mm
Track profile height		32 mm
Track tension	Deflection	30 - 40 mm
	Force	7.3 kg
SUSPENSION		
Front suspension		LTS
Front shock		MC
Front suspension max. travel		160 mm
Rear suspension	59 Yeti 600 ACE	PPS 5900 A
	69 Yeti 600 ACE	PPS 6900 A
Front arm shock		MC
Rear arm shock		MC

SPECIFICATIONS

MODEL		59 YETI 600 ACE, 69 YETI 600 ACE
ELECTRICAL SYSTEM		
Lightning system output		12V/650W
Headlights bulb HI/LOW beam		2 x 60/55 Watts (H-4)
Taillight bulb		Led
Spark plug		NGK CR7EB
Fuses/Relays	F1 Battery	30 A
	F2 Relay/Start Button	5 A
	F3 Starter Solenoid	10 A
	F4 Fan	15 A
	F5 HIC	10 A
	F6 HIC/Gauge	10 A
	F7 Front PW Outlet and heaters	10 A
	F8 Lighting	20 A
	F9 Horn	5 A
	F10 Rear Power Outlet	5 A
	R1 Run Relay	-
	R2 Load Relay	-
	R3 Load Relay	-
	R4 Fan Relay	-
DIMENSIONS AND WEIGHT		
Vehicle overall length		3250 mm
Vehicle overall width		1070mm
Vehicle overall height		1340 mm
Dry weight	59 Yeti 600 ACE	295 kg
	69 Yeti 600 ACE	311 kg
Ski type		ADJ
Ski stance		900 mm

MODEL		59 YETI 552
ENGINE		
Engine type	Rotax 550SK, axial fan cooled w/cylinder reed porting	
Cylinders	2	
Displacement	553,4 cm ³	
Bore	76 mm	
Stroke	61 mm	
Maximum horsepower engine RPM	6800 RPM	
Carburetion	2 x VM 30 Choke	
Exhaust system	Single tuned pipe, baffle muffler	
Recommended fuel type	Regular unleaded	
Minimum octane	95 E10	
Fuel tank capacity	45 L	
DRIVE SYSTEM		
Drive pulley type	eDrive	
Driven pulley type	QRS	
Engagement	2600 RPM	
Gear Ratio	1	3,86
	2	2,30
	R	3,68
Drive sprocket number of teeth	7	
Oil type (gearbox)	XP-S synthetic chain case oil	
Brake system	Hydraulic, XU brake type	
Brake system fluid	DOT 4	
Track nominal width	500 mm	
Track nominal length	3923 mm	
Track profile height	32 mm	
Track tension	Deflection	30 - 40 mm
	Force	7.3 kg

SPECIFICATIONS

MODEL	59 YETI 552
SUSPENSION	
Front suspension	LTS
Front shock	MC
Front suspension max. travel	160 mm
Rear suspension	PPS 5900 A
Front arm shock	MC
Rear arm shock	MC
ELECTRICAL SYSTEM	
Lightning system output	12V/340W
Headlights bulb HI/LOW beam	2 x 60/55 Watts (H-4)
Taillight bulb	Led
Spark plug	BRC9ECS-5
Fuse	20A
DIMENSIONS AND WEIGHT	
Vehicle overall length	3250 mm
Vehicle overall width	1070mm
Vehicle overall height	1340 mm
Dry weight	278 kg
Ski type	ADJ
Ski stance	900 mm

DECLARATION OF CONFORMITY

DECLARATION OF CONFORMITY

According to EC machinery directive 2006/42/EC, annex 2A

Producer: BRP Finland Oy
Isoaavantie 7
96320 Rovaniemi, Finland

**I, the undersigned, hereby declare that these
model year 2012 snowmobiles:**

000LSCD00	000STCA00	000SCCB00	000LRCB00	000LACB00
000SNCA00	000SHCB00	000SCCC00	000LRCD00	000LRCA00
000LFCB00	000SUCA00	000SDCA00	000LYCB00	000FDCA00
000SJCA00	000SUCC00	000SECA00	000FECA00	000FCCA00
000LACC00	000SCCA00	000SECC00	000FFCA00	000SFCA00

conform to the directive(s) and standard(s) as specified.

EMC Directive 2004/108/EEC
EC Machinery Directive 2006/42/EC

the following directives, technical standards and
specifications have been used:

EMC: EN 55012: 2007
97/24

Machinery: SFS-EN ISO 12100 1:2003
SFS-EN ISO 12100 2:2003
SFS-EN ISO 14121-1:2007



Signature
Risto Perttula
Director, R&D
BRP Finland Oy

Rovaniemi, 5.4.2011
Place and date

full name and identification of the person empowered to sign on behalf of the manufacturer

DECLARATION OF CONFORMITY

Vibrations in the seat (EN 1032, ISO 5008), is less than 0,5 m/s².

Vibrations in the handle (EN 1032, ISO 5008), is less than 2,5 m/s².

MAINTENANCE INFORMATION

BREAK-IN INSPECTION

After the first 10 hours or 500 km of operation, whichever comes first, your vehicle have to be inspected by an authorized Lynx dealer. The break-in inspection is very important and must not be neglected.

NOTE: The break-in inspection is at the expense of the vehicle owner.

BREAK-IN INSPECTION (2-STROKE)
Inspect engine motor mounts
Inspect exhaust system and check for leaks
Tighten exhaust manifold screws to specified torque
Check coolant level
Inspect fuel lines and connections
Inspect throttle cable
Inspect oil injection pump adjustment (All except E-TEC)
Inspect drive belt
Visually inspect drive pulley
Tighten drive pulley retaining screw to specified torque
Inspect driven pulley
Inspect spark plugs (All except E-TEC)
Adjust and align track
Change chaincase / gearbox oil
Retorque gearbox cover screws both sides of speedometer sensor connector to 10Nm (Only XU Models)
Adjust drive chain (Not for models equipped with gearbox)
Check brake fluid level
Inspect brake hose, pads and disk
Inspect steering mechanism
Inspect skis and runners
Tighten frame pyramid rod screws to specified torque
Inspect front suspension
Inspect rear suspension and slider shoes
Lubricate front and rear suspension

BREAK-IN INSPECTION (4-STROKE)
Inspect engine seals and gaskets for leaks
Inspect exhaust system and check for leaks
Check coolant level
Change engine oil and filter
Inspect fuel lines and connections
Inspect throttle cable
Inspect drive belt
Visually inspect drive pulley
Tighten drive pulley retaining screw to specified torque
Inspect driven pulley
Adjust and align track
Change chaincase / gearbox oil
Retorque gearbox cover screws both sides of speedometer sensor connector to 10Nm (Only XU Models)
Adjust drive chain (Not for models equipped with gearbox)
Check brake fluid level
Inspect brake hose, pads and disk
Inspect steering mechanism
Inspect skis and runners
Tighten frame pyramid rod screws to specified torque
Inspect front suspension
Inspect rear suspension and slider shoes
Lubricate front and rear suspension

PERIODIC MAINTENANCE CHART

WARNING

It is recommended that the assistance of an authorized LYNX dealer be periodically obtained on other components/systems not covered in this guide. Unless otherwise specified, engine must be cold and not running. Remove the tether cord cap (DESS key) before performing any maintenance or adjustment, unless otherwise specified. Vehicle must be parked in a safe place, away from the trail.

WARNING

Observe WARNINGS and CAUTIONS mentioned throughout this guide which are relevant to the item being checked. When component conditions seem less than satisfactory, replace with genuine BRP parts or approved equivalents.

Some items may not apply to your particular model. Refer to *MAINTENANCE* in *SHOP MANUAL* for more details.

MAINTENANCE SCHEDULE (2-STROKE)

NOTE: The maintenance schedule does not exempt the pre-ride inspection.

EVERY 1 500 KM
T/A shocks oil change / service. First at 1500 km, then every 3000 km or once a year.
Models with chaincase: Adjust drive chain
Models with gearbox: Check oil level

EVERY 3 000 KM OR 1 YEAR (WHICHEVER COMES FIRST)
Inspect heat shields
Inspect engine motor mounts
Inspect exhaust system and check for leaks
Inspect cooling system cap, hoses and clamps and check for leaks
Replace spark plugs (All except of E-TEC)
Clean RAVE valves
Inspect RAVE valves solenoid
Adjust engine stopper
Visually inspect and clean drive pulley
Tighten drive pulley retaining screw to specified torque
Clean driven pulley
Adjust and align track
Inspect brake hose, pads and disk
Inspect steering mechanism
Inspect front suspension
Inspect rear suspension and stopper strap. PPS Suspension: Replace stopper strap.
Lubricate front and rear suspension whenever the vehicle is used in wet conditions (wet snow, rain, puddles)
Lubricate QRS axle gearbox end. (XU models)

MAINTENANCE SCHEDULE (2-STROKE)

**EVERY 6 000 KM OR 2 YEARS
(WHICHEVER COMES FIRST)**

Inspect fuel pump strainer and replace if necessary

Replace spark plugs (800 E-TEC only)

Replace brake fluid

Inspect throttle cable

**EVERY 10 000 KM OR 3 YEARS
(WHICHEVER COMES FIRST)**

Replace oil filter (E-TEC: Inspect oil pump strainer and clean if needed)

Replace spark plugs (600 E-TEC only)

EVERY 5 YEARS

Replace in-line fuel filter

Replace engine coolant

MAINTENANCE SCHEDULE (4-STROKE)

NOTE: The maintenance schedule does not exempt the pre-ride inspection.

EVERY 1 500 KM
T/A shocks oil change / service. First at 1500 km, then every 3000 km or once a year
Models with chaincase: Adjust drive chain
Models with gearbox: Check oil level

EVERY 3 000 KM OR 1 YEAR (WHICHEVER COMES FIRST)
Inspect heat shields
Replace drive pulley O-rings (1200 4-TEC only)
Clean drive pulley
Tighten drive pulley retaining screw to specified torque
Check driven pulley preload
Clean driven pulley
Adjust and align track
Inspect brake hose, pads and disk
Inspect steering mechanism
Inspect front suspension
Inspect rear suspension and stopper strap. PPS Suspension: Replace stopper strap.
Lubricate front and rear suspension whenever the vehicle is used in wet conditions (wet snow, rain, puddles)
Lubricate QRS axle gearbox end. (XU models)

EVERY 6 000 KM OR AT PRE-SEASON (WHICHEVER COMES FIRST)
Change engine oil and filter

EVERY 6 000 KM OR 2 YEARS (WHICHEVER COMES FIRST)
Replace fuel pump outlet filter
Replace drive pulley slider shoes and inspect ramps (1200 4-TEC only)
Replace brake fluid
Inspect throttle cable

MAINTENANCE SCHEDULE (4-STROKE)

**EVERY 10 000 KM OR 3 YEARS
(WHICHEVER COMES FIRST)**

Replace spark plugs

EVERY 20 000 KM

Check valve clearance and adjust if necessary. (1200 4-TEC only)

EVERY 5 YEARS

Replace engine coolant

PRESEASON PREPARATION

PRESEASON PREPARATION (2-STROKE)
Inspect engine motor mounts
Check exhaust system condition and check for leaks
Tighten exhaust manifold screws or nuts to specified torque
Replace spark plugs. (All except E-TEC)
Inspect cooling system cap, hoses and clamps
Check coolant density
Inspect crankshaft PTO seal
Inspect fuel lines and connections
Clean and inspect throttle body
Inspect throttle cable
Inspect drive belt (adjust at every drive belt replacement)
Clean and visually inspect drive pulley
Clean and inspect driven pulley
Inspect, adjust and align track
Adjust drive chain (Not for models equipped with gearbox)
Change chaincase / gearbox oil
Check brake fluid level
Inspect brake hose, pads and disk
Inspect steering mechanism
Inspect skis and runners
Inspect front suspension
Inspect rear suspension stopper strap
Charge battery (if so equipped)
Adjust headlight beam aiming

PRESEASON PREPARATION (4-STROKE)

Visually inspect engine seals and gaskets and check for leaks

Check exhaust system condition and check for leaks

Change engine oil and filter

Check coolant density

Inspect fuel lines and connections

Clean and inspect throttle body

Inspect throttle cable

Inspect drive belt (adjust at every drive belt replacement)

Clean and visually inspect drive pulley

Clean and inspect driven pulley

Inspect, adjust and align track

Adjust drive chain (Not for models equipped with gearbox)

Change chaincase / gearbox oil

Check brake fluid level

Inspect brake hose, pads and disk

Inspect steering mechanism

Inspect skis and runners

Inspect front suspension

Inspect rear suspension and stopper strap.

Charge battery (if so equipped)

Adjust headlight beam aiming

STORAGE

During summer, or when a snowmobile is not in use for more than three months, proper storage is a necessity.

STORAGE
Clean the vehicle
Add fuel stabilizer to fuel following the product manufacturer recommendations Run the engine after adding the product to the fuel
2-Stroke models: Lubricate engine. See owners manual for instruction.
Lubricate brake lever pivot
Inspect and lubricate rear suspension
Charge battery monthly to keep it fully charge during storage
Block muffler with rags
Lift rear of vehicle until track is clear of the ground. Do not release track tension
Lubricate front and rear suspension

MAINTENANCE PROCEDURES

Air Intake Silencer Prefilter Verification

Ensure that air intake silencer prefilter is properly installed and in good condition, replace if damaged.



1. Filter

To remove prefilter, simply pull it out.

To install prefilter, push it back in place making sure it is properly secured.

Cooling System

Engine coolant level

The engine coolant tank is located behind the upper RH side panel. See *HOOD AND SIDE PANELS* for removal procedure.

The cold level line is just above the retaining clamp.

Check coolant level at room temperature with the cap removed. Liquid should be at cold level line (engine cold) of coolant tank.

To add coolant, remove front coolant tank fixation and slightly pull the tank outwards to make room for the cap.

NOTE: When checking coolant level at low temperature it may be slightly below the cold level line.

If additional a large amount of coolant has to be added or if entire system has to be refilled, refer to an authorized LYNX dealer.

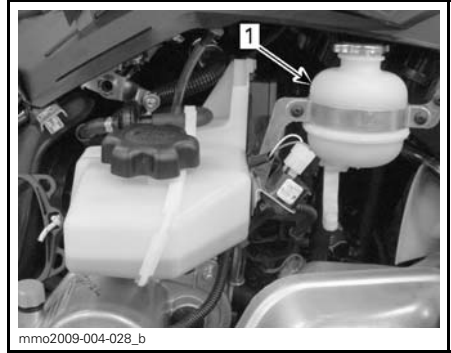

TYPICAL

1. Coolant tank

Engine Oil (1200 4-TEC and 600 ACE)

Recommended Engine Oil

ENGINE	RECOMMENDED ENGINE OIL
600 ACE	XPS SYNTHETIC OIL (WINTER GRADE)
1200 4-TEC	XPS SYNTHETIC OIL (WINTER GRADE)

NOTICE The engine of this snowmobile has been developed and validated using the BRP XPS™ Synthetic 4-stroke oil. BRP strongly recommends the use of its XPS Synthetic 4-stroke oil at all times. Damages caused by oil which is not suitable for the engine will not be covered by the BRP limited warranty.

Use SAE 0W40 synthetic-based oil that meets or exceeds the requirements for API service classification SM, SL or SJ.

NOTICE Check level every 10 hours of use and refill if necessary. Do not overfill. Operating the engine with an improper level may severely damage engine. Wipe off any spillage.

Place vehicle on a level surface and proceed as follows to check oil level:

1. Start engine and let it reach its normal operating temperature. Engine is at normal temperature when rear radiator gets warm, indicating that the thermostat is open.
2. Let engine run at idle for approximately 30 seconds.
3. Stop engine.
4. Remove the drive belt guard, refer to DRIVE BELT GUARD.
5. Remove dipstick from the filler tube, then wipe it clean.
6. Completely insert dipstick in the filler tube.
7. Remove dipstick and check the oil level. Oil level should be between the MIN and MAX marks as shown, add if necessary.

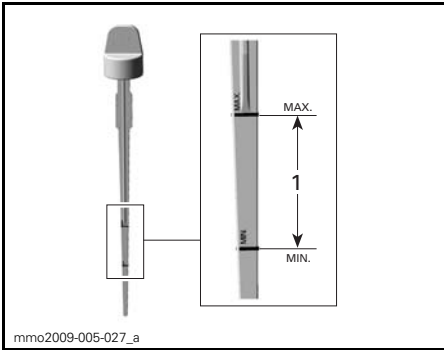

1. Oil level between MIN and MAX

CAUTION Engine oil can be very hot

Exhaust System

The tail pipe of the muffler should be centered with the exit hole in the bottom pan. Exhaust system must be free of rust or leaks. Make sure that gear clamps are properly tightened.

The exhaust system is designed to reduce noise and to improve the total performance of the engine. Modification may be in violation of local laws.

CAUTION If any exhaust system component is removed, modified or damaged, severe engine damage may result.

Drive belt Guard

Drive Belt Guard Removal

WARNING

NEVER operate engine:

- without shields and belt guard securely installed
- with hood and/or side panels opened or removed.

NEVER attempt to make adjustments to moving parts while engine is running.

NOTE: Belt guard is purposely made slightly oversize to maintain tension on its pins and retainers preventing undue noise and vibration. It is important that this tension be maintained when reinstalling.

Remove the tether cord cap (DESS key).

Refer to *HOOD AND SIDE PANELS* and open engine compartment LH side panel.

Remove retaining pin.

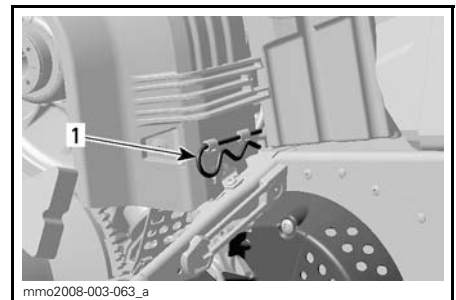

1. Retaining pin

Lift rear portion of guard then release from front tabs.

Drive Belt Guard Installation

When reinstalling belt guard, position its cutaway toward front of snowmobile.

Place belt guard front openings over tabs.

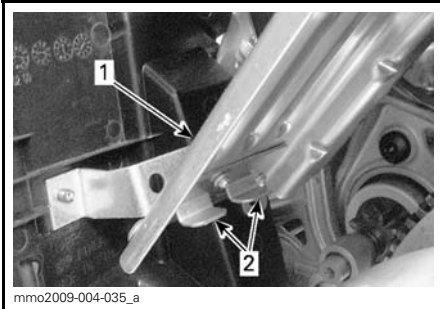

TYPICAL
1. Belt guard
2. Tabs

Position the grommet over the retaining rod.

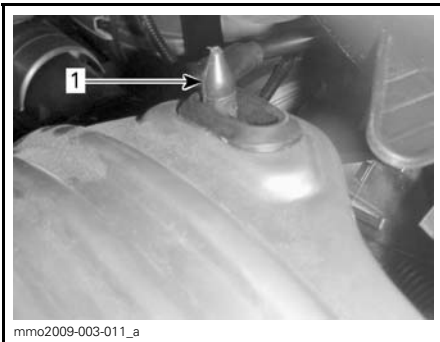

1. Retaining rod

Position rear portion of the belt guard over the retainer and secure it using the retaining pin.

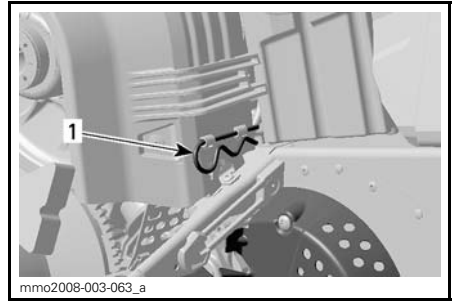

1. Retaining pin

Brake Fluid Level

CAUTION Vehicle must be on a level surface before checking any fluid levels.

Check brake fluid (DOT 4) in reservoir for proper level. Add fluid (DOT 4) as required.

CAUTION Use only DOT 4 brake fluid from a sealed container. Never use any other types of fluid.

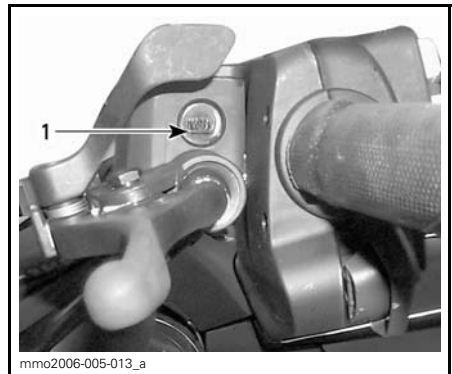

TYPICAL — BRAKE FLUID RESERVOIR
1. Minimum

Brake Condition

⚠ WARNING

The brake mechanism on your snowmobile is an essential safety device. Keep this mechanism in proper working condition. Above all, do not operate the snowmobile without an effective brake system. Periodically verify the condition/wear of the brake pads.

Brake Adjustment

No adjustment is provided for hydraulic brake. See an authorized LYNX dealer if any problems.

Gearbox Oil

Recommended Gearbox Oil

Use XP-S SYNTHETIC CHAINCASE OIL (P/N 413 803 300).

NOTICE Use only the recommended type of oil when servicing. Do not mix synthetic oil with other types of oil.

Gearbox Oil Level

With the vehicle on a level surface, check the oil level by removing the check plug on the left side of gearbox.

Oil level must reach the threaded hole's lower edge.

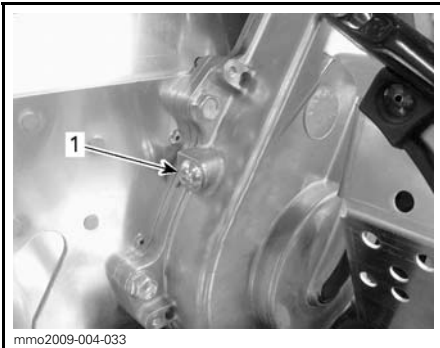

1. Check plug

To add oil, proceed as follows:

1. Remove the filler cap.



TYPICAL

1. Filler cap

2. Pour recommended oil in gearbox by the filler hole until oil comes out by the check plug hole.
3. Reinstall check plug and torque to 10 N•m (89 lbf•in)

Drive Belt

Drive Belt Inspection

Inspect drive belt for cracks, fraying or abnormal wear (uneven wear, wear on one side, missing cogs, cracked fabric). If abnormal wear is noted, probable cause could be pulley misalignment, excessive RPM with frozen track, fast starts without warm-up period, burred or rusty sheave, oil on belt or distorted spare belt. Contact an authorized LYNX dealer

Drive Belt Removal

1. Remove DESS key from post.
2. Open LH side panel, refer to *HOOD AND SIDE PANELS*.
3. Remove belt guard, refer to *BELT GUARD REMOVAL*.
4. Insert the driven pulley expander provided in the tool kit in the threaded hole on the adjuster hub as shown.

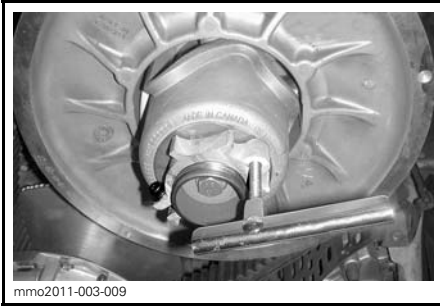

mmo2011-003-009

PULLEY EXPANDER ON ALUMINUM ADJUSTER HUB

5. Open the driven pulley by screwing the tool in.
6. Remove the belt by slipping it over the top of the driven pulley, then over the drive pulley.

Drive Belt Installation

1. If necessary, open the driven pulley, refer to *DRIVE BELT REMOVAL* above.
2. Slip the belt over the drive pulley, then over the driven pulley.

NOTICE Do not force or use tools to pry the belt into place, as this could cut or break the cords in the belt.

NOTE: The maximum drive belt life span is obtained when belt is installed with arrows in the direction of rotation.

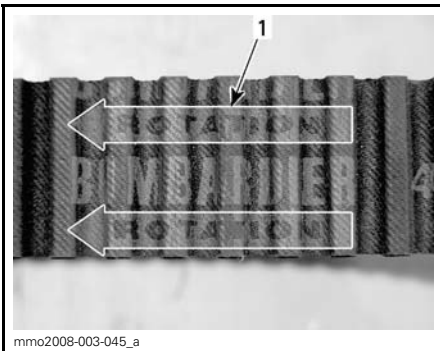

mmo2008-003-045_a

1. To be pointed in the direction of rotation

3. Unscrew and remove the driven pulley expander from the pulley.
4. Rotate the driven pulley several times to properly set the belt between the sheaves.
5. If a new belt was installed, adjust the belt height. Refer to *DRIVE BELT HEIGHT ADJUSTMENT* below.
6. Install belt guard, refer to *DRIVE BELT GUARD INSTALLATION*
7. Close side panel, refer to *HOOD AND SIDE PANELS*

Drive Belt Height Adjustment

The drive belt height must be checked every time a new belt is installed.

To adjust the drive belt height, proceed as follows:

1. Remove D.E.S.S. key from post.
2. Open LH side panel, refer to *HOOD AND SIDE PANELS*.
3. Remove belt guard, refer to *DRIVE BELT GUARD REMOVAL*
4. Loosen the clamping screw.

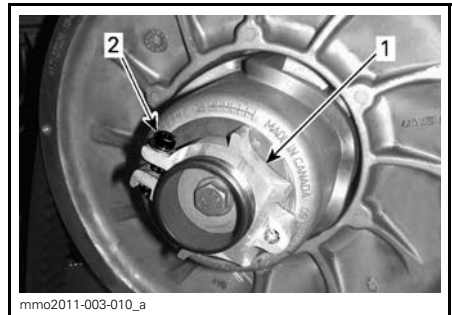

mmo2011-003-010_a

ALUMINUM ADJUSTER HUB

1. Adjuster hub
2. Clamping screw

5. Using the suspension adjustment tool provided in the tool kit, turn the ring 1/4 turn at a time then rotate the driven pulley to properly set the belt between the pulley sheaves.



ALUMINUM ADJUSTER HUB
1. Suspension adjustment tool

NOTE: The adjustment ring has left hand treads

Belt without External Cogs

Repeat step 5 until the external surface of drive belt exceeds driven pulley edge by 0mm.

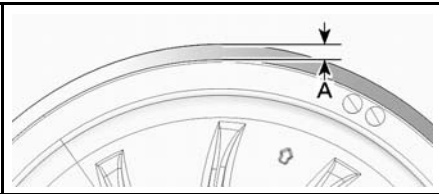

PRELIMINARY SETTING
1. 0mm

Belt with External Cogs

Repeat step 5 until the bottom of grooves on the external side of drive belt are flush with the driven pulley edges.

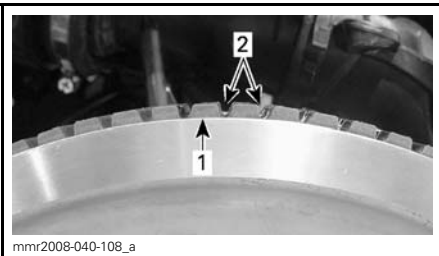

PRELIMINARY SETTING
1. Driven pulley edge
2. External drive belt grooves

All Drive Belt Types

NOTE: Turning the ring counterclockwise lowers the belt in the pulley. Turning the ring clockwise raises the belt in the pulley.

6. Firmly tighten the clamping screw. If possible, tighten to $5.5\text{ N}\cdot\text{m} \pm 0.5\text{ N}\cdot\text{m}$ ($49\text{ lbf}\cdot\text{in} \pm 4\text{ lbf}\cdot\text{in}$) using a torque wrench.
7. Install belt guard, refer to *DRIVE BELT GUARD INSTALLATION*.
8. Close side panel, refer to *HOOD AND SIDE PANELS*.

NOTE: This setting is correct as a preliminary adjustment for most models and belt types. In some cases, when starting the engine, the vehicle could creep, indicating that the belt is too tight.

If the vehicle creeps, lower the drive belt height from the preliminary setting. Repeat procedure until creeping stops.

Reverse Activation

NOTE: The reverse may not activate or may be harder to activate if the belt is positioned too high in the driven pulley. If reverse activation does not work properly, ensure the drive belt is properly adjusted. Adjust the drive belt lower in the driven pulley if needed.

Drive Pulley

Drive Pulley Adjustment

The drive pulley is factory calibrated for sea level operation.

600 ACE

No adjustment required.

600 HO E-TEC and 1200 4-TEC

⚠ WARNING

Remove the tether cord cap (DESS key) before performing any maintenance or adjustment, unless otherwise specified. Vehicle must be parked in a safe place, away from the trail.

The drive pulley is factory calibrated to transmit maximum engine power at a predefined RPM. Factors such as ambient temperature, altitude or surface condition may vary this critical engine RPM thus affecting snowmobile efficiency.

This adjustable drive pulley allows setting maximum engine RPM to maintain maximum power.

Calibration screws should be adjusted so that actual maximum engine RPM matches the maximum horsepower RPM.

ENGINE	MAXIMUM HORSEPOWER RPM
550 SK	6800 RPM (± 100)
600 HO E-TEC	8100 RPM (± 100)
1200 4-TEC	7800 RPM (± 100)

NOTE: Use precision digital tachometer for engine RPM adjustment.

NOTE: The adjustment has an effect on high RPM only.

Calibration screw has a notch on top of its head.

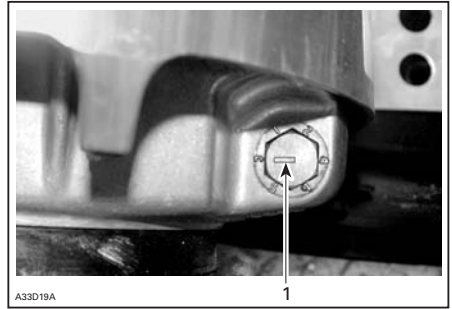

TYPICAL
1. Notch

There are 6 positions numbered 1 to 6. Each position modifies maximum engine RPM by about 200 RPM.

Lower position numbers decrease engine RPM in steps of 200 RPM and higher position numbers increase it in steps of 200 RPM.

Example:

Calibration screw is set at position 4 and is changed to position 6. So maximum engine RPM is increased by 400 RPM.

Procedure

Just loosen locking nut enough to pull calibration screw partially out and adjust to desired position. Do not completely remove the locking nut. Torque locking nuts to 10 N•m (89 lbf•in).

NOTICE Do not completely remove calibration screw otherwise internal washers will fall off. Always adjust all 3 calibration screws and make sure they are all set to the same position.

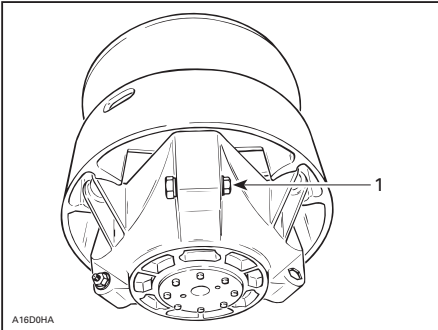
**TYPICAL**

1. Loosen just enough to permit rotating of calibrate screw

⚠ WARNING

NEVER disassemble or modify the drive pulley.

Improper assembly or modifications could cause the pulley to explode violently under the stress generated by the high rotational speed. This could lead to serious injury including the possibility of death.

See your LYNX dealer to maintain or service the drive pulley. Improper servicing or maintenance may affect performance and reduce belt life. Always respect maintenance schedules.

⚠ WARNING

NEVER operate engine:

- without shields and belt guard securely installed
- with hood and/or side panels opened or removed.

NEVER attempt to make adjustments to moving parts while engine is running.

Track**Track Inspection****⚠ WARNING**

Remove the tether cord cap (DESS key) before performing any maintenance or adjustment, unless otherwise specified. Vehicle must be parked in a safe place, away from the trail.

Remove the tether cord cap (DESS key).

Lift the rear of the snowmobile and support it with a wide-base snowmobile mechanical stand with a rear deflector panel. With the engine off, rotate the track by hand, and inspect condition. If worn or cut, or if track fibers are exposed, or if missing or defective inserts or guides are noted; contact an authorized LYNX dealer.

⚠ WARNING

Riding with a damaged track could lead to a loss of control, resulting in a risk of serious injury or death.

Track Tension and Alignment

NOTE: Track tension and alignment are interrelated. Do not adjust one without the other.

⚠ WARNING

To prevent serious injury to individuals near the snowmobile:

- NEVER stand behind or near a moving track
- always use a wide-base snowmobile stand with a rear deflector panel
- when the track is raised off the ground, only run it at the lowest possible speed.

Centrifugal force could cause debris, damaged or loose studs, pieces of torn track, or an entire severed track to be violently thrown backwards out of the tunnel with tremendous force, possibly resulting in the loss of a leg or other serious injury.

Tension

NOTE: Ride the snowmobile in snow about 15 to 20 minutes prior to adjusting track tension.

Remove the tether cord cap (DESS key).

Lift rear of snowmobile and support it with a wide-base snowmobile mechanical stand.

Allow the suspension to extend normally and check gap halfway between front and rear idler wheels. Measure between slider shoe bottom and inside of track. The gap should be as given in *SPECIFICATIONS* at the end of this guide. If the track tension is too loose, track will have a tendency to thump.

NOTE: A belt tension tester (P/N 414 348 200) may be used to measure deflection as well as force applied.

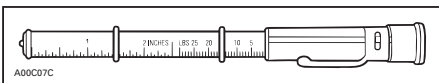

BELT TENSION TESTER

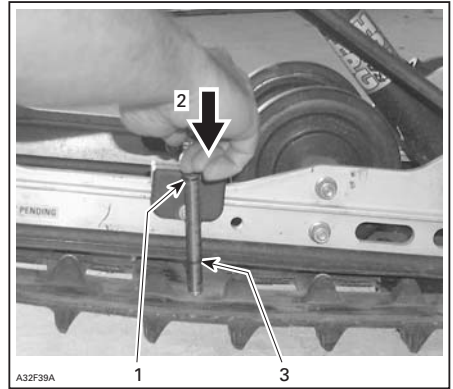

TYPICAL

1. Top tool O-ring positioned at 7.3 kg (16 lb)
2. Push on top portion of tool until it contacts the top O-ring
3. Measured track deflection

NOTICE Too much tension will result in power loss and excessive stresses on suspension components.

To adjust track tension:

- Remove the tether cord cap (DESS key).
- Remove rear wheel caps (if so equipped).
- Loosen the rear idler wheel retaining bolts.
- Loosen the lock nuts, then turn adjustment bolts to adjust.

If correct tension is unattainable, contact an authorized LYNX dealer.

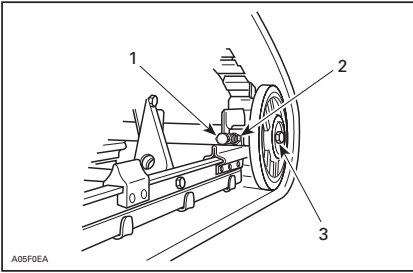

TYPICAL

1. Adjustment bolt
 2. Lock nut
 3. Idler wheel retaining bolt
- Retighten lock nuts and idler wheels retaining bolts.
 - Check track alignment as described below.

Alignment

⚠ WARNING

Before checking track alignment, ensure that the track is free of all particles which could be thrown out while track is rotating. Keep hands, tools, feet and clothing clear of track. Always lift the snowmobile on a wide-base stand with a rear deflector panel. Ensure no one is standing in close proximity to the snowmobile, especially at the rear of the track. Never rotate track at high speed. Centrifugal force could cause debris, pieces of torn track, or an entire severed track to be violently thrown backwards out of the tunnel with tremendous force, possibly resulting in the loss of a leg or other serious injury.

Start the engine and accelerate slightly so that track barely turns. This must be done in a short period of time (about 5 seconds).

Check that the track is well centered; equal distance on both sides between edges of track guides and slider shoes.

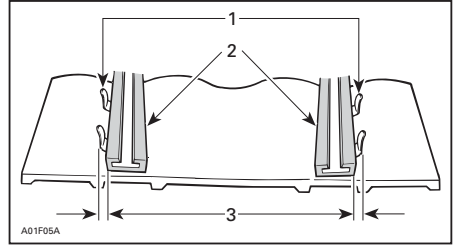

1. Guides
2. Slider shoes
3. Equal distance

If off center, perform alignment as follows:

⚠ WARNING

Remove the tether cord cap (DESS key) before performing any maintenance or adjustment, unless otherwise specified. Vehicle must be parked in a safe place, away from the trail.

- Remove the tether cord cap (DESS key).
- Loosen rear idler wheel retaining bolts.
- Tighten the adjustment bolt on side where the slider shoe is the farthest from the track insert guides.

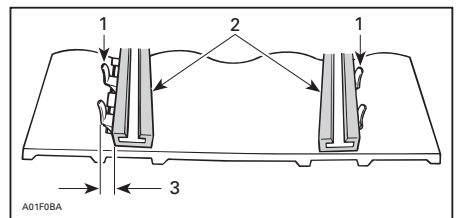

1. Guides
2. Slider shoes
3. Tighten on this side

- Tighten lock nuts
- Torque idler wheels retaining bolts to 48 N•m (35 lbf•ft).

⚠ WARNING

Make sure all fasteners are properly tightened to avoid losing an idler wheel or causing the track to lock.

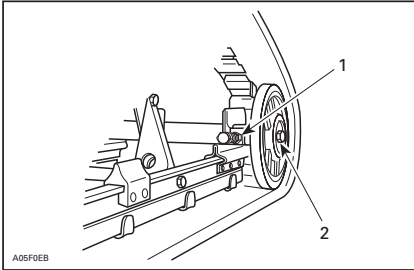

TYPICAL

1. Lock nut
2. Retaining bolts

- Start engine and rotate track slowly to recheck alignment.
- Reposition snowmobile on ground.
- Install rear wheel caps if so equipped.

Rear Suspension Condition

Visually inspect all suspension components including slider shoes, springs, wheels, etc.

NOTE: During normal driving, snow will act as a lubricant and coolant for the slider shoes. Extensive riding on ice or sanded snow, will create excessive heat build-up and cause premature slider shoe wear.

Suspension Stopper Strap Condition

Inspect stopper strap for wear and cracks, bolt and nut for tightness. If loose inspect holes for deformation. Replace as required. Torque nut to $9\text{ N}\cdot\text{m}$ ($80\text{ lbf}\cdot\text{in}$)

Rear Suspension Lubrication

Lubricate rear suspension at grease fittings using SUSPENSION GREASE (P/N 293 550 033.) Refer to *MAINTENANCE SCHEDULE* for maintenance frequency.

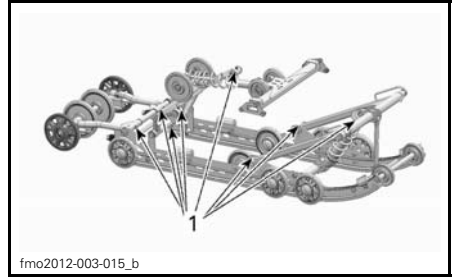

1. Grease fittings

Steering and front suspension

Visually inspect steering and front suspension for tightness of components (steering arms, control arms and links, tie rods, ball joints, ski bolts, ski legs, etc.). If necessary, contact an authorized LYNX dealer.

Front Suspension Lubrication (LTS)

Lubricate front suspension at grease fittings using suspension synthetic grease (P/N 293 550 033). Refer to *MAINTENANCE SCHEDULE* for maintenance frequency.

There is one grease fitting on each side. Each one is located on the front frame just below the steering arm.

Generally, 4 to 5 grease gun strokes is sufficient.

If too much grease is injected, the overflow will come out at steering levers and ski legs. Wipe off any excess of grease to avoid contact with other parts.

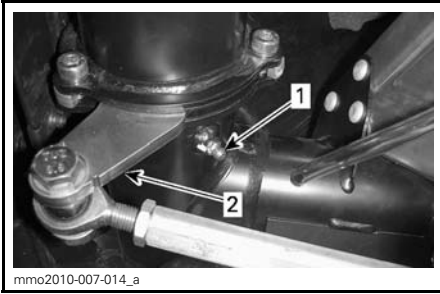

LH SIDE SHOWN

1. Grease fitting
2. Steering arm

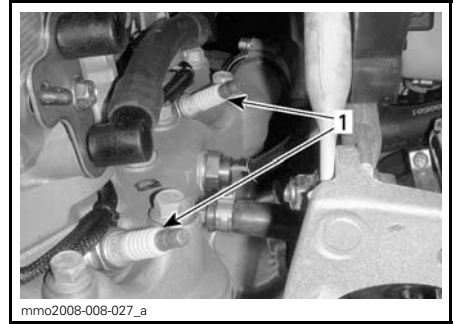

LH SIDE OF ENGINE COMPARTMENT

1. Spark plugs

Using tools from tool kit, unscrew spark plugs one turn.

Skis

Wear and Condition of Skis and Runners

Check the condition of the skis and ski runner carbides. If worn, contact an authorized LYNX dealer.

⚠ WARNING

Excessively worn skis and/or ski runners will adversely affect snowmobile control.

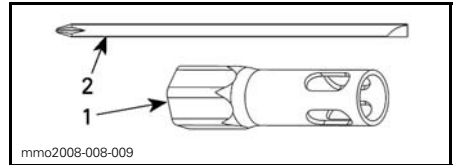

1. 16 mm socket
2. Screwdriver rod

Clean spark plugs and cylinder heads with pressurized air if possible.

Recommended Spark Plug

⚠ CAUTION Use only spark plug mentioned list below. It must be installed to a specific torque, refer to *SPARK PLUG INSTALLATION* for proper installation procedure.

Spark Plug Removal/Installation

Removal

- Open LH side panel.
- Remove belt guard, refer to *BELT GUARD REMOVAL*.
- Unplug spark plug cables.

⚠ WARNING

Always wear safety goggles when using pressurized air.

Unscrew spark plugs completely then remove them.

Installation

Prior to installation, make sure that contact surfaces of cylinder head and spark plugs are free of grime.

Using a feeler gauge, verify spark plug gap.

Replace spark plug if not within specifications.

CAUTION Do not attempt to adjust gap on these plugs.

Model	Spark plug type	Spark plug gap
Xtrim Commander 600 E-TEC, Adventure Grand Tourer 600 E-TEC	NGK PZFR6F	Not adjustable. 0.8 + 0 mm/- 0.1 mm
59 YETI 552	BRC9ECS-5	Not adjustable. 0.45 mm ± 0.05
ADVENTURE GRAND TOURER 1200 4-TEC	NGK CR8EKB	Not adjustable 0.75mm ± 0.05
59 Yeti 600 ACE, 69 Yeti 600 ACE	NGK CR7EB	0.75mm ± 0.05

Screw spark plugs into cylinder head by hand until it bottoms.

Tighten plugs using tools from tool kit or with a torque wrench and a proper socket.

Using Tools from Tool Kit

Use the 16 mm socket and the screwdriver rod from the vehicle tool kit.

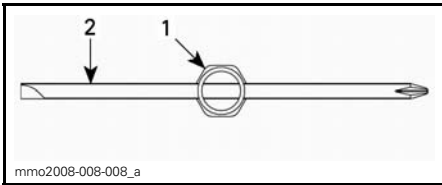

TOP VIEW

- 16 mm socket
- Screwdriver rod

Torque spark plugs as per the following illustrations.

NOTE: Ensure spark and washer sits properly on cylinder head.

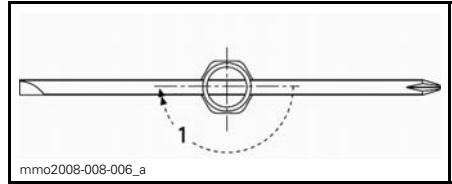

NEW SPARK PLUG

- Torque 1/2 of a turn

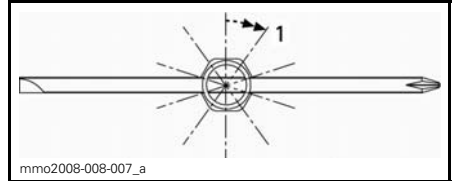

USED SPARK PLUG

- Torque 1/10 of a turn

Using a Torque Wrench.

Torque spark plugs to 27.5 N•m (20.3 lbf•ft).

Engine Stopper

Engine Stopper Adjustment

The engine stopper is located on the LH front engine support, in front of the drive pulley.

- Remove DESS key from post.
- Remove the LH lower side panel, refer to *HOOD AND SIDE PANELS*.
- Remove drive belt guard, refer to *DRIVE BELT GUARD REMOVAL* in this section.
- Loosen the three bolts retaining the engine stopper to the engine support without removing them.
- Apply a downward pressure on the engine stopper with your fingers while tightening the screws just enough to obtain contact between the screw heads and the surface of the stopper.
- Torque screws to 10 N•m (89 lbf•in)

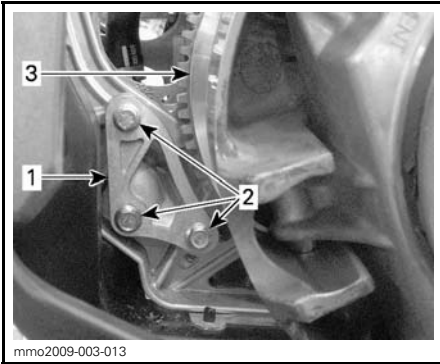

1. Engine stopper
2. Engine stopper screws
3. Drive pulley

NOTICE Serious pulley damage can occur if the engine stopper and its screws are not properly installed.

Fuses

Fuse Removal/Inspection

The electrical system is protected with fuses, the fuse holders are located in the engine compartment.

Check fuse condition and replace it if necessary.

To remove fuse from holder, pull fuse out. Check if filament is melted.

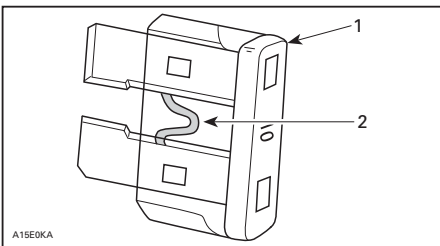

1. Fuse
2. Check if melted

CAUTION Do not use a higher rated fuse as this can cause severe damage to electrical components and/or be a potential fire.

⚠ WARNING

If fuse has burnt out, source of malfunction should be determined and corrected before restarting. See an authorized LYNX dealer for servicing.

Fuse Location

The fuse/fuse box is located behind the front seat cover at the LH front lower portion of seat.

Refer to the decal inside the fuse box cover or the *SPECIFICATIONS* section for fuse identification.

To access the fuse box, carefully pull seat cover out of the aluminum extrusion by pulling the plastic strip downwards and sideways at the same time.



PULL STRIP



1. Fuse box



550 MODEL, FUSE

Close upholstery by pushing the strip back in the aluminium extrusion.

BODY/FRAME

Vehicle Cleaning and Protection

Remove any dirt or rust.

To clean the entire vehicle, use only flannel cloths or equivalent.

CAUTION It is necessary to use flannel cloths or equivalent on windshield and hood to avoid damaging further surfaces to clean.

To remove grease, oil and grime, use Heavy duty cleaner (P/N 293 110 001) (spray can 400 g) and (P/N 293 110 002) (4 L).

CAUTION Do not use Heavy duty cleaner on decals or vinyl.

To remove stubborn dirt from all plastic and vinyl surfaces, use Vinyl & Plastic Cleaner ((P/N 413 711 200) (6 x 1 L)).

To remove scratches on windshield or hood use the Scratch Remover Kit (P/N 861 774 800).

CAUTION Never clean plastic parts or hood with strong detergent, degreasing agent, paint thinner, acetone, products containing chlorine, etc.

Clean sheaves of both pulleys using Pulley flange cleaner (P/N 413 711 809).

Inspect the hood and repair any damage.

Touch up all metal spots where paint has been scratched off. Spray all metal parts including shock chromed rods with XP-S Lube (P/N 293 600 016).

Wax painted portion of the vehicle for better protection.

NOTE: Apply wax on glossy finish only. Protect the vehicle with a cover to prevent dust accumulation during storage.

CAUTION The snowmobile has to be stored in a cool and dry place and covered with an opaque tarpaulin. This will prevent sun rays and grime from affecting plastic components and vehicle finish.

Lift rear of vehicle until track is clear of the ground. Install on a wide-base snowmobile mechanical stand with a rear deflector panel.

WARNING

Do not attempt to lift the vehicle by hand alone. Use appropriate lifting device or have assistance to share lifting stress in order to avoid risk of strain injuries.

NOTE: Do not release track tension.

Bulb Replacement

Always check light operation after bulb replacement.

Headlamp

CAUTION Never touch glass portion of an halogen bulb with bare fingers, it shortens its operating life. If glass is touched, clean it with isopropyl alcohol which will not leave a film on the bulb.

By using a small screwdriver, release multifunction gauge locking tabs.

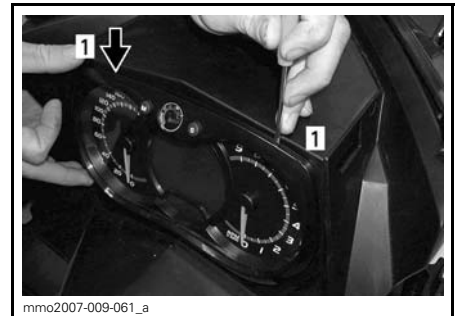

1. Locking tab

Gently pull on multifunction gauge and set aside.



Unplug burnt bulb connector. Remove the rubber boot.

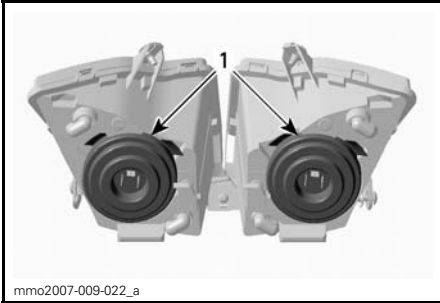

1. Rubber boot

Press and pull both sides of the spindle at the same time to release it from bulb support.

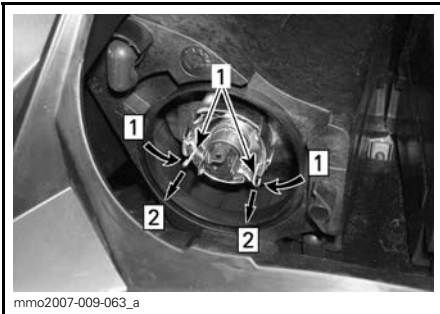

Step 1: Step 1: Push both sides
Step 2: Step 2: Pull to release

1. Spindle

Pull bulb and replace. Properly reinstall parts.



PULL BULB AND REPLACE

Headlamp Beam Aiming

Remove multifunction gauge, refer to *BULB REPLACEMENT*. Turn knob to adjust beam height.

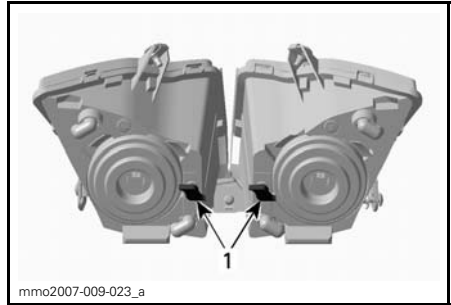

TYPICAL

1. Knob

Taillight

1. Open fastenings screws and remove taillight assembly.

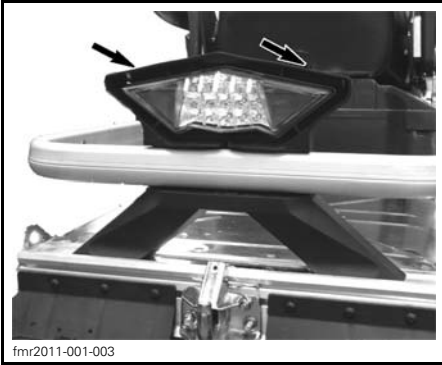

Led taillight leds cannot be replaced.
If failed change taillight assy. Fasten
new taillight by screws.

STORAGE AND PRESEASON PREPARATION

⚠ WARNING

Have an authorized LYNX dealer inspect fuel and oil systems integrity as specified in *PERIODIC MAINTENANCE CHART*.

Storage

During summer, or when a snowmobile is not in use for more than one month that proper storage is a necessity.

To prepare your snowmobile, refer to an authorized LYNX dealer.

Engine Cooling System

Antifreeze should be replaced every 2 years or 6000 km to prevent antifreeze deterioration.

The antifreeze replacement and a density test should be performed by an authorized LYNX dealer.

⚠ CAUTION Improper antifreeze mixture might allow freezing of the liquid in the cooling system if vehicle is stored in area where freezing point is reached. This would seriously damage the engine. Failure to replace the antifreeze for storage may allow its degradation that could result in poor cooling when engine will be used.

⚠ CAUTION Do not run engine during storage period.

Engine Storage Mode (E-TEC)

Like other 2-stroke engines, the 600 HO E-TEC has to be properly lubricated at storage for internal parts protection. The E-TEC system offers a built-in engine lubrication function can be initiated by the operator.

To engage procedure, do the following:

1. Place the vehicle in a well ventilated area.

2. Start the engine and let it run at idle speed until it reaches its operating temperature (watch the coolant temperature on the display).
3. Push the SET (S) button to select odometer mode.



NOTE: The storage mode does not function in other modes (trip A, trip B and hr trip).

4. Press and hold the SET (S) button and simultaneously depress the HI/LOW beam switch repeatedly several times.
5. Release switch and button when **PUSH "S"** appears in the display.



6. Again, press and hold the SET (S) button 2 - 3 seconds.
7. When **OIL** appears in display, release the button and wait the end of the procedure.

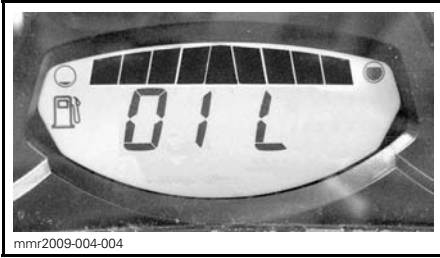

Do not touch anything during engine lubrication cycle.

The engine lubrication procedure takes approximately 1 minute. During this time the engine RPM will increase slightly.

At the end of engine lubrication procedure, the ECM will turn the engine off.

Remove tether cord.

NOTICE Do not start the engine during storage period.

Engine Lubrication Procedure (550F)

NOTICE Fuel stabilizer should be added prior to engine lubrication to ensure carburetor protection against varnish deposits.

Engine internal parts must be lubricated to protect them from possible corrosion during the storage period.

Proceed as follows:

1. Place the vehicle in a well ventilated area and start the engine.
2. Start the engine and let it run at idle speed until it reaches its operating temperature.
3. Stop the engine.
4. Remove the primary air intake silencer as follows:
 - 4.1 Remove LH side panel. Refer to *CONTROLS, INSTRUMENTS AND EQUIPMENT* section.

- 4.2 Remove drive belt guard. Refer to *CONTROLS, INSTRUMENTS AND EQUIPMENT* section.
- 4.3 Lift tab on rear section of connector tube.
- 4.4 Twist tube adapter counter clockwise and pull it off the primary silencer slightly.

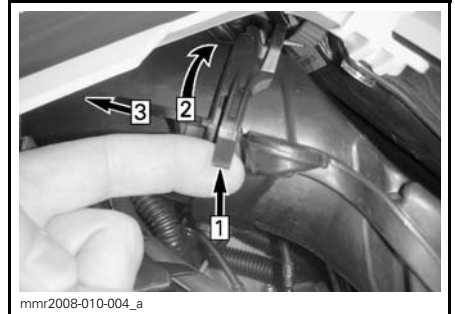

TYPICAL

- Step 1: Lift tab
 Step 2: Twist adapter
 Step 3: Pull off

- 4.5 Press locking tab securing the primary air intake silencer and pull silencer out of adapter plate.

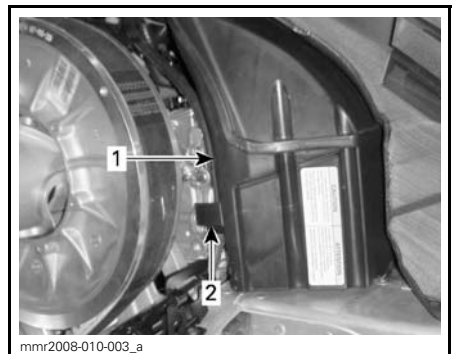

1. Primary air intake silencer
2. Primary intake silencer locking tab

5. Restart engine and run at idle speed.

6. Inject storage oil into each carburetor/throttle body until the engine stalls, or until a sufficient quantity of oil has entered the engine (approximately half a can).
7. With the engine stopped, remove the spark plugs and spray XPS STORAGE OIL (EXCEPT U.S. COUNTRY) (P/N 413 711 600) or XPS STORAGE OIL (U.S. COUNTRY ONLY) (P/N 413 711 900) into each cylinder.
8. Slowly crank engine 2 or 3 revolutions to lubricate cylinders.
9. Reinstall spark plugs and primary air intake silencer.

Preseason Preparation

Refer to an authorized LYNX dealer.

NOTICE Have carburetors cleaned before restarting engine.

WARRANTY

BRP FINLAND OY INTERNATIONAL LIMITED WARRANTY: 2012 LYNX® SNOWMOBILES

1) SCOPE OF THE LIMITED WARRANTY

BRP Finland Oy ("BRP") warrants its 2012 LYNX snowmobiles from defects in material or workmanship for the period and under the conditions described below.

All genuine LYNX parts and accessories, installed by an authorized BRP distributor/dealer (as hereinafter defined) at the time of delivery of the 2012 LYNX snowmobile, carry the same warranty as that of the snowmobile.

Use of the product for racing or any other competitive activity, at any point, even by a previous owner, will render this warranty null and void.

2) WARRANTY COVERAGE PERIOD

This warranty will be in effect from the date of delivery to the first retail consumer or the date the product is first put into use, whichever occurs first and for a period of:

A) TWELVE (12) CONSECUTIVE MONTHS, for private use owners

B) TWELVE (12) CONSECUTIVE MONTHS, for commercial use owners

C) TWENTY FOUR (24) CONSECUTIVE MONTHS, for private use owners when product was sold in a member state of the European Union and Russia. The repair or replacement of parts or the performance of service under this warranty does not extend the life of this warranty beyond its original expiration date.

3) CONDITIONS TO HAVE WARRANTY COVERAGE

This warranty coverage is available only on 2012 LYNX snowmobile purchased as new and unused by its first owner from a BRP distributor/dealer authorized to distribute LYNX products in the country in which the sale occurred ("BRP distributor/dealer"), and then only after the BRP specified pre-delivery inspection process is completed and documented. Warranty coverage only becomes available upon proper registration of the product by an authorized BRP distributor/dealer. Moreover, this warranty coverage is only available if the LYNX snowmobile is purchased in the country in which the purchaser resides. BRP will not honor this limited warranty to any private use owner or commercial use owner if the preceding conditions have not been met. Such limitations are necessary in order to allow BRP to preserve both the safety of its products, and also that of its consumers and the general public.

Routine maintenance outlined in the Operator's Guide must be timely performed in order to maintain warranty coverage. BRP reserves the right to make warranty coverage contingent upon proof of proper maintenance.

4) WHAT TO DO TO OBTAIN WARRANTY COVERAGE

The customer must notify a servicing BRP distributor/dealer within two (2) months of the appearance of a defect, and provide it with reasonable access to the product and reasonable opportunity to repair it. The customer must also present to the authorized BRP distributor/dealer, proof of purchase of the product and must sign the repair/work order prior to starting the repair in order to validate the warranty repair. All parts replaced under this limited warranty become the property of BRP.

5) WHAT BRP WILL DO

BRP's obligations under this warranty are limited to, at its sole discretion, repairing parts found defective under normal use, maintenance and service, or replacing such parts with new genuine LYNX parts without charge for parts and labor, at any authorized BRP distributor/dealer during the warranty coverage period.

BRP reserves the right to improve or modify products from time to time without assuming any obligation to modify products previously manufactured.

6) EXCLUSIONS

The following are not warranted under any circumstances:

- Normal wear and tear;
- Routine maintenance items, tune ups, adjustments;
- Damage caused by failure to provide proper maintenance and/or storage, as described in the Operator's Guide;
- Damage resulting from removal of parts, improper repairs, service, maintenance, modifications or use of parts not manufactured or approved by BRP or resulting from repairs done by a person that is not an authorized servicing BRP distributor/dealer;
- Damage caused by abuse, abnormal use, neglect, use of the product on surfaces other than snow, or operation of the product in a manner inconsistent with the recommended operation described in the Operator's Guide;
- Damage resulting from accident, submersion, fire, theft, vandalism or any act of God;
- Operation with fuels, oils or lubricants which are not suitable for use with the product (see the Operator's Guide);
- Snow or water ingestion;
- Incidental or consequential damages, or damages of any kind including without limitation towing, storage, telephone, rental, taxi, inconvenience, insurance coverage, loan payments, loss of time, loss of income; and
- Damage resulting from studs installed on tracks if the installation does not conform to BRP's instructions.

7) LIMITATIONS OF LIABILITY

THIS WARRANTY IS EXPRESSLY GIVEN AND ACCEPTED IN LIEU OF ANY AND ALL OTHER WARRANTIES, EXPRESSED OR IMPLIED, INCLUDING WITHOUT LIMITATION ANY WARRANTY OF MERCHANTABILITY OR FITNESS FOR A PARTICULAR PURPOSE. TO THE EXTENT THAT THEY CANNOT BE DISCLAIMED, THE IMPLIED WARRANTIES ARE LIMITED IN DURATION TO THE LIFE OF THE EXPRESS WARRANTY. INCIDENTAL AND CONSEQUENTIAL DAMAGES ARE EXCLUDED FROM COVERAGE UNDER THIS WARRANTY. SOME STATES/ PROVINCES DO NOT ALLOW FOR THE DISCLAIMERS, LIMITATIONS AND EXCLUSIONS IDENTIFIED ABOVE, AS A RESULT, THEY MAY NOT APPLY TO YOU. THIS WARRANTY GIVES YOU SPECIFIC RIGHTS, AND YOU MAY ALSO HAVE OTHER LEGAL RIGHTS WHICH MAY VARY FROM STATE TO STATE, OR PROVINCE TO PROVINCE.

Neither the distributor, any BRP distributor/dealer nor any other person has been authorized to make any affirmation, representation or warranty regarding the product, other than those contained in this limited warranty, and if made, shall not be enforceable against BRP.

BRP reserves the right to modify this warranty at any time, being understood that such modification will not alter the warranty conditions applicable to the products sold while this warranty is in effect.

8) TRANSFER

If the ownership of a product is transferred during the warranty coverage period, this warranty shall also be transferred and be valid for the remaining coverage period provided BRP or an authorized BRP distributor / dealer receives a proof that the former owner agreed to the transfer of ownership, in addition to the co-ordinates of the new owner.

9) CONSUMER ASSISTANCE

1. In the event of a controversy or a dispute in connection with this limited warranty, BRP suggests that you try to resolve the issue at the dealership level. We recommend discussing the issue with the authorized distributor/dealer's service manager or owner.
2. If further assistance is required, the distributor's service department should be contacted in order to resolve the matter.
3. If the matter still remains unresolved then contact BRP by writing to us at the address below.

ADDRESS:

BRP-FINLAND OY
SERVICE DEPARTMENT
P.O. BOX 8040
FIN-96101 ROVANIEMI
FINLAND

PRIVACY OBLIGATIONS/DISCLAIMER

We wish to inform you that your coordinates will be used for safety and warranty purposes. Sometimes, we also use the coordinates of our clients to inform them about our products and to present them offers. Should you prefer not to receive information on our products, services and offers, please let us know by writing to the address below.

Also note that, from time to time, carefully selected and trustworthy organizations may be permitted to use the coordinates of our clients to promote quality products and services. If you prefer not to have your name and address released, please let us know by writing to the address below:

FOR SCANDINAVIAN AND EUROPEAN COUNTRIES:

BRP FINLAND OY

Service Department

Isoaavantie 7

FIN-96320 Rovaniemi

Finland

Fax +358 16 3420 316

CHANGE OF ADDRESS/OWNERSHIP

If your address has changed or if you are the new owner of the vehicle, be sure to notify BRP by either:

- mailing one of the cards hereinafter using of the following mail address;
- contacting an authorized LYNX dealer or distributor.

Mail address:

FOR SCANDINAVIAN AND EUROPEAN COUNTRIES:

BRP FINLAND OY
Service Department
Isoaavantie 7
FIN-96320 Rovaniemi
Finland
Fax: +358 16 3420 316

In case of change of ownership, please join a proof that the former owner agreed to the transfer.

Notifying BRP, even after the expiration of the limited warranty, is very important as it enables BRP to reach the vehicle owner if necessary, like when safety recalls are initiated. It is the owner's responsibility to notify BRP.

STOLEN UNITS: If your personal vehicle is stolen, you should notify BRP or an authorized LYNX dealer. We will ask you to provide your name, address, phone number, the vehicle identification number and the date it was stolen.



brp.com

LYNX[®]



© [™] and the BRP logo are trademarks of Bombardier Recreational Products Inc. or its affiliates.