

LYNX®



**BRUKERHÅNDBOK
OPERATOR'S GUIDE
UTILITY SERIES • 2011**

NO/EN 619 900 245

OPERATOR'S MANUAL LYNX® 2011

Yeti® 550
Yeti® Pro 550
Yeti® Pro V-800

SAFETY WARNING

Disregarding any of the safety precautions and instructions contained in this Operator's Guide or on-product warnings may result in injury, including the possibility of death.
This Operator's Guide should remain with the unit at time of resale.



Lynx products are manufactured by BRP.

The following are trademarks of Bombardier Recreational Products Inc. or its subsidiaries.

LYNX ®

RER™

ROTAX™

YETI ®

DESS™

FOREWORD

Congratulations on your purchase of a new Lynx snowmobile. Whatever model you have chosen, it is backed by the Bombardier Recreational Products inc. (BRP) warranty and a network of authorized Lynx snowmobile dealers ready to provide the parts, service or accessories you may require.

The Operator's Guide has been prepared to acquaint the owner/operator and passenger with this new snowmobile and its various controls, maintenance and safe riding instructions. This guide is indispensable for the proper use of the product and should be kept with this snowmobile at all times.

Make sure you read and understand the content of this Operator's Guide.

After reading, please keep this Operator's Guide with the snowmobile. If the snowmobile is resold, please give the guide to the new owner for his awareness. An extra copy of the Operator's Guide is available from your Lynx snowmobile dealer at no charge.

If you have any question regarding any topic whether or not it is covered in this Operator's Guide, please send a written letter to BRP to following address:

BRP Finland OY
Service Department
P.O. Box 8039
FIN-96101 ROVANIEMI
FINLAND

Tel +358 16 3208 111

This guide uses the following safety alert symbol in conjunction with signal words to indicate a potential personal injury hazard.

WARNING

Indicates a potentially hazardous situation which, if not avoided, could result in death or serious injury.

CAUTION

Indicates a potentially hazardous situation which, if not avoided, may result in minor or moderate injury. When used without the safety alert symbol , potential hazard exists for property damage only.

NOTE: Indicates supplementary information needed to fully complete an instruction.

Although the mere reading of such information does not eliminate the hazard, the understanding and application of the information will promote the correct use of the vehicle.

Your dealer is committed to your satisfaction. He has taken training to perform the initial set-up and inspection of your snowmobile as well as completed the final adjustment required to suit your specific weight and riding environment before you took possession. At delivery, your dealer would have explained the snowmobile controls and provided you with a brief explanation of the various suspension adjustments. We trust you have taken full advantage of this!

At delivery, you were also informed of the warranty coverage and have completed the Warranty Registration process.

The information and components/system descriptions contained in this guide are correct at time of publication. BRP, however maintains a policy of continuous improvement of its products without imposing upon itself any obligation to install them on products previously manufactured.

Because of its ongoing commitment to product quality and innovation, BRP reserves the right at any time to discontinue or change specifications, designs, features, models or equipment without incurring obligation.

The illustrations in this document show the typical construction of the different assemblies and, in all cases, may not reproduce the full detail or exact shape of the parts shown, however, they represent parts which have the same or a similar function.

It is understood that this guide may be translated into another language. In the event of any discrepancy, the English version shall prevail.

Specifications are given in the SI metric system with the SAE U.S. equivalent in parentheses. Where precise accuracy is not required, some conversions are rounded off for easier use.

Most components of this snowmobile are built with parts dimensioned in the metric system. Most fasteners are metric and must not be replaced by customary fasteners or vice versa.

We recommend genuine BRP products for replacement parts and accessories. They've been specially designed for your vehicle and manufactured to meet BRP's demanding standards.

For any questions pertaining to the warranty and its application, consult the WARRANTY section in this guide, and/or an authorized Lynx dealer.

TABLE OF CONTENTS

SAFETY INFORMATION

IMPORTANT BASIC SAFETY MEASURES.....	8
LAWS AND REGULATIONS.....	12
RIDING THE VEHICLE.....	13
Principle of Operation	13
How to Ride	13
Carrying a Passenger	15
Terrain/Riding Variations	17
Transporting and Towing	21

VEHICLE INFORMATION

HOW TO IDENTIFY YOU SNOWMOBILE.....	24
Serial numbers	24
CONTROLS/INSTRUMENTS	25
1) Throttle lever	25
2) Brake lever.....	25
3) Parking brake button or lever	25
4) Pilot Lamps	26
5) Gear shift lever.....	27
6) Handlebar.....	27
7) Holding strap	27
8) Ignition switch / START button	27
9) Tether cut-out switch	28
10) DESS pilot lamp	29
11) Engine cut-out switch.....	29
12) Electric horn.....	29
13) Headlamp dimmer switch	30
14) Rewind starter handle	30
15) Choke lever	30
16) Odometer	30
17) Trip meter	30
18) Trip meter reset button	31
19) Fuel tank cap/gauge	31
20) Heating grip switch.....	32
21) Heated throttle lever switch.....	32
22) Hood latches	32
23) Power outlet	32
24) Fuse.....	33
25) Tool kit	34
26) Front grab handle/front bumper.....	34
27) Storage compartment.....	34

28) Rear rack	35
29) Hitch	35
30) Modular Seat	35
31) Adjustable suspension	36
SUSPENSION TROUBLESHOOT.....	39
In deep snow	39
FUEL AND OIL	40
Recommended fuel	40
Fuel System Antifreeze	40
Recommended Injection oil (550 / Pro 550 (2-tec models))	41
Recommended engine oil (Pro v-800 (4-tec model))	41
Gear box oil	41
Cold weather carburetion modifications	41
BREAK-IN PERIOD.....	42
Engine	42
Drive Belt	42
10 Hour Inspection	42
PRE OPERATION CHECKLIST	43
OPERATING INSTRUCTIONS.....	44
Propulsion	44
Turning	44
Stopping	44
Starting the engine	44
Shutting down the engine	46
VEHICLE WARM-UP	47
POST OPERATION CARE.....	48
SPECIAL OPERATIONS	49
Engine overheating	49
Fuel flooded engine	49
Rear suspension slider shoe sticking	49
Towing an Accessory	50
Towing Another Snowmobile	50
Transporting the Vehicle	50
FLUID LEVELS	51
Brake system	51
Engine oil level	52
Injection oil system	52
Cooling system	53
BATTERY.....	54
Removal	54
Dry battery	54
Battery Maintenance	54
Off Season Storage	55
Battery Safety	55

MAINTENANCE	57
Vehicle cleaning and protection	57
Drive belt removal and installation	58
TRA Drive pulley adjustment	59
Drive belt condition	60
Brake condition.....	61
Brake adjustment	61
Rear suspension condition.....	61
Suspension stopper strap condition	61
Track condition	61
Track tension and alignment.....	61
Steering and front suspension mechanism	62
Wear and condition of skis and runners.....	62
Exhaust system.....	62
Air filter cleaning	63
Bulb replacement.....	63
ENGINE SYSTEM	66
Engine Oil Level.....	66
Engine Oil/Oil Filter Change	66
STORAGE AND PRESEASON PREPARATION	68
Storage.....	68
Preseason preparation	68
TROUBLESHOOTING	69
Monitoring beeper coded signals	69
Troubleshooting.....	71
SPECIFICATIONS	73
DECLARATION OF CONFORMITY	79

MAINTENANCE INFORMATION

BREAK-IN INSPECTION	82
PERIODIC MAINTENANCE CHART	84
MAINTENANCE SCHEDULE (2-STROKE)	85
MAINTENANCE SCHEDULE (4-STROKE)	87
PRESEASON PREPARATION	89
STORAGE	91

WARRANTY

BRP FINLAND OY INTERNATIONAL LIMITED WARRANTY: 2011 LYNX® SNOWMOBILES	94
PRIVACY OBLIGATIONS/DISCLAIMER	97
CHANGE OF ADDRESS/OWNERSHIP	98

SAFETY INFORMATION

IMPORTANT BASIC SAFETY MEASURES

Training

- △ Basic training is required for the safe operation of any snowmobile. Study your Operator's Guide paying particular attention to cautions and warnings. Join your local snowmobile club: its social activities and trail systems are planned for both fun and safety. Obtain basic instructions from your snowmobile dealer, friend, fellow club member or enroll in your state or provincial safety training program.
- △ Always show a new operator how to start and stop the vehicle. Indicate the correct riding positions and, above all else, only allow him to operate the snowmobile in a restricted flat area — at least until he is completely familiar with its operation. If there is a local snowmobile operator's training course existing, have him enroll.

Performance

- △ The performance of some snowmobiles may significantly exceed that of other snowmobiles you have operated. Therefore, use by novice or inexperienced operators is not recommended.
- △ Snowmobiles are used in many areas and in many snow conditions. Not all models perform the same in similar conditions. Always consult your snowmobile dealer when selecting the snowmobile model for your particular needs and uses.
- △ Injury or death may result to the snowmobile operator, passenger or bystander if the snowmobile is used in risky conditions which are beyond the driver's, passenger's or snowmobile's capabilities or intended use.

Age

- △ BRP recommends the operator has at least 16 years old of age. Follow your local legislation.

Speed

- △ Speeding can be fatal. In many cases, you cannot react or respond quickly enough to the unexpected. Always ride at a speed which is suitable to the trail, weather conditions and your own ability. Know your local rules. Speed limit may be in effect and meant to be observed.

Riding

- △ Always keep right hand side of the trail.
- △ Always keep a safe distance from other snowmobiles and bystanders.
- △ Remember, promotional material may show risky maneuvers performed by professional riders under ideal and/or controlled conditions. You should never attempt any such risky maneuvers if they are beyond your level of riding ability.
- △ Never ride after consuming drugs or alcohol or if you feel tired or ill. Operate your snowmobile prudently.
- △ Your snowmobile is not designed to be operated on public streets, roads or highways.
- △ Snowmobiling at night can be a delightful experience but because of reduced visibility, be extra cautious. Avoid unfamiliar terrain and be sure your lights are working. Always carry a flashlight and spare light bulbs.

- ⚠ Nature is wonderful but don't let it distract your attention from driving. If you want to truly appreciate winter's scenery, stop your snowmobile on the side of the trail so that **you** don't become a hazard to others.
- ⚠ Fences represent a very serious threat for both you and your snowmobile. Give a wide berth to telephone poles or posts.
- ⚠ Hidden wires unseen from a distance can cause serious accidents.
- ⚠ Always wear an approved safety helmet, eye protection and a face shield. This also applies to your passenger.
- ⚠ Be aware of inherent risks associated with riding off trails, such as avalanche and other natural or man made hazards or obstacles.
- ⚠ Avoid road traveling. If you must do so, and it is permitted, reduce speed. The snowmobile is not designed to operate or turn on paving. When crossing a road, make a full stop, then look carefully in both directions before crossing at a 90° angle. Be wary of parked vehicles.
- ⚠ Tailgating another snowmobile should be avoided. If the snowmobile in front of you slows for any reason, its driver and passenger could be harmed through your neglect. Maintain a safe stopping distance between you and the snowmobile in front of you. Depending on the terrain condition, stopping may require a little more space than you think. Play it safe. Be prepared to use evasive driving.
- ⚠ Venturing out alone with your snowmobile could also be hazardous. You could run out of fuel, have an accident, or damage your snowmobile. Remember, your snowmobile is capable of traveling further in half an hour than you may be able to walk in a day. Use the "buddy system". Always ride with a friend or member of your snowmobile club. Even then, tell someone where you are going and the approximate time you plan to return.
- ⚠ Meadows sometimes have low areas where water accumulate and freezes over in winter. This ice is usually glare ice. Attempting to turn or brake on this surface could cause your vehicle to spin out of control. Never brake or attempt speeding or turning on glare ice. If you do happen to travel over such a condition, reduce speed by carefully releasing the throttle.
- ⚠ Never "jump" with your snowmobile. This should be left to professional stunt men. Don't show off. Be responsible.
- ⚠ While on safari, do not "gun" the throttle. Snow and ice can be thrown back into the path of a following snowmobile. In addition, when "gunning" the throttle, the vehicle digs into and leaves an irregular snow surface for others.
- ⚠ Safaris are both fun and enjoyable but don't show off or overtake others in the group. A less experienced operator might try to do the same as you and fail. When riding with others, limit your abilities to the experience of others.

Operation

- ⚠ Always make a pre-start inspection **BEFORE** you turn on the ignition.

- ⚠ In an emergency, the snowmobile engine can be stopped by activating the engine cut-out switch, pulling the tether cord cap or turning off the key.
- ⚠ Throttle mechanism should be checked for free movement and return to idle position before starting engine.
- ⚠ Always engage parking brake when vehicle is not in use.
- ⚠ Never run the engine in a non-ventilated area and/or if vehicle is left unattended.
- ⚠ Never operate the engine without belt guard securely installed or, with hood or access/side panels open or removed. Never run the engine without drive belt installed. Running an unloaded engine such as without drive belt or with track raised, can be dangerous.
- ⚠ **Electric start models only:** Never charge or boost a battery while installed on snowmobile.
- ⚠ Ensure the path behind is clear of obstacles or bystanders before proceeding in reverse.
- ⚠ Do not leave your keys in the ignition switch, it is an invitation to thieves and a danger to young children.
- ⚠ Raising the rear of your snowmobile while the engine is running could cause snow, ice or debris to be thrown back at an observer. Never raise the rear of the vehicle while the engine is running. To clear or inspect the track, stop the engine, tilt the vehicle on its side and remove blockage with a piece of wood or branch. Never allow anyone near a rotating snowmobile track.

Maintenance

- ⚠ Know your snowmobile and treat it with the respect and care due of any power driven machine. Common sense, proper handling and routine maintenance will result in safer and enjoyable use.
- ⚠ Only perform procedures as detailed in this guide. Unless otherwise specified, engine should be turned OFF and cold for all lubrication, adjustment and maintenance procedures.
- ⚠ Never have the engine running while the hood is open. Even at idle, a snowmobile engine is turning around 1,800 revolutions per minute. Always turn off the ignition before opening the hood for any reason.
- ⚠ Never remove any original equipment from your snowmobile. Each vehicle has many built in safety features. Such features include various guards and consoles, plus reflective materials and warning labels.
- ⚠ A poorly maintained snowmobile itself can be a potential hazard. Excessively worn components could render the vehicle completely inoperative. Keep the snowmobile in good working condition at all times. Follow your pre-operation check, weekly, monthly and annually routine maintenance and lubrication procedures as detailed in this guide. Consult a snowmobile dealer or acquire a shop manual and proper tools and equipment if other repairs or service is required.
- ⚠ Do not stud the track unless it as been approved for studs. At speed, a studded track that as not been approved for studs could tear and separate from vehicle posing a risk of severe injury or death.

Fuel

⚠ Always stop the engine before refueling. Fuel is flammable and explosive under certain conditions. Always work in a well-ventilated area. Do not smoke or allow open flames or sparks in the vicinity. Open cap slowly. If a differential pressure condition is noticed (whistling sound heard when loosening fuel tank cap) have vehicle inspected and/or repaired before further operation. Do not overfill or top off the fuel tank before placing the vehicle in a warm area. As temperature increases, fuel expands and might overflow. Always wipe off any fuel spillage from the vehicle. Periodically verify fuel system.

Basics for Passenger

- ⚠ Never ride as a passenger unless the snowmobile is equipped with a passenger seat and backrest, and sit only on the designated passenger seat.
- ⚠ Always wear a DOT approved helmet and follow the same dressing guidelines as those recommended for the operator and described in this guide.
- ⚠ Make sure that you are able to achieve a stable stance, both feet resting positively on the footboards of footrests with good grip, and that you are able to hold on firmly to the handholds.
- ⚠ Once underway, if you feel uncomfortable or insecure for any reason, don't wait, tell the driver to slow down or stop.

LAWS AND REGULATIONS

⚠ Know your local laws.

Federal, state, provincial and local government agencies have enacted laws and regulations pertaining to the safe use and operation of snowmobiles. It is your responsibility as a snowmobiler to learn and obey these laws and regulations. Respect and observance will result in safer snowmobiling for all.

Be aware of the liability property damages and insurance laws regarding your equipment.

RIDING THE VEHICLE

Before venturing on the trails, operate the snowmobile in a restricted flat area until you are completely familiar with its operation and feel comfortable that you can safely tackle a more demanding task. Have an enjoyable and safe ride.

Principle of Operation

Propulsion

Depressing throttle lever increases engine RPM causing the drive pulley to engage. Depending on models, engine RPM must be between 2500 and 4200 before drive pulley engagement will occur.

Outer sheave of drive pulley moves toward inner sheave, forcing the drive belt to move upward on the drive pulley and simultaneously forcing the sheaves apart on the driven pulley.

The driven pulley senses the load on the track and limits the belt movement. The result is an optimized speed ratio between engine RPM and the speed of the vehicle at any time.

WARNING

Never operate engine without belt guard securely installed or, with hood or access/side panels open or removed.

Power is transferred to the track through the chaincase or gearbox and drive axle.

WARNING

Always use a wide-base snowmobile mechanical stand to properly support vehicle during any track verification. Slowly accelerate engine in order to rotate track at very low speed when it is not on ground.

Turning

Handlebar controls the steering of the vehicle. As the handlebar is rotated to right or left, the skis are turned right or left to steer the snowmobile.

Stopping

Before riding your snowmobile, you should understand how to stop it. This is done by releasing the throttle and gradually depressing the brake lever on the left side of the handlebar. In an emergency, you may stop your vehicle by pressing the engine cut-out switch located near the throttle control and applying the brake. Remember, a snowmobile cannot "stop on a dime". Braking characteristics vary with deep snow, packed snow or ice. If the track is locked during hard braking, skidding may result.

How to Ride

How to Dress

Proper snowmobile clothing should be worn. It should be comfortable and not too tight. Always check the weather forecast before going on a ride. Dress for the coldest weather expected. Thermal underwear next to the skin also provides a good insulation.

DOT approved helmets are recommended at all times. They provide both warmth and reduce injury. A stocking type cap, balaclava and face mask should always be carried or worn. Goggles or a face shield that attach to the helmet are indispensable.

Hands should be protected by a pair of snowmobile gloves or mitts which have sufficient insulation and allow use of thumbs and fingers for operation of controls.

Rubber bottom boots with either a nylon or a leather top, with removable felt liners are best suited for snowmobiling.

You should keep yourself as dry as possible when snowmobiling. When you come indoors, take your snowmobile suit and boots off and make certain they dry properly.

Do not wear long scarfs and loose apparels that could get caught in moving parts.

What to Bring

Every snowmobiler should carry at least the following basic parts and tools that can help him and others in an emergency:

- this Operator's Guide
- spare spark plugs and wrench
- friction tape
- spare drive belt
- spare starter rope
- spare light bulbs
- tool kit (including at least pliers, screwdriver, adjustable wrench)
- knife
- flashlight.

Include other items depending on the length and time of your ride.

Riding Position

Your riding position and balance are the two basic principles of making your snowmobile go where you want it to. When turning on the side of a hill, you and your passenger must be ready to shift body weight to help it turn in the desired direction. Driver and passenger(s) must never attempt this maneuvering by placing feet outside of the vehicle. Experience will teach you how much lean to put into turns at different speeds and how much you will have to lean into a slope to maintain proper balance.

Generally, the riding position for best balance and control is sitting. However, the posting, kneeling or standing positions are also used under certain conditions.

The novice driver should become familiar with the snowmobile through practice on a level area at slow speeds before venturing afield.

WARNING

Do not attempt any maneuvers if they are beyond your abilities.

Sitting

Feet on the running boards, body mid-way back on seat is an ideal position when operating the snowmobile over familiar, smooth terrain. Knees and hips should remain flexible to absorb shocks.



Standing

Place both feet on the running boards. Knees should be flexed to absorb the shock from surface bumps. This is an effective position to see better and to shift weight as conditions dictate. Avoid abrupt stop.

Posting

A semi-sitting position with the body off the seat and the feet under the body in a sort of squatting posture, thus allowing the legs to absorb the shocks when traveling over uneven terrain. Avoid abrupt stops.



Carrying a Passenger

Certain snowmobiles are designed for an operator only, others can allow one passenger only, and others can allow up to two passengers. Refer to the indications on the vehicles to know if any particular snowmobile can accommodate passengers or not, and if so, how many. Always respect those indications. Overloading is dangerous because snowmobiles are not designed for it.

Kneeling

This position is achieved by placing one foot firmly on the running board and the opposite knee on the seat. Avoid abrupt stops.

Even when passengers are allowed, you must make sure that the persons who would like to become passengers are physically fit for snowmobiling.

⚠ WARNING

Any passenger must be able to firmly lay his feet on the footrests and keep his hands on the grab handles or seat strap at all times when seated. Respecting those physical criteria is important to ensure that the passenger is stable and to reduce the risks of ejection.

On snowmobiles allowing two passengers, if you have an adult and a child for passenger, BRP recommends that the child sits in the center location. This allows an adult sitting in the rear seat to keep a visual contact with the child and hold him if necessary. In addition, the child is best protected against the wind and cold temperature if seated in the center location.

Each operator has a responsibility to ensure the safety of his passengers and should inform them of snowmobiling basics.

⚠ WARNING

- Passengers must only sit on designated passenger seats. Never allow anyone to sit between the handlebar and the operator.
- Each passenger seat must have a strap or grab handles and meet SSCC standards.
- Passengers and operators must always wear DOT approved helmets and warm clothing appropriate for snowmobiling. Make sure that no skin is exposed.
- Once underway, if a passenger feels uncomfortable or unsecure for any reason, he must not wait, and tell the driver to slowdown or stop.

Riding with passengers on board is different than riding alone. The operator has the benefit of knowing what will be the next maneuver and is able to prepare himself accordingly. The operator also benefits from the support of his grip on the handlebar. In contrast, the passengers have to rely on the operator's careful and safe operation of the vehicle. In addition, "body english" is limited with passengers, and the operator can sometimes see more of the trail ahead than the passengers. Therefore, smooth starting and stopping are required with passengers, and the operator must slow down. The operator must also warn passengers of side hills, bumps, branches, etc. An unforeseen bump can leave you passenger-less. Remind your passengers to lean into the turn with you, without causing the vehicle to topple. Be extremely careful, go more slowly and check the passengers frequently.

⚠ WARNING

- When riding with a passenger:**
- Braking ability and steering control are reduced. Decrease speed and allow extra space to maneuver.
 - Adjust suspension according to weight.

For complete information on how to adjust the suspension, please refer to the section of this Operator's Guide entitled SUSPENSION ADJUSTMENTS under OPERATING INSTRUCTIONS and to the relevant label on the belt guard.

Use extra caution and go even more slowly with young passengers. Check frequently to make certain the child has a firm grip and is properly positioned with his feet on the running boards.

Terrain/Riding Variations

Groomed Trail

On a maintained trail, sitting is the most preferred riding position. Do not race and, above all, keep to the right hand side of the trail. Be prepared for the unexpected. Observe all trail signs. Do not zigzag from one side of the trail to the other.

Ungroomed Trail

Unless there has been a fresh snowfall you can expect "washboard" and snowdrift conditions. Taken at excessive speeds, such conditions can be physically harmful. Slow down. Hold on the handlebar and assume a posting position. Feet should be under the body assuming a crouched position to absorb any jarring effect. On longer stretches of "washboard" trails, the kneeling position of one knee on the seat can be adopted. This provides a certain amount of comfort, while at the same time keeps the body loose and capable of vehicle control. Beware of hidden rocks or tree stumps partially hidden by a recent snowfall.

Deep Snow

In deep "powder" snow, your vehicle could begin to "bog" down. If this occurs, turn in as wide an arc as possible and look for a firmer base. If you do get "bogged", and it happens to everyone, do not spin your track as this makes the vehicle sink deeper. Instead, turn the engine off, get off and move the back of the vehicle onto new snow. Then tramp a clear path ahead of the vehicle. A few feet will generally suffice. Restart the engine. Assume the standing position and rock the vehicle gently as you steadily and slowly apply the throttle. Depending on whether the front or rear end of the vehicle is sinking, your feet should be placed on the opposing end of the running boards. Never place foreign material beneath the track for support. Do not allow anyone to stand in front of, or to the rear of, the snowmobile with the engine running. Stay away from the track. Personal injury will result if contact is made with the revolving track.

Frozen Water

Traveling frozen lakes and rivers can be fatal. Avoid waterways. If you are in an unfamiliar area, ask the local authorities or residents about the ice condition, inlets, outlets, springs, fast moving currents or other hazards. Never attempt to operate your snowmobile on ice that may be too weak to support you and the vehicle. Operating a snowmobile on ice or icy surfaces can be very dangerous if you do not observe certain precautions. The very nature of ice is foreign to good control of a snowmobile or any vehicle. Traction for starting, turning or stopping is much less than that on snow. Thus, these distances can be multiplied manyfold. Steering is minimal, and uncontrolled spins are an ever present danger. When operating on ice, drive slowly with caution. Allow yourself plenty of room for stopping and turning. This is especially true at night.

Hard Packed Snow

Don't underestimate hard packed snow. It can be difficult to negotiate as both skis and track do not have as much traction. Best advice is to slow down and avoid rapid acceleration, turning or braking.

Uphill

There are two types of hills you can encounter — the open hill on which there are few trees, cliffs or other obstacles, and a hill that can only be climbed directly. On an open hill, the approach is to climb it by side hilling or slaloming. Approach at an angle. Adopt a kneeling position. Keep your weight on the uphill side at all times. Maintain a steady, safe speed. Continue as far as you can in this direction, then switch to an opposite hill angle and riding position.

A direct climb could present problems. Choose the standing position, accelerate before you start the climb and then reduce throttle pressure to prevent track slippage.

In either case, vehicle speed should be as fast as the incline demands. Always slow down as you reach the crest. If you cannot proceed further, don't spin your track. Turn the engine off, free the skis by pulling them out and downhill, place the rear of the snowmobile uphill restart the engine and ease it out with slow even throttle pressure. Position yourself to avoid tipping over, then descend.

Downhill

Downhill driving requires that you have full control of your vehicle at all times. On steeper hills, keep your center of gravity low and both hands on the handlebar. Maintain slight throttle pressure and allow the machine to run downhill with the engine operating. If a higher than safe speed is reached, slow down by braking but apply the brake with frequent light pressure. Never jam the brake and lock the track.

Side Hill

When crossing a side hill or traversing up or downhill, certain procedures must be followed. All riders should lean towards the slope as required for stability. The preferred operating positions are the kneeling position, with the knee of the down hill leg on the seat and the foot of the uphill leg on the running board, or the posting position. Be prepared to shift your weight quickly as needed. Side hills and steep slopes are not recommended for a beginner or a novice snowmobiler.

Slush

Slush should be avoided at all times. Always check for slush before starting across any lake or river. If dark spots appear in your tracks, get off the ice immediately. Ice and water can be thrown rearward into the path of a following snowmobile. Getting a vehicle out of a slush area is strenuous and in some cases, impossible.

Fog or Whiteouts

On land or water, fog or visibility-limiting snow can form. If you have to proceed into the fog or heavy snow, do so slowly with your lights on and watch intently for hazards. If you are not sure of your way, do not proceed. Keep a safe distance behind other snowmobilers to improve visibility and reaction time.

Unfamiliar Territory

Whenever you enter an area that is new to you, drive with extreme caution. Go slow enough to recognize potential hazards such as fences or fence posts, brooks crossing your path, rocks, sudden dips, guy wires and countless other obstacles which could result in a termination of your snowmobile ride. Even when following existing tracks, be cautious. Travel at a speed so you can see what is around the next bend or over the top of the hill.

Bright Sunshine

Bright sunny days can considerably reduce your vision. The glare from sun and snow may blind you to the extent that you cannot easily distinguish ravines, ditches or other obstacles. Goggles with colored lenses should always be worn under these conditions.

Unseen Obstruction

There may be obstructions hidden beneath the snow. Driving off established trails and in the woods requires reduced speed and increased vigilance. Driving too fast in an area can make even minor obstacles very hazardous. Even hitting a small rock or stump could throw your snowmobile out of control and cause injury to its riders. Stay on established trails to reduce your exposure to hazards. Be safe, slow down and enjoy the scenery.

Hidden Wires

Always be on the lookout for hidden wires, especially in areas that may have been farmed at one time or any other. Too many accidents have been caused by running into wires in the fields, guy wires next to poles and roads, and into chains and wires used as road closures. Slow speeds are a must.

Obstacles and Jumping

Unplanned jumps of snowdrifts, snowplow ridges, culverts or indistinguishable objects can be dangerous. You can avoid them by wearing the proper color lenses or face shields and by operating at a lower speed.

Jumping a snowmobile is an unsafe and dangerous practice. However, if the trail does suddenly drop away from you, crouch (stand) towards the rear of the vehicle and keep the skis up and straight ahead. Apply partial throttle and brace yourself for the impact. Knees must be flexed to act as shock absorbers.

Turning

Depending on terrain conditions, there are two preferred ways to turn or corner a snowmobile. For most snow surfaces, “body english” is the key to turning. Leaning towards the inside of the turn and positioning body weight on the inside foot will create a “banking” condition beneath the track. By adopting this position and positioning yourself as far forward as possible, weight will be transferred to the inside ski.

On occasion, you will find that the only way to turn the vehicle about in deep snow is to pull the snowmobile around. Do not over-exert yourself. Get assistance. Remember to always lift using your legs as opposed to your back.



Road Crossing

In some cases, you will be approaching the road from a ditch or snowbank. Choose a place where you know you can climb without difficulty. Use the standing position and proceed with only as much speed needed to crest the bank. Stop completely at the top of the bank and wait for all traffic to clear. Judge the drop to the roadway. Cross the road at a 90° angle. If you encounter another snowbank on the opposite side, position your feet near the rear of the vehicle. Remember, your snowmobile is not designed to operate on bare pavement and steering on this type of surface is more difficult.

Railroad Crossing

Never ride on railroad tracks. It is illegal. Railroad tracks and railroad rights-of-way are private property. A snowmobile is no match for a train. When crossing a railroad track, stop, look and listen.

Night Rides

The amount of natural and artificial light at a given time can effect your ability to see or to be seen. Nighttime snowmobiling is delightful. It can be a unique experience if you acknowledge your reduced visibility. Before you start, make certain your lights are clean and work properly. Drive at speeds that will allow you to stop in time when you see an unknown or dangerous object ahead. Stay on established trails and never operate in unfamiliar territory. Avoid rivers and lakes. Guy wires, barbed wire fences, cabled road entrances and other objects such as tree limbs are difficult to see at night. Never drive alone. Always carry a flashlight. Keep away from residential areas and respect the right of others to sleep.

Safari Riding

Before starting out, designate a “trail boss” to lead the party and another person to follow-up at the end of the party. Ensure that all members of the party are aware of the proposed route and destination. Make certain that you are carrying all necessary tools and equipment and that you have sufficient fuel to complete the trip. Never overtake the trail boss or, for that matter, any other snowmobile. Use down-the-line hand signals to indicate hazards or intent of direction change. Assist others whenever necessary.

It is always IMPORTANT to keep a safe distance between each snowmobile. Always maintain a safe interval and allow sufficient stopping distance. Don't be a tailgater. Know the position of the machine ahead.

Signals

If you intend to stop, raise either hand straight above your head. A left turn is indicated by extending your left hand straight out in the proper direction. For right turns, extend the left arm and raise the hand to a vertical position so it forms a right angle at the elbow. Every snowmobiler should relay any signal to the ones behind.

Trail Stops

Whenever possible, pull off the trail when you stop. This will reduce the hazard to other snowmobilers using the trail.

Trails and Signs

Trail signs are used to control, direct or regulate the use of snowmobiles on trails. Become familiar with all signs used in the area where you are snowmobiling.

Transporting and Towing

Follow transporting and towing instructions explained further in this guide.

VEHICLE INFORMATION

HOW TO IDENTIFY YOUR SNOWMOBILE

Serial numbers

The main components of your snowmobile (engine and frame) are identified by different serial numbers. It may sometimes become necessary to locate these numbers for warranty purposes or to trace your snowmobile in the event of loss.

These numbers are required by the Lynx dealers to complete warranty claims properly. No warranty will be allowed by BRP if the engine serial number or VIN is removed or mutilated in any way. We strongly recommend that you take all the serial numbers on your snowmobile and supply them to your insurance company.



1. Vehicle description decal

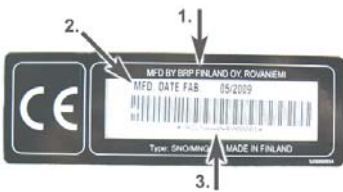

1. Manufacturer name
2. Manufacturing date
3. Vehicle identification number (VIN)

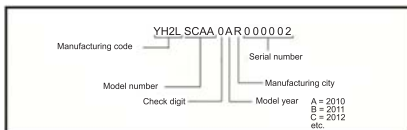

VIN DESCRIPTION

Engine serial number

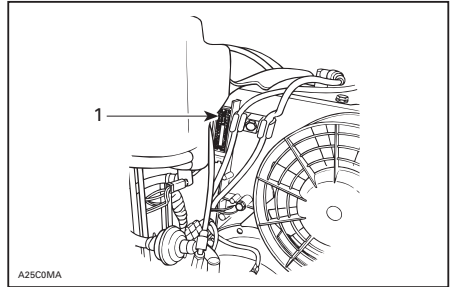

550F ENGINE TYPE

FAN COOLED

1. Engine serial number

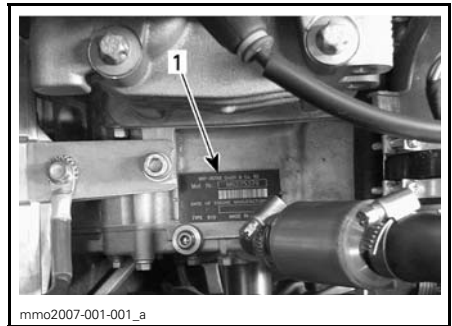

V-800 ENGINE TYPE

4-TEC MODELS

1. Engine serial number

CONTROLS/INSTRUMENTS

1) Throttle lever

Located on the right side of handlebar. When compressed, it controls the engine speed and the engagement of the transmission. When released, engine speed returns automatically to idle.

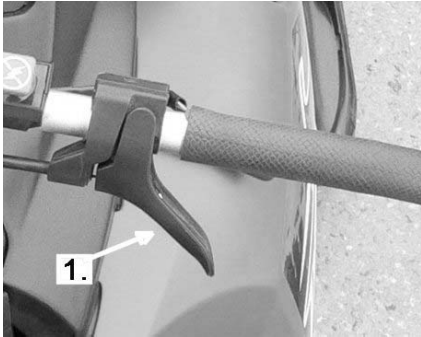

1. Throttle lever

2) Brake lever

Located on the left side of handlebar. When compressed, the brake is applied. When released, it automatically returns to its original position. Braking effect is proportional to the pressure applied on the lever and to the type of terrain and its snow coverage.

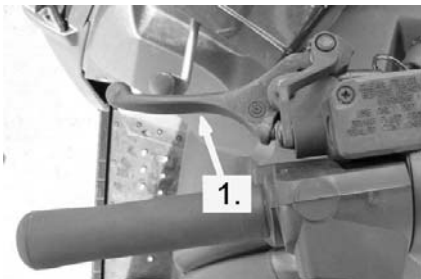

1. Brake lever

3) Parking brake button or lever

Hydraulic brake

Located on left side of handlebar. Parking brake should be used whenever snowmobile is parked.

NOTE: Never leave your snowmobile on downhill only with parking brake engaged.

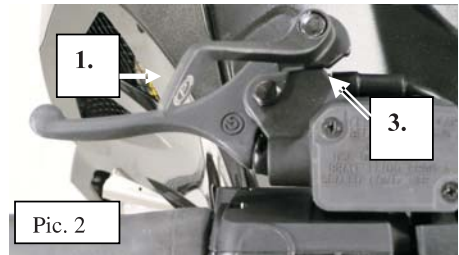
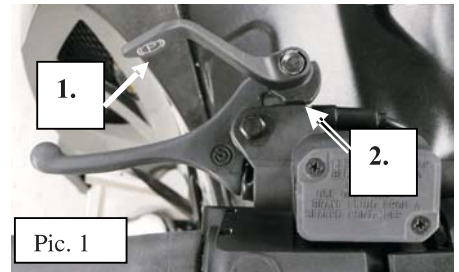

1. Locking lever
2. Position 1
3. Position 2

WARNING

Make sure parking brake is fully disengaged before operating the snowmobile.

WARNING

Locking keeps brake lever engaged and keeps pressure against brake disc.

Anyhow, this pressure may decrease so low, that it will not keep vehicle in place. Never leave the snowmobile on hill only with parking brake applied.

4) Pilot Lamps

Reverse (Red)



This pilot lamp will light up when reverse is selected.

DESS Status (Red)



This lamp will light up to confirm DESS status. Refer to previous paragraphs for description.

High Beam (Blue)



Lights when headlamp is on HIGH beam.

Engine Overheat Warning (Red)



If this lamp glows, reduce snowmobile speed and run snowmobile in loose snow or stop engine immediately.

Low Battery Voltage (Red)



This lamp will light up to indicate a low battery voltage condition. See an authorized Lynx dealer as soon as possible.

Injection Oil Level/Engine Oil Pressure



550 / Pro 550 (2-stroke) models

This pilot lamp will glow up when injection oil level is low. Stop vehicle in a safe place then, replenish injection oil reservoir.

Pro V-800 model

This pilot lamp will glow up when engine oil pressure is too low. Stop vehicle in a safe place then, check oil level and replenish as described in *ENGINE OIL LEVEL*.

Restart engine, oil pilot lamp must turn off after few seconds. If oil pilot lamp still glows up, stop engine and have lubrication system inspected by an authorized Lynx dealer.

Engine Management System (EMS) (Red)



This lamp will light up to indicate a trouble. Refer to *TROUBLESHOOTING* for trouble code meaning and remedy.

5) Gear shift lever

These models are equipped with 4-position gear shift lever; 2 gears forward, reverse gear and free position between 1. and 2. gear.

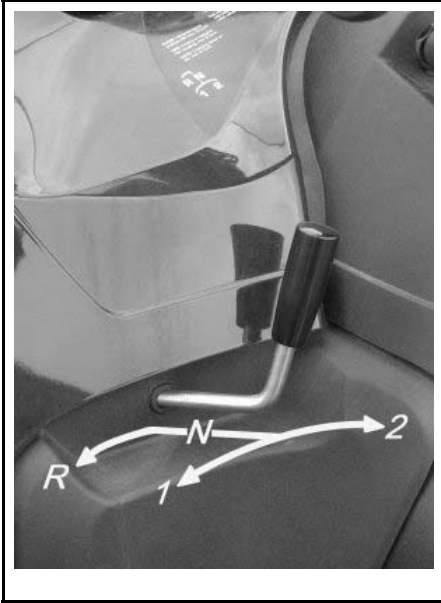

Shifting procedure

NOTE: Shift the gear only when engine is running at idle and the speed is below 20 km/h.

Come to complete stop before selecting reverse gear. Do not force lever. If unable to shift, apply throttle to move snowmobile. Stop vehicle, then try again.

NOTE: These models (not 4-TEC model): Whenever shifting the gear the snowmobile has to be completely stopped, otherwise the gear system may get broken.

6) Handlebar

The handlebar controls the steering of the snowmobile. As the handlebar is rotated to right or left, the skis are turned right or left to steer the snowmobile. Handlebar height is adjustable. See an authorized Lynx dealer.

7) Holding strap

Holding strap provides a grip for driver when side-hilling.

8) Ignition switch / START button

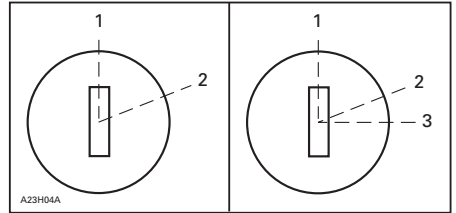

MANUAL START/ELECTRIC START MODELS
1. OFF
2. ON
3. START

Manual Starting

To start the engine, turn the key to ON position, then pull rewind starter grip. To stop the engine, turn the key to OFF position.

Electric Starting

To start engine, turn key to START position and hold until engine has started. See illustration above.

Only 550 / Pro 550

NOTE: Do not hold START button more than 10 seconds at a time. A rest period of 30 seconds should be observed between the cranking cycles to allow electric starter to cool down. Holding START button when engine has started could damage electric starter mechanism.

Release key as soon as the engine starts. Key returns to ON position as soon as it is released.

If engine does not start on first try, turn key back to OFF position and wait a few seconds before restarting.

To stop engine, turn key to OFF position.

NOTE: Engine may be manually started with rewind starter if necessary.

If starter does not operate, check starting system fuse condition. refer to **FUSES**.

Start Mode

To start engine, push START button and hold until engine has started.

NOTE: Do not hold START button more than 10 seconds. A rest period should be observed between the cranking cycles to let starter cool down. Holding START button when engine has started could damage electric starter mechanism.

9) Tether cut-out switch

It shuts off engine preventing snowmobile to runaway if the operator falls off the vehicle accidentally.

Operation

Attach to clothing eyelet than snap tether cord cap over post before starting engine.

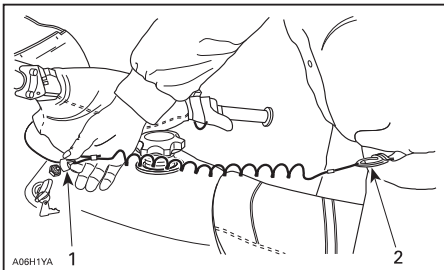

1. Snap over post
2. Attach to eyelet

If emergency engine shut off is required, completely pull tether cord cap from post.

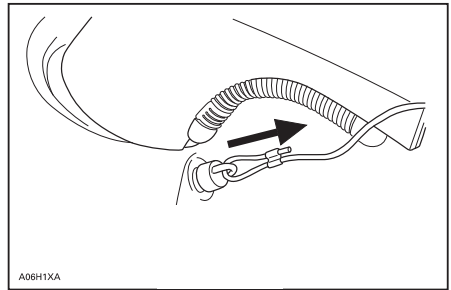

TYPICAL

Yeti Pro V-800; Liquid-Cooled Model

On these models tether cut out switch is part of tether cut out system. This system serves 3 functions. It shuts off engine preventing snowmobile to runaway if the operator falls off the vehicle accidentally.

Through the D.E.S.S.™ (Digitally Encoded Security System), it acts as a lock by preventing unauthorized use of your snowmobile thus deterring theft.

Finally, it prevents unintentional electric starter operation in vehicles so equipped by disabling the electric starter and ignition circuits in the MPEM or ECU.

DESS (Digitally Encoded Security System) Description

This system is digitally encoded to provide you and your snowmobile with the equivalent security as a conventional lock key.

The tether cord cap provided with your snowmobile contains an electronic chip in which a unique digital code is permanently memorized. Your authorized Lynx dealer programs this key code in the MPEM or ECU of your snowmobile to allow engine operation above 3000 RPM if and only if this unique code has been read after engine starting.

If a tether cord cap with different code is installed, the engine will start but cannot reach drive pulley engagement speed to move vehicle.

Additional Tether Cord Caps

The MPEM/ECU of your snowmobile can be programmed by your authorized Lynx dealer to accept 8 different key codes (tether cord caps).

DESS Pilot Lamp Codes

DESS pilot lamp blinking slowly (one time per 1,5 second) means that a bad connection has been detected. Vehicle can not be driven.

To check for bad connection, remove tether cord cap. Make sure the tether cord cap is free of dirt or snow. Reinstall cap and restart engine. If a blink still occurs, contact an authorized dealer.

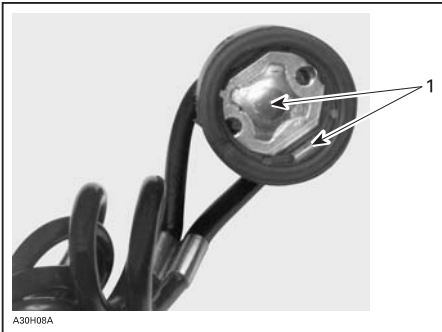

1. Free of dirt and snow

A DESS pilot lamp blinking 3 times per second means that you have installed a cap with a code that MPEM of this snowmobile was not programmed to recognize (wrong key). Vehicle can not be driven.

10) DESS pilot lamp

This lamp will light up to confirm DESS status. Refer to previous paragraphs for description.

11) Engine cut-out switch

This push-pull type or toggle type switch is located on the right side of the handlebar. To stop the engine in an emergency, select OFF position and simultaneously apply the brake. To restart, button must be at the ON position.

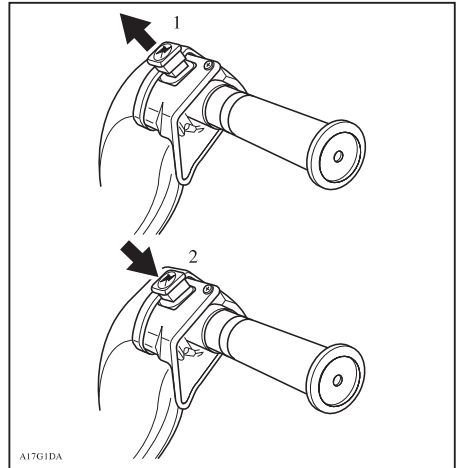

- 1. ON
- 2. OFF

All operators of the snowmobile should familiarize themselves with the function of this device by using it several times on first outing and whenever stopping the engine there-after. This engine cut-out procedure will become a reflex and will prepare operators for emergency situations requiring its use.

12) Electric horn

Electric horn button is located on left hand side of handlebar

Yeti Pro V-800 (EU) model only

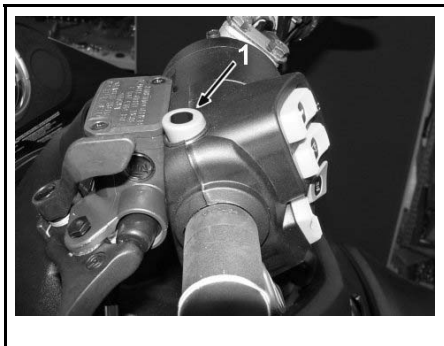

1. Electric horn button

13) Headlamp dimmer switch

Located on left hand side of handlebar, allows selection of headlamp beam. Note that lights are automatically ON whenever the engine is running.



14) Rewind starter handle

550 / PRO 550 models

Auto-rewind type located on right hand side of snowmobile. Pull handle slowly until a resistance is felt then pull vigorously. Slowly release handle.

15) Choke lever

550 / Pro 550 models

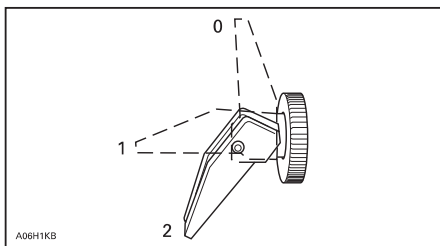

1. OFF
2. Position 1
3. Position 2

Initial Cold Starting

NOTE: Do not operate the throttle lever with the choke lever on.

Move the choke lever to position 2 and start the engine. As soon as the engine starts move the lever to position 1. After a few seconds (10 seconds maximum) move the choke lever to position OFF.

NOTE: In severe cold weather, colder than -20°C you may need to flip choke lever from OFF position to position 1 a couple of times once engine is started.

Warm engine starting

Start the engine without any choke. If the engine will not start after two pulls of the rope or two 5 second attempts with the electric starter move choke lever to position 1. Start the engine without activating the throttle lever. As soon as the engine starts move the choke lever to OFF.

16) Odometer

Odometer records the total distance travelled in kilometers. It can be reset when needed.

17) Trip meter

Records the distance travelled. It can be reset when needed.

18) Trip meter reset button

To reset the meter, push the button until all the numbers are zero (0).

These models are equipped with electronic speedometer. It shows the speed either in kilometers or miles per hour.

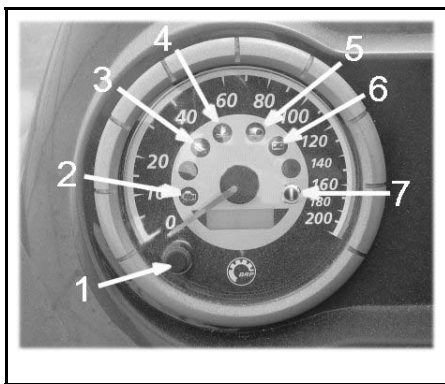

1. Mode button
2. Engine Management System (EMS) pilot lamp
3. Oil pressure pilot lamp
4. Cooling liquid pilot lamp
5. High beam pilot lamp
6. Battery charge pilot lamp
7. Brake pilot lamp

Electronic speed- and tachometer

Records total distance travelled until it is reset.

Mode button

Depress the mode button to change display. Each time engine is started, display shows odometer. From that point depressing mode button again to return the odometer.

Depressing mode button again will change display for the resettable hourmeter. Push mode button again to return to odometer.

Push and hold mode button for 2 seconds to reset the tripmeter or the resettable hourmeter depending on the one displayed.

Odometer

Odometer records the total distance travelled and display it in kilometers.

Trip Meter

Records distance travelled since it has been reset. Distance travelled is displayed in kilometers.

Resettable hour meter

Records engine running time in hours and minutes since it has been reset.

Push and hold mode button for 2 seconds to reset the resettable hour meter.

Electronic display code

If your speedometer shows "SCALE" in the display, it means that the display selector button is stuck in the down position or depressed when the electrical system was activated.

At vehicle speed of 90 km/h and more the mode LCD screen will show speed only instead of the selected mode.

NOTE: At the electronic speedometer display appears "9-9" when you power up the vehicle. This means that the speedometer is calibrated to 9 toothed drive sprocket.

19) Fuel tank cap/gauge

Unscrew to fill up tank then fully tighten. Fuel tank cap features a mechanical gauge.

Located at rear of fuel tank cap the gauge facilitates fuel level reading.

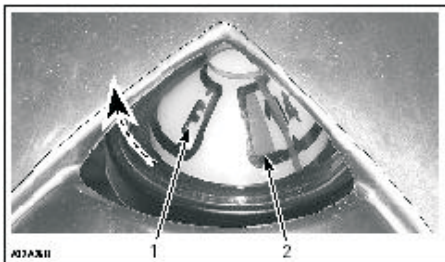

1. Full
2. Empty

WARNING

Always stop the engine before refueling. Fuel is flammable and explosive under certain conditions. Always work in a well ventilated area. Do not smoke or allow open flames or sparks in the vicinity. Open cap slowly. If a differential pressure condition is noticed (whistling sound heard when loosening fuel tank cap) have vehicle inspected and/or repaired before further operation. Do not overfill or top off the fuel tank before placing the vehicle in a warm area. As temperature increases, fuel expands and might overflow. Always wipe off any fuel spillage from the vehicle. Periodically verify fuel system.

NOTE: Do not sit or lean on seat when fuel tank cap is not properly installed.

20) Heating grip switch

It is a three-position switch. Select the desired position to keep your hands at a comfortable temperature.

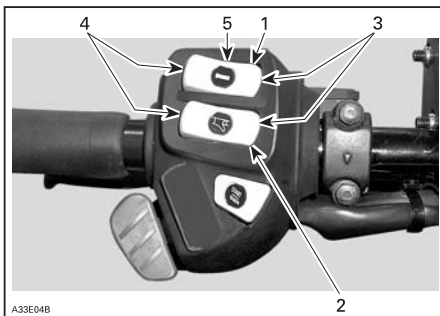

1. Heated grip switch
2. Heated throttle lever switch
3. Hot
4. Warm
5. OFF

21) Heated throttle lever switch

Three-position switch. Select the desired position to keep your right thumb at a comfortable temperature. See illustration.

22) Hood latches

Stretch and unhook the latches to unlock the hood from its anchors. Lift hood gently until stopped by retaining device. Close hood slowly then hook up latches.

23) Power outlet

A 12-volt electric appliance may be connected to the jack connector. Electric current is supplied when ever engine is running. See FUSES for electric power outlet fuse location.

MODELS	MAXIMUM OUTPUT CURRENT	LOCATION
Yeti Pro V-800	20 amperes	Rear rack
	5 amperes	Dashboard
Yeti 550 / Pro 550	5 amperes	Dashboard



TYPICAL — ELECTRIC POWER OUTLET

Yeti Pro V-800 Model

With the engine running, use the toggle switch mounted on the multi-switch housing to supply current to the rear rack power outlet.

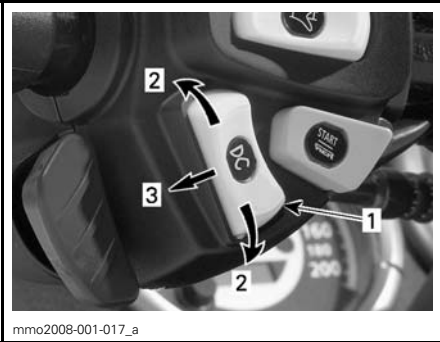

MULTI-SWITCH HOUSING

1. Rear power outlet switch
2. Upper/Lower ON position
3. Middle OFF position

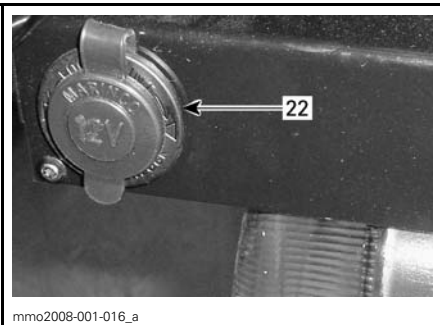

YETI PRO V-800 MODEL — REAR RACK

22. Electric power outlet

24) Fuse

To remove fuse from holder, pull fuse out. Check if filament is melted.

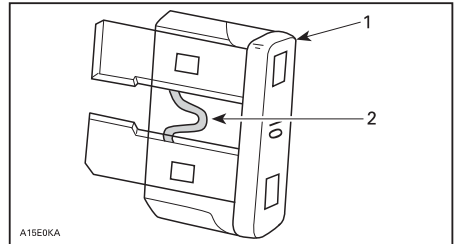

1. Fuse
2. Check if melted

550 / Pro 550F Models

FUSE	DESCRIPTION	LOCATION
20 A	Ground protection (includes electric power outlet)	Engine compartment

Ground Protection

CAUTION: This fuse should always be disconnected before doing any maintenance under the hood. This is to prevent any unexpected electrical activation.



ENGINE COMPARTMENT — UNDERNEATH CONSOLE

1. Fuse holder

Fuse for starting system and electric power outlet

Starting system and electric power outlet is protected (if equipped) with 20 ampere fuse. If the starter and electric power outlet is out of function, check the fuse condition and replace if needed.

NOTE: Do not use a higher rated fuse as this can cause severe damage to electric components and/or fire.

To open fuse box push on cover tab and tilt cover.

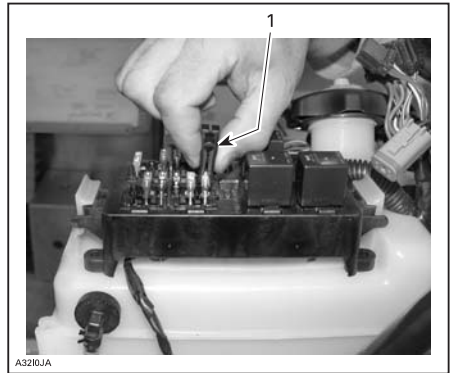

1. Fuse remover/installer

25) Tool kit

A tool kit containing tools for basic maintenance is supplied with the engine. Tool bag is located under the seat or hood.

26) Front grab handle/front bumper

To be used whenever front of snowmobile requires manual lifting.



1. Push tab

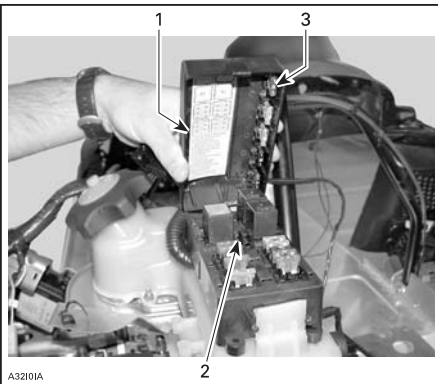

1. Fuse description decal
2. Fuse remover/installer
3. Spare fuses

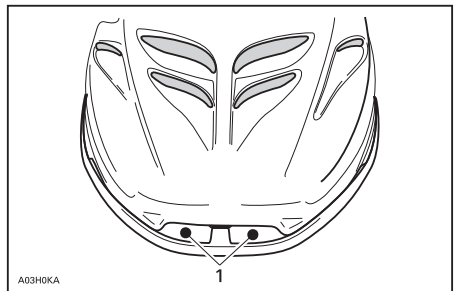

1. Front grab handles

NOTE: Do not use skis to pull or lift snowmobile.

27) Storage compartment

Depending on model, storage compartment situates either under the seat or inside of the seat.

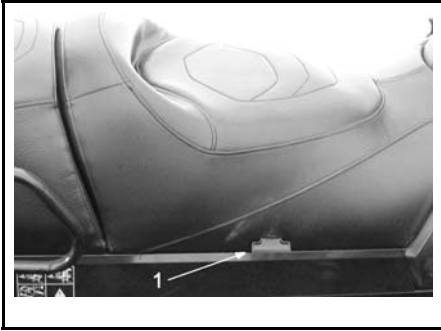

1. Open latch

28) Rear rack

Always readjust suspension according to the load. The capacity of this rack is limited. [Max 20 kg] Ride at very low speed when loaded. Avoid speed over bumps.

29) Hitch

The hitch can be used to pull most equipment. Use a rigid tow bar.

NOTE: Remember to lock the hitch locking latch with a lock pin.

Following picture shows how much load is allowed and to transport and to pull. This decal is found at end of rear racket on your own vehicle.

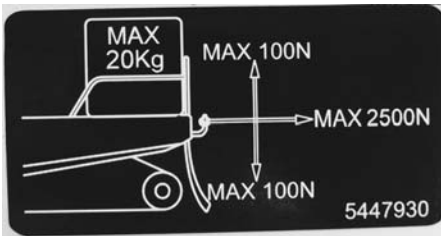

30) Modular Seat

Those models can be converted into a snowmobile with one (1) seat only instead of two (2). This could be useful if you want to increase the cargo area.

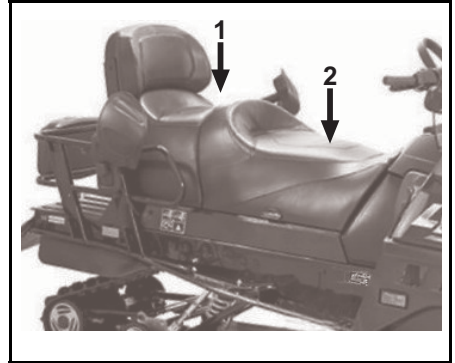

TYPICAL

1. Passenger seat (removable)
2. Driver seat

To remove the passenger seat, lift seat latch, then tip driver seat over.

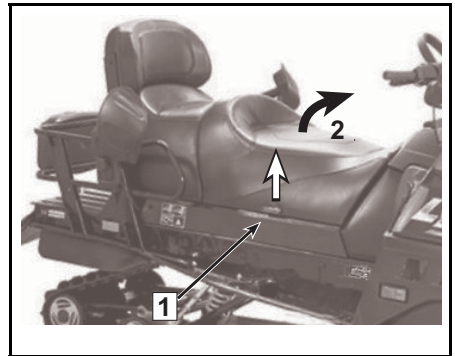

TYPICAL

1. Seat latch
2. Tip driver seat over

Slide the passenger seat forward, then lift to remove.

CAUTION: On models equipped with passenger seat grab handles, unplug the heated grips connector before removing the passenger seat.

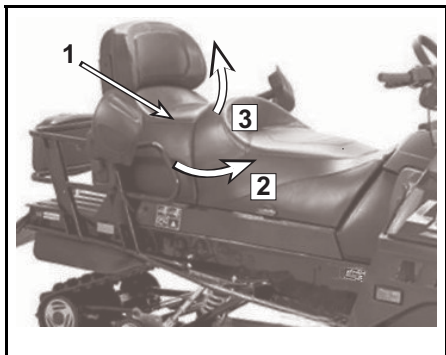

TYPICAL

1. Passenger seat
2. Slide seat forward
3. Lift seat to remove

CAUTION: Take care to store the passenger seat properly to avoid any damages.

⚠ WARNING

NEVER carry a passenger if the backrest is not installed properly

⚠ WARNING

NEVER use the hole left by removing the passenger seat to sit a passenger. The passenger could hurt his back or suffer other serious injuries due to his seating position.

⚠ WARNING

All objects in rear rack must be properly latched. Do not carry any breakable objects. Excessive weight in rack may reduce steering ability.

Installation is the reverse of removal procedure. Pay attention to the following.

⚠ WARNING

Make sure that the passenger seat is locked securely in place before using the snowmobile.

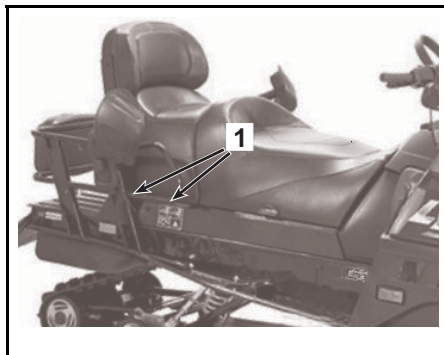

TYPICAL

1. Passenger seat hooks

Rear grab handles

Rear grab handles provides a grip for the passenger. Rear grab handle height can be adjusted.

Lift up adjustment lock, move rear grab handle to desired position. Fasten adjustment lock. Proceed same on opposite side.

Adjustable backrest

The backrest position and support angle may be adjusted to suit driver or passenger convenience.

31) Adjustable suspension

1. Rear Springs — Comfort

IMPORTANT: Make sure that all objects to be transported are in place in rear rack and under the seat.

- Grab rear bumper and lift until suspension is fully extended.
- From this point, rear of snowmobile should collapse by 50 to 75 mm (2 to 3 in) when driver, passenger (if so applicable) and load take place.
- Measure at rear bumper as shown in next illustration.

⚠ WARNING

Do not attempt to lift the vehicle by hand alone. Use appropriate lifting device or have assistance to share lifting stress in order to avoid risk of strain injuries.

Rear Springs Adjustment

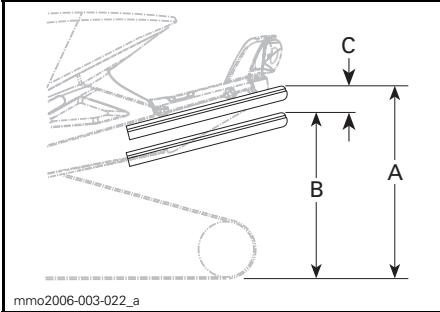

mmo2006-003-022_a

TYPICAL — PROPER ADJUSTMENT

- A. Suspension fully extended
- B. Suspension has collapse with driver, passenger and load added
- C. Distance between dimension A and B, must not exceed 50 to 75 mm (2 to 3 in), see table

REAR SPRINGS ADJUSTMENT

"C"	CAUSE	SOLUTION
50 to 75 mm (2 to 3 in)	No adjustment required	
More than 75 mm (3 in)	Adjustment too soft	Increase preload
Less than 50 mm (2 in)	Adjustment too hard	Decrease preload

Increase Spring Preload

Easy ride XWLS / WLS suspension

CAUTION: To increase preload, always turn the left side adjustment cam in a clockwise direction, and the right side cam in a counterclockwise direction. Left and right adjustment cams may be at different settings.

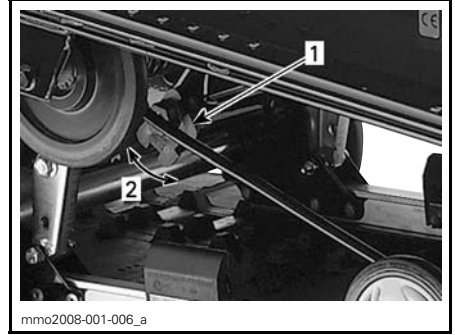

mmo2008-001-006_a

TYPICAL

1. Adjustment cam
2. Turn to increase spring preload

Decrease Spring Preload

Easy ride XWLS / WLS suspension

CAUTION: To decrease preload, always turn the left side adjustment cam in a counterclockwise direction, the right side cam in a clockwise direction. Left and right adjustment cams may be at different settings.

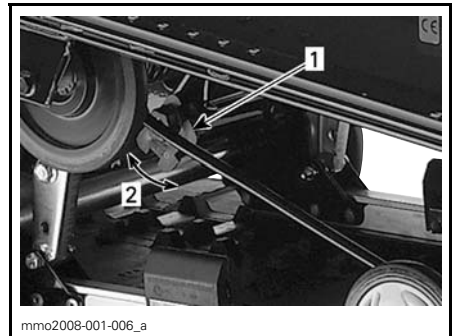

mmo2008-001-006_a

1. Pull on handle
2. Turn to decrease spring preload

2. Suspended Extension Adjustment

Suspended extension can be adjusted according to the load and snow conditions.

For better deep snow performance or to increase reverse performance in deep snow, first loosen lock nut, then tighten nut 3/4 turn after contacting washers. Retighten lock nut. Adjust the same on both sides.

For trail riding with a load or for pulling a load, first loosen lock nut. Turn to a maximum preload of 3 turns after nut touching washers. Retighten lock nut. Adjust the same on both sides.

3. Shackle Movement Limiter

For deep snow riding, do not install horse shoe washers.

For trail riding with passenger and/or weight, install 1 horse shoe washer under each rubber stoppers.

For trail riding with heavy load and/or pulling a load, use 2 horse shoe washers under each rubber stoppers.

CAUTION: Always install same amount of washers on both sides.

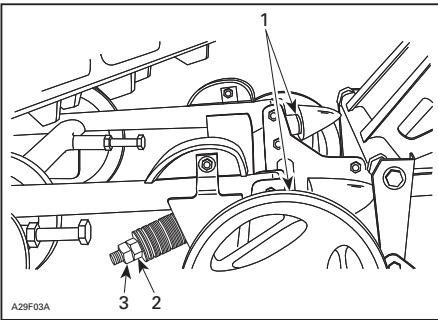

1. Horse shoe washer(s)
2. Nut
3. Lock nut

4. Stopper Strap — Weight Transfer

- Ride at low speed, then fully accelerate.
- Note steering behavior.
- Adjust stopper strap length accordingly.

CAUTION: Whenever stopper strap length is changed, track tension must be readjusted.

⚠ WARNING

Before proceeding with any suspension adjustment, remember:

- Park in a safe place.
- Remove DESS key or tether cord cap.
- Lift rear of vehicle off the ground with suitable lifting device.
- Make sure lifting device is stable and secure.

STOPPER STRAP			
WEIGHT TRANSFER		ADJUSTMENTS	
STEERING	TRACK (skis)	PROBLEM	SOLUTION
Comfortable	Good weight transfer (light pressure)	No adjustment required	
Light	Too much weight transfer (lift off the ground)	Strap too long	Reduce strap length
Heavy	Not enough weight transfer (heavy pressure)	Strap too short	Increase strap length

Strap Length Adjustment

Easy ride XWLS / WLS suspension

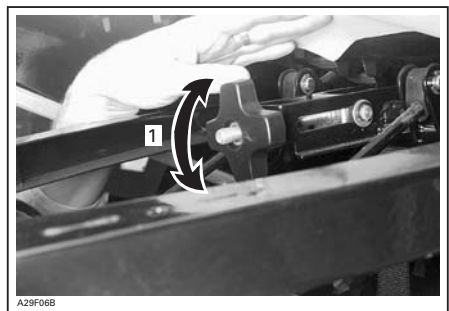

1. Screw or unscrew knob to vary strap length

SUSPENSION TROUBLESHOOT

PROBLEM	CORRECTIVE MEASURES
Front suspension wandering.	<ul style="list-style-type: none">– Check ski alignment and camber angle adjustment. See an authorized Lynx dealer– Reduce rear spring preload.
Snowmobile seems unstable and seems to pivot around its centre.	<ul style="list-style-type: none">– Reduce rear suspension front arm pressure.– Increase rear spring preload.
Steering feels to heavy.	<ul style="list-style-type: none">– Increase front arm strap length.
Rear of snowmobile seems to stiff.	<ul style="list-style-type: none">– Reduce rear spring preload.
Rear of snowmobile seems to soft.	<ul style="list-style-type: none">– Increase rear spring preload.
Rear suspension front shock absorber is frequently bottoming.	<ul style="list-style-type: none">– Lengthen stopper strap.
Track spins too much at start.	<ul style="list-style-type: none">– Lengthen stopper strap.– Change driving position.

In deep snow

When operating the snowmobile in deep snow, it may be necessary to vary extension adjustment, stopper strap and/or riding position, to change the angle at which the track rides on the snow. Operator's familiarity with the various adjustments as well as snow conditions will dictate the most efficient combination.

FUEL AND OIL

Recommended fuel

Refer to TECHNICAL DATA in the end of this manual.

NOTE: Never experiment with other fuels or fuel ratios. The use of un-recommended fuel can result in snowmobile performance deterioration and damage to critical parts in the fuel system and engine components.

MINIMUM OCTANE RATING		
ENGINES	95 RON	98 RON
550	X	X
V-800 4-TEC	X	X

WARNING

Do not overfill or top off the fuel tank before placing the vehicle in a warm area. As temperature increases, fuel expands and might overflow. Fuel is inflammable and explosive under certain conditions. Wipe off any fuel spillage from the vehicle.

Fuel System Antifreeze

When using oxygenated fuel, additional gas line antifreeze or water absorbing additives are not required and should not be used.

Recommended Injection oil (550 / Pro 550 (2-tec models))

Use BRP Synthetic Blend 2-stroke injection oil (P/N 293 600 071) or BRP Synthetic 2-stroke injection oil (P/N 293 600 045) or BRP Mineral 2-stroke injection oil (P/N 413 803 000).

CAUTION: Do not mismatch oil reservoir cap with fuel tank cap. On some models there is fuel gauge together with fuel tank cap. Oil reservoir cap is identified "OIL". Use only oil, which flows at -40°.

Oil is in injection oil reservoir.

Use only 2-stroke engine oil.

CAUTION: Never use four-stroke mineral or synthetic oil. Do not mix these with outboard motor oil. Do not use NMMA TC-W, TC-W2 or TC-W3 outboard oil. Avoid mixing different brands of API TC oil as resulting chemical reactions may cause severe engine damage.

Always maintain a sufficient amount of recommended oil in the injection oil reservoir.

CAUTION: Check level and refill every time you refuel. Do not mismatch oil reservoir cap with fuel tank cap. Install cap that is identified with OIL

Recommended engine oil (Pro v-800 (4-tec model))

Pro v-800 (4-tec model): Use SAE 0W40 synthetic-based oil that meets or exceeds the requirements for API service classification SM, SL or SJ. Always check the API service label certification on the oil container, it must contain at least one of the above standards.

NOTE: This is the only recommended viscosity to ensure proper cold start and optimum engine protection at high RPM and temperature.

ENGINE	RECOMMENDED ENGINE OIL
V-800 4-TEC	XP-S 0W40 synthetic oil

Gear box oil

Recommendation 75W140.

Cold weather carburetion modifications

All vehicles has been calibrated for -20°C. They can be operated at warmer winter temperatures without problems.

CAUTION: For colder temperatures than - 20°C, carburetor(s) must be recalibrated to avoid engine damage. Refer to an authorized Lynx dealer.

BREAK-IN PERIOD

Engine

IMPORTANT: A break-in period of 10-15 hours (about 500 km) is required for Rotax engines before running the snowmobile at full throttle.

During break-in period, maximum throttle should not exceed $\frac{3}{4}$. However, brief full acceleration and speed variations contribute to a good break-in.

All models except 4-tec model: To assure additional protection during the initial engine break-in, 500 ml of recommended injection oil should be added to fuel for the first full filling of fuel tank.

Have spark plugs cleaned after engine break-in.

Drive Belt

A new drive belt requires a break-in period of 50 km. Avoid strong acceleration/deceleration, pulling a load or high speed cruising

10 Hour Inspection

We suggest that after the first 10 hours of operation— 500 km — or 30 days after the purchase, whichever comes first, your snowmobile be checked by an authorized Lynx dealer.

NOTE: The 10 hour inspection is at expense of the snowmobile owner.

PRE OPERATION CHECKLIST

- Remove snow and ice from body including seat, footrests, lights, controls and instruments.
- Verify that track and idler wheels are not frozen and free to turn.
- Activate the brake control and make sure the brake fully applies before the brake control lever touches the handlebar grip. It must fully return when released.
- Check the parking device. Apply parking brake and check if it operates easily and smoothly.
- Activate the throttle control lever several times to check that it operates easily and smoothly.
- Check operation of ignition switch, head lamp switch, taillight, brake light, pilot lamps and tether/cut-out switches.
- Verify that skis and steering operate freely. Check corresponding action of skis versus handlebar.
- Check fuel and injection oil for levels and leaks. Replenish as necessary and see an authorized Lynx dealer in case of any leaks.
- Verify that air filter(s) is free of snow, if so equipped.
- Make certain your snowmobile is pointed away from people or objects before you start it.
- Be warmly dressed with clothing designed for snowmobiling.

OPERATING INSTRUCTIONS

Propulsion

Depressing throttle lever increases engine RPM causing the drive pulley to engage. Depending on models engine RPM must be between 2500 and 4200 before drive pulley engagement will occur.

Outer sheave of drive pulley moves toward inner sheave, forcing drive belt to move upward on the drive pulley and simultaneously forcing the sheaves apart on the driven pulley.

The driven pulley senses the load on the track and limits the belt movement. The result is an optimized speed ratio between engine RPM and the speed of the vehicle at any time.

Power is transferred to the track through the chaincase or gearbox and drive axle.

Turning

Handlebar controls the steering of the vehicle. As the handlebar is rotated to right or left, the skis are turned right or left to steer the snowmobile.

Stopping

Before riding your snowmobile, you should understand how to stop it. This is done by releasing the throttle and gradually depressing the brake lever on the left side of the handlebar.

In an emergency, you may stop your vehicle by pressing the engine cut-out switch located near the throttle control and applying the brake.

Remember, a snowmobile cannot "stop on a dime". Braking characteristics vary with deep snow, packed snow or ice. If the track is locked during hard braking, skidding may result.

Starting the engine

Check throttle lever operation.

Ensure that the engine cut out switch is in the ON position.

Ensure that the tether cord cap is in position and that the cord is attached to your clothing eyelet.

Choke equipped vehicles

Initial cold starting: Do not operate the throttle lever with the choke lever on.

When temperature is below - 10°C

Move the choke lever to position 2 and start the engine. As soon as the engine starts move the lever to position 1. After a few seconds (max.10 seconds) move the choke lever to OFF position.

NOTE: In severe cold weather, colder than - 20°C you may need to flip choke lever from OFF to position 1 a couple of times once engine is started.

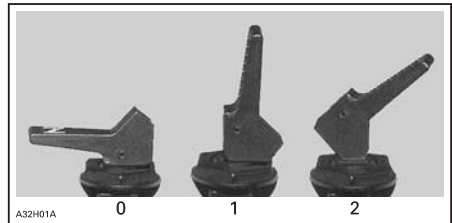

1. OFF
2. Position 1
3. Position 2

When temperature is above - 10°C

Move the choke lever to position 1.

Grab the handle firmly and start the engine or electric starter if it is equipped.

As soon as the engine starts move the choke lever to OFF.

Pro V-800 (4-tec model)

Initial cold starting and warm engine starting

Use the electric starter.

CAUTION: Pro V-800 (4-tec model): If the battery is empty, engine cannot be started. Charge the battery or replace it if necessary.

550 / Pro 550 Warm engine starting

Start the engine without any choke. If the engine will not start after two pulls of the rope or two 5 second attempts with the electric starter move choke lever to position 1. Start the engine without activating the throttle lever. As soon as the engine starts move the choke lever to OFF.

Electrical starting (if so equipped)

- Depressing the START-button will engage the electric starter and start the engine.
- Release button immediately when engine has started.

⚠ WARNING
Do not apply throttle while starting.

⚠ WARNING
Do not use electric starter for more than 10 seconds. A rest period should be observed between the cranking cycles to let electric starter cool down. Using electric starter when engine has started could damage electric starter mechanism.

NOTE: If for any reason, the engine cannot be cranked electrically, start engine manually using the rewind starter.

Rewind starter

All the fan cooled models: Set the key to ignition switch and turn to ON position.

Grab the handle firmly and crank the engine.

NOTE: There is no rewind starter handle in Pro V-800 (4-tec model).

550 / Pro 550

Emergency starting

The engine can be started with the emergency starter rope supplied with the tool kit.

Remove belt guard.

Do not wind the starting grope around your hand. Hold rope by the handle only. Do not start the snowmobile by the drive pulley unless it is a true emergency situation. Have the snowmobile repaired as soon as possible.

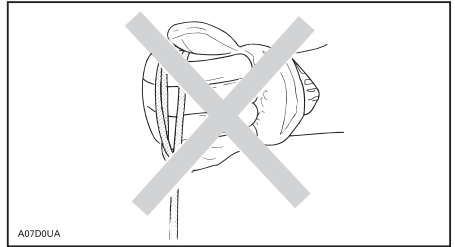

Attach one end of the emergency rope to rewind handle.

NOTE: The spark plug socket can be used as an emergency handle.

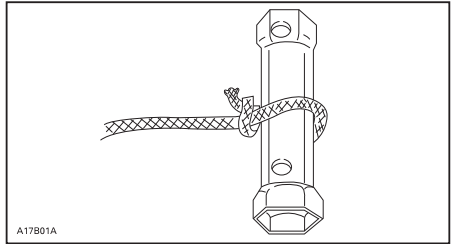

Attach the other end of emergency rope to the starter clip supplied in the tool kit.

Hook up clip on drive pulley.

Wind the rope tightly around drive pulley. When pulled, pulley must rotate counterclockwise.

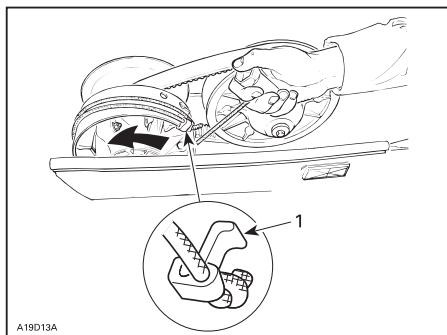

1. *Clip*

Pull the rope using a sharp, crisp pull so the rope comes free of the drive pulley. Start the engine as per usual manual starting.

When starting the snowmobile in an emergency situation, using drive pulley, do not reinstall the belt guard and return slowly to have snowmobile repaired.

Shutting down the engine

Release throttle lever and wait until engine has returned to idle speed.

Shut down the engine using either ignition switch, engine cut-out switch or tether cut-out switch.

NOTE: In 4-tec models the shut down the engine must be done only by engine cut-out switch. This gives the fan to operate longer if the engine has gone under heavy pulling conditions this is to prevent overheating. Do not remove the tether cut-out switch until the fan has stopped.

⚠ WARNING

Always remove tether cord cap and key when vehicle is not in operation in order to prevent accidental engine starting or to avoid unauthorized use by others or theft.

VEHICLE WARM-UP

Before every ride, vehicle has to be warmed up as follows:

Snowmobile must be securely supported by the rear bumper using a wide-base snowmobile mechanical stand. Track must be 100 mm off the ground.

Start engine and allow it to warm up two or three minutes at idle speed.

Release barking brake.

WARNING

Make sure wide-base snowmobile mechanical stand is stable. Stay clear of the front of vehicle and the track. Do not use too much throttle during warm-up or when track is free-hanging.

Apply throttle until drive pulley engages. Let track rotate at low speed for several turns. The lower the vehicle temperature is the longer vehicle warm-up should be.

Shut-off the engine and remove the wide base snowmobile mechanical stand.

Skis may be frozen on the ground. Grab both skis one at a time by their loops and lift their front end slightly off the ground.

After restarting engine, the vehicle can be driven at low speed for the first 2 or 3 minutes of riding. After that, it may be driven up to the legal speed limit as per normal safety practices.

POST OPERATION CARE

Shut down the engine. Install rear of vehicle on a wide-base snowmobile mechanical stand.

Remove snow and ice from rear suspension, track, front suspension, mechanism and skis.

Protect vehicle with a snowmobile cover.

SPECIAL OPERATIONS

Engine overheating

NOTE: (4-tec only) If the buzzer activates during high temperatures, turn off the engine by engine cut-off switch, if this is not applied and the temperature continues to increase the engine will shut down by EMS system (Engine Management System) automatically. The vehicle will not shut down if it is being driven and it will require that it is stopped without touching the throttle for 30 seconds before doing so. If the buzzer activates shortly after driving again, check the coolant level and fill it if necessary. If the buzzer still activates after shortly please contact nearest authorized LYNX dealer for further investigation.

Fan cooled models: Shut down the engine.

Check for clogged air duct passages. Remove any foreign materials.

Check for proper fan belt condition and tension.

Liquid cooled models: Engine overheating pilot lamp will light up if engine is too hot.

Reduce snowmobile speed and run snowmobile in loose snow or stop engine immediately.

Check for adequate coolant level. See an authorized Lynx dealer.

Low Battery (only 4-tec models): When overheating pilot lamp light up does the fan starts to rotate, this usually takes down the voltage level under its working level from this point will EMS (Engine Management System) increase the idle speed to 1500 RPM. This gives naturally more current to the battery and starts to charge it up. If the battery pilot lamp stops lighting (on V-800 it flashes) this means that the battery loading up. But still the idle speed does not come down at this time, the engine must be stopped before it starts to operate in normal idle speed which is for V-800, 1200 RPM.

Fuel flooded engine

Install new spark plugs and restart engine.

Rear suspension slider shoe sticking

Slider shoes are cooled and lubricated by snow. When riding at moderate or high speed on a thin-snow-covered surface, slider shoes may stick on metallic track guides.

Run snowmobile on a surface covered by snow or drive snowmobile at very low speed.

Have slider shoes inspected by an authorized Lynx dealer.

NOTE: This situation comes up the more high profile track is. Avoid driving on hard packed snow, ice surface or other surface, that has not enough snow to ensure the lubrication.

It is noticeable that tracks with 35 mm or more high profile are not meant for the trail ride (hard surface) but only for the deep snow ride. If the vehicle which is equipped with this kind of track, is driven on hard packed snow, slider shoes may stick on track metallic parts or the track can get damaged.

Towing an Accessory

Always use a rigid tow bar to tow an accessory. Any towed accessory should have reflectors on both sides and at the rear. Check local laws for brake lights requirements.

WARNING

Never tow an accessory with a rope. Always use a rigid tow bar. Using a rope would result in a collision between the object and the snowmobile and possibly in a tip over in case of a rapid deceleration or on a downward slope.

Towing Another Snowmobile

If a snowmobile is disabled and must be towed use a rigid tow bar, remove the drive belt and tow at moderate speed.

CAUTION: Always remove the drive belt of the snowmobile that is to be towed to prevent damage to its belt and drive system.

In an emergency situation only, if a rigid tow bar is not available, a rope can be used provided you proceed with extra caution.

Remove the drive belt, attach the rope to the ski legs (spindles), have someone sit on the towed snowmobile to activate the brake, and tow at low speed.

CAUTION: In order to prevent damage to the steering system, never attach the tow rope to the ski loops (handles).

WARNING

Never ride at high speed when towing a disabled snowmobile. Proceed slowly with extra caution.

Transporting the Vehicle

Make sure that oil reservoir and fuel tank caps are properly installed.

Tilt bed trailers can easily be equipped with a winch mechanism to afford maximum safety in loading. Simple as it may seem, never drive your snowmobile onto a tilt bed trailer or any other kind of trailer or vehicle. Many serious accidents have resulted from driving up and over a trailer. Anchor your vehicle securely, front and rear, even on short hauls. Be certain all equipment is securely fastened. Cover your snowmobile when trailering to prevent road grime from causing damage.

Be certain your trailer meets state or provincial requirement. Ensure the hitch and safety chains are secure and the brake, turn indicators and clearance lights all function.

FLUID LEVELS

WARNING

It is recommended that the assistance of an authorized Lynx dealer be periodically obtained on other components/systems not covered in this guide. Unless otherwise specified, engine must be cold and not running. The tether cord cap must be removed for all maintenance procedures.

CAUTION: Vehicle must be on a level surface before checking any fluid levels.

Brake system

Check brake fluid in reservoir for proper level. Add fluid as required.

CAUTION: Use only DOT 4 brake fluid from a sealed container.

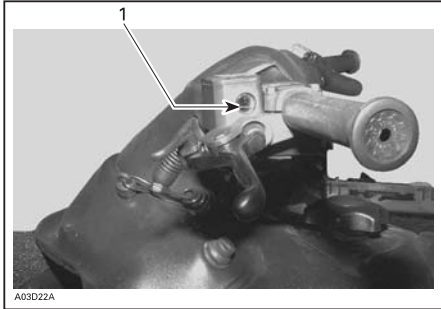

BRAKE FLUID RESERVOIR

1. Minimum

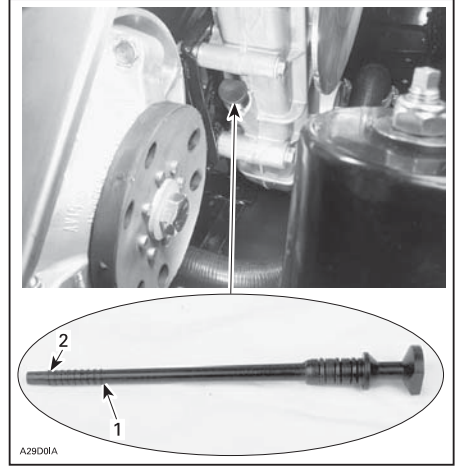

1. Full level mark
2. Lower level mark

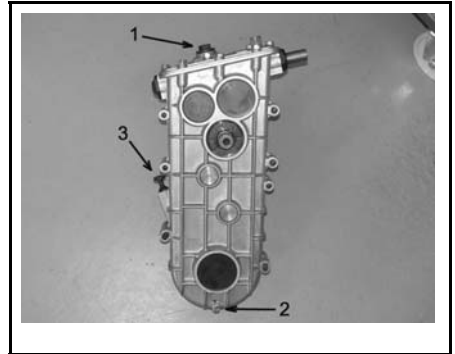

1. Oil filling cap
2. Oil drain plug
3. Dipstick

Gear box models: To check, pull dipstick. Oil should reach level mark.

NOTE: Before initial start-up, the oil level may be higher than the full mark. After first outing, oil level will decrease as the upper oil cavity fills with oil.

NOTE: Use only recommended types of oil when servicing. Do not mix this synthetic oil with other types of oil.

Engine oil level

V-810 engine type: Before checking the oil level the engine must be shut down for 5 minutes. Snowmobile must be on a level surface. Pull out the dipstick and wipe off the oil from the dipstick with a suitable rag or paper. Put the dipstick back and pull out it again, check the oil level and fill if it is necessary. There are capacity of 0,5 liter oil between lower and full mark.

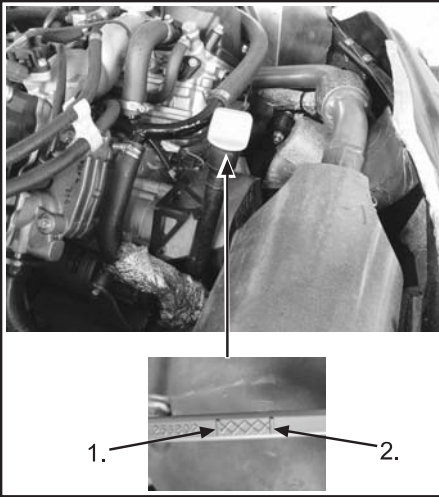

1. Full level mark
2. Lower level mark

Add Bombardier synthetic oil OW-40 through dipstick hole as required.

Injection oil system

Always maintain a sufficient amount of recommended injection oil in the injection oil reservoir.

NOTE: Never allow oil reservoir to be almost empty.

WARNING

Check level and refill every time you are refuelling vehicle. Wipe off any spillage. Oil is highly flammable when heated.

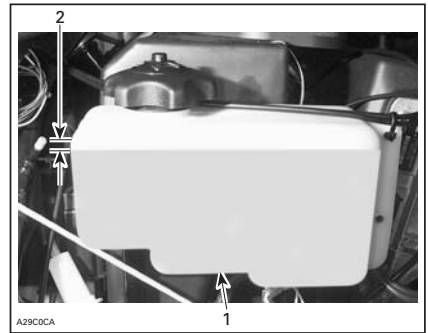

550F ENGINE

1. Injection oil reservoir
2. Maximum level: 13mm (1/2 in) from top

Cooling system

Check coolant level at room temperature. Liquid should be at COLD LEVEL line (engine cold) of coolant tank.

NOTE: When checking level at low temperature it may be slightly lower than mark.

If additional coolant is necessary or if entire system has to be refilled, refer to an authorized Lynx dealer.

4-TEC model (V-800)



**YETI PRO V-800-EXPANSION TANK
NEAR THE MUFFLER**

1. Max level
2. Min level
3. Coolant expansion tank

BATTERY



BATTERY LOCATION

Removal

WARNING

Battery BLACK negative cable must always be disconnected first and connected last.

WARNING

Never charge or boost battery while installed. Battery electrolyte contains sulfuric acid which is corrosive and poisonous. In case of contact with skin, flush with water and call a physician immediately.

WARNING

If battery casing is damaged, wear a suitable pair of nonabsorbent gloves when removing the battery by hand.

WARNING

Battery caps do not have vent holes. Make sure that vent tube is not obstructed.

Dry battery

These batteries are not wet type batteries. Electrolyte level can not be checked.

NOTE: During the summer storage the battery (specially dry battery) has to be charged at least once a month. Otherwise the battery can not function in the beginning of season.

Battery Maintenance

Perform Monthly Maintenance

A battery only requires a little monthly maintenance to perform perfectly. Keep the battery charged to 100%, recharging when the lights dim, the starter sounds weak, or the battery hasn't been used in more than two weeks. Other than that, follow this simple check list every month:

- Check the electrolyte level
- Keep the top free of grime
- Check cables, clamps, and case for obvious damage or loose connections
- Clean terminals and connectors as necessary
- Check inside for excessive sediment, sulfation or mossing
- Make sure the exhaust tube is free of kinks and clogs
- Replace caps firmly

Finish up by testing the battery with either a hydrometer or voltmeter. To extend the service life of your battery, make monthly battery maintenance part of your routine.

Storing Your Battery

If the vehicle is in storage or used infrequently, disconnect the battery cable to eliminate drain from electrical equipment. Charge the battery every two weeks.

For extended storage, remove the battery from the vehicle and charge to 100%. Charge the battery every month if stored at temperatures below 16° C (60° F). If stored in a warm area above 16° C (60° F), charge every two weeks. Make sure batteries are stored out of reach of children.

Off Season Storage

If at all possible, remove the battery from the vehicle. Clean the battery and terminals using a solution of baking soda and water if there is any concern of electrolyte outside of the battery. Make sure that nothing enters the battery during cleaning. You can also use this same solution to clean the battery compartment of the vehicle to help neutralize any electrolyte that may be present. Rinse with clean water and dry thoroughly.

After the battery is cleaned, inspect for any signs of damage or extraordinary wear that may have occurred while in service. If you have any concerns about the condition of your battery, you should seek the advice of a mechanic or a battery specialist.

Upon determining there is no concern of damage, for conventional batteries, check the electrolyte levels. The level of electrolyte must be maintained above the minimum and at or below the maximum level line on the side of the battery. Check only when on a flat level service. If you need to increase the level, carefully add distilled water avoiding any overflow. Once the levels are adjusted, charge the battery referring to the manufacturers instructions.

Sealed VRLA batteries, or those referred to, as "Maintenance Free" do not require you to maintain the electrolyte levels. Sealed VRLA batteries must never be opened once in service or permanent damage and failure will occur. As with the conventional batteries, once you have cleaned and inspected the battery, charge it per the manufacturers instructions.

With the batteries in a full state of charge, you may wish to store it in a cool dry area away from children and pets. You may also choose to reinstall it in the vehicle. Either way, allow yourself access to the battery so you can periodically check your state of charge, or simply attach a battery charger/ maintainer to it.

NOTE: Maintaining your battery state of charge during extended periods of storage is essential to insure the maximum service life is delivered

Battery Safety

Proper Clothing

Always wear a face shield or safety goggles. Wear plastic gloves to prevent acid burns. An apron or smock will protect your clothes.

Working With Acid

Clean up acid spills immediately using a water and baking soda solution to neutralize (ca. 0,5 kg (1lb). baking soda in ca. 4 liter (1 gallon) of water).

Make sure the acid container is clearly marked and the work area is well-lighted and well-ventilated.

If sulfuric acid is swallowed or splashed in the eyes, treat immediately. Sulfuric acid in the eyes can cause blindness. Serious internal injuries or death can result if swallowed. Used as an electrolyte, sulfuric acid can burn the skin.

⚠ ABSOLUTELY NO SMOKING, SPARKS OR FLAMES AROUND CHARGING BATTERIES. Charging gives off hydrogen and oxygen, which explode if ignited.

ANTIDOTES: For acid on the skin, flush with water. If acid is swallowed drink large quantities of milk or water, followed by milk of magnesia, vegetable oil or beaten eggs. Do not induce vomiting. Call a poison control center or doctor immediately. For acid in the eyes, flush for several minutes with water and seek immediate medical attention.

Charging Safety

When charging conventional batteries, loosen vent caps and ventilate charging area. A buildup of hydrogen and oxygen in the battery or in the charging area can create an explosion hazard.

If the battery feels hot to the touch during charging, STOP. Allow the battery to cool before charging again. Heat damages the plates, and a battery that is too hot can explode.

NEVER put the red sealing cap back on the battery once you take it off. If you do, gases will become trapped and could explode

Make sure the vent tube isn't kinked or blocked. Otherwise, gases could build up and explode.

Properly connect the charger to the battery: positive charger lead to positive battery post and negative charger lead to negative battery post. Unplug the charger or turn it off before you disconnect the leads, which will cut down on the chance of sparks.

MAINTENANCE

Vehicle cleaning and protection

Remove any dirt or rust.

To clean the entire vehicle, use only flannel cloths or equivalent.

CAUTION: It is necessary to use flannel cloths or equivalent on windshield and hood to avoid damaging further surfaces to clean.

To clean the entire vehicle, including bottom pan and metallic parts use Bombardier Cleaner (P/N 293 110 001) spray can 400 g and (P/N 293 110 002 (4 L)).

CAUTION: Do not use Bombardier Cleaner on decals or vinyl.

For vinyl and plastic parts use Vinyl & Plastic Cleaner (P/N 413 711 200 (6 x 1 L)).

To remove scratches on windshield or hood use BOMBARDIER Scratch Remover Kit (P/N 861 774 800).

CAUTION: Never clean plastic parts or hood with strong detergent, degreasing agent, paint thinner, acetone, products containing chlorine, etc.

Clean sheaves of both pulleys using BOMBARDIER Pulley flange cleaner (P/N 413 711 809).

Inspect the hood and repair any damage.

Touch up all metal spots where paint has been scratched off. Spray all metal parts including shock chromed rods with BOMBARDIER LUBE (P/N 293 600 016).

Wax the hood and the painted portion of the frame for better protection.

Apply wax on glossy finish only. Protect the vehicle with a cover to prevent dust accumulation during storage.

The snowmobile has to be stored in a cold and dry place and covered with an opaque tarpaulin. This will prevent sun rays from affecting vehicle finish.

Lift rear of vehicle until track is off the ground. Install on a mechanical stand.

Do not release track tension.

Drive belt removal and installation

Remove tether cord cap. Open engine compartment.

1. Remove air silencer

Removing air silencer

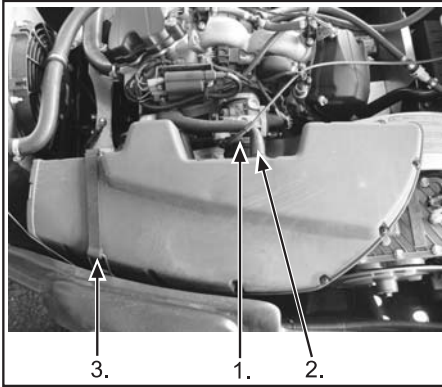

1. Collar screw
2. Vent hose
3. Latch

Loosen collar screw on air silencer grommet.

Disconnect engine vent hose from air silencer.

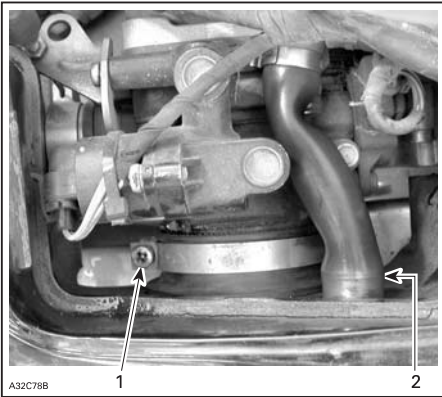

1. Collar screw
2. Engine vent hose

Remove latch from air silencer.
Remove air silencer

2. Remove belt guard

Belt guard removal

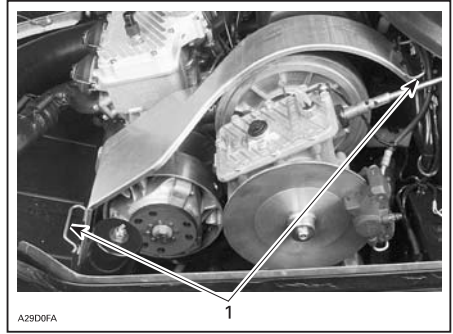

1. Pin retaining

Remove pins, located at both ends of the belt guard

Remove belt guard

3. Remove belt

Removing belt

Turn sliding half clockwise then, pull on drive belt to open driven pulley. Follow instruction on decals for belt removal and installation.

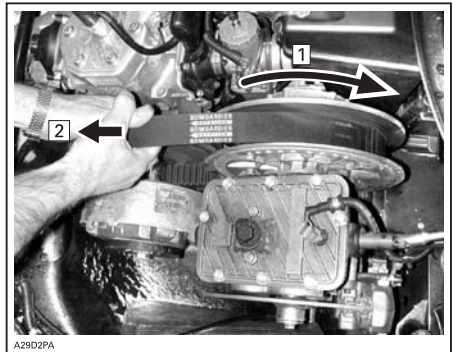

1. Turn sliding half clockwise
2. Pull belt to open driven pulley

Slip the belt over the top edge of the sliding half, as shown.

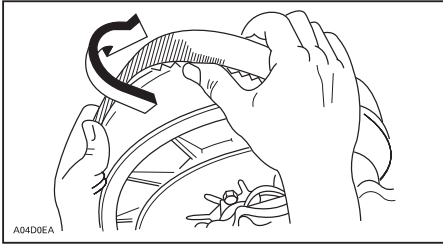

Installation

The maximum drive belt life span is obtained when the belt has the proper rotation direction. Install it so the arrow printed on belt is pointing at front of vehicle.

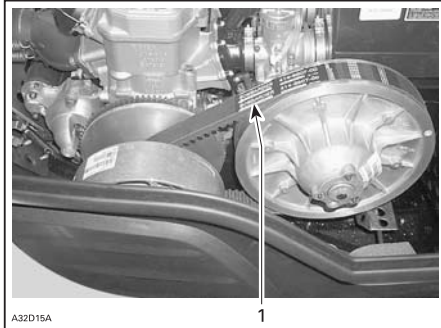

1. Arrow pointing at front of vehicle

CAUTION: Do not force or use tools to pry the belt into place, as this could cut or break the cords in the belt.

Clean sheaves of both pulleys using BOMBARDIER Parts Cleaner (P/N 413 711 809).

To install the drive belt, first place belt between drive pulley sheaves. Then, between driven pulley sheaves, finishing with bottom.

Follow instructions on belt guard.

Reinstall belt guard.

When reinstalling belt guard, position its cutaway toward front of snowmobile. Refer to decal in belt guard.

NOTE: Belt guard is purposely made slightly oversize to maintain tension on its pins and retainers preventing undue noise and vibration. It is important that this tension be maintained when reinstalling.

TRA Drive pulley adjustment

The drive pulley is factory calibrated to transmit maximum engine power at a predefined RPM. refer to TECHNICAL DATA at the end of this guide. Factors such as ambient temperature, altitude or surface condition may vary this critical engine RPM thus affecting snowmobile efficiency.

Calibration screws should be adjusted so that actual maximum engine RPM in vehicle matches with the maximum horsepower RPM.

Use precision digital tachometer for engine RPM adjustment.

The adjustment has an effect on high RPM only.

To adjust, turn calibration screws.

CAUTION: Exceeding the engine RPM results to engine damage. Follow the adjustment sets according technical data.

Calibration screw has a notch on top of its head. There are 6 positions numbered 1 to 6.

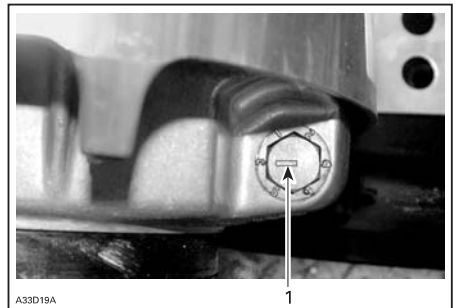

1. Notch

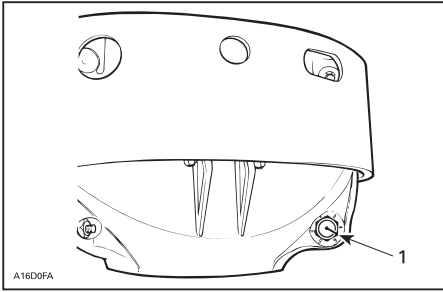

1. Notch

There are 6 positions numbered 1 to 6. Note that in position 1 the number is substituted by a dot (due to its location on casting).

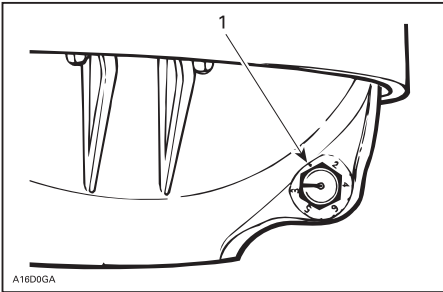

TRA DRIVE PULLEY

1. Position 1 (not numbered)

Lower position numbers decrease engine RPM in steps of 200 RPM and higher position numbers increase it in steps of 200 RPM.

EXAMPLE: Calibration screw is set at position 4 and is changed to position 6: So maximum engine RPM is increased by 400 RPM.

Adjust as follows: (only if calibrations are changed)

Loosen locking nut enough to pull calibration screw partially out and adjust to desired position. Do not completely remove the locking nut. Torque nut to 10 Nm.

CAUTION: Do not completely remove calibration screw otherwise inside washer will fall off. Always adjust all 3 calibration screws and make sure they are all set at the same number.

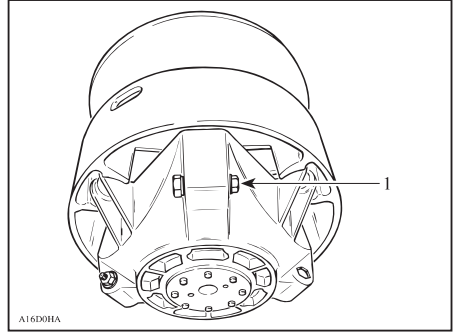

1. Loosen just enough to permit rotating of calibrate screw

WARNING

Always reinstall belt guard. Do not operate engine with hood open or belt guard removed. Improper servicing, modification or poor adjustment may affect drive pulley performance and belt life. Refer to an authorized Lynx dealer.

Drive belt condition

Inspect belt for cracks, fraying or abnormal wear (uneven wear, wear on one side, missing cogs, cracked fabric). If abnormal wear is noted, probable cause could be pulley misalignment, excessive RPM with frozen track, fast starts without warm-up period, burred or rusty sheave, oil on belt or distorted spare belt. Contact an authorized Lynx dealer.

Check the drive belt width. Replace the drive belt if width is less than the minimum width recommended in TECHNICAL DATA.

Brake condition

WARNING

The brake mechanism on your snowmobile is an essential safety device. Keep this mechanism in proper working condition. Above all, do not operate the snowmobile without an effective brake system. Periodically verify the condition/wear of the brake pads.

Brake adjustment

Mechanical brake: The brake mechanism is self-adjusting type.

Hydraulic brake: No adjustment is provided for hydraulic brake. See an authorized Lynx dealer if any problems.

Rear suspension condition

Visually inspect all suspension components including slider shoes, springs, wheels, etc.

NOTE: During normal driving, snow will act as a lubricant and coolant for the slider shoes. Extensive riding on ice or sanded snow, will create excessive heat build-up and cause premature slider shoe wear.

Suspension stopper strap condition

Inspect stopper strap for wear and cracks, bolt and nut for tightness. If loose inspect holes for deformation. Replace as required. Torque nut to 7 Nm.

Track condition

Lift the rear of the snowmobile and support it with a wide-base snowmobile mechanical stand. Rotate the track by hand, and inspect condition. If worn or cut, or if track fibers are exposed, or if missing or defective inserts or guides are noted, contact an authorized Lynx dealer.

WARNING

Do not operate or rotate track if torn, damaged or excessively worn.

Track tension and alignment

Ride the snowmobile in snow about 15 to 20 minutes prior to adjusting track tension.

Lift rear of snowmobile and support it with a wide-base snowmobile mechanical stand.

Allow the suspension to extend normally and check the gap half-way between front and rear idler wheels. Measure between slider shoe bottom and inside of track. The gap should be as given in TECHNICAL DATA.

WARNING

Track tension must be as describe in technical data. Too loose track may cause an accident.

IMPORTANT: Too much tension will result in power loss and excessive stresses on suspension components.

To adjust track tension:

Remove idler wheel cover. Loosen rear idler wheel fastening screws. Turn adjustment screws if required. If correct tension is unattainable, contact an authorized Lynx dealer.

WARNING

Do not try to check the tension with engine on. Turn ignition switch to OFF. Do not touch rotating track, it may cause injuries.

Alignment

WARNING

Before checking track alignment, ensure that the track is free of all particles which could be thrown out while track is rotating. Keep hands, tools and clothing clear of track.

Start the engine and accelerate slightly so that track barely turns. This must be done in a short period of time (15 to 20 seconds). Check that the track is well centred.

Check that the track is well centred; equal distance on both sides between edges of track guides and slider shoes.

Stop engine prior to adjusting. Loosen rear idler wheel retaining screws. Tighten the adjustment screw on side where the slider shoe is the farthest from the track insert guides.

Tighten lock nuts and retaining screws.

WARNING

Tighten the nuts properly. If lock nuts or adjustment screws are not tightened properly, the track may become loose and get damaged.

Restart engine and rotate track slowly to recheck alignment.

Reposition snowmobile on ground.

NOTE: A belt tension tester (P/N 414 348 200) may be used to measure deflection as well as force applied.

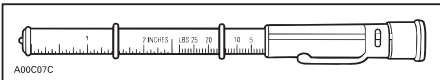

BELT TENSION TESTER

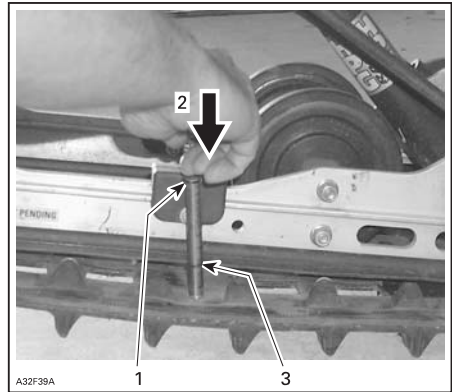

1. Top tool O-ring positioned at 7,3 kg
2. Push on top portion of tool until it contacts the top O-ring
3. Measured track deflection (refer to technical data sheet)

Steering and front suspension mechanism

Visually inspect steering and front suspension mechanism for tightness of components (steering arms, control arms and links, tie rods, ball joints, ski coupler bolts, etc.).

If necessary, contact an authorized Lynx dealer.

Wear and condition of skis and runners

Check the condition of the skis, ski runners and ski runner carbides. If worn, contact an authorized Lynx dealer.

WARNING

Excessively worn skis and/or ski runners will affect snowmobile control.

Exhaust system

The exhaust system is designed to reduce noise and to improve the total performance of the engine. If any exhaust system component is removed, modified or damaged, severe engine damage may result.

Air filter cleaning

While riding in deep powder snow, periodically stop then shake the snow from the filter. Check that air silencer is clean and dry and properly reinstall the filter.

Leaving the snowmobile uncovered during a snowfall or riding in deep powder snow may block air filter and choke the engine. Open the hood, remove the air filter out of air silencer, shake the snow from filter and properly reinstall the filter.

SECONDARY FILTER INSTALLED ON AIR SILENCER

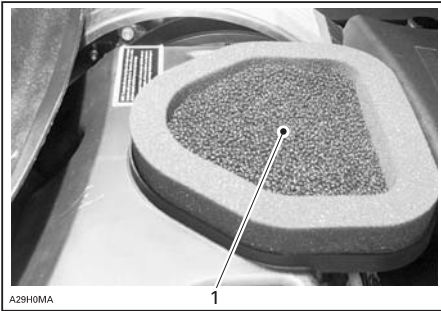

1. Secondary air filter

REMOVAL OF FILTER FROM ITS GRILL

Check that the air silencer is clean and dry and properly reinstall the filter.

CAUTION: Snowmobile have been calibrated with the filter installed. Operating the snowmobile without it may cause engine damage.

Bulb replacement

Always check light operation after bulb replacement.

CAUTION: Never touch glass portion of an halogen bulb with bare fingers, it shortens its operating life. If glass is touched, clean it with isopropyl alcohol which will not leave a film on the bulb.

If headlamp bulb is burnt: Remove windshield, unplug the connector from the bulb, remove the protector cap and bulb retainer clips. Install new headlamp bulb.

Instruments

Bulb socket is always behind the instrument under a black rubber boot. Pull rubber boot and pull bulb out of socket.

Headlight beam aiming

Turn knob to adjust beam height.

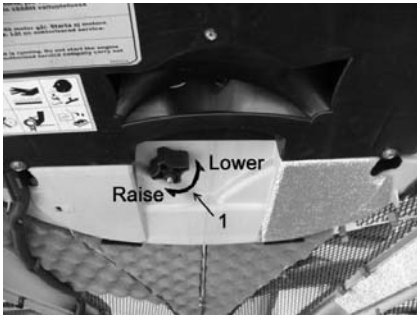

1. Knob

If any headlight bulb is burnt, remove windshield and unplug bulb connector. Remove the rubber boot.



1. Bulb connector
2. Rubber boot

Turn bulb locking ring counterclockwise to remove it. Detach the bulb and replace. Properly reinstall parts.

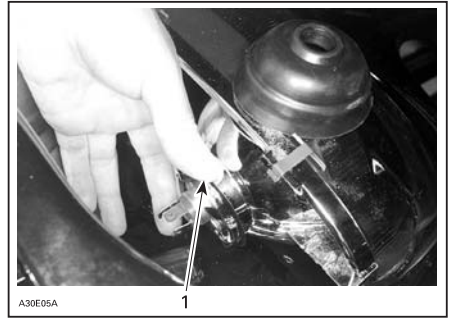

1. Locking ring

Unplug burnt bulb connector. Remove the rubber boot.

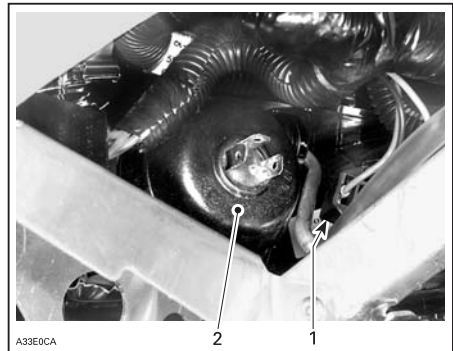

1. Bulb connector
2. Rubber boot

Turn bulb locking ring counterclockwise to remove it. Detach the bulb and replace. Properly reinstall parts.

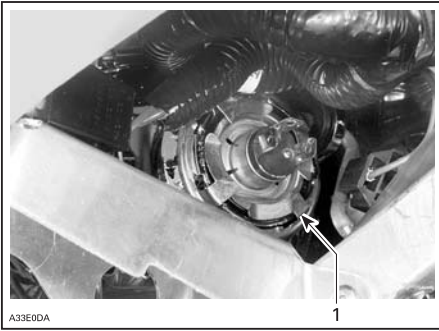

1. Locking ring

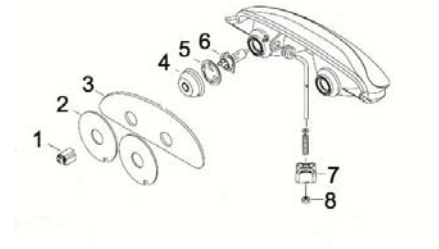

1. Bulb connector
2. Plastic plate
3. Filter
4. Cover
5. Bulb holder
6. Bulb
7. Adjusting knob
8. Elastic stop nut M6

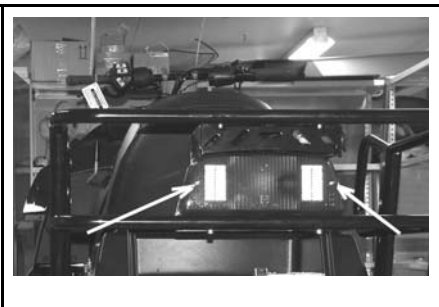

If taillight bulb is burnt, expose the bulb by removing the red plastic lens. To remove, unscrew the 2 lens screws.

ENGINE SYSTEM

Engine Oil Level

Pro V-800

CAUTION: Check level frequently and refill if necessary. **Do not overfill.** Operating the engine with an improper level may severely damage engine. Wipe off any spillage.

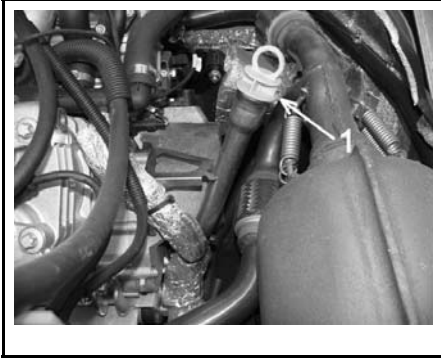

RH SIDE OF ENGINE COMPARTMENT

1. Dipstick

With vehicle on a level surface and engine cold, not running, check the oil level as follows:

1. Remove dipstick and wipe clean.
2. Reinstall dipstick.
3. Remove and check oil level. It should be near or equal to the upper mark.

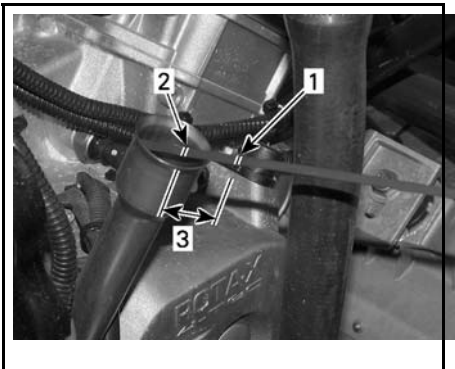

1. Full
2. Add
3. Operating range

To add oil, remove dipstick. Place a funnel into the dipstick tube to avoid spillage.

Add a small amount of recommended oil and recheck oil level.

Repeat the above procedures until oil level reaches the dipstick's upper mark. **Do not overfill.**

Properly reinstall dipstick.

Engine Oil/Oil Filter Change

Yeti Pro V-800

Snowmobile has to stand on a level surface.

1. Let engine run until it reaches normal running temperature.
2. Shut down the engine.
3. Remove dipstick.

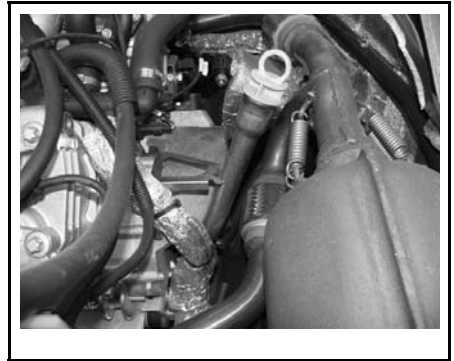

CAUTION: Yeti-Pro 800 model; use applicable pump to change oil trough dipstick pipe.



11. Run engine 30 seconds, shut off engine. Let engine be shut off 30 seconds and check oil level. Add oil if necessary to reach upper oil level mark.
12. Run engine for a while and check that no oil leakage appear.

⚠ WARNING

Do not touch hot oil by hand !

CAUTION: Dispose used oil and oil filter by following your local regulations.

4. Remove oil filter by opening the filter cover (1) and remove filter cartridge.



5. Replace new oil filter cartridge.
6. Fasten oil filter cover.
7. Fasten drain plug.
8. Fill up recommended oil through dipstick pipe. (See quantity on TECHNICAL SPECIFICATION SECTION for specific model).
9. Check oil level by dipstick. Add oil if necessary to reach upper oil level mark.
10. Install dipstick carefully.

STORAGE AND PRESEASON PREPARATION

WARNING

Have an authorized LYNX dealer inspect fuel and oil systems integrity as specified in PERIODIC MAINTENANCE CHART.

Storage

It is during summer, or when a snowmobile is not in use for more than one month that proper storage is a necessity.

Engine cooling system

Antifreeze should be replaced for the storage period to prevent antifreeze deterioration. The antifreeze replacement and a density test should be performed by an authorized LYNX dealer.

CAUTION: Improper antifreeze mixture might allow freezing of the liquid in the cooling system if vehicle is stored in area where freezing point is reached. This would seriously damage the engine. Failure to replace the antifreeze for storage may cause its degradation which could result in poor cooling when engine will be used.

CAUTION: Do not run engine during storage period.

Preseason preparation

Refer to an authorized LYNX dealer.

CAUTION: Have carburetor(s) cleaned-up before restarting engine on so equipped models.

TROUBLESHOOTING

Monitoring beeper coded signals

CODED SIGNAL	POSSIBLE CAUSE	REMEDY
2 short beeps (when engine is started). DESS/RER pilot lamp also blinks.	Confirms that proper tether cord cap is installed.	Normal condition.
1 short beep every 1,5 seconds (when engine is started). DESS/RER pilot lamp also blinks. Engine cannot reach engagement speed. Vehicle cannot be driven.	Bad DESS system connection. Defective tether cord cap. Dirt or snow in tether cord cap. Defective DESS post.	Reinstall tether cord cap correctly over post. Use another programmed tether cord cap. Clean tether cord cap. Contact an authorized Lynx dealer.
1 long beep per second. SDI 0,5 sec beep every 0,5 sec	Reverse is selected	Vehicle can be driven in reverse
3 short beeps per second. DESS/RER pilot lamp also blinks. Engine cannot reach pulley engagement. Vehicle cannot be driven.	Wrong tether cord cap is installed	Install proper tether cord cap.
3 short beeps per second. Engine overheating pilot lamp also blinks. SDI 80ms beep every 260ms temp lamp also blinks.	Engine is overheating	Stop engine immediately and allow to cool. If trouble persists, see an authorized Lynx dealer.
3 short beeps per second. Oil pilot lamp also lights up.	Low oil pressure on 4 –tec models.	Stop engine immediately and allow to cool. If trouble persists, see an authorized Lynx dealer.
3 short beeps per second. Battery pilot lamp also lights up. SDI 80ms beep every 260ms batt lamp also blinks.	Low battery voltage	Check battery and charging system, see an authorized Lynx dealer.
4 short beeps every 2 minutes. Oil pilot lamp also lights up.	Low oil level on 2 –tec models.	Check oil level and add oil as soon as possible.
4 short beeps every 2 minutes. Engine pilot lamp also lights every 3 seconds.	Too high battery voltage. DESS system has detected a shorted key installed on DESS post.	Use another programmed tether cord cap.

CODED SIGNAL	POSSIBLE CAUSE	REMEDY
4 short beeps every 2 minutes. Engine pilot lamp also lights up. SDI 2 sec beep every 58 second lamp, remains on.	Defect in engine management system. (EMS)	See an authorized Lynx dealer.
4 short beeps every 2 minutes. Engine pilot lamp blinks every 1 second. SDI 2 sec beep every 15 seconds, lamp remains on.	Defect in engine management system. (EMS)	See an authorized Lynx dealer.

Troubleshooting

ENGINE TURNS OVER BUT FAILS TO START

- 1. Ignition switch, engine cut-out switch or tether cord is OFF position.**
 - Place all the switches to ON position.
- 2. Faulty fuse on V-800 models**
 - Check F4 fuse on V-800 models.
- 3. Mixture not rich enough to start cold engine.**
 - Check fuel tank and check starting procedure, particularly use of the choke or primer.
- 4. Flooded engine (spark plug wet when removed).**
 - Do not choke. Remove wet spark plug, turn ignition switch to OFF and crank engine several times. Install clean, dry spark plug. Start engine following usual starting procedure. If engine continues to flood, see an authorized Lynx dealer. SDI opening the throttle fully during cranking will switch off the fuel.
- 5. No fuel to the engine (spark plug dry when removed).**
 - Check fuel tank level; turn fuel valve on if applicable; check fuel filter; replace if clogged; check condition of fuel and impulse lines and their connections. A failure of the fuel pump or carburetor has occurred; contact an authorized Lynx dealer.
- 6. Spark plug/ignition (no spark).**
 - Remove spark plug (s) then reconnect to spark cap. Check that engine cut-out switch is at the ON position and the tether cut-out cord cap is snapped over the receptacle. Start engine with spark plug (s) grounded to engine away from spark plug hole. If trouble persists, contact an authorized Lynx dealer.
- 7. Engine compression.**
 - As the engine is pulled over with the rewind starter, "cycles" of resistance should be felt as piston goes past top dead center (each piston on multi-cylinder engines). If no pulsating resistance is felt, it suggests a major loss of compression. Contact an authorized Lynx dealer.

ENGINE LACKS ACCELERATION OR POWER

- 1. Fouled or defective spark plug.**
 - Check item "Engine turns over but fails to start".
- 2. Lack of fuel to engine.**
 - See item "Engine turns over but fails to start".
- 3. Carburetor adjustments.**
 - Contact an authorized Lynx dealer.
- 4. Drive belt worn too thin.**
 - If the drive belt has lost more than 3 mm of its original width, it will affect vehicle performance.
- 5. Drive and driven pulleys require servicing.**
 - Contact an authorized Lynx dealer.

ENGINE LACKS ACCELERATION OR POWER (cont'd)

6. Engine is overheating.

- *On liquid cooled engines: Check coolant level, pressure cap, thermostat and for air locks in cooling system. On fan cooled engines: Check fan belt and its tension; clean cooling fins of engine; if overheating persists, contact an authorized Lynx dealer.*
- *V-800: Observe the fan function. Check fuse F10.*

ENGINE BACKFIRES

1. Faulty spark plug.

- *See item "Engine turns over but fails to start".*

2. Engine is running too hot.

- *See item "Engine lacks acceleration or power".*

3. Ignition timing is incorrect or there is an ignition system failure.

- *Contact an authorized Lynx dealer.*

ENGINE MISFIRES

1. Fouled/defective/worn spark plug.

- *Clean/verify spark plug gap and identification number. Replace as required.*

2. Too much oil supplied in engine.

- *Improper oil pump adjustment, refer to an authorized Lynx dealer. Too rich fuel/oil mixture (only during break-in period). Drain fuel tank and refill with appropriate mixture ratio.*

3. Water in fuel.

- *Drain fuel system and refill with fresh fuel. Replace fuel filter if needed.*

SNOWMOBILE CANNOT REACH FULL SPEED

1. Drive belt.

- *Check item "Engine lacks acceleration or power".*

2. Incorrect track adjustment.

- *See MAINTENANCE or an authorized Lynx dealer for proper alignment and tension adjustments.*

3. Pulleys misaligned.

- *Contact an authorized Lynx dealer.*

4. Engine.

- *See item "Engine lacks acceleration or power".*

SPECIFICATIONS

MODEL	YETI PRO		YETI	
	550 F			
ENGINE				
Type	552			
Number of cylinder	2			
Displacement	cm ³ (in ³)	553.4 (33.78)		
Bore (standard)	mm (in)	76.00 (2.992)		
Stroke	mm (in)	61.0 (2.402)		
Maximum power engine speed	± 100 RPM	6750		
Carburetor / Throttle body type	2 x VM30 Choke			
DRIVE SYSTEM				
Drive pulley type	TRA™ III			
Driven pulley type	NDT 6K VSA			
Engagement	2800 RPM			
Drive belt part number	605 348 425			
Drive sprocket number of teeth	8			
Brake system	Hydraulic			
ELECTRICAL				
Magneto generator output	340 W			
Spark plug	Make	NGK		
	Quantity	2		
	Type	BR9ES		
	Gap	0.45 mm (.018 in)		
Head lamp bulb	60/55 Watts (H-4)			
Taillight bulb	8/27			
Fuse	Starting system	20 A (includes electric power outlet)		

MODEL		YETI PRO	YETI
		550 F	
SUSPENSION			
Front	Type	LTS 900mm	
	Travel	150 (5.9)	
Rear	Type	Easy Ride XWLS	Easy Ride WLS
	Travel	210 mm (8.3 in)	
TRACK			
Track (W x L / H) mm (in)		600 x 3968 / 32 (23.6 x 156 / 1,26)	500 x 3968 / 32 (19.7 x 156 /1.26)
Tension mm (in)		40 - 50 (1-9/16 - 1-31/32) ⁽¹⁾	
Alignment		⁽²⁾	
DIMENSION			
Dry weight		301 kg (663.6 lb)	277 kg (610.7 lb)
Overall length		3040 mm (119.7 in)	3070 mm(120.9 in)
Overall width		1080 mm (42.5 in)	1155 mm (45.6 in)
Overall height		1370 mm (53.9 in)	

MODEL		YETI PRO	YETI
		550 F	
LIQUIDS AND GREASES			
Engine oil		XP-ST [™] synthetic 2-stroke oil OR XP-ST [™] 2-stroke synthetic blend OR XP-ST [™] mineral injection oil	
Fuel	Type	Regular unleaded gasoline	
	Octane	95 RON	
Gearbox		XP-ST [™] synthetic chaincase oil	
Brake		SRF (DOT 4) or GTLMA (DOT 4)	
CAPACITY			
Engine oil reservoir	L (U.S. oz)	2.5 (84.5)	
Fuel tank	L (U.S. gal)	42 (11,0)	
Chaincase/gearbox oil	mL (U.S. oz)	500 (16.9)	
Brake fluid	mL (U.S. oz)	500 (16.9)	
<p>(1) and (2): See at end of specifications. Because of its ongoing commitment to product quality and innovation, BRP reserves the right, at any time, to make changes in design and specifications and/or to make additions to, or improvements in its products without imposing any obligation upon itself to install them on its products previously manufactured.</p>			

- (1) Measure gap between slider shoe and bottom inside of track when exerting a downward pull of 7.3 kg (16 lb) to the track.
- (2) Equal distance between edges of track guides and slider shoes.

MODEL		YETI
		PRO V-800
ENGINE SYSTEM		
Engine type		Rotax 4-tec V-800
Number of cylinder		2
Displacement	cm ³ (in ³)	800 (48.8)
Bore	mm (in)	91 (3.58)
Stroke	mm (in)	61.5 (2.42)
Maximum engine speed	± 100 RPM	7250
Fuel system type		VDO EMS, 1 injector per cylinder
Exhaust system		Exhaust pipe, muffler
DRIVE SYSTEM		
Drive pulley type		TRA IV
Driven pulley type		NDT 6K VSA
Drive belt part number		605 348 425
ELECTRICAL		
Magneto generator output		462 W
Spark plug	Make	NGK
	Quantity	2
	Type	DCPR8E
	Gap	0.7 to 0.8 mm (.027 to .031 in)
Headlamp bulb		60/55 Watts (H-4)
Taillight bulb		5/21
Fuse		Refer to <i>FUSE</i> section
SUSPENSION		
Front	Type	LTS (900 mm)
	Travel	150 mm (5.9 in)
Rear	Type	Easy Ride XWLS
	Travel	210 mm (8.3 in)

MODEL		YETI
		PRO V-800
TRACK		
Track (W x L / H) mm (in)		600 x 3968 / 32 (23.6 x 156 / 1.26)
Tension mm (in)		40 - 50 (1-9/16 - 1-31/32) ⁽¹⁾
Alignment		⁽²⁾
DIMENSION		
Dry mass		330kg (727.5 lb)
Overall length		3070 mm (120.7 in)
Overall width		1155 mm (45.5 in)
Overall height		1370 mm (53.9 in)
LIQUIDS AND GREASES		
Engine oil		XP-ST [™] 0W40 synthetic 4-stroke oil
Coolant		Premixed coolant or ethylene-glycol/water mix (50% coolant, 50% distilled water)
Fuel	Type	Regular unleaded gasoline
	Octane	95 RON
Gearbox		XP-ST [™] synthetic chaincase oil
Brake		SRF (DOT 4) or GTLMA (DOT 4)

MODEL		YETI
		PRO V-800
CAPACITY		
Engine oil	Engine	Oil change with filter: 2 L (67.6 L (U.S. oz))
	Reservoir	N.A.
Cooling system	L (U.S. oz)	4 (135)
Fuel tank	L (U.S. gal)	42 (11.0)
Gearbox oil	mL (U.S. oz)	500 (16.9)
Brake fluid	mL (U.S. oz)	500 (17)
⁽¹⁾ to ⁽³⁾ : See at end of specifications. Because of its ongoing commitment to product quality and innovation, BRP reserves the right, at any time, to make changes in design and specifications and/or to make additions to, or improvements in its products without imposing any obligation upon itself to install them on its products previously manufactured.		

⁽¹⁾ Measure gap between slider shoe and bottom inside of track when exerting a downward pull of 7.3 kg (16 lb) to the track.

⁽²⁾ Equal distance between edges of track guides and slider shoes.

CAUTION: ⁽³⁾ Do not attempt to adjust gap on DCPR8E, spark plug

The EC-Declaration of Conformity does not appear in this version of the Operator's Guide.

Please refer to the printed version that was delivered with your vehicle.

Vibrations in the seat (EN 1032, ISO 5008), is less than 0,5 m/s².

Vibrations in the handle (EN 1032, ISO 5008), is less than 2,5 m/s².

MAINTENANCE INFORMATION

BREAK-IN INSPECTION

After the first 10 hours or 500 km of operation, whichever comes first, your vehicle have to be inspected by an authorized Lynx dealer. The break-in inspection is very important and must not be neglected.

NOTE: The break-in inspection is at the expense of the vehicle owner.

BREAK-IN INSPECTION (2-STROKE)
Inspect engine motor mounts
Inspect exhaust system and check for leaks
Tighten exhaust manifold screws to specified torque
Check coolant level
Inspect fuel lines and connections
Inspect throttle cable
Inspect oil injection pump adjustment (All except E-TEC)
Inspect drive belt
Visually inspect drive pulley
Tighten drive pulley retaining screw to specified torque
Inspect driven pulley
Inspect spark plugs (All except E-TEC)
Adjust and align track
Change chaincase oil
Retorque gearbox cover screws both sides of speedometer sensor connector to 10Nm (Only XU Models)
Adjust drive chain (Not for models equipped with gearbox)
Check brake fluid level
Inspect brake hose, pads and disk
Inspect steering mechanism
Inspect skis and runners
Tighten frame pyramid rod screws to specified torque
Inspect front suspension
Inspect rear suspension and slider shoes

BREAK-IN INSPECTION (4-STROKE)

Inspect engine seals and gaskets for leaks

Inspect exhaust system and check for leaks

Check coolant level

Change engine oil and filter

Inspect fuel lines and connections

Inspect throttle cable

Inspect drive belt

Visually inspect drive pulley

Tighten drive pulley retaining screw to specified torque

Inspect driven pulley

Adjust and align track

Change chaincase oil

Retorque gearbox cover screws both sides of speedometer sensor connector to 10Nm (Only XU Models)

Adjust drive chain (Not for models equipped with gearbox)

Check brake fluid level

Inspect brake hose, pads and disk

Inspect steering mechanism

Inspect skis and runners

Tighten frame pyramid rod screws to specified torque

Inspect front suspension

Inspect rear suspension and slider shoes

PERIODIC MAINTENANCE CHART

WARNING

It is recommended that the assistance of an authorized LYNX dealer be periodically obtained on other components/systems not covered in this guide. Unless otherwise specified, engine must be cold and not running. Remove tether cord cap before performing any maintenance or adjustment, unless otherwise specified. Vehicle must be parked in a safe place, away from the trail.

WARNING

Observe WARNINGS and CAUTIONS mentioned throughout this guide which are relevant to the item being checked. When component conditions seem less than satisfactory, replace with genuine BRP parts or approved equivalents.

Some items may not apply to your particular model. Refer to *MAINTENANCE* in *SHOP MANUAL* for more details.

MAINTENANCE SCHEDULE (2-STROKE)

NOTE: The maintenance schedule does not exempt the pre-ride inspection.

EVERY 1 500 KM
T/A shocks oil change. First at 1500 km, then every 3000 km or once a year.
Models with chaincase: Adjust drive chain
Models with gearbox: Check oil level

EVERY 3 000 KM OR 1 YEAR (WHICHEVER COMES FIRST)
Inspect engine motor mounts
Inspect exhaust system and check for leaks
Inspect cooling system cap, hoses and clamps and check for leaks
Replace spark plugs (All except of E-TEC)
Clean RAVE valves
Inspect RAVE valves solenoid
Adjust engine stopper
Visually inspect and clean drive pulley
Tighten drive pulley retaining screw to specified torque
Clean driven pulley
Adjust and align track
Inspect brake hose, pads and disk
Inspect steering mechanism
Inspect front suspension
Inspect rear suspension and stopper strap. PPS Suspension: Replace stopper strap.
Lubricate front and rear suspension whenever the vehicle is used in wet conditions (wet snow, rain, puddles)
Lubricate QRS axle gearbox end. (XU models)

**EVERY 6 000 KM OR 2 YEARS
(WHICHEVER COMES FIRST)**

Replace oil filter

Replace fuel filter

Replace spark plugs (800 E-TEC only)

Replace brake fluid

Inspect throttle cable

**EVERY 10 000 KM OR 3 YEARS
(WHICHEVER COMES FIRST)**

Replace spark plugs (600 E-TEC only)

EVERY 5 YEARS

Replace engine coolant

MAINTENANCE SCHEDULE (4-STROKE)

NOTE: The maintenance schedule does not exempt the pre-ride inspection.

EVERY 1 500 KM
T/A shocks oil change. First at 1500 km, then every 3000 km or once a year
Models with chaincase: Adjust drive chain
Models with gearbox: Check oil level

EVERY 3 000 KM OR 1 YEAR (WHICHEVER COMES FIRST)
Replace drive pulley O-rings (1200 4-TEC only)
Clean drive pulley
Tighten drive pulley retaining screw to specified torque
Clean driven pulley
Adjust and align track
Inspect brake hose, pads and disk
Inspect steering mechanism
Inspect front suspension
Inspect rear suspension and stopper strap. PPS Suspension: Replace stopper strap.
Lubricate front and rear suspension whenever the vehicle is used in wet conditions (wet snow, rain, puddles)
Lubricate QRS axle gearbox end. (XU models)

EVERY 6 000 KM OR AT PRE-SEASON (WHICHEVER COMES FIRST)
Change engine oil and filter

EVERY 6 000 KM OR 2 YEARS (WHICHEVER COMES FIRST)
Replace fuel filter
Inspect drive pulley sliders and replace if necessary (1200 4-TEC only)
Replace brake fluid
Inspect throttle cable

**EVERY 10 000 KM OR 3 YEARS
(WHICHEVER COMES FIRST)**

Replace spark plugs

EVERY 20 000 KM

Check valve clearance and adjust if necessary. (1200 4-TEC only)

EVERY 5 YEARS

Replace engine coolant

PRESEASON PREPARATION

PRESEASON PREPARATION (2-STROKE)
Inspect engine motor mounts
Check exhaust system condition and check for leaks
Tighten exhaust manifold screws or nuts to specified torque
Replace spark plugs. (All except E-TEC)
Inspect cooling system cap, hoses and clamps
Check coolant density
Inspect crankshaft PTO seal
Inspect fuel lines and connections
Clean and inspect throttle body
Inspect throttle cable
Inspect drive belt (adjust at every drive belt replacement)
Clean and visually inspect drive pulley
Clean and inspect driven pulley
Inspect, adjust and align track
Adjust drive chain (Not for models equipped with gearbox)
Change chaincase oil
Check brake fluid level
Inspect brake hose, pads and disk
Inspect steering mechanism
Inspect skis and runners
Inspect front suspension
Inspect rear suspension stopper strap
Charge battery (if so equipped)
Adjust headlight beam aiming

PRESEASON PREPARATION (4-STROKE)

Visually inspect engine seals and gaskets and check for leaks

Check exhaust system condition and check for leaks

Change engine oil and filter

Check coolant density

Inspect fuel lines and connections

Clean and inspect throttle body

Inspect throttle cable

Inspect drive belt (adjust at every drive belt replacement)

Clean and visually inspect drive pulley

Clean and inspect driven pulley

Inspect, adjust and align track

Adjust drive chain (Not for models equipped with gearbox)

Change chaincase oil

Check brake fluid level

Inspect brake hose, pads and disk

Inspect steering mechanism

Inspect skis and runners

Inspect front suspension

Inspect rear suspension and stopper strap.

Charge battery (if so equipped)

Adjust headlight beam aiming

STORAGE

During summer, or when a snowmobile is not in use for more than three months, proper storage is a necessity.

STORAGE
Clean the vehicle
Add fuel stabilizer to fuel following the product manufacturer recommendations Run the engine after adding the product to the fuel
2-Stroke models: Lubricate engine. See owners manual for instruction.
Lubricate brake lever pivot
Inspect and lubricate rear suspension
Charge battery monthly to keep it fully charge during storage
Block muffler with rags
Lift rear of vehicle until track is clear of the ground. Do not release track tension

WARRANTY

BRP FINLAND OY INTERNATIONAL LIMITED WARRANTY: 2011 LYNX® SNOWMOBILES

1) SCOPE OF THE LIMITED WARRANTY

BRP Finland Oy ("BRP") warrants its 2011 LYNX snowmobiles from defects in material or workmanship for the period and under the conditions described below.

All genuine LYNX parts and accessories, installed by an authorized BRP distributor/dealer (as hereinafter defined) at the time of delivery of the 2011 LYNX snowmobile, carry the same warranty as that of the snowmobile.

Use of the product for racing or any other competitive activity, at any point, even by a previous owner, will render this warranty null and void.

2) WARRANTY COVERAGE PERIOD

This warranty will be in effect from the date of delivery to the first retail consumer or the date the product is first put into use, whichever occurs first and for a period of:

A) TWELVE (12) CONSECUTIVE MONTHS, for private use owners

B) TWELVE (12) CONSECUTIVE MONTHS, for commercial use owners

C) TWENTY FOUR (24) CONSECUTIVE MONTHS, for private use owners when product was sold in a member state of the European Union and Russia. The repair or replacement of parts or the performance of service under this warranty does not extend the life of this warranty beyond its original expiration date.

3) CONDITIONS TO HAVE WARRANTY COVERAGE

This warranty coverage is available only on 2011 LYNX snowmobile purchased as new and unused by its first owner from a BRP distributor/dealer authorized to distribute LYNX products in the country in which the sale occurred ("BRP distributor/dealer"), and then only after the BRP specified pre-delivery inspection process is completed and documented. Warranty coverage only becomes available upon proper registration of the product by an authorized BRP distributor/dealer. Moreover, this warranty coverage is only available if the LYNX snowmobile is purchased in the country in which the purchaser resides. BRP will not honor this limited warranty to any private use owner or commercial use owner if the preceding conditions have not been met. Such limitations are necessary in order to allow BRP to preserve both the safety of its products, and also that of its consumers and the general public.

Routine maintenance outlined in the Operator's Guide must be timely performed in order to maintain warranty coverage. BRP reserves the right to make warranty coverage contingent upon proof of proper maintenance.

4) WHAT TO DO TO OBTAIN WARRANTY COVERAGE

The customer must notify a servicing BRP distributor/dealer within two (2) months of the appearance of a defect, and provide it with reasonable access to the product and reasonable opportunity to repair it. The customer must also present to the authorized BRP distributor/dealer, proof of purchase of the product and must sign the repair/work order prior to starting the repair in order to validate the warranty repair. All parts replaced under this limited warranty become the property of BRP.

5) WHAT BRP WILL DO

BRP's obligations under this warranty are limited to, at its sole discretion, repairing parts found defective under normal use, maintenance and service, or replacing such parts with new genuine LYNX parts without charge for parts and labor, at any authorized BRP distributor/dealer during the warranty coverage period.

BRP reserves the right to improve or modify products from time to time without assuming any obligation to modify products previously manufactured.

6) EXCLUSIONS

The following are not warranted under any circumstances:

- Normal wear and tear;
- Routine maintenance items, tune ups, adjustments;
- Damage caused by failure to provide proper maintenance and/or storage, as described in the Operator's Guide;
- Damage resulting from removal of parts, improper repairs, service, maintenance, modifications or use of parts not manufactured or approved by BRP or resulting from repairs done by a person that is not an authorized servicing BRP distributor/dealer;
- Damage caused by abuse, abnormal use, neglect, use of the product on surfaces other than snow, or operation of the product in a manner inconsistent with the recommended operation described in the Operator's Guide;
- Damage resulting from accident, submersion, fire, theft, vandalism or any act of God;
- Operation with fuels, oils or lubricants which are not suitable for use with the product (see the Operator's Guide);
- Snow or water ingestion;
- Incidental or consequential damages, or damages of any kind including without limitation towing, storage, telephone, rental, taxi, inconvenience, insurance coverage, loan payments, loss of time, loss of income; and
- Damage resulting from studs installed on tracks if the installation does not conform to BRP's instructions.

7) LIMITATIONS OF LIABILITY

THIS WARRANTY IS EXPRESSLY GIVEN AND ACCEPTED IN LIEU OF ANY AND ALL OTHER WARRANTIES, EXPRESSED OR IMPLIED, INCLUDING WITHOUT LIMITATION ANY WARRANTY OF MERCHANTABILITY OR FITNESS FOR A PARTICULAR PURPOSE. TO THE EXTENT THAT THEY CANNOT BE DISCLAIMED, THE IMPLIED WARRANTIES ARE LIMITED IN DURATION TO THE LIFE OF THE EXPRESS WARRANTY. INCIDENTAL AND CONSEQUENTIAL DAMAGES ARE EXCLUDED FROM COVERAGE UNDER THIS WARRANTY. SOME STATES/ PROVINCES DO NOT ALLOW FOR THE DISCLAIMERS, LIMITATIONS AND EXCLUSIONS IDENTIFIED ABOVE, AS A RESULT, THEY MAY NOT APPLY TO YOU. THIS WARRANTY GIVES YOU SPECIFIC RIGHTS, AND YOU MAY ALSO HAVE OTHER LEGAL RIGHTS WHICH MAY VARY FROM STATE TO STATE, OR PROVINCE TO PROVINCE.

Neither the distributor, any BRP distributor/dealer nor any other person has been authorized to make any affirmation, representation or warranty regarding the product, other than those contained in this limited warranty, and if made, shall not be enforceable against BRP.

BRP reserves the right to modify this warranty at any time, being understood that such modification will not alter the warranty conditions applicable to the products sold while this warranty is in effect.

8) TRANSFER

If the ownership of a product is transferred during the warranty coverage period, this warranty shall also be transferred and be valid for the remaining coverage period provided BRP or an authorised BRP distributor / dealer receives a proof that the former owner agreed to the transfer of ownership, in addition to the co-ordinates of the new owner.

9) CONSUMER ASSISTANCE

- a) In the event of a controversy or a dispute in connection with this limited warranty, BRP suggests that you try to resolve the issue at the dealership level. We recommend discussing the issue with the authorized distributor/dealer's service manager or owner.
- b) If further assistance is required, the distributor's service department should be contacted in order to resolve the matter.
- c) If the matter still remains unresolved then contact BRP by writing to us at the address below.

ADDRESS:

BRP-FINLAND OY
SERVICE DEPARTMENT
P.O. BOX 8039
FIN-96101 ROVANIEMI
FINLAND

© 2010 Bombardier Recreational Products Inc. All rights reserved.

® Registered trademark of Bombardier Recreational Products Inc.

PRIVACY OBLIGATIONS/DISCLAIMER

We wish to inform you that your coordinates will be used for safety and warranty purposes. Sometimes, we also use the coordinates of our clients to inform them about our products and to present them offers. Should you prefer not to receive information on our products, services and offers, please let us know by writing to the address below.

Also note that, from time to time, carefully selected and trustworthy organizations may be permitted to use the coordinates of our clients to promote quality products and services. If you prefer not to have your name and address released, please let us know by writing to the address below:

FOR SCANDINAVIAN AND EUROPEAN COUNTRIES:

BRP FINLAND OY
Service Department
Isoaavantie 7
FIN-96320 Rovaniemi
Finland
Fax +358 16 3420 316

CHANGE OF ADDRESS/OWNERSHIP

If your address has changed or if you are the new owner of the vehicle, be sure to notify BRP by either:

- mailing one of the cards hereinafter using of the following mail address;
- contacting an authorized LYNX dealer or distributor.

Mail address:

FOR SCANDINAVIAN AND EUROPEAN COUNTRIES:

BRP FINLAND OY
Service Department
Isoaavantie 7
FIN-96320 Rovaniemi
Finland
Fax: +358 16 3420 316

In case of change of ownership, please join a proof that the former owner agreed to the transfer.

Notifying BRP, even after the expiration of the limited warranty, is very important as it enables BRP to reach the vehicle owner if necessary, like when safety recalls are initiated. It is the owner's responsibility to notify BRP.

STOLEN UNITS: If your personal vehicle is stolen, you should notify BRP or an authorized LYNX dealer. We will ask you to provide your name, address, phone number, the vehicle identification number and the date it was stolen.



brp.com

LYNX



® ™ and the BRP logo are trademarks of Bombardier Recreational Products Inc. or its affiliates.