

LYNX®



**BRUKERHÅNDBOK
OPERATOR'S GUIDE
RE-X SERIES • 2011**

NO/EN 619 900 253

OPERATOR'S MANUAL 2011

Rave™ 550
Rave™SC 600HO E-TEC
Rave™ RE 600HO E-TEC
Rave™ RE 800 E-TEC
Xtrim™ 550
Xtrim™ SC 600HO E-TEC
Xtrim™ 800R BoonDocker

SAFETY WARNING

Disregarding any of the safety precautions and instructions contained in this Operator's Guide, or on-product warnings may result in injury, including the possibility of death.

This Operator's Guide should remain with the snowmobile at time of resale.



Lynx products are manufactured by BRP .

The following are trademarks of Bombardier Recreational Products Inc. or its subsidiaries.

DESS™

3-D RAVE™

ROTAX™

LYNX®

HPG™

RER™

E-TEC®

TRA™

FOREWORD

Congratulations on your purchase of a new Lynx snowmobile. Whatever model you have chosen, it is backed by the Bombardier Recreational Products inc. (BRP) warranty and a network of authorized Lynx snowmobile dealers ready to provide the parts, service or accessories you may require.

The Operator's Guide has been prepared to acquaint the owner/operator and passenger with this new snowmobile and its various controls, maintenance and safe riding instructions. This guide is indispensable for the proper use of the product and should be kept with this snowmobile at all times.

Make sure you read and understand the content of this Operator's Guide.



After reading, please keep this Operator's Guide with the snowmobile. If the snowmobile is resold, please give the guide to the new owner for his awareness. An extra copy of the Operator's Guide is available from your Lynx snowmobile dealer at no charge.

If you have any question regarding any topic whether or not it is covered in this Operator's Guide, please send a written letter to BRP to following address:

BRP Finland OY
Service Department
P.O. Box 8039
FIN-96101 ROVANIEMI
FINLAND
Tel +358 16 3208 111

This guide uses the following safety alert symbol in conjunction with signal words to indicate a potential personal injury hazard.

 WARNING
Indicates a potentially hazardous situation which, if not avoided, could result in death or serious injury.

 **CAUTION** Indicates a potentially hazardous situation which, if not avoided, may result in minor or moderate injury. When used without the safety alert symbol , potential hazard exists for property damage only.

NOTE: Indicates supplementary information needed to fully complete an instruction.

Although the mere reading of such information does not eliminate the hazard, the understanding and application of the information will promote the correct use of the vehicle.

Your dealer is committed to your satisfaction. He has taken training to perform the initial set-up and inspection of your snowmobile as well as completed the final adjustment required to suit your specific weight and riding environment before you took possession. At delivery, your dealer would have explained the snowmobile controls and provided you with a brief explanation of the various suspension adjustments. We trust you have taken full advantage of this!

At delivery, you were also informed of the warranty coverage and have completed the Warranty Registration process.

The information and components/system descriptions contained in this guide are correct at time of publication. BRP, however maintains a policy of continuous improvement of its products without imposing upon itself any obligation to install them on products previously manufactured.

Because of its ongoing commitment to product quality and innovation, BRP reserves the right at any time to discontinue or change specifications, designs, features, models or equipment without incurring obligation.

The illustrations in this document show the typical construction of the different assemblies and, in all cases,

may not reproduce the full detail or exact shape of the parts shown, however, they represent parts which have the same or a similar function.

It is understood that this guide may be translated into another language. In the event of any discrepancy, the English version shall prevail.

Specifications are given in the SI metric system with the SAE U.S. equivalent in parentheses. Where precise accuracy is not required, some conversions are rounded off for easier use.

Most components of this snowmobile are built with parts dimensioned in the metric system. Most fasteners are metric and must not be replaced by customary fasteners or vice versa.

We recommend genuine BRP products for replacement parts and accessories. They've been specially designed for your vehicle and manufactured to meet BRP's demanding standards.

For any questions pertaining to the warranty and its application, consult the WARRANTY section in this guide, and/or an authorized Lynx dealer.

TABLE OF CONTENTS

FOREWORD	1
-----------------------	----------

SAFETY INFORMATION

IMPORTANT BASIC SAFETY MEASURES	8
Training	8
Performance	8
Age	8
Speed	8
Riding	8
Operation	9
Maintenance	10
Fuel	10
Basics for Passenger	11
LAWS AND REGULATIONS	12
RIDING THE VEHICLE	13
Principle of Operation	13
How to Ride	13
Carrying a Passenger	15
Terrain/Riding Variations	16
Transporting and Towing	20

ENVIRONMENT INFORMATION

GENERAL	22
JUST WHAT IS LIGHT TREADING?	23
WHY IS LIGHT TREADING SMART	24

VEHICLE INFORMATION

HOW TO IDENTIFY YOUR SNOWMOBILE	26
Vehicle Description Decal	26
Serial Numbers	26
CONTROLS/INSTRUMENTS/EQUIPMENT	28
1) Speedometer	31
2) Tachometer (RPM)	31
3) Gauge Digital Display	31
4) Gauge Multifunction Digital Display	33
5) Gauge Pilot Lamps	42
6) Gauge MODE (M) Button (not in 550 engine models)	45
7) Gauge SET (S) Button (not in 550 engine models)	45
8) Throttle Lever	45
9) Brake Lever	45
10) Parking Brake Lever	45
11) Multi-Switch Housing	46

CONTROLS/INSTRUMENTS/EQUIPMENT (cont'd)	
12) Handlebar	48
13) Holding Strap	48
14) Tether Cut-Out Switch	49
15) Engine Cut-Out Switch	50
16) Rewind Starter Handle	51
17) Choke Lever (550 models only)	51
18) Fuel Tank Cap	51
19) Hood and Side Panels	51
20) Fuses	52
21) Grab Handle/Bumper	53
22) Storage Compartment (Some models only)	53
23) Tool Kit	54
24) Spark Plug Storage	54
25) Spare Drive Belt Holder	54
26) Shields and Guards	54
27) Track	55
28) 1+1 Seat	55
29) Rear Passenger Heating Grip Switch	57
30) Rear Grab Handles	57
31) Rear Rack	57
32) 12-Volt Power Outlet	57
33) C-Type Hitch	57
RECOMMENDED FUEL AND OIL	60
Recommended Fuel	60
Recommended Oil	60
BREAK-IN PERIOD	62
Engine	62
Belt	62
10-Hour Inspection	62
OPERATING INSTRUCTIONS	63
Pre-Operation Check	63
Engine Starting Procedure	64
Carburetor Engine Starting Procedure (550 models)	65
Vehicle Warm-Up	65
Shifting in Reverse	66
Shutting Off the Engine	66
Post-Operation Care	67
SPECIAL OPERATING INSTRUCTIONS	68
Riding at High Altitudes	68
Riding in Cold Weather	68
Emergency Starting	68
Towing an Accessory	69
Towing Another Snowmobile	69
Transporting the Vehicle	69

SUSPENSION ADJUSTMENTS	71
Adjustable suspension	71
Front Suspension Shock Damping.....	75
Suspension Troubleshooting Chart.....	76
Deep Snow Riding	76
TROUBLESHOOTING	77
Beeper Codes	77
General.....	77
SPECIFICATIONS	80
DECLARATION OF CONFORMITY	88
<i>MAINTENANCE INFORMATION</i>	
PERIODIC MAINTENANCE CHART	90
BREAK-IN INSPECTION	91
MAINTENANCE SCHEDULE (2-STROKE)	92
PRESEASON PREPARATION	94
STORAGE	95
ENGINE SYSTEM	96
Air Intake Silencer Prefilter Verification.....	96
Air Filter with Dual Air Intake (E-TEC 800R engines only)	96
Cooling System	96
Exhaust System.....	96
DRIVE SYSTEM	97
Belt Guard Removal and Installation.....	97
Brake Fluid Level	97
Brake Condition	98
Brake Adjustment.....	98
Chaincase Oil.....	98
Drive Chain Tension.....	98
Drive Belt Inspection.....	99
Drive Belt Replacement	99
Drive Belt Height Adjustment	99
Drive Pulley Adjustment.....	101
Track Condition	102
Track Tension and Alignment.....	102
REAR SUSPENSION	106
Rear Suspension Condition	106
Suspension Stopper Strap Condition.....	106
STEERING AND FRONT SUSPENSION	107
Wear and Condition of Skis and Runners.....	107
ELECTRICAL SYSTEM	108
Recommended Spark Plug.....	108
Spark Plug Removal/Installation	108

ELECTRICAL SYSTEM (cont'd)	
Fuse Removal/Inspection	109
BODY/FRAME.....	111
Vehicle Cleaning and Protection	111
Bulb Replacement	111
Headlamp Beam Aiming.....	112
STORAGE AND PRESEASON PREPARATION.....	113
Storage.....	113
Preseason Preparation	114

WARRANTY

BRP FINLAND OY INTERNATIONAL LIMITED WARRANTY: 2011 LYNX® SNOWMOBILES	116
PRIVACY OBLIGATIONS/DISCLAIMER	119
CHANGE OF ADDRESS/OWNERSHIP.....	120

SAFETY INFORMATION

IMPORTANT BASIC SAFETY MEASURES

Training

▲ Basic training is required for the safe operation of any snowmobile. Study your Operator's Guide paying particular attention to cautions and warnings. Join your local snowmobile club: its social activities and trail systems are planned for both fun and safety. Obtain basic instructions from your snowmobile dealer, friend, fellow club member or enroll in your local training program.

▲ Always show a new operator how to start and stop the vehicle. Indicate the correct riding positions and, above all else, only allow him to operate the snowmobile in a restricted flat area — at least until he is completely familiar with its operation. If there is a local snowmobile operator's training course existing, have him enroll.

Performance

▲ The performance of some snowmobiles may significantly exceed that of other snowmobiles you have operated. Therefore, use by novice or inexperienced operators is not recommended.

▲ Snowmobiles are used in many areas and in many snow conditions. Not all models perform the same in similar conditions. Always consult your snowmobile dealer when selecting the snowmobile model for your particular needs and uses.

▲ Injury or death may result to the snowmobile operator, passenger or bystander if the snowmobile is used in risky conditions which are beyond the driver's, passenger's or snowmobile's capabilities or intended use.

Age

▲ BRP recommends the operator has at least 16 years old of age. Follow your local legislation.

Speed

▲ Speeding can be fatal. In many cases, you cannot react or respond quickly enough to the unexpected. Always ride at a speed which is suitable to the trail, weather conditions and your own ability. Know your local rules. Speed limit may be in effect and meant to be observed.

Riding

▲ Always keep right hand side of the trail.

▲ Always keep a safe distance from other snowmobiles and bystanders.

▲ Remember, promotional material may show risky maneuvers performed by professional riders under ideal and/or controlled conditions. You should never attempt any such risky maneuvers if they are beyond your level of riding ability.

▲ Never ride after consuming drugs or alcohol or if you feel tired or ill. Operate your snowmobile prudently.

▲ Your snowmobile is not designed to be operated on public streets, roads or highways.

▲ Snowmobiling at night can be a delightful experience but because of reduced visibility, be extra cautious. Avoid unfamiliar terrain and be sure your lights are working. Always carry a flashlight and spare light bulbs.

▲ Nature is wonderful but don't let it distract your attention from driving. If you want to truly appreciate winter's scenery, stop your snowmobile on the side of the trail so that **you** don't become a hazard to others.

▲ Fences represent a very serious threat for both you and your snowmobile. Give a wide berth to telephone poles or posts.

▲ Hidden wires unseen from a distance can cause serious accidents.

- ▲ Always wear an approved safety helmet, eye protection and a face shield. This also applies to your passenger.
- ▲ Be aware of inherent risks associated with riding off trails, such as avalanche and other natural or man made hazards or obstacles.
- ▲ Avoid road traveling. If you must do so, and it is permitted, reduce speed. The snowmobile is not designed to operate or turn on paving. When crossing a road, make a full stop, then look carefully in both directions before crossing at a 90° angle. Be wary of parked vehicles.
- ▲ Tailgating another snowmobile should be avoided. If the snowmobile in front of you slows for any reason, its driver and passenger could be harmed through your neglect. Maintain a safe stopping distance between you and the snowmobile in front of you. Depending on the terrain condition, stopping may require a little more space than you think. Play it safe. Be prepared to use evasive driving.
- ▲ Venturing out alone with your snowmobile could also be hazardous. You could run out of fuel, have an accident, or damage your snowmobile. Remember, your snowmobile is capable of traveling further in half an hour than you may be able to walk in a day. Use the "buddy system". Always ride with a friend or member of your snowmobile club. Even then, tell someone where you are going and the approximate time you plan to return.
- ▲ Meadows sometimes have low areas where water accumulate and freezes over in winter. This ice is usually glare ice. Attempting to turn or brake on this surface could cause your vehicle to spin out of control. Never brake or attempt speeding or turning on glare ice. If you do happen to travel over such a condition, reduce speed by carefully releasing the throttle.
- ▲ Never "jump" with your snowmobile. This should be left to professional stunt men. Don't show off. Be responsible.
- ▲ While on safari, do not "gun" the throttle. Snow and ice can be thrown back into the path of a following snowmobile. In addition, when "gunning" the throttle, the vehicle digs into and leaves an irregular snow surface for others.
- ▲ Safaris are both fun and enjoyable but don't show off or overtake others in the group. A less experienced operator might try to do the same as you and fail. When riding with others, limit your abilities to the experience of others.

Operation

- ▲ Always make a pre-start inspection BEFORE you turn on the ignition.
- ▲ In an emergency, the snowmobile engine can be stopped by activating the engine cut-out switch, pulling the tether cord cap or turning off the key.
- ▲ Throttle mechanism should be checked for free movement and return to idle position before starting engine.
- ▲ Always engage parking brake when vehicle is not in use.
- ▲ Never run the engine in a non-ventilated area and/or if vehicle is left unattended.

- ▲ Never operate the engine without belt guard securely installed or, with hood or access/side panels open or removed. Never run the engine without drive belt installed. Running an unloaded engine such as without drive belt or with track raised, can be dangerous.
- ▲ **Electric start models only:** Never charge or boost a battery while installed on snowmobile.
- ▲ Ensure the path behind is clear of obstacles or bystanders before proceeding in reverse.
- ▲ Do not leave your keys in the ignition switch, it is an invitation to thieves and a danger to young children.
- ▲ Raising the rear of your snowmobile while the engine is running could cause snow, ice or debris to be thrown back at an observer. Never raise the rear of the vehicle while the engine is running. To clear or inspect the track, stop the engine, tilt the vehicle on its side and remove blockage with a piece of wood or branch. Never allow anyone near a rotating snowmobile track.

Maintenance

- ▲ Know your snowmobile and treat it with the respect and care due of any power driven machine. Common sense, proper handling and routine maintenance will result in safer and enjoyable use.
- ▲ Only perform procedures as detailed in this guide. Unless otherwise specified, engine should be turned OFF and cold for all lubrication, adjustment and maintenance procedures.
- ▲ Never have the engine running while the hood is open. Even at idle, a snowmobile engine is turning around 1,800 revolutions per minute. Always turn off the ignition before opening the hood for any reason.

- ▲ Never remove any original equipment from your snowmobile. Each vehicle has many built in safety features. Such features include various guards and consoles, plus reflective materials and warning labels.
- ▲ A poorly maintained snowmobile itself can be a potential hazard. Excessively worn components could render the vehicle completely inoperative. Keep the snowmobile in good working condition at all times. Follow your pre-operation check, weekly, monthly and annually routine maintenance and lubrication procedures as detailed in this guide. Consult a snowmobile dealer or acquire a shop manual and proper tools and equipment if other repairs or service is required.
- ▲ Do not stud the track unless it as been approved for studs. At speed, a studded track that as not been approved for studs could tear and separate from vehicle posing a risk of severe injury or death.

Fuel

- ▲ Always stop the engine before refueling. Fuel is flammable and explosive under certain conditions. Always work in a well-ventilated area. Do not smoke or allow open flames or sparks in the vicinity. Open cap slowly. If a differential pressure condition is noticed (whistling sound heard when loosening fuel tank cap) have vehicle inspected and/or repaired before further operation. Do not overfill or top off the fuel tank before placing the vehicle in a warm area. As temperature increases, fuel expands and might overflow. Always wipe off any fuel spillage from the vehicle. Periodically verify fuel system.

Basics for Passenger

- ▲** Never ride as a passenger unless the snowmobile is equipped with a passenger seat, and sit only on the designated passenger seat.
- ▲** Always wear a DOT approved helmet and follow the same dressing guidelines as those recommended for the operator and described in this guide.
- ▲** Make sure that you are able to achieve a stable stance, both feet resting positively on the footboards of footrests with good grip, and that you are able to hold on firmly to the handholds.
- ▲** Once underway, if you feel uncomfortable or insecure for any reason, don't wait, tell the driver to slow down or stop.

LAWS AND REGULATIONS

▲ Know your local laws.

State, provincial and local government agencies have enacted laws and regulations pertaining to the safe use and operation of snowmobiles. It is your responsibility as a snowmobiler to learn and obey these laws and regulations. Respect and observance will result in safer snowmobiling for all.

Be aware of the liability property damages and insurance laws regarding your equipment.

RIDING THE VEHICLE

Before venturing on the trails, operate the snowmobile in a restricted flat area until you are completely familiar with its operation and feel comfortable that you can safely tackle a more demanding task. Have an enjoyable and safe ride.

Principle of Operation

Propulsion

Depressing throttle lever increases engine RPM causing the drive pulley to engage. Depending on models, engine RPM must be between 2500 and 4200 before drive pulley engagement will occur.

Outer sheave of drive pulley moves toward inner sheave, forcing the drive belt to move upward on the drive pulley and simultaneously forcing the sheaves apart on the driven pulley.

The driven pulley senses the load on the track and limits the belt movement. The result is an optimized speed ratio between engine RPM and the speed of the vehicle at any time.

WARNING

Never operate engine without belt guard securely installed or, with hood or access/side panels open or removed.

Power is transferred to the track through the chaincase or gearbox and drive axle.

WARNING

Always use a wide-base snowmobile mechanical stand to properly support vehicle during any track verification. Slowly accelerate engine in order to rotate track at very low speed when it is not on ground.

Turning

Handlebar controls the steering of the vehicle. As the handlebar is rotated to right or left, the skis are turned right or left to steer the snowmobile.

Stopping

Before riding your snowmobile, you should understand how to stop it. This is done by releasing the throttle and gradually depressing the brake lever on the left side of the handlebar. In an emergency, you may stop your vehicle by pressing the engine cut-out switch located near the throttle control and applying the brake. Remember, a snowmobile cannot "stop on a dime". Braking characteristics vary with deep snow, packed snow or ice. If the track is locked during hard braking, skidding may result.

How to Ride

How to Dress

Proper snowmobile clothing should be worn. It should be comfortable and not too tight. Always check the weather forecast before going on a ride. Dress for the coldest weather expected. Thermal underwear next to the skin also provides a good insulation.

DOT approved helmets are recommended at all times. They provide both warmth and reduce injury. A stocking type cap, balaclava and face mask should always be carried or worn. Goggles or a face shield that attach to the helmet are indispensable.

Hands should be protected by a pair of snowmobile gloves or mitts which have sufficient insulation and allow use of thumbs and fingers for operation of controls.

Rubber bottom boots with either a nylon or a leather top, with removable felt liners are best suited for snowmobiling.

You should keep yourself as dry as possible when snowmobiling. When you come indoors, take your snowmobile suit and boots off and make certain they dry properly.

Do not wear long scarfs and loose apparels that could get caught in moving parts.

What to Bring

Every snowmobiler should carry at least the following basic parts and tools that can help him and others in an emergency:

- this Operator's Guide
- spare spark plugs and wrench
- friction tape
- spare drive belt
- spare starter rope
- spare light bulbs
- tool kit (including at least pliers, screwdriver, adjustable wrench)
- knife
- flashlight.

Include other items depending on the length and time of your ride.

Riding Position

Your riding position and balance are the two basic principles of making your snowmobile go where you want it to. When turning on the side of a hill, you and your passenger must be ready to shift body weight to help it turn in the desired direction. Driver and passenger(s) must never attempt this maneuvering by placing feet outside of the vehicle. Experience will teach you how much lean to put into turns at different speeds and how much you will have to lean into a slope to maintain proper balance.

Generally, the riding position for best balance and control is sitting. However, the posting, kneeling or standing positions are also used under certain conditions.

The novice driver should become familiar with the snowmobile through practice on a level area at slow speeds before venturing afield.

WARNING

Do not attempt any maneuvers if they are beyond your abilities.

Sitting

Feet on the running boards, body mid-way back on seat is an ideal position when operating the snowmobile over familiar, smooth terrain. Knees and hips should remain flexible to absorb shocks.



Posting

A semi-sitting position with the body off the seat and the feet under the body in a sort of squatting posture, thus allowing the legs to absorb the shocks when traveling over uneven terrain. Avoid abrupt stops.



Kneeling

This position is achieved by placing one foot firmly on the running board and the opposite knee on the seat. Avoid abrupt stops.



Standing

Place both feet on the running boards. Knees should be flexed to absorb the shock from surface bumps. This is an effective position to see better and to shift weight as conditions dictate. Avoid abrupt stop.



Carrying a Passenger

Certain snowmobiles are designed for an operator only, others can allow one passenger only, and others can allow up to two passengers. Refer to the registration papers on the vehicles to know if any particular snowmobile can accommodate passengers or not, and if so, how many. Always respect those indications. Overloading is dangerous because snowmobiles are not designed for it.

Even when passengers are allowed, you must make sure that the persons who would like to become passengers are physically fit for snowmobiling.

⚠ WARNING

Any passenger must be able to firmly lay his feet on the footrests and keep his hands on the grab handles or seat strap at all times when seated. Respecting those physical criteria is important to ensure that the passenger is stable and to reduce the risks of ejection.

Each operator has a responsibility to ensure the safety of his passengers and should inform them of snowmobiling basics.

⚠ WARNING

- Passengers must only sit on designated passenger seats. Never allow anyone to sit between the handlebar and the operator.
- Each passenger seat must have a strap or grab handles and meet SSCC standards.
- Passengers and operators must always wear DOT approved helmets and warm clothing appropriate for snowmobiling. Make sure that no skin is exposed.
- Once underway, if a passenger feels uncomfortable or unsecure for any reason, he must not wait, and tell the driver to slow-down or stop.

Riding with passengers on board is different than riding alone. The operator has the benefit of knowing what will be the next maneuver and is able to prepare himself accordingly. The operator also benefits from the support of his grip on the handlebar. In contrast, the passengers have to rely on the operator's careful and safe operation of

the vehicle. In addition, “body english” is limited with passengers, and the operator can sometimes see more of the trail ahead than the passengers. Therefore, smooth starting and stopping are required with passengers, and the operator must slow down. The operator must also warn passengers of side hills, bumps, branches, etc. An unforeseen bump can leave you passenger-less. Remind your passengers to lean into the turn with you, without causing the vehicle to topple. Be extremely careful, go more slowly and check the passengers frequently.

⚠ WARNING

When riding with a passenger:

- Braking ability and steering control are reduced. Decrease speed and allow extra space to maneuver.
- Adjust suspension according to weight.

For complete information on how to adjust the suspension, please refer to the section of this Operator’s Guide entitled SUSPENSION ADJUSTMENTS under OPERATING INSTRUCTIONS and to the relevant label on the belt guard.

Use extra caution and go even more slowly with young passengers. Check frequently to make certain the child has a firm grip and is properly positioned with his feet on the running boards.

Terrain/Riding Variations

Groomed Trail

On a maintained trail, sitting is the most preferred riding position. Do not race and, above all, keep to the right hand side of the trail. Be prepared for the unexpected. Observe all trail signs. Do not zigzag from one side of the trail to the other.

Ungroomed Trail

Unless there has been a fresh snowfall you can expect “washboard” and snowdrift conditions. Taken at excessive speeds, such conditions can be physically harmful. Slow down. Hold on the handlebar and assume a posting position. Feet should be under the body assuming a crouched position to absorb any jarring effect. On longer stretches of “washboard” trails, the kneeling position of one knee on the seat can be adopted. This provides a certain amount of comfort, while at the same time keeps the body loose and capable of vehicle control. Beware of hidden rocks or tree stumps partially hidden by a recent snowfall.

Deep Snow

In deep “powder” snow, your vehicle could begin to “bog” down. If this occurs, turn in as wide an arc as possible and look for a firmer base. If you do get “bogged”, and it happens to everyone, do not spin your track as this makes the vehicle sink deeper. Instead, turn the engine off, get off and move the back of the vehicle onto new snow. Then tramp a clear path ahead of the vehicle. A few feet will generally suffice. Restart the engine. Assume the standing position and rock the vehicle gently as you steadily and slowly apply the throttle. Depending on whether the front or rear end of the vehicle is sinking, your feet should be placed on the opposing end of the running boards. Never place foreign material beneath the track for support. Do not allow anyone to stand in front of, or to the rear of, the snowmobile with the engine running. Stay away from the track. Personal injury will result if contact is made with the revolving track.

Frozen Water

Traveling frozen lakes and rivers can be fatal. Avoid waterways. If you are in an unfamiliar area, ask the local authorities or residents about the ice condi-

tion, inlets, outlets, springs, fast moving currents or other hazards. Never attempt to operate your snowmobile on ice that may be too weak to support you and the vehicle. Operating a snowmobile on ice or icy surfaces can be very dangerous if you do not observe certain precautions. The very nature of ice is foreign to good control of a snowmobile or any vehicle. Traction for starting, turning or stopping is much less than that on snow. Thus, these distances can be multiplied manyfold. Steering is minimal, and uncontrolled spins are an ever present danger. When operating on ice, drive slowly with caution. Allow yourself plenty of room for stopping and turning. This is especially true at night.

Hard Packed Snow

Don't underestimate hard packed snow. It can be difficult to negotiate as both skis and track do not have as much traction. Best advice is to slow down and avoid rapid acceleration, turning or braking.

Uphill

There are two types of hills you can encounter — the open hill on which there are few trees, cliffs or other obstacles, and a hill that can only be climbed directly. On an open hill, the approach is to climb it by side hilling or slaloming. Approach at an angle. Adopt a kneeling position. Keep your weight on the uphill side at all times. Maintain a steady, safe speed. Continue as far as you can in this direction, then switch to an opposite hill angle and riding position.

A direct climb could present problems. Choose the standing position, accelerate before you start the climb and then reduce throttle pressure to prevent track slippage.

In either case, vehicle speed should be as fast as the incline demands. Always slow down as you reach the crest. If you cannot proceed further, don't spin

your track. Turn the engine off, free the skis by pulling them out and downhill, place the rear of the snowmobile uphill restart the engine and ease it out with slow even throttle pressure. Position yourself to avoid tipping over, then descend.

Downhill

Downhill driving requires that you have full control of your vehicle at all times. On steeper hills, keep your center of gravity low and both hands on the handlebar. Maintain slight throttle pressure and allow the machine to run downhill with the engine operating. If a higher than safe speed is reached, slow down by braking but apply the brake with frequent light pressure. Never jam the brake and lock the track.

Side Hill

When crossing a side hill or traversing up or downhill, certain procedures must be followed. All riders should lean towards the slope as required for stability. The preferred operating positions are the kneeling position, with the knee of the down hill leg on the seat and the foot of the uphill leg on the running board, or the posting position. Be prepared to shift your weight quickly as needed. Side hills and steep slopes are not recommended for a beginner or a novice snowmobiler.

Slush

Slush should be avoided at all times. Always check for slush before starting across any lake or river. If dark spots appear in your tracks, get off the ice immediately. Ice and water can be thrown rearward into the path of a following snowmobile. Getting a vehicle out of a slush area is strenuous and in some cases, impossible.

Fog or Whiteouts

On land or water, fog or visibility-limiting snow can form. If you have to proceed into the fog or heavy snow, do

so slowly with your lights on and watch intently for hazards. If you are not sure of your way, do not proceed. Keep a safe distance behind other snowmobilers to improve visibility and reaction time.

Unfamiliar Territory

Whenever you enter an area that is new to you, drive with extreme caution. Go slow enough to recognize potential hazards such as fences or fence posts, brooks crossing your path, rocks, sudden dips, guy wires and countless other obstacles which could result in a termination of your snowmobile ride. Even when following existing tracks, be cautious. Travel at a speed so you can see what is around the next bend or over the top of the hill.

Bright Sunshine

Bright sunny days can considerably reduce your vision. The glare from sun and snow may blind you to the extent that you cannot easily distinguish ravines, ditches or other obstacles. Goggles with colored lenses should always be worn under these conditions.

Unseen Obstruction

There may be obstructions hidden beneath the snow. Driving off established trails and in the woods requires reduced speed and increased vigilance. Driving too fast in an area can make even minor obstacles very hazardous. Even hitting a small rock or stump could throw your snowmobile out of control and cause injury to its riders. Stay on established trails to reduce your exposure to hazards. Be safe, slow down and enjoy the scenery.

Hidden Wires

Always be on the lookout for hidden wires, especially in areas that may have been farmed at one time or any other. Too many accidents have been

caused by running into wires in the fields, guy wires next to poles and roads, and into chains and wires used as road closures. Slow speeds are a must.

Obstacles and Jumping

Unplanned jumps of snowdrifts, snowplow ridges, culverts or indistinguishable objects can be dangerous. You can avoid them by wearing the proper color lenses or face shields and by operating at a lower speed.

Jumping a snowmobile is an unsafe and dangerous practice. However, if the trail does suddenly drop away from you, crouch (stand) towards the rear of the vehicle and keep the skis up and straight ahead. Apply partial throttle and brace yourself for the impact. Knees must be flexed to act as shock absorbers.

Turning

Depending on terrain conditions, there are two preferred ways to turn or corner a snowmobile. For most snow surfaces, "body english" is the key to turning. Leaning towards the inside of the turn and positioning body weight on the inside foot will create a "banking" condition beneath the track. By adopting this position and positioning yourself as far forward as possible, weight will be transferred to the inside ski.

On occasion, you will find that the only way to turn the vehicle about in deep snow is to pull the snowmobile around. Do not over-exert yourself. Get assistance. Remember to always lift using your legs as opposed to your back.



Road Crossing

In some cases, you will be approaching the road from a ditch or snowbank. Choose a place where you know you can climb without difficulty. Use the standing position and proceed with only as much speed needed to crest the bank. Stop completely at the top of the bank and wait for all traffic to clear. Judge the drop to the roadway. Cross the road at a 90° angle. If you encounter another snowbank on the opposite side, position your feet near the rear of the vehicle. Remember, your snowmobile is not designed to operate on bare pavement and steering on this type of surface is more difficult.

Railroad Crossing

Never ride on railroad tracks. It is illegal. Railroad tracks and railroad rights-of-way are private property. A snowmobile is no match for a train. When crossing a railroad track, stop, look and listen.

Night Rides

The amount of natural and artificial light at a given time can effect your ability to see or to be seen. Nighttime snowmobiling is delightful. It can be a unique experience if you acknowledge your reduced visibility. Before you start, make certain your lights are clean and work properly. Drive at speeds that will allow you to stop in time when you see an unknown or dangerous object ahead. Stay on established trails and never operate in

unfamiliar territory. Avoid rivers and lakes. Guy wires, barbed wire fences, cabled road entrances and other objects such as tree limbs are difficult to see at night. Never drive alone. Always carry a flashlight. Keep away from residential areas and respect the right of others to sleep.

Safari Riding

Before starting out, designate a "trail boss" to lead the party and another person to follow-up at the end of the party. Ensure that all members of the party are aware of the proposed route and destination. Make certain that you are carrying all necessary tools and equipment and that you have sufficient fuel to complete the trip. Never overtake the trail boss or, for that matter, any other snowmobile. Use down-the-line hand signals to indicate hazards or intent of direction change. Assist others whenever necessary.

It is always IMPORTANT to keep a safe distance between each snowmobile. Always maintain a safe interval and allow sufficient stopping distance. Don't be a tailgater. Know the position of the machine ahead.

Signals

If you intend to stop, raise either hand straight above your head. A left turn is indicated by extending your left hand straight out in the proper direction. For right turns, extend the left arm and raise the hand to a vertical position so it forms a right angle at the elbow. Every snowmobiler should relay any signal to the ones behind.

Trail Stops

Whenever possible, pull off the trail when you stop. This will reduce the hazard to other snowmobilers using the trail.

Trails and Signs

Trail signs are used to control, direct or regulate the use of snowmobiles on trails. Become familiar with all signs used in the area where you are snowmobiling.

Transporting and Towing

Follow transporting and towing instructions explained further in this guide.

ENVIRONMENT INFORMATION

GENERAL

Wildlife compliments your snowmobiling day. Snowmobile tracks provide firm ground over which animals can travel from area to area. Do not violate this privilege by chasing or harassing wildlife. Fatigue and exhaustion can lead to animal's death. Avoid areas posted for the protection or feeding of wildlife.

If you happen to be fortunate enough to see an animal, stop your snowmobile and observe quietly.

The guidelines that we support are not designed to limit your snowmobiling fun, but to preserve the beautiful freedom that you can experience only on a snowmobile! These guidelines will keep snowmobilers healthy, happy and able to introduce others to what they know and enjoy about their favorite winter pastime. So, the next time you hit the trails on a cool, crisp and clear winter day, we ask you to remember that you are paving the way for the future of our sport. Help us lead it down the right path! From all of us at BRP, thank you for doing your share.

There is nothing more exhilarating than snowmobiling. Venturing onto snowmobile trails that criss-cross the wild areas of forests an exciting and healthy winter sport. However, as the number of people using these recreational parks increases, so does the potential for damage to the environment. Abuse of land, facilities and resources inevitably leads to restrictions and closures of both private and public land.

In essence, the greatest threat to our sport, is all around us. Which leaves us with one logical choice. When we snowmobile, we must always ride responsibly.

The vast majority respect the law and the environment. Each of us must set an example for those who are new to the sport, young and old alike.

It is in every one's best interest to tread lightly into our recreational areas. Because, in the long run, to protect the sport we must preserve the environment.

Recognizing the importance of this issue and the need for snowmobilers to do their share in preserving areas that make it possible to enjoy our sport, BRP has developed the "Light Treading Is Smart Sledding" campaign for snowmobilers.

Light Treading refers to more than the tread of our tracks. It's a statement of concern, respect and willingness to take the lead and take action. It applies to the environment in general, its proper care and maintenance, its natural inhabitants and all enthusiasts and the public at large who enjoy the great outdoors. With this theme, we invite all snowmobilers to remember that respecting the environment is not only critical to the future of our industry but to future generations.

Light Treading in no way suggests you should curb your appetite for snowmobiling fun! It simply means tread with respect!

JUST WHAT IS LIGHT TREADING?

The fundamental objective of Light Treading is one of respect for where and how you ride a snowmobile. You're a light treader when you follow the principles below.

Become informed. Obtain maps, regulations and other information from the Forest Service or from other public land agencies. Learn the rules and follow them and that goes for speed limits, too!

Avoid running over young trees, shrubs, and grasses and don't cut wood. On flatlands or areas where trail riding is popular, it's important to ride only where authorized. Remember, there is a link between protecting your environment and your own safety.

Respect wildlife and be particularly sensitive of animals that are rearing young or suffering from food shortage. Stress can sap scarce energy reserves. Refrain from riding in areas where only animals are intended to tread!

Obey gate closures and regulatory signs and remember, light treaders don't litter!

Stay out of wilderness areas. They're closed to all vehicles. Know where the boundaries are.

Obtain permission to travel across private land. Respect the rights of landowners and other people's privacy. Remember, snowmobile technology has lowered the noise factor considerably, but you still shouldn't rev your engines where quiet "is the order of the day".

WHY IS LIGHT TREADING SMART

Snowmobilers know all too well the efforts that have been made throughout the sport's history to enjoy access to areas where people can snowmobile safely and responsibly. This effort continues today, as strong as ever.

Respecting the areas where we ride... wherever they may be... is the only way to ensure their future enjoyment. That's one major reason why we know you'll agree that Light Treading is smart sledding! And there are more.

Enjoying the opportunity to see winter and all its natural majestic wonders, is an experience cherished by snowmobilers. Light Treading will preserve this opportunity and will make it possible for us to expose others to the beauty of winter and the unique thrill of our sport! Light Treading will help our sport to grow!

Finally, Light Treading is the sign of a smart snowmobiler. You don't have to leave big tracks or careen through a virgin forest to show you can ride. So whether you're driving a high performance Lynx, a sporty Lynx RE-X snowmobile or any other make or model, show you know what you're doing. Show you know how to send snow flying and make tracks with a light touch!

VEHICLE INFORMATION

HOW TO IDENTIFY YOUR SNOWMOBILE

Vehicle Description Decal

Vehicle description decal is located on right hand side of tunnel.



TYPICAL

1. Vehicle description decal

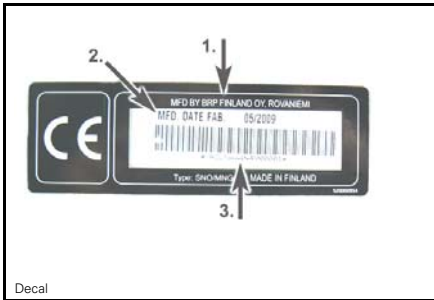

VEHICLE DESCRIPTION DECAL

1. Manufacturer name
2. Manufacturing date
3. Vehicle identification number (VIN)

Serial Numbers

The main components of your snowmobile (engine and frame) are identified by different serial numbers. It may sometimes become necessary to locate these numbers for warranty purposes or to trace your snowmobile in the event of loss. These numbers are required by the authorized Lynx dealer to complete warranty claims properly. No warranty will be allowed by BRP if the engine serial number or vehicle identification number (VIN) is removed or mutilated in any way. We strongly recommend that you take note of all the serial numbers on your snowmobile and supply them to your insurance company.

Vehicle Identification Number (VIN) Location

VIN is scribed on vehicle description decal. See above. It is also engraved on tunnel near vehicle description decal.

Model Number Location

Model number is part of vehicle identification number (VIN).

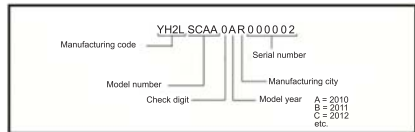

VIN DESCRIPTION

Engine Serial Number Location

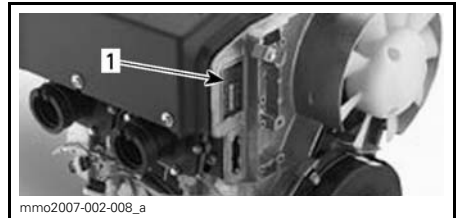

550 ENGINE

1. Engine serial number

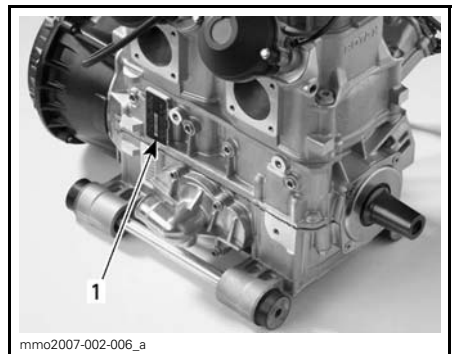

800R E-TEC ENGINE

1. Engine serial number

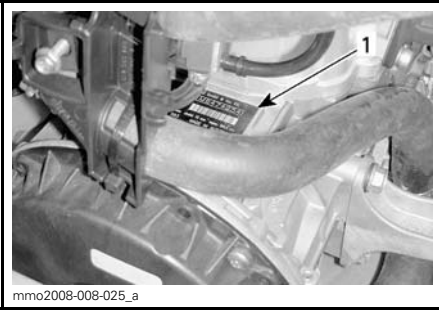

**600 HO E-TEC® ENGINE — RH SIDE OF
ENGINE COMPARTMENT**

1. Engine serial number

CONTROLS/INSTRUMENTS/EQUIPMENT

NOTE: Some controls/instruments/equipment do not apply or are optional on some models. In these cases their reference numbers are deliberately missing in the illustrations.

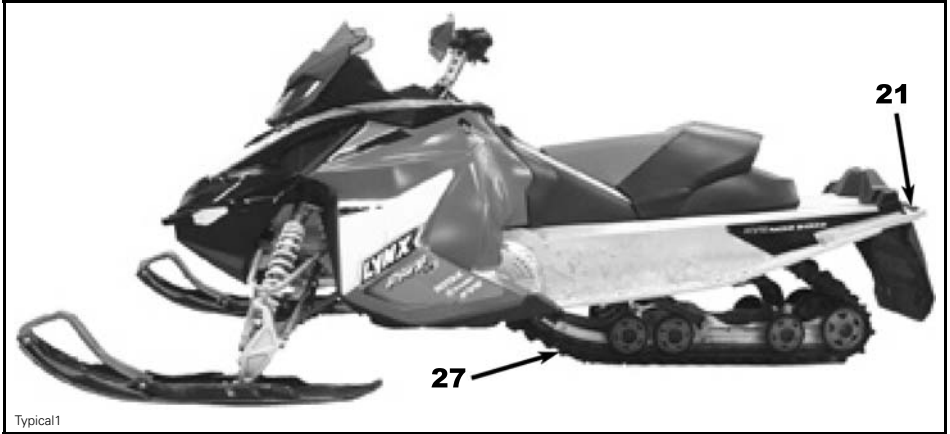

TYPICAL

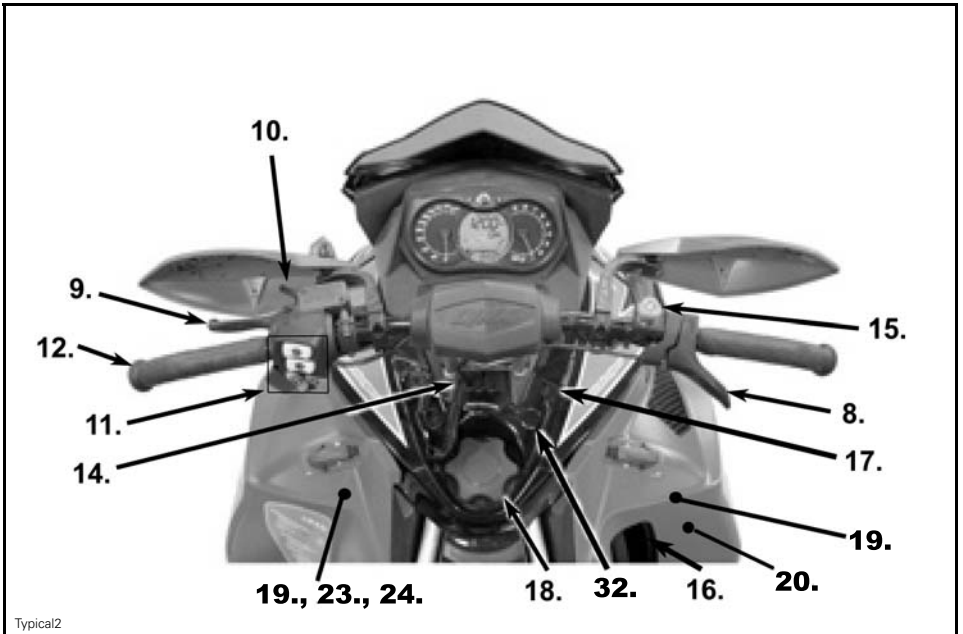

TYPICAL

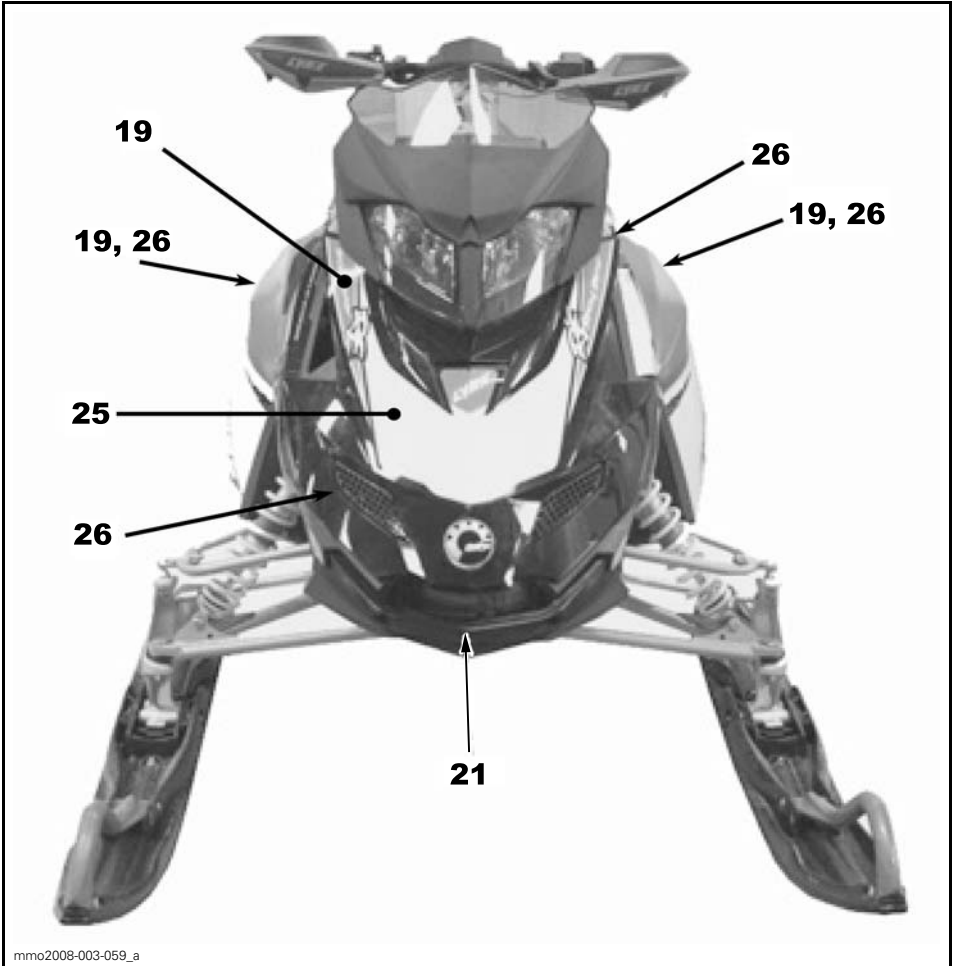

mmo2008-003-059_a

TYPICAL

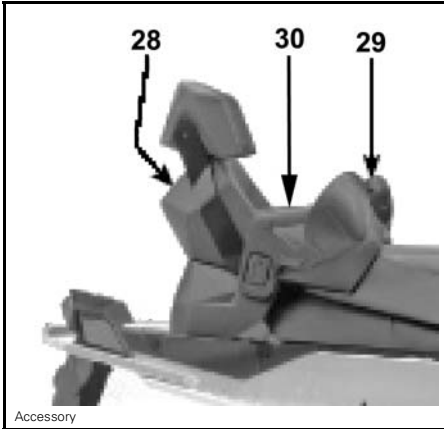

ACCESSORY

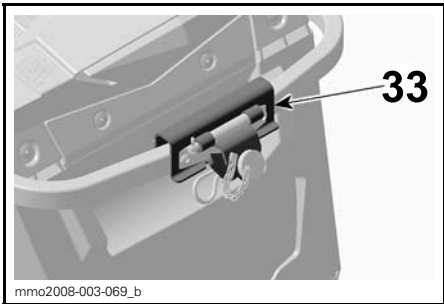
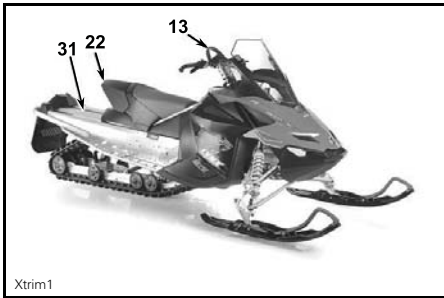

XTRIM MODELS ONLY

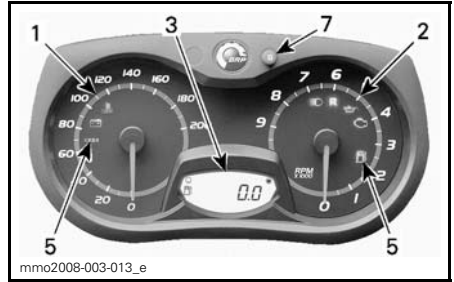

ANALOG/DIGITAL GAUGE

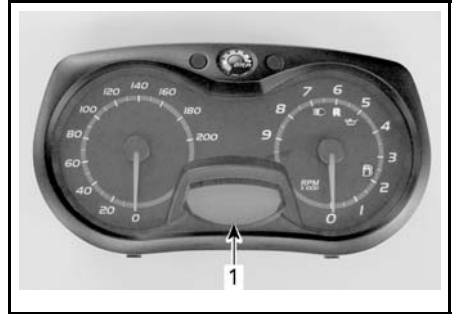

ANALOG/DIGITAL GAUGE

1. Digital display

NOTE: Some features are not applicable to all models or may be available as an option.

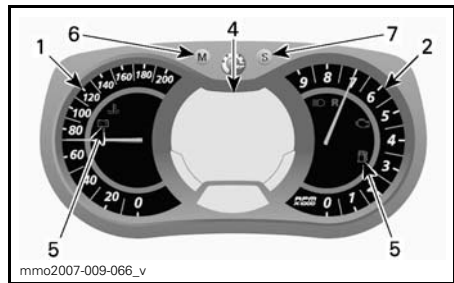

MULTIFUNCTION ANALOG/DIGITAL GAUGE

1. Speedometer
2. Tachometer (RPM)
3. Gauge Digital Display
4. Gauge Multifunction Digital Display
5. Gauge Pilot Lamps
6. Gauge MODE (M) Button
7. Gauge SET (S) Button
8. Throttle Lever
9. Brake Lever
10. Parking Brake Lever
11. Multi-Switch Housing
12. Handlebar
13. Holding Strap
14. Tether Cut-Out Switch
15. Engine Cut-Out Switch
16. Rewind Starter Handle
17. Choke Lever
18. Fuel Tank Cap
19. Hood and Side Panels
20. Fuses
21. Grab Handle/Bumper
22. Storage Compartment
23. Tool Kit
24. Spark Plug Storage
25. Spare Drive Belt Holder
26. Shields and Guards
27. Track
28. 1+1 Seat
29. Rear Passenger Heating Grip Switch
30. Rear Grab Handles
31. Rear Rack
32. 12-Volt Power Outlet
33. C-Type Hitch

1) Speedometer

Measures vehicle speed in miles or kilometers.

The speedometer is factory preset in Metric units but it is possible to change it to Imperial units, contact an authorized LYNX dealer for unit settings.

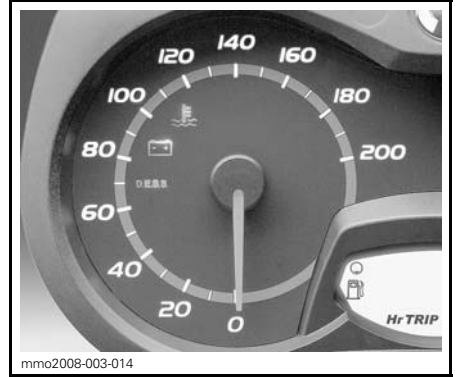

LH PORTION OF GAUGE

2) Tachometer (RPM)

Measures engine revolution per minute (RPM). Multiply by 1000 to obtain the actual revolutions.



RH PORTION OF GAUGE

3) Gauge Digital Display

Digital display that supplies several real time useful information to the driver.

⚠ WARNING

Reading the gauge digital display can distract from the operation of the vehicle, particularly from constantly scanning the environment. This could lead to a collision resulting in severe injuries or death. Before reading the gauge digital display, ensure your environment is clear and free from obstacle, and bring the vehicle to a low speed. Before proceeding with any adjustments, park vehicle in a safe place and away from the trail.

The digital display is factory preset in Metric units but it is possible to change it to Imperial units, contact an authorized LYNX dealer for unit settings.

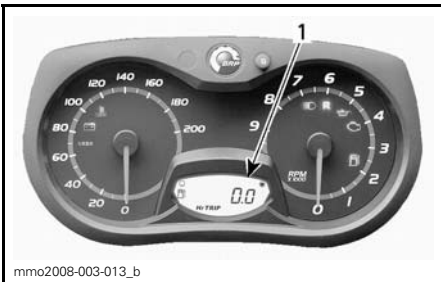

ANALOG/DIGITAL GAUGE
1. Digital display

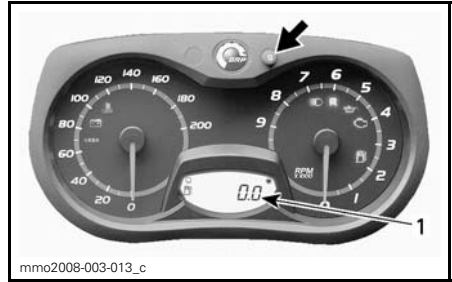

1. Odometer (Km/Mi) mode

B) Trip Meter "A" or "B" (not in 550 engine models)

Trip meters records distance travelled since it has been reset.

Push the SET (S) button to select trip meter (TRIP A/TRIP B) mode.

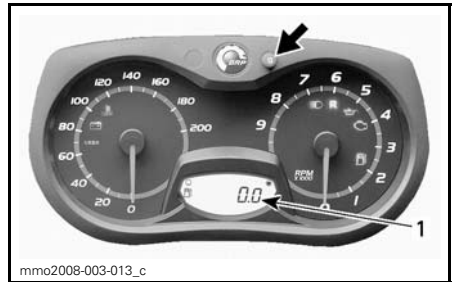

1. Trip meter (TRIP A/TRIP B) mode

Push and hold the SET (S) button to re-set.

DISPLAY FEATURES	
FUNCTIONS	REFER TO TOPICS
Odometer	A)
Trip meter "A" or "B"	B)
Trip hour meter	C)
Fuel level	D)

A) Odometer

Records the total distance travelled.

Push the SET (S) button to select odometer (Km/Mi) mode.



C) Trip Hour Meter (not in 550 engine models)

Records vehicle running time when the electrical system is activated since it has been reset.

Push the SET (S) button to select trip hour meter (HrTRIP) mode.

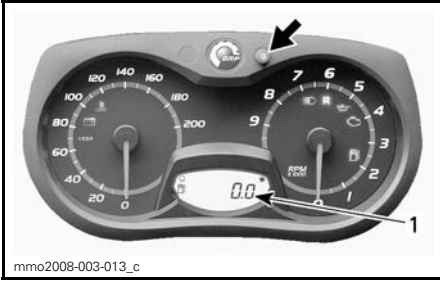

1. Trip hour meter (HrTRIP) mode

Push and hold the SET (S) button to reset.



D) Fuel Level

Bar gauge that continuously indicates the amount of fuel left in the fuel tank.

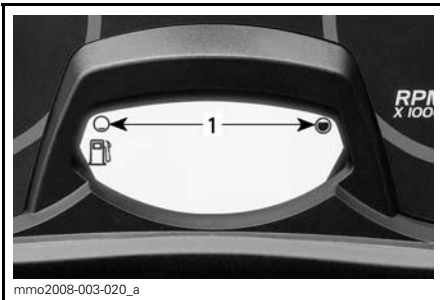

FUEL LEVEL

1. Operating range

4) Gauge Multifunction Digital Display

Multifunction digital display that supplies several real time useful information to the driver in English.

⚠ WARNING

Reading the gauge digital display can distract from the operation of the vehicle, particularly from constantly scanning the environment. This could lead to a collision resulting in severe injuries or death. Before reading the gauge digital display, ensure your environment is clear and free from obstacle, and bring the vehicle to a low speed. Before proceeding with any adjustments, park vehicle in a safe place and away from the trail.

Also, the multifunction digital display is factory preset in Metric units but it is possible to change it to Imperial units, contact an authorized LYNX dealer for unit settings.

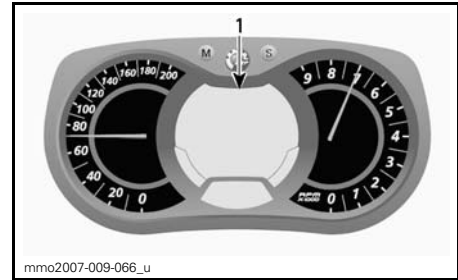

MULTIFUNCTION ANALOG/DIGITAL GAUGE
1. Multifunction display

DISPLAY FEATURES	
FUNCTIONS	REFER TO TOPICS
Speedometer	A)
Tachometer (RPM)	B)
Odometer	C)
Trip meter "A" or "B"	D)
Trip hour meter	E)
Fuel level	F)
Altitude	G)
Top speed	H)
Average speed	I)
Heated grips heating intensity	J)
Heated throttle lever heating intensity	K)
Instant fuel consumption	L)
Total fuel consumption	M)
Message Display	N)

A) Speedometer

In addition of the analog type speedometer, vehicle speed can also be displayed via the multifunction display.

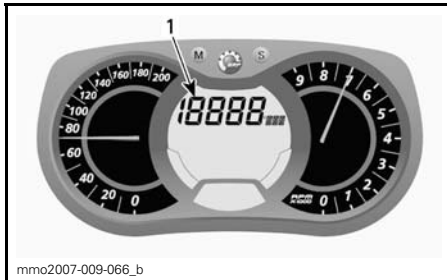

1. Vehicle speed display

To display vehicle speed, proceed as follow.

Push the MODE (M) button to select display.



NOTE: Display will flash for approximately 5 seconds, then will return to the previously selected mode if display is not changed.

Push the SET (S) button to select speedometer (Km/h/MPH) mode.

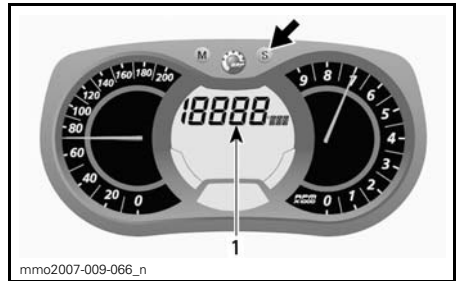

1. Speedometer (Km/h/MPH) mode

Push the MODE (M) button to confirm selection or wait 5 seconds.

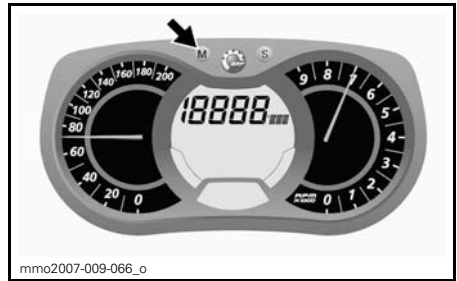

B) Tachometer (RPM)

In addition of the analog type tachometer, RPM can also be displayed via the multifunction display.

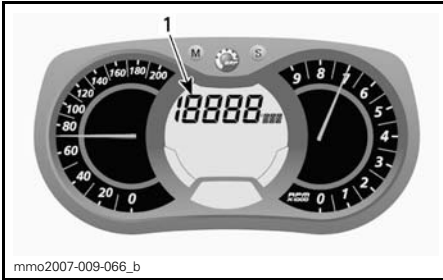

1. RPM display

To display RPM, proceed as follow.

Push the MODE (M) button to select display.

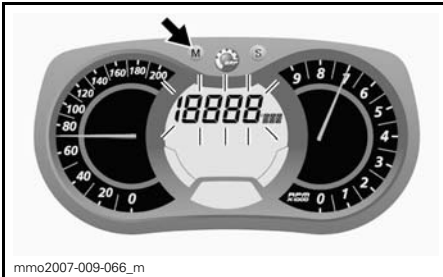

NOTE: Display will flash for approximately 5 seconds, then will return to the previously selected mode if display is not changed.

Push SET (S) button to select RPM mode.

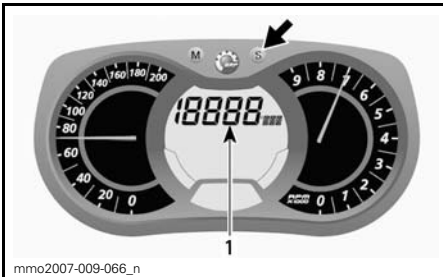

1. RPM mode

Push the MODE (M) button to confirm selection or wait 5 seconds.

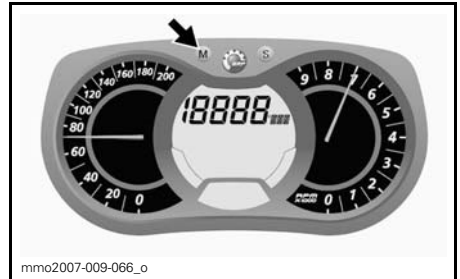

C) Odometer

Records the total distance travelled.

Push the SET (S) button to select odometer (Km/Mi) mode.

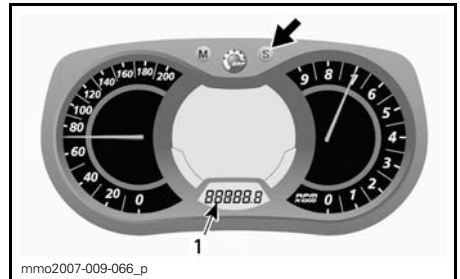

1. Odometer (Km/Mi) mode

D) Trip Meter "A" or "B"

Trip meters records distance travelled since it has been reset.

Push the SET (S) button to select trip meter (TRIP A/TRIP B) mode.

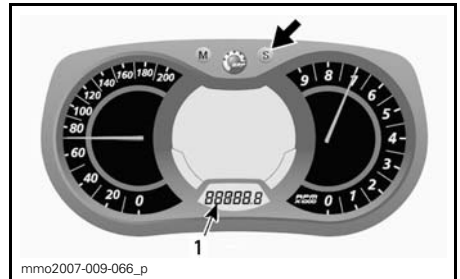

1. Trip meter (TRIP A/TRIP B) mode

Push and hold the SET (S) button to re-set.

NOTE: On E-TEC models, resetting TRIP B mode will also reset TOTAL FUEL CONSUMPTION.

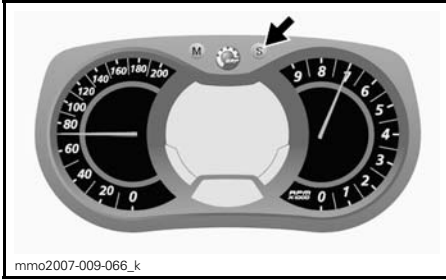

E) Trip Hour Meter

Records vehicle running time when the electrical system is activated since it has been reset.

Push the SET (S) button to select trip hour meter (HrTRIP) mode.

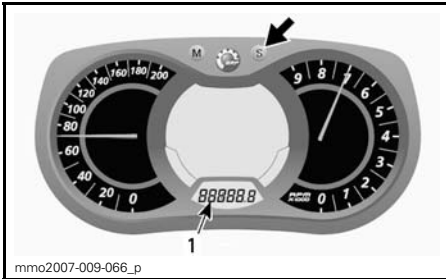

1. Trip hour meter (HrTRIP) mode

Push and hold the SET (S) button to re-set.

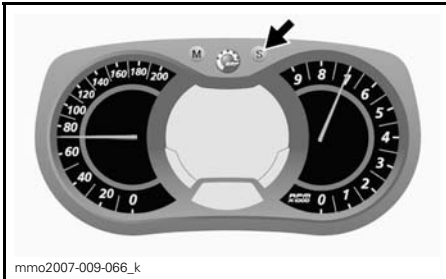

F) Fuel Level

Bar gauge that continuously indicates the amount of fuel left in the fuel tank.

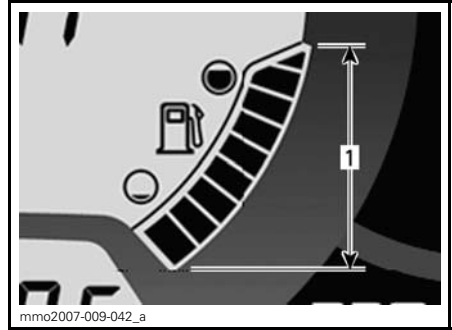

FUEL LEVEL

1. Operating range

G) Altitude

Displays vehicle altitude above sea level in meters or feet.

Vehicle altitude can be displayed via **display 1** or **display 2** of the multifunction display.

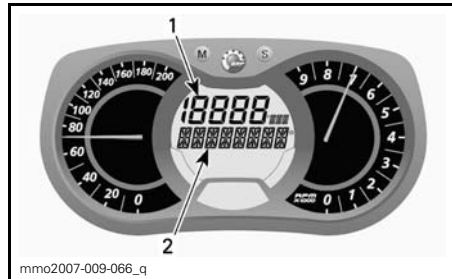

MULTIFUNCTION DISPLAY

1. Display 1
2. Display 2

Via Display 1

To display vehicle altitude via **display 1**, proceed as follow.

Push the MODE (M) button to select display.



NOTE: Display will flash for approximately 5 seconds, then will return to the previously selected mode if display is not changed.

Push the SET (S) button to select altitude (M/FT) mode.



Via Display 2

To display vehicle altitude via **display 2**, proceed as follow.

Push the MODE (M) button 2 times within a second to select display.

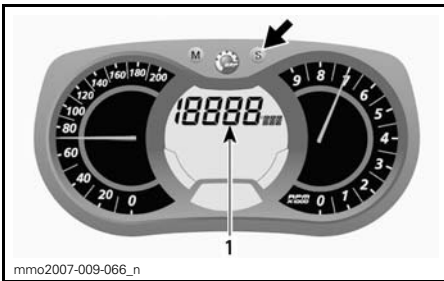

1. Altitude (M/FT) mode

Look for the following symbol to ensure proper mode.



ALTITUDE MODE

Push the MODE (M) button to confirm selection or wait 5 seconds.

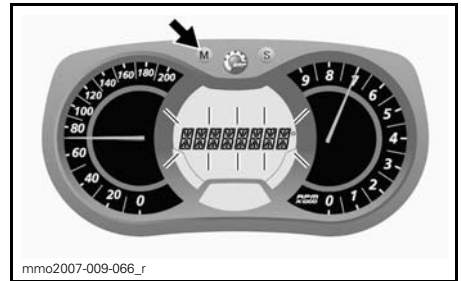

NOTE: Display will flash for approximately 5 seconds, then will return to the previously selected mode if display is not changed.

Push the SET (S) button to select altitude (M/FT) mode.

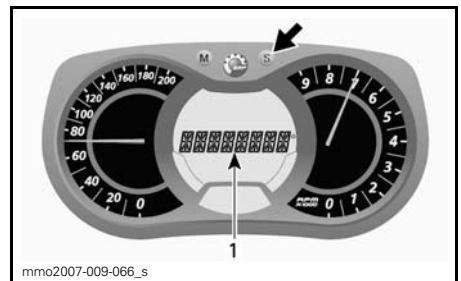

1. Altitude (M/FT) mode

Look for the following symbol to ensure proper mode.

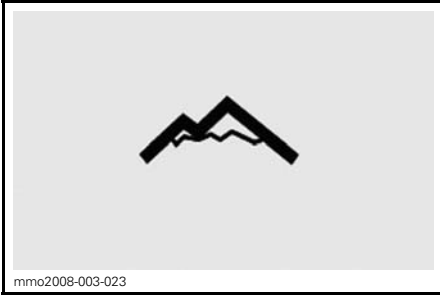

ALTITUDE MODE

Push MODE (M) button to confirm selection or wait 5 seconds.

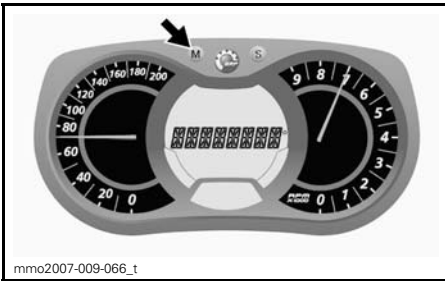

H) Top Speed

Records vehicle top speed since it has been reset.

To display vehicle top speed, proceed as follow.

Push the MODE (M) button to select display.

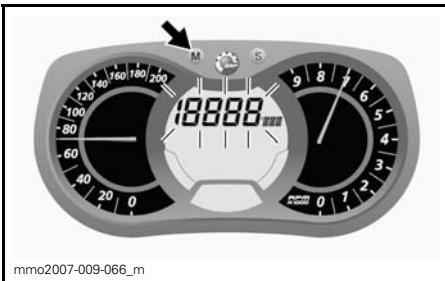

NOTE: Display will flash for approximately 5 seconds, then will return to the previously selected mode if display is not changed.

Push the SET (S) button to select top speed (TOP_SPD) mode.

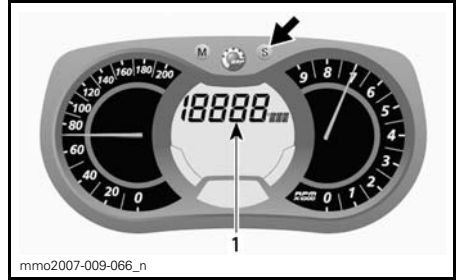

1. Top speed (TOP_SPD) mode

Push the MODE (M) button to confirm selection or wait 5 seconds.

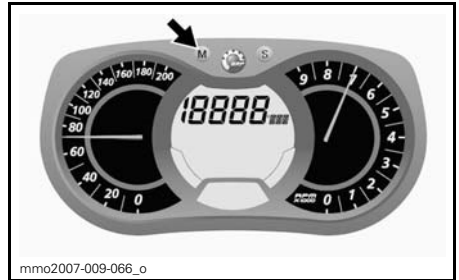

To reset, push the MODE (M) to select mode.

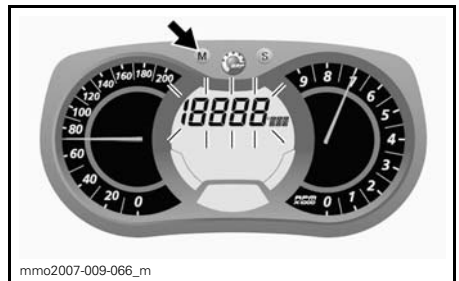

Push and hold the SET (S) button within 5 seconds to reset.

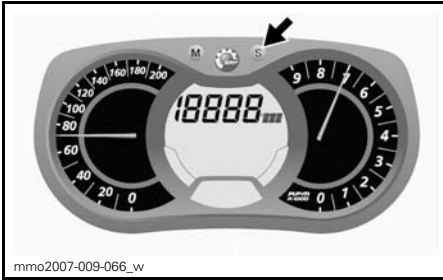

Push the MODE (M) button to confirm selection or wait 5 seconds.

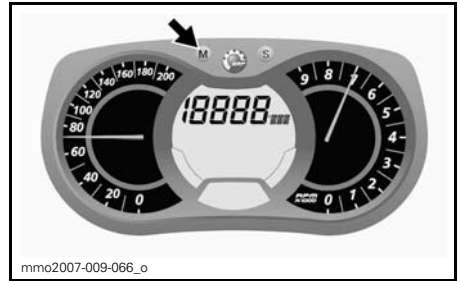

To reset, push the MODE (M) to select mode.

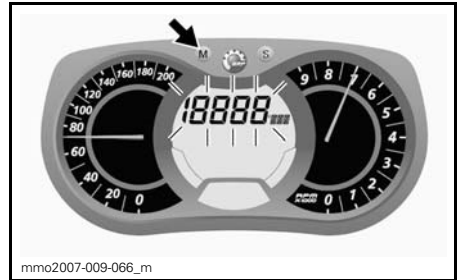

Push and hold the SET (S) button within 5 seconds to reset.

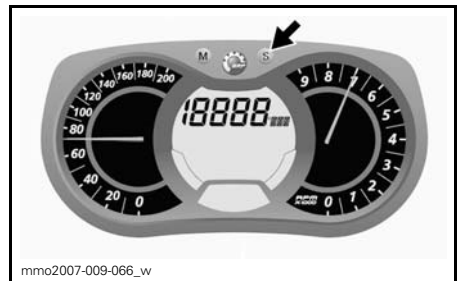

J) Heated Grips Heating Intensity

Bar gauge that indicates heating intensity.

Refer to *HEATING GRIPS SWITCH* for more details.

I) Average Speed

Records vehicle average speed since it has been reset.

To display vehicle average speed, proceed as follow.

Push the MODE (M) button to select display.

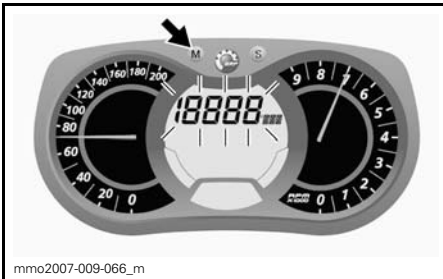

NOTE: Display will flash for approximately 5 seconds, then will return to the previously selected mode if display is not changed.

Push SET (S) button to select vehicle average speed (AVR_SPD) mode.

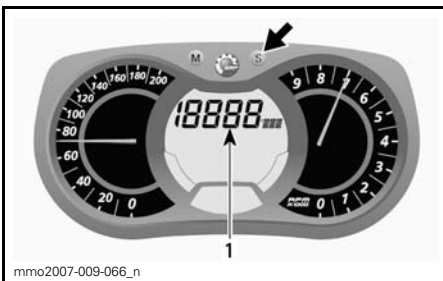

1. Vehicle average speed (AVR_SPD) mode

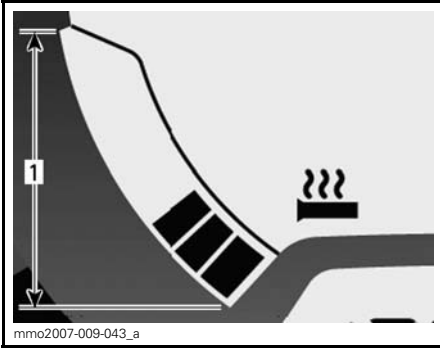

HEATING GRIPS

1. Operating range

K) Heated Throttle Lever Heating Intensity

Bar gauge that indicates heating intensity.

Bar gauge will be displayed instead of the fuel level with the activation of the heating throttle lever switch. When released, display will return to fuel level.

Refer to *HEATING THROTTLE LEVER SWITCH* for more details.

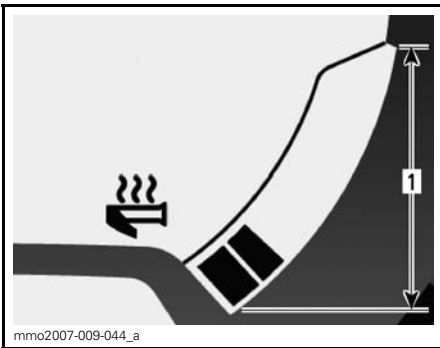

HEATING THROTTLE LEVEL

1. Operating range

L) Instant Fuel Consumption

E-TEC Models Only

Calculates vehicle average fuel consumption while riding.

To display vehicle average fuel consumption, proceed as follow.

Push the MODE (M) button to select display.



NOTE: Display will flash for approximately 5 seconds, then will return to the previously selected mode if display is not changed.

Push SET (S) button to select instant fuel consumption (L/100 km) mode.

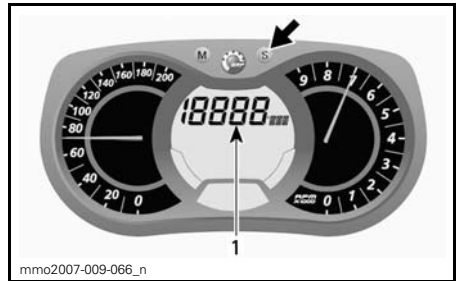

1. Instant fuel consumption (L/100 km) mode

Push the MODE (M) button to confirm selection or wait 5 seconds.

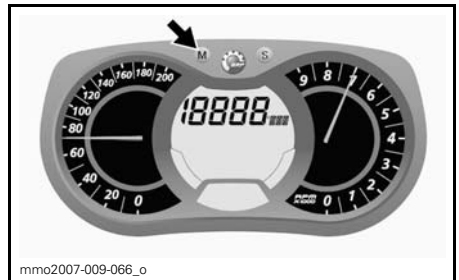

M) Total Fuel Consumption

E-TEC Models Only

Records vehicle average fuel consumption since it has been reset.

To display vehicle total fuel consumption, proceed as follow.

Push the MODE (M) button to select display.



NOTE: Display will flash for approximately 5 seconds, then will return to the previously selected mode if display is not changed.

Push the SET (S) button to select total fuel consumption (TC) mode.

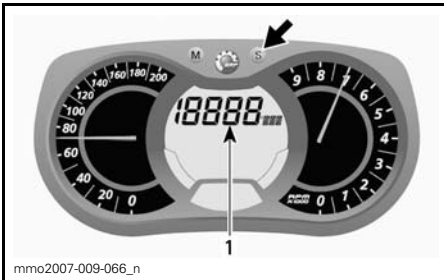

1. Total fuel consumption (TC) mode

Look for the abbreviation (TC) to ensure proper mode.

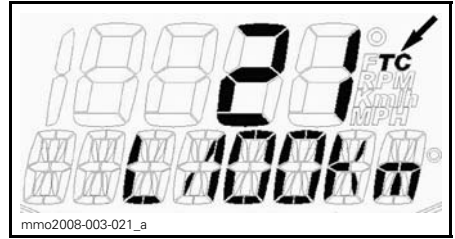

TYPICAL

Push the MODE (M) button to confirm selection or wait 5 seconds.



To reset, set the trip meter to TRIP B. Refer to *TRIP METER "A" OR "B"* for more details.

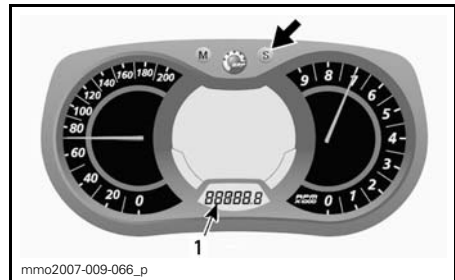

1. Trip meter (TRIP B) mode

Push and hold the SET (S) button to reset.

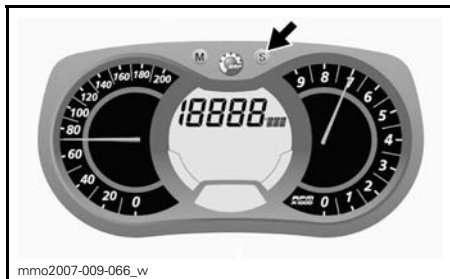

N) Message Display

This display is used as a complement of the pilot lamps to catch your attention and to give you a brief description if an anomaly occurs or to inform you of a particular condition.

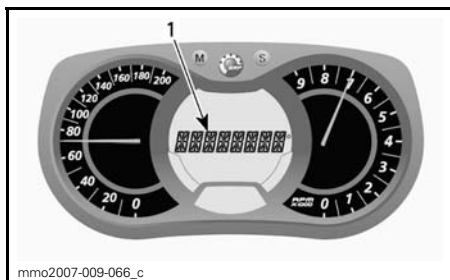

1. Message display

Message will be displayed with a beep code and pilot lamp(s).

Refer to *GAUGE PILOT LAMPS* for more details on beeper codes and what to do depending on the message.

MESSAGE	DESCRIPTION
ENGINE	Engine is overheating
CHECK ENGINE	Engine fault
LOW BAT/ HIGH BAT	Low/high battery voltage (if so equipped)
REVERSE	Reverse is selected
REV. FAIL	Reverse fail, try again
LOW OIL	Injection oil level is low (this is not available in 550 engine models)
KNOCK	Ensure recommended fuel is used
SHUTDOWN	Engine overheating problem

5) Gauge Pilot Lamps

Gauge pilot lamp(s) will inform you if an anomaly occurs or to inform you of a particular condition.











TYPICAL — PILOT LAMPS

Pilot lamp can flash alone or in combination with another lamp.







Beeper codes will be heard and messages (depending on gauge model) will be displayed to catch your attention.

Refer to the following table for more details.

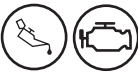
NOTE: Message display is not available on all gauges.

PILOT LAMP(S) ON	BEEPER	MESSAGE DISPLAY	DESCRIPTION
	Fast short beeps	ENGINE	Engine is overheating, reduce snowmobile speed and run in loose snow or stop engine immediately and allow engine to cool. Check cooling system.
	4 short beeps every 2 minutes	LOW BAT	Indicate a low or high battery voltage condition. See an authorized LYNX dealer as soon as possible.
		HIGH BAT	
	Fast short beeps	LOW OIL	Critical low injection oil level. Stop vehicle in a safe place then, replenish injection oil reservoir as soon as possible.
	4 short beeps	CHECK ENGINE	Engine fault, see an authorized LYNX dealer as soon as possible.
	4 short beeps every 2 minutes	KNOCK	<ul style="list-style-type: none"> - Ensure recommended fuel is used. - Check fuel quality, replace if necessary. - If fault still occurs, contact an authorized LYNX dealer.
	Continuously beeps	SHUTDOWN	Shutdown procedure in force due to engine overheating problem, remove tether cord cap (DESS key) and contact an authorized Lynx dealer.
	4 short beeps every 2 minutes	LOW OIL	Injection oil level is low. Stop vehicle in a safe place then, replenish injection oil reservoir.
	—	—	Low fuel level. One (1) bar left in fuel level display. Replenish fuel tank as soon as possible.
	Slow long beeps	REVERSE	Electronic reverse is selected.
	3 short beeps	REV. FAIL	Engine rotation did not change after reverse try, try again.
	—	—	Headlamp is in HI beam position
DESS	Refer to <i>DESS PILOT LAMP CODES</i> in <i>TETHER CUT-OUT SWITCH</i>		

E-TEC engine

PILOT LAMP(S) ON	BEEPER	DESCRIPTION
	Continuous fast short beeps	Engine, muffler or ECM is/are overheating, engine is limited to 5500 RPM. Stop engine as soon as possible and allow components to cool. Check cooling system.
	Continuous fast short beeps	<ul style="list-style-type: none"> - Critical low injection oil level. Stop vehicle in a safe place as soon as possible then, replenish injection oil reservoir before restarting engine. - If oil injection level is high, it then indicates a failure of the oil injection system, see an authorized LYNX dealer as soon as possible.
	4 short beeps	Engine, muffler or ECM is/are overheating, reduce snowmobile speed and run in loose snow or stop engine and allow components to cool. Check cooling system.
	4 short beeps	Engine management system fault that can change the normal operation of the engine, see an authorized LYNX dealer as soon as possible.
	4 short beeps every 2 minutes	<ul style="list-style-type: none"> - Engine under protection mode. - Ensure recommended fuel is used. - Check fuel quality, replace if necessary. - If fault still occurs, contact an authorized LYNX dealer.
	Continuously beeps	<ul style="list-style-type: none"> - Engine shutdown procedure in force due to an overheating during too long idle. - Fuel pump problem, contact an authorized LYNX dealer.
	4 short beeps every 2 minutes	Injection oil level is low. Replenish injection oil reservoir as soon as possible.
	—	Low fuel level. One (1) bar left in fuel level display. Replenish fuel tank as soon as possible.
	Slow long beeps	Electronic reverse is selected.
	3 short beeps	Engine rotation did not change after reverse try, try again.
	—	Headlamp is in HI beam position.
DESS	Refer to <i>DESS PILOT LAMP CODES</i> in <i>TETHER CUT-OUT SWITCH</i> .	

6) Gauge MODE (M) Button (not in 550 engine models)

Multifunction Analog/Digital Gauge Only

Button use to navigate in gauge multi-function display.

NOTE: MODE (M) button on the multi-switch housing has the same functions and can also be used.

7) Gauge SET (S) Button (not in 550 engine models)

Button use to navigate, adjust or reset gauge multifunction display.

NOTE: SET (S) button on the multi-switch housing has the same functions and can also be used.

8) Throttle Lever

Designed to be thumb activated. When squeezed, it increases the engine speed and engages the transmission. When released, engine speed returns automatically to idle.

⚠ WARNING

Test the throttle lever operation each time before starting the engine. The lever must return to its original position once released. Otherwise, do not start engine.

9) Brake Lever

When squeezed, the brake is applied. When released, it automatically returns to its original position. Braking effect is proportional to the pressure applied on the lever and to the type of terrain and its snow coverage.

10) Parking Brake Lever

Parking brake should be used whenever snowmobile is parked.

⚠ WARNING

Make sure parking brake is fully disengaged before operating the snowmobile. When you ride the vehicle, brake pads that are caused to drag by a continuous pressure on the lever may cause damage to the brake system and cause loss of braking capacity and/or fire.

To Engage Mechanism

Squeeze brake lever and maintain while pulling locking lever with a finger. When brake lever is held at halfway the parking brake should be fully applied.

⚠ CAUTION Parking brake position can vary depending on brake pads wear. Ensure when the parking brake is applied that the vehicle stays securely in place.

NOTE: Locking lever can be adjusted in two different positions.

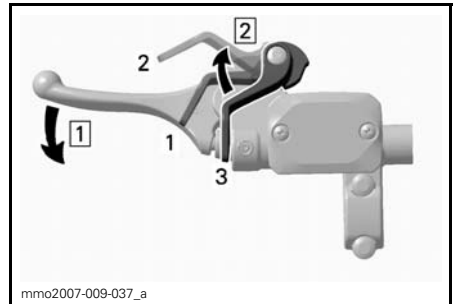

TYPICAL — ENGAGE MECHANISM

Step 1: Step 1: Squeeze and maintain brake lever

Step 2: Step 2: Adjust locking lever

1. Position 1
2. Position 2
3. OFF

To Release Mechanism

Squeeze brake lever. Locking lever will automatically return to its original position. Always release parking brake before riding.

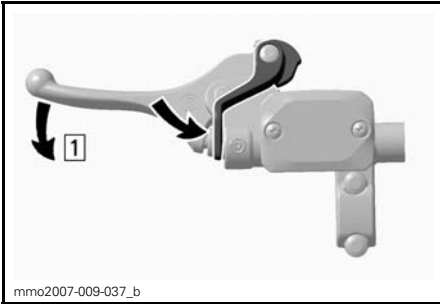

TYPICAL — RELEASE MECHANISM
Step 1: Step 1: Squeeze brake lever

11) Multi-Switch Housing

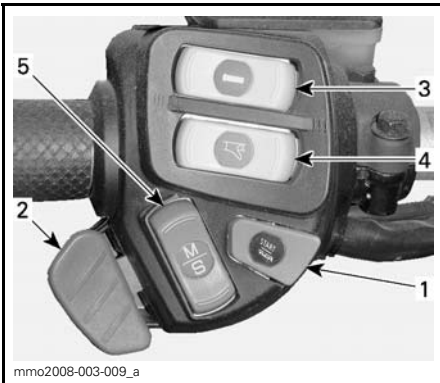

TYPICAL
1. Electronic Reverse (RER) button
2. Headlamp dimmer switch
3. Heating grips
4. Heating throttle lever
5. Mode/set button

Electronic Reverse (RER™) Button

When pressed, it allows selection the electronic reverse, refer to *SHIFTING IN REVERSE* in *OPERATING INSTRUCTIONS* section for procedure.

11 a) Headlamp dimmer switch on Rave 600, 800 ETEC, BoonDocker

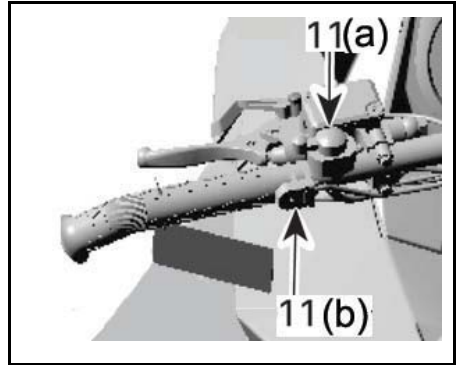

RAVE 600, 800 ETEC/ BOONDOCKER

11 b) Electronic Reverse (RER™) Button on Rave 600, 800 ETEC, BoonDocker

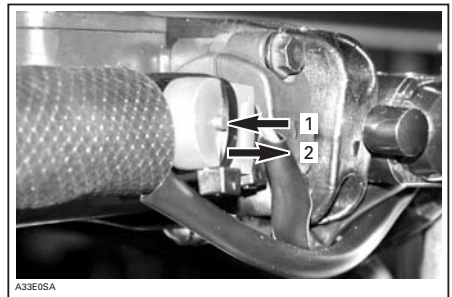

1. Button depressed position
2. Button released position

Headlamp Dimmer Switch

When pressed, it allows selection of headlamp HI or LOW beam. Lights are automatically ON whenever the engine is running.

Heating Grips Switch

Select the desired position to keep your hands at a comfortable temperature.

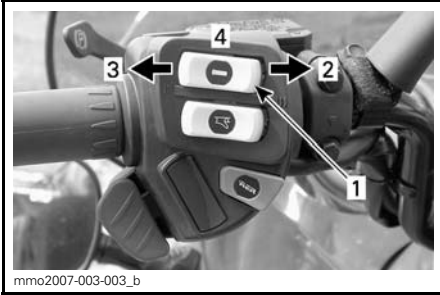
550 models.**TYPICAL**

1. Heating grip switch
2. Hot
3. Warm
4. Off

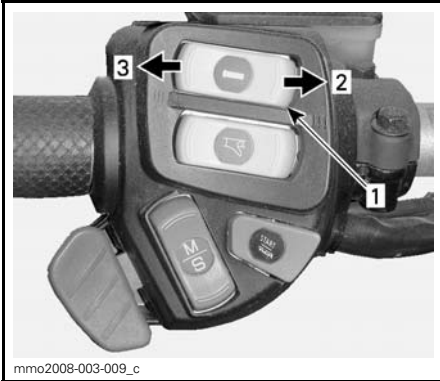
All other RE-X models

1. Heating grip switch
2. Warmer
3. Colder

On the above mentioned models, grips heating intensity will be displayed via the multifunction display

Heating grips will be in OFF position when there are no bars left in the display.

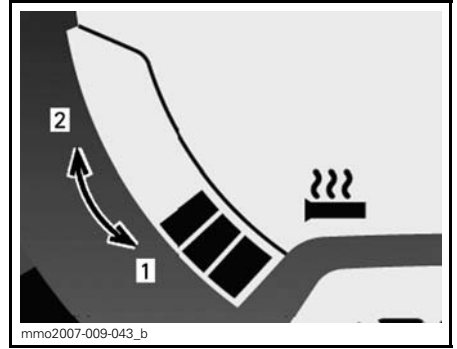
**MULTIFUNCTION GAUGE — HEATING INTENSITY**

1. Colder
2. Warmer

Heating Throttle Lever Switch

Select the desired position to keep your thumb at a comfortable temperature.

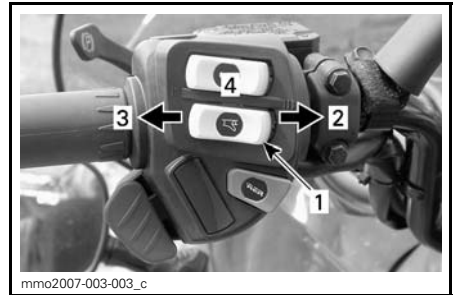
550 models.**TYPICAL**

1. Heated throttle lever switch
2. Hot
3. Warm
4. Off

All other RE-X models.

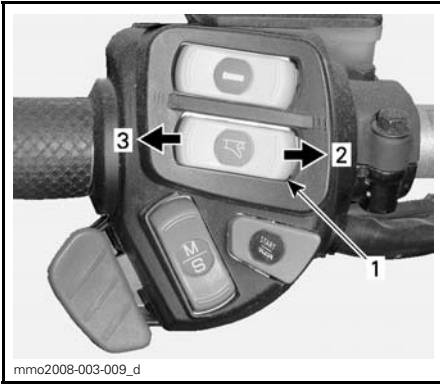

1. Heated throttle lever switch
2. Warmer
3. Colder

Heating throttle lever will be in OFF position when there are no bars left in the display.

NOTE: Bar gauge will be displayed with the activation of the throttle lever switch. When released, display will return to fuel tank level.

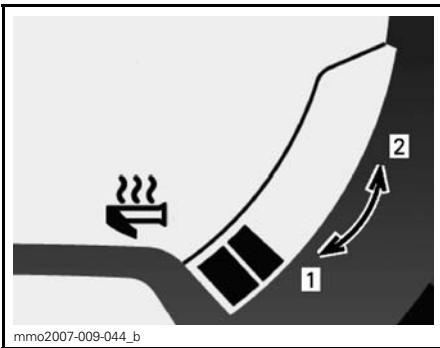

MULTIFUNCTION GAUGE — HEATING INTENSITY

1. Colder
2. Warmer

Mode/Set Button (not in 550 engine models)

All other RE-X models.

This button can be used instead of the two buttons on top of the analog/digital gauge to facilitate gauge adjustments:

- When pushed upward, it has the same functions as the MODE (M) button.
- When pushed downward, it has the same functions as the SET (S) button.

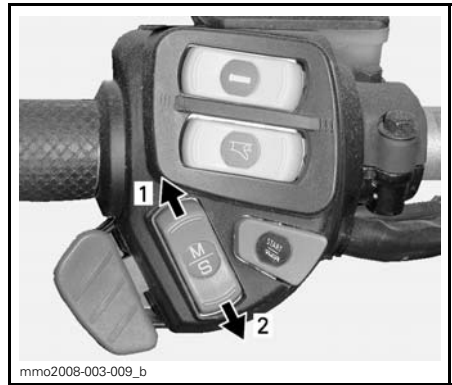

MULTIFUNCTION GAUGE

1. MODE function
2. SET function

12) Handlebar

The handlebar controls the steering of the snowmobile. As the handlebar is rotated to right or left, the skis are turned right or left to steer the snowmobile.

⚠ WARNING

Fast reverse while turning, could result in loss of stability and control.

13) Holding Strap

Xtrim Models only

Holding strap provides a grip for driver when side-hilling.

⚠ WARNING

This strap is not for towing, lifting or other purpose than temporary use as a grab handle during side-hilling. Always keep at least one hand on handlebar.

14) Tether Cut-Out Switch**General**

When the tether cord cap (DESS key) is removed, it shuts the engine off preventing snowmobile to runaway if the operator falls off the vehicle accidentally.

⚠ WARNING

Always remove the tether cord cap (DESS key) when vehicle is not in operation in order to prevent accidental engine starting, to avoid unauthorized use by children or others or theft.

Operation

Attach tether cord eyelet to clothing, then snap cap (DESS key) over post before starting engine.

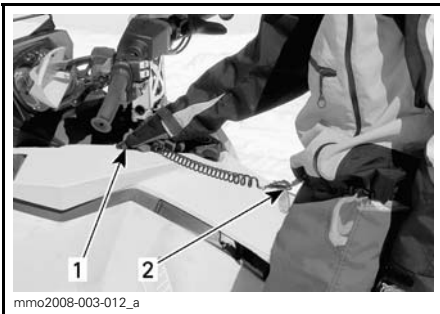
**TYPICAL**

1. Snap over post
2. Attach to clothing

If emergency engine shut off is required, pull tether cord cap (DESS key) from post completely.

DESS (Digitally Encoded Security System) Key/Cut-Out Switch

NOTE: 550 Engine model has not DESS system!

On these models, the tether cord cap (DESS key) is digitally encoded to provide you and your snowmobile with the equivalent security of a conventional lock key and it shuts off the engine preventing snowmobile to runaway if the operator falls off the vehicle accidentally.

The DESS key provided with your snowmobile contains an electronic chip which features a unique permanently memorized digital code. Your authorized LYNX dealer programs this key in the ECM (Engine Control Module) of your snowmobile to allow engine operation above 3000 RPM if and only if this unique code has been read after engine starting.

If another DESS key is installed, the engine will start but will not reach drive pulley engagement speed to move vehicle.

Make sure the DESS key is free of dirt or snow.

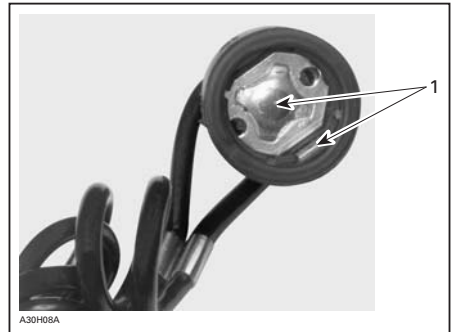
**DESS KEY**

1. Free of dirt or snow

Additional DESS Keys

The ECM of your snowmobile can be programmed by your authorized LYNX dealer to accept 8 different keys.

We recommend the purchase of additional keys from your authorized LYNX dealer. If you have more than one DESS-equipped LYNX snowmobile, each can be programmed by your authorized LYNX dealer to accept the other vehicles keys.

DESS Pilot Lamp Codes

NOTE: If any code still occurs, contact an authorized LYNX dealer.

WARNING SIGNALS		DESCRIPTION
BEEPER	DISPLAY MESSAGE	
2 shorts	WEL-COME...	Personalized welcome message, good key
Slow short beeps/repetitive	CHECK KEY	Unable to read key (bad connection) Make sure the key is free of dirt or snow. Reinstall key and restart engine. Vehicle can not be driven.
Fast short beeps/repetitive	BAD KEY	Invalid key or key not programmed Use the proper key for this vehicle or have the key programmed. Vehicle can not be driven.

15) Engine Cut-Out Switch

Push-pull type switch. To stop the engine in an emergency, select OFF position (down) and simultaneously apply the brake. To restart, button must be at the ON position (up).



OFF POSITION



ON POSITION

All operators of the snowmobile should familiarize themselves with the function of this device by using it several times on first outing and whenever stopping the engine thereafter. This engine cut-out procedure will become a reflex and will prepare operators for emergency situations requiring its use.

⚠ WARNING

If the switch has been used in an emergency caused by a suspected malfunction, the source of the malfunction should be determined and corrected before restarting engine. See an authorized LYNX dealer for servicing.

16) Rewind Starter Handle

Auto-rewind type located on right hand side of snowmobile. To engage mechanism, pull handle slowly until a resistance is felt then pull vigorously. Slowly release handle.

17) Choke Lever (550 models only)

See proper usage instructions in *OPERATING INSTRUCTIONS* section.

This device features a 3-position lever to facilitate cold start.

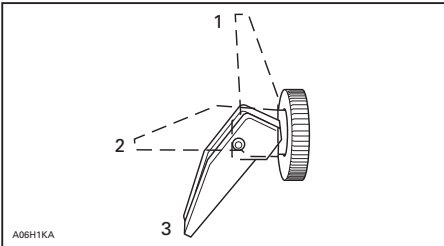

1. OFF
2. Position 2
3. Position 3

Initial Cold Starting

NOTE: Do not operate the throttle lever with the choke lever on.

Move the choke lever to position 3 and start the engine. As soon as the engine starts, move the lever to position 2. After a few seconds (10 seconds maximum) move the choke lever to OFF.

NOTE: In severe cold weather, colder than -20°C you may need to flip choke lever from OFF to position 1 a couple of times once engine is started.

Warm Engine Starting

Start the engine without any choke. If the engine will not start after two pulls of the rope or two 5 second attempts with the electric starter move choke lever to position 2. Start the engine without activating the throttle lever. As soon as the engine starts move the choke lever to OFF.

18) Fuel Tank Cap

Unscrew to fill up tank then fully tighten.

⚠ WARNING

Always stop the engine before refueling. Fuel is flammable and explosive under certain conditions. Always work in a well ventilated area. Do not smoke or allow open flames or sparks in the vicinity. Open cap slowly. If a differential pressure condition is noticed (whistling sound heard when loosening fuel tank cap) have vehicle inspected and/or repaired before further operation. Do not overfill or top off the fuel tank before placing the vehicle in a warm area. As temperature increases, fuel expands and might overflow. Always wipe off any fuel spillage from the vehicle. Periodically verify fuel system. When vehicle operating you recognize fuel smell take contact to nearest authorized Lynx dealer to check and repair vehicle fuel system.

NOTE: Do not sit or lean on seat when fuel tank cap is not properly installed. Do not open fuel tank cap when engine is running.

19) Hood and Side Panels

Hood

To open hood, release hood retaining pins then slide hood towards the front of the vehicle.

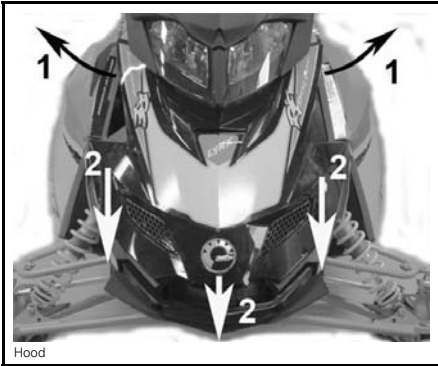

*Step 1: Step 1: Release retaining pins
Step 2: Step 2: Slide hood towards the front*

Side Panels

To open a side panel, stretch and unhook the latches.

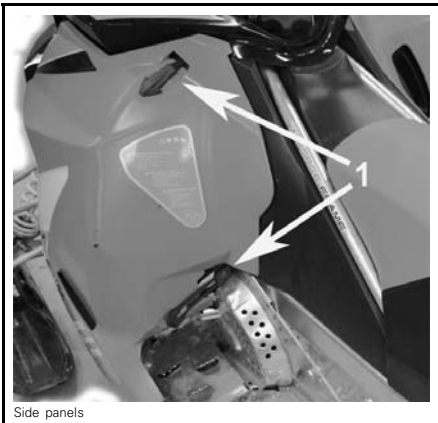

*TYPICAL
1. Latches*

20) Fuses

The electrical system is protected with fuses, refer to *MAINTENANCE* for details.

The fuse holders are located in the engine compartment.

⚠ CAUTION Do not use a higher rated fuse as this can cause severe damage to electrical components and/or be a potential fire.

⚠ WARNING
If fuse has burnt out, source of malfunction should be determined and corrected before restarting. See an authorized LYNX dealer for servicing.

All Engines

Manual Start



*RH SIDE OF ENGINE COMPARTMENT
1. Fuse location*

Electric Start

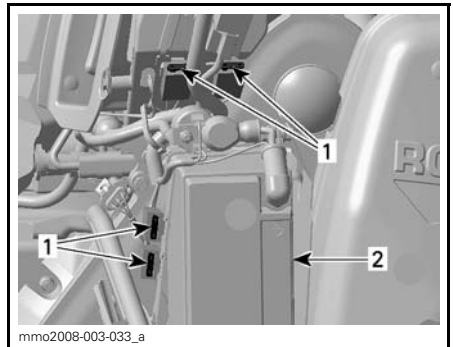

*RH SIDE OF ENGINE COMPARTMENT
1. Fuse location
2. Battery*

Electric Fuel Level Sender

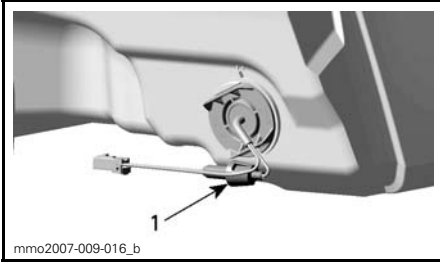

mmo2007-009-016_b

BEHIND AIR INTAKE SILENCER

1. Fuse location

21) Grab Handle/Bumper

To be used whenever snowmobile requires manual lifting.

⚠ WARNING

Do not attempt to lift the vehicle by hand alone. Use appropriate lifting device or have assistance to share lifting stress in order to avoid risk of strain injuries.

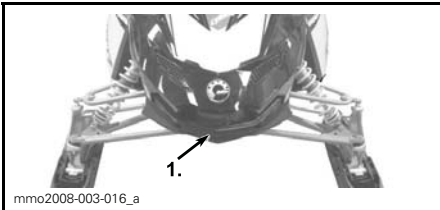

mmo2008-003-016_a

FRONT

1. Grab handle/bumper

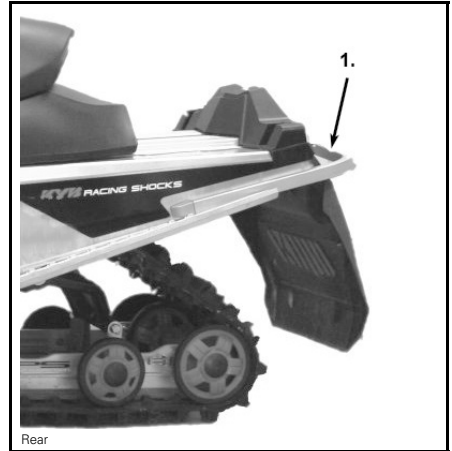

Rear

REAR

1. Grab handle/bumper

⚠ CAUTION Do not use skis to pull or lift snowmobile.

22) Storage Compartment (Some models only)

⚠ WARNING

All storage compartments must be properly latched and they must not contain any sharp, heavy or breakable objects.

⚠ CAUTION MAXIMUM load is 1.8 kg evenly distributed.

Pull latch slightly upward then, backward to unlock cover.

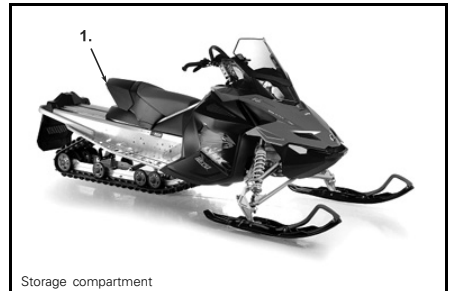

Storage compartment

1. Storage compartment

23) Tool Kit

A tool kit containing tools for basic maintenance is supplied with the vehicle.

Tool bag is located in engine compartment on pulley guard.



Tool kit

1. Tool kit

24) Spark Plug Storage

A space is provided in the tool kit to keep spare spark plugs dry and prevent shocks that might affect the adjustment or break them.

NOTE: Spare spark plugs are not supplied with snowmobile.

NOTE: Check spare spark plug gap according to *SPECIFICATIONS* before installation.

⚠ CAUTION Do not attempt to adjust spark plug gap.

25) Spare Drive Belt Holder

A spare drive belt can be stored in holder.

NOTE: Spare drive belt is not supplied with the snowmobile.

⚠ CAUTION To avoid damages to the drive belt, ensure that belt does not come in contact with tuned pipe when installed in its support.

All models except BoonDocker and Rave 800 ETEC

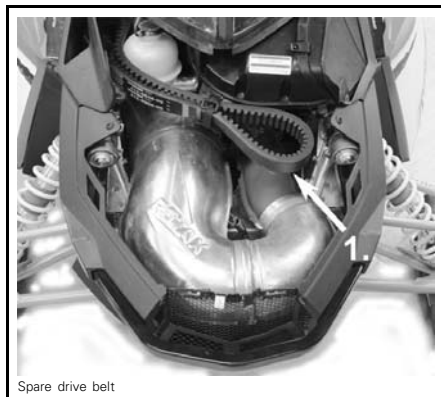

Spare drive belt

INSTALLED CORRECTLY

1. Ensure there is no contact with tuned pipe

BoonDocker and Rave 800 ETEC

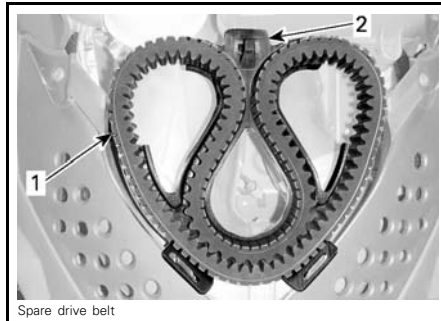

Spare drive belt

INSTALLED CORRECTLY

1. Drive belt
2. Drive belt holder

26) Shields and Guards

⚠ WARNING

Never operate engine without belt guard securely installed or, with hood, brake disk guard or side panels opened or removed.

Your snowmobile is provided with a number of shields and guards. Leave these in place on your vehicle as they are designed to keep clothing and hands out of moving parts and away

from hot components. Never attempt to make adjustments to any moving part while the engine is running.



mmo2008-003-015_b

TYPICAL

1. Side panels
2. Upper front hood
3. Lower front hood

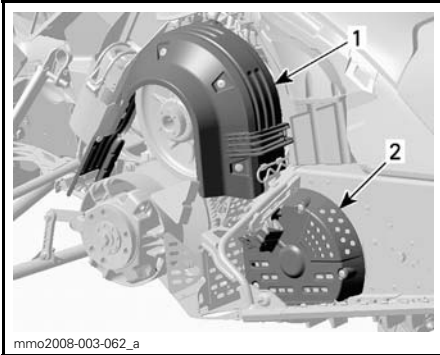

mmo2008-003-062_a

1. Belt guard
2. Brake disk guard

27) Track

⚠ WARNING

Never stud a track that has not been approved for studs. Installing studs on an unapproved track could increase the risk of the track tearing or severing, possibly resulting in serious injury or death.

Before proceeding with the installation of special studs on tracks you must contact your authorized LYNX snowmobile dealer for current specific stud-
ding availability and applications.

BRP does **not recommend** to ride a snowmobile equipped with high lug profile track at **high speed** in a trail, on hard packed surfaces or ice for an extended period of time.

In the event that you have to, **reduce your speed**, then minimize the distance you ride on those surfaces.

⚠ CAUTION Running those tracks at high speed in a trail, on hard packed surfaces or ice put more stress on the lugs, which tend to heat up as a result. To avoid potential degradation or damage to the track, reduce your speed, then minimize the distance you ride on those surfaces.

For general instructions on maintenance of tracks, refer to the sections *TRACK CONDITION* and *TRACK TENSION AND ALIGNMENT* in the *MAINTENANCE* section of this guide.

28) 1+1 Seat

Xtrim® models only (as option).

⚠ WARNING

Any passenger must be able to firmly lay is feet on the footrests and keep his hands on the grab handles at all times when seated. Respecting those physical criteria is important to ensures that the passenger is stable and to reduce the risks of ejection.

1+1 Seat Removal

Unplug 1+1 seat connector.

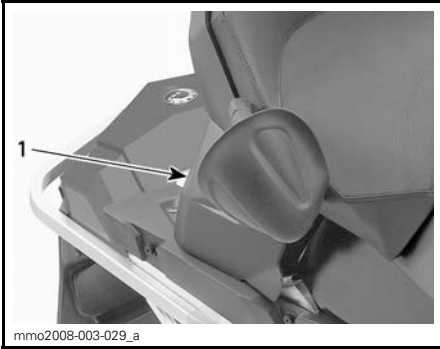

1. Connector location

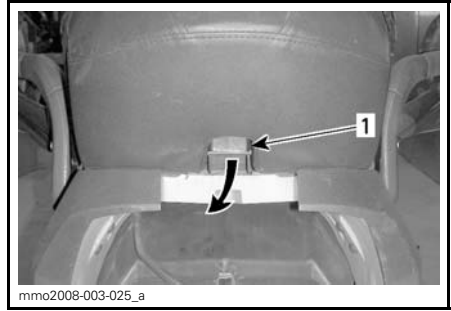

1. Seat latch

Continue lifting movement until you can release the front retaining device then completely remove seat.

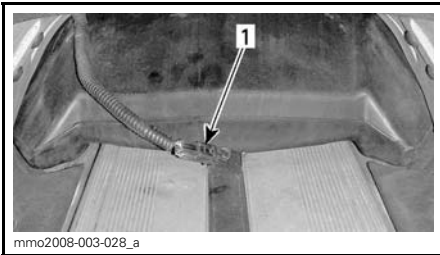

1. Connector

Push and hold seat latch while gently lifting rear of seat.



1. Retaining device

⚠ CAUTION Make sure to unplug seat harness before removing seat.

1+1 Seat Installation

Insert seat retaining device into set base.

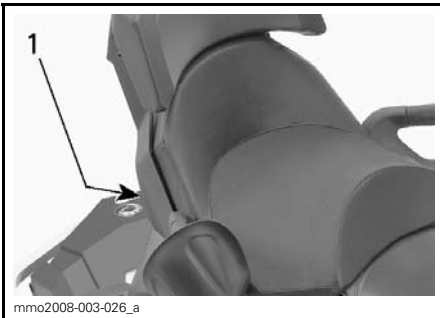

1. Seat latch location



1. Retaining device

When seat rests in its position, firmly push seat down to latch.

NOTE: A distinctive snap will be felt. Double check that the seat is secure by giving it a tug to confirm proper latching.

⚠ WARNING
 Make sure seat is securely latched before riding.

Connect 1+1 seat connector.

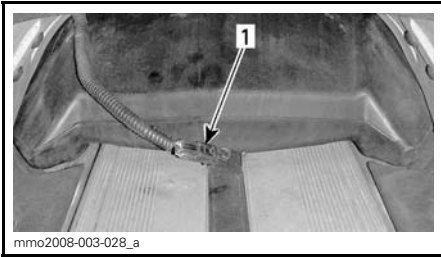

1. Connector

29) Rear Passenger Heating Grip Switch

Xtrim RE-X models only (as option)

Three-position switch. Select the desired position to keep rear passenger's hands at a comfortable temperature.

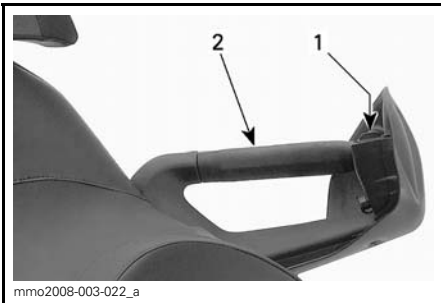

PASSENGER LH GRAB HANDLE

1. Switch
2. LH grab handle

30) Rear Grab Handles

Xtrim models only

Rear grab handles provides a grip for the passenger.

31) Rear Rack

⚠ WARNING
 All objects in rear rack must be properly latched. Do not carry any breakable objects. Excessive weight in rack may reduce steering ability.

⚠ CAUTION Always readjust suspension according to the load. The capacity of this rack is limited, the **MAXIMUM** cargo load is 15.8 Kg (35 lb). Ride at very low speed when loaded. Avoid speed over bumps.

32) 12-Volt Power Outlet

Xtrim models Only (except BoonDocker)

A 12-volt electric appliance may be connected to that jack connector. Electric current is supplied whenever engine is running.

33) C-Type Hitch

Xtrim models only (no hitch on BoonDocker).

⚠ CAUTION Refer to decal on vehicle for towing weight capacities.

⚠ WARNING
 Never tow an accessory with a rope. Always use a rigid tow bar. Using a rope would result in a collision between the object and the snowmobile and possibly in a tip over in case of a rapid deceleration or on a downward slope.

How to use the C-Type Hitch

Detach hitch from its support by removing the hairpin.

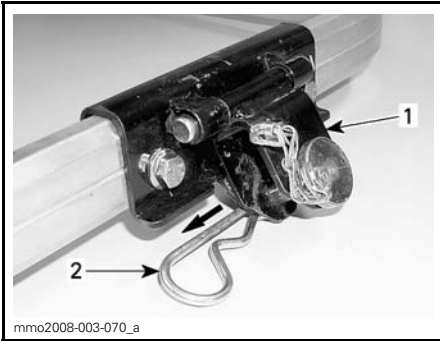

1. Hitch
2. Hairpin

Remove rod from hitch then attach rigid tow bar to hitch using the same rod.



- TYPICAL**
1. Rod

Secure rod to hitch using hairpin previously removed.

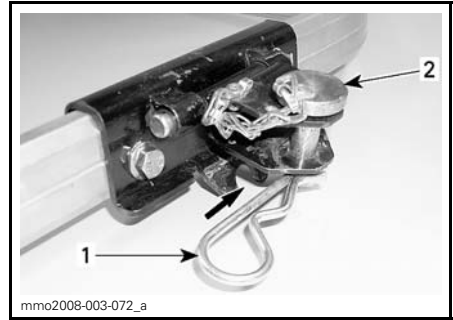

- TYPICAL**
1. Hairpin
 2. Rod

⚠ CAUTION To avoid damages to the vehicle, always release hitch from its support. Ensure hitch moves freely when towing accessories.

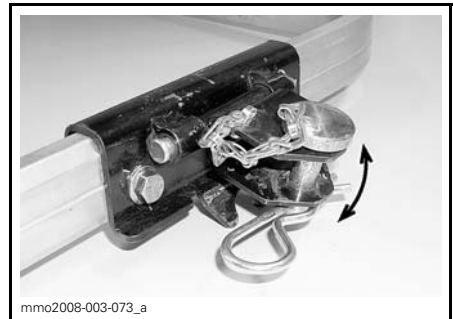

HITCH MOVES FREELY WHEN TOWING

To avoid noise from hitch when not in use, secure hitch to its support by using the hairpin.

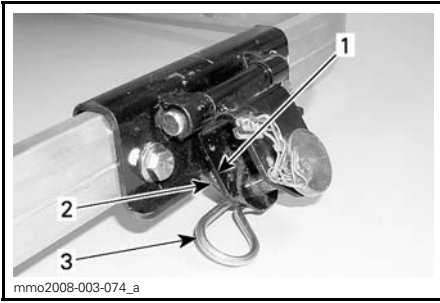

HITCH NOT IN USE

1. Hitch
2. Support
3. Hairpin

RECOMMENDED FUEL AND OIL

Recommended Fuel

Use unleaded gasoline available from most service stations or oxygenated fuel containing a maximum total of 10% of ethanol or methanol or both. The gasoline used must have the following recommended minimum octane number.

OCTANE NUMBER		
98 E (RON)		
95 E (RON)	▼	▼
ENGINES	95	98
550SK	X	X
600 HO E-TEC	X	X
800R E-TEC	X	X

⚠ CAUTION Never experiment with other fuels or fuel ratios. The use of unrecommended fuel can result in snowmobile performance deterioration and damage to critical parts in the fuel system and engine components. Do not mistake oil reservoir cap for fuel tank cap. Oil reservoir cap is identified OIL.

⚠ WARNING

Always stop the engine before refueling. Fuel is flammable and explosive under certain conditions. Always work in a well ventilated area. Do not smoke or allow open flames or sparks in the vicinity. Open cap slowly. If a differential pressure condition is noticed (whistling sound heard when loosening fuel tank cap) have vehicle inspected and/or repaired before further operation. Do not overfill or top off the fuel tank before placing the vehicle in a warm area. As temperature increases, fuel expands and might overflow. Always wipe off any fuel spillage from the vehicle. Periodically verify fuel system.

Fuel System Antifreeze

When using oxygenated fuel, additional gas line antifreeze or water absorbing additives are not required and should be not used.

Recommended Oil

⚠ CAUTION Use only injection oil that flows at -40°C (-40°F). Do not mismatch oil reservoir cap with fuel tank cap. Oil reservoir cap is identified OIL.

Always maintain a sufficient amount of recommended injection oil in the injection oil reservoir.

Use only two-stroke engine injection oil sold by authorized LYNX dealers.

⚠ CAUTION Check level and refill every time you refuel.

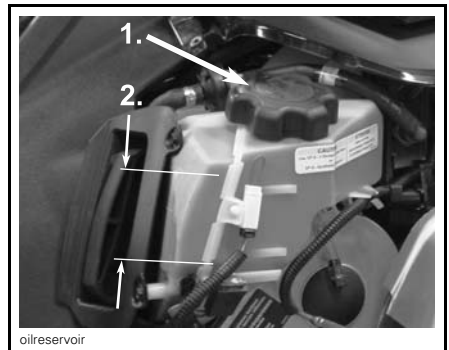

TYPICAL

1. Injection oil reservoir
2. Level marks (1/4, 1/2, 3/4)

⚠ WARNING

Do not overfill. Reinstall cap and fully tighten. Wipe off any oil spills. Oil is highly flammable when heated.

RECOMMENDED INJECTION OIL			
XP-S synthetic oil (P/N 619590106) ⁽²⁾ ⁽³⁾			
XP-S synthetic blend (P/N 619590103) ⁽²⁾ ⁽³⁾			
XP-S mineral injection oil ⁽⁴⁾			
ENGINES	▼	▼	▼
550 SK	X	X	X
600 HO E-TEC	—	X ⁽¹⁾	X
800R E-TEC	—	—	X

(1) Preferred.

⚠ CAUTION ⁽²⁾ XP-S synthetic oil and XP-S synthetic blend oil are specially formulated and tested for the severe requirements of the 600 HO E-TEC and other engines. Use of any other brand two-stroke oil may void the limited warranty. Use only XP-S synthetic oil or XP-S synthetic blend. There is no known equivalent on the market for the moment. If a high quality equivalent were available, it could be used.

XP-S synthetic oil and XP-S synthetic ⁽³⁾ blend injection oil are compatible, they can be mixed together.

⁽⁴⁾ If XP-S mineral injection oil is not available, API TC high-quality low ash 2-stroke injection oil may be used.

⚠ CAUTION Never use four-stroke petroleum or synthetic motor oil and never mix these with outboard motor oil. Do not use NMMA TC-W, TC-W2 or TC-W3 outboard two-stroke engine oils or ashless two-stroke engine oils. Avoid mixing different brands of API TC oil as resulting chemical reactions may cause severe engine damage.

XP-S Mineral Injection

This is a special blend of basic oil and additives specially selected to ensure unequalled lubrication, engine cleanliness and minimum spark plug fouling.

XP-S Synthetic and XP-S Synthetic Blend Oil

The XP-S synthetic blend and XP-S synthetic oil **provides superior lubrication**, reduced engine component wear and oil deposit, thus maintaining maximum-level performance and anti-friction properties. These synthetic and synthetic blend injection oil meets the latest ASTM and JASO standards by ensuring high biodegradability and low exhaust smoke.

BREAK-IN PERIOD

Engine

⚠ CAUTION A break-in period of 10 operating hours — 500 km (300 miles) — is required before running the snowmobile at full throttle.

During break-in period, maximum throttle should not exceed 3/4 opening. However, brief full acceleration and speed variations contribute to a good break-in.

⚠ CAUTION Engine overheating, continued wide open throttle runs and prolonged cruising without speed variations should be avoided, this can cause engine damage during the break-in period.

550 Engine Only

To assure additional protection during the initial engine break-in, 500 mL of recommended injection oil should be added to fuel for the first full filling of fuel tank. Have spark plugs cleaned after engine break-in.

E-TEC Models

During a predetermined period, the engine management system controls some engine parameters.

The duration is based on fuel volume. It will take approximately two fuel tanks to complete the break-in.

During this period:

- The engine performance and behavior will not be optimal.
- The fuel and oil consumption will be higher.

Belt

A new drive belt requires a break-in period of 50 km . Avoid strong acceleration/deceleration, pulling a load or high speed cruising.

10-Hour Inspection

NOTE: The 10-hour inspection is at the expense of the snowmobile owner.

As with any precision piece of mechanical equipment, we suggest that after the first 10 hours of operation or 500 km, whichever comes first, your snowmobile be checked by an authorized LYNX dealer. This inspection will also give you the opportunity to discuss the unanswered questions you may have encountered during the first hours of operation.

OPERATING INSTRUCTIONS

Pre-Operation Check

WARNING

The pre-operation check is very important prior to operating the vehicle. Always check the proper operation of critical controls, safety features and mechanical components before starting. If not done as specified here, severe injury or death might occur.

- Remove snow and ice from body including seat, footrests, controls and instruments.
- Lights — The headlamp, the taillight and the brake light are standard equipment. Be sure lights are clear of dirt, slush or snow and are in good working order or condition.
- Verify that track and idler wheels are free to turn and not frozen.

WARNING

Always use a wide base snowmobile mechanical stand to properly support vehicle during any track verification. Slowly accelerate engine in order to rotate track at very low speed when it is not on ground.

- Activate the brake control lever and make sure the brake fully applies before the brake control lever touches the handlebar grip. It must fully return when released.
- Check the parking device. Apply parking brake and check if it operates properly.
- Activate the throttle control lever several times to check that it operates easily and smoothly.

WARNING

Throttle lever must operate easily and smoothly. It must return to idle position when released.

- Check operation of tether cord cap (DESS key), engine cut-out switches, headlamp switch (HI-LO), taillight, brake light and pilot lamps.
- Verify that skis and steering operate freely. Check corresponding action of skis versus handlebar.
- Check fuel and oil for levels and leaks. Replenish as necessary and see an authorized LYNX dealer in case of any leaks.
- Verify that air silencer prefilter is free of snow.
- All storage compartments must be properly latched and they must not contain any heavy or breakable objects. Hood and side panels must be also properly latched.

WARNING

All adjustable features should be positioned at optimal setting. Securely tighten all adjustment locks.

- Make certain your snowmobile is pointed away from people or objects before you start it. No one is to be standing in front of or in back of the snowmobile.
- Be warmly dressed with clothing designed for snowmobiling.

PRE-OPERATION CHECK LIST

ITEM	OPERATION	✓
Body including seat, footrests, lights, controls and instruments	Check that there is no snow or ice.	
Track and idler wheels	Check for free movement.	
Brake lever	Check proper action.	
Parking device	Check proper action.	
Throttle lever	Check proper action.	
Switches and lights	Check proper action. Tether cord must be attached to driver clothing eyelet.	
Skis and steering	Check for free movement and proper action.	
Fuel and oil	Check for proper level and leaks.	
Air silencer prefilter	Check that there is no snow or ice.	
Adjustable features	Check for optimal adjustment and securely tightened adjustment locks.	
Storage compartment	Check for proper latching and no heavy or breakable objects.	
Vehicle vicinity	Snowmobile must be pointed away from people or objects. No one is to be standing in front of or in back of the snowmobile.	
Clothing	Be warmly dressed with clothing designed for snowmobiling.	

Engine Starting Procedure**General****Procedure**

1. Recheck throttle control lever operation.
2. Ensure that the tether cord cap (DESS key) is in position and that the cord is attached to your clothing eyelet.
3. Ensure that the engine cutout switch is in the ON position.

Manual Starting

1. Grab manual starter handle, pull handle slowly until a resistance is felt, then hold handle firmly and pull vigorously to start engine.

 WARNING

Do not apply throttle while starting.

Electric Starting (if so equipped)

Depressing the START/RER button will engage the electric starter and start the engine.

Release button immediately when engine has started.

⚠ WARNING

Do not apply throttle while starting.

⚠ CAUTION Do not use electric starter for more than 10 seconds. A rest period should be observed between the cranking cycles to let electric starter cool down. Using electric starter when engine has started could damage electric starter mechanism.

NOTE: If for any reason, the engine cannot be cranked electrically, start engine manually using the rewind starter.

Carburetor Engine Starting Procedure (550 models)

Procedure

1. Recheck throttle control lever operation.
2. Ensure that the tether cord cap (DESS key) is in position and that the cord attached to your clothing eyelet.
3. Ensure that the engine cutout switch is in the ON position.
4. Activate the choke according to the temperature as explained below.

Choke Application

Initial Cold Starting When Temperature is Below - 10°C (+ 15°F)

NOTE: Do not operate the throttle lever with the choke lever on.

Set the choke lever to position 3.

NOTE: After the engine is started, let engine warm up at fast idle until engine speed drops. Then, close off choke to ensure proper air-fuel mixture.

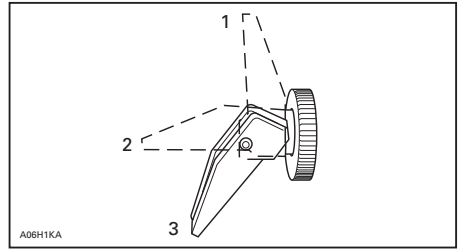

1. OFF
2. Position 2
3. Position 3

Initial Cold Starting When Temperature is Above - 10°C (above + 15°F)

Set the choke lever to position 2.

NOTE: After the engine is started, close off choke to ensure proper air-fuel mixture.

Warm Engine Starting

Start the engine without any choke. If the engine will not start after two pulls of the rope or two 5 second attempts with the electric starter move choke lever to position 2. Start the engine without activating the throttle lever. As soon as the engine starts move the choke lever to OFF.

Vehicle Warm-Up

Before every ride, vehicle has to be warmed up as follows.

Engage parking brake.

Snowmobile must be securely supported by the rear bumper using a wide-base snowmobile mechanical stand. Track must be 100 mm (4 in) off the ground.

Attach tether cord to operator's clothing eyelet.

Start engine and allow it to warm up two or three minutes at idle speed.

Disengage parking brake.

⚠ WARNING

Make sure wide-base snowmobile mechanical stand is stable. Stay clear of the front of vehicle and the track. Do not use too much throttle during warm-up or when track is free-hanging.

Apply throttle until drive pulley engages. Let track rotate at low speed for several turns. The lower the vehicle temperature, the longer vehicle warm-up should be.

Shut-off the engine and remove the wide-base snowmobile mechanical stand.

Skis may be frozen on the ground. Grab both skis one at a time by their loops and lift their front end slightly off the ground.

After restarting engine, the vehicle can be driven at low speed for the first 2 or 3 minutes of riding. After that, it may be driven up to the legal speed limit as per normal safety practices.

Shifting in Reverse

When the engine is running, depressing the RER button will slow down engine RPM to almost a stop and advance the ignition timing to cause direction change in crankshaft rotation.

- Engine will automatically shift into forward when re-starting after stopping or stalling.
- Shifting procedure will take place only when the engine is running.
- If engine is running at a speed above 4300 RPM, the reverse function of the RER button is cancelled.
- It is recommended to warm up the engine to its normal operating temperature before shifting.

Shifting in Reverse**⚠ WARNING**

Shifting to reverse mode on these snowmobiles is done by depressing the RER button when the engine is running. Wait until the reverse alarm sounds and the RER pilot lamp comes on in the dash before operating throttle to proceed in reverse. The reverse speed of these snowmobiles is not limited. Always proceed with caution as fast reverse could result in loss of vehicle stability. Come to complete stop before depressing RER button. Always remain seated and apply the brake before shifting. Ensure the path behind is clear of obstacles or bystanders before proceeding.

With the snowmobile completely stopped and engine running at idle, press and release the RER button.

The RER pilot lamp will blink when the snowmobile is engaged in reverse.

Apply throttle slowly and evenly. Allow drive pulley to engage then accelerate carefully.

Shifting in Forward

With the snowmobile completely stopped and engine running at idle, press and release the RER button.

RER pilot lamp will stop.

Apply throttle slowly and evenly. Allow drive pulley to engage then accelerate carefully.

Shutting Off the Engine

Release throttle lever and wait until engine has returned to idle speed.

Shut off the engine using either engine cut-out switch or tether cord cap (DESS key) engine cut-out switch.

⚠ WARNING

Always remove the tether cord cap (DESS key) when vehicle is not in operation in order to prevent accidental engine starting or to avoid unauthorized use by children or others or theft.

Post-Operation Care

Shut off the engine. Install rear of vehicle on a wide-base snowmobile mechanical stand.

Remove snow and ice from rear suspension, track, front suspension, steering mechanism and skis.

Always cover your snowmobile when leaving it outside overnight or during extended periods of inactivity. This will protect it from frost and snow as well as help retain its appearance.

SPECIAL OPERATING INSTRUCTIONS

Riding at High Altitudes

⚠ CAUTION Failure to re-calibrate may cause serious engine damage.

Refer to an authorized LYNX dealer..

Riding in Cold Weather

Carburetor Equipped Models

All vehicles have been calibrated for - 20°C (- 4°F). They can be operated at warmer winter temperatures without risk of problems.

⚠ CAUTION For colder temperatures than - 20°C (- 4°F), carburetor(s) must be recalibrated to avoid engine damage. Refer to an authorized LYNX dealer.

Refer also to *RIDING AT HIGH ALTITUDES OR SEA LEVEL*.

Emergency Starting

The engine can be started with the emergency starter rope supplied with the tool kit.

Remove belt guard.

⚠ WARNING

Do not wind starting rope around your hand. Hold rope by the handle only. Do not start the snowmobile by the drive pulley unless it is a true emergency situation. Have the snowmobile repaired as soon as possible.

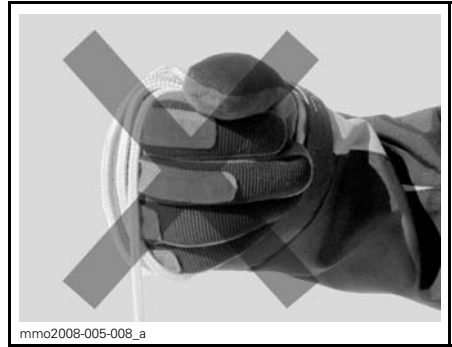

Attach one end of emergency rope to rewind handle.

NOTE: The spark plug socket can be used as an emergency handle.

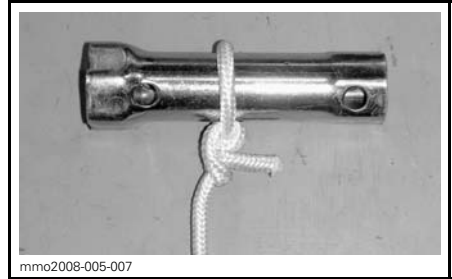

Attach the other end of emergency rope to the starter clip supplied in the tool kit.

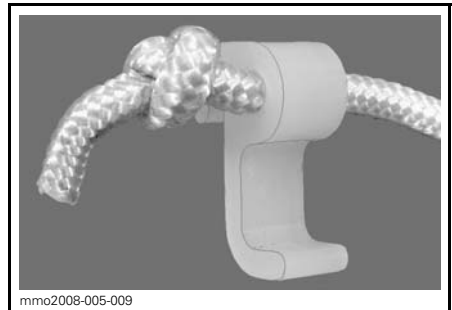

Hook up clip on drive pulley.

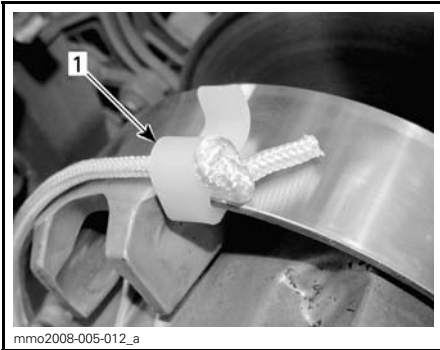

1. Clip installation location

Wind the rope tightly around drive pulley. When pulled, pulley must rotate counterclockwise.

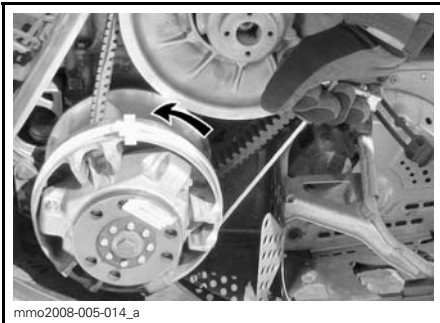

Pull the rope using a sharp, crisp pull so the rope comes free of the drive pulley. Start engine as per usual manual starting.

⚠ WARNING

When starting the snowmobile in an emergency situation, using drive pulley, do not reinstall the belt guard and return slowly to have snowmobile repaired.

Towing an Accessory

Always use a rigid tow bar to tow an accessory. Any towed accessory should have reflectors on both sides and at the rear. Check local laws for brake light(s) requirements.

⚠ WARNING

Never tow an accessory with a rope. Always use a rigid tow bar. Using a rope would result in a collision between the object and the snowmobile and possibly in a tip over in case of a rapid deceleration or on a downward slope.

Towing Another Snowmobile

If a snowmobile is disabled and must be towed use a rigid tow bar, remove the drive belt from disabled snowmobile and tow at moderate speed.

⚠ CAUTION Always remove the drive belt of the snowmobile that is to be towed to prevent damage to its belt and drive system.

In an emergency situation only, if a rigid tow bar is not available, a rope can be used provided you proceed with extra caution. In some areas, it may be illegal to do so. Check with state or local authorities.

Remove the drive belt, attach the rope to the ski legs (spindles), have someone sit on the towed snowmobile to activate the brake, and tow at low speed.

⚠ CAUTION In order to prevent damage to the steering system, never attach the tow rope to the ski loops (handles).

⚠ WARNING

Never ride at high speed when towing a disabled snowmobile. Proceed slowly with extra caution.

Transporting the Vehicle

Make sure that oil reservoir and fuel tank caps are properly installed.

Tilt bed trailers can easily be equipped with a winch mechanism to afford maximum safety in loading. Simple as it may seem, never drive your snowmobile onto a tilt bed trailer or any other kind of trailer or vehicle. Many serious accidents have resulted from driving up and over a trailer. Anchor your vehicle securely, front and rear, even on short hauls. Be certain all equipment is securely fastened. Cover your snowmobile when trailering to prevent road grime from causing damage.

Be certain your trailer meets state or provincial requirements. Ensure the hitch and safety chains are secure and the brake, turn indicators and clearance lights all function.

SUSPENSION ADJUSTMENTS

Snowmobile handling and comfort depend upon suspension adjustments.

Choice of suspension adjustments vary with carrying load, driver's weight, personal preference, riding speed and field condition.

REAR SUSPENSION TYPE		
MODELS	TYPE	
	PPS 120	PPS 146
Rave 550, Rave 600 HO E-TEC and Rave 800R E-TEC	X	—
Xtrim 550, Xtrim 600 HO E-TEC and Xtrim 800R E-TEC	—	X

Adjustable suspension

NOTE: Some adjustments may not apply to your snowmobile. Use special keys in tool kit (SOME MODELS).

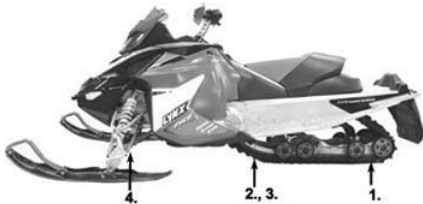

1. Rear springs - comfort and ride height
2. Center spring - handling
3. Stopper strap - snowmobile weight transfer
4. Front shock - handling

Suspension adjustments

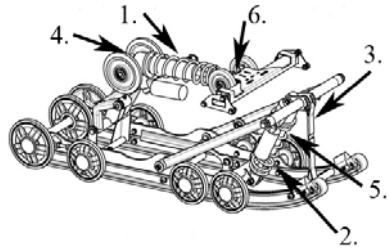

TYPICAL — PPS

1. Rear springs adjustable for comfort and ride height
2. Center spring for steering behavior
3. Stopper strap for snowmobile weight transfer
4. Rear shock motion ratio — Damping strength
5. Center shock motion ratio — Damping strength (not seen on picture)
6. Rebound strength adjustment

Following are guidelines to fine-tune suspension.

The best way to set up the suspension, is to start from factory settings, then customize each adjustment one at a time. It may be necessary to readjust center spring after adjusting front springs for instance. Test run the snowmobile under the same conditions; trail, speed, snow, driver riding position, etc. Change one adjustment and retest. Proceed methodically until you are satisfied.

⚠ WARNING

Always remove tether cord cap before performing any maintenance or adjustment, unless otherwise specified. Vehicle must be parked in a safe place, away from the trail. Always lift the front of vehicle off the ground with a suitable lifting device before adjusting ski suspension. Lift the rear of vehicle off the ground with a wide-base snowmobile stand with a rear deflector panel before rear suspension adjustment.

⚠ WARNING

Do not attempt to lift the vehicle by hand alone. Use appropriate lifting device to avoid risk of strain injuries. Always make sure the lifting device is stable and secure before proceeding to adjust the suspension components.

⚠ CAUTION Whenever adjusting rear suspension, check track tension and adjust as necessary.

Slight suspension bottoming occurring under the worst riding conditions indicates a good choice of spring preload.

NOTE: Some models may come from factory equipped with Take/Apart (T/A) shocks. These can be rebuilt or re-calibrated. See an authorized Lynx dealer. Take/Apart type of shock absorbers need service at least once a year or after 1500km (refer to maintenance schedule).

SHOCK ABSORBER ADJUSTMENTS

Screw Ring Type Shock

In some models you have to first open lock ring then turn adjust ring to position wanted.

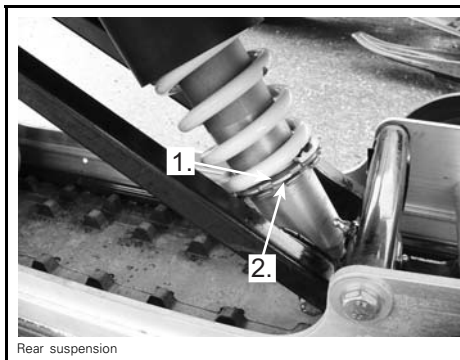

IN SOME MODELS

1. Increase or decrease spring preload
2. Locking ring

Shock dampening adjustment

In some models you may adjust also dampening strength of shock.

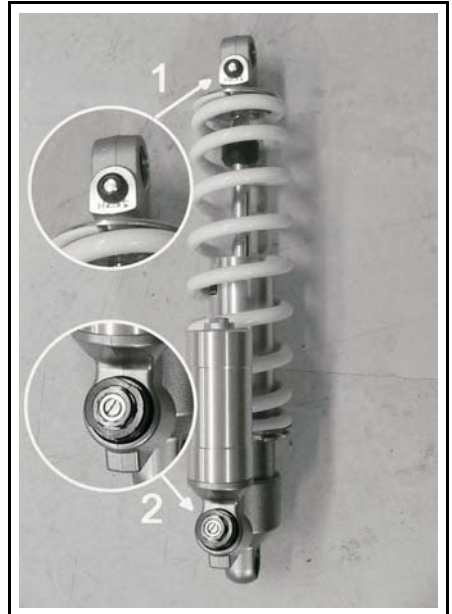

IN SOME MODELS ONLY

1. Rebound adjustment.
2. Compression adjustment.

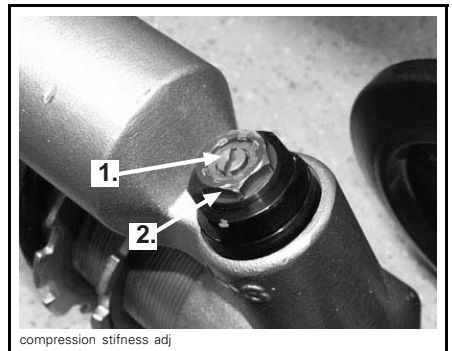

1. Low speed compression adjuster (flat screwdriver)
2. High speed compression adjuster (17mm wrench)

Turning the small brass screw [1] clockwise increases the low-speed compression dampening.

Turning the red nut [2] clockwise increases the high-speed compression dampening.

These adjustments have no effect on rebound dampening.

Rear Springs — Comfort

IMPORTANT: Make sure that all objects to be transported are in place in storage compartment and rear rack.

- Grab rear bumper and lift until suspension is fully extended.
- From this point, rear of snowmobile should collapse by 50 to 75 mm (2 to 3 in) when driver and passenger (if so applicable) take place. Measure at rear bumper as shown in next photo.

⚠ WARNING

Do not attempt to lift the vehicle by hand alone. Use appropriate lifting device or have assistance to share lifting stress in order to avoid risk of strain injuries.

Rear Springs Adjustment

"C"	CAUSE	SOLUTION
50 to 75 mm (2 to 3 in)	No adjustment required	
More than 75 mm (3 in)	Too soft of adjustment	Increase preload (see preload adjustment)
Less than 50 mm (2 in)	Too hard of adjustment	Decrease preload (see preload adjustment)

NOTE: Xtrim models only. When carrying passenger adjust rear shock spring preload to 17mm (normal adjustment 8mm).

Center Spring — Steering Behavior

- Ride at moderate speed on a trail.
- If handlebar is felt too easy or too hard to turn, adjust center spring accordingly.

⚠ WARNING

Before proceeding with any suspension adjustment, remember:

- park in a safe place
- remove tether cord cap
- lift rear of vehicle off the ground with a wide-base snowmobile stand with a rear deflector panel
- make sure lifting device is stable and secure.

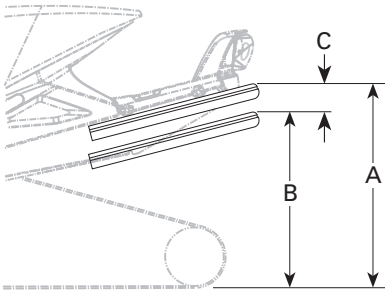

TYPICAL — PROPER ADJUSTMENT
 A. Suspension fully extended
 B. Suspension has collapse with driver, passenger(s) and load added
 C. Distance between dimension A and B, must not exceed 50 to 75 mm (2 to 3 in), see table

Preload Adjustment

CENTER SPRING ADJUSTMENT				
STEERING BEHAVIOR			ADJUSTMENT	
VEHICLE SPEED	HANDLE-BAR	STEERING ATTITUDE	PROBLEM	SOLUTION
Moderate	Easy to turn	Neutral	No adjustment required	
	Harder to turn	Oversteering	Too soft of adjustment	Increase preload
	Very easy to turn	Understeering	Too hard of adjustment	Decrease preload

Stopper Strap — Weight Transfer

- Ride at low speed then fully accelerate.
- Note steering behavior.
- Adjust stopper strap length accordingly,

⚠ WARNING

Before proceeding with any suspension adjustment, remember:

- park in a safe place
- remove tether cord cap
- lift rear of vehicle off the ground with suitable lifting device
- make sure lifting device is stable and secure.

⚠ CAUTION Whenever stopper strap length is changed, track tension must be readjusted.

Strap Adjustment

STOPPER STRAP — WEIGHT TRANSFER				
WEIGHT TRANSFER			ADJUSTMENTS	
STEERING BEHAVIOR	TRACK	SKIS	PROBLEM	SOLUTION
Comfortable	Good weight transfer	Light pressure	No adjustment required	
Light	Too much weight transfer	Lift off the ground	Too long strap	Reduce strap length
Heavy	Not enough weight transfer	Heavy pressure	Too short strap	Increase strap length

Front Springs — Handling

- Ride at moderate speed and check for proper handling.
- Adjust front springs accordingly.

⚠ WARNING

Before proceeding with any suspension adjustment, remember:

- park in a safe place
- remove tether cord cap
- lift rear of vehicle off the ground with a wide-base snowmobile stand with a rear deflector panel
- make sure lifting device is stable and secure.

⚠ WARNING

Always adjust both front springs to same position.

Preload Adjustment

FRONT SPRINGS ADJUSTMENT			
HAND-LING	STEE-RING	PROB-LEM	SOLU-TION
Good	Comfortable	No adjustment required	
Bad	Too easy to turn	Too soft of adjustment	Increase spring preload
Bad	Hard to turn	Too hard of adjustment	Decrease spring preload

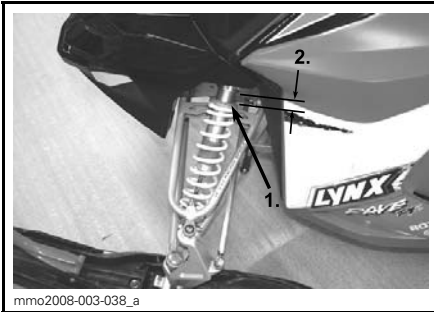

mmo2008-003-038_a

1. Adjustment ring
2. Ring positions

⚠ CAUTION Make sure that both front springs are still pre loaded when front of vehicle is off the ground.



mmo2008-003-032_a

FRONT SUSPENSION

1. Front springs for handling

Following are guidelines to fine-tune suspension.

The best way to set up the suspension, is to start from factory settings, then customize each adjustment one at a time. Adjustments 2 through 6 are interrelated. It may be necessary to

readjust center spring after adjusting front springs for instance. Test run the snowmobile under the same conditions; trail, speed, snow, driver riding position, etc. Change one adjustment and retest. Proceed methodically until you are satisfied.

⚠ WARNING

Always remove the tether cord cap (DESS key) before performing any maintenance or adjustment, unless otherwise specified. Vehicle must be parked in a safe place, away from the trail. Always lift the front of vehicle off the ground with a suitable lifting device before adjusting ski suspension. Lift the rear of vehicle off the ground with a wide-base snowmobile stand with a rear deflector panel before rear suspension adjustment.

⚠ WARNING

Do not attempt to lift the vehicle by hand alone. Use appropriate lifting device to avoid risk of strain injuries. Always make sure the lifting device is stable and secure before proceeding to adjust the suspension components.

⚠ CAUTION Whenever adjusting rear suspension, check track tension and adjust as necessary.

Front Suspension Shock Damping

Rave/Xtrim 600 HO E-TEC and Rave/Xtrim 800R E-TEC Only

Compression/Rebound Adjustment

Front shock on the above mentioned models feature a compression/rebound adjustment.

Turn the damping adjuster accordingly. Turning it clockwise increases shock damping action (stiffer).

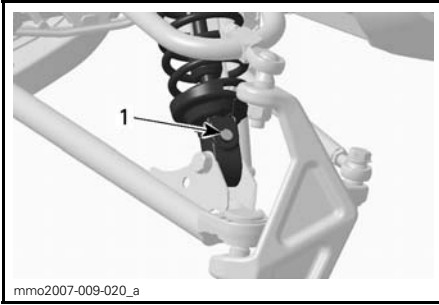

TYPICAL
1. Damping adjuster

Suspension Troubleshooting Chart

PROBLEM	CORRECTIVE MEASURES
Front suspension wandering	Check ski alignment and camber angle adjustment. See an authorized LYNX dealer. Reduce ski ground pressure. <ul style="list-style-type: none"> – Reduce front suspension spring preload. – Increase center spring preload. – Reduce rear spring preload.
Snowmobile seems unstable and seems to pivot around its center	Reduce rear suspension front arm pressure. <ul style="list-style-type: none"> – Reduce center spring preload. – Increase rear spring preload. – Increase front suspension spring preload.
Steering feels too heavy	Reduce ski ground pressure. <ul style="list-style-type: none"> – Reduce front suspension spring preload. – Increase center spring preload.
Rear of snowmobile seems too stiff	Reduce rear spring preload.
Rear of snowmobile seems too soft	Increase rear spring preload.
Rear suspension front shock absorber is frequently bottoming	Increase center spring preload.
Track spins too much at start	Lengthen stopper strap.

Deep Snow Riding

When operating the snowmobile in deep snow, it may be necessary to vary stopper strap length and/or riding position, to change the angle at which the track rides on the snow. Operator's fa-

miliarity with the various adjustments as well as snow conditions will dictate the most efficient combination.

TROUBLESHOOTING

Beeper Codes

Beeper codes are used to inform you on the DESS system operation and/or as a complement of the pilot lamps to catch your attention if an anomaly occurs or to inform you of a particular condition.

For more details on DESS system beeper codes, refer to *DESS PILOT LAMP CODES* in *TETHER CUT-OUT SWITCH*.

For more details on gauge pilot lamps, refer to *GAUGE PILOT LAMPS*.

For any beep code not listed in this Operator's Guide, refer to an authorized LYNX dealer.

General

ENGINE IS CRANKED BUT FAILS TO START.

- 1. Engine cut-out switch is in OFF position or tether cord cap (DESS key) away from post.**
 - *Place engine cut-out switch in the ON position and install tether cord cap (DESS key) on post.*
- 2. Mixture not rich enough to start cold engine.**
 - *Check fuel tank level and check starting procedure, particularly use of the choke.*
- 3. Flooded engine (spark plug wet when removed).**
 - *Do not choke. Remove wet spark plug, place engine cut-out switch in OFF position and crank engine several times. Install clean dry spark plug.*
 - *Start engine following usual starting procedure. If engine continues to flood, see an authorized LYNX dealer.*
- 4. No fuel to the engine (spark plug dry when removed).**
 - *Check fuel tank level; check condition of fuel and impulse lines and their connections. A failure of the fuel pump or carburetor has occurred. Contact an authorized LYNX dealer.*
- 5. Spark plug/ignition (no spark).**
 - *Remove spark plug(s) then reconnect to spark cap. Check that engine cut-out switch is at the ON position and the tether cord cap (DESS key) snapped over the receptacle.*
 - *Start engine with spark plug(s) grounded to engine away from spark plug hole. If no spark appears, replace spark plug. If trouble persists, contact an authorized LYNX dealer.*
- 6. Engine compression.**
 - *As the engine is pulled over with the rewind starter, "cycles" of resistance should be felt as piston goes past top dead center (each piston on multi-cylinder engines).*
 - *If no pulsating resistance is felt, it suggests a major loss of compression. Contact an authorized LYNX dealer.*

ENGINE LACKS ACCELERATION OR POWER.

1. **DESS did not read tether cord cap (DESS KEY) code. DESS pilot lamp blinks once every 1.5 seconds. Engine can not exceed 3000 RPM.**
 - *Properly install tether cord cap (DESS key).*
2. **DESS has read a different code than the one programmed. DESS pilot lamp blinks rapidly (3 times per second). Engine can not exceed 3000 RPM.**
 - *Install a tether cord cap (DESS key) for which this snowmobile was programmed.*
3. **Fouled or defective spark plug.**
 - *Check item 5 of ENGINE TURNS OVER BUT FAILS TO START.*
4. **Lack of fuel to engine.**
 - *Check item 4 of ENGINE TURNS OVER BUT FAILS TO START.*
5. **Carburetor adjustments.**
 - *Contact an authorized LYNX dealer.*
6. **Drive belt worn too thin.**
 - *If the drive belt has lost more than 3 mm (1/8 in) of its original width, it will affect vehicle performance.*
 - *Replace drive belt.*
7. **Drive and driven pulleys require servicing.**
 - *Contact an authorized LYNX dealer.*

ENGINE BACKFIRES.

1. **DESS did not read tether cord cap (DESS key) code. DESS pilot lamp blinks once every 1.5 seconds. Engine can not exceed 3000 RPM.**
 - *Properly install tether cord cap (DESS key).*
2. **DESS has read a different tether cord cap (DESS key) code than the one programmed. DESS pilot lamp blinks rapidly (3 times per second). Engine can not exceed 3000 RPM.**
 - *Install a tether cord cap (DESS key) for which this snowmobile was programmed.*
3. **Faulty spark plug (carbon accumulation).**
 - *See item 5 of ENGINE TURNS OVER BUT FAILS TO START.*
4. **Engine is running too hot.**
 - *See item 6 of ENGINE LACKS ACCELERATION OR POWER.*
5. **Ignition timing is incorrect or there is an ignition system failure.**
 - *Contact an authorized LYNX dealer.*

ENGINE MISFIRES.

1. **DESS did not read tether cord cap (DESS key) code. DESS pilot lamp blinks once every 1.5 seconds. Engine can not exceed 3000 RPM.**
 - *Properly install tether cord cap (DESS key).*

ENGINE MISFIRES. (cont'd)

2. **DESS has read a different code than the one programmed. DESS pilot lamp blinks rapidly (3 times per second). Engine can not exceed 3000 RPM.**
 - *Install a tether cord cap (DESS key) for which this snowmobile was programmed.*
3. **Fouled/defective/worn spark plugs.**
 - *Clean/verify spark plug gap and identification number. Replace as required.*
4. **Too much oil supplied to engine.**
 - *Improper oil pump adjustment, refer to an authorized LYNX dealer.*
5. **Water in fuel.**
 - *Drain fuel system and refill with fresh fuel.*

SNOWMOBILE CANNOT REACH FULL SPEED.

1. **Drive belt.**
 - *Check item 6 of ENGINE LACKS ACCELERATION OR POWER.*
2. **Incorrect track adjustment.**
 - *See MAINTENANCE and/or an authorized LYNX dealer for proper alignment and tension adjustments.*
3. **Pulleys misaligned.**
 - *Contact an authorized LYNX dealer.*
4. **Engine.**
 - *See items 1, 2, 6 and 7 of ENGINE LACKS ACCELERATION OR POWER.*

SPECIFICATIONS

NOTE: Because of its ongoing commitment to product quality and innovation, BRP reserves the right, at any time, to make changes in design and specifications and/or to make additions to, or improvements in its products without imposing any obligation upon itself to install them on its products previously manufactured.

MODEL		RAVE	XTRIM
		550	550
Engine System			
Engine type		Rotax 550SK, axial fan cooled w/cylinder reed porting	
Cylinders		2	
Displacement (cc)		553,4	
Bore (mm)		76	
Stroke (mm)		61	
Maximum engine speed		6800 RPM	
Carburetion		2 x VM30 Choke	
Exhaust system		Single tuned pipe, baffle muffler	
Fan belt part number		420 980 517	
Drive System			
Drive pulley type		TRA III	
Driven pulley type		LPV VSA	
Drive belt part number		417 300 367 (3)	
Engagement (RPM)		3900	3000
Small sprocket number of teeth		21 steel	17 steel
Large sprocket number of teeth		45	
Drive sprocket number of teeth		8	
Brake system		Hydraulic, R-EX T type brake lever	
Track nominal width (mm)		380	406
Track nominal length (mm)		3052	3705
Track profile height		25	39
Track adjustment	Deflection (mm)	30-35	40-45
	Force ⁽¹⁾ (kg)	7,3	
Track alignment		Equal distance between edges of track guides and slider shoes	
Suspension			
Front suspension		A- LFS	
Front shock		HP-Gas, TA36	HP-Gas, 36
Front suspension max. travel (mm)		242	210

MODEL		RAVE	XTRIM
		550	550
Suspension (cont'd)			
Rear suspension		PPS-120	PPS-146
Front arm shock		HP-Gas, TA36	HP-Gas 36
Rear arm shock		HP-Gas, TA36	HP-Gas 36
Rear suspension max. travel	(mm)	390	
Electrical			
Lightning system output		340 Watts @ 6000 RPM	
Headlamp bulb HI/LOW beam		2 x 60/55 Watts (H4)	
Taillight bulb		21/5W	
Spark plug	Type	NGK BR9ES	
	Gap	0,45 ± 0,05mm	
Fuse		Refer to FUSE section	
Dimensions			
Vehicle overall length	(mm)	2870	3230
Vehicle overall width	(mm)	1225	
Vehicle overall height	(mm)	1130	1210
Mass	(kg)	208	229
Ski stance	(mm)	1080	975 (+42 adj.)
Liquids			
Recommended fuel type		Regular unleaded	
Minimum octane	RON	95E	
Recommended oil (engine) ⁽³⁾		XP-S 2 stroke mineral injection oil	
Brake system fluid		SRF (DOT4) or GTLMA (DOT4)	
Oil type (chaincase/transmission)		XP-S synthetic chaincase oil	
Capacities			
Fuel tank	(L)	39	
Oil tank	(L)	3,7	
<p>(1) Measure gap between slider shoe and bottom inside track when exerting a downward pull to the track.</p> <p>(2) Drive belt height must be adjusted every time a new drive belt is installed. Confirm drive belt part number application with an authorized Lynx dealer.</p> <p>(3) Note: Although XP-S mineral 2–stroke injection oil or XP-S semi-synthetic 2–stroke injection oil is recommended as a minimum level oil for your vehicle, XP-S Synthetic 2–stroke injection oil is recommended to offer even better protection for your vehicle in extreme conditions.</p>			

SPECIFICATIONS

MODEL		RAVE SC 600 HO E-TEC/ RAVE RE 600 HO E-TEC/ XTRIM SC 600 HO E-TEC
ENGINE SYSTEM		
Engine type		Rotax 600 HO E-TEC, liquid cooled w/Reed valve,3-D RAVE
Cylinders		2
Displacement	cc (in ³)	594.4
Bore	mm (in)	72
Stroke	mm (in)	73
Maximum engine speed		8100 RPM
Carburetion		Direct injection E-TEC
Exhaust system		Single tuned pipe, baffle muffler
DRIVE SYSTEM		
Drive pulley type		TRA III
Driven pulley type		QRS
Engagement		3400 RPM
Drive belt part number		417 300 383 ⁽³⁾
Small sprocket number of teeth	Rave SC 600 HO E-TEC	25
Small sprocket number of teeth	Rave RE 600 HO E-TEC	23
Small sprocket number of teeth	Xrim SC 600 HO E-TEC	22
Large sprocket number of teeth	Rave SC 600 HO E-TEC / Rave RE 600 HO E-TEC	45
Large sprocket number of teeth	Xtrim SC 600 HO E-TEC	45
Drive sprocket number of teeth		8
Brake system		Hydraulic, RE-X brake type
Track nominal width	Rave SC 600 HO E-TEC / Rave RE 600 HO E-TEC	380 mm
Track nominal width	Xtrim SC 600 HO E-TEC	406 mm

MODEL		RAVE SC 600 HO E-TEC/ RAVE RE 600 HO E-TEC/ XTRIM SC 600 HO E-TEC
DRIVE SYSTEM (Cont'd)		
Track nominal length	Rave SC 600 HO E-TEC / Rave RE 600 HO E-TEC	3052 mm
Track nominal length	Xtrim SC 600 HO E-TEC	3705 mm
Track nominal height	Rave SC 600 HO E-TEC	32 mm
	Rave RE 600 HO E-TEC	38 mm
	Xtrim SC 600 HO E-TEC	39 mm
Track tension	Deflection Rave SC 600 HO E-TEC / Rave RE 600 HO E-TEC	30-35 mm
	Deflection Xtrim SC 600 HO E-TEC	40-44 mm
	Force ⁽¹⁾	7.3 kg
Track alignment		Equal distance between edges of track guides and slider shoes
SUSPENSION		
Front suspension		A-LFS
Front shock	Rave SC 600 HO E-TEC / Xtrim SC 600 Ho E-TEC	KYB 36 R
Front shock	Rave RE 600 HO E-TEC	KYB 40 HLCR
Front suspension max. travel		242 mm
Rear suspension	Rave SC 600 HO E-TEC / Rave RE 600 HO E-TEC	PPS-120
Rear suspension	Xtrim SC 600 HO E-TEC	PPS-146
Front arm shock	Rave SC 600 HO E-TEC / Xtrim SC 600 HO E-TEC	KYB 36
Front arm shock	Rave RE 600 HO E-TEC	KYB 46 HLCR
Rear arm shock	Rave SC 600 HO E-TEC / Xtrim SC 600 HO E-TEC	KYB 46
Rear arm shock	Rave RE 600 HO E-TEC/	KYB 46 HLCR
Rear suspension max. travel		390 mm

SPECIFICATIONS

MODEL		RAVE SC 600 HO E-TEC/ RAVE RE 600 HO E-TEC/ XTRIM SC 600 HO E-TEC
ELECTRICAL		
Lightning system output		12V/55V/1200W
Headlamp bulb HI/LOW beam		2 x 60/55 Watts (H-4)
Taillight bulb		Led
Spark plug	Type	NGK PZFR6F ⁽²⁾
	Gap	Not adjustable (0.8 +0/-0.1mm)
	Torque	Refer to SPARK PLUG INSTALLATION for proper intallation procedure
Fuse		Refer to <i>FUSE</i> section
Vehicle overall length	Rave SC 600 HO E-TEC / Rave RE 600 HO E-TEC	2870 mm
Vehicle overall lenght	Xtrim SC 600 HO E-TEC	3230 mm
Vehicle overall width		1225 mm
Vehicle overall height	Rave SC 600 HO E-TEC / Rave RE 600 HO E-TEC	1130 mm
Vehicle overall height	Xtrim SC 600 HO E-TEC	1210 mm
DIMENSIONS		
Official dry weight	Rave SC 600 HO E-TEC / Rave RE 600 HO E-TEC	222 kg
	Xtrim SC 600 HO E-TEC	240 kg
Ski stance	Rave SC 600 HO E-TEC / Rave RE 600 HO E-TEC	1080 mm
	Xtrim SC 600 HO E-TEC	1080 mm (-42 adj)

MODEL		RAVE SC 600 HO E-TEC/ RAVE RE 600 HO E-TEC/ XTRIM SC 600 HO E-TEC
LIQUIDS		
Recommended fuel type		Regular unleaded
Recommended fuel octane level		95 E (RON)
Recommended oil (engine)		Refer to <i>RECOMMENDED OIL</i> section
Brake system fluid		SRF (DOT 4) or GTLMA (DOT 4)
Oil type (chaincase)		XP-S synthetic chaincase oil
Coolant	Mixture	Ethyl glycol/water mix (50% coolant, 50% distilled water). Use coolant specifically designed for aluminum engines
	Premix	(P/N 219 700 362) 12 x 1 L
CAPACITIES		
Fuel tank	L	39
Oil tank	L	3.7
⁽¹⁾ Measure gap between slider shoe and bottom inside track when exerting a downward pull to the track. ⁽²⁾ CAUTION: Do not attempt to adjust gap on this plug. ⁽³⁾ Drive belt height must be adjusted every time a new drive belt is installed. Confirm drive belt part number application with an authorized LYNX dealer.		

SPECIFICATIONS

MODEL		RAVE RE 800R E-TEC	XTRIM BOONDOCKER 800R E-TEC
Engine System			
Engine type		Rotax 800R E-TEC	
Cylinders		2	
Displacement (cc)		799,5	
Bore (mm)		82	
Stroke (mm)		76	
Maximum engine speed		8000 RPM	
Carburetion		Direct injection E-TEC	
Exhaust system		Single tuned pipe, baffle muffler	
Drive System			
Drive pulley type		TRA 7	
Driven pulley type		QRS	
Drive belt part number		417300391 (3)	
Engagement (RPM)		3800	
Small sprocket number of teeth		25	21
Large sprocket number of teeth		45	
Drive sprocket number of teeth		8	
Brake system		Hydraulic, R-EX T brake type	
Track nominal width (mm)		380	406
Track nominal length (mm)		3052	3705
Track profile height		38	44
Track adjustment	Deflection (mm)	30-35	40-45
	Force ⁽¹⁾ (kg)	7,3	
Track alignment		Equal distance between edges of track guides and slider shoes	
Suspension			
Front suspension		A- LFS	
Front shock		KYB 40 HLCR	KYB 36 R
Front suspension max. travel (mm)		242	
Suspension (cont'd)			
Rear suspension		PPS-120	PPS-146
Front arm shock		KYB 46 HLCR	KYB 36
Rear arm shock		KYB 46 HLCR	KYB 46

MODEL		RAVE RE 800R E-TEC	XTRIM BOONDOCKER 800R E-TEC
Rear suspension max. travel	(mm)	390	
Electrical			
Lightning system output		12V / 55V / 1200 W	
Headlamp bulb HI/LOW beam		2 x 60/55 Watts (H-4)	
Taillight bulb		Led	
Spark plug	Type	NGK BR9ECS ⁽²⁾	
	Gap	Not adjustable (0.80 ± 0.05 mm)	
Fuse		Refer to FUSE section	
Dimensions			
Vehicle overall length	(mm)	2870	3230
Vehicle overall width	(mm)	1225 - 1162	3230
Vehicle overall height	(mm)	1130	1210
Mass	(kg)	224	234
Ski stance	(mm)	1080	975 (+42 adj.)
Liquids			
Recommended fuel type		Premium unleaded	
Minimum octane	RON	95E	
Recommended oil (engine) ⁽³⁾		Refer to <i>RECOMMENDED OIL</i> section	
Brake system fluid		SRF (DOT4) or GTLMA (DOT4)	
Oil type (chaincase / transmission)		XP-S synthetic chaincase oil	
Capacities			
Fuel tank	(L)	39	
Oil tank	(L)	3,7	
<p>⁽¹⁾ Measure gap between slider shoe and bottom inside track when exerting a downward pull to the track.</p> <p>⁽²⁾ CAUTION: Do not attempt to adjust gap on this plug.</p> <p>⁽³⁾ Drive belt height must be adjusted every time a new drive belt is installed. Confirm drive belt part number application with an authorized LYNX dealer.</p>			

The EC-Declaration of Conformity does not appear in this version of the Operator's Guide.

Please refer to the printed version that was delivered with your vehicle.

MAINTENANCE INFORMATION

PERIODIC MAINTENANCE CHART

WARNING

It is recommended that the assistance of an authorized LYNX dealer be periodically obtained on other components/systems not covered in this guide. Unless otherwise specified, engine must be cold and not running. Remove the tether cord cap (DESS key) before performing any maintenance or adjustment, unless otherwise specified. Vehicle must be parked in a safe place, away from the trail.

WARNING

Observe WARNINGS and CAUTIONS mentioned throughout this guide which are relevant to the item being checked. When component conditions seem less than satisfactory, replace with genuine BRP parts or approved equivalents.

Some items may not apply to your particular model. Refer to *MAINTENANCE* in *SHOP MANUAL* for more details.

BREAK-IN INSPECTION

After the first 10 hours or 500 km (300 mi) of operation, whichever comes first, your vehicle have to be inspected by an authorized Lynx dealer. The break-in inspection is very important and must not be neglected.

NOTE: The break-in inspection is at the expense of the vehicle owner.

BREAK-IN INSPECTION (2-STROKE)
Inspect engine motor mounts
Inspect exhaust system and check for leaks
Tighten exhaust manifold screws to specified torque
Check coolant level
Inspect fuel lines and connections
Inspect throttle cable
Inspect oil injection pump adjustment (All except E-TEC)
Inspect drive belt
Visually inspect drive pulley
Tighten drive pulley retaining screw to specified torque
Inspect driven pulley
Inspect spark plugs (All except E-TEC)
Adjust and align track
Change chaincase oil
Retorque gearbox cover screws both sides of speedometer sensor connector to 10Nm (Only XU Models)
Adjust drive chain (Not for models equipped with gearbox)
Check brake fluid level
Inspect brake hose, pads and disk
Inspect steering mechanism
Inspect skis and runners
Tighten frame pyramid rod screws to specified torque
Inspect front suspension
Inspect rear suspension and slider shoes

MAINTENANCE SCHEDULE (2-STROKE)

NOTE: The maintenance schedule does not exempt the pre-ride inspection.

EVERY 1 500 KM
T/A shocks oil change. First at 1500 km, then every 3000 km or once a year.
Models with chaincase: Adjust drive chain
Models with gearbox: Check oil level

EVERY 3 000 KM OR 1 YEAR (WHICHEVER COMES FIRST)
Inspect engine motor mounts
Inspect exhaust system and check for leaks
Inspect cooling system cap, hoses and clamps and check for leaks
Replace spark plugs (All except of E-TEC)
Clean RAVE valves
Inspect RAVE valves solenoid
Adjust engine stopper
Visually inspect and clean drive pulley
Tighten drive pulley retaining screw to specified torque
Clean driven pulley
Adjust and align track
Inspect brake hose, pads and disk
Inspect steering mechanism
Inspect front suspension
Inspect rear suspension and stopper strap. PPS Suspension: Replace stopper strap.
Lubricate front and rear suspension whenever the vehicle is used in wet conditions (wet snow, rain, puddles)
Lubricate QRS axle gearbox end. (XU models)

**EVERY 6 000 KM OR 2 YEARS
(WHICHEVER COMES FIRST)**

Replace oil filter

Replace fuel filter

Replace spark plugs (800 E-TEC only)

Replace brake fluid

Inspect throttle cable

**EVERY 10 000 KM OR 3 YEARS
(WHICHEVER COMES FIRST)**

Replace spark plugs (600 E-TEC only)

EVERY 5 YEARS

Replace engine coolant

PRESEASON PREPARATION

PRESEASON PREPARATION (2-STROKE)
Inspect engine motor mounts
Check exhaust system condition and check for leaks
Tighten exhaust manifold screws or nuts to specified torque
Replace spark plugs. (All except E-TEC)
Inspect cooling system cap, hoses and clamps
Check coolant density
Inspect crankshaft PTO seal
Inspect fuel lines and connections
Clean and inspect throttle body
Inspect throttle cable
Inspect drive belt (adjust at every drive belt replacement)
Clean and visually inspect drive pulley
Clean and inspect driven pulley
Inspect, adjust and align track
Adjust drive chain (Not for models equipped with gearbox)
Change chaincase oil
Check brake fluid level
Inspect brake hose, pads and disk
Inspect steering mechanism
Inspect skis and runners
Inspect front suspension
Inspect rear suspension stopper strap
Charge battery (if so equipped)
Adjust headlight beam aiming

STORAGE

During summer, or when a snowmobile is not in use for more than three months, proper storage is a necessity.

STORAGE
Clean the vehicle
Add fuel stabilizer to fuel following the product manufacturer recommendations Run the engine after adding the product to the fuel
2-Stroke models: Lubricate engine. See owners manual for instruction.
Lubricate brake lever pivot
Inspect and lubricate rear suspension
Charge battery monthly to keep it fully charge during storage
Block muffler with rags
Lift rear of vehicle until track is clear of the ground. Do not release track tension

ENGINE SYSTEM

Air Intake Silencer Prefilter Verification

Ensure that air intake silencer prefilter is properly installed and in good condition, replace if damaged.



Air Filter with Dual Air Intake (E-TEC 800R engines only)

Air Filter Verification

There are two air intake pre-filters, one on each side of the console.

Ensure the air intake prefilters are properly installed, clean and in good condition.



1. RH Air filter

Cooling System

Check coolant level at room temperature. Liquid should be at cold level line (engine cold) of coolant tank.

NOTE: When checking level at low temperature it may be slightly lower than the mark.

If additional a large amount of coolant has to be added or if entire system has to be refilled, refer to an authorized LYNX dealer.

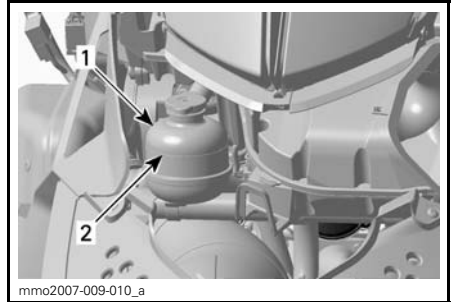

TYPICAL

1. Coolant tank
2. COLD LEVEL line

Exhaust System

The tail pipe of the muffler should be centered with the exit hole in the bottom pan. Exhaust system must be free of rust or leaks. Make sure that gear clamps are properly tightened.

The exhaust system is designed to reduce noise and to improve the total performance of the engine. Modification may be in violation of local laws.

⚠ CAUTION If any exhaust system component is removed, modified or damaged, severe engine damage may result.

DRIVE SYSTEM

Belt Guard Removal and Installation

⚠ WARNING

NEVER operate engine:

- without shields and belt guard securely installed
- with hood and/or side panels opened or removed.

NEVER attempt to make adjustments to moving parts while engine is running.

NOTE: Belt guard is purposely made slightly oversize to maintain tension on its pins and retainers preventing undue noise and vibration. It is important that this tension be maintained when re-installing.

Remove the tether cord cap (DESS key).

Open engine compartment LH side panel.

Remove retaining pin.

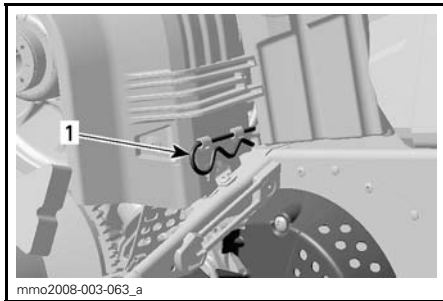

1. Retaining pin

Lift rear portion of guard then release from front tabs.

When reinstalling belt guard, position its cutaway toward front of snowmobile.

Place belt guard slots over tabs first, then snap the other end in rear retainer.

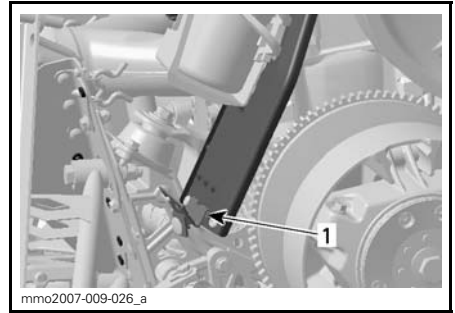

TYPICAL

1. Slots

Secure belt guard using retaining pin.

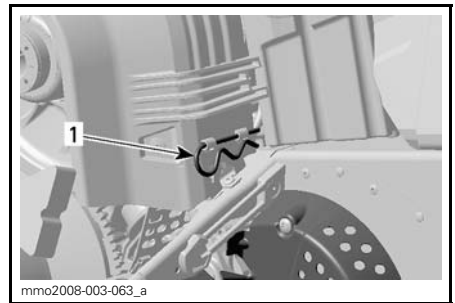

1. Retaining pin

Brake Fluid Level

⚠ CAUTION Vehicle must be on a level surface before checking any fluid levels.

Check brake fluid (DOT 4) in reservoir for proper level. Add fluid (DOT 4) as required.

⚠ CAUTION Use only DOT 4 brake fluid from a sealed container. Never use any other types of fluid.

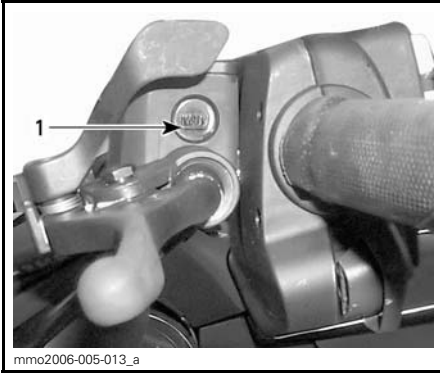

TYPICAL — BRAKE FLUID RESERVOIR
1. Minimum

Brake Condition

⚠ WARNING

The brake mechanism on your snowmobile is an essential safety device. Keep this mechanism in proper working condition. Above all, do not operate the snowmobile without an effective brake system. Periodically verify the condition/wear of the brake pads.

Brake Adjustment

No adjustment is provided for hydraulic brake. See an authorized LYNX dealer if any problems.

Chaincase Oil

Recommended Oil

Use XP-S synthetic chaincase oil (P/N 413 803 300).

⚠ CAUTION Use only the recommended type oil when servicing. Do not mix synthetic oil with other types of oil.

Oil Level Verification

With the vehicle on a level surface, check the oil level by removing the magnetic check plug on the left side of chaincase. Oil level must be equal with the lower edge.

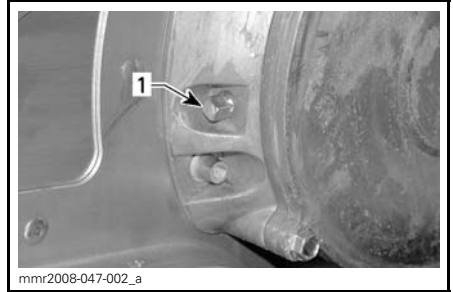

1. Magnetic check plug

NOTE: It is normal to find metallic particles stuck to magnetic check plug. If bigger pieces of metal are found, remove the chaincase cover and inspect the chaincase parts.

Remove metal particles from magnetic check plug.

To add oil, remove the filler cap on chaincase cover.

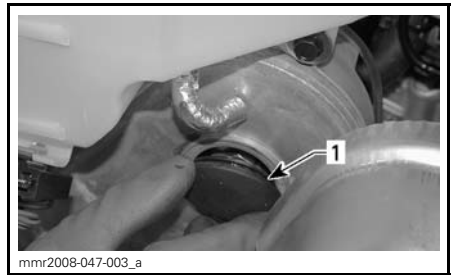

1. Filler cap

Pour recommended oil in chaincase by the filler hole until oil comes out by the magnetic check plug hole. Reinstall magnetic check plug and torque to 6 N•m (53 lbf•in)

Drive Chain Tension

Contact an authorized LYNX dealer.

Drive Belt Inspection

Inspect belt for cracks, fraying or abnormal wear (uneven wear, wear on one side, missing cogs, cracked fabric). If abnormal wear is noted, probable cause could be pulley misalignment, excessive RPM with frozen track, fast starts without warm-up period, burred or rusty sheave, oil on belt or distorted spare belt. Contact an authorized LYNX dealer.

Drive Belt Replacement

Drive Belt Removal

1. Remove DESS key from post.
2. Open LH side panel, refer to *BODY*.
3. Remove belt guard, refer to *BELT GUARD REMOVAL*.
4. Insert the driven pulley expander provided in the tool kit in the threaded hole on the adjuster hub as shown.

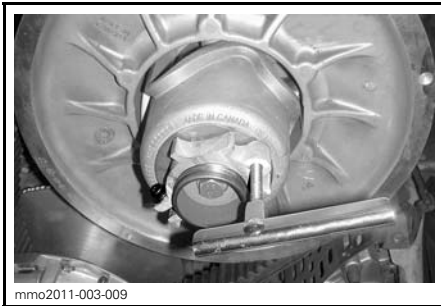

PULLEY EXPANDER ON ALUMINUM ADJUSTER HUB

5. Open the driven pulley by screwing the tool in.
6. Remove the belt by slipping it over the top of the driven pulley, then over the drive pulley.

Drive Belt Installation

1. If necessary, open the driven pulley, refer to *DRIVE BELT REMOVAL* above.

2. Slip the belt over the drive pulley, then over the driven pulley.

NOTICE Do not force or use tools to pry the belt into place, as this could cut or break the cords in the belt.

NOTE: The maximum drive belt life span is obtained when belt is installed with arrows in the direction of rotation.

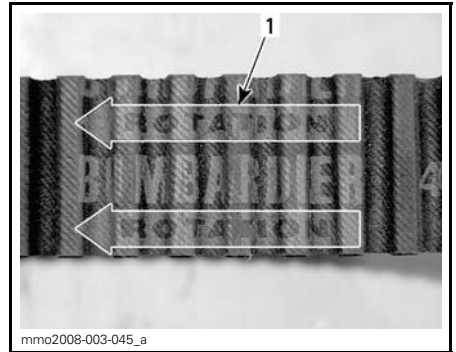

1. To be pointed in the direction of rotation

3. Unscrew and remove the driven pulley expander from the pulley.
4. Rotate the driven pulley several times to properly set the belt between the sheaves.
5. If a new belt was installed, adjust the belt height. Refer to *DRIVE BELT HEIGHT ADJUSTMENT* below.
6. Install belt guard, refer to *DRIVE BELT GUARD INSTALLATION*
7. Close side panel, refer to *BODY*

Drive Belt Height Adjustment

The drive belt height must be checked every time a new belt is installed.

To adjust the drive belt height, proceed as follows:

1. Remove D.E.S.S. key from post.
2. Open LH side panel, refer to *BODY*.

- Remove belt guard, refer to *DRIVE BELT GUARD REMOVAL*
- Loosen the clamping screw.



PRELIMINARY SETTING

- 2mm (.079 in)

Belt with External Cogs

Repeat step 5 until the bottom of grooves on the external side of drive belt are flush with the driven pulley.

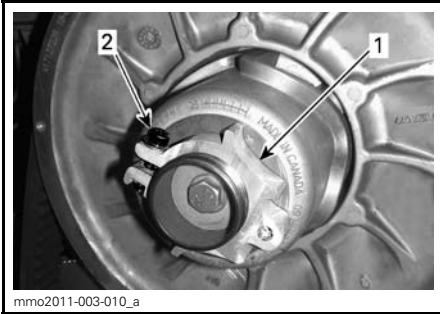

ALUMINUM ADJUSTER HUB

- Adjuster hub
- Clamping screw

- Using the suspension adjustment tool provided in the tool kit, turn the ring 1/4 turn at a time then rotate the driven pulley to properly set the belt between the pulley sheaves.

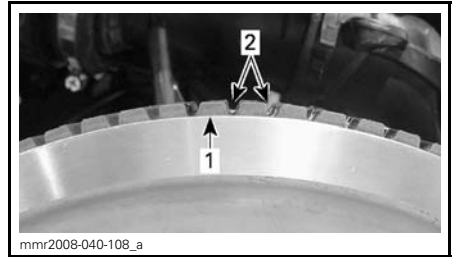

PRELIMINARY SETTING

- Driven pulley edge
- External drive belt grooves

All Drive Belt Types

NOTE: Turning the ring counterclockwise lowers the belt in the pulley. Turning the ring clockwise raises the belt in the pulley.

- Firmly tighten the clamping screw. If possible, tighten to $5.5 \text{ N}\cdot\text{m} \pm 0.5 \text{ N}\cdot\text{m}$ ($49 \text{ lbf}\cdot\text{in} \pm 4 \text{ lbf}\cdot\text{in}$) using a torque wrench.

- Install belt guard, refer to *DRIVE BELT GUARD INSTALLATION*.

- Close side panel, refer to *BODY*.

NOTE: This setting is correct as a preliminary adjustment for most models and belt types. In some cases, when starting the engine, the vehicle could creep, indicating that the belt is too tight.



ALUMINUM ADJUSTER HUB

- Suspension adjustment tool

NOTE: The adjustment ring has left hand treads

Belt without External Cogs

Repeat step 5 until the external surface of drive belt exceeds driven pulley edge by 2mm (.079 in).

If the vehicle creeps, lower the drive belt height from the preliminary setting. Repeat procedure until creeping stops.

Reverse Activation

NOTE: The reverse may not activate or may be harder to activate if the belt is positioned too high in the driven pulley. If reverse activation does not work properly, ensure the drive belt is properly adjusted. Adjust the drive belt lower in the driven pulley if needed.

Drive Pulley Adjustment

⚠ WARNING

Remove the tether cord cap (DESS key) before performing any maintenance or adjustment, unless otherwise specified. Vehicle must be parked in a safe place, away from the trail.

General

The drive pulley is factory calibrated to transmit maximum engine power at a predefined RPM. Factors such as ambient temperature, altitude or surface condition may vary this critical engine RPM thus affecting snowmobile efficiency.

This adjustable drive pulley allows setting maximum engine RPM to maintain maximum power.

Calibration screws should be adjusted so that actual maximum engine RPM matches the maximum horsepower RPM.

ENGINE	MAXIMUM HORSEPOWER RPM
550 SK	6800 RPM (± 100)
600 HO E-TEC	8100 RPM (± 100)
800 R E-TEC	8000 RPM (± 100)

NOTE: Use precision digital tachometer for engine RPM adjustment.

NOTE: The adjustment has an effect on high RPM only.

Calibration screw has a notch on top of its head.

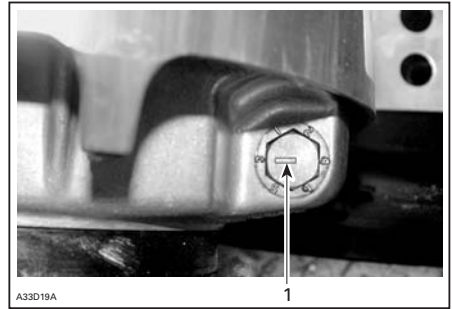

TYPICAL

1. Notch

There are 6 positions numbered 1 to 6. Each position modifies maximum engine RPM by about 200 RPM.

Lower position numbers decrease engine RPM in steps of 200 RPM and higher position numbers increase it in steps of 200 RPM.

Example:

Calibration screw is set at position 4 and is changed to position 6. So maximum engine RPM is increased by 400 RPM.

Adjustment

Just loosen locking nut enough to pull calibration screw partially out and adjust to desired position. Do not completely remove the locking nut. Torque locking nuts to 10 N•m (89 lbf•in).

⚠ CAUTION Do not completely remove calibration screw otherwise internal washers will fall off. Always adjust all 3 calibration screws and make sure they are all set to the same position.

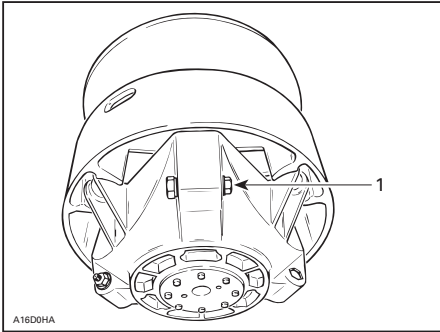
**TYPICAL**

1. Loosen just enough to permit rotating of calibrate screw

⚠ WARNING

NEVER disassemble or modify the drive pulley.

Improper assembly or modifications could cause the pulley to explode violently under the stress generated by the high rotational speed. This could lead to serious injury including the possibility of death.

See your LYNX dealer to maintain or service the drive pulley. Improper servicing or maintenance may affect performance and reduce belt life. Always respect maintenance schedules.

⚠ WARNING

NEVER operate engine:

- without shields and belt guard securely installed
- with hood and/or side panels opened or removed.

NEVER attempt to make adjustments to moving parts while engine is running.

Track Condition**⚠ WARNING**

Remove the tether cord cap (DESS key) before performing any maintenance or adjustment, unless otherwise specified. Vehicle must be parked in a safe place, away from the trail.

Remove the tether cord cap (DESS key).

Lift the rear of the snowmobile and support it with a wide-base snowmobile mechanical stand with a rear deflector panel. With the engine off, rotate the track by hand, and inspect condition. If worn or cut, or if track fibers are exposed, or if missing or defective inserts or guides are noted; contact an authorized LYNX dealer.

Look for any defects, such as:

- perforations in the track
- tears in the track
- lugs that are broken or torn off, exposing portions of rods
- delamination of the rubber
- broken rods
- missing track guide(s).

If your track shows signs of deterioration, it must be replaced immediately. When in doubt, ask your dealer.

⚠ WARNING

Riding with a damaged track could lead to a loss of control, resulting in a risk of serious injury or death.

Track Tension and Alignment

NOTE: Track tension and alignment are interrelated. Do not adjust one without the other.

⚠ WARNING

To prevent serious injury to individuals near the snowmobile:

- NEVER stand behind or near a moving track
- always use a wide-base snowmobile stand with a rear deflector panel
- when the track is raised off the ground, only run it at the lowest possible speed.

Centrifugal force could cause debris, damaged or loose studs, pieces of torn track, or an entire severed track to be violently thrown backwards out of the tunnel with tremendous force, possibly resulting in the loss of a leg or other serious injury.

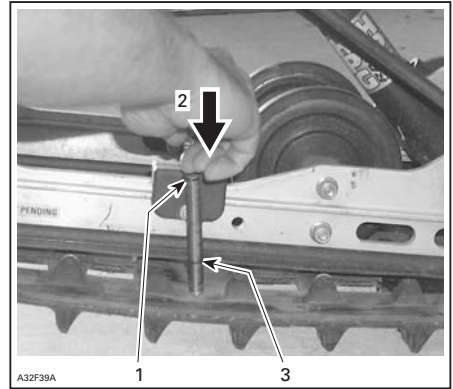

TYPICAL

1. Top tool O-ring positioned at 7.3 kg (16 lb)
2. Push on top portion of tool until it contacts the top O-ring
3. Measured track deflection (See specifications section to find your model track deflection)

Tension

NOTE: Ride the snowmobile in snow about 15 to 20 minutes prior to adjusting track tension.

Remove the tether cord cap (DESS key).

Lift rear of snowmobile and support it with a wide-base snowmobile mechanical stand.

Allow the suspension to extend normally and check gap halfway between front and rear idler wheels. Measure between slider shoe bottom and inside of track. The gap should be as given in *SPECIFICATIONS* at the end of this guide. If the track tension is too loose, track will have a tendency to thump.

NOTE: A belt tension tester (P/N 414 348 200) may be used to measure deflection as well as force applied.

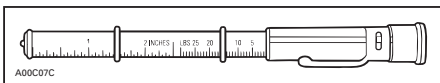

BELT TENSION TESTER

⚠ CAUTION Too much tension will result in power loss and excessive stresses on suspension components.

To adjust track tension:

- Remove the tether cord cap (DESS key).
- Remove rear wheel caps (if so equipped).
- Loosen the rear idler wheel retaining bolts.
- Turn adjustment bolts to adjust.

If correct tension is unattainable, contact an authorized LYNX dealer.

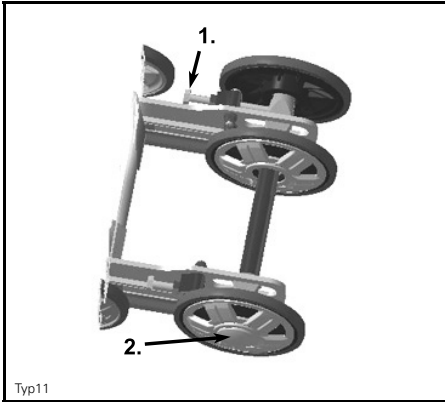

Typ11

TYPICAL

1. Adjustment bolts
2. Loosen bolt

- Retighten retaining bolts.
- Check track alignment as described below.

Alignment

⚠ WARNING

Before checking track alignment, ensure that the track is free of all particles which could be thrown out while track is rotating. Keep hands, tools, feet and clothing clear of track. Always lift the snowmobile on a wide-base stand with a rear deflector panel. Ensure no one is standing in close proximity to the snowmobile, especially at the rear of the track. Never rotate track at high speed.

Centrifugal force could cause debris, pieces of torn track, or an entire severed track to be violently thrown backwards out of the tunnel with tremendous force, possibly resulting in the loss of a leg or other serious injury.

Start the engine and accelerate slightly so that track barely turns. This must be done in a short period of time (15 to 20 seconds).

Check that the track is well centered; equal distance on both sides between edges of track guides and slider shoes.

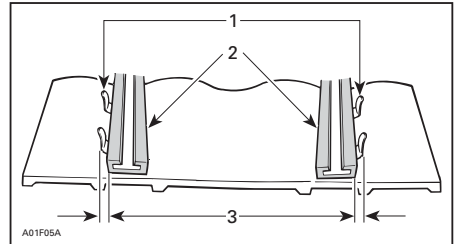

1. Guides
2. Slider shoes
3. Equal distance

To Adjust Track Alignment:

⚠ WARNING

Remove the tether cord cap (DESS key) before performing any maintenance or adjustment, unless otherwise specified. Vehicle must be parked in a safe place, away from the trail.

- Remove the tether cord cap (DESS key).
- Loosen rear idler wheel retaining bolts.
- Tighten the adjustment bolt on side where the slider shoe is the farthest from the track insert guides.

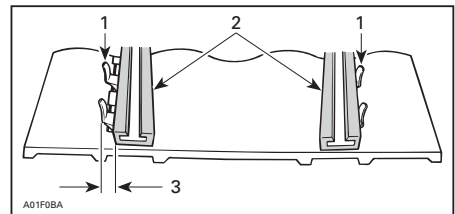

1. Guides
2. Slider shoes
3. Tighten on this side

Tighten retaining bolts.

⚠ WARNING

Properly tighten wheel retaining bolts, otherwise wheel may come off and cause track to "lock".

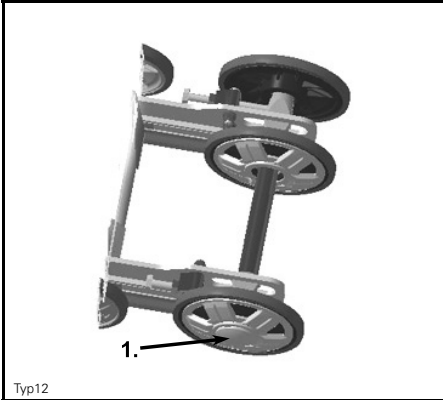

Typ12

TYPICAL

1. Retighten to 48 N•m

Restart engine and rotate track slowly to recheck alignment.

Reposition snowmobile on ground.

Install rear wheel caps if so equipped.

REAR SUSPENSION

Rear Suspension Condition

Visually inspect all suspension components including slider shoes, springs, wheels, etc.

NOTE: During normal driving, snow will act as a lubricant and coolant for the slider shoes. Extensive riding on ice or sanded snow, will create excessive heat build-up and cause premature slider shoe wear.

Suspension Stopper Strap Condition

Inspect stopper strap for wear and cracks, bolt and nut for tightness. If loose inspect holes for deformation. Replace as required. Torque nut to 11 N•m (97 lbf•in)

STEERING AND FRONT SUSPENSION

Visually inspect steering and front suspension for tightness of components (steering arms, control arms and links, tie rods, ball joints, ski bolts, ski legs, etc.). If necessary, contact an authorized LYNX dealer.

Wear and Condition of Skis and Runners

Check the condition of the skis and ski runner carbides. If worn, contact an authorized LYNX dealer.

 **WARNING**

Excessively worn skis and/or ski runners will adversely affect snowmobile control.

ELECTRICAL SYSTEM

Recommended Spark Plug

⚠ CAUTION Use only spark plug mentioned list below. It must be installed to a specific torque, refer to *SPARK PLUG INSTALLATION* for proper installation procedure.

Spark Plug Removal/Installation

Removal

Open LH side panel.

Remove belt guard, refer to *BELT GUARD REMOVAL*.

Unplug spark plug cables.



LH SIDE OF ENGINE COMPARTMENT

1. Spark plugs

Using tools from tool kit, unscrew spark plugs one turn.

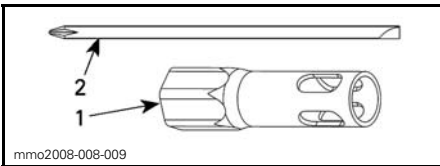

1. 16 mm socket

2. Screwdriver rod

Clean spark plugs and cylinder heads with pressurized air if possible.

⚠ WARNING

Always wear safety goggles when using pressurized air.

Unscrew spark plugs completely then remove them.

Installation

Prior to installation, make sure that contact surfaces of cylinder head and spark plugs are free of grime.

Using a feeler gauge, verify spark plug gap.

Replace spark plug if not within specifications.

⚠ CAUTION Do not attempt to adjust gap on these plugs.

Model/spark plug type	Spark plug gap
Rave 550/ NGK BR 9 ES	0.45 + 0.05 mm/-0,05mm
Rave 600 HO E-TEC/NGK PZFR6F	Not adjustable. 0.8 + 0.05 mm/-0.1 mm
Rave 800R E-TEC / NGK PFR7AB	Not adjustable. 0.75 + 0.05 mm/-0.05 mm

Screw spark plugs into cylinder head by hand until it bottoms.

Tighten plugs using tools from tool kit or with a torque wrench and a proper socket.

Using Tools from Tool Kit

Use the 16 mm socket and the screwdriver rod from the vehicle tool kit.

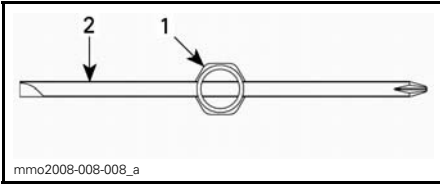
**TOP VIEW**

1. 16 mm socket
2. Screwdriver rod

Torque spark plugs as per the following illustrations.

NOTE: Ensure spark and washer sits properly on cylinder head.

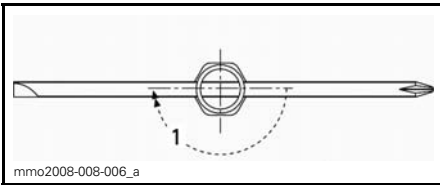
**NEW SPARK PLUG**

1. Torque 1/2 of a turn

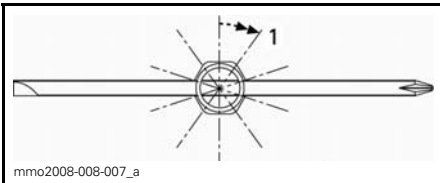
**USED SPARK PLUG**

1. Torque 1/10 of a turn

Using a Torque Wrench.

Torque spark plugs to 27.5 N•m (20.3 lbf•ft).

Fuse Removal/Inspection

The electrical system is protected with fuses, the fuse holders are located in the engine compartment.

Check fuse condition and replace it if necessary.

To remove fuse from holder, pull fuse out. Check if filament is melted.

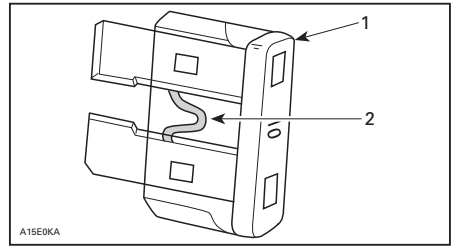

1. Fuse
2. Check if melted

CAUTION Do not use a higher rated fuse as this can cause severe damage to electrical components and/or be a potential fire.

WARNING

If fuse has burnt out, source of malfunction should be determined and corrected before restarting. See an authorized LYNX dealer for servicing.

**TYPICAL — RH SIDE OF ENGINE COMPARTMENT**

1. 5 A main fuse

550 Engines

Manual Start

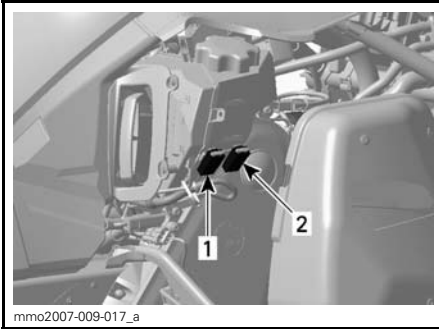

RH SIDE OF ENGINE COMPARTMENT

1. 15 A headlight fuse (RED/ORANGE wire)
2. 15 A accessories fuse (RED/YELLOW wire)

Electric Fuel Level Sender

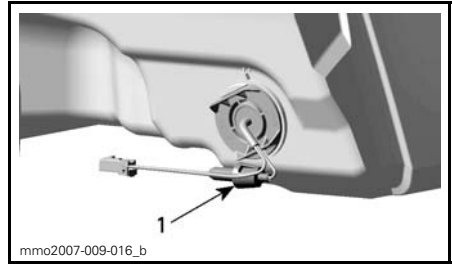

BEHIND AIR INTAKE SILENCER

1. 0.25 A fuse

Electric Start

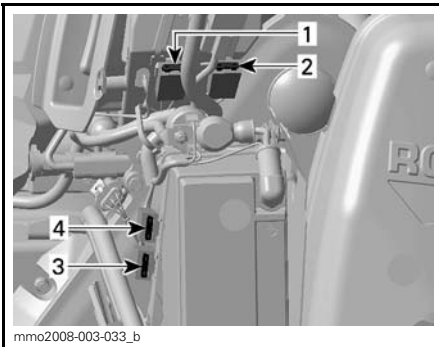

RH SIDE OF ENGINE COMPARTMENT

1. 15 A headlight fuse (RED/ORANGE wire)
2. 15 A accessories fuse (RED/YELLOW wire)
3. 30 A charging system
4. 5 A ECM (Engine Control Module)

BODY/FRAME

Vehicle Cleaning and Protection

Remove any dirt or rust.

To clean the entire vehicle, use only flannel cloths or equivalent.

⚠ CAUTION It is necessary to use flannel cloths or equivalent on windshield and hood to avoid damaging further surfaces to clean.

To remove grease, oil and grime, use Heavy duty cleaner (P/N 293 110 001) (spray can 400 g) and (P/N 293 110 002) (4 L).

⚠ CAUTION Do not use Heavy duty cleaner on decals or vinyl.

To remove stubborn dirt from all plastic and vinyl surfaces, use Vinyl & Plastic Cleaner ((P/N 413 711 200) (6 x 1 L)).

To remove scratches on windshield or hood use the Scratch Remover Kit (P/N 861 774 800).

⚠ CAUTION Never clean plastic parts or hood with strong detergent, degreasing agent, paint thinner, acetone, products containing chlorine, etc.

Clean sheaves of both pulleys using Pulley flange cleaner (P/N 413 711 809).

Inspect the hood and repair any damage.

Touch up all metal spots where paint has been scratched off. Spray all metal parts including shock chromed rods with XP-S Lube (P/N 293 600 016).

Wax painted portion of the vehicle for better protection.

NOTE: Apply wax on glossy finish only. Protect the vehicle with a cover to prevent dust accumulation during storage.

⚠ CAUTION The snowmobile has to be stored in a cool and dry place and covered with an opaque tarpaulin. This will prevent sun rays and grime from affecting plastic components and vehicle finish.

Lift rear of vehicle until track is clear of the ground. Install on a wide-base snowmobile mechanical stand with a rear deflector panel.

⚠ WARNING
Do not attempt to lift the vehicle by hand alone. Use appropriate lifting device or have assistance to share lifting stress in order to avoid risk of strain injuries.

NOTE: Do not release track tension.

Bulb Replacement

Always check light operation after bulb replacement.

Headlamp

⚠ CAUTION Never touch glass portion of an halogen bulb with bare fingers, it shortens its operating life. If glass is touched, clean it with isopropyl alcohol which will not leave a film on the bulb.

By using a small screwdriver, release multifunction gauge locking tabs.

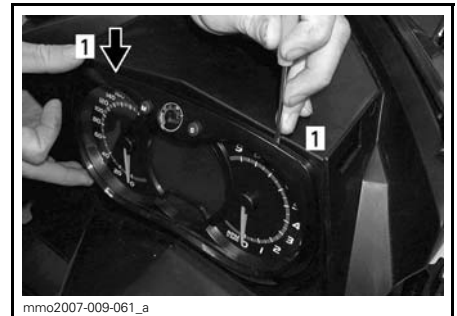

1. Locking tab

Gently pull on multifunction gauge and set aside.



Unplug burnt bulb connector. Remove the rubber boot.

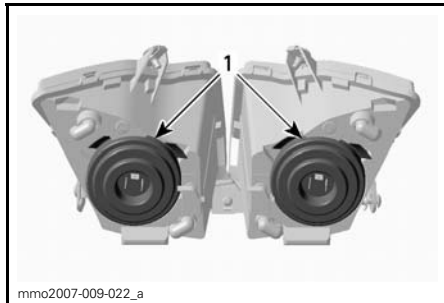

1. Rubber boot

Press and pull both sides of the spindle at the same time to release it from bulb support.

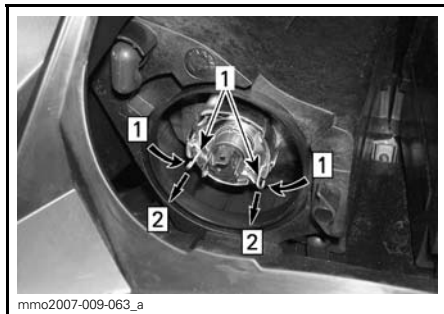

Step 1: Step 1: Push both sides
Step 2: Step 2: Pull to release

1. Spindle

Pull bulb and replace. Properly reinstall parts.



PULL BULB AND REPLACE

Taillight

If taillight bulb is burnt, expose the bulb by removing the red plastic lens. To remove, unscrew the 2 lens screws.

Led taillight leds cannot be replaced. If failed change taillight assy. Fasten new taillight by screws.

Headlamp Beam Aiming

Remove multifunction gauge, refer to *BULB REPLACEMENT*. Turn knob to adjust beam height.

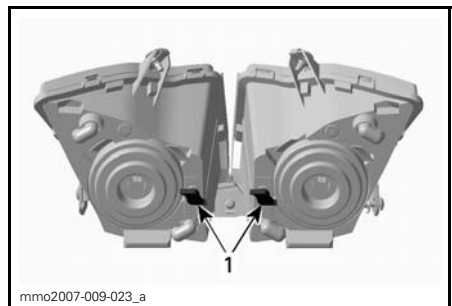

TYPICAL

1. Knob

STORAGE AND PRESEASON PREPARATION

⚠ WARNING

Have an authorized LYNX dealer inspect fuel and oil systems integrity as specified in *PERIODIC MAINTENANCE CHART*.

Storage

It is during summer, or when a snowmobile is not in use for more than one month that proper storage is a necessity.

To prepare your snowmobile, refer to an authorized LYNX dealer.

Engine Cooling System

Antifreeze should be replaced every 5 years or 6000 km to prevent antifreeze deterioration.

The antifreeze replacement and a density test should be performed by an authorized LYNX dealer.

⚠ CAUTION Improper antifreeze mixture might allow freezing of the liquid in the cooling system if vehicle is stored in area where freezing point is reached. This would seriously damage the engine. Failure to replace the antifreeze for storage may allow its degradation that could result in poor cooling when engine will be used.

⚠ CAUTION Do not run engine during storage period.

Engine Storage Mode

E-TEC Engines

Like other 2-stroke engines, the E-TEC has to be properly lubricated at storage for internal parts protection. The E-TEC system offers a built-in engine lubrication function can be initiated by the operator.

To engage procedure, do the following:

1. Place the vehicle in a well ventilated area.

2. Start the engine and let it run at idle speed until it reaches its operating temperature (watch the coolant temperature on the display).
3. Push the SET (S) button to select odometer mode.

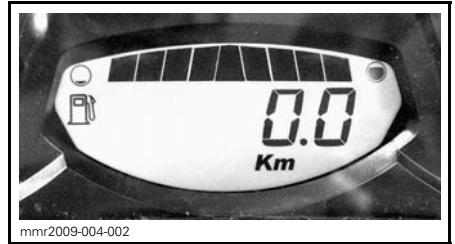

NOTE: The storage mode does not function in other modes (trip A, trip B and hr trip).

4. Press and hold the SET (S) button and simultaneously depress the HI/LOW beam switch repeatedly several times.
5. Release switch and button when **PUSH "S"** appears in the display.



6. Again, press and hold the SET (S) button 2 - 3 seconds.
7. When **OIL** appears in display, release the button and wait the end of the procedure.

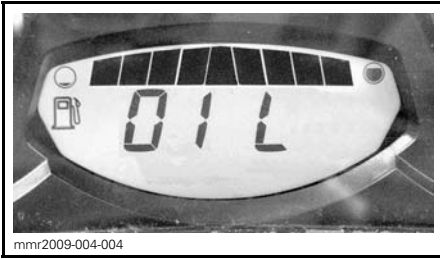

The engine lubrication procedure takes approximately 1 minute. During this time the engine RPM will increase slightly.

At the end of engine lubrication procedure, the ECM will turn the engine off.

Remove tether cord.

NOTICE Do not start the engine during storage period.

Preseason Preparation

Refer to an authorized LYNX dealer.

CAUTION Have carburetors cleaned-up before restarting engine.

WARRANTY

BRP FINLAND OY INTERNATIONAL LIMITED WARRANTY: 2011 LYNX® SNOWMOBILES

1) SCOPE OF THE LIMITED WARRANTY

BRP Finland Oy ("BRP") warrants its 2011 LYNX snowmobiles from defects in material or workmanship for the period and under the conditions described below.

All genuine LYNX parts and accessories, installed by an authorized BRP distributor/dealer (as hereinafter defined) at the time of delivery of the 2011 LYNX snowmobile, carry the same warranty as that of the snowmobile.

Use of the product for racing or any other competitive activity, at any point, even by a previous owner, will render this warranty null and void.

2) WARRANTY COVERAGE PERIOD

This warranty will be in effect from the date of delivery to the first retail consumer or the date the product is first put into use, whichever occurs first and for a period of:

A) TWELVE (12) CONSECUTIVE MONTHS, for private use owners

B) TWELVE (12) CONSECUTIVE MONTHS, for commercial use owners

C) TWENTY FOUR (24) CONSECUTIVE MONTHS, for private use owners when product was sold in a member state of the European Union. The repair or replacement of parts or the performance of service under this warranty does not extend the life of this warranty beyond its original expiration date.

3) CONDITIONS TO HAVE WARRANTY COVERAGE

This warranty coverage is available only on 2011 LYNX snowmobile purchased as new and unused by its first owner from a BRP distributor/dealer authorized to distribute LYNX products in the country in which the sale occurred ("BRP distributor/dealer"), and then only after the BRP specified pre-delivery inspection process is completed and documented. Warranty coverage only becomes available upon proper registration of the product by an authorized BRP distributor/dealer. Moreover, this warranty coverage is only available if the LYNX snowmobile is purchased in the country in which the purchaser resides. BRP will not honor this limited warranty to any private use owner or commercial use owner if the preceding conditions have not been met. Such limitations are necessary in order to allow BRP to preserve both the safety of its products, and also that of its consumers and the general public.

Routine maintenance outlined in the Operator's Guide must be timely performed in order to maintain warranty coverage. BRP reserves the right to make warranty coverage contingent upon proof of proper maintenance.

4) WHAT TO DO TO OBTAIN WARRANTY COVERAGE

The customer must notify a servicing BRP distributor/dealer within two (2) months of the appearance of a defect, and provide it with reasonable access to the product and reasonable opportunity to repair it. The customer must also present to the authorized BRP distributor/dealer, proof of purchase of the product and must sign the repair/work order prior to starting the repair in order to validate the warranty repair. All parts replaced under this limited warranty become the property of BRP.

5) WHAT BRP WILL DO

BRP's obligations under this warranty are limited to, at its sole discretion, repairing parts found defective under normal use, maintenance and service, or replacing such parts with new genuine LYNX parts without charge for parts and labor, at any authorized BRP distributor/dealer during the warranty coverage period.

BRP reserves the right to improve or modify products from time to time without assuming any obligation to modify products previously manufactured.

6) EXCLUSIONS

The following are not warranted under any circumstances:

- Normal wear and tear;
- Routine maintenance items, tune ups, adjustments;
- Damage caused by failure to provide proper maintenance and/or storage, as described in the Operator's Guide;
- Damage resulting from removal of parts, improper repairs, service, maintenance, modifications or use of parts not manufactured or approved by BRP or resulting from repairs done by a person that is not an authorized servicing BRP distributor/dealer;
- Damage caused by abuse, abnormal use, neglect, use of the product on surfaces other than snow, or operation of the product in a manner inconsistent with the recommended operation described in the Operator's Guide;
- Damage resulting from accident, submersion, fire, theft, vandalism or any act of God;
- Operation with fuels, oils or lubricants which are not suitable for use with the product (see the Operator's Guide);
- Snow or water ingestion;
- Incidental or consequential damages, or damages of any kind including without limitation towing, storage, telephone, rental, taxi, inconvenience, insurance coverage, loan payments, loss of time, loss of income; and
- Damage resulting from studs installed on tracks if the installation does not conform to BRP's instructions.

7) LIMITATIONS OF LIABILITY

THIS WARRANTY IS EXPRESSLY GIVEN AND ACCEPTED IN LIEU OF ANY AND ALL OTHER WARRANTIES, EXPRESSED OR IMPLIED, INCLUDING WITHOUT LIMITATION ANY WARRANTY OF MERCHANTABILITY OR FITNESS FOR A PARTICULAR PURPOSE. TO THE EXTENT THAT THEY CANNOT BE DISCLAIMED, THE IMPLIED WARRANTIES ARE LIMITED IN DURATION TO THE LIFE OF THE EXPRESS WARRANTY. INCIDENTAL AND CONSEQUENTIAL DAMAGES ARE EXCLUDED FROM COVERAGE UNDER THIS WARRANTY. SOME STATES/ PROVINCES DO NOT ALLOW FOR THE DISCLAIMERS, LIMITATIONS AND EXCLUSIONS IDENTIFIED ABOVE, AS A RESULT, THEY MAY NOT APPLY TO YOU. THIS WARRANTY GIVES YOU SPECIFIC RIGHTS, AND YOU MAY ALSO HAVE OTHER LEGAL RIGHTS WHICH MAY VARY FROM STATE TO STATE, OR PROVINCE TO PROVINCE.

Neither the distributor, any BRP distributor/dealer nor any other person has been authorized to make any affirmation, representation or warranty regarding the product, other than those contained in this limited warranty, and if made, shall not be enforceable against BRP.

BRP reserves the right to modify this warranty at any time, being understood that such modification will not alter the warranty conditions applicable to the products sold while this warranty is in effect.

8) TRANSFER

If the ownership of a product is transferred during the warranty coverage period, this warranty shall also be transferred and be valid for the remaining coverage period provided BRP or an authorized BRP distributor / dealer receives a proof that the former owner agreed to the transfer of ownership, in addition to the co-ordinates of the new owner.

9) CONSUMER ASSISTANCE

1. In the event of a controversy or a dispute in connection with this limited warranty, BRP suggests that you try to resolve the issue at the dealership level. We recommend discussing the issue with the authorized distributor/dealer's service manager or owner.
2. If further assistance is required, the distributor's service department should be contacted in order to resolve the matter.
3. If the matter still remains unresolved then contact BRP by writing to us at the address below.

ADDRESS:

BRP-FINLAND OY
SERVICE DEPARTMENT
P.O. BOX 8039
FIN-96101 ROVANIEMI
FINLAND

© 2010 Bombardier Recreational Products Inc. All rights reserved.

® Registered trademark of Bombardier Recreational Products Inc.

PRIVACY OBLIGATIONS/DISCLAIMER

We wish to inform you that your coordinates will be used for safety and warranty purposes. Sometimes, we also use the coordinates of our clients to inform them about our products and to present them offers. Should you prefer not to receive information on our products, services and offers, please let us know by writing to the address below.

Also note that, from time to time, carefully selected and trustworthy organizations may be permitted to use the coordinates of our clients to promote quality products and services. If you prefer not to have your name and address released, please let us know by writing to the address below:

FOR SCANDINAVIAN AND EUROPEAN COUNTRIES:

BRP FINLAND OY

Service Department

Isoaavantie 7

FIN-96320 Rovaniemi

Finland

Fax +358 16 3420 316

CHANGE OF ADDRESS/OWNERSHIP

If your address has changed or if you are the new owner of the vehicle, be sure to notify BRP by either:

- mailing one of the cards hereinafter using of the following mail address;
- contacting an authorized LYNX dealer or distributor.

Mail address:

FOR SCANDINAVIAN AND EUROPEAN COUNTRIES:

BRP FINLAND OY
Service Department
Isoaavantie 7
FIN-96320 Rovaniemi
Finland
Fax: +358 16 3420 316

In case of change of ownership, please join a proof that the former owner agreed to the transfer.

Notifying BRP, even after the expiration of the limited warranty, is very important as it enables BRP to reach the vehicle owner if necessary, like when safety recalls are initiated. It is the owner's responsibility to notify BRP.

STOLEN UNITS: If your personal vehicle is stolen, you should notify BRP or an authorized LYNX dealer. We will ask you to provide your name, address, phone number, the vehicle identification number and the date it was stolen.

CHANGE OF ADDRESS

CHANGE OF OWNERSHIP



VEHICLE IDENTIFICATION NUMBER

Model Number

Vehicle Identification Number (V.I.N.)

OLD ADDRESS
OR PREVIOUS OWNER:

NAME

NO.

STREET

APT

CITY

STATE/PROVINCE

ZIP/POSTAL CODE

COUNTRY

TELEPHONE

NEW ADDRESS
OR NEW OWNER:

NAME

NO.

STREET

APT

CITY

STATE/PROVINCE

ZIP/POSTAL CODE

COUNTRY

TELEPHONE

E-MAIL ADDRESS

V00A2F

CHANGE OF ADDRESS

CHANGE OF OWNERSHIP



VEHICLE IDENTIFICATION NUMBER

Model Number

Vehicle Identification Number (V.I.N.)

OLD ADDRESS
OR PREVIOUS OWNER:

NAME

NO.

STREET

APT

CITY

STATE/PROVINCE

ZIP/POSTAL CODE

COUNTRY

TELEPHONE

NEW ADDRESS
OR NEW OWNER:

NAME

NO.

STREET

APT

CITY

STATE/PROVINCE

ZIP/POSTAL CODE

COUNTRY

TELEPHONE

E-MAIL ADDRESS

V00A2F



brp.com

LYNX



® ™ and the BRP logo are trademarks of Bombardier Recreational Products Inc. or its affiliates.