



**OPERATOR'S GUIDE  
RAVE RS 600 • 2010**

EN

**LYNX**



# OPERATOR'S MANUAL 2010

Rave R<sup>SM</sup> 600

## SAFETY WARNING

Disregarding any of the safety precautions and instructions contained in this Operator's Guide, or on-product warnings may result in injury, including the possibility of death.

This Operator's Guide should remain with the snowmobile at time of resale.



Lynx products are manufactured by BRP.

The following are trademarks of Bombardier Recreational Products Inc. or its subsidiaries.

DESS<sup>SM</sup>

3-D RAVE<sup>SM</sup>

ROTAX<sup>SM</sup>

LYNX<sup>®</sup>

HPG<sup>SM</sup>

RER<sup>SM</sup>

E-TEC<sup>®</sup>

TRA<sup>SM</sup>

---

# FOREWORD

Congratulations on your purchase of a new Lynx snowmobile. Whatever model you have chosen, it is backed by the Bombardier Recreational Products inc. (BRP) warranty and a network of authorized Lynx snowmobile dealers ready to provide the parts, service or accessories you may require.

The Operator's Guide has been prepared to acquaint the owner/operator and passenger with this new snowmobile and its various controls, maintenance and safe riding instructions. This guide is indispensable for the proper use of the product and should be kept with this snowmobile at all times.

Make sure you read and understand the content of this Operator's Guide.



After reading, please keep this Operator's Guide with the snowmobile. If the snowmobile is resold, please give the guide to the new owner for his awareness. An extra copy of the Operator's Guide is available from your Lynx snowmobile dealer at no charge.

If you have any question regarding any topic whether or not it is covered in this Operator's Guide, please send a written letter to BRP to following address:

BRP Finland OY  
Service Department  
P.O. Box 8039  
FIN-96101 ROVANIEMI  
FINLAND  
Tel +358 16 3208 111

This guide uses the following safety alert symbol in conjunction with signal words to indicate a potential personal injury hazard.

 <b>WARNING</b>
Indicates a potentially hazardous situation which, if not avoided, could result in death or serious injury.

 **CAUTION** Indicates a potentially hazardous situation which, if not avoided, may result in minor or moderate injury. When used without the safety alert symbol , potential hazard exists for property damage only.

**NOTE:** Indicates supplementary information needed to fully complete an instruction.

Although the mere reading of such information does not eliminate the hazard, the understanding and application of the information will promote the correct use of the vehicle.

Your dealer is committed to your satisfaction. He has taken training to perform the initial set-up and inspection of your snowmobile as well as completed the final adjustment required to suit your specific weight and riding environment before you took possession. At delivery, your dealer would have explained the snowmobile controls and provided you with a brief explanation of the various suspension adjustments. We trust you have taken full advantage of this!

At delivery, you were also informed of the warranty coverage and have completed the Warranty Registration process.

The information and components/system descriptions contained in this guide are correct at time of publication. BRP, however maintains a policy of continuous improvement of its products without imposing upon itself any obligation to install them on products previously manufactured.

Because of its ongoing commitment to product quality and innovation, BRP reserves the right at any time to discontinue or change specifications, designs, features, models or equipment without incurring obligation.

The illustrations in this document show the typical construction of the different assemblies and, in all cases,

may not reproduce the full detail or exact shape of the parts shown, however, they represent parts which have the same or a similar function.

It is understood that this guide may be translated into another language. In the event of any discrepancy, the English version shall prevail.

Specifications are given in the SI metric system with the SAE U.S. equivalent in parentheses. Where precise accuracy is not required, some conversions are rounded off for easier use.

Most components of this snowmobile are built with parts dimensioned in the metric system. Most fasteners are metric and must not be replaced by customary fasteners or vice versa.

We recommend genuine BRP products for replacement parts and accessories. They've been specially designed for your vehicle and manufactured to meet BRP's demanding standards.

For any questions pertaining to the warranty and its application, consult the WARRANTY section in this guide, and/or an authorized Lynx dealer.

---

# TABLE OF CONTENTS

**FOREWORD** ..... 1

## ***SAFETY INFORMATION***

**IMPORTANT BASIC SAFETY MEASURES** ..... 8

- Training ..... 8
- Performance ..... 8
- Age ..... 8
- Speed ..... 8
- Riding ..... 8
- Operation ..... 9
- Maintenance ..... 10
- Fuel ..... 11
- Basics for Passenger ..... 11

**LAWS AND REGULATIONS** ..... 12

**RIDING THE VEHICLE** ..... 13

- Principle of Operation ..... 13
- How to Ride ..... 13
- Carrying a Passenger ..... 15
- Terrain/Riding Variations ..... 16
- Transporting and Towing ..... 20

## ***ENVIRONMENT INFORMATION***

**GENERAL** ..... 22

**JUST WHAT IS LIGHT TREADING?** ..... 23

**WHY IS LIGHT TREADING SMART** ..... 24

## ***VEHICLE INFORMATION***

**HOW TO IDENTIFY YOUR SNOWMOBILE** ..... 26

- Vehicle Description Decal ..... 26
- Serial Numbers ..... 26

**CONTROLS/INSTRUMENTS/EQUIPMENT** ..... 27

- 1) Handlebar ..... 27
- 2) Throttle Lever ..... 27
- 3) Brake Lever ..... 28
- 4) Parking Brake Lever ..... 28
- 5) Tether Stop Switch ..... 28
- 6) Engine Stop Switch ..... 29
- 7) Primer Button ..... 29
- 8) Rewind Starter Handle ..... 29
- 9) Pre-Heat Switch ..... 29
- 10) High Beam/Low Beam Switch ..... 30
- 11) Heated Grips/Heated Throttle Lever Switch ..... 30

<b>CONTROLS/INSTRUMENTS/EQUIPMENT (cont'd)</b>	
12) Analog Speedometer and Tachometer.....	30
13) Gauge MODE (M) Button .....	31
14) Gauge SET (S) Button.....	31
15) Gauge Multifunction Digital Display .....	31
16) Gauge Pilot Lamps.....	39
17) Grab Handle/Bumper .....	39
<b>CONTROLS/INSTRUMENTS/EQUIPMENT .....</b>	<b>27</b>
1) Handlebar .....	27
2) Throttle Lever.....	27
3) Brake Lever .....	28
4) Parking Brake Lever .....	28
5) Tether Stop Switch .....	28
6) Engine Stop Switch .....	29
7) Primer Button.....	29
8) Rewind Starter Handle.....	29
9) Pre-Heat Switch .....	29
10) High Beam/Low Beam Switch.....	30
11) Heated Grips/Heated Throttle Lever Switch.....	30
12) Analog Speedometer and Tachometer.....	30
13) Gauge MODE (M) Button .....	31
14) Gauge SET (S) Button.....	31
15) Gauge Multifunction Digital Display .....	31
16) Gauge Pilot Lamps.....	39
17) Grab Handle/Bumper .....	39
<b>FUEL AND OIL.....</b>	<b>41</b>
Recommended Fuel .....	41
Outside North America .....	41
Fuel System Antifreeze.....	41
Recommended oil .....	41
XP-S Synthetic and Synthetic Blend Oil .....	42
Premix Fuel/Oil Ratio .....	43
<b>BREAK-IN PERIOD.....</b>	<b>44</b>
Engine.....	44
Belt.....	44
10-Hour Inspection.....	44
<b>OPERATING INSTRUCTIONS.....</b>	<b>45</b>
Pre-Operation Check.....	45
Engine Starting Procedure .....	46
Carburetor Engine Starting Procedure .....	47
Vehicle Warm-Up.....	47
Shutting Off the Engine.....	48
Post-Operation Care .....	48
<b>SPECIAL OPERATING INSTRUCTIONS .....</b>	<b>49</b>
Riding at High Altitudes.....	49
Riding in Cold Weather .....	49

<b>SPECIAL OPERATING INSTRUCTIONS (cont'd)</b>	
Emergency Starting .....	49
Towing an Accessory .....	50
Towing Another Snowmobile .....	50
Transporting the Vehicle .....	51
<b>SUSPENSION ADJUSTMENTS .....</b>	<b>52</b>
Adjustable suspension .....	52
Front Suspension Shock Damping .....	56
Ski Stance .....	56
Suspension Troubleshooting Chart .....	57
Deep Snow Riding .....	58
<b>TECHNICAL GUIDELINES .....</b>	<b>59</b>
<b>MONITORING SYSTEM .....</b>	<b>61</b>
Pilot Lamps, Messages and Beeper Codes .....	61
<b>SPECIFICATIONS .....</b>	<b>62</b>
<b>DECLARATION OF CONFORMITY .....</b>	<b>65</b>
<b>MAINTENANCE INFORMATION</b>	
<b>2-STROKE MAINTENANCE CHART (FAN AND LIQUID COOLED) .....</b>	<b>69</b>
<b>ENGINE SYSTEM .....</b>	<b>73</b>
Air Intake Silencer Prefilter Verification .....	73
Cooling System .....	73
Exhaust System .....	73
<b>DRIVE SYSTEM .....</b>	<b>74</b>
Belt Guard Removal and Installation .....	74
Brake Fluid Level .....	74
Brake Condition .....	75
Brake Adjustment .....	75
Chaincase Oil .....	75
Drive Chain Tension .....	75
Drive Belt Inspection .....	76
Drive Belt Replacement (Ring Type Adjuster) .....	76
Drive Belt Height Adjustment (Ring Type Pulley Adjuster) .....	76
Drive Pulley Adjustment .....	78
Track Condition .....	79
Track Tension and Alignment .....	79
<b>REAR SUSPENSION .....</b>	<b>83</b>
Rear Suspension Condition .....	83
Suspension Stopper Strap Condition .....	83
<b>STEERING AND FRONT SUSPENSION .....</b>	<b>84</b>
Wear and Condition of Skis and Runners .....	84
<b>ELECTRICAL SYSTEM .....</b>	<b>85</b>
Spark Plug Removal/Installation .....	85
Fuse Removal/Inspection .....	85

<b>BODY/FRAME</b> .....	<b>87</b>
Vehicle Cleaning and Protection .....	87
Bulb Replacement .....	87
Headlamp Beam Aiming.....	88
<b>STORAGE AND PRESEASON PREPARATION</b> .....	<b>89</b>
Storage.....	89
Preseason Preparation .....	89

**WARRANTY**

<b>LIMITED WARRANTY VALIDATION</b> .....	<b>92</b>
<b>BRP FINLAND OY INTERNATIONAL LIMITED WARRANTY: 2010 LYNX® SNOWMOBILES</b> .....	<b>93</b>
<b>PRIVACY OBLIGATIONS/DISCLAIMER</b> .....	<b>96</b>
<b>CHANGE OF ADDRESS/OWNERSHIP</b> .....	<b>97</b>



# ***SAFETY INFORMATION***

---

# IMPORTANT BASIC SAFETY MEASURES

## Training

▲ Basic training is required for the safe operation of any snowmobile. Study your Operator's Guide paying particular attention to cautions and warnings. Join your local snowmobile club: its social activities and trail systems are planned for both fun and safety. Obtain basic instructions from your snowmobile dealer, friend, fellow club member or enroll in your local training program.

▲ Always show a new operator how to start and stop the vehicle. Indicate the correct riding positions and, above all else, only allow him to operate the snowmobile in a restricted flat area — at least until he is completely familiar with its operation. If there is a local snowmobile operator's training course existing, have him enroll.

## Performance

▲ The performance of some snowmobiles may significantly exceed that of other snowmobiles you have operated. Therefore, use by novice or inexperienced operators is not recommended.

▲ Snowmobiles are used in many areas and in many snow conditions. Not all models perform the same in similar conditions. Always consult your snowmobile dealer when selecting the snowmobile model for your particular needs and uses.

▲ Injury or death may result to the snowmobile operator, passenger or bystander if the snowmobile is used in risky conditions which are beyond the driver's, passenger's or snowmobile's capabilities or intended use.

## Age

▲ BRP recommends the operator has at least 16 years old of age. Follow your local legislation.

## Speed

▲ Speeding can be fatal. In many cases, you cannot react or respond quickly enough to the unexpected. Always ride at a speed which is suitable to the trail, weather conditions and your own ability. Know your local rules. Speed limit may be in effect and meant to be observed.

## Riding

▲ Always keep right hand side of the trail.

▲ Always keep a safe distance from other snowmobiles and bystanders.

▲ Remember, promotional material may show risky maneuvers performed by professional riders under ideal and/or controlled conditions. You should never attempt any such risky maneuvers if they are beyond your level of riding ability.

▲ Never ride after consuming drugs or alcohol or if you feel tired or ill. Operate your snowmobile prudently.

▲ Your snowmobile is not designed to be operated on public streets, roads or highways.

▲ Snowmobiling at night can be a delightful experience but because of reduced visibility, be extra cautious. Avoid unfamiliar terrain and be sure your lights are working. Always carry a flashlight and spare light bulbs.

▲ Nature is wonderful but don't let it distract your attention from driving. If you want to truly appreciate winter's scenery, stop your snowmobile on the side of the trail so that **you** don't become a hazard to others.

▲ Fences represent a very serious threat for both you and your snowmobile. Give a wide berth to telephone poles or posts.

▲ Hidden wires unseen from a distance can cause serious accidents.

- ▲ Always wear an approved safety helmet, eye protection and a face shield. This also applies to your passenger.
- ▲ Be aware of inherent risks associated with riding off trails, such as avalanche and other natural or man made hazards or obstacles.
- ▲ Avoid road traveling. If you must do so, and it is permitted, reduce speed. The snowmobile is not designed to operate or turn on paving. When crossing a road, make a full stop, then look carefully in both directions before crossing at a 90° angle. Be wary of parked vehicles.
- ▲ Tailgating another snowmobile should be avoided. If the snowmobile in front of you slows for any reason, its driver and passenger could be harmed through your neglect. Maintain a safe stopping distance between you and the snowmobile in front of you. Depending on the terrain condition, stopping may require a little more space than you think. Play it safe. Be prepared to use evasive driving.
- ▲ Venturing out alone with your snowmobile could also be hazardous. You could run out of fuel, have an accident, or damage your snowmobile. Remember, your snowmobile is capable of traveling further in half an hour than you may be able to walk in a day. Use the "buddy system". Always ride with a friend or member of your snowmobile club. Even then, tell someone where you are going and the approximate time you plan to return.
- ▲ Meadows sometimes have low areas where water accumulate and freezes over in winter. This ice is usually glare ice. Attempting to turn or brake on this surface could cause your vehicle to spin out of control. Never brake or attempt speeding or turning on glare ice. If you do happen to travel over such a condition, reduce speed by carefully releasing the throttle.
- ▲ Never "jump" with your snowmobile. This should be left to professional stunt men. Don't show off. Be responsible.
- ▲ While on safari, do not "gun" the throttle. Snow and ice can be thrown back into the path of a following snowmobile. In addition, when "gunning" the throttle, the vehicle digs into and leaves an irregular snow surface for others.
- ▲ Safaris are both fun and enjoyable but don't show off or overtake others in the group. A less experienced operator might try to do the same as you and fail. When riding with others, limit your abilities to the experience of others.

## Operation

- ▲ Always make a pre-start inspection BEFORE you turn on the ignition.
- ▲ In an emergency, the snowmobile engine can be stopped by activating the engine cut-out switch, pulling the tether cord cap or turning off the key.
- ▲ Throttle mechanism should be checked for free movement and return to idle position before starting engine.
- ▲ Always engage parking brake when vehicle is not in use.
- ▲ Never run the engine in a non-ventilated area and/or if vehicle is left unattended.

- ▲ Never operate the engine without belt guard securely installed or, with hood or access/side panels open or removed. Never run the engine without drive belt installed. Running an unloaded engine such as without drive belt or with track raised, can be dangerous.
- ▲ Do not leave your keys in the ignition switch, it is an invitation to thieves and a danger to young children.
- ▲ Raising the rear of your snowmobile while the engine is running could cause snow, ice or debris to be thrown back at an observer. Never raise the rear of the vehicle while the engine is running. To clear or inspect the track, stop the engine, tilt the vehicle on its side and remove blockage with a piece of wood or branch. Never allow anyone near a rotating snowmobile track.

## Maintenance

- ▲ Know your snowmobile and treat it with the respect and care due of any power driven machine. Common sense, proper handling and routine maintenance will result in safer and enjoyable use.
- ▲ Only perform procedures as detailed in this guide. Unless otherwise specified, engine should be turned OFF and cold for all lubrication, adjustment and maintenance procedures.
- ▲ Never have the engine running while the hood is open. Even at idle, a snowmobile engine is turning around 1,800 revolutions per minute. Always turn off the ignition before opening the hood for any reason.
- ▲ Never remove any original equipment from your snowmobile. Each vehicle has many built in safety features. Such features include various guards and consoles, plus reflective materials and warning labels.

- ▲ A poorly maintained snowmobile itself can be a potential hazard. Excessively worn components could render the vehicle completely inoperative. Keep the snowmobile in good working condition at all times. Follow your pre-operation check, weekly, monthly and annually routine maintenance and lubrication procedures as detailed in this guide. Consult a snowmobile dealer or acquire a shop manual and proper tools and equipment if other repairs or service is required.
- ▲ Do not stud the track unless it as been approved for studs. At speed, a studded track that as not been approved for studs could tear and separate from vehicle posing a risk of severe injury or death. See an authorized LYNX dealer for current specific studding availability and applications.
- ▲ You may stud the track on this vehicle model. However, you MUST only use the BRP approved type stud for use on LYNX snowmobiles. DO NOT EVER use conventional studs because the track thickness is thinner then our standard tracks. The stud could tear off of track and separate from vehicle posing a potential risk of severe injury or death..

## Fuel

⚠ Always stop the engine before refueling. Fuel is flammable and explosive under certain conditions. Always work in a well-ventilated area. Do not smoke or allow open flames or sparks in the vicinity. Open cap slowly. If a differential pressure condition is noticed (whistling sound heard when loosening fuel tank cap) have vehicle inspected and/or repaired before further operation. Do not overfill or top off the fuel tank before placing the vehicle in a warm area. As temperature increases, fuel expands and might overflow. Always wipe off any fuel spillage from the vehicle. Periodically verify fuel system.

## Basics for Passenger

- ⚠ Never ride as a passenger unless the snowmobile is equipped with a passenger seat, and sit only on the designated passenger seat.
- ⚠ Always wear a DOT approved helmet and follow the same dressing guidelines as those recommended for the operator and described in this guide.
- ⚠ Make sure that you are able to achieve a stable stance, both feet resting positively on the footboards of footrests with good grip, and that you are able to hold on firmly to the handholds.
- ⚠ Once underway, if you feel uncomfortable or insecure for any reason, don't wait, tell the driver to slow down or stop.

---

# LAWS AND REGULATIONS

## ▲ Know your local laws.

State, provincial and local government agencies have enacted laws and regulations pertaining to the safe use and operation of snowmobiles. It is your responsibility as a snowmobiler to learn and obey these laws and regulations. Respect and observance will result in safer snowmobiling for all.

Be aware of the liability property damages and insurance laws regarding your equipment.

---

# RIDING THE VEHICLE

Before venturing on the trails, operate the snowmobile in a restricted flat area until you are completely familiar with its operation and feel comfortable that you can safely tackle a more demanding task. Have an enjoyable and safe ride.

## Principle of Operation

### Propulsion

Depressing throttle lever increases engine RPM causing the drive pulley to engage. Depending on models, engine RPM must be between 2500 and 4200 before drive pulley engagement will occur.

Outer sheave of drive pulley moves toward inner sheave, forcing the drive belt to move upward on the drive pulley and simultaneously forcing the sheaves apart on the driven pulley.

The driven pulley senses the load on the track and limits the belt movement. The result is an optimized speed ratio between engine RPM and the speed of the vehicle at any time.

### **WARNING**

Never operate engine without belt guard securely installed or, with hood or access/side panels open or removed.

Power is transferred to the track through the chaincase or gearbox and drive axle.

### **WARNING**

Always use a wide-base snowmobile mechanical stand to properly support vehicle during any track verification. Slowly accelerate engine in order to rotate track at very low speed when it is not on ground.

### Turning

Handlebar controls the steering of the vehicle. As the handlebar is rotated to right or left, the skis are turned right or left to steer the snowmobile.

### Stopping

Before riding your snowmobile, you should understand how to stop it. This is done by releasing the throttle and gradually depressing the brake lever on the left side of the handlebar. In an emergency, you may stop your vehicle by pressing the engine cut-out switch located near the throttle control and applying the brake. Remember, a snowmobile cannot "stop on a dime". Braking characteristics vary with deep snow, packed snow or ice. If the track is locked during hard braking, skidding may result.

## How to Ride

### How to Dress

Proper snowmobile clothing should be worn. It should be comfortable and not too tight. Always check the weather forecast before going on a ride. Dress for the coldest weather expected. Thermal underwear next to the skin also provides a good insulation.

DOT approved helmets are recommended at all times. They provide both warmth and reduce injury. A stocking type cap, balaclava and face mask should always be carried or worn. Goggles or a face shield that attach to the helmet are indispensable.

Hands should be protected by a pair of snowmobile gloves or mitts which have sufficient insulation and allow use of thumbs and fingers for operation of controls.

Rubber bottom boots with either a nylon or a leather top, with removable felt liners are best suited for snowmobiling.

You should keep yourself as dry as possible when snowmobiling. When you come indoors, take your snowmobile suit and boots off and make certain they dry properly.

Do not wear long scarfs and loose apparels that could get caught in moving parts.

### What to Bring

Every snowmobiler should carry at least the following basic parts and tools that can help him and others in an emergency:

- this Operator's Guide
- spare spark plugs and wrench
- friction tape
- spare drive belt
- spare starter rope
- spare light bulbs
- tool kit (including at least pliers, screwdriver, adjustable wrench)
- knife
- flashlight.

Include other items depending on the length and time of your ride.

### Riding Position

Your riding position and balance are the two basic principles of making your snowmobile go where you want it to. When turning on the side of a hill, you and your passenger must be ready to shift body weight to help it turn in the desired direction. Driver and passenger(s) must never attempt this maneuvering by placing feet outside of the vehicle. Experience will teach you how much lean to put into turns at different speeds and how much you will have to lean into a slope to maintain proper balance.

Generally, the riding position for best balance and control is sitting. However, the posting, kneeling or standing positions are also used under certain conditions.

The novice driver should become familiar with the snowmobile through practice on a level area at slow speeds before venturing afield.

## WARNING

Do not attempt any maneuvers if they are beyond your abilities.

### Sitting

Feet on the running boards, body mid-way back on seat is an ideal position when operating the snowmobile over familiar, smooth terrain. Knees and hips should remain flexible to absorb shocks.



### Posting

A semi-sitting position with the body off the seat and the feet under the body in a sort of squatting posture, thus allowing the legs to absorb the shocks when traveling over uneven terrain. Avoid abrupt stops.





## Kneeling

This position is achieved by placing one foot firmly on the running board and the opposite knee on the seat. Avoid abrupt stops.



## Standing

Place both feet on the running boards. Knees should be flexed to absorb the shock from surface bumps. This is an effective position to see better and to shift weight as conditions dictate. Avoid abrupt stop.



## Carrying a Passenger

Certain snowmobiles are designed for an operator only, others can allow one passenger only, and others can allow up to two passengers. Refer to the indications (registration papers) on the vehicles to know if any particular snowmobile can accommodate passengers or not, and if so, how many. Always respect those indications. Overloading is dangerous because snowmobiles are not designed for it.

Even when passengers are allowed, you must make sure that the persons who would like to become passengers are physically fit for snowmobiling.

### **⚠ WARNING**

Any passenger must be able to firmly lay his feet on the footrests and keep his hands on the grab handles or seat strap at all times when seated. Respecting those physical criteria is important to ensure that the passenger is stable and to reduce the risks of ejection.

Each operator has a responsibility to ensure the safety of his passengers and should inform them of snowmobiling basics.

### **⚠ WARNING**

- Passengers must only sit on designated passenger seats. Never allow anyone to sit between the handlebar and the operator.
- Each passenger seat must have a strap or grab handles and meet SSCC standards.
- Passengers and operators must always wear DOT approved helmets and warm clothing appropriate for snowmobiling. Make sure that no skin is exposed.
- Once underway, if a passenger feels uncomfortable or unsecure for any reason, he must not wait, and tell the driver to slow-down or stop.

Riding with passengers on board is different than riding alone. The operator has the benefit of knowing what will be the next maneuver and is able to prepare himself accordingly. The operator also benefits from the support of his grip on the handlebar. In contrast, the passengers have to rely on the operator's careful and safe operation of

the vehicle. In addition, “body english” is limited with passengers, and the operator can sometimes see more of the trail ahead than the passengers. Therefore, smooth starting and stopping are required with passengers, and the operator must slow down. The operator must also warn passengers of side hills, bumps, branches, etc. An unforeseen bump can leave you passenger-less. Remind your passengers to lean into the turn with you, without causing the vehicle to topple. Be extremely careful, go more slowly and check the passengers frequently.

### **WARNING**

When riding with a passenger:

- Braking ability and steering control are reduced. Decrease speed and allow extra space to maneuver.
- Adjust suspension according to weight.

For complete information on how to adjust the suspension, please refer to the section of this Operator’s Guide entitled SUSPENSION ADJUSTMENTS under OPERATING INSTRUCTIONS and to the relevant label on the belt guard.

Use extra caution and go even more slowly with young passengers. Check frequently to make certain the child has a firm grip and is properly positioned with his feet on the running boards.

## **Terrain/Riding Variations**

### **Groomed Trail**

On a maintained trail, sitting is the most preferred riding position. Do not race and, above all, keep to the right hand side of the trail. Be prepared for the unexpected. Observe all trail signs. Do not zigzag from one side of the trail to the other.

### **Ungroomed Trail**

Unless there has been a fresh snowfall you can expect “washboard” and snowdrift conditions. Taken at excessive speeds, such conditions can be physically harmful. Slow down. Hold on the handlebar and assume a posting position. Feet should be under the body assuming a crouched position to absorb any jarring effect. On longer stretches of “washboard” trails, the kneeling position of one knee on the seat can be adopted. This provides a certain amount of comfort, while at the same time keeps the body loose and capable of vehicle control. Beware of hidden rocks or tree stumps partially hidden by a recent snowfall.

### **Deep Snow**

In deep “powder” snow, your vehicle could begin to “bog” down. If this occurs, turn in as wide an arc as possible and look for a firmer base. If you do get “bogged”, and it happens to everyone, do not spin your track as this makes the vehicle sink deeper. Instead, turn the engine off, get off and move the back of the vehicle onto new snow. Then tramp a clear path ahead of the vehicle. A few feet will generally suffice. Restart the engine. Assume the standing position and rock the vehicle gently as you steadily and slowly apply the throttle. Depending on whether the front or rear end of the vehicle is sinking, your feet should be placed on the opposing end of the running boards. Never place foreign material beneath the track for support. Do not allow anyone to stand in front of, or to the rear of, the snowmobile with the engine running. Stay away from the track. Personal injury will result if contact is made with the revolving track.

### **Frozen Water**

Traveling frozen lakes and rivers can be fatal. Avoid waterways. If you are in an unfamiliar area, ask the local authorities or residents about the ice condi-

tion, inlets, outlets, springs, fast moving currents or other hazards. Never attempt to operate your snowmobile on ice that may be too weak to support you and the vehicle. Operating a snowmobile on ice or icy surfaces can be very dangerous if you do not observe certain precautions. The very nature of ice is foreign to good control of a snowmobile or any vehicle. Traction for starting, turning or stopping is much less than that on snow. Thus, these distances can be multiplied manyfold. Steering is minimal, and uncontrolled spins are an ever present danger. When operating on ice, drive slowly with caution. Allow yourself plenty of room for stopping and turning. This is especially true at night.

### **Hard Packed Snow**

Don't underestimate hard packed snow. It can be difficult to negotiate as both skis and track do not have as much traction. Best advice is to slow down and avoid rapid acceleration, turning or braking.

### **Uphill**

There are two types of hills you can encounter — the open hill on which there are few trees, cliffs or other obstacles, and a hill that can only be climbed directly. On an open hill, the approach is to climb it by side hilling or slaloming. Approach at an angle. Adopt a kneeling position. Keep your weight on the uphill side at all times. Maintain a steady, safe speed. Continue as far as you can in this direction, then switch to an opposite hill angle and riding position.

A direct climb could present problems. Choose the standing position, accelerate before you start the climb and then reduce throttle pressure to prevent track slippage.

In either case, vehicle speed should be as fast as the incline demands. Always slow down as you reach the crest. If you cannot proceed further, don't spin

your track. Turn the engine off, free the skis by pulling them out and downhill, place the rear of the snowmobile uphill restart the engine and ease it out with slow even throttle pressure. Position yourself to avoid tipping over, then descend.

### **Downhill**

Downhill driving requires that you have full control of your vehicle at all times. On steeper hills, keep your center of gravity low and both hands on the handlebar. Maintain slight throttle pressure and allow the machine to run downhill with the engine operating. If a higher than safe speed is reached, slow down by braking but apply the brake with frequent light pressure. Never jam the brake and lock the track.

### **Side Hill**

When crossing a side hill or traversing up or downhill, certain procedures must be followed. All riders should lean towards the slope as required for stability. The preferred operating positions are the kneeling position, with the knee of the down hill leg on the seat and the foot of the uphill leg on the running board, or the posting position. Be prepared to shift your weight quickly as needed. Side hills and steep slopes are not recommended for a beginner or a novice snowmobiler.

### **Slush**

Slush should be avoided at all times. Always check for slush before starting across any lake or river. If dark spots appear in your tracks, get off the ice immediately. Ice and water can be thrown rearward into the path of a following snowmobile. Getting a vehicle out of a slush area is strenuous and in some cases, impossible.

### **Fog or Whiteouts**

On land or water, fog or visibility-limiting snow can form. If you have to proceed into the fog or heavy snow, do

so slowly with your lights on and watch intently for hazards. If you are not sure of your way, do not proceed. Keep a safe distance behind other snowmobilers to improve visibility and reaction time.

### **Unfamiliar Territory**

Whenever you enter an area that is new to you, drive with extreme caution. Go slow enough to recognize potential hazards such as fences or fence posts, brooks crossing your path, rocks, sudden dips, guy wires and countless other obstacles which could result in a termination of your snowmobile ride. Even when following existing tracks, be cautious. Travel at a speed so you can see what is around the next bend or over the top of the hill.

### **Bright Sunshine**

Bright sunny days can considerably reduce your vision. The glare from sun and snow may blind you to the extent that you cannot easily distinguish ravines, ditches or other obstacles. Goggles with colored lenses should always be worn under these conditions.

### **Unseen Obstruction**

There may be obstructions hidden beneath the snow. Driving off established trails and in the woods requires reduced speed and increased vigilance. Driving too fast in an area can make even minor obstacles very hazardous. Even hitting a small rock or stump could throw your snowmobile out of control and cause injury to its riders. Stay on established trails to reduce your exposure to hazards. Be safe, slow down and enjoy the scenery.

### **Hidden Wires**

Always be on the lookout for hidden wires, especially in areas that may have been farmed at one time or any other. Too many accidents have been

caused by running into wires in the fields, guy wires next to poles and roads, and into chains and wires used as road closures. Slow speeds are a must.

### **Obstacles and Jumping**

Unplanned jumps of snowdrifts, snowplow ridges, culverts or indistinguishable objects can be dangerous. You can avoid them by wearing the proper color lenses or face shields and by operating at a lower speed.

Jumping a snowmobile is an unsafe and dangerous practice. However, if the trail does suddenly drop away from you, crouch (stand) towards the rear of the vehicle and keep the skis up and straight ahead. Apply partial throttle and brace yourself for the impact. Knees must be flexed to act as shock absorbers.

### **Turning**

Depending on terrain conditions, there are two preferred ways to turn or corner a snowmobile. For most snow surfaces, "body english" is the key to turning. Leaning towards the inside of the turn and positioning body weight on the inside foot will create a "banking" condition beneath the track. By adopting this position and positioning yourself as far forward as possible, weight will be transferred to the inside ski.

On occasion, you will find that the only way to turn the vehicle about in deep snow is to pull the snowmobile around. Do not over-exert yourself. Get assistance. Remember to always lift using your legs as opposed to your back.



## Road Crossing

In some cases, you will be approaching the road from a ditch or snowbank. Choose a place where you know you can climb without difficulty. Use the standing position and proceed with only as much speed needed to crest the bank. Stop completely at the top of the bank and wait for all traffic to clear. Judge the drop to the roadway. Cross the road at a 90° angle. If you encounter another snowbank on the opposite side, position your feet near the rear of the vehicle. Remember, your snowmobile is not designed to operate on bare pavement and steering on this type of surface is more difficult.

## Railroad Crossing

Never ride on railroad tracks. It is illegal. Railroad tracks and railroad rights-of-way are private property. A snowmobile is no match for a train. When crossing a railroad track, stop, look and listen.

## Night Rides

The amount of natural and artificial light at a given time can effect your ability to see or to be seen. Nighttime snowmobiling is delightful. It can be a unique experience if you acknowledge your reduced visibility. Before you start, make certain your lights are clean and work properly. Drive at speeds that will allow you to stop in time when you see an unknown or dangerous object ahead. Stay on established trails and never operate in

unfamiliar territory. Avoid rivers and lakes. Guy wires, barbed wire fences, cabled road entrances and other objects such as tree limbs are difficult to see at night. Never drive alone. Always carry a flashlight. Keep away from residential areas and respect the right of others to sleep.

## Safari Riding

Before starting out, designate a "trail boss" to lead the party and another person to follow-up at the end of the party. Ensure that all members of the party are aware of the proposed route and destination. Make certain that you are carrying all necessary tools and equipment and that you have sufficient fuel to complete the trip. Never overtake the trail boss or, for that matter, any other snowmobile. Use down-the-line hand signals to indicate hazards or intent of direction change. Assist others whenever necessary.

It is always IMPORTANT to keep a safe distance between each snowmobile. Always maintain a safe interval and allow sufficient stopping distance. Don't be a tailgater. Know the position of the machine ahead.

## Signals

If you intend to stop, raise either hand straight above your head. A left turn is indicated by extending your left hand straight out in the proper direction. For right turns, extend the left arm and raise the hand to a vertical position so it forms a right angle at the elbow. Every snowmobiler should relay any signal to the ones behind.

## Trail Stops

Whenever possible, pull off the trail when you stop. This will reduce the hazard to other snowmobilers using the trail.

## **Trails and Signs**

Trail signs are used to control, direct or regulate the use of snowmobiles on trails. Become familiar with all signs used in the area where you are snowmobiling.

## **Transporting and Towing**

Follow transporting and towing instructions explained further in this guide.

# ***ENVIRONMENT INFORMATION***

---

## GENERAL

Wildlife compliments your snowmobiling day. Snowmobile tracks provide firm ground over which animals can travel from area to area. Do not violate this privilege by chasing or harassing wildlife. Fatigue and exhaustion can lead to animal's death. Avoid areas posted for the protection or feeding of wildlife.

If you happen to be fortunate enough to see an animal, stop your snowmobile and observe quietly.

The guidelines that we support are not designed to limit your snowmobiling fun, but to preserve the beautiful freedom that you can experience only on a snowmobile! These guidelines will keep snowmobilers healthy, happy and able to introduce others to what they know and enjoy about their favorite winter pastime. So, the next time you hit the trails on a cool, crisp and clear winter day, we ask you to remember that you are paving the way for the future of our sport. Help us lead it down the right path! From all of us at BRP, thank you for doing your share.

There is nothing more exhilarating than snowmobiling. Venturing onto snowmobile trails that criss-cross the wild areas of forests an exciting and healthy winter sport. However, as the number of people using these recreational parks increases, so does the potential for damage to the environment. Abuse of land, facilities and resources inevitably leads to restrictions and closures of both private and public land.

In essence, the greatest threat to our sport, is all around us. Which leaves us with one logical choice. When we snowmobile, we must always ride responsibly.

The vast majority respect the law and the environment. Each of us must set an example for those who are new to the sport, young and old alike.

It is in every one's best interest to tread lightly into our recreational areas. Because, in the long run, to protect the sport we must preserve the environment.

Recognizing the importance of this issue and the need for snowmobilers to do their share in preserving areas that make it possible to enjoy our sport, BRP has developed the "Light Treading Is Smart Sledding" campaign for snowmobilers.

Light Treading refers to more than the tread of our tracks. It's a statement of concern, respect and willingness to take the lead and take action. It applies to the environment in general, its proper care and maintenance, its natural inhabitants and all enthusiasts and the public at large who enjoy the great outdoors. With this theme, we invite all snowmobilers to remember that respecting the environment is not only critical to the future of our industry but to future generations.

Light Treading in no way suggests you should curb your appetite for snowmobiling fun! It simply means tread with respect!



---

# JUST WHAT IS LIGHT TREADING?

The fundamental objective of Light Treading is one of respect for where and how you ride a snowmobile. You're a light treader when you follow the principles below.

**Become informed.** Obtain maps, regulations and other information from the Forest Service or from other public land agencies. Learn the rules and follow them and that goes for speed limits, too!

**Avoid** running over young trees, shrubs, and grasses and don't cut wood. On flatlands or areas where trail riding is popular, it's important to ride only where authorized. Remember, there is a link between protecting your environment and your own safety.

**Respect wildlife** and be particularly sensitive of animals that are rearing young or suffering from food shortage. Stress can sap scarce energy reserves. Refrain from riding in areas where only animals are intended to tread!

**Obey** gate closures and regulatory signs and remember, light treaders don't litter!

**Stay out** of wilderness areas. They're closed to all vehicles. Know where the boundaries are.

**Obtain permission** to travel across private land. Respect the rights of landowners and other people's privacy. Remember, snowmobile technology has lowered the noise factor considerably, but you still shouldn't rev your engines where quiet "is the order of the day".

---

## WHY IS LIGHT TREADING SMART

Snowmobilers know all too well the efforts that have been made throughout the sport's history to enjoy access to areas where people can snowmobile safely and responsibly. This effort continues today, as strong as ever.

Respecting the areas where we ride... wherever they may be... is the only way to ensure their future enjoyment. That's one major reason why we know you'll agree that Light Treading is smart sledding! And there are more.

Enjoying the opportunity to see winter and all its natural majestic wonders, is an experience cherished by snowmobilers. Light Treading will preserve this opportunity and will make it possible for us to expose others to the beauty of winter and the unique thrill of our sport! Light Treading will help our sport to grow!

Finally, Light Treading is the sign of a smart snowmobiler. You don't have to leave big tracks or careen through a virgin forest to show you can ride. So whether you're driving a high performance Lynx, a sporty Lynx RE-X snowmobile or any other make or model, show you know what you're doing. Show you know how to send snow flying and make tracks with a light touch!

# ***VEHICLE INFORMATION***

# HOW TO IDENTIFY YOUR SNOWMOBILE

## Vehicle Description Decal

Vehicle description decal is located on right hand side of tunnel.



### TYPICAL

1. Vehicle description decal

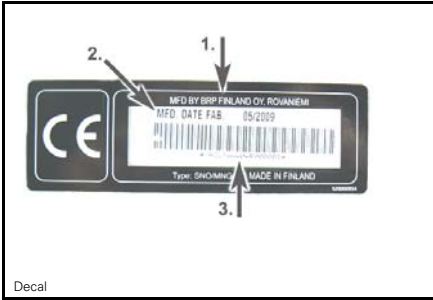

### VEHICLE DESCRIPTION DECAL

1. Manufacturer name
2. Manufacturing date
3. Vehicle identification number (VIN)

## Serial Numbers

The main components of your snowmobile (engine and frame) are identified by different serial numbers. It may sometimes become necessary to locate these numbers for warranty purposes or to trace your snowmobile in the event of loss. These numbers are required by the authorized Lynx dealer to complete warranty claims properly. No warranty will be allowed by BRP if the engine serial number or vehicle identification number (VIN) is removed or mutilated in any way. We strongly recommend that you take note of all the serial numbers on your snowmobile and supply them to your insurance company.

## Vehicle Identification Number (VIN) Location

VIN is scribed on vehicle description decal. See above. It is also engraved on tunnel near vehicle description decal.

## Model Number Location

Model number is part of vehicle identification number (VIN).

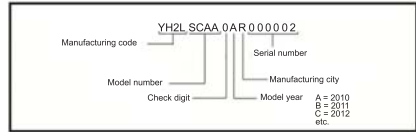

### VIN DESCRIPTION

## Engine Serial Number Location



### 600RS (593) ENGINE

1. Engine serial number

# CONTROLS/INSTRUMENTS/EQUIPMENT

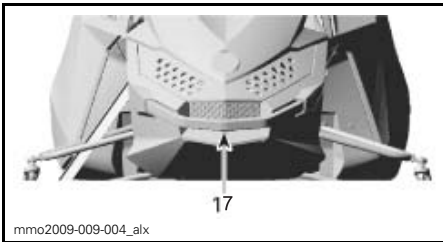
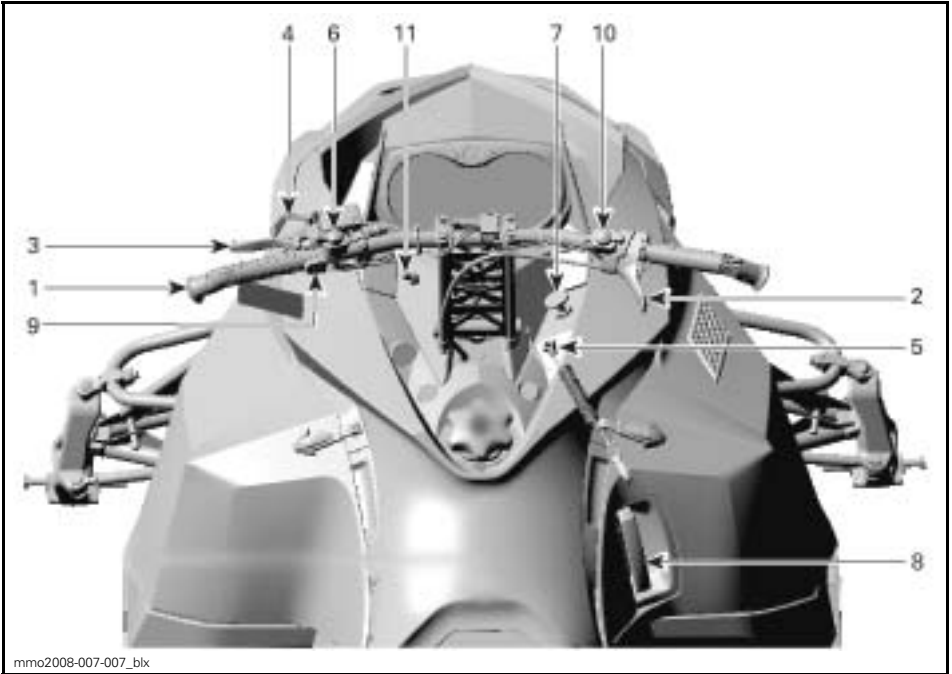

## 1) Handlebar

The handlebar controls the steering of the snowmobile. As the handlebar is rotated to right or left, the skis are turned right or left to steer the snowmobile.

## 2) Throttle Lever

Designed to be thumb activated. When squeezed, it increases the engine speed and engages the transmission. When released, engine speed returns automatically to idle.

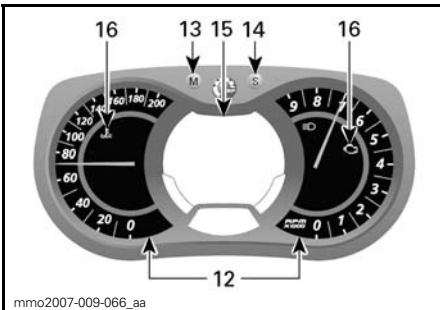

MULTIFUNCTION ANALOG/DIGITAL GAUGE

### **⚠ WARNING**

Test the throttle lever operation each time before starting the engine. The lever must return to its original position once released. Otherwise, do not start engine.

### 3) Brake Lever

When squeezed, the brake is applied. When released, it automatically returns to its original position. Braking effect is proportional to the pressure applied on the lever and to the type of terrain and its snow coverage.

### 4) Parking Brake Lever

Parking brake should be used whenever snowmobile is parked.

#### **⚠ WARNING**

Make sure parking brake is fully disengaged before operating the snowmobile. When you ride the vehicle, brake pads that are caused to drag by a continuous pressure on the lever may cause damage to the brake system and cause loss of braking capacity and/or fire.

#### To Engage Mechanism

Squeeze brake lever and maintain while pulling locking lever with a finger. When brake lever is held at halfway the parking brake should be fully applied.

**NOTICE** Parking brake position can vary depending on brake pads wear. Ensure when the parking brake is applied that the vehicle stays securely in place.

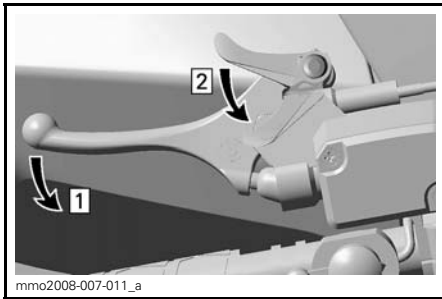

**TYPICAL — ENGAGE MECHANISM**  
 Step 1: Squeeze and maintain brake lever  
 Step 2: Adjust locking lever

#### To Release Mechanism

Squeeze brake lever. Locking lever will automatically return to its original position. Always release parking brake before riding.

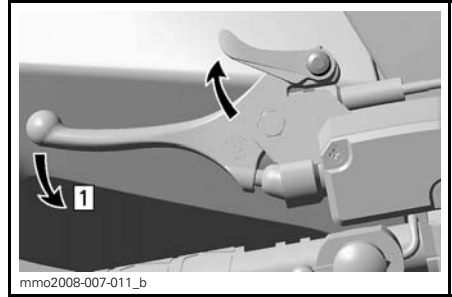

**TYPICAL — RELEASE MECHANISM**  
 Step 1: Squeeze brake lever

### 5) Tether Stop Switch

#### General

When the tether cord cap is removed, it shuts the engine off preventing snowmobile to runaway if the operator falls off the vehicle accidentally.

#### **⚠ WARNING**

Always remove the tether cord cap when vehicle is not in operation in order to prevent accidental engine starting, to avoid unauthorized use by children or others or theft.

#### Operation

Attach tether cord eyelet to clothing, then snap cap over post before starting engine.

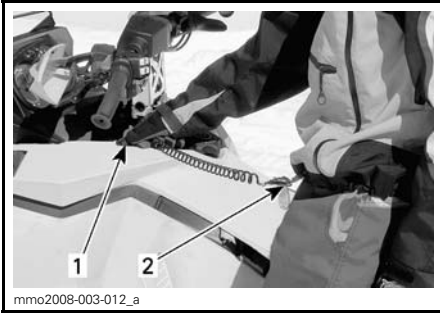
**TYPICAL**

1. Snap over post
2. Attach to clothing

If emergency engine shut off is required, pull tether cord cap from post completely.

## 6) Engine Stop Switch

Located on right side of handlebar this switch is used to stop the engine.

To stop the engine in an emergency, select OFF position (up or down) and simultaneously apply the brake. To restart, switch must be at the ON position (middle).

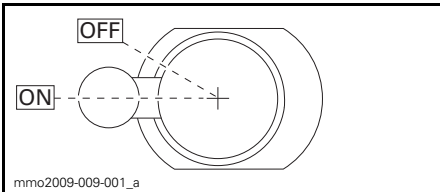

All operators of the snowmobile should familiarize themselves with the function of this device by using it several times on first outing and whenever stopping the engine thereafter. This engine shut off procedure will become a reflex and will prepare operators for emergency situations requiring its use.

## **!** WARNING

If the switch has been used in an emergency caused by a suspected malfunction, the source of the malfunction should be determined and corrected before restarting engine. See an authorized LYNX dealer for servicing.

## 7) Primer Button

Pull and push button. It is not necessary when engine is warm.

To prime, activate button until a pumping resistance is felt. From this point, pump 2 or 3 times to inject fuel in intake manifold. After priming, ensure that primer button is pushed back.

**NOTE:** In very cold temperature, it is recommended to rotate primer button 3 - 4 turns prior to pull it. This will eliminate the possibility of sticking.

## 8) Rewind Starter Handle

Auto-rewind type located on right hand side of snowmobile. To engage mechanism, pull handle slowly until a resistance is felt then pull vigorously. Slowly release handle.

## 9) Pre-Heat Switch

### Racing Application Only

**NOTE:** This switch must be removed on vehicles modified for warranty validation.

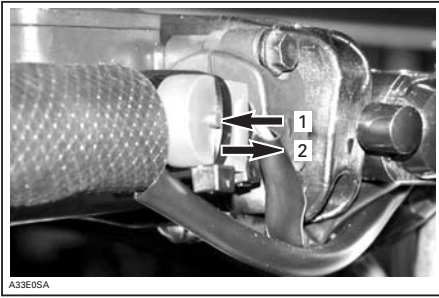

1. Button depressed: Pre-heat timing curve
2. Button released: Normal timing curve

After starting the engine, push and hold the pre-heat switch button in order to pre-heat the tuned pipe.

Release pre-heat switch button once the tuned is pre-heated.

## 10) High Beam/Low Beam Switch

Allows selection of headlamp high beam or low beam.

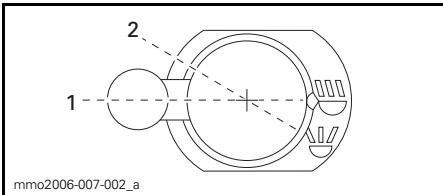

1. Low beam
2. High beam

## 11) Heated Grips/Heated Throttle Lever Switch

Select the desired position to keep your hands and thumb at a comfortable temperature.

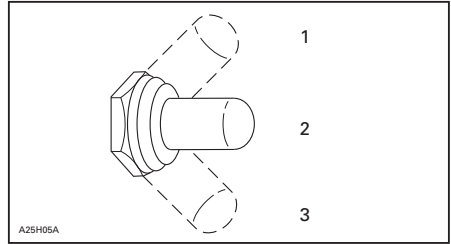

1. Hot
2. Warm
3. Off

## 12) Analog Speedometer and Tachometer

### Speedometer

Measures vehicle speed in miles or kilometers.

The speedometer is factory preset in Imperial units but it is possible to change it to metric units, contact an authorized LYNX dealer for unit settings.



LH PORTION OF GAUGE

### Tachometer (RPM)

Measures engine revolution per minute (RPM). Multiply by 1000 to obtain the actual revolutions.





RH PORTION OF GAUGE

### 13) Gauge MODE (M) Button

Button use to navigate in gauge multi-function display.

### 14) Gauge SET (S) Button

Button use to navigate, adjust or reset gauge multifunction display.

### 15) Gauge Multifunction Digital Display

Multifunction digital display that supplies several real time useful information to the driver either in imperial or metric units, contact an authorized LYNX dealer for units setting.

Also, the multifunction digital display is factory preset in Imperial units but it is possible to change it to metric units, contact an authorized LYNX dealer for unit settings.



MULTIFUNCTION ANALOG/DIGITAL GAUGE  
1. Multifunction display

**⚠ WARNING**

Reading the gauge digital display can distract from the operation of the vehicle, particularly from constantly scanning the environment. This could lead to a collision resulting in severe injuries or death. Before reading the gauge digital display, ensure your environment is clear and free from obstacle, and bring the vehicle to a low speed. Before proceeding with any adjustments, park vehicle in a safe place and away from the trail.

DISPLAY FEATURES	
FUNCTIONS	REFER TO TOPICS
Speedometer	A
Tachometer (RPM)	B
Odometer	C
Trip meter "A" or "B"	D
Trip hour meter	E
Top speed	F
Top RPM	G
Average speed	H
Message display	I
Lap record mode	J
Exhaust gas temperature	K
Throttle position display	L

## A) Speedometer

In addition of the analog type speedometer, vehicle speed can also be displayed via the multifunction display.

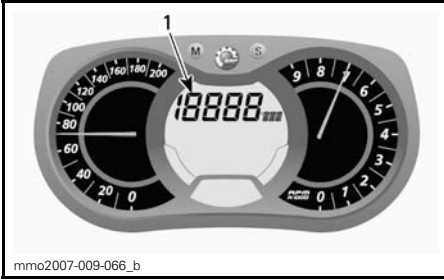

1. Vehicle speed display

To display vehicle speed, proceed as follows:

1. Press the MODE (M) button to select display.

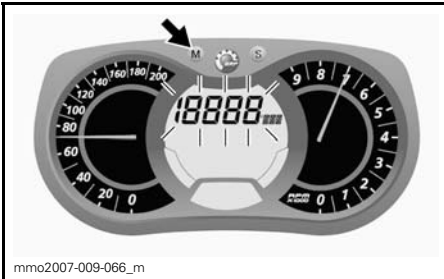

**NOTE:** Display will flash for approximately 5 seconds, then will return to the previously selected mode if display is not changed.

2. While display flashes, press the SET (S) button to scroll and select speedometer mode.

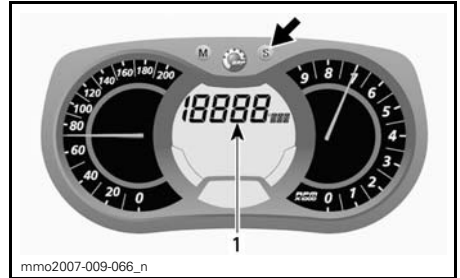

1. Speedometer mode

3. Press the MODE (M) button to confirm selection or wait 5 seconds.

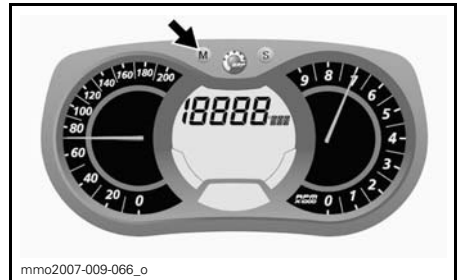

## B) Tachometer (RPM)

In addition of the analog type tachometer, RPM can also be displayed via the multifunction display.

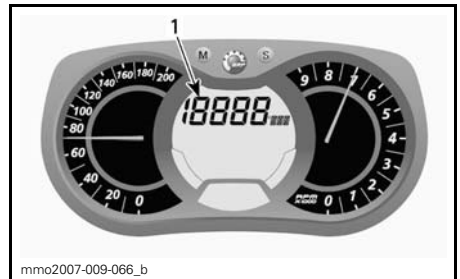

1. RPM display

To display RPM, proceed as follows:

1. Press the MODE (M) button to select display.



**NOTE:** Display will flash for approximately 5 seconds, then will return to the previously selected mode if display is not changed.

2. While display flashes, press SET (S) button to scroll and select RPM mode.

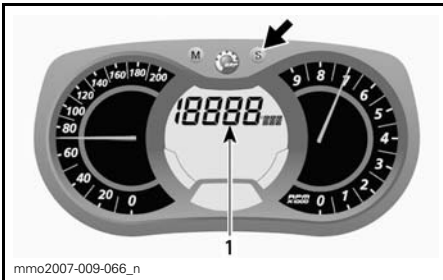

1. RPM mode

3. Press the MODE (M) button to confirm selection or wait 5 seconds.

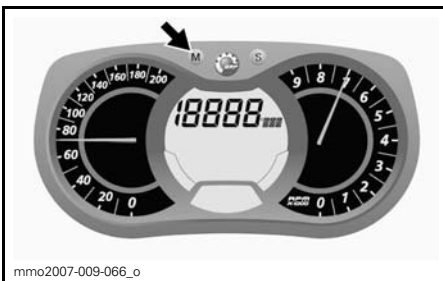

### C) Odometer

Records the total distance travelled. Press the SET (S) button to select odometer mode.

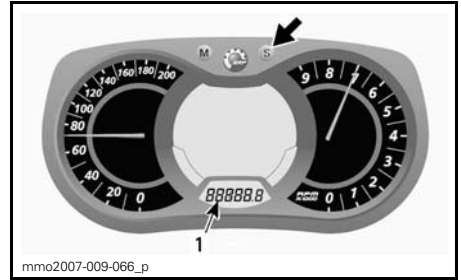

1. Odometer mode

### D) Trip Meter "A" or "B"

Trip meters records distance travelled since it has been reset.

Press the SET (S) button to select trip meter (TRIP A/TRIP B) mode.

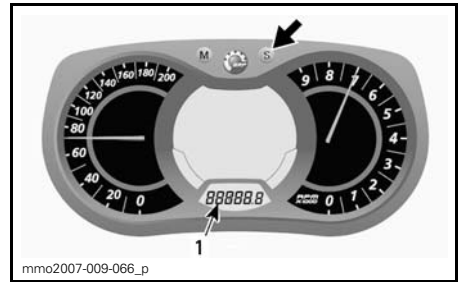

1. Trip meter (TRIP A/TRIP B) mode

Press and hold the SET (S) button to reset.

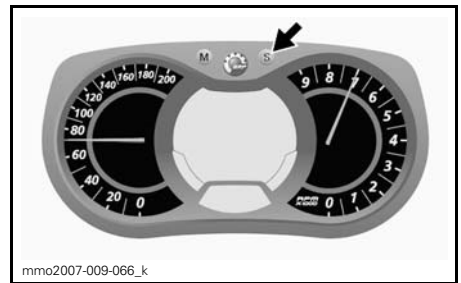

### E) Trip Hour Meter

Records vehicle running time when the electrical system is activated since it has been reset.

Press the SET (S) button to select trip hour meter (HrTRIP) mode.

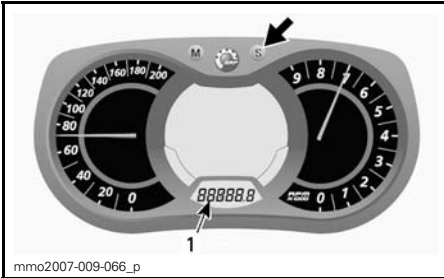

1. Trip hour meter (HrTRIP) mode

Press and hold the SET (S) button to re-set.

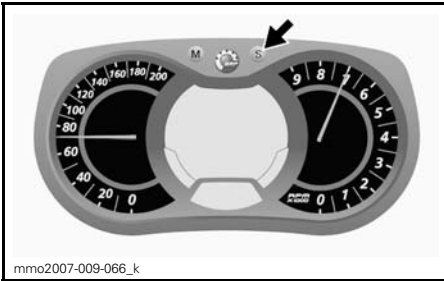

## F) Top Speed

Records vehicle top speed since it has been reset.

To display vehicle top speed, proceed as follows:

1. Press the MODE (M) button to select display.



**NOTE:** Display will flash for approximately 5 seconds, then will return to the previously selected mode if display is not changed.

2. While display flashes, press the SET (S) button to scroll and select top speed (TOP\_SPD) mode.

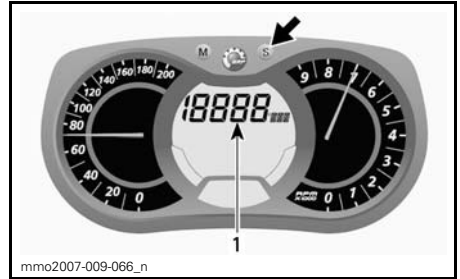

1. Top speed (TOP\_SPD) mode

3. Press the MODE (M) button to confirm selection or wait 5 seconds.



To reset, press the MODE (M) to select mode.

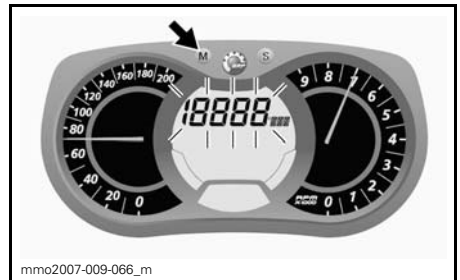

Press and hold the SET (S) button within 5 seconds to reset.

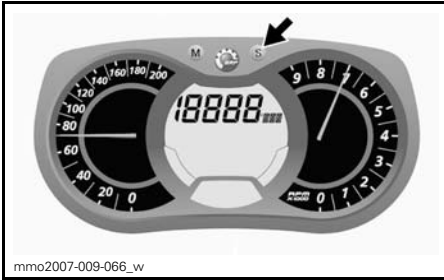

3. Press the MODE (M) button to confirm selection or wait 5 seconds.



To reset, press the MODE (M) to select mode.

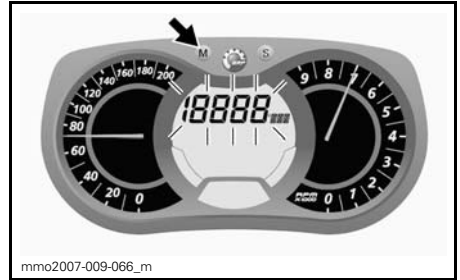

Press and hold the SET (S) button within 5 seconds to reset.

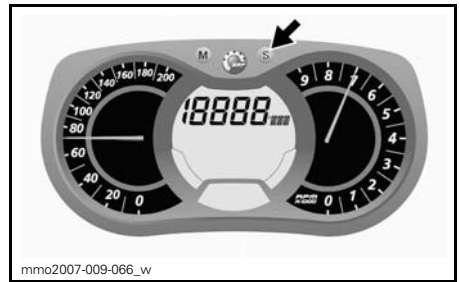

## H) Average Speed

Records vehicle average speed since it has been reset.

To display vehicle average speed, proceed as follows:

1. Press the MODE (M) button to select display.

## G) Top RPM

Records engine top revolution per minute (RPM) since it has been reset.

To display engine top revolution per minute, proceed as follows:

1. Press the MODE (M) button to select display.

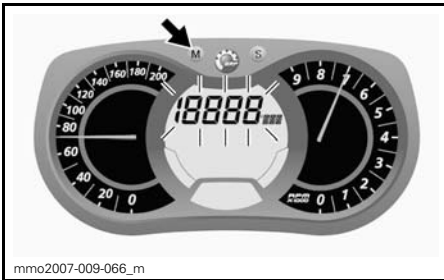

**NOTE:** Display will flash for approximately 5 seconds, then will return to the previously selected mode if display is not changed.

2. While display flashes, press the SET (S) button to scroll and select top RPM (TOP\_RPM) mode.

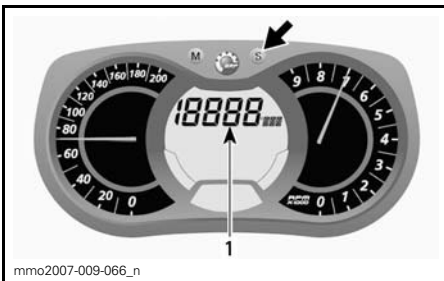

1. Top RPM (TOP\_RPM) mode



**NOTE:** Display will flash for approximately 5 seconds, then will return to the previously selected mode if display is not changed.

2. While display flashes, press SET (S) button to scroll and select vehicle average speed (AVR\_SPD) mode.



Press and hold the SET (S) button within 5 seconds to reset.

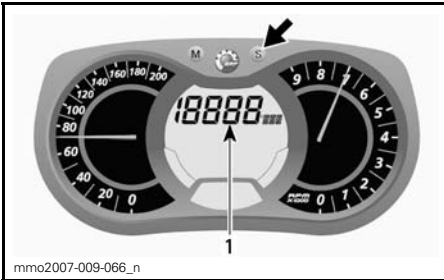
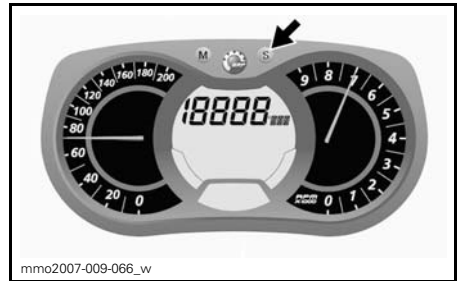

1. Vehicle average speed (AVR\_SPD) mode

3. Press the MODE (M) button to confirm selection or wait 5 seconds.



To reset, press the MODE (M) to select mode.

## I) Message Display

This display is used as a complement of the pilot lamps to give you a brief description if an anomaly occurs or to inform you of a particular condition.

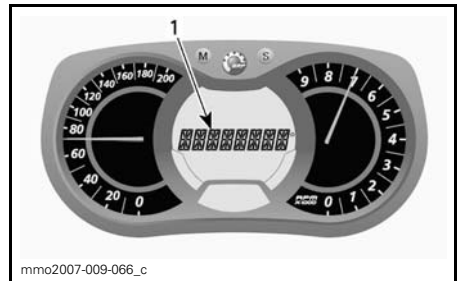

1. Message display

Messages are displayed along with a beep codes and pilot lamps.

Refer to *MONITORING SYSTEM* for details.

## J) Lap Record Mode

With this mode, vehicle speed, engine revolutions per minute (RPM) and a preselected function in display 1 can be recorded at the same time during a period of time defined by the operator.

Also, a possibility of nine (9) different sessions (laps) can be recorded for a maximum total of 2-1/2 minutes.

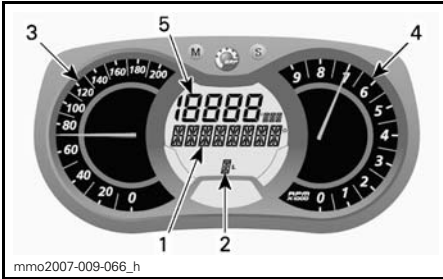

### LAP RECORD MODE

1. Lap record mode display
2. Sessions (laps)
3. Vehicle speed
4. Engine revolution per minute (RPM)
5. Preselected function

### To Activate Lap Record Mode

1. Press the SET (S) button to select the odometer mode in display 3.
2. Press and hold SET (S) button for 2 seconds to activate mode, REC will be displayed to indicate that record mode has been selected.



1. Record mode
2. Odometer

3. Press the SET (S) button to scroll between modes.

Available modes are: STOP, REC (record) or PLAY.

### To Record

1. Select REC (record) mode.

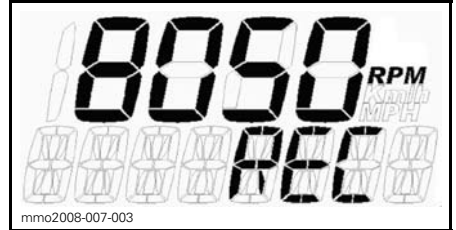

### RECORD MODE

2. Press the MODE (M) button to start recording.
3. While recording, press the MODE (M) button again each time you want to record a new lap time (from 1 to 9 laps).

Press the SET (S) button to stop recording.

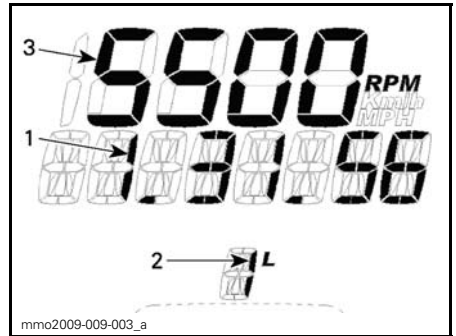

### RECORD MODE

1. Recording time
2. Lap/session
3. Selected mode

To record another session, press the SET (S) button until REC (record) mode appears in display. Repeat same procedure previously described to record.

### To Review Recorded Data

Select PLAY mode.

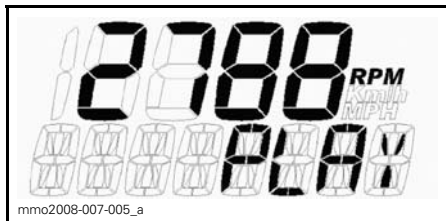

**PLAY MODE**

1. Press the MODE (M) button to play recorded data.

All recorded data (speedometer, tachometer and the preselected mode in display 1) will be displayed at the same time.

2. Press the SET (S) button to stop recorded lap OR press the MODE (M) button to switch to another recorded lap.

**NOTE:** Pressing the SET (S) button will stop time of the lap in progress, then the display will show the recorded time length of that lap and will switch automatically to the following recorded lap after 5 seconds.

At the end of all recorded laps, STOP will appear in display.

To review recorded data again, press the SET (S) button to return to PLAY mode. Repeat same procedure previously described to review.

To record other laps, press the SET (S) button to switch to REC (record) mode. Repeat same procedure previously described to record.

Press and hold SET (S) button for 5 seconds to exit the lap record mode, the previously selected mode will be displayed.

**K) Exhaust Gas Temperature**

Displays real time exhaust gas temperature and records the maximum reading.

To display exhaust gas temperature, proceed as follows:

1. Press the MODE (M) button to select display.



**NOTE:** Display will flash for approximately 5 seconds, then will return to the previously selected mode if display is not changed.

2. While display flashes, press the SET (S) button to scroll and select exhaust gas temperature (EGTM) mode.

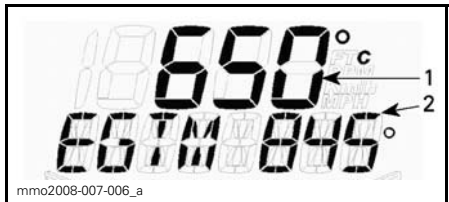

**EXHAUST GAS TEMPERATURE (EGTM) MODE**

1. Current temperature
2. Maximum temperature recorded
3. Press the MODE (M) button to confirm selection or wait 5 seconds.

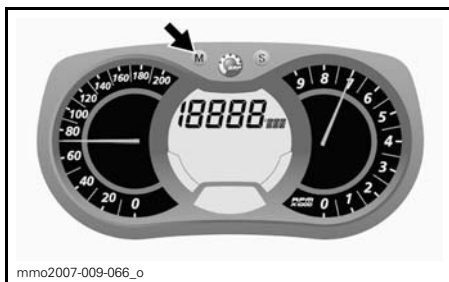

To reset maximum temperature recorded, press the MODE (M) to select mode.





Press and hold the SET (S) button within 5 seconds to reset.

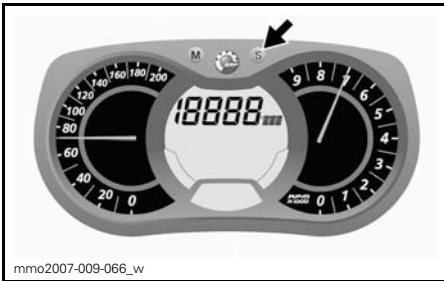

### L) Throttle Position Display

Displays real time throttle opening in percentage from approximately 0 to 100%.

To display throttle position, proceed as follows:

1. Press the MODE (M) button to select display.



**NOTE:** Display will flash for approximately 5 seconds, then will return to the previously selected mode if display is not changed.

2. While display flashes, press the SET (S) button to scroll and select throttle position (TPS) mode.

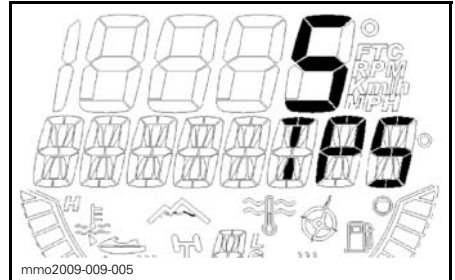

### THROTTLE POSITION MODE

3. Press the MODE (M) button to confirm selection or wait 5 seconds.



### 16) Gauge Pilot Lamps

Gauge pilot lamps will inform you if an anomaly occurs or to inform you of a particular condition.

See *MONITORING SYSTEM* for details.

### 17) Grab Handle/Bumper

To be used whenever snowmobile requires manual lifting.

**⚠ WARNING**

Do not attempt to lift the vehicle by hand alone. Use appropriate lifting device or have assistance to share lifting stress in order to avoid risk of strain injuries.

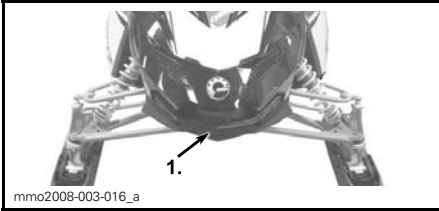

**FRONT**

1. Grab handle/bumper

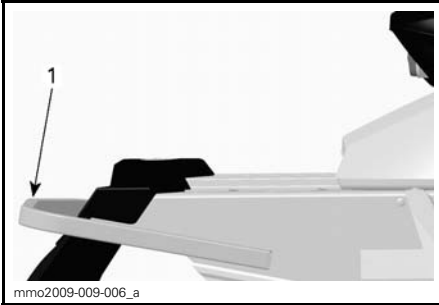

**REAR**

1. Grab handle/bumper

**NOTICE** Do not use skis to pull or lift snowmobile.

# FUEL AND OIL

## Recommended Fuel

**NOTICE** This vehicle has no oil pump, oil must be mixed with fuel. Refer to *RECOMMENDED OIL* for proper fuel/oil ratio.

Use premium unleaded gasoline available from most service stations or oxygenated fuel containing a maximum total of 10% of ethanol or methanol or both. The gasoline used must have the following recommended minimum octane rating.

## Outside North America

OCTANE RATING	
98 RON	▼
ENGINE	98
600 RS	X

**NOTICE** Never experiment with other fuels or fuel ratios. The use of not recommended fuel can result in snowmobile performance deterioration and damage to critical parts in the fuel system and engine components.

## Fuel System Antifreeze

When using oxygenated fuel, additional gas line antifreeze or water absorbing additives are not required and should be not used.

When using non-oxygenated fuel, we highly recommend the use of isopropyl base gas line antifreeze in a proportion of 150 ml (5 U.S. oz) of gas line antifreeze added to 40 liters (10-1/2 U.S. gal) of gas.

This precaution is in order to reduce the risk of frost buildup in carburetors or other fuel system components which may lead, in certain cases, to high fuel consumption or severe damage to engine.

**NOTE:** Use only methyl hydrate free gas line antifreeze.

## ⚠ WARNING

Always stop the engine before refueling. Fuel is flammable and explosive under certain conditions. Always work in a well ventilated area. Do not smoke or allow open flames or sparks in the vicinity. Open cap slowly. If a differential pressure condition is noticed (whistling sound heard when loosening fuel tank cap) have vehicle inspected and/or repaired before further operation. Do not overfill or top off the fuel tank before placing the vehicle in a warm area. As temperature increases, fuel expands and might overflow. Always wipe off any fuel spillage from the vehicle. Periodically verify fuel system.

## Recommended oil

This vehicle has no oil pump, oil must be mixed with fuel at the ratio of **33:1** in a jerrycan then, be poured in the fuel tank.

Refer to *PREMIX FUEL/OIL RATIO* table below as a guideline to properly premix oil with fuel.

**NOTICE** Never experiment with other fuel/oil ratios. Use only oil that can flow at - 40°C (- 40°F).

Use only two-stroke engine injection oil, sold by authorized LYNX dealers.

2-STROKE ENGINE INJECTION OIL		
XP-S SYNTHETIC OIL (P/N 619 590 106)		
XP-S SYNTHETIC BLEND OIL (P/N 619 590 103)		
ENGINES	▼	▼
600 RS	X	X

**NOTICE** The XP-S synthetic oil and XP-S synthetic blend oil are specially formulated and tested for the severe requirements of the 600 RS engine. Use of any other brand two-stroke oil may void the limited warranty. Use only XP-S recommended 2-stroke oil. There is no known equivalent on the market for the moment. If a high quality equivalent were available, it could be used.

**NOTICE** Never use four-stroke petroleum or synthetic motor oil and never mix these with outboard motor oil. Do not use NMMA TC-W, TC-W2 or TC-W3 outboard two-stroke engine oils or ashless two-stroke engine oils. Avoid mixing different brands of API TC oil as resulting chemical reactions may cause severe engine damage.

## **XP-S Synthetic and Synthetic Blend Oil**

The XP-S synthetic and XP-S synthetic blend 2-stroke oil provides superior lubrication, reduced engine component wear and oil deposit, thus maintaining maximum-level performance and antifriction properties. These injection oils meet the latest ASTM and JASO standards by ensuring high biodegradability and low exhaust smoke.

# Premix Fuel/Oil Ratio



**NOTICE** Warning label on the vehicle

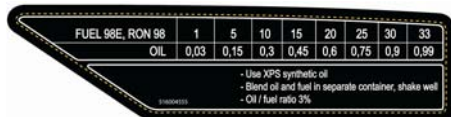

**NOTICE** Fuel / oil label on the vehicle

---

# BREAK-IN PERIOD

## Engine

**⚠ CAUTION** A break-in period of 10 operating hours — 500 km (300 miles) — is required before running the snowmobile at full throttle.

During break-in period, maximum throttle should not exceed 3/4 opening. However, brief full acceleration and speed variations contribute to a good break-in.

**⚠ CAUTION** Engine overheating, continued wide open throttle runs and prolonged cruising without speed variations should be avoided, this can cause engine damage during the break-in period.

## Belt

A new drive belt requires a break-in period of 50 km . Avoid strong acceleration/deceleration, pulling a load or high speed cruising.

## 10-Hour Inspection

**NOTE:** The 10-hour inspection is at the expense of the snowmobile owner.

As with any precision piece of mechanical equipment, we suggest that after the first 10 hours of operation or 500 km, whichever comes first, your snowmobile be checked by an authorized LYNX dealer. This inspection will also give you the opportunity to discuss the unanswered questions you may have encountered during the first hours of operation.

# OPERATING INSTRUCTIONS

## Pre-Operation Check

### WARNING

The pre-operation check is very important prior to operating the vehicle. Always check the proper operation of critical controls, safety features and mechanical components before starting. If not done as specified here, severe injury or death might occur.

- Remove snow and ice from body including seat, footrests, controls and instruments.
- Lights — The headlamp, the taillight and the brake light are standard equipment. Be sure lights are clear of dirt, slush or snow and are in good working order or condition.
- Verify that track and idler wheels are free to turn and not frozen.

### WARNING

Always use a wide base snowmobile mechanical stand to properly support vehicle during any track verification. Slowly accelerate engine in order to rotate track at very low speed when it is not on ground.

- Activate the brake control lever and make sure the brake fully applies before the brake control lever touches the handlebar grip. It must fully return when released.
- Check the parking device. Apply parking brake and check if it operates properly.
- Activate the throttle control lever several times to check that it operates easily and smoothly.

### WARNING

Throttle lever must operate easily and smoothly. It must return to idle position when released.

- Check operation of tether cord cap, engine cut-out switches, headlamp switch (HI-LO), taillight, brake light and pilot lamps.
- Verify that skis and steering operate freely. Check corresponding action of skis versus handlebar.
- Check fuel and oil for levels and leaks. Replenish as necessary and see an authorized LYNX dealer in case of any leaks.
- Verify that air silencer prefilter is free of snow.

### WARNING

All adjustable features should be positioned at optimal setting. Securely tighten all adjustment locks.

- Make certain your snowmobile is pointed away from people or objects before you start it. No one is to be standing in front of or in back of the snowmobile.
- Be warmly dressed with clothing designed for snowmobiling.

## PRE-OPERATION CHECK LIST

ITEM	OPERATION	✓
Body including seat, footrests, lights, controls and instruments	Check that there is no snow or ice.	
Track and idler wheels	Check for free movement.	
Brake lever	Check proper action.	
Parking device	Check proper action.	
Throttle lever	Check proper action.	
Switches and lights	Check proper action. Tether cord must be attached to driver clothing eyelet.	
Skis and steering	Check for free movement and proper action.	
Fuel and oil	Check for proper level and leaks.	
Air silencer prefilter	Check that there is no snow or ice.	
Adjustable features	Check for optimal adjustment and securely tightened adjustment locks.	
Vehicle vicinity	Snowmobile must be pointed away from people or objects. No one is to be standing in front of or in back of the snowmobile.	
Clothing	Be warmly dressed with clothing designed for snowmobiling.	

## Engine Starting Procedure

### General

### Procedure

1. Recheck throttle control lever operation.
2. Ensure that the tether cord cap is in position and that the cord is attached to your clothing eyelet.
3. Ensure that the engine cutout switch is in the ON position.

### Manual Starting

1. Grab manual starter handle, pull handle slowly until a resistance is felt, then hold handle firmly and pull vigorously to start engine.

### WARNING

Do not apply throttle while starting.

### Electric Starting (if so equipped)

Depressing the START/RER button will engage the electric starter and start the engine.

Release button immediately when engine has started.

### WARNING

Do not apply throttle while starting.



**⚠ CAUTION** Do not use electric starter for more than 10 seconds. A rest period should be observed between the cranking cycles to let electric starter cool down. Using electric starter when engine has started could damage electric starter mechanism.

**NOTE:** If for any reason, the engine cannot be cranked electrically, start engine manually using the rewind starter.

## Carburetor Engine Starting Procedure

### Procedure

1. Recheck throttle control lever operation.
2. Ensure that the tether cord cap is in position and that the cord attached to your clothing eyelet.
3. Ensure that the engine cutout switch is in the ON position.
4. Activate the choke according to the temperature as explained below.

### Choke Application

**Initial Cold Starting When Temperature is Below - 10°C (+ 15°F)**

**NOTE:** Do not operate the throttle lever with the choke lever on.

Set the choke lever to position 3.

**NOTE:** After the engine is started, let engine warm up at fast idle until engine speed drops. Then, close off choke to ensure proper air-fuel mixture.

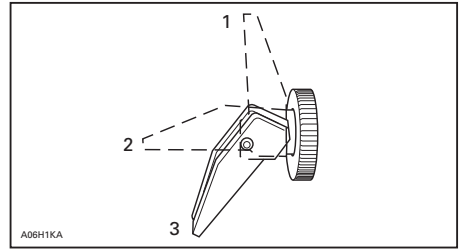

1. OFF
2. Position 2
3. Position 3

**Initial Cold Starting When Temperature is Above - 10°C (above + 15°F)**

Set the choke lever to position 2.

**NOTE:** After the engine is started, close off choke to ensure proper air-fuel mixture.

### Warm Engine Starting

Start the engine without any choke. If the engine will not start after two pulls of the rope or two 5 second attempts with the electric starter move choke lever to position 2. Start the engine without activating the throttle lever. As soon as the engine starts move the choke lever to OFF.

### Vehicle Warm-Up

Before every ride, vehicle has to be warmed up as follows.

Engage parking brake.

Snowmobile must be securely supported by the rear bumper using a wide-base snowmobile mechanical stand. Track must be 100 mm (4 in) off the ground.

Attach tether cord to operator's clothing eyelet.

Start engine and allow it to warm up two or three minutes at idle speed.

**NOTE:** It is not recommended to let engine running at idle speed for more than 10 minutes.

Disengage parking brake.

**⚠ WARNING**

Make sure wide-base snowmobile mechanical stand is stable. Stay clear of the front of vehicle and the track. Do not use too much throttle during warm-up or when track is free-hanging.

Apply throttle until drive pulley engages. Let track rotate at low speed for several turns. The lower the vehicle temperature, the longer vehicle warm-up should be.

Shut-off the engine and remove the wide-base snowmobile mechanical stand.

Skis may be frozen on the ground. Grab both skis one at a time by their loops and lift their front end slightly off the ground.

After restarting engine, the vehicle can be driven at low speed for the first 2 or 3 minutes of riding. After that, it may be driven up to the legal speed limit as per normal safety practices.

## Shutting Off the Engine

Release throttle lever and wait until engine has returned to idle speed.

Shut off the engine using either engine Stop switch or tether cord cap engine Stop switch.

**⚠ WARNING**

Always remove the tether cord cap when vehicle is not in operation in order to prevent accidental engine starting or to avoid unauthorized use by children or others or theft.

## Post-Operation Care

Shut off the engine. Install rear of vehicle on a wide-base snowmobile mechanical stand.

Remove snow and ice from rear suspension, track, front suspension, steering mechanism and skis.

Always cover your snowmobile when leaving it outside overnight or during extended periods of inactivity. This will protect it from frost and snow as well as help retain its appearance.

# SPECIAL OPERATING INSTRUCTIONS

## Riding at High Altitudes

**⚠ CAUTION** Failure to re-calibrate may cause serious engine damage.

Refer to an authorized LYNX dealer..

## Riding in Cold Weather

All vehicles have been calibrated for - 20°C (- 4°F). They can be operated at warmer winter temperatures without risk of problems.

**⚠ CAUTION** For colder temperatures than - 20°C (- 4°F), carburetor(s) must be recalibrated to avoid engine damage. Refer to an authorized LYNX dealer.

Refer also to *RIDING AT HIGH ALTITUDES OR SEA LEVEL*.

## Emergency Starting

The engine can be started with the emergency starter rope supplied with the tool kit.

Remove belt guard.

### **⚠ WARNING**

Do not wind starting rope around your hand. Hold rope by the handle only. Do not start the snowmobile by the drive pulley unless it is a true emergency situation. Have the snowmobile repaired as soon as possible.

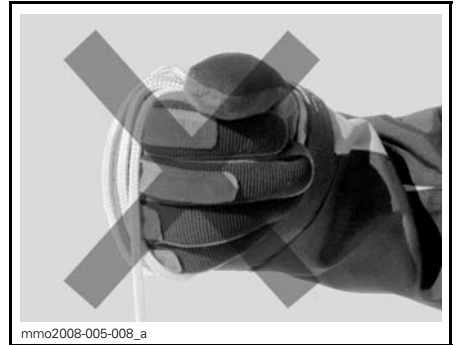

Attach one end of emergency rope to rewind handle.

**NOTE:** The spark plug socket can be used as an emergency handle.

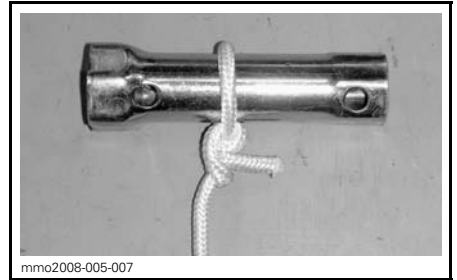

Attach the other end of emergency rope to the starter clip supplied in the tool kit.

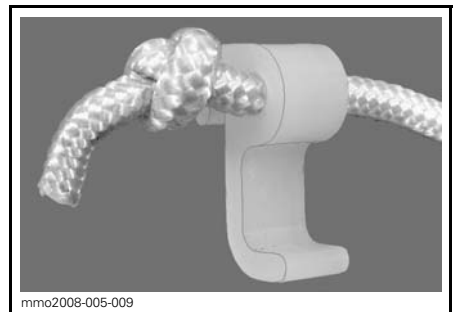

Hook up clip on drive pulley.

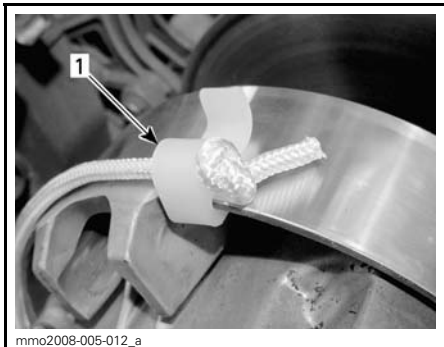

1. Clip installation location

Wind the rope tightly around drive pulley. When pulled, pulley must rotate counterclockwise.

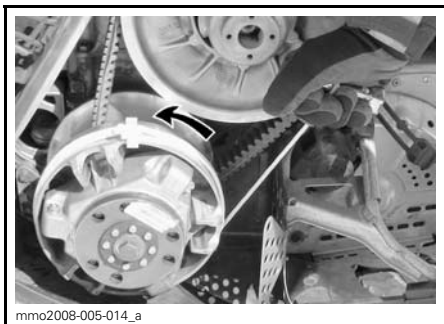

Pull the rope using a sharp, crisp pull so the rope comes free of the drive pulley. Start engine as per usual manual starting.

**⚠ WARNING**

When starting the snowmobile in an emergency situation, using drive pulley, do not reinstall the belt guard and return slowly to have snowmobile repaired.

**Towing an Accessory**

Always use a rigid tow bar to tow an accessory. Any towed accessory should have reflectors on both sides and at the rear. Check local laws for brake light(s) requirements.

**⚠ WARNING**

Never tow an accessory with a rope. Always use a rigid tow bar. Using a rope would result in a collision between the object and the snowmobile and possibly in a tip over in case of a rapid deceleration or on a downward slope.

**Towing Another Snowmobile**

If a snowmobile is disabled and must be towed use a rigid tow bar, remove the drive belt from disabled snowmobile and tow at moderate speed.

**⚠ CAUTION** Always remove the drive belt of the snowmobile that is to be towed to prevent damage to its belt and drive system.

In an emergency situation only, if a rigid tow bar is not available, a rope can be used provided you proceed with extra caution. In some areas, it may be illegal to do so. Check with state or local authorities.

Remove the drive belt, attach the rope to the ski legs (spindles), have someone sit on the towed snowmobile to activate the brake, and tow at low speed.

**⚠ CAUTION** In order to prevent damage to the steering system, never attach the tow rope to the ski loops (handles).

**⚠ WARNING**

Never ride at high speed when towing a disabled snowmobile. Proceed slowly with extra caution.

## Transporting the Vehicle

Make sure that oil reservoir and fuel tank caps are properly installed.

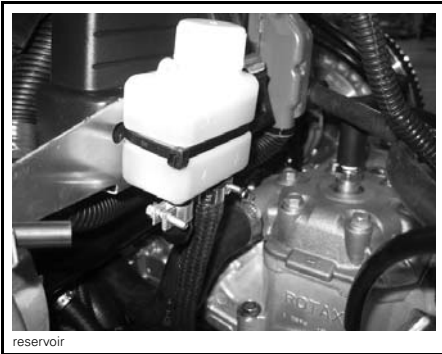

Tilt bed trailers can easily be equipped with a winch mechanism to afford maximum safety in loading. Simple as it may seem, never drive your snowmobile onto a tilt bed trailer or any other kind of trailer or vehicle. Many serious accidents have resulted from driving up and over a trailer. Anchor your vehicle securely, front and rear, even on short hauls. Be certain all equipment is securely fastened. Cover your snowmobile when trailering to prevent road grime from causing damage.

Be certain your trailer meets state or provincial requirements. Ensure the hitch and safety chains are secure and the brake, turn indicators and clearance lights all function.

# SUSPENSION ADJUSTMENTS

Snowmobile handling and comfort depend upon suspension adjustments.

Choice of suspension adjustments vary with carrying load, driver's weight, personal preference, riding speed and field condition.

REAR SUSPENSION TYPE	
MODEL	TYPE
	PPS 120
Rave 600RS	X

## Adjustable suspension

NOTE: Some adjustments may not apply to your snowmobile. Use special keys in tool kit (SOME MODELS).

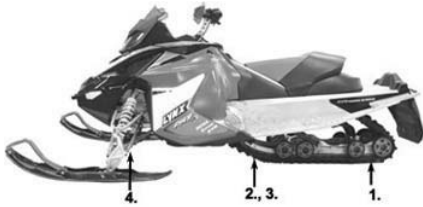

1. Rear springs - comfort and ride height
2. Center spring - handling
3. Stopper strap - snowmobile weight transfer
4. Front shock - handling

## Suspension adjustments

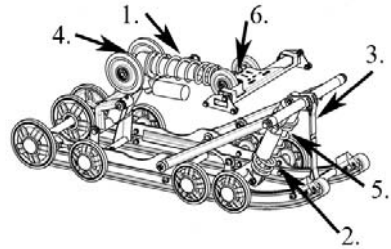

### TYPICAL — PPS

1. Rear springs adjustable for comfort and ride height
2. Center spring for steering behavior
3. Stopper strap for snowmobile weight transfer
4. Rear shock motion ratio — Damping strength
5. Center shock motion ratio — Damping strength (not seen on picture)
6. Rebound strength adjustment

Following are guidelines to fine-tune suspension.

The best way to set up the suspension, is to start from factory settings, then customize each adjustment one at a time. It may be necessary to readjust center spring after adjusting front springs for instance. Test run the snowmobile under the same conditions; trail, speed, snow, driver riding position, etc. Change one adjustment and retest. Proceed methodically until you are satisfied.

## **⚠ WARNING**

Always remove tether cord cap before performing any maintenance or adjustment, unless otherwise specified. Vehicle must be parked in a safe place, away from the trail. Always lift the front of vehicle off the ground with a suitable lifting device before adjusting ski suspension. Lift the rear of vehicle off the ground with a wide-base snowmobile stand with a rear deflector panel before rear suspension adjustment.

**⚠ WARNING**

Do not attempt to lift the vehicle by hand alone. Use appropriate lifting device to avoid risk of strain injuries. Always make sure the lifting device is stable and secure before proceeding to adjust the suspension components.

**⚠ CAUTION** Whenever adjusting rear suspension, check track tension and adjust as necessary.

Slight suspension bottoming occurring under the worst riding conditions indicates a good choice of spring preload.

**NOTE:** Some models may come from factory equipped with Take/Apart (T/A) shocks. These can be rebuilt or re-calibrated. See an authorized Lynx dealer. Take/Apart type of shock absorbers need service at least once a year or after 1500km (refer to maintenance schedule).

**SHOCK ABSORBER ADJUSTMENTS*****Screw Ring Type Shock***

In some models you have to first open lock ring then turn adjust ring to position wanted.

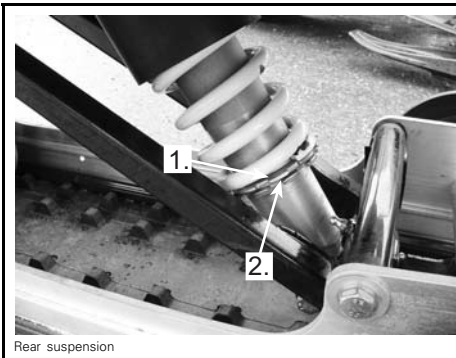

Rear suspension

**IN SOME MODELS**

1. Increase or decrease spring preload
2. Locking ring

***Shock dampening adjustment***

In some models you may adjust also dampening strength of shock.

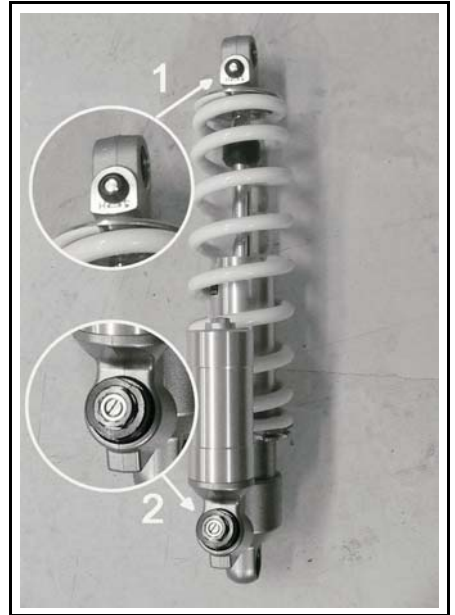
**IN SOME MODELS ONLY**

1. Rebound adjustment.
2. Compression adjustment.

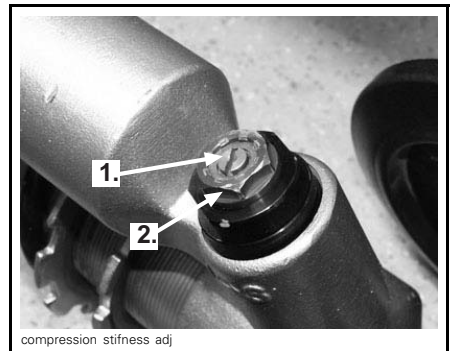

compression stiffness adj

1. Low speed compression adjuster (flat screwdriver)
2. High speed compression adjuster (17mm wrench)

Turning the small brass screw [1] clockwise increases the low-speed compression dampening.

Turning the red nut [2] clockwise increases the high-speed compression dampening.

These adjustment have no effect on rebound dampening.

**Rear Springs — Comfort**

**IMPORTANT:** Make sure that all objects to be transported are in place in storage compartment and rear rack.

- Grab rear bumper and lift until suspension is fully extended.
- From this point, rear of snowmobile should collapse by 50 to 75 mm (2 to 3 in) when driver and passenger (if so applicable) take place. Measure at rear bumper as shown in next photo.

**⚠ WARNING**  
Do not attempt to lift the vehicle by hand alone. Use appropriate lifting device or have assistance to share lifting stress in order to avoid risk of strain injuries.

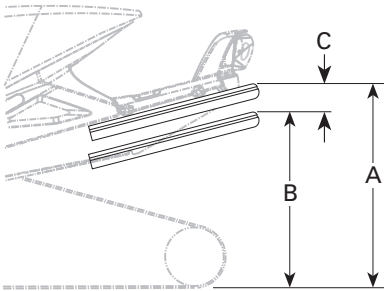

- TYPICAL — PROPER ADJUSTMENT**
- A. Suspension fully extended
  - B. Suspension has collapse with driver, passenger(s) and load added
  - C. Distance between dimension A and B, must not exceed 50 to 75 mm (2 to 3 in), see table

**Rear Springs Adjustment**

"C"	CAUSE	SOLUTION
50 to 75 mm (2 to 3 in)	No adjustment required	
More than 75 mm (3 in)	Too soft of adjustment	Increase preload (see preload adjustment)
Less than 50 mm (2 in)	Too hard of adjustment	Decrease preload (see preload adjustment)

**Center Spring — Steering Behavior**

- Ride at moderate speed on a trail.
- If handlebar is felt too easy or too hard to turn, adjust center spring accordingly.

**⚠ WARNING**  
Before proceeding with any suspension adjustment, remember:

- park in a safe place
- remove tether cord cap
- lift rear of vehicle off the ground with a wide-base snowmobile stand with a rear deflector panel
- make sure lifting device is stable and secure.

**Preload Adjustment**

CENTER SPRING ADJUSTMENT				
STEERING BEHAVIOR			ADJUSTMENT	
VEHICLE SPEED	HANDLE-BAR	STEERING ATTITUDE	PROBLEM	SOLUTION
Moderate	Easy to turn	Neutral	No adjustment required	
	Harder to turn	Oversteering	Too soft of adjustment	Increase preload
	Very easy to turn	Understeering	Too hard of adjustment	Decrease preload



**Stopper Strap — Weight Transfer**

- Ride at low speed then fully accelerate.
- Note steering behavior.
- Adjust stopper strap length accordingly,

**⚠ WARNING**

Before proceeding with any suspension adjustment, remember:

- park in a safe place
- remove tether cord cap
- lift rear of vehicle off the ground with suitable lifting device
- make sure lifting device is stable and secure.

**⚠ CAUTION** Whenever stopper strap length is changed, track tension must be readjusted.

**Strap Adjustment**

STOPPER STRAP — WEIGHT TRANSFER				
WEIGHT TRANSFER			ADJUSTMENTS	
STEERING BEHAVIOR	TRACK	SKIS	PROBLEM	SOLUTION
Comfortable	Good weight transfer	Light pressure	No adjustment required	
Light	Too much weight transfer	Lift off the ground	Too long strap	Reduce strap length
Heavy	Not enough weight transfer	Heavy pressure	Too short strap	Increase strap length

**Front Springs — Handling**

- Ride at moderate speed and check for proper handling.
- Adjust front springs accordingly.

**⚠ WARNING**

Before proceeding with any suspension adjustment, remember:

- park in a safe place
- remove tether cord cap
- lift rear of vehicle off the ground with a wide-base snowmobile stand with a rear deflector panel
- make sure lifting device is stable and secure.

**⚠ WARNING**

Always adjust both front springs to same position.

**Preload Adjustment**

FRONT SPRINGS ADJUSTMENT			
HANDLING	STEERING	PROBLEM	SOLUTION
Good	Comfortable	No adjustment required	
Bad	Too easy to turn	Too soft of adjustment	Increase spring preload
Bad	Hard to turn	Too hard of adjustment	Decrease spring preload

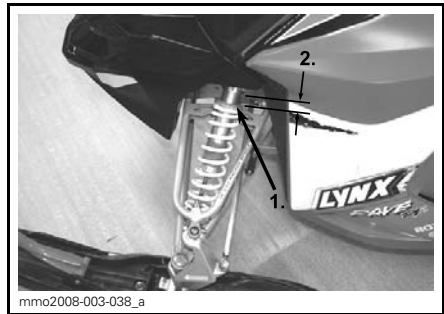

1. Adjustment ring
2. Ring positions

**⚠ CAUTION** Make sure that both front springs are still pre loaded when front of vehicle is off the ground.

**⚠ WARNING**

Always remove the tether cord cap before performing any maintenance or adjustment, unless otherwise specified. Vehicle must be parked in a safe place, away from the trail. Always lift the front of vehicle off the ground with a suitable lifting device before adjusting ski suspension. Lift the rear of vehicle off the ground with a wide-base snowmobile stand with a rear deflector panel before rear suspension adjustment.

**⚠ WARNING**

Do not attempt to lift the vehicle by hand alone. Use appropriate lifting device to avoid risk of strain injuries. Always make sure the lifting device is stable and secure before proceeding to adjust the suspension components.

**⚠ CAUTION** Whenever adjusting rear suspension, check track tension and adjust as necessary.

**Front Suspension Shock Damping**

**Compression/Rebound Adjustment**

Front shock on the above mentioned models feature a compression/rebound adjustment.

Turn the damping adjuster accordingly. Turning it clockwise increases shock damping action (stiffer).

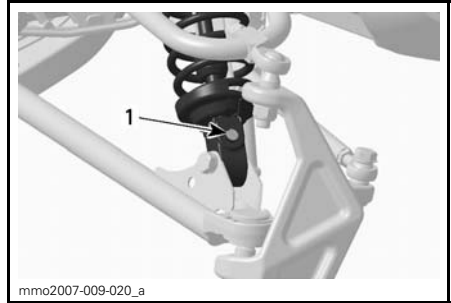

TYPICAL  
1. Damping adjuster

**Ski Stance**

The ski stance can be set at two different positions by placing spacers outside or inside the ski legs. The ski stance is measured from the center of skis, see table below.

SPACER POSITION	SKI STANCE
Inside	1065 mm (41.93 in)
Outside	1108 mm (43.64 in)

To set the desired ski stance, proceed as follows:

1. Lift front of vehicle and secure.
2. Remove the nut and pull ski bolt out.

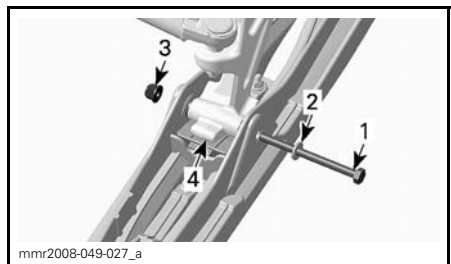

TYPICAL  
1. Ski bolt  
2. Washer  
3. Nut  
4. Ski leg

3. Install spacer inside for the narrower setting or outside for the wider setting.

**⚠ WARNING**

Proceed to the same setting for both skis.

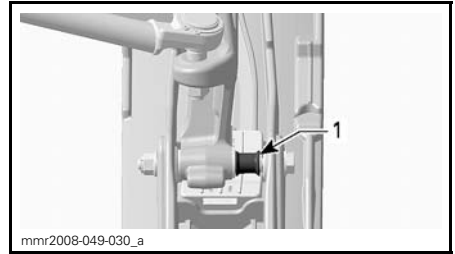

**WIDER STANCE — LEFT SKI SHOWN**

1. Spacer here for the wider stance

4. Install ski bolt and torque nut to 32 N•m (24 lbf•ft).

**NOTE:** Always consult your local regulations concerning the snowmobile width limitations before riding on a trail.

**Suspension Troubleshooting Chart**

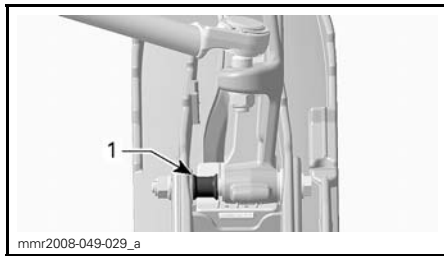

**NARROWER STANCE — LEFT SKI SHOWN**

1. Spacer here for the narrower stance

PROBLEM	CORRECTIVE MEASURES
Front suspension wandering	Check ski alignment and camber angle adjustment. See an authorized LYNX dealer. Reduce ski ground pressure. <ul style="list-style-type: none"> <li>– Reduce front suspension spring preload.</li> <li>– Increase center spring preload.</li> <li>– Reduce rear spring preload.</li> </ul>
Snowmobile seems unstable and seems to pivot around its center	Reduce rear suspension front arm pressure. <ul style="list-style-type: none"> <li>– Reduce center spring preload.</li> <li>– Increase rear spring preload.</li> <li>– Increase front suspension spring preload.</li> </ul>
Steering feels too heavy	Reduce ski ground pressure. <ul style="list-style-type: none"> <li>– Reduce front suspension spring preload.</li> <li>– Increase center spring preload.</li> </ul>
Rear of snowmobile seems too stiff	Reduce rear spring preload.
Rear of snowmobile seems too soft	Increase rear spring preload.
Rear suspension front shock absorber is frequently bottoming	Increase center spring preload.
Track spins too much at start	Lengthen stopper strap.

## **Deep Snow Riding**

When operating the snowmobile in deep snow, it may be necessary to vary stopper strap length and/or riding position, to change the angle at which the track rides on the snow. Operator's familiarity with the various adjustments as well as snow conditions will dictate the most efficient combination.

---

# TECHNICAL GUIDELINES

---

## ENGINE IS CRANKED BUT FAILS TO START.

---

1. **Engine stop switch is in OFF position or tether cord cap away from post.**
  - *Place engine stop switch in the ON position and install tether cord cap on post.*
2. **Mixture not rich enough to start cold engine.**
  - *Check fuel tank level and check starting procedure, particularly use of the primer.*
3. **Flooded engine (spark plug wet when removed).**
  - *Do not use primer. Remove wet spark plug, place engine stop switch in OFF position and crank engine several times. Install clean dry spark plug.*
  - *Start engine following usual starting procedure. If engine continues to flood, see an authorized Lynx dealer.*
4. **No fuel to the engine (spark plug dry when removed).**
  - *Check fuel tank level; check condition of fuel and impulse lines and their connections. Possible failure of the fuel pump or carburetor. Contact an authorized Lynx dealer.*
5. **Spark plug/ignition (no spark).**
  - *Remove spark plug(s) then reconnect to spark cap. Check that engine stop switch is at the ON position and the tether cord cap snapped over the receptacle.*
  - *Start engine with spark plug(s) grounded to engine away from spark plug hole. If no spark appears, replace spark plug. If trouble persists, contact an authorized Lynx dealer.*
6. **Engine compression.**
  - *As the engine is pulled over with the rewind starter, “cycles” of resistance should be felt as piston goes past top dead center (each piston on multi-cylinder engines).*
  - *If no pulsating resistance is felt, it suggests a major loss of compression. Contact an authorized Lynx dealer.*

---

## ENGINE LACKS POWER/SNOWMOBILE DOES NOT REACH FULL SPEED.

---

1. **Fouled or defective spark plug.**
  - *Check item 5 of ENGINE IS CRANKED BUT FAILS TO START.*
2. **Lack of fuel to engine.**
  - *Check item 4 of ENGINE IS CRANKED BUT FAILS TO START.*
3. **Carburetor adjustments.**
  - *Contact an authorized Lynx dealer.*
4. **Drive belt worn too thin.**
  - *If the drive belt has lost more than 3 mm (1/8 in) of its original width, it will affect vehicle performance.*
  - *Replace drive belt.*
5. **Pulleys misaligned or defective.**
  - *Contact an authorized Lynx dealer.*

**ENGINE LACKS POWER/SNOWMOBILE DOES NOT REACH FULL SPEED. (cont'd)**

---

**6. Incorrect track adjustment.**

- *See MAINTENANCE and/or an authorized Lynx dealer for proper alignment and tension adjustments.*

**ENGINE BACKFIRES.**

---

**1. Faulty spark plug (carbon accumulation).**

- *See item 5 of ENGINE IS CRANKED BUT FAILS TO START.*

**2. Engine is running too hot.**

- 
- *Check coolant level, see MAINTENANCE PROCEDURES.*
- *Check heat exchangers cleanliness. Clean if necessary.*
- *If coolant level is correct and heat exchangers are clean, contact an authorized Lynx dealer.*

**3. Ignition timing is incorrect or there is an ignition system failure.**

- *Contact an authorized Lynx dealer.*

**ENGINE MISFIRES.**

---

**1. Fouled/defective/worn spark plugs.**

- *Clean/verify spark plug gap and identification number. Replace as required.*

**2. Water in fuel.**

- *Drain fuel system and refill with fresh fuel.*

# MONITORING SYSTEM

## Pilot Lamps, Messages and Beeper Codes

Gauge pilot lamps will inform you if an anomaly occurs or to inform you of a particular condition.



TYPICAL — PILOT LAMPS

This display is used as a complement of the pilot lamps to give you a brief description if an anomaly occurs or to inform you of a particular condition.

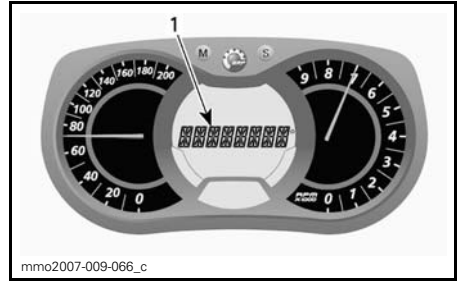

1. Message display

The message is displayed along with a beeper code and a pilot lamp.

Beeper codes will be heard and messages (depending on gauge model) will be displayed to catch your attention.

See table below for details.

PILOT LAMP(S) ON	BEEPER	MESSAGE DISPLAY	DESCRIPTION
	Fast short beeps	ENGINE OVERHEAT	Engine is overheating, reduce snowmobile speed and run in loose snow or stop engine immediately and allow engine to cool. Check cooling system.
	4 short beeps	CHECK ENGINE	Engine fault, see an authorized Ski-Doo dealer as soon as possible.
	Continuously beeps	SHUTDOWN	Shutdown procedure in force due to engine overheating problem, remove tether cord cap and contact an authorized Ski-Doo dealer.

# SPECIFICATIONS

**NOTE:** Because of its ongoing commitment to product quality and innovation, BRP reserves the right, at any time, to make changes in design and specifications and/or to make additions to, or improvements in its products without imposing any obligation upon itself to install them on its products previously manufactured.

MODEL		RAVE 600RS
<b>ENGINE SYSTEM</b>		
Engine type	Rotax™ 600RS, liquid cooled w/Reed valve,	
Cylinders	2	
Displacement	cm (in <sup>3</sup> )	594,4 (36.27)
Bore	mm	72 (2.83)
Stroke	mm	73 (2.87)
Maximum horsepower RPM	8400 RPM	
Carburetion	2 x TMX-38	
Exhaust system	Single tuned pipe, baffle muffler	
<b>DRIVE SYSTEM</b>		
Drive pulley type	TRA™ III light	
Driven pulley type	Team rapid reaction	
Engagement	5250 RPM	
Small sprocket number of teeth	23	
Large sprocket number of teeth	49	
Drive sprocket number of teeth	8	
Brake system	Hydraulic, RE-X brake type	
Track nominal width	380 mm	
Track nominal length	3052 mm	
Track profile height	44 mm	
Track tension	Deflection	30-35 mm (1-3/16 - 1-3/8 in)
	Force <sup>(1)</sup>	7.3 kg (16 lb)
Track alignment	Equal distance between edges of track guides and slider shoes	



MODEL		RAVE 600RS
<b>SUSPENSION</b>		
Front suspension		A-LFS
Front shock		40mm HLCR™ T/A
Front suspension max. travel		242 mm
Rear suspension		PPS-120
Rear shock		46mm HLCR T/A
Rear suspension max. travel		390 mm
<b>ELECTRICAL</b>		
Lightning system output		360 Watts @ 6000 RPM
Headlamp bulb HI/LOW beam		2 x 60/55 Watts (H-4)
Taillight bulb		5/21
Spark plug	Type	NGK BR9ECS-5 <sup>(2)</sup>
	Gap	Not adjustable (0,5 mm +/- 0,1mm )
Fuse		Refer to <i>FUSE</i> section
<b>DIMENSIONS</b>		
Vehicle overall length		2748 mm
Vehicle overall width		1225 mm
Vehicle overall height		1130 mm
Official dry weight		199 kg
Ski stance		1080 mm

**SPECIFICATIONS**

<b>MODEL</b>		<b>RAVE 600RS</b>
<b>LIQUIDS</b>		
Mixing oil type		XP-S synthetic blend oil (PN 619 590 103)
Fuel/oil ratio		33:1
Recommended fuel type		Regular unleaded
Minimum octane		98 E
Recommended oil (engine)		Refer to <i>RECOMMENDED OIL</i> section
Brake system fluid		SRF (DOT 4) or GTLMA (DOT 4)
Oil type (chaincase/transmission)		XP-S synthetic chaincase oil
Coolant	Mixture	Ethyl glycol/water mix (50% coolant, 50% distilled water). Use coolant specifically designed for aluminum engines
	Premix	(P/N 219 700 362) 12 x 1 L
<b>CAPACITIES</b>		
Fuel tank	L	22 (5.3 U.S. gal)
Cooling system	L	4.5 (152 U.S.fl oz)
<p><sup>(1)</sup> Measure gap between slider shoe and bottom inside track when exerting a downward pull to the track.</p> <p><sup>(2)</sup> <b>CAUTION: Do not attempt to adjust gap on this plug.</b></p> <p><b>NOTE:</b> Drive belt height must be adjusted every time a new drive belt is installed. Confirm drive belt part number application with an authorized LYNX dealer.</p>		

The EC-Declaration of Conformity does not appear in this version of the Operator's Guide.

Please refer to the printed version that was delivered with your vehicle.



# ***MAINTENANCE INFORMATION***

---

## PERIODIC MAINTENANCE CHART

### **WARNING**

It is recommended that the assistance of an authorized LYNX dealer be periodically obtained on other components/systems not covered in this guide. Unless otherwise specified, engine must be cold and not running. Remove the tether cord cap before performing any maintenance or adjustment, unless otherwise specified. Vehicle must be parked in a safe place, away from the trail.

### **WARNING**

Observe WARNINGS and CAUTIONS mentioned throughout this guide which are relevant to the item being checked. When component conditions seem less than satisfactory, replace with genuine BRP parts or approved equivalents.

Some items may not apply to your particular model. Refer to *MAINTENANCE* in *SHOP MANUAL* for more details.

# 2-STROKE MAINTENANCE CHART (FAN AND LIQUID COOLED)

A: ADJUST C: CLEAN I: INSPECT L: LUBRICATE R: REPLACE T: PROCEED WITH TASK	10-HOUR OR 500 KM INITIAL INSPECTION <sup>(1)</sup>							
	WEEKLY OR EVERY 250 km <sup>(2)</sup>							
	MONTHLY OR EVERY 1000 km <sup>(3)</sup>							
	ONCE A YEAR OR EVERY 3000 km <sup>(1)</sup>							
	EVERY 2 YEARS OR 6000 km <sup>(1) (4)</sup>							
	storage <sup>(1)</sup>							
	Preseason <sup>(1)</sup>							
PART/TASK								
<b>ENGINE</b>								
Rewind starter and rope					I,L,C	I		REWIND STARTER
Engine motor mounts	I			I		I		ENGINE REMOVAL AND INSTALLATION
Exhaust system	I			I		I		EXHAUST SYSTEM
Exhaust manifold screws	I						I	
Cooling system cap, hoses and clamps	I			I			I	COOLING SYSTEM
Coolant	I				R			
Crankshaft PTO Seal <sup>(5)</sup>							I	BOTTOM END
RAVE valves <sup>(5)</sup>				C				TOP END
RAVE valves (E-TEC)	Clean every 3 years or 10000 km							
RAVE valves solenoid (not 593 SS)				I				
Air filter			I,C				I,C	AIR INTAKE SYSTEM
Air silencer prefilter			I				I	
Engine lubrication						T		STORAGE PROCEDURE
<b>LUBRICATION SYSTEM</b>								
Injection oil filter (All except E-TEC)					R			OIL INJECTION SYSTEM
Oil injection pump (All except E-TEC)	A			A			A	OIL INJECTION PUMP

2-STROKE MAINTENANCE CHART (FAN AND LIQUID COOLED)

A: ADJUST C: CLEAN I: INSPECT L: LUBRICATE R: REPLACE T: PROCEED WITH TASK	<b>10-HOUR OR 500 KM INITIAL INSPECTION <sup>(1)</sup></b>							
	<b>WEEKLY OR EVERY 250 km <sup>(2)</sup></b>							
	<b>MONTHLY OR EVERY 1000 km <sup>(3)</sup></b>							
	<b>ONCE A YEAR OR EVERY 3000 km <sup>(1)</sup></b>							
	<b>EVERY 2 YEARS OR 6000 km <sup>(1)</sup> (4)</b>							
	<b>storage <sup>(1)</sup></b>							
<b>Preseason <sup>(1)</sup></b>								
<b>PART/TASK</b>								
<b>FUEL SYSTEM</b>								
Add fuel stabilizer						T	<i>STORAGE PROCEDURE</i>	
Fuel filter					R		<i>PRESEASON PREPARATION</i>	
Fuel lines, fuel rail and connections	I			I			<i>FUEL SYSTEM</i>	
Carburetor (All except SDI and E-TEC)						A,C		
Throttle cable	I			I				
Throttle	I			I	L			
Choke (All except SDI and E-TEC)	I			I				
Throttle body (SDI and E-TEC) <sup>(5)</sup>						C	<i>INJECTION SYSTEM</i>	
<b>ELECTRICAL SYSTEM</b>								
EMS fault codes <sup>(5)</sup>	I					I	<i>MONITORING SYSTEM/FAULT CODES</i>	
Spark plugs <sup>(5)</sup> (7)	I		I				<i>IGNITION SYSTEM</i>	
Spark plugs (E-TEC)	Replace every 3 years or 10000 km							
Battery (if so equipped) <sup>(8)</sup>	I		I			I	<i>CHARGING SYSTEM</i>	
Wiring harnesses and cables <sup>(5)</sup>	I		I			I	<i>ELECTRICAL CONNECTORS</i>	
Operation of lighting system (HI/LO beam, taillight and brake light)	I	I				I	<i>LIGHTS, INSTRUMENTS AND ACCESSORIES</i>	
Headlamp beam aiming				I		I		
Engine cut-out switch and tether cut-out switch operation test	I	I				I		



A: ADJUST C: CLEAN I: INSPECT L: LUBRICATE R: REPLACE T: PROCEED WITH TASK	10-HOUR OR 500 KM INITIAL INSPECTION <sup>(1)</sup>							
	WEEKLY OR EVERY 250 km <sup>(2)</sup>							
	MONTHLY OR EVERY 1000 km <sup>(3)</sup>							
	ONCE A YEAR OR EVERY 3000 km <sup>(1)</sup>							
	EVERY 2 YEARS OR 6000 km <sup>(1) (4)</sup>							
	storage <sup>(1)</sup>							
	Preseason <sup>(1)</sup>							
PART/TASK								
<b>DRIVE SYSTEM</b>								
Drive belt condition	I	I					I	<i>DRIVE BELT</i>
Drive belt height adjustment	EVERY BELT REPLACEMENT							
Drive and driven pulley	I		I	C		I	C	<i>DRIVE PULLEY and DRIVEN PULLEY</i>
Tightening torque of drive pulley screw	I			I				<i>DRIVE PULLEY</i>
Driven pulley preload <sup>(12)</sup>	I			I		I		
Drive chain tension (not for models equipped with gearbox)	A	A				A		<i>CHAINCASE OR GEARBOX</i>
Chaincase / Gearbox oil <sup>(9)</sup>	I <sup>(9)</sup>		I <sup>(9)</sup>	<sup>(9)</sup>		R	I	
Drive axle end bearing (axle without brake disc) <sup>(6)</sup>	L		L			L		<i>DRIVE SYSTEM</i>
Drive axle end bearing (axle with brake disc)						I		
Countershaft (Fan cooled models) <sup>(6)</sup>	L		L			L		<i>COUNTERSHAFT AND BRAKE</i>
Track condition	I		I			I		<i>TRACK</i>
Track tension and alignment	A	AS REQUIRED						
<b>BRAKE SYSTEM</b>								
Brake fluid	I	I				R	I	<i>COUNTERSHAFT AND BRAKE</i>
Brake hose, pads and disk	I	I					I	

2-STROKE MAINTENANCE CHART (FAN AND LIQUID COOLED)

A: ADJUST C: CLEAN I: INSPECT L: LUBRICATE R: REPLACE T: PROCEED WITH TASK	<b>10-HOUR OR 500 KM INITIAL INSPECTION <sup>(1)</sup></b>											
	<b>WEEKLY OR EVERY 250 km <sup>(2)</sup></b>											
	<b>MONTHLY OR EVERY 1000 km <sup>(3)</sup></b>											
	<b>ONCE A YEAR OR EVERY 3000 km <sup>(1)</sup></b>											
	<b>EVERY 2 YEARS OR 6000 km <sup>(1)</sup> (4)</b>											
	<b>storage <sup>(1)</sup></b>											
<b>Preseason <sup>(1)</sup></b>												
<b>PART/TASK</b>												
<b>SUSPENSION</b>												
Front suspension <sup>(6)</sup> (10)	I,L		I	L		I,L						<i>FRONT SUSPENSION</i>
Rear suspension <sup>(6)</sup> (10)	I		I,L			I,L						<i>REAR SUSPENSION</i>
Suspension stopper strap(s) <sup>(11)</sup>				I		I						
<b>STEERING SYSTEM</b>												
Steering mechanism <sup>(6)</sup>	A,I,L		A,I	L		A,I,L						<i>STEERING AND HANDLEBAR</i>
Skis and runners	I	I				I						<i>SKIS AND STEERING ALIGNMENT</i>
<b>VEHICLE</b>												
Engine compartment	C		C			C						<i>STORAGE PROCEDURE</i>
Vehicle cleaning and protection	T		T			T						

(1) TO BE PERFORMED BY AN AUTHORIZED LYNX DEALER.

(2) TO BE PERFORMED BY OWNER

(3) TO BE PERFORMED BY OWNER, OR BY AN AUTHORIZED LYNX DEALER IF REQUESTED.

(4) IN ADDITION TO EVERY 3000 KM SERVICE TASK.

(5) EMISSION-RELATED

(6) LUBRICATE WHENEVER THE VEHICLE IS USED IN WET CONDITIONS (WET SNOW, RAIN, PUDDLES).

(7) BEFORE INSTALLING NEW SPARK PLUGS AT PRESEASON PREPARATION, IT IS SUGGESTED TO BURN EXCESS STORAGE OIL BY STARTING THE ENGINE WITH THE OLD SPARK PLUGS. ONLY PERFORM THIS OPERATION IN A WELL-VENTILATED AREA.

(8) UNDER SUMMER STORAGE CHARGE THE BATTERY AT LEAST ONCE A MONTH.

(9) GEARBOX MODELS ONLY: OIL CHANGE, REPLACE AFTER 10 H / 500 KM SERVICE AND AFTER EVERY 3000 KM OR ONCE YEAR. OIL LEVEL MUST BE INSPECTED AFTER EVERY 1000 KM OR MONTHLY.

(10) IF YOUR SNOWMOBILE IS EQUIPPED WITH TAKE A PART SHOCK,

FIRST OIL CHANGE HAS TO BE PERFORMED AFTER 1500 KM OR EVEN BEFORE IN HARD USAGE. AFTER THAT ONCE A SEASON OR AFTER 3000 KM WHICH EVER OCCURS FIRST.

(11) CHANGE THE STOPPER STRAP AFTER EVERY 3000 KM (ONLY PPS REAR SUSPENSION)

(12) GEARBOX MODELS ONLY

# ENGINE SYSTEM

## Air Intake Silencer Prefilter Verification

Ensure that air intake silencer prefilter is properly installed and in good condition, replace if damaged.



## Cooling System

Check coolant level at room temperature. Liquid should be at cold level line (engine cold) of coolant tank.

**NOTE:** When checking level at low temperature it may be slightly lower than the mark.

If additional coolant is necessary or if entire system has to be refilled, refer to an authorized LYNX dealer.

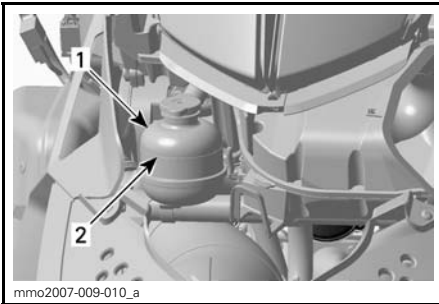

**TYPICAL**

1. Coolant tank
2. COLD LEVEL line

## Exhaust System

The tail pipe of the muffler should be centered with the exit hole in the bottom pan. Exhaust system must be free of rust or leaks. Make sure that gear clamps are properly tightened.

The exhaust system is designed to reduce noise and to improve the total performance of the engine. Modification may be in violation of local laws.

**⚠ CAUTION** If any exhaust system component is removed, modified or damaged, severe engine damage may result.

# DRIVE SYSTEM

## Belt Guard Removal and Installation

### **⚠ WARNING**

NEVER operate engine:

- without shields and belt guard securely installed
- with hood and/or side panels opened or removed.

NEVER attempt to make adjustments to moving parts while engine is running.

**NOTE:** Belt guard is purposely made slightly oversize to maintain tension on its pins and retainers preventing undue noise and vibration. It is important that this tension be maintained when reinstalling.

Remove the tether cord cap .

Open engine compartment LH side panel.

Remove retaining pin.

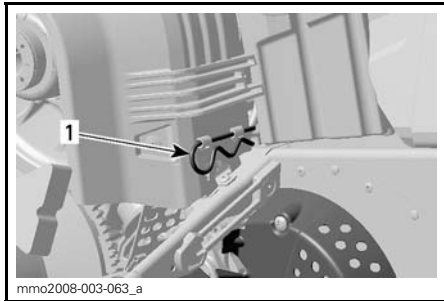

1. Retaining pin

Lift rear portion of guard then release from front tabs.

When reinstalling belt guard, position its cutaway toward front of snowmobile.

Place belt guard slots over tabs first, then snap the other end in rear retainer.

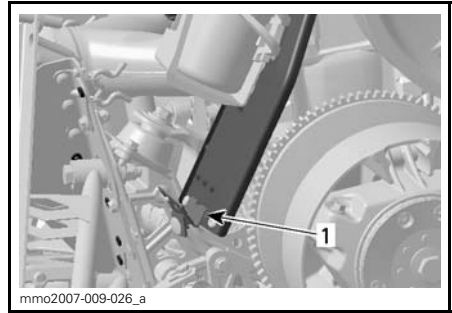

TYPICAL

1. Slots

Secure belt guard using retaining pin.

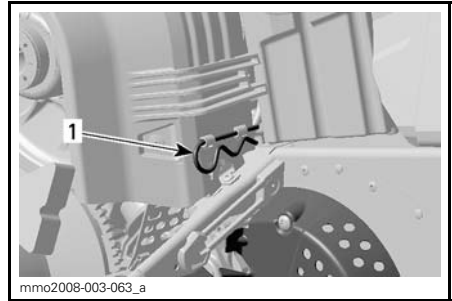

1. Retaining pin

## Brake Fluid Level

**⚠ CAUTION** Vehicle must be on a level surface before checking any fluid levels.

Check brake fluid (DOT 4) in reservoir for proper level. Add fluid (DOT 4) as required.

**⚠ CAUTION** Use only DOT 4 brake fluid from a sealed container. Never use any other types of fluid.

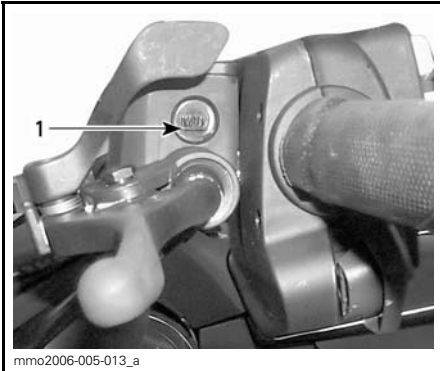

mmo2006-005-013\_a

**TYPICAL — BRAKE FLUID RESERVOIR**

1. Minimum

**Brake Condition****⚠ WARNING**

The brake mechanism on your snowmobile is an essential safety device. Keep this mechanism in proper working condition. Above all, do not operate the snowmobile without an effective brake system. Periodically verify the condition/wear of the brake pads.

**Brake Adjustment**

No adjustment is provided for hydraulic brake. See an authorized LYNX dealer if any problems.

**Chaincase Oil****Recommended Oil**

Use XP-S synthetic chaincase oil (P/N 413 803 300).

**⚠ CAUTION** Use only the recommended type oil when servicing. Do not mix synthetic oil with other types of oil.

**Oil Level Verification**

With the vehicle on a level surface, check the oil level by removing the magnetic check plug on the left side of chaincase. Oil level must be equal with the lower edge.

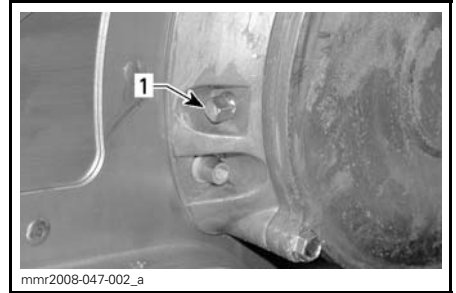

mmr2008-047-002\_a

1. Magnetic check plug

**NOTE:** It is normal to find metallic particles stuck to magnetic check plug. If bigger pieces of metal are found, remove the chaincase cover and inspect the chaincase parts.

Remove metal particles from magnetic check plug.

To add oil, remove the filler cap on chaincase cover.

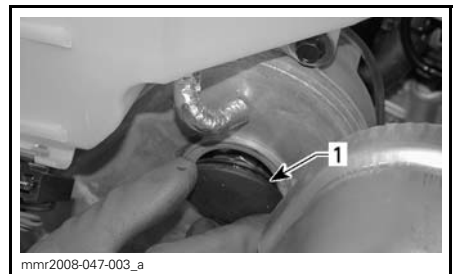

mmr2008-047-003\_a

1. Filler cap

Pour recommended oil in chaincase by the filler hole until oil comes out by the magnetic check plug hole. Reinstall magnetic check plug and torque to 6 N•m (53 lbf•in)

**Drive Chain Tension**

See an authorized LYNX.

## Drive Belt Inspection

Inspect belt for cracks, fraying or abnormal wear (uneven wear, wear on one side, missing cogs, cracked fabric). If abnormal wear is noted, probable cause could be pulley misalignment, excessive RPM with frozen track, fast starts without warm-up period, burred or rusty sheave, oil on belt or distorted spare belt. Contact an authorized LYNX dealer.

## Drive Belt Replacement (Ring Type Adjuster)

### Drive Belt Removal

1. Remove tether key from post.
2. Open LH side panel, refer to *BODY*.
3. Remove belt guard, refer to *BELT GUARD REMOVAL*.
4. Insert the driven pulley expander provided in the tool kit in the threaded hole on the adjuster hub as shown.

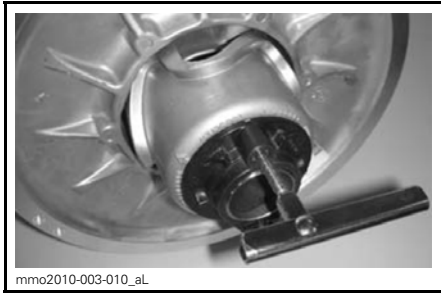

5. Open the driven pulley by screwing the tool in.
6. Remove the belt by slipping it over the top of the driven pulley, then over the drive pulley.

### Drive Belt Installation

1. If necessary, open the driven pulley, refer to *DRIVE BELT REMOVAL* above.
2. Slip the belt over the drive pulley, then over the driven pulley.

**NOTICE** Do not force or use tools to pry the belt into place, as this could cut or break the cords in the belt.

**NOTE:** The maximum drive belt life span is obtained when belt is installed with arrows in the direction of rotation.

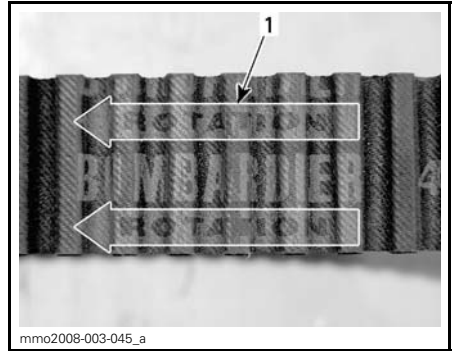

1. To be pointed in the direction of rotation
3. Unscrew and remove the driven pulley expander from the pulley.
4. Rotate the driven pulley several times to properly set the belt between the sheaves.
5. If a new belt was installed, adjust the belt height. Refer to *DRIVE BELT HEIGHT ADJUSTMENT* below.
6. Install belt guard, refer to *DRIVE BELT GUARD INSTALLATION*
7. Close side panel, refer to *BODY*

## Drive Belt Height Adjustment (Ring Type Pulley Adjuster)

The drive belt height must be checked every time a new belt is installed.

To adjust the drive belt height, proceed as follows:

1. Remove tether key from post.
2. Open LH side panel, refer to *BODY*.
3. Remove belt guard, refer to *DRIVE BELT GUARD REMOVAL*

4. Loosen the clamping screw.

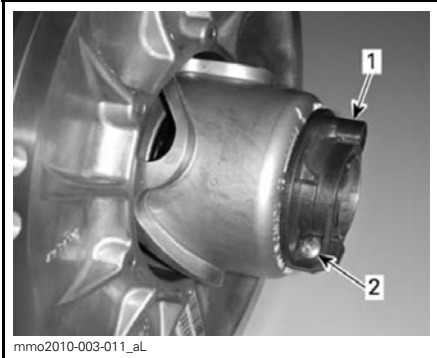

1. Adjuster
2. Clamping screw

5. Using the suspension adjustment tool provided in the tool kit, turn the ring 1/4 turn at a time then rotate the driven pulley to properly set the belt between the pulley sheaves.



1. Adjustment tool

**NOTE:** The adjustment ring has left hand threads

### ***Belt without External Cogs***

Repeat step 5 until the external surface of drive belt exceeds driven pulley edge by 2mm (.079 in).

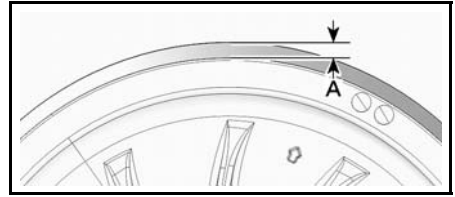

### **PRELIMINARY SETTING**

1. 2mm (.079 in)

### ***Belt with External Cogs***

Repeat step 5 until the bottom of grooves on the external side of drive belt are flush with the driven pulley edges.

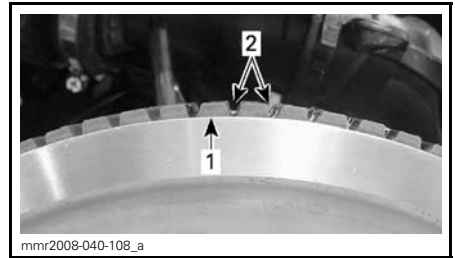

### **PRELIMINARY SETTING**

1. Driven pulley edge
2. External drive belt grooves

### ***All Drive Belt Types***

**NOTE:** Turning the ring counterclockwise lowers the belt in the pulley. Turning the ring clockwise raises the belt in the pulley.

6. Firmly tighten the clamping screw. If possible, tighten to  $5.5\text{N}\cdot\text{m} \pm 0.5\text{N}\cdot\text{m}$  ( $49\text{ lbf}\cdot\text{in} \pm 4\text{ lbf}\cdot\text{in}$ ) using a torque wrench.

7. Install belt guard, refer to **DRIVE BELT GUARD INSTALLATION**.

8. Close side panel, refer to **BODY**.

**NOTE:** This setting is correct as a preliminary adjustment for most models and belt types. In some cases, when starting the engine, the vehicle could creep, indicating that the belt is too tight.

If the vehicle creeps, lower the drive belt height from the preliminary setting. Repeat procedure until creeping stops.

### Reverse Activation

**NOTE:** The reverse may not activate or may be harder to activate if the belt is positioned too high in the driven pulley. If reverse activation does not work properly, ensure the drive belt is properly adjusted. Adjust the drive belt lower in the driven pulley if needed.

### Drive Pulley Adjustment

#### **⚠ WARNING**

Remove the tether cord cap before performing any maintenance or adjustment, unless otherwise specified. Vehicle must be parked in a safe place, away from the trail.

#### General

The drive pulley is factory calibrated to transmit maximum engine power at a predefined RPM. Factors such as ambient temperature, altitude or surface condition may vary this critical engine RPM thus affecting snowmobile efficiency.

This adjustable drive pulley allows setting maximum engine RPM to maintain maximum power.

Calibration screws should be adjusted so that actual maximum engine RPM matches the maximum horsepower RPM.

ENGINE	MAXIMUM HORSEPOWER RPM
600RS	8400 RPM (± 100)

**NOTE:** Use precision digital tachometer for engine RPM adjustment.

**NOTE:** The adjustment has an effect on high RPM only.

Calibration screw has a notch on top of its head.

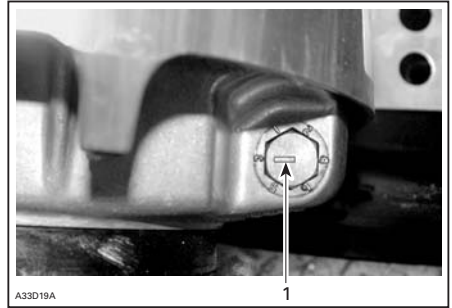

**TYPICAL**  
1. Notch

There are 6 positions numbered 1 to 6. Each position modifies maximum engine RPM by about 200 RPM.

Lower position numbers decrease engine RPM in steps of 200 RPM and higher position numbers increase it in steps of 200 RPM.

Example:

Calibration screw is set at position 4 and is changed to position 6. So maximum engine RPM is increased by 400 RPM.

#### Adjustment

Just loosen locking nut enough to pull calibration screw partially out and adjust to desired position. Do not completely remove the locking nut. Torque locking nuts to 10 N•m (89 lbf•in).

**⚠ CAUTION** Do not completely remove calibration screw otherwise internal washers will fall off. Always adjust all 3 calibration screws and make sure they are all set to the same position.

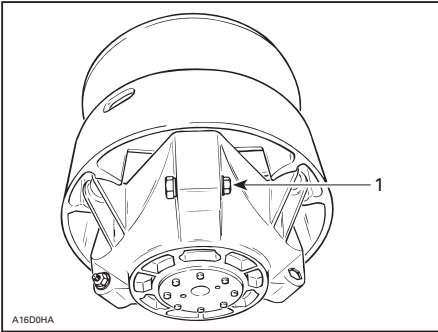

**TYPICAL**

1. Loosen just enough to permit rotating of calibrate screw

**⚠ WARNING**

**NEVER** disassemble or modify the drive pulley.

Improper assembly or modifications could cause the pulley to explode violently under the stress generated by the high rotational speed. This could lead to serious injury including the possibility of death.

See your LYNX dealer to maintain or service the drive pulley. Improper servicing or maintenance may affect performance and reduce belt life. Always respect maintenance schedules.

**⚠ WARNING**

**NEVER** operate engine:

- without shields and belt guard securely installed
- with hood and/or side panels opened or removed.

**NEVER** attempt to make adjustments to moving parts while engine is running.

**Track Condition****⚠ WARNING**

Remove the tether cord cap before performing any maintenance or adjustment, unless otherwise specified. Vehicle must be parked in a safe place, away from the trail.

Remove the tether cord cap .

Lift the rear of the snowmobile and support it with a wide-base snowmobile mechanical stand with a rear deflector panel. With the engine off, rotate the track by hand, and inspect condition. If worn or cut, or if track fibers are exposed, or if missing or defective inserts or guides are noted; contact an authorized LYNX dealer.

Look for any defects, such as:

- perforations in the track
- tears in the track
- lugs that are broken or torn off, exposing portions of rods
- delamination of the rubber
- broken rods
- missing track guide(s).

If your track shows signs of deterioration, it must be replaced immediately. When in doubt, ask your dealer.

**⚠ WARNING**

Riding with a damaged track could lead to a loss of control, resulting in a risk of serious injury or death.

**Track Tension and Alignment**

**NOTE:** Track tension and alignment are interrelated. Do not adjust one without the other.

## ⚠ WARNING

To prevent serious injury to individuals near the snowmobile:

- NEVER stand behind or near a moving track
- always use a wide-base snowmobile stand with a rear deflector panel
- when the track is raised off the ground, only run it at the lowest possible speed.

Centrifugal force could cause debris, damaged or loose studs, pieces of torn track, or an entire severed track to be violently thrown backwards out of the tunnel with tremendous force, possibly resulting in the loss of a leg or other serious injury.

## Tension

**NOTE:** Ride the snowmobile in snow about 15 to 20 minutes prior to adjusting track tension.

Remove the tether cord cap .

Lift rear of snowmobile and support it with a wide-base snowmobile mechanical stand.

Allow the suspension to extend normally and check gap halfway between front and rear idler wheels. Measure between slider shoe bottom and inside of track. The gap should be as given in *SPECIFICATIONS* at the end of this guide. If the track tension is too loose, track will have a tendency to thump.

**NOTE:** A belt tension tester (P/N 414 348 200) may be used to measure deflection as well as force applied.

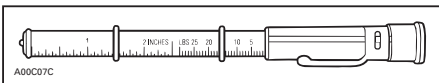

**BELT TENSION TESTER**

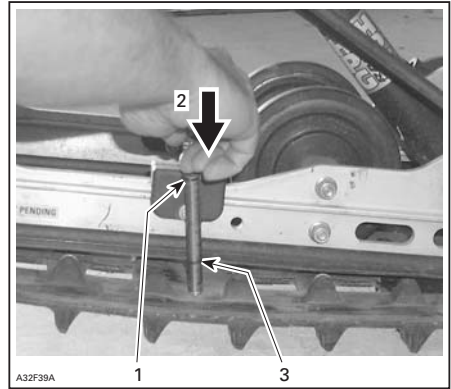

## TYPICAL

1. Top tool O-ring positioned at 7.3 kg (16 lb)
2. Push on top portion of tool until it contacts the top O-ring
3. Measured track deflection

**⚠ CAUTION** Too much tension will result in power loss and excessive stresses on suspension components.

To adjust track tension:

- Remove the tether cord cap .
- Remove rear wheel caps (if so equipped).
- Loosen the rear idler wheel retaining bolts.
- Turn adjustment bolts to adjust.

If correct tension is unattainable, contact an authorized LYNX dealer.

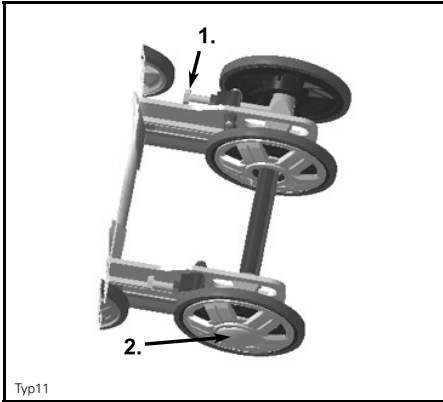

Typ11

**TYPICAL**

1. Adjustment bolts
2. Loosen bolt

- Retighten retaining bolts.
- Check track alignment as described below.

**Alignment****⚠ WARNING**

Before checking track alignment, ensure that the track is free of all particles which could be thrown out while track is rotating. Keep hands, tools, feet and clothing clear of track. Always lift the snowmobile on a wide-base stand with a rear deflector panel. Ensure no one is standing in close proximity to the snowmobile, especially at the rear of the track. Never rotate track at high speed. Centrifugal force could cause debris, pieces of torn track, or an entire severed track to be violently thrown backwards out of the tunnel with tremendous force, possibly resulting in the loss of a leg or other serious injury.

Start the engine and accelerate slightly so that track barely turns. This must be done in a short period of time (15 to 20 seconds).

Check that the track is well centered; equal distance on both sides between edges of track guides and slider shoes.

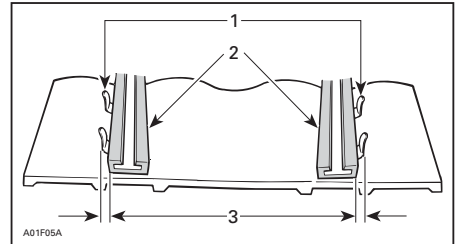

1. Guides
2. Slider shoes
3. Equal distance

**To Adjust Track Alignment:****⚠ WARNING**

Remove the tether cord cap before performing any maintenance or adjustment, unless otherwise specified. Vehicle must be parked in a safe place, away from the trail.

- Remove the tether cord cap.
- Loosen rear idler wheel retaining bolts.
- Tighten the adjustment bolt on side where the slider shoe is the farthest from the track insert guides.

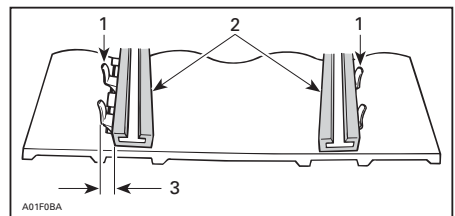

1. Guides
2. Slider shoes
3. Tighten on this side

Tighten retaining bolts.

**⚠ WARNING**

Properly tighten wheel retaining bolts, otherwise wheel may come off and cause track to "lock".

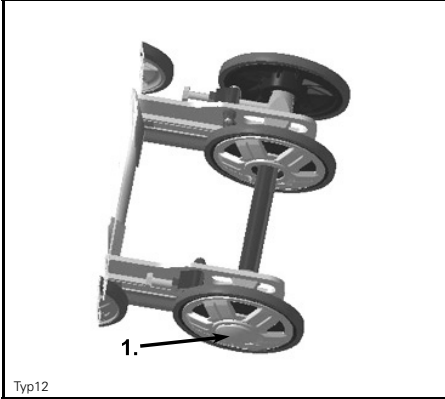

Typ12

**TYPICAL**

1. Retighten to 48 N•m

Restart engine and rotate track slowly to recheck alignment.

Reposition snowmobile on ground.

Install rear wheel caps if so equipped.

---

# REAR SUSPENSION

## Rear Suspension Condition

Visually inspect all suspension components including slider shoes, springs, wheels, etc.

**NOTE:** During normal driving, snow will act as a lubricant and coolant for the slider shoes. Extensive riding on ice or sanded snow, will create excessive heat build-up and cause premature slider shoe wear.

## Suspension Stopper Strap Condition

Inspect stopper strap for wear and cracks, bolt and nut for tightness. If loose inspect holes for deformation. Replace as required. Torque nut to 11 N•m (97 lbf•in)

---

## STEERING AND FRONT SUSPENSION

Visually inspect steering and front suspension for tightness of components (steering arms, control arms and links, tie rods, ball joints, ski bolts, ski legs, etc.). If necessary, contact an authorized LYNX dealer.

### **Wear and Condition of Skis and Runners**

Check the condition of the skis and ski runner carbides. If worn, contact an authorized LYNX dealer.

 **WARNING**

Excessively worn skis and/or ski runners will adversely affect snowmobile control.

# ELECTRICAL SYSTEM

## Spark Plug Removal/Installation

1. Open LH side panel, refer to *BODY*.
2. Remove belt guard, refer to *DRIVE BELT GUARD REMOVAL*.
3. Carefully unplug spark plug cables twisting and pulling the cable boots.
4. Using tools from tool kit, unscrew spark plugs one turn.

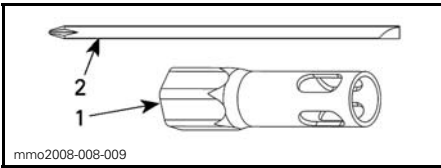

1. 19 mm socket
2. Screwdriver rod

5. Clean spark plugs and cylinder heads with pressurized air if possible.

### **⚠ WARNING**

Always wear safety goggles when using pressurized air.

6. Unscrew spark plugs completely then remove them.

## Installation

Prior to installation, make sure that contact surfaces of cylinder head and spark plugs are free of grime.

1. Using a feeler gauge, verify spark plug gap.
2. Replace spark plug if not within specifications. Refer to *SPECIFICATIONS*.

**NOTICE** Do not attempt to adjust gap on these spark plugs.

3. Screw each spark plug into cylinder head by hand until it bottoms.

4. Perform the final tightening using the appropriate tools from the tool kit or with a torque wrench and a proper socket.
  - If a torque wrench is used, torque to 27.5 N•m (20.3 lbf•ft).
  - If the tools from the tool kit are used, tighten 1/2 turn for a new spark plug and 1/10 turn for a used spark plug.
5. Connect spark plug wires.

## Fuse Removal/Inspection

The electrical system is protected with fuses, the fuse holders are located in the engine compartment.

Check fuse condition and replace it if necessary.

To remove fuse from holder, pull fuse out. Check if filament is melted.

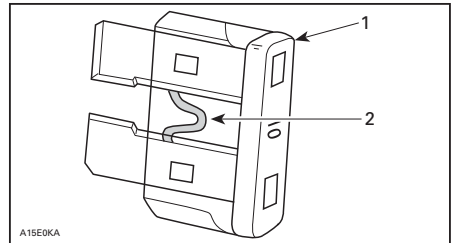

1. Fuse
2. Check if melted

**⚠ CAUTION** Do not use a higher rated fuse as this can cause severe damage to electrical components and/or be a potential fire.

### **⚠ WARNING**

If fuse has burnt out, source of malfunction should be determined and corrected before restarting. See an authorized LYNX dealer for servicing.

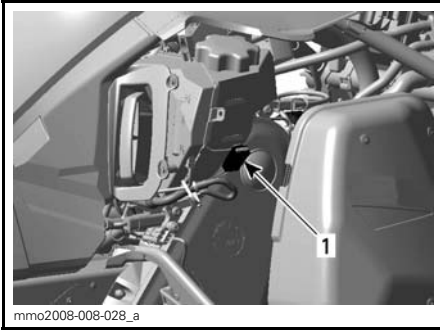

TYPICAL — RH SIDE OF ENGINE COMPARTMENT  
1. 5 A main fuse

## 593 Engines

### Manual Start

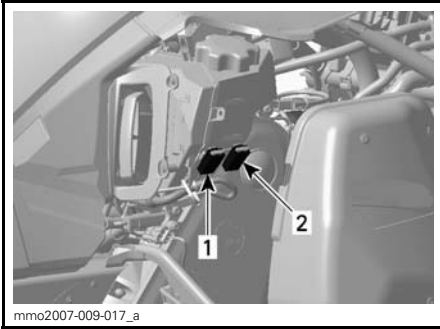

RH SIDE OF ENGINE COMPARTMENT  
1. 15 A headlight fuse (RED/ORANGE wire)  
2. 15 A accessories fuse (RED/YELLOW wire)

## Charging System

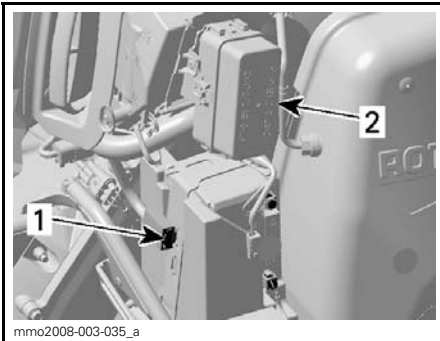

RH SIDE OF ENGINE COMPARTMENT  
1. 30 A fuse  
2. Fuse box



# BODY/FRAME

## Vehicle Cleaning and Protection

Remove any dirt or rust.

To clean the entire vehicle, use only flannel cloths or equivalent.

**⚠ CAUTION** It is necessary to use flannel cloths or equivalent on windshield and hood to avoid damaging further surfaces to clean.

To remove grease, oil and grime, use Heavy duty cleaner (P/N 293 110 001) (spray can 400 g) and (P/N 293 110 002) (4 L).

**⚠ CAUTION** Do not use Heavy duty cleaner on decals or vinyl.

To remove stubborn dirt from all plastic and vinyl surfaces, use Vinyl & Plastic Cleaner ((P/N 413 711 200) (6 x 1 L)).

To remove scratches on windshield or hood use the Scratch Remover Kit (P/N 861 774 800).

**⚠ CAUTION** Never clean plastic parts or hood with strong detergent, degreasing agent, paint thinner, acetone, products containing chlorine, etc.

Clean sheaves of both pulleys using Pulley flange cleaner (P/N 413 711 809).

Inspect the hood and repair any damage.

Touch up all metal spots where paint has been scratched off. Spray all metal parts including shock chromed rods with XP-S Lube (P/N 293 600 016).

Wax painted portion of the vehicle for better protection.

**NOTE:** Apply wax on glossy finish only. Protect the vehicle with a cover to prevent dust accumulation during storage.

**⚠ CAUTION** The snowmobile has to be stored in a cool and dry place and covered with an opaque tarpaulin. This will prevent sun rays and grime from affecting plastic components and vehicle finish.

Lift rear of vehicle until track is clear of the ground. Install on a wide-base snowmobile mechanical stand with a rear deflector panel.

**⚠ WARNING**

Do not attempt to lift the vehicle by hand alone. Use appropriate lifting device or have assistance to share lifting stress in order to avoid risk of strain injuries.

**NOTE:** Do not release track tension.

## Bulb Replacement

Always check light operation after bulb replacement.

### Headlamp

**⚠ CAUTION** Never touch glass portion of an halogen bulb with bare fingers, it shortens its operating life. If glass is touched, clean it with isopropyl alcohol which will not leave a film on the bulb.

By using a small screwdriver, release multifunction gauge locking tabs.

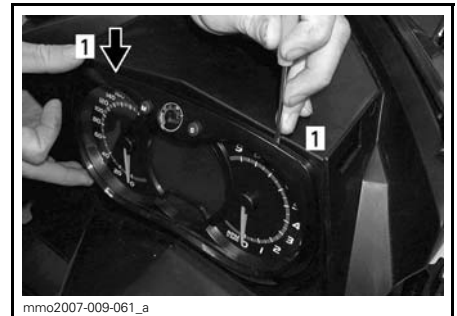

1. Locking tab

Gently pull on multifunction gauge and set aside.



Unplug burnt bulb connector. Remove the rubber boot.

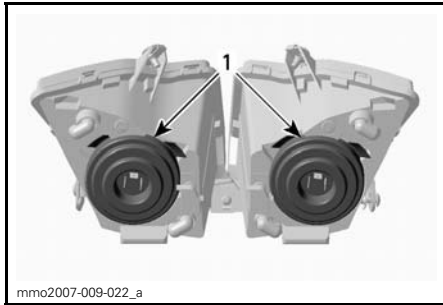

1. Rubber boot

Press and pull both sides of the spindle at the same time to release it from bulb support.

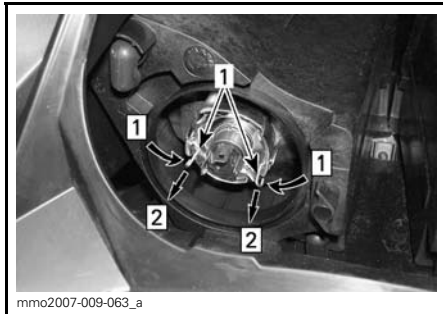

Step 1: Step 1: Push both sides

Step 2: Step 2: Pull to release

1. Spindle

Pull bulb and replace. Properly reinstall parts.



PULL BULB AND REPLACE

### Taillight Bulb Replacement

To expose the bulb, remove the red plastic lens by removing the lens screws.

### Headlamp Beam Aiming

Remove multifunction gauge, refer to *BULB REPLACEMENT*. Turn knob to adjust beam height.

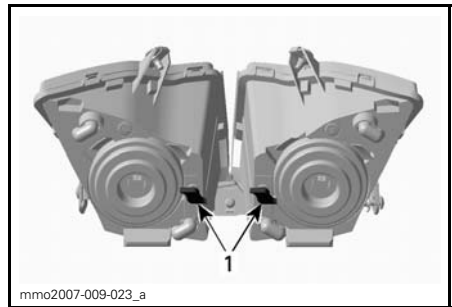

TYPICAL

1. Knob

---

# STORAGE AND PRESEASON PREPARATION

## **WARNING**

Have an authorized LYNX dealer inspect fuel and oil systems integrity as specified in *PERIODIC MAINTENANCE CHART*.

## **Storage**

It is during summer, or when a snowmobile is not in use for more than one month that proper storage is a necessity.

To prepare your snowmobile, refer to an authorized LYNX dealer.

## **Engine Cooling System**

Antifreeze should be replaced every 2 years or 6000 km to prevent antifreeze deterioration.

The antifreeze replacement and a density test should be performed by an authorized LYNX dealer.

 **CAUTION** Improper antifreeze mixture might allow freezing of the liquid in the cooling system if vehicle is stored in area where freezing point is reached. This would seriously damage the engine. Failure to replace the antifreeze for storage may allow its degradation that could result in poor cooling when engine will be used.

 **CAUTION** Do not run engine during storage period.

## **Preseason Preparation**

Refer to an authorized LYNX dealer.

 **CAUTION** Have carburetors cleaned-up before restarting engine.



# ***WARRANTY***

---

## LIMITED WARRANTY VALIDATION

Model 600 RS is designed for snowcross racing purpose and engine does not work reliably in trail riding, because riding environment might be so much different in trail than in snowcross track. We will not apply warranty for vehicles in ANY racing usage, but we can apply warranty for vehicles which are NOT in racing usage, if authorized dealer makes modifications for vehicle for customers expense at the same time when PDI is done. See an authorized LYNX dealer for servicing.

---

# **BRP FINLAND OY INTERNATIONAL LIMITED WARRANTY: 2010 LYNX® SNOWMOBILES**

## **1) SCOPE OF THE LIMITED WARRANTY**

BRP Finland Oy ("BRP") warrants its 2010 LYNX snowmobiles from defects in material or workmanship for the period and under the conditions described below.

All genuine LYNX parts and accessories, installed by an authorized BRP distributor/dealer (as hereinafter defined) at the time of delivery of the 2010 LYNX snowmobile, carry the same warranty as that of the snowmobile.

Use of the product for racing or any other competitive activity, at any point, even by a previous owner, will render this warranty null and void.

## **2) WARRANTY COVERAGE PERIOD**

This warranty will be in effect from the date of delivery to the first retail consumer or the date the product is first put into use, whichever occurs first and for a period of:

A) TWELVE (12) CONSECUTIVE MONTHS, for private use owners

B) TWELVE (12) CONSECUTIVE MONTHS, for commercial use owners

C) TWENTY FOUR (24) CONSECUTIVE MONTHS, for private use owners when product was sold in a member state of the European Union. The repair or replacement of parts or the performance of service under this warranty does not extend the life of this warranty beyond its original expiration date.

## **3) CONDITIONS TO HAVE WARRANTY COVERAGE**

This warranty coverage is available only on 2010 LYNX snowmobile purchased as new and unused by its first owner from a BRP distributor/dealer authorized to distribute LYNX products in the country in which the sale occurred ("BRP distributor/dealer"), and then only after the BRP specified pre-delivery inspection process is completed and documented. Warranty coverage only becomes available upon proper registration of the product by an authorized BRP distributor/dealer. Moreover, this warranty coverage is only available if the LYNX snowmobile is purchased in the country in which the purchaser resides. BRP will not honor this limited warranty to any private use owner or commercial use owner if the preceding conditions have not been met. Such limitations are necessary in order to allow BRP to preserve both the safety of its products, and also that of its consumers and the general public.

Routine maintenance outlined in the Operator's Guide must be timely performed in order to maintain warranty coverage. BRP reserves the right to make warranty coverage contingent upon proof of proper maintenance.

## **4) WHAT TO DO TO OBTAIN WARRANTY COVERAGE**

The customer must notify a servicing BRP distributor/dealer within two (2) months of the appearance of a defect, and provide it with reasonable access to the product and reasonable opportunity to repair it. The customer must also present to the authorized BRP distributor/dealer, proof of purchase of the product and must sign the repair/work order prior to starting the repair in order to validate the warranty repair. All parts replaced under this limited warranty become the property of BRP.

## **5) WHAT BRP WILL DO**

BRP's obligations under this warranty are limited to, at its sole discretion, repairing parts found defective under normal use, maintenance and service, or replacing such parts with new genuine LYNX parts without charge for parts and labor, at any authorized BRP distributor/dealer during the warranty coverage period.

BRP reserves the right to improve or modify products from time to time without assuming any obligation to modify products previously manufactured.

## **6) EXCLUSIONS**

The following are not warranted under any circumstances:

- Normal wear and tear;
- Routine maintenance items, tune ups, adjustments;
- Damage caused by failure to provide proper maintenance and/or storage, as described in the Operator's Guide;
- Damage resulting from removal of parts, improper repairs, service, maintenance, modifications or use of parts not manufactured or approved by BRP or resulting from repairs done by a person that is not an authorized servicing BRP distributor/dealer;
- Damage caused by abuse, abnormal use, neglect, use of the product on surfaces other than snow, or operation of the product in a manner inconsistent with the recommended operation described in the Operator's Guide;
- Damage resulting from accident, submersion, fire, theft, vandalism or any act of God;
- Operation with fuels, oils or lubricants which are not suitable for use with the product (see the Operator's Guide);
- Snow or water ingestion;
- Incidental or consequential damages, or damages of any kind including without limitation towing, storage, telephone, rental, taxi, inconvenience, insurance coverage, loan payments, loss of time, loss of income; and
- Damage resulting from studs installed on tracks if the installation does not conform to BRP's instructions.

## **7) LIMITATIONS OF LIABILITY**

THIS WARRANTY IS EXPRESSLY GIVEN AND ACCEPTED IN LIEU OF ANY AND ALL OTHER WARRANTIES, EXPRESSED OR IMPLIED, INCLUDING WITHOUT LIMITATION ANY WARRANTY OF MERCHANTABILITY OR FITNESS FOR A PARTICULAR PURPOSE. TO THE EXTENT THAT THEY CANNOT BE DISCLAIMED, THE IMPLIED WARRANTIES ARE LIMITED IN DURATION TO THE LIFE OF THE EXPRESS WARRANTY. INCIDENTAL AND CONSEQUENTIAL DAMAGES ARE EXCLUDED FROM COVERAGE UNDER THIS WARRANTY. SOME STATES/ PROVINCES DO NOT ALLOW FOR THE DISCLAIMERS, LIMITATIONS AND EXCLUSIONS IDENTIFIED ABOVE, AS A RESULT, THEY MAY NOT APPLY TO YOU. THIS WARRANTY GIVES YOU SPECIFIC RIGHTS, AND YOU MAY ALSO HAVE OTHER LEGAL RIGHTS WHICH MAY VARY FROM STATE TO STATE, OR PROVINCE TO PROVINCE.



Neither the distributor, any BRP distributor/dealer nor any other person has been authorized to make any affirmation, representation or warranty regarding the product, other than those contained in this limited warranty, and if made, shall not be enforceable against BRP.

BRP reserves the right to modify this warranty at any time, being understood that such modification will not alter the warranty conditions applicable to the products sold while this warranty is in effect.

## **8) TRANSFER**

If the ownership of a product is transferred during the warranty coverage period, this warranty shall also be transferred and be valid for the remaining coverage period provided BRP or an authorised BRP distributor / dealer receives a proof that the former owner agreed to the transfer of ownership, in addition to the co-ordinates of the new owner.

## **9) CONSUMER ASSISTANCE**

1. In the event of a controversy or a dispute in connection with this limited warranty, BRP suggests that you try to resolve the issue at the dealership level. We recommend discussing the issue with the authorized distributor/dealer's service manager or owner.
2. If further assistance is required, the distributor's service department should be contacted in order to resolve the matter.
3. If the matter still remains unresolved then contact BRP by writing to us at the address below.

### **ADDRESS:**

BRP-FINLAND OY  
SERVICE DEPARTMENT  
P.O. BOX 8039  
FIN-96101 ROVANIEMI  
FINLAND

© 2009 Bombardier Recreational Products Inc. All rights reserved.

® Registered trademark of Bombardier Recreational Products Inc.

---

## **PRIVACY OBLIGATIONS/DISCLAIMER**

We wish to inform you that your coordinates will be used for safety and warranty purposes. Sometimes, we also use the coordinates of our clients to inform them about our products and to present them offers. Should you prefer not to receive information on our products, services and offers, please let us know by writing to the address below.

Also note that, from time to time, carefully selected and trustworthy organizations may be permitted to use the coordinates of our clients to promote quality products and services. If you prefer not to have your name and address released, please let us know by writing to the address below:

### **FOR SCANDINAVIAN AND EUROPEAN COUNTRIES:**

**BRP FINLAND OY**  
Service Department  
Isoaavantie 7  
FIN-96320 Rovaniemi  
Finland  
Fax +358 16 3420 316

---

## CHANGE OF ADDRESS/OWNERSHIP

If your address has changed or if you are the new owner of the vehicle, be sure to notify BRP by either:

- mailing one of the cards hereinafter using of the following mail address;
- contacting an authorized LYNX dealer or distributor.

Mail address:

### **FOR SCANDINAVIAN AND EUROPEAN COUNTRIES:**

**BRP FINLAND OY**  
Service Department  
Isoaavantie 7  
FIN-96320 Rovaniemi  
Finland  
Fax: +358 16 3420 316

In case of change of ownership, please join a proof that the former owner agreed to the transfer.

Notifying BRP, even after the expiration of the limited warranty, is very important as it enables BRP to reach the vehicle owner if necessary, like when safety recalls are initiated. It is the owner's responsibility to notify BRP.

**STOLEN UNITS:** If your personal vehicle is stolen, you should notify BRP or an authorized LYNX dealer. We will ask you to provide your name, address, phone number, the vehicle identification number and the date it was stolen.



CHANGE OF ADDRESS

CHANGE OF OWNERSHIP



VEHICLE IDENTIFICATION NUMBER

Model Number

Vehicle Identification Number (V.I.N.)

Model Number

Vehicle Identification Number (V.I.N.)

OLD ADDRESS  
OR PREVIOUS OWNER:

NAME

NO.

STREET

APT

CITY

STATE/PROVINCE

ZIP/POSTAL CODE

COUNTRY

TELEPHONE

NEW ADDRESS  
OR NEW OWNER:

NAME

NO.

STREET

APT

CITY

STATE/PROVINCE

ZIP/POSTAL CODE

COUNTRY

TELEPHONE

V00A2F

CHANGE OF ADDRESS

CHANGE OF OWNERSHIP



VEHICLE IDENTIFICATION NUMBER

Model Number

Vehicle Identification Number (V.I.N.)

Model Number

Vehicle Identification Number (V.I.N.)

OLD ADDRESS  
OR PREVIOUS OWNER:

NAME

NO.

STREET

APT

CITY

STATE/PROVINCE

ZIP/POSTAL CODE

COUNTRY

TELEPHONE

NEW ADDRESS  
OR NEW OWNER:

NAME

NO.

STREET

APT

CITY

STATE/PROVINCE

ZIP/POSTAL CODE

COUNTRY

TELEPHONE

V00A2F





*brp.com*

**LYNX**



© and the BRP logo are trademarks of Bombardier Recreational Products Inc. or its affiliates.