

**LYNX**



LEON VALLEY



2009

Operator's manual 2009

EN

## OPERATOR'S MANUAL LYNX 2009

Adventure™ V-800  
Ranger™ V-800  
Ranger™ 550

### SAFETY WARNING

Disregarding any of the safety precautions and instructions contained in this Operator's Guide, or on-product warnings may result in injury, including the possibility of death.  
This Operator's Guide should remain with the unit at time of resale.



LYNX products are manufactured by BRP.

Bombardier\* Lite

\* Trademark of Bombardier Inc. used under license.

The following are trademarks of Bombardier Recreational Products Inc. or its subsidiaries.

LYNX®  
ROTAX™

RERT™  
Pilot™

RF™  
TRA™

SC™  
DESS™

---

# FOREWORD

Congratulations on your purchase of a new LYNX snowmobile. Whatever model you have chosen, it is backed by the Bombardier Recreational Products. (BRP) warranty and a network of authorized LYNX snowmobile dealers ready to provide the parts, service or accessories you may require.

The Operator's Guide has been prepared to acquaint the owner/operator and passenger with this new snowmobile and its various controls, maintenance and safe riding instructions. This guide is indispensable for the proper use of the product and should be kept with this snowmobile at all times.

Make sure you read and understand the content of this Operator's Guide.

After reading, please keep this Operator's Guide with the snowmobile. If the snowmobile is resold, please give the guide to the new owner for his awareness.

Also note that the guide is available in several languages.

If you have any question regarding any topic whether or not it is covered in this Operator's Guide, please contact your Dealer.

This guide uses the following safety alert symbol in conjunction with signal words to indicate a potential personal injury hazard.

## WARNING

Indicates a potentially hazardous situation which, if not avoided, could result in death or serious injury.

## CAUTION

Indicates a potentially hazardous situation which, if not avoided, may result in minor or moderate injury. When used without the safety alert symbol , potential hazard exists for property damage only.

**NOTE:** Indicates supplementary information needed to fully complete an instruction.

## WARNING

### **2-UP vs 1-UP models:**

Throughout this Operator's Guide, the term "1-UP" refers to vehicles designed to carry the operator only while the term "2-UP" refers to vehicles designed to carry also a passenger.

**Make sure to identify and follow the warnings and instructions that are applicable to your specific model.**

Although the mere reading of such information does not eliminate the hazard, the understanding and application of the information will promote the correct use of the vehicle.

Your dealer is committed to your satisfaction. He has taken training to perform the initial set-up and inspection of your snowmobile as well as completed the final adjustment required to suit your specific weight and riding environment before you took possession. At delivery, your dealer would have explained the snowmobile controls and provided you with a brief explanation of the various suspension adjustments. We trust you have taken full advantage of this!

At delivery, you were also informed of the warranty coverage and have completed the Warranty Registration process.

The information and components/system descriptions contained in this guide are correct at time of publication. BRP, however maintains a policy of continuous improvement of its products without imposing upon itself any obligation to install them on products previously manufactured.

Because of its ongoing commitment to product quality and innovation, BRP reserves the right at any time to discontinue or change specifications, designs, features, models or equipment without incurring obligation.

The illustrations in this document show the typical construction of the different assemblies and, in all cases, may not reproduce the full detail or exact shape of the parts shown, however, they represent parts which have the same or a similar function.

It is understood that this guide may be translated into another language. In the event of any discrepancy, the English version shall prevail.

Specifications are given in the SI metric system. Where precise accuracy is not required, some conversions are rounded off for easier use.

Most components of this snowmobile are built with parts dimensioned in the metric system. Most fasteners are metric and must not be replaced by customary fasteners or vice versa.

We recommend genuine BRP products for replacement parts and accessories. They've been specially designed for your vehicle and manufactured to meet BRP's demanding standards.

For any questions pertaining to the warranty and its application, consult the *WARRANTY* section in this guide, and/or an authorized LYNX dealer.

---

# TABLE OF CONTENTS

## ***SAFETY INFORMATION***

<b>INTRODUCTION</b> .....	<b>8</b>
<b>IMPORTANT BASIC SAFETY MEASURES</b> .....	<b>9</b>
<b>LAWS AND REGULATIONS</b> .....	<b>13</b>
<b>RIDING THE VEHICLE</b> .....	<b>14</b>
Principle of Operation .....	14
How to Ride .....	14
Carrying a Passenger .....	16
Terrain/Riding Variations .....	18
Transporting and Towing .....	22
<b>TRACTION ENHANCING PRODUCTS</b> .....	<b>23</b>
<b>SAFETY LABELING</b> .....	<b>27</b>

## ***ENVIRONMENT INFORMATION***

<b>GENERAL</b> .....	<b>34</b>
<b>JUST WHAT IS LIGHT TREADING?</b> .....	<b>35</b>
<b>WHY IS LIGHT TREADING SMART</b> .....	<b>36</b>

## ***VEHICLE INFORMATION***

<b>HOW TO IDENTIFY YOUR SNOWMOBILE</b> .....	<b>38</b>
<b>CONTROLS/INSTRUMENTS/EQUIPMENT</b> .....	<b>40</b>
1) Speedometer .....	41
2) Tachometer .....	43
3) Pilot Lamps .....	43
4) Throttle Lever .....	43
5) Brake Lever .....	43
6) Parking Brake Lever .....	43
7) Multi-Function Switch .....	44
8) Handlebar .....	45
9) Ignition Switch .....	45
10) Tether Cut-Out Switch .....	46
11) Engine Cut-Out Switch .....	47
12) Rewind Starter Handle .....	47
13) Choke Lever .....	47
14) Fuel Tank Cap/Gauge .....	48
15) Windshield .....	48
16) Hood and Side Panel Latches .....	48
17) Fuses .....	49
18) Front Bumper / Grab Handle .....	51

19) Seat Strap .....	52
20) Storage Compartment .....	52
21) Rear Rack .....	52
22) Tool Kit .....	52
23) Spark Plug Holder .....	52
24) Spare Drive Belt Compartment .....	53
25) Hitch .....	53
26) Shields and Guards .....	53
27) Track .....	53
28) Holding Strap .....	53
29) Rear Grab Handles .....	54
30) Adjustable Mirrors .....	54
31) Backrest .....	54
32) Gear Shift Lever .....	54
<b>RECOMMENDED FUEL AND OIL .....</b>	<b>55</b>
<b>BREAK-IN PERIOD .....</b>	<b>57</b>
<b>OPERATING INSTRUCTIONS .....</b>	<b>58</b>
Pre-Operation Check .....	58
Engine Starting Procedure (2-Stroke) .....	59
Engine Starting Procedure (4-Stroke) .....	60
Vehicle Warm-Up .....	61
Shutting Off the Engine .....	61
Post-Operation Care .....	61
Suspension Adjustments .....	61
<b>SPECIAL OPERATING INSTRUCTIONS .....</b>	<b>67</b>
Riding at High Altitudes or Sea Level .....	67
Riding in Cold Weather .....	67
Emergency Starting .....	67
Towing an Accessory .....	68
Towing Another Snowmobile .....	68
Transporting the Vehicle .....	68
<b>TROUBLESHOOTING .....</b>	<b>70</b>
<b>SPECIFICATIONS .....</b>	<b>73</b>

### ***MAINTENANCE INFORMATION***

<b>PERIODIC MAINTENANCE CHART .....</b>	<b>80</b>
<b>2-STROKE MAINTENANCE CHART (FAN AND LIQUID COOLED) .....</b>	<b>81</b>
<b>4-STROKE MAINTENANCE CHART (V-800 AND 1203) .....</b>	<b>85</b>
<b>ENGINE SYSTEM .....</b>	<b>88</b>
Air Filter Cleaning .....	88
Coolant Level .....	88
Exhaust System .....	89
Injection Oil Level .....	89
Engine Oil Level .....	90
Engine Oil/Oil Filter Change .....	90

<b>DRIVE SYSTEM.....</b>	<b>92</b>
Belt Guard Removal and Installation .....	92
Brake Fluid Level.....	93
Brake Condition .....	94
Brake Adjustment.....	94
Chaincase Oil Level.....	94
Chaincase Oil Change .....	95
Drive Chain Tension .....	95
Drive Belt Condition .....	95
Drive Belt Removal/Installation.....	95
Drive Belt Height Adjustment .....	97
Drive Pulley Adjustment .....	99
Track Condition.....	100
Track Tension and Alignment .....	101
<b>ELECTRICAL SYSTEM .....</b>	<b>104</b>
Battery Electrolyte .....	104
<b>REAR SUSPENSION .....</b>	<b>105</b>
<b>STEERING AND FRONT SUSPENSION.....</b>	<b>106</b>
<b>BODY/FRAME.....</b>	<b>107</b>
Vehicle Cleaning and Protection.....	107
Bulb Replacement .....	107
Headlamp Beam Aiming .....	108
<b>STORAGE AND PRESEASON PREPARATION .....</b>	<b>109</b>

## ***WARRANTY***

<b>BRP FINLAND OY INTERNATIONAL LIMITED WARRANTY: 2009 LYNX® SNOWMOBILES .....</b>	<b>112</b>
<b>PRIVACY OBLIGATIONS/DISCLAIMER .....</b>	<b>115</b>
<b>CHANGE OF ADDRESS/OWNERSHIP .....</b>	<b>116</b>





# ***SAFETY INFORMATION***

---

## INTRODUCTION

Everyone is a beginner the first time he sits behind the controls of a snowmobile regardless of previous experience in driving an automobile, a motorcycle or a motorboat. The safe use of your snowmobile is dependent on many conditions such as visibility, speed, weather, environment, traffic, vehicle condition and the condition of the driver.

Each operator has a responsibility to ensure the safety of his/her passenger, if any, and of other recreationists or bystanders.

You are responsible for proper operation of your vehicle as well as training those whom you allow to ride or drive. There may be noticeable handling and performance differences from one snowmobile to the other.

A snowmobile is relatively simple to operate but like any other vehicle or mechanical equipment, it can be hazardous if you or a passenger are reckless, thoughtless or inattentive. We encourage you to have an Annual Safety Inspection of your snowmobile. Please contact an authorized LYNX dealer for further details. Finally, we urge you to visit an authorized LYNX dealer periodically for regular and safety maintenance, as well as snowmobile accessories you may require.

---

# IMPORTANT BASIC SAFETY MEASURES

## Training

- △ Basic training is required for the safe operation of any snowmobile. Study your Operator's Guide paying particular attention to cautions and warnings. Join your local snowmobile club: its social activities and trail systems are planned for both fun and safety. Obtain basic instructions from your snowmobile dealer, friend, fellow club member or enroll in your state or provincial safety training program.
- △ Always show a new operator how to start and stop the vehicle. Indicate the correct riding positions and, above all else, only allow him to operate the snowmobile in a restricted flat area — at least until he is completely familiar with its operation. If there is a local snowmobile operator's training course existing, have him enroll.

## Performance

- △ The performance of some snowmobiles may significantly exceed that of other snowmobiles you have operated. Therefore, use by novice or inexperienced operators is not recommended.
- △ Snowmobiles are used in many areas and in many snow conditions. Not all models perform the same in similar conditions. Always consult your snowmobile dealer when selecting the snowmobile model for your particular needs and uses.
- △ Injury or death may result to the snowmobile operator, passenger or bystander if the snowmobile is used in risky conditions which are beyond the driver's, passenger's or snowmobile's capabilities or intended use.

## Age

- △ BRP recommends the operator has at least 16 years old of age. NOTE! Follow your local regulation !

## Speed

- △ Speeding can be fatal. In many cases, you cannot react or respond quickly enough to the unexpected. Always ride at a speed which is suitable to the trail, weather conditions and your own ability. Know your local rules. Speed limit may be in effect and meant to be observed.

## Riding

- △ Always keep right hand side of the trail.
- △ Always keep a safe distance from other snowmobiles and bystanders.
- △ Remember, promotional material may show risky maneuvers performed by professional riders under ideal and/or controlled conditions. You should never attempt any such risky maneuvers if they are beyond your level of riding ability.
- △ Never ride after consuming drugs or alcohol or if you feel tired or ill. Operate your snowmobile prudently.
- △ Your snowmobile is not designed to be operated on public streets, roads or highways.
- △ Snowmobiling at night can be a delightful experience but because of reduced visibility, be extra cautious. Avoid unfamiliar terrain and be sure your lights are working. Always carry a flashlight and spare light bulbs.

- ⚠ Nature is wonderful but don't let it distract your attention from driving. If you want to truly appreciate winter's scenery, stop your snowmobile on the side of the trail so that you don't become a hazard to others.
- ⚠ Fences represent a very serious threat for both you and your snowmobile. Give a wide berth to telephone poles or posts.
- ⚠ Hidden wires unseen from a distance can cause serious accidents.
- ⚠ Always wear an approved safety helmet, eye protection and a face shield. This also applies to your passenger.
- ⚠ Be aware of inherent risks associated with riding off trails, such as avalanche and other natural or man made hazards or obstacles.
- ⚠ Avoid road traveling. If you must do so, and it is permitted, reduce speed. The snowmobile is not designed to operate or turn on paving. When crossing a road, make a full stop, then look carefully in both directions before crossing at a 90° angle. Be wary of parked vehicles.
- ⚠ Tailgating another snowmobile should be avoided. If the snowmobile in front of you slows for any reason, its driver and passenger could be harmed through your neglect. Maintain a safe stopping distance between you and the snowmobile in front of you. Depending on the terrain condition, stopping may require a little more space than you think. Play it safe. Be prepared to use evasive driving.
- ⚠ Venturing out alone with your snowmobile could also be hazardous. You could run out of fuel, have an accident, or damage your snowmobile. Remember, your snowmobile is capable of traveling further in half an hour than you may be able to walk in a day. Use the "buddy system". Always ride with a friend or member of your snowmobile club. Even then, tell someone where you are going and the approximate time you plan to return.
- ⚠ Meadows sometimes have low areas where water accumulate and freezes over in winter. This ice is usually glare ice. Attempting to turn or brake on this surface could cause your vehicle to spin out of control. Never brake or attempt speeding or turning on glare ice. If you do happen to travel over such a condition, reduce speed by carefully releasing the throttle.
- ⚠ Never "jump" with your snowmobile. This should be left to professional stunt men. Don't show off. Be responsible.
- ⚠ While on safari, do not "gun" the throttle. Snow and ice can be thrown back into the path of a following snowmobile. In addition, when "gunning" the throttle, the vehicle digs into and leaves an irregular snow surface for others.
- ⚠ Safaris are both fun and enjoyable but don't show off or overtake others in the group. A less experienced operator might try to do the same as you and fail. When riding with others, limit your abilities to the experience of others.

## Operation

- ⚠ Always make a pre-start inspection BEFORE you turn on the ignition.
- ⚠ In an emergency, the snowmobile engine can be stopped by activating the engine cut-out switch, pulling the tether cord cap or turning off the key.
- ⚠ Throttle mechanism should be checked for free movement and return to idle position before starting engine.
- ⚠ Always engage parking brake when vehicle is not in use.
- ⚠ Never run the engine in a non-ventilated area and/or if vehicle is left unattended.
- ⚠ Never operate the engine without belt guard securely installed or, with hood or access/side panels open or removed. Never run the engine without drive belt installed. Running an unloaded engine such as without drive belt or with track raised, can be dangerous.
- ⚠ **Electric start models only:** Never charge or boost a battery while installed on snowmobile.
- ⚠ Ensure the path behind is clear of obstacles or bystanders before proceeding in reverse.
- ⚠ Do not leave your keys in the ignition switch, it is an invitation to thieves and a danger to young children.
- ⚠ Raising the rear of your snowmobile while the engine is running could cause snow, ice or debris to be thrown back at an observer. Never raise the rear of the vehicle while the engine is running. To clear or inspect the track, stop the engine, tilt the vehicle on its side and remove blockage with a piece of wood or branch. Never allow anyone near a rotating snowmobile track.

## Maintenance

- ⚠ Know your snowmobile and treat it with the respect and care due of any power driven machine. Common sense, proper handling and routine maintenance will result in safer and enjoyable use.
- ⚠ Only perform procedures as detailed in this guide. Unless otherwise specified, engine should be turned OFF and cold for all lubrication, adjustment and maintenance procedures.
- ⚠ Never have the engine running while the hood is open. Even at idle, a snowmobile engine is turning around 1,800 revolutions per minute. Always turn off the ignition before opening the hood for any reason.
- ⚠ Never remove any original equipment from your snowmobile. Each vehicle has many built in safety features. Such features include various guards and consoles, plus reflective materials and warning labels.
- ⚠ A poorly maintained snowmobile itself can be a potential hazard. Excessively worn components could render the vehicle completely inoperative. Keep the snowmobile in good working condition at all times. Follow your pre-operation check, weekly, monthly and annually routine maintenance and lubrication procedures as detailed in this guide. Consult a snowmobile dealer or acquire a shop manual and proper tools and equipment if other repairs or service is required.
- ⚠ Do not stud the track unless it has been approved for studs. At speed, a studded track that has not been approved for studs could tear and separate from vehicle posing a risk of severe injury or death.

## **Fuel**

- ⚠ Always stop the engine before refueling. Fuel is flammable and explosive under certain conditions. Always work in a well-ventilated area. Do not smoke or allow open flames or sparks in the vicinity. Open cap slowly. If a differential pressure condition is noticed (whistling sound heard when loosening fuel tank cap) have vehicle inspected and/or repaired before further operation. Do not overfill or top off the fuel tank before placing the vehicle in a warm area. As temperature increases, fuel expands and might overflow. Always wipe off any fuel spillage from the vehicle. Periodically verify fuel system.

## **Basics for Passenger**

- ⚠ Never ride as a passenger unless the snowmobile is equipped with a passenger seat, and sit only on the designated passenger seat.
- ⚠ Always wear a DOT approved helmet and follow the same dressing guidelines as those recommended for the operator and described in this guide.
- ⚠ Make sure that you are able to achieve a stable stance, both feet resting positively on the footboards of footrests with good grip, and that you are able to hold on firmly to the handholds.
- ⚠ Once underway, if you feel uncomfortable or insecure for any reason, don't wait, tell the driver to slow down or stop.

---

## LAWS AND REGULATIONS

⚠ Know your local laws.

Federal, state, provincial and local government agencies have enacted laws and regulations pertaining to the safe use and operation of snowmobiles. It is your responsibility as a snowmobiler to learn and obey these laws and regulations. Respect and observance will result in safer snowmobiling for all.

Be aware of the liability property damages and insurance laws regarding your equipment.

---

# RIDING THE VEHICLE

Before venturing on the trails, operate the snowmobile in a restricted flat area until you are completely familiar with its operation and feel comfortable that you can safely tackle a more demanding task. Have an enjoyable and safe ride.

## Principle of Operation

### Propulsion

Depressing throttle lever increases engine RPM causing the drive pulley to engage. Depending on models engine RPM must be between 2500 and 4200 before drive pulley engagement will occur.

Outer sheave of drive pulley moves toward inner sheave, forcing the drive belt to move upward on the drive pulley and simultaneously forcing the sheaves apart on the driven pulley.

The driven pulley senses the load on the track and limits the belt movement. The result is an optimized speed ratio between engine RPM and the speed of the vehicle at any time.

### WARNING

Never operate engine without belt guard securely installed or, with hood or access/side panels open or removed.

Power is transferred to the track through the chaincase or gearbox and drive axle.

### WARNING

Always use a wide-base snowmobile mechanical stand to properly support vehicle during any track verification. Slowly accelerate engine in order to rotate track at very low speed when it is not on ground.

### Turning

Handlebar controls the steering of the vehicle. As the handlebar is rotated to right or left, the skis are turned right or left to steer the snowmobile.

### Stopping

Before riding your snowmobile, you should understand how to stop it. This is done by releasing the throttle and gradually depressing the brake lever on the left side of the handlebar. In an emergency, you may stop your vehicle by pressing the engine cut-out switch located near the throttle control and applying the brake. Remember, a snowmobile cannot "stop on a dime". Braking characteristics vary with deep snow, packed snow or ice. If the track is locked during hard braking, skidding may result.

## How to Ride

### How to Dress

Proper snowmobile clothing should be worn. It should be comfortable and not too tight. Always check the weather forecast before going on a ride. Dress for the coldest weather expected. Thermal underwear next to the skin also provides a good insulation.

DOT approved helmets are recommended at all times. They provide both warmth and reduce injury. A stocking type cap, balaclava and face mask should always be carried or worn. Goggles or a face shield that attach to the helmet are indispensable.

Hands should be protected by a pair of snowmobile gloves or mitts which have sufficient insulation and allow use of thumbs and fingers for operation of controls.



Rubber bottom boots with either a nylon or a leather top, with removable felt liners are best suited for snowmobiling.

You should keep yourself as dry as possible when snowmobiling. When you come indoors, take your snowmobile suit and boots off and make certain they dry properly.

Do not wear long scarfs and loose apparel that could get caught in moving parts.

### What to Bring

Every snowmobiler should carry at least the following basic parts and tools that can help him and others in an emergency:

- this Operator's Guide
- spare spark plugs and wrench
- friction tape
- spare drive belt
- spare starter rope
- spare light bulbs
- tool kit (including at least pliers, screwdriver, adjustable wrench)
- knife
- flashlight.

Include other items depending on the length and time of your ride.

### Riding Position

Your riding position and balance are the two basic principles of making your snowmobile go where you want it to. When turning on the side of a hill, you and your passenger must be ready to shift body weight to help it turn in the desired direction. Driver and passenger(s) must never attempt this maneuvering by placing feet outside of the vehicle. Experience will teach you how much lean to put into turns at different speeds and how much you will have to lean into a slope to maintain proper balance.

Generally, the riding position for best balance and control is sitting. However, the posting, kneeling or standing positions are also used under certain conditions.

The novice driver should become familiar with the snowmobile through practice on a level area at slow speeds before venturing afield.

**⚠ WARNING**  
Do not attempt any maneuvers if they are beyond your abilities.

### Sitting

Feet on the running boards, body mid-way back on seat is an ideal position when operating the snowmobile over familiar, smooth terrain. Knees and hips should remain flexible to absorb shocks.



## Posting

A semi-sitting position with the body off the seat and the feet under the body in a sort of squatting posture, thus allowing the legs to absorb the shocks when traveling over uneven terrain. Avoid abrupt stops.



## Standing

Place both feet on the running boards. Knees should be flexed to absorb the shock from surface bumps. This is an effective position to see better and to shift weight as conditions dictate. Avoid abrupt stop.



## Kneeling

This position is achieved by placing one foot firmly on the running board and the opposite knee on the seat. Avoid abrupt stops.



## Carrying a Passenger

Certain snowmobiles are designed for an operator only, others can allow one passenger only, and others can allow up to two passengers. Refer to the indications on the vehicles to know if any particular snowmobile can accommodate passengers or not, and if so, how many. Always respect those indications. Overloading is dangerous because snowmobiles are not designed for it.

Even when passengers are allowed, you must make sure that the persons who would like to become passengers are physically fit for snowmobiling.

### **WARNING**

Any passenger must be able to firmly lay his feet on the footrests and keep his hands on the grab handles or seat strap at all times when seated. Respecting those physical criteria is important to ensure that the passenger is stable and to reduce the risks of ejection.

On snowmobiles allowing two passengers, if you have an adult and a child for passenger, BRP recommends that the child sits in the center location. This allows an adult sitting in the rear seat to keep a visual contact with the child and hold him if necessary. In addition, the child is best protected against the wind and cold temperature if seated in the center location.

Each operator has a responsibility to ensure the safety of his passengers and should inform them of snowmobiling basics.

### **WARNING**

- Passengers must only sit on designated passenger seats. Never allow anyone to sit between the handlebar and the operator.
- Each passenger seat must have a strap or grab handles and meet SSCC standards.
- Passengers and operators must always wear DOT approved helmets and warm clothing appropriate for snowmobiling. Make sure that no skin is exposed.
- Once underway, if a passenger feels uncomfortable or insecure for any reason, he must not wait, and tell the driver to slow-down or stop.

Riding with passengers on board is different than riding alone. The operator has the benefit of knowing what will be the next maneuver and is able to prepare himself accordingly. The operator also benefits from the support of his grip on the handlebar. In contrast, the passengers have to rely on the operator's careful and safe operation of the vehicle. In addition, "body english" is limited with passengers, and the operator can sometimes see more of the trail ahead than the passengers. Therefore, smooth starting and stopping are required with passengers, and the operator must slow down. The operator must also warn passengers of side hills, bumps, branches, etc. An unforeseen bump can leave you passenger-less. Remind your passengers to lean into the turn with you, without causing the vehicle to topple. Be extremely careful, go more slowly and check the passengers frequently.

### **WARNING**

When riding with a passenger:

- Braking ability and steering control are reduced. Decrease speed and allow extra space to maneuver.
- Adjust suspension according to weight.

For complete information on how to adjust the suspension, please refer to the section of this Operator's Guide entitled *SUSPENSION ADJUSTMENTS* under *OPERATING INSTRUCTIONS* and to the relevant label on the belt guard.

Use extra caution and go even more slowly with young passengers. Check frequently to make certain the child has a firm grip and is properly positioned with his feet on the running boards.

## **Terrain/Riding Variations**

### **Groomed Trail**

On a maintained trail, sitting is the most preferred riding position. Do not race and, above all, keep to the right hand side of the trail. Be prepared for the unexpected. Observe all trail signs. Do not zigzag from one side of the trail to the other.

### **Ungroomed Trail**

Unless there has been a fresh snowfall you can expect "washboard" and snowdrift conditions. Taken at excessive speeds, such conditions can be physically harmful. Slow down. Hold on the handlebar and assume a posting position. Feet should be under the body assuming a crouched position to absorb any jarring effect. On longer stretches of "washboard" trails, the kneeling position of one knee on the seat can be adopted. This provides a certain amount of comfort, while at the same time keeps the body loose and capable of vehicle control. Beware of hidden rocks or tree stumps partially hidden by a recent snowfall.

### **Deep Snow**

In deep "powder" snow, your vehicle could begin to "bog" down. If this occurs, turn in as wide an arc as possible and look for a firmer base. If you do get "bogged", and it happens to everyone, do not spin your track as this makes the vehicle sink deeper. Instead, turn the engine off, get off and move the back of the vehicle onto new snow. Then tramp a clear path ahead of the vehicle. A few feet will generally suffice. Restart the engine. Assume the standing position and rock the vehicle gently as you steadily and slowly apply the throttle. Depending on whether the front or rear end of the vehicle is sinking, your feet should be placed on the opposing end of the running boards. Never place foreign material beneath the track for support. Do not allow anyone to stand in front of, or to the rear of, the snowmobile with the engine running. Stay away from the track. Personal injury will result if contact is made with the revolving track.

## **Frozen Water**

Traveling frozen lakes and rivers can be fatal. Avoid waterways. If you are in an unfamiliar area, ask the local authorities or residents about the ice condition, inlets, outlets, springs, fast moving currents or other hazards. Never attempt to operate your snowmobile on ice that may be too weak to support you and the vehicle. Operating a snowmobile on ice or icy surfaces can be very dangerous if you do not observe certain precautions. The very nature of ice is foreign to good control of a snowmobile or any vehicle. Traction for starting, turning or stopping is much less than that on snow. Thus, these distances can be multiplied manyfold. Steering is minimal, and uncontrolled spins are an ever present danger. When operating on ice, drive slowly with caution. Allow yourself plenty of room for stopping and turning. This is especially true at night.

## **Hard Packed Snow**

Don't underestimate hard packed snow. It can be difficult to negotiate as both skis and track do not have as much traction. Best advice is to slow down and avoid rapid acceleration, turning or braking.

## **Uphill**

There are two types of hills you can encounter — the open hill on which there are few trees, cliffs or other obstacles, and a hill that can only be climbed directly. On an open hill, the approach is to climb it by side hilling or slalom-ing. Approach at an angle. Adopt a kneeling position. Keep your weight on the uphill side at all times. Maintain a steady, safe speed. Continue as far as you can in this direction, then switch to an opposite hill angle and riding position.

A direct climb could present problems. Choose the standing position, accelerate before you start the climb and then reduce throttle pressure to prevent track slippage.

In either case, vehicle speed should be as fast as the incline demands. Always slow down as you reach the crest. If you cannot proceed further, don't spin your track. Turn the engine off, free the skis by pulling them out and downhill, place the rear of the snowmobile uphill restart the engine and ease it out with slow even throttle pressure. Position yourself to avoid tipping over, then descend.

## **Downhill**

Downhill driving requires that you have full control of your vehicle at all times. On steeper hills, keep your center of gravity low and both hands on the handlebar. Maintain slight throttle pressure and allow the machine to run downhill with the engine operating. If a higher than safe speed is reached, slow down by braking but apply the brake with frequent light pressure. Never jam the brake and lock the track.

## **Side Hill**

When crossing a side hill or traversing up or downhill, certain procedures must be followed. All riders should lean towards the slope as required for stability. The preferred operating positions are the kneeling position, with the knee of the down hill leg on the seat and the foot of the uphill leg on the running board, or the posting position. Be prepared to shift your weight quickly as needed. Side hills and steep slopes are not recommended for a beginner or a novice snowmobiler.

## **Slush**

Slush should be avoided at all times. Always check for slush before starting across any lake or river. If dark spots appear in your tracks, get off the ice immediately. Ice and water can be thrown rearward into the path of a following snowmobile. Getting a vehicle out of a slush area is strenuous and in some cases, impossible.

## **Fog or Whiteouts**

On land or water, fog or visibility-limiting snow can form. If you have to proceed into the fog or heavy snow, do so slowly with your lights on and watch intently for hazards. If you are not sure of your way, do not proceed. Keep a safe distance behind other snowmobilers to improve visibility and reaction time.

## **Unfamiliar Territory**

Whenever you enter an area that is new to you, drive with extreme caution. Go slow enough to recognize potential hazards such as fences or fence posts, brooks crossing your path, rocks, sudden dips, guy wires and countless other obstacles which could result in a termination of your snowmobile ride. Even when following existing tracks, be cautious. Travel at a speed so you can see what is around the next bend or over the top of the hill.

## **Bright Sunshine**

Bright sunny days can considerably reduce your vision. The glare from sun and snow may blind you to the extent that you cannot easily distinguish ravines, ditches or other obstacles. Goggles with colored lenses should always be worn under these conditions.

## **Unseen Obstruction**

There may be obstructions hidden beneath the snow. Driving off established trails and in the woods requires reduced speed and increased vigilance. Driving too fast in an area can make even minor obstacles very hazardous. Even hitting a small rock or stump could throw your snowmobile out of control and cause injury to its riders. Stay on established trails to reduce your exposure to hazards. Be safe, slow down and enjoy the scenery.

## **Hidden Wires**

Always be on the lookout for hidden wires, especially in areas that may have been farmed at one time or another. Too many accidents have been caused by running into wires in the fields, guy wires next to poles and roads, and into chains and wires used as road closures. Slow speeds are a must.

## **Obstacles and Jumping**

Unplanned jumps of snowdrifts, snowplow ridges, culverts or indistinguishable objects can be dangerous. You can avoid them by wearing the proper color lenses or face shields and by operating at a lower speed.

Jumping a snowmobile is an unsafe and dangerous practice. However, if the trail does suddenly drop away from you, crouch (stand) towards the rear of the vehicle and keep the skis up and straight ahead. Apply partial throttle and brace yourself for the impact. Knees must be flexed to act as shock absorbers.

## Turning

Depending on terrain conditions, there are two preferred ways to turn or corner a snowmobile. For most snow surfaces, “body english” is the key to turning. Leaning towards the inside of the turn and positioning body weight on the inside foot will create a “banking” condition beneath the track. By adopting this position and positioning yourself as far forward as possible, weight will be transferred to the inside ski.

On occasion, you will find that the only way to turn the vehicle about in deep snow is to pull the snowmobile around. Do not over-exert yourself. Get assistance. Remember to always lift using your legs as opposed to your back.



## Road Crossing

In some cases, you will be approaching the road from a ditch or snowbank. Choose a place where you know you can climb without difficulty. Use the standing position and proceed with only as much speed needed to crest the bank. Stop completely at the top of the bank and wait for all traffic to clear. Judge the drop to the roadway. Cross the road at a 90° angle. If you encounter another snowbank on the opposite side, position your feet near the rear of the vehicle. Remember, your snowmobile is not designed to operate on bare pavement and steering on this type of surface is more difficult.

## Railroad Crossing

Never ride on railroad tracks. It is illegal. Railroad tracks and railroad rights-of-way are private property. A snowmobile is no match for a train. When crossing a railroad track, stop, look and listen.

## Night Rides

The amount of natural and artificial light at a given time can effect your ability to see or to be seen. Nighttime snowmobiling is delightful. It can be a unique experience if you acknowledge your reduced visibility. Before you start, make certain your lights are clean and work properly. Drive at speeds that will allow you to stop in time when you see an unknown or dangerous object ahead. Stay on established trails and never operate in unfamiliar territory. Avoid rivers and lakes. Guy wires, barbed wire fences, cabled road entrances and other objects such as tree limbs are difficult to see at night. Never drive alone. Always carry a flashlight. Keep away from residential areas and respect the right of others to sleep.

## Safari Riding

Before starting out, designate a “trail boss” to lead the party and another person to follow-up at the end of the party. Ensure that all members of the party are aware of the proposed route and destination. Make certain that you are carrying all necessary tools and equipment and that you have sufficient fuel to complete the trip. Never overtake the trail boss or, for that matter, any other snowmobile. Use down-the-line hand signals to indicate hazards or intent of direction change. Assist others whenever necessary.

It is always IMPORTANT to keep a safe distance between each snowmobile. Always maintain a safe interval and allow sufficient stopping distance. Don't be a tailgater. Know the position of the machine ahead.

### **Signals**

If you intend to stop, raise either hand straight above your head. A left turn is indicated by extending your left hand straight out in the proper direction. For right turns, extend the left arm and raise the hand to a vertical position so it forms a right angle at the elbow. Every snowmobiler should relay any signal to the ones behind.

### **Trail Stops**

Whenever possible, pull off the trail when you stop. This will reduce the hazard to other snowmobilers using the trail.

### **Trails and Signs**

Trail signs are used to control, direct or regulate the use of snowmobiles on trails. Become familiar with all signs used in the area where you are snowmobiling.

### **Transporting and Towing**

Follow transporting and towing instructions explained further in this guide.



# TRACTION ENHANCING PRODUCTS

**NOTE:** This section is applicable to snowmobiles equipped with a factory installed pre-studded Ice Series track or a track that has been approved by BRP for studs installation.

Using more positive carbide ski runners and traction enhancing products (Ice Series tracks or approved studded tracks) on your snowmobile will change its behavior, particularly in terms of manoeuvrability, acceleration, and braking.

Using traction enhancing products gives a better grip on packed snow and ice, but has no noticeable effect on soft snow. For this reason, driving a snowmobile equipped with traction enhancing products (Ice Series tracks, approved studded tracks, carbide ski runners) requires a certain adaptation period. If your snowmobile is equipped with traction enhancing products, be sure to take plenty of time to get used to the way it handles when turning, accelerating, and braking.

Also, always check local regulations concerning the use of traction enhancing products on snowmobiles. Always drive your snowmobile in a responsible manner, respecting the environment and other people's property.

## Manoeuvrability

Using traction enhancing products makes the snowmobile grip the ground better at the rear. The use of carbide runners is therefore required to give the skis a better grip, so that the front and rear of the snowmobile are in balance. While off-the-shelf carbide ski runners are adequate, they don't necessarily give you optimal control, since that depends on your personal preferences, your riding style, and how your suspension is set.

## WARNING

If the front and rear of the snowmobile are out of balance due to an incorrect combination of traction enhancing products and runners, the snowmobile may tend to oversteer or understeer, which could lead to a loss of control.

### Oversteering

In certain conditions, using more positive carbide ski runners without traction enhancing products could make the snowmobile prone to oversteering, see illustration.

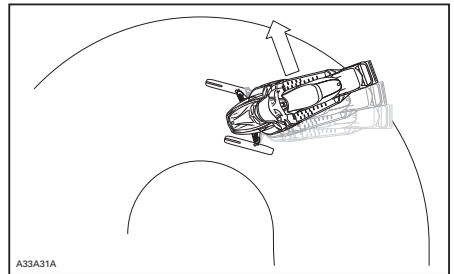

OVERSTEERING

### Understeering

In certain conditions, the use of traction enhancing products could make the snowmobile prone to understeering if the skis are not equipped with more positive carbide runners, see illustration.

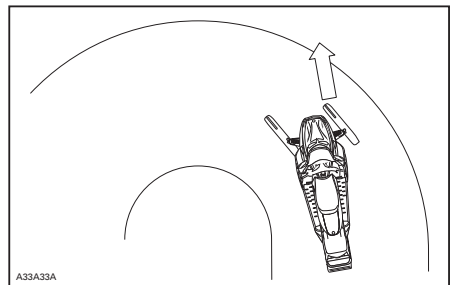

UNDERSTEERING

## Controlled Driving

A balanced combination of carbide ski runners and traction enhancing products ensures adequate control and better handling, see illustration.

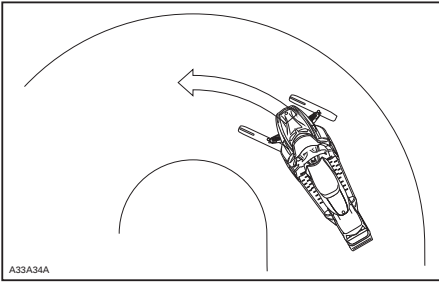

*CONTROLLED DRIVING*

## Acceleration

Using traction enhancing products will allow your sled to accelerate better on packed snow and ice but will have no noticeable effect on soft snow. This can cause sudden variations in traction under certain conditions.

### **WARNING**

To prevent surprises that could lead to a loss of control of the snowmobile, possibly resulting in serious injury or death:

- Always go easy on the throttle.
- NEVER try to spin the track to make the rear of the snowmobile skid.

This could cause debris or ice to be thrown violently backwards, possibly injuring others nearby or on snowmobiles behind you.

## Braking

As in the case of acceleration, using traction enhancing products will give you better braking capacity on packed snow or ice but will have no noticeable effect on soft snow. Braking may thus vary suddenly under certain conditions. Be sure to use restraint in braking to keep from blocking the track in order to avoid surprises that could lead to a loss of control.

## Important Safety Rules

### **WARNING**

To prevent serious injury to individuals near the snowmobile:

- NEVER stand behind or near a moving track.
- Always use a wide-base snowmobile stand with a rear deflector panel.
- When the track is raised off the ground, only run it at the lowest possible speed.

Centrifugal force could cause debris, damaged or loose studs, pieces of torn track, or an entire severed track to be violently thrown backwards out of the tunnel with tremendous force, possibly resulting in the loss of a leg or other serious injury.

## Effects of Traction Enhancing Products on the Life of the Snowmobile

The use of traction enhancing products can increase the load and the stress on certain snowmobile components, as well as the vibration level. This can cause premature wear on parts such as belts, brake linings, bearings, chain, chaincase sprocket, and on approved studded tracks, shorten track life. Always proceed with a visual inspection of your track before each use. For more information, refer to *MAINTENANCE/REPLACEMENT* section further in this guide.

Traction enhancing products can also cause serious damage to your snowmobile if it is not equipped with the tunnel protectors designed for your particular model. Damage to the electrical wiring or perforation of the heat exchangers are potential hazards, that could cause the engine to overheat and be severely damaged.

### **WARNING**

If tunnel protectors are excessively worn or not installed, the gas tank could be punctured, causing a fire.

**CAUTION:** Ask your dealer for the appropriate tunnel protectors model and kit number required for your snowmobile.

**NOTE:** Consult the BRP limited warranty to find out what warranty limitations are related to the use of studs.

## Installation of Studs on BRP Approved Tracks

### **WARNING**

Never stud a track that has not been approved for studs. Approved tracks can be identified by a stud symbol (see illustration) molded into the track surface. Installing studs on an unapproved track could increase the risk of the track tearing or severing, possibly resulting in serious injury or death.

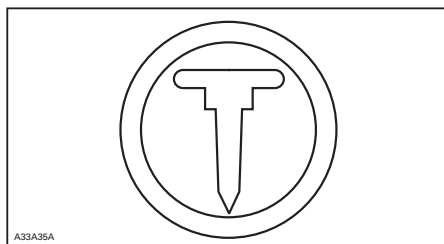

**APPROVED TRACKS CAN BE IDENTIFIED BY THIS SYMBOL**

To ensure safe and proper installation, BRP recommends to have the studs installed by your dealer.

- Use only studs, mounting plates, and nuts sold by BRP.
- Never use studs that exceed the height of your snowmobile's track profile by more than 9.5 mm (3/8 in).

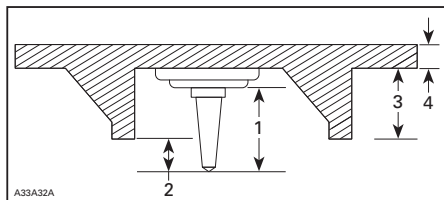

### **INSTALLATION OF STUDS**

1. Stud size
2. Penetration range 6.4 to 9.5 mm (1/4 to 3/8 in)
3. Track lug height
4. Track belt thickness

 **WARNING**

- Studs should only be installed in the locations indicated by molded bulges in the track surface.
- Never stud a track with a profile of 35 mm (1.375 in) or more.
- The number of studs installed must always perfectly match the pattern of molded bulges in the track.
- Always consult the traction product manufacturer's installation instructions and recommendations before having your dealer install studs and runners. It is very important to follow the torque specifications for the stud bolts.

**INSTALLING AN INCORRECT NUMBER OF STUDS OR AN IMPROPER INSTALLATION CAN INCREASE THE RISK OF THE TRACK TEARING OR SEVERING, POSSIBLY RESULTING IN SERIOUS INJURY OR DEATH.**

**Maintenance/Replacement**

PROCEED WITH A VISUAL INSPECTION OF YOUR TRACK BEFORE EACH USE.

Look for any defects, such as:

- perforations in the track
- tears in the track (particularly around traction holes on studded tracks)
- lugs that are broken or torn off, exposing portions of rods
- delamination of the rubber
- broken rods
- broken studs (studded tracks)
- bent studs (studded tracks)
- missing studs
- studs that are torn off the track
- missing track guide(s).

On Ice Series pre-studded tracks, broken or missing studs can not be replaced.

On approved studded tracks, replace broken or damaged studs immediately. If your track shows signs of deterioration, it must be replaced immediately. When in doubt, ask your dealer. Always proceed with a visual inspection of your track before each use.

 **WARNING**

**Riding with a damaged track or studs could lead to loss of control, resulting in a risk of serious injury or death.**

# SAFETY LABELING

Safety standards for snowmobiles have been adopted by the Snowmobile Safety and Certification Committee (SSCC) of which BRP is a proud participating member. Assurance that your snowmobile meets these standards is easily checked by locating the Certification Label on a right vertical portion of the vehicle.

This label shows that an independent testing laboratory has verified compliance with the SSCC safety standards.



Other important labels on the vehicle are WARNING or CAUTION labels relating to safety, maintenance and/or snowmobile operation. Ensure all such labeling is retained on the vehicle and its content is followed by vehicle operator and passenger.

If missing or damaged, the decals can be replaced. See an authorized LYNX dealer.

Please read the following instructions carefully before operating this snowmobile.



LH SIDE PANEL



RH SIDE PANEL

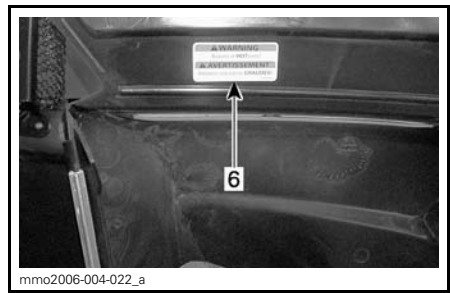

INSIDE RH SIDE PANEL

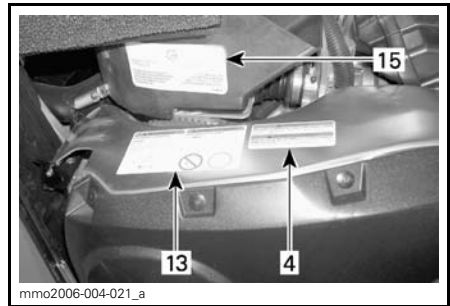

PULLEY GUARD — FAN-COOLED

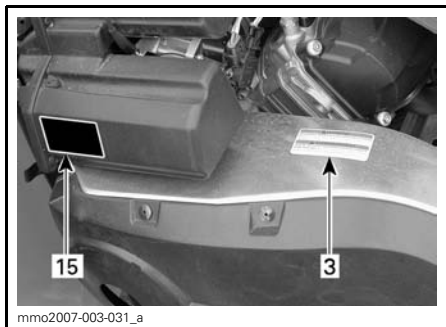

mmo2007-003-031\_a

**PULLEY GUARD — LIQUID-COOLED**

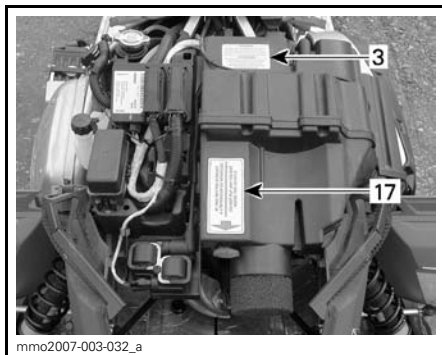

mmo2007-003-032\_a

**AIR INTAKE SILENCER (ENGINE SIDE) — LIQUID-COOLED**



mmo2006-004-025\_a

**AIR INTAKE SILENCER (BODY SIDE) — FAN-COOLED**

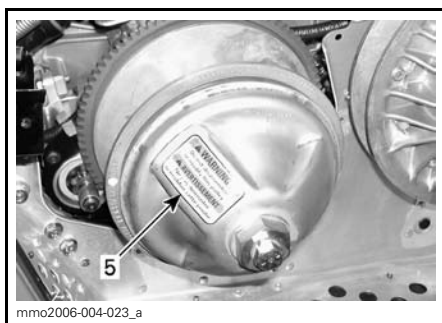

mmo2006-004-023\_a

**DRIVE PULLEY — FAN-COOLED**

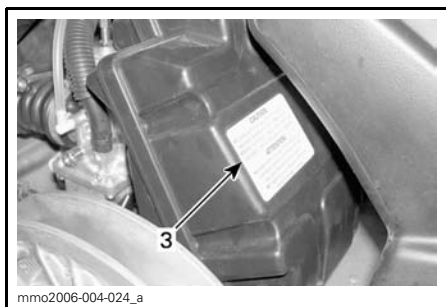

mmo2006-004-024\_a

**AIR INTAKE SILENCER (ENGINE SIDE) — FAN-COOLED**



mmo2007-003-033\_a

**REAR CARGO AREA — (2-UP)**

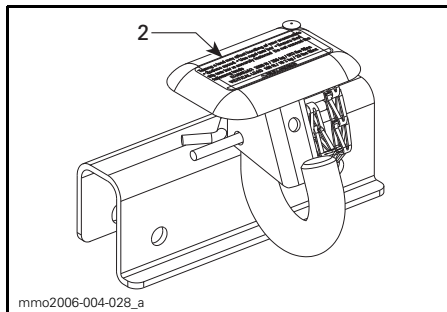

EUROPEAN MODELS

### Instruction 1

#### ⚠ WARNING

**BEFORE STARTING :**

1. Attach tether cord to your clothing.
2. Check proper operation of the throttle and brake levers each time before starting. They must return to their initial position when released.
3. Apply parking brake.
4. Turn handlebars **all** the way in both directions to check for interference and insure free operation.

**AFTER STARTING :**

1. Pull-out tether cord to check if engine shuts off.
2. Re-start and push in engine cut-off switch to check if engine shuts off.
3. Disengage parking brake before riding to avoid fading.

A33A2CA

#### ⚠ AVERTISSEMENT

**AVANT DE DÉMARRER :**

1. Attachez le cordon coupe-circuit à votre vêtement.
2. Vérifiez le bon fonctionnement des manettes d'accélérateur et de frein avant chaque démarrage. Elles doivent revenir à leur position initiale lorsque relâchées.
3. Engagez le frein de stationnement.
4. Tourner le guidon au maximum de chaque côté pour vérifier les interférences et le libre fonctionnement.

**APRÈS LE DÉMARRAGE :**

1. Déconnectez le cordon coupe-circuit pour vérifier qu'il arrête le moteur.
2. Redémarrez et enfoncez le bouton d'arrêt d'urgence pour vérifier qu'il arrête le moteur.
3. Désengagez le frein de stationnement avant le départ pour éviter la surchauffe et la perte du frein.

516 002 670

### Instruction 2

Towing a load may affect handling of your snowmobile.  
 • Reduce speed. • Use rigid tow bar. • Ensure that the tow bar is securely fastened. Do not exceed the following loads:

DRAWBAR xxx Kg / xxx lbs Max.  
 VERTICAL LOAD xx Kg / xx lbs Max.

#### ⚠ WARNING

mimo2007-003-034\_aen

ENGLISH LABEL

Le remorquage d'une charge peut affecter le comportement de votre motoneige. • Réduisez votre vitesse. • Utilisez une barre d'accouplement rigide. • Vérifiez que la barre d'accouplement soit bien verrouillée. Ne pas excéder les charges maximales:

EFFORT DE TRACTION xxxKg / xxxlbs Max.  
 CHARGE VERTICALE xx Kg /xxlbs Max.

#### ⚠ AVERTISSEMENT

mimo2007-003-034\_afr

FRENCH LABEL

### Instruction 3

#### CAUTION

- To comply with noise regulations, this engine is designed to operate with an air intake silencer.
- Operation without air intake silencer or with one not properly installed may cause engine damage.

#### ATTENTION

- Le moteur a été conçu pour fonctionner avec ce silencieux d'admission afin de se conformer aux lois et règlements relatifs au bruit.
- Son absence ou une mauvaise installation peut endommager le moteur.

A01A2EA

516 001 191

### Instruction 4

#### ⚠ WARNING

This guard must ALWAYS be in place when engine is running. Beware of rotating parts – they could cause injuries or catch your clothing.

#### ⚠ AVERTISSEMENT

Ce garde-courroie doit TOUJOURS être en place lorsque le moteur fonctionne. Attention aux pièces en rotation – elles peuvent vous blesser ou capter vos vêtements.

516 002 670

A33A2FA

### Instruction 5

#### ⚠ WARNING

Do not disassemble or modify this pulley.

#### ⚠ AVERTISSEMENT

Ne pas démonter ni modifier cette poulie.

516 001 726

mimo2006-003-006\_a

### Instruction 6

#### ⚠ WARNING

Beware of HOT parts!

#### ⚠ AVERTISSEMENT

Attention aux pièces CHAUDES!

516002664

A33A2GA

## Instruction 8

<p><b>⚠ WARNING</b></p> <p><b>ALL DRIVERS AND PASSENGERS MUST READ THE FOLLOWING:</b></p> <p>Avoid surprises! <b>BE ON THE LOOK-OUT</b> for the unexpected.</p> <p>Operate defensively.</p> <ul style="list-style-type: none"> <li>• Scan constantly for people, objects, conditions and upcoming vehicles.</li> <li>• Avoid thin ice / open water.</li> <li>• Use extra caution whenever off-trail.</li> </ul>	<p><b>⚠ AVERTISSEMENT</b></p> <p><b>TOUS LES CONDUCTEURS ET PASSENGERS DOIVENT LIRE CE QUI SUIT:</b></p> <p>Évitez les surprises! <b>SOYEZ AUX AGUETS</b> pour les imprévus.</p> <p>Conduisez défensivement.</p> <ul style="list-style-type: none"> <li>• Scrutez constamment pour repérer personnes, objets, conditions et autres véhicules.</li> <li>• Évitez la glace mince / étendue d'eau non gelée.</li> <li>• Redoublez de vigilance hors sentier.</li> </ul>
<p><b>ALWAYS wear a DOT approved HELMET and clothing appropriate for snowmobiling.</b></p>	<p><b>TOUJOURS porter un CASQUE approuvé DOT et des vêtements appropriés à la motoneige.</b></p>
<p><b>NEVER ride after consuming alcohol or drugs even as a passenger.</b></p>	<p><b>Ne JAMAIS utiliser ce véhicule sous l'influence de drogues ou alcool même en tant que passager.</b></p>

51602908

mmo2006-004-002

## Instruction 9

<p><b>⚠ WARNING</b></p> <p>This vehicle is designed for one (1) operator and as many passengers as there are seats with straps or handgrips installed on the vehicle conforming to SSCC standards.</p> <p>When riding with a passenger:</p> <ul style="list-style-type: none"> <li>• Braking ability and steering control are reduced. <b>Decrease speed</b> and allow extra space to maneuver.</li> <li>• <b>Adjust suspensions</b> according to weight.</li> </ul> <p>REMEMBER : YOU ARE RESPONSIBLE FOR THE SAFETY OF YOUR PASSENGER!</p>	<p><b>⚠ AVERTISSEMENT</b></p> <p>Ce véhicule a été conçu pour un (1) conducteur et autant de passagers qu'il y a de sièges avec courroies ou poignées installés sur le véhicule et rencontrant la norme SSCC.</p> <p>Lors de la conduite avec passager :</p> <ul style="list-style-type: none"> <li>• La capacité de freinage et la direction sont réduites. <b>Réduisez votre vitesse</b> et prévoyez plus d'espace pour manœuvrer.</li> <li>• <b>Ajustez les suspensions</b> selon le poids.</li> </ul> <p>N'OUBLIEZ PAS : VOUS ÊTES RESPONSABLE DE LA SÉCURITÉ DE VOTRE PASSAGER!</p>
--	--

516 002 972

A33A2KA

## Instruction 10

<p><b>⚠ WARNING</b></p> <ul style="list-style-type: none"> <li>• Read and understand all warning labels and operator's guide before operation. If guide is missing, ask your dealer for a new one.</li> <li>• <b>Get familiar with your vehicle.</b> Inexperienced riders may overlook risks and be surprised by vehicle's specific behavior and terrain conditions. Ride slowly.</li> <li>• <b>Excessive speed and reckless driving can kill ! ALWAYS</b> adjust your speed according to snow conditions and circumstances.</li> <li>• <b>Steering control and braking ability may be reduced</b> on hard-pack snow, ice or roads. Reduce speed &amp; allow more space to stop or turn.</li> <li>• <b>Respect laws on minimum operator age.</b> Manufacturer recommends a minimum operating age of <b>16 years old</b>.</li> </ul>	<p><b>⚠ AVERTISSEMENT</b></p> <ul style="list-style-type: none"> <li>• Lire et comprendre toutes les étiquettes d'avertissements et le guide du conducteur avant utilisation. Si le guide est introuvable, demandez-en un nouveau à votre concessionnaire.</li> <li>• <b>Familiarisez-vous avec votre véhicule.</b> Les personnes inexpérimentées peuvent sous-estimer les risques et être surpris par le comportement spécifique du véhicule et des conditions du terrain. Conduisez lentement.</li> <li>• <b>La vitesse excessive et la conduite irresponsable peuvent causer la mort! TOUJOURS</b> adapter votre vitesse selon les conditions de neige et les circonstances environnantes.</li> <li>• <b>Le contrôle de la direction et le freinage peuvent être réduits</b> sur la neige compactée, la glace ou les routes. Réduisez votre vitesse et allouez plus d'espace pour tourner ou freiner.</li> <li>• <b>Respectez les lois sur l'âge minimal du conducteur.</b> Le fabricant recommande que le conducteur soit âgé d'au moins <b>16 ans</b>.</li> </ul>
---	--

516 002 971

mmo2006-004-003

## Instruction 11

<p><b>⚠ WARNING</b></p> <ul style="list-style-type: none"> <li>• NEVER STAND BEHIND or near a rotating track.</li> <li>• Only spin track at lowest possible speed whenever off the ground. Broken track or debris could be projected with great force which could sever legs or cause other serious injuries.</li> </ul>	<p><b>⚠ AVERTISSEMENT</b></p> <ul style="list-style-type: none"> <li>• NE JAMAIS SE TENIR DERRIÈRE ou près d'une chenille qui tourne.</li> <li>• Seulement faire tourner la chenille à la vitesse la plus basse possible lorsque soulevée de terre. Une chenille brisée ou des débris pourraient être projetés avec grande puissance pouvant sectionner une jambe ou causer d'autres blessures sérieuses.</li> </ul>
--	--

A33A2NA

## Instruction 12

<p><b>⚠ WARNING</b></p> <p><b>NEVER SIT IN CARGO AREA.</b></p> <p>Exceeding maximum cargo load may affect steering control and braking ability.</p> <p>MAXIMUM cargo load : XX Kg /XX Lbs.</p>	<p><b>⚠ AVERTISSEMENT</b></p> <p><b>NE JAMAIS S'ASSEoir À LA PLACE DU CARGO.</b></p> <p>Excéder le poids maximal du cargo peut affecter le contrôle de la direction et la capacité de freinage.</p> <p>Charge MAXIMALE cargo : XX Kg /XX Lbs.</p>
--	---

mmo2007-002-002

## Instruction 13

<p><b>⚠ WARNING</b></p> <p><b>EMERGENCY STARTING</b></p> <ul style="list-style-type: none"> <li>• NEVER wind rope around your hand.</li> <li>• If starter clip remained stuck, your hand could be pulled in by the clutch.</li> <li>• See operator's guide for proper procedure.</li> </ul>	<p><b>⚠ AVERTISSEMENT</b></p> <p><b>DÉMARRAGE D'URGENCE</b></p> <ul style="list-style-type: none"> <li>• Ne JAMAIS enrouler la corde autour de votre main.</li> <li>• Si l'agraffe restait attachée sur la poulie motrice, votre main pourrait être entraînée dans la poulie.</li> <li>• Voir votre guide de l'opérateur pour connaître la méthode d'utilisation adéquate.</li> </ul>
---	---

A33A2PA

FAN-COOLED MODELS

## Instruction 14

<p><b>⚠ WARNING</b></p> <p></p>	<p><b>⚠ AVERTISSEMENT</b></p> <p></p>	<p></p>
--	--	--

mmo2006-003-007\_A

EUROPEAN MODELS



## Instruction 17

**⚠ WARNING**

- *This is not a storage compartment.*
- *Do not use this space for storage purpose. Objects put in this space can limit steering and can cause an accident ending in injury or death.*

**⚠ AVERTISSEMENT**

- *Ceci n'est pas un espace de rangement.*
- *Ne pas insérer d'objet dans le compartiment avant du véhicule, car cette action peut occasionner un blocage de la conduite pouvant entraîner de graves blessures ou la mort.*



mmo2007-003-036

## Hang Tag

**VEHICLE ENGINE DESCRIPTION:**  
**XXXXX**

EPA CERTIFIED

NER (NORMALIZED EMISSION RATE) =   
ON A 0 TO 10 SCALE, 0 BEING THE CLEANEST

**\*NOT TO BE REMOVED PRIOR TO SALE**



704901107

vmo2006-005-009\_en



# ***ENVIRONMENT INFORMATION***

---

## GENERAL

Wildlife compliments your snowmobiling day. Snowmobile tracks provide firm ground over which animals can travel from area to area. Do not violate this privilege by chasing or harassing wildlife. Fatigue and exhaustion can lead to animal's death. Avoid areas posted for the protection or feeding of wildlife.

If you happen to be fortunate enough to see an animal, stop your snowmobile and observe quietly.

The guidelines that we support are not designed to limit your snowmobiling fun, but to preserve the beautiful freedom that you can experience only on a snowmobile! These guidelines will keep snowmobilers healthy, happy and able to introduce others to what they know and enjoy about their favorite winter pastime. So, the next time you hit the trails on a cool, crisp and clear winter day, we ask you to remember that you are paving the way for the future of our sport. Help us lead it down the right path! From all of us at BRP, thank you for doing your share.

There is nothing more exhilarating than snowmobiling. Venturing onto snowmobile trails that criss-cross the wild areas is an exciting and healthy winter sport. However, as the number of people using these recreational parks increases, so does the potential for damage to the environment. Abuse of land, facilities and resources inevitably leads to restrictions and closures of both private and public land.

In essence, the greatest threat to our sport, is all around us. Which leaves us with one logical choice. When we snowmobile, we must always ride responsibly.

The vast majority respect the law and the environment. Each of us must set an example for those who are new to the sport, young and old alike.

It is in every one's best interest to tread lightly into our recreational areas. Because, in the long run, to protect the sport we must preserve the environment.

Recognizing the importance of this issue and the need for snowmobilers to do their share in preserving areas that make it possible to enjoy our sport, BRP has developed the "Light Treading Is Smart Sledding" campaign for snowmobilers.

Light Treading refers to more than the thread of our tracks. It's a statement of concern, respect and willingness to take the lead and take action. It applies to the environment in general, its proper care and maintenance, its natural inhabitants and all enthusiasts and the public at large who enjoy the great outdoors. With this theme, we invite all snowmobilers to remember that respecting the environment is not only critical to the future of our industry but to future generations.

Light Treading in no way suggests you should curb your appetite for snowmobiling fun! It simply means tread with respect!

---

## JUST WHAT IS LIGHT TREADING?

The fundamental objective of Light Treading is one of respect for where and how you ride a snowmobile. You're a light treader when you follow the principles below.

**Become informed.** Obtain maps, regulations and other information from the Forest Service or from other public land agencies. Learn the rules and follow them and that goes for speed limits, too!

**Avoid** running over young trees, shrubs, and grasses and don't cut wood. On flatlands or areas where trail riding is popular, it's important to ride only where authorized. Remember, there is a link between protecting your environment and your own safety.

**Respect wildlife** and be particularly sensitive of animals that are rearing young or suffering from food shortage. Stress can sap scarce energy reserves. Refrain from riding in areas where only animals are intended to tread!

**Obey** gate closures and regulatory signs and remember, light treaders don't litter!

**Stay out** of wilderness areas. They're closed to all vehicles. Know where the boundaries are.

**Obtain permission** to travel across private land. Respect the rights of landowners and other people's privacy. Remember, snowmobile technology has lowered the noise factor considerably, but you still shouldn't rev your engines where quiet "is the order of the day".

---

## WHY IS LIGHT TREADING SMART

Snowmobilers know all too well the efforts that have been made throughout the sport's history to enjoy access to areas where people can snowmobile safely and responsibly. This effort continues today, as strong as ever.

Respecting the areas where we ride... wherever they may be... is the only way to ensure their future enjoyment. That's one major reason why we know you'll agree that Light Treading Is Smart Sledding! And there are more.

Enjoying the opportunity to see winter and all its natural majestic wonders, is an experience cherished by snowmobilers. Light Treading will preserve this opportunity and will make it possible for us to expose others to the beauty of winter and the unique thrill of our sport! Light Treading will help our sport to grow!

Finally, Light Treading is the sign of a smart snowmobiler. You don't have to leave big tracks or careen through a virgin forest to show you can ride. So whether you're driving a high performance LYNX snowmobile, show you know what you're doing. Show you know how to send snow flying and make tracks with a light touch!

# ***VEHICLE INFORMATION***

# HOW TO IDENTIFY YOUR SNOWMOBILE

## Vehicle Description Decal

Vehicle description decal is located on right hand side of tunnel.



### TYPICAL

1. Vehicle description decal

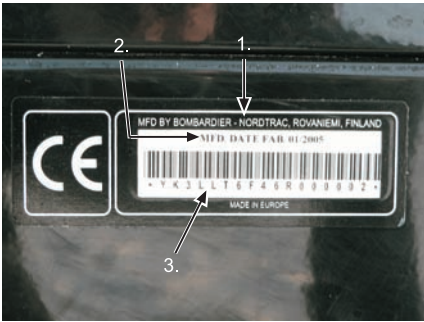

### VEHICLE DESCRIPTION DECAL

1. Manufacturer name
2. Manufacturing date
3. Vehicle identification number (VIN)

## Serial Numbers

The main components of your snowmobile (engine and frame) are identified by different serial numbers. It may sometimes become necessary to locate these numbers for warranty purposes or to trace your snowmobile in the event of loss. These numbers are required by the authorized LYNX dealer to complete warranty claims properly. No warranty will be allowed by BRP if the engine serial number or vehicle identification number (VIN) is removed or mutilated in any way. We strongly recommend that you take note of all the serial numbers on your snowmobile and supply them to your insurance company.

## Vehicle Identification Number (VIN) Location

VIN is scribed on vehicle description decal. See above. It is also engraved on tunnel near vehicle description decal.

## Model Number Location

Model number is part of vehicle identification number (VIN).

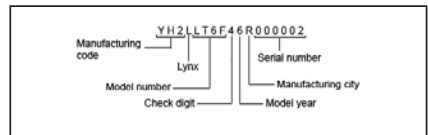

### VIN DESCRIPTION

## Engine Serial Number Location

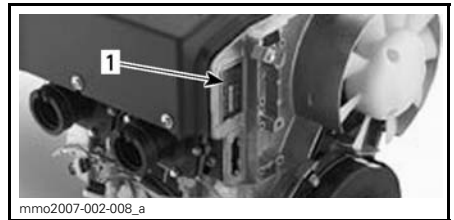

### FAN-COOLED — 552 ENGINE TYPE

1. Engine serial number



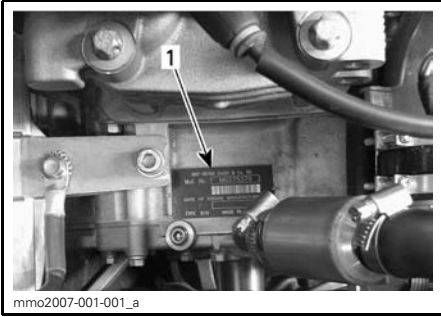

mmo2007-001-001\_a

**LIQUID-COOLED — V-810 ENGINE TYPE**  
1. Engine serial number

# CONTROLS/INSTRUMENTS/EQUIPMENT

NOTE: Some controls/instruments/equipment do not apply or are optional on some models. In these cases their reference numbers are deliberately missing in the illustrations.

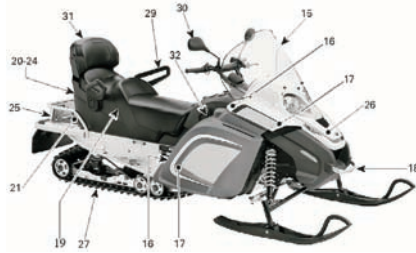

TYPICAL — 2-UP MODEL

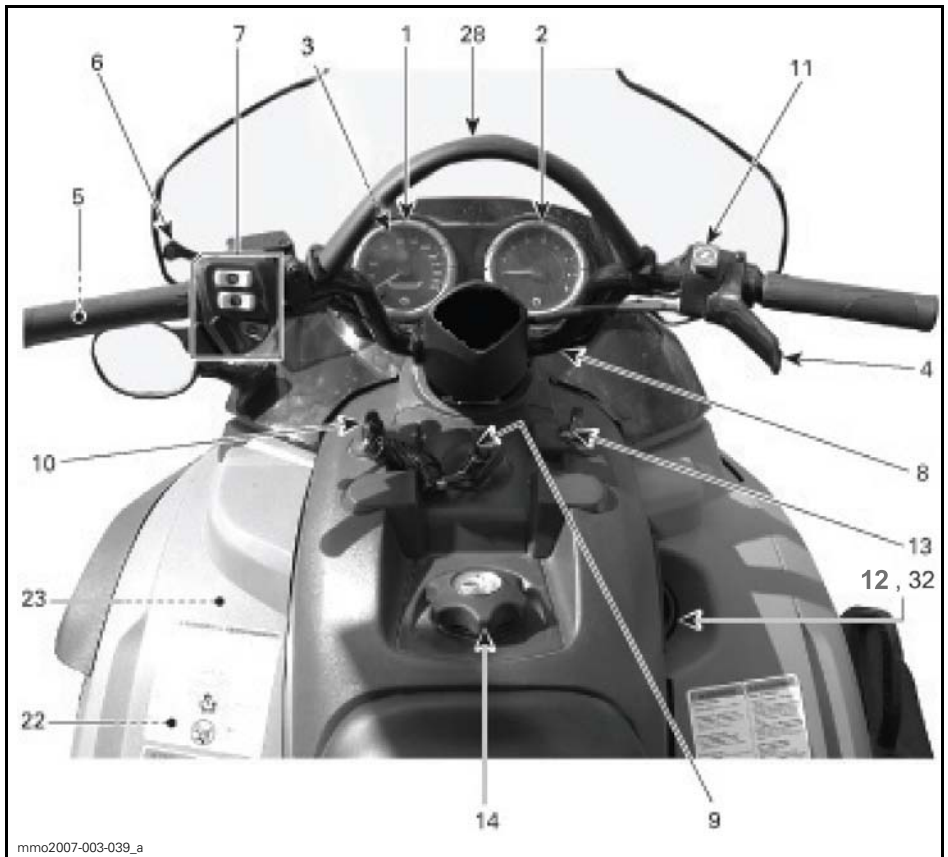

TYPICAL — CONSOLE

1. Speedometer
2. Tachometer
3. Pilot lamps
4. Throttle lever
5. Brake lever
6. Parking brake lever
7. Multi-function switch
8. Handlebar
9. Ignition switch
10. Tether cut-out switch
11. Engine cut-out switch
12. Rewind starter handle
13. Choke lever
14. Fuel tank cap/gauge
15. Windshield
16. Hood and side panel latches
17. Fuses
18. Front bumper/grab handle
19. Seat strap
20. Storage compartment
21. Rear rack
22. Tool kit
23. Spark plug holder
24. Spare drive belt compartment
25. Hitch
26. Shields and guards
27. Track
28. Holding strap
29. Rear grab handles
30. Adjustable mirrors
31. Backrest
32. Gear shift lever

## 1) Speedometer

### *If so Equipped*

Electronic speedometer that may show speed in km/h or MPH.

Refer to *UNIT SELECTION (MPH VS KM/H)* for changing units.

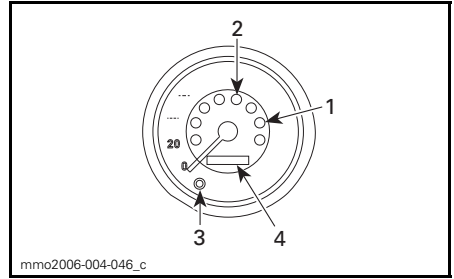

### **FAN-COOLED MODELS**

1. Reverse (RER) pilot lamp
2. High beam pilot lamp
3. Mode button
4. Multi-function display

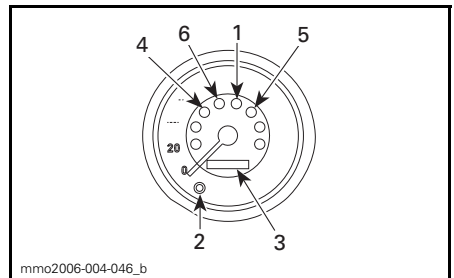

### **LIQUID COOLED MODELS**

1. High beam pilot lamp
2. Mode button
3. Multi-function display
4. Engine oil pressure pilot lamp
5. Low battery voltage pilot lamp
6. Engine overheat pilot lamp

## **Unit Selection (MPH vs km/h)**

The speedometer is factory preset in miles but it is possible to change it to kilometer reading, refer to the following procedure or contact an authorized LYNX dealer.

**NOTE:** Speedometer, odometer and trip meter will have their units (kilometer or miles) changed all together.

Stop engine.

Open LH and RH side panels.

Unplug hood harness.

Open hood.

Underneath hood, look for:

- 1 circuit male connector housing with BLACK/GREY wire

- 1 circuit female connector housing with YELLOW/BLACK wire.



**CONNECTOR LOCATION**

Plug connectors together to change units from miles to kilometers.

Unplug to return to miles reading.

### **Pilot Lamps**

#### **Reverse (RER) (fan-cooled)**

This pilot lamp will light up when reverse is selected.

#### **High Beam**

This pilot lamp will light up when head-lamp is on HIGH beam.

### **Liquid Cooled Models Only**

#### **Low Battery Voltage**

This lamp will light up to indicate a low battery voltage condition (**on so equipped models**). See an authorized LYNX dealer as soon as possible.

#### **Engine Oil Pressure**

This pilot lamp will light up when engine oil pressure is too low. Stop vehicle in a safe place then, check oil level and replenish as described in *ENGINE OIL LEVEL*.

Restart engine, oil pilot lamp must turn off after few seconds. If oil pilot lamp still lights up, stop engine and have lubrication system inspected by an authorized LYNX dealer.

### **Engine Overheat**

If this lamp blinks (1 short and 1 long beep will also be heard), the engine is overheating, reduce snowmobile speed and run snowmobile in loose snow or stop engine immediately and allow engine to cool. Check cooling system.

### **Mode Button**

Depress mode button to change multi-function display.

### **Multi-function Display**

**NOTE:** Each time engine is started, display shows odometer.

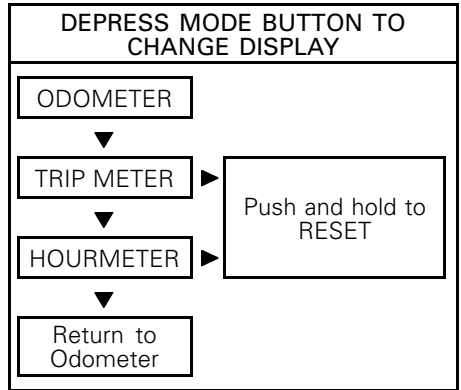

### **Odometer**

Odometer records the total distance travelled and displays it either in miles or kilometers.

### **Trip Meter (resetable)**

Records distance travelled since it has been reset. Distance travelled is displayed either in miles or kilometers.

### **Hourmeter (resetable)**

Records engine running time in hours and minutes since it has been reset.

Push and hold mode button for 2 seconds to reset the hourmeter.

## Multi-Function Display Code

If your speedometer shows **SCALE** in the multi-function display, it means that the display selector button is stuck in the down position or depressed when the electrical system was activated.

## 2) Tachometer

### *If so Equipped*

Direct-reading dial indicates the number of thousand of revolutions per minute (RPM) of the engine.

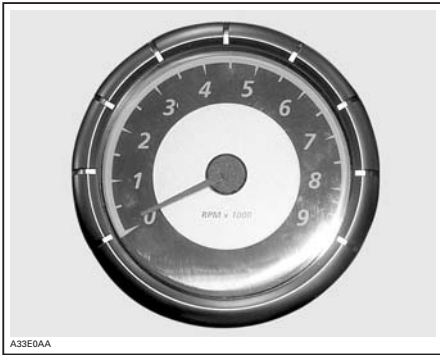

TYPICAL — MULTIPLY THE READING BY 1000

## 3) Pilot Lamps

### *Models without Speedometer*

#### Reverse Pilot Lamp (Red)



This pilot lamp will light up when reverse is selected.

#### High Beam Pilot Lamp (Blue)



Lights when headlamp is on HIGH beam.

## 4) Throttle Lever

Located on the right hand side of handlebar and designed to be thumb activated. When squeezed, it increases the engine speed and engages the transmission. When released, engine speed returns automatically to idle.

### **WARNING**

Test the throttle lever operation each time before starting the engine. The lever must return to its original position once released. Otherwise, do not start engine.

## 5) Brake Lever

Located on the left hand side of handlebar. When squeezed, the brake is applied. When released, it automatically returns to its original position. Braking effect is proportional to the pressure applied on the lever and to the type of terrain and its snow coverage.

## 6) Parking Brake Lever

Located on left hand side of handlebar. Parking brake should be used whenever snowmobile is parked.

Whenever parking brake is applied and engine is running, injection oil level/parking brake pilot lamp lights up to remind you that it is engaged.

### **WARNING**

Make sure parking brake is fully disengaged before operating the snowmobile. When you ride the vehicle, brake pads that are caused to drag by a continuous pressure on the lever may cause damage to the brake system and cause loss of braking capacity and/or fire.

## To Engage Mechanism

Squeeze brake lever and maintain while pushing locking lever with your thumb. When brake lever is held at halfway the parking brake should be fully applied.

**NOTE:** Locking lever can be adjusted in two different positions.

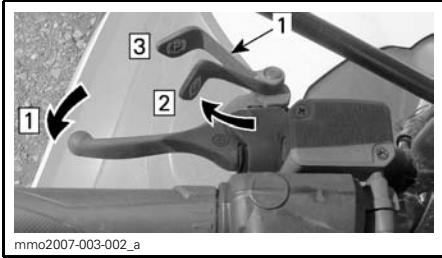

mmo2007-003-002\_a

### **PARKING BRAKE**

1. Locking lever

Step 1: Squeeze brake lever and maintain

Step 2: Push locking lever to 1<sup>st</sup> position

Step 3: Push locking lever to 2<sup>nd</sup> position

## To Release Mechanism

Squeeze brake lever. Locking lever will automatically return to its original position. Always release parking brake before riding.

## 7) Multi-Function Switch

The controls located on this multi-function switch are:

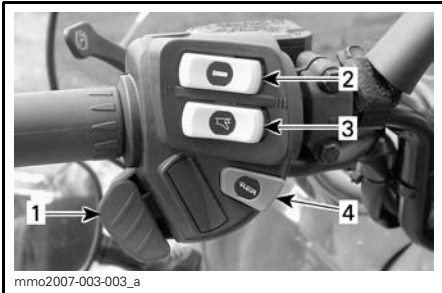

mmo2007-003-003\_a

1. Headlamp
2. Heated grips
3. Heated throttle lever
4. Reverse (RER)

## Headlamp Dimmer Switch

Allows selection of headlamp beam. Note that lights are automatically ON whenever the engine is running.

## Heated Grips

It is a three-position switch. Select the desired position to keep your hands at a comfortable temperature.

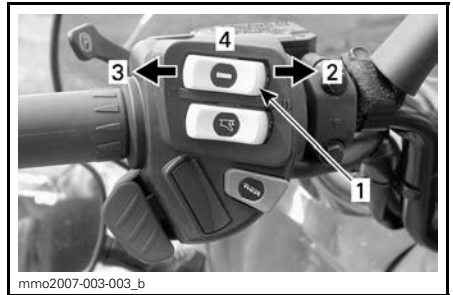

mmo2007-003-003\_b

### **TYPICAL**

1. Heating grip switch
2. Hot
3. Warm
4. Off

## Heated Throttle Lever

It is a three-position switch. Select the desired position to keep your thumb at a comfortable temperature.

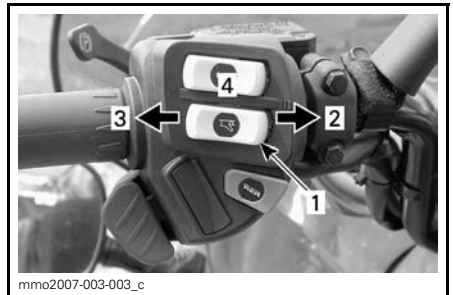

mmo2007-003-003\_c

### **TYPICAL**

1. Heated throttle lever switch
2. Hot
3. Warm
4. Off

## Reverse (RER)

### Fan-Cooled Models

#### General

When the engine is running, depressing the RER button will command the engine to reverse crankshaft rotation as driving the snowmobile in reverse is achieved by changing the direction of rotation of the engine, not by shifting the chaincase in reverse gear.

When depressing the RER button, the electronic module will practically slow down the engine RPM to a stop and advance the ignition timing to cause crankshaft rotation reversing.

Engine will automatically shift into forward when starting after stopping or stalling.

Shifting procedure will take place only when the engine is running.

If engine is running at a speed above 4300 RPM, the reverse function of the RER button is cancelled.

It is recommended to warm up the engine to its normal operating temperature before shifting.

#### Shifting in Reverse

### WARNING

Shifting to reverse mode on these snowmobiles is done by depressing the RER button when the engine is running. Wait until the reverse alarm sounds and the RER pilot lamp comes on in the dash before operating throttle to proceed in reverse. The reverse speed of these snowmobiles is not limited. Always proceed with caution as fast reverse could result in loss of vehicle stability. Come to complete stop before depressing RER button. Always remain seated and apply the brake before shifting. Ensure the path behind is clear of obstacles or bystanders before proceeding.

With the snowmobile completely stopped and engine running at idle, press and release the RER button.

The reverse (RER™) pilot lamp will blink and a warning buzzer will sound once every second with a half a second duration when the snowmobile is engaged in reverse.

Apply throttle slowly and evenly. Allow drive pulley to engage then accelerate carefully.

#### Shifting in Forward

With the snowmobile completely stopped and engine running at idle, press and release the RER button.

Reverse (RER) pilot lamp and warning buzzer will stop.

Apply throttle slowly and evenly. Allow drive pulley to engage then accelerate carefully.

## 8) Handlebar

The handlebar controls the steering of the snowmobile. As the handlebar is rotated to right or left, the skis are turned right or left to steer the snowmobile.

### WARNING

Fast reverse while turning, could result in loss of stability and control.

## 9) Ignition Switch

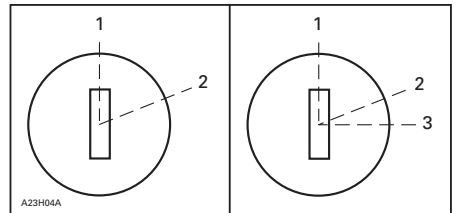

MANUAL START/ELECTRIC START MODELS

1. OFF
2. ON
3. START

## 2-Stroke Engine

### Manual Starting

To start the engine, first turn the key to ON position then, pull rewind starter grip. To stop the engine, turn the key to OFF position.

### Electric Starting

To start engine, turn key to START position and hold until engine has started. See illustration above.

**CAUTION:** Do not use electric starter for more than 10 seconds. A rest period should be observed between the cranking cycles to let electric starter cool down. Using electric starter when engine has started could damage electric starter mechanism.

Release key as soon as the engine starts. Key returns to ON position as soon as it is released.

If engine does not start on first try, turn key back to OFF position and wait a few seconds before restarting. To stop engine, turn key to OFF position.

**NOTE:** Engine may be manually started with rewind starter if necessary.

If starter does not operate, check starting system fuse condition. Refer to *FUSES*.

## 4-Stroke Engine

### Manual Starting

There is no manual starting on these models.

### Electric Starting

To start engine, turn key to START position and hold until engine has started. See illustration above.

**NOTE:** If for any reason, the battery is dead, engine cannot be started. Have the battery recharged or replaced.

**CAUTION:** Do not use electric starter for more than 10 seconds. A rest period should be observed between the cranking cycles to let electric starter cool down. Using electric starter when engine has started could damage electric starter mechanism.

Release key as soon as the engine starts. Key returns to ON position as soon as it is released.

If engine does not start on first try, turn key back to OFF position and wait a few seconds before restarting. To stop engine, turn key to OFF position.

If starter does not operate, check starting system fuse condition. Refer to *FUSES*.

**NOTE:** When turning the key to OFF position and removing the key, the vehicle electrical system will take a few seconds to shut down.

## 10) Tether Cut-Out Switch

### General

When the tether cord cap is removed, it shuts the engine off preventing snowmobile to runaway if the operator falls off the vehicle accidentally.

### **WARNING**

Always remove tether cord cap and key when vehicle is not in operation in order to prevent accidental engine starting, to avoid unauthorized use by children or others or theft.

### Operation

Attach tether cord eyelet to clothing, then snap tether cord cap over post before starting engine.



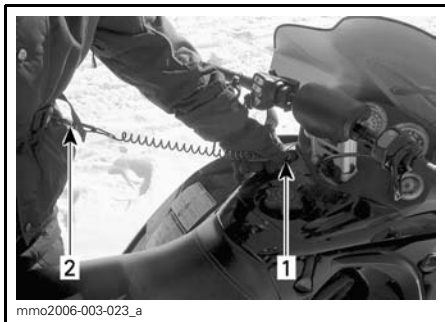

**TYPICAL**

1. Snap over post
2. Attach to eyelet

If emergency engine shut off is required, completely pull tether cord cap from post.

### 11) Engine Cut-Out Switch

This push-pull type switch is located on the right hand side of the handlebar. To stop the engine in an emergency, select OFF position and simultaneously apply the brake. To restart, button must be at the ON position.

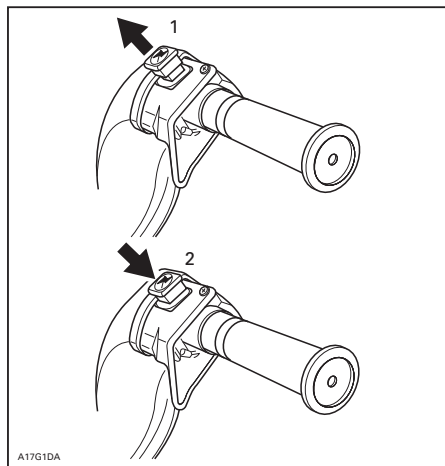

**TYPICAL**

1. ON
2. OFF

All operators of the snowmobile should familiarize themselves with the function of this device by using it several times on first outing and whenever stopping the engine thereafter. This engine cut-out procedure will become a reflex and will prepare operators for emergency situations requiring its use.

**⚠ WARNING**

If the switch has been used in an emergency caused by a suspected malfunction, the source of the malfunction should be determined and corrected before restarting engine. See an authorized LYNX dealer for servicing.

### 12) Rewind Starter Handle

#### *Fan-Cooled Models*

Auto-rewind type located on right hand side of snowmobile. To engage mechanism, pull handle slowly until a resistance is felt then pull vigorously. Slowly release handle.

### 13) Choke Lever

This device features a 3-position lever to facilitate cold start.

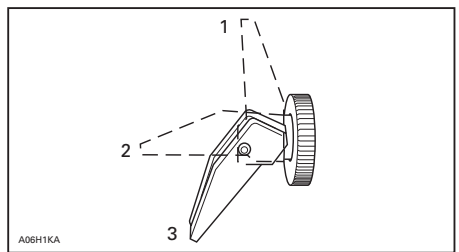

1. OFF
2. Position 2
3. Position 3

### Initial Cold Starting

**NOTE:** Do not operate the throttle lever with the choke lever on.

Move the choke lever to position 3 and start the engine. As soon as the engine starts move the lever to position 2. After a few seconds (10 seconds maximum) move the choke lever to OFF.

**NOTE:** In severe cold weather, colder than  $-20^{\circ}\text{C}$  ( $-4^{\circ}\text{F}$ ) you may need to flip choke lever from OFF to position 1 a couple of times once engine is started.

### Warm Engine Starting

Start the engine without any choke. If the engine will not start after two pulls of the rope or two 5 second attempts with the electric starter move choke lever to position 2. Start the engine without activating the throttle lever. As soon as the engine starts move the choke lever to OFF.

### 14) Fuel Tank Cap/Gauge

Unscrew to fill up tank then fully tighten.

Fuel tank cap features a mechanical gauge.

### WARNING

Always stop the engine before refueling. Fuel is flammable and explosive under certain conditions. Always work in a well ventilated area. Do not smoke or allow open flames or sparks in the vicinity. Open cap slowly. If a differential pressure condition is noticed (whistling sound heard when loosening fuel tank cap) have vehicle inspected and/or repaired before further operation. Do not overfill or top off the fuel tank before placing the vehicle in a warm area. As temperature increases, fuel expands and might overflow. Always wipe off any fuel spillage from the vehicle. Periodically verify fuel system.

**NOTE:** Do not sit or lean on seat when fuel tank cap is not properly installed.

### 15) Windshield

Windshield provides operator comfort, as well as protection by deflecting wind and snow away from the operator.

### 16) Hood and Side Panel Latches

#### Side Panels Latch

To open a side panel, stretch and unhook the latch.



1. Latch

Push on top portion of side panel to release it from hood.

Open side panel.

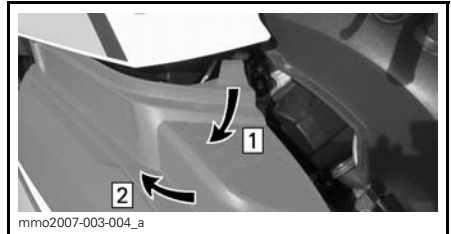

Step 1: Push to release  
Step 2: Open side panel

To remove a side panel remove by pulling up both locking devices from hinge.

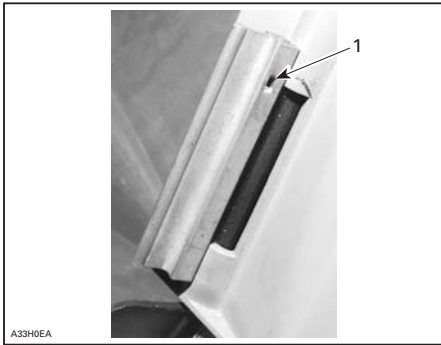

1. Locking device

## Hood Latches

To open hood, open side panels first to have access to hood latches, refer to procedure above.

On RH side of vehicle, unplug hood harness.

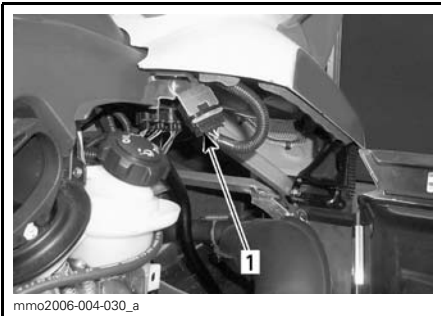

**TYPICAL — FAN-COOLED MODELS**  
1. Hood harness

Stretch and unhook the hood latches.

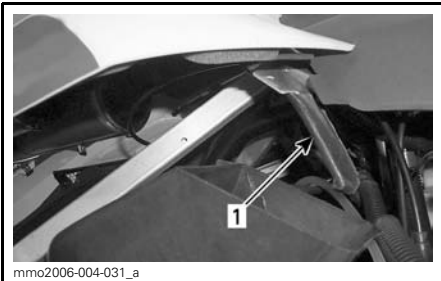

**TYPICAL ON BOTH SIDES**  
1. Latch

To remove hood, lift hood in a vertical position then pull to remove.



**HOOD REMOVAL**

## 17) Fuses

### Fuse Removal/Inspection

Check fuse condition and replace it if necessary.

To remove fuse from holder, pull fuse out. Check if filament is melted.

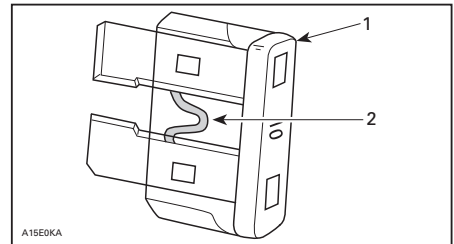

1. Fuse  
2. Check if melted

**CAUTION:** Do not use a higher rated fuse as this can cause severe damage to electric components and/or fire.

### **⚠ WARNING**

If fuse has burnt out, source of malfunction should be determined and corrected before restarting. See an authorized LYNX dealer for servicing.

## Description/Location

### Fan-Cooled Models

MODEL	FUSE	DESCRIPTION	LOCATION
Manual start	20 A	Ground protection	Behind RH footrest
Electric start	30 A	Charging system	Top of battery
	20 A	Ground protection	

### Ground Protection

**CAUTION:** This fuse should always be disconnected before doing any maintenance under the hood. This is to prevent any unexpected electrical activation.

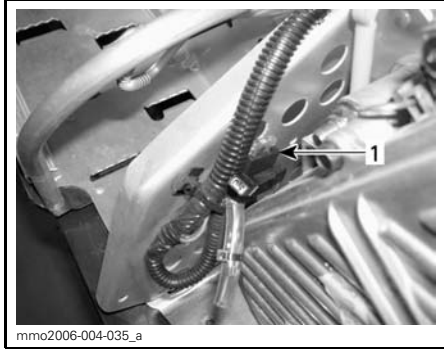

**MANUAL START MODELS — BEHIND RH FOOTREST**

1. Ground protection fuse



**ELECTRIC START MODELS**

1. Ground protection fuse

## Charging System



**ELECTRIC START MODELS**

1. Charging system fuse

### Liquid Cooled Models

FUSE	DESCRIPTION	LOCATION
30 A	Charging system	On battery support
5 A	Fuel injectors	F1
10 A	Fuel pump/ignition coil	F2
5 A	Engine Control Module (ECM)/Crankshaft Position Sensor (CPS)	F3
5 A	Cluster/reverse alarm/speed sensor/relay	F4
15 A	Heated grips and thumb/power outlet/visor outlet/taillight	F5
15 A	Headlamp	F6

Fuse box

## Charging System

**CAUTION:** This fuse should always be disconnected before doing any maintenance under the hood. This is to prevent any unexpected electrical activation.

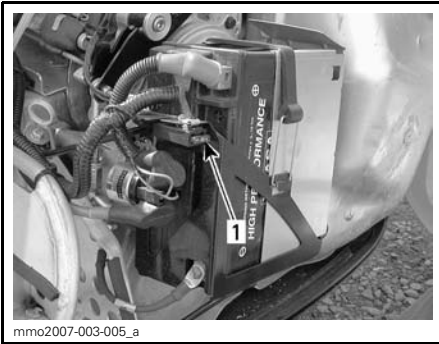

mmo2007-003-005\_a

1. Charging system fuse

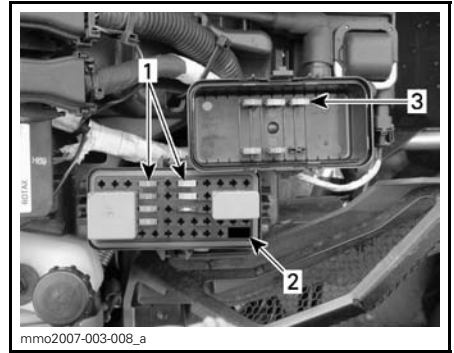

mmo2007-003-008\_a

1. Fuses
2. Fuse remover/installer tool
3. Spare fuses

## Fuse Box

Open side panels.

Open and remove front hood.



mmo2007-003-007\_a

RH SIDE OF VEHICLE

1. Fuse box

To open fuse box push on cover tabs and pull cover.

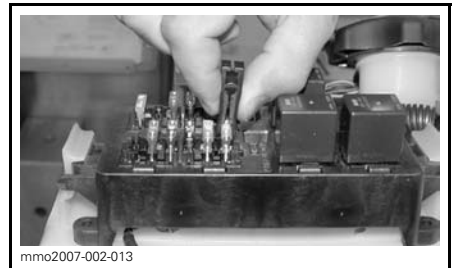

mmo2007-002-013

TYPICAL — REMOVE FUSE USING TOOL

## 18) Front Bumper / Grab Handle

To be used whenever front of snowmobile requires manual lifting.

### **⚠ WARNING**

Do not attempt to lift the vehicle by hand alone. Use appropriate lifting device or have assistance to share lifting stress in order to avoid risk of strain injuries.

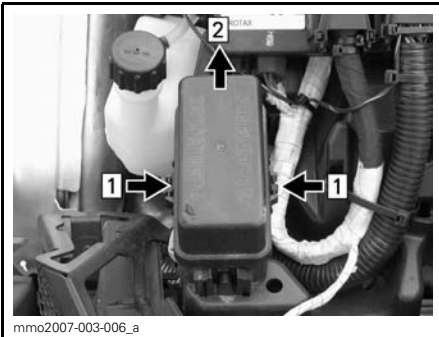

mmo2007-003-006\_a

FUSE BOX COVER

Step 1: Push on tabs

Step 2: Pull cover



1. Front grab handle

**CAUTION:** Do not use skis to pull or lift snowmobile.

**CAUTION:** Never use the front bumper to lift the snowmobile for maintenance purpose.

## 19) Seat Strap

Seat strap provides a grip for the passenger.

## 20) Storage Compartment

### **⚠ WARNING**

Storage compartment must be properly latched and must not contain any heavy or breakable objects.

To gain access to the storage compartment, unfasten buckles then pull on seat panel.

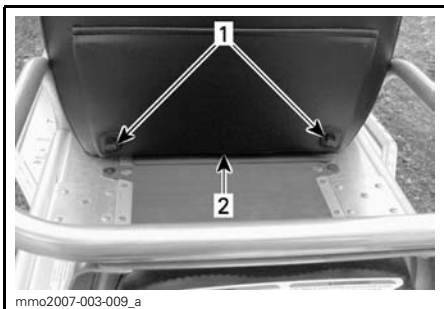

**STORAGE COMPARTMENT — 2-UP MODELS**

1. Buckles
2. Seat panel

## 21) Rear Rack

### **⚠ WARNING**

All objects in rear rack must be properly latched. Do not carry any breakable objects. Excessive weight in rack may reduce steering ability.

**CAUTION:** Always readjust suspension according to the load. The capacity of this rack is limited, refer to weight recommendation decal on vehicle cargo rack. Ride at very low speed when loaded. Avoid speed over bumps.

## 22) Tool Kit

A tool kit containing tools for basic maintenance is supplied with the vehicle.

Tool bag is located in engine compartment above left hand side toehold.

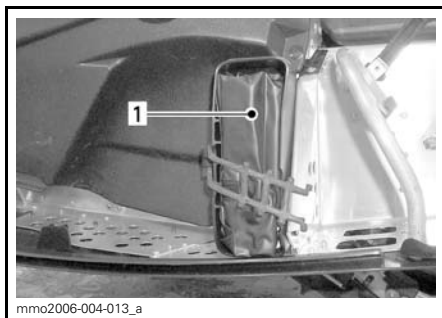

1. Tool kit

## 23) Spark Plug Holder

### **Fan-Cooled Models**

To keep spare spark plugs dry and prevent shocks that might affect the adjustment or break them, a holder is provided in engine compartment.

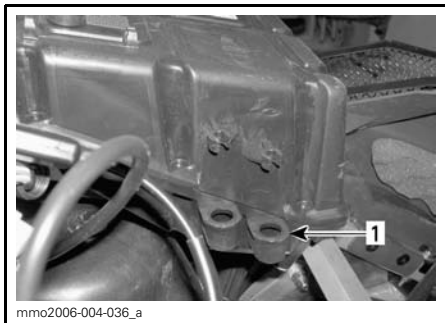

**SPARK PLUG HOLDER ON AIR INTAKE SILENCER (BODY SIDE)**

1. Spare spark plugs holder

**NOTE:** Spare spark plugs are not supplied with snowmobile.

**NOTE:** Check spare spark plug gap according to *SPECIFICATIONS* before installation.

## 24) Spare Drive Belt Compartment

A spare drive belt can be stored in storage compartment. For more details, refer to *STORAGE COMPARTMENT*.

**NOTE:** Spare drive belt is not supplied with the snowmobile.

## 25) Hitch

The hitch can be used to pull most equipment. Use a rigid tow bar.

## 26) Shields and Guards

### **WARNING**

Never operate engine without belt guard securely installed or, with hood or access/side panels open or removed.

Your snowmobile is provided with a number of shields and guards. Leave these in place on your vehicle as they are designed to keep clothing and hands out of moving parts and away from hot components. Never attempt to make adjustments to any moving part while the engine is running.

## 27) Track

Depending on the model of snowmobile that you own, your vehicle may come with a track for which the manufacturer permits the installation of studs, or a track for which the manufacturer forbids it.

Tracks approved for the installation of studs have a stud symbol (see illustration) molded into the track surface, and tracks not approved bear a forbidden stud symbol (see illustration).

Before proceeding with the installation of studs on tracks for which it is allowed, you must first acquaint yourself with the safety instructions related to the studding of tracks, found in the section entitled *TRACTION ENHANCING PRODUCTS* in the *SAFETY INFORMATION* section at the beginning of this guide. This section also provides other important information that you must consider before having studs installed on a track.

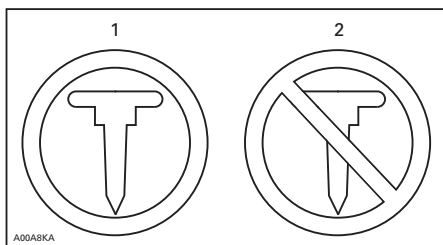

**TRACK SYMBOLS**

1. Approved
2. NOT approved

For general instructions on maintenance of tracks, refer to the sections *TRACK CONDITION* and *TRACK TENSION AND ALIGNMENT* in the *MAINTENANCE* section of this guide.

## 28) Holding Strap

Holding strap provides a grip for driver when side-hilling.

**⚠ WARNING**

This strap is not for towing, lifting or other purpose than temporary use as a grab bar during side-hilling. Always keep at least one hand on handlebar.

**29) Rear Grab Handles**

Rear grab handles provides a grip for the passenger.

**30) Adjustable Mirrors**

Each mirror can be adjusted to suit driver's preference.

**⚠ WARNING**

Adjust with vehicle at rest in a safe place.

**31) Backrest**

Fixed backrest to increase passenger comfort.

**32) Gear Shift Lever**

**4-Stroke Models**

These models are equipped with a mechanical reverse controlled by a 2-position gear shift lever.

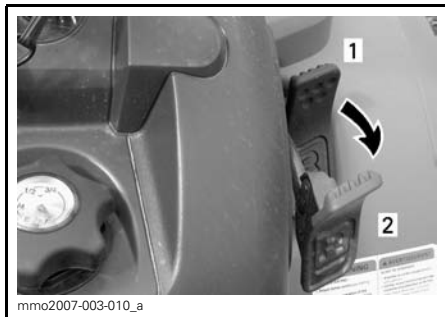

- 1. Forward
- 2. Reverse

**Shifting Procedure**

**⚠ WARNING**

The reverse speed of these snowmobiles is not limited. Always proceed with caution as fast reverse could result in loss of vehicle stability and control. Come to complete stop before selecting reverse gear. Wait until the reverse alarm sounds before operating throttle to proceed in reverse. Always remain seated and apply the brake before shifting. Ensure the path behind is clear of obstacles or bystanders before proceeding.

With snowmobile completely stopped and engine at idle, move lever to engage in desired gear.

Do not force lever. If unable to shift, apply throttle to move snowmobile, stop vehicle then, try again.



# RECOMMENDED FUEL AND OIL

## Recommended Fuel

Use unleaded gasoline available from most service stations or oxygenated fuel containing a maximum total of 10% of ethanol or methanol or both. The gasoline used must have the following recommended minimum octane number.

LOCATION	OCTANE NUMBER
Inside North America	(87 (RON + MON)/2)
Outside North America	95E (RON)

**CAUTION:** Never experiment with other fuels or fuel ratios. The use of unrecommended fuel can result in snowmobile performance deterioration and damage to critical parts in the fuel system and engine components. Do not mistake oil reservoir cap for fuel tank cap. Oil reservoir cap is identified OIL.

### WARNING

Always stop the engine before refueling. Fuel is flammable and explosive under certain conditions. Always work in a well ventilated area. Do not smoke or allow open flames or sparks in the vicinity. Open cap slowly. If a differential pressure condition is noticed (whistling sound heard when loosening fuel tank cap) have vehicle inspected and/or repaired before further operation. Do not overfill or top off the fuel tank before placing the vehicle in a warm area. As temperature increases, fuel expands and might overflow. Always wipe off any fuel spillage from the vehicle. Periodically verify fuel system.

## Fuel System Antifreeze

When using oxygenated fuel, additional gas line antifreeze or water absorbing additives are not required and should be not used.

When using non-oxygenated fuel, we highly recommend the use of isopropyl base gas line antifreeze in a proportion of 150 mL (5 U.S. oz) of gas line antifreeze added to 40 liters (10-1/2 U.S. gal) of gas.

This precaution is in order to reduce the risk of frost buildup in carburetor(s) which may lead, in certain cases, to high fuel consumption or severe damage to engine.

**NOTE:** Use only methyl hydrate free gas line antifreeze.

## Recommended Oil

### 2-Stroke Engine

**CAUTION:** Use only injection oil that flows at - 40°C (- 40°F). Do not mismatch oil reservoir cap with fuel tank cap. Oil reservoir cap is identified OIL.

Oil is contained in the injection oil reservoir.

Use only two-stroke engine injection oil sold by authorized LYNX dealers.

OIL TYPE
XP-S™ mineral injection oil <sup>(1)</sup> or XP-S Synthetic Blend 2-Stroke Injection or XP-S Fully Synthetic 2-Stroke Injection oil

<sup>(1)</sup> If XP-S™ mineral injection oil is not available, API TC high-quality low ash two-stroke injection oil may be used.

XP-S™ mineral injection oil is a special blend of basic oil and additives especially selected to ensure unequalled lubrication, engine cleanliness and minimum spark plug fouling.

**CAUTION:** Never use four-stroke petroleum or synthetic motor oil and never mix these with outboard motor oil. Do not use NMMA TC-W, TC-W2 or TC-W3 outboard two-stroke engine oils or ashless two-stroke engine oils. Avoid mixing different brands of API TC oil as resulting chemical reactions may cause severe engine damage.

Always maintain a sufficient amount of recommended oil in the injection oil reservoir.

**CAUTION:** Check level and refill every time you refuel. Do not mismatch oil reservoir cap with fuel tank cap. Install cap that is identified OIL.

 **WARNING**

Do not overfill. Reinstall cap and fully tighten. Wipe off any oil spills. Oil is highly flammable.

### 4-Stroke Engine

Use SAE 0W 40 synthetic-based oil that meets or exceeds the requirements for API service classification SM, SL or SJ. Always check the API service label certification on the oil container, it must contain at least one of the above standards.

**NOTE:** This is the only recommended viscosity to ensure proper cold start and optimum engine protection at high RPM and temperature.

MODEL	OIL TYPE
V-800 Series	XP-S™ 0W 40 synthetic oil or an equivalent

---

# BREAK-IN PERIOD

## Engine

**CAUTION:** A break-in period of 10 operating hours — 500 km (300 miles) — is required before running the snowmobile at full throttle.

During break-in period, maximum throttle should not exceed 3/4. However, brief full acceleration and speed variations contribute to a good break-in.

**CAUTION:** Engine overheating, continued wide open throttle runs and prolonged cruising without speed variations should be avoided, this can cause engine damage during the break-in period.

### *Models Equipped with 2-Stroke Engines*

To assure additional protection during the initial engine break-in, 500 mL (18 imp. oz) of recommended injection oil should be added to fuel for the first full filling of fuel tank. Have spark plugs cleaned after engine break-in.

## Belt

A new drive belt requires a break-in period of 50 km (30 miles). Avoid strong acceleration/deceleration, pulling a load or high speed cruising.

## 10-Hour Inspection

**NOTE:** The 10-hour inspection is at the expense of the snowmobile owner.

As with any precision piece of mechanical equipment, we suggest that after the first 10 hours of operation or 500 km (300 miles), whichever comes first, your snowmobile be checked by an authorized LYNX dealer. This inspection will also give you the opportunity to discuss the unanswered questions you may have encountered during the first hours of operation.

---

# OPERATING INSTRUCTIONS

## Pre-Operation Check

### WARNING

The pre-operation check is very important prior to operating the vehicle. Always check the proper operation of critical controls, safety features and mechanical components before starting. If not done as specified here, severe injury or death might occur.

- Remove snow and ice from body including seat, footrests, controls and instruments.
- Lights — The headlamp, the taillight and the brake light are standard equipment. Be sure lights are clear of dirt, slush or snow and are in good working order or condition.
- Verify that track and idler wheels are free to turn and not frozen.

### WARNING

Always use a wide base snowmobile mechanical stand to properly support vehicle during any track verification. Slowly accelerate engine in order to rotate track at very low speed when it is not on ground.

- Activate the brake control lever and make sure the brake fully applies before the brake control lever touches the handlebar grip. It must fully return when released.
- Check the parking device. Apply parking brake and check if it operates properly.
- Activate the throttle control lever several times to check that it operates easily and smoothly.

### WARNING

Throttle lever must operate easily and smoothly. It must return to idle position when released.

- Check operation of tether and engine cutout switches, ignition switch, headlamp switch (HI-LO), taillight, brake light and pilot lamps.
- Check gear shift lever position (**4-stroke models only**).
- Verify that skis and steering operate freely. Check corresponding action of skis versus handlebar.
- Check fuel and oil for levels and leaks. Replenish as necessary and see an authorized LYNX dealer in case of any leaks.
- Verify that air filter(s) is free of snow, if so equipped.
- All storage compartments must be properly latched and they must not contain any heavy or breakable objects. Hood must be also properly latched.

### WARNING

All adjustable features should be positioned at optimal setting. Securely tighten all adjustment locks.

- Make certain your snowmobile is pointed away from people or objects before you start it. No one is to be standing in front of or in back of the snowmobile.
- Be warmly dressed with clothing designed for snowmobiling.

PRE-OPERATION CHECK LIST		
ITEM	OPERATION	✓
Body including seat, footrests, lights, controls and instruments	Check that there is no snow or ice.	
Track and idler wheels	Check for free movement.	
Brake lever	Check proper action.	
Parking device	Check proper action.	
Throttle lever	Check proper action.	
Switches and lights	Check proper action. Tether cord must be attached to driver clothing eyelet.	
Skis and steering	Check for free movement and proper action.	
Fuel and oil	Check for proper level and leaks.	
Air filter	Check that there is no snow or ice.	
Adjustable features	Check for optimal adjustment and securely tightened adjustment locks.	
Storage compartment	Check for proper latching and no heavy or breakable objects.	
Vehicle vicinity	Snowmobile must be pointed away from people or objects. No one is to be standing in front of or in back of the snowmobile.	
Clothing	Be warmly dressed with clothing designed for snowmobiling.	

## Engine Starting Procedure (2-Stroke)

### Procedure

- Recheck throttle control lever operation.
- Ensure that the tether cord cap is in position and that the cord is attached to your clothing eyelet.
- Ensure that the engine cutout switch is in the ON position.
- Turn ignition key to ON position.
- Activate the choke according to the temperature as explained below.

### Choke Application

Initial Cold Starting When Temperature is **Below** - 10°C (+ 15°F)

**NOTE:** Do not operate the throttle lever with the choke lever on.

Set the choke lever to position 3.

Start the engine using the manual or electric starter (if so equipped).

After the engine is started, let engine warm up at fast idle until engine speed drops. Then, close off choke to ensure proper air-fuel mixture.

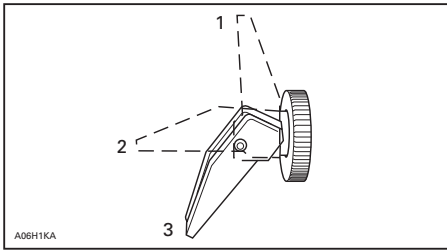

1. OFF
2. Position 2
3. Position 3

### Initial Cold Starting When Temperature is **Above** - 10°C (above + 15°F)

Set the choke lever to position 2.

Start the engine using the manual or electric starter (if so equipped).

After the engine is started, close off choke to ensure proper air-fuel mixture.

### Warm Engine Starting

Start the engine without any choke using the manual or electric starter (if so equipped).

If the engine will not start after two pulls of the rope or two 5 second attempts with the electric starter move choke lever to position 2. Start the engine without activating the throttle lever. As soon as the engine starts move the choke lever to OFF.

### Procedure (cont'd)

#### Manual Starting

- Grab manual starter handle, pull handle slowly until a resistance is felt, then hold handle firmly and pull vigorously to start engine.

#### Electric Starting (if so equipped)

## ⚠ WARNING

Never depress throttle while starting engine.

**CAUTION:** Do not use electric starter for more than 10 seconds. A rest period should be observed between the cranking cycles to let electric starter cool down. Using electric starter when engine has started could damage electric starter mechanism.

- Turn key clockwise until starter engages.
- Release key immediately when engine has started.

**NOTE:** If for any reason, the engine cannot be cranked electrically, leave ignition key to ON position and start engine manually using the rewind starter.

## Engine Starting Procedure (4-Stroke)

### Procedure

- Recheck throttle control lever operation.
- Ensure that the tether cord cap is in position and that the cord is attached to your clothing eyelet.
- Ensure that the engine cutout switch is in the ON position.
- Turn ignition key to ON position.

**NOTE:** Engine will not start if the throttle lever is depressed.

**CAUTION:** Do not use electric starter for more than 10 seconds. A rest period should be observed between the cranking cycles to let electric starter cool down. Using electric starter when engine has started could damage electric starter mechanism.

- Turn key clockwise until starter engages.
- Release key immediately when engine has started.

**NOTE:** If for any reason, the battery is dead, engine cannot be started. Have the battery recharged or replaced.

## Vehicle Warm-Up

Before every ride, vehicle has to be warmed up as follows.

Snowmobile must be securely supported by the rear bumper using a wide-base snowmobile mechanical stand. Track must be 100 mm (4 in) off the ground.

Attach tether cord to operator's clothing eyelet.

Start engine and allow it to warm up two or three minutes at idle speed.

Release parking brake.

### WARNING

**Make sure wide-base snowmobile mechanical stand is stable. Stay clear of the front of vehicle and the track. Do not use too much throttle during warm-up or when track is free-hanging.**

Apply throttle until drive pulley engages. Let track rotate at low speed for several turns. The lower the vehicle temperature is the longer vehicle warm-up should be.

Shut-off the engine and remove the wide-base snowmobile mechanical stand.

Skis may be frozen on the ground. Grab both skis one at a time by their loops and lift their front end slightly off the ground.

After restarting engine, the vehicle can be driven at low speed for the first 2 or 3 minutes of riding. After that, it may be driven up to the legal speed limit as per normal safety practices.

## Shutting Off the Engine

Release throttle lever and wait until engine has returned to idle speed.

Shut off the engine using either ignition switch, engine cut-out switch or tether cut-out switch.

### WARNING

**Always remove tether cord cap and key when vehicle is not in operation in order to prevent accidental engine starting or to avoid unauthorized use by children or others or theft.**

## Post-Operation Care

Shut off the engine. Install rear of vehicle on a wide-base snowmobile mechanical stand.

Remove snow and ice from rear suspension, track, front suspension, steering mechanism and skis.

Always cover your snowmobile when leaving it overnight or during extended periods of inactivity. This will protect it from freezing as well as retain its appearance.

## Suspension Adjustments

Snowmobile handling and comfort depend upon suspension adjustments.

For factory recommended adjustments refer to decal on the belt guard. It describes settings for optimum comfort according to load for your LYNX model.

Choice of suspension adjustments vary with carrying load, driver's weight, personal preference, riding speed and field condition.

**NOTE:** Some adjustments may not apply to your snowmobile. Use special keys in tool kit.

REAR SUSPENSION	
MODELS	TYPE
Adventure V800	SC
Ranger V-800	RCG-A
Ranger 550F	RCG-A

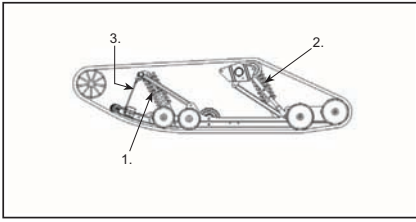

#### TYPICAL — RCG-SUSPENSION

1. Center spring for steering behavior
2. Rear spring for comfort and ride height
3. Stopper strap for snowmobile weight transfer

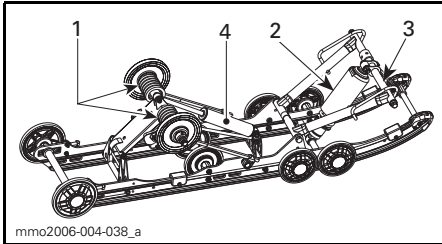

#### TYPICAL — SC-SUSPENSION

1. Rear springs adjustable cams for comfort and ride height
2. Center spring for steering behavior
3. Stopper strap for snowmobile weight transfer
4. Rear shock motion ratio — Damping strength (not adjustable)
6. Front springs for handling (not adjustable on all models) (not shown)

Following are guidelines to fine-tune suspension.

The best way to set up the suspension, is to start from factory settings, then customize each adjustment one at a time. Adjustments 2 through 6 are interrelated. It may be necessary to readjust center spring after adjusting front springs for instance. Test run the snowmobile under the same conditions; trail, speed, snow, driver riding position, etc. Change one adjustment and retest. Proceed methodically until you are satisfied.

### **WARNING**

Always remove tether cord cap before performing any maintenance or adjustment, unless otherwise specified. Vehicle must be parked in a safe place, away from the trail. Always lift the front of vehicle off the ground with a suitable lifting device before adjusting ski suspension. Lift the rear of vehicle off the ground with a wide-base snowmobile stand with a rear deflector panel before rear suspension adjustment.

### **WARNING**

Do not attempt to lift the vehicle by hand alone. Use appropriate lifting device to avoid risk of strain injuries. Always make sure the lifting device is stable and secure before proceeding to adjust the suspension components.

**CAUTION:** Whenever adjusting rear suspension, check track tension and adjust as necessary.

Slight suspension bottoming occurring under the worst riding conditions indicates a good choice of spring preload.

### **Rear Springs — Comfort**

**IMPORTANT:** Make sure that all objects to be transported are in place in storage compartment and rear rack.

- Grab rear bumper and lift until suspension is fully extended.
- From this point, rear of snowmobile should collapse by 50 to 75 mm (2 to 3 in) when driver and passenger (if so applicable) take place. Measure at rear bumper as shown in next photo.



## ⚠ WARNING

Do not attempt to lift the vehicle by hand alone. Use appropriate lifting device or have assistance to share lifting stress in order to avoid risk of strain injuries.

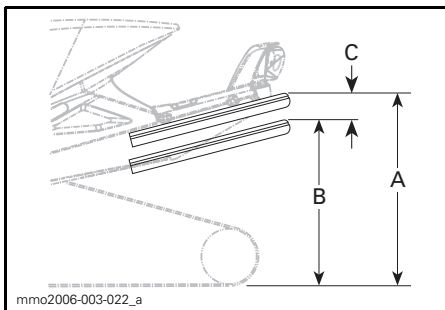

mmo2006-003-022\_a

### TYPICAL — PROPER ADJUSTMENT

- A. Suspension fully extended
- B. Suspension has collapsed with driver, passenger(s) and load added
- C. Distance between dimension A and B, must not exceed 50 to 75 mm (2 to 3 in), see table

### REAR SPRINGS ADJUSTMENT

"C"	CAUSE	SOLUTION
50 to 75 mm (2 to 3 in)	No adjustment required	
More than 75 mm (3 in)	Adjusted too soft	Increase preload
Less than 50 mm (2 in)	Adjusted too hard	Decrease preload

### Preload Adjustment

**NOTE:** Left and right adjustment cams may be at different settings.

CAM POSITIONS	SPRING PRELOAD
1	Minimum
2	Minimum/Intermediate
3	Intermediate/Maximum
4	Maximum

**CAUTION:** To increase preload, always turn the left side adjustment cam in a clockwise direction, and the right side cam in a counterclockwise direction.

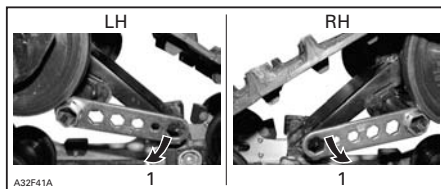

### TYPICAL

1. Increase spring preload



1. Increase spring preload (RCG)

**CAUTION:** To decrease preload, always turn the left side adjustment cam in a counterclockwise direction, the right side cam in a clockwise direction.

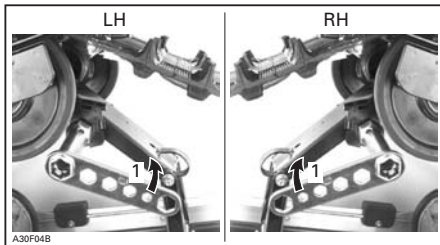

### TYPICAL

1. Decrease spring preload



1. Decrease spring preload (RCG)

### Center Spring — Steering Behavior

- Ride at moderate speed on a trail.
- If handlebar is felt too easy or too hard to turn, adjust center spring accordingly.

#### **WARNING**

Before proceeding with any suspension adjustment, remember:

- park in a safe place
- remove tether cord cap
- lift rear of vehicle off the ground with a wide-base snowmobile stand with a rear deflector panel
- make sure lifting device is stable and secure.

#### **CENTER SPRING ADJUSTMENT**

HANDLEBAR (steering attitude)	PROBLEM	SOLUTION
Easy to turn (neutral)	No adjustment required	
Harder to turn (oversteering)	Adjusted too soft	Increase preload
Very easy to turn (understeering)	Adjusted too hard	Decrease preload

### Preload Adjustment

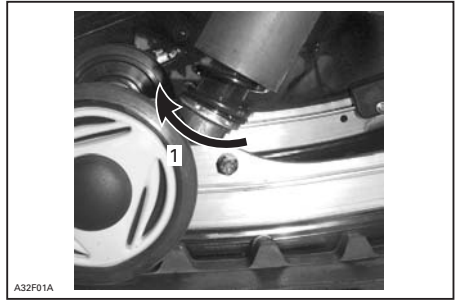

#### *TYPICAL*

1. Use adjuster wrench provided in tool kit to increase or decrease preload

### Stopper Strap — Weight Transfer

- Ride at low speed then fully accelerate.
- Note steering behavior.
- Adjust stopper strap length accordingly.

#### **WARNING**

Before proceeding with any suspension adjustment, remember:

- park in a safe place
- remove tether cord cap
- lift rear of vehicle off the ground with suitable lifting device
- make sure lifting device is stable and secure.

**CAUTION:** Whenever stopper strap length is changed, track tension must be readjusted.

STOPPER STRAP — WEIGHT TRANSFER			
WEIGHT TRANSFER		ADJUSTMENTS	
Steering	Track (skis)	Problem	Solution
Comfortable	Good weight transfer (light pressure)	No adjustment required	
Light	Too much weight transfer (lift off the ground)	Strap too long	Reduce strap length
Heavy	Not enough weight transfer (heavy pressure)	Strap too short	Increase strap length

### Strap Adjustment

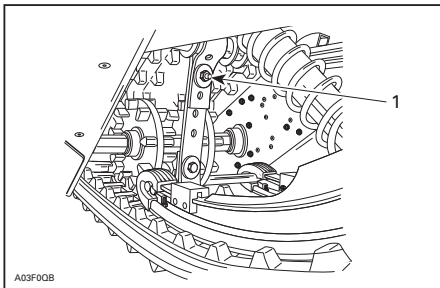

#### TYPICAL

1. Increase or decrease strap length by bolting to a different hole

### Front Springs — Handling

**NOTE:** Front shock springs are adjustable on some models only.

- Ride at moderate speed and check for proper handling.
- Adjust front springs accordingly.

⚠ **WARNING**

Before proceeding with any suspension adjustment, remember:

- park in a safe place
- remove tether cord cap
- lift rear of vehicle off the ground with a wide-base snowmobile stand with a rear deflector panel
- make sure lifting device is stable and secure.

⚠ **WARNING**

Always adjust both front springs to same position.

FRONT SPRINGS ADJUSTMENT			
HANDLING	STEERING	PROBLEM	SOLUTION
Good	Comfortable	No adjustment required	
Bad	Too easy to turn	Adjusted too soft	Increase spring preload
Bad	Hard to turn	Adjusted too hard	Decrease spring preload

### Preload Adjustment

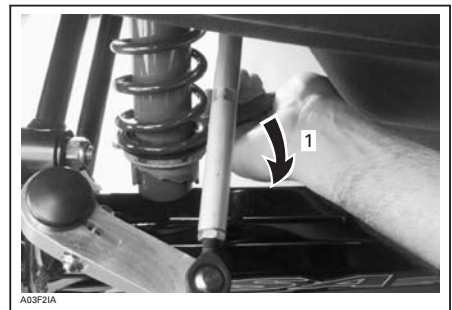

#### TYPICAL

1. Increase or decrease spring preload

**CAUTION:** Make sure that both front springs are still pre loaded when front of vehicle is off the ground.

## SUSPENSION TROUBLESHOOTING CHART

PROBLEM	CORRECTIVE MEASURES
Front suspension wandering	<ul style="list-style-type: none"> <li>– Check ski alignment and camber angle adjustment. See an authorized LYNX dealer.</li> <li>– Reduce ski ground pressure.</li> <li>• Increase center spring preload.</li> <li>• Reduce rear spring preload.</li> </ul>
Snowmobile seems unstable and seems to pivot around its center	<ul style="list-style-type: none"> <li>– Reduce rear suspension front arm pressure.</li> <li>• Reduce center spring preload.</li> <li>• Increase rear spring preload.</li> </ul>
Steering feels too heavy	<ul style="list-style-type: none"> <li>– Reduce ski ground pressure.</li> <li>• Increase center spring preload.</li> </ul>
Rear of snowmobile seems too stiff	<ul style="list-style-type: none"> <li>– Reduce rear spring preload.</li> </ul>
Rear of snowmobile seems too soft	<ul style="list-style-type: none"> <li>– Increase rear spring preload.</li> </ul>
Rear suspension front shock absorber is frequently bottoming	<ul style="list-style-type: none"> <li>– Lengthen stopper strap.</li> <li>– Increase center spring preload.</li> </ul>
Track spins too much at start	<ul style="list-style-type: none"> <li>– Lengthen stopper strap.</li> <li>– Move thicker part of coupling block downward.</li> </ul>

### **In Deep Snow**

When operating the snowmobile in deep snow, it may be necessary to vary stopper strap length and/or riding position, to change the angle at which the track rides on the snow. Operator's familiarity with the various adjustments as well as snow conditions will dictate the most efficient combination.

# SPECIAL OPERATING INSTRUCTIONS

## Riding at High Altitudes or Sea Level

**CAUTION:** Failure to re-calibrate may cause serious engine damage.

Those models are calibrated for **SEA LEVEL** operation.

Operating above 600 m (2000 ft) requires parts and adjustments.

Refer to an authorized LYNX dealer for proper calibration modifications.

## Riding in Cold Weather

All vehicles have been calibrated for - 20°C (- 4°F). They can be operated at warmer winter temperatures without problems.

**CAUTION:** For colder temperatures than - 20°C (- 4°F), carburetor(s) must be recalibrated to avoid engine damage. Refer to an authorized LYNX dealer.

Refer also to *RIDING AT HIGH ALTITUDES OR SEA LEVEL* in previous pages.

## Emergency Starting

### Fan-Cooled Models Only

The engine can be started with the emergency starter rope supplied with the tool kit.

Remove belt guard.

### **WARNING**

Do not wind starting rope around your hand. Hold rope by the handle only. Do not start the snowmobile by the drive pulley unless it is a true emergency situation. Have the snowmobile repaired as soon as possible.

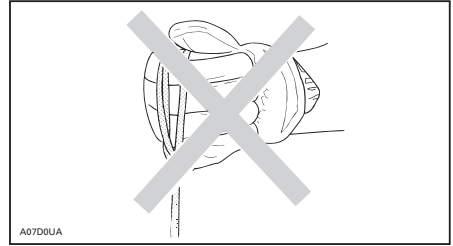

Attach one end of emergency rope to rewind handle.

**NOTE:** The spark plug socket can be used as an emergency handle.

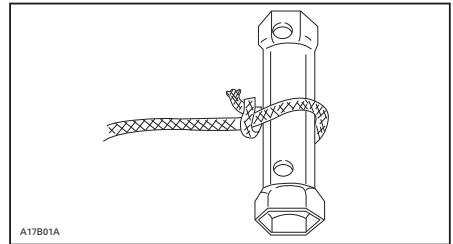

### TYPICAL

Attach the other end of emergency rope to the starter clip supplied in the tool kit.

Hook up clip on drive pulley.

Wind the rope tightly around drive pulley. When pulled, pulley must rotate counterclockwise.

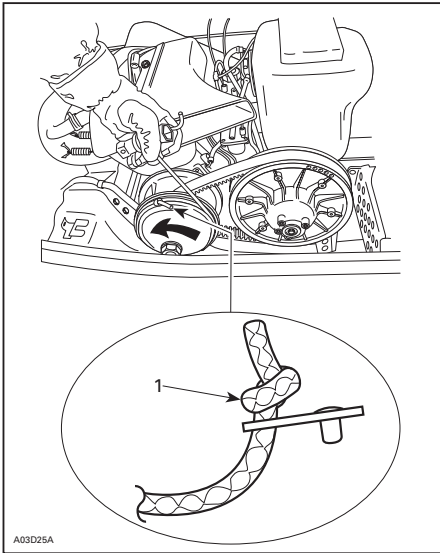

A03025A

**TYPICAL**

1. Knot on this side

Pull the rope using a sharp, crisp pull so the rope comes free of the drive pulley.

Start engine as per usual manual starting.

**⚠ WARNING**

When starting the snowmobile in an emergency situation, using drive pulley, do not reinstall the belt guard and return slowly to have snowmobile repaired.

**Towing an Accessory**

Always use a rigid towbar to tow an accessory. Any towed accessory should have reflectors on both sides and at the rear. Check local laws for brake lights requirements.

**⚠ WARNING**

Never tow an accessory with a rope. Always use a rigid towbar. Using a rope would result in a collision between the object and the snowmobile and possibly in a tip over in case of a rapid deceleration or on a downward slope.

**Towing Another Snowmobile**

If a snowmobile is disabled and must be towed use a rigid towbar, remove the drive belt and tow at moderate speed.

**CAUTION:** Always remove the drive belt of the snowmobile that is to be towed to prevent damage to its belt and drive system.

In an emergency situation only, if a rigid towbar is not available, a rope can be used provided you proceed with extra caution.

Remove the drive belt, attach the rope to the ski legs (spindles), have someone sit on the towed snowmobile to activate the brake, and tow at low speed.

**CAUTION:** In order to prevent damage to the steering system, never attach the tow rope to the ski loops (handles).

**⚠ WARNING**

Never ride at high speed when towing a disabled snowmobile. Proceed slowly with extra caution.

**Transporting the Vehicle**

Make sure that oil reservoir and fuel tank caps are properly installed.

Tilt bed trailers can easily be equipped with a winch mechanism to afford maximum safety in loading. Simple as it may seem, never drive your snowmobile onto a tilt bed trailer or any other kind of trailer or vehicle. Many serious accidents have resulted from driving up and over a trailer. Anchor your vehicle securely, front and rear, even on short hauls. Be certain all equipment is securely fastened. Cover your snowmobile when trailering to prevent road grime from causing damage.

Be certain your trailer meets state or provincial requirement. Ensure the hitch and safety chains are secure and the brake, turn indicators and clearance lights all function.

---

# TROUBLESHOOTING

---

## 1 LONG BEEP PER SECOND.

### 1. Reverse is selected.

- *Vehicle can be driven in reverse.*

---

## BATTERY PILOT LAMP LIGHTS UP.

### 1. No charging.

- *Check battery and charging system.*

---

## ENGINE TURNS OVER BUT FAILS TO START.

### 1. Throttle lever was depressed while starting engine.

- *Do not operate the throttle lever while starting engine.*

### 2. Ignition switch or engine cut-out switch in OFF position or tether cord cap away from post.

- *Place engine cut-out switch in the ON position and install tether cord cap on post.*

### 3. Mixture not rich enough to start cold engine.

- *Check fuel tank level and check starting procedure, particularly use of the choke.*

### 4. Flooded engine (spark plug wet when removed).

#### 2-STROKE ENGINE

- *Do not choke. Remove wet spark plug, turn ignition switch to OFF and crank engine several times. Install clean dry spark plug.*
- *Start engine following usual starting procedure. If engine continues to flood, see an authorized LYNX dealer.*

#### 4-STROKE ENGINE

- *Remove wet spark plug. Install clean dry spark plug.*
- *Start engine following usual starting procedure. If engine continues to flood, see an authorized LYNX dealer.*

### 5. No fuel to the engine (spark plug dry when removed).

- *Check fuel tank level; turn fuel valve on if applicable; check fuel filter; replace if clogged; check condition of fuel and impulse lines and their connections. A failure of the fuel pump or carburetor has occurred. Contact an authorized LYNX dealer.*

### 6. Spark plug/ignition (no spark).

- *Remove spark plug(s) then reconnect to spark cap. Check that engine cut-out switch is at the ON position and the tether cut-out cord cap is snapped over the receptacle.*
- *Start engine with spark plug(s) grounded to engine away from spark plug hole. If no spark appears, replace spark plug. If trouble persists, contact an authorized LYNX dealer.*



## **ENGINE TURNS OVER BUT FAILS TO START. (cont'd)**

---

### **7. Engine compression.**

- *As the engine is pulled over with the rewind starter, "cycles" of resistance should be felt as piston goes past top dead center (each piston on multi-cylinder engines).*
- *If no pulsating resistance is felt, it suggests a major loss of compression. Contact an authorized LYNX dealer.*

## **ENGINE LACKS ACCELERATION OR POWER.**

---

### **1. Fouled or defective spark plug.**

- *Check item 6 of ENGINE TURNS OVER BUT FAILS TO START.*

### **2. Lack of fuel to engine.**

- *Check item 5 of ENGINE TURNS OVER BUT FAILS TO START.*

### **3. Carburetor adjustments.**

- *Contact an authorized LYNX dealer.*

### **4. Drive belt worn too thin.**

- *If the drive belt has lost more than 3 mm (1/8 in) of its original width, it will affect vehicle performance.*
- *Replace drive belt.*

### **5. Drive and driven pulleys require servicing.**

- *Contact an authorized LYNX dealer.*

### **6. Engine is overheating**

- *On liquid cooled engines: Check coolant level, pressure cap, thermostat and for air locks in cooling system.*
- *On fan cooled engines: Check fan belt and its tension; clean cooling fins of engine; if overheating persists, contact an authorized dealer.*

## **ENGINE BACKFIRES.**

---

### **1. Faulty spark plug (carbon accumulation).**

- *See item 6 of ENGINE TURNS OVER BUT FAILS TO START.*

### **2. Engine is running too hot.**

- *See item 6 of ENGINE LACKS ACCELERATION OR POWER.*

### **3. Ignition timing is incorrect or there is an ignition system failure.**

- *Contact an authorized LYNX dealer.*

## **ENGINE MISFIRES.**

---

### **1. Fouled/defective/worn spark plugs.**

- *Clean/verify spark plug gap and identification number. Replace as required.*

### **2. Too much oil supplied to engine.**

- *Improper oil pump adjustment, refer to an authorized LYNX dealer.*
- *On premixed models only, improper fuel/oil mixture. Drain fuel tank and refill with appropriate mixture ratio.*

### **3. Water in fuel.**

- *Drain fuel system and refill with fresh fuel.*

## **SNOWMOBILE CANNOT REACH FULL SPEED.**

---

### **1. Drive belt.**

- *Check items 4 and 5 of ENGINE LACKS ACCELERATION OR POWER.*

### **2. Incorrect track adjustment.**

- *See MAINTENANCE and/or an authorized LYNX dealer for proper alignment and tension adjustments.*

### **3. Pulleys misaligned.**

- *Contact an authorized LYNX dealer.*

### **4. Engine.**

- *See items 1 to 6 of ENGINE LACKS ACCELERATION OR POWER.*

### **5. Clutch adjustment required for snow conditions.**

- *See "DRIVE PULLEY ADJUSTMENT" in this book.*

## SPECIFICATIONS

**NOTE:** Because of its ongoing commitment to product quality and innovation, BRP reserves the right, at any time, to make changes in design and specifications and/or to make additions to, or improvements in its products without imposing any obligation upon itself to install them on its products previously manufactured.

FAN-COOLED MODELS		RANGER™ 550
		550 F
<b>ENGINE SYSTEM</b>		
Engine type		Rotax 550 fan-cooled
Cylinders		2
Displacement	cc (in <sup>3</sup> )	553.4 (33.8)
Bore	mm (in)	76 (3)
Stroke	mm (in)	61 (2.4)
Maximum engine speed		7000 RPM
Carburetion		2 x VM-30
Exhaust system		Single tuned pipe, baffle muffler
<b>DRIVE SYSTEM</b>		
Drive pulley type		IBC
Driven pulley type		LPV 27
Drive belt part number		415 060 600 <sup>(2)</sup>
Engagement		2700 RPM
Small sprocket number of teeth		17
Large sprocket number of teeth		45
Drive sprocket number of teeth		9
Brake system		Hydraulic, RT™-type brake lever
Track nominal width		380 mm (15 in)
Track nominal length		3968 mm
Track profile height		32 mm
Track adjustment	Deflection	35 - 40 mm (1-3/8 - 1-9/16 in)
	Force <sup>(1)</sup>	7.3 kg (16 lb)
Track alignment		Equal distance between edges of track guides and slider shoes

FAN-COOLED MODELS		RANGER™ 550
		550 F
<b>SUSPENSION</b>		
Front suspension	Single A-Arm	
Front shock	MC 25	
Front suspension max. travel	160 mm (6.3 in)	
Rear suspension	RCG-A	
Front arm shock	HP-GAS 36	
Rear arm shock	HP-GAS 36	
Rear suspension max. travel	340 mm	
<b>ELECTRICAL</b>		
Lightning system output	340 Watts	
Headlamp bulb HI/LOW beam	2 x 60/55 Watts (H-4)	
Taillight bulb	8/27	
Spark plug	Type	NGK BR9ES
	Gap	0.45 ± 0.05 mm (.018 ± .002 in)
Fuse	Refer to <i>FUSE</i> section	
<b>DIMENSIONS</b>		
Vehicle overall length	3310 mm	
Vehicle overall width	1167 mm	
Vehicle overall height	1300 mm (51.2 in)	
Official dry weight	240 kg	
Ski stance	812 mm	

FAN-COOLED MODELS		RANGER™ 550
		550 F
<b>LIQUIDS</b>		
Recommended fuel type		Regular unleaded
Minimum octane	Inside North America	(87 (RON + MON)/2)
	Outside North America	95E RON
Recommended oil (engine)		XP-S mineral injection oil (3)
Brake system fluid		SRF (DOT 4) or GTLMA (DOT 4)
Oil type (chaincase/transmission)		XP-S synthetic chaincase oil
<b>CAPACITIES</b>		
Fuel tank	L (U.S. gal)	34 (9)
Oil tank	L (U.S. oz)	3.5 (118)
Brake fluid	mL (U.S. oz)	200 (6.8)
<p>(1) Measure gap between slider shoe and bottom inside track when exerting a downward pull to the track.</p> <p>(2) Drive belt height must be adjusted every time a new drive belt is installed. Confirm drive belt part number application with an authorized LYNX dealer.</p> <p>(3) NOTE: Although XP-S mineral 2-stroke injection oil or XP-S semi synthetic 2-stroke injection oil is recommended as a minimum level oil for your vehicle, XP-S Synthetic 2-stroke injection oil is recommended to offer even better protection for your vehicle in extreme conditions.</p>		

LIQUID-COOLED MODELS		ADVENTURE™ V-800	RANGER™ V-800
		V-810	V-810
<b>ENGINE</b>			
Engine Type		Rotax 4-TEC V-800	
Cylinders		2	
Displacement	cm <sup>3</sup> (in <sup>3</sup> )	800 (48.8)	
Bore	mm (in)	91 (3.58)	
Stroke	mm (in)	62 (2.44)	
Maximum engine speed	± 100 RPM	7250	
Fuel system type		EFI 46 mm throttle body, 1 injector per cylinder	
Exhaust system		Exhaust pipe, muffler	
<b>DRIVE SYSTEM</b>			
Drive pulley type		TRA™ IV	
Driven pulley type		LPV VSA	
Drive belt part number		417 300 197 <sup>(2)</sup>	
Engagement		2100 RPM	
Small sprocket number of teeth		19	17
Large sprocket number of teeth		44	
Drive sprocket number of teeth		9	
Brake system		Hydraulic, RT™-type brake lever	
Track nominal width		406 mm	380 mm
Track nominal length		3456 mm	3968 mm
Track profile height		32 mm	
Track adjustment		Deflection	
		35 - 40 mm (1-3/8 - 1-9/16 in)	
		Force <sup>(1)</sup>	
		7.3 kg (16 lb)	
Track alignment		Equal distance between edges of track guides and slider shoes	

LIQUID-COOLED MODELS	ADVENTURE™ V-800		RANGER™ V-800	
	V-810		V-810	
<b>SUSPENSION</b>				
Front suspension		Single A-Arm		
Front shock		HP-GAS 36		MC 25
Front suspension max. travel		160 mm (6.3 in)		160 mm (6.3 in)
Rear suspension		SC		RCG-A
Front arm shock		HP-GAS 36		
Rear arm shock		HP-GAS 36		
Rear suspension max. travel		330 mm		340 mm
<b>ELECTRICAL</b>				
Lightning system output		380 Watts		
Headlamp bulb HI/LOW beam		2 x 60/55 Watts (H-4)		
Taillight bulb		8/27		
Spark plug	Make	NGK DCPR8E		
	Gap	0.7 to 0.8 mm (.027 to .031 in)		
Fuse		Refer to <i>FUSE</i> section		
<b>DIMENSION</b>				
Vehicle overall length		3025 mm		3310 mm
Vehicle overall width		1167 mm		
Vehicle overall height		1300 mm		
Official dry weight		250 kg		270 kg
Ski stance		990 mm		812 mm

LIQUID-COOLED MODELS		ADVENTURE™ V-800	RANGER™ V-800
		V-810	V-810
<b>LIQUIDS</b>			
Recommended fuel type		Regular unleaded	
Minimum octane	Inside North America	(87 (RON + MON)/2)	
	Outside North America	95E RON	
Engine oil		XP-S™ 0W40 synthetic 4-stroke oil	
Coolant		Premixed coolant or ethylene-glycol/water mix (50% coolant, 50% distilled water)	
Oil (chaincase/gearbox) type		XP-S™ synthetic chaincase oil	
Brake system fluid		SRF (DOT 4) or GTLMA (DOT 4)	
<b>CAPACITIES</b>			
Engine oil		Oil change with filter: 2 L (2.1 U.S. quarts)	
Cooling system		4.3 L	4.6 L
Fuel tank	L (U.S. gal)	34 (9)	
Chaincase/gearbox oil	mL (U.S. oz)	250 (8.5)	
Brake fluid	mL (U.S. oz)	200 (6.8)	
(1) Measure gap between slider shoe and bottom inside track when exerting a downward pull to the track.			
(2) Drive belt height must be adjusted every time a new drive belt is installed. Confirm drive belt part number application with an authorized LYNX dealer.			



# ***MAINTENANCE INFORMATION***

---

## PERIODIC MAINTENANCE CHART

### **WARNING**

It is recommended that the assistance of an authorized LYNX dealer be periodically obtained on other components/systems not covered in this guide. Unless otherwise specified, engine must be cold and not running. Remove tether cord cap before performing any maintenance or adjustment, unless otherwise specified. Vehicle must be parked in a safe place, away from the trail.

### **WARNING**

Observe WARNINGS and CAUTIONS mentioned throughout this guide which are relevant to the item being checked. When component conditions seem less than satisfactory, replace with genuine BRP parts or approved equivalents.

Some items may not apply to your particular model.

# 2-STROKE MAINTENANCE CHART (FAN AND LIQUID COOLED)

A: ADJUST C: CLEAN I: INSPECT L: LUBRICATE R: REPLACE T: PROCEED WITH TASK	10-HOUR OR 500 KM INITIAL INSPECTION <sup>(1)</sup>										
	WEEKLY OR EVERY 250 KM <sup>(2)</sup>										
	MONTHLY OR EVERY 1000 KM <sup>(3)</sup>										
	ONCE A YEAR OR EVERY 3000 KM <sup>(1)</sup>										
	EVERY 2 YEARS OR 6000 KM <sup>(1)</sup> <sup>(4)</sup>										
	STORAGE <sup>(1)</sup>										
	PRESEASON <sup>(1)</sup>										
PART/TASK											
ENGINE											
Rewind starter and rope						I,L,C	I	<i>REWIND STARTER</i>			
Engine motor mounts	I			I	I			<i>ENGINE REMOVAL AND INSTALLATION</i>			
Exhaust system	I			I	I			<i>EXHAUST SYSTEM</i>			
Exhaust manifold screws	I						I				
Cooling system cap, hoses and clamps	I			I			I	<i>COOLING SYSTEM</i>			
Coolant	I				R						
Crankshaft PTO Seal <sup>(5)</sup>							I	<i>BOTTOM END</i>			
RAVE valves <sup>(5)</sup>				C				<i>TOP END</i>			
RAVE valves (E-TEC)	Clean every 3 years or 10000 km										
RAVE valves solenoid (not 593 SS)				I							
Air filter			I,C				I,C	<i>AIR INTAKE SYSTEM</i>			
Air silencer prefilter			I				I				
Engine lubrication						T		<i>STORAGE PROCEDURE</i>			
LUBRICATION SYSTEM											
Injection oil filter (All except E-TEC)					R			<i>OIL INJECTION SYSTEM</i>			
Oil injection pump (All except E-TEC)	A			A			A	<i>OIL INJECTION PUMP</i>			

A: ADJUST C: CLEAN I: INSPECT L: LUBRICATE R: REPLACE T: PROCEED WITH TASK	10-HOUR OR 500 KM INITIAL INSPECTION <sup>(1)</sup>									
	WEEKLY OR EVERY 250 KM <sup>(2)</sup>									
	MONTHLY OR EVERY 1000 KM <sup>(3)</sup>									
	ONCE A YEAR OR EVERY 3000 KM <sup>(1)</sup>									
	EVERY 2 YEARS OR 6000 KM <sup>(1)(4)</sup>									
	STORAGE <sup>(1)</sup>									
	PRESEASON <sup>(1)</sup>									
PART/TASK										
<b>FUEL SYSTEM</b>										
Add fuel stabilizer							T			<i>STORAGE PROCEDURE</i>
Fuel filter						R				<i>PRESEASON PREPARATION</i>
Fuel lines, fuel rail and connections	I				I				I	<i>FUEL SYSTEM</i>
Carburetor (All except SDI and E-TEC)									A,C	
Throttle cable	I				I				I	
Throttle	I				I	L			I	
Choke (All except SDI and E-TEC)	I				I				I	
Throttle body (SDI and E-TEC) <sup>(5)</sup>									C	<i>INJECTION SYSTEM</i>
<b>ELECTRICAL SYSTEM</b>										
EMS fault codes <sup>(5)</sup>	I						I			<i>MONITORING SYSTEM/FAULT CODES</i>
Spark plugs <sup>(5)(7)</sup>	I		I						R	<i>IGNITION SYSTEM</i>
Spark plugs (E-TEC)	Replace every 3 years or 10000 km									
Battery (if so equipped) <sup>(8)</sup>	I		I				I		I	<i>CHARGING SYSTEM</i>
Wiring harnesses and cables <sup>(5)</sup>	I		I				I			<i>ELECTRICAL CONNECTORS</i>
Operation of lighting system (HI/LO beam, taillight and brake light)	I	I					I			<i>LIGHTS, INSTRUMENTS AND ACCESSORIES</i>
Headlamp beam aiming					I				I	
Engine cut-out switch and tether cut-out switch operation test	I	I					I			

A: ADJUST C: CLEAN I: INSPECT L: LUBRICATE R: REPLACE T: PROCEED WITH TASK	10-HOUR OR 500 KM INITIAL INSPECTION <sup>(1)</sup>										
	WEEKLY OR EVERY 250 KM <sup>(2)</sup>										
	MONTHLY OR EVERY 1000 KM <sup>(3)</sup>										
	ONCE A YEAR OR EVERY 3000 KM <sup>(1)</sup>										
	EVERY 2 YEARS OR 6000 KM <sup>(1)(4)</sup>										
	STORAGE <sup>(1)</sup>										
PRESEASON <sup>(1)</sup>											
PART/TASK											
<b>DRIVE SYSTEM</b>											
Drive belt condition	I	I								I	<i>DRIVE BELT</i>
Drive belt height adjustment	EVERY BELT REPLACEMENT										
Drive and driven pulley	I		I	C			I			C	<i>DRIVE PULLEY and DRIVEN PULLEY</i>
Tightening torque of drive pulley screw	I			I							<i>DRIVE PULLEY</i>
Driven pulley preload <sup>(12)</sup>	I			I			I				
Drive chain tension (not for models equipped with gearbox)	A	A					A				<i>CHAINCASE OR GEARBOX</i>
Chaincase / Gearbox oil <sup>(9)</sup>	I <sup>(9)</sup>		I <sup>(9)</sup>	I <sup>(9)</sup>			R		I		
Drive axle end bearing (axle without brake disc) <sup>(6)</sup>	L		L				L				<i>DRIVE SYSTEM</i>
Drive axle end bearing (axle with brake disc)							I				
Countershaft (Fan cooled models) <sup>(6)</sup>	L		L				L				<i>COUNTERSHAFT AND BRAKE</i>
Track condition	I		I				I				<i>TRACK</i>
Track tension and alignment	A	AS REQUIRED									
<b>BRAKE SYSTEM</b>											
Brake fluid	I	I					R			I	<i>COUNTERSHAFT AND BRAKE</i>
Brake hose, pads and disk	I	I								I	

A: ADJUST C: CLEAN I: INSPECT L: LUBRICATE R: REPLACE T: PROCEED WITH TASK	<b>10-HOUR OR 500 KM INITIAL INSPECTION <sup>(1)</sup></b>											
	<b>WEEKLY OR EVERY 250 KM <sup>(2)</sup></b>											
	<b>MONTHLY OR EVERY 1000 KM <sup>(3)</sup></b>											
	<b>ONCE A YEAR OR EVERY 3000 KM <sup>(1)</sup></b>											
	<b>EVERY 2 YEARS OR 6000 KM <sup>(1)(4)</sup></b>											
	<b>STORAGE <sup>(1)</sup></b>											
	<b>PRESEASON <sup>(1)</sup></b>											
<b>PART/TASK</b>												
<b>SUSPENSION</b>												
Front suspension <sup>(6)(10)</sup>	I,L			I	L			I,L				<i>FRONT SUSPENSION</i>
Rear suspension <sup>(6)(10)</sup>	I			I,L				I,L				<i>REAR SUSPENSION</i>
Suspension stopper strap(s) <sup>(11)</sup>					I			I				
<b>STEERING SYSTEM</b>												
Steering mechanism <sup>(6)</sup>	A,I,L			A,I	L			A,I,L				<i>STEERING AND HANDLEBAR</i>
Skis and runners	I	I						I				<i>SKIS AND STEERING ALIGNMENT</i>
<b>VEHICLE</b>												
Engine compartment	C			C				C				<i>STORAGE PROCEDURE</i>
Vehicle cleaning and protection	T			T				T				

(1) TO BE PERFORMED BY AN AUTHORIZED LYNX DEALER.

(2) TO BE PERFORMED BY OWNER

(3) TO BE PERFORMED BY OWNER, OR BY AN AUTHORIZED LYNX DEALER IF REQUESTED.

(4) IN ADDITION TO EVERY 3000 KM SERVICE TASK.

(5) EMISSION-RELATED

(6) LUBRICATE WHENEVER THE VEHICLE IS USED IN WET CONDITIONS (WET SNOW, RAIN, PUDDLES).

(7) BEFORE INSTALLING NEW SPARK PLUGS AT PRESEASON PREPARATION, IT IS SUGGESTED TO BURN EXCESS STORAGE OIL BY STARTING THE ENGINE WITH THE OLD SPARK PLUGS. ONLY PERFORM THIS OPERATION IN A WELL-VENTILATED AREA.

(8) UNDER SUMMER STORAGE CHARGE THE BATTERY AT LEAST ONCE A MONTH.

(9) GEARBOX MODELS ONLY: OIL CHANGE, REPLACE AFTER 10 H / 500 KM SERVICE AND AFTER EVERY 3000 KM OR ONCE YEAR. OIL LEVEL MUST BE INSPECTED AFTER EVERY 1000 KM OR MONTHLY.

(10) IF YOUR SNOWMOBILE IS EQUIPPED WITH TAKE A PART SHOCK, FIRST OIL

CHANGE HAS TO BE PERFORMED AFTER 1500 KM OR EVEN BEFORE IN HARD USAGE. AFTER THAT ONCE A SEASON OR AFTER 3000 KM WHICH EVER OCCURS FIRST.

(11) CHANGE THE STOPPER STRAP AFTER EVERY 3000 KM (ONLY PPS REAR SUSPENSION)

(12) GEARBOX MODELS ONLY

# 4-STROKE MAINTENANCE CHART (V-800 AND 1203)

A: ADJUST C: CLEAN I: INSPECT L: LUBRICATE R: REPLACE T: PROCEED WITH TASK	10-HOUR OR 500 KM INITIAL INSPECTION <sup>(1)</sup>										
	WEEKLY OR EVERY 250 KM <sup>(2)</sup>										
	MONTHLY OR EVERY 1000 KM <sup>(3)</sup>										
	ONCE A YEAR OR EVERY 3000 KM <sup>(1)</sup>										
	EVERY 2 YEARS OR 6000 KM <sup>(1) (4)</sup>										
	STORAGE <sup>(1)</sup>										
	PRESEASON <sup>(1)</sup>										
PART/TASK											
ENGINE											
Oil and filter replacement	R					R	R				LUBRICATION SYSTEM
Engine supports	I				I		I				ENGINE REMOVAL AND INSTALLATION
Exhaust system	I				I		I				EXHAUST SYSTEM
Cooling system	I				I				I		COOLING SYSTEM
Coolant	I					R					
Condition of seals <sup>(5)</sup>	I								I		ENGINE
Valve adjustment (V-810)	I,T				I,T						CYLINDER AND HEAD
Valve adjustment (1203)	Every 20000 km										
Engine lubrication							T				STORAGE
FUEL											
Add fuel stabilizer							T				STORAGE
Fuel filter						R					FUEL TANK AND FUEL PUMP
Fuel lines and connections	I				I				I		ENGINE MANAGEMENT
Throttle body <sup>(5)</sup>									C		
Throttle cable	I				I				I		
Air filter			C						C		AIR INTAKE SYSTEM
Air intake system									I,C		

A: ADJUST C: CLEAN I: INSPECT L: LUBRICATE R: REPLACE T: PROCEED WITH TASK	<b>10-HOUR OR 500 KM INITIAL INSPECTION <sup>(1)</sup></b>									
	<b>WEEKLY OR EVERY 250 KM <sup>(2)</sup></b>									
	<b>MONTHLY OR EVERY 1000 KM <sup>(3)</sup></b>									
	<b>ONCE A YEAR OR EVERY 3000 KM <sup>(1)</sup></b>									
	<b>EVERY 2 YEARS OR 6000 KM <sup>(1) (4)</sup></b>									
	<b>STORAGE <sup>(1)</sup></b>									
<b>PRESEASON <sup>(1)</sup></b>										
<b>PART/TASK</b>										
<b>ELECTRICAL SYSTEM</b>										
EMS fault codes <sup>(5)</sup>	I					I				<i>DIAGNOSTIC PROCEDURE</i>
Spark plugs <sup>(7)</sup>	I					R				<i>SPARK PLUG</i>
Battery <sup>(8)</sup>	I		I				I	I		<i>BATTERY</i>
Headlamp beam aiming				I				I		<i>LIGHTS, INSTRUMENTS AND ACCESSORIES</i>
Wiring harnesses, cables and lines	I		I				I			<i>ELECTRONIC MANAGEMENT</i>
Operation of lighting system (HI/LO beam, brake light, etc.) test operation of engine cut-out switch and tether cut-out switch	I	I					I			<i>IGNITION SYSTEM</i>
<b>DRIVE SYSTEM</b>										
Drive belt condition	I	I						I		<i>DRIVE BELT</i>
Drive belt height adjustment	EACH BELT REPLACEMENT									
Drive and driven pulley	I		I	C			I	C		<i>DRIVE PULLEY AND DRIVEN PULLEY</i>
Drive pulley screw (torque)	I			I				I		<i>DRIVE PULLEY</i>
Driven pulley preload <sup>(11)</sup>	I			I				I		<i>DRIVEN PULLEY</i>
Drive chain tension (not for models equipped with gearbox)	A	A					A			<i>CHAINCASE</i>
Countershaft (RF V-810)	L	L					L			<i>COUNTERSHAFT AND BRAKE</i>
<b>BRAKE SYSTEM</b>										
Brake fluid	I	I				R		I		<i>BRAKE</i>
Brake hose, pads and disk	I	I						I		
<b>TRANSMISSION</b>										
Chaincase / Gearbox oil <sup>(9)</sup>	(9)		(9)	<sup>(9)</sup>			R	I		<i>GEARBOX OR CHAINCASE</i>
Drive axle end bearing (axle without brake disc) <sup>(6)</sup>	L		L				L			<i>DRIVE SYSTEM</i>
Drive axle end bearing (axle with brake disc)							I			



A: ADJUST C: CLEAN I: INSPECT L: LUBRICATE R: REPLACE T: PROCEED WITH TASK	<b>10-HOUR OR 500 KM INITIAL INSPECTION (1)</b>										
	<b>WEEKLY OR EVERY 250 KM (2)</b>										
	<b>MONTHLY OR EVERY 1000 KM (3)</b>										
	<b>ONCE A YEAR OR EVERY 3000 KM (1)</b>										
	<b>EVERY 2 YEARS OR 6000 KM (1) (4)</b>										
	<b>STORAGE (1)</b>										
<b>PRESEASON (1)</b>											
<b>PART/TASK</b>											
<b>SUSPENSION</b>											
Suspension adjustments	A	AS REQUIRED									<i>SUSPENSION AND SKI</i>
Suspension (10)	I	I	I,L				I,L				
Suspension stopper strap					I		I				
Track condition	I		I				I				
Track tension and alignment	A	AS REQUIRED									
<b>STEERING/FRONT SUSPENSION</b>											
Steering and front suspension mechanism lubrication (6)	A,I,L		A,I	L			A,I,L				<i>STEERING SYSTEM</i>
Wear and condition of skis and runners	I	I					I				
<b>VEHICLE</b>											
Engine compartment	C		C				C				
Vehicle cleaning and protection	C		C				C				

(1) TO BE PERFORMED BY AN AUTHORIZED LYNX DEALER.

(2) TO BE PERFORMED BY OWNER

(3) TO BE PERFORMED BY OWNER, OR BY AN AUTHORIZED LYNX DEALER IF REQUESTED.

(4) IN ADDITION TO EVERY 3000 KM SERVICE TASK.

(5) EMISSION-RELATED

(6) LUBRICATE WHENEVER THE VEHICLE IS USED IN WET CONDITIONS (WET SNOW, RAIN, PUDDLES).

(7) BEFORE INSTALLING NEW SPARK PLUGS AT PRESEASON PREPARATION, IT IS SUGGESTED TO BURN EXCESS STORAGE OIL BY STARTING THE ENGINE WITH THE OLD SPARK PLUGS. ONLY PERFORM THIS OPERATION IN A WELL-VENTILATED AREA.

(8) UNDER SUMMER STORAGE CHARGE THE BATTERY AT LEAST ONCE A MONTH.

(9) GEARBOX MODELS ONLY: OIL CHANGE, REPLACE AFTER 10 H / 500 KM SERVICE AND AFTER EVERY 3000 KM OR ONCE YEAR. OIL LEVEL MUST BE INSPECTED AFTER EVERY 1000 KM OR MONTHLY.

(10) IF YOUR SNOWMOBILE IS EQUIPPED WITH TAKE A PART SHOCK, FIRST OIL CHANGE HAS TO BE PERFORMED AFTER 1500 KM OR EVEN BEFORE IN HARD USAGE. AFTER THAT ONCE A SEASON OR AFTER 3000 KM WHICH EVER OCCURS FIRST.

(11) GEARBOX MODELS ONLY

# ENGINE SYSTEM

## Air Filter Cleaning

### 2-Stroke Engine



LH SIDE — AIR FILTER LOCATION

1. Air filter



1. Removal of filter from its grill

### 4-Stroke Engine

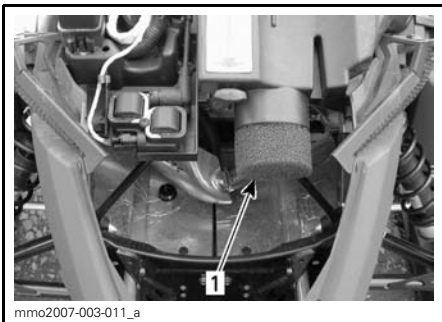

ENGINE COMPARTMENT— AIR FILTER LOCATION

1. Air filter



PULL ON FILTER TO REMOVE

### All Models

Check that the air silencer is clean and dry and properly reinstall the filter.

**CAUTION:** Snowmobile engines have been calibrated with the filters installed. Operating the snowmobile without them may cause engine damage.

### Coolant Level

#### 4-Stroke Engine

**CAUTION:** Vehicle must be on a level surface before checking any fluid levels.

Check coolant level at room temperature. Liquid should be between the minimum and maximum level lines (engine cold) of the overflow coolant tank and at the maximum level line for the coolant tank.

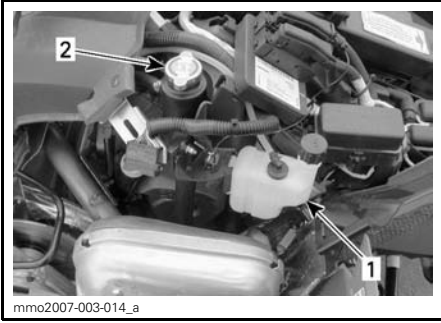

**ENGINE COMPARTMENT — LH SIDE**

1. Overflow coolant tank
2. Coolant tank

**NOTE:** When checking level at low temperature it may be slightly lower than the mark.

If additional coolant is necessary or if entire system has to be refilled, refer to an authorized LYNX dealer.

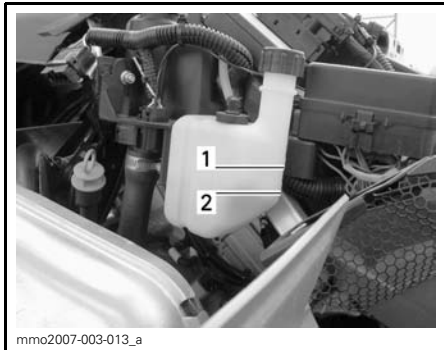

**OVERFLOW COOLANT TANK — LH SIDE**

1. Maximum coolant level
2. Minimum coolant level



**COOLANT TANK — LH SIDE**

1. Fill to maximum line if necessary

**Exhaust System**

The tail pipe of the muffler should be centered with the exit hole in the bottom pan. Exhaust system must be free of rust or leaks. Make sure that gear clamps are properly tightened.

The exhaust system is designed to reduce noise and to improve the total performance of the engine. Modification may be in violation of local laws.

**CAUTION:** If any exhaust system component is removed, modified or damaged, severe engine damage may result.

**Injection Oil Level**

**2-Stroke Engine**

Always maintain a sufficient amount of recommended injection oil in the injection oil reservoir.

**CAUTION:** Never allow oil reservoir to be almost empty. Do not mismatch oil reservoir cap with fuel tank cap. Install cap that is identified OIL.

**⚠ WARNING**

Check level and refill every time you refuel. Be careful not to overfill. Wipe off any spillage. Oil is highly flammable when heated.

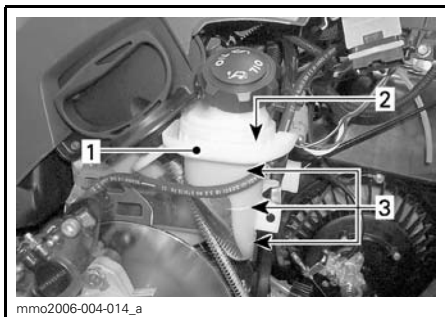

mmo2006-004-014\_a

**TYPICAL**

1. Injection oil reservoir
2. Maximum level indicator: 13 mm (1/2 in) from top
3. Level marks (1/4, 1/2, 3/4)

## Engine Oil Level

### 4-Stroke Engine

**CAUTION:** Check level frequently and refill if necessary. **Do not overfill.** Operating the engine with an improper level may severely damage engine. Wipe off any spillage.

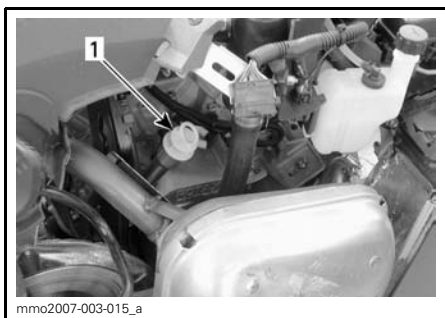

mmo2007-003-015\_a

**RH SIDE OF ENGINE COMPARTMENT**

1. Dipstick

With vehicle on a level surface and engine cold, not running, check the oil level as follows:

1. Remove dipstick and wipe clean.
2. Reinstall dipstick.
3. Remove and check oil level. It should be near or equal to the upper mark.

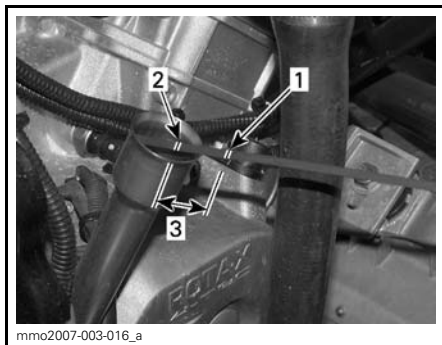

mmo2007-003-016\_a

1. Full
2. Add
3. Operating range

To add oil, remove dipstick. Place a funnel into the dipstick tube to avoid spillage.

Add a small amount of recommended oil and recheck oil level.

Repeat the above procedures until oil level reaches the dipstick's upper mark. **Do not overfill.**

Properly reinstall dipstick.

## Engine Oil/Oil Filter Change

### 4-Stroke Engine

Let snowmobile stand on a level surface.

1. Let engine run until it reach normal running temperature.
2. Shut off engine.
3. Remove dipstick.

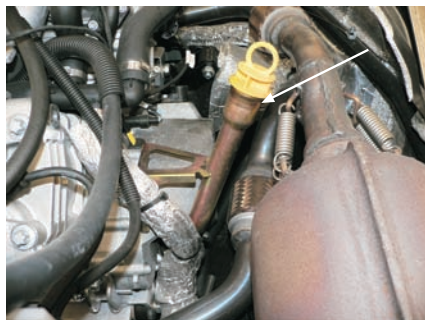

4. Open drainplug (1) and drain oil into the oil waste can.

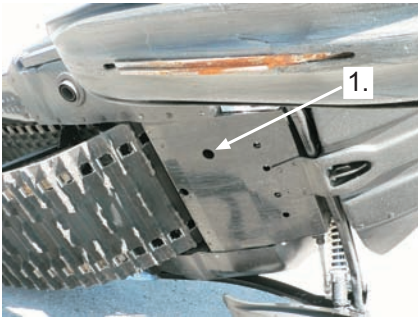

13. Run engine for a while and check that no oil leakage appear.

**⚠ WARNING**

Do not touch hot oil by hand !

**CAUTION:** Dispose used oil by following your local regulations.

5. Remove oilfilter (1) by open the filter cover and remove filter cartridge.

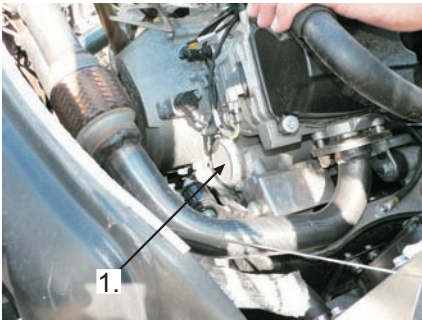

6. Replace by new oilfilter cartridge.
7. Fasten oilfilter cover.
8. Fasten drainplug.
9. Fill up recommended oil through dipstick pipe. (See quantity on TECHNICAL SPECIFICATION SECTION for specific model).
10. Check oil level by dipstick. Add oil if necessary to reach upper oil level mark.
11. Install dipstick carefully.
12. Run engine 30 seconds, shut off engine. Let engine be shut off 30 seconds and check oil level. Add oil if necessary to reach upper oil level mark.

## DRIVE SYSTEM

### Belt Guard Removal and Installation

#### WARNING

NEVER operate engine:

- without shields and belt guard securely installed
  - with hood opened or removed.
- NEVER attempt to make adjustments to moving parts while engine is running.

**NOTE:** Belt guard is purposely made slightly oversize to maintain tension on its pins and retainers preventing undue noise and vibration. It is important that this tension be maintained when reinstalling.

#### **2-Stroke Models**

- Remove tether cord cap.
- Open LH engine compartment.
- Open retainer to release pin then pull belt guard out of vehicle.

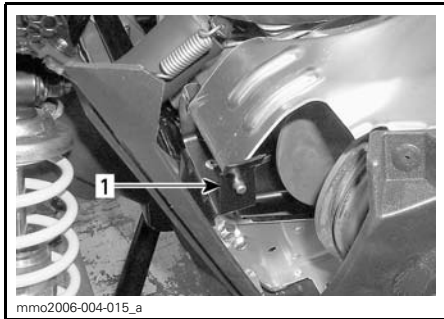

**TYPICAL**  
1. Pin retainer

When reinstalling belt guard, position its cutaway toward front of snowmobile.

Place belt guard slots over tabs first, then snap the other end in retainer.

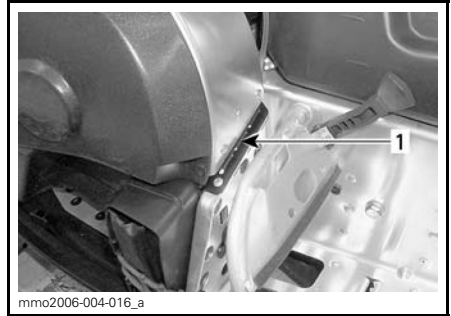

**TYPICAL**  
1. Slots

The installation is the reverse of removal procedure.

#### **4-Stroke Models**

##### **Removal**

- Remove tether cord cap.
- Open LH engine compartment.
- Remove retaining pin.



1. Retaining pin

Push on front tab to release belt guard retaining pin.

Pull on belt guard to remove.



mmo2007-003-019\_a

Step 1: Push on tab  
 Step 2: Pull on belt guard to remove

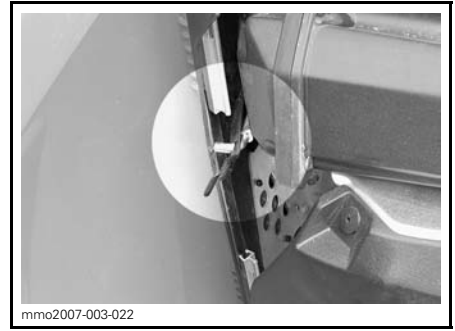

mmo2007-003-022

**FRONT RETAINING PIN PROPERLY SECURED**

## Installation

Insert rear portion of belt guard behind toolkit support.

Install rear retaining pin.

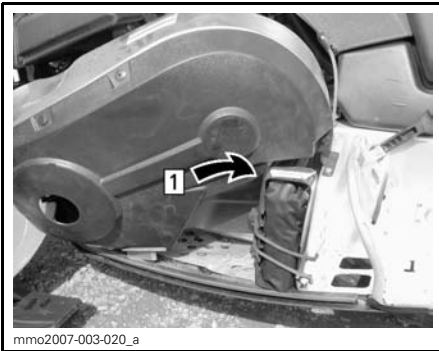

mmo2007-003-020\_a

Step 1: Insert rear portion first

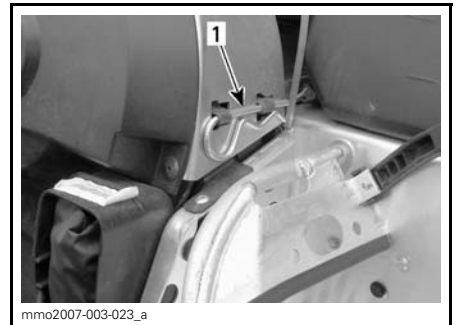

mmo2007-003-023\_a

1. Retaining pin

Position belt guard in place then secure front retaining pin on its support.

## Brake Fluid Level

**CAUTION:** Vehicle must be on a level surface before checking any fluid levels.

Check brake fluid (DOT 4) in reservoir for proper level. Add fluid (DOT 4) as required.

**CAUTION:** Use only DOT 4 brake fluid from a sealed container. Never use any other types of fluid.

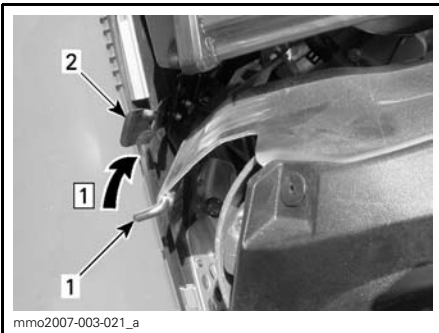

mmo2007-003-021\_a

1. Retaining pin  
 2. Support

Step 1: Secure retaining pin on its support



1. Brake fluid reservoir

## Brake Condition

### WARNING

The brake mechanism on your snowmobile is an essential safety device. Keep this mechanism in proper working condition. Above all, do not operate the snowmobile without an effective brake system. Periodically verify the condition/wear of the brake pads.

## Brake Adjustment

No adjustment is provided for hydraulic brake. See an authorized LYNX dealer if any problems.

## Chaincase Oil Level

**CAUTION:** Vehicle must be on a level surface before checking any fluid levels.

With snowmobile on a level surface, check the oil level by removing dipstick. Oil level must be between lower and upper marks.

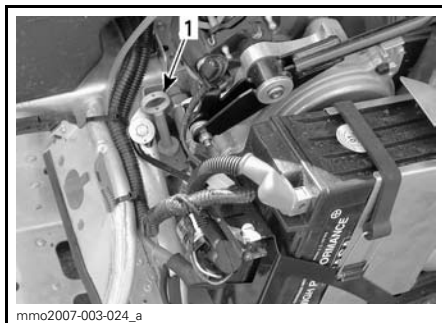

TYPICAL — RH SIDE OF ENGINE COMPARTMENT

1. Dipstick location

**NOTE:** It is normal to find metallic particles stuck to dipstick magnet. If bigger pieces of metal are found, see an authorized LYNX dealer.

Remove metal particles from magnet.

Refill up to upper mark using recommended oil, refer to *SPECIFICATIONS*.

**CAUTION:** Do not use other un-recommended types of oil when servicing. Do not mix synthetic oil with other types of oil.

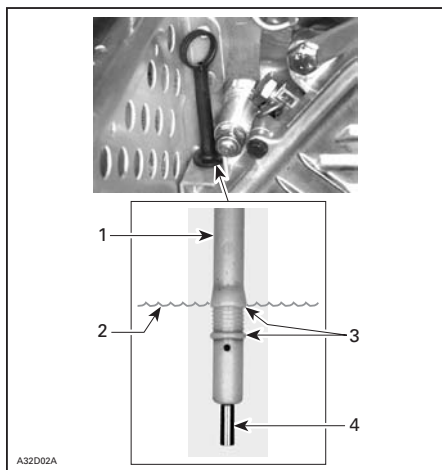

### TYPICAL

1. Dipstick
2. Oil level
3. Level between marks
4. Magnet



## Chaincase Oil Change

Let snowmobile stand on a level surface.

- 1) Remove dipstick (1).



- 2) Open the drainplug (1) and let oil run out from chaincase into a oil waste can.



- 3) Fasten the drainplug.
- 4) Fill up with recommended oil through dipstick hole (see TECHNICAL SPECIFICATION SECTION for oil type and capacity).
- 5) Check oil level by dipstick. Add if necessary to reach upper level mark.



- 6) Install dipstick properly.

**CAUTION:** Dispose used oil by following your local regulations.

## Drive Chain Tension

Remove hair pin.

Fully tighten tensioner adjustment screw by hand, then back off only far enough for hair pin to engage in locking hole.

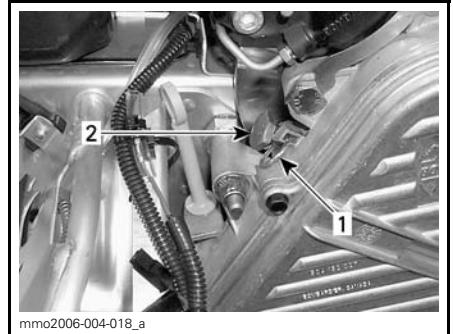

TYPICAL — RH SIDE OF ENGINE COMPARTMENT

1. Hair pin
2. Adjustment screw

## Drive Belt Condition

Inspect belt for cracks, fraying or abnormal wear (uneven wear, wear on one side, missing cogs, cracked fabric). If abnormal wear is noted, probable cause could be pulley misalignment, excessive RPM with frozen track, fast starts without warm-up period, burred or rusty sheave, oil on belt or distorted spare belt. Contact an authorized LYNX dealer.

## Drive Belt Removal/Installation

### **⚠ WARNING**

Remove tether cord cap before performing any maintenance or adjustment, unless otherwise specified. Vehicle must be parked in a safe place, away from the trail.

## Removal

**NOTE:** Removal and installation of drive belt is easier when driven pulley is held with brake so that it can not rotate. Apply parking brake, for this purpose.

Remove tether cord cap. Open engine compartment LH panel and remove belt guard.

Open the driven pulley with the drive belt installer/remover provided in tool bag.

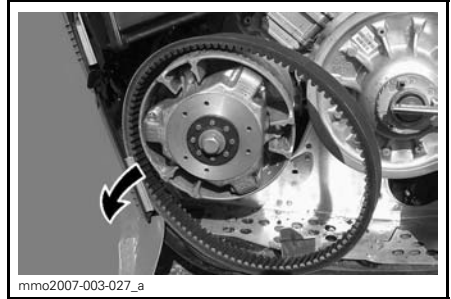

**TYPICAL**

Clean sheaves of both pulleys using Pulley flange cleaner (P/N 413 711 809).

## Installation

To install the drive belt, reverse the removal procedure, however pay attention to the following:

The maximum drive belt life span is obtained when the belt has the proper rotation direction. See arrow on belt.

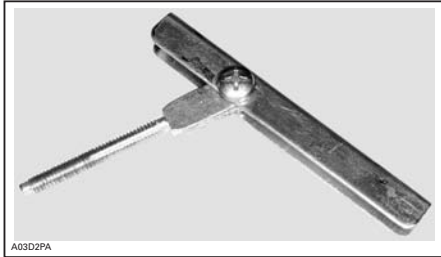

**DRIVE BELT INSTALLER/REMOVER**

Screw drive belt installer/remover in the free threaded hole and tighten to open the pulley. Remove belt.

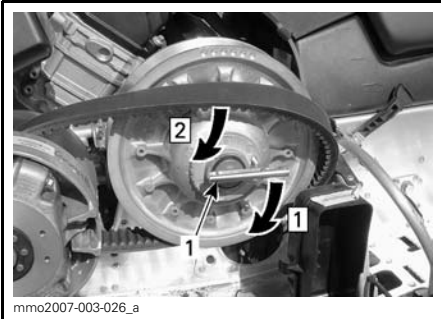

1. Drive belt installer/remover
- Step 1: Tighten to open pulley
- Step 2: Remove belt

Slip the belt over the top edge of the sliding half of driven pulley, as shown in previous photo.

Slip belt under drive pulley then, remove it from vehicle.

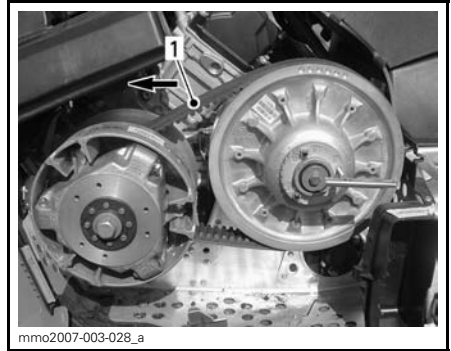

**TYPICAL**

1. Arrow pointing front of vehicle

**CAUTION:** Do not force or use tools to pry the belt into place, as this could cut or break the cords in the belt.

To install the drive belt, first place belt between drive pulley sheaves. Then, between driven pulley sheaves, finishing with bottom.

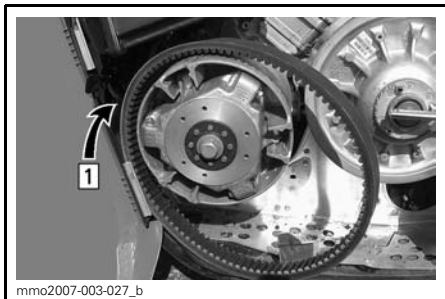

mmo2007-003-027\_b

Step 1: Place belt between drive pulley sheaves

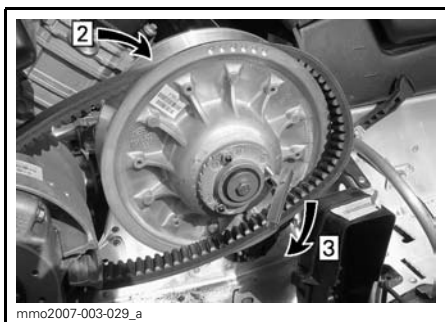

mmo2007-003-029\_a

Step 2: Then, between driven pulley sheaves

Step 3: Finish with bottom

Remove drive belt installer/remover. Reinstall belt guard.

Close LH side panel.

## Drive Belt Height Adjustment

To obtain maximum vehicle performance and drive belt longevity, drive belt height adjustment must be performed every time a new drive belt is installed.

**NOTE:** If correct adjustment is unattainable, contact an authorized LYNX dealer.

The drive belt cord should be flush with driven pulley edge. Adjust as required.

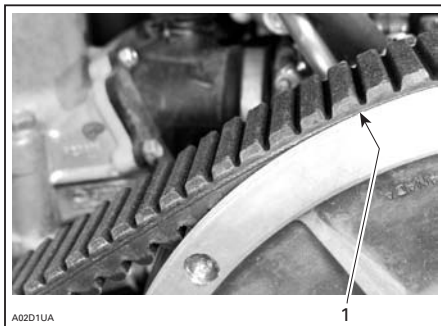

A02D1UA

TYPICAL

1. Flush

### Fan Cooled Models

To Lower Drive Belt in the Driven Pulley:



mmr2006-028-002

- Loosen both driven pulley adjusting nuts.

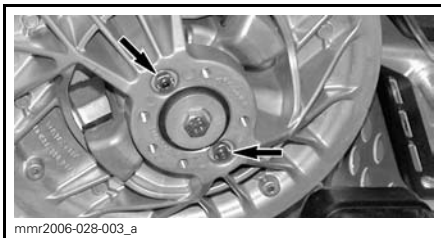

mmr2006-028-003\_a

- Turn Allen screws clockwise. Turn Allen screws 1/4 turn at a time, then rotate driven pulley to allow drive belt to settle in pulley. Check height, repeat as required.
- Torque adjusting nuts to 7.5 N•m (66 lbf•in).

## To Raise Drive Belt in the Driven Pulley:



- Loosen both driven pulley adjusting nuts.

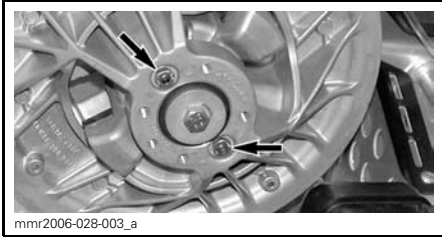

- Turn Allen screws counterclockwise. Turn Allen screws 1/4 turn at a time, then rotate driven pulley to allow drive belt to settle in pulley. Check height, repeat as required.
- Torque adjusting nuts to 7.5 N•m (66 lbf•in).

### **Liquid Cooled Models**

Loosen screws and turn adjustment ring as follows:

- To lower belt in driven pulley: turn adjustment ring counterclockwise and tighten the screws.
- To raise belt in driven pulley: turn ring clockwise and tighten the adjustment screws.

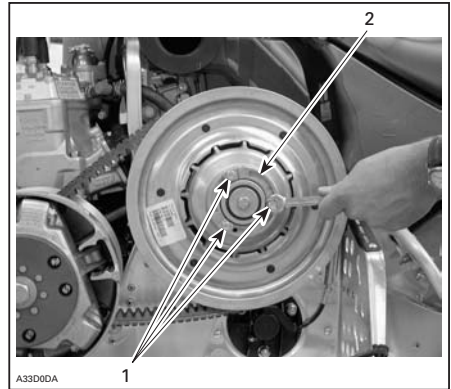

1. Screws
2. Adjustment ring

Turn the adjustment ring up to one notch, tighten the screws, then rotate driven pulley to allow drive belt to settle in pulley. Check height, if required the adjustment ring can be turned up to 1/4 or 1/2 the notch. Check height, repeat as required.



### **DRIVEN PULLEY NOTCHES**

**NOTE:** Notches are there on the driven pulley for reference purpose only and the desired adjustment can be attained at any point.

# Drive Pulley Adjustment

## 4-Stroke Models Only

### **WARNING**

Remove tether cord cap before performing any maintenance or adjustment, unless otherwise specified. Vehicle must be parked in a safe place, away from the trail.

### General

The drive pulley is factory calibrated to transmit maximum engine power at a predefined RPM. Refer to *SPECIFICATIONS* section in this guide. Factors such as ambient temperature, altitude or surface condition may vary this critical engine RPM thus affecting snowmobile efficiency.

This adjustable drive pulley allows setting maximum engine RPM in the vehicle to maintain maximum power.

Calibration screws should be adjusted so that actual maximum engine RPM in vehicle matches with the maximum horsepower RPM.

**NOTE:** Use precision digital tachometer for engine RPM adjustment.

**NOTE:** The adjustment has an effect on high RPM only.

Calibration screw has a notch on top of its head.

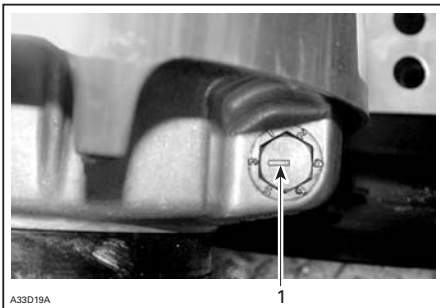

1. Notch

There are 6 positions numbered 1 to 6. On TRA drive pulley, note that in position 1 the number is substituted by a dot (due to its location on casting).

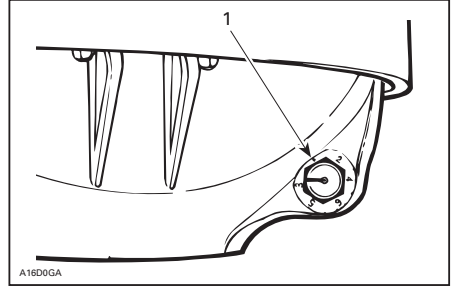

### TRA DRIVE PULLEY

1. Position 1 (not numbered)

Each position modifies maximum engine RPM by about 200 RPM.

Lower position numbers decrease engine RPM in steps of 200 RPM and higher position numbers increase it in steps of 200 RPM.

Example:

Calibration screw is set at position 4 and is changed to position 6. So maximum engine RPM is increased by 400 RPM.

### Adjustment

Just loosen locking nut enough to pull calibration screw partially out and adjust to desired position. Do not completely remove the locking nut. Torque locking nuts to 10 N•m (89 lbf•in).

**CAUTION:** Do not completely remove calibration screw otherwise internal washers will fall off. Always adjust all 3 calibration screws and make sure they are all set to the same position.

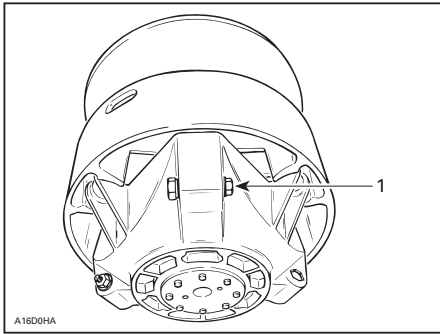

**TYPICAL**

1. Loosen just enough to permit rotating of calibrate screw

**⚠ WARNING**

**NEVER** disassemble or modify the drive pulley.

Improper assembly or modifications could cause the pulley to explode violently under the stress generated by the high rotational speed. This could lead to serious injury including the possibility of death.

See your LYNX dealer to maintain or service the drive pulley. Improper servicing or maintenance may affect performance and reduce belt life. Always respect maintenance schedules.

**⚠ WARNING**

**NEVER** operate engine:

- without shields and belt guard securely installed
  - with hood opened or removed.
- NEVER** attempt to make adjustments to moving parts while engine is running.

**Track Condition**

**⚠ WARNING**

Remove tether cord cap before performing any maintenance or adjustment, unless otherwise specified. Vehicle must be parked in a safe place, away from the trail.

Remove tether cord cap.

Lift the rear of the snowmobile and support it with a wide-base snowmobile mechanical stand with a rear deflector panel. With the engine off, rotate the track by hand, and inspect condition. If worn or cut, or if track fibers are exposed, or if missing or defective inserts or guides are noted; contact an authorized LYNX dealer.

**Snowmobiles Equipped with Traction Enhancing Products**

If your snowmobile is equipped with a BRP approved studded track or a Ice Series pre-studded track, **PROCEED WITH A VISUAL INSPECTION OF YOUR TRACK BEFORE EACH USE.**

Look for any defects, such as:

- perforations in the track
- tears in the track (particularly around traction holes on studded tracks)
- lugs that are broken or torn off, exposing portions of rods
- delamination of the rubber
- broken rods
- broken studs (studded tracks)
- bent studs (studded tracks)
- missing studs
- studs that are torn off the track
- missing track guide(s).

On Ice Series pre-studded tracks, broken or missing studs can not be replaced.

On approved studded tracks, replace broken or damaged studs immediately. If your track shows signs of deterioration, it must be replaced immediately. When in doubt, ask your dealer.

**⚠ WARNING**  
 Riding with a damaged track or studs could lead to a loss of control, resulting in a risk of serious injury or death.

For complete information on traction enhancing products, please refer to the section entitled *TRACTION ENHANCING PRODUCTS* in the *SAFETY INFORMATION* section at the beginning of this Operator's Guide.

**Track Tension and Alignment**

**NOTE:** Track tension and alignment are interrelated. Do not adjust one without the other.

**⚠ WARNING**  
 To prevent serious injury to individuals near the snowmobile:

- NEVER stand behind or near a moving track
- always use a wide-base snowmobile stand with a rear deflector panel
- when the track is raised off the ground, only run it at the lowest possible speed.

Centrifugal force could cause debris, damaged or loose studs, pieces of torn track, or an entire severed track to be violently thrown backwards out of the tunnel with tremendous force, possibly resulting in the loss of a leg or other serious injury.

**Tension**

**NOTE:** Ride the snowmobile in snow about 15 to 20 minutes prior to adjusting track tension.

Remove the tether cord cap.

Lift rear of snowmobile and support it with a wide-base snowmobile mechanical stand.

Allow the suspension to extend normally and check gap halfway between front and rear idler wheels. Measure between slider shoe bottom and inside of track. The gap should be as given in *SPECIFICATIONS* in this guide. If the track tension is too loose, track will have a tendency to thump.

**NOTE:** A belt tension tester (P/N 414 348 200) may be used to measure deflection as well as force applied.

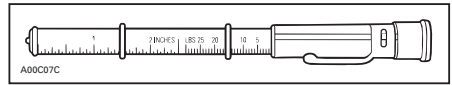

*BELT TENSION TESTER*

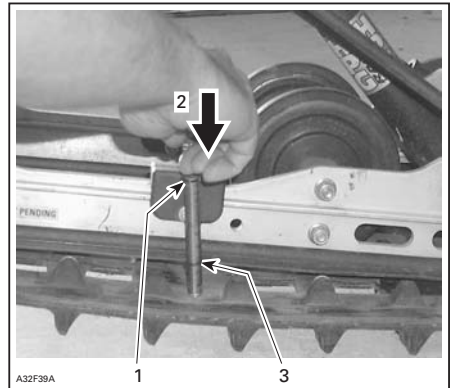

**TYPICAL**

1. Top tool O-ring positioned at 7.3 kg (16 lb)
2. Push on top portion of tool until it contacts the top O-ring
3. Measured track deflection

**CAUTION:** Too much tension will result in power loss and excessive stresses on suspension components.

To adjust track tension:

- Remove the tether cord cap.
- On some models, remove rear wheel caps.

- Loosen the rear idler wheel retaining screws.
- Turn adjustment screws to adjust.

If correct tension is unattainable, contact an authorized LYNX dealer.

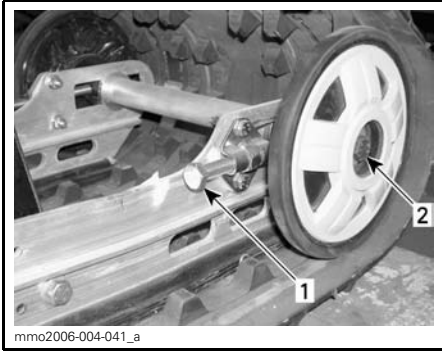

mmo2006-004-041\_a

- TYPICAL — SC**
1. Adjustment screw
  2. Loosen screw

- Retighten retaining screws and lock nuts (on so equipped models).
- Check track alignment as described below.

### Alignment

#### **WARNING**

Before checking track alignment, ensure that the track is free of all particles which could be thrown out while track is rotating. Keep hands, tools, feet and clothing clear of track. Always lift the snowmobile on a wide-base stand with a rear deflector panel. Ensure no one is standing in close proximity to the snowmobile, especially at the rear of the track. Never rotate track at high speed. Centrifugal force could cause debris, damaged or loose studs, pieces of torn track, or an entire severed track to be violently thrown backwards out of the tunnel with tremendous force, possibly resulting in the loss of a leg or other serious injury.

Start the engine and accelerate slightly so that track barely turns. This must be done in a short period of time (15 to 20 seconds).

Check that the track is well centered; equal distance on both sides between edges of track guides and slider shoes.

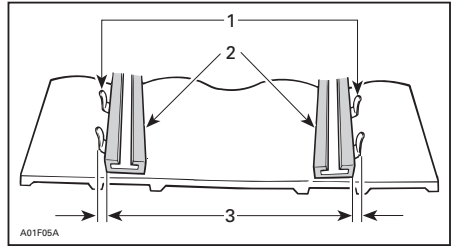

1. Guides
2. Slider shoes
3. Equal distance

### To Adjust Track Alignment:

#### **WARNING**

Remove tether cord cap before performing any maintenance or adjustment, unless otherwise specified. Vehicle must be parked in a safe place, away from the trail.

- Remove the tether cord cap.
- Loosen rear idler wheel retaining screws.
- Loosen the lock nuts (on so equipped models).
- Tighten the adjustment screw on side where the slider shoe is the farthest from the track insert guides.

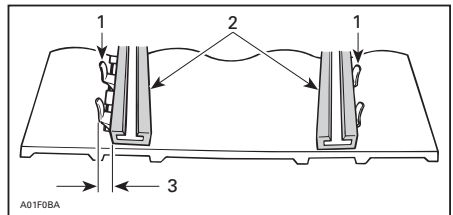

1. Guides
2. Slider shoes
3. Tighten on this side



Tighten lock nuts (some models only) and retaining screws.

**⚠ WARNING**

If lock nuts are not tightened properly, the adjusting screws could loosen causing the track to become extremely loose and, under some operating conditions, allow the idler wheels to climb over the track lugs forcing the track against the tunnel causing the track to "lock". Properly tighten wheel retaining screws, otherwise wheel may come off and cause track to "lock".

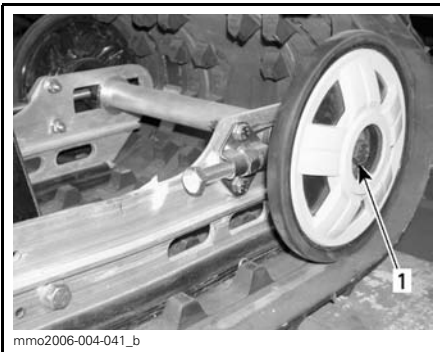

**TYPICAL — SC**

1. Retighten to 48 N•m (35 lbf•ft)

Restart engine and rotate track slowly to recheck alignment.

Reposition snowmobile on ground.

Install rear wheel caps if so equipped.

---

# ELECTRICAL SYSTEM

## Battery Electrolyte

### *Electric Start Models Only*

These vehicles are equipped with a maintenance-free battery. Electrolyte level can not be checked.

#### **WARNING**

BLACK negative battery cable must always be disconnected first and connected last.

#### **WARNING**

Never charge or boost battery while installed. Battery electrolyte contains sulfuric acid which is corrosive and poisonous. In case of contact with skin, flush with water and call a physician immediately.

#### **WARNING**

Should the battery casing be damaged, wear a suitable pair of non-absorbent gloves when removing the battery by hand.

**CAUTION:** Should any electrolyte spillage occur, immediately wash off with a solution of baking soda and water to prevent damage to vehicle components.

**CAUTION:** Battery has to be charged at least once a month during storage.

---

## REAR SUSPENSION

### **Rear Suspension Condition**

Visually inspect all suspension components including slider shoes, springs, wheels, etc.

**NOTE:** During normal driving, snow will act as a lubricant and coolant for the slider shoes. Extensive riding on ice or sanded snow, will create excessive heat build-up and cause premature slider shoe wear.

### **Suspension Stopper Strap Condition**

Inspect stopper strap for wear and cracks, bolt and nut for tightness. If loose inspect holes for deformation. Replace as required. Torque nut to 11 N•m (97 lbf•in).

---

## STEERING AND FRONT SUSPENSION

Visually inspect steering and front suspension for tightness of components (steering arms, control arms and links, tie rods, ball joints, ski bolts, ski legs, etc.). If necessary, contact an authorized LYNX dealer.

### **Wear and Condition of Skis and Runners**

Check the condition of the skis, ski runners and ski runner carbides (if so equipped). If worn, contact an authorized LYNX dealer.



#### **WARNING**

Excessively worn skis and/or ski runners will adversely affect snowmobile control.

---

## BODY/FRAME

### Vehicle Cleaning and Protection

Remove any dirt or rust.

To clean the entire vehicle, use only flannel cloths or equivalent.

**CAUTION:** It is necessary to use flannel cloths or equivalent on windshield and hood to avoid damaging further surfaces to clean.

To clean the entire vehicle, including bottom pan and metallic parts use Heavy duty cleaner (P/N 293 110 001) (spray can 400 g) and (P/N 293 110 002) (4 L).

**CAUTION:** Do not use Heavy duty cleaner on decals or vinyl.

For vinyl and plastic parts use Vinyl & Plastic Cleaner (P/N 413 711 200) (6 x 1 L).

To remove scratches on windshield or hood use the Scratch Remover Kit (P/N 861 774 800).

**CAUTION:** Never clean plastic parts or hood with strong detergent, degreasing agent, paint thinner, acetone, products containing chlorine, etc.

Clean sheaves of both pulleys using Pulley flange cleaner (P/N 413 711 809).

Inspect the hood and repair any damage.

Touch up all metal spots where paint has been scratched off. Spray all metal parts including shock chromed rods with XP-S Lube (P/N 293 600 016).

Wax the hood and the painted portion of the frame for better protection.

**NOTE:** Apply wax on glossy finish only. Protect the vehicle with a cover to prevent dust accumulation during storage.

**CAUTION:** The snowmobile has to be stored in a cool and dry place and covered with an opaque tarpaulin. This will prevent sun rays and grime from affecting plastic components and vehicle finish.

Lift rear of vehicle until track is clear of the ground. Install on a wide-base snowmobile mechanical stand with a rear deflector panel.

### WARNING

Do not attempt to lift the vehicle by hand alone. Use appropriate lifting device or have assistance to share lifting stress in order to avoid risk of strain injuries.

**NOTE:** Do not release track tension.

### Bulb Replacement

Always check light operation after bulb replacement.

### Headlamp

**CAUTION:** Never touch glass portion of an halogen bulb with bare fingers, it shortens its operating life. If glass is touched, clean it with isopropyl alcohol which will not leave a film on the bulb.

Unplug burnt bulb connector.

Turn bulb locking ring counterclockwise to remove it. Detach the bulb and replace. Properly reinstall parts.



mmo2006-004-042\_a

1. Locking ring

## Taillight

If taillight bulb is burnt, expose the bulb by removing the red plastic lens. To remove, unscrew the 2 lens screws.

## Headlamp Beam Aiming

Open left side panel. Turn screw to adjust beam height.



mmo2006-004-042\_b

1. Screw

---

## STORAGE AND PRESEASON PREPARATION

### **WARNING**

Have an authorized LYNX dealer inspect fuel and oil systems integrity as specified in *PERIODIC MAINTENANCE CHART*.

### **Storage**

It is during summer, or when a snowmobile is not in use for more than one month that proper storage is a necessity.

To prepare your snowmobile, refer to an authorized LYNX dealer.

### **Preseason Preparation**

Refer to an authorized LYNX dealer.

**CAUTION:** Have carburetor(s) cleaned-up before restarting engine.





# ***WARRANTY***

---

# **BRP FINLAND OY INTERNATIONAL LIMITED WARRANTY: 2009 LYNX® SNOWMOBILES**

## **1) SCOPE OF THE LIMITED WARRANTY**

BRP Finland Oy ("BRP") warrants its 2009 LYNX snowmobiles from defects in material or workmanship for the period and under the conditions described below.

All genuine LYNX parts and accessories, installed by an authorized BRP distributor/dealer (as hereinafter defined) at the time of delivery of the 2009 LYNX snowmobile, carry the same warranty as that of the snowmobile.

Use of the product for racing or any other competitive activity, at any point, even by a previous owner, will render this warranty null and void.

## **2) WARRANTY COVERAGE PERIOD**

This warranty will be in effect from the date of delivery to the first retail consumer or the date the product is first put into use, whichever occurs first and for a period of:

A) TWELVE (12) CONSECUTIVE MONTHS, for private use owners

B) TWELVE (12) CONSECUTIVE MONTHS, for commercial use owners

C) TWENTY FOUR (24) CONSECUTIVE MONTHS, for private use owners when product was sold in a member state of the European Union. The repair or replacement of parts or the performance of service under this warranty does not extend the life of this warranty beyond its original expiration date.

## **3) CONDITIONS TO HAVE WARRANTY COVERAGE**

This warranty coverage is available only on 2009 LYNX snowmobile purchased as new and unused by its first owner from a BRP distributor/dealer authorized to distribute LYNX products in the country in which the sale occurred ("BRP distributor/dealer"), and then only after the BRP specified pre-delivery inspection process is completed and documented. Warranty coverage only becomes available upon proper registration of the product by an authorized BRP distributor/dealer. Moreover, this warranty coverage is only available if the LYNX snowmobile is purchased in the country in which the purchaser resides. BRP will not honor this limited warranty to any private use owner or commercial use owner if the preceding conditions have not been met. Such limitations are necessary in order to allow BRP to preserve both the safety of its products, and also that of its consumers and the general public.

Routine maintenance outlined in the Operator's Guide must be timely performed in order to maintain warranty coverage. BRP reserves the right to make warranty coverage contingent upon proof of proper maintenance.

## **4) WHAT TO DO TO OBTAIN WARRANTY COVERAGE**

The customer must notify a servicing BRP distributor/dealer within two (2) months of the appearance of a defect, and provide it with reasonable access to the product and reasonable opportunity to repair it. The customer must also present to the authorized BRP distributor/dealer, proof of purchase of the product and must sign the repair/work order prior to starting the repair in order to validate the warranty repair. All parts replaced under this limited warranty become the property of BRP.

## **5) WHAT BRP WILL DO**

BRP's obligations under this warranty are limited to, at its sole discretion, repairing parts found defective under normal use, maintenance and service, or replacing such parts with new genuine LYNX parts without charge for parts and labor, at any authorized BRP distributor/dealer during the warranty coverage period.

BRP reserves the right to improve or modify products from time to time without assuming any obligation to modify products previously manufactured.

## **6) EXCLUSIONS**

The following are not warranted under any circumstances:

- Normal wear and tear;
- Routine maintenance items, tune ups, adjustments;
- Damage caused by failure to provide proper maintenance and/or storage, as described in the Operator's Guide;
- Damage resulting from removal of parts, improper repairs, service, maintenance, modifications or use of parts not manufactured or approved by BRP or resulting from repairs done by a person that is not an authorized servicing BRP distributor/dealer;
- Damage caused by abuse, abnormal use, neglect, use of the product on surfaces other than snow, or operation of the product in a manner inconsistent with the recommended operation described in the Operator's Guide;
- Damage resulting from accident, submersion, fire, theft, vandalism or any act of God;
- Operation with fuels, oils or lubricants which are not suitable for use with the product (see the Operator's Guide);
- Snow or water ingestion;
- Incidental or consequential damages, or damages of any kind including without limitation towing, storage, telephone, rental, taxi, inconvenience, insurance coverage, loan payments, loss of time, loss of income; and
- Damage resulting from studs installed on tracks if the installation does not conform to BRP's instructions.

## **7) LIMITATIONS OF LIABILITY**

THIS WARRANTY IS EXPRESSLY GIVEN AND ACCEPTED IN LIEU OF ANY AND ALL OTHER WARRANTIES, EXPRESSED OR IMPLIED, INCLUDING WITHOUT LIMITATION ANY WARRANTY OF MERCHANTABILITY OR FITNESS FOR A PARTICULAR PURPOSE. TO THE EXTENT THAT THEY CANNOT BE DISCLAIMED, THE IMPLIED WARRANTIES ARE LIMITED IN DURATION TO THE LIFE OF THE EXPRESS WARRANTY. INCIDENTAL AND CONSEQUENTIAL DAMAGES ARE EXCLUDED FROM COVERAGE UNDER THIS WARRANTY. SOME STATES/ PROVINCES DO NOT ALLOW FOR THE DISCLAIMERS, LIMITATIONS AND EXCLUSIONS IDENTIFIED ABOVE, AS A RESULT, THEY MAY NOT APPLY TO YOU. THIS WARRANTY GIVES YOU SPECIFIC RIGHTS, AND YOU MAY ALSO HAVE OTHER LEGAL RIGHTS WHICH MAY VARY FROM STATE TO STATE, OR PROVINCE TO PROVINCE.

Neither the distributor, any BRP distributor/dealer nor any other person has been authorized to make any affirmation, representation or warranty regarding the product, other than those contained in this limited warranty, and if made, shall not be enforceable against BRP.

BRP reserves the right to modify this warranty at any time, being understood that such modification will not alter the warranty conditions applicable to the products sold while this warranty is in effect.

## **8) TRANSFER**

If the ownership of a product is transferred during the warranty coverage period, this warranty shall also be transferred and be valid for the remaining coverage period provided BRP or an authorised BRP distributor / dealer receives a proof that the former owner agreed to the transfer of ownership, in addition to the co-ordinates of the new owner.

## **9) CONSUMER ASSISTANCE**

- a) In the event of a controversy or a dispute in connection with this limited warranty, BRP suggests that you try to resolve the issue at the dealership level. We recommend discussing the issue with the authorized distributor/dealer's service manager or owner.
- b) If further assistance is required, the distributor's service department should be contacted in order to resolve the matter.
- c) If the matter still remains unresolved then contact BRP by writing to us at the address below.

### **ADDRESS:**

BRP-FINLAND OY  
SERVICE DEPARTMENT  
P.O. BOX 8039  
FIN-96101 ROVANIEMI  
FINLAND

© 2008 Bombardier Recreational Products Inc. All rights reserved.

® Registered trademark of Bombardier Recreational Products Inc.

---

## **PRIVACY OBLIGATIONS/DISCLAIMER**

We wish to inform you that your coordinates will be used for safety and warranty purposes. Sometimes, we also use the coordinates of our clients to inform them about our products and to present them offers. Should you prefer not to receive information on our products, services and offers, please let us know by writing to the address below.

Also note that, from time to time, carefully selected and trustworthy organizations may be permitted to use the coordinates of our clients to promote quality products and services. If you prefer not to have your name and address released, please let us know by writing to the address below:

### **FOR SCANDINAVIAN AND EUROPEAN COUNTRIES:**

**BRP FINLAND OY**  
Service Department  
Ahjotie 30  
FIN-96320 Rovaniemi  
Finland  
Fax +358 16 3420 316

---

## **CHANGE OF ADDRESS/OWNERSHIP**

If your address has changed or if you are the new owner of the vehicle, be sure to notify BRP by either:

- mailing one of the cards hereinafter using of the following mail address;
- contacting an authorized LYNX dealer or distributor.

Mail address:

### **FOR SCANDINAVIAN AND EUROPEAN COUNTRIES:**

**BRP FINLAND OY**  
Service Department  
Ahjotie 30  
FIN-96320 Rovaniemi  
Finland  
Fax: +358 16 3420 316

In case of change of ownership, please join a proof that the former owner agreed to the transfer.

Notifying BRP, even after the expiration of the limited warranty, is very important as it enables BRP to reach the vehicle owner if necessary, like when safety recalls are initiated. It is the owner's responsibility to notify BRP.

**STOLEN UNITS:** If your personal vehicle is stolen, you should notify BRP or an authorized LYNX dealer. We will ask you to provide your name, address, phone number, the vehicle identification number and the date it was stolen.





CHANGE OF ADDRESS

CHANGE OF OWNERSHIP

VEHICLE IDENTIFICATION NUMBER

Model Number

Vehicle Identification Number (V.I.N.)

Model Number

Vehicle Identification Number (V.I.N.)

OLD ADDRESS  
OR PREVIOUS OWNER:

NAME

NO.

STREET

APT

CITY

STATE/PROVINCE

ZIP/POSTAL CODE

COUNTRY

TELEPHONE

NEW ADDRESS  
OR NEW OWNER:

NAME

NO.

STREET

APT

CITY

STATE/PROVINCE

ZIP/POSTAL CODE

COUNTRY

TELEPHONE

V00A2F



CHANGE OF ADDRESS

CHANGE OF OWNERSHIP

VEHICLE IDENTIFICATION NUMBER

Model Number

Vehicle Identification Number (V.I.N.)

Model Number

Vehicle Identification Number (V.I.N.)

OLD ADDRESS  
OR PREVIOUS OWNER:

NAME

NO.

STREET

APT

CITY

STATE/PROVINCE

ZIP/POSTAL CODE

COUNTRY

TELEPHONE

NEW ADDRESS  
OR NEW OWNER:

NAME

NO.

STREET

APT

CITY

STATE/PROVINCE

ZIP/POSTAL CODE

COUNTRY

TELEPHONE

V00A2F







**LYNX**



[brp.com](http://brp.com)