

LYNX



LEON VALLEY



2009

Operator's manual 2009

EN

OPERATOR'S MANUAL LYNX® 2009

RAVE™ FC 550
Xtrim™ FC 550
Adventure™ LX 550

SAFETY WARNING

Disregarding any of the safety precautions and instructions contained in this Operator's Guide or on-product warnings may result in injury, including the possibility of death. This Operator's Guide should remain with the unit at time of resale.



Lynx products are manufactured by BRP.

The following are trademarks of Bombardier Recreational Products Inc. or its subsidiaries.

LYNX ®

RER™

ROTAX™

DESS™

FOREWORD

Congratulations on your purchase of a new Lynx snowmobile. Whatever model you have chosen, it is backed by the Bombardier Recreational Products inc. (BRP) warranty and a network of authorized Lynx snowmobile dealers ready to provide the parts, service or accessories you may require.

The Operator's Guide has been prepared to acquaint the owner/operator and passenger with this new snowmobile and its various controls, maintenance and safe riding instructions. This guide is indispensable for the proper use of the product and should be kept with this snowmobile at all times.

Make sure you read and understand the content of this Operator's Guide.

After reading, please keep this Operator's Guide with the snowmobile. If the snowmobile is resold, please give the guide to the new owner for his awareness. An extra copy of the Operator's Guide is available from your Lynx snowmobile dealer.

If you have any question regarding any topic whether or not it is covered in this Operator's Guide, please send a written letter to BRP to following address:

BRP Finland OY
Service Department
P.O. Box 8039
FIN-96101 ROVANIEMI
FINLAND

This guide uses the following safety alert symbol in conjunction with signal words to indicate a potential personal injury hazard.

WARNING

Indicates a potentially hazardous situation which, if not avoided, could result in death or serious injury.

CAUTION

Indicates a potentially hazardous situation which, if not avoided, may result in minor or moderate injury. When used without the safety alert symbol , potential hazard exists for property damage only.

NOTE: Indicates supplementary information needed to fully complete an instruction.

Although the mere reading of such information does not eliminate the hazard, the understanding and application of the information will promote the correct use of the vehicle.

Your dealer is committed to your satisfaction. He has taken training to perform the initial set-up and inspection of your snowmobile as well as completed the final adjustment required to suit your specific weight and riding environment before you took possession. At delivery, your dealer would have explained the snowmobile controls and provided you with a brief explanation of the various suspension adjustments. We trust you have taken full advantage of this!

At delivery, you were also informed of the warranty coverage and have completed the Warranty Registration process.

The information and components/system descriptions contained in this guide are correct at time of publication. BRP, however maintains a policy of continuous improvement of its products without imposing upon itself any obligation to install them on products previously manufactured.

Because of its ongoing commitment to product quality and innovation, BRP reserves the right at any time to discontinue or change specifications, designs, features, models or equipment without incurring obligation.

The illustrations in this document show the typical construction of the different assemblies and, in all cases, may not reproduce the full detail or exact shape of the parts shown, however, they represent parts which have the same or a similar function.

It is understood that this guide may be translated into another language. In the event of any discrepancy, the English version shall prevail.

Specifications are given in the SI metric system. Where precise accuracy is not required, some conversions are rounded off for easier use.

Most components of this snowmobile are built with parts dimensioned in the metric system. Most fasteners are metric and must not be replaced by customary fasteners or vice versa.

We recommend genuine BRP products for replacement parts and accessories. They've been specially designed for your vehicle and manufactured to meet BRP's demanding standards.

For any questions pertaining to the warranty and its application, consult the WARRANTY section in this guide, and/or an authorized Lynx dealer.

TABLE OF CONTENTS

SAFETY INFORMATION

IMPORTANT BASIC SAFETY MEASURES.....	8
LAWS AND REGULATIONS.....	12
RIDING THE VEHICLE.....	13
Principle of Operation	13
How to Ride	13
Carrying a Passenger	15
Terrain/Riding Variations.....	16

VEHICLE INFORMATION

HOW TO IDENTIFY YOUR SNOWMOBILE	22
Serial numbers	22
CONTROLS/INSTRUMENTS	23
1) Fuel gauge	23
2) Throttle lever	23
3) Brake lever.....	24
4) Parking brake lever	24
5) RER button	25
6) Handlebar	25
7) Ignition switch / START/RER button	26
8) Tether cut-out switch	27
9) Engine cut-out switch	28
10) Headlamp dimmer switch	29
11) Pilot lamps	29
12) Rewind starter handle	29
13) Choke lever	30
14) Speedometer	30
15) Odometer	30
16) Trip meter	30
17) Trip meter reset button	30
18) Tachometer	31
19) Fuel tank cap.....	31
20) Heating grip switch.....	31
21) Heated throttle lever switch.....	32
22) Hood opening / closing	32
23) Power outlet (some models)	35
24) Fuse.....	35
25) Front grab handle/front bumper.....	37
26) Storage compartment.....	37
27) Rear rack	37
28) Tool kit	38

29) Spark plug holder	38
30) Hitch	38
31) Adjustable suspension	39
SUSPENSION TROUBLESHOOTING.....	44
In deep snow.....	44
FUEL AND OIL	45
Recommended fuel.....	45
Fuel System Antifreeze	45
Recommended oil	45
Chaincase oil	45
Cold weather carburetion modifications	45
BREAK-IN PERIOD.....	46
Engine.....	46
Drive Belt	46
10 Hour Inspection	46
OPERATING INSTRUCTIONS.....	47
Pre-Operation Check	47
Carburetor Engine Starting Procedure.....	48
Emergency Starting.....	49
Shutting off the engine.....	50
VEHICLE WARM-UP	51
POST OPERATION CARE.....	52
SPECIAL OPERATIONS.....	53
Engine overheating	53
Fuel flooded engine.....	53
Rear suspension slider shoe sticking.....	53
Towing an Accessory	53
Towing Another Snowmobile.....	53
Transporting the Vehicle.....	53
FLUID LEVELS	55
Brake system.....	55
Chaincase oil	55
Injection oil system	56
BATTERY.....	57
Removal	57
Dry battery.....	57
MAINTENANCE.....	58
Vehicle cleaning and protection	58
Drive belt removal and installation	58
Drive chain tension	60
Chaincase oil change	61
TRA Drive pulley adjustment (Only RAVE 550)	61
Drive belt condition	63
Brake condition.....	63
Brake adjustment.....	63

Rear suspension condition	63
Suspension stopper strap condition	63
Track condition	63
Track tension and alignment	63
Steering and front suspension mechanism	64
Wear and condition of skis and runners	65
Exhaust system	65
Air filter cleaning	65
Headlamp beam aiming	65
Bulb replacement (some models)	66
Bulb replacement (some models)	67
Tail light bulb change	68
Spark plug change	69
STORAGE AND PRESEASON PREPARATION	70
Storage	70
Preseason preparation	70
TROUBLESHOOTING	71
Monitoring beeper coded signals	71
Troubleshooting	73
TECHNICAL DATA	75

MAINTENANCE INFORMATION

PERIODIC MAINTENANCE CHART	80
2-STROKE MAINTENANCE CHART (FAN AND LIQUID COOLED)	81

WARRANTY

BRP FINLAND OY INTERNATIONAL LIMITED WARRANTY: 2009 LYNX® SNOWMOBILES	86
PRIVACY OBLIGATIONS/DISCLAIMER	89
CHANGE OF ADDRESS/OWNERSHIP	90

SAFETY INFORMATION

IMPORTANT BASIC SAFETY MEASURES

Training

- △ Basic training is required for the safe operation of any snowmobile. Study your Operator's Guide paying particular attention to cautions and warnings. Join your local snowmobile club: its social activities and trail systems are planned for both fun and safety. Obtain basic instructions from your snowmobile dealer, friend, fellow club member or enroll in your state or provincial safety training program.
- △ Always show a new operator how to start and stop the vehicle. Indicate the correct riding positions and, above all else, only allow him to operate the snowmobile in a restricted flat area — at least until he is completely familiar with its operation. If there is a local snowmobile operator's training course existing, have him enroll.

Performance

- △ The performance of some snowmobiles may significantly exceed that of other snowmobiles you have operated. Therefore, use by novice or inexperienced operators is not recommended.
- △ Snowmobiles are used in many areas and in many snow conditions. Not all models perform the same in similar conditions. Always consult your snowmobile dealer when selecting the snowmobile model for your particular needs and uses.
- △ Injury or death may result to the snowmobile operator, passenger or bystander if the snowmobile is used in risky conditions which are beyond the driver's, passenger's or snowmobile's capabilities or intended use.

Age

- △ BRP recommends the operator has at least 16 years old of age. Follow your local legislation.

Speed

- △ Speeding can be fatal. In many cases, you cannot react or respond quickly enough to the unexpected. Always ride at a speed which is suitable to the trail, weather conditions and your own ability. Know your local rules. Speed limit may be in effect and meant to be observed.

Riding

- △ Always keep right hand side of the trail.
- △ Always keep a safe distance from other snowmobiles and bystanders.
- △ Remember, promotional material may show risky maneuvers performed by professional riders under ideal and/or controlled conditions. You should never attempt any such risky maneuvers if they are beyond your level of riding ability.
- △ Never ride after consuming drugs or alcohol or if you feel tired or ill. Operate your snowmobile prudently.
- △ Your snowmobile is not designed to be operated on public streets, roads or highways.
- △ Snowmobiling at night can be a delightful experience but because of reduced visibility, be extra cautious. Avoid unfamiliar terrain and be sure your lights are working. Always carry a flashlight and spare light bulbs.

- ⚠ Nature is wonderful but don't let it distract your attention from driving. If you want to truly appreciate winter's scenery, stop your snowmobile on the side of the trail so that **you** don't become a hazard to others.
- ⚠ Fences represent a very serious threat for both you and your snowmobile. Give a wide berth to telephone poles or posts.
- ⚠ Hidden wires unseen from a distance can cause serious accidents.
- ⚠ Always wear an approved safety helmet, eye protection and a face shield. This also applies to your passenger.
- ⚠ Be aware of inherent risks associated with riding off trails, such as avalanche and other natural or man made hazards or obstacles.
- ⚠ Avoid road traveling. If you must do so, and it is permitted, reduce speed. The snowmobile is not designed to operate or turn on paving. When crossing a road, make a full stop, then look carefully in both directions before crossing at a 90° angle. Be wary of parked vehicles.
- ⚠ Tailgating another snowmobile should be avoided. If the snowmobile in front of you slows for any reason, its driver and passenger could be harmed through your neglect. Maintain a safe stopping distance between you and the snowmobile in front of you. Depending on the terrain condition, stopping may require a little more space than you think. Play it safe. Be prepared to use evasive driving.
- ⚠ Venturing out alone with your snowmobile could also be hazardous. You could run out of fuel, have an accident, or damage your snowmobile. Remember, your snowmobile is capable of traveling further in half an hour than you may be able to walk in a day. Use the "buddy system". Always ride with a friend or member of your snowmobile club. Even then, tell someone where you are going and the approximate time you plan to return.
- ⚠ Meadows sometimes have low areas where water accumulate and freezes over in winter. This ice is usually glare ice. Attempting to turn or brake on this surface could cause your vehicle to spin out of control. Never brake or attempt speeding or turning on glare ice. If you do happen to travel over such a condition, reduce speed by carefully releasing the throttle.
- ⚠ Never "jump" with your snowmobile. This should be left to professional stunt men. Don't show off. Be responsible.
- ⚠ While on safari, do not "gun" the throttle. Snow and ice can be thrown back into the path of a following snowmobile. In addition, when "gunning" the throttle, the vehicle digs into and leaves an irregular snow surface for others.
- ⚠ Safaris are both fun and enjoyable but don't show off or overtake others in the group. A less experienced operator might try to do the same as you and fail. When riding with others, limit your abilities to the experience of others.

Operation

- ⚠ Always make a pre-start inspection **BEFORE** you turn on the ignition.

- ⚠ In an emergency, the snowmobile engine can be stopped by activating the engine cut-out switch, pulling the tether cord cap or turning off the key.
- ⚠ Throttle mechanism should be checked for free movement and return to idle position before starting engine.
- ⚠ Always engage parking brake when vehicle is not in use.
- ⚠ Never run the engine in a non-ventilated area and/or if vehicle is left unattended.
- ⚠ Never operate the engine without belt guard securely installed or, with hood or access/side panels open or removed. Never run the engine without drive belt installed. Running an unloaded engine such as without drive belt or with track raised, can be dangerous.
- ⚠ **Electric start models only:** Never charge or boost a battery while installed on snowmobile.
- ⚠ Ensure the path behind is clear of obstacles or bystanders before proceeding in reverse.
- ⚠ Do not leave your keys in the ignition switch, it is an invitation to thieves and a danger to young children.
- ⚠ Raising the rear of your snowmobile while the engine is running could cause snow, ice or debris to be thrown back at an observer. Never raise the rear of the vehicle while the engine is running. To clear or inspect the track, stop the engine, tilt the vehicle on its side and remove blockage with a piece of wood or branch. Never allow anyone near a rotating snowmobile track.

Maintenance

- ⚠ Know your snowmobile and treat it with the respect and care due of any power driven machine. Common sense, proper handling and routine maintenance will result in safer and enjoyable use.
- ⚠ Only perform procedures as detailed in this guide. Unless otherwise specified, engine should be turned OFF and cold for all lubrication, adjustment and maintenance procedures.
- ⚠ Never have the engine running while the hood is open. Even at idle, a snowmobile engine is turning around 1,800 revolutions per minute. Always turn off the ignition before opening the hood for any reason.
- ⚠ Never remove any original equipment from your snowmobile. Each vehicle has many built in safety features. Such features include various guards and consoles, plus reflective materials and warning labels.
- ⚠ A poorly maintained snowmobile itself can be a potential hazard. Excessively worn components could render the vehicle completely inoperative. Keep the snowmobile in good working condition at all times. Follow your pre-operation check, weekly, monthly and annually routine maintenance and lubrication procedures as detailed in this guide. Consult a snowmobile dealer or acquire a shop manual and proper tools and equipment if other repairs or service is required.
- ⚠ Do not stud the track unless it as been approved for studs. At speed, a studded track that as not been approved for studs could tear and separate from vehicle posing a risk of severe injury or death.

Fuel

⚠ Always stop the engine before refueling. Fuel is flammable and explosive under certain conditions. Always work in a well-ventilated area. Do not smoke or allow open flames or sparks in the vicinity. Open cap slowly. If a differential pressure condition is noticed (whistling sound heard when loosening fuel tank cap) have vehicle inspected and/or repaired before further operation. Do not overfill or top off the fuel tank before placing the vehicle in a warm area. As temperature increases, fuel expands and might overflow. Always wipe off any fuel spillage from the vehicle. Periodically verify fuel system.

Basics for Passenger

- ⚠ Never ride as a passenger unless the snowmobile is equipped with a passenger seat, and sit only on the designated passenger seat.
- ⚠ Always wear a DOT approved helmet and follow the same dressing guidelines as those recommended for the operator and described in this guide.
- ⚠ Make sure that you are able to achieve a stable stance, both feet resting positively on the footboards of footrests with good grip, and that you are able to hold on firmly to the handholds.
- ⚠ Once underway, if you feel uncomfortable or insecure for any reason, don't wait, tell the driver to slow down or stop.

LAWS AND REGULATIONS

⚠ Know your local laws.

Federal, state, provincial and local government agencies have enacted laws and regulations pertaining to the safe use and operation of snowmobiles. It is your responsibility as a snowmobiler to learn and obey these laws and regulations. Respect and observance will result in safer snowmobiling for all.

Be aware of the liability property damages and insurance laws regarding your equipment.

RIDING THE VEHICLE

Before venturing on the trails, operate the snowmobile in a restricted flat area until you are completely familiar with its operation and feel comfortable that you can safely tackle a more demanding task. Have an enjoyable and safe ride.

Principle of Operation

Propulsion

Depressing throttle lever increases engine RPM causing the drive pulley to engage. Depending on models, engine RPM must be between 2500 and 4200 before drive pulley engagement will occur.

Outer sheave of drive pulley moves toward inner sheave, forcing the drive belt to move upward on the drive pulley and simultaneously forcing the sheaves apart on the driven pulley.

The driven pulley senses the load on the track and limits the belt movement. The result is an optimized speed ratio between engine RPM and the speed of the vehicle at any time.

WARNING

Never operate engine without belt guard securely installed or, with hood or access/side panels open or removed.

Power is transferred to the track through the chaincase or gearbox and drive axle.

WARNING

Always use a wide-base snowmobile mechanical stand to properly support vehicle during any track verification. Slowly accelerate engine in order to rotate track at very low speed when it is not on ground.

Turning

Handlebar controls the steering of the vehicle. As the handlebar is rotated to right or left, the skis are turned right or left to steer the snowmobile.

Stopping

Before riding your snowmobile, you should understand how to stop it. This is done by releasing the throttle and gradually depressing the brake lever on the left side of the handlebar. In an emergency, you may stop your vehicle by pressing the engine cut-out switch located near the throttle control and applying the brake. Remember, a snowmobile cannot "stop on a dime". Braking characteristics vary with deep snow, packed snow or ice. If the track is locked during hard braking, skidding may result.

How to Ride

How to Dress

Proper snowmobile clothing should be worn. It should be comfortable and not too tight. Always check the weather forecast before going on a ride. Dress for the coldest weather expected. Thermal underwear next to the skin also provides a good insulation.

DOT approved helmets are recommended at all times. They provide both warmth and reduce injury. A stocking type cap, balaclava and face mask should always be carried or worn. Goggles or a face shield that attach to the helmet are indispensable.

Hands should be protected by a pair of snowmobile gloves or mitts which have sufficient insulation and allow use of thumbs and fingers for operation of controls.

Rubber bottom boots with either a nylon or a leather top, with removable felt liners are best suited for snowmobiling.

You should keep yourself as dry as possible when snowmobiling. When you come indoors, take your snowmobile suit and boots off and make certain they dry properly.

Do not wear long scarfs and loose apparel that could get caught in moving parts.

What to Bring

Every snowmobiler should carry at least the following basic parts and tools that can help him and others in an emergency:

- this Operator's Guide
- spare spark plugs and wrench
- friction tape
- spare drive belt
- spare starter rope
- spare light bulbs
- tool kit (including at least pliers, screwdriver, adjustable wrench)
- knife
- flashlight.

Include other items depending on the length and time of your ride.

Riding Position

Your riding position and balance are the two basic principles of making your snowmobile go where you want it to. When turning on the side of a hill, you and your passenger must be ready to shift body weight to help it turn in the desired direction. Driver and passenger(s) must never attempt this maneuvering by placing feet outside of the vehicle. Experience will teach you how much lean to put into turns at different speeds and how much you will have to lean into a slope to maintain proper balance.

Generally, the riding position for best balance and control is sitting. However, the posting, kneeling or standing positions are also used under certain conditions.

The novice driver should become familiar with the snowmobile through practice on a level area at slow speeds before venturing afield.

⚠ WARNING

Do not attempt any maneuvers if they are beyond your abilities.

Sitting

Feet on the running boards, body mid-way back on seat is an ideal position when operating the snowmobile over familiar, smooth terrain. Knees and hips should remain flexible to absorb shocks.



Posting

A semi-sitting position with the body off the seat and the feet under the body in a sort of squatting posture, thus allowing the legs to absorb the shocks when traveling over uneven terrain. Avoid abrupt stops.



Kneeling

This position is achieved by placing one foot firmly on the running board and the opposite knee on the seat. Avoid abrupt stops.



Standing

Place both feet on the running boards. Knees should be flexed to absorb the shock from surface bumps. This is an effective position to see better and to shift weight as conditions dictate. Avoid abrupt stop.



Carrying a Passenger

Certain snowmobiles are designed for an operator only, others can allow one passenger only, and others can allow up to two passengers. Refer to the indications on the vehicles to know if any particular snowmobile can accommodate passengers or not, and if so, how many. Always respect those indications. Overloading is dangerous because snowmobiles are not designed for it.

Even when passengers are allowed, you must make sure that the persons who would like to become passengers are physically fit for snowmobiling.

⚠ WARNING

Any passenger must be able to firmly lay his feet on the footrests and keep his hands on the grab handles or seat strap at all times when seated. Respecting those physical criteria is important to ensure that the passenger is stable and to reduce the risks of ejection.

On snowmobiles allowing two passengers, if you have an adult and a child for passenger, BRP recommends that the child sits in the center location. This allows an adult sitting in the rear seat to keep a visual contact with the child and hold him if necessary. In addition, the child is best protected against the wind and cold temperature if seated in the center location.

Each operator has a responsibility to ensure the safety of his passengers and should inform them of snowmobiling basics.

WARNING

- Passengers must only sit on designated passenger seats. Never allow anyone to sit between the handlebar and the operator.
- Each passenger seat must have a strap or grab handles and meet SSCC standards.
- Passengers and operators must always wear DOT approved helmets and warm clothing appropriate for snowmobiling. Make sure that no skin is exposed.
- Once underway, if a passenger feels uncomfortable or unsecure for any reason, he must not wait, and tell the driver to slowdown or stop.

Riding with passengers on board is different than riding alone. The operator has the benefit of knowing what will be the next maneuver and is able to prepare himself accordingly. The operator also benefits from the support of his grip on the handlebar. In contrast, the passengers have to rely on the operator's careful and safe operation of the vehicle. In addition, "body english" is limited with passengers, and the operator can sometimes see more of the trail ahead than the passengers. Therefore, smooth starting and stopping are required with passengers, and the operator must slow down. The operator must also warn passengers of side hills, bumps, branches, etc. An unforeseen bump can leave you passenger-less. Remind your passengers to lean into the turn with you, without causing the vehicle to topple. Be extremely careful, go more slowly and check the passengers frequently.

WARNING

When riding with a passenger:

- Braking ability and steering control are reduced. Decrease speed and allow extra space to maneuver.
- Adjust suspension according to weight.

For complete information on how to adjust the suspension, please refer to the section of this Operator's Guide entitled SUSPENSION ADJUSTMENTS under OPERATING INSTRUCTIONS and to the relevant label on the belt guard.

Use extra caution and go even more slowly with young passengers. Check frequently to make certain the child has a firm grip and is properly positioned with his feet on the running boards.

Terrain/Riding Variations

Groomed Trail

On a maintained trail, sitting is the most preferred riding position. Do not race and, above all, keep to the right hand side of the trail. Be prepared for the unexpected. Observe all trail signs. Do not zigzag from one side of the trail to the other.

Ungroomed Trail

Unless there has been a fresh snowfall you can expect “washboard” and snowdrift conditions. Taken at excessive speeds, such conditions can be physically harmful. Slow down. Hold on the handlebar and assume a posturing position. Feet should be under the body assuming a crouched position to absorb any jarring effect. On longer stretches of “washboard” trails, the kneeling position of one knee on the seat can be adopted. This provides a certain amount of comfort, while at the same time keeps the body loose and capable of vehicle control. Beware of hidden rocks or tree stumps partially hidden by a recent snowfall.

Deep Snow

In deep “powder” snow, your vehicle could begin to “bog” down. If this occurs, turn in as wide an arc as possible and look for a firmer base. If you do get “bogged”, and it happens to everyone, do not spin your track as this makes the vehicle sink deeper. Instead, turn the engine off, get off and move the back of the vehicle onto new snow. Then tramp a clear path ahead of the vehicle. A few feet will generally suffice. Restart the engine. Assume the standing position and rock the vehicle gently as you steadily and slowly apply the throttle. Depending on whether the front or rear end of the vehicle is sinking, your feet should be placed on the opposing end of the running boards. Never place foreign material beneath the track for support. Do not allow anyone to stand in front of, or to the rear of, the snowmobile with the engine running. Stay away from the track. Personal injury will result if contact is made with the revolving track.

Frozen Water

Traveling frozen lakes and rivers can be fatal. Avoid waterways. If you are in an unfamiliar area, ask the local authorities or residents about the ice condition, inlets, outlets, springs, fast moving currents or other hazards. Never attempt to operate your snowmobile on ice that may be too weak to support you and the vehicle. Operating a snowmobile on ice or icy surfaces can be very dangerous if you do not observe certain precautions. The very nature of ice is foreign to good control of a snowmobile or any vehicle. Traction for starting, turning or stopping is much less than that on snow. Thus, these distances can be multiplied manyfold. Steering is minimal, and uncontrolled spins are an ever present danger. When operating on ice, drive slowly with caution. Allow yourself plenty of room for stopping and turning. This is especially true at night.

Hard Packed Snow

Don't underestimate hard packed snow. It can be difficult to negotiate as both skis and track do not have as much traction. Best advice is to slow down and avoid rapid acceleration, turning or braking.

Uphill

There are two types of hills you can encounter — the open hill on which there are few trees, cliffs or other obstacles, and a hill that can only be climbed directly. On an open hill, the approach is to climb it by side hilling or slalomming. Approach at an angle. Adopt a kneeling position. Keep your weight on the uphill side at all times. Maintain a steady, safe speed. Continue as far as you can in this direction, then switch to an opposite hill angle and riding position.

A direct climb could present problems. Choose the standing position, accelerate before you start the climb and then reduce throttle pressure to prevent track slippage.

In either case, vehicle speed should be as fast as the incline demands. Always slow down as you reach the crest. If you cannot proceed further, don't spin your track. Turn the engine off, free the skis by pulling them out and downhill, place the rear of the snowmobile uphill restart the engine and ease it out with slow even throttle pressure. Position yourself to avoid tipping over, then descend.

Downhill

Downhill driving requires that you have full control of your vehicle at all times. On steeper hills, keep your center of gravity low and both hands on the handlebar. Maintain slight throttle pressure and allow the machine to run downhill with the engine operating. If a higher than safe speed is reached, slow down by braking but apply the brake with frequent light pressure. Never jam the brake and lock the track.

Side Hill

When crossing a side hill or traversing up or downhill, certain procedures must be followed. All riders should lean towards the slope as required for stability. The preferred operating positions are the kneeling position, with the knee of the down hill leg on the seat and the foot of the uphill leg on the running board, or the posting position. Be prepared to shift your weight quickly as needed. Side hills and steep slopes are not recommended for a beginner or a novice snowmobiler.

Slush

Slush should be avoided at all times. Always check for slush before starting across any lake or river. If dark spots appear in your tracks, get off the ice immediately. Ice and water can be thrown rearward into the path of a following snowmobile. Getting a vehicle out of a slush area is strenuous and in some cases, impossible.

Fog or Whiteouts

On land or water, fog or visibility-limiting snow can form. If you have to proceed into the fog or heavy snow, do so slowly with your lights on and watch intently for hazards. If you are not sure of your way, do not proceed. Keep a safe distance behind other snowmobilers to improve visibility and reaction time.

Unfamiliar Territory

Whenever you enter an area that is new to you, drive with extreme caution. Go slow enough to recognize potential hazards such as fences or fence posts, brooks crossing your path, rocks, sudden dips, guy wires and countless other obstacles which could result in a termination of your snowmobile ride. Even when following existing tracks, be cautious. Travel at a speed so you can see what is around the next bend or over the top of the hill.

Bright Sunshine

Bright sunny days can considerably reduce your vision. The glare from sun and snow may blind you to the extent that you cannot easily distinguish ravines, ditches or other obstacles. Goggles with colored lenses should always be worn under these conditions.

Unseen Obstruction

There may be obstructions hidden beneath the snow. Driving off established trails and in the woods requires reduced speed and increased vigilance. Driving too fast in an area can make even minor obstacles very hazardous. Even hitting a small rock or stump could throw your snowmobile out of control and cause injury to its riders. Stay on established trails to reduce your exposure to hazards. Be safe, slow down and enjoy the scenery.

Hidden Wires

Always be on the lookout for hidden wires, especially in areas that may have been farmed at one time or another. Too many accidents have been caused by running into wires in the fields, guy wires next to poles and roads, and into chains and wires used as road closures. Slow speeds are a must.

Obstacles and Jumping

Unplanned jumps of snowdrifts, snowplow ridges, culverts or indistinguishable objects can be dangerous. You can avoid them by wearing the proper color lenses or face shields and by operating at a lower speed.

Jumping a snowmobile is an unsafe and dangerous practice. However, if the trail does suddenly drop away from you, crouch (stand) towards the rear of the vehicle and keep the skis up and straight ahead. Apply partial throttle and brace yourself for the impact. Knees must be flexed to act as shock absorbers.

Turning

Depending on terrain conditions, there are two preferred ways to turn or corner a snowmobile. For most snow surfaces, "body english" is the key to turning. Leaning towards the inside of the turn and positioning body weight on the inside foot will create a "banking" condition beneath the track. By adopting this position and positioning yourself as far forward as possible, weight will be transferred to the inside ski.

On occasion, you will find that the only way to turn the vehicle about in deep snow is to pull the snowmobile around. Do not over-exert yourself. Get assistance. Remember to always lift using your legs as opposed to your back.



Road Crossing

In some cases, you will be approaching the road from a ditch or snowbank. Choose a place where you know you can climb without difficulty. Use the standing position and proceed with only as much speed needed to crest the bank. Stop completely at the top of the bank and wait for all traffic to clear. Judge the drop to the roadway. Cross the road at a 90° angle. If you encounter another snowbank on the opposite side, position your feet near the rear of the vehicle. Remember, your snowmobile is not designed to operate on bare pavement and steering on this type of surface is more difficult.

Railroad Crossing

Never ride on railroad tracks. It is illegal. Railroad tracks and railroad rights-of-way are private property. A snowmobile is no match for a train. When crossing a railroad track, stop, look and listen.

Night Rides

The amount of natural and artificial light at a given time can effect your ability to see or to be seen. Nighttime snowmobiling is delightful. It can be a unique experience if you acknowledge your reduced visibility. Before you start, make certain your lights are clean and work properly. Drive at speeds that will allow you to stop in time when you see an unknown or dangerous object ahead. Stay on established trails and never operate in unfamiliar territory. Avoid rivers and lakes. Guy wires, barbed wire fences, cabled road entrances and other objects such as tree limbs are difficult to see at night. Never drive alone. Always carry a flashlight. Keep away from residential areas and respect the right of others to sleep.

Safari Riding

Before starting out, designate a "trail boss" to lead the party and another person to follow-up at the end of the party. Ensure that all members of the party are aware of the proposed route and destination. Make certain that you are carrying all necessary tools and equipment and that you have sufficient fuel to complete the trip. Never overtake the trail boss or, for that matter, any other snowmobile. Use down-the-line hand signals to indicate hazards or intent of direction change. Assist others whenever necessary.

It is always IMPORTANT to keep a safe distance between each snowmobile. Always maintain a safe interval and allow sufficient stopping distance. Don't be a tailgater. Know the position of the machine ahead.

Signals

If you intend to stop, raise either hand straight above your head. A left turn is indicated by extending your left hand straight out in the proper direction. For right turns, extend the left arm and raise the hand to a vertical position so it forms a right angle at the elbow. Every snowmobiler should relay any signal to the ones behind.

Trail Stops

Whenever possible, pull off the trail when you stop. This will reduce the hazard to other snowmobilers using the trail.

Trails and Signs

Trail signs are used to control, direct or regulate the use of snowmobiles on trails. Become familiar with all signs used in the area where you are snowmobiling.

Transporting and Towing

Follow transporting and towing instructions explained further in this guide.

VEHICLE INFORMATION

HOW TO IDENTIFY YOUR SNOWMOBILE

Serial numbers

The main components of your snowmobile (engine and frame) are identified by different serial numbers. It may sometimes become necessary to locate these numbers for warranty purposes or to trace your snowmobile in the event of loss.

These numbers are required by the Lynx dealers to complete warranty claims properly. No warranty will be allowed by BRP if the engine serial number or VIN is removed or mutilated in any way. We strongly recommend that you take all the serial numbers on your snowmobile and supply them to your insurance company.

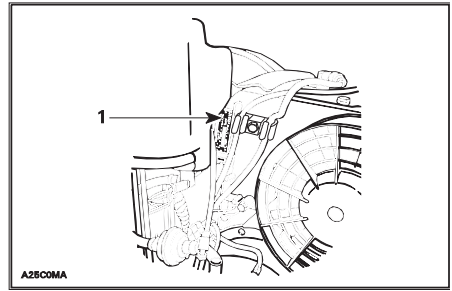
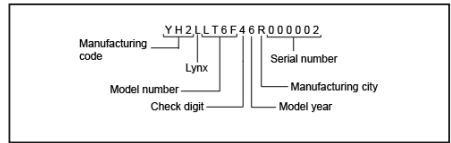

1. Engine serial number

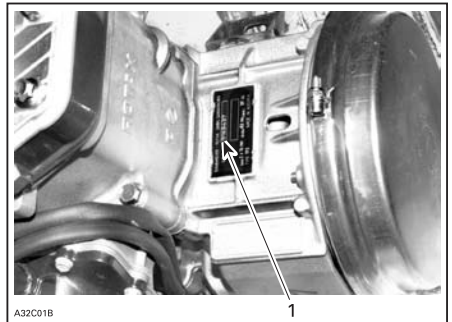

1. Engine serial number

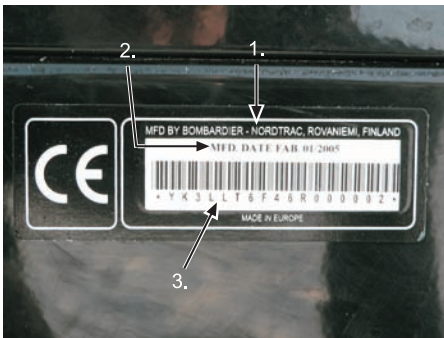

1. Manufacturer name
2. Manufacturing date
3. Vehicle identification number (VIN)

CONTROLS/INSTRUMENTS

NOTE: Some controls/instruments do not apply to some models.

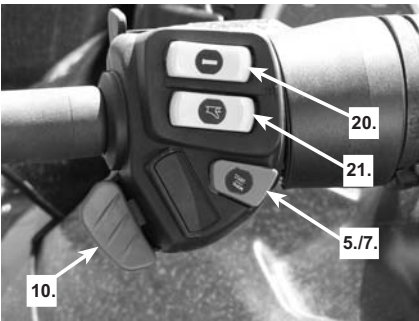
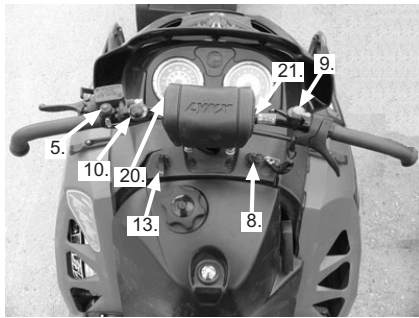
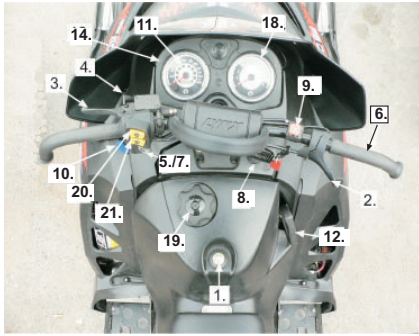

Electronical fuel gauge

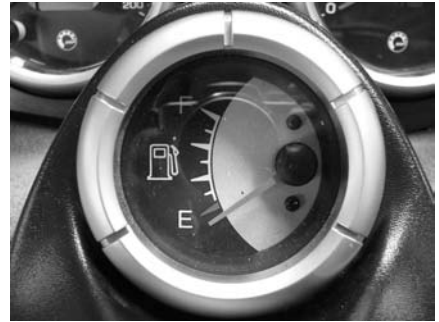

Mechanical fuel gauge



2) Throttle lever

Located on the right side of handlebar. When compressed, it controls the engine speed and the engagement of the transmission. When released, engine speed returns automatically to idle.

1) Fuel gauge

NOTE: Electronical fuel gauge is found only in some models.

3) Brake lever

Located on the left side of handlebar. When compressed, the brake is applied. When released, it automatically returns to its original position. Braking effect is proportional to the pressure applied on the lever and to the type of terrain and its snow coverage.

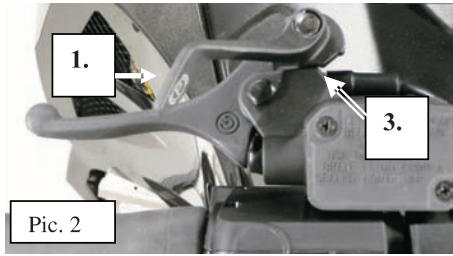
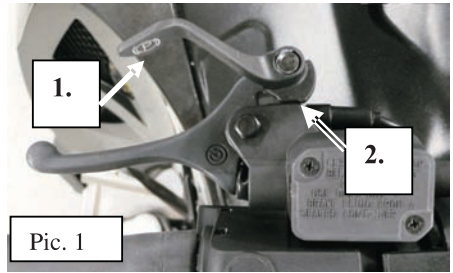

1. Locking lever
2. Position 1
3. Position 2

4) Parking brake lever

Hydraulic brake

To engage mechanism, squeeze brake lever and maintain while pulling locking lever with a finger. Brake lever in picture 1 is compressed 25% of applying brakes and in picture 2 is compressed 50% of applying brakes.

To release mechanism, squeeze brake lever. Locking lever will automatically return to its original position. Brake lever now returns to rest position. Always release parking brake before riding.

Located on left side of handlebar. Parking brake should be used whenever snowmobile is parked. Whenever parking brake is applied and engine is running, injection oil level/parking brake pilot lamp lights up to remind you that it is engaged. Never leave your snowmobile on downhill only with parking brake engaged.

WARNING

Locking keeps brake lever engaged and keeps pressure against brake disc. Anyhow, this pressure may decrease so low, that it will not keep vehicle in place. Never leave the snowmobile on hill only with parking brake applied.

WARNING

Make sure parking brake is fully disengaged before operating the snowmobile.

5) RER button

Electric reverse

Some models: These models are equipped with an electronic reverse (RER), which is controlled by a RER button.

Reverse shift can be used when the snowmobile is stopped and engine is running at idle.

Engine is running automatically forward when the snowmobile is started after stalling or stopping.

Shifting in reverse

With the snowmobile completely stopped and engine running at idle, press and release the RER button.

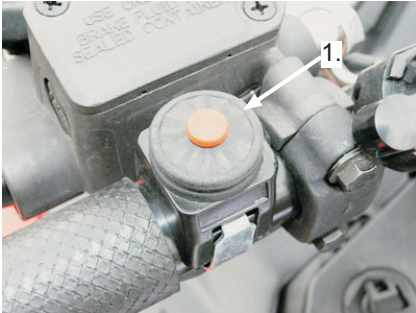

1. RER button

The reverse pilot lamp blink and a reverse alarm will sound once every second with a half a second duration when the snowmobile is engaged in reverse.

Apply throttle slowly and evenly. Allow drive pulley to engage then accelerate carefully.

Shifting in forward

With the snowmobile completely stopped and engine running at idle, press and release the RER button.

Reverse pilot lamp and reverse alarm will stop.

Apply throttle slowly and evenly. Allow drive pulley to engage then accelerate carefully.

6) Handlebar

The handlebar controls the steering of the snowmobile. As the handlebar is rotated to right or left, the skis are turned right or left to steer the snowmobile. Handlebar height is adjustable. See an authorized Lynx dealer.

7) Ignition switch / START/RER button

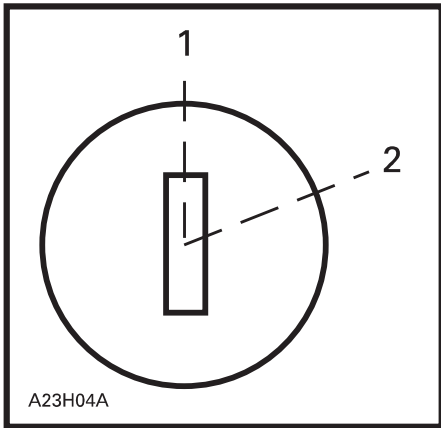

MANUAL START

1. OFF
2. ON

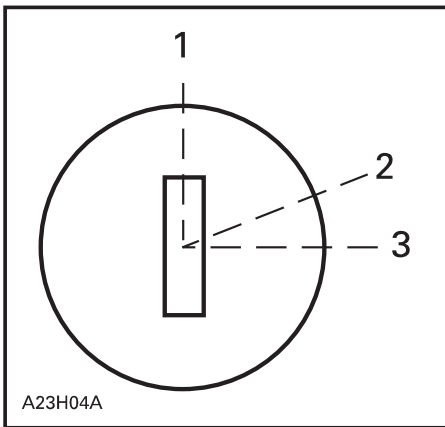

ELECTRIC START MODELS

1. OFF
2. ON
3. START

START/RER button



ELECTRIC START MODELS

1. START (PRESS THE BUTTON)

START/RER button has two functions.

When the engine is not running, depressing the START/RER button and hold until engine has started.

When the engine is running, depressing the START/RER button will command the engine to reverse crankshaft rotation as driving the snowmobile in reverse is achieved by changing the direction of rotation of the engine, not by shifting the chain case in reverse gear.

When depressing the START/RER button, the MPEM or ECU will practically slow down the engine RPM to a stop and advance the ignition timing to cause crankshaft rotation reversing.

Engine will automatically shift into forward when starting after stopping or stalling.

Shifting procedure will take place only when the engine is running.

If engine is running at a speed above 3800 RPM, the reverse function of the START/RER button is cancelled.

It is recommended to warm up the engine to its normal operating temperature before shifting.

Start Mode

To start engine, push START/RER button and hold until engine has started.

NOTE: Do not hold START/RER button more than 10 seconds. A rest period should be observed between the cranking cycles to let starter cool down. Holding START/RER button when engine has started could damage starter mechanism.

Manual Starting

To start the engine, pull switch off button to on position, set the safety lanyard on its position, turn key ON position then pull rewind starter grip. To stop the engine, press switch off button down.

Electric Starting

To start engine, pull switch off button to on position, set safety lanyard on its position, turn key to START position (or press start button) until engine has started. To stop the engine, press switch off button down.

NOTE: Do not use electric starter for more than 10 seconds. If start/rer button is pressed when engine has started it could damage electric starter mechanism.

Release button as soon as the engine starts.

If engine does not start on first try, wait a few seconds before restarting. To stop engine, press switch off button down.

NOTE: Engine may be manually started with rewind starter if necessary.

If starter does not operate, check starting system fuse condition. refer to FUSES.

8) Tether cut-out switch



It shuts off engine preventing snowmobile to runaway if the operator falls off the vehicle accidentally.

Operation

Attach to clothing eyelet than snap tether cord cap over post before starting engine.

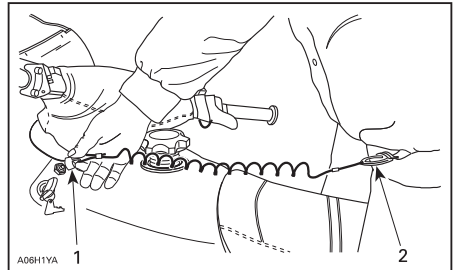

1. Snap over post
2. Attach to eyelet

If emergency engine shut off is required, completely pull tether cord cap from post.

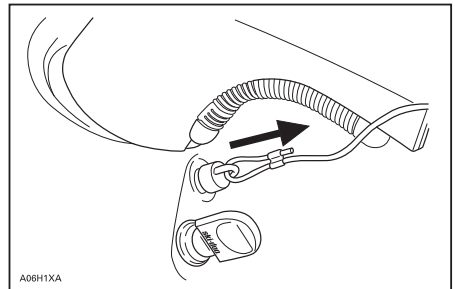

9) Engine cut-out switch

This push-pull type is switch located on the right side of the handlebar. To stop the engine in an emergency, select OFF position (DOWN) and simultaneously apply the brake. To restart, button must be at the ON position (UP).

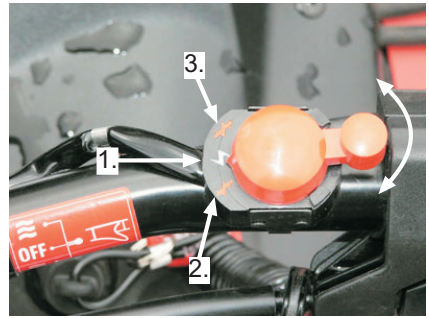

1. AT THE MIDDLE SWITCH IS "ON"-POSITION
2. WHEN TURNED COUNTERCLOCKWISE FROM THE MIDDLE SWITCH IS "OFF"-POSITION
3. WHEN TURNED CLOCKWISE FROM THE MIDDLE SWITCH IS "OFF"-POSITION

All operators of the snowmobile should familiarize themselves with the function of this device by using it several times on first outing and whenever stopping the engine there-after. This engine cut-out procedure will become a reflex and will prepare operators for emergency situations requiring its use.

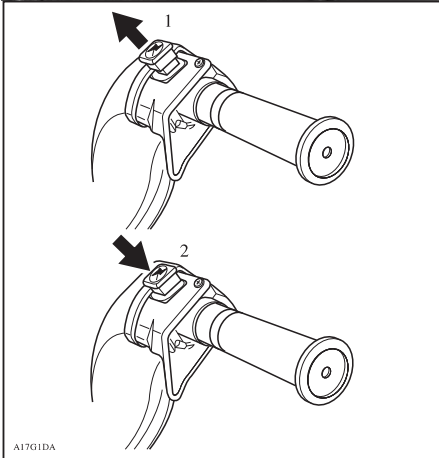

1. ON
2. OFF

Some models have following cut out switch

10) Headlamp dimmer switch

Located on left hand side of handlebar, allows selection of headlamp beam. Note that lights are automatically ON whenever the engine is running.

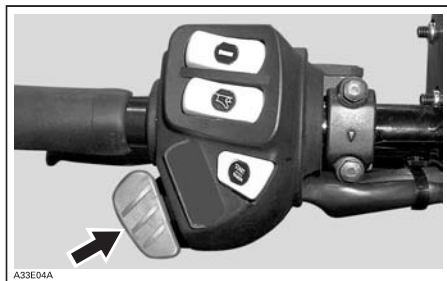

High beam pilot lamp (Blue)

Lights when headlamp is on HIGH beam.

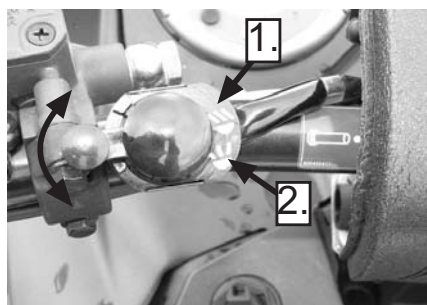

1. LOW BEAM
2. HIGH BEAM



11) Pilot lamps

NOTE: All models do not have all lamp functions mentioned below. It varies by the engine type, accessory level and model.

Oil pilot lamp

2-tec models: This pilot lamp will glow up when injection oil level is low. Stop vehicle in a safe place, then refill injection oil reservoir.

Restart engine, oil pilot lamp must turn off after few seconds. If oil pilot lamp still glows up, stop engine and have lubrication system inspected by an authorized Lynx dealer.

12) Rewind starter handle

Auto-rewind type located on right hand side of snowmobile. Pull handle slowly until a resistance is felt then pull vigorously. Slowly release handle.



13) Choke lever



Choke lever on position 0 (=OFF). (See now in picture).

Choke have 3 steps 0-position as in picture = choke off, then when turned one step up 1-position = choke half position and when turned totally 2-position = choke has full effect.

14) Speedometer

Electric speedometer

Direct reading screen shows speed in km/h.

Records total distance travelled until it is reset.

Mode button

Depress the mode button to change display. Each time engine is started, display shows odometer. From that point depressing mode button again to return the odometer.

Depressing mode button again will change display for the resettable hourmeter. Push mode button again to return to odometer.

Push and hold mode button for 2 seconds to reset the tripmeter or the resettable hourmeter depending on the one displayed.

15) Odometer

Odometer records the total distance travelled in kilometers.

16) Trip meter

Records the distance travelled. It can be reset when needed.

17) Trip meter reset button

To reset the meter, push the button until all the numbers are zero (0).

Resettable hourmeter

Records engine running time in hours and minutes since it has been reset.

Push and hold mode button for 2 seconds to reset the resettable hourmeter.

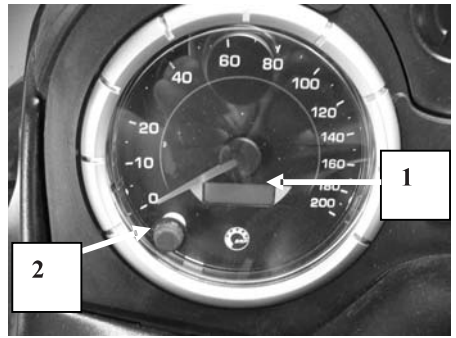

ELECTRONIC SPEEDOMETER

1. Odometer, Trip meter, Hour meter
2. Reset button (Mode button)

Electronic display code

If your speedometer shows "SCALE" in the display, it means that the display selector button is stuck in the down position or depressed when the electrical system was activated.

Some models: At vehicle speed of 90 km/h and more the mode LCD screen will show speed only instead of the selected mode.

NOTE: At the electronic speedometer display appears "9-9" when you power up the vehicle. This means that the speedometer is calibrated to 9 teathed drive sprocket.

18) Tachometer

Direct-reading dial indicates the number of thousand of revolutions per minute (RPM) of the engine.



TYPICAL — MULTIPLY THE READING BY 1000

19) Fuel tank cap



Unscrew to fill up tank then fully tighten.

WARNING

Stop the engine before refueling. Fuel is inflammable and explosive under certain conditions. Open cap slowly. Do not smoke or allow open flames or sparks in the vicinity. Do not overfill or top off the fuel tank before placing the vehicle in a warm area. As temperature increases, fuel expands and might overflow. Wipe off any fuel spillage from the vehicle.

20) Heating grip switch

It is a three-position switch. Select the desired position to keep your hands at a comfortable temperature.

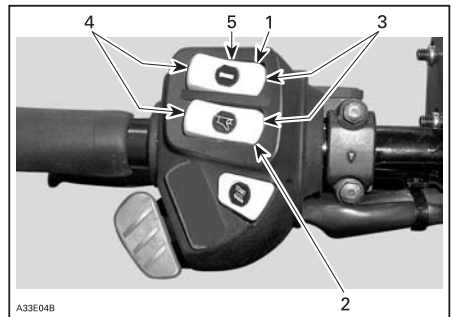

SOME MODELS

1. Heated grip switch
2. Heated throttle lever switch
3. Hot
4. Warm
5. OFF

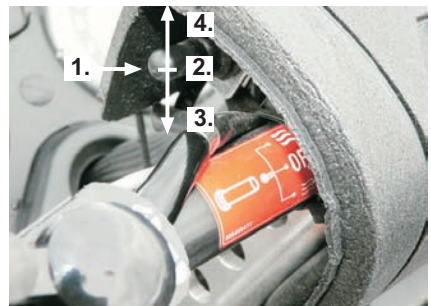

SOME MODELS

1. Heated grip switch
2. OFF (middle)
3. WARM (down)
4. HOT (up)

Passenger grip heating switch (only some models)

Three-position switch. Select the desired position to keep rear passenger's hands at comfortable temperature.



PASSENGER HEATING GRIP SWITCH ON PASSENGER GRAB HANDLE

1. Heated passenger grip switch
2. OFF (middle)
3. WARM
4. HOT

21) Heated throttle lever switch

Three-position switch. Select the desired position to keep your right thumb at a comfortable temperature. See illustration.

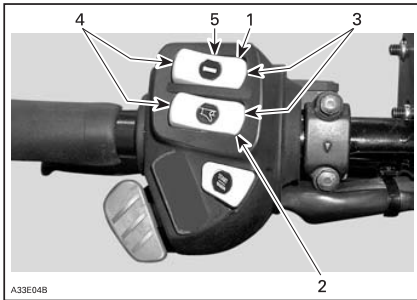

SOME MODELS

1. Heated grip switch
2. Heated throttle lever switch
3. Hot
4. Warm
5. OFF

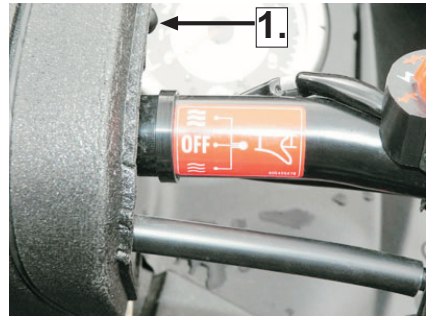

SOME MODELS

1. Heated throttle lever switch
2. OFF (middle)
3. HOT (up)
4. WARM (down)

22) Hood opening / closing

Side hoods (SOME MODELS)

Stretch and unhook the latches to unlock the hood from its anchors.



HOOD LATCH

Lift up the fastening pin from the hole and gently open the side hood.



Side hoods (SOME MODELS)

Stretch and unhook the latches to unlock the hood from its anchors. Open the side hood.



If you like to remove complete side panel, open the lockings and remove side hood.

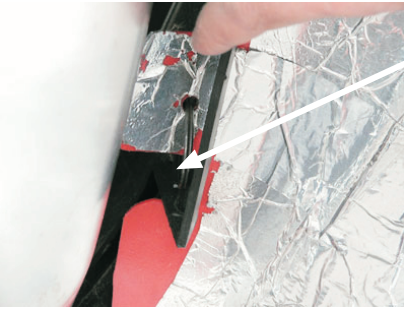

When closing the side hoods pay attention the lower edge assembly into the groove. Also other edges should be assembled carefully.

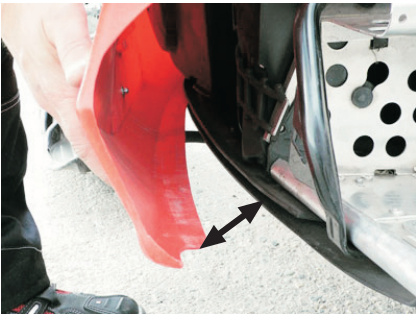

Upper hood (SOME MODELS)

Lift up the pin from the hole (both sides of unit).



Pull the upper hood to forward.



Front hook inside the upper hood.

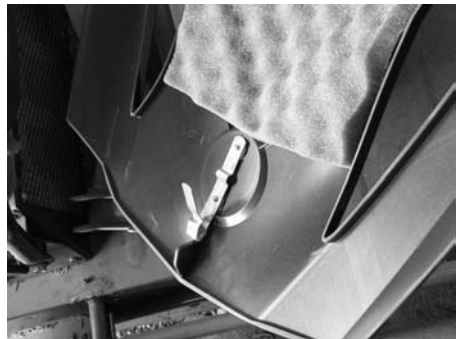

Opening for the hook when installing upper hood.

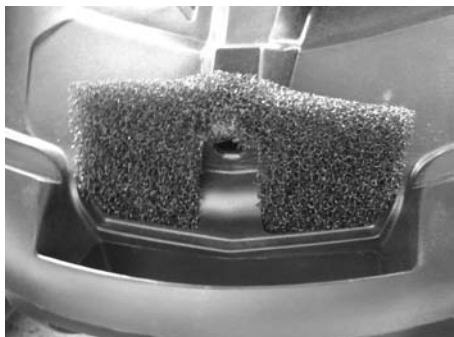

While assembly repeat opposite and assemble side hood lower edge carefully to groove.

Upper hood (SOME MODELS)

Open side hoods first, then open front latch.



Open electrical connector at right side of vehicle by pressing the connector locking before lift up upper hood.



Remove upper hood by lifting up and moving forward.



When assemble upper hood install nut [1] to the hole [2] on the bottom pan and fix the front latch to its position.

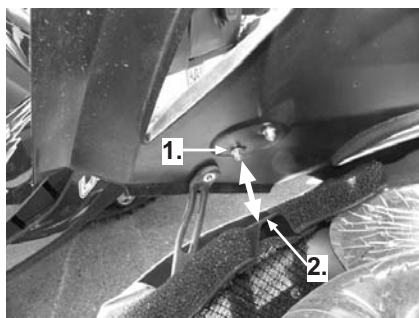

Install front of the hood then assemble rear part of hood to the openings.

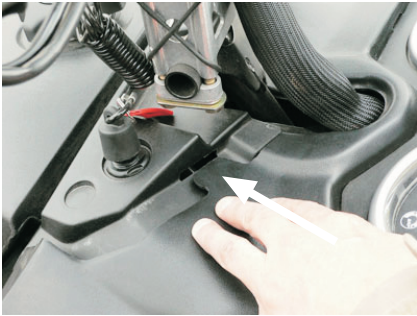

23) Power outlet (some models)

A 12-volt electric appliance may be connected to that jack connector. Electric current is supplied when ever engine is running. See FUSES for electric power outlet fuse location.



24) Fuse

To remove fuse from holder, pull fuse out. Check if filament is melted.

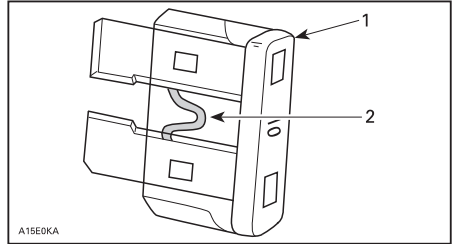

1. Fuse
2. Check if melted

Fan-cooled models

MODEL	FUSE	DESCRIPTION	LOCATION
Manual start	30 A	Lights and accessories	Close to oil filling neck
Electric start	10 A	Charging system	
	30 A	Lights and accessories	
	20 A	Starter relay	

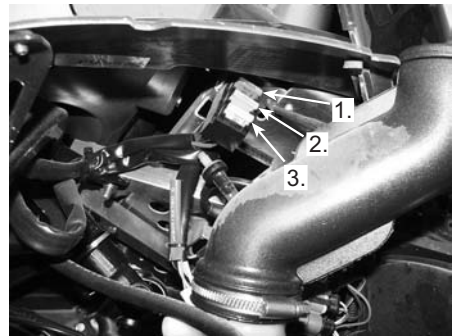

1. Charging fuse 10 A
2. Lights and all others accessories 30 A
3. Starter relay fuse 20 A

Fuse for starting system and electric power outlet

Starting system and electric power outlet is protected (if equipped) with 20 ampere fuse. If the starter and electric power outlet is out of function, check the fuse condition and replace if needed.

NOTE: Do not use a higher rated fuse as this can cause severe damage to electric components and/or fire.



To open fuse box push on cover tab and tilt cover.



SOME MODELS

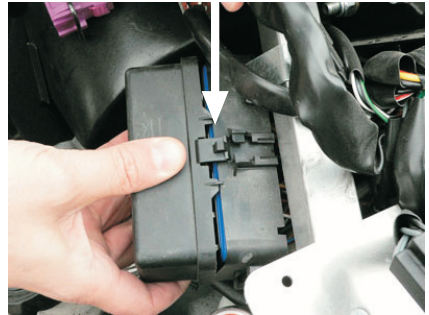

1. Push tab

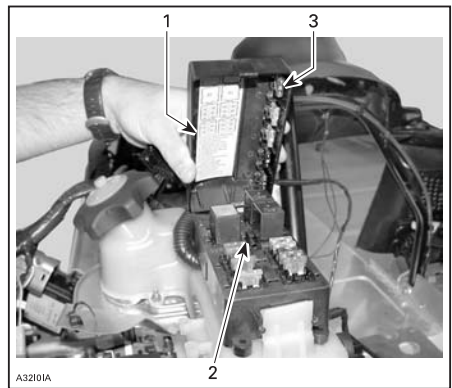

1. Fuse description decal
2. Fuse remover/installer
3. Spare fuses

SOME MODELS

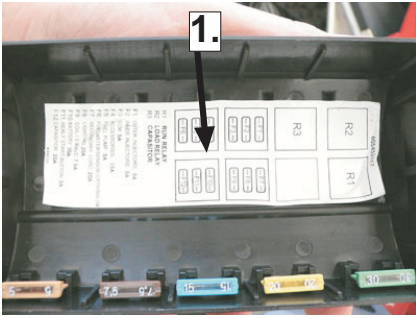

25) Front grab handle/front bumper

To be used whenever front of snowmobile requires manual lifting.



1. Front grab handle

NOTE: Do not use skis to pull or lift snowmobile.

26) Storage compartment

Situates inside the seat (rear).



27) Rear rack

Always readjust suspension according to the load. The capacity of this rack is limited. Ride at very low speed when loaded. Avoid speed over bumps. See maximum load capacity on the decal.

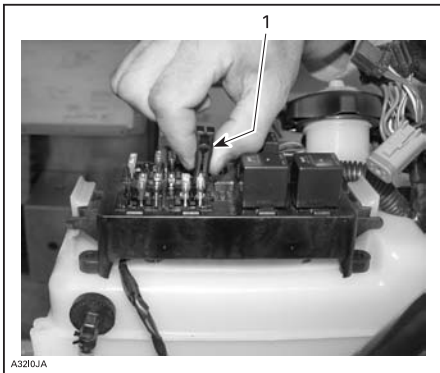

1. Fuse remover/installer

28) Tool kit

A tool kit containing tools for basic maintenance is supplied with the vehicle. Tool bag is located inside in engine compartment the left side hood.



29) Spark plug holder



Some models: To keep spare spark plugs dry and prevent shocks that might affect the adjustment or break them, a holder is provided in engine compartment.

Firmly tighten them into the holder with spark plug socket (in tool kit) to ensure that they will not be loosened by vibrations.

Spare spark plugs are not supplied with a new snowmobile.

Adjust spare spark plug gap according the TECHNICAL DATA before installation.

CAUTION: Do not attempt to adjust gap on spark plug BR8ECS and BR9ECS; it is not adjustable.

30) Hitch

The hitch can be used to pull most equipment. Use a rigid tow bar.

NOTE: Remember to lock the hitch locking latch with a lock pin.

Check the decal on your own vehicle. There is a description of how much load is allowed to transport and to pull.



On this decal (in the picture), max. pulling load is 2500N vertical load for hitch is 10.2kg.

NOTE: When pulling load rear suspension and ski adjustment may needed.

31) Adjustable suspension

Snowmobile handling and comfort depend upon suspension adjustments.

Choice of suspension adjustments vary with carrying load, driver's weight, personal preference, riding speed and field condition.

NOTE: Some adjustments may not apply to your snowmobile. Use special keys in tool kit (SOME MODELS).

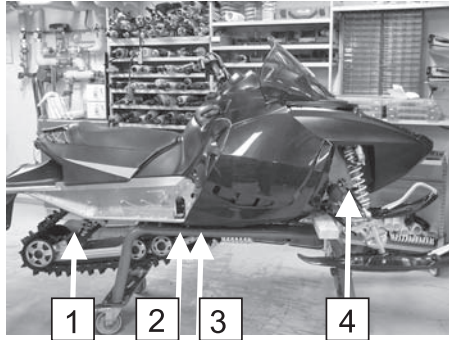

1. Rear springs - comfort and ride height
2. Center spring - handling
3. Stopper strap - snowmobile weight transfer
4. Front shock - handling

Suspension adjustments

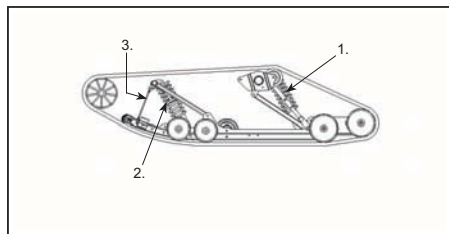

TYPICAL — RCG 2

1. Rear springs adjustable for comfort and ride height
2. Center spring for steering behavior
3. Stopper strap for snowmobile weight transfer
4. Front springs for handling (not shown)

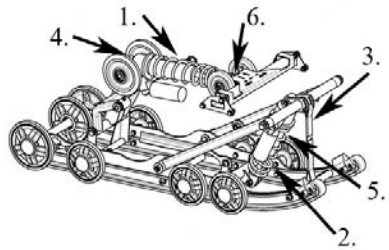

TYPICAL — PPS

1. Rear springs adjustable for comfort and ride height
2. Center spring for steering behavior
3. Stopper strap for snowmobile weight transfer
4. Rear shock motion ratio — Damping strength
5. Center shock motion ratio — Damping strength (not seen on picture)
6. Rebound strength adjustment

Following are guidelines to fine-tune suspension.

The best way to set up the suspension, is to start from factory settings, then customize each adjustment one at a time. It may be necessary to readjust center spring after adjusting front springs for instance. Test run the snowmobile under the same conditions; trail, speed, snow, driver riding position, etc. Change one adjustment and retest. Proceed methodically until you are satisfied.

WARNING

Always remove tether cord cap before performing any maintenance or adjustment, unless otherwise specified. Vehicle must be parked in a safe place, away from the trail. Always lift the front of vehicle off the ground with a suitable lifting device before adjusting ski suspension. Lift the rear of vehicle off the ground with a wide-base snowmobile stand with a rear deflector panel before rear suspension adjustment.

WARNING

Do not attempt to lift the vehicle by hand alone. Use appropriate lifting device to avoid risk of strain injuries. Always make sure the lifting device is stable and secure before proceeding to adjust the suspension components.

CAUTION: Whenever adjusting rear suspension, check track tension and adjust as necessary.

Slight suspension bottoming occurring under the worst riding conditions indicates a good choice of spring preload.

NOTE: Some models may come from factory equipped with Take/Apart (T/A) shocks. These can be rebuilt or re-calibrated. See an authorized Lynx dealer. Take/Apart type of shock absorbers need service at least once a year or after 1500km (refer to maintenance schedule).

SHOCK ABSORBER ADJUSTMENTS

Cam Type Shock

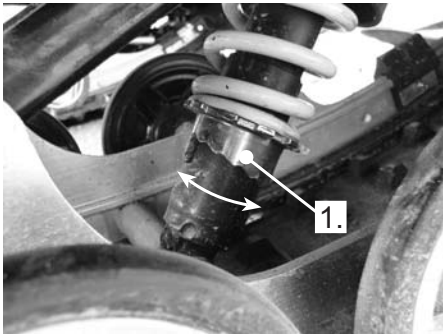

IN SOME MODELS
1. Increase or decrease spring preload with spring cam

Screw Ring Type Shock

In some models you have to first open lock ring then turn adjust ring to position wanted.

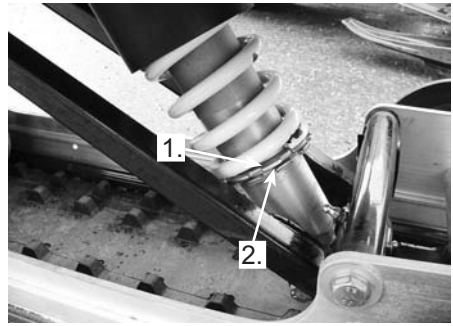

IN SOME MODELS
1. Increase or decrease spring preload
2. Locking ring

Screw Type Shock

In some models you have to turn plastic ring to increase or decrease spring preload.

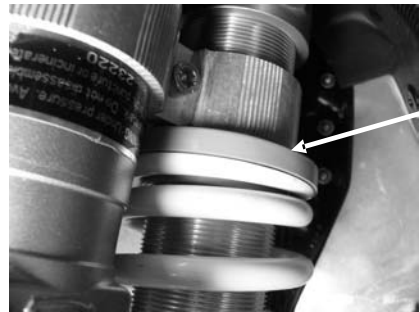

IN SOME MODELS
1. Increase or decrease spring preload

Shock dampening adjustment

In some models you may adjust also dampening strength of shock.

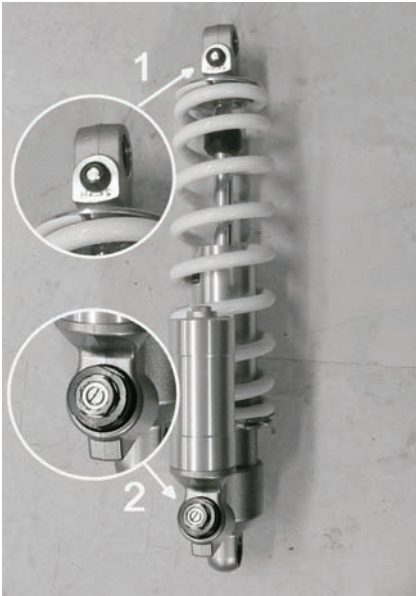

IN SOME MODELS ONLY

1. Rebound adjustment.
2. Compression adjustment.

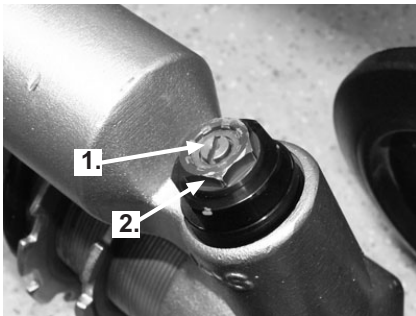

1. Low speed compression adjuster (flat screwdriver)
2. High speed compression adjuster (17mm wrench)

Turning the small brass screw [1] clockwise increases the low-speed compression dampening.

Turning the red nut [2] clockwise increases the high-speed compression dampening.

These adjustment have no effect on rebound dampening.

Rear Springs — Comfort

IMPORTANT: Make sure that all objects to be transported are in place in storage compartment and rear rack.

- Grab rear bumper and lift until suspension is fully extended.
- From this point, rear of snowmobile should collapse by 50 to 75 mm (2 to 3 in) when driver and passenger (if so applicable) take place. Measure at rear bumper as shown in next photo.

⚠ WARNING

Do not attempt to lift the vehicle by hand alone. Use appropriate lifting device or have assistance to share lifting stress in order to avoid risk of strain injuries.

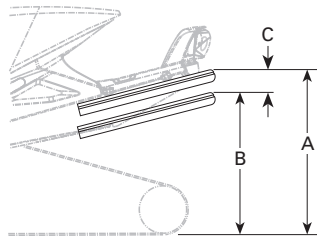

TYPICAL — PROPER ADJUSTMENT

- A. Suspension fully extended
- B. Suspension has collapse with driver, passenger(s) and load added
- C. Distance between dimension A and B, must not exceed 50 to 75 mm (2 to 3 in), see table

Rear Springs Adjustment

"C"	CAUSE	SOLUTION
50 to 75 mm (2 to 3 in)	No adjustment required	
More than 75 mm (3 in)	Too soft of adjustment	Increase preload (see preload adjustment)
Less than 50 mm (2 in)	Too hard of adjustment	Decrease preload (see preload adjustment)

Center Spring — Steering Behavior

- Ride at moderate speed on a trail.
- If handlebar is felt too easy or too hard to turn, adjust center spring accordingly.

WARNING

Before proceeding with any suspension adjustment, remember:

- park in a safe place
- remove tether cord cap
- lift rear of vehicle off the ground with a wide-base snowmobile stand with a rear deflector panel
- make sure lifting device is stable and secure.

CENTER SPRING ADJUSTMENT

STEERING BEHAVIOR		ADJUSTMENT		
VEHICLE SPEED	HANDLE-BAR	STEERING ATTITUDE	PROB-LEM	SOLU-TION
Mode- rate	Easy to turn	Neutral	No adjustment required	
	Harder to turn	Over-steering	Too soft of adjustment	Increase preload
	Very easy to turn	Under-steering	Too hard of adjustment	Decrease preload

Preload Adjustment

Stopper Strap — Weight Transfer

- Ride at low speed then fully accelerate.
- Note steering behavior.
- Adjust stopper strap length accordingly.

WARNING

Before proceeding with any suspension adjustment, remember:

- park in a safe place
- remove tether cord cap
- lift rear of vehicle off the ground with suitable lifting device
- make sure lifting device is stable and secure.

CAUTION: Whenever stopper strap length is changed, track tension must be readjusted.

STOPPER STRAP — WEIGHT TRANSFER				
WEIGHT TRANSFER			ADJUSTMENTS	
STEERING BEHAVIOR	TRACK	SKIS	PROB-LEM	SOLU-TION
Comfortable	Good weight transfer	Light pressure	No adjustment required	
Light	Too much weight transfer	Lift off the ground	Too long strap	Reduce strap length
Heavy	Not enough weight transfer	Heavy pressure	Too short strap	Increase strap length

Strap Adjustment

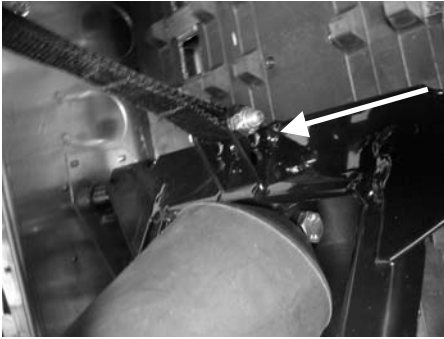

TYPICAL

1. Increase or decrease strap length by bolting to a different hole

Front Springs — Handling

- Ride at moderate speed and check for proper handling.
- Adjust front springs accordingly.

WARNING

Before proceeding with any suspension adjustment, remember:

- park in a safe place
- remove tether cord cap
- lift rear of vehicle off the ground with a wide-base snowmobile stand with a rear deflector panel
- make sure lifting device is stable and secure.

WARNING

Always adjust both front springs to same position.

FRONT SPRINGS ADJUSTMENT

HANDLING	STEERING	PROBLEM	SOLUTION
Good	Comfortable	No adjustment required	
Bad	Too easy to turn	Too soft of adjustment	Increase spring preload
Bad	Hard to turn	Too hard of adjustment	Decrease spring preload

Preload Adjustment

CAUTION: Make sure that both front springs are still pre loaded when front of vehicle is off the ground.

SUSPENSION TROUBLESHOOTING

PROBLEM	CORRECTIVE MEASURES
Front suspension wandering.	<ul style="list-style-type: none"> - Check ski alignment and camber angle adjustment. See an authorized Lynx dealer - Reduce ski ground pressure. - Reduce front suspension spring preload. - Increase center spring preload. - Reduce rear spring preload.
Snowmobile seems unstable and seems to pivot around its centre.	<ul style="list-style-type: none"> - Reduce rear suspension front arm pressure. - Reduce center spring preload. - Increase rear spring preload. - Increase front suspension spring preload.
Steering feels too heavy.	<ul style="list-style-type: none"> - Reduce ski ground pressure. - Reduce front suspension spring preload. - Increase center spring preload.
Rear of snowmobile seems too stiff.	<ul style="list-style-type: none"> - Reduce rear spring preload.
Rear of snowmobile seems too soft.	<ul style="list-style-type: none"> - Increase rear spring preload.
Rear suspension front shock absorber is frequently bottoming.	<ul style="list-style-type: none"> - Lengthen stopper strap. - Increase center shock preload.
Track spins too much at start.	<ul style="list-style-type: none"> - Lengthen stopper strap. - Change driving position.

In deep snow

When operating the snowmobile in deep snow, it may be necessary to vary extension adjustment, stopper strap and/or riding position, to change the angle at which the track rides on the snow. Operator's familiarity with the various adjustments as well as snow conditions will dictate the most efficient combination.

FUEL AND OIL

Recommended fuel

Refer to TECHNICAL DATA in the end of this manual.

NOTE: Never experiment with other fuels or fuel ratios. The use of un-recommended fuel can result in snowmobile performance deterioration and damage to critical parts in the fuel system and engine components.

WARNING

Do not overfill or top off the fuel tank before placing the vehicle in a warm area. As temperature increases, fuel expands and might overflow. Fuel is inflammable and explosive under certain conditions. Wipe off any fuel spillage from the vehicle.

Fuel System Antifreeze

When using oxygenated fuel (typical), additional gas line antifreeze or water absorbing additives are not required and should not be used.

Recommended oil

Oil reservoir cap is identified "OIL". Use only oil, which flows at -40°.

Oil is in injection oil reservoir. (Some models pre-mixed with fuel). Use BRP snowmobile injection oil.

Use only 2-stroke engine injection oil.

Refer to TECHNICAL DATA in the end of this manual to find right oil type for your vehicle.

CAUTION: Never use four-stroke mineral or synthetic oil. Do not mix these with outboard motor oil. Do not use NMMA TC-W, TC-W2 or TC-W3 outboard oil. Avoid mixing different brands of API TC oil as resulting chemical reactions may cause severe engine damage.

Always maintain a sufficient amount of recommended oil in the injection oil reservoir.

CAUTION: Check level and refill every time you refuel. Do not mismatch oil reservoir cap with fuel tank cap.

Chaincase oil

Recommendation Bombardier Synthetic Chaincase Oil (P/N 413803300, 12x355 ml).

Cold weather carburetion modifications

All vehicles has been calibrated for -20°C. They can be operated at warmer winter temperatures without problems.

CAUTION: For colder temperatures than -20°C, carburetor(s) must be recalibrated to avoid engine damage. Refer to an authorized Lynx dealer.

BREAK-IN PERIOD

Engine

IMPORTANT: A break-in period of 10-15 hours (about 500 km) is required for Rotax engines before running the snowmobile at full throttle.

During break-in period, maximum throttle should not exceed $\frac{3}{4}$. However, brief full acceleration and speed variations contribute to a good break-in.

All models: To assure additional protection during the initial engine break-in, 500 ml of recommended injection oil should be added to fuel for the first full filling of fuel tank. Have spark plugs cleaned after engine break-in.

Drive Belt

A new drive belt requires a break-in period of 50 km. Avoid strong acceleration/deceleration, pulling a load or high speed cruising.

Refer to TECHNICAL DATA in the end of this manual to find right drive belt for your vehicle.

10 Hour Inspection

We suggest that after the first 10 hours of operation — 500 km — or 30 days after the purchase, whichever comes first, your snowmobile be checked by an authorized Lynx dealer.

NOTE: The 10 hour inspection is at expense of the snowmobile owner.

OPERATING INSTRUCTIONS

WARNING

Never use engine on idle speed too long time because snowmobile cooling system does not work on idle. Cooling system works only when driving with unit. When engine is cold it can be used on idle max 1-2 minutes, when engine is warm just few seconds. Never leave unit on idle without control.

WARNING

Always use a wide base snowmobile mechanical stand to properly support vehicle during any track verification. Slowly accelerate engine in order to rotate track at very low speed when it is not on ground.

Pre-Operation Check

WARNING

The pre-operation check is very important prior to operating the vehicle. Always check the proper operation of critical controls, safety features and mechanical components before starting. If not done as specified here, severe injury or death might occur.

- Remove snow and ice from body including seat, footrests, controls and instruments.
- Lights — The head lamp, the taillight and the brake light are standard equipment. Be sure lights are clear of dirt, slush or snow and are in good working order or condition.
- Verify that track, idler wheels and rear suspension are free to turn and not frozen.

- Activate the brake control lever and make sure the brake fully applies before the brake control lever touches the handlebar grip. It must fully return when released.
- Check the parking device. Apply parking brake and check if it operates properly.
- Activate the throttle control lever several times to check that it operates easily and smoothly and it returns to the idle position when released.

WARNING

Throttle lever must operate easily and smoothly. It must return to idle position when released.

- Check operation of tether and engine cutout switches, ignition switch, head lamp switch (HI-LO), taillight, brake light and pilot lamps.
- Verify that skis and steering operate freely. Check corresponding action of skis versus handlebar.
- Check fuel and oil for levels and leaks. Replenish as necessary and see an authorized Lynx dealer in case of any leaks.
- Verify that air filter(s) is free of snow, if so equipped.
- All storage compartments must be properly latched and they must not contain any heavy or breakable objects. Hood must be also properly latched.

WARNING

All adjustable features should be positioned at optimal setting. Securely tighten all adjustment locks.

- Make certain your snowmobile is pointed away from people or objects before you start it. No one is to be standing in front of or in back of the snowmobile.

- Be warmly dressed with clothing designed for snowmobiling.

PRE-OPERATION CHECK LIST

ITEM	OPERATION	✓
Body including seat, footrests, lights, controls and instruments	Check that there is no snow or ice.	
Track, suspension and idler wheels	Check for free movement.	
Brake lever	Check proper action.	
Parking device	Check proper action.	
Throttle lever	Check proper action.	
Switches and lights	Check proper action. Tether cord must be attached to driver clothing eyelet.	
Skis and steering	Check for free movement and proper action.	
Fuel and oil	Check for proper level and leaks.	
Air filter	Check that there is no snow or ice.	
Adjustable features	Check for optimal adjustment and securely tightened adjustment locks.	
Storage compartment	Check for proper latching and no heavy or breakable objects.	
Vehicle vicinity	Snowmobile must be pointed away from people or objects. No one is to be standing in front of or in back of the snowmobile.	
Clothing	Be warmly dressed with clothing designed for snowmobiling.	

Carburetor Engine Starting Procedure

Procedure

- Recheck throttle control lever operation.
- Ensure that the tether cord cap is in position and that the cord is attached to your clothing eyelet.
- Ensure that the engine cut-out switch is in the ON position.

- On fan-cooled models, turn ignition key to ON position.
- Activate the choke according to the temperature as explained below.

Choke Application

Initial Cold Starting When Temperature is Below - 10°C (+ 15°F)

NOTE: Do not operate the throttle lever with the choke lever on.

Set the choke lever to position 3.

NOTE: After the engine is started, let engine warm up at fast idle until engine speed drops. Then, close off choke to ensure proper air-fuel mixture.

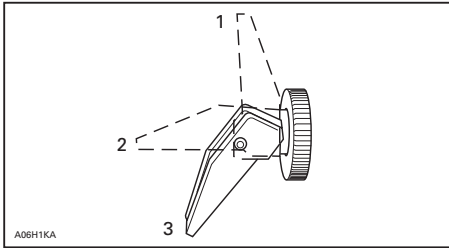

- 1. OFF
- 2. Position 2
- 3. Position 3

Initial Cold Starting When Temperature is Above - 10°C (above + 15°F)

Set the choke lever to position 2.

NOTE: After the engine is started, close off choke to ensure proper air-fuel mixture.

Warm Engine Starting

Start the engine without any choke. If the engine will not start after two pulls of the rope or two 5 second attempts with the electric starter move choke lever to position 2. Start the engine without activating the throttle lever. As soon as the engine starts move the choke lever to OFF.

Procedure (Cont'd)

Manual Starting

- Grab manual starter handle, pull handle slowly until a resistance is felt, then hold handle firmly and pull vigorously to start engine.

Electric Starting (if so equipped)

⚠ WARNING

Never depress throttle while starting engine.

CAUTION: Do not use electric starter for more than 10 seconds. A rest period should be observed between the cranking cycles to let electric starter cool down. Using electric starter when engine has started could damage electric starter mechanism.

Fan Cooled Models

- Turn key clockwise until starter engages.
- Release key immediately when engine has started.

NOTE: If for any reason, the engine cannot be cranked electrically, leave ignition key to ON position and start engine manually using the rewind starter.

NOTE: If for any reason, the engine cannot be cranked electrically, start engine manually using the rewind starter.

Emergency Starting

The engine can be started with the emergency starter rope supplied with the tool kit.

Remove belt guard.

⚠ WARNING

Do not wind starting rope around your hand. Hold rope by the handle only. Do not start the snowmobile by the drive pulley unless it is a true emergency situation. Have the snowmobile repaired as soon as possible.

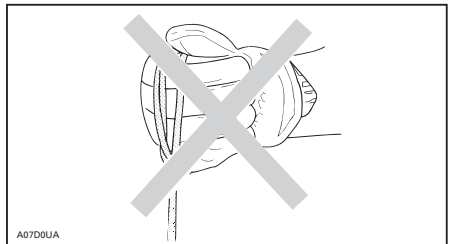

Attach one end of emergency rope to rewind handle.

NOTE: The spark plug socket can be used as an emergency handle.

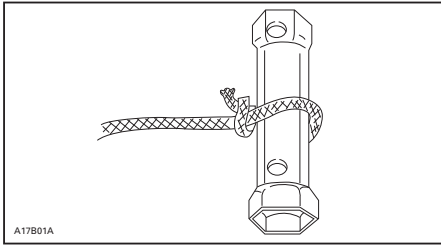

TYPICAL

Attach the other end of emergency rope to the starter clip supplied in the tool kit.

Hook up clip on drive pulley.

Wind the rope tightly around drive pulley. When pulled, pulley must rotate counterclockwise.

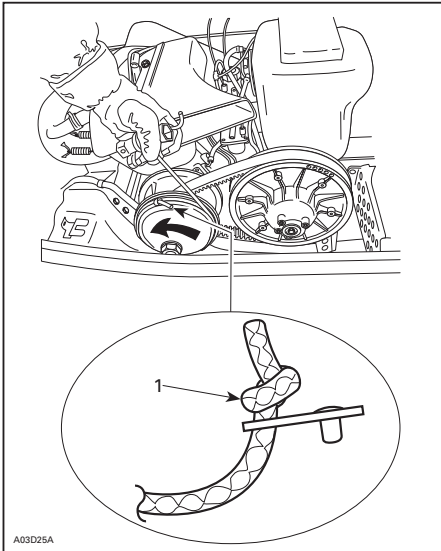

TYPICAL — FAN-COOLED MODELS

1. Knot on this side

Pull the rope using a sharp, crisp pull so the rope comes free of the drive pulley.

Start engine as per usual manual starting.

⚠ WARNING

When starting the snowmobile in an emergency situation, using drive pulley, do not reinstall the belt guard and return slowly to have snowmobile repaired.

Shutting off the engine

Release throttle lever and wait until engine has returned to idle speed.

Shut off the engine using engine cut-out switch.

⚠ WARNING

Always remove tether cord cap and key when vehicle is not in operation in order to prevent accidental engine starting or to avoid unauthorized use by others or theft.

VEHICLE WARM-UP

Before every ride, vehicle has to be warmed up as follows:

Snowmobile must be securely supported by the rear bumper using a wide-base snowmobile mechanical stand. Track must be 100 mm off the ground.

Start engine and allow it to warm up one or two minutes at idle speed, anyway if needed give some throttle that engine runs smoothly. Never let unit idle without control.

Release barking brake.



WARNING

Make sure wide-base snowmobile mechanical stand is stable. Stay clear of the front of vehicle and the track. Do not use too much throttle during warm-up or when track is free-hanging.

Apply throttle until drive pulley engages. Let track rotate at low speed for several turns. The lower the vehicle temperature is the longer vehicle warm-up should be.

Shut-off the engine and remove the wide base snowmobile mechanical stand.

Skis may be frozen on the ground. Grab both skis one at a time by their loops and lift their front end slightly off the ground.

After restarting engine, the vehicle can be driven at low speed for the first 2 or 3 minutes of riding. After that, it may be driven up to the legal speed limit as per normal safety practices.

POST OPERATION CARE

Shut down the engine. Install rear of vehicle on a wide-base snowmobile mechanical stand.

Remove snow and ice from rear suspension, track, front suspension, mechanism and skis.

Protect vehicle with a snowmobile cover.

SPECIAL OPERATIONS

Engine overheating

Fan cooled models: Shut off the engine.

Check for clogged air duct passages. Remove any foreign materials.

Check for proper fan belt condition and tension.

Fuel flooded engine

Install new spark plugs and restart engine.

Rear suspension slider shoe sticking

Slider shoes are cooled and lubricated by snow. When riding at moderate or high speed on a thin-snow-covered surface, slider shoes may stick on metallic track guides.

Run snowmobile on a surface covered by snow or drive snowmobile at very low speed.

Have slider shoes inspected by an authorized Lynx dealer.

NOTE: This situation comes up the more high profile track is. Avoid driving on hard packed snow, ice surface or other surface, that has not enough snow to ensure the lubrication.

It is noticeable that tracks with 40 mm or more high profile are not meant for the trail ride (hard surface) but only for the deep snow ride. If the vehicle which is equipped with this kind of track, is driven on hard packed snow, slider shoes may stick on track metallic parts or the track can get damaged.

Towing an Accessory

Always use a rigid tow bar to tow an accessory. Any towed accessory should have reflectors on both sides and at the rear. Check local laws for brake lights requirements.

WARNING

Never tow an accessory with a rope. Always use a rigid tow bar. Using a rope would result in a collision between the object and the snowmobile and possibly in a tip over in case of a rapid deceleration or on a downward slope.

Towing Another Snowmobile

If a snowmobile is disabled and must be towed use a rigid tow bar, remove the drive belt and tow at moderate speed.

CAUTION: Always remove the drive belt of the snowmobile that is to be towed to prevent damage to its belt and drive system.

In an emergency situation only, if a rigid tow bar is not available, a rope can be used provided you proceed with extra caution.

Remove the drive belt, attach the rope to the ski legs (spindles), have someone sit on the towed snowmobile to activate the brake, and tow at low speed.

CAUTION: In order to prevent damage to the steering system, never attach the tow rope to the ski loops (handles).

WARNING

Never ride at high speed when towing a disabled snowmobile. Proceed slowly with extra caution.

Transporting the Vehicle

Make sure that oil reservoir and fuel tank caps are properly installed.

Tilt bed trailers can easily be equipped with a winch mechanism to afford maximum safety in loading. Simple as it may seem, never drive your snowmobile onto a tilt bed trailer or any other kind of trailer or vehicle. Many serious accidents have resulted from driving up and over a trailer. Anchor your vehicle securely, front and rear, even on short hauls. Be certain all equipment is securely fastened. Cover your snowmobile when trailering to prevent road grime from causing damage.

Be certain your trailer meets state or provincial requirement. Ensure the hitch and safety chains are secure and the brake, turn indicators and clearance lights all function.

FLUID LEVELS

WARNING

It is recommended that the assistance of an authorized Lynx dealer be periodically obtained on other components/systems not covered in this guide. Unless otherwise specified, engine must be cold and not running. The tether cord cap must be removed for all maintenance procedures.

CAUTION: Vehicle must be on a level surface before checking any fluid levels.

Brake system

Check brake fluid in reservoir for proper level. Add fluid as required.

CAUTION: Use only DOT 4 brake fluid from a sealed container.

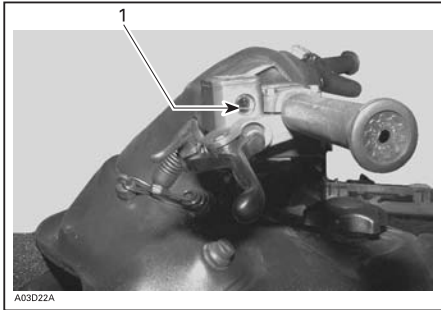

BRAKE FLUID RESERVOIR

1. Minimum

Chaincase oil

Chain case models: Check the oil level by removing dipstick. Oil level must be between lower and upper marks.

NOTE: It is normal to find metallic particles stuck to dipstick magnet. If bigger pieces of metal are found, see an authorized Lynx dealer.

Remove metal particles from magnet.

Refill up to upper mark using recommended oil. XP-S synthetic chaincase oil P/N 413803300.

NOTE: Do not use unrecommended other types of oil when servicing. Do not mix synthetic oil with other types of oil.

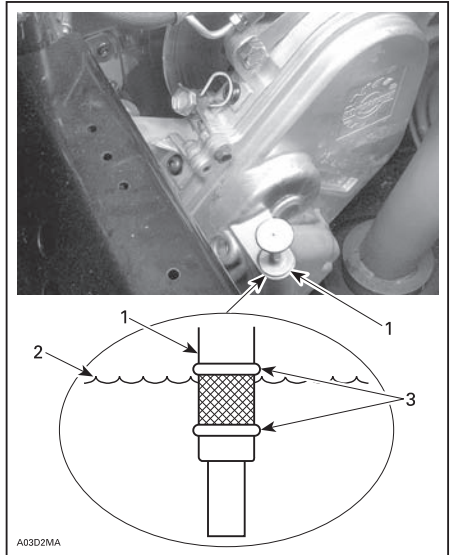

1. Dipstick
2. Oil level
3. Level between marks

Injection oil system

Always maintain a sufficient amount of recommended injection oil in the injection oil reservoir.

NOTE: Never allow oil reservoir to be almost empty.

WARNING

Check level and refill every time you are refuelling vehicle. Wipe off any spillage. Oil is highly flammable when heated.



OIL TANK CAP



SEE MAX OIL LEVEL DECAL ON THE SIDE OF THE OIL TANK

BATTERY

Removal

WARNING

Battery BLACK negative cable must always be disconnected first and connected last.

WARNING

Never charge or boost battery while installed. Battery electrolyte contains sulfuric acid which is corrosive and poisonous. In case of contact with skin, flush with water and call a physician immediately.

WARNING

Should the battery casing be damaged, wear a suitable pair of non-absorbent gloves when removing the battery by hand.

WARNING

Battery caps have do not have vent holes. Make sure that vent tube is not obstructed.

Dry battery

These batteries are maintenance-free battery. Electrolyte level can not be checked.

NOTE: During the summer storage the battery (also dry battery) has to be charged at least once a month. Otherwise the battery do not work in the beginning of season.

MAINTENANCE

Vehicle cleaning and protection

Remove any dirt or rust.

To clean the entire vehicle, use only flannel cloths or equivalent.

CAUTION: It is necessary to use flannel cloths or equivalent on windshield and hood to avoid damaging further surfaces to clean.

To clean the entire vehicle, including bottom pan and metallic parts use Bombardier Cleaner (P/N 293 110 001) spray can 400 g and (P/N 293 110 002 (4 L)).

CAUTION: Do not use Bombardier Cleaner on decals or vinyl.

For vinyl and plastic parts use Vinyl & Plastic Cleaner (P/N 413 711 200 (6 x 1 L)).

To remove scratches on windshield or hood use BOMBARDIER Scratch Remover Kit (P/N 861 774 800).

CAUTION: Never clean plastic parts or hood with strong detergent, degreasing agent, paint thinner, acetone, products containing chlorine, etc.

Clean sheaves of both pulleys using BOMBARDIER Pulley flange cleaner (P/N 413 711 809).

Inspect the hood and repair any damage.

Touch up all metal spots where paint has been scratched off. Spray all metal parts including shock chromed rods with BOMBARDIER LUBE (P/N 293 600 016).

Wax the hood and the painted portion of the frame for better protection.

Apply wax on glossy finish only. Protect the vehicle with a cover to prevent dust accumulation during storage.

The snowmobile has to be stored in a cold and dry place and covered with an opaque tarpaulin. This will prevent sun rays from affecting vehicle finish.

Lift rear of vehicle until track is off the ground. Install on a mechanical stand.

Do not release track tension.

Drive belt removal and installation

Remove tether cord cap. Open side hood.

Some models only: remove upper intake silencer first.



Lift up the intake silencer clamp.



1. Intake silencer clamp.

Remove intake silencer. First rear part out, pull lower edge and pull to rear to remove intake silencer. Remove cables connected to intake silencer (some models). At reinstallation do not forget to connect air temperature sensor otherwise a trouble code will appear.



Open the drive belt cover front side.



Lift cover front side up and bend it to out from unit to get it removed.

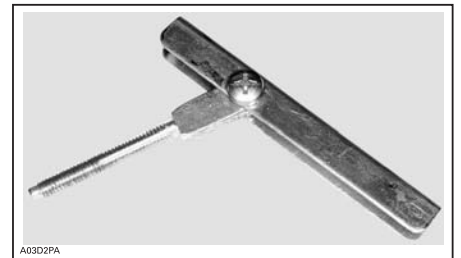

DRIVE BELT INSTALLER/REMOVER

NOTE: There is two type of drive belt installer tool in toolbox (mm and inches)

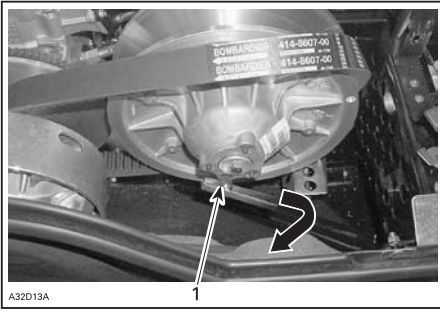

1. Tighten to open pulley

Screw tool in the threaded hole and tighten to open the pulley. Remove belt.

Slip the belt over the top edge of the sliding half, as shown.

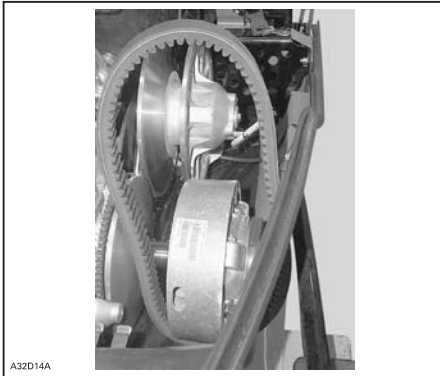
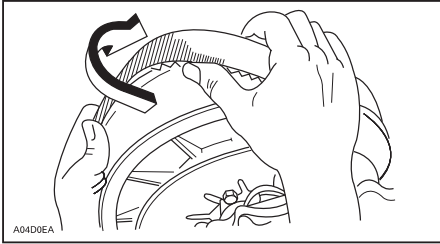

TYPICAL

Installation

The maximum drive belt life span is obtained when the belt has the proper rotation direction. Install it so the arrow printed on belt is pointing at front of vehicle.

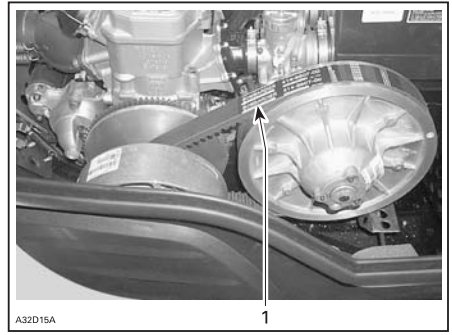

1. Arrow pointing at front of vehicle

CAUTION: Do not force or use tools to pry the belt into place, as this could cut or break the cords in the belt.

Clean sheaves of both pulleys using BOMBARDIER Parts Cleaner (P/N 413 711 809).

To install the drive belt, first place belt between drive pulley sheaves. Then, between driven pulley sheaves, finishing with bottom.

Follow instructions on belt guard.

Reinstall belt guard.

NOTE: Belt guard is purposely made slightly oversize to maintain tension on its retainers preventing undue noise and vibration. It is important that this tension be maintained when reinstalling.

Drive chain tension

Remove hair pin.

Fully tighten tensioner adjustment screw by hand, then back off only far enough for hair pin to engage in locking hole.

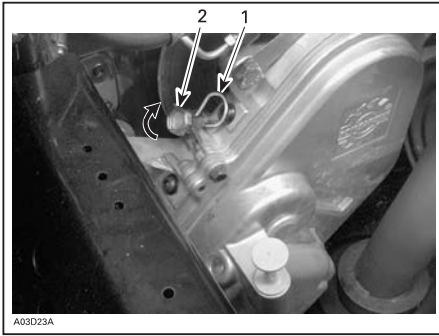

1. Hair pin
2. Adjustment screw

Set barrel below the chaincase and open the drainplug [2] and let the oil run out to the barrel.

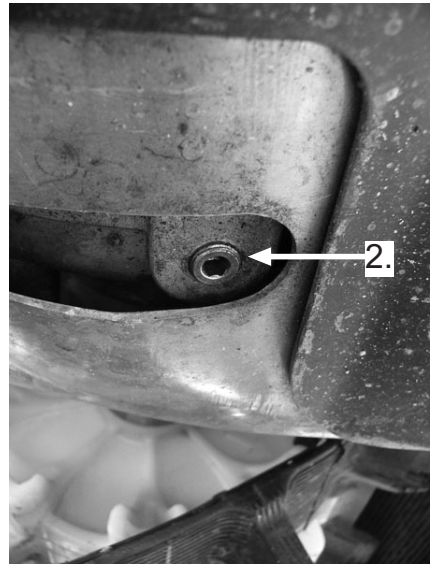

When oil is out from chaincase, close the drainplug.

Add new oil through dipstick hole to the full level of dipstick. See from TECHNICAL DATA section for right oil type.

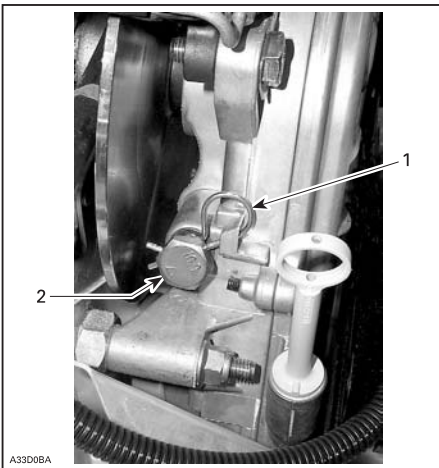

1. Hair pin
2. Adjustment screw

TRA Drive pulley adjustment (Only RAVE 550)

The drive pulley is factory calibrated to transmit maximum engine power at a predefined RPM. Refer to TECHNICAL DATA at the end of this guide. Factors such as ambient temperature, altitude or surface condition may vary this critical engine RPM thus affecting snowmobile efficiency.

Calibration screws should be adjusted so that actual maximum engine RPM in vehicle matches with the maximum horsepower RPM.

Use precision digital tachometer for engine RPM adjustment.

Chaincase oil change

Open the side hood.
Remove dipstick [1].

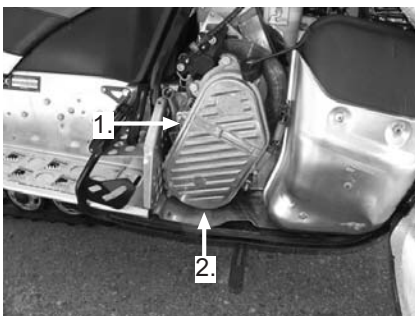

The adjustment has an effect on high RPM only.

To adjust, turn calibration screws.

CAUTION: Exceeding the engine RPM results to engine damage. Never exceed maximum RPM. Follow the adjustment sets according technical data.

Calibration screw has a notch on top of its head. There are 6 positions numbered 1 to 6.

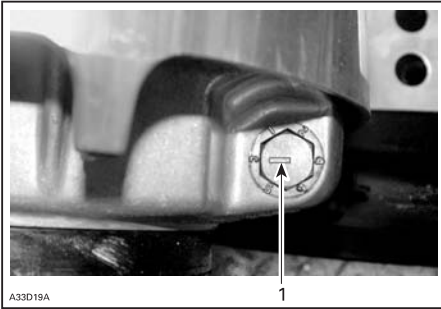

1. Notch

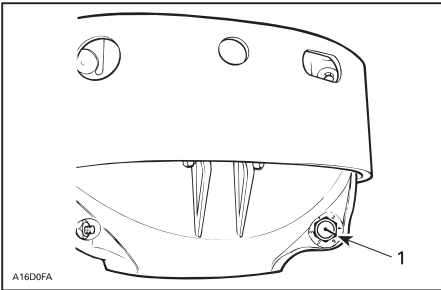

1. Notch

There are 6 positions numbered 1 to 6. Note that in position 1 the number is substituted by a dot (due to its location on casting).

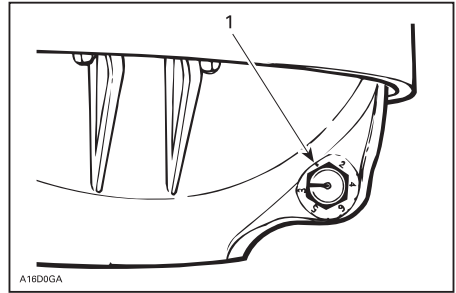

TRA DRIVE PULLEY

1. Position 1 (not numbered)

Lower position numbers decrease engine RPM in steps of 200 RPM and higher position numbers increase it in steps of 200 RPM.

EXAMPLE: Calibration screw is set at position 4 and is changed to position 6: So maximum engine RPM is increased by 400 RPM.

Adjust as follows: (only if calibrations are changed)

Loosen locking nut enough to pull calibration screw partially out and adjust to desired position. Do not completely remove the locking nut. Torque nut to 10 Nm.

CAUTION: Do not completely remove calibration screw otherwise inside washer will fall off. Always adjust all 3 calibration screws and make sure they are all set at the same number.

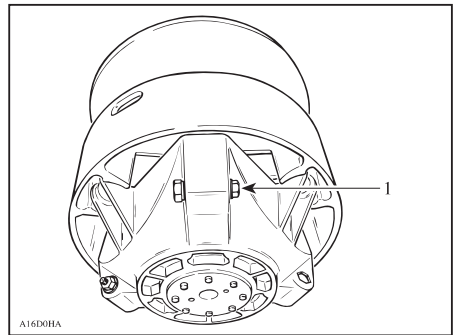

1. Loosen just enough to permit rotating of calibrate screw

WARNING

Always reinstall belt guard. Do not operate engine with hood open or belt guard removed. Improper servicing, modification or poor adjustment may affect drive pulley performance and belt life. Refer to an authorized Lynx dealer.

Drive belt condition

Inspect belt for cracks, fraying or abnormal wear (uneven wear, wear on one side, missing cogs, cracked fabric). If abnormal wear is noted, probable cause could be pulley misalignment, excessive RPM with frozen track, fast starts without warm-up period, burred or rusty sheave, oil on belt or distorted spare belt. Contact an authorized Lynx dealer.

Check the drive belt width. Replace the drive belt if width is less than the minimum width recommended in TECHNICAL DATA.

Brake condition

WARNING

The brake mechanism on your snowmobile is an essential safety device. Keep this mechanism in proper working condition. Above all, do not operate the snowmobile without an effective brake system. Periodically verify the condition/wear of the brake pads.

Brake adjustment

Hydraulic brake: No adjustment is provided for hydraulic brake. See an authorized Lynx dealer if any problems.

Rear suspension condition

Visually inspect all suspension components including slider shoes, springs, wheels, etc.

NOTE: During normal driving, snow will act as a lubricant and coolant for the slider shoes. Extensive riding on ice or sanded snow, will create excessive heat build-up and cause premature slider shoe wear.

Suspension stopper strap condition

Inspect stopper strap from wear and cracks, bolt and nut for tightness. If loose inspect holes for deformation. Replace as required.

Track condition

Lift the rear of the snowmobile and support it with a wide-base snowmobile mechanical stand. Rotate the track by hand, and inspect condition. If worn or cut, or if track fibers are exposed, or if missing or defective inserts or guides are noted, contact an authorized Lynx dealer.

WARNING

Do not operate or rotate track if torn, damaged or excessively worn.

Track tension and alignment

Ride the snowmobile in snow about 15 to 20 minutes prior to adjusting track tension.

Lift rear of snowmobile and support it with a wide-base snowmobile mechanical stand.

Allow the suspension to extend normally and check the gap half-way between front and rear idler wheels. Measure between slider shoe bottom and inside of track. The gap should be as given in TECHNICAL DATA.

WARNING

Track tension must be as describe in technical data. Too loose track may cause an accident.

IMPORTANT: Too much tension will result in power loss and excessive stresses on suspension components.

To adjust track tension:

Remove rear idler wheel cover. Loosen rear idler wheel fastening screws. Turn adjustment screws if required. If correct tension is unattainable, contact an authorized Lynx dealer.

WARNING

Do not try to check the tension with engine on. Press/turn cut-out switch to OFF position or Do not touch rotating track, it may cause injuries.

Track alignment

WARNING

Before checking track alignment, ensure that the track is free of all particles which could be thrown out while track is rotating. Keep hands, tools and clothing clear of track.

Start the engine and accelerate slightly so that track barely turns. This must be done in a short period of time (15 to 20 seconds). Check that the track is well centred.

Check that the track is well centred; equal distance on both sides between edges of track guides and slider shoes.

Stop engine prior to adjusting. Loosen rear idler wheel retaining screws. Tighten the adjustment screw on side where the slider shoe is the farthest from the track insert guides.

Tighten lock nuts and retaining screws.

WARNING

Tighten the nuts properly. If lock nuts or adjustment screws are not tightened properly, the track may become loose and get damaged.

Restart engine and rotate track slowly to recheck alignment.

Reposition snowmobile on ground.

NOTE: A belt tension tester (P/N 414 348 200) may be used to measure deflection as well as force applied.

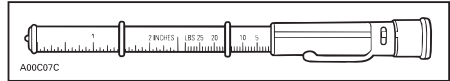

BELT TENSION TESTER

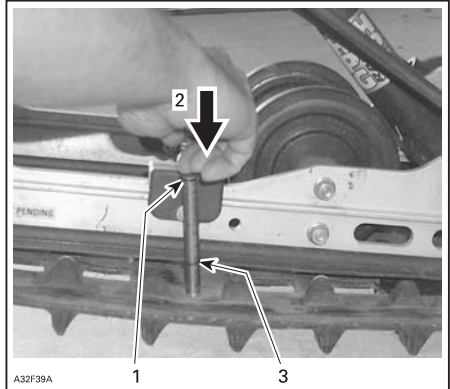

1. Top tool O-ring positioned at (example 7,3 kg, see technical data)
2. Push on top portion of tool until it contacts the top O-ring
3. Measured track deflection

Steering and front suspension mechanism

Visually inspect steering and front suspension mechanism for tightness of components (steering arms, control arms and links, tie rods, ball joints, ski coupler bolts, etc.).

If necessary, contact an authorized Lynx dealer.

Wear and condition of skis and runners

Check the condition of the skis, ski runners and ski runner carbides. If worn, contact an authorized Lynx dealer.

WARNING

Excessively worn skis and/or ski runners will affect snowmobile control.

Exhaust system

The exhaust system is designed to reduce noise and to improve the total performance of the engine. If any exhaust system component is removed, modified or damaged, severe engine damage may result.

Air filter cleaning

While riding in deep powder snow, periodically stop then shake the snow from the filter. Check that air silencer is clean and dry and properly reinstall the filter.

Leaving the snowmobile uncovered during a snowfall or riding in deep powder snow may block air filter and choke the engine. Open the sidehood, remove the air filters out of from air silencer and middle hood, shake the snow from filters and properly reinstall the filter.



Check that the air silencer is clean and dry and properly reinstall the filter.

CAUTION: Snowmobile have been calibrated with the filter installed. Operating the snowmobile without it may cause engine damage.

Headlamp beam aiming

Turn knob to adjust beam height.



Bulb replacement (some models)

CAUTION: Never touch glass portion of an halogen bulb with bare fingers, it shortens its operating life. If glass is touched, clean it with isopropyl alcohol which will not leave a film on the bulb.

Headlamp bulb change

If any headlamp bulb is burnt, open the side hoods.

Pull rewind starter rope out about 40cm and make a knot to get free play for panel.



Open console big plastic nut round the fuel tank refill hole.



Lift console front edge up (pin in the rubber ring).

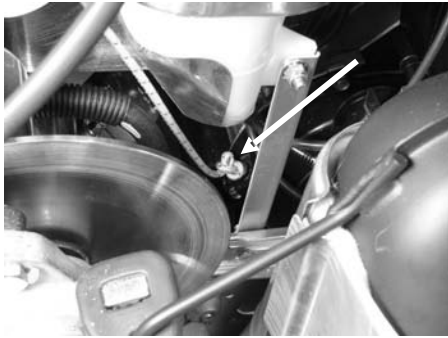

Open console side screws 2pcs.



Lift the console rear edge until you have enough space to work with head lamp bulbs.



Unplug burnt bulb connector. Remove the rubber boot.

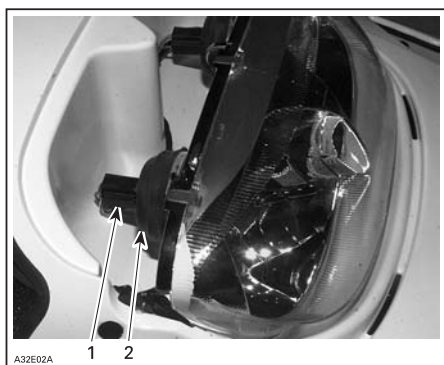

1. Bulb connector
2. Rubber boot

Turn bulb locking ring counter clockwise to remove it. Detach the bulb and replace. Properly reinstall parts.

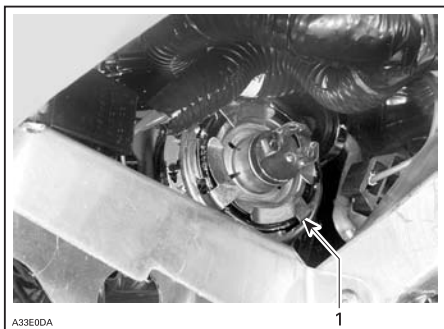

1. Locking ring

NOTE: Always check light operation after bulb replacement !

Bulb replacement (some models)

CAUTION: Never touch glass portion of an halogen bulb with bare fingers, it shortens its operating life. If glass is touched, clean it with isopropyl alcohol which will not leave a film on the bulb.

Headlamp bulb change

If any headlamp bulb is burnt, open the side hoods.

Open the upper hood. (See more details from "Hood opening"-section.



Unplug burnt bulb connector. Remove the rubber boot.



1. Bulb connector
2. Rubber boot

Turn bulb locking ring counter clockwise to remove it. Detach the bulb and replace. Properly reinstall parts.

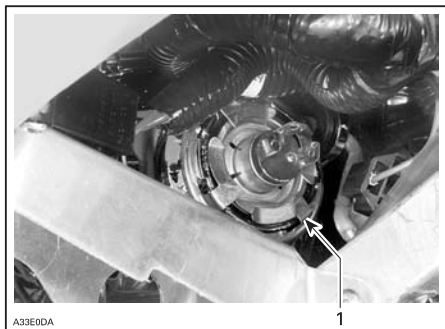

1. Locking ring

NOTE: Always check light operation after bulb replacement !

Tail light bulb change

Open the tail light lens by opening screws (1.) and change bulb.



Some models with small tail light.

Pull tail light lens and base together from its location. It is fixed by plastic pins through cushions to the base plate.



Turn bulb base to the counter clockwise to open the bulb base from tail light.



Pull old bulb from the base. Do not touch new bulb by your finger.



Spark plug change

- Open the left side panel.
- Remove intake silencer.
- Remove spark plug cable.
- Clean carefully cylinder head surface round the spark plug.
- Open the spark plug by using spark plug removal tool.



STORAGE AND PRESEASON PREPARATION

WARNING

Have an authorized LYNX dealer inspect fuel, cooling and oil systems integrity as specified in PERIODIC MAINTENANCE CHART.

Storage

During summer, or when a snowmobile is not in use for more than one month that proper storage is a necessity. Engine, cooling and fuel system need to be serviced to manage over the storage period without damages.

CAUTION: Improper antifreeze mixture might allow freezing of the liquid in the cooling system if vehicle is stored in area where freezing point is reached. This would seriously damage the engine. Failure to replace the antifreeze for storage may cause its degradation which could result in poor cooling when engine will be used.

CAUTION: Do not run engine during storage period.

Preseason preparation

Refer to an authorized LYNX dealer.

CAUTION: Have carburetor(s) cleaned-up before restarting engine on so equipped models.

TROUBLESHOOTING

Monitoring beeper coded signals

CODED SIGNAL	POSSIBLE CAUSE	REMEDY
2 short beeps (when engine is started). DESS/RER pilot lamp also blinks.	Confirms that proper tether cord cap is installed.	Normal condition.
1 short beep every 1,5 seconds (when engine is started). DESS/RER pilot lamp also blinks. Engine cannot reach engagement speed. Vehicle cannot be driven.	Bad DESS system connection. Defective tether cord cap. Dirt or snow in tether cord cap. Defective DESS post.	Reinstall tether cord cap correctly over post. Use another programmed tether cord cap. Clean tether cord cap. Contact an authorized Lynx dealer.
1 long beep per second. SDI 0,5 sec beep every 0,5 sec	Reverse is selected	Vehicle can be driven in reverse
3 short beeps per second. DESS/RER pilot lamp also blinks. Engine cannot reach pulley engagement. Vehicle cannot be driven.	Wrong tether cord cap is installed	Install proper tether cord cap.
3 short beeps per second. Engine overheating pilot lamp also blinks. SDI 80ms beep every 260ms temp lamp also blinks.	Engine is overheating	Stop engine immediately and allow to cool. If trouble persists, see an authorized Lynx dealer.
3 short beeps per second. Battery pilot lamp also lights up. SDI 80ms beep every 260ms batt lamp also blinks.	Low battery voltage	Check battery and charging system, see an authorized Lynx dealer.
4 short beeps every 2 minutes. Oil pilot lamp also lights up.	Low oil level on 2 –tec models.	Check oil level and add oil as soon as possible.
4 short beeps every 2 minutes. Engine pilot lamp also lights every 3 seconds.	Too high battery voltage. DESS system has detected a shorted key installed on DESS post.	Use another programmed tether cord cap.

CODED SIGNAL	POSSIBLE CAUSE	REMEDY
4 short beeps every 2 minutes. Engine pilot lamp also lights up. SDI 2 sec beep every 58 second lamp, remains on.	Defect in engine management system. (EMS)	See an authorized Lynx dealer.
4 short beeps every 2 minutes. Engine pilot lamp blinks every 1 second. SDI 2 sec beep every 15 seconds, lamp remains on.	Defect in engine management system. (EMS)	See an authorized Lynx dealer.

Troubleshooting

ENGINE TURNS OVER BUT FAILS TO START

- 1. Ignition switch, engine cut-out switch or tether cord is OFF position.**
 - Place all the switches to ON position.
- 2. Mixture not rich enough to start cold engine.**
 - Check fuel tank and check starting procedure, particularly use of the choke or primer.
- 3. Flooded engine (spark plug wet when removed).**
 - Do not choke. Remove wet spark plug, turn ignition switch to OFF and crank engine several times. Install clean, dry spark plug. Start engine following usual starting procedure. If engine continues to flood, see an authorized Lynx dealer.
- 4. No fuel to the engine (spark plug dry when removed).**
 - Check fuel tank level; turn fuel valve on if applicable; check fuel filter; replace if clogged; check condition of fuel and impulse lines and their connections. A failure of the fuel pump or carburetor has occurred; contact an authorized Lynx dealer.
- 5. Spark plug/ignition (no spark).**
 - Remove spark plug (s) then reconnect to spark cap. Check that engine cut-out switch is at the ON position and the tether cut-out cord cap is snapped over the receptacle. Start engine with spark plug (s) grounded to engine away from spark plug hole. If trouble persists, contact an authorized Lynx dealer.
- 6. Engine compression.**
 - As the engine is pulled over with the rewind starter, "cycles" of resistance should be felt as piston goes past top dead center (each piston on multi-cylinder engines). If no pulsating resistance is felt, it suggests a major loss of compression. Contact an authorized Lynx dealer.

ENGINE LACKS ACCELERATION OR POWER

- 1. Fouled or defective spark plug.**
 - Check item "Engine turns over but fails to start".
- 2. Lack of fuel to engine.**
 - See item "Engine turns over but fails to start".
- 3. Carburetor adjustments.**
 - Contact an authorized Lynx dealer.
- 4. Drive belt worn too thin.**
 - If the drive belt has lost more than 3 mm of its original width, it will affect vehicle performance.
- 5. Drive and driven pulleys require servicing.**
 - Contact an authorized Lynx dealer.
- 6. Engine is overheating.**
 - On fan cooled engines: Check fan belt and its tension; clean cooling fins of engine; if overheating persists, contact an authorized Lynx dealer.

ENGINE BACKFIRES

1. Faulty spark plug.

- *See item “Engine turns over but fails to start”.*

2. Engine is running too hot.

- *See item “Engine lacks acceleration or power”.*

3. Ignition timing is incorrect or there is an ignition system failure.

- *Contact an authorized Lynx dealer.*

ENGINE MISFIRES

1. Fouled/defective/worn spark plug.

- *Clean/verify spark plug gap and identification number. Replace as required.*

2. Too much oil supplied in engine.

- *Improper oil pump adjustment, refer to an authorized Lynx dealer. Too rich fuel/oil mixture (only during break-in period). Drain fuel tank and refill with appropriate mixture ratio.*

3. Water in fuel.

- *Drain fuel system and refill with fresh fuel. Replace fuel filter if needed.*

SNOWMOBILE CANNOT REACH FULL SPEED

1. Drive belt.

- *Check item “Engine lacks acceleration or power”.*

2. Incorrect track adjustment.

- *See MAINTENANCE or an authorized Lynx dealer for proper alignment and tension adjustments.*

3. Pulleys misaligned.

- *Contact an authorized Lynx dealer.*

4. Engine.

- *See item “Engine lacks acceleration or power”.*

5. Clutch adjustment required for snow conditions.

- *See TRA drive pulley adjustment in this book.*

TECHNICAL DATA

MODEL	RAVE	XTRIM	ADVENTURE
	550	550	550
Engine System			
Engine type	Rotax 552, axial fan cooled w/cylinder reed porting		
Cylinders	2		
Displacement (cc)	553,4		
Bore (mm)	76		
Stroke (mm)	61		
Maximum engine speed	7000 RPM		
Carburetion	2 x VM34 Choke		
Exhaust system	Single tuned pipe, baffle muffler		
Fan belt part number	420 980 517		
Drive System			
Drive pulley type	TRA III	IBC	
Driven pulley type	LPV VSA	LPV	
Drive belt part number (2)	417 300 197	415 060 600	415 060 600
Engagement (RPM)	3000	3500	3000
Small sprocket number of teeth	21	19	19
Large sprocket number of teeth	43		
Drive sprocket number of teeth	9		
Brake system	Hydraulic, RT type brake lever		
Track nominal width (mm)	381		
Track nominal length (mm)	3072	3648	3648
Track profile height	32		
Track adjustment	Deflection (mm)	20–25	
	Force ⁽¹⁾ (kg)	7,3	
Track alignment	Equal distance between edges of track guides and slider shoes		

MODEL		RAVE	XTRIM	ADVENTURE
		550	550	550
Suspension				
Front suspension		A-VRC +	A-VRC +	A-VRC
Front shock		HP-Gas, TA36	HP-Gas 30	HP-Gas 30
Front suspension max. travel	(mm)	260		
Rear suspension		PPS	PPS	RCG
Front arm shock		HP-Gas, TA36	HP-Gas 36	HP-Gas 36
Rear arm shock		HP-Gas, TA36	HP-Gas 36	HP-Gas 36
Rear suspension max. travel	(mm)	390	390	340
Electrical				
Lightning system output		340 Watts @ 6000 RPM		
Headlamp bulb HI/LOW beam		2 x 60/55 Watts (H4)		
Taillight bulb		17W	21/5W	21/5W
Spark plug	Type	NGK BR9ES		
	Gap	0,45 ± 0,05mm		
Fuse		Refer to FUSE section		
Dimensions				
Vehicle overall length	(mm)	2875	3155	3155
Vehicle overall width	(mm)	1245		
Vehicle overall height	(mm)	1195	1305	1340
Mass	(kg)	215	231	257
Ski stance	(mm)	1080		

MODEL	RAVE	XTRIM	ADVENTURE
	550	550	550
Liquids			
Recommended fuel type		Regular unleaded	
Minimum octane	RON	95E	
Recommended oil (engine) ⁽³⁾		XP-S 2 stroke mineral injection oil	
Brake system fluid		SRF (DOT4) or GTLMA (DOT4)	
Oil type (chaincase/transmission)		XP-S synthetic chaincase oil	
Capacities			
Fuel tank	(L)	38	
Oil tank	(L)	3,5	
<p>(1) Measure gap between slider shoe and bottom inside track when exerting a downward pull to the track.</p> <p>(2) Drive belt height must be adjusted every time a new drive belt is installed. Confirm drive belt part number application with an authorized Lynx dealer.</p> <p>(3) Note: Although XP-S mineral 2–stroke injection oil or XP-S semi-synthetic 2–stroke injection oil is recommended as a minimum level oil for your vehicle, XP-S Synthetic 2–stroke injection oil is recommended to offer even better protection for your vehicle in extreme conditions.</p>			

MAINTENANCE INFORMATION

PERIODIC MAINTENANCE CHART

WARNING

It is recommended that the assistance of an authorized LYNX dealer be periodically obtained on other components/systems not covered in this guide. Unless otherwise specified, engine must be cold and not running. Remove tether cord cap before performing any maintenance or adjustment, unless otherwise specified. Vehicle must be parked in a safe place, away from the trail.

WARNING

Observe WARNINGS and CAUTIONS mentioned throughout this guide which are relevant to the item being checked. When component conditions seem less than satisfactory, replace with genuine BRP parts or approved equivalents.

Some items may not apply to your particular model.

2-STROKE MAINTENANCE CHART (FAN AND LIQUID COOLED)

PART/TASK	10-HOUR OR 500 KM INITIAL INSPECTION ⁽¹⁾							
	WEEKLY OR EVERY 250 KM ⁽²⁾							
	MONTHLY OR EVERY 1000 KM ⁽³⁾							
	ONCE A YEAR OR EVERY 3000 KM ⁽¹⁾							
	EVERY 2 YEARS OR 6000 KM ⁽¹⁾ ⁽⁴⁾							
	STORAGE ⁽¹⁾							
	PRESEASON ⁽¹⁾							
ENGINE								
Rewind starter and rope					I,L,C	I		REWIND STARTER
Engine motor mounts	I			I	I			ENGINE REMOVAL AND INSTALLATION
Exhaust system	I			I	I			EXHAUST SYSTEM
Exhaust manifold screws	I					I		
Cooling system cap, hoses and clamps	I			I			I	COOLING SYSTEM
Coolant	I				R			
Crankshaft PTO Seal ⁽⁵⁾							I	BOTTOM END
RAVE valves ⁽⁵⁾				C				TOP END
RAVE valves (E-TEC)	Clean every 3 years or 10000 km							
RAVE valves solenoid (not 593 SS)				I				
Air filter			I,C				I,C	AIR INTAKE SYSTEM
Air silencer prefilter			I				I	
Engine lubrication						T		STORAGE PROCEDURE
LUBRICATION SYSTEM								
Injection oil filter (All except E-TEC)					R			OIL INJECTION SYSTEM
Oil injection pump (All except E-TEC)	A			A			A	OIL INJECTION PUMP

A: ADJUST C: CLEAN I: INSPECT L: LUBRICATE R: REPLACE T: PROCEED WITH TASK	10-HOUR OR 500 KM INITIAL INSPECTION ⁽¹⁾									
	WEEKLY OR EVERY 250 KM ⁽²⁾									
	MONTHLY OR EVERY 1000 KM ⁽³⁾									
	ONCE A YEAR OR EVERY 3000 KM ⁽¹⁾									
	EVERY 2 YEARS OR 6000 KM ⁽¹⁾⁽⁴⁾									
	STORAGE ⁽¹⁾									
	PRESEASON ⁽¹⁾									
PART/TASK										
FUEL SYSTEM										
Add fuel stabilizer							T			<i>STORAGE PROCEDURE</i>
Fuel filter						R				<i>PRESEASON PREPARATION</i>
Fuel lines, fuel rail and connections	I				I				I	<i>FUEL SYSTEM</i>
Carburetor (All except SDI and E-TEC)									A,C	
Throttle cable	I				I				I	
Throttle	I				I	L			I	
Choke (All except SDI and E-TEC)	I				I				I	
Throttle body (SDI and E-TEC) ⁽⁵⁾									C	<i>INJECTION SYSTEM</i>
ELECTRICAL SYSTEM										
EMS fault codes ⁽⁵⁾	I						I			<i>MONITORING SYSTEM/FAULT CODES</i>
Spark plugs ⁽⁵⁾⁽⁷⁾	I		I						R	<i>IGNITION SYSTEM</i>
Spark plugs (E-TEC)	Replace every 3 years or 10000 km									
Battery (if so equipped) ⁽⁸⁾	I		I				I		I	<i>CHARGING SYSTEM</i>
Wiring harnesses and cables ⁽⁵⁾	I		I				I			<i>ELECTRICAL CONNECTORS</i>
Operation of lighting system (HI/LO beam, taillight and brake light)	I	I					I			<i>LIGHTS, INSTRUMENTS AND ACCESSORIES</i>
Headlamp beam aiming					I				I	
Engine cut-out switch and tether cut-out switch operation test	I	I					I			

PART/TASK	10-HOUR OR 500 KM INITIAL INSPECTION ⁽¹⁾										
	WEEKLY OR EVERY 250 KM ⁽²⁾										
	MONTHLY OR EVERY 1000 KM ⁽³⁾										
	ONCE A YEAR OR EVERY 3000 KM ⁽¹⁾										
	EVERY 2 YEARS OR 6000 KM ⁽¹⁾⁽⁴⁾										
	STORAGE ⁽¹⁾										
PRESEASON ⁽¹⁾											
DRIVE SYSTEM											
Drive belt condition	I	I								I	<i>DRIVE BELT</i>
Drive belt height adjustment	EVERY BELT REPLACEMENT										
Drive and driven pulley	I		I	C			I			C	<i>DRIVE PULLEY and DRIVEN PULLEY</i>
Tightening torque of drive pulley screw	I			I							<i>DRIVE PULLEY</i>
Driven pulley preload ⁽¹²⁾	I			I			I				
Drive chain tension (not for models equipped with gearbox)	A	A					A				<i>CHAINCASE OR GEARBOX</i>
Chaincase / Gearbox oil ⁽⁹⁾	I ⁽⁹⁾		I ⁽⁹⁾	⁽⁹⁾			R		I		
Drive axle end bearing (axle without brake disc) ⁽⁶⁾	L		L				L				<i>DRIVE SYSTEM</i>
Drive axle end bearing (axle with brake disc)							I				
Countershaft (Fan cooled models) ⁽⁶⁾	L		L				L				<i>COUNTERSHAFT AND BRAKE</i>
Track condition	I		I				I				<i>TRACK</i>
Track tension and alignment	A	AS REQUIRED									
BRAKE SYSTEM											
Brake fluid	I	I					R			I	<i>COUNTERSHAFT AND BRAKE</i>
Brake hose, pads and disk	I	I								I	

A: ADJUST C: CLEAN I: INSPECT L: LUBRICATE R: REPLACE T: PROCEED WITH TASK	10-HOUR OR 500 KM INITIAL INSPECTION ⁽¹⁾											
	WEEKLY OR EVERY 250 KM ⁽²⁾											
	MONTHLY OR EVERY 1000 KM ⁽³⁾											
	ONCE A YEAR OR EVERY 3000 KM ⁽¹⁾											
	EVERY 2 YEARS OR 6000 KM ⁽¹⁾⁽⁴⁾											
	STORAGE ⁽¹⁾											
	PRESEASON ⁽¹⁾											
PART/TASK												
SUSPENSION												
Front suspension ⁽⁶⁾⁽¹⁰⁾	I,L			I	L			I,L				<i>FRONT SUSPENSION</i>
Rear suspension ⁽⁶⁾⁽¹⁰⁾	I			I,L				I,L				<i>REAR SUSPENSION</i>
Suspension stopper strap(s) ⁽¹¹⁾					I			I				
STEERING SYSTEM												
Steering mechanism ⁽⁶⁾	A,I,L			A,I	L			A,I,L				<i>STEERING AND HANDLEBAR</i>
Skis and runners	I	I						I				<i>SKIS AND STEERING ALIGNMENT</i>
VEHICLE												
Engine compartment	C			C				C				<i>STORAGE PROCEDURE</i>
Vehicle cleaning and protection	T			T				T				

(1) TO BE PERFORMED BY AN AUTHORIZED LYNX DEALER.

(2) TO BE PERFORMED BY OWNER

(3) TO BE PERFORMED BY OWNER, OR BY AN AUTHORIZED LYNX DEALER IF REQUESTED.

(4) IN ADDITION TO EVERY 3000 KM SERVICE TASK.

(5) EMISSION-RELATED

(6) LUBRICATE WHENEVER THE VEHICLE IS USED IN WET CONDITIONS (WET SNOW, RAIN, PUDDLES).

(7) BEFORE INSTALLING NEW SPARK PLUGS AT PRESEASON PREPARATION, IT IS SUGGESTED TO BURN EXCESS STORAGE OIL BY STARTING THE ENGINE WITH THE OLD SPARK PLUGS. ONLY PERFORM THIS OPERATION IN A WELL-VENTILATED AREA.

(8) UNDER SUMMER STORAGE CHARGE THE BATTERY AT LEAST ONCE A MONTH.

(9) GEARBOX MODELS ONLY: OIL CHANGE, REPLACE AFTER 10 H / 500 KM SERVICE AND AFTER EVERY 3000 KM OR ONCE YEAR. OIL LEVEL MUST BE INSPECTED AFTER EVERY 1000 KM OR MONTHLY.

(10) IF YOUR SNOWMOBILE IS EQUIPPED WITH TAKE A PART SHOCK, FIRST OIL

CHANGE HAS TO BE PERFORMED AFTER 1500 KM OR EVEN BEFORE IN HARD USAGE. AFTER THAT ONCE A SEASON OR AFTER 3000 KM WHICH EVER OCCURS FIRST.

(11) CHANGE THE STOPPER STRAP AFTER EVERY 3000 KM (ONLY PPS REAR SUSPENSION)

(12) GEARBOX MODELS ONLY

WARRANTY

BRP FINLAND OY INTERNATIONAL LIMITED WARRANTY: 2009 LYNX® SNOWMOBILES

1) SCOPE OF THE LIMITED WARRANTY

BRP Finland Oy ("BRP") warrants its 2009 LYNX snowmobiles from defects in material or workmanship for the period and under the conditions described below.

All genuine LYNX parts and accessories, installed by an authorized BRP distributor/dealer (as hereinafter defined) at the time of delivery of the 2009 LYNX snowmobile, carry the same warranty as that of the snowmobile.

Use of the product for racing or any other competitive activity, at any point, even by a previous owner, will render this warranty null and void.

2) WARRANTY COVERAGE PERIOD

This warranty will be in effect from the date of delivery to the first retail consumer or the date the product is first put into use, whichever occurs first and for a period of:

A) TWELVE (12) CONSECUTIVE MONTHS, for private use owners

B) TWELVE (12) CONSECUTIVE MONTHS, for commercial use owners

C) TWENTY FOUR (24) CONSECUTIVE MONTHS, for private use owners when product was sold in a member state of the European Union. The repair or replacement of parts or the performance of service under this warranty does not extend the life of this warranty beyond its original expiration date.

3) CONDITIONS TO HAVE WARRANTY COVERAGE

This warranty coverage is available only on 2009 LYNX snowmobile purchased as new and unused by its first owner from a BRP distributor/dealer authorized to distribute LYNX products in the country in which the sale occurred ("BRP distributor/dealer"), and then only after the BRP specified pre-delivery inspection process is completed and documented. Warranty coverage only becomes available upon proper registration of the product by an authorized BRP distributor/dealer. Moreover, this warranty coverage is only available if the LYNX snowmobile is purchased in the country in which the purchaser resides. BRP will not honor this limited warranty to any private use owner or commercial use owner if the preceding conditions have not been met. Such limitations are necessary in order to allow BRP to preserve both the safety of its products, and also that of its consumers and the general public.

Routine maintenance outlined in the Operator's Guide must be timely performed in order to maintain warranty coverage. BRP reserves the right to make warranty coverage contingent upon proof of proper maintenance.

4) WHAT TO DO TO OBTAIN WARRANTY COVERAGE

The customer must notify a servicing BRP distributor/dealer within two (2) months of the appearance of a defect, and provide it with reasonable access to the product and reasonable opportunity to repair it. The customer must also present to the authorized BRP distributor/dealer, proof of purchase of the product and must sign the repair/work order prior to starting the repair in order to validate the warranty repair. All parts replaced under this limited warranty become the property of BRP.

5) WHAT BRP WILL DO

BRP's obligations under this warranty are limited to, at its sole discretion, repairing parts found defective under normal use, maintenance and service, or replacing such parts with new genuine LYNX parts without charge for parts and labor, at any authorized BRP distributor/dealer during the warranty coverage period.

BRP reserves the right to improve or modify products from time to time without assuming any obligation to modify products previously manufactured.

6) EXCLUSIONS

The following are not warranted under any circumstances:

- Normal wear and tear;
- Routine maintenance items, tune ups, adjustments;
- Damage caused by failure to provide proper maintenance and/or storage, as described in the Operator's Guide;
- Damage resulting from removal of parts, improper repairs, service, maintenance, modifications or use of parts not manufactured or approved by BRP or resulting from repairs done by a person that is not an authorized servicing BRP distributor/dealer;
- Damage caused by abuse, abnormal use, neglect, use of the product on surfaces other than snow, or operation of the product in a manner inconsistent with the recommended operation described in the Operator's Guide;
- Damage resulting from accident, submersion, fire, theft, vandalism or any act of God;
- Operation with fuels, oils or lubricants which are not suitable for use with the product (see the Operator's Guide);
- Snow or water ingestion;
- Incidental or consequential damages, or damages of any kind including without limitation towing, storage, telephone, rental, taxi, inconvenience, insurance coverage, loan payments, loss of time, loss of income; and
- Damage resulting from studs installed on tracks if the installation does not conform to BRP's instructions.

7) LIMITATIONS OF LIABILITY

THIS WARRANTY IS EXPRESSLY GIVEN AND ACCEPTED IN LIEU OF ANY AND ALL OTHER WARRANTIES, EXPRESSED OR IMPLIED, INCLUDING WITHOUT LIMITATION ANY WARRANTY OF MERCHANTABILITY OR FITNESS FOR A PARTICULAR PURPOSE. TO THE EXTENT THAT THEY CANNOT BE DISCLAIMED, THE IMPLIED WARRANTIES ARE LIMITED IN DURATION TO THE LIFE OF THE EXPRESS WARRANTY. INCIDENTAL AND CONSEQUENTIAL DAMAGES ARE EXCLUDED FROM COVERAGE UNDER THIS WARRANTY. SOME STATES/ PROVINCES DO NOT ALLOW FOR THE DISCLAIMERS, LIMITATIONS AND EXCLUSIONS IDENTIFIED ABOVE, AS A RESULT, THEY MAY NOT APPLY TO YOU. THIS WARRANTY GIVES YOU SPECIFIC RIGHTS, AND YOU MAY ALSO HAVE OTHER LEGAL RIGHTS WHICH MAY VARY FROM STATE TO STATE, OR PROVINCE TO PROVINCE.

Neither the distributor, any BRP distributor/dealer nor any other person has been authorized to make any affirmation, representation or warranty regarding the product, other than those contained in this limited warranty, and if made, shall not be enforceable against BRP.

BRP reserves the right to modify this warranty at any time, being understood that such modification will not alter the warranty conditions applicable to the products sold while this warranty is in effect.

8) TRANSFER

If the ownership of a product is transferred during the warranty coverage period, this warranty shall also be transferred and be valid for the remaining coverage period provided BRP or an authorised BRP distributor / dealer receives a proof that the former owner agreed to the transfer of ownership, in addition to the co-ordinates of the new owner.

9) CONSUMER ASSISTANCE

- a) In the event of a controversy or a dispute in connection with this limited warranty, BRP suggests that you try to resolve the issue at the dealership level. We recommend discussing the issue with the authorized distributor/dealer's service manager or owner.
- b) If further assistance is required, the distributor's service department should be contacted in order to resolve the matter.
- c) If the matter still remains unresolved then contact BRP by writing to us at the address below.

ADDRESS:

BRP-FINLAND OY
SERVICE DEPARTMENT
P.O. BOX 8039
FIN-96101 ROVANIEMI
FINLAND

© 2008 Bombardier Recreational Products Inc. All rights reserved.

® Registered trademark of Bombardier Recreational Products Inc.

PRIVACY OBLIGATIONS/DISCLAIMER

We wish to inform you that your coordinates will be used for safety and warranty purposes. Sometimes, we also use the coordinates of our clients to inform them about our products and to present them offers. Should you prefer not to receive information on our products, services and offers, please let us know by writing to the address below.

Also note that, from time to time, carefully selected and trustworthy organizations may be permitted to use the coordinates of our clients to promote quality products and services. If you prefer not to have your name and address released, please let us know by writing to the address below:

FOR SCANDINAVIAN AND EUROPEAN COUNTRIES:

BRP FINLAND OY

Service Department

Ahjotie 30

FIN-96320 Rovaniemi

Finland

Fax +358 16 3420 316

CHANGE OF ADDRESS/OWNERSHIP

If your address has changed or if you are the new owner of the vehicle, be sure to notify BRP by either:

- mailing one of the cards hereinafter using of the following mail address;
- contacting an authorized LYNX dealer or distributor.

Mail address:

FOR SCANDINAVIAN AND EUROPEAN COUNTRIES:

BRP FINLAND OY
Service Department
Ahjotie 30
FIN-96320 Rovaniemi
Finland
Fax: +358 16 3420 316

In case of change of ownership, please join a proof that the former owner agreed to the transfer.

Notifying BRP, even after the expiration of the limited warranty, is very important as it enables BRP to reach the vehicle owner if necessary, like when safety recalls are initiated. It is the owner's responsibility to notify BRP.

STOLEN UNITS: If your personal vehicle is stolen, you should notify BRP or an authorized LYNX dealer. We will ask you to provide your name, address, phone number, the vehicle identification number and the date it was stolen.



CHANGE OF ADDRESS

CHANGE OF OWNERSHIP

VEHICLE IDENTIFICATION NUMBER

Model Number

Vehicle Identification Number (V.I.N.)

Model Number

Vehicle Identification Number (V.I.N.)

OLD ADDRESS
OR PREVIOUS OWNER:

NAME

NO.

STREET

APT

CITY

STATE/PROVINCE

ZIP/POSTAL CODE

COUNTRY

TELEPHONE

NEW ADDRESS
OR NEW OWNER:

NAME

NO.

STREET

APT

CITY

STATE/PROVINCE

ZIP/POSTAL CODE

COUNTRY

TELEPHONE

V00A2F



CHANGE OF ADDRESS

CHANGE OF OWNERSHIP

VEHICLE IDENTIFICATION NUMBER

Model Number

Vehicle Identification Number (V.I.N.)

Model Number

Vehicle Identification Number (V.I.N.)

OLD ADDRESS
OR PREVIOUS OWNER:

NAME

NO.

STREET

APT

CITY

STATE/PROVINCE

ZIP/POSTAL CODE

COUNTRY

TELEPHONE

NEW ADDRESS
OR NEW OWNER:

NAME

NO.

STREET

APT

CITY

STATE/PROVINCE

ZIP/POSTAL CODE

COUNTRY

TELEPHONE

V00A2F



LYNX



brp.com