

2101571



**LYNX**<sup>®</sup>

The European Champion!

**2005**

**Käyttäjän käsikirja  
Operator's manual**

# OPERATOR'S MANUAL LYNX 2005

Rave 440/800

Enduro Sport/600SDI/550/400

Adventure 800

Touring V-1000

Sport Touring 600 SDI

Ranger 600

ENGLISH

# CONTENT

**SAFETY MEASURES ..... 5**

**WARRANTY ..... 6**

**HOW TO IDENTIFY YOUR SNOWMOBILE ..... 9**

Vehicle serial number ..... 9

Engine serial number ..... 9

**CONTROLS / INSTRUMENTS ..... 10**

1. Throttle lever ..... 11

2. Brake lever ..... 11

3. Parking brake lever ..... 11

4. Brake / parking brake / low oil level pilot lamp (Red) ..... 12

5. Gear shift lever or RER button ..... 12

6. Reverse indicator lamp ..... 15

7. Handle bar ..... 15

8. Ignition switch/START/RER button ..... 15

9. Tether cut-out switch ..... 16

10. DESS pilot lamp ..... 17

11. Emergency cut-out switch ..... 17

12. Headlamp dimmer switch ..... 18

13. High beam pilot lamp (Blue) ..... 20

14. Rewind starter handle ..... 20

15. Choke lever ..... 20

16. Primer ..... 21

17. Speedometer ..... 21

18. Odometer ..... 21

19. Trip meter ..... 21

20. Trip meter reset button/mode button ..... 21

21. Fuel tank cap/gauge ..... 23

22. Engine overheating warning lamp (Red) ..... 23

23. Heated grip and throttle lever switch ..... 23

24. Heated throttle lever switch ..... 24

25. Hood latches ..... 24

26. Electric power outlet ..... 25

27. Fuse ..... 25

28. Front bumper ..... 27

29. Storage compartment ..... 27

30. Rear rack ..... 27

31. Tool kit ..... 27

32. Spark plug holder ..... 27

33. Seat strap ..... 28

34. Hitch .....	28
35. Adjustable suspension .....	28
36. Engine temperature warning light .....	28
Guidelines .....	29
Suspension troubleshooting .....	36
In deep snow .....	36

## **FUEL AND OIL ..... 36**

Recommended fuel .....	36
Recommended oil .....	

## **COLD WEATHER CARBURETION MODIFICATIONS ..... 38**

### **BREAK-IN PERIOD ..... 39**

Engine .....	39
Drive belt .....	39
10 hour inspection .....	39

### **PRE-OPEARATION CHECK ..... 40**

### **CHECK LIST ..... 40**

### **OPERATION INSTRUCTIONS ..... 40**

Operations .....	40
Starting the engine .....	41
Manual starting .....	42
Shutting off the engine .....	44

### **VEHICLE WARM UP ..... 45**

### **POST-OPERATION CARE ..... 45**

### **SPECIAL OPERATIONS ..... 45**

Riding at high altitudes .....	45
Engine overheating .....	45
Fuel flooded engine .....	46
Rear suspension slider shoe sticking .....	46

### **FLUID LEVELS ..... 46**

Brake system .....	46
Chain case oil level/Gearbox oil level .....	47
Oil injection system .....	47

Cooling system .....	49
Battery .....	50
<b>MAINTENANCE .....</b>	<b>51</b>
Vehicle cleaning and protection .....	51
Belt guard removal and installation .....	52
Drive belt removal and installation .....	52
Drive chain tension .....	57
TRA drive pulley adjustment .....	58
Drive belt condition .....	60
Brake condition .....	60
Brake adjustment .....	60
Rear suspension condition .....	60
Suspension stopper strap condition .....	60
Track condition .....	60
Track tension and alignment .....	61
Steering and front suspension mechanism .....	62
Wear and condition of skis and runners .....	62
Exhaust system .....	63
Air filter cleaning .....	63
Headlight .....	64
<b>STORAGE AND PRE-SEASON PREPARATION .....</b>	<b>66</b>
Storage .....	66
Pre-season preparation .....	66
<b>TROUBLESHOOTING .....</b>	<b>67</b>

## SAFETY MEASURES

- \* For vehicle with a parking brake, always engage brake when snowmobile is not in use.
- \* Throttle mechanism should be checked for free movement before starting engine.
- \* The snowmobile can be stopped by activating the emergency cut-out switch, pulling the tether cord or turning off the ignition key (if equipped).
- \* Engine should be running only when belt guard is secured in place. Never run the engine without drive belt installed. Running an unloaded engine can prove to be dangerous.
- \* Never run the engine when the track is raised off the ground or with the hood opened or removed.
- \* Do not stud the track. At speed it may cause the track to tear and separate from vehicle posing a risk of severe injury or death.
- \* Never start the engine in closed area or indoors.
- \* Maintain your snowmobile in top mechanical condition at all times.
- \* Snowmobile is not designed to be operated on public streets, roads or highways. In most countries it is considered an illegal operation.
- \* Never charge or boost battery while installed on snowmobile.
- \* Do not lubricate throttle and/or brake cables and housings.

# **BRP INTERNATIONAL LIMITED WARRANTY: 2005 LYNX® SNOWMOBILES**

## **1. SCOPE OF THE LIMITED WARRANTY**

Bombardier-Nordtrac Oy (“BRP”) warrants its 2005 LYNX snowmobiles from defects in material or workmanship for the period and under the conditions described below.

All genuine LYNX parts and accessories, installed by an authorized BRP distributor/dealer (as hereinafter defined) at the time of delivery of the 2005 LYNX snowmobile, carry the same warranty as that of the snowmobile.

Use of the product for racing or any other competitive activity, at any point, even by a previous owner, will render this warranty null and void.

## **2. WARRANTY COVERAGE PERIOD**

This warranty will be in effect from the date of delivery to the first retail consumer or the date the product is first put into use, whichever occurs first and for a period of:

- A) TWELVE (12) CONSECUTIVE MONTHS, for private use owners
- B) TWELVE (12) CONSECUTIVE MONTHS, for commercial use owners
- C) TWENTY FOUR (24) CONSECUTIVE MONTHS, for private use owners when product was sold in a member state of the European Union.

The repair or replacement of parts or the performance of service under this warranty does not extend the life of this warranty beyond its original expiration date.

## **3. CONDITIONS TO HAVE WARRANTY COVERAGE**

This warranty coverage is available only on 2005 LYNX snowmobile purchased as new and unused by its first owner from a BRP distributor/dealer authorized to distribute LYNX products in the country in which the sale occurred ( “BRP distributor/dealer”), and then only after the BRP specified pre-delivery inspection process is completed and documented. Warranty coverage only becomes available upon proper registration of the product by an authorized BRP distributor/dealer. Moreover, this warranty coverage is only available if the LYNX snowmobile is purchased in the country or union of countries in which the purchaser resides. BRP will not honor this limited warranty to any private use owner or commercial use owner if the preceding conditions have not been met. Such limitations are necessary in order to allow BRP to preserve both the safety of its products, and also that of its consumers and the general public.

Routine maintenance outlined in the Operator’s Guide must be timely performed in order to maintain warranty coverage. BRP reserves the right to make warranty coverage contingent upon proof of proper maintenance.



## 4. WHAT TO DO TO OBTAIN WARRANTY COVERAGE

The customer must notify a servicing BRP distributor/dealer within two (2) months of the appearance of a defect, and provide it with reasonable access to the product and reasonable opportunity to repair it. The customer must also present to the authorized BRP distributor/dealer, proof of purchase of the product and must sign the repair/work order prior to starting the repair in order to validate the warranty repair. All parts replaced under this limited warranty become the property of BRP.

## 5. WHAT BRP WILL DO

BRP's obligations under this warranty are limited to, at its sole discretion, repairing parts found defective under normal use, maintenance and service, or replacing such parts with new genuine LYNX parts without charge for parts and labor, at any authorized BRP distributor/dealer during the warranty coverage period.

BRP reserves the right to improve or modify products from time to time without assuming any obligation to modify products previously manufactured.

## 6. EXCLUSIONS

The following are not warranted under any circumstances:

- Normal wear and tear;
- Routine maintenance items, tune ups, adjustments;
- Damage caused by failure to provide proper maintenance and/or storage, as described in the Operator's Guide;
- Damage resulting from removal of parts, improper repairs, service, maintenance, modifications or use of parts not manufactured or approved by BRP or resulting from repairs done by a person that is not an authorized servicing BRP distributor/dealer;
- Damage caused by abuse, abnormal use, neglect, use of the product on surfaces other than snow, or operation of the product in a manner inconsistent with the recommended operation described in the Operator's Guide;
- Damage resulting from accident, submersion, fire, theft, vandalism or any act of God;
- Operation with fuels, oils or lubricants which are not suitable for use with the product (see the Operator's Guide);
- Snow or water ingestion;
- Incidental or consequential damages, or damages of any kind including without limitation towing, storage, telephone, rental, taxi, inconvenience, insurance coverage, loan payments, loss of time, loss of income; and
- Damage resulting from studs installed on tracks if the installation does not conform to BRP's instructions.



## 7. LIMITATIONS OF LIABILITY

THIS WARRANTY IS EXPRESSLY GIVEN AND ACCEPTED IN LIEU OF ANY AND ALL OTHER WARRANTIES, EXPRESSED OR IMPLIED, INCLUDING WITHOUT LIMITATION ANY WARRANTY OF MERCHANTABILITY OR FITNESS FOR A PARTICULAR PURPOSE. TO THE EXTENT THAT THEY CANNOT BE DISCLAIMED, THE IMPLIED WARRANTIES ARE LIMITED IN DURATION TO THE LIFE OF THE EXPRESS WARRANTY. INCIDENTAL AND CONSEQUENTIAL DAMAGES ARE EXCLUDED FROM COVERAGE UNDER THIS WARRANTY. SOME STATES/ PROVINCES DO NOT ALLOW FOR THE DISCLAIMERS, LIMITATIONS AND EXCLUSIONS IDENTIFIED ABOVE, AS A RESULT, THEY MAY NOT APPLY TO YOU. THIS WARRANTY GIVES YOU SPECIFIC RIGHTS, AND YOU MAY ALSO HAVE OTHER LEGAL RIGHTS WHICH MAY VARY FROM STATE TO STATE, OR PROVINCE TO PROVINCE.

Neither the distributor, any BRP distributor/dealer nor any other person has been authorized to make any affirmation, representation or warranty regarding the product, other than those contained in this limited warranty, and if made, shall not be enforceable against BRP.

BRP reserves the right to modify this warranty at any time, being understood that such modification will not alter the warranty conditions applicable to the products sold while this warranty is in effect.

## 8. TRANSFER

If the ownership of a product is transferred during the warranty coverage period, this warranty shall also be transferred and be valid for the remaining coverage period provided BRP or an authorised BRP distributor / dealer receives a proof that the former owner agreed to the transfer of ownership, in addition to the co-ordinates of the new owner.

## 9. CONSUMER ASSISTANCE

- (a) In the event of a controversy or a dispute in connection with this limited warranty, BRP suggests that you try to resolve the issue at the dealership level. We recommend discussing the issue with the authorized distributor/dealer's service manager or owner.
- (b) If further assistance is required, the distributor's service department should be contacted in order to resolve the matter.
- (a) If the matter still remains unresolved then contact BRP by writing to us at the address listed below.

BOMBARDIER-NORDTRAC OY  
SERVICE DEPARTMENT  
P.O. BOX 8040  
FIN-96101 ROVANIEMI  
FINLAND

# HOW TO IDENTIFY YOUR SNOWMOBILE

## Serial numbers

The main components of your snowmobile (engine and frame) are identified by different serial numbers. It may sometimes become necessary to locate these numbers for warranty purposes or to trace your snowmobile in the event of loss.

These numbers are required by the Lynx dealers to complete warranty claims properly. No warranty will be allowed by Bombardier if the engine serial number or VIN is removed or mutilated in any way. We strongly recommend that you take all the serial numbers on your snowmobile and supply them to your insurance company.

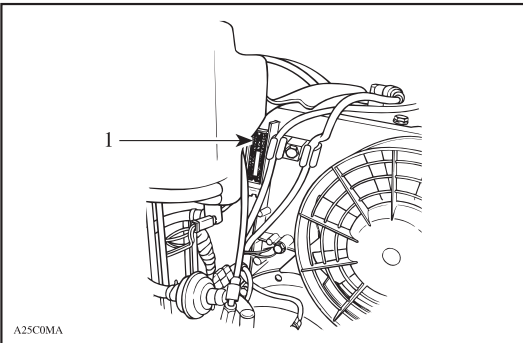
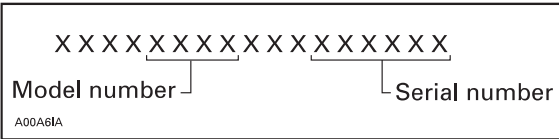

1. Engine serial number

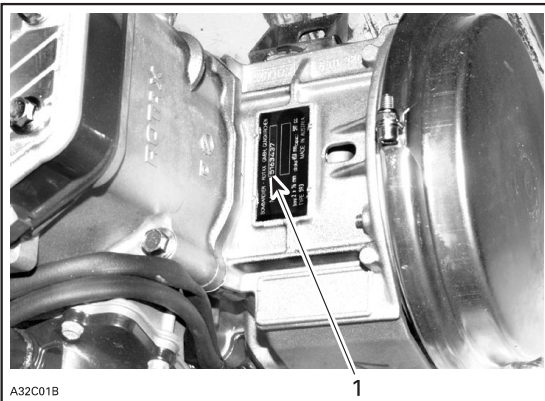

1. Engine serial number

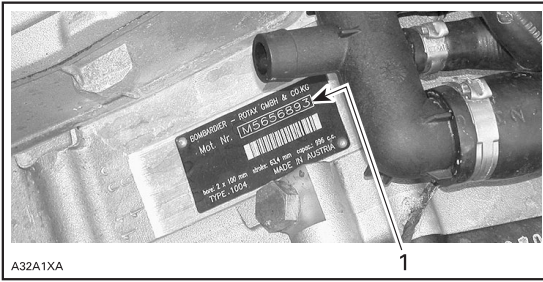

A32A1XA

4-tec models

1. Engine serial number

## CONTROLS / INSTRUMENTS

**NOTE!** Some controls/instruments do not apply to some models.

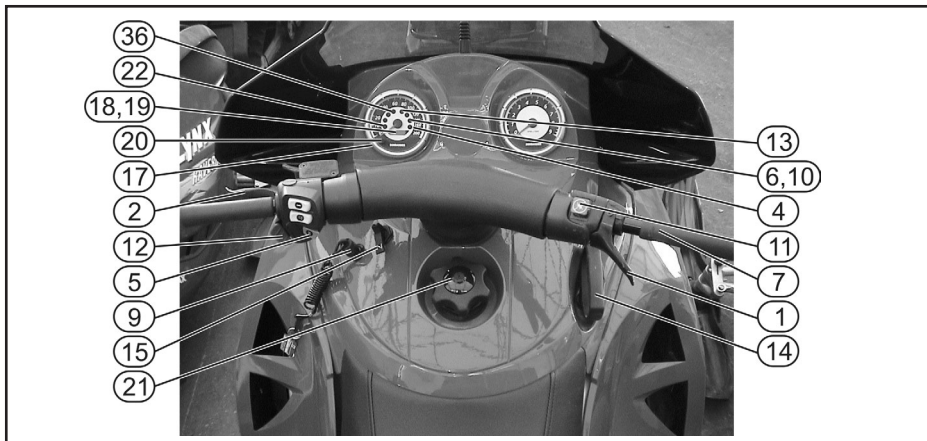

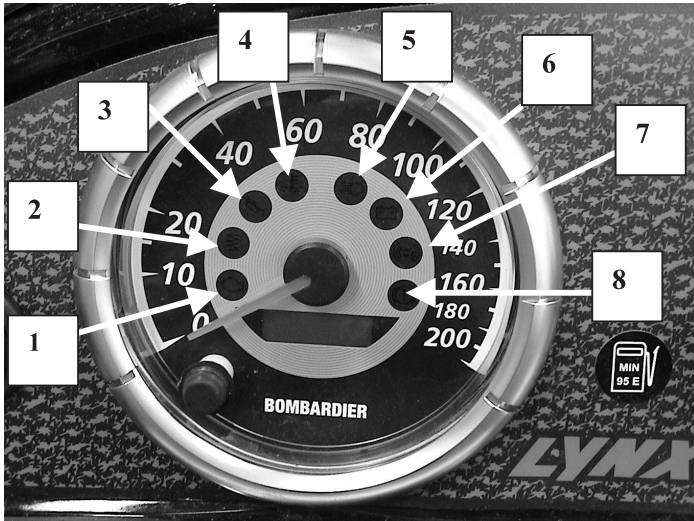

1. Engine Management System (EMS) pilot lamp
2. Air shock pilot lamp (not in use on Lynx)
3. Oil pressure pilot lamp
4. Cooling liquid pilot lamp
5. High beam pilot lamp
6. Low battery voltage pilot lamp
7. DESS pilot lamp
8. Brake pilot lamp

## 1. Throttle lever

Located on the right side of handlebar. When compressed, it controls the engine speed and the engagement of the transmission. When released, engine speed returns automatically to idle.

## 2. Brake lever

Located on the left side of handlebar. When compressed, the brake is applied. When released, it automatically returns to its original position. Braking effect is proportional to the pressure applied on the lever and to the type of terrain and its snow coverage.

## 3. Parking brake button or lever

Located on left side of handlebar. Parking brake should be used whenever snowmobile is parked.

Whenever parking brake is applied and engine is running, injection oil level/parking brake pilot lamp lights up to remind you that it is engaged. Never leave your snowmobile on downhill only with parking brake engaged.

## WARNING!

Make sure parking brake is fully disengaged before operating the snowmobile.

### Hydraulic brake

To engage mechanism, squeeze brake lever and maintain while pulling locking lever with a finger. Brake lever is now compressed halfway applying brakes.

To release mechanism, squeeze brake lever. Locking lever will automatically return to its original position. Brake lever now returns to rest position. Always release parking brake before riding.

## WARNING!

Locking keeps brake lever engaged and keeps pressure against brake disc. Anyhow, this pressure may decrease so low, that it will not keep vehicle in place. Never leave the snowmobile on hill only with parking brake applied.

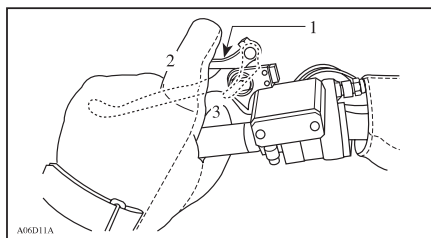

1. Locking lever
2. OFF
3. ON

### 4. Brake/Parking brake/Low oil level pilot lamp (Red)

Lights when brake or parking brake is applied (with engine running).

This pilot lamp also lights up when injection oil level is low (with engine running). Check oil level and replenish as soon as possible.

### 5. Gear shift lever or RER button

**Touring V-1000:** This model is equipped with a mechanical reverse controlled by a 2-position gear shift lever.

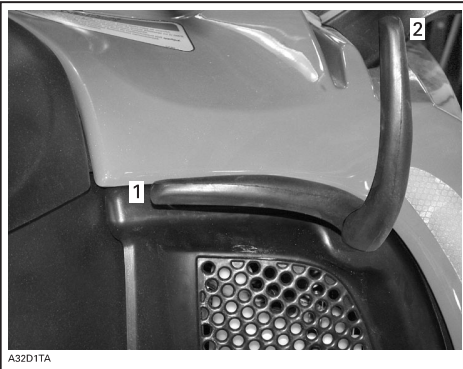

1. Forward
2. Reverse

**NOTE:** These models: Whenever shifting the gear the snowmobile has to be completely stopped, otherwise the gear system may get damaged.

**Electric reverse**

**Some models:** These models are equipped with an electronic reverse (RER), which is controlled by a RER button.

Reverse shift can be used when the snowmobile is stopped and engine is running at idle.

Engine is running automatically forward when the snowmobile is started after stalling or stopping.

**Shifting in reverse**

With the snowmobile completely stopped and engine running at idle, press and release the RER button.

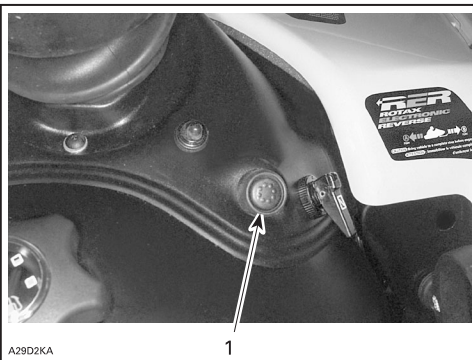

1. RER button

The reverse pilot lamp blink and a reverse alarm will sound once every second with a half a second duration when the snowmobile is engaged in reverse.

Apply throttle slowly and evenly. Allow drive pulley to engage then accelerate carefully.

### **Shifting in forward**

With the snowmobile completely stopped and engine running at idle, press and release the RER button.

Reverse pilot lamp and reverse alarm will stop.

Apply throttle slowly and evenly. Allow drive pulley to engage then accelerate carefully

### **RER Modification at high altitude**

At high altitude, the RER system needs a different engine timing curve to work properly.

#### **Non DPM™ Liquid-Cooled Models**

Before using the reverse system, first select the altitude mode that changes engine timing curve.

To do so, push and hold START/RER button with engine running. After 2 seconds, one beep is heard meaning that the low altitude mode is can be selected. Releasing START/RER button just after hearing that one beep will select the low altitude mode. The reverse system is now ready to operate in high altitude regions. Shifting in reverse is achieved as described above in Shifting in Reverse.

To select high altitude mode, push and hold START/RER button until 2 beeps are heard. Release button within one second. The reverse system is now ready to operate in hig (**n**) altitudes. Shifting in reverse is achieved as described above in Shifting in Reverse.

As long as the START/RER button is pushed and held the RER system switches from one mode to the other. One beep then 2 beeps the one beep then 2 beeps and so on are heard with one second interval. The mode to be selected corresponds to the last beep code heard.

The selected altitude mode is kept in memory until a new one is chosen — whether the engine is stopped or not.

#### **DPM Liquid-Cooled Models**

These vehicles are equipped with a Digital Performance Management (DPM) system. This system takes care of the altitude mode required by the RER.

No START/RER button operation is needed to select a mode. Just follow Shifting in Reverse above.



## 6. Reverse pilot lamp

This pilot lamp will light up when reverse is selected.

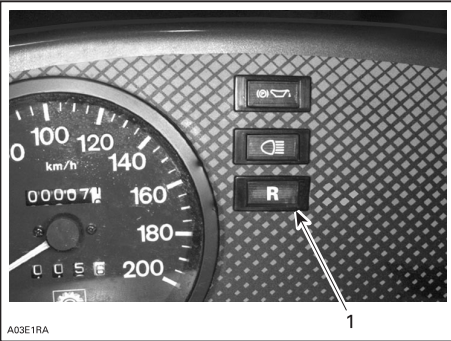

1. Reverse pilot lamp

## 7. Handlebar

The handlebar controls the steering of the snowmobile. As the handlebar is rotated to right or left, the skis are turned right or left to steer the snowmobile. Handlebar height is adjustable. See an authorized Lynx dealer.

## 8. Ignition switch / START/RER button

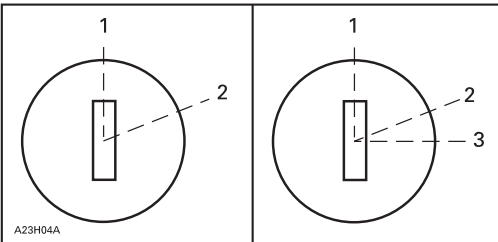

### Manual start

1. OFF
2. ON

### Electric start models

1. OFF
2. ON
3. START

### Manual Starting

To start the engine, turn the key to ON position, then pull rewind starter grip, To stop the engine, turn the key to OFF position.

### Electric Starting

To start engine, turn key to START position and hold until engine has started. See illustration above.

**NOTE:** Do not use electric starter for more than 15 seconds. If start/rer button is pressed when engine has started it could damage electric starter mechanism.

Release key as soon as the engine starts. Key returns to ON position as soon as it is released.

If engine does not start on first try, turn key back to OFF position and wait a few seconds before restarting. To stop engine, turn key to OFF position.

**NOTE:** Engine may be manually started with rewind starter if necessary.

If starter does not operate, check starting system fuse condition. refer to FUSES.

## **START/RER button**

START/RER button has two functions.

When the engine is not running, depressing the START/RER button and hold until engine has started.

When the engine is running, depressing the START/RER button will command the engine to reverse crankshaft rotation as driving the snowmobile in reverse is achieved by changing the direction of rotation of the engine, not by shifting the chain case in reverse gear.

When depressing the START/RER button, the MPEM will practically slow down the engine RPM to a stop and advance the ignition timing to cause crankshaft rotation reversing.

Engine will automatically shift into forward when starting after stopping or stalling.

Shifting procedure will take place only when the engine is running.

If engine is running at a speed above 3800 RPM, the reverse function of the START/RER button is cancelled.

It is recommended to warm up the engine to its normal operating temperature before shifting.

### **Start Mode**

To start engine, push START/RER button and hold until engine has started.

**NOTE!** Do not hold START/RER button more than 10 seconds. A rest period should be observed between the cranking cycles to let starter cool down. Holding START/RER button when engine has started could damage starter mechanism.

## **9. Tether cut-out switch**

It shuts off engine preventing snowmobile to runaway if the operator falls off the vehicle accidentally.

## Operation

Attach to clothing eyelet than snap tether cord cap over post before starting engine.

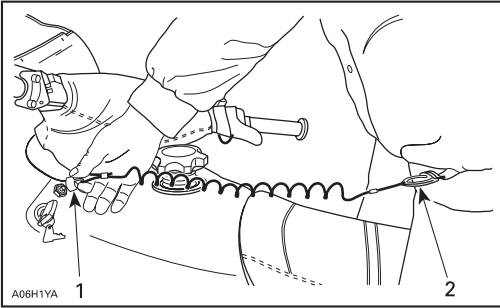

1. Snap over post
2. Attach to eyelet

If emergency engine shut off is required, completely pull tether cord cap from post.

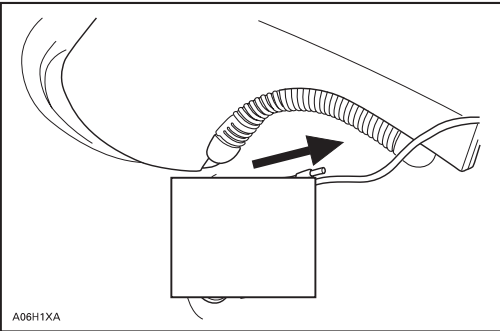

*Typical*

### Some Liquid-Cooled Models

On these models tether cut-out switch is part of tether cut-out system. This system serves 3 functions. It shuts off engine preventing snowmobile to runaway if the operator falls off the vehicle accidentally.

Through the D.E.S.S.<sup>™</sup> (Digitally Encoded Security System), it acts as a lock by preventing unauthorized use of your snowmobile thus deterring theft.

Finally, it prevents unintentional electric starter operation in vehicles so equipped by disabling the electric starter and ignition circuits in the MPEM or ECU.

### DESS (Digitally Encoded Security System) Description

This system is digitally encoded to provide you and your snowmobile with the equivalent security as a conventional lock key.

The tether cord cap provided with your snowmobile contains an electronic chip in which a

unique digital code is permanently memorized. You authorized Lynx dealer programs this key code in the MPEM or ECU of your snowmobile to allow engine operation above 3000 RPM if and only if this unique code has been read after engine starting.

If a tether cord cap with different code is installed, the engine will start but cannot reach drive pulley engagement speed to move vehicle.

### **Additional Tether Cord Caps**

The MPEM/ECU of your snowmobile can be programmed by your authorized Lynx dealer to accept 8 different key codes (tether cord caps).

### **DESS Pilot Lamp Codes**

DESS pilot lamp blinking slowly (one time per 1,5 second) means that a bad connection has been detected. Vehicle can not be driven.

To check for bad connection, remove tether cord cap. Make sure the tether cord cap is free of dirt or snow. Reinstall cap and restart engine. If a blink still occurs, contact an authorized dealer.

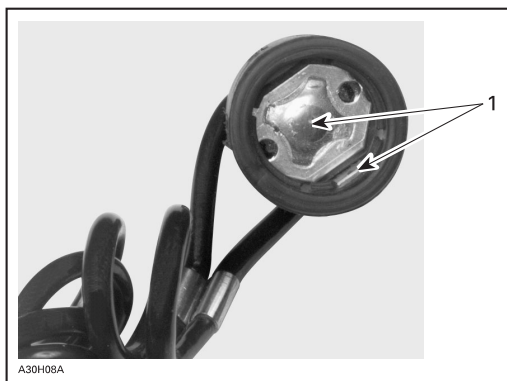

*1. Free of dirt and snow*

A DESS pilot lamp blinking 3 times per second means that you have installed a cap with a code that MPEM of this snowmobile was not programmed to recognize (wrong key). Vehicle can not be driven.

## **10. DESS pilot lamp**

This lamp will light up to confirm DESS status. Refer to previous paragraphs for description.

## **11. Engine cut-out switch**

This push-pull type or toggle type switch is located on the right side of the handlebar. To stop the engine in an emergency, select OFF position and simultaneously apply the brake. To restart, button must be at the ON position.

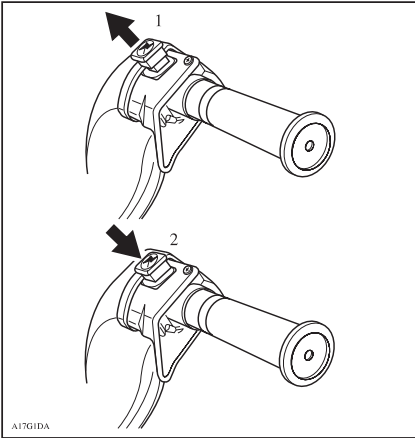

- 1. ON
- 2. OFF

All operators of the snowmobile should familiarize themselves with the function of this device by using it several times on first outing and whenever stopping the engine there-after. This engine cut-out procedure will become a reflex and will prepare operators for emergency situations requiring its use

## 12. Headlamp dimmer switch

Located on left hand side of handlebar, allows selection of headlamp beam. Note that lights are automatically ON whenever the engine is running.

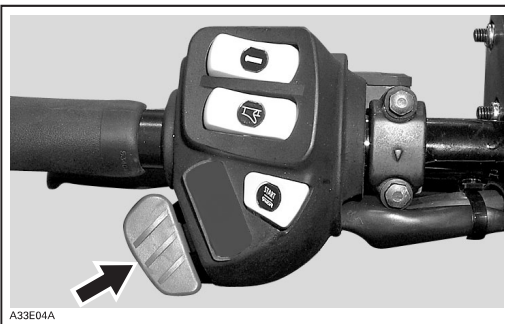
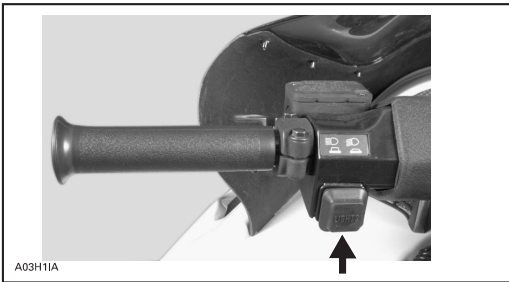

### 13. High beam pilot lamp (Blue)

Lights when headlamp is on HIGH beam.

#### Oil pilot lamp

**2-tec models:** This pilot lamp will glow up when injection oil level is low. Stop vehicle in a safe place then, replenish injection oil reservoir.

**4-tec models:** This pilot lamp will glow up when engine oil pressure is too low. Stop vehicle in a safe place then, check oil level and replenish as described in FLUID LEVEL.

Restart engine, oil pilot lamp must turn off after few seconds. If oil pilot lamp still glows up, stop engine and have lubrication system inspected by an authorized Lynx dealer.

#### Low battery voltage pilot lamp

This lamp will light up to indicate a low battery voltage condition. See an authorized Lynx dealer as soon as possible.

#### Engine Management System (EMS) pilot lamp

This lamp will light up to indicate a trouble. Refer to "TROUBLESHOOTING" for trouble code meaning and remedy.

### 14. Rewind starter handle

Auto-rewind type located on right hand side of snowmobile. Pull handle slowly until a resistance is felt then pull vigorously. Slowly release handle.

### 15. Choke lever

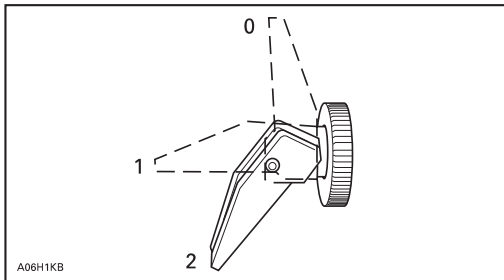

- 0. OFF
- 1. Position 1
- 2. Position 2

## Initial Cold Starting

**NOTE:** Do not operate the throttle lever with the choke lever on. Move the choke lever to position 2 and start the engine. As soon as the engine starts move the lever to position 1. After a few seconds (10 seconds maximum) move the choke lever to position OFF.

**NOTE:** In severe cold weather, colder than - 20°C you may need to flip choke lever from OFF position to position 1 a couple of times once engine is started.

## Warm engine starting

Start the engine without any choke. If the engine will not start after two pulls of the rope or two 5 second attempts with the electric starter move choke lever to position 1. Start the engine without activating the throttle lever. As soon as the engine starts move the choke lever to OFF.

## 16. Primer button

Pull and push button. It is not necessary when engine is warm.

To prime, activate button until a pumping resistance is felt. From this point, pump 2 or 3 times to inject fuel in intake manifold. After priming, ensure that primer button is pushed back.

**NOTE:** In very cold temperature, it is recommended to rotate primer button 3 - 4 turns prior to pull it. This will eliminate the possibility of sticking.

## 17. Speedometer

**Fan models and some liquid-cooled models:** Direct reading screen shows speed in km/h.

## 18. Odometer

Odometer records the total distance travelled in kilometers. It can be reset when needed.

## 19. Trip meter

Records the distance travelled. It can be reset when needed.

## 20. Trip meter reset button

To reset the meter, push the button until all the numbers are zero (0).

*Electronic speedometer*



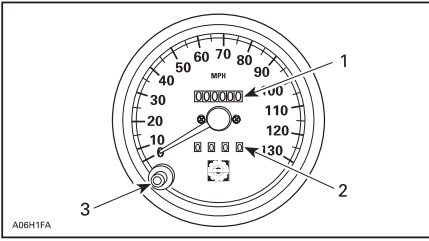

1. Odometer
2. Trip meter
3. Reset button



*Push and hold the button for 2 seconds to reset the hourmeter.*

**Some liquid-cooled models:** These models are equipped with electronic speedometer. It shows the speed either in kilometres or miles per hour.



*Electronic speedo- and tachometer*

Records total distance travelled until it is reset.

### Mode button

Depress the mode button to change display. Each time engine is started, display shows odometer. From that point depress mode button again to return the odometer.

Depressing mode button again will change display for the resetable hourmeter. Push mode button again to return to odometer.

Push and hold mode button for 2 seconds to reset the tripmeter or the resetable hourmeter depending on the one displayed.

**Some models:** At vehicle speed of 90 km/h and more the mode LCD screen will show speed only instead of the selected mode.

### Resetable hourmeter

Records engine running time in hours and minutes since it has been reset.

**All models:** Push and hold mode button for 2 seconds to reset the resetable hourmeter.

## 21. Fuel tank cap/gauge

Unscrew to fill up tank then fully tighten. Fuel tank cap features a mechanical gauge.

### WARNING!

Stop the engine before refueling. Fuel is inflammable and explosive under certain conditions. Open cap slowly. Do not smoke or allow open flames or sparks in the vicinity. Do not overfill or top off the fuel tank before placing the vehicle in a warm area. As temperature increases, fuel expands and might overflow. Wipe off any fuel spillage from the vehicle.

## 22. Engine overheat warning light (Red)

If this lamp glows; reduce snowmobile speed and run snowmobile in loose snow or stop engine immediately.

## 23. Heating grip switch

It is a three –position switch. Select the desired position to keep your hands at a comfortable temperature.

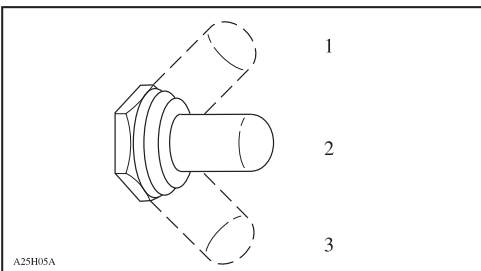

1.HOT 2. OFF 3. WARM

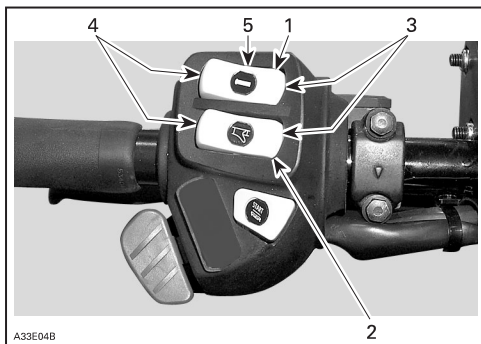

**Some models**

1. Heated grip switch
2. Heated throttle lever switch
3. Hot
4. Warm
5. OFF

**24. Heated throttle lever switch**

Three-position switch. Select the desired position to keep your right thumb at a comfortable temperature. See illustration.

**Rear passengers heating grip switches**

Three-position switch. Select the desired position to keep rear passenger's hands at comfortable temperature.



*Right side of passenger grab handle*  
 1. Heating grab handle switch

**25. Hood latches**

Stretch and unhook the latches to unlock the hood from its anchors. Lift hood gently until stopped by retaining device. Close hood slowly then hook up latches.

## 26. Power outlet

A 12-volt electric appliance may be connected to that jack connector. Electric current is supplied when ever engine is running. See FUSES for electric power outlet fuse location.



## 27. Fuse

To remove fuse from holder, pull fuse out. Check if filament is melted.

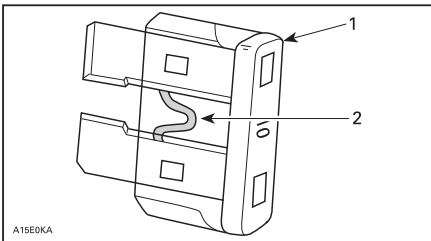

1. Fuse
2. Check if melted

### Fuse for starting system and electric power outlet

Starting system and electric power outlet is protected (if equipped) with 20 ampere fuse. If the starter and electric power outlet is out of function, check the fuse condition and replace if needed.

**NOTE:** Do not use a higher rated fuse as this can cause severe damage to electric components and/or fire.

**4-tec models and SDI:** To open fuse box push on cover tab and tilt cover.

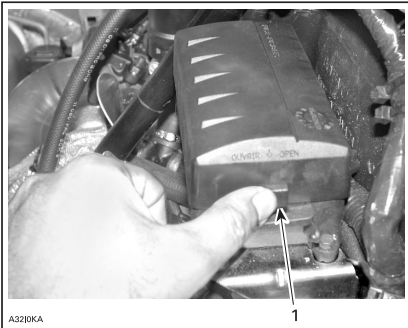

*1. Push tab*

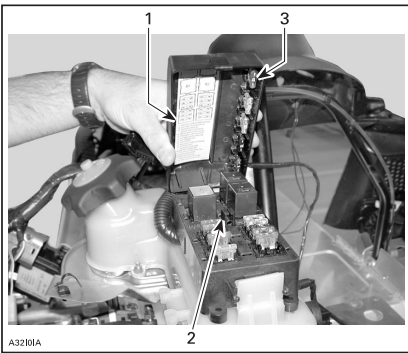

*1. Fuse description decal  
2. Fuse remover/installer  
3. Spare fuses*

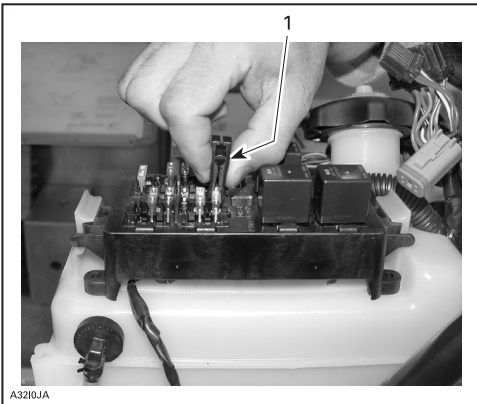

*1. Fuse remover/installer*

## 28. Front grab handle/ front bumper

To be used whenever front of snowmobile requires manual lifting.

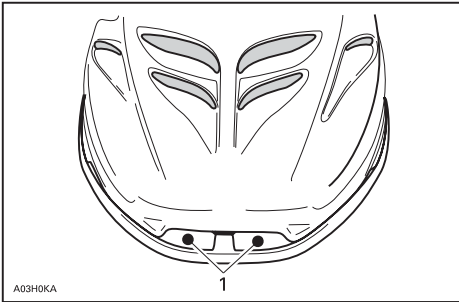

1. Front grab handles

**NOTE:** Do not use skis to pull or lift snowmobile.

## 29. Storage compartment

Depending on model, storage compartment situates either under the seat or inside of the seat.

## 30. Rear rack

**Some models:** Always readjust suspension according to the load. The capacity of this rack is limited. Ride at very low speed when loaded. Avoid speed over bumps.

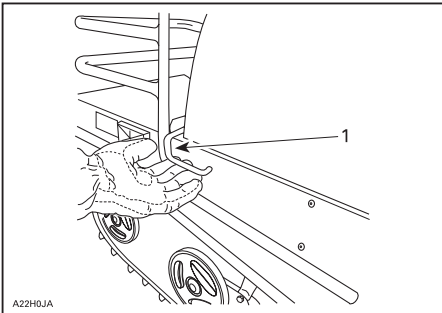

1. Open latch

## 31. Tool kit

A tool kit containing tools for basic maintenance is supplied with the engine. Tool bag is located under the seat or hood.

## 32. Spark plug holder

**Some models:** To keep spare spark plugs dry and prevent shocks that might affect the adjustment or break them, a holder is provided in engine compartment.

Firmly tighten them into the holder with spark plug socket (in tool kit) to ensure that they will not be loosened by vibrations.

Spare spark plugs are not supplied with a new snowmobile.

Adjust spare spark plug gap according the TECHNICAL DATA before installation.

**CAUTION:** Do not attempt to adjust gap on spark plug BR9ECS; it is not adjustable.

### 33. Seat strap

Seat strap provides a grip for the passenger.

### 34. Hitch

The hitch can be used to pull most equipment. Use a rigid tow bar.

**NOTE!** Remember to lock the hitch locking latch with a lock pin.

Check the decal on your own vehicle. There is a description of how much load is allowed and to transport and to pull.

### 35. Adjustable suspension

Snowmobile handling and comfort depend upon suspension adjustments.

Choice of suspension adjustments vary with carrying load, driver's weight, personal preference, riding speed and field condition.

**NOTE:** Some adjustments may not apply to your snowmobile. Use special keys in tool kit.

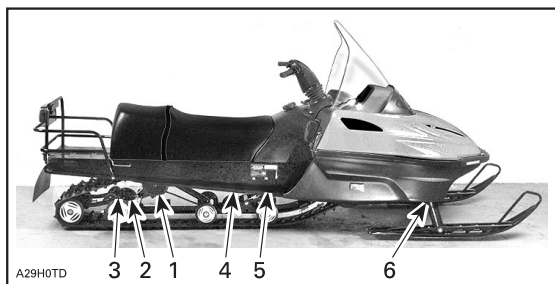

1. Rear springs - comfort and ride height
2. Suspended extension – reverse performance, load and snow conditions
3. Shackle movement – reverse performance, load and snow conditions
4. Center spring - handling
5. Stopper strap – snowmobile weight transfer
6. Front shock - handling



## Guidelines to adjust suspension

The best way to set up suspension, is to start from factory settings then customize each adjustment one at a time. Adjustments 2 through 6 are interrelated. It may be necessary to readjust center spring after adjusting front springs for instance. Test run the snowmobile under the same conditions; trail, speed, snow, driver riding position, etc. Change one adjustment and retest. Proceed methodically until you are satisfied.

**NOTE:** Whenever adjusting rear suspension, check track tension and adjust as necessary.

Slight suspension bottoming occurring under the worst riding conditions indicates a good choice of spring preload.

### 1. Rear Springs — Comfort

**IMPORTANT:** Make sure that all objects to be transported are in place in rear rack and under the seat.

When driver and passenger (if applicable) take place, rear of snowmobile should collapse by 50 to 75 mm.



*Proper adjustment*  
A. 50 to 75 mm



*Too soft of adjustment*

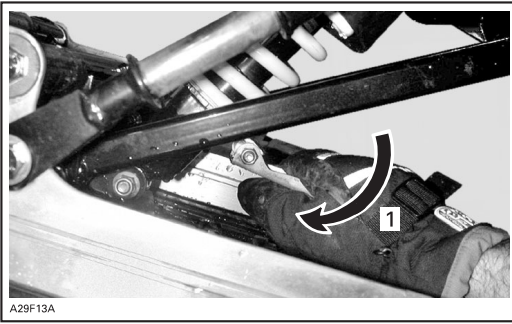

1. Increase spring preload



Too hard of adjustment



1. From the highest position, turn adjuster to select lowest position then, turn adjuster to the desired position

## 2. Center Spring — Steering Behavior

Ride at moderate speed on a trail. If handlebar is felt too hard to turn, adjust centre spring accordingly.



Good adjustment at moderate speed

1. Handlebar easy to turn – *neutral steering attitude*



*Too soft of adjustment*

1. Handlebar harder to turn — *oversteering attitude*

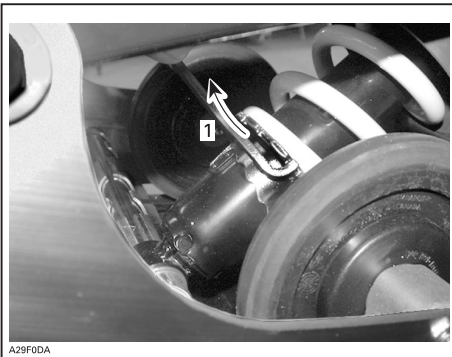

1. Use adjuster wrench provided in tool kit to increase preload



A03F2PA

*Too hard of adjustment-too much preload*

1. Handlebar is very easy to turn – understeering attitude

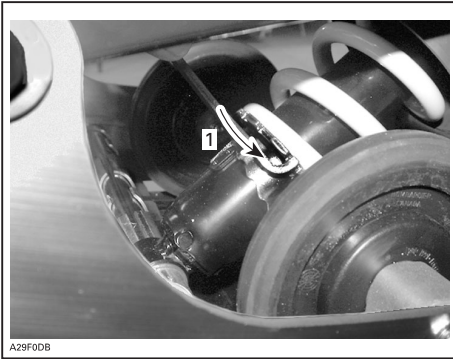

A29F0DB

1. Use adjuster wrench provided in tool kit to decrease preload

### 3. Stopper Strap — Weight Transfer

Ride at low speed then fully accelerate. Note steering behavior. Adjust stopper strap length accordingly.

**NOTE:** Whenever stopper strap length is changed, track tension must be readjusted.

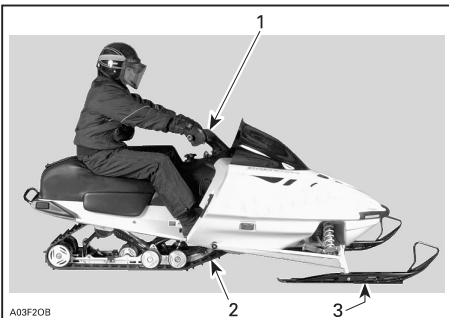

A03F20B

*Good adjustment at full acceleration*

- 1. Comfortable steering
- 2. Good weight transfer to the track
- 3. Light pressure of skis on the ground



*Too long strap*  
*1. Skis lift off the ground*

OR



*Too short strap*  
*1. Heavy steering*

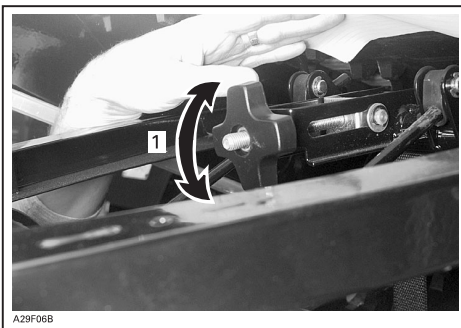

*1. Screw or unscrew knob to vary strap length*



A29F0FA

1. Bolt stopper strap to a different hole

#### 4. Front Springs — Handle

Ride at moderate speed and check for proper handling. Adjust front springs accordingly.



A03F2PA

*Proper adjustment*

1. Good handling and comfortable steering

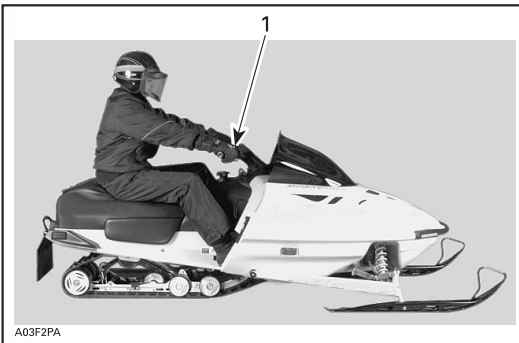

A03F2PA

*Too soft of adjustment*

1. Bad handling

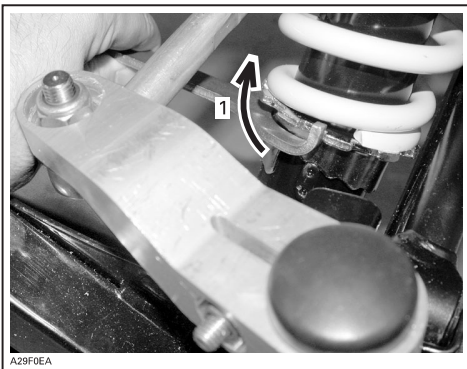

*1. Increase spring preload*



*Too hard of adjustment*  
*1. Steering hard to turn*

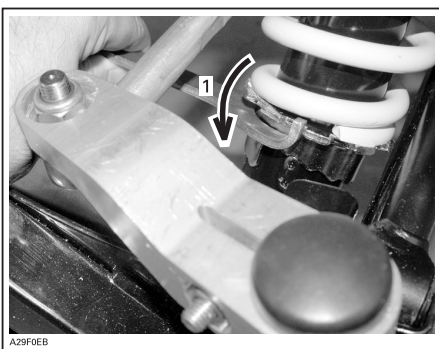

*1. Decrease spring preload*



## SUSPENSION TROUBLESHOOT

PROBLEM	CORRECTIVE MEASURES
Front suspension wandering	-Check ski alignment and camber angle adjustment. See an authorized Lynx dealer. -Reduce ski ground pressure. Reduce front suspension spring preload. Increase center spring preload. Reduce rear spring preload.
Snowmobile seems unstable and seems to pivot around its centre.	-Reduce rear suspension front arm pressure. Reduce center spring preload. Increase rear spring preload . Increase front suspension spring preload.
Steering feels too heavy.	-Reduce ski ground pressure. Reduce front suspension spring preload. Increase center spring preload.
Rear of snowmobile seems too stiff.	-Reduce rear spring preload.
Rear of snowmobile seems too soft.	-Increase rear spring preload.
Rear suspension front shock absorber is frequently bottoming.	-Lengthen stopper strap. -Increase center shock preload.
Track spins too much at start.	-Lengthen stopper strap. -Change driving position.

### In deep snow

When operating the snowmobile in deep snow, it may be necessary to vary extension adjustment, stopper strap and/or riding position, to change the angle at which the track rides on the snow. Operator's familiarity with the various adjustments as well as snow conditions will dictate the most efficient combination.

## FUEL AND OIL

### Recommended fuel

Refer to TECHNICAL DATA in the end of this manual.

**NOTE:** Never experiment with other fuels or fuel rations. The use of unrecommended fuel can result in snowmobile performance deterioration and damage to critical parts in the fuel system and engine components.

### WARNING!

Do not overfill or top off the fuel tank before placing the vehicle in a warm area. As temperature increases, fuel expands and might overflow. Fuel is inflammable and explosive under certain conditions. Wipe off any fuel spillage from the vehicle.

## Fuel System Antifreeze

When using oxygenated fuel, additional gas line antifreeze or water absorbing additives are not required and should not be used.

## Recommended oil

**CAUTION:** Do not mismatch oil reservoir cap with fuel tank cap. On some models there is fuel gauge together with fuel tank cap. Oil reservoir cap is identified "OIL". Use only oil, which flows at -40°.

Oil is in injection oil reservoir.

Use Bombardier snowmobile injection oil or synthetic injection oil.

Use only 2-stroke engine oil.

MODEL	OIL TYPE
SDI	Formula XP-S II
2-tec models	XP-S II or fully synthetic equivalent oil has to be used on this model

**NOTE:** Formula XP-S II is fully synthetic oil.

BOMBARDIER injection oil is a blend of basic oil and additives especially selected to ensure unequalled lubrication, engine cleanliness and minimum spark plug fouling.

The BOMBARDIER FORMULA XP-S synthetic injection oil provides superior lubrication, reduced engine component wear and oil deposit, thus maintaining maximum-level performance. This synthetic injection oil meets the latest ASTM and JASO standards.

**CAUTION:** Never use four-stroke mineral or synthetic oil. Do not mix these with outboard motor oil. Do not use NMMA TC-W, TC-W2 or TC-W3 outboard oil. Avoid mixing different brands of API TC oil as resulting chemical reactions may cause severe engine damage.

Always maintain a sufficient amount of recommended oil in the injection oil reservoir.

**CAUTION:** Check level and refill every time you refuel. Do not mismatch oil reservoir cap with fuel tank cap. Install cap that is identified with OIL

**4-tec models:** These models are equipped with 4-stroke engine. Use Bombardier 4-stroke synthetic oil 0W 40 (P/N: 293 600 054) 12x1l or fully synthetic equivalent oil.

## Gear box oil

Recommendation 75W140 (P/N 413803300, 12x355 ml).

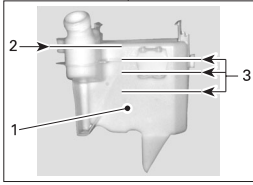

A32C27A

1. Injection oil reservoir
2. Max level: 13 mm from top
3. Level marks ( $\frac{1}{4}$ ,  $\frac{1}{2}$ ,  $\frac{3}{4}$ )

## COLD WEATHER CARBURETION MODIFICATIONS

All vehicles has been calibrated for - 20°C. They can be operated at warmer winter temperatures without problems.

**CAUTION:** For colder temperatures than - 20°C, carburetor(s) must be recalibrated to avoid engine damage. Refer to an authorized Lynx dealer.

### Heated carburetor valve

The heated carburetor valve should be closed except:

- When riding between -5° C and +5°C in a high relative humidity.
- When riding in deep powder snow.
- When following another snowmobile which makes dust snow.

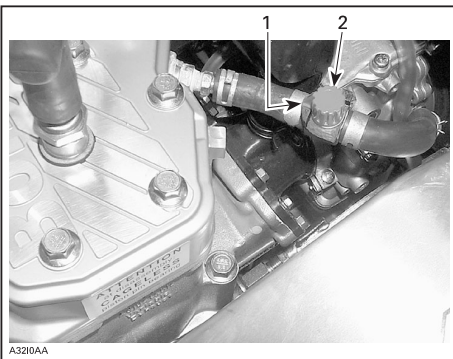

A3210AA

*Some liquid cooled models*

1. ON
2. OFF

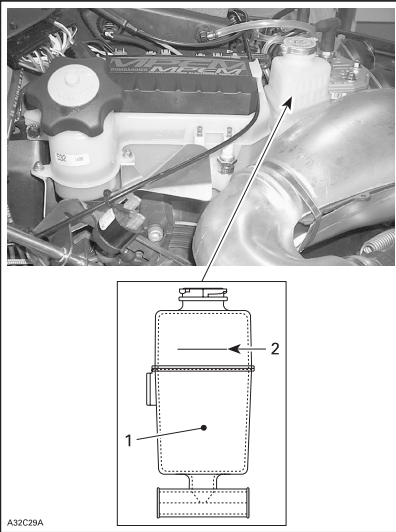

1. Coolant tank
2. COLD LEVEL (engine cold)

## BREAK-IN PERIOD

### Engine

#### IMPORTANT

A break-in period of 10-15 hours (about 500 km) is required for Rotax engines before running the snowmobile at full throttle.

During break-in period, maximum throttle should not exceed  $\frac{3}{4}$ . However, brief full acceleration and speed variations contribute to a good break-in.

**All models except 4-tec models and 2-tec SDI models:** To assure additional protection during the initial engine break-in, 500 ml of recommended injection oil should be added to fuel for the first full filling of fuel tank.

(P/N 1471599, 20x1l). Have spark plugs cleaned after engine break-in.

**2-tec SDI models:** To assure additional protection during the initial engine break-in, 500 ml fully synthetic XP-S II oil.

### Drive Belt

A new drive belt requires a break-in period of 50 km. Avoid strong acceleration/deceleration, pulling a load or high speed cruising .

### 10 Hour Inspection

We suggest that after the first 10 hours of operation— 500 km — or 30 days after the purchase, whichever comes first, your snowmobile be checked by an authorized Lynx dealer.

**NOTE!** The 10 hour inspection is at expense of the snowmobile owner.

## PRE OPERATION CHECK

- Remove snow and ice from body including seat, footrests, lights, controls and instruments.
- Verify that track and idler wheels are not frozen and free to turn.
- Activate the brake control and make sure the brake fully applies before the brake control lever touches the handlebar grip. It must fully return when released.
- Check the parking device. Apply parking brake and check if it operates easily and smoothly.
- Activate the throttle control lever several times to check that it operates easily and smoothly.
- Check operation of ignition switch, headlamp switch, taillight, brake light, pilot lamps and tether/cut-out switches.
- Verify that skis and steering operate freely. Check corresponding action of skis versus handlebar.
- Check fuel and injection oil for levels and leaks. Replenish as necessary and see an authorized Lynx dealer in case of any leaks.
- Verify that air filter(s) is free of snow, if so equipped.
- Make certain your snowmobile is pointed away from people or objects before you start it.
- Be warmly dressed with clothing designed for snowmobiling.

## OPERATING INSTRUCTION

### Propulsion

Depressing throttle lever increases engine RPM causing the drive pulley to engage. Depending on models engine RPM must be between 2500 and 4200 before drive pulley engagement will occur.

Outer sheave of drive pulley moves toward inner sheave, forcing drive belt to move upward on the drive pulley and simultaneously forcing the sheaves apart on the driven pulley.

The driven pulley senses the load on the track and limits the belt movement. The result is an optimized speed ratio between engine RPM and the speed of the vehicle at any time.

Power is transferred to the track through the chaincase or gearbox and drive axle.

### Turning

Handlebar controls the steering of the vehicle. As the handlebar is rotated to right or left, the skis are turned right or left to steer the snowmobile.

### Stopping

Before riding your snowmobile, you should understand how to stop it. This is done by releasing the throttle and gradually depressing the brake lever on the left side of the handlebar.

In an emergency, you may stop your vehicle by pressing the engine cut-out switch located near the throttle control and applying the brake.

Remember, a snowmobile cannot "stop on a dime". Braking characteristics vary with deep snow, packed snow or ice. If the track is locked during hard braking, skidding may result.

### Starting the engine

Check throttle lever operation.

Ensure that the engine cut-out switch is in the ON position.

Ensure that the tether cord cap is in position and that the cord is attached to your clothing eyelet.

### Primer equipped vehicles

**Starting the engine:** To prime, activate button until a pumping resistance is felt.

From this point, pump 2 or 3 times to inject fuel in intake manifold.

After priming, ensure that primer button is pushed back.

**NOTE:** In very cold temperature, it is recommended to rotate primer button 3 - 4 turns prior to pull it. This will eliminate the possibility of sticking.

**NOTE:** Priming is not necessary when engine is warm.

### Choke equipped vehicles

**Initial cold starting:** Do not operate the throttle lever with the choke lever on.

#### When temperature is below - 10°C

Move the choke lever to position 2 and start the engine. As soon as the engine starts move the lever to position 1. After a few seconds (max.10 seconds) move the choke lever to OFF position.

**NOTE:** In severe cold weather, colder than - 20°C you may need to flip choke lever from OFF to position 1 a couple of times once engine is started.

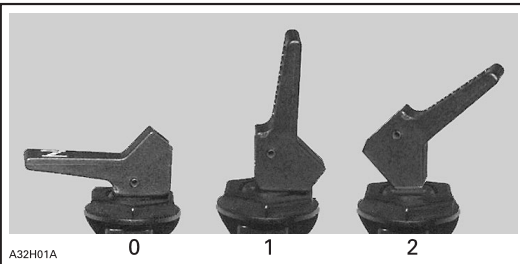

- 0. OFF
- 1. Position 1
- 2. *Position 2*

## When temperature is above - 10°C

Move the choke lever to position 1.

Grab the handle firmly and start the engine or electric starter if it is equipped.

As soon as the engine starts move the choke lever to OFF.

## 4-tec models

Initial cold starting and warm engine starting

Use the electric starter.

**CAUTION:** 4-tec model: If the battery is empty, engine cannot be started. Charge the battery or replace it if necessary.

## Warm engine starting

Start the engine without any choke. If the engine will not start after two pulls of the rope or two 5 second attempts with the electric starter move choke lever to position 1. Start the engine without activating the throttle lever. As soon as the engine starts move the choke lever to OFF.

## Rewind starter

**All the models except 4-tec models:** Set the key to ignition switch and turn to ON position.

Grab the handle firmly and crank the engine.

## WARNING!

Do not activate the throttle lever during starting.

**NOTE:** There is no rewind starter handle in 4-tec model.

## Electric starting

Set key to ignition switch.

Turn the key to clockwise direction until starter engages.

Release the key immediately when engine starts.

**NOTE:** Do not use electric starter longer than 10 seconds.

**NOTE:** If the vehicle cannot be started, in some reasons, with electric starter, set ignition key to ON position and start the engine using rewind starter handle.

## All models except 4-tec models

Emergency starting

The engine can be started with the emergency starter rope supplied with the tool kit.

Remove belt guard.

Do not wind the starting grope around your hand. Hold rope by the handle only. Do not start the snowmobile by the drive pulley unless it is a true emergency situation. Have the snowmobile repaired as soon as possible.

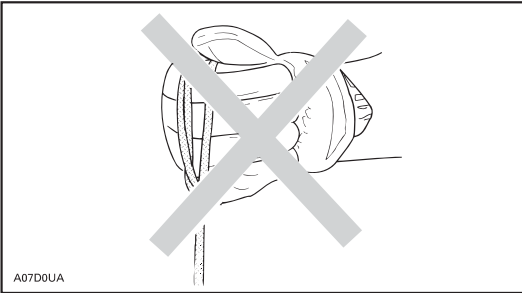

Attach one end of emergency rope to rewind handle.

**NOTE:** The spark plug socket can be used as an emergency handle.

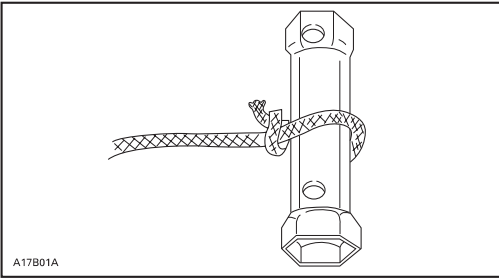

Attach the other end of emergency rope to the starter clip supplied in the tool kit.  
Hook up clip on drive pulley.

Wind the rope tightly around drive pulley. When pulled, pulley must rotate counterclockwise.

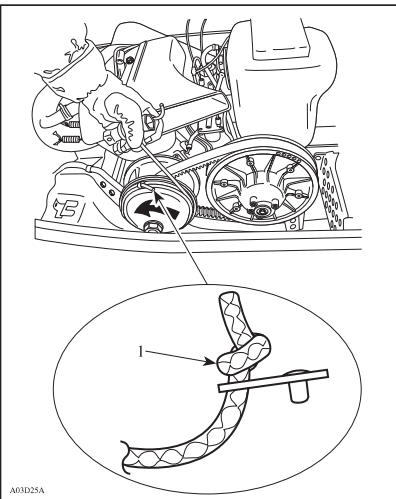

1. Knot on this side



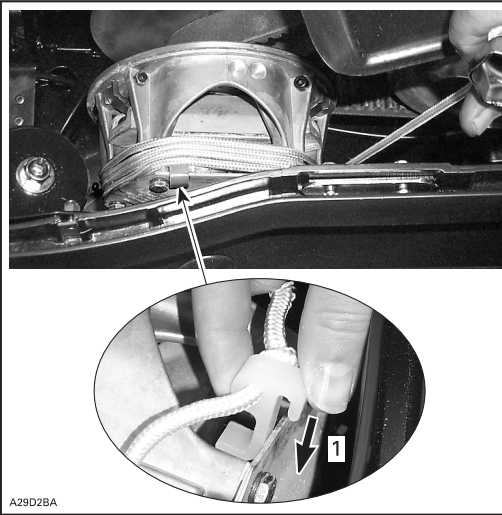

A29D2BA

1. Hook up starter clip

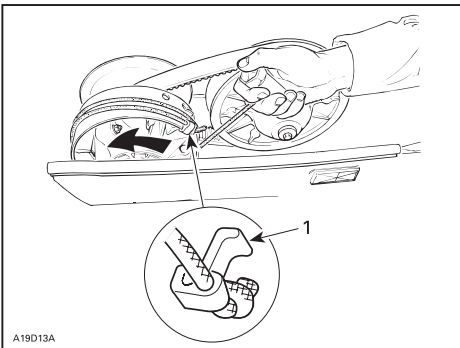

A19D13A

1. Clip

Pull the rope using a sharp, crisp pull so the rope comes free of the drive pulley. Start the engine as per usual manual starting.

When starting the snowmobile in an emergency situation, using drive pulley, do not reinstall the belt guard and return slowly to have snowmobile repaired.

**Shutting off the engine**

Release throttle lever and wait until engine has returned to idle speed.

Shut off the engine using either ignition switch, engine cut-out switch or tether cut-out switch.

**WARNING!**

Always remove tether cord cap and key when vehicle is not in operation in order to prevent accidental engine starting or to avoid unauthorized use by others or theft.

## VEHICLE WARM-UP

Before every ride, vehicle has to be warmed up as follows:

Snowmobile must be securely supported by the rear bumper using a wide-base snowmobile mechanical stand. Track must be 100 mm off the ground.

Start engine and allow it to warm up two or three minutes at idle speed.

Release parking brake.

### WARNING!

Make sure wide-base snowmobile mechanical stand is stable. Stay clear of the front of vehicle and the track. Do not use too much throttle during warm-up or when track is free-hanging.

Apply throttle until drive pulley engages. Let track rotate at low speed for several turns. The lower the vehicle temperature is the longer vehicle warm-up should be.

Shut-off the engine and remove the wide base snowmobile mechanical stand.

Skis may be frozen on the ground. Grab both skis one at a time by their loops and lift their front end slightly off the ground.

After restarting engine, the vehicle can be driven at low speed for the first 2 or 3 minutes of riding. After that, it may be driven up to the legal speed limit as per normal safety practices.

## POST OPERATION CARE

Shut off the engine. Install rear of vehicle on a wide-base snowmobile mechanical stand.

Remove snow and ice from rear suspension, track, front suspension, mechanism and skis.

Protect vehicle with a snowmobile cover.

### Engine overheating

#### IMPORTANT NOTICE!

4-tec models: Engine idling more than 10 minutes after driving may cause engine overheating.

**Fan cooled models:** Shut off the engine.

Check for clogged air duct passages. Remove any foreign materials.

Check for proper fan belt condition and tension.

**Liquid cooled models:** Engine overheating pilot lamp will light up if engine is too hot.

Reduce snowmobile speed and run snowmobile in loose snow or stop engine immediately.

Check for adequate coolant level. See an authorized Lynx dealer.

## Fuel flooded engine

Install new spark plugs and restart engine.

## Rear suspension slider shoe sliding

Slider shoes are cooled and lubricated by snow. When riding at moderate or high speed on a thin-snow-covered surface, slider shoes may stick on metallic track guides.

Run snowmobile on a surface covered by snow or drive snowmobile at very low speed.

Have slider shoes inspected by an authorized Lynx dealer.

**NOTE!** This situation comes up the more high profile track is. Avoid driving on hard packed snow, ice surface or other surface, that has not enough snow to ensure the lubrication.

It is noticeable that tracks with 35 mm or more high profile are not meant for the trail ride (hard surface) but only for the deep snow ride. If the vehicle which is equipped with this kind of track, is driven on hard packed snow, slider shoes may stick on track metallic parts or the track can get damaged.

## FLUID LEVELS

### WARNING!

It is recommended that the assistance of an authorized Lynx dealer be periodically obtained on other components/systems not covered in this guide. Unless otherwise specified, engine must be cold and not running. The tether cord cap must be removed for all maintenance procedures.

**CAUTION:** Vehicle must be on a level surface before checking any fluid levels.

## Brake system

Check brake fluid in reservoir for proper level. Add fluid as required.

**CAUTION:** Use only DOT 4 brake fluid from a sealed container.

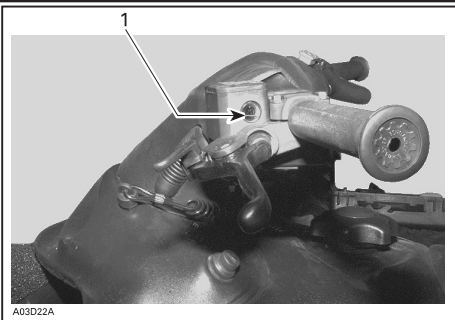

Brake fluid reservoir  
1. Minimum

**Chain case models:** Check the oil level by removing dipstick. Oil level must be between lower and upper marks.

**NOTE:** It is normal to find metallic particles stuck to dipstick magnet. If bigger pieces of metal are found, see an authorized Lynx dealer.

Remove metal particles from magnet.

Refill up to upper mark using recommended oil.

**NOTE:** Do not use unrecommended other types of oil when servicing. Do not mix synthetic oil with other types of oil.

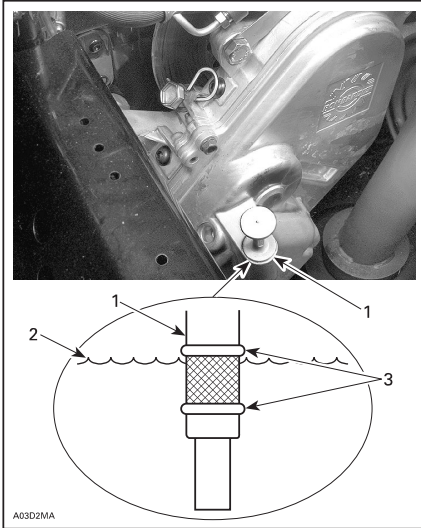

- 1. Dipstick
- 2. Oil level
- 3. Level between marks

### Engine oil level

**4-tec models:** Make sure engine is at operating temperature. Snowmobile must be on a level surface. Leave engine running at idle for 30 seconds. Stop engine and wipe the dipstick. Dipstick must be completely screwed in before checking oil level. Oil level must be between minimum and maximum marks on dipstick.

### Injection oil system

Always maintain a sufficient amount of recommended injection oil in the injection oil reservoir.

**NOTE:** Never allow oil reservoir to be almost empty.

## WARNING!

Check level and refill every time you refuel. Wipe off any spillage. Oil is highly flammable when heated.

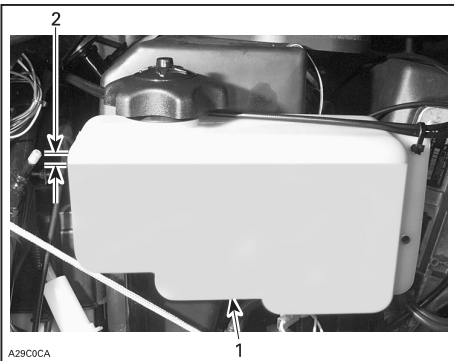

1. Injection oil reservoir
2. Maximum level: 13 mm from top

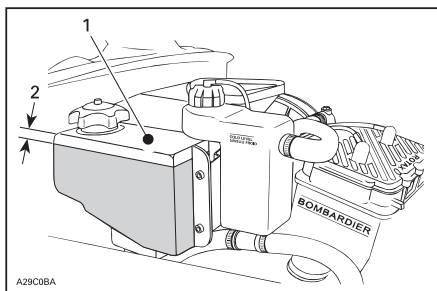

1. Injection oil reservoir
2. Maximum level: 13 mm from top

### 4-tec engine oil

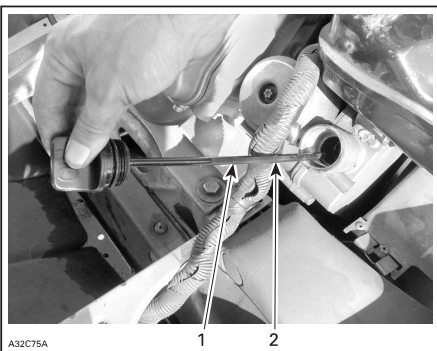

1. Maximum
2. Minimum

There is a capacity of 0, 5 l between the two marks.

Add Bombardier synthetic oil OW40 through dipstick hole as required.

## Cooling system

Check coolant level at room temperature. Liquid should be at COLD LEVEL line (engine cold) of coolant tank.

**NOTE:** When checking level at low temperature it may be slightly lower than mark.

If additional coolant is necessary or if entire system has to be refilled, refer to an authorized Lynx dealer.



1. COLD LEVEL line

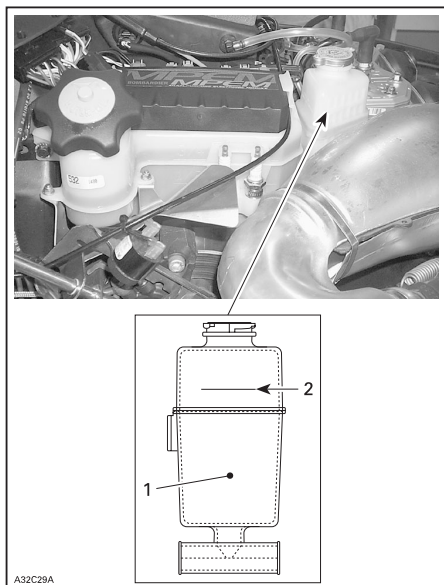

1. Coolant tank  
2. COLD LEVEL line

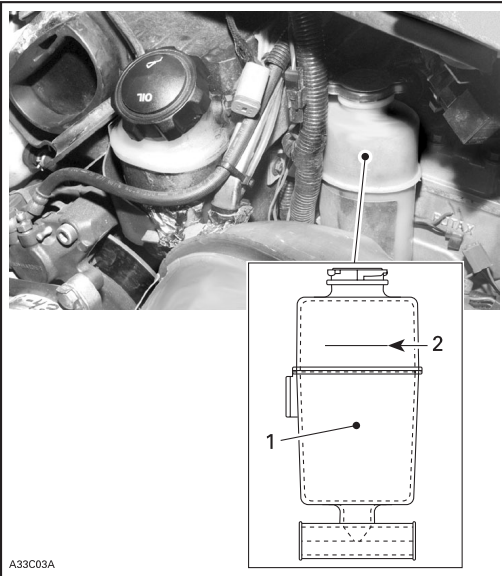

A33C03A

1. Coolant tank
2. COLD LEVEL line

## BATTERY

### Removal

#### WARNING!

Battery BLACK negative cable must always be disconnected first and connected last.

#### WARNING!

Never charge or boost battery while installed. Battery electrolyte contains sulfuric acid which is corrosive and poisonous. In case of contact with skin, flush with water and call a physician immediately.

#### WARNING!

Should the battery casing be damaged, wear a suitable pair of non-absorbent gloves when removing the battery by hand.

#### WARNING!

Battery caps have do not have vent holes. Make sure that vent tube is not obstructed.

### Dry battery

These batteries are maintenance-free battery. Electrolyte level can not be checked.

**NOTE:** During the summer storage the battery (also dry battery) has to be charged at least once a month. Otherwise the battery can not function in the beginning of season.

## MAINTENANCE

### Vehicle cleaning and protection

Remove any dirt or rust.

To clean the entire vehicle, use only flannel cloths or equivalent.

**CAUTION:** It is necessary to use flannel cloths or equivalent on windshield and hood to avoid damaging further surfaces to clean.

To clean the entire vehicle, including bottom pan and metallic parts use Bombardier Cleaner (P/N 293 110 001) spray can 400 g and (P/N 293 110 002 (4 L)).

**CAUTION:** Do not use Bombardier Cleaner on decals or vinyl.

For vinyl and plastic parts use Vinyl & Plastic Cleaner (P/N 413 711 200 (6 x 1 L)).

To remove scratches on windshield or hood use BOMBARDIER Scratch Remover Kit (P/N 861 774 800).

**CAUTION:** Never clean plastic parts or hood with strong detergent, degreasing agent, paint thinner, acetone, products containing chlorine, etc.

Clean sheaves of both pulleys using BOMBARDIER Pulley flange cleaner (P/N 413 711 809).

Inspect the hood and repair any damage.

Touch up all metal spots where paint has been scratched off. Spray all metal parts including shock chromed rods with BOMBARDIER LUBE (P/N 293 600 016).

Wax the hood and the painted portion of the frame for better protection.

Apply wax on glossy finish only. Protect the vehicle with a cover to prevent dust accumulation during storage.

The snowmobile has to be stored in a cold and dry place and covered with an opaque tarpaulin. This will prevent sun rays from affecting vehicle finish.

Lift rear of vehicle until track is off the ground. Install on a mechanical stand.

Do not release track tension.



## Drive belt removal and installation

1. Remove tether cord cap. Open engine compartment.

### 4-tec models only

2. Remove air silencer access panel

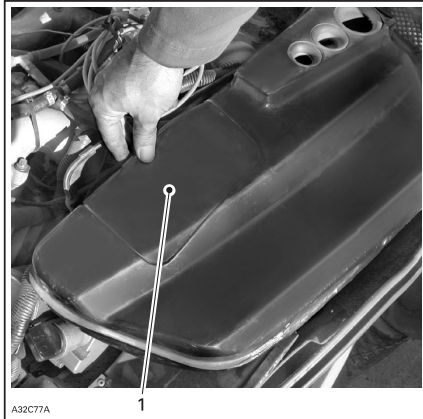
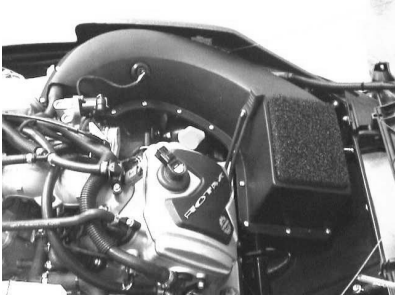

3. Loosen collar screw on air silencer grommet.

4. Disconnect engine vent hose from air silencer.

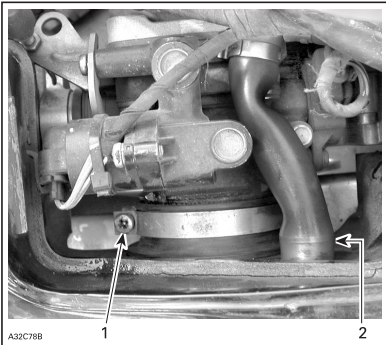

1. Collar screw

2. Engine vent hose

5. Disconnect air temperature sensor at rear of air silencer.

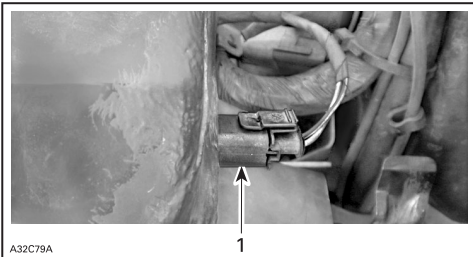

1. Air temperature sensor

At reinstallation do not forget to connect air temperature sensor otherwise a trouble code will appear.

**Other models:**

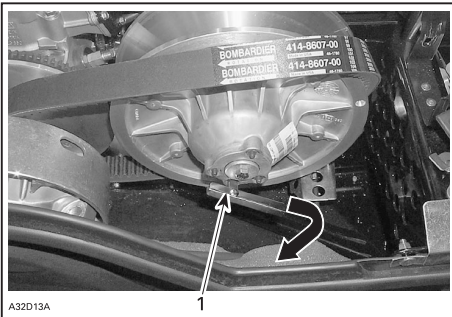

1. Tighten to open pulley



- 1. Guard
- 2. Retaining pins

Stop engine using tether cord.

Open hood. Pull out clip then, open pin retainer. Remove belt guard.

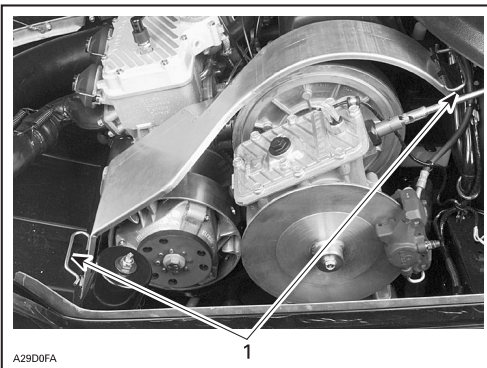

1. Pin retaining

ENGLISH

Screw tool in the threaded hole and tighten to open the pulley. Remove belt.

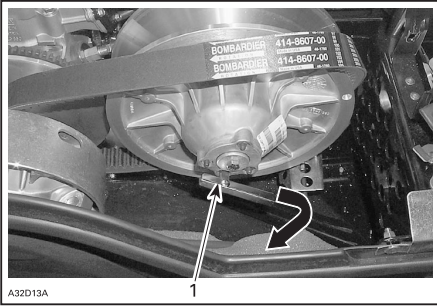

*1. Tighten to open pulley*

Slip the belt over the top edge of the sliding half, as shown.

When reinstalling belt guard, position its cut-away toward front of snowmobile. Refer to decal in belt guard.

**NOTE:** Belt guard is purposely made slightly oversize to maintain tension on its pins and retainers preventing undue noise and vibration. It is important that this tension be maintained when reinstalling.

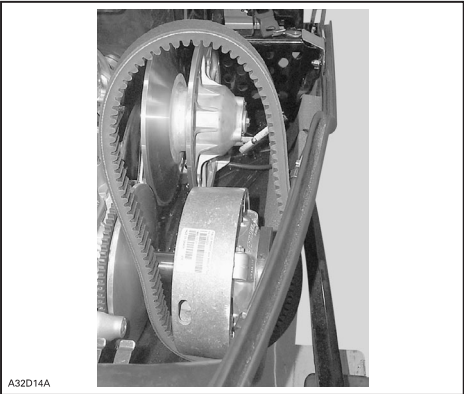

*Typical*

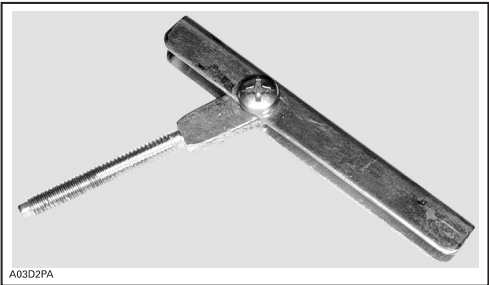

*Drive belt installer/ remover*

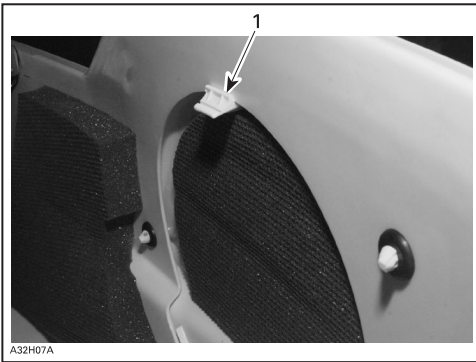

1. Push tab down and pull panel out of bottom pan



*Pull panel out of bottom pan*

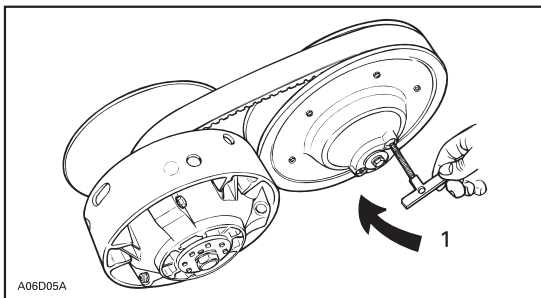

1. *Tighten to open pulley*

Turn sliding half clockwise then, pull on drive belt to open driven pulley. Follow instruction on decals for belt removal and installation.

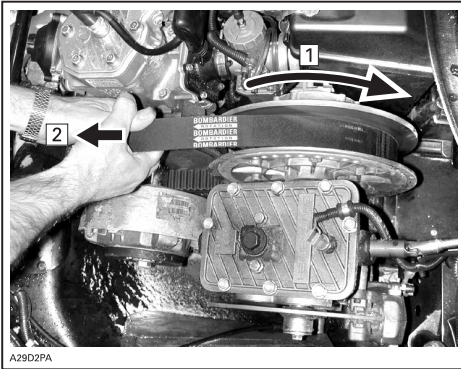

1. Turn sliding half clockwise
2. Pull belt to open driven pulley

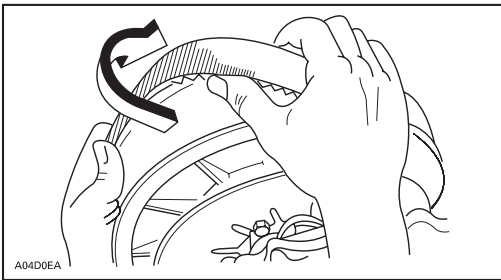

Slip the belt over the top edge of the sliding half, as shown.

### Installation

The maximum drive belt life span is obtained when the belt has the proper rotation direction. Install it so the arrow printed on belt is pointing at front of vehicle.

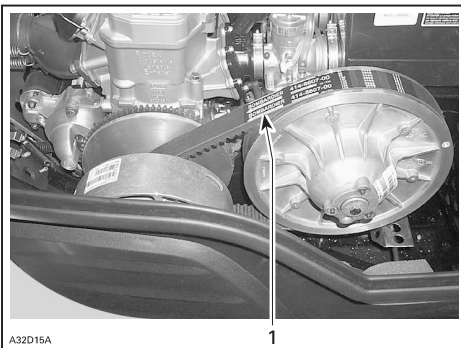

1. Arrow pointing at front of vehicle

**CAUTION:** Do not force or use tools to pry the belt into place, as this could cut or break the cords in the belt.

Clean sheaves of both pulleys using BOMBARDIER Parts Cleaner (P/N 413 711 809).

To install the drive belt, first place belt between drive pulley sheaves. Then, between driven pulley sheaves, finishing with bottom.

Follow instructions on belt guard.

Reinstall belt guard.

## Drive chain tension

**Chain case models :** Remove hair pin.

Fully tighten tensioner adjustment screw by hand, then back off only far enough for hair pin to engage in locking hole.

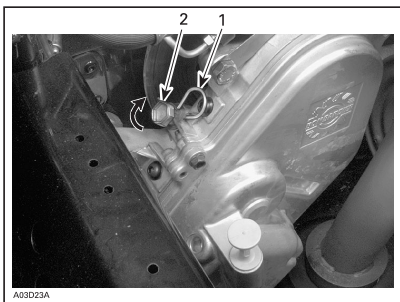

1. Hair pin
2. Adjustment screw

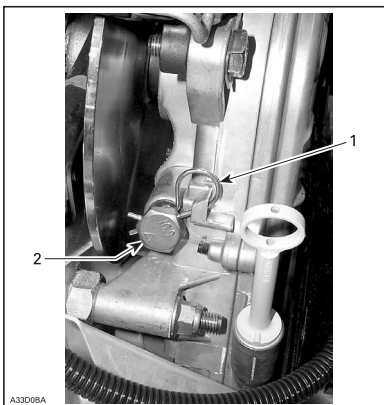

1. Hair pin
2. Adjustment screw

## TRA Drive pulley adjustment

The drive pulley is factory calibrated to transmit maximum engine power at a predefined RPM. refer to TECHNICAL DATA at the end of this guide. Factors such as ambient temperature, altitude or surface condition may vary this critical engine RPM thus affecting snowmobile efficiency.

Calibration screws should be adjusted so that actual maximum engine RPM in vehicle matches with the maximum horsepower RPM.

Use precision digital tachometer for engine RPM adjustment.

The adjustment has an effect on high RPM only.

To adjust, turn calibration screws.

**CAUTION!** Exceeding the engine RPM results to engine damage. Follow the adjustment sets according technical data.

Calibration screw has a notch on top of its head. There are 6 positions numbered 1 to 6.

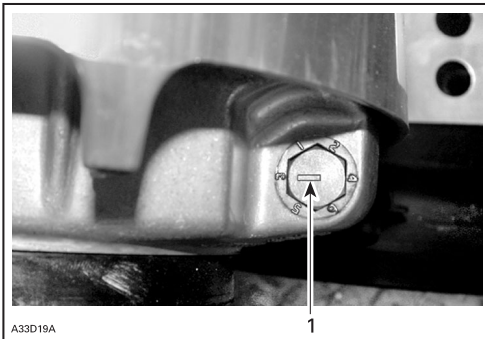

1. Notch

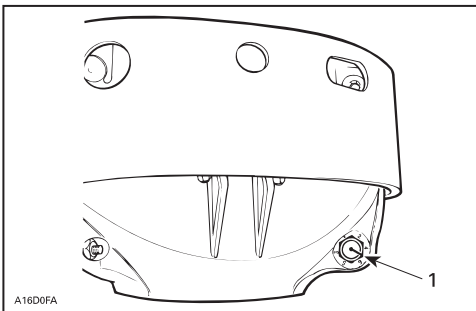

1. Notch

There are 6 positions numbered 1 to 6. Note that in position 1 the number is substituted by a dot (due to its location on casting).

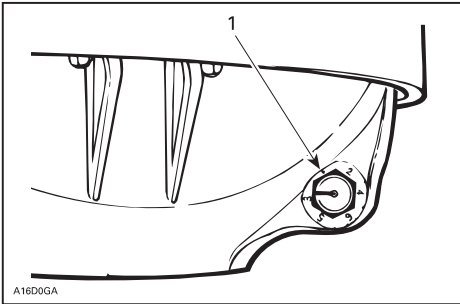

*TRA drive pulley*

*1. Position 1 (not numbered)*

Lower position numbers decrease engine RPM in steps of 200 RPM and higher position numbers increase it in steps of 200 RPM.

**EXAMPLE:** Calibration screw is set at position 4 and is changed to position 6: So maximum engine RPM is increased by 400 RPM.

Adjust as follows: (only if calibrations are changed)

Loosen locking nut enough to pull calibration screw partially out and adjust to desired position. Do not completely remove the locking nut. Torque nut to 10 Nm.

**CAUTION:** Do not completely remove calibration screw otherwise inside washer will fall off. Always adjust all 3 calibration screws and make sure they are all set at the same number.

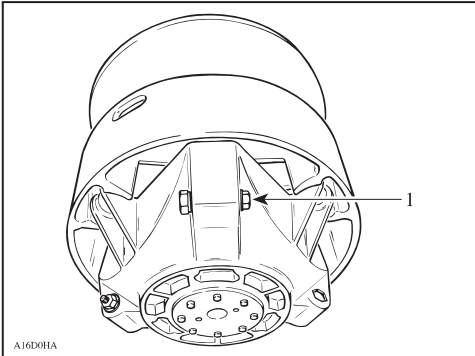

*1. Loosen just enough to permit rotating of calibrate screw*

ENGLISH

**WARNING!**

Always reinstall belt guard. Do not operate engine with hood open or belt guard removed. Improper servicing, modification or poor adjustment may affect drive pulley performance and belt life. Refer to an authorized Lynx dealer.



## Drive belt condition

Inspect belt for cracks, fraying or abnormal wear (uneven wear, wear on one side, missing cogs, cracked fabric). If abnormal wear is noted, probable cause could be pulley misalignment, excessive RPM with frozen track, fast starts without warm-up period, burred or rusty sheave, oil on belt or distorted spare belt. Contact an authorized Lynx dealer.

Check the drive belt width. Replace the drive belt if width is less than the minimum width recommended in TECHNICAL DATA.

## Brake condition

### WARNING!

The brake mechanism on your snowmobile is an essential safety device. Keep this mechanism in proper working condition. Above all, do not operate the snowmobile without an effective brake system. Periodically verify the condition/wear of the brake pads.

## Brake adjustment

**Mechanical brake:** The brake mechanism is self-adjusting type.

**Hydraulic brake:** No adjustment is provided for hydraulic brake. See an authorized Lynx dealer if any problems.

## Rear suspension condition

Visually inspect all suspension components including slider shoes, springs, wheels, etc.

**NOTE:** During normal driving, snow will act as a lubricant and coolant for the slider shoes. Extensive riding on ice or sanded snow, will create excessive heat build-up and cause premature slider shoe wear

## Suspension stopper strap condition

Inspect stopper strap for wear and cracks, bolt and nut for tightness. If loose inspect holes for deformation. Replace as required. Torque nut to 7 Nm.

## Track condition

Lift the rear of the snowmobile and support it with a wide-base snowmobile mechanical stand. Rotate the track by hand, and inspect condition. If worn or cut, or if track fibers are exposed, or if missing or defective inserts or guides are noted, contact an authorized Lynx dealer.

### WARNING!

Do not operate or rotate track if torn, damaged or excessively worn.

## Track tension and alignment

Ride the snowmobile in snow about 15 to 20 minutes prior to adjusting track tension.

Lift rear of snowmobile and support it with a wide-base snowmobile mechanical stand.

Allow the suspension to extend normally and check the gap half-way between front and rear idler wheels. Measure between slider shoe bottom and inside of track. The gap should be as given in TECHNICAL DATA.

### WARNING!

Track tension must be as describe in technical data. Too loose track may cause an accident.

**IMPORTANT:** Too much tension will result in power loss and excessive stresses on suspension components.

To adjust track tension:

Remove idler wheel cover. Loosen rear idler wheel fastening screws. Turn adjustment screws if required. If correct tension is unattainable, contact an authorized Lynx dealer.

### WARNING!

Do not try to check the tension with engine on. Turn ignition switch to OFF. Do not touch rotating track, it may cause injuries.

## Alignment

### WARNING!

Before checking track alignment, ensure that the track is free of all particles which could be thrown out while track is rotating. Keep hands, tools and clothing clear of track.

Start the engine and accelerate slightly so that track barely turns. This must be done in a short period of time (15 to 20 seconds). Check that the track is well centred.

Check that the track is well centred; equal distance on both sides between edges of track guides and slider shoes.

Stop engine prior to adjusting. Loosen rear idler wheel retaining screws. Tighten teh adjustment screw on side where the slider shoe is the farthest from the track insert guides.

Tighten lock nuts and retaining screws.

### WARNING!

Tighten the nuts properly. If lock nuts or adjustment screws are not tightened properly, the track may become loose and get damaged.

Restart engine and rotate track slowly to recheck alignment.

Reposition snowmobile on ground.

**NOTE:** A belt tension tester (P/N 414 348 200) may be used to measure deflection as well as force applied.

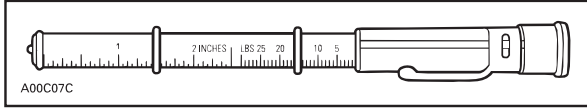

*Belt tension tester*

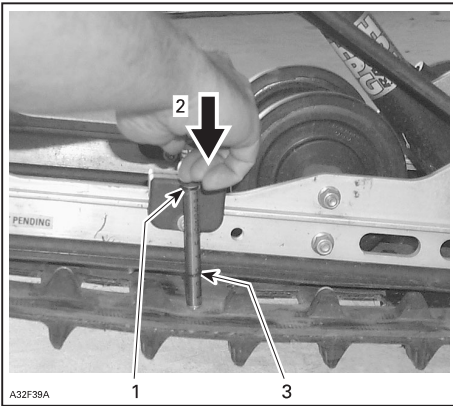

1. Top tool O-ring positioned at 7,3 kg
2. Push on top portion of tool until it contacts the top O-ring
3. Measured track deflection

### Steering and front suspension mechanism

Visually inspect steering and front suspension mechanism for tightness of components (steering arms, control arms and links, tie rods, ball joints, ski coupler bolts, etc.)

If necessary, contact an authorized Lynx dealer.

### Wear and condition of skis and runner

Check the condition of the skis, ski runners and ski runner carbides. If worn, contact an authorized Lynx dealer.

### WARNING!

Excessively worn skis and/or ski runners will affect snowmobile control.

## Exhaust system

The exhaust system is designed to reduce noise and to improve the total performance of the engine. If any exhaust system component is removed, modified or damaged, severe engine damage may result.

### Air filter cleaning

While riding in deep powder snow, periodically stop then shake the snow from the filter. Check that air silencer is clean and dry and properly reinstall the filter.

Leaving the snowmobile uncovered during a snowfall or riding in deep powder snow may block air filter and choke the engine. Open the hood, remove the air filter out of air silencer, shake the snow from filter and properly reinstall the filter.



Removal of filter from its grill

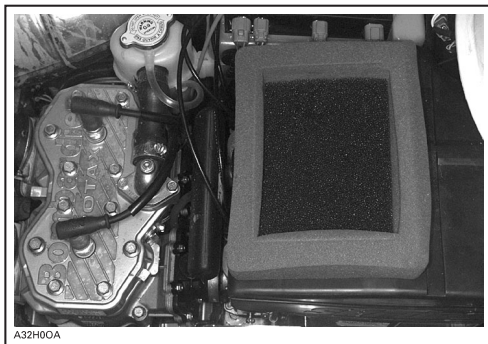

*Secondary filter installed on air silencer*

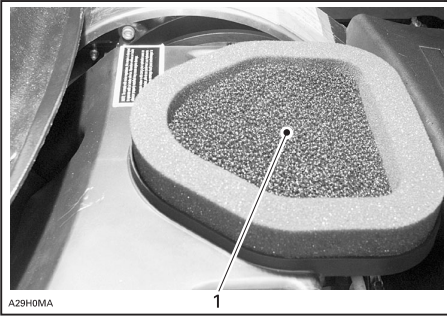

1. Air filter installed on top of air silencer

Check that the air silencer is clean and dry and properly reinstall the filter.

**CAUTION:** Snowmobile have been calibrated with the filter installed. Operating the snowmobile without it may cause engine damage.

### Bulb replacement

Always check light operation after bulb replacement.

**CAUTION:** Never touch glass portion of an halogen bulb with bare fingers, it shortens its operating life. If glass is touched, clean it with isopropyl alcohol which will not leave a film on the bulb.

**Some models:** If headlamp bulb is burnt: Remove headlight moulding and windshield, unplug the connector from the bulb, remove the protector cap and bulb retainer clips. Install new headlamp bulb.

**Some models:** If the headlamp bulb is burnt: Remove windshield and headlamp moulding, unplug connector from headlamp, remove protector cap and turn bulb off, install new headlamp bulb.

### Instruments

Bulb socket is always behind the instrument under a black rubber boot. Pull rubber boot and pull bulb out of socket.

### Headlamp beam aiming

Turn knob to adjust beam height.



1. Knob

If any headlamp bulb is burnt, remove windshield and unplug burnt bulb connector. Remove the rubber boot.



A32E02A

1 2

1. Bulb connector
2. Rubber boot

Turn bulb locking ring counterclockwise to remove it. Detach the bulb and replace. Properly reinstall parts.

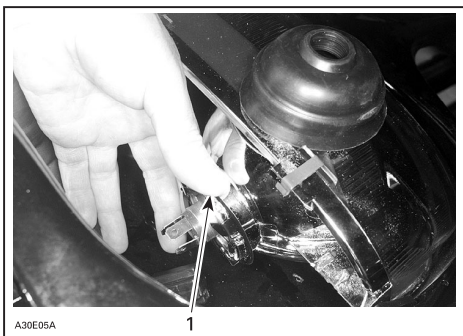

A30E05A

1

1. Locking ring

Unplug burnt bulb connector. Remove the rubber boot.

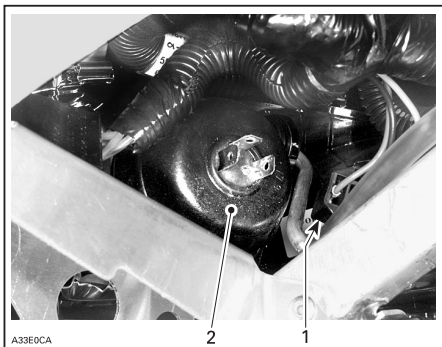

A33E0CA

2

1

1. Bulb connector
2. Rubber boot

Turn bulb locking ring counterclockwise to remove it. Detach the bulb and replace. Properly reinstall parts.

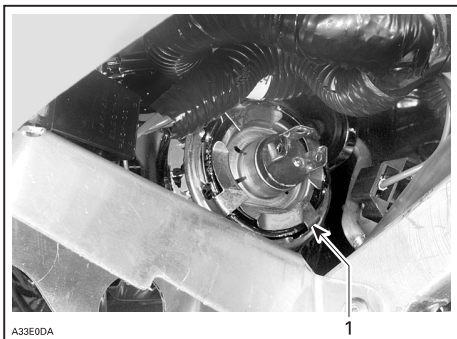

### *1. Locking ring*

If taillight bulb is burnt, expose the bulb by removing the red plastic lens. To remove, unscrew the 2 lens screws.

### **Storage**

It is during summer, or when a snowmobile is not in use for more than one month that proper storage is a necessity.

### **Rear grab handles**

Rear grab handles provides a grip for the passenger. Rear grab handle height can be adjusted.

Lift up adjustment lock, move rear grab handle to desired position. Fasten adjustment lock. Proceed same on opposite side.

### **Adjustable backrest**

The backrest position and support angle may be adjusted to suit driver or passenger convenience.

## TROUBLESHOOTING

### Monitoring beeper coded signals:

CODED SIGNAL	POSSIBLE CAUSE	REMEDY
2 short beeps (when engine is started). DESS/RER pilot lamp also blinks.	Confirms that proper tether cord cap is installed.	Normal condition.
1 short beep every 1,5 seconds (when engine is started). DESS/RER pilot lamp also blinks. Engine cannot reach engagement speed. Vehicle cannot be driven.	Bad DESS system connection. Defective tether cord cap. Dirt or snow in tether cord cap. Defective DESS post.	Reinstall tether cord cap correctly over post. Use another programmed tether cord cap. Clean tether cord cap. Contact an authorized Lynx dealer.
1 long beep per second	Reverse is selected	Vehicle can be driven in reverse
3 short beeps per second. DESS/RER pilot lamp also blinks. Engine cannot reach pulley engagement. Vehicle cannot be driven.	Wrong tether cord cap is installed	Install proper tether cord cap.
3 short beeps per second. Engine overheating pilot lamp also blinks.	Engine is overheating	Stop engine immediately and allow to cool. If trouble persists, see an authorized Lynx dealer.
3 short beeps per second. Oil pilot lamp also lights up.	Low oil pressure on 4 –tec models.	Stop engine immediately and check oil level and add oil as soon as possible. If trouble persists, see an authorized Lynx dealer.
3 short beeps per second. Battery pilot lamp also lights up.	Low battery voltage	Check battery and charging system, see an authorized Lynx dealer.
4 short beeps every 2 minutes. Oil pilot lamp also lights up.	Low oil level on 2 –tec models.	Check oil level and add oil as soon as possible.
4 short beeps every 2 minutes. Engine pilot lamp also lights every 3 seconds.	Too high battery voltage. DESS system has detected a shorted key installed on DESS post.	Use another programmed tether cord cap.



<b>CODED SIGNAL</b>	<b>POSSIBLE CAUSE</b>	<b>REMEDY</b>
4 short beeps every 2 minutes. Engine pilot lamp also lights up.	Defect in engine management system. (EMS)	See an authorized Lynx dealer.
4 short beeps every 2 minutes. Engine pilot lamp blinks every 1 second.	Defect in engine management system. (EMS)	See an authorized Lynx dealer.

<b>TROUBLESHOOTING</b>	
<b>SYMPTON: Engine turns over but fails to start</b>	
<b>POSSIBLE CAUSES</b>	<b>WHAT TO DO</b>
Ignition switch, engine cut-out switch or tether cord is OFF position.	Place all the switches to ON position.
Mixture not rich enough to start cold engine.	Check fuel tank and check starting procedure, particularly use of the choke or primer.
Flooded engine (spark plug wet when removed).	Do not choke. Remove wet spark plug, turn ignition switch to OFF and crank engine several times. Install clean, dry spark plug. Start engine following usual starting procedure. If engine continues to flood, see an authorized Lynx dealer.
No fuel to the engine (spark plug dry when removed).	Check fuel tank level; turn fuel valve on if applicable; check fuel filter; replace if clogged; check condition of fuel and impulse lines and their connections. A failure of the fuel pump or carburetor has occurred; contact an authorized Lynx dealer.
Spark plug/ignition (no spark).	Remove spark plug (s) then reconnect to spark cap. Check that engine cut-out switch is at the ON position and the tether cut-out cord cap is snapped over the receptacle. Start engine with spark plug (s) grounded to engine away from spark plug hole. If trouble persists, contact an authorized Lynx dealer.
Engine compression.	As the engine is pulled over with the rewind starter, "cycles" of resistance should be felt as piston goes past top dead center (each piston on multi-cylinder engines). If no pulsating resistance is felt, it suggests a major loss of compression. Contact an authorized Lynx dealer.

<b>SYMPTON: Engine lacks acceleration or power</b>	
<b>POSSIBLE CAUSES</b>	<b>WHAT TO DO</b>
Fouled or defective spark plug	Check item "Engine turns over but fails to start"
Lack of fuel to engine	See item "Engine turns over but fails to start"
Carburetor adjustments	Contact an authorized Lynx dealer.
Drive belt worn too thin	If the drive belt has lost more than 3 mm of its original width, it will affect vehicle performance.
Drive and driven pulleys require servicing	Contact an authorized Lynx dealer.
Engine is overheating	On liquid cooled engines: Check coolant level, pressure cap, thermostat and air locks in cooling system. On fan cooled engines: Check fan belt and its tension; clean cooling fins of engine; if overheating persists, contact an authorized Lynx dealer.

<b>SYMPTON: Engine backfires</b>	
<b>POSSIBLE CAUSES</b>	<b>WHAT TO DO</b>
Faulty spark plug	See item "Engine turns over but fails to start"
Engine is running too hot	See item "Engine lacks acceleration or power"
Ignition timing is incorrect or there is an ignition system failure	Contact an authorized Lynx dealer

<b>SYMPTON: Engine misfires</b>	
<b>POSSIBLE CAUSES</b>	<b>WHAT TO DO</b>
Fouled/defective/worn spark plug	Clean/verify spark plug gap and identification number. Replace as required.
Too much oil supplied in engine	Improper oil pump adjustment, refer to an authorized Lynx dealer. Too rich fuel/oil mixture (only during break-in period). Drain fuel tank and refill with appropriate mixture ratio.
Water in fuel	Drain fuel system and refill with fresh fuel. Replace fuel filter if needed.

<b>SYMPTOM: Snowmobile cannot reach full speed</b>	
<b>POSSIBLE CAUSES</b>	<b>WHAT TO DO</b>
Drive belt	Check item "Engine lacks acceleration or power"
Incorrect track adjustment	See MAINTENANCE or an authorized Lynx dealer for proper alignment and tension adjustments.
Pulleys misaligned	Contact an authorized Lynx dealer.
Engine	See item "Engine lacks acceleration or power".

	<b>Rave 800</b>	<b>Enduro Sport</b>	<b>Enduro 600 SDI</b>	<b>Rave 440</b>	<b>Adeventure 800</b>	<b>Touring V-1000</b>
Engine	793 HO	593SS	593 HO SDI	453	793 HO	V-1000
Max power RPM	101kw/7950	76kw/8000	85kw/8000		101kw/7950	60kw/7250
Spark plug						
Type NGK	BR9ECS	BR9ECS	BR9ECS	NGK BR9 ES	BR9ECS	NGK DCPR8E
Gap mm	0,45 +/- 0,05	0,45 +/- 0,05	0,80 +/- 0,05	0,45 +/- 0,05	0,45 +/- 0,05	0,7- 0,8
Track						
Width x length mm	380 x 3070	380 x 3070	380 x 3070	380 x 3070	380 x 3648	380 x 3648
Tension mm						
Fluids						
Fuel	95E	95E	95E	98E + 3,3% inj.oil	95E	95E
Oil type	Bombardier Rotax Injection Oil			* Inj.oil XP-S II		
	Bombardier Rotax Injection Oil			Bombardier Rotax Injection Oil		
Oil type gearbox	SAE 75W-140 API GL5 Hypoidi S					
Liquid/water solution l	1:1	1:1	1:1	1:1	1:1	1:1
Volumes						
Fuel tank	38	38	38	38	38	38
Oil tank l	4,3	4,3	4,3	-	3,5	-
Liquid volume l	3,8	3,8	3,8	3,8	3,8	3,8
Oil volume gearbox l	0,25	0,25	0,25	0,25	0,25	0,25
Thermostat °C	42	42	42	42	42	80
Fan belt mm						
Dive belt mm						
Headlight W	60/55	60/55	60/55	60/55	60/55	60/55
Taillight W	21	21	21	21	21	21
Brake light W	5	5	5	5	5	5

	<b>Sport Touring 600 SDI</b>	<b>Enduro 550</b>	<b>Enduro 400</b>	<b>Ranger 600</b>	
Engine	539(R)HO SDI	552(R) F	377(R) F	593(R) SS	
Max power RPM	85/8000	46/7500	35,5/7150	76/8000	
Spark plug					
Type NGK	BR9ECS	NGK BR9 ES	NGK BR9 ES	BR9 ECS	
Gap mm	0,80 +/- 0,05	0,45 +/- 0,05	0,80 +/- 0,05	0,45 +/- 0,05	
Track					
Width x length mm	380x3648	380x3072	380x3072	380x3648	
Tension mm					
Fluids					
Fuel	95E	98E + 2% inj.oil	98E	95E	
Oil type	*Inj.oil XP-S II	Inj.oil XP-S II or equivalent	Bombardier Rotax Inj. oil	Bombardier Rotax Inj.oil	
Oil type gearbox		SAE 75W-140 API GL5 Hypoidi S			
Liquid/water solution l	1:1			1:1	
Volumes					
Fuel tank	38	38	38	38	
Oil tank l	3,5	3,5	3,5	3,5	
Liquid volume l	3,8			3,8	
Oil volume gearbox l	0,25	0,25	0,25	0,25	
Thermostat °C	42			42	
Fan belt mm					
Dive belt mm					
Headlight W	60/55	60/55	60/55	60/55	
Taillight W	21	21	21	21	
Brake light W	5	5	5	5	



