

# BOMBARDIER\* ATV



## OPERATOR'S GUIDE

Includes  
Safety,  
vehicle and  
maintenance  
information

# 2006 DS250™

### WARNING

Read this guide thoroughly.  
It contains important safety information.  
Minimum recommended operator age:  
16 years.  
Do not remove this *Operator's Guide* from  
the vehicle.

2 1 9 0 0 0 4 1 4



This Operator's Guide utilizes the following symbols to emphasize particular information:

 The Safety Alert Symbol indicates a potential personal injury hazard.

 **WARNING** Indicates a potential hazard that, if not avoided, could result in serious injury or death.

**CAUTION:** Denotes an instruction which, if not followed, could severely damage vehicle components.

 **WARNING**

**YOUR VEHICLE CAN BE HAZARDOUS TO OPERATE.** A collision or rollover can occur quickly, even during routine maneuvers such as turning and driving on hills or over obstacles, if you fail to take proper precautions. For your safety, understand and follow all the warnings contained in this Operator's Guide and the labels on your vehicle. **Failure to follow these warnings can result in SEVERE INJURY OR DEATH!** Keep this Operator's Guide with the vehicle at all times.

 **WARNING**

Disregarding any of the safety precautions and instructions contained in this Operator's Guide, Safety Videocassette and on-product labels could cause injury including the possibility of death!

All safety documentation should remain with the vehicle at the time of sale. All content of the Safety Information section should be interpreted by the reader as a warning which, if not followed, may result in injury including the possibility of death.

The following trademarks are the property of Bombardier Recreational Products Inc.:

XP-STM

---

# FOREWORD

Congratulations on your purchase of a new Bombardier\* recreational vehicle. It is backed by the BRP warranty and a network of authorized Bombardier ATV distributors/dealers ready to provide the parts, service or accessories you may require.

Your distributor/dealer is committed to your satisfaction. He has taken training to perform the initial setup and inspection of your vehicle as well as completed the final adjustment before you took possession. At delivery, your distributor/dealer would have explained the operation, maintenance and safety features of the vehicle. We trust you have taken full advantage of this! If you need more complete servicing information, please ask your distributor/dealer.

At delivery, you were also informed of the warranty coverage and completed the Warranty Registration Form which is to be sent to us for processing. In the near future you should be receiving a warranty card which will confirm our receipt of the registration as well as be used for warranty or recall purposes.

You are invited to contact our customer assistance center should you experience problems which cannot be resolved by an authorized Bombardier ATV distributor/dealer.

It is understood that this Operator's Guide may be translated into another language. In the event of any discrepancy, the English version shall prevail. Throughout this document the masculine is used to denote the masculine or feminine.

The information and components/system descriptions contained in this document are correct at the time of publication. BRP, however, maintains a policy of continuous improvement of its products without imposing upon itself any obligation to install them on products previously manufactured. Due to late changes, some differences between the manufactured product and the descriptions and/or specifications in this guide may occur. BRP reserves the right at any time to discontinue or change specifications, designs, features, models or equipment without incurring any obligation upon itself.

The illustrations in this document show the typical construction of the different assemblies and may not reproduce the full detail or exact shape of the parts. However, they represent parts that have the same or similar function.

The use of RIGHT and LEFT indications in the text always refers to driving position (when sitting on vehicle).

Specifications are given in the international metric system with the SAE U.S. equivalent in parenthesis. Where precise accuracy is not required, some conversions are rounded off for easier use.

We recommend genuine BRP products for replacement parts and accessories. They've been especially designed for your vehicle and manufactured to meet BRP's demanding standards.

A Shop Manual can be obtained for complete service and maintenance information and more repair information.

---

# TABLE OF CONTENTS

While reading this Operator's Guide, remember that:

## **WARNING**

Indicates a potential hazard that, if not avoided, could result in serious injury or death.

<b>NOTICE</b> .....	<b>7</b>
European Community .....	7
<b>INTRODUCTION</b> .....	<b>8</b>

### ***SAFETY INFORMATION***

<b>SPECIAL SAFETY MESSAGES</b> .....	<b>10</b>
<b>OPERATION WARNINGS</b> .....	<b>13</b>
<b>SAFETY WARNING</b> .....	<b>39</b>
Pre-Operation Check .....	40
Clothing .....	41
Carrying Loads .....	42
Hauling a Trailer .....	42
Working with your Vehicle .....	42
Recreational Riding .....	42
Environment.....	43
Design Limitation .....	43
Off-Highway Operation.....	44
General Operating and Safety Precautions .....	44
Uphill Driving .....	44
Downhill Driving .....	45
Side Hilling.....	45
Drop-Offs .....	45
Riding Techniques .....	45
Routine Maintenance.....	52
<b>HANG TAG</b> .....	<b>53</b>
<b>LOCATION OF THE IMPORTANT LABELS</b> .....	<b>54</b>

### ***VEHICLE INFORMATION***

<b>HOW TO IDENTIFY YOUR ATV</b> .....	<b>60</b>
<b>CONTROLS/INSTRUMENTS/EQUIPMENT</b> .....	<b>62</b>
1) Throttle Lever .....	64
2) Front Brake Lever.....	64
3) Rear Brake Lever.....	64
4) Parking Brake.....	65

5) Transmission Lever .....	65
6) Multi-Function Switch .....	66
7) Indicator Lamps .....	68
8) Ignition Switch .....	68
9) Fuel Tank Cap .....	69
10) Fuel Valve .....	69
11) Front/Rear Brake Pedal .....	70
12) Footpeg.....	70
13) Tool Kit.....	70
14) Radiator Cap .....	71
15) Fuse.....	71
16) Vehicle Lock.....	71
17) Horn Button .....	72
18) Hazard Warning Switch.....	72
19) Seat Latch .....	72
20) 12-Volt Power Outlet.....	73
21) Speedometer .....	73
<b>LIQUIDS.....</b>	<b>75</b>
Fuel.....	75
Engine Oil.....	75
Gearbox Oil .....	77
Engine Coolant.....	77
Brake Fluid.....	78
Battery .....	79
<b>BREAK-IN PERIOD.....</b>	<b>80</b>
<b>OPERATING INSTRUCTIONS.....</b>	<b>81</b>
General.....	81
Pre-Operation Check .....	81
Initial Cold Starting.....	81
Warm Engine Starting.....	82
Stopping the Engine .....	82
Shifting the Transmission .....	82
<b>SPECIAL PROCEDURES .....</b>	<b>84</b>
Flooded Engine.....	84
Engine Overheat .....	84
Post-Operation Care.....	85
Turn Over .....	85
ATV Immersion.....	85
Storage and Preseason Preparation .....	85

<b>CARGO AND TRANSPORTATION</b> .....	<b>86</b>
<b>TROUBLESHOOTING</b> .....	<b>88</b>
<b>SPECIFICATIONS</b> .....	<b>92</b>

## ***MAINTENANCE INFORMATION***

<b>MAINTENANCE CHART</b> .....	<b>98</b>
<b>GENERAL</b> .....	<b>102</b>
<b>ENGINE</b> .....	<b>103</b>
Oil Change and Oil Strainer Cleaning .....	103
Gearbox Oil Replacement .....	104
Coolant Replacement .....	104
Drive Belt .....	105
Valve Adjustment .....	105
Radiator .....	106
Air Injection Valve Filter Cleaning .....	106
<b>CARBURETOR</b> .....	<b>108</b>
<b>AIR INTAKE SYSTEM</b> .....	<b>109</b>
Air Box Draining .....	109
Air Filter Cleaning .....	109
<b>ELECTRICAL</b> .....	<b>111</b>
Spark Plug .....	111
Battery .....	111
Fuse .....	112
Bulb Replacement .....	112
<b>DRIVE TRAIN</b> .....	<b>115</b>
Drive Chain .....	115
Sprocket and Pinion .....	116
Wheel .....	117
Wheel Bearing/Bushings Condition .....	117
Tires/Wheels .....	117
<b>STEERING SYSTEM</b> .....	<b>119</b>
Throttle Cable Lubrication .....	119
Throttle Lever Adjustment .....	120
<b>SUSPENSION</b> .....	<b>121</b>
Adjustment .....	121
Lubrication .....	121
Inspection .....	121
<b>BRAKE</b> .....	<b>123</b>
Front Brake .....	123
Rear Brake .....	123
Parking Brake .....	123
Brake Cable Lubrication .....	123

Inspection.....	124
Brake Fluid Replacement .....	124
<b>BODY/FRAME.....</b>	<b>125</b>
Engine Area .....	125
Hitch/Trailer Ball Condition (if so equipped) .....	125
Fasteners .....	125
Seat Fasteners .....	125
Vehicle Cleaning and Protection.....	125

***WARRANTY***

<b>BRP INTERNATIONAL LIMITED WARRANTY: 2006 BOMBARDIER* ATV PRODUCTS .....</b>	<b>128</b>
<b>PRIVACY OBLIGATION/DISCLAIMER.....</b>	<b>132</b>
<b>CHANGE OF ADDRESS/OWNERSHIP .....</b>	<b>133</b>





# NOTICE

This Operator's Guide has been prepared to acquaint the owner/operator of a new vehicle with the various vehicle controls, maintenance and safe operating instructions. It is indispensable for the proper use of the product.

This Operator's Guide uses the following symbols.

## WARNING

Indicates a potential hazard that, if not avoided, could result in serious injury or death.

**CAUTION:** Denotes an instruction which, if not followed, could severely damage vehicle components.

**NOTE:** Indicates supplementary information needed to fully complete an instruction.

Although the mere reading of such information does not eliminate the hazard, the understanding and application of the information will promote the correct use of this vehicle.

To fully appreciate the pleasures, enjoyment and excitement of using this vehicle, there are some basic rules that **MUST** be observed and followed by any user.

## European Community

This warning applies only in the European Countries where on road usage is allowed.

## WARNING

### On road use:

- This vehicle is built for OFF-ROAD purposes only. It may be used for short distances on paved surfaces at reduced speed, in order to move the vehicle from an off-road location to another.
- When driving this vehicle on roads, always refrain from speeding and substantially reduce vehicle speed when turning.
- Failure to do so can cause a loss of vehicle control, possibly resulting in serious injury.

### Front winch:

- The front winch hook of the so equipped vehicle must be removed and stored when riding the vehicle on public trails and/or roads.
- Failure to do so can increase the risk of injury to bystanders.

---

# INTRODUCTION

Your distributor/dealer should have provided you with some basic information on the particular controls and features of your new vehicle. Please take the time to study this Operator's Guide and all on-product warning labels as well as the Safety Videocassette that came with this vehicle. They more completely describe what you should know about this vehicle before riding it.

Whether you are a new user or an experienced rider, it is important for your personal safety that you know the controls and features of this vehicle. Equally important is knowing how to properly ride.

Irrespective of your age, experience or state regulations, it is always prudent for you or any other person who may ride your vehicle, to take an approved safe riding course. Please check with your distributor/dealer or local authorities for availability in your area. If you are a completely new rider, this should be done before your first ride. Your instructor should be able to provide advice on local conditions and safe riding practices particular to the area.

Riding conditions vary from place to place. Each is subject to weather conditions which may radically change from time to time and from season to season.

Riding on sand is different than riding on snow or through forests or marshes. Each location may require a greater degree of awareness and skill. Show good judgement. Always proceed with caution. Please do not take any unnecessary risks that could leave you stranded or possibly injured.

The contents of this Operator's Guide provide riding information which has been proven reliable by other users. They are not intended as a definitive means of avoiding accidents. How you apply this information, coupled with your mental and physical condition, the particular terrain hazard and your risk acceptance level will have an effect on your riding experience. Have fun... and ride responsibly.

This Operator's Guide has been prepared to acquaint the owner/operator of a new vehicle with the various vehicle controls, maintenance and safe operating instructions. They are indispensable for the proper use of the product.

We would be pleased to receive any comments on the content and format of this Operator's Guide, the Safety Videocassette or on-product warnings labels.

# ***SAFETY INFORMATION***

---

## SPECIAL SAFETY MESSAGES

**THIS VEHICLE IS NOT A TOY AND CAN BE HAZARDOUS TO OPERATE.**

This vehicle handles differently from other vehicles including motorcycles and cars. A collision or rollover can occur quickly, even during routine maneuvers such as turning and driving on hills or over obstacles, if you fail to take proper precautions.

**SEVERE INJURY OR DEATH** can result if you do not follow these instructions:

- ⚠ Read this Operator's Guide and all on-product warning labels carefully and follow the operating procedures described. Watch and pay attention to the Safety Videocassette before operation.
- ⚠ Never operate this vehicle without proper instruction. Take a training course. Beginners should receive training from a certified instructor. Contact an authorized Bombardier ATV distributor/dealer to find out about available training course nearest you.
- ⚠ Always follow this age recommendation: A person under 16 years old should never operate this vehicle.
- ⚠ Never carry a passenger on this vehicle.
- ⚠ Never operate this vehicle on any paved surfaces unless it is for short distances, at reduced speed and in order to move the vehicle from an off-road location to another.
- ⚠ Always respect the road traffic law when you operate this vehicle on the roadway, even a dirt or gravel road.
- ⚠ Never take place on this vehicle without wearing an approved helmet that fits properly. You should also wear eye protection (goggles or face shield), gloves, boots, long sleeved shirt or jacket, and long pants.
- ⚠ Never consume alcohol or drugs before or while riding this vehicle.
- ⚠ Never operate at excessive speeds. Always go at a speed that is proper for the terrain, visibility, and operating conditions, and your experience.
- ⚠ Never attempt wheelies, jumps, or other stunts.
- ⚠ Always inspect your vehicle each time you use it to make sure it is in safe operating condition. Always follow the inspection and maintenance procedures and schedules described in this Operator's Guide.
- ⚠ Always keep both hands on the handlebars and both feet on the footrests of the vehicle during operation.
- ⚠ Always go slowly and be extra careful when operating on unfamiliar terrain. Always be alert to changing terrain conditions when operating this vehicle.
- ⚠ Never operate on excessively rough, slippery or loose terrain until you have learned and practiced the skills necessary to control this vehicle on such terrain. Always be especially cautious on these kinds of terrain.
- ⚠ Always follow proper procedures for turning as described further in this Operator's Guide. Practice turning at low speeds before attempting to turn at faster speeds. Do not turn at excessive speed.

- ⚠ Never operate this vehicle on hills too steep for the vehicle or for your abilities. Practice on smaller hills before attempting larger hills.
- ⚠ Always follow proper procedures for climbing hills as described further in this Operator's Guide. Check the terrain carefully before you start up any hill. Never climb hills with excessively slippery or loose surfaces. Shift your weight forward. Never open the throttle suddenly or make sudden gear changes. Never go over the top of any hill at high speed.
- ⚠ Always follow proper procedures for going down hills and for braking on hills as described further in this Operator's Guide. Check the terrain carefully before you start down any hill. Shift your weight backward. Never go down a hill at high speed. Avoid going down a hill at an angle that would cause the vehicle to lean sharply to one side. Go straight down the hill where possible.
- ⚠ Always follow proper procedures for crossing the side of a hill as described further in this Operator's Guide. Avoid hills with excessively slippery or loose surfaces. Shift your weight to the uphill side of the vehicle. Never attempt to turn the vehicle around on any hill until you have mastered the turning technique described in this Operator's Guide on level ground. Avoid crossing the side of a steep hill if possible.
- ⚠ Always use proper procedures if you stall or roll backwards when climbing a hill. To avoid stalling, use proper gear and maintain a steady speed when climbing a hill. If you stall or roll backwards, follow the special procedure for braking described in this Operator's Guide. Dismount on the uphill side or to a side if pointed straight uphill. Turn the vehicle around and remount, following the procedure described further in this Operator's Guide.
- ⚠ Always check for obstacles before operating in a new area. Never attempt to operate over large obstacles, such as large rocks or fallen trees. Always follow proper procedures when operating over obstacles as described further in this Operator's Guide.
- ⚠ Always be careful when skidding or sliding. Learn to safely control skidding or sliding by practicing at low speeds and on level smooth terrain. On extremely slippery surfaces, such as ice, go slowly and be very cautious in order to reduce the chance of skidding out of control.
- ⚠ Never operate this vehicle in fast flowing water or in water deeper than that specified in this Operator's Guide. Remember that wet brakes may have reduced stopping ability. Test your brakes after leaving water. If necessary, apply them several times to let friction dry out the pads.
- ⚠ Always be sure there are no obstacles or people behind the vehicle when you operate in reverse. When it is safe to proceed in reverse, go slowly.
- ⚠ Always use the size and type tires specified further in this Operator's Guide. Always maintain proper tire pressure as described further in this Operator's Guide.

- ⚠ Never modify this vehicle through improper installation or use of accessories. Only use BRP's approved accessories. Do not install passenger seat.
- ⚠ Never exceed the stated load limits for this vehicle including operator, all other loads and added accessories. Cargo should be properly distributed and securely attached. Reduce speed and follow instructions in this manual for carrying cargo or pulling a trailer. Allow greater distance for braking.
- ⚠ FOR MORE INFORMATION ABOUT ATV SAFETY, contact an authorized BRP ATV distributor/dealer to find out about available training courses nearest you.

# OPERATION WARNINGS

While reading this Operator's Guide, remember that:

## **WARNING**

Indicates a potential hazard that, if not avoided, could result in serious injury or death.

**NOTE:** The following illustrations are general representations only. Your model may differ.

## **WARNING**



V00A0AQ

### **POTENTIAL HAZARD**

Operating this vehicle without proper instruction.

### **WHAT CAN HAPPEN**

The risk of an accident is greatly increased if the operator does not know how to operate this vehicle properly in different situations and on different types of terrain.

### **HOW TO AVOID THE HAZARD**

Beginning and inexperienced operators should complete the training course offered by BRP. They should then regularly practice the skills learned in the course and the operating techniques described in this Operator's Guide.

For more information about the training course, contact an authorized Bombardier ATV distributor/dealer.



V00A01Q

**POTENTIAL HAZARD**

Failure to follow the age recommendations for this vehicle.

**WHAT CAN HAPPEN**

A lack of respect for this age recommendation can lead to severe injury or death of the child.

Even though a child may be within the age group for which this vehicle is recommended, he may not have the skills, abilities, or judgment needed to operate this vehicle safely and may be involved in a serious accident.

**HOW TO AVOID THE HAZARD**

No one under 16 should operate this vehicle.



 **WARNING**



V00A02Q

**POTENTIAL HAZARD**

Carrying a passenger on this vehicle.

**WHAT CAN HAPPEN**

Greatly reduces your ability to balance and control this vehicle.

Could cause an accident, resulting in harm to you and/or your passenger.

**HOW TO AVOID THE HAZARD**

Never carry passenger. Even with a long seat that provides unrestricted operator movement, it is not designed nor intended to carry passenger(s).

## WARNING



V00A04Q

### **POTENTIAL HAZARD**

Operating this vehicle on public streets or roads.

### **WHAT CAN HAPPEN**

You can collide with another vehicle. Paved surfaces may seriously affect handling and control of the vehicle, and may cause the vehicle to go out of control.

### **HOW TO AVOID THE HAZARD**

If an road usage is allowed in your area, operate your vehicle on paved surface for short distance and for the only purpose of moving the vehicle from an off-road usage to another.

Always operate the vehicle at low speed (never exceed 65 km/h (40 MPH)) and reduce the speed before making a turn.

Always respect all road traffic laws when operating your vehicle on public streets or roads.

## **WARNING**



V00A06Q

### **POTENTIAL HAZARD**

Riding this vehicle without wearing an approved helmet, eye protection and protective clothing.

### **WHAT CAN HAPPEN**

The following items concern all ATV's operator:

- riding without an approved helmet increases the chances of a severe head injury or death in the event of an accident
- riding without eye protection can result in an accident and increases the chances of a severe injury in the event of an accident
- riding without protective clothing increases the chances of severe injury in the event of an accident.

### **HOW TO AVOID THE HAZARD**

Always wear an approved helmet that fits properly. You should also wear:

- eye protection (goggles or face shield)
- gloves and boots
- long sleeved shirt or jacket
- long pants.

**⚠ WARNING**



V00A07Q

**POTENTIAL HAZARD**

Riding this vehicle after consuming alcohol or drugs.

**WHAT CAN HAPPEN**

- Could seriously affect your judgment.
- Could cause you to react more slowly.
- Could affect your balance and perception.
- Could result in an accident or death.

**HOW TO AVOID THE HAZARD**

Never consume alcohol or drugs before or while riding this vehicle.

**⚠ WARNING**

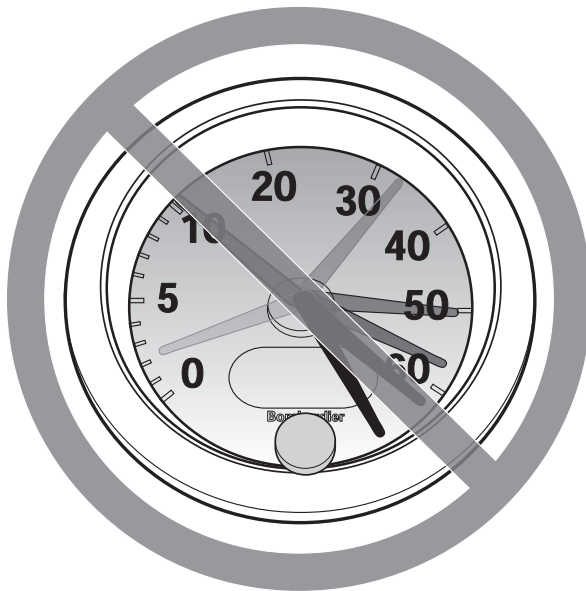

V00A08Q

**POTENTIAL HAZARD**

Operating this vehicle at excessive speeds.

**WHAT CAN HAPPEN**

Increases your chances of losing control of the vehicle, which can result in an accident.

**HOW TO AVOID THE HAZARD**

Always travel at a speed which is proper for the terrain, visibility and operating conditions, and your experience. The maximum speed authorized with this vehicle is 65 km/h (40 MPH). Always reduce speed before making a turn.

 **WARNING**

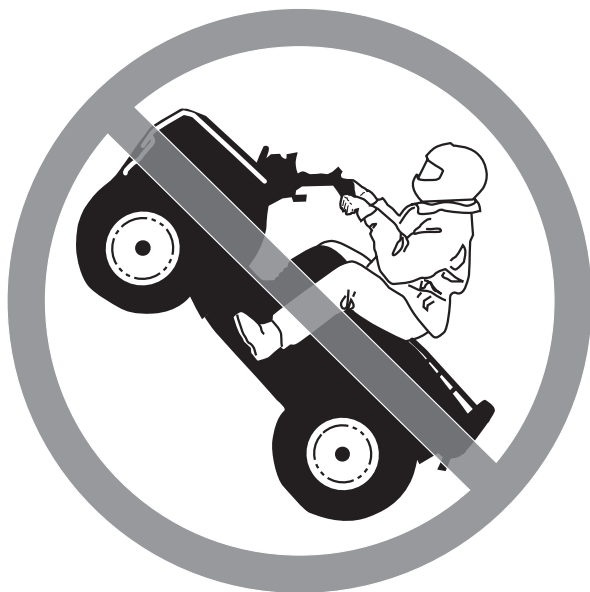

V00A09Q

**POTENTIAL HAZARD**

Attempting wheelies, jumps and other stunts.

**WHAT CAN HAPPEN**

Increases the chance of an accident, including an overturn.

**HOW TO AVOID THE HAZARD**

Never attempt stunts, such as wheelies or jumps. Do not try to show off.

 **WARNING**

**POTENTIAL HAZARD**

Failure to inspect the vehicle before operating.  
Failure to properly maintain the vehicle.

**WHAT CAN HAPPEN**

Increases the possibility of an accident or equipment damage.

**HOW TO AVOID THE HAZARD**

Always inspect your vehicle each time you use it to make sure the vehicle is in safe operating condition.

Always follow the inspection and maintenance procedures and schedules described further in this Operator's Guide.

 **WARNING**

**POTENTIAL HAZARD**

Riding on frozen waterways.

**WHAT CAN HAPPEN**

Severe injury or death can result if the vehicle and/or operator break through the ice.

**HOW TO AVOID THE HAZARD**

Never ride this vehicle on a frozen surface before you are sure the ice is thick enough and sound enough to support the vehicle and its load, as well as the force that is created by a moving vehicle.

**⚠ WARNING**



V00A0BQ

**POTENTIAL HAZARD**

Removing hands from handlebar or feet from the footrests during operation.

**WHAT CAN HAPPEN**

Removing even one hand or foot can reduce your ability to control the vehicle or could cause you to lose your balance and fall off the vehicle. If you remove a foot from the footrests, your foot or leg may come into contact with the rear wheels, which could injure you or cause an accident.

**HOW TO AVOID THE HAZARD**

Always keep both hands on the handlebar and both feet on the footrests during vehicle operation.



**⚠ WARNING**

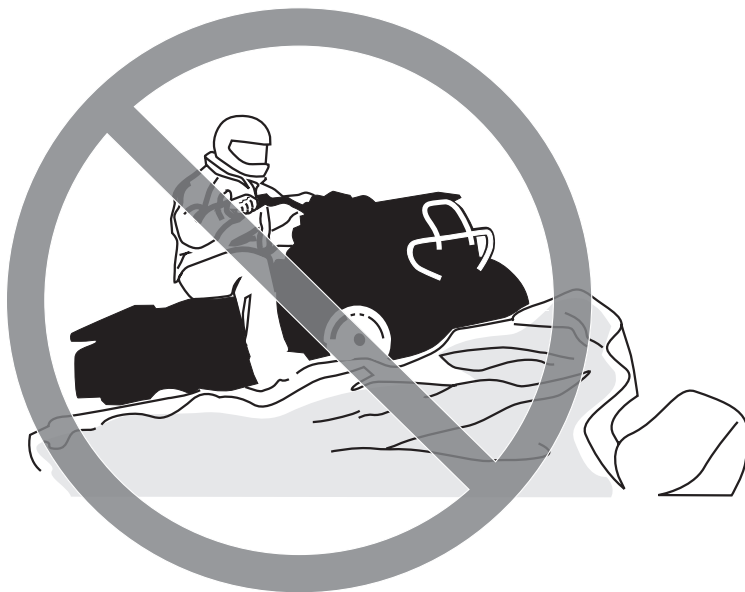

V00A0CQ

**POTENTIAL HAZARD**

Failure to use extra care when operating this vehicle on unfamiliar terrain.

**WHAT CAN HAPPEN**

You can come upon hidden rocks, bumps, or holes, without enough time to react.

Could result in the vehicle overturning or loss of control.

**HOW TO AVOID THE HAZARD**

Go slowly and be extra careful when operating on unfamiliar terrain.

Always be alert to changing terrain conditions when operating the vehicle.

## WARNING



V00A0DQ

### **POTENTIAL HAZARD**

Failure to use extra care when operating on excessively rough, slippery or loose terrain.

### **WHAT CAN HAPPEN**

Could cause loss of traction or vehicle control, which could result in an accident, including an overturn.

### **HOW TO AVOID THE HAZARD**

Do not operate on excessively rough, slippery or loose terrain until you have learned and practiced the skills necessary to control this vehicle on such terrain.

Always be especially cautious on these kinds of terrain.

 **WARNING**



V00A0EQ

**POTENTIAL HAZARD**

Turning improperly.

**WHAT CAN HAPPEN**

Vehicle could go out of control, causing a collision or overturn.

**HOW TO AVOID THE HAZARD**

Always follow proper procedures for turning as described further in this Operator's Guide. Practice turning at low speeds before attempting to turn at faster speeds.

Do not turn at excessive speed.

## WARNING



V00A0QQ

### **POTENTIAL HAZARD**

Operating on excessively steep hills.

### **WHAT CAN HAPPEN**

The vehicle can overturn more easily on extremely steep hills than on level surfaces or small hills.

### **HOW TO AVOID THE HAZARD**

Never operate this vehicle on hills too steep for the vehicle or for your abilities.

Practice on smaller hills before attempting larger hills.

**⚠ WARNING**



V00A0FQ

**POTENTIAL HAZARD**

Climbing hills improperly.

**WHAT CAN HAPPEN**

Could cause loss of control or cause vehicle to overturn.

**HOW TO AVOID THE HAZARD**

Always follow proper procedures for climbing hills as described further in this Operator's Guide.

Always check the terrain carefully before you start up any hill.

Never climb hills with excessively slippery or loose surfaces.

Shift your weight forward.

Never open the throttle suddenly or make sudden gear changes. The vehicle could flip over backwards.

Never go over the top of any hill at high speed. An obstacle, a sharp drop, or another vehicle or person could be on the other side of the hill.

 **WARNING**



V00A0GQ

**POTENTIAL HAZARD**

Going down a hill improperly.

**WHAT CAN HAPPEN**

Could cause loss of control or cause vehicle to overturn.

**HOW TO AVOID THE HAZARD**

Always follow proper procedures for going down hills as described further in this Operator's Guide. **NOTE:** A special technique is required when braking as you go down a hill.

Always check the terrain carefully before you start down any hill.

Shift your weight backward.

Never go down a hill at high speed.

Avoid going down a hill at an angle which would cause the vehicle to lean sharply to one side. Go straight down the hill where possible.

**⚠ WARNING**



V00A0HQ

**POTENTIAL HAZARD**

Improperly crossing hills or turning on hills.

**WHAT CAN HAPPEN**

Could cause loss of control or cause vehicle to overturn.

**HOW TO AVOID THE HAZARD**

Never attempt to turn the vehicle around on any hill until you have mastered the turning technique as described further in this Operator's Guide on level ground. Be very careful when turning on any hill.

Avoid crossing the side of a steep hill if possible.

***When crossing the side of a hill:***

Always follow proper procedures as described further in this Operator's Guide.

Avoid hills with excessively slippery or loose surfaces.

Shift your weight to the uphill side of the vehicle.

## **WARNING**



V00A0IQ

### **POTENTIAL HAZARD**

Stalling, rolling backwards or improperly dismounting while climbing a hill.

### **WHAT CAN HAPPEN**

Could result in vehicle overturning.

### **HOW TO AVOID THE HAZARD**

Use proper gear and maintain steady speed when climbing a hill.

#### ***If you lose all forward speed:***

Keep your weight uphill. Never open the throttle suddenly or make sudden gear changes. The vehicle could flip over backwards.

Apply the brakes.

Lock parking brake after you are stopped.

Dismount on uphill side, or to a side if pointed straight uphill.

#### ***If you begin rolling backwards:***

Keep your weight uphill. Never open the throttle suddenly or make sudden gear changes. The vehicle could flip over backwards.

Never apply the rear brake while rolling backwards.

Apply the front brake gradually.

When fully stopped, apply rear brake as well and lock parking brake.

Dismount on uphill side, or to a side if pointed straight uphill.

Turn the vehicle around and remount, following the procedure described further in this Operator's Guide.



**⚠ WARNING**



V00A0JQ

**POTENTIAL HAZARD**

Improperly operating over obstacles.

**WHAT CAN HAPPEN**

Could cause loss of control or a collision.

Could cause the vehicle to overturn.

**HOW TO AVOID THE HAZARD**

Before operating in a new area, check for obstacles.

Never attempt to ride over large obstacles, such as large rocks or fallen trees.

When you go over obstacles, always follow proper procedures as described further in this Operator's Guide.

**⚠ WARNING**



V00A0KQ

**POTENTIAL HAZARD**

Skidding or sliding improperly.

**WHAT CAN HAPPEN**

You may lose control of this vehicle.

You may also regain traction unexpectedly, which may cause the vehicle to overturn.

**HOW TO AVOID THE HAZARD**

Learn to safely control skidding or sliding by practicing at low speeds and on level smooth terrain.

On extremely slippery surfaces, such as ice, go slowly and be very cautious in order to reduce the chance of skidding or sliding out of control.

**⚠ WARNING**



V00A0LQ

**POTENTIAL HAZARD**

Operating this vehicle through deep or fast flowing water.

**WHAT CAN HAPPEN**

Tires may float, causing loss of traction and loss of control, which could lead to an accident.

**HOW TO AVOID THE HAZARD**

Never operate this vehicle in fast flowing water or in water deeper than that specified further in this Operator's Guide.

Check water depth and current before you attempt to cross any water. Water should not go above footrests.

Remember that wet brakes may have reduced stopping ability. Test your brakes after leaving water. If necessary, apply them several times to let friction dry out the pads.

**⚠ WARNING**



V00A0MQ

**POTENTIAL HAZARD**

Improperly operating in reverse.

**WHAT CAN HAPPEN**

You could hit an obstacle or person behind the vehicle, resulting in serious injury.

**HOW TO AVOID THE HAZARD**

When you select reverse gear, make sure there are no obstacles or people behind the vehicle. When it is safe to proceed, go slowly.

 **WARNING**



V00A00Q

**POTENTIAL HAZARD**

Operating this vehicle with improper tires, or with improper or uneven tire pressure.

**WHAT CAN HAPPEN**

Use of improper tires on this vehicle, or operation of this vehicle with improper or uneven tire pressure, may cause loss of control, and increases the risk of an accident.

**HOW TO AVOID THE HAZARD**

Always use the size and type of tires specified further in this Operator's Guide for this vehicle.

Always maintain proper tire pressure as described further in this Operator's Guide.

**⚠ WARNING**



V00A0N0

**POTENTIAL HAZARD**

Operating this vehicle with improper modifications.

**WHAT CAN HAPPEN**

Improper installation of accessories or modification of this vehicle may cause changes in handling which in some situations could lead to an accident.

**HOW TO AVOID THE HAZARD**

Never modify this vehicle through improper installation or use of accessories. All parts and accessories added to this vehicle should be approved by BRP and should be installed and used according to instructions. If you have questions, consult an authorized Bombardier ATV distributor/dealer.

Do not install passenger seat or use the racks to carry a passenger.

**⚠ WARNING**



V00A0PQ

**POTENTIAL HAZARD**

Overloading this vehicle or carrying or towing cargo improperly.

**WHAT CAN HAPPEN**

Could cause changes in vehicle handling which could lead to an accident.

**HOW TO AVOID THE HAZARD**

Never exceed the stated load capacity for this vehicle including operator, as well as other loads and added accessories.

Cargo should be properly distributed and securely attached.

Reduce speed when carrying cargo or pulling a trailer. Allow greater distance for braking.

Always follow the instructions in this Operator's Guide for carrying cargo or pulling a trailer.

**⚠ WARNING**



V03M01Q

**POTENTIAL HAZARD**

Transporting inflammable or dangerous material can lead to explosions.

**WHAT CAN HAPPEN**

This can cause serious injury or death.

**HOW TO AVOID THE HAZARD**

Never transport inflammable or dangerous material.

While reading this Operator's Guide, remember that:

**⚠ WARNING**

Indicates a potential hazard that, if not avoided, could result in serious injury or death.



---

## **SAFETY WARNING**

To fully appreciate the pleasures and excitement of riding this vehicle, there are some basic rules and tips that you should follow. Some may be new to you while others may be common sense or obvious. Irrespective, we ask that you take a few minutes to read this Operator's Guide completely before you operate this vehicle.

Information in this Operator's Guide is limited. It is strongly recommended that you obtain further information and training from your local authorities, ATV clubs or a recognized ATV training organization.

BRP does not recommend anyone under the age of 16 to ride a vehicle having an engine higher than 90 cc. For the child's safety, we strongly recommend you also follow and enforce this recommendation. You are the sole judge of a rider's capability to understand the risks and operate a vehicle safely.

Persons with cognitive or physical impairments or who are high risk takers have an increased exposure to overturns or collisions which may result in injury including death.

Become completely familiar with the operational controls and the general operation of the vehicle before venturing into off road conditions. Practice driving in a suitable area free of hazards and feel the response of each control. Drive at low speeds. Higher speeds require greater experience, knowledge and suitable riding conditions.

Not all vehicles are the same. Each has its own unique performance characteristics, controls and features. Each will ride and handle differently.

Never assume that the vehicle will go everywhere safely. Sudden changes in terrain caused by holes, depressions, banks, softer or harder "ground" or other irregularities may cause the vehicle to topple or become unstable. To avoid this, slow down and always observe the terrain ahead. If the vehicle does begin to topple or tipover, it is usually the best advice to immediately get off... **AWAY** from the direction of the tipover!

## Pre-Operation Check

### WARNING

The pre-operation check is very important prior to operating the vehicle. Always check the proper operation of critical controls, safety features and mechanical components before starting. If not done, severe injury or death might occur.

Before using this vehicle, the operator should always:

- Remove vehicle lock.
- Apply parking brake and check if it operates properly.
- Check tire pressure and condition.
- Check wheels and bearings for wear and damage.
- Check location of controls and ensure they work properly.
- Verify if steering operates freely.
- Activate throttle control lever several times to ensure it operates freely. It must return to idle position when released.
- Activate the brake lever and brake pedal to make sure the brakes fully apply. Lever and pedal must fully return when released.
- Ensure transmission lever is working then reset in NEUTRAL position.
- Check drive chain for adjustment and lubrication.
- Check sprockets for wear and damages.
- Check fuel, oil and coolant levels.
- Check for oil leaks on the engine/transmission and drive train components.
- Ensure fuel valve is in fully open position (ON).
- Clean headlamps, direction indicator lamps and brake lamp.
- Ensure front access compartment cover is properly latched.

- Ensure seat is properly latched.
- If you transport cargo, respect load capacity.
- If you are pulling a trailer or other equipment, ensure it respects the tongue capacity and towing capacity. Ensure trailer is properly secured to hitch.
- Look and feel for loose parts while engine is off. Check fasteners.
- Ensure the path of travel is free of persons and obstacles.
- Check operation of ignition switch, start button, engine stop switch, headlamp and direction switches as well as hazard warning button.
- Start engine, remove parking brake and drive forward slowly a few feet then apply all brakes individually to test them.

**Correct any problem you may have found before riding. See an authorized Bombardier ATV distributor/dealer as necessary.**

# Clothing

Actual weather conditions should help you decide how to dress. However, it is important that the operator always wear the appropriate protective clothing and apparel, including an approved helmet, eye protection, boots, gloves, long sleeved shirt and pants. This type of clothing will provide you protection from some of the minor hazards you may encounter en route. Operator must never wear loose clothing such as a scarf that may get entangled in the vehicle or on tree branches and shrubs. Depending on conditions, antifogging goggles or sunglasses may be required. Different colored lenses available for goggles or sunglasses help you distinguish terrain variations. Sunglasses should only be worn during the daytime.

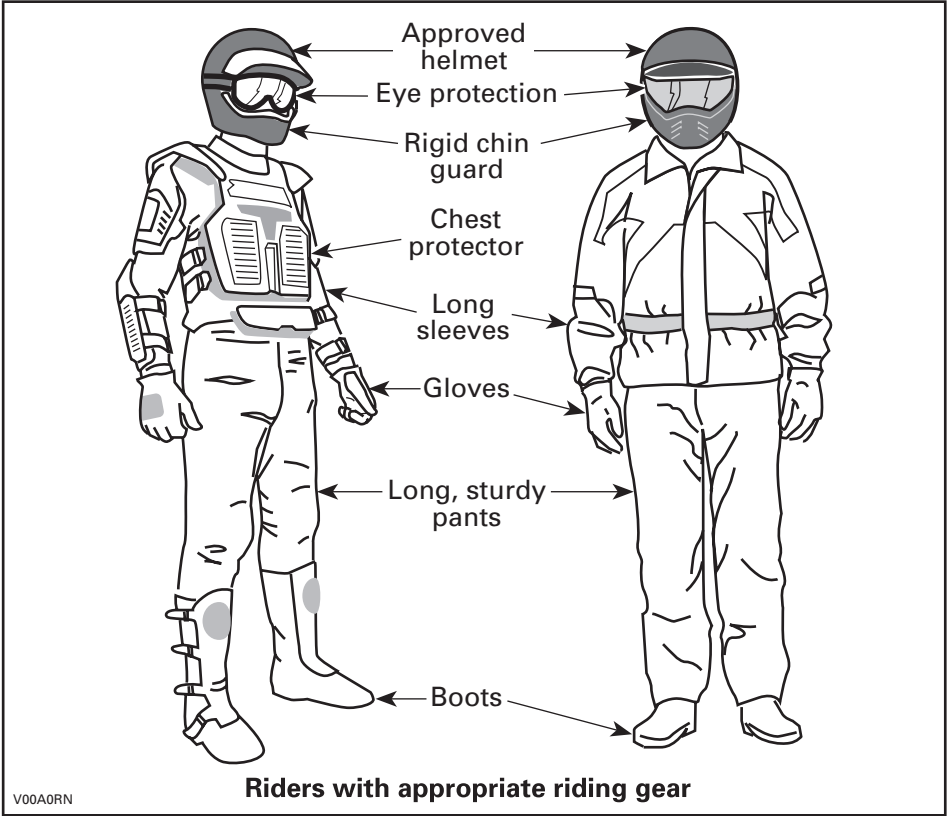

## Carrying Loads

Any load carried on the vehicle will affect the stability and control of the vehicle. For this reason, do not exceed the load limits of the vehicle's manufacturer. Always make sure the load is secured and cannot interfere with your proper control. Always be aware that the "load" may slide or fall off and create an accident. Avoid loads that may protrude sideways and get snagged or caught in brush or other obstacles. Avoid covering and obstructing the headlamp or brake lamp with the cargo.

This vehicle is designed specifically to carry an operator only. Even with a long seat that provide unrestricted operator movements, they are not designed nor intended to carry passenger(s). Do not install passenger seat or use the racks or their location to carry passenger(s) (if so equipped). Carrying passenger(s) may affect the stability and your control of the vehicle.

## Hauling a Trailer

Riding this vehicle with a trailer substantially increases the risk of toppling, especially on inclined slopes. If a trailer is used behind the vehicle make sure that its hitch is compatible with the one on the vehicle. Make sure the trailer is horizontal with the vehicle. (In some instances a special extension may have to be installed on the vehicle hitch). Use security chains to secure the trailer with the vehicle. This vehicle may require additional stopping distance if hauling heavy loads, especially on inclined surfaces. Be careful not to skid or slide. When stopped or parked, block the vehicle and trailer wheels from possible movement. Always make sure load is evenly distributed on the trailer. Use caution when disconnecting a loaded trailer; it or its load may topple on you or others. Do not turn at high speeds. Always use low gear range and slow down a lot.

## Working with your Vehicle

Your vehicle can help you perform some LIGHT tasks. A variety of accessories are available from your authorized Bombardier ATV distributor/dealer. However, always respect the load and capacities of the vehicle. Overloading of the vehicle can overstress the components and cause failure. To prevent possible injury, it is equally important to follow the instructions and warnings that accompany the accessory. Avoid any physical exertion through lifting or pulling of heavy loads or manpowering the vehicle. (Continue to read *RECREATIONAL RIDING* below.)

## Recreational Riding

Respect the rights and limitations of others. Stay away from areas designated for other types of off road use. This includes snowmobile trails, equestrian trails, cross country ski trails, mountain bike trails etc. Never assume there are no other users on the trail. Always stay to the complete right of the trail and do not zig zag to one side of the trail then the other. Be prepared to stop or pull off to the side if another trail user appears in front of you.

Join a local ATV club. They will provide you with a map and advice or inform you where you can ride. If a club does not exist in your area, help start one. Group riding and club activities provide a pleasurable, social experience.

Always keep a safe distance from other riders. Your judgment of speed, terrain conditions, weather, mechanical condition of your vehicle and the "trust in judgment" you have in others around you will help you make a better choice of appropriate safe distance. This vehicle, like any other motorized vehicle, cannot stop "on a dime".

Always operate this vehicle at low speed, do not exceed 65 km/h (40 MPH), and reduce the speed before making a turn when the vehicle is operated on the roadway.

Before you ride, tell someone where you are planning to travel and your expected time of return. Never consume alcohol or drugs before or while riding!

Depending on the length of your ride, carry additional tools or emergency equipment. Find out where you can get additional gasoline and oil. Be prepared for the possible conditions you may encounter. An emergency first aid kit should always be a consideration.

## **Environment**

One of the benefits of this vehicle is that it can take you off the beaten path away from most communities. However, you should always respect nature and the rights of others to enjoy it. Do not ride in environmentally sensitive areas. Do not drive over forest crops or shrubs... nor cut down trees or take down fencing... nor spin your wheels and destroy the terrain. "Tread Lightly".

Chasing wildlife is in many areas illegal. Wildlife can die of exhaustion after being chased by a motorized vehicle. If you encounter animals on the trail, stop and observe quietly and with caution. It will be one of the better memories of your life.

Observe the rule... "what you take in, carry out". Do not litter. Do not start campfires unless you have permission to do so... and then only ... away from dry areas. The hazards you may create on the trail may cause injury to others or yourself, even at a later date.

Respect farm lands. Always obtain the permission of the landowner before riding on private land. Respect crops, farm animals and property lines. If you come to a closed a gate, close it again after yourself.

Finally, do not pollute streams, lakes or rivers and do not modify the engine or muffling system, or remove any of its components.

## **Design Limitation**

Although the vehicle is exceptionally rugged for its class, it is still a light vehicle by definition and its operation must be restricted to its proper purpose.

The addition of weight to any part of the vehicle changes its gravitational stability and modifies its performance.

## **Off-Highway Operation**

The very nature of off-highway operation is dangerous. Any terrain, which has not been specially prepared to carry vehicles, presents an inherent danger where angularity, terrain substance and exact steepness are unpredictable. The terrain itself presents a continual element of danger, which must be knowingly accepted by anyone venturing over it.

An operator who takes a vehicle off-road should always exercise the utmost care in selecting the safest path and keeping close watch on the terrain ahead of him. On no account should the vehicle be operated by anyone who is not completely familiar with the driving instructions applicable to the vehicle, nor should it be operated on steep or treacherous terrain.

## **General Operating and Safety Precautions**

Care, caution, experience and driving skill are the best precautions against the hazards of vehicle operation.

Whenever there is the slightest doubt that the vehicle can safely negotiate an obstacle or a particular piece of terrain, always choose an alternate route.

In off-road operation, power and traction, not speed, are important. Never drive faster than visibility and your own ability to select a safe route permit.

Constantly watch the terrain ahead for sudden changes in slopes or obstacles, such as rocks or stumps, that may cause loss of stability, resulting in tipover or rollover.

Never operate the vehicle if the controls do not function normally.

When operating in reverse, check that the path behind the vehicle is free of people or obstacles. Proceed slowly and avoid sharp turns.

When stopped or parked, always apply the parking brake. This is especially important when parking on a slope. On very steep inclines or if the vehicle is carrying cargo, the wheels should be blocked using rocks or bricks. Remember to turn the fuel valve to the closed position.

## **Uphill Driving**

Due to configuration, this vehicle has excellent climbing ability, so much so that tipover is possible before traction is lost. For example, it's common to encounter terrain situations where the top of the hill has eroded to a point that the hill peak rises very sharply. The vehicle can readily negotiate such a condition, however, in doing so, when the front of the vehicle is driven to a point that the vehicle's balance changes rearward tipover can occur.

The same situation may apply if an embedded object causes the front of the vehicle to climb more than desired. If such a situation occurs take an alternate route. Be aware of side hilling dangers when doing so.

It is also wise to know the terrain condition on the other side of the hill or bank. All too often there exists a sharp drop-off that is impossible to negotiate or descend.

## Downhill Driving

This vehicle can climb slopes that are steeper than it can safely descend. Therefore, it is essential to assure that a safe route exists to descend a slope before you climb it.

Decelerating while negotiating a slippery downhill slope could "toboggan" the vehicle. Maintain steady speed and/or accelerate slightly to regain control.

## Side Hilling

Whenever possible, such operation should be avoided. If necessary, do so with extreme caution. Side hilling on steep inclines could result in rollover. In addition, slippery or unfirm surfaces could result in uncontrollable side sliding. Do not attempt to turn the vehicle downhill with the slide. Avoid all objects or depressions that will intensify the raising of one side of the vehicle higher than the other, thus causing rollover.

## Drop-Offs

This vehicle will "bottom-out" and usually stop if either the front or rear wheels are driven over a drop-off. If the drop is sharp or deep, the vehicle will nose dive and tipover.

### **WARNING**

Avoid negotiating drop-offs. Reverse and select an alternate route.

## Riding Techniques

Riding your vehicle too fast for the conditions may result in injury. Apply only enough throttle to proceed safely. Statistics show that high speed turns usually result in mishaps and injury. Always remember that this vehicle is heavy! Its pure weight alone may entrap you should it fall and pin you down.

This vehicle is not designed for jumping nor can it, or you, absorb the energy of high impacts such as jumping. Performing "wheelies" can cause the vehicle to flip over onto you. Both practices have a high risk for you and should be avoided at all times.

To maintain proper control it is strongly advised that you keep your hands on the handlebar and within easy reach of all controls. The same holds true for your feet. To minimize the possibility of any leg or foot injury, keep your feet on the footrests at all times. Do not direct your toes outwards nor place your foot out to assist turning as they can be hit or snagged by passing obstacles or may contact the wheels.

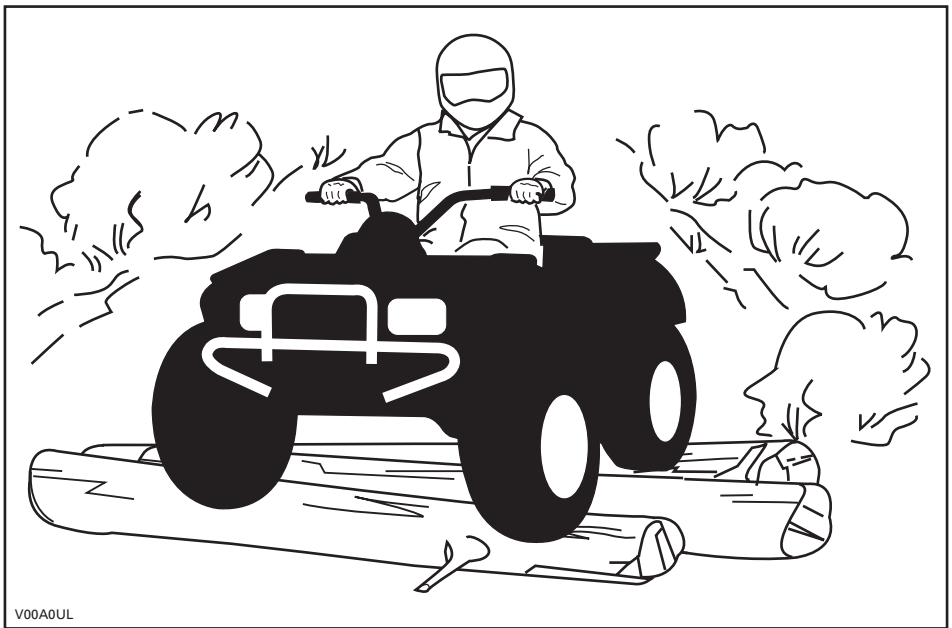

Even though there is an adequate suspensions system on this vehicle there are "washboard" or rough terrain conditions that will make you feel uncomfortable and even cause back injury. "Posting" or riding in a crouched position will often be required. Slow down and allow your flexed legs to absorb impact.

If a road usage is allowed in your area, operate your vehicle on paved surface only for short distance and for the only purpose of moving the vehicle from an off-road usage to another. Always operate your vehicle at low speed (never exceed 65 km/h (40 MPH)) and reduce the speed before making a turn. Always respect all road traffic laws when operating your vehicle on public roads or streets. If you have to cross a road, the lead driver should get off his vehicle the observe and give direction to the other riders. The last person after crossing then assists the lead driver to cross. Do not travel on sidewalks. They are designated for pedestrian use.

Water can be a unique hazard. If it is too deep the vehicle may "float" and topple. Check the water depth and current before you attempt to cross any water. Water should not go above the footrest. Be wary of slippery surfaces such as rocks, grass, logs, etc., both in the water and on its banks. A loss of traction may occur. Do not attempt to enter the water at high speed. The water will act as a brake and could throw you.



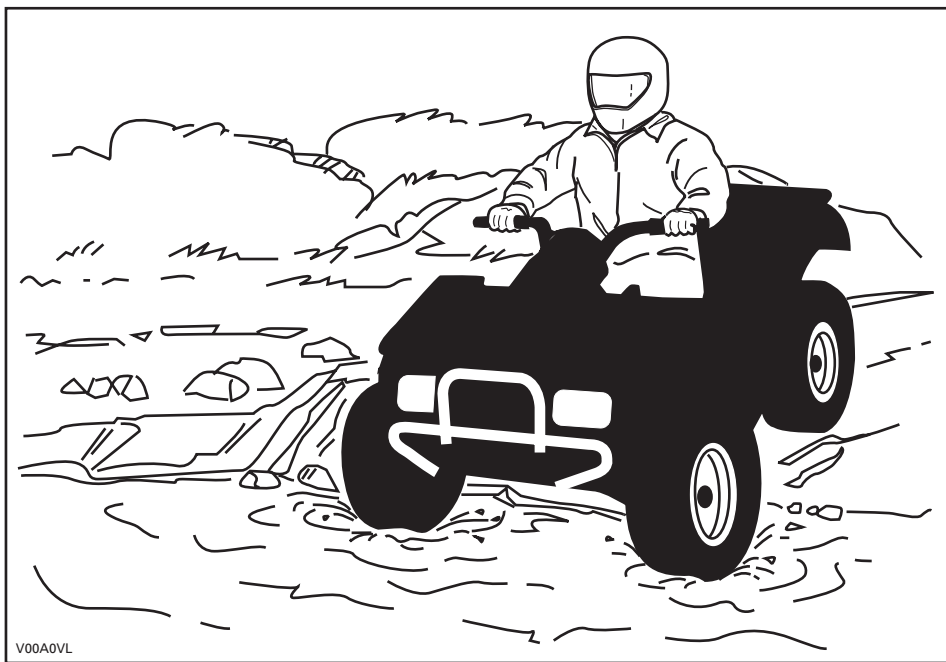

Water will affect the braking ability of your vehicle. Make sure you dry the brakes by applying them several times after the vehicle leaves the water.

Mud or marsh lands may be encountered near water. Be prepared for sudden "holes" or changes in depth. Similarly so, be watchful of hazards such as rocks, logs, etc., partially covered by vegetation.

If your trip crosses frozen waterways, make sure that the ice is thick enough and sound enough to support the total weight of yourself, the vehicle and its load. Be ever watchful of open water... it is a sure indication that the ice thickness will vary. If in doubt, do not attempt to cross.

Ice will also affect the control of vehicle. Slow down and do not "gun" the throttle. This will only result in spinning of the tires and possible tipover of the vehicle. Avoid rapid braking. This again will possibly result in an uncontrolled slide and tipover of the vehicle. Slush should be avoided at all times since it could block the operation or controls of the vehicle.

Sand and riding on sand dunes or on snow is another unique experience but there are some basic precautions that should be observed. Wet, deep or fine sand/snow may create a loss of traction and cause the vehicle to slide, drop off or become "bogged" down. If this occurs look for a firmer base. Again, the best advice is to slow down and be watchful of the conditions.

When riding in sand dunes it is advisable to equip the vehicle with an antenna type safety flag. This will help make your location more visible to others over the next sand dune. Proceed carefully should you see another safety flag ahead. Since the antenna type safety flag can snag and rebound on your body if caught, do not use it in areas where there are low hanging branches or obstacles.

Riding on loose stones or gravel is very similar to riding on ice. They will affect the steering of vehicle... possibly causing it to slide and tipover especially at high speeds. In addition, braking distance may be affected. Remember that "gunning" the throttle or sliding may cause loose stones to be ejected rearwards into the path of another rider's way. Never do it deliberately.

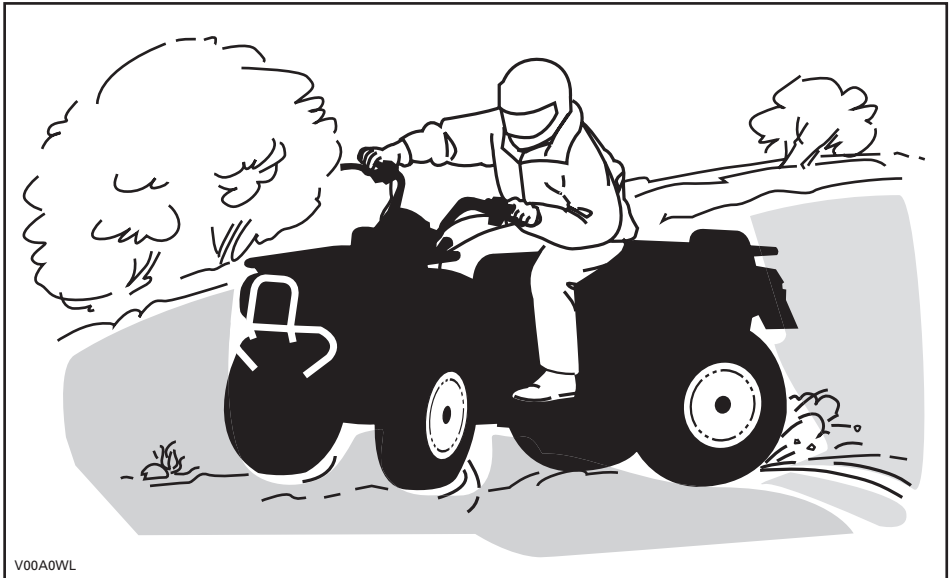

If you do get into a slide or skid, it may help to turn the handlebar into the direction of the skid until you regain control. Never jam the brakes and lock the wheels.

Respect and follow all posted trail signs. They are there to help you and others.

Obstacles in the "trail" should be traversed with caution. This includes loose rocks, fallen trees, slippery surfaces, fences, posts, and embankments and depressions. You should avoid them whenever possible. Remember that some obstacles are too large or dangerous to cross and should be avoided. Small rocks or fallen trees may be safely crossed... approach at a 90° angle. Stand on the footrests while keeping your knees flexed. Adjust speed without losing momentum and do not "gun" the throttle. Hold handgrips firmly. Place your body weight rearwards and proceed. Do not try to lift the vehicle front wheels off the ground. Be aware that the object may be slippery or may move while crossing.

When driving on hills or slopes two things are highly important... be prepared for slippery surfaces or terrain variations and obstacles and... use proper body positioning.

## Uphill

Keep your body weight forward towards the top of the hill. Keep your feet on the footpegs and shift into low gear then accelerate and when necessary, change gear quickly as you climb. Do not over-speed since this may cause the front of the vehicle to lift from the ground and fall back on you. If the hill is too steep and you cannot proceed or the vehicle begins to roll backwards, apply the brake, being careful not to slide. Dismount then use the "U" turn or "K" turn (while walking back, next to the vehicle on the up hill side and with a hand on the brake lever, slowly back the rear of the vehicle toward the top of the hill then drive downhill). Always walk or dismount on the upside of the slope while keeping clear of the vehicle and its rotating wheels. Do not try to hold on to the vehicle if it begins to topple. Stay clear. Do not ride over the crest of the hill at high speed. Obstacles, including sharp drop-offs, may exist.

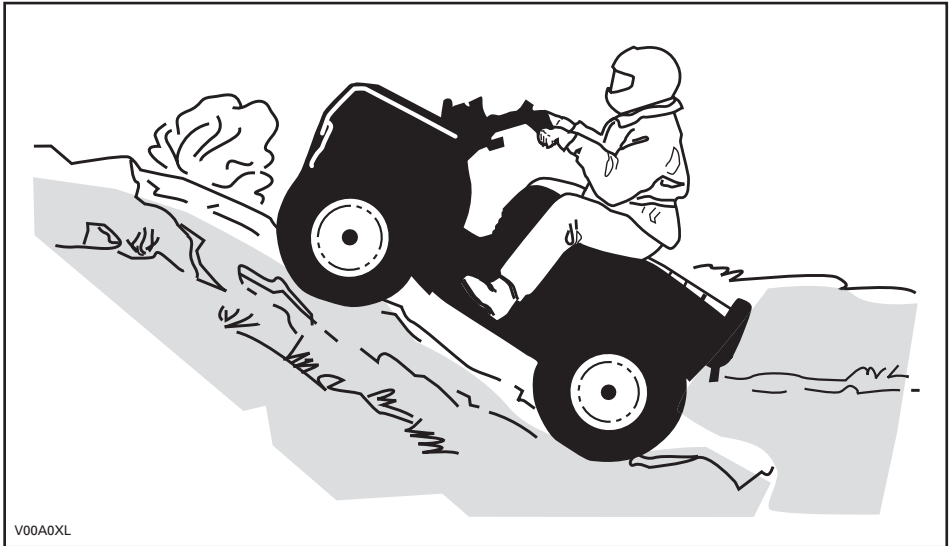

## Downhill

Keep your body weight rearwards. Apply the brake gradually to prevent skidding. Do not “coast” down the slope using solely engine compression or in neutral gear.

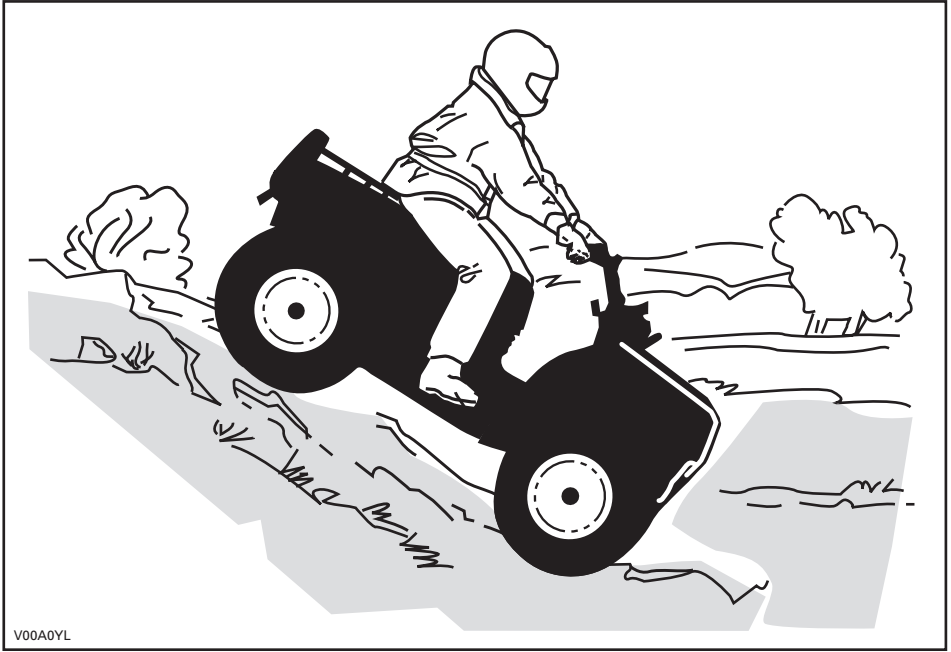

While reading this Operator's Guide, remember that:

### **WARNING**

Indicates a potential hazard that, if not avoided, could result in serious injury or death.

## Side Hilling

This is one of the **most risky** types of riding since it may drastically change the balance of the vehicle. It should be avoided wherever possible. If it is necessary to do so however, it is important that you **ALWAYS** keep your body weight on the upside of the slope... and be prepared to dismount on that side should the vehicle begin to topple. **Do not try to stop or save the vehicle from damage.**



V00A0ZL

## **Routine Maintenance**

Once your ride completed, it is wise to remove any build up of snow, ice, mud and grime. Not only will this help you keep your vehicle longer and in good condition for resale but will eliminate potential hazards the next time you use the vehicle. Wash your vehicle in warm soapy water then allow it to dry. (A towel may help). Do not wash your vehicle outside during freezing weather. Apply appropriate lubrication as described in the *MAINTENANCE* section.

Part of your responsibility towards safety is to respect the contents of this Operator's Guide. It provides valuable advice on how to properly take care of your vehicle. If further assistance is required your authorized Bombardier ATV distributor/dealer is always willing to help.

Modification of the vehicle to increase speed and performance may violate the terms and conditions of your vehicle limited warranty. In addition, certain modifications including the removal of engine or exhaust components are illegal under most laws.

Changing the wheel and/or tire size may affect the stability of the vehicle. Incorrect tire pressure may lead to blow outs or cause a tire to move around on its rim and become lost or damaged. Wheels or tires which are damaged should always be replaced.

# HANG TAG

This vehicle comes with a hang tag and labels containing important safety information.

Any person who rides this vehicle should read and understand this information before riding.

**R**  
**RECREATIONAL MODEL**

**THIS ATV IS FOR  
RECREATIONAL USE.**

**OPERATOR ONLY-NO PASSENGERS**

---

**NO OPERATOR UNDER AGE 16**

---

**THIS CATEGORY R (RECREATIONAL) ATV IS  
FOR OFF ROAD USE ONLY. IT IS MAINLY FOR  
GENERAL RECREATIONAL USE BUT IT MAY  
ALSO BE USED FOR UTILITY PURPOSES.**

---

**TRAINING COURSES TO TEACH ATV RIDING SKILLS  
ARE AVAILABLE. FOR INFORMATION CONTACT  
YOUR DEALER.**

---





**CHECK WITH YOUR DEALER TO FIND OUT ABOUT  
STATE OR LOCAL LAWS REGARDING ATV  
OPERATION.**

**THIS HANGTAG IS NOT TO BE REMOVED BEFORE SALE.**

V07M11L 704900930

**⚠ WARNING**

Improper ATV use can result in SEVERE INJURY or DEATH.

			
<b>ALWAYS USE AN APPROVED HELMET AND PROTECTIVE GEAR.</b>	<b>NEVER USE ON PUBLIC ROADS.</b>	<b>NEVER CARRY PASSENGERS.</b>	<b>NEVER USE WITH DRUGS OR ALCOHOL.</b>

**NEVER operate:**

- without proper training or instructions.
- at speeds too fast for your skills or the conditions.
- on public roads - a collision can occur with another vehicle.
- with a passenger - passengers affect balance and steering and increase risk of losing control.

**ALWAYS:**

- use proper riding techniques to avoid vehicle overturns on hills and rough terrain and in turns.
- avoid paved surfaces - pavement may seriously affect handling and control.

**LOCATE AND READ OPERATOR'S GUIDE.  
FOLLOW ALL INSTRUCTIONS & WARNINGS.**

---

## LOCATION OF THE IMPORTANT LABELS

The following labels are on your vehicle and they should be considered permanent parts of the vehicle. If missing or damaged, they can be replaced free of charge. See an authorized Bombardier ATV distributor/dealer.

**NOTE:** The following illustrations used in this Operator's Guide are a general representation only. Your model may differ.



# Label 1



vmo2006-014-001\_a

## Label 1

**⚠ WARNING**

Improper ATV use can result in **SEVERE INJURY** or **DEATH**.



ALWAYS USE AN APPROVED HELMET AND PROTECTIVE GEAR.



NEVER USE ON PUBLIC ROADS.



NEVER CARRY PASSENGERS.



NEVER USE WITH DRUGS OR ALCOHOL.

**NEVER** operate:

- without proper training or instructions.
- at speeds too fast for your skills or the conditions.
- on public roads - a collision can occur with another vehicle.
- with a passenger - passengers affect balance and steering and increase risk of losing control.

**ALWAYS:**

- use proper riding techniques to avoid vehicle overturns on hills and rough terrain and in turns.
- avoid paved surfaces - pavement may seriously affect handling and control.

LOCATE AND READ OPERATOR'S GUIDE.  
FOLLOW ALL INSTRUCTIONS & WARNINGS.

704 900 001

V01M01Z

## Label 2

**⚠ WARNING**



Operating this ATV if you are under the age of 16 increases your chance of **SEVERE INJURY** or **DEATH**.

**NEVER** operate this ATV if you are under age 16.

704 900 011

V01M02Z

## Label 3

**⚠ WARNING**



**NEVER** ride as a passenger. Passengers can cause a loss of control, resulting in **SEVERE INJURY** or **DEATH**.

704 900 005

V01M07Z

## Label 4

**⚠ WARNING**

Improper tire pressure or overloading can cause loss of control, resulting in **SEVERE INJURY** or **DEATH**.

**ALWAYS** maintain proper tire pressure as shown.

**NEVER** set tire pressure below minimum. It could cause the tire to dislodge from the rim.

**NEVER** exceed the vehicle load capacity (XXX kg) including weight of operator, cargo, accessories and trailer tongue weight.

**ATV LOADING and TRAILER TOWING**

- Cargo loading or trailer towing can affect stability and handling.
- When loaded with cargo or towing a trailer:
  - reduce speed.
  - allow more distance to stop.
  - avoid hills and rough terrain.

LOAD	COLD TIRE PRESSURE
UP TO XXX kg (XXX lb)	FRONT MAX: XX kPa (XX psi)
in SEVERE INJURY or DEATH.	REAR MAX: XX kPa (XX psi)
	REAR MIN: XX kPa (XX psi)

vmo2006-007-002\_aen

vmo2006-007-002\_aen

## Label 5

**DRIVE CHAIN**

**DRIVE CHAIN MUST BE WELL ADJUSTED AND LUBRICATED. FREE PLAY IS 15-25mm (5/8-1")**

**WITH DRIVER ON VEHICLE. SEE OWNERS MANUAL FOR COMPLETE INSTRUCTIONS.**

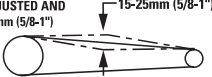

vmo2006-014-002\_aen

vmo2006-014-002\_aen

## Label 6

**CAUTION**

- ATV MUST** be stopped before shifting transmission lever.
- Always apply foot brake to shift from **NEUTRAL (N)**.

704 900 210

V06M0EY

## Label 7



**EMISSION CONTROL  
INFORMATION**

**RENSEIGNEMENTS SUR LE  
DISPOSITIF ANTIPOLLUTION**

THIS VEHICLE IS NOT SUBJECT TO  
PHASE-IN EPA EMISSION STANDARDS  
AND RELATED REQUIREMENTS FOR  
MODEL YEAR 2006 APPLICABLE  
UNDER 40 CFR 1051.

CE VÉHICULE N'EST PAS  
CONCERNÉ PAR LES NORMES  
2006 DE L'EPA DES É.-U. EN VERTU  
DE LA RÉGLEMENTATION 40 CFR 1051.

512 000 138

512060138

## Label 8

**WARNING**

**This warning applies only in European  
Countries where on road usage is allowed.**

**On Road Use**

This ATV is built for "OFF ROAD" purposes only.  
It may be used for short distances on paved surfaces  
at reduced speed, in order to move the vehicle from  
an off road location to another.

When driving this ATV on roads, always refrain from  
speeding and substantially reduce vehicle speed  
when turning.

Failure to do so can cause a loss of vehicle control,  
possibly resulting in serious injury or death.

**Front Winch**

The front winch hook of the so equipped ATV's must  
be removed and stored when riding the vehicle on  
public trails and/or roads.

Failure to do so can increase the risk of injury to  
bystanders.

704 900 400

V01M0PY

## Label 9





 FND OG LÆS BRUGERVEJLEDNINGEN,  
OVERHOLD ALLE INSTRUKTIONER OG  
ADVARSLER.

 ZOEK DE GEBRUIKERSHANDLEDING OP  
EN LEES HEM HOUD U AAN ALLE  
AANWIJZINGEN EN WAARSCHUWINGEN.

 LOCALISER ET LIRE LE GUIDE DE  
L'OPÉRATEUR, SUIVRE TOUS LES  
CONSIGNES ET AVERTISSEMENTS.

 PAKKANNA JA LUE KÄYTTÄJÄN OPAS,  
NOUDATA KÄYTTÖOHJEITA  
JA VAROITUKSIA.

 BETRIEBSANLEITUNG AUSFINDIG  
MACHEN UND LESEN.  
ALLE ANWEISUNGEN UND  
WARNHINWEISE BEFOLGEN.



 ΒΡΕΙΤΕ ΚΑΙ ΔΙΑΒΑΣΤΕ ΤΟΝ ΟΔΗΓΟ  
ΧΡΗΣΤΗ. ΑΚΟΛΟΥΘΗΣΤΕ ΟΛΕΣ ΤΙΣ  
ΟΔΗΓΙΕΣ ΚΑΙ ΠΡΟΒΟΛΕΥΣΕΙΣ.

 LEGGERE IL MANUALE  
DELL'OPERATORE, SEGUIRE TUTTE LE  
ISTRUZIONI E AVVERTENZE.

 LOCALIZAR E LER O GUIA DE OPERAÇÃO,  
OBSERVAR TODAS AS INSTRUÇÕES E  
MENSAGENS DE AVISO.

 UBICAR Y LEER LA GUÍA DEL  
OPERADOR. ATENERSE A TODAS LAS  
INSTRUCCIONES Y MENSAJES  
DE ADVERTENCIA.

 TA REDA PÅ INSTRUKTIONSBOKEN  
OCH LÄS DEN, UPPMÄRKSAMMA  
ALLA ANVISNINGAR OCH VARNINGAR.



704 901 177

vmo2006-014-003\_a



# ***VEHICLE INFORMATION***

# HOW TO IDENTIFY YOUR ATV

The main components of your vehicle (engine and frame) are identified by different serial numbers. It may sometimes become necessary to locate these numbers for warranty purposes or to trace your vehicle in the event of loss. These numbers are required by the authorized Bombardier ATV distributor/dealer to complete warranty claims properly. No warranty will be allowed by BRP Inc. if the engine identification number (EIN) or vehicle identification number (VIN) is removed or mutilated in any way. We strongly recommend that you take note of all the serial numbers on your vehicle and supply them to your insurance company.

## Vehicle Identification Number Location



1. VIN (Vehicle Identification Number)
2. Model

## Engine Identification Number Location



vmo2006-014-005\_a

# CONTROLS/INSTRUMENTS/EQUIPMENT

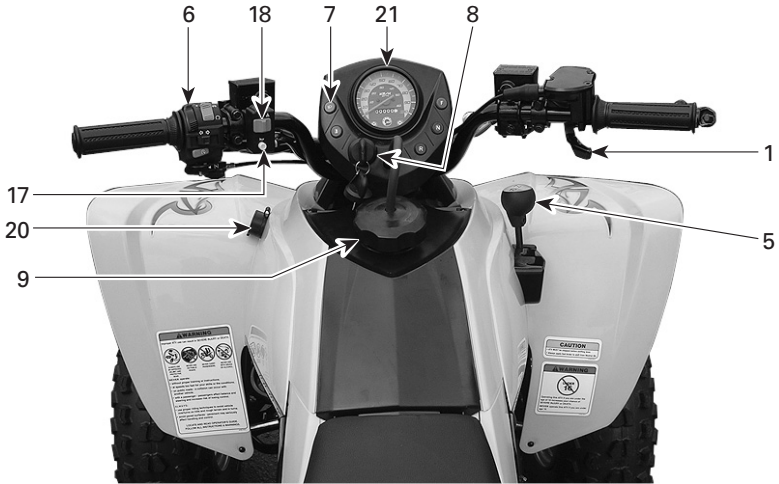

vmo2006-014-006\_a





vmo2006-014-007\_a

While reading this Operator's Guide, remember that:

## **WARNING**

Indicates a potential hazard that, if not avoided, could result in serious injury or death.

**NOTE:** This section gives basic functions of the various controls of your ATV. For more details of how to operate one control in conjunction with some others, refer to *OPERATING INSTRUCTIONS* further in this section.

### **1) Throttle Lever**

Located on the right side of handlebar. When pushed, it increases the engine speed that allows the engagement of the transmission on the selected gear.

When released, the engine speed should return automatically to idle and the vehicle will gradually slow down.

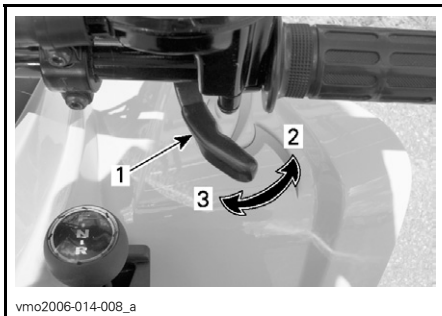

1. Throttle lever
2. To accelerate
3. To decelerate

### **2) Front Brake Lever**

Located on the right side of handlebar. When compressed, the front brakes are applied. When released, it should automatically return to its original position. Braking effect is proportional to the force applied on the lever and to the type and condition of the terrain.

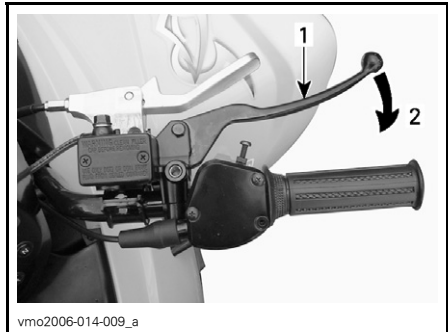

1. Brake lever
2. To apply brake

### **3) Rear Brake Lever**

Located on the left side of handlebar. When compressed, the rear brake is applied. When released, it should automatically return to its original position. Braking effect is proportional to the force applied on the lever and to the type and condition of the terrain.

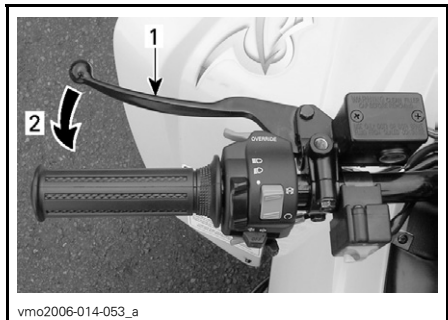

1. Brake lever
2. To apply brake

## 4) Parking Brake

Located on right side of handlebar. When applied, it prevents the vehicle from moving. Useful when the brake needs to be locked for example such as doing a K-turn, during transportation or when the vehicle is not in operation.

### **WARNING**

Always use the parking brake **and** engage the **FORWARD** position on the transmission lever when the vehicle is not in operation.

### **WARNING**

Make sure parking brake is fully disengaged before operating the ATV. Riding the vehicle with a continuous pressure on the brakes may cause damage to the brake system and cause loss of braking capacity and/or fire.

To engage mechanism: Pull parking brake lever until it is locked in place.

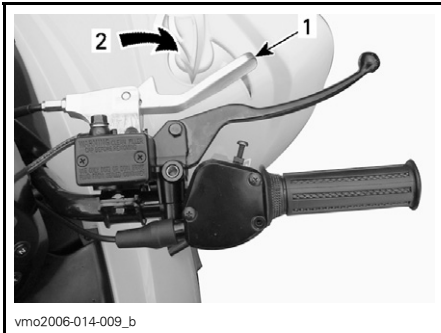

#### **ON POSITION**

1. Brake lever lock
2. Pull to apply parking brake

To release mechanism: Push parking brake back in place. Brake lever should return to rest position. Always release parking brake before riding.

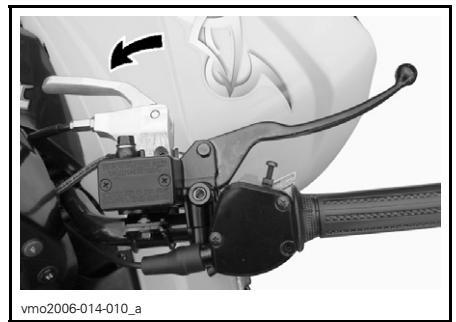

#### **OFF POSITION**

## 5) Transmission Lever

Located at the front, on the right side of vehicle. A 3-position lever: R, N and F.

**CAUTION:** Always completely stop the vehicle and apply the brake prior to moving the transmission lever.

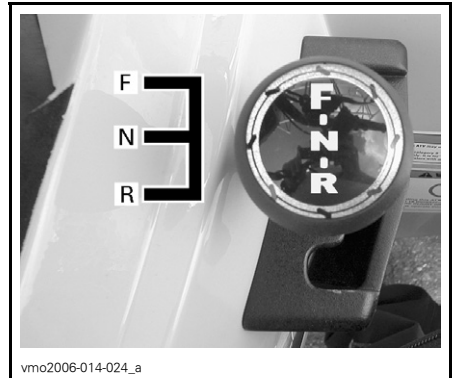

#### **TRANSMISSION LEVER PATTERN**

To change the transmission position, completely stop vehicle, apply brakes then move lever to the desired position while moving lever forward or backward. Do not force lever.

**NOTE:** Any shifting attempt at high RPM or without brakes applied will stop engine.

## R: Reverse

This allows the vehicle to go backward. This vehicle is equipped with a reverse speed limiter system. Refer to *OVERRIDE BUTTON* further, for more informations.

### **WARNING**

Before moving vehicle in reverse, ensure the path behind is clear of obstacles or bystanders. Remain seated.

## N: Neutral

This position disengages the transmission to allow manual vehicle movement or towing.

## F: Forward

It is the normal driving range. It allows the vehicle to reach its maximum speed.

## 6) Multi-Function Switch

The multi-function switch is located on the left side of the handlebar.



The controls located on this multi-function switch are:

### **Headlamp Switch**

It is located on top of the multi-function switch.

Place switch to LO for the low beam and taillight, HI for the high beam and taillight and OFF to close the headlamp and taillight.

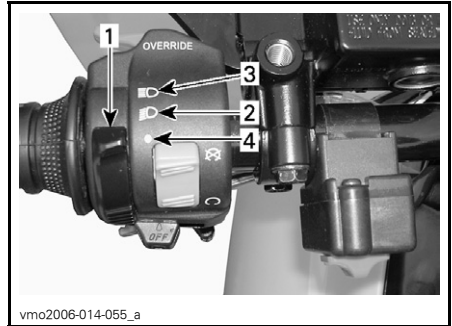

1. Headlamp switch
2. Low beam position
3. High beam position
4. OFF position

### **Engine Stop Switch**

Located on top of multi-function switch.

**NOTE:** The engine will not turn if the engine stop switch is turned to OFF position.

This switch can be used to stop engine and as an emergency control.

**NOTE:** While engine can be stopped by turning ignition key to OFF position, we recommend the engine be stopped by the engine stop switch.

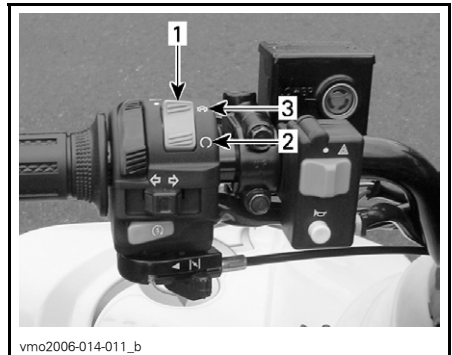

1. Engine stop switch
2. RUN position
3. OFF position

## Engine Start Button

To start engine: depress and hold the start button, release immediately after engine is started.



1. Engine start button

To stop engine: fully release throttle lever then use the engine stop switch.

## Override Button

Located in front of multi-function switch.



1. Override button

This button is used to override the reverse speed limiter system and while power backing up. To do this, squeeze and hold the override button then activate the throttle lever. Release the button when the maneuver is completed.

## WARNING

Never activate the override button while throttle is open as loss of control may result, causing severe personal injury or death.

## Direction Indicator Switch

To activate the direction indicator lamps, push the switch button on the right side or the left side, depending which direction you picked. Push on switch button to reset when the turn is completed.



1. Direction indicator switch

## Choke Lever

Located at bottom of multi-function switch. This device features a variable lever to ease cold start.

Position OFF is for normal use with a warm engine.



vmo2006-014-025

**TYPICAL — CHOKE LEVER IN THE OFF POSITION**

The full choke position is used for low-engine temperature.



vmo2006-014-026

**TYPICAL — CHOKE LEVER IN THE FULL CHOKE POSITION**

The other positions between OFF and FULL position, will be use depending on the engine temperature.

## 7) Indicator Lamps



vmo2006-014-027

### High intensity (Blue)



When this indicator light is on, it indicates HIGH BEAM is selected on the headlamps.

### Engine Temperature/Oil Pressure Lamp (red)



This light turns on when the ignition switch is turned ON and remains on until engine is running. When this indicator light is ON, it indicates the engine is overheating. If engine overheats, refer to *ENGINE OVERHEAT* in *SPECIAL PROCEDURES*.

### Forward Lamp (blue)



When lit, it indicates the transmission is in forward position.

### Reverse Lamp (red)



When lit, it indicates the transmission is in reverse position.

### Neutral Lamp (green)



When lit, it indicates the transmission is in neutral position.

### Direction Indicator (green)



When the indicator light blinks, it indicates which direction indicator, left or right, is in operation.

## 8) Ignition Switch

Key-operated, 2-position switch: OFF, ON.

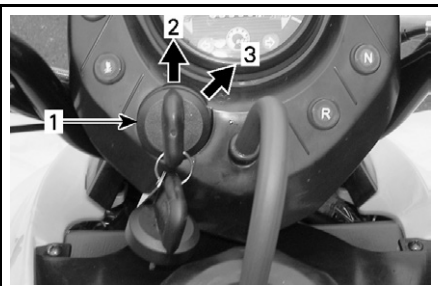

vmo2006-014-029\_a

**TYPICAL**

1. Ignition switch
2. OFF position
3. ON position (position light on)

Insert key in switch and turn to ON position. To remove key, turn key to OFF then pull it out.

Remember that having the lights on (headlamps and/or position light) without the engine running discharges the battery. Always turn ignition to OFF after engine has been stopped.

**NOTE:** While engine can be stopped by turning ignition key OFF, we recommend the engine be stopped by the engine stop switch.

## 9) Fuel Tank Cap

Unscrew counterclockwise and remove cap to allow fuel tank filling then fully tighten clockwise.

**NOTE:** Ensure that vent tube is properly installed.

## ⚠ WARNING

Always stop engine before refueling. Open cap slowly. If a differential pressure condition is noticed (whistling sound heard when loosening fuel tank cap) have vehicle inspected and/or repaired before further operation. Fuel is flammable and explosive under certain conditions. Never use an open flame to check fuel level. Never smoke or allow flame or spark in vicinity. Always work in a well-ventilated area. Never top up the fuel tank before placing the vehicle in a warm area. As temperature increases, fuel expands and may overflow. Always wipe off any fuel spillage from the vehicle.

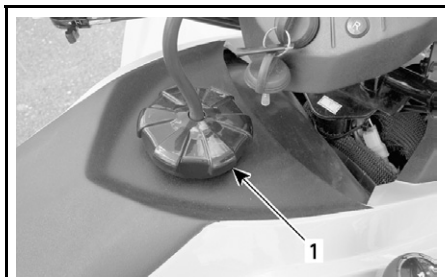

vmo2006-014-012\_a

**TYPICAL**

1. Fuel tank cap

## 10) Fuel Valve

Located on right side of vehicle under seat. 3-position rotary valve: OFF, ON, RES. Rotate the tap to align its pointer with ON, OFF or RES.

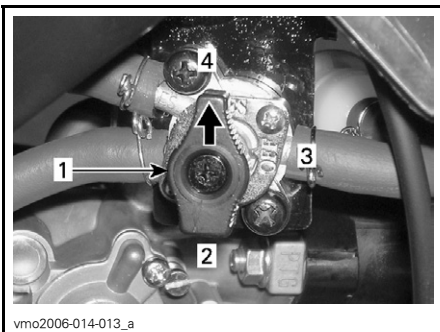

vmo2006-014-013\_a

1. Align the pointer toward the desired position
2. ON position
3. OFF position
4. RES position

## OFF

Stops fuel supply to carburetor.

**CAUTION:** Turn valve to OFF position when ATV is not being operated or when transporting.

## ON

Allows fuel to flow to carburetor. This is the normal position for operation of the vehicle.

## RES (RESERVE)

When fuel is exhausted in the fuel tank when in the ON position, an emergency supply of fuel is available by turning the tab to RES. The reserve contains approximately 10% of the fuel tank capacity. Use only this position when the ON supply is empty.

When down to the reserve, refuel as soon as possible. Ensure to turn the valve back to the ON position after refuelling.

**CAUTION:** Improper opening of fuel valve will restrict the flow of fuel. Make sure valve is fully opened while running.

## 11) Front/Rear Brake Pedal

Located in front of the right footpeg. When pressed down, both front and rear brakes are applied. When released, it should return to its original position. Braking effect is proportional to the force applied on the pedal and to the type and condition of the terrain.

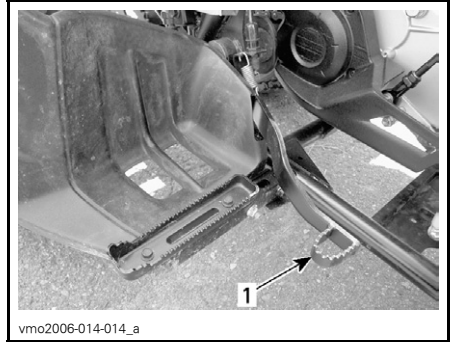

vmo2006-014-014\_a

1. Front/rear brake pedal

## 12) Footpeg

Use this area to maintain your feet stable.

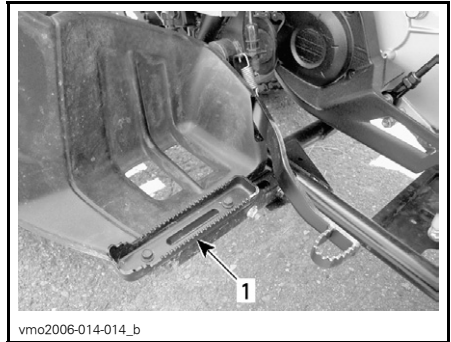

vmo2006-014-014\_b

1. Footpeg

## 13) Tool Kit

The tool kit is located in the service compartment underneath the seat.



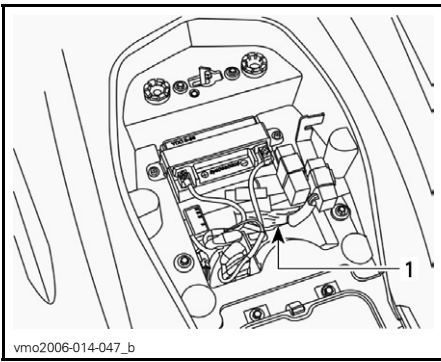

vmo2006-014-047\_b

1. Tool kit

The fuse holder is located in the service compartment underneath the seat.

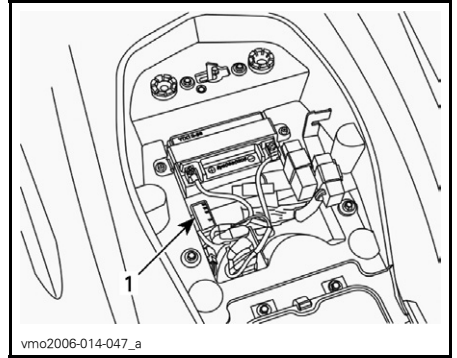

vmo2006-014-047\_a

1. Fuse holder

## 14) Radiator Cap

Located under front access cover. It provides access to the radiator filling neck.

### WARNING

In order to avoid potential burns, do not remove the radiator cap if the engine is hot.

Turn radiator cap counterclockwise to remove. When finished, properly reinstall radiator cap and access cover.

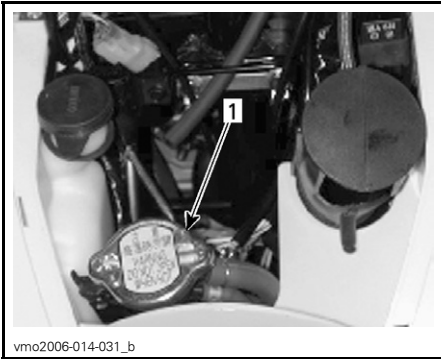

vmo2006-014-031\_b

1. Radiator cap

## 16) Vehicle Lock

The vehicle lock is located on the steering stem directly below the steering head.

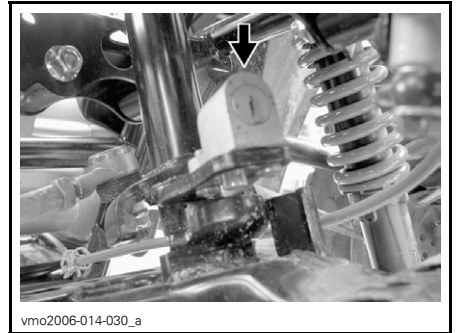

vmo2006-014-030\_a

VEHICLE LOCK

- Turn the handlebar fully to the left.
- Insert the ignition switch key into the lock.
- Turn the key clockwise to lock the handlebar.
- Remove the ignition switch key.
- When unlocking, simply turn the key counterclockwise.

## 15) Fuse

The electrical system is protected with fuses. Refer to *MAINTENANCE* section for details.

- NOTE:** – As a safety precaution, or for theft prevention, lock the handlebar when parked.
- Once locked, turn the handlebar on both sides to make sure it is properly locked.
  - When leaving the vehicle, remember to remove the key.

## 17) Horn Button

This button is located on the multifunction switch housing.

To activate horn, press the button. Release immediately after horn is set off.

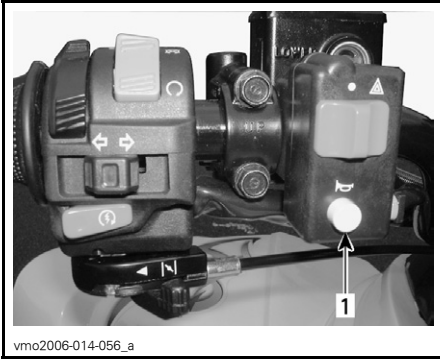

1. Horn button

## 18) Hazard Warning Switch

Device fitted to the vehicle that operates a simultaneous flashing of all direction indicators, used when the vehicle is stationary to indicate that the vehicle is temporarily obstructing traffic.



1. Hazard warning switch

**To activate:** turn the ignition switch ON and use the toggle warning switch.

**NOTE:** Once hazards lights are turned on, ignition switch can be turned OFF and key removed.

**To deactivate (ignition switch in ON position):** use the toggle warning switch.

**(ignition switch in OFF position):** turn the ignition switch ON and use the toggle warning switch.

**NOTE:** Having the hazard lights on (even with the ignition switch in OFF position) for a long period of time without the engine running will discharge the battery.

## 19) Seat Latch

Located underneath the rear fender, it allows the removal of the seat to gain access to the service compartment.

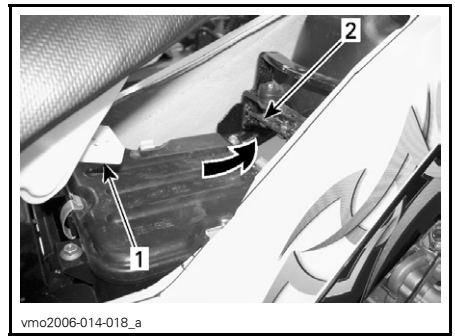
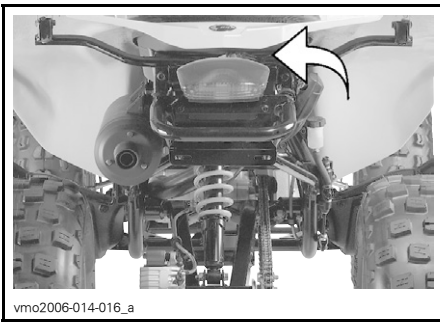

1. Tab
2. Hook

## Seat Removal

Unlock seat using latch lever.  
Gently lift rear of seat while pulling rearward to release.



1. Seat latch

## Seat Installation

Insert seat tab into frame hook.  
When seat rests in its position, firmly push seat down to latch.

**NOTE:** A distinctive snap will be felt. Double check that the seat is secure by giving it a tug to confirm proper latching.

**⚠ WARNING**

Make sure seat is securely latched before riding.

## 20) 12-Volt Power Outlet

Convenient for handheld spotlight or other portable equipment.  
Remove protective cap to use. Always reinstall it after use to protect against weather.

Do not exceed the rating capacity. See *SPECIFICATIONS*.

An auxiliary supply is available to connect additional accessories. Two wires are hidden in the wiring harness at the rear of vehicle. See an authorized Bombardier ATV distributor/dealer for more details.

## 21) Speedometer

This vehicle is equipped with a speedometer. It indicates the speed of the vehicle in MPH and km/h.

The speedometer is backlit when the ignition switch is turned ON.

## Odometer

Odometer records the total distance traveled in kilometers.

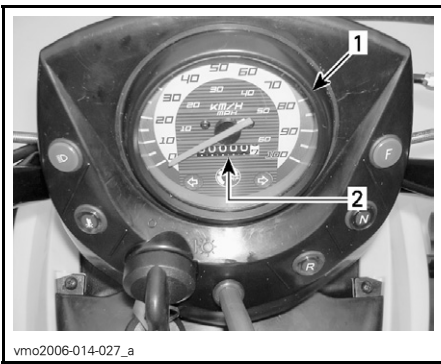

1. Speedometer
2. Odometer

# LIQUIDS

While reading this Operator's Guide, remember that:

## **WARNING**

Indicates a potential hazard that, if not avoided, could result in serious injury or death.

**NOTE:** This section specifies the recommended liquids and procedures to check their levels. Refer to *MAINTENANCE* for procedures to replace the liquids.

## **Fuel**

### **Recommended Fuel**

Use regular unleaded gasoline, available from most service stations or oxygenated fuel containing a maximum total of 10% of ethanol or methanol or both. The gasoline used must have the following recommended minimum octane number.

OCTANE NUMBER
92 RON

**CAUTION:** Never experiment with other fuels. The use of unrecommended fuel can result in vehicle performance deterioration and damage to critical parts in the fuel system and engine components.

**CAUTION:** Never mix oil with fuel. This ATV has a 4-stroke engine. Oil must be added to engine base only.

## **Fuel Level**

### **WARNING**

Always stop engine before refueling. Open cap slowly. If a differential pressure condition is noticed (whistling sound heard when loosening fuel tank cap) have vehicle inspected and/or repaired before further operation. Fuel is flammable and explosive under certain conditions. Never use an open flame to check fuel level. Never smoke or allow flame or spark in vicinity. Always work in a well-ventilated area. Never top up the fuel tank before placing the vehicle in a warm area. As temperature increases, fuel expands and may overflow. Always wipe off any fuel or oil spillage from the vehicle.

## **Engine Oil**

### **Recommended Oil**

Use 4-stroke engine oil that meets or exceeds the requirements for API service classification SM, SL or SJ. Always check the API service label on the oil container to be sure it includes the letters SM, SL or SJ. Only use high-quality high-detergent oil.

**NOTE:** For improved overall performance and wear protection use XP-S 5W40 synthetic 4-stroke oil (P/N 293 600 039).

## Oil Viscosity

SAE 10W30 or XP-S 10W40 4-stroke oil (P/N 219 700 346) is recommended for all seasons.

However, during the hottest days of the summer and bitter cold days of the winter, refer to the following chart to select the proper viscosity.

**NOTE:** For improved overall performance and wear protection use XP-S 5W40 synthetic 4-stroke oil (P/N 293 600 039).

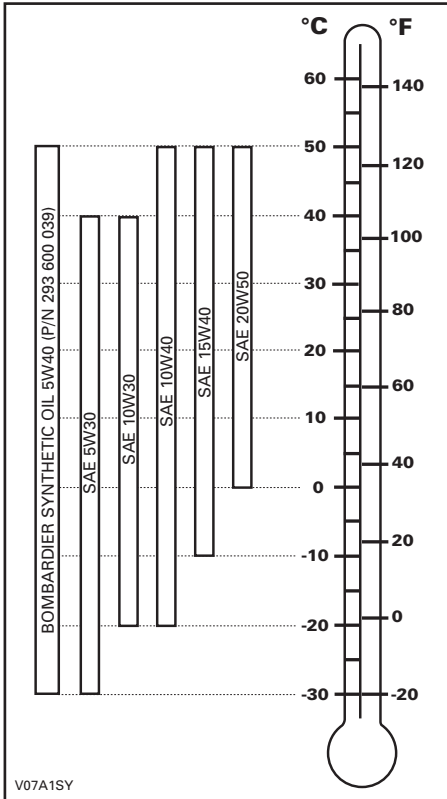

## Oil Level

**CAUTION:** Check level frequently and refill if necessary. Do not overfill. Operating the engine with an improper level may severely damage engine. Wipe off any spillage.

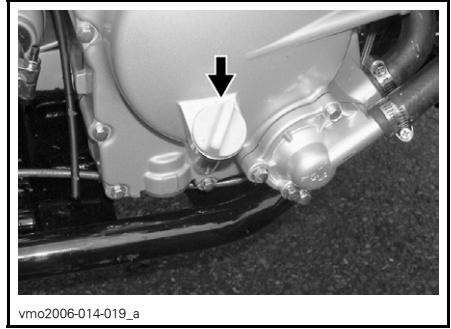

*RH SIDE OF ENGINE*

With vehicle on a level surface and engine cold, not running, check the oil level as follows:

1. Unscrew dipstick then remove it and wipe clean.
2. Reinstall dipstick (do not screw it in).
3. Remove and check oil level. It should be near or equal to the upper mark.

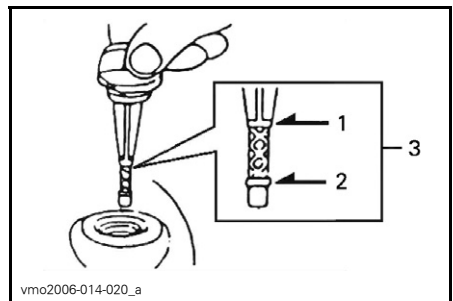

1. Full
2. Add
3. Operating range

To add oil, remove dipstick.

Place a funnel into the dipstick tube to avoid spillage.

Add a small amount of recommended oil and recheck oil level.

Repeat the operation until oil level reaches the dipstick's full mark. **Do not overfill.**

Properly tighten dipstick.

## Gearbox Oil

### Recommended Oil

Use XP-S chaincase oil (P/N 413 801 900) or an equivalent.

**CAUTION:** Do not use unrecommended other types of oil when servicing. Do not mix with other types of oil.

### Gearbox Oil Level

See an authorized Bombardier ATV distributor/dealer.

### Gearbox Oil Replacement

To change gearbox oil, refer to *MAINTENANCE* section.

## Engine Coolant

### Recommended Coolant

Always use ethylene-glycol antifreeze containing corrosion inhibitors specifically for internal combustion aluminum engines.

Cooling system must be filled with Bombardier premixed coolant (P/N 219 700 362) or with distilled water and antifreeze solution (50% water, 50% antifreeze).

### Coolant Level

Coolant reservoir is located underneath RH front fender.

## **WARNING**

Check coolant level with engine cold. Never add coolant in cooling system when engine is hot.

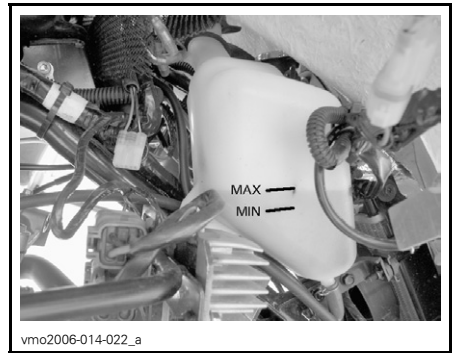

### COOLANT LEVEL

With vehicle on a level surface, liquid should be between MIN. and MAX. level marks of coolant reservoir.

**NOTE:** When checking level at temperature lower than 20°C (68°F), it may be slightly lower than MIN. mark.

To gain access to coolant reservoir, remove front fender access cover.

Pull on upper portion of cover to remove tab from rubber grommets.

Pull cover downward to release lower tabs from front fender.

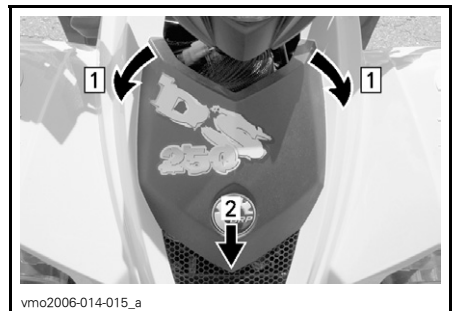

Step 1: Pull front tab from grommets  
Step 2: Pull cover downward to release

Add coolant up to MAX. mark if required. Use a funnel to avoid spillage. **Do not overfill.**

Properly reinstall and tighten filler cap. Reinstall front fender access cover.

If the coolant is added in the coolant reservoir, check the level in the radiator too. Add coolant if necessary.

## **⚠ WARNING**

**In order to avoid potential burns, do not remove the radiator cap if the engine is hot.**

**NOTE:** A cooling system that frequently requires coolant is the indication of leaks or engine problems. See an authorized Bombardier ATV distributor/dealer.

To gain access to the radiator, remove front fender access cover (see procedure above).

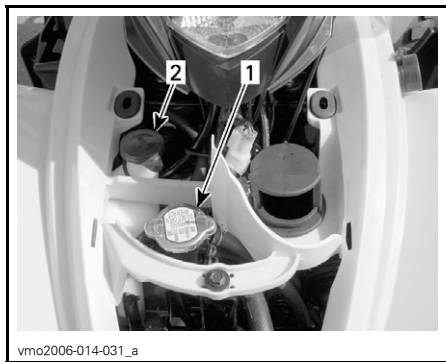

### **TYPICAL**

1. Radiator cap
2. Coolant reservoir cap

## **Coolant Replacement**

Refer to *MAINTENANCE* section.

## **Brake Fluid**

### **Recommended Fluid**

Always use brake fluid meeting the specification DOT 4 only.

**CAUTION:** To avoid serious damage to the braking system, do not use fluids other than the recommended one, nor mix different fluids for topping up.

### **Fluid Level**

With vehicle on a level surface, check brake fluid in reservoir for proper level. It should be above MIN. mark.

Add fluid as required. **Do not overfill.** Clean filler cap before removing.

**CAUTION:** Use only DOT 4 brake fluid from a sealed container. Do not use brake fluid taken from old or already opened containers.

**NOTE:** A low level may indicate leaks or worn brake pads. See an authorized Bombardier ATV distributor/dealer.

### **Handlebar Fluid Reservoirs**

Turn handlebar in the straight-ahead position to ensure reservoirs are leveled. Check the brake fluid level, the reservoir is full when the fluid reaches of the top of window.

Visually inspect lever boot condition. Check for cracks, tears, etc. Replace if damaged.



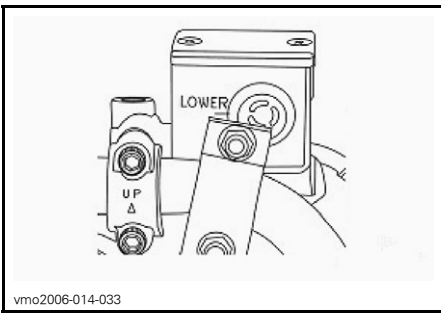

*TYPICAL*

## Rear Fluid Reservoir

With vehicle on a level surface, brake fluid should be between MIN. and MAX. level marks.

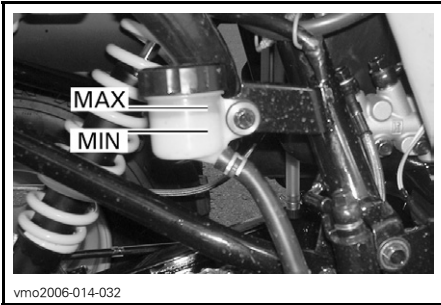

*UNDERNEATH RH REAR FENDER*

## Battery

This vehicle is equipped with a dry type battery that requires no maintenance.

**NOTE:** Refer to *MAINTENANCE* for removal and installation procedures.

---

# BREAK-IN PERIOD

## Engine

A break-in period of 10 operating hours is required before running the vehicle at sustained full throttle.

**CAUTION:** Never mix oil with fuel. This vehicle has a 4-stroke engine.

During this period, maximum throttle should not exceed  $\frac{3}{4}$ . However, brief full acceleration and speed variations contribute to a good break-in. Continued wide open throttle accelerations, prolonged cruising speeds and engine overheating are detrimental during the break-in period.

## Belt

A new belt requires a break-in period of 50 km (30 mi). Avoid strong acceleration/deceleration, pulling a load or high speed cruising.

## 10-Hour Inspection

**NOTE:** The 10-hour inspection is at the expense of the vehicle owner.

As with any precision piece of mechanical equipment, we suggest that after the first 10 hours, 200 km (125 mi) or 30 days after the purchase, whichever comes first, your vehicle be inspected by an authorized Bombardier ATV distributor/dealer. This inspection will give you the opportunity to discuss the unanswered questions you may have encountered during the first hours of operation.

While reading this Operator's Guide, remember that:

### **WARNING**

Indicates a potential hazard that, if not avoided, could result in serious injury or death.

# OPERATING INSTRUCTIONS

## General

Transmission lever must be on NEUTRAL and brakes applied (front or rear) to allow engine starting.

To start engine, place the engine stop switch to RUN position, insert key in ignition switch and turn to ON then press start button.

## Pre-Operation Check

### WARNING

The pre-operation check is very important prior to operating the vehicle. Always check the proper operation of critical controls, safety features and mechanical components before starting. If not done as specified here, severe injury or death might occur.

Before using this vehicle, the operator should always:

- Apply parking brake and check if it operates properly.
- Check tire pressure and condition.
- Check wheels and bearings for wear and damage.
- Check location of controls and ensure they work properly.
- Verify if steering operates freely.
- Activate throttle control lever several times to ensure it operates freely. It must return to idle position when released.
- Activate the brake levers and brake pedal to make sure the brakes fully apply. Levers and pedal must fully return when released.
- Ensure transmission lever is working then reset in NEUTRAL position.
- Check drive chain for adjustment and lubrication.

- Check sprockets for wear and damages.
- Check tightening of rear axle fasteners.
- Check swing arm, if any lateral play is detected **DO NOT USE THE VEHICLE**.
- Check fuel, oil and coolant levels.
- Check for oil leaks on the engine and the transmission.
- Ensure fuel valve is in fully open position (ON).
- Clean headlamps and taillight.
- Ensure seat is properly tightened.
- If you transport cargo, respect load capacity. Ensure cargo is properly secured to the racks.
- If you are pulling a trailer or other equipment, ensure it respects the tongue capacity and towing capacity. Ensure trailer is properly secured to hitch.
- Look and feel for loose parts while engine is off. Check fasteners.
- Ensure the path of travel is free of persons and obstacles.
- Check operation of ignition switch, start button, engine stop switch and headlamps.
- Start engine, remove parking brake and drive forward slowly a few feet then apply all brakes individually to test them.

**Correct any problem you may have found before riding. See an authorized Bombardier ATV distributor/dealer as necessary.**

## Initial Cold Starting

Insert key in ignition switch and turn to ON.

**NOTE:** Do not forget, place the engine stop switch to RUN position and apply brakes (front or rear).

In cold weather, colder than 0°C (32°F), place the choke lever to full choke position.

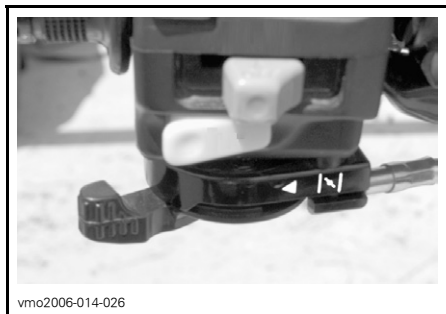

vmo2006-014-026

#### **FULL CHOKE POSITION**

Press start button and hold until engine starts.

**CAUTION:** Do not hold start button more than 20 seconds. A rest period should be observed between the cranking cycles to let starter cool down. Pay attention not to discharge battery.

**NOTE:** Throttle assist may be used to help engine starting faster. Press the throttle lever slightly. If too much throttle is used the choke system will not be activated.

Release start button immediately when engine has started.

After a few seconds, move the choke lever from full choke position to an intermediate position until the best engine RPM is achieved.

**NOTE:** Overusing choke may flood engine and make it hard to start. Refer to *SPECIAL PROCEDURES* if it occurs.

When the engine is warm, push the choke lever to OFF and release brakes.

## **Warm Engine Starting**

Start the engine as explained above but without the choke. If the engine does not start after two 5-second attempts with the electric starter, move the choke lever and place it half way position. Start the engine without activating the throttle lever. After a few seconds, push the choke lever to OFF.

## **Stopping the Engine**

### **⚠ WARNING**

**Avoid parking vehicle on slope.**

Release throttle and completely stop the vehicle.

Apply the parking brake.

Set transmission lever in FORWARD position.

Push the engine stop switch in OFF position.

Turn key in ignition switch to OFF position.

Remove key from ignition switch.

## **Shifting the Transmission**

Let engine idle to warm up.

Apply brakes and select the gear range F.

Release brakes.

**CAUTION:** Make sure parking brake is fully disengaged before operating the ATV.

Gradually press the throttle lever to increase engine speed and thus engaging the continuously variable transmission (CVT).

At the opposite, when the throttle lever is released, the engine speed decreases.

**NOTE:** Engine will stop if any shifting is done at high RPM.

## Using the Reverse

**CAUTION:** When changing from forward to reverse, or vice-versa, always completely stop the vehicle and apply the brake prior to moving the transmission lever.

The same procedures as *SHIFTING THE TRANSMISSION* above apply except for the following.

Set the transmission lever in REVERSE position.

# SPECIAL PROCEDURES

## Flooded Engine

When the engine does not start after several attempts, the engine may be fuel flooded. Proceed as follows.

Turn ignition switch to ON and ensure choke is not applied.

Ensure the transmission lever is on NEUTRAL position.

Fully press throttle lever and hold while starting the engine.

As soon as the engine starts, release throttle lever. Do not race engine.

### If it does not work:

Clean the spark plug cap area then remove it. Remove the spark plug (tools are supplied in tool kit).

### **⚠ WARNING**

Always wear eye protector and gloves when the spark plug hole is cleaned.

Crank engine several times. Install new spark plug if possible or clean and dry spark plug.

Start engine as explained above. If engine continues to flood, see an authorized Bombardier ATV distributor/dealer.

**NOTE:** Make sure to verify that there is no fuel in engine oil, if so, replace engine oil.

## Engine Overheat

If engine overheats and indicator light turns on, try the following:

- Check and clean radiator fins. See *MAINTENANCE* section.

### **⚠ WARNING**

The radiator can be very hot, wear gloves before touching radiator.

- Reduce vehicle speed but try to keep vehicle moving to supply air to radiator. If engine is still overheating after approximately one minute, stop vehicle and set transmission to NEUTRAL and apply parking brake. Stop engine.
- Let engine cool down. Check coolant level and refill if possible.

### **⚠ WARNING**

In order to avoid potential burns, do not remove the radiator cap or refill cooling system when engine is hot.

- Restart the engine, if the light does not turn off right after engine starting, stop engine and disconnect the temperature sensor.

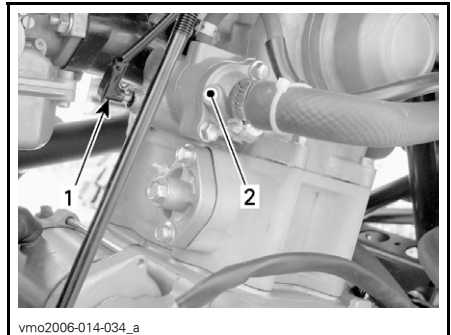

vmo2006-014-034\_a

1. Temperature sensor
2. Thermostat housing

Restart engine. If the light turn off and the engine is cold or warm, not hot, a potential problem with the sensor or engine part is possible. Use the vehicle as little as possible and see an authorized Bombardier ATV distributor/dealer as soon as possible.

## Post-Operation Care

When vehicle is used in salt-water environment (beach area, launching/loading boats etc.), rinsing the vehicle with fresh water is necessary to preserve vehicle and its components. Metallic parts lubrication is highly recommended. Use BOMBARDIER LUBE (P/N 293 600 016) or an equivalent. This must be performed at the end of each operating day.

When vehicle is operated in muddy conditions, rinsing the vehicle is recommended to preserve vehicle and its components and to keep lights clean.

**NOTE:** Never use a high pressure washer to clean the vehicle **USE LOW PRESSURE ONLY** (like a garden hose). The high pressure can cause electrical or mechanical damages.

## Turn Over

When vehicle is turned over or stays tilted on the side, replace the vehicle in its normal operating position (on all four wheels) and wait 3 to 5 minutes before starting engine. Before starting engine, check engine oil and coolant levels and refill if necessary.

## ATV Immersion

Should the ATV become immersed, it will be necessary to take it to an authorized Bombardier ATV distributor/dealer as soon as possible. **DO NOT START THE ENGINE!** Immersion of the ATV can cause serious damage if the correct restart procedure is not followed.

## Storage and Preseason Preparation

### **WARNING**

Have an authorized Bombardier ATV distributor/dealer inspect fuel system integrity as specified in *MAINTENANCE CHART*.

When a vehicle is not in use for more than one month, proper storage is a necessity.

See an authorized Bombardier ATV distributor/dealer for proper procedures.

When using your ATV after storage, a preparation is required. See an authorized Bombardier ATV distributor/dealer for proper procedures.

# CARGO AND TRANSPORTATION

While reading this Operator's Guide, remember that:

## WARNING

Indicates a potential hazard that, if not avoided, could result in serious injury or death.

## Cargo

## WARNING

If your vehicle is equipped to carry loads with optional racks and/or trailer hitch approved by BRP, vehicle handling, stability and braking distance will be affected. Correct loading and weight distribution are therefore important. Never overload, tow or carry cargo improperly. Always ensure the cargo is safely secured and properly distributed on the rack(s) before operating the vehicle. Safely reduce speed according to terrain conditions when carrying cargo or pulling a trailer. Allow greater distance for braking. Always secure cargo as low as possible on the rack(s) to reduce the effect of a higher center of gravity. Failure to follow the recommendations here could cause changes in vehicle handling which could lead to an accident resulting in severe injuries including the possibility of death.

When carrying cargo on the vehicle, respect these maximum loads.

MAXIMUM LOADS		
Total load allowed	150 kg (330 lb)	Includes operator, all other loads and added accessories.

## Transportation

When transporting a vehicle, secure vehicle to trailer or in pickup box with suitable tie-downs. Using ordinary ropes is not recommended.

## WARNING



V00A174

Never tip this vehicle on end for transporting. We recommend that you carry the vehicle in its normal operating position (on all 4 wheels).

- Place the fuel valve to OFF position.
- Select the FORWARD position and set the parking brake to ON position.
- Secure the vehicle by the front and rear bumpers.



**CAUTION:** Attaching vehicle at other locations may damage the vehicle.

### Front Location



vmo2006-014-063\_a

*FRONT BUMPER STRAP LOCATIONS*

### Rear Location



vmo2006-014-064\_a

*REAR BUMPER STRAP LOCATION*

## **WARNING**

Do not tow this vehicle behind a car or other vehicle. Use a trailer.

---

# TROUBLESHOOTING

---

## ENGINE DOES NOT TURN

---

- 1. Ignition switch is in the OFF position.**
  - *Place switch to the ON position.*
- 2. Engine stop switch**
  - *Make sure that the engine stop switch is in ON position.*
- 3. Transmission is not set on NEUTRAL.**
  - *Set transmission in NEUTRAL and apply brakes (front or rear).*
- 4. Brakes are not applied**
  - *Apply brakes (front or rear) and set transmission in NEUTRAL.*
- 5. Burnt fuse.**
  - *Check main fuse condition.*
- 6. Weak battery or loose connections.**
  - *Check charging system fuse.*
  - *Check connections and terminals condition.*
  - *Have the battery checked.*
  - *Contact an authorized Bombardier ATV distributor/dealer.*

---

## ENGINE TURNS OVER BUT FAILS TO START

---

- 1. Mixture not rich enough to start cold engine.**
  - *Check fuel tank level and check starting procedure, particularly use of the choke.*
- 2. Flooded engine (spark plug wet when removed).**
  - *Refer to SPECIAL PROCEDURES.*
- 3. No fuel to the engine (spark plug dry when removed).**
  - *Check fuel tank level; turn fuel valve to ON (also try on RES). A failure of the fuel pump or carburetor may have occurred.*
  - *Contact an authorized Bombardier ATV distributor/dealer.*
- 4. Spark plug/ignition (no spark).**
  - *Check main fuse condition.*
  - *Remove spark plug then reconnect to spark plug cap.*
  - *Check that ignition switch and/or engine stop switch is/are at the ON position.*
  - *Start engine with spark plug grounded to the engine away from spark plug hole. If no spark appears, replace spark plug.*
  - *If trouble persists, contact an authorized Bombardier ATV distributor/dealer.*

## **ENGINE TURNS OVER BUT FAILS TO START (cont'd)**

---

### **5. Engine compression.**

- *If no pulsating resistance is felt, it suggests a major loss of compression.*
- *Contact an authorized Bombardier ATV distributor/dealer.*

## **ENGINE LACKS ACCELERATION OR POWER**

---

### **1. Fouled or damaged spark plug.**

- *Check item ENGINE TURNS OVER BUT FAILS TO START.*

### **2. Lack of fuel to engine.**

- *Check item ENGINE TURNS OVER BUT FAILS TO START.*

### **3. Carburetor adjustments.**

- *Contact an authorized Bombardier ATV distributor/dealer.*

### **4. Engine is overheating.**

- *Check ENGINE OVERHEATING in SPECIAL PROCEDURES.*
- *If overheating persists, contact an authorized Bombardier ATV distributor/dealer.*

### **5. Air filter/box plugged or dirty.**

- *Check air filter and clean if necessary.*
- *Check deposits in air box drain.*
- *Check the position of the air intake tube.*

### **6. CVT dirty or worn-out.**

- *Contact an authorized Bombardier ATV distributor/dealer.*

### **7. Parking brake is applied**

- *Disengage parking brake.*

### **8. Improper valves adjustment**

- *Contact an authorized Bombardier ATV distributor/dealer.*

## **ENGINE BACKFIRE**

---

### **1. Exhaust system leakage.**

- *Contact an authorized Bombardier ATV distributor/dealer.*

### **2. Engine is running too hot.**

- *See ENGINE LACKS ACCELERATION OR POWER.*

### **3. Ignition timing is incorrect or there is an ignition system failure.**

- *Contact an authorized Bombardier ATV distributor/dealer.*

### **4. Improper carburetor setting.**

- *Contact an authorized Bombardier ATV distributor/dealer.*

### **5. Fouled/damaged/worn spark plug.**

- *Clean/verify spark plug and heat range. Replace as required.*

## **ENGINE BACKFIRE (cont'd)**

---

### **6. Antipollution system failed**

- *Contact an authorized Bombardier ATV distributor/dealer.*

## **ENGINE MISFIRE**

---

### **1. Fouled/damaged/worn spark plug.**

- *Clean/verify spark plug and heat range. Replace as required.*

### **2. Water in fuel.**

- *Drain fuel system and refill with fresh fuel.*

## **UNUSUAL ENGINE NOISE**

---

### **1. Valve adjustment.**

- *Contact an authorized Bombardier ATV distributor/dealer.*

### **2. Chain tensioner plugged.**

- *Contact an authorized Bombardier ATV distributor/dealer.*

### **3. Timing chain wear.**

- *Contact an authorized Bombardier ATV distributor/dealer.*

### **4. CVT contamination**

- *Contact an authorized Bombardier ATV distributor/dealer.*

## **VEHICLE CANNOT REACH FULL SPEED**

---

### **1. Engine.**

- *See ENGINE LACKS ACCELERATION OR POWER.*

### **2. Parking brake.**

- *Ensure parking brake is completely removed.*

### **3. Air filter/box plugged or dirty.**

- *Check air filter and clean if necessary.*
- *Check deposits in air box drain.*
- *Check the position of the air intake tube.*

### **4. CVT dirty or worn-out.**

- *Contact an authorized Bombardier ATV distributor/dealer.*

## **TRANSMISSION LEVER IS HARD TO MOVE**

---

### **1. Transmission gears are in a position that prevents the transmission lever to work.**

- *Rock the vehicle back and forth to move the gears in the transmission and allow the transmission lever to be set.*

### **2. Engine idle speed is set too high.**

- *Adjust the idle speed. Refer to the SPECIFICATIONS.*

## **TRANSMISSION LEVER IS HARD TO MOVE (cont'd)**

---

### **3. CVT dirty or worn-out.**

- *Contact an authorized Bombardier ATV distributor/dealer.*

## **THE RPM INCREASES BUT THE VEHICLE DOES NOT MOVE**

---

### **1. The transmission is in NEUTRAL position.**

- *Set transmission in REVERSE or FORWARD.*

### **2. CVT dirty or worn-out.**

- *Contact an authorized Bombardier ATV distributor/dealer.*

### **3. Water in the CVT housing.**

- *Contact an authorized Bombardier ATV distributor/dealer.*

# SPECIFICATIONS

<b>VEHICLE MODEL</b>	<b>DS250</b>	
<b>ENGINE</b>		
Type	4 stroke. Single overhead camshaft engine, liquid cooled.	
Number of cylinder	Single cylinder	
Number of valves	4 valves with mechanical lifters (adjustable)	
Displacement	249.4 cc (15.22 cu. in)	
Bore	71 mm (2.8 in)	
Stroke	63 mm (2.5 in)	
Starting system	Electric starter	
Compression ratio	10.6:1	
Lubrication	Forced circulation and splashing	
Air filter	Sponge wet type	
<b>TRANSMISSION</b>		
Transmission	Continuously Variable Transmission (CVT)	
<b>COOLING</b>		
Type	Liquid cooled	
Radiator	Front mounted	
<b>CARBURETION</b>		
Carburetor	Type	Kehin PTG 23 with manual choke
Choke		Variable
Idle speed	± 100	1700 RPM

VEHICLE MODEL		DS250
<b>ELECTRICAL</b>		
Magneto generator	Type	338 W @ 5000 RPM
Ignition type		CDI (Capacitor Discharge Ignition)
Ignition timing		Not adjustable
Spark plug	Make	NGK
	Type	CR8E
	Gap	0.8 mm (.031 in)
Number of spark plug		1
Battery	Type	Dry type battery
	Volt	12 volts, 10 Ah (Ampere hour)
Starting system		Electric start
Headlamp bulb		2 x 35 W
Taillight bulb		1 x 5/21 W
Turn signal light bulb		4 x 21 W
Indicator lamps		1.7 W
Fuses	Fan motor	10 A
	Headlamps	15 A
	Other lamps	15 A
	Main fuse	30 A
<b>DRIVE TRAIN</b>		
Rear axle		Chain driven/solid axle
Turning radius		3.5 m (138 in) at low speed
<b>SUSPENSION</b>		
Front	Type	Independent suspension — double A-arm, 2 shock absorbers (oil)
	Travel	140 mm (5.5 in)
Rear	Type	Rigid swing-arm, 1 shock absorber (oil)
	Travel	170 mm (6.7 in)
<b>TIRES</b>		
Pressure	Front	34 kPa (5.0 PSI) maximum 26 kPa (3.8 PSI) minimum
	Rear	
Size	Front	22 x 7-10
	Rear	20 x 11-9

VEHICLE MODEL		DS250
<b>WHEELS</b>		
Size	Front	AT 10 x 5.5
	Rear	AT 9 x 8
Wheel nuts torque		50 N•m (37 lbf•ft)
<b>BRAKES</b>		
Front		Hydraulic, 2 discs
Rear		Hydraulic, 1 disc
Parking device		Seperate RH lock lever on handlebar.
<b>LOADING CAPACITY</b>		
Total vehicle load allowed		150 kg (330 lb) includes operator, all other loads and added accessories.
<b>DIMENSIONS</b>		
Dry mass		195 kg (429 lb)
Overall length		1.830 m (72 in)
Overall width		1.030 m (40.5 in)
Overall height		1.105 m (43.5 in)
Seat height		800 mm (31.5 in)
Wheel base		1.187 m (47 in)
Ground clearance	Center of ATV	260 mm (10.2 in)



VEHICLE MODEL		DS250
<b>LIQUIDS and GREASES</b>		
Engine oil type		SAE 4-stroke mineral-based. API classification SM, SL or SJ or XP-S 5W40 synthetic 4-stroke oil. Refer to <i>OIL VISCOSITY CHART</i> for other grade
Gearbox oil		85W-140 or XP-S chaincase oil
Coolant		Ethylene-glycol/water mix (50% coolant, 50% distilled water). Use BRP premixed coolant or a coolant specially designed for aluminum engines
Fuel	Type	Regular unleaded gasoline
	Octane	92 RON or higher
Brake		Brake fluid, DOT 4
<b>CAPACITIES</b>		
Fuel tank		12 L (3.2 U.S. gal)
Engine		1.4 L (1.48 U.S. quarts) Oil change: 1.2 L (1.27 U.S. quarts)
Gearbox oil		Oil change: 800 mL (27 U.S. oz.)
Coolant		850 mL (28.7 U.S. quarts) (engine and radiator)

A: Ampere

RPM: Revolution Per Minute

W: Watt

Because of our ongoing commitment to product quality and innovation, BRP reserves the right, at any time, to make changes in design and specifications and/or to make additions to, or improvements in its products without imposing any obligation upon itself to install them on its products previously manufactured.



# ***MAINTENANCE INFORMATION***

# MAINTENANCE CHART

The maintenance is very important, if you are not familiar with safe service practices and adjustment procedures, see your authorized Bombardier ATV distributor/dealer.

PERIODIC MAINTENANCE CHART						
A: ADJUST C: CLEAN I: INSPECT L: LUBRICATE R: REPLACE T: PROCEED WITH TASK	INITIAL INSPECTION 10 H OR 30 DAYS OR 200 KM (125 mi)					
	(To be performed by an authorized Bombardier ATV dealer. The initial maintenance is very important and must not be neglected.)					
	25 H OR 500 KM (310 mi)					
	50 H OR 1000 KM (620 mi)					
	100 H OR 1 YEAR OR 2000 KM (1250 mi)					
200 H OR 2 YEARS OR 4000 KM (2485 mi)						
TO BE PERFORMED BY						
PART/TASK						LEGEND
ENGINE/TRANSMISSION						
Engine oil level <sup>(2)</sup>	EVERY RIDE			Customer		(2) Pre-ride inspection item. (3) Every 100 hours, check coolant strength. (4) More often under severe use such dusty area, sand, snow, wet or muddy conditions. (7) Must be cleaned with every engine oil change.
Engine oil	R	R			Dealer	
Engine oil strainer <sup>(7)</sup>	C				Dealer	
Gearbox oil	I			R	Customer/Dealer	
Valve clearance adjustment	T		T		Dealer	
Engine mounting fasteners	I		I		Dealer	
Exhaust system	I		I		Dealer	
Condition of seals	I		I		Dealer	
Coolant <sup>(2)</sup>	I		<sup>(3)</sup>	R	Customer	
Radiator cap/cooling system pressure test	I			I	Dealer	
Radiator condition/cleanliness (radiator fins) <sup>(4)</sup>	I	I			Customer	
Drive belt				I	Dealer	
Drive and driven pulleys condition/cleanliness				I, C	Dealer	
CVT air inlet/outlet duct condition/cleanliness	I, C	I, C			Dealer	

## PERIODIC MAINTENANCE CHART

A: ADJUST  
 C: CLEAN  
 I: INSPECT  
 L: LUBRICATE  
 R: REPLACE  
 T: PROCEED WITH TASK

INITIAL INSPECTION 10 H OR 30 DAYS OR 200 KM (125 mi)  
 (To be performed by an authorized Bombardier ATV dealer. The initial maintenance is very important and must not be neglected.)

25 H OR 500 KM (310 mi)

50 H OR 1000 KM (620 mi)

100 H OR 1 YEAR OR 2000 KM (1250 mi)

200 H OR 2 YEARS OR 4000 KM (2485 mi)

TO BE PERFORMED BY

**PART/TASK**

**LEGEND**

### FUEL

Part/Task	I	C	L	R	T	Customer/Dealer	
Air filter/air injection valve filter		I, C (4)		R (4)		Customer	(4) More often under severe use such dusty area, sand, snow, wet or muddy conditions.
Fuel filter	I			I	R	Dealer	
Fuel lines and connections	I			I		Dealer	
Carburetor	A			A		Dealer	

### ELECTRICAL

Part/Task	I	C	L	R	T	Customer/Dealer	
Spark plug <sup>(5)</sup>	I			R		Customer	(2) Pre-ride inspection item. (5) Make sure the spark plug is correctly gapped.
Ignition timing	I		I			Dealer	
Battery connections	I		I			Customer	
Wiring harnesses, cables and lines	I			I		Dealer	
Condition of ignition switch, start button and engine stop switch <sup>(2)</sup>	I			I		Customer	
Condition of lighting system (HI/LO intensity, brake lamp, headlamp aiming, etc.) <sup>(2)</sup>	I			I		Customer	

### DRIVE TRAIN

Part/Task	I	C	L	R	T	Customer/Dealer	
Drive chain lubrication						EVERY RIDE	—
Drive chain slider condition						EVERY RIDE	
Drive chain adjustment						EVERY RIDE	
Sprockets	I			I		Customer	
Wheel bearing condition				I		Customer	

## PERIODIC MAINTENANCE CHART

INITIAL INSPECTION 10 H OR 30 DAYS OR 200 KM (125 mi)

(To be performed by an authorized Bombardier ATV dealer. The initial maintenance is very important and must not be neglected.)

25 H OR 500 KM (310 mi)

50 H OR 1000 KM (620 mi)

100 H OR 1 YEAR OR 2000 KM (1250 mi)

200 H OR 2 YEARS OR 4000 KM (2485 mi)

TO BE PERFORMED BY

A: ADJUST  
C: CLEAN  
I: INSPECT  
L: LUBRICATE  
R: REPLACE  
T: PROCEED WITH TASK

**PART/TASK**

**LEGEND**

### STEERING

Handlebar fasteners <sup>(2)</sup>	I			I		Dealer	(2) Pre-ride inspection item. (4) More often under severe use such dusty area, sand, snow, wet or muddy conditions.
Throttle/housing/cable condition <sup>(2)</sup>	I		I			Customer	
Choke condition <sup>(2)</sup>	I			I		Customer	
Steering system (column, bearing, etc.)	I			I	(4)	Dealer	
Tie rod ends	I		I			Dealer	
Wheel nuts/studs <sup>(2)</sup>	I		I			Customer	
Tires pressure and wear <sup>(2)</sup>					EVERY RIDE	Customer	
Front wheels alignment	I			I		Dealer	

### SUSPENSION

Swing arm <sup>(2)</sup>				I		Customer	(2) Pre-ride inspection item.
Shock absorbers <sup>(2)</sup>			I			Customer	
A-arms			I			Customer	

### BRAKE

Brake fluid (front and rear) <sup>(2)</sup>	I	I			R <sup>(6)</sup>	Customer	(2) Pre-ride inspection item. (4) More often under severe use such dusty area, sand, snow, wet or muddy conditions.
Parking brake cable adjustment <sup>(6)</sup>	I		I			Customer	
Brake pads <sup>(6)</sup>		I				Customer	(6) Brake fluid replacement or any brake system repairs must be performed by an authorized BRP ATV dealer.
Brake system (discs, hoses, etc.) <sup>(6)</sup>				I		Customer	

## PERIODIC MAINTENANCE CHART

A: ADJUST  
 C: CLEAN  
 I: INSPECT  
 L: LUBRICATE  
 R: REPLACE  
 T: PROCEED WITH TASK

INITIAL INSPECTION 10 H OR 30 DAYS OR 200 KM (125 mi)  
 (To be performed by an authorized Bombardier ATV dealer. The initial maintenance is very important and must not be neglected.)

25 H OR 500 KM (310 mi)

50 H OR 1000 KM (620 mi)

100 H OR 1 YEAR OR 2000 KM (1250 mi)

200 H OR 2 YEARS OR 4000 KM (2485 mi)

TO BE PERFORMED BY

**PART/TASK**

**LEGEND**

### BODY/FRAME

Engine compartment	C		C		Customer	(4) More often under severe use such dusty area, sand, snow, wet or muddy conditions.
Frame			I		Dealer	
Hitch/trailer ball condition (if installed)	EVERY RIDE				Customer	
Chassis Fasteners			I		Customer	
Seat fasteners	EVERY RIDE				Customer	
Vehicle cleaning and protection			C (4)		Customer	

---

## GENERAL

While reading this Operator's Guide, remember that:

### **WARNING**

Indicates a potential hazard that, if not avoided, could result in serious injury or death.

### **WARNING**

Unless otherwise specified, engine should not be running for all maintenance procedures.

Before performing any service or inspection operation on the vehicle, wait until the engine and exhaust have cooled down to avoid potential burns.

### **WARNING**

Should removal of a locking device (e.g. lock tabs, self-locking fasteners, etc.) be required when undergoing disassembly/assembly, always replace with a new one.

The following covers the maintenance items that can be performed by the customer if desired. Other items found in maintenance chart must be performed by an authorized Bombardier ATV distributor/dealer.

**NOTE:** Among other things, this section gives the procedures to replace the liquids. Refer to *LIQUIDS* for procedures to check levels and refill.



# ENGINE

## Oil Change and Oil Strainer Cleaning

Oil is to be replaced and oil strainer cleaned at the same time. Oil change should be done with a warm engine.

### **WARNING**

The engine oil can be very hot. Wait until engine oil is warm.

- Ensure vehicle is on a level surface.
- Remove dipstick.
- Clean the drain plug area.
- Place a drain pan under the engine drain plug area.
- Unscrew drain plug.

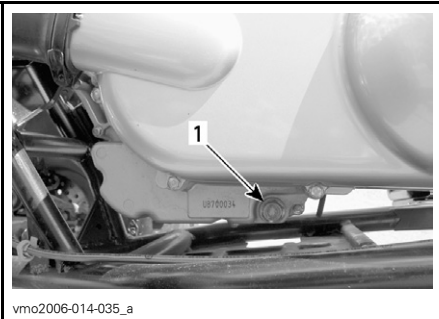

**LH SIDE UNDERNEATH CVT COVER**  
1. Oil drain plug

- Unscrew the oil strainer cover.
- Allow enough time for oil to flow out of oil strainer hole.

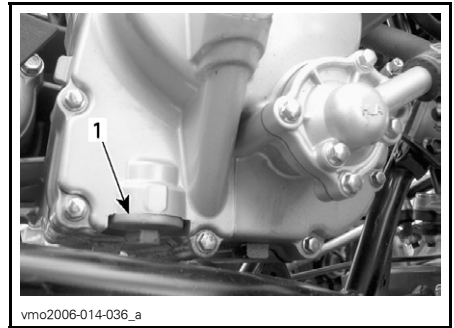

**RH SIDE OF ENGINE**  
1. Oil strainer cover

- Remove oil strainer and spring.
- To clean oil strainer, use a solvent then dry with compressed air.

### **WARNING**

Always wear eye protector. Chemicals can cause a rash break out and an injury to your eyes.

- NOTE:** Check cover O-ring and replace it if necessary.
- Wipe out any oil spillage on engine.

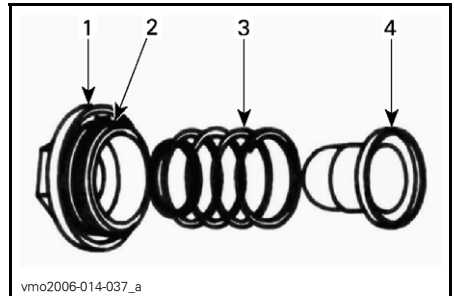

- 1. Cover
- 2. O-ring
- 3. Spring
- 4. Strainer

- Reinstall oil strainer, spring, O-ring and torque cover to 15 N•m (133 lbf•in).
- Verify drain plug washer condition and replace it if necessary.

Clean washer area on engine and drain plug then reinstall plug and torque it to 39 N•m (29 lbf•ft).

Refill engine at the proper level with the recommended oil. Refer to *SPECIFICATIONS* for capacity.

**NOTE:** Engine oil quantity is also written on the dipstick.

Start engine and let idle for a few minutes. Ensure oil strainer and drain plug areas are not leaking.

Stop engine. Wait a while to allow oil to flow down to crankcase then check oil level. Refill as necessary.

Dispose of oil as per your local environmental regulations.

## Gearbox Oil Replacement

Place the vehicle on a level surface.

Remove the drive chain protector.

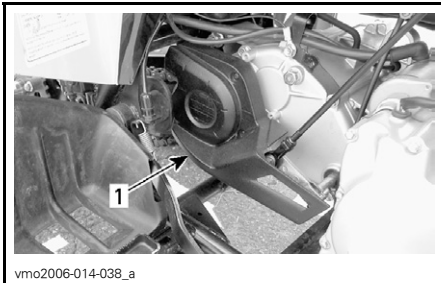

1. Drive chain protector

Clean fill and drain plug areas.

Remove gearbox fill plug.

Place a drain pan under the gearbox drain plug area then remove plug.

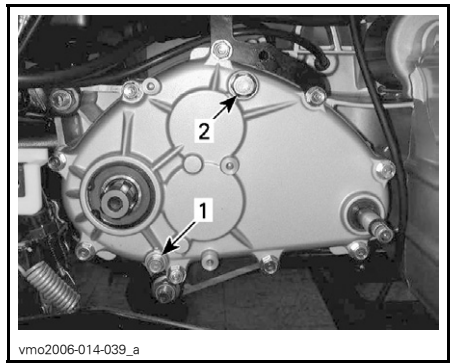

1. Gearbox drain plug  
2. Gearbox fill plug

**NOTE:** To completely drain the gearbox, place a jack under the left footpeg and tilt the vehicle toward the right side.

When the gearbox is empty, install and torque the drain plug at 9 N•m (80 lbf•in) and replace the vehicle on the ground.

Refill gearbox, using 800 mL (27 U.S. oz) of XP-S chaincase oil (P/N 413 801 900) or an equivalent.

**NOTE:** Gearbox oil quantity is also written on the gearbox cover.

**CAUTION:** Do not use other unrecommended types of oil when servicing. Do not mix with other types of oil.

Reinstall and torque oil fill plug to 39 N•m (29 lbf•ft).

## Coolant Replacement

### **WARNING**

In order to avoid potential burns, do not remove the radiator cap or loosen the coolant drain plug if the engine is hot.

Remove front fender access cover.

Turn the radiator cap counterclockwise and remove it.

Unscrew the drain plug located on the right side of engine and drain the coolant into a suitable container.

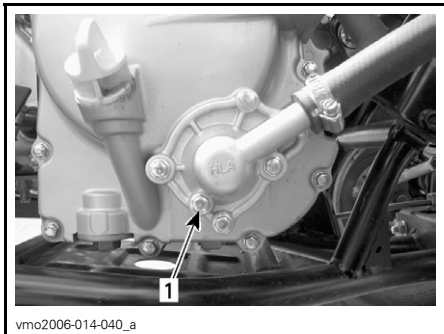

1. Cooling drain plug

Unplug the by-pass hose on the top of thermostat housing.

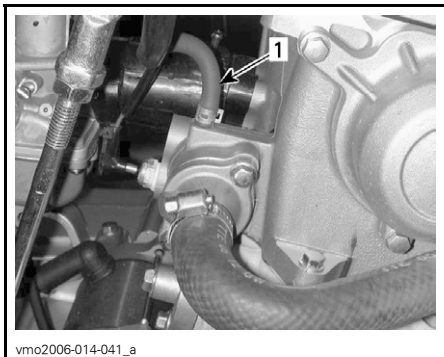

1. By-pass hose

Drain the system completely and reinstall the drain plug.

Pinch hose between radiator and thermostat housing with a large hose pincher (P/N 529 032 500).



vmo2006-014-043\_a

### HOSE PINCHER LOCATION

Lift the front of vehicle high enough to have front wheels off the ground.

Fill the radiator until the coolant comes out by the thermostat housing by-pass hose hole. Install the by-pass hose then remove the hose pincher.

**NOTE:** If no coolant comes out by the by-pass hose hole, squeeze the lower radiator hose several times until coolant comes out.

Complete the radiator filling.

Check the level in the coolant reservoir and refill if necessary.

Run engine at idle with the radiator cap off. Slowly add additional coolant if necessary.

At this point, wait until engine reaches normal operating temperature. Depress the throttle lever two or three times; then add coolant if required.

Install radiator cap. Inspect all connections for leaks and check coolant level in the reservoir.

## Drive Belt

See an authorized Bombardier ATV distributor/dealer to inspect and/or replace the drive belt.

## Valve Adjustment

See an authorized Bombardier ATV distributor/dealer for valves adjustment.

Insufficient clearance will cause loss of power and possibly damage the valves. Excessive clearance will cause noise.

## Radiator

Periodically check the radiator area for cleanliness.

Inspect radiating fins. They must be clean, free of mud, dirt, leaves and any other deposit that would prevent the radiator to cool properly.

Remove as much deposits as you can with your hands. If water is available in proximity, try rinsing the radiating fins.

If available, use a garden hose to rinse the radiating fins.

### **WARNING**

Never clean radiator with your hands when it is hot. Let the radiator cool down before cleaning.

**CAUTION:** Be careful not to damage the radiating fins when cleaning. Do not use any object/tool that could damage the fins. The fins are purposely thin parts to allow efficient cooling. **WHEN HOSING, USE LOW PRESSURE ONLY. NEVER USE A HIGH PRESSURE WASHER.**

See an authorized Bombardier ATV distributor/dealer to check the performance of the cooling system.

## Air Injection Valve Filter Cleaning



vmo2006-014-066\_b

### *LH SIDE OF ENGINE*

1. Air injection valve

Disconnect hoses from air injection valve.

Remove air injection valve from its support.

While holding one half, turn the other half counterclockwise to open.

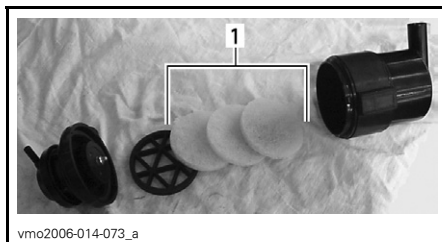

vmo2006-014-073\_a

1. Filters

Pour cleaning solution (P/N 219 700 341) or an equivalent into a bucket. Put filters in to soak.

While filters soaks, clean inside the air injection valve.

Rinse filters with warm water until all cleaning solution disappears.

**NOTE:** If air filters are still dirty, replace them with new ones.

Then, let filters dry completely.

When finished, properly reinstall removed parts in the reverse order of their removal.

---

## **CARBURETOR**

See an authorized Bombardier ATV distributor/dealer each year to verify and clean the fuel system.

# AIR INTAKE SYSTEM

**CAUTION:** Never remove or modify any component in the air box. The engine carburetion is calibrated to operate specifically with these components. Otherwise, engine performance degradation or damage can occur.

## Air Box Draining

Periodically inspect air box drain tube for liquid or deposits.

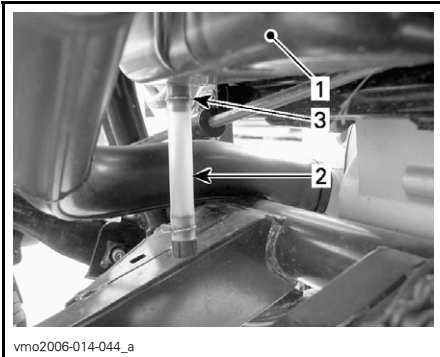

### TYPICAL

1. Air box
2. Drain tube
3. Clamp

**NOTE:** If vehicle is used in dusty area, inspect more frequently than specified in *MAINTENANCE CHART*.

If liquid/deposits are found, squeeze and remove the clamp. Pull drain tube out and empty it.

**CAUTION:** Do not start engine when liquid/deposits are found in the drain tube.

When liquid/deposits are found, the air filter must be inspected/dried/replaced depending on its condition.

## Air Filter Cleaning

### Air Filter Removal

**CAUTION:** Never remove or modify any component in the air box. The engine carburetion is calibrated to operate specifically with these components. Otherwise, engine performance degradation or damage can occur.

Remove seat.

Release clamps and remove air box cover.

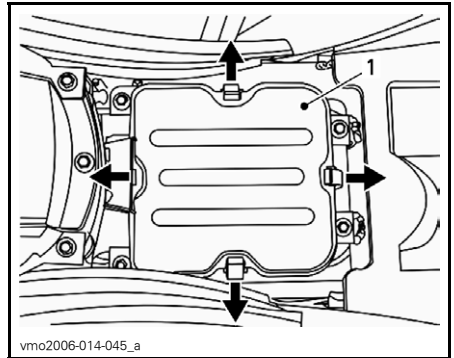

1. Air box cover

Loosen clamp and remove retaining screw, then remove air filter.

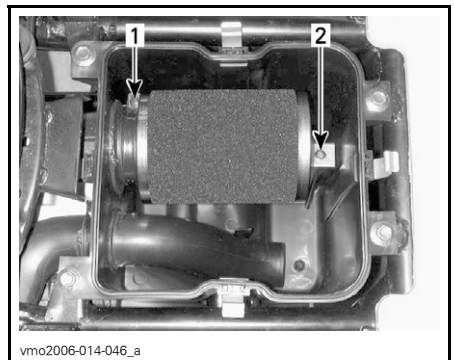

1. Clamp
2. Retaining screw

Pour cleaning solution (P/N 219 700 341) or an equivalent into a bucket. Put the filter in to soak.

While filter soaks, clean inside the air box.

Rinse the filter with warm water until all cleaning solution disappears.

**NOTE:** If the air filter foam is still dirty, replace it with a new one.

Then, let the filter dry completely.

When the filter is dried, re-oiled with air filter oil (P/N 219 700 340) or an equivalent.

**CAUTION:** Engine performance degradation or severe damages can occur if the air filter is not properly maintained and/or if it not well oiled.

### **Air Filter Installation**

Properly reinstall removed parts in the reverse order of their removal.

**NOTE:** Make sure that air box cover is installed properly.



# ELECTRICAL

## **WARNING**

Unless otherwise informed, always turn ignition switch to OFF before performing any maintenance or repair on electrical system.

## Spark Plug

### Removal

Unplug spark plug cable.

Unscrew spark plug one turn.

Clean spark plug and cylinder head with pressurized air if possible.

## **WARNING**

Always wear safety goggles when using pressurized air.

Unscrew spark plug completely then remove them.



LH SIDE OF ENGINE  
1. Spark Plug

### Installation

Prior to installation make sure that contact surface of cylinder head and spark plug is free of grime.

Using a feeler gauge, set the spark plug gap to 0.8 mm (0.31 in).

Apply anti-seize lubricant over spark plug threads to prevent a possible seizure.

Screw spark plug into cylinder head by hand and tighten with a torque wrench and a proper socket.

Torque spark plug to 11 N•m (97 lbf•in).

## Battery

## **WARNING**

Never charge a battery while installed in vehicle.

Clean battery post with a wire brush. Apply dielectric grease (P/N 293 550 004) or an equivalent on post to protect against oxidation.

### Removal

Disconnect BLACK (-) cable first then RED (+) cable.

## **WARNING**

Always respect this order for disassembly; disconnect BLACK (-) cable first.

Remove the holding strap.

Remove battery from vehicle.

### Cleaning

Clean battery, battery casing, cables and battery posts using a solution of baking soda and water.

Remove corrosion from battery cable terminals and battery posts using a firm wire brush. Battery top should be cleaned by soft brush and any grease-cutting soap or baking soda solution.

### Installation

Reinstall battery in vehicle.

## **WARNING**

Connect RED (+) cable first then BLACK (-) cable. Always connect RED (+) cable first.

### **Fuse**

If fuses are damaged, replace them by one of the same rating.

**CAUTION:** Do not use a higher rated fuse as this can cause severe damage.

Fuses are located underneath the seat in the service compartment. Remove the seat to allow an access at the fuse holder.

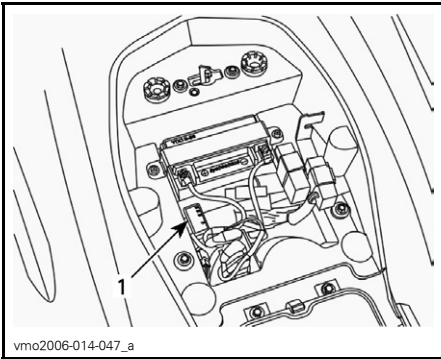

vmo2006-014-047\_a  
1. Fuse holder

To remove fuse from holder, unclip and remove holder cover then pull fuse out. Check if filament is melted.

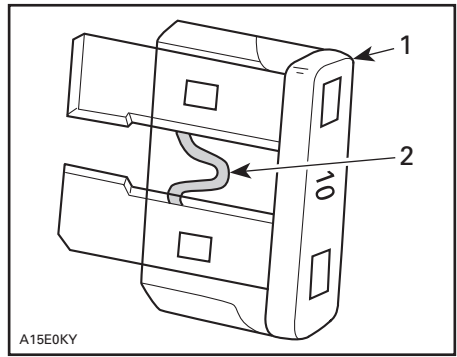

A15E0KY  
1. Fuse  
2. Check if melted

### **Bulb Replacement**

Always check light operation after replacement.

### **Headlamp**

**CAUTION:** Never touch glass portion of an halogen bulb with bare fingers, it shortens its operating life. If glass is touched, clean it with isopropyl alcohol which will not leave a film on the bulb.

To unplug connector, remove rubber protector from headlamp housing, then pull on connector using a wiggle movement.

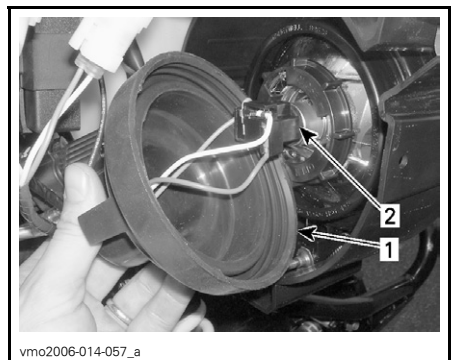

vmo2006-014-057\_a  
1. Remove rubber protector  
2. Pull on connector using a wiggle movement

Unlock bulb holder by turning it counterclockwise.

Replace bulb.

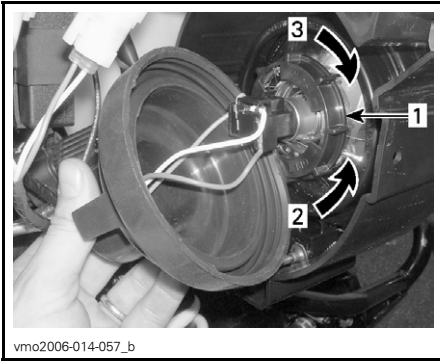

vmo2006-014-057\_b

1. Bulb holder
2. Unlock (open)
3. Lock (close)

Properly reinstall removed parts in the reverse order of their removal.

### Adjust beam aiming as follows:

Turn knob to adjust beam height orientation to your convenience. Adjust both headlamps evenly.

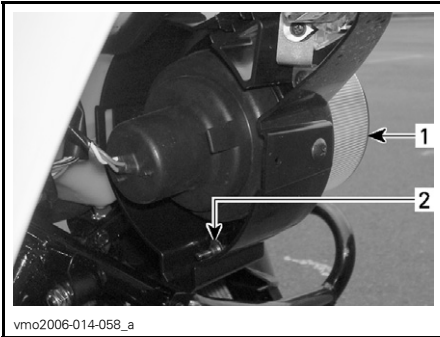

vmo2006-014-058\_a

1. Headlamp housing
2. Beam height adjustment

### Taillight

Unscrew lens screws to expose bulb.

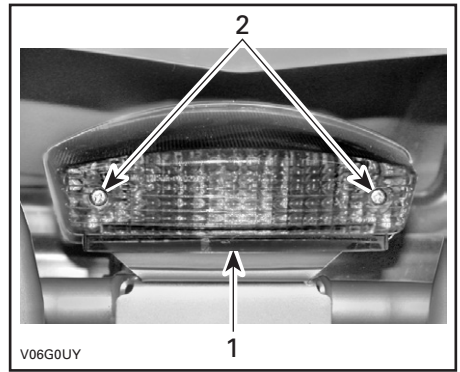

V06G0UY

### TYPICAL

1. Lens
2. Screws

Push bulb in and hold while turning counterclockwise to release.

Install the new bulb by first pushing in while turning clockwise. Reinstall lens.

### Front Direction Indicator Lamps

Remove rubber protector then pull on rubber bulb housing to gain access to bulb.

Replace bulb.



vmo2006-014-071

**PULL ON BULB HOUSING TO REMOVE**

### Rear Direction Indicator Lamps

Unscrew housing cover screws and lower housing retaining screws.

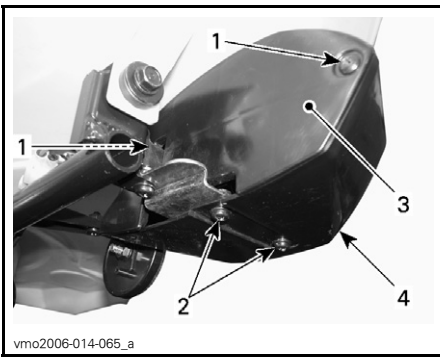

vmo2006-014-065\_a

1. Housing cover screws
2. Lower housing screws
3. Housing cover
4. Housing

Release housing from rear fender then remove lamp housing.

Install the new bulb by first pushing in while turning clockwise.

Properly reinstall removed parts in the reverse order of their removal.

### Position Light



vmo2006-014-069\_a

### BULB ACCESS

Pull on rubber bulb housing to gain access to bulb.

Replace bulb.



vmo2006-014-067\_a

### RELEASE HOUSING FROM REAR FENDER

Remove lamp lens.

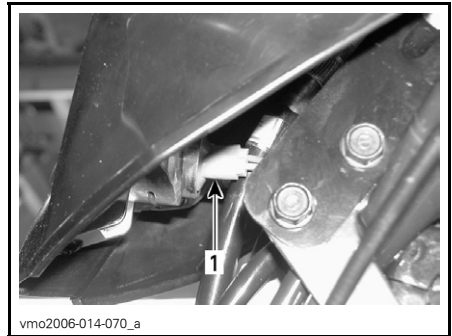

vmo2006-014-070\_a

1. Bulb housing



vmo2006-014-068\_a

### PULL ON LENS TO REMOVE

1. Lamp lens

Push bulb in and hold while turning counterclockwise to release.

# DRIVE TRAIN

## Drive Chain

Adjust and lubricate drive chain before each use.

### **WARNING**

Place ignition switch to OFF before checking, adjusting or lubricating the drive chain.

**CAUTION:** Never operate this vehicle with the drive chain too loose or too tight as severe damage to the drive components can occur.

### **Inspection**

This ATV is equipped with O-ring sealed permanently greased pins and rollers. Before operating the vehicle, always inspect the drive chain.

Check the free play of drive chain and adjust if necessary.

Check for damage or missing O-ring or rollers.

### **Cleaning and Lubrication**

**CAUTION:** Never wash the chain with a high pressure washer or gasoline. Damage to the O-ring will result, causing premature wear and drive chain failure.

Clean the side surfaces of the chain with a dry cloth.

**NOTE:** Do not brush chain.

Lubricate only with an approved O-ring chain lubricant. Other commercial chain lubricants may contain solvent which could damage the O-rings.

### **Adjustment**

**NOTE:** Never adjust drive chain with the driver seated on the vehicle. Remove all load on vehicle.

Select a level surface and set transmission to NEUTRAL.

Loosen chain tensioner lock bolts and caliper support bolt.

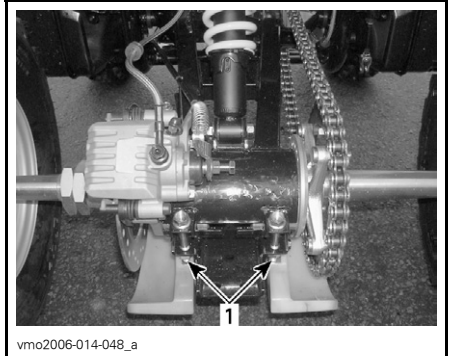

1. Chain tensioner lock bolts



1. Caliper support bolt

Insert adjuster lock through sprocket hub and into chain tensioner.

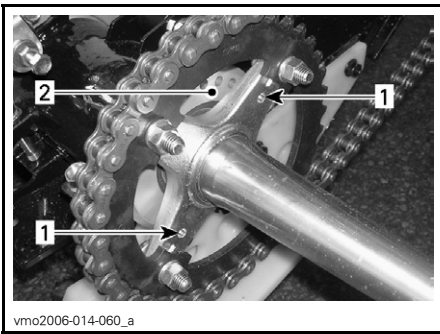

1. Sprocket hub holes
2. Chain tensioner

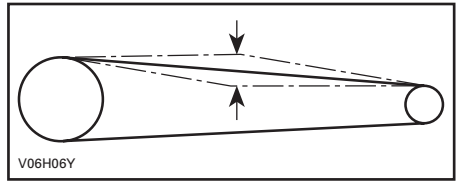

Tighten the chain tensioner lock bolts to 50 N•m (37 lbf•ft).

**CAUTION:** Never operate this vehicle with the drive chain too loose or too tight as severe damage to the drive components can occur.

When the adjustment is done, repeat the above procedure to check the deflection several times at different spots on the chain.

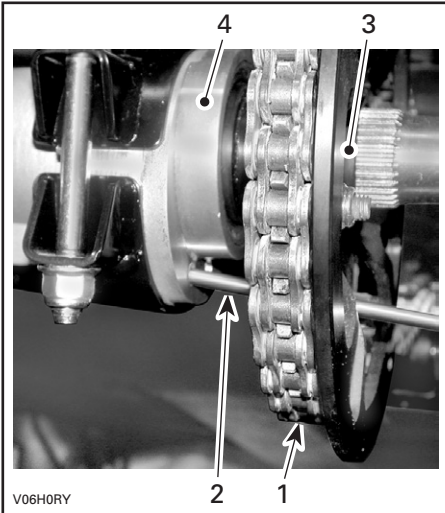

**TYPICAL**

1. Drive chain
2. Adjuster lock
3. Sprocket hub
4. Chain tensioner

Adjust chain deflection by slowly moving the ATV forward or backward.

The deflection on the top of the chain should be between 15 and 25 mm (5/8 and 1 in).

## Sprocket and Pinion

Check the sprocket axle and pinion for distortion, excessive wear or other damages.

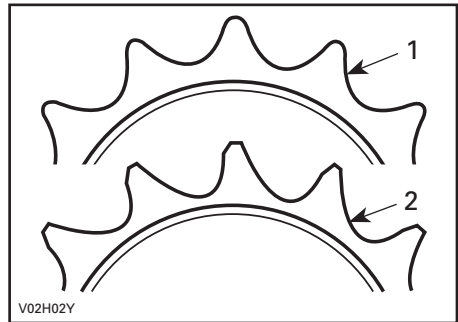

1. Good
2. Replace

**CAUTION:** Replace chain, sprocket axle and pinion together to prevent rapid chain and sprocket wear. Install a new retaining ring each time the pinion is removed.

## Wheel

Occasionally, wheel nuts should be removed to apply anti-seize lubricant on studs to ease future removal. This is particularly important when vehicle is used in salt-water environment or in mud. Remove one nut at a time, lubricate then retorque to 50 N•m (37 lbf•ft).

## Wheel Bearing/Bushings Condition

Push and pull the wheels from the upper edge to feel the play. See an authorized Bombardier ATV distributor/dealer if there is any play.

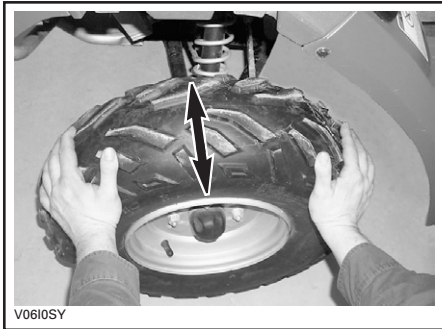

TYPICAL

## Tires/Wheels

### Tire Pressure

#### **WARNING**

Tire pressure greatly affects vehicle handling and stability. Under-pressure may cause tire to deflate and rotate on wheel. Overpressure may burst the tire. Always follow recommended pressure. Since tires are low-pressure types, a manual pump should be used.

Check pressure when tires are “cold” before using the vehicle. Tire pressure changes with temperature and altitude. Recheck pressure if one of these conditions has changed.

For your convenience, a pressure gauge is supplied in tool kit.

TIRE PRESSURE		
UP to 150 kg (330 lb)	MAX.	FRONT/REAR 34 kPa (5 PSI)
	MIN.	26 kPa (3.8 PSI)

Although the tires are specifically designed for off-road use, a flat may still occur. Therefore, it is recommended to carry a tire pump and a repair kit.

### Tire/Wheel Condition

Check tire for damage and wear. Replace if necessary.

Do not rotate tires. The front and rear tires have a different size. The tires are directional and their rotation must be kept in a specific direction for proper operation.

### Wheel Removal

Loosen nuts then lift vehicle. Place a support under vehicle. Remove nuts then remove wheel.

At installation, it is recommended to apply anti-seize lubricant on threads. Gently tighten nuts in a criss-cross sequence then apply a final torque of 50 N•m (37 lbf•ft).

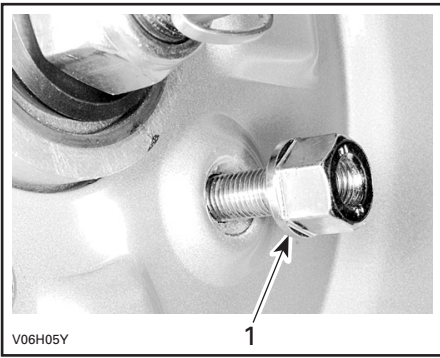

*TYPICAL*

1. *Taper side of nut*

**CAUTION:** Always use the recommended wheel nuts. Using a different nut could cause damages to the rim.



# STEERING SYSTEM

## Throttle Cable Lubrication

The throttle cable must be lubricated with silicone cable lubricant (P/N 293 600 041) or an equivalent.

### **WARNING**

Always use a silicone-based lubricant. Using another lubricant (like water-based lubricant) could cause the throttle lever/cable sticking or stiffness.

Open the throttle lever housing.

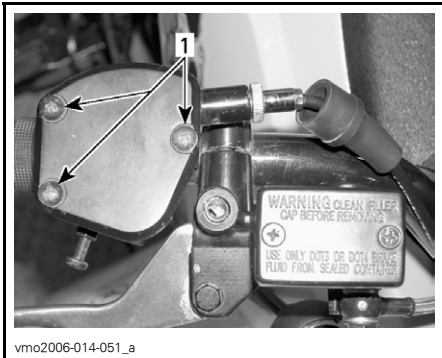

1. Remove screws

Slide the rubber protector to expose the cable adjuster.

Unscrew the lock nut of the cable adjuster then screw in the adjuster to release the cable tension.

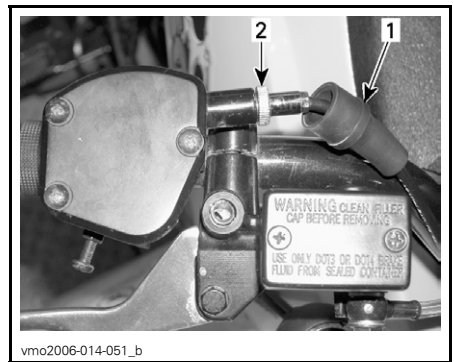

1. Rubber protector  
2. Cable adjuster

Remove the cable from the throttle lever.

**NOTE:** Slide cable in clip slot and remove the end of cable from clip.

Remove the carburetor cap on top of the carburetor. Place the carburetor cap far from carburetor body.

Install the cable luber (P/N 529 035 738) on the cable.

Insert the needle of spray can in the cable luber hole.

### **WARNING**

Always wear eye protection and gloves when you lubricate a cable.

**NOTE:** Place a rag around the cable luber to prevent the lubricant splash.

Add lubricant until it runs out at carburetor end of the throttle cable.

Let the cable hang during approximately 15 minutes or until no lubricant flows out of cable.

Reinstall carburetor cap.

Reinstall and adjust the cable.

## Throttle Lever Adjustment

Slide rubber protector back to expose throttle cable adjuster.

Loosen lock nut then turn the adjuster to obtain correct throttle lever free play.

**NOTE:** Measure throttle free play at the tip of throttle lever.

Tighten lock nut and reinstall protector.

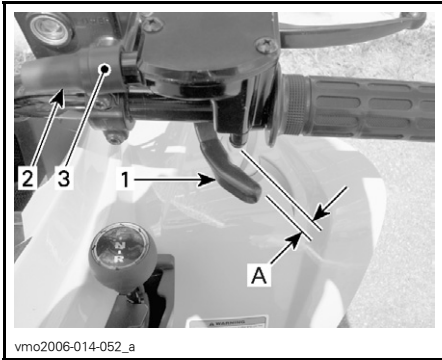

1. Throttle lever
  2. Protector
  3. Cable adjuster
- A. 1 to 3 mm (.039 to .118 in)

With the transmission lever on NEUTRAL position, start the engine. Check if the throttle cable is adjusted correctly by turning handlebar fully right then fully left. If the engine RPM increases, readjust the throttle lever free play.

# SUSPENSION

## Adjustment

### **WARNING**

Adjust both springs to the same length. Uneven adjustment can cause poor handling and loss of stability and/or control, and increase the risk of an accident.

Spring preload may vary from rider to rider depending upon their weight. Preload can be changed by setting both lock nuts up or down to compress the spring to different lengths.

Shorten the spring for a firmer ride and rough road condition.

Lengthen the spring for a light load and a smooth road condition.

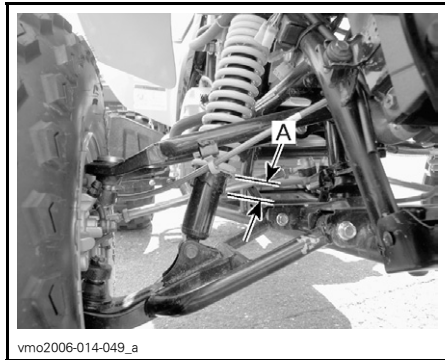

### **FRONT SUSPENSION**

A. Same length on both sides

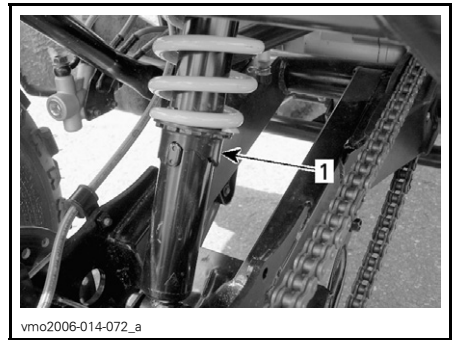

### **REAR SUSPENSION**

1. Preload cam

## Lubrication

### Swing Arm

Lubricate swing arm pivots. Use synthetic grease (P/N 293 550 033) or an equivalent.

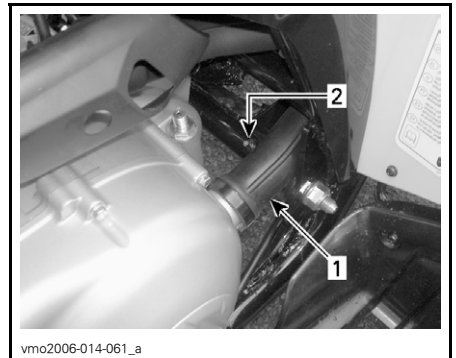

### **LH SIDE OF VEHICLE**

1. CVT duct
2. Grease fitting

## Inspection

### Front and Rear Suspension

Inspect shock absorbers for oil leaks and fasteners for tightness. See an authorized Bombardier ATV distributor/dealer as necessary.

## **Swing Arm**

Check swing arm for distortion, cracks or bending. See an authorized Bombardier ATV distributor/dealer if any problem is detected.

## **A-Arms**

Check A-arms for cracks, bending or other damages. See an authorized Bombardier ATV distributor/dealer as necessary.

# BRAKE

## **WARNING**

Any brake system repair should be performed by an authorized Bombardier ATV distributor/dealer.

### Front Brake

The front brakes are hydraulic disc types. These brakes are self-adjusting and require no adjustment.

### Rear Brake

The rear brake employs two systems. The first system uses a cable; an adjustment is necessary. See *PARKING BRAKE* cable adjustment.

The second system is hydraulic and requires no adjustment.

### Parking Brake

#### Cable Adjustment

Ensure that parking brake is in OFF position (not locked).

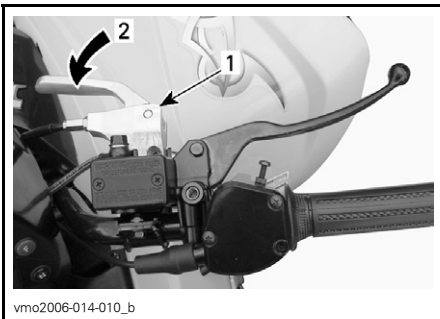

1. Brake lever
2. OFF position

Loosen rear caliper cable adjuster locking nut.

Turn cable adjuster clockwise until a small resistance is felt.

Turn cable adjuster counterclockwise just enough so that there is no contact between cable adjuster and caliper piston.

Tighten lock nut and verify that parking brake is working properly.

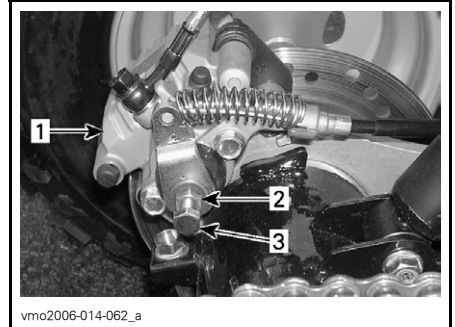

1. Rear caliper
2. Lock nut
3. Cable adjuster

**CAUTION:** Make sure that rear wheels are locked when parking brake is in ON position and that wheels moves freely when parking brake is in OFF position.

### Brake Cable Lubrication

Remove cable from hand lever.

Put the cable luber (P/N 529 035 738) on the cable.

Insert the needle of the spray can in the hole.

Spray a small quantity of silicone cable lubricant (P/N 293 600 041) or and equivalent. Repeat this procedure until the silicone lubricant exits the other end of the cable.

**⚠ WARNING**

Always use a silicone-based lubricant. Using another lubricant (like water-based lubricant) could cause brake cable sticking or stiffness.

## Inspection

**⚠ WARNING**

See an authorized Bombardier ATV distributor/dealer to repair or replace any components of the brake system.

Check the following to keep the brakes in a good operating condition:

- brake cable adjustment
- brake system for fluid leaks
- brake for spongy feel
- brake discs for excessive wear and surface condition
- brake pads for wear, damage or looseness.

**SERVICE LIMITS**

Brake pads thickness	2 mm (.079 in)
Brake discs thickness	2 mm (.079 in)
Maximum discs warpage	0.15 mm (.010 in)

## Brake Fluid Replacement

**⚠ WARNING**

The brake fluid replacement or any brake system repairs should be performed by an authorized Bombardier ATV distributor/dealer.

---

# BODY/FRAME

## Engine Area

Check engine area for any damage and leaks. Ensure all hose clamps are properly secured and no hose is cracked, kinked or otherwise damaged.

Inspect muffler, battery and reservoir fastening devices.

Check electrical connections for corrosion and tightness.

Replace or have damaged parts repaired.

## Hitch/Trailer Ball Condition (if so equipped)

Check tightness of fasteners and tightness/condition of trailer ball. Properly retighten as necessary and replace ball if worn.

## Fasteners

Check fastener condition and tightness on the vehicle. Retighten as required.

## Seat Fasteners

Check tightness of seat fasteners. Retorque or replace if necessary.

## Vehicle Cleaning and Protection

Never use the high pressure washer to clean the vehicle **USE LOW PRESSURE ONLY** (like a garden hose). The high pressure can cause electrical or mechanical damages.

Painted parts which are damaged should be properly repainted to prevent rust.

When required, wash the body with hot water and soap (only use mild detergent). Apply non-abrasive wax.

**CAUTION:** Never clean plastic parts with strong detergent, degreasing agent, paint thinner, acetone, etc.





# ***WARRANTY***

---

# **BRP INTERNATIONAL LIMITED WARRANTY: 2006 BOMBARDIER\* ATV PRODUCTS**

## **1) SCOPE OF THE LIMITED WARRANTY**

Bombardier Recreational Products INC. (hereinafter "BRP"), warrants its 2006 Bombardier ATV products from defects in material or workmanship for the period described below.

All genuine Bombardier parts and accessories, installed by an authorized Bombardier distributor/dealer (as hereinafter defined) at the time of delivery of the 2006 Bombardier ATV product, carry the same warranty as that of the ATV.

Use of the product for racing or any other competitive activity, at any point, even by a previous owner, will render this warranty null and void.

## **2) WARRANTY COVERAGE PERIOD**

This warranty will be in effect FROM THE DATE OF DELIVERY TO THE FIRST RETAIL CONSUMER or the date the product is first put into use, whichever occurs first and for a period of:

SIX (6) CONSECUTIVE MONTHS, for private use or commercial use owners.<sup>1</sup>

The repair or replacement of parts or the performance of service under this warranty does not extend the life of this warranty beyond its original expiration date.

## **3) CONDITIONS TO HAVE WARRANTY COVERAGE**

This warranty coverage is available only on 2006 Bombardier ATV products purchased as new and unused by its first owner from a Bombardier distributor/dealer authorized to distribute Bombardier ATV products in the country in which the sale occurred (hereinafter "Bombardier ATV distributor/dealer"), and then only after the BRP specified pre-delivery inspection process is completed and documented. Warranty coverage only becomes available upon proper registration of the product by an authorized Bombardier ATV distributor/dealer. Such limitations are necessary in order to allow BRP to preserve both the safety of its products, and also that of its consumers and the public.

Routine maintenance outlined in the *OPERATOR'S GUIDE* must be timely performed in order to maintain warranty coverage. BRP reserves the right to make warranty coverage contingent upon proof of proper maintenance.

1. The warranty is TWENTY FOUR (24) consecutive months if the product was sold in any of the member states of the European Union (EC directive 1999/44/EC). The warranty period, however, is SIX (6) consecutive months if the product is used for commercial purposes.

#### **4) WHAT TO DO TO OBTAIN WARRANTY COVERAGE**

The customer must notify a servicing Bombardier ATV distributor/dealer within two (2) days of the appearance of a defect, and provide it with reasonable access to the product and reasonable opportunity to repair it. The customer must also present to the authorized Bombardier distributor/dealer, proof of purchase of the product and must sign the repair/work order prior to starting the repair in order to validate the warranty repair. All parts replaced under this limited warranty become the property of BRP.

#### **5) WHAT BRP WILL DO**

BRP's obligations under this warranty are limited to, at its sole discretion, repairing parts found defective under normal use, maintenance and service, or replacing such parts with new genuine Bombardier parts without charge for parts and labor, at any authorized Bombardier distributor/dealer.

BRP reserves the right to improve or modify products from time to time without assuming any obligation to modify products previously manufactured.

#### **6) EXCLUSIONS - ARE NOT WARRANTED**

The following are not warranted under any circumstances:

- Normal wear and tear;
- Routine maintenance items, tune ups, adjustments;
- Damage caused by failure to provide proper maintenance and/or storage, as described in the *OPERATOR'S GUIDE*;
- Damage resulting from removal of parts, improper repairs, service, maintenance, modifications or use of parts not manufactured or approved by BRP or resulting from repairs done by a person that is not an authorized servicing Bombardier distributor/dealer;
- Damage caused by abuse, abnormal use, neglect or operation of the product in a manner inconsistent with the recommended operation described in the *OPERATOR'S GUIDE*;
- Damage resulting from accident, submersion, fire, theft, vandalism or any act of God;
- Operation with fuels, oils or lubricants which are not suitable for use with the product (see the *OPERATOR'S GUIDE*);
- Water or snow ingestion;
- Incidental or consequential damages, or damages of any kind including without limitation towing, storage, telephone, rental, taxi, inconvenience, insurance coverage, loan payments, loss of time, loss of income.

## **7) LIMITATIONS OF LIABILITY**

THIS WARRANTY IS EXPRESSLY GIVEN AND ACCEPTED IN LIEU OF ANY AND ALL OTHER WARRANTIES, EXPRESSED OR IMPLIED, INCLUDING WITHOUT LIMITATION ANY WARRANTY OF MERCHANTABILITY OR FITNESS FOR A PARTICULAR PURPOSE. TO THE EXTENT THAT THEY CANNOT BE DISCLAIMED, THE IMPLIED WARRANTIES ARE LIMITED IN DURATION TO THE LIFE OF THE EXPRESS WARRANTY. INCIDENTAL AND CONSEQUENTIAL DAMAGES ARE EXCLUDED FROM COVERAGE UNDER THIS WARRANTY. SOME STATES/PROVINCES DO NOT ALLOW FOR THE DISCLAIMERS, LIMITATIONS AND EXCLUSIONS IDENTIFIED ABOVE, AS A RESULT, THEY MAY NOT APPLY TO YOU. THIS WARRANTY GIVES YOU SPECIFIC RIGHTS, AND YOU MAY ALSO HAVE OTHER LEGAL RIGHTS WHICH MAY VARY FROM COUNTRY TO COUNTRY.

Neither the distributor, any Bombardier ATV dealer nor any other person has been authorized to make any affirmation, representation or warranty regarding the product, other than those contained in this limited warranty, and if made, shall not be enforceable against BRP.

BRP reserves the right to modify this warranty at any time, being understood that such modification will not alter the warranty conditions applicable to the products sold while this warranty is in effect.

## **8) TRANSFER**

If the ownership of a product is transferred during the warranty coverage period, this warranty shall also be transferred and be valid for the remaining coverage period provided that BRP is notified of such transfer of ownership in the following way:

BRP or an authorized Bombardier ATV distributor/dealer receives a proof that the former owner agreed to the transfer of ownership, in addition to the coordinates of the new owner. The distributor will then forward this information directly to BRP

## **9) CONSUMER ASSISTANCE**

- a) In the event of a controversy or a dispute in connection with this BRP LIMITED WARRANTY, BRP suggests that you try to resolve the issue at the dealership level. We recommend discussing the issue with the authorized dealer's service manager or owner.
- b) If further assistance is required, the distributor's service department should be contacted in order to resolve the matter.
- c) If the matter still remains unresolved then contact BRP by writing to us at the address listed below.

**BRP EUROPEAN DISTRIBUTION  
BOMBARDIER ATV  
CUSTOMER SERVICE  
SWITZERLAND  
TEL : +41 21 318 78 00**

© 2005 Bombardier Recreational Products Inc. All rights reserved.

® Registered trademark of Bombardier Recreational Products Inc. or its subsidiaries.

\* Trademark of Bombardier Inc., used under license.

---

## **PRIVACY OBLIGATION/DISCLAIMER**

We wish to inform you that your coordinates will be used for safety and warranty purposes. Sometimes, we also use the coordinates of our clients to inform them about our products and to present them offers. Should you prefer not to receive information on our product, services and offers, please let us know by writing to the address below.

Also note that, from time to time, carefully selected and trustworthy organizations may be permitted to use the coordinates of our clients to promote quality products and services. If you prefer not to have your name and address released, please let us know by writing to the address below.

BRP European Distribution  
Warranty Department  
Chemin de Messidor 5-7  
1006 Lausanne  
Switzerland  
Fax Number: +41 21 318 78 01



AFFIX  
PROPER  
POSTAGE



BRP European Distribution  
Warranty Department  
Chemin de Messidor 5-7  
1006 Lausanne  
Switzerland

V00A2G





AFFIX  
PROPER  
POSTAGE



BRP European Distribution  
Warranty Department  
Chemin de Messidor 5-7  
1006 Lausanne  
Switzerland

V00A2G

**ATV MODEL No.** \_\_\_\_\_

**VEHICLE IDENTIFICATION NUMBER (V.I.N.)** \_\_\_\_\_

**ENGINE IDENTIFICATION NUMBER (E.I.N.)** \_\_\_\_\_

**Owner:** \_\_\_\_\_  
NAME

\_\_\_\_\_  
No. STREET APT

\_\_\_\_\_  
CITY STATE/PROVINCE ZIP/POSTAL CODE

**Purchase Date** \_\_\_\_\_  
YEAR MONTH DAY

**Warranty Expiry Date** \_\_\_\_\_  
YEAR MONTH DAY

To be completed by the dealer at the time of the sale.

DEALER IMPRINT AREA

Please verify with your dealer to ensure your vehicle has been registered with BRP.

While reading this Operator's Guide, remember that:

 **WARNING**

Indicates a potential hazard that, if not avoided, could result in serious injury or death.

2006



## WARNING

### **THIS VEHICLE CAN BE HAZARDOUS TO OPERATE.**

A collision or rollover can occur quickly, even during routine manoeuvres such as turning and driving on hills or over obstacles, if you fail to take proper precautions.

**SEVERE INJURY OR DEATH** can result if you do not follow these instructions:

- **BEFORE YOU OPERATE THIS ATV, READ THIS OPERATOR'S GUIDE AND ALL ON-PRODUCT LABELS.**
- **NEVER OPERATE THIS ATV WITHOUT PROPER INSTRUCTIONS.** Beginners should complete a certified training course.
- **NEVER CARRY A PASSENGER.** You increase your risk of losing control if you carry a passenger.
- **NEVER OPERATE THIS VEHICLE ON ANY PAVED SURFACE** unless it is for short distances, at reduced speed and in order to move the vehicle from an off-road location to another.
- **ALWAYS RESPECT THE ROAD TRAFFIC LAWS** when you operate this vehicle on the roadway, even a dirt or gravel road.
- **ALWAYS WEAR AN APPROVED HELMET,** eye protection, and protective clothing.
- **NEVER CONSUME ALCOHOL OR DRUGS** before or while operating this vehicle.
- **NEVER OPERATE THIS VEHICLE AT EXCESSIVE SPEEDS.** You increase your risk of losing control if you operate this vehicle at speeds too fast for the terrain, visibility conditions, or your experience. The maximum speed authorized with this vehicle is 65 Km/h (40 Mph).
- **NEVER ATTEMPT WHEELIES, JUMPS, OR OTHER STUNTS.**



©™™ TRADEMARKS OF BOMBARDIER RECREATIONAL PRODUCTS INC. OR ITS AFFILIATES.  
\*TRADEMARK OF BOMBARDIER INC. USED UNDER LICENSE.  
©2005 BOMBARDIER RECREATIONAL PRODUCTS INC. ALL RIGHTS RESERVED. PRINTED IN TAIWAN.

219 100 414

CA

OPERATOR'S GUIDE, DS 250 CE / ENGLISH  
GUIDE DU CONDUCTEUR, DS 250 CE / ANGLAIS

FAIT AU / MADE IN TAIWAN

U/M:P.C.

