

# BOMBARDIER\* ATV

## OPERATOR'S GUIDE

INCLUDES  
SAFETY, VEHICLE AND MAINTENANCE  
INFORMATION



RALLY™ 200

**⚠ WARNING**

Read this guide thoroughly.  
It contains important safety information.  
Minimum recommended operator age: 16 years.  
Do not remove this *Operator's Guide* from  
the vehicle.

This Operator's Guide utilizes the following symbols to emphasize particular information:



The Safety Alert Symbol indicates a potential personal injury hazard.



**WARNING** Indicates a potentially hazardous situation which, if not avoided, could result in serious injury or death.

**CAUTION:** Denotes an instruction which, if not followed, may damage the vehicle and/or components.

## **WARNING**

**YOUR VEHICLE CAN BE HAZARDOUS TO OPERATE.** A collision or rollover can occur quickly, even during routine maneuvers such as turning and driving on hills or over obstacles, if you fail to take proper precautions.

For your safety, understand and follow all the warnings contained in this Operator's Guide and the labels on your vehicle. **Failure to follow these warnings can result in SEVERE INJURY OR DEATH.**

Keep this Operator's Guide with the vehicle at all times.

## **WARNING**

Disregarding any of the safety precautions and instructions contained in this Operator's Guide, Safety Videocassette and on-product labels could cause injury including the possibility of death!

All safety documentation should remain with the vehicle at the time of sale.

All content of the Safety Information section should be interpreted by the reader as a warning which if not followed, may result in injury including the possibility of death.

In Canada, products are distributed by Bombardier Recreational Products Inc. (BRP). In USA, products are distributed by Bombardier Motor Corporation of America.

The following trademarks are the property of Bombardier Recreational Products Inc.:

RALLY™

Printed in the E.U. (ATV RALLY EN 2005.fm)

®™ Trademarks of Bombardier Recreational Products Inc. or its affiliates.

©2005 Bombardier Recreational Products Inc. All rights reserved.

\* Bombardier and the sprocket design are trademarks of Bombardier Inc., used under license.

---

# FOREWORD

Congratulations on your purchase of a new Bombardier\* recreational vehicle. It is backed by the BRP warranty and a network of authorized Bombardier ATV dealers ready to provide the parts, service or accessories you may require.

Your dealer is committed to your satisfaction. He has taken training to perform the initial setup and inspection of your vehicle as well as completed the final adjustment before you took possession. At delivery, your dealer would have explained for the operation, maintenance and safety features of the vehicle. We trust you have taken full advantage of this! If you need more complete servicing information, please ask your dealer.

At delivery, you were also informed of the warranty coverage and completed the Warranty Registration Form which is to be sent to us for processing. In the near future you should be receiving a warranty card which will confirm our receipt of the registration as well as be used for warranty or recall purposes.

You are invited to contact our customer assistance center should you experience problems which cannot be resolved by an authorized Bombardier ATV dealer.

It is understood that this Operator's Guide may be translated into another language. In the event of any discrepancy, the English version shall prevail. Throughout this document, the masculine is used to denote the masculine or feminine.

The information and components/system descriptions contained in this document are correct at the time of publication. Bombardier Recreational Products Inc. however, maintains a policy of continuous improvement of its products without imposing upon itself any obligation to install them on products previously manufactured. Due to late changes, some differences between the manufactured product and the descriptions and/or specifications in this Guide may occur. BRP reserves the right at any time to discontinue or change specifications, designs, features, models or equipment without incurring any obligation upon itself.

The illustrations in this document show the typical construction of the different assemblies and may not reproduce the full detail or exact shape of the parts. However, they represent parts that have the same or similar function.

The use of RIGHT and LEFT indications in the text, always refers to driving position (when sitting on vehicle).

Specifications are given in the SI metric system with the SAE U.S. equivalent in parenthesis. Where precise accuracy is not required, some conversions are rounded off for easier use.

We recommend genuine Bombardier products for replacement parts and accessories. They've been especially designed for your vehicle and manufactured to meet of BRP's demanding standards.

A Shop Manual can be obtained for complete service and maintenance information and more repair information.

---

# TABLE OF CONTENTS

While reading this Operator's Guide, remember that:

## **WARNING**

Indicates a potential hazard that, if not avoided, could result in serious injury or death.

<b>NOTICE</b> .....	<b>5</b>
<b>INTRODUCTION</b> .....	<b>6</b>
<b><i>SAFETY INFORMATION</i></b>	
<b>SPECIAL SAFETY MESSAGES</b> .....	<b>8</b>
<b>OPERATION WARNINGS</b> .....	<b>10</b>
<b>SAFETY WARNING</b> .....	<b>37</b>
Pre-Operation Check.....	38
Clothing .....	39
Carrying Loads .....	40
Hauling a Trailer .....	40
Working with your vehicle.....	40
Recreational Riding .....	40
Environment .....	41
Design Limitation .....	41
Off-Highway Operation .....	42
General Operating and Safety Precautions.....	42
Uphill Driving .....	42
Downhill Driving.....	43
Side hilling .....	43
Drop-Offs .....	43
Riding Techniques.....	43
Routine Maintenance.....	49
<b>LOCATION OF THE IMPORTANT LABELS</b> .....	<b>50</b>
<b>VEHICLE INFORMATION</b> .....	<b>53</b>
<b>HOW TO IDENTIFY YOUR ATV</b> .....	<b>54</b>
Vehicle Identification Number Location .....	54
Engine Identification Number Location.....	55
<b>NOISE EMISSION CONTROL SYSTEM REGULATION</b> .....	<b>56</b>
<b>EMISSION REQUIREMENTS</b> .....	<b>56</b>
<b>CONTROLS/COMPONENTS/INSTRUMENTS</b> .....	<b>57</b>
1) Throttle Lever .....	59
2) Front Brake Lever .....	59
3) Rear Brake Lever .....	60
4) Brake Lever Lock .....	60
5) Transmission Lever.....	60
6) Multi-function Switch .....	61

7) Indicator Lamps.....	64
8) Ignition Switch .....	64
9) Fuel Tank Cap.....	65
10) Fuel Valve .....	65
11) Rear Brake Pedal.....	66
12) Footpeg .....	66
13) Tool Box .....	66
14) Front/Rear Cargo Racks .....	67
15) Radiator Cap .....	67
16) Fuse .....	67
<b>LIQUIDS.....</b>	<b>68</b>
Fuel.....	68
Engine/Transmission Oil .....	68
Gearbox Oil.....	70
Engine Coolant .....	71
Coolant Replacement.....	72
Brake Fluid.....	72
Battery .....	73
<b>BREAK-IN PERIOD.....</b>	<b>74</b>
Engine.....	74
Belt.....	74
10-Hour Inspection .....	74
<b>PRE-OPERATION CHECK.....</b>	<b>75</b>
<b>OPERATING INSTRUCTIONS .....</b>	<b>76</b>
General.....	76
Initial Cold Starting.....	76
Warm Engine Starting.....	76
Stopping the Engine .....	76
Shifting the Transmission .....	77
<b>SPECIAL PROCEDURES .....</b>	<b>78</b>
Flooded Engine.....	78
Engine Overheat.....	78
Post-Operation Care.....	79
Turn Over.....	79
ATV Immersion .....	79
Storage and Preseason Preparation .....	79
<b>CARGO AND TRANSPORTATION .....</b>	<b>80</b>
Transportation.....	80
<b><i>MAINTENANCE INFORMATION</i></b>	
<b>MAINTENANCE CHART .....</b>	<b>84</b>
<b>MAINTENANCE.....</b>	<b>87</b>
Engine.....	87
Carburetor.....	91

Air Intake System .....	92
Electrical .....	93
Battery .....	93
Drive Train .....	97
Steering System .....	101
Suspension .....	102
Lubrication .....	103
Brakes .....	103
Inspection .....	104
Body/Frame .....	104
<b>TROUBLESHOOTING .....</b>	<b>105</b>
<b>SPECIFICATIONS.....</b>	<b>108</b>
<b>INTERNATIONAL SYSTEM METRIC INFORMATION.....</b>	<b>112</b>
<b><i>WARRANTY</i></b>	
<b>BRP INTERNATIONAL LIMITED WARRANTY: 2005 BOMBARDIER*</b>	
<b>ATV PRODUCTS.....</b>	<b>114</b>
<b>PRIVACY OBLIGATION/DISCLAIMER .....</b>	<b>117</b>
<b>CHANGE OF ADDRESS/OWNERSHIP .....</b>	<b>119</b>
<b>CHANGE OF ADDRESS/OWNERSHIP .....</b>	<b>121</b>

---

## NOTICE

This Operator's Guide has been prepared to acquaint the owner/operator of a new vehicle with the various vehicle controls, maintenance and safe operating instructions. It is indispensable for the proper use of the product. This Operator's Guide uses the following symbols.

### **WARNING**

Indicates a potentially hazardous situation which, if not avoided, could result in serious injury or death.

**CAUTION:** Denotes an instruction which, if not followed, could severely damage vehicle components.

**NOTE:** Indicates supplementary information needed to fully complete an instruction.

Although the mere reading of such information does not eliminate the hazard, the understanding and application of the information will promote the correct use of this vehicle.

To fully appreciate the pleasures, enjoyment and excitement of using this vehicle, there are some basic rules that **MUST** be observed and followed by any user.

---

# INTRODUCTION

Your selling dealer should have provided you with some basic information on the particular controls and features of your new vehicle. Please take the time to study this Operator's Guide and all on-product warning labels as well as the Safety Videocassette that came with the ATV. They more completely describe what you should know about this vehicle before riding it.

Whether you are a new user or an experienced rider, it is important for your personal safety that you know the controls and features of the this vehicle. Equally important is knowing how to properly ride.

Irrespective of your age, experience or state regulations, it is always prudent for you or any other person who may ride your vehicle, to take an approved safe riding course. Please check with your dealer or local authorities for availability in your area. If you are a completely new rider, this should be done before your first ride. Your instructor should be able to provide advice on local conditions and safe riding practices particular to the area.

Riding conditions vary from place to place. Each is subject to weather conditions which may radically change from time to time and from season to season. Riding on sand is different than riding on snow or through forests or marshes. Each location may require a greater degree of awareness and skill may not be suitable with a passenger. Show good judgement. Always proceed with caution. Please do not take any unnecessary risks that could leave you or your passenger stranded or possibly injured.

The contents of this Operator's Guide provide riding information which has been proven reliable by other users. They are not intended as a definitive means of avoiding accidents. How you apply this information, coupled with your mental and physical condition, the particular terrain hazard and your risk acceptance level will have an effect on your riding experience. Have fun... and ride responsibly.

This Operator's Guide has been prepared to acquaint the owner/operator of a new vehicle with the various vehicle controls, maintenance and safe operating instructions. They are indispensable for the proper use of the product.

We would be pleased to receive any comments on the content and format of this Operator's Guide, the Safety Videocassette or on-product warnings labels.



# ***SAFETY INFORMATION***

---

## SPECIAL SAFETY MESSAGES

### **THIS VEHICLE IS NOT A TOY AND CAN BE HAZARDOUS TO OPERATE.**

This vehicle handles differently from other vehicles including motorcycles and cars. A collision or rollover can occur quickly, even during routine maneuvers such as turning and driving on hills or over obstacles, if you fail to take proper precautions.

**SEVERE INJURY OR DEATH** can result if you do not follow these instructions:

- ⚠ Read this Operator's Guide and all on-product warning labels carefully and follow the operating procedures described. Watch and pay attention to the Safety Videocassette before operation.
- ⚠ Never operate this vehicle without proper instruction. Take a training course.
- ⚠ Always follow this age recommendation: A person under 16 years old should never operate this vehicle.
- ⚠ Never carry a passenger on this vehicle.
- ⚠ Never operate this vehicle on any paved surfaces, including sidewalks, driveways, parking lots and streets.
- ⚠ Never operate this vehicle on any public street, road or highway, even a dirt or gravel one.
- ⚠ Never take place on this vehicle without wearing an approved helmet that fits properly. You should also wear eye protection (goggles or face shield), gloves, boots, long sleeved shirt or jacket, and long pants.
- ⚠ Never consume alcohol or drugs before or while riding this vehicle.
- ⚠ Never operate at excessive speeds. Always go at a speed that is proper for the terrain, visibility, and operating conditions, and your experience.
- ⚠ Never attempt wheelies, jumps, or other stunts.
- ⚠ Always inspect your vehicle each time you use it to make sure it is in safe operating condition. Always follow the inspection and maintenance procedures and schedules described in this Operator's Guide.
- ⚠ Always keep both hands on the handlebars and both feet on the footpegs of the vehicle during operation.
- ⚠ Always go slowly and be extra careful when operating on unfamiliar terrain. Always be alert to changing terrain conditions when operating the vehicle.
- ⚠ Never operate on excessively rough, slippery or loose terrain until you have learned and practiced the skills necessary to control the vehicle on such terrain. Always be especially cautious on these kinds of terrain.
- ⚠ Always follow proper procedures for turning as described further in this Operator's Guide. Practice turning at low speeds before attempting to turn at faster speeds. Do not turn at excessive speed.
- ⚠ Never operate the vehicle on hills too steep for the vehicle or for your abilities. Practice on smaller hills before attempting larger hills.

- △ Always follow proper procedures for climbing hills as described further in this Operator's Guide. Check the terrain carefully before you start up any hill. Never climb hills with excessively slippery or loose surfaces. Shift your weight forward. Never open the throttle suddenly or make sudden gear changes. Never go over the top of any hill at high speed.
- △ Always follow proper procedures for going down hills and for braking on hills as described further in this Operator's Guide. Check the terrain carefully before you start down any hill. Shift your weight backward. Never go down a hill at high speed. Avoid going down a hill at an angle that would cause the vehicle to lean sharply to one side. Go straight down the hill where possible.
- △ Always follow proper procedures for crossing the side of a hill as described further in this Operator's Guide. Avoid hills with excessively slippery or loose surfaces. Shift your weight to the uphill side of the vehicle. Never attempt to turn the vehicle around on any hill until you have mastered the turning technique described in this Operator's Guide on level ground. Avoid crossing the side of a steep hill if possible.
- △ Always use proper procedures if you stall or roll backwards when climbing a hill. To avoid stalling, use proper gear and maintain a steady speed when climbing a hill. If you stall or roll backwards, follow the special procedure for braking described further in this Operator's Guide. Dismount on the uphill side or to a side if pointed straight uphill. Turn the vehicle around and remount, following the procedure described further in this Operator's Guide.
- △ Always check for obstacles before operating in a new area. Never attempt to ride over large obstacles, such as large rocks or fallen trees. Always follow proper procedures when riding over obstacles as described further in this Operator's Guide.
- △ Always be careful when skidding or sliding. Learn to safely control skidding or sliding by practicing at low speeds and on level, smooth terrain. On extremely slippery surfaces, such as ice, go slowly and be very cautious in order to reduce the chance of skidding out of control.
- △ Never operate this vehicle in fast flowing water or in water deeper than that specified further in this Operator's Guide. Remember that wet brakes may have reduced stopping ability. Test your brakes after leaving water. If necessary, apply them several times to let friction dry out the pads.
- △ Always be sure there are no obstacles or people behind you when you operate in reverse. When it is safe to proceed in reverse, go slowly.
- △ Always use the size and type tires specified further in this Operator's Guide. Always maintain proper tire pressure as described further in this guide.
- △ Never modify this vehicle through improper installation or use of accessories. Only use BRP's approved accessories. Do not install passenger seat or use racks to carry a passenger.
- △ Never exceed the stated load limits for this vehicle including operator, all other loads and added accessories. Cargo should be properly distributed and securely attached. Reduce speed and follow instructions in this manual for carrying cargo or pulling a trailer. Allow greater distance for braking.
- △ FOR MORE INFORMATION ABOUT ATV SAFETY, contact an authorized ATV dealer to find out about the training courses nearest you.

# OPERATION WARNINGS

While reading this Operator's Guide, remember that:

## WARNING

Indicates a potential hazard that, if not avoided, could result in serious injury or death.

The following warnings and their format have been requested by the United States Consumer Product Safety Commission and are required to be in this Operator's Guide for all ATVs.

**NOTE:** The following illustrations are general representations only. Your model may differ.

## WARNING



V00A0AQ

### **POTENTIAL HAZARD**

Operating this vehicle without proper instruction.

### **WHAT CAN HAPPEN**

The risk of an accident is greatly increased if the operator does not know how to operate this vehicle properly in different situations and on different types of terrain.

### **HOW TO AVOID THE HAZARD**

Beginning and inexperienced operators should complete the training course offered by BRP. They should then regularly practice the skills learned in the course and the operating techniques described in this Operator's Guide.



V00A01Q

**POTENTIAL HAZARD**

Failure to follow the age recommendations for this vehicle.

**WHAT CAN HAPPEN**

A lack of respect for this age recommendation can lead to severe injury or death of the child. Even though a child may be within the age group for which this vehicle is recommended, he may not have the skills, abilities, or judgment needed to operate the ATV safely and may be involved in a serious accident.

**HOW TO AVOID THE HAZARD**

No one under 16 should operate this vehicle.

**⚠ WARNING**



V00A02Q

**POTENTIAL HAZARD**

Carrying a passenger on this vehicle.

**WHAT CAN HAPPEN**

Greatly reduces your ability to balance and control this vehicle.  
Could cause an accident, resulting in harm to you and/or your passenger.

**HOW TO AVOID THE HAZARD**

Never carry a passenger. Even with a long seat that provides unrestricted operator movement, it is not designed nor intended to carry passenger(s).

**⚠ WARNING**

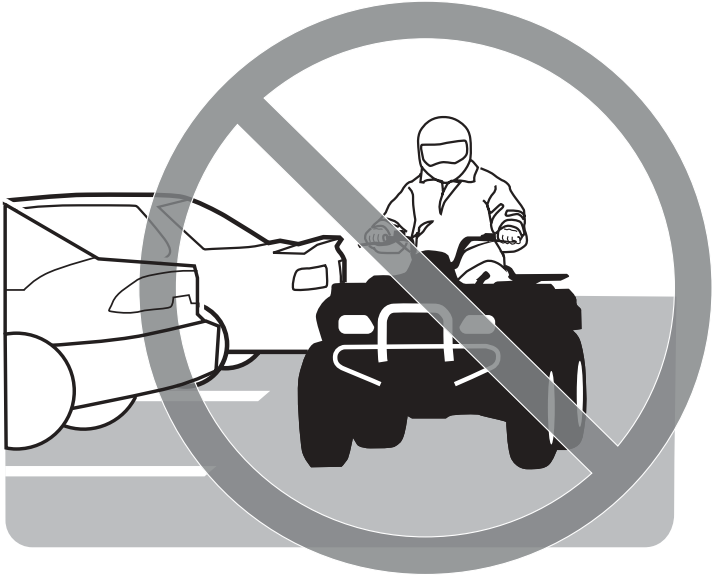

V00A03Q

**POTENTIAL HAZARD**

Operating this ATV on paved surfaces.

**WHAT CAN HAPPEN**

The ATV's tires are designed for off-road use only, not for use on pavement. Paved surfaces may seriously affect handling and control of this vehicle, and may cause the vehicle to go out of control.

**HOW TO AVOID THE HAZARD**

Never operate this vehicle on any paved surfaces, including sidewalks, driveways, parking lots and streets.

**⚠ WARNING**



V00A04Q

**POTENTIAL HAZARD**

Operating this vehicle on public streets, roads or highways.

**WHAT CAN HAPPEN**

You can collide with another vehicle.

**HOW TO AVOID THE HAZARD**

Never operate this vehicle on any public street, road or highway, even a dirt or gravel one. In many states or provinces it is illegal to operate ATVs on public streets, roads or highways.



## **WARNING**



V00A06Q

### **POTENTIAL HAZARD**

Riding this vehicle without wearing an approved helmet, eye protection and protective clothing.

### **WHAT CAN HAPPEN**

The following items concern all ATV's operator:

- riding without an approved helmet increases the chances of a severe head injury or death in the event of an accident
- riding without eye protection can result in an accident and increases the chances of a severe injury in the event of an accident
- riding without protective clothing increases the chances of severe injury in the event of an accident.

### **HOW TO AVOID THE HAZARD**

Always wear an approved helmet that fits properly. You should also wear:

- eye protection (goggles or face shield)
- gloves and boots
- long sleeved shirt or jacket
- long pants.

## WARNING



V00A07Q

### **POTENTIAL HAZARD**

Riding this vehicle after consuming alcohol or drugs.

### **WHAT CAN HAPPEN**

Could seriously affect your judgment.  
Could cause you to react more slowly.  
Could affect your balance and perception.  
Could result in an accident or death.

### **HOW TO AVOID THE HAZARD**

Never consume alcohol or drugs before or while riding this vehicle.

 **WARNING**

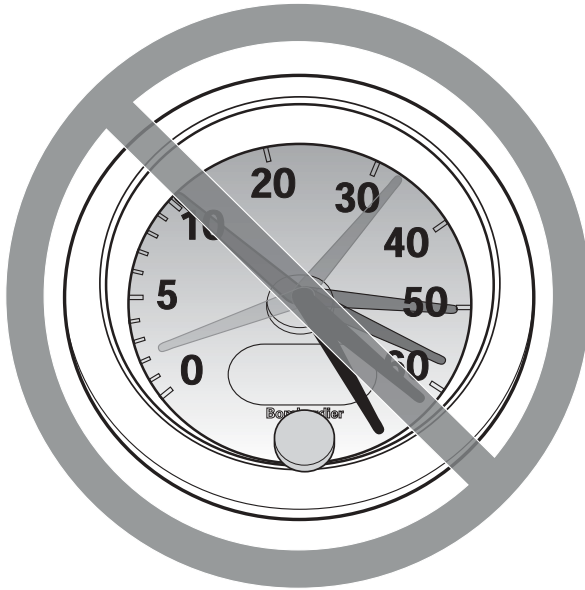

V00A08Q

**POTENTIAL HAZARD**

Operating this ATV at excessive speeds.

**WHAT CAN HAPPEN**

Increases your chances of losing control of the vehicle, which can result in an accident.

**HOW TO AVOID THE HAZARD**

Always travel at a speed which is proper for the terrain, visibility and operating conditions, and your experience.

 **WARNING**

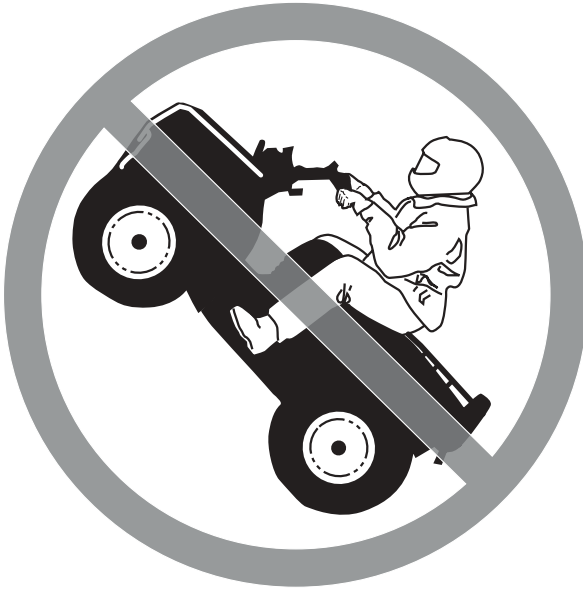

V00A09Q

**POTENTIAL HAZARD**

Attempting wheelies, jumps and other stunts.

**WHAT CAN HAPPEN**

Increases the chance of an accident, including an overturn.

**HOW TO AVOID THE HAZARD**

Never attempt stunts, such as wheelies or jumps. Do not try to show off.

## **WARNING**

### **POTENTIAL HAZARD**

Failure to inspect the vehicle before operating.  
Failure to properly maintain the vehicle.

### **WHAT CAN HAPPEN**

Increases the possibility of an accident or equipment damage.

### **HOW TO AVOID THE HAZARD**

Always inspect your vehicle each time you use it to make sure the vehicle is in safe operating condition.

Always follow the inspection and maintenance procedures and schedules described further in this Operator's Guide.

## **WARNING**

### **POTENTIAL HAZARD**

Riding on frozen waterways.

### **WHAT CAN HAPPEN**

Severe injury or death can result if the vehicle and/or operator break through the ice.

### **HOW TO AVOID THE HAZARD**

Never ride this vehicle on a frozen surface before you are sure the ice is thick enough and sound enough to support the vehicle and its load, as well as the force that is created by a moving vehicle.

## **WARNING**



V00A0BQ

### **POTENTIAL HAZARD**

Removing hands from handlebar or feet from the footrests during operation.

### **WHAT CAN HAPPEN**

Removing even one hand or foot can reduce your ability to control the vehicle or could cause you to lose your balance and fall off the vehicle. If you remove a foot from the footrests, your foot or leg may come into contact with the rear wheels, which could injure you or cause an accident.

### **HOW TO AVOID THE HAZARD**

Always keep both hands on the handlebar and both feet on the footrests during vehicle operation.

## WARNING

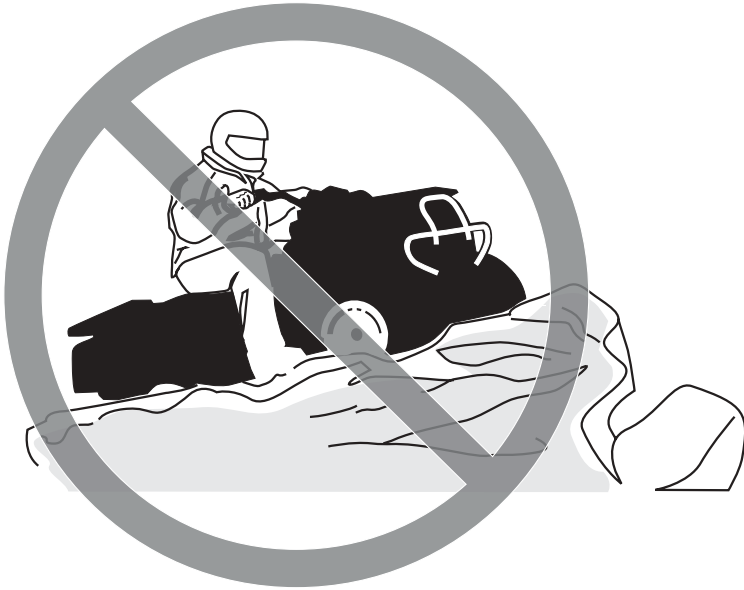

V00A0CQ

### **POTENTIAL HAZARD**

Failure to use extra care when operating this vehicle on unfamiliar terrain.

### **WHAT CAN HAPPEN**

You can come upon hidden rocks, bumps, or holes, without enough time to react. Could result in the vehicle overturning or loss of control.

### **HOW TO AVOID THE HAZARD**

Go slowly and be extra careful when operating on unfamiliar terrain. Always be alert to changing terrain conditions when operating the vehicle.

## WARNING



V00A0DQ

### **POTENTIAL HAZARD**

Failure to use extra care when operating on excessively rough, slippery or loose terrain.

### **WHAT CAN HAPPEN**

Could cause loss of traction or vehicle control, which could result in an accident, including an overturn.

### **HOW TO AVOID THE HAZARD**

Do not operate on excessively rough, slippery or loose terrain until you have learned and practiced the skills necessary to control this vehicle on such terrain.  
Always be especially cautious on these kinds of terrain.



 **WARNING**



V00A0EQ

**POTENTIAL HAZARD**

Turning improperly.

**WHAT CAN HAPPEN**

This vehicle could go out of control, causing a collision or overturn.

**HOW TO AVOID THE HAZARD**

Always follow proper procedures for turning as described further in this Operator's Guide. Practice turning at low speeds before attempting to turn at faster speeds. Do not turn at excessive speed.

**⚠ WARNING**



V00A0QQ

**POTENTIAL HAZARD**

Operating on excessively steep hills.

**WHAT CAN HAPPEN**

The vehicle can overturn more easily on extremely steep hills than on level surfaces or small hills.

**HOW TO AVOID THE HAZARD**

Never operate this vehicle on hills too steep for the vehicle or for your abilities. Practice on smaller hills before attempting larger hills.

## **WARNING**



V00A0FQ

### **POTENTIAL HAZARD**

Climbing hills improperly.

### **WHAT CAN HAPPEN**

Could cause loss of control or cause vehicle to overturn.

### **HOW TO AVOID THE HAZARD**

Always follow proper procedures for climbing hills as described further in this Operator's Guide.

Always check the terrain carefully before you start up any hill.

Never climb hills with excessively slippery or loose surfaces.

Shift your weight forward.

Never open the throttle suddenly or make sudden gear changes. The vehicle could flip over backwards.

Never go over the top of any hill at high speed. An obstacle, a sharp drop, or another vehicle or person could be on the other side of the hill.

## WARNING



V00A0GQ

### **POTENTIAL HAZARD**

Going down a hill improperly.

### **WHAT CAN HAPPEN**

Could cause loss of control or cause vehicle to overturn.

### **HOW TO AVOID THE HAZARD**

Always follow proper procedures for going down hills as described further in this Operator's Guide. **NOTE:** A special technique is required when braking as you go down a hill.

Always check the terrain carefully before you start down any hill.

Shift your weight backward.

Never go down a hill at high speed.

Avoid going down a hill at an angle which would cause the vehicle to lean sharply to one side.

Go straight down the hill where possible.

## WARNING



V00A0HQ

### **POTENTIAL HAZARD**

Improperly crossing hills or turning on hills.

### **WHAT CAN HAPPEN**

Could cause loss of control or cause vehicle to overturn.

### **HOW TO AVOID THE HAZARD**

Never attempt to turn the vehicle around on any hill until you have mastered the turning technique as described further in this Operator's Guide on level ground. Be very careful when turning on any hill.

Avoid crossing the side of a steep hill if possible.

#### **When crossing the side of a hill:**

Always follow proper procedures as described further in this Operator's Guide.

Avoid hills with excessively slippery or loose surfaces.

Shift your weight to the uphill side of the vehicle.

## WARNING



V00A01Q

### **POTENTIAL HAZARD**

Stalling, rolling backwards or improperly dismounting while climbing a hill.

### **WHAT CAN HAPPEN**

Could result in vehicle overturning.

### **HOW TO AVOID THE HAZARD**

Use proper gear and maintain steady speed when climbing a hill.

#### **If you lose all forward speed:**

Keep weight uphill. Never open the throttle suddenly or make sudden gear changes. The vehicle could flip over backwards.

Apply the brakes.

Lock parking brake after you are stopped.

Dismount on uphill side, or to a side if pointed straight uphill.

#### **If you begin rolling backwards:**

Keep weight uphill.

Apply the brakes gradually.

When fully stopped, lock parking brake.

Dismount on uphill side, or to a side if pointed straight uphill.

Turn the ATV around and remount, following the procedure described further in this Operator's Guide.

**⚠ WARNING**



V00A0JQ

**POTENTIAL HAZARD**

Improperly operating over obstacles.

**WHAT CAN HAPPEN**

Could cause loss of control or a collision. Could cause the vehicle to overturn.

**HOW TO AVOID THE HAZARD**

Before operating in a new area, check for obstacles.

Never attempt to ride over large obstacles, such as large rocks or fallen trees.

When you go over obstacles, always follow proper procedures as described further in this Operator's Guide.

**⚠ WARNING**



V00A0KQ

**POTENTIAL HAZARD**

Skidding or sliding improperly.

**WHAT CAN HAPPEN**

You may lose control of this vehicle.

You may also regain traction unexpectedly, which may cause the vehicle to overturn.

**HOW TO AVOID THE HAZARD**

Learn to safely control skidding or sliding by practicing at low speeds and on level, smooth terrain.

On extremely slippery surfaces, such as ice, go slowly and be very cautious in order to reduce the chance of skidding or sliding out of control.



## WARNING



V00A0LQ

### **POTENTIAL HAZARD**

Operating this vehicle through deep or fast flowing water.

### **WHAT CAN HAPPEN**

Tires may float, causing loss of traction and loss of control, which could lead to an accident.

### **HOW TO AVOID THE HAZARD**

Never operate this vehicle in fast flowing water or in water deeper than that specified further in this Operator's Guide.

Check water depth and current before you attempt to cross any water. Water should not go above footrests.

Remember that wet brakes may have reduced stopping ability. Test your brakes after leaving water. If necessary, apply them several times to let friction dry out the pads.

**⚠ WARNING**



V00A0MQ

**POTENTIAL HAZARD**

Improperly operating in reverse.

**WHAT CAN HAPPEN**

You could hit an obstacle or person behind the vehicle, resulting in serious injury.

**HOW TO AVOID THE HAZARD**

When you select reverse gear, make sure there are no obstacles or people behind the vehicle. When it is safe to proceed, go slowly.

 **WARNING**



V00A00Q

**POTENTIAL HAZARD**

Operating this vehicle with improper tires, or with improper or uneven tire pressure.

**WHAT CAN HAPPEN**

Use of improper tires on this vehicle, or operation of this vehicle with improper or uneven tire pressure, may cause loss of control, and increases the risk of an accident.

**HOW TO AVOID THE HAZARD**

Always use the size and type of tires specified further in this Operator's Guide for this vehicle. Always maintain proper tire pressure as described further in this Operator's Guide.

## **WARNING**



V00A0NQ

### **POTENTIAL HAZARD**

Operating this vehicle with improper modifications.

### **WHAT CAN HAPPEN**

Improper installation of accessories or modification of this vehicle may cause changes in handling which in some situations could lead to an accident.

### **HOW TO AVOID THE HAZARD**

Never modify this vehicle through improper installation or use of accessories. All parts and accessories added to this vehicle should be approved by BRP and should be installed and used according to instructions. If you have questions, consult an authorized Bombardier ATV dealer.

Do not install passenger seat or use the racks to carry a passenger.

## **WARNING**



V00A0PQ

### **POTENTIAL HAZARD**

Overloading this vehicle or carrying or towing cargo improperly.

### **WHAT CAN HAPPEN**

Could cause changes in vehicle handling which could lead to an accident.

### **HOW TO AVOID THE HAZARD**

Never exceed the stated load capacity for this vehicle including operator as well as other loads and added accessories.

Cargo should be properly distributed and securely attached.

Reduce speed when carrying cargo. Allow greater distance for braking.

Always follow the instructions in this Operator's Guide for carrying cargo.

**⚠ WARNING**



V03M01Q

**POTENTIAL HAZARD**

Transporting inflammable or dangerous material can lead to explosions.

**WHAT CAN HAPPEN**

This can cause serious injury or death.

**HOW TO AVOID THE HAZARD**

Never transport inflammable or dangerous material.

While reading this Operator's Guide, remember that:

**⚠ WARNING**

Indicates a potential hazard that, if not avoided, could result in serious injury or death.

---

## SAFETY WARNING

To fully appreciate the pleasures and excitement of riding this vehicle, there are some basic rules and tips that you should follow. Some may be new to you while others may be common sense or obvious. Irrespective, we ask that you take a few minutes to read this Operator's Guide completely before you operate the vehicle.

Information in this Operator's Guide is limited. It is strongly recommended that you obtain further information and training from your local authorities, ATV clubs or a recognized ATV training organization.

ATV manufacturers do not recommend anyone under the age of 16 to ride an ATV having an engine higher than 90 cc. For the child's safety, we strongly recommend you also follow and enforce this recommendation. You are the sole judge of a rider's capability to understand the risks and operate a vehicle safely.

Persons with cognitive or physical impairments or are high risk takers have an increased exposure to overturns or collisions which may result in injury including death.

Become completely familiar with the operational controls and the general operation of the vehicle before venturing into off road conditions. Practice driving in a suitable area free of hazards and feel the response of each control. Drive at low speeds. Higher speeds requires greater experience, knowledge and suitable riding conditions.

Not all vehicles are the same. Each has its own unique performance characteristics, controls and features. Each will ride and handle differently.

Never assume that the vehicle will go everywhere safely. Sudden changes in terrain caused by holes, depressions, banks, softer or harder "ground" plus others, may cause the vehicle to topple or become unstable. To avoid this, slow down and always observe the terrain ahead. If the vehicle does begin to topple or tipover, it is usually the best advice to immediately get off... AWAY from the direction of the tipover!

## Pre-Operation Check

### **WARNING**

The pre-operation check is very important prior to operating the vehicle. Always check the proper operation of critical controls, safety features and mechanical components before starting. If not done, severe injury or death might occur.

Before using this vehicle, the operator should always:

- a) Apply parking brake and check if it operates properly.
- b) Check tire pressure and condition.
- c) Check wheels and bearings for wear and damage.
- d) Check location of controls and ensure they work properly.
- e) Verify if steering operates freely.
- f) Activate throttle control lever several times to ensure it operates freely. It must return to idle position when released.
- g) Activate the brake levers and brake pedal to make sure the brakes fully apply. They must fully return when released.
- h) Ensure transmission lever is working then reset in NEUTRAL position.
- i) Check drive chain for adjustment and lubrication.
- j) Check sprockets for wear and damages.
- k) Check fuel, oil and coolant levels.

- l) Check for oil leaks on the engine and the transmission.
- m) Ensure fuel valve is in fully open position (ON).
- n) Clean headlamps and taillight.
- o) Ensure seat is properly tightened.
- p) If you transport cargo, respect load capacity. Ensure cargo is properly secured to the racks.
- q) If you are pulling a trailer or other equipment, ensure it respects the tongue capacity and towing capacity. Ensure trailer is properly secured to hitch.
- r) Look and feel for loose parts while engine is off. Check fasteners.
- s) Ensure the path of travel is free of persons and obstacles.
- t) Check operation of ignition switch, start button, engine stop switch and headlamps.
- u) Start engine, remove parking brake and drive forward slowly a few feet then apply all brakes individually to test them.

Correct any problem you may have found before riding. See an authorized Bombardier ATV dealer as necessary.



## Clothing

Actual weather conditions should help you decide how to dress. However, it is important that the operator always wears the appropriate protective clothing and apparel, including an approved helmet, eye protection, boots, gloves, long sleeved shirt and pants. This type of clothing will provide you protection from some of the minor hazards you may encounter en route. Operator must never wear loose clothing such as a scarf that may get entangled in the vehicle or on tree branches and shrubs. Depending on conditions, antifogging goggles or sun glasses may be required. Different colored lenses available for goggles or sun glasses help you distinguish terrain variations. Sun glasses should only be worn during the daytime.

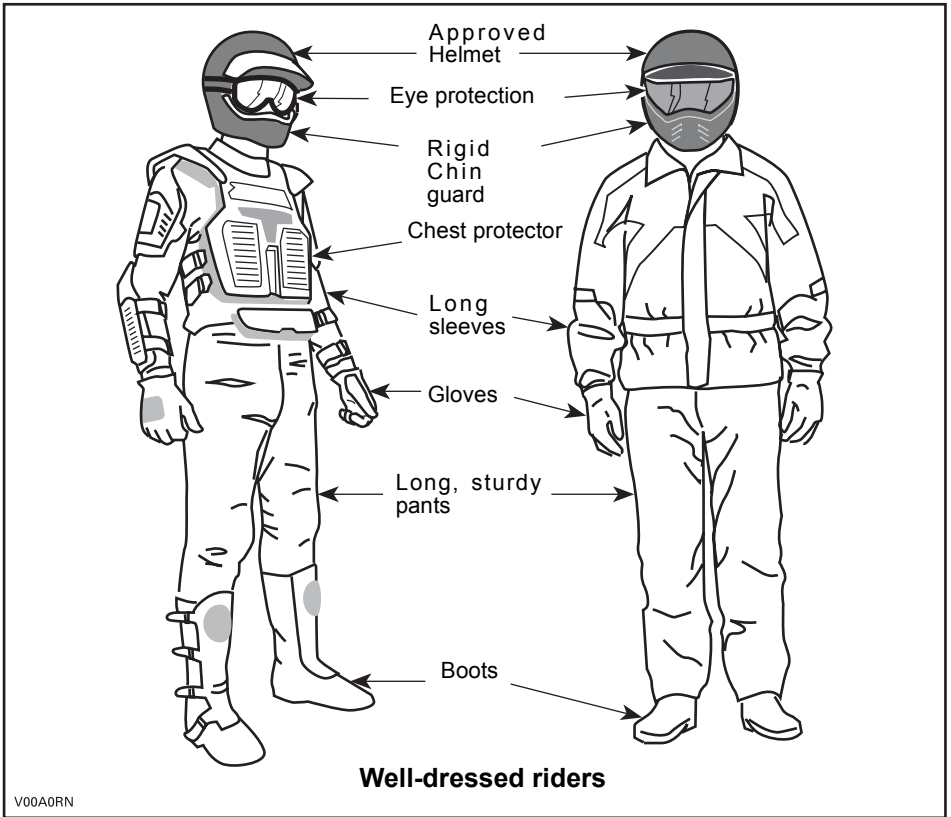

## Carrying Loads

Any load carried on the vehicle's carrying rack(s) will affect the stability and control of the vehicle. For this reason, do not exceed the load limits of the vehicle manufacturer. Always make sure the load is secured and cannot interfere with your proper control. Always be aware that the "load" may slide or fall off and create an accident. Avoid loads that may protrude sideways and get snagged or caught in brush or other obstacles. Avoid covering and obstructing the headlamp or taillight with the cargo.

This vehicle is designed specifically to carry an operator only. Even with a long seat that provides unrestricted operator movements, they are not designed nor intended to carry passenger(s). Carrying passenger (s) will affect the stability and your control of the ATV.

## Hauling a Trailer

Riding this vehicle with a trailer substantially increases the risk of toppling, especially on inclined slopes. If a trailer is used behind the vehicle make sure that its hitch is compatible with the one on the vehicle. Make sure the trailer is horizontal with the vehicle. (In some instances a special extension may have to be installed on the vehicle hitch). Use security chains to secure the trailer with the vehicle. The vehicle may require additional stopping distance if hauling heavy loads, especially on inclined surfaces. Be careful not to skid or slide. When stopped or parked, block the vehicle and trailer wheels from possible movement. Always make sure load is evenly distributed on the trailer. Use caution when disconnecting a loaded trailer; it or its load may topple on you or others. Do not turn at high speeds. Always use low gear range and slow down a lot.

## Working with your vehicle

Your vehicle can help you perform a number of different LIGHT tasks ranging from snow removal to pulling wood or carrying cargo. A variety of accessories are available from your authorized Bombardier ATV dealer. However, always respect the load and capacities of the vehicle. Overloading of the vehicle can overstress the components and cause failure. To prevent possible injury, it is equally important to follow the instructions and warnings that accompany the accessory. Avoid any physical exertion through lifting or pulling of heavy loads or manpowering the vehicle. (Continue to read RECREATIONAL RIDING below).

## Recreational Riding

Respect the rights and limitations of others. Stay away from areas designated for other types of off road use. This includes snowmobile trails, equestrian trails, cross country ski trails, mountain bike trails etc. Never assume there are no other users on the trail. Always stay to the complete right of the trail and do not zig zag to one side of the trail then the other. Be prepared to stop or pull off to the side if another trail user appears in front of you.

Join a local ATV club. They will provide you with a map and advice or inform you where you can ride. If a club does not exist in your area, help start one. Group riding and club activities provide a pleasurable, social experience.

Always keep a safe distance from other riders. Your judgment of speed, terrain conditions, weather, mechanical condition of your vehicle and the “trust in judgment” you have in others around you will help you make a better choice of appropriate safe distance. This vehicle, like any other motorized vehicle, cannot stop “on a dime”.

Before you ride, tell someone where you are planning to travel and your expected time of return. Never consume alcohol or drugs before or while riding!

Depending on the length of your ride, carry additional tools or emergency equipment. Find out where you can get additional gasoline and oil. Be prepared for the possible conditions you may encounter. An emergency first aid kit should always be a consideration.

## **Environment**

One of the benefits of this vehicle is that it can take you off the beaten path away from most communities. However, you should always respect nature and the rights of others to enjoy it. Do not ride in environmentally sensitive areas. Do not drive over forest crops or shrubs... nor cut down trees or take down fencing... nor spin your wheels and destroy the terrain. “Tread Lightly”.

Chasing wildlife is in many areas illegal. Wildlife can die of exhaustion after being chased by a motorized vehicle. If you encounter animals on the trail, stop and observe quietly and with caution. It will be one of the better memories of your life.

Observe the rule... “what you take in, carry out”. Do not litter. Do not start campfires unless you have permission to do so... and then only... away from dry areas. The hazards you may create on the trail may cause injury to others or yourself, even at a later date.

Respect farm lands. Always obtain the permission of the landowner before riding on private land. Respect crops, farm animals and property lines. If you come to a closed gate, close it again after yourself.

Finally, do not pollute streams, lakes or rivers and do not modify the engine or muffling system, or remove any of its components.

## **Design Limitation**

Although the vehicle is exceptionally rugged for its class, it is still a light vehicle by definition and its operation must be restricted to its proper purpose.

The addition of weight to any part of the vehicle changes its gravitational stability and modifies its performance.

## Off-Highway Operation

The very nature of off-highway operation is dangerous. Any terrain, which has not been specially prepared to carry vehicles, presents an inherent danger where angularity, terrain substance and exact steepness are unpredictable. The terrain itself presents a continual element of danger, which must be knowingly accepted by anyone venturing over it.

An operator who takes a vehicle off-road should always exercise the utmost care in selecting the safest path and keeping close watch on the terrain ahead of him. On no account should the vehicle be operated by anyone who is not completely familiar with the driving instructions applicable to the vehicle, nor should it be operated on steep or treacherous terrain.

## General Operating and Safety Precautions

Care, caution, experience and driving skill are the best precautions against the hazards of vehicle operation.

Whenever there is the slightest doubt that the vehicle can safely negotiate an obstacle or a particular piece of terrain, always choose an alternate route.

In off-road operation, power and traction, not speed, are important. Never drive faster than visibility and your own ability to select a safe route permit.

Constantly watch the terrain ahead for sudden changes in slopes or obstacles, such as rocks or stumps, that may cause loss of stability, resulting in tipover or rollover.

Never operate the vehicle if the controls do not function normally.

When operating in reverse, check that the path behind the vehicle is free of people or obstacles. Proceed slowly and avoid sharp turns.

When stopped or parked, always apply the parking brake. This is especially important when parking on a slope. On very steep inclines or if the vehicle is carrying cargo, the wheels should be blocked using rocks or bricks. Remember to turn the fuel valve to the closed position.

## Uphill Driving

Due to configuration, this vehicle has excellent climbing ability, so much so that tip-over is possible before traction is lost. For example, it's common to encounter terrain situations where the top of the hill has eroded to a point that the hill peak rises very sharply. The vehicle can readily negotiate such a condition, however, in doing so, when the front of the vehicle is driven to a point that the vehicle's balance changes rearward tipover can occur.

The same situation may apply if an embedded object causes the front of the vehicle to climb more than desired. If such a situation occurs take an alternate route. Be aware of side hilling dangers when doing so.

It is also wise to know the terrain condition on the other side of the hill or bank. All too often there exists a sharp drop-off that is impossible to negotiate or descend.

## Downhill Driving

This vehicle can climb slopes that are steeper than it can safely descend. Therefore, it is essential to assure that a safe route exists to descend a slope before you climb it.

Decelerating while negotiating a slippery downhill slope could “toboggan” the vehicle. Maintain steady speed and/or accelerate slightly to regain control.

## Side hilling

Whenever possible, such operation should be avoided. If necessary, do so with extreme caution. Side hilling on steep inclines could result in rollover. In addition, slippery or unfirm surfaces could result in uncontrollable side sliding. Do not attempt to turn the vehicle downhill with the slide. Avoid all objects or depressions that will intensify the raising of one side of the vehicle higher than the other, thus causing rollover.

## Drop-Offs

This vehicle will “bottom-out” and usually stop if either the front or rear wheels are driven over a drop-off. If the drop is sharp or deep, the vehicle will nose dive and tipover.

### **WARNING**

Avoid negotiating drop-offs. Reverse and select an alternate route.

## Riding Techniques

Riding your vehicle too fast for the conditions may result in injury. Apply only enough throttle to proceed safely. Statistics show that high speed turns usually result in mishaps and injury. Always remember that this vehicle is heavy! Its pure weight alone may entrap you should it fall and pin you down.

This vehicle is not designed for jumping nor can it, or you, absorb the energy of high impacts such as jumping. Performing “wheelies” can cause the vehicle to flip over onto you. Both practices have a high risk for you and should be avoided at all times.

To maintain proper control it is strongly advised that you keep your hands on the handlebar and within easy reach of all controls. The same holds true for your feet. To minimize the possibility of any leg or foot injury, keep your feet on the footrests at all times. Do not direct your toes outwards nor place your foot out to assist turning as they can be hit or snagged by passing obstacles or may contact the wheels.

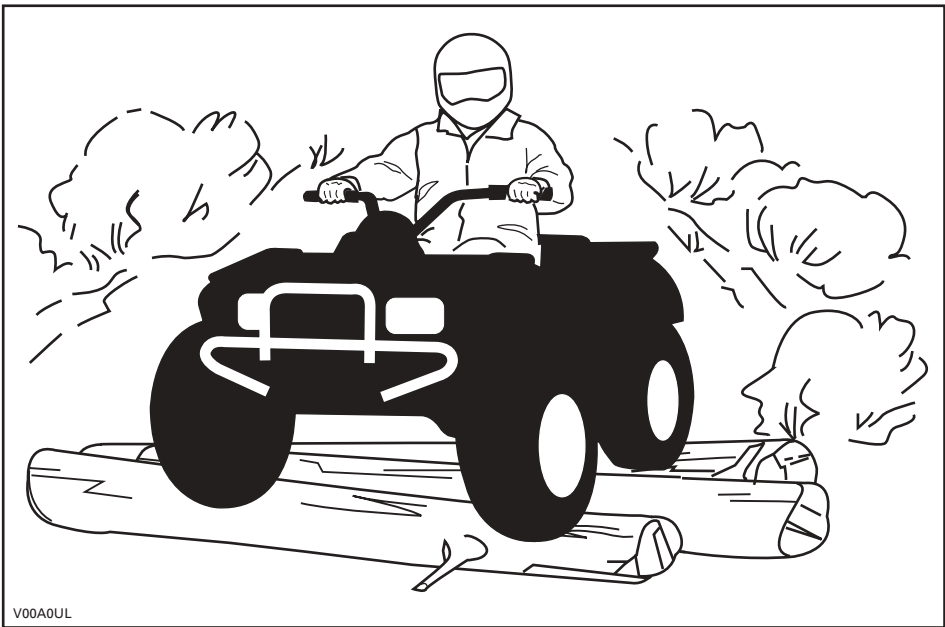

V00A0UL

Even though there is an adequate suspensions system on an this vehicle there are “washboard” or rough terrain conditions that will make you feel uncomfortable and even cause back injury. “Posting” or riding in a crouched position will often be required. Slow down and allow your flexed legs to absorb impact.

This vehicle is not designed for riding on roads or highways. In most places it is an illegal practice. Riding your vehicle on roads or highways could cause a collision to occur with another vehicle. ATV tires are not suited for paved road use. Pavement may seriously affect the handling and control of the vehicle. Riding on roads or soft shoulders may confuse other road users, especially if your lights are on. If you have to cross a road, the lead driver should get off his vehicle then observe and give directions to the other riders. The last person after crossing then assists the lead driver to cross. Do not travel sidewalks. They are designated for pedestrian use.

Water can be a unique hazard. If it is too deep the vehicle may “float” and topple. Check the water depth and current before you attempt to cross any water. Water should not go above the footrest. Be wary of slippery surfaces such as rocks, grass, logs, etc., both in the water and on its banks. A loss of traction may occur. Do not attempt to enter the water at high speed. The water will act as a brake and could throw you.

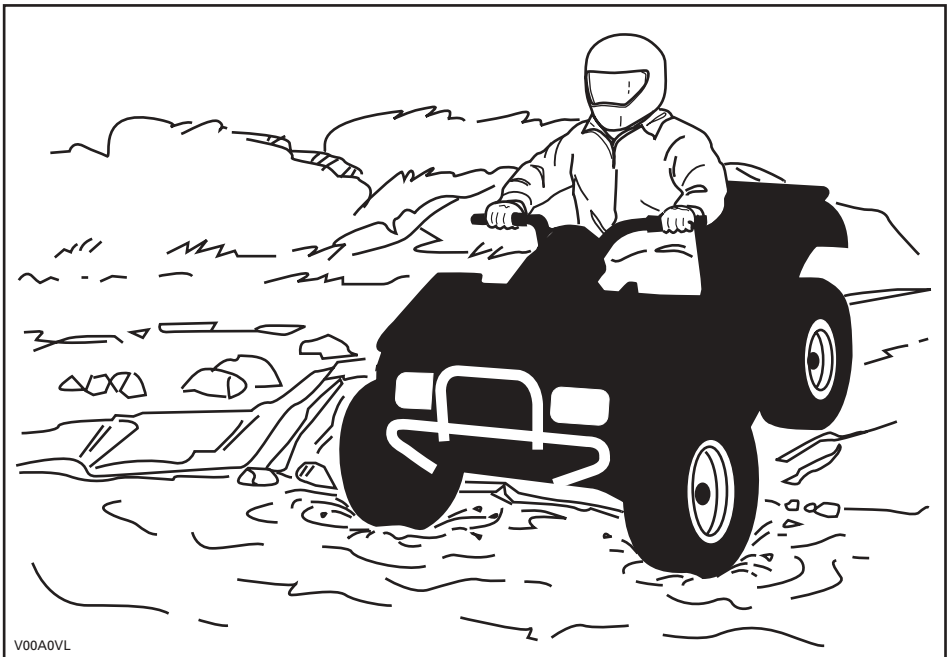

V00A0VL

Water will affect the braking ability of your vehicle. Make sure you dry the brakes by applying them several times after the vehicle leaves the water.

Mud or marsh lands may be encountered near water. Be prepared for sudden “holes” or changes in depth. Similarly so, be watchful of hazards such as rocks, logs, etc., partially covered by vegetation.

If your trip crosses frozen waterways, make sure that the ice is thick enough and sound enough to support the total weight of yourself, the vehicle and its load. Be ever watchful of open water... it is a sure indication that the ice thickness will vary. If in doubt, do not attempt to cross.

Ice will also affect the control of an vehicle. Slow down and do not “gun” the throttle. This will only result in spinning of the tires and possible tipover of the vehicle. Avoid rapid braking. This again will possibly result in an uncontrolled slide and tipover of the vehicle. Slush should be avoided at all times since it could block the operation or controls of the vehicle.

Sand and riding on sand dunes or on snow is another unique experience but there are some basic precautions that should be observed. Wet, deep or fine sand/snow may create a loss of traction and cause the vehicle to slide, drop off or become “bogged” down. If this occurs look for a firmer base. Again, the best advice is to slow down and be watchful of the conditions.

When riding in sand dunes it is advisable to equip the ATV with an antenna type safety flag. This will help make your location more visible to others over the next sand dune. Proceed carefully should you see another safety flag ahead. Since the antenna type safety flag can snag and rebound on your body if caught, do not use it in areas where there are low hanging branches or obstacles.

Riding on loose stones or gravel is very similar to riding on ice. They will affect the steering of the vehicle... possibly causing it to slide and tipover especially at high speeds. In addition, braking distance may be effected. Remember that “gunning” the throttle or sliding may cause loose stones to be ejected rearwards into the path of another rider’s way. Never do it deliberately.

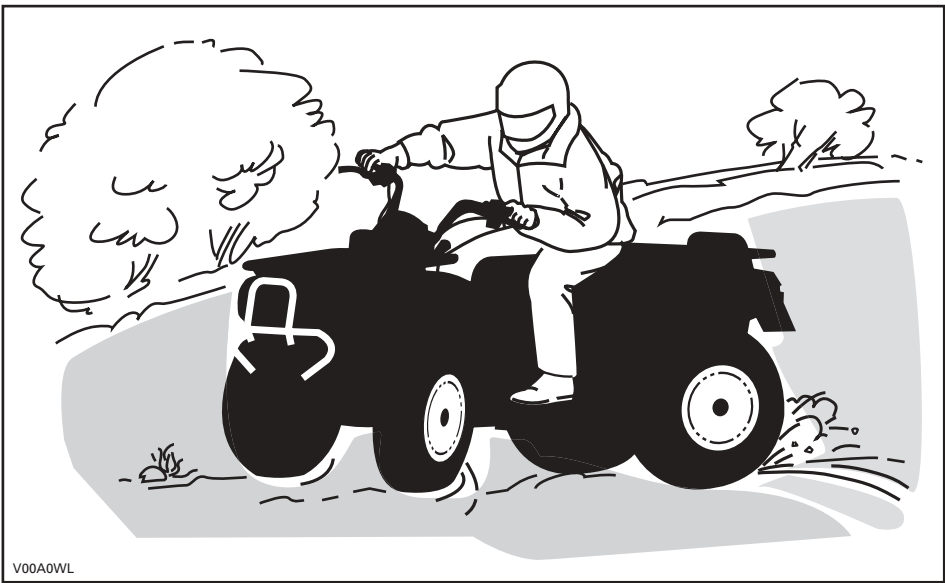

V00A0WL

If you do get into a slide or skid, it may help to turn the handlebar into the direction of the skid until you regain control. Never jam the brakes and lock the wheels.

Respect and follow all posted trail signs. They are there to help you and others.

Obstacles in the "trail" should be traversed with caution. This includes loose rocks, fallen trees, slippery surfaces, fences, posts, and embankments and depressions. You should avoid them whenever possible. Remember that some obstacles are too large or dangerous to cross and should be avoided. Small rocks or fallen trees may be safely crossed... approach at a 90° angle. Stand on the footrests while keeping your knees flexed. Adjust speed without losing momentum and do not "gun" the throttle. Hold handgrips firmly. Place your body weight rearwards and proceed. Do not try to lift the ATV front wheels off the ground. Be aware that the object may be slippery or may move while crossing.

When driving on hills or slopes two things are highly important... be prepared for slippery surfaces or terrain variations and obstacles and... use proper body positioning.



## Uphill

Keep your body weight forward towards the top of the hill. Keep your feet on the footpegs and shift into low gear then accelerate and when necessary, change gear quickly as you climb. Do not over-speed since this may cause the front of the vehicle to lift from the ground and fall back on you. If the hill is too steep and you cannot proceed or the vehicle begins to roll backwards, apply the brake, being careful not to slide. Dismount then use the "U" turn or "K" turn (while walking back, next to the vehicle on the up hill side and with a hand on the brake lever, slowly back the rear of the vehicle toward the top of the hill then drive downhill). Always walk or dismount on the upside of the slope while keeping clear of the vehicle and its rotating wheels. Do not try to hold on to an vehicle if it begins to topple. Stay clear. Do not ride over the crest of the hill at high speed. Obstacles, including sharp drop-offs, may exist.

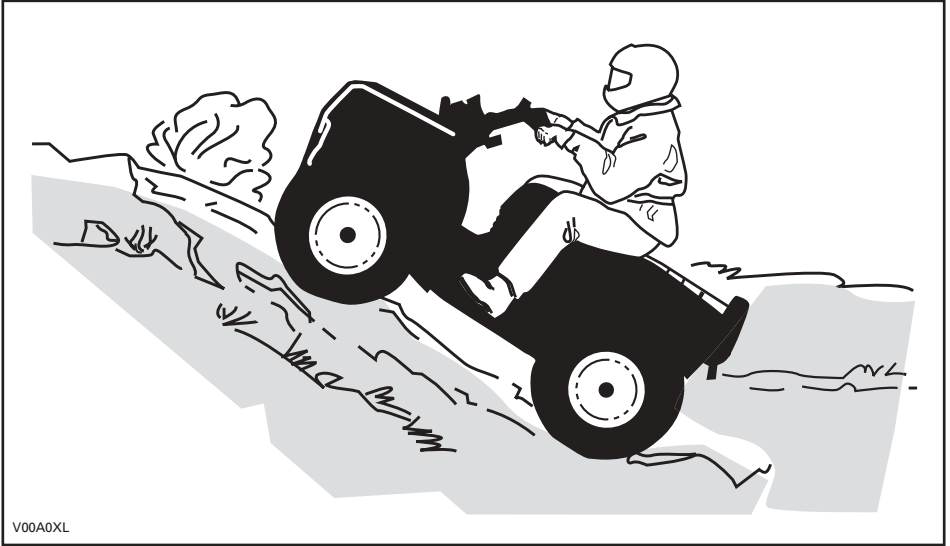

## Downhill

Keep your body weight rearwards. Apply the brake gradually to prevent skidding. Do not "coast" down the slope using solely engine compression or in neutral gear.

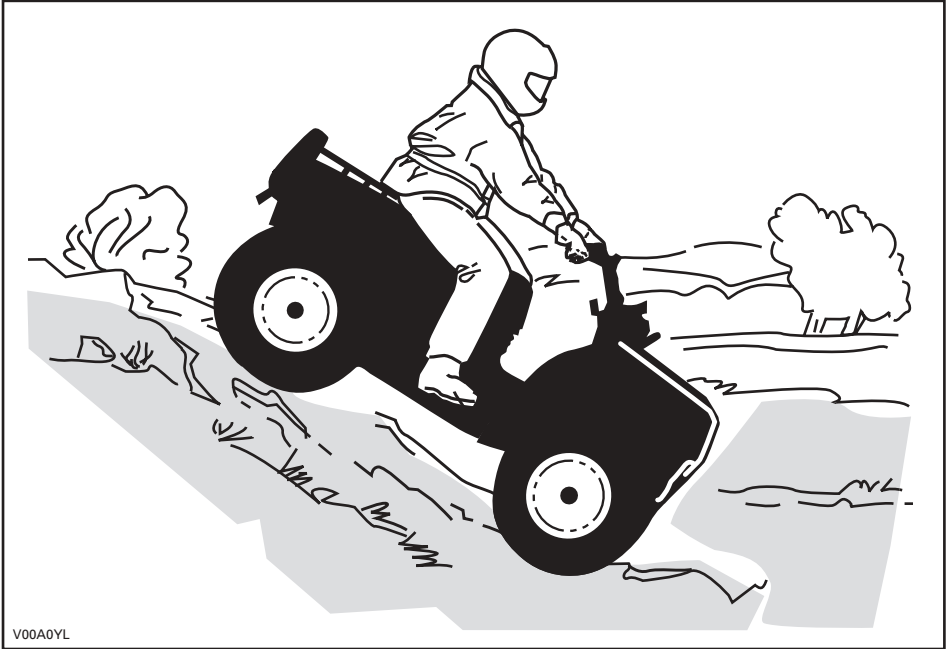

V00A0YL

## Side hilling

This is one of the most risky types of riding since it may drastically change the balance of the vehicle. It should be avoided wherever possible. If it is necessary to do so however, it is important that you ALWAYS keep your body weight on the upside of the slope... and be prepared to dismount on that side should the vehicle begin to topple. Do not try to stop or save the vehicle from damage.



## Routine Maintenance

Once your ride is completed it is wise to remove any build up of snow, ice, mud and grime. Not only will this help you keep the vehicle longer and in good condition for resale but will eliminate potential hazards the next time you use the vehicle. Wash your vehicle in warm soapy water then allow it to dry. (A towel may help). Do not wash the vehicle outside during freezing weather. Apply appropriate lubrication as described in the MAINTENANCE section.

Part of your responsibility towards safety is to respect the contents of this Operator's Guide. It provides valuable advise on how to properly take care of your ATV. If further assistance is required your authorized Bombardier ATV dealer is always willing to help.

Modification of the vehicle to increase speed and performance may violate the terms and conditions of your vehicle limited warranty. In addition, certain modifications including the removal of engine or exhaust components are illegal under most laws.

Changing the wheel and/or tire size may affect the stability of the ATV. Incorrect tire pressure may lead to blow outs or cause a tire to move around on its rim and become lost or damaged. Wheels or tires which are damaged should always be replaced.

# LOCATION OF THE IMPORTANT LABELS

The following labels are on your vehicle and they should be considered permanent parts of the vehicle. If missing or damaged, they can be replaced free of charge. See an authorized Bombardier ATV dealer.

NOTE: The following illustrations used in this Operator's Guide are a general representation only. Your model may differ.

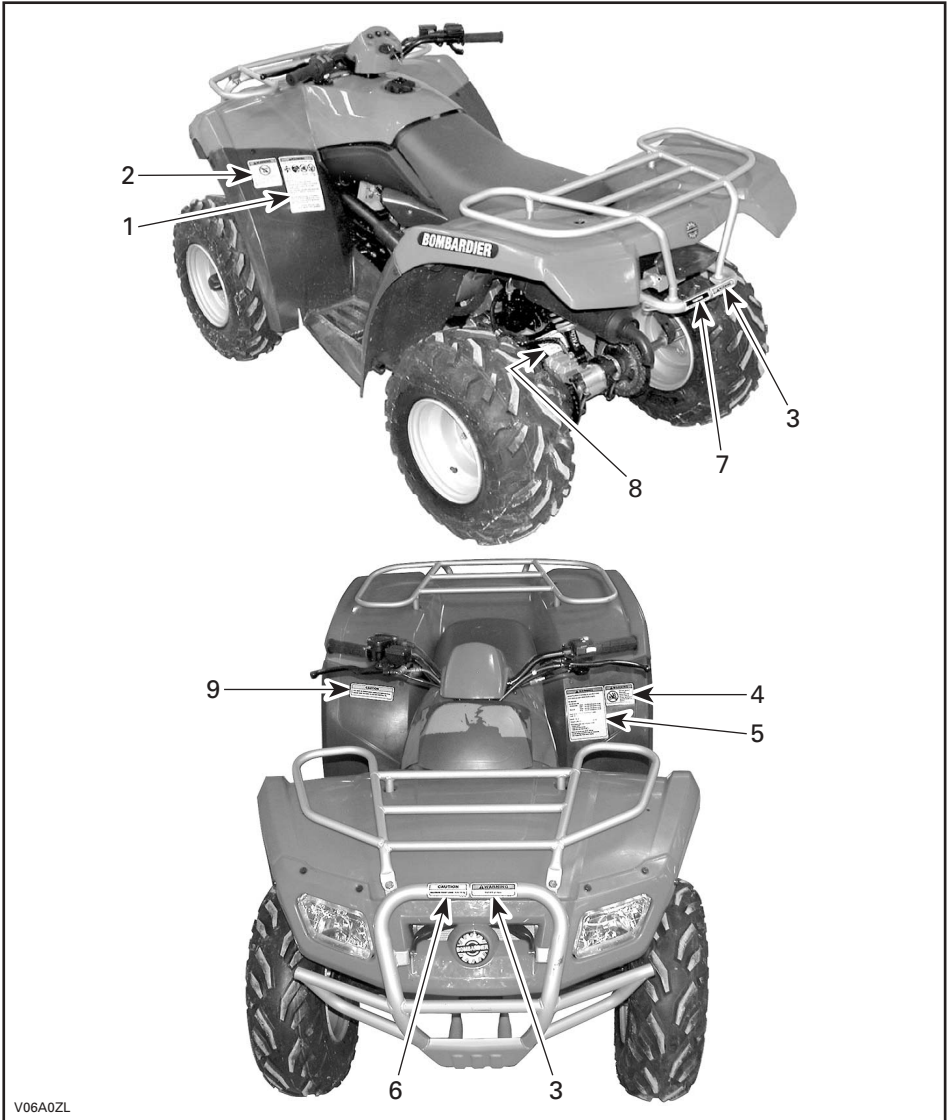

V06A0ZL

## LABEL 1

**⚠ WARNING**

Improper ATV use can result in SEVERE INJURY or DEATH.



**ALWAYS USE AN APPROVED HELMET AND PROTECTIVE GEAR.**

**NEVER USE ON PUBLIC ROADS.**

**NEVER CARRY PASSENGERS**

**NEVER USE WITH DRUGS OR ALCOHOL.**

**NEVER operate:**

- without proper training or instructions.
- at speeds too fast for your skills or the conditions.
- on public roads - a collision can occur with another vehicle.
- with a passenger - passengers affect balance and steering and increase risk of losing control.

**ALWAYS:**

- use proper riding techniques to avoid vehicle overturns on hills and rough terrain and in turns.
- avoid paved surfaces - pavement may seriously affect handling and control.

**LOCATE AND READ OPERATOR'S GUIDE. FOLLOW ALL INSTRUCTIONS & WARNINGS.**

704 900 001

V01M01Z

## LABEL 2

**⚠ WARNING**

**UNDER 16**

Operating this ATV if you are under the age of 16 increases your chance of SEVERE INJURY or DEATH. NEVER operate this ATV if you are under age 16.

704 900 011

V01M02Z

## LABEL 3

**⚠ WARNING**

**NEVER sit here.**

704 900 017

V01M050

## LABEL 4

**⚠ WARNING**



**NEVER ride as a passenger. Passengers can cause a loss of control, resulting in SEVERE INJURY or DEATH.**

704 900 005

V01M07Z

## LABEL 5

**⚠ WARNING**

Improper tire pressure or overloading can cause loss of control. Loss of control can result in SEVERE INJURY or DEATH.

**TIRE PRESSURE**

- Set with tires cold:
- Recommended:  
FRONT: 24.2 kPa,(0.25 kgf/cm<sup>2</sup>). 3.5 psi  
REAR: 24.2 kPa,(0.25 kgf/cm<sup>2</sup>). 3.5 psi
- Minimum:  
FRONT: 20.7 kPa,(0.21 kgf/cm<sup>2</sup>). 3.0 psi  
REAR: 20.7 kPa,(0.21 kgf/cm<sup>2</sup>). 3.0 psi
- Never set tire pressure below minimum. It could cause the tire to dislodge from the rim.

**LOADING / TRAILER TOWING**

- Cargo or trailer affect stability and handling.
- When loading with cargo or towing a trailer:
  - Reduce speed.
  - Allow more room to stop.
  - Avoid hills and rough terrain.
- Maximum Vehicle Load: 386 lb. (175 kg). Includes weight of operator, cargo and accessories (and if applicable, trailer tongue weight).

704 900 229

V06M0AY

## LABEL 6

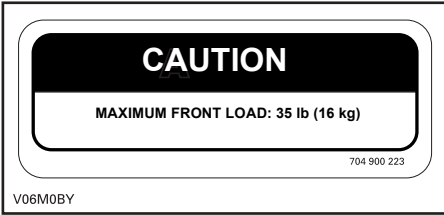

## LABEL 7

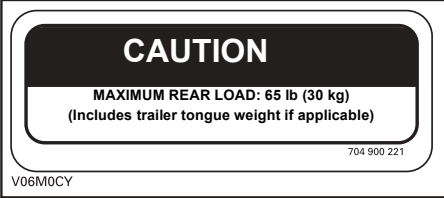

## LABEL 8

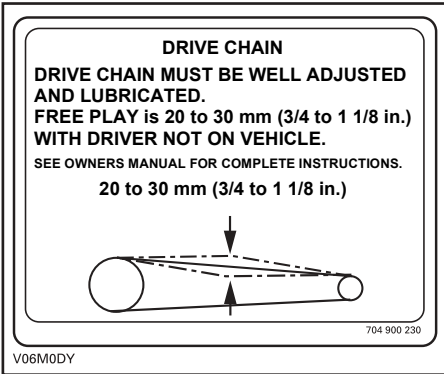

## LABEL 9

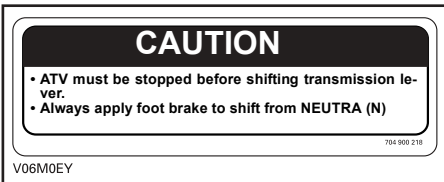

# ***VEHICLE INFORMATION***

# HOW TO IDENTIFY YOUR ATV

The main components of your vehicle (engine and frame) are identified by different serial numbers. It may sometimes become necessary to locate these numbers for warranty purposes or to trace your vehicle in the event of loss. These numbers are required by the authorized Bombardier ATV dealer to complete warranty claims properly. No warranty will be allowed by BRP if the engine identification number (EIN) or vehicle identification number (VIN) is removed or mutilated in any way. We strongly recommend that you take note of all the serial numbers on your vehicle and supply them to your insurance company.

## Vehicle Identification Number Location



1. VIN (Vehicle Identification Number)
2. Model



# Engine Identification Number Location

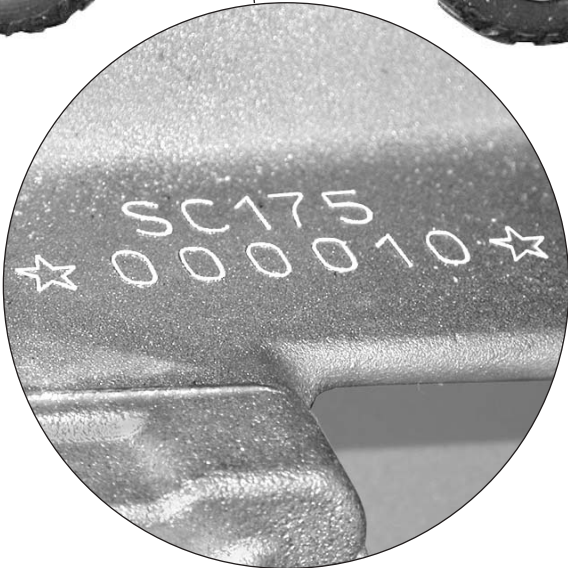

V06A18L

---

# NOISE EMISSION CONTROL SYSTEM REGULATION

## Tampering with Noise Control System Is Prohibited!

U.S. Federal law and Canadian provincial laws may prohibit the following acts or the causing there of:

1. The removal or rendering inoperative by any person other than for purposes of maintenance, repair or replacement of any device or element of design incorporated into any new vehicle for the purpose of noise control prior to its sale or delivery to the ultimate purchaser or while it is in use or
2. The use of the vehicle after such device or element of design has been removed or rendered inoperative by any person.

## Among those Acts Presumed to Constitute Tampering Are the Acts Listed Below:

1. Removal or alteration or the puncturing of the muffler or any engine component which conducts removal of engine exhaust gases.
2. Removal or alteration or the puncturing of any part of the intake system.
3. Replacing any moving parts of the vehicle or parts of the exhaust or intake system, with parts other than those specified by the manufacturer.
4. Lack of proper maintenance.

---

## EMISSION REQUIREMENTS

The California Air Resources Board (CARB) requires that your ATV complies with applicable exhaust emissions standards during its useful life, when operated and maintained according to the instructions supplied.

A non-compliance Red Label (as well as a Green Label) is obtained annually during California Vehicle registration. The appropriate label is denoted by the vehicle identification number (in the 8th character detailed herein).

VEHICLE CATEGORY	VIN 8 <sup>th</sup> CHARACTER
Non-complying Red Label	Must denote a C or 3
Complying Green Label	Any alphanumeric designation other than a C or 3

# CONTROLS/COMPONENTS/INSTRUMENTS

NOTE: Some controls/instruments/equipment are optional.

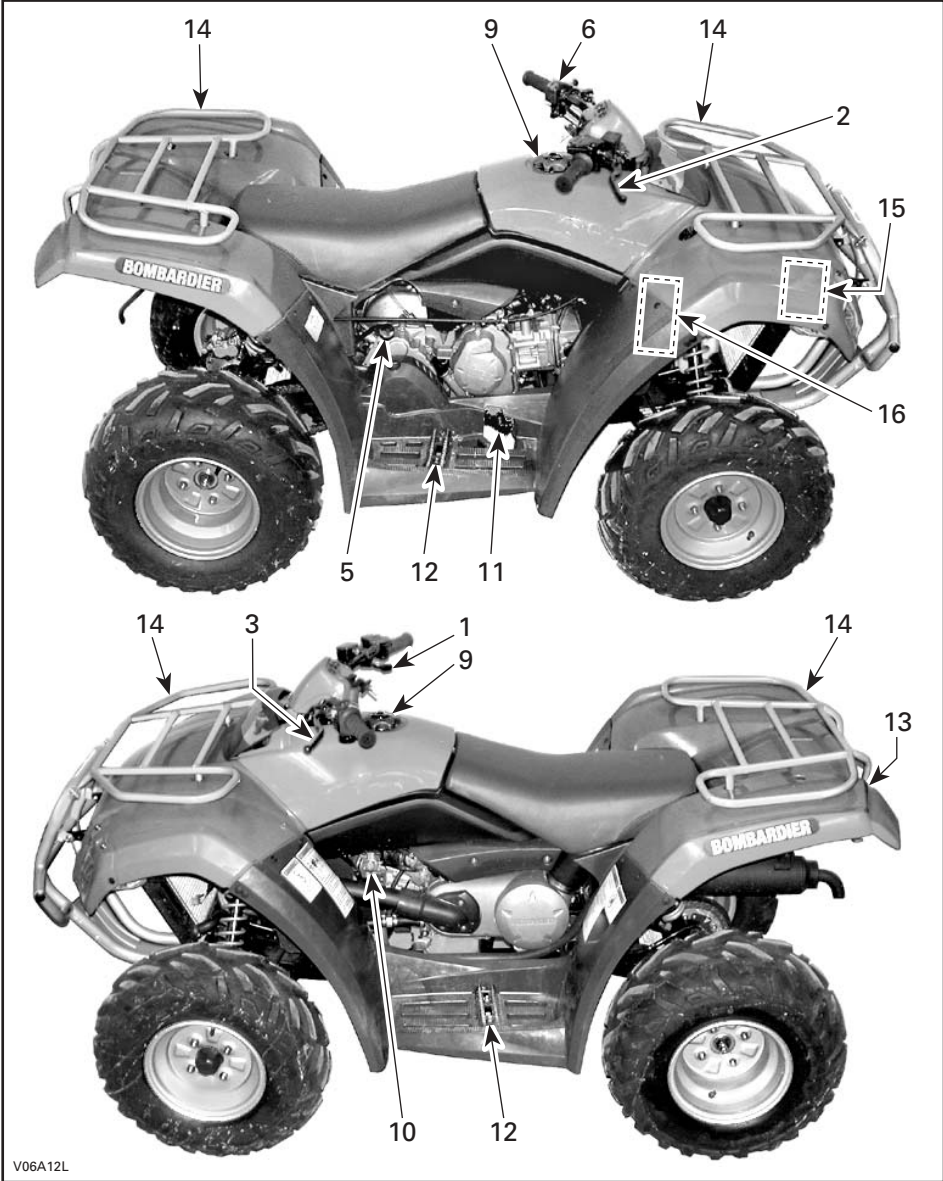

V06A12L

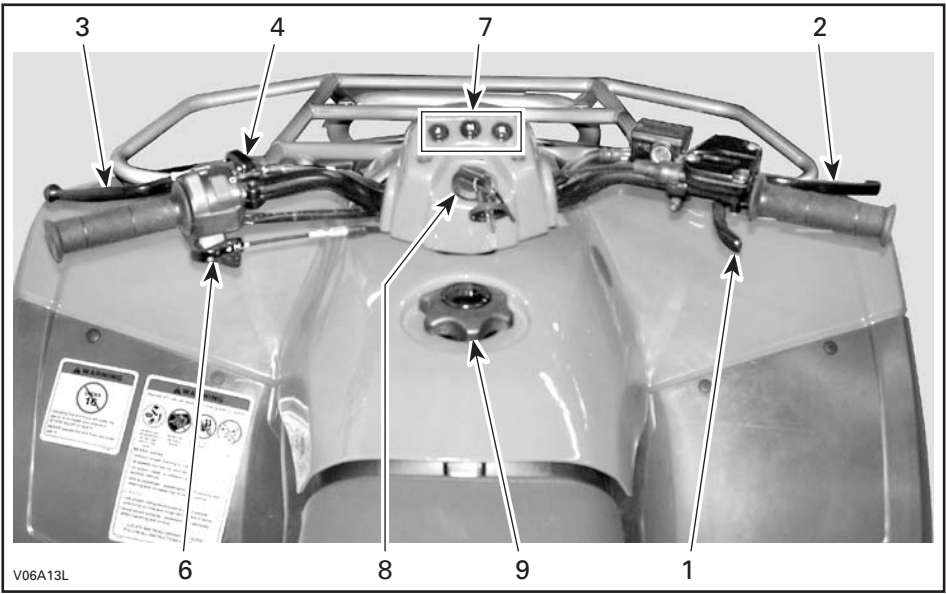

While reading this Operator's Guide, remember that:

## **WARNING**

Indicates a potential hazard that, if not avoided, could result in serious injury or death.

**NOTE:** This section gives basic functions of the various controls of your ATV. For more details of how to operate one control in conjunction with some others, refer to OPERATING INSTRUCTIONS further in this section.

### **1) Throttle Lever**

Located on the right side of handlebar. When pushed, it increases the engine speed that allows the engagement of the transmission on the selected gear.

When released, the engine speed should return automatically to idle and the vehicle will gradually slow down.

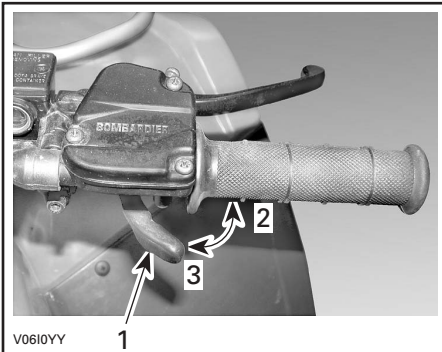

1. *Throttle lever*
2. *To accelerate*
3. *To decelerate*

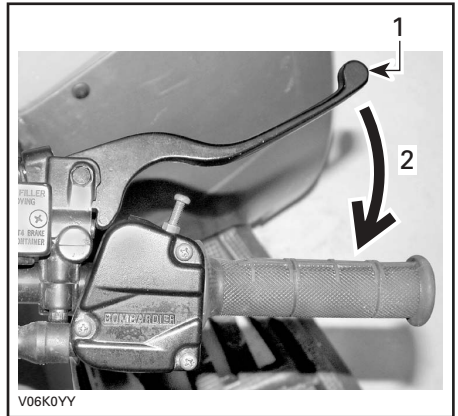

1. *Brake lever*
2. *To apply brake*

### **2) Front Brake Lever**

Located on the right side of handlebar. When compressed, the brake is applied. When released, it should automatically return to its original position. Braking effect is proportional to the force applied on the lever and to the type and condition of the terrain.

### 3) Rear Brake Lever

Located on the left side of handlebar. When compressed, the brake is applied. When released, it should automatically return to its original position. Braking effect is proportional to the force applied on the lever and to the type and condition of the terrain.

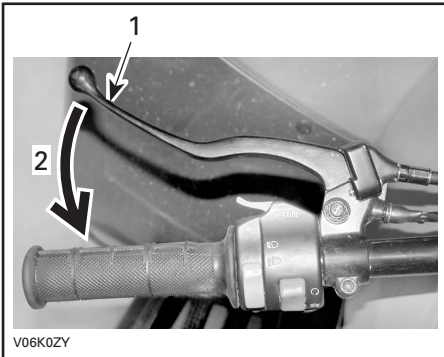

1. Clutch lever
2. To disengage

### 4) Brake Lever Lock

Located on left side of handlebar on the rear brake lever. When applied, it prevents the vehicle from moving. Useful when the brake needs to be locked for example such as doing a K-turn, during transportation or when the vehicle is not in operation.

## WARNING

Always use the brake lever lock and engage the HI position on the transmission lever when the vehicle is not in operation.

## WARNING

Make sure brake lever lock is fully disengaged before operating the ATV.

When you ride the vehicle, brakes that are caused to drag by a continuous pressure on the lever may cause damage to the brake system and cause loss of braking capacity and/or fire.

To engage mechanism: Squeeze brake lever and push down the brake lever lock with a finger. Brake lever is now compressed and applying rear brakes.

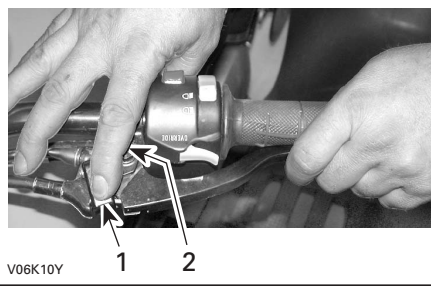

1. Brake lever lock
2. Press to apply parking break

To release mechanism: Squeeze brake lever. Lever lock should automatically return to its original position. Brake lever should return to rest position. Always release brake lever lock before riding.

### 5) Transmission Lever

Located on the right side of vehicle, at the rear of the engine. A 3-position lever: R, N, and H. To change the transmission position, completely stop vehicle then move lever to the desired position while moving lever upward or downward. Do not force lever. If unable to shift, gently apply throttle and release it immediately then, wait engine RPM returns to stable idle and try again.

**CAUTION:** Always completely stop the vehicle and apply the brake prior to moving the transmission lever.

R: Reverse

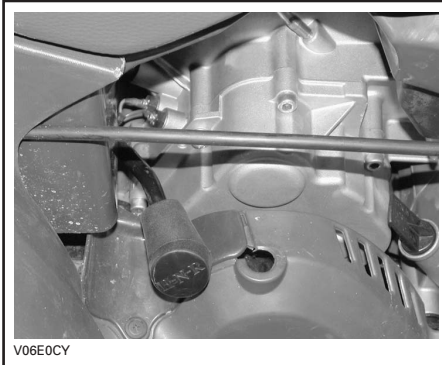

**REVERSE POSITION**

This allows the vehicle to go backward. This vehicle is equipped with a reverse speed limiter system. Refer to **VERRIDE BUTTON** further, for more informations.

**⚠ WARNING**

When moving vehicle in reverse, ensure the path behind is clear of obstacles or bystanders. Remain seated.

N: Neutral



**NEUTRAL POSITION**

This position disengages the transmission to allow manual vehicle movement or towing.

H: High gear

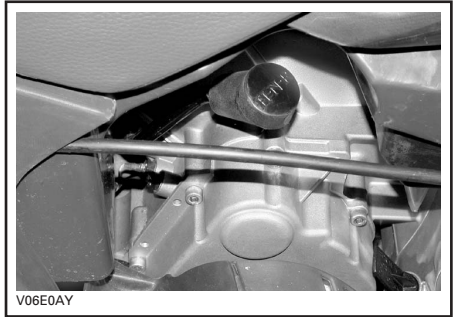

**HI POSITION**

This selects the high speed range of the transmission in the gearbox. It is the normal driving speed range. It allows the vehicle to reach its maximum speed.

## 6) Multi-function Switch

The multifunction switch is located on the left side of the handlebar.

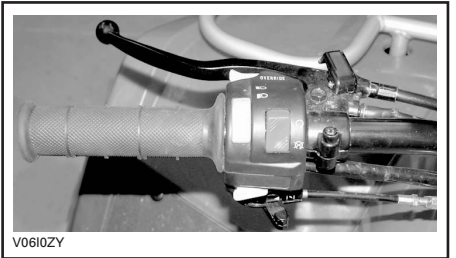

The controls located on this multi-function switch are:



## Headlamp Switch

Located on the top of multi-function switch. Place switch to LO for the low beam and tail-light. Place switch to HI for the high beam and taillight.

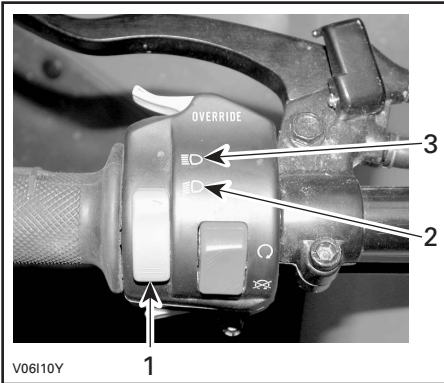

1. Headlamp switch
2. Low beam position
3. High beam position

NOTE: Place ignition switch to ON “without light” position to close the headlamp.

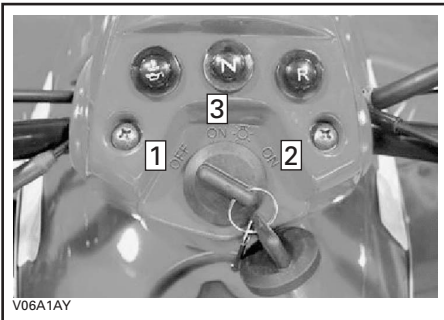

1. OFF
2. ON position “without light”
3. ON position “with light”

## Engine Stop Switch

Located at the middle of multi-function switch, at the right of headlamp switch. The engine will run over but will not start if the engine stop switch is turned to OFF position.

This switch can be used to stop engine and as an emergency control.

NOTE: While engine can be stopped by turning ignition key OFF, we recommend the engine be stopped by the engine stop switch.

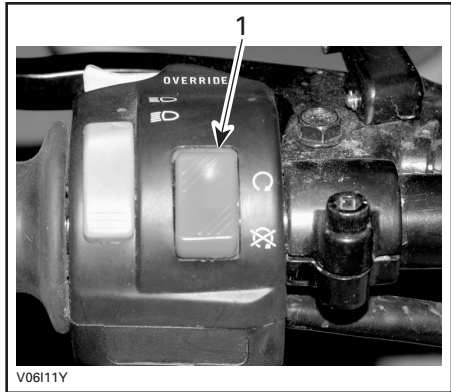

1. Engine stop switch

## Start Button

Located below engine stop switch.

To start engine, place the engine stop switch to RUN.

Press and hold the start button. Release immediately after engine is started.

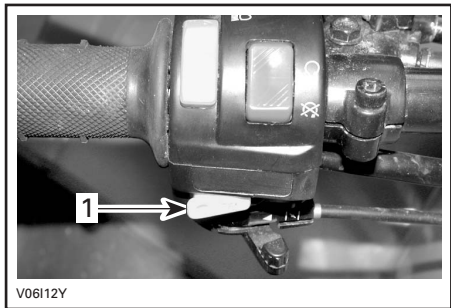

1. Start button



To stop engine, fully release throttle lever then use the engine stop switch.

## Override Button

Located in front of multi-function switch.

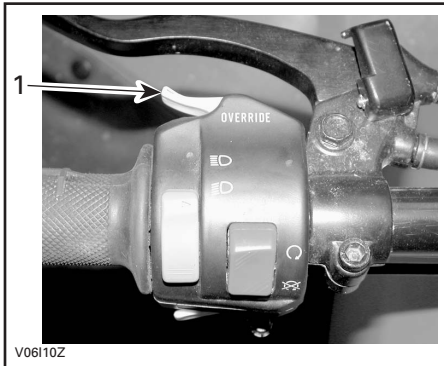

1. Override button

This button is used to override the reverse speed limiter system and while power backing up. To do this, squeeze and hold the override button then activate the throttle lever. Release the button when the maneuver is completed.

### **WARNING**

Never activate the override button while throttle is open as loss of control may result, causing severe personal injury or death.

## Choke Lever

Located at bottom of multifunction switch. This device features a variable lever to ease cold start.

Position OFF is for normal use with a warm engine.



**CHOKE LEVER IN THE OFF POSITION**

The full choke position is used for lower engine temperature.



**CHOKE LEVER IN THE FULL CHOKE POSITION**

The other positions between OFF and FULL position, will be use depending on the engine temperature.

## 7) Indicator Lamps

### Engine Temperature/Oil Pressure Lamp (red)



This light turns on when the ignition switch is turned ON and remains on until the engine is running.

When this indicator light is ON, it indicates the engine is overheating or a low oil pressure condition of the engine.

If engine overheats, refer to ENGINE OVERHEAT in SPECIAL PROCEDURES.

**CAUTION:** If the light does not turn off right after engine starting, stop the engine. See an authorized Bombardier ATV dealer. Do not use the vehicle until repaired.

### Reverse Lamp (red)



When lit, it indicates the transmission is in reverse position.

### Neutral Lamp (green)



When lit, it indicates the transmission is in reverse position.

## 8) Ignition Switch

Located in the middle of cluster.

Key-operated, 3-position switch: OFF, ON without lights and ON with lights.

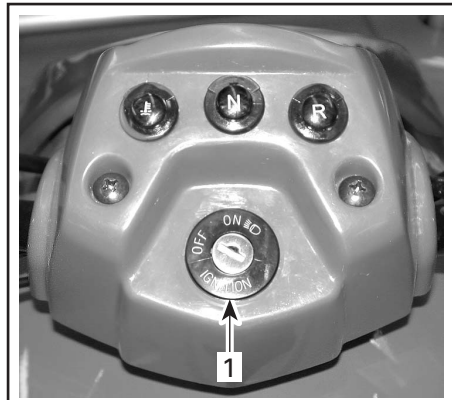

V06G00Y

### 1. Ignition switch

Insert key in switch and turn to the desired position. To remove key, turn key to OFF then pull it out.

The ON with lights position, turns on all lights with either the engine running or not. Remember that having the lights on without the engine running discharges the battery. Always turn ignition to OFF after engine has been stopped.

**NOTE:** While engine can be stopped by turning ignition key OFF, we recommend the engine be stopped by pushing the engine stop switch.

## 9) Fuel Tank Cap

Unscrew counterclockwise and remove cap to allow fuel tank filling then fully tighten clockwise.

### **WARNING**

Always stop engine before refueling. Open cap slowly. If a differential pressure condition is noticed (whistling sound heard when loosening fuel tank cap) have vehicle inspected and/or repaired before further operation. Fuel is flammable and explosive under certain conditions. Never use an open flame to check fuel level. Never smoke or allow flame or spark in vicinity. Always work in a well-ventilated area. Never top up the fuel tank before placing the vehicle in a warm area. As temperature increases, fuel expands and may overflow. Always wipe off any fuel spillage from the vehicle.

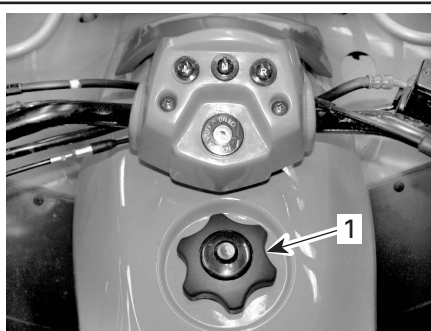

V06F0RY

1. Fuel tank cap

## 10) Fuel Valve

Located on left side of vehicle under seat. 3-position rotary valve: OFF, ON, RES. Rotate the tab to align its pointer with ON, OFF or RES.

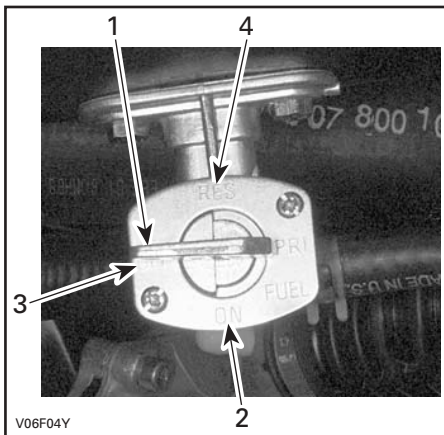

V06F04Y

1. Align this pointer toward the desired position
2. ON position
3. OFF position
4. RES position

### OFF

Stops fuel supply to carburetor.

**CAUTION:** Turn valve to OFF position when ATV is not being operated or when transporting.

### ON

Allows fuel to flow to carburetor. This is the normal position for operation of the vehicle.

## RES (RESERVE)

When fuel is exhausted in the fuel tank when in the ON position, an emergency supply of fuel is available by turning the tab to RES. The reserve contains approximately 30% of the fuel tank capacity. Use only this position when the ON supply is empty.

When down to the reserve, refuel as soon as possible. Ensure to turn the valve back to the ON position after refuelling.

**CAUTION:** Improper opening of fuel valve will restrict the flow of fuel. Make sure valve is fully opened while running.

## 11) Rear Brake Pedal

Located on the right footrest. When pressed down, the rear brake is applied. When released, it should return to its original position. Braking effect is proportional to the force applied on the pedal and to the type and condition of the terrain.

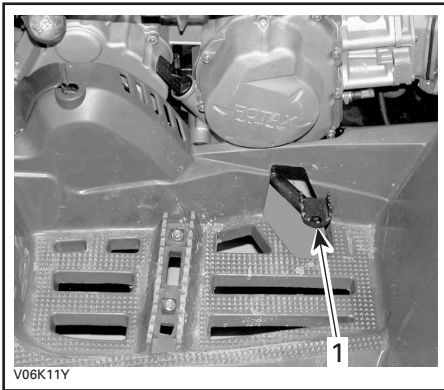

1. Rear brake pedal

## 12) Footpeg

Located on footrest. Use this area to maintain your feet stable.

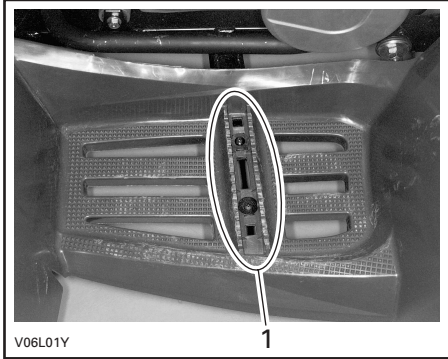

1. Footpeg

## 13) Tool Box

Located at the rear of the vehicle, under bumper. The toolbox contains tools for basis maintenance and this Operator's Guide.

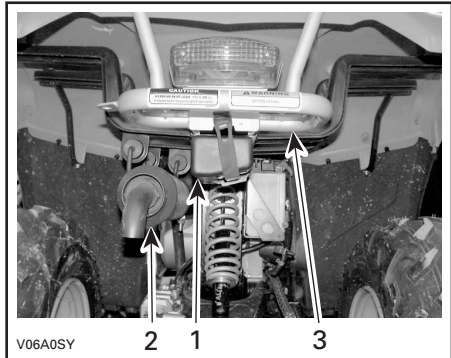

1. Tool box  
2. Muffler  
3. Rear bumper

The tools included in the tool box are:

- pliers (1)
- screwdriver (1)
- open wrench 10/13 mm (1)
- open wrench 15/17 mm (1)
- socket wrench 10/13 mm (1)
- socket wrench 16/18 mm (1)
- tire pressure gauge (1)
- adjuster lock for drive chain adjustment (1)
- fuse 15 A (1).

#### 14) Front/Rear Cargo Racks

Located on top of chassis at front and rear. Convenient racks to carry material.

### WARNING

Ensure to properly secure material to racks. Do not overload. Ensure load does not interfere with visibility and/or steering. Do not carry passenger(s).

Refer to SPECIFICATIONS for carrying loads and cargo weight distribution recommendations.

#### 15) Radiator Cap

Located under front fender. It provides access to the radiator filling neck.

### WARNING

In order to avoid potential burns, do not remove the radiator cap if the engine is hot.

Turn radiator cap counterclockwise to remove. When finished, properly reinstall radiator cap.

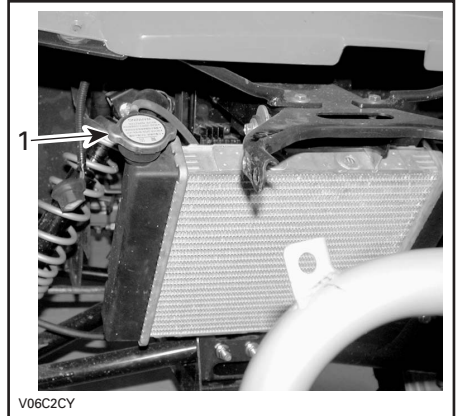

1. Radiator cap

#### 16) Fuse

The electrical system is protected with a fuse. Refer to MAINTENANCE section for details. The fuse holder is located behind right front shock, near coolant reservoir.

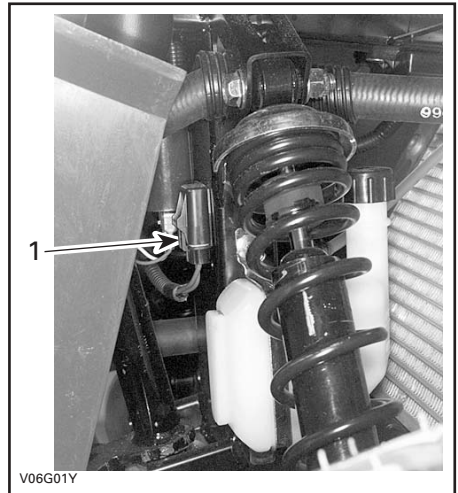

1. Fuse holder

---

# LIQUIDS

While reading this Operator's Guide, remember that:

## WARNING

Indicates a potential hazard that, if not avoided, could result in serious injury or death.

NOTE: This section specifies the recommended liquids and procedures to check their levels. Refer to MAINTENANCE for procedures to replace the liquids.

## Fuel

### Recommended Fuel

Use regular unleaded gasoline or gasohol containing less than 10% of ethanol or methanol, available from most service stations. The gasoline used must have an octane number of  $87((R + M)/2)$  or higher.

NOTE: In most service station, pump octane number corresponds to  $(R + M)/2$  octane number. Usually a sticker can be found on the pump.

**CAUTION:** Never experiment with other fuels. The use of unrecommended fuel can result in vehicle performance deterioration and damage to critical parts in the fuel system and engine components.

**CAUTION:** Never mix oil with fuel. This ATV has a 4-stroke engine. Oil must be added to engine base only.

## Fuel Level

### WARNING

Always stop engine before refueling. Open cap slowly. If a differential pressure condition is noticed (whistling sound heard when loosening fuel tank cap) have vehicle inspected and/or repaired before further operation. Fuel is flammable and explosive under certain conditions. Never use an open flame to check fuel level. Never smoke or allow flame or spark in vicinity. Always work in a well-ventilated area. Never top up the fuel tank before placing the vehicle in a warm area. As temperature increases, fuel expands and may overflow. Always wipe off any fuel or oil spillage from the vehicle.

## Engine/Transmission Oil

### Recommended Oil

Use 4-stroke engine oil that meets or exceeds the requirements for API service classification SG, SH or SJ. Always check the API service label on the oil container to be sure it includes the letters SG, SH or SJ. Only use high-quality high-detergent oil.

NOTE: For improved overall performance and wear protection use Bombardier synthetic oil 5W40 (P/N 293 600 039).

## Oil Viscosity

SAE 5W30 is recommended for all seasons. However during the hottest days of the summer and bitter cold days of the winter, refer to the following chart to select the proper viscosity.

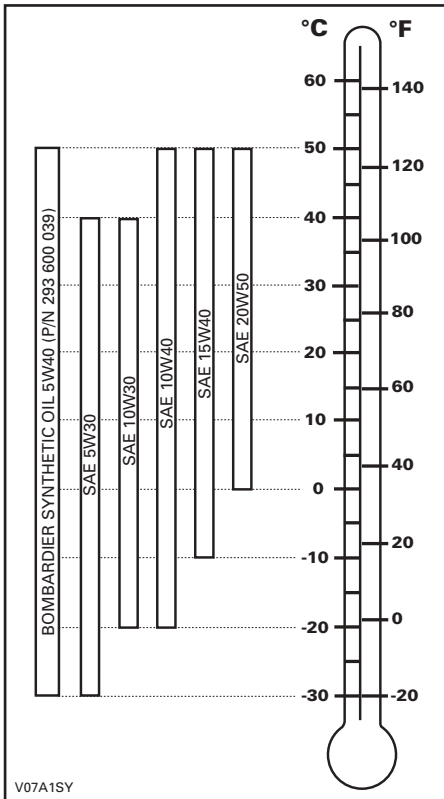

## Oil Level

**CAUTION:** Check level frequently and refill if necessary. Do not overfill. Operating the engine with an improper level may severely damage engine. Wipe off any spillage.

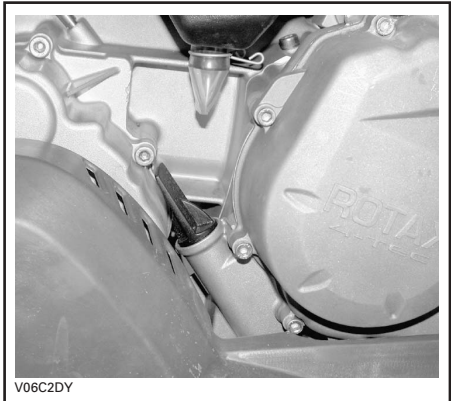

### *RH SIDE OF ENGINE*

With vehicle on a level surface and engine cold, not running, check the oil level as follows:

1. Unscrew dipstick then remove it and wipe clean.
2. Reinstall dipstick, screw it in completely.
3. Remove and check oil level. It should be near or equal to the upper mark.

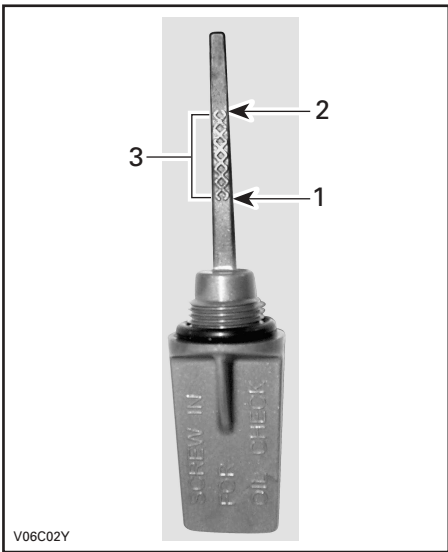

V06C02Y

1. Full
2. Add
3. Operating range

To add oil, remove dipstick.

Place a funnel into the dipstick tube to avoid spillage.

Add a small amount of recommended oil and recheck oil level.

Repeat the operation until oil level reaches the dipstick's full mark. Do not overfill.

Properly tighten dipstick.

## Gearbox Oil

### Recommended Oil

Use Bombardier chaincase oil (P/N 413 801 900) or an equivalent.

**CAUTION:** Do not use unrecommended other types of oil when servicing. Do not mix with other types of oil.

### Gearbox Oil Level

**CAUTION:** Check level and refill if necessary. Do not overfill. Operating the gearbox with an improper level may severely damage gearbox. Wipe off any spillage.

Place the vehicle on a level surface. Select NEUTRAL position then apply parking brake. Check the gearbox oil level plug.

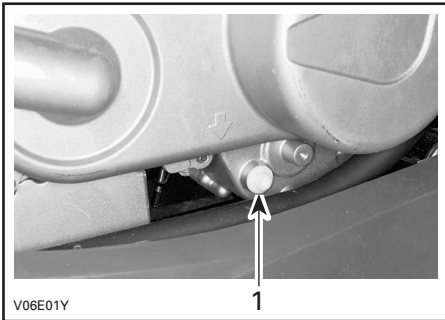

V06E01Y

1. Oil level plug

## WARNING

In order to avoid potential burns, do not remove gearbox oil level plug if exhaust is hot.

The oil should be level with the bottom of the oil level hole. REfill as required until gearbox oil level flows through oil level hole.

To change gearbox oil, refer to MAINTENANCE section.



## Engine Coolant

### Recommended Coolant

Always use ethylene-glycol antifreeze containing corrosion inhibitors specifically for internal combustion aluminum engines.

Cooling system must be filled with Bombardier premixed coolant (P/N 219 700 362) or with distilled water and antifreeze solution (50% water, 50% antifreeze).

### Coolant Level

#### **WARNING**

Check coolant level with engine cold. Never add coolant in cooling system when engine is hot.

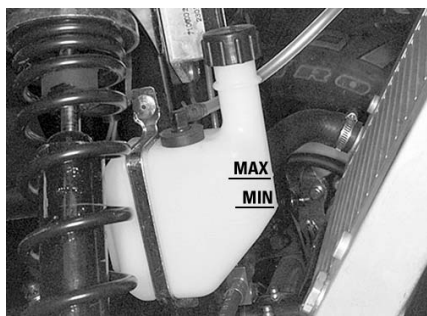

V06A0CY

With vehicle on a level surface, liquid should be between MIN. and MAX. level marks of coolant reservoir.

NOTE: When checking level at temperature lower than 20°C (68°F), it may be slightly lower than MIN. mark.

Add coolant up to MAX. mark if required. Use a funnel to avoid spillage. Do not overfill.

Properly reinstall and tighten filler cap.

If coolant is added in the coolant reservoir, check the level in the radiator too. Add coolant if necessary.

#### **WARNING**

In order to avoid potential burns, do not remove the radiator cap if the engine is hot.

NOTE: A cooling system that frequently requires coolant is the indication of leaks or engine problems. See an authorized Bombardier ATV dealer.

To gain access to the radiator, proceed as follows:

- Remove bolts retaining the top and the middle of front bumper then loosen the lower bolts.

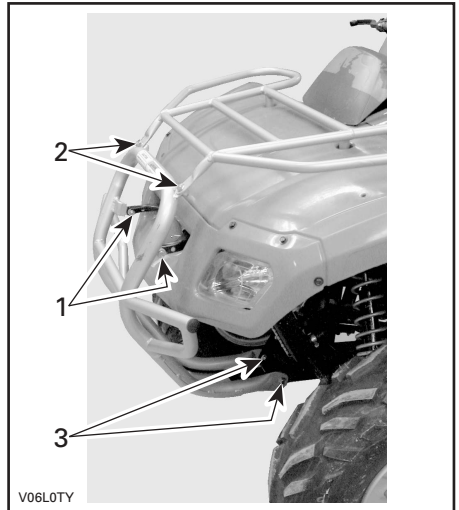

V06L0TY

1. Middle bolts
2. Upper bolts
3. Lower bolts

- Remove fascia screws, 8 screws in total.

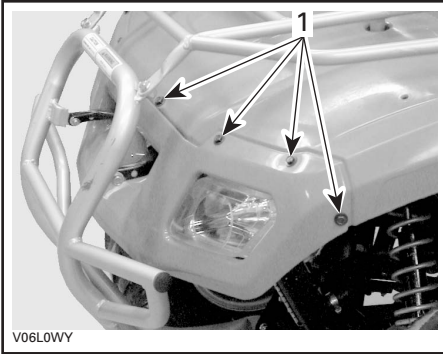

1. *Facia screws*

Reinstall all parts properly in the reverse order of removal procedure.

## Coolant Replacement

Refer to MAINTENANCE section.

## Brake Fluid

### Recommended Fluid

Always use brake fluid meeting the specification DOT 4 only.

**CAUTION:** To avoid serious damage to the braking system, do not use fluids other than the recommended one, nor mix different fluids for topping up.

## Fluid Level

With vehicle on a level surface, check brake fluid in reservoirs for proper level. They should be above MIN. mark.

Add fluid as required. Do not overfill.

Clean filler cap before moving.

**CAUTION:** Use only DOT 4 brake fluid from a sealed container. Do not use brake fluid taken from old or already opened containers.

**NOTE:** A low level may indicate leaks or worn brake pads. See an authorized Bombardier ATV dealer.

### Brake Lever Fluid Reservoir

Turn steering in the straight-ahead position to ensure reservoir is level.

Check brake fluid level, the reservoir is full when fluid reaches of the top of window.

Visually inspect lever boot condition. Check for cracks, tears etc. Replace if damaged.

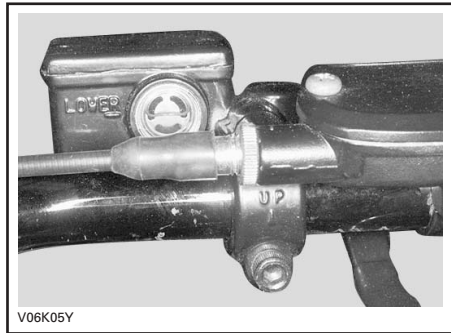

## Battery

This vehicle is equipped with an electrolyte type battery that requires a minimum of maintenance.

NOTE: Refer to MAINTENANCE section to remove or install the battery.

## Electrolyte Level

Place the vehicle on a level surface.

Check electrolyte level by the rear right inner fender. Use a flashlight if necessary. **Do not use an open flame.**

The electrolyte should be between lower and upper marks. If level is low, remove battery from vehicle to add distilled water.

## Refilling

Place battery on a level surface.

Unscrew caps and add distilled water up to upper mark as required. Do not overfill.



1. Upper mark
2. Lower mark

Properly retighten caps.

---

# BREAK-IN PERIOD

## Engine

A break-in period of 10 operating hours is required before running the vehicle at sustained full throttle.

**CAUTION:** Never mix oil with fuel. This vehicle has a 4-stroke engine. Oil must be added to engine base only.

During this period, maximum throttle should not exceed 3/4. However, brief full acceleration and speed variations contribute to a good break-in. Continued wide open throttle accelerations, prolonged cruising speeds and engine overheating are detrimental during the break-in period.

## Belt

A new belt required a break-in period of 50 km (30 miles). Avoid strong acceleration/deceleration, pulling a load or high speed cruising.

## 10-Hour Inspection

As with any precision piece of mechanical equipment, we suggest that after the first 10 hours, 200 km (125 m.) or 30 days after the purchase, whichever comes first, your vehicle be inspected by an authorized Bombardier ATV dealer. This inspection will give you the opportunity to discuss the unanswered questions you may have encountered during the first hours of operation.

---

The 10-hour inspection is at the expense of the vehicle owner.

---

While reading this Operator's Guide, remember that:

### **WARNING**

Indicates a potential hazard that, if not avoided, could result in serious injury or death.

---

## PRE-OPERATION CHECK

### **WARNING**

The pre-operation check is very important prior to operating the vehicle. Always check the proper operation of critical controls, safety features and mechanical components before starting. If not done as specified here, severe injury or death might occur.

- u) Start engine, remove parking brake and drive forward slowly a few feet then apply all brakes individually to test them.

Correct any problem you may have found before riding. See an authorized Bombardier ATV dealer as necessary.

Before using this vehicle, the operator should always:

- a) Apply parking break and check if it operates properly.
- b) Check tire pressure and condition.
- c) Check wheels and bearings for wear and damage.
- d) Check location of controls and ensure they work properly.
- e) Verify if steering operates freely.
- f) Activate throttle control lever several times to ensure it operates freely. It must return to idle position when released.
- g) Activate the brake lever and foot pedal to make sure the brakes fully apply. Lever and pedal must fully return when released.
- h) Ensure transmission lever is working then reset in NEUTRAL position.
- i) Check drive chain for lubrication and adjustment.
- j) Check sprockets for wear and damages.
- k) Check fuel, oil and coolant levels.
- l) Check for oil leaks on the engine and the transmission.
- m) Ensure fuel valve is in fully open position (ON).
- n) Clean headlamps and taillight.
- o) Ensure seat is properly tightened.
- p) If you transport cargo, respect load capacity. Ensure cargo is properly secured to the racks.
- q) If you are pulling a trailer or other equipment, ensure it respects the tongue capacity and towing capacity. Ensure trailer is properly secured to hitch.
- r) Look and feel for loose parts while engine is off. Check fasteners.
- s) Ensure the path of travel is free of persons and obstacles.
- t) Check operation of ignition switch, start button, engine stop switch and headlamps.

# OPERATING INSTRUCTIONS

## General

Transmission lever must be on NEUTRAL to allow engine starting.

To start engine, place the engine stop switch to RUN position, insert key in ignition switch and turn to ON then press start button.

For your convenience, an override mode allows the engine to be started with the transmission lever in any position. Press and hold the front brake lever while pressing the start button.

## Initial Cold Starting

Insert key in ignition switch and turn to ON.

**NOTE:** Do not forget place the engine stop switch to RUN position.

In cold weather, colder than 0°C (32°F), place the choke lever to full choke position.



Press start button and hold until engine starts.

**CAUTION:** Do not hold start button more than 30 seconds. A rest period should be observed between the cranking cycles to let starter cool down. Pay attention not to discharge battery.

**NOTE:** Throttle assist may be used to help engine starting faster. Press the throttle lever slightly. If too much throttle is used the choke system will not be activated.

Release start button immediately when engine has started.

After a few seconds, move the choke lever from full choke position to an intermediate position until the best engine RPM is achieved.

**NOTE:** Overusing choke may flood engine and make it hard to start. Refer to SPECIAL PROCEDURES if it occurs.

When the engine is warm, push the choke lever to OFF and release brakes.

## Warm Engine Starting

Start the engine as explained above but without the choke. If the engine does not start after two 5-second attempts with the electric starter, move the choke lever and place it half way position. Start the engine without activating the throttle lever. After a few seconds, push the choke lever to OFF.

## Stopping the Engine

### **WARNING**

Avoid parking vehicle on slope.

Release throttle and completely stop the vehicle.

Apply the parking brake by using brake lever lock on brake lever.

Set transmission lever in NEUTRAL position.

Push the engine stop switch in OFF position.

Turn key in ignition switch to OFF.

Remove key from ignition switch.

## Shifting the Transmission

Let engine idle to warm up.

Apply brakes and select the desired gear range H.

Release brakes.

**CAUTION:** Make sure parking brake is fully disengaged before operating the ATV.

Gradually press the throttle lever to increase engine speed add thus engaging the continuously variable transmission (CVT).

At the opposite, when the throttle lever is released, the engine speed decreases.

## Using the Reverse

**CAUTION:** When changing from forward to reverse, or vice-versa, always completely stop the vehicle and apply the brake prior to moving the transmission lever.

The same procedures as SHIFTING THE TRANSMISSION above apply except for the following.

Set the transmission lever in REVERSE position.

# SPECIAL PROCEDURES

## Flooded Engine

When the engine does not start after several attempts, the engine may be fuel flooded. Proceed as follows.

Turn ignition switch to ON and ensure choke is not applied.

Ensure the transmission lever is on NEUTRAL.

Fully press throttle lever and hold while starting the engine.

As soon as the engine starts, release throttle lever. Do not race engine.

If it does not work:

Clean the spark plug cap area then remove it. Remove the spark plug (tools are supplied in tool box).

### WARNING

Always wear eye protector and gloves when the spark plug hole is cleaned.

Crank engine several times. Install new spark plug if possible or clean and dry spark plug. Start engine as explained above. If engine continues to flood, see an authorized Bombardier ATV dealer.

## Engine Overheat

If engine overheats and indicator light turns ON, try the following:

- Check and clean radiator fins. See MAINTENANCE section.

### WARNING

The radiator can be very hot, wear gloves before touching the radiator.

- Reduce vehicle speed but try to keep vehicle moving to supply air to radiator. If engine is still overheating after approximately one minute, stop vehicle and set transmission to NEUTRAL and apply parking brake. Stop engine.
- Let engine cool down. Check coolant level and refill if possible.

### WARNING

In order to avoid potential burns, do not remove the radiator cap or refill cooling system when engine is hot.

- Restart the engine, if the light does not turn off right after engine starting, stop engine and disconnect the temperature sensor.

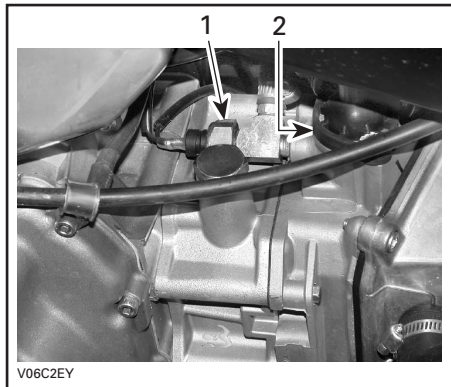

1. Temperature sensor
2. Thermostat housing



Restart engine. If the light stays on, a low oil pressure of the engine must be considered. Stop engine immediately. Otherwise, if the light turns off and the engine is cold or warm, not hot, a potential problem with the sensor or engine part is possible. Use the vehicle as little as possible and see an authorized Bombardier ATV dealer as soon as possible.

## Post-Operation Care

When vehicle is used in salt-water environment (beach area, launching/loading boats, etc.), rinsing the vehicle with fresh water is necessary to preserve vehicle and its components. Metallic parts lubrication is highly recommended. Use BOMBARDIER LUBE (P/N 293 600 016) or an equivalent. This must be performed at the end of each operating day.

When vehicle is operated in muddy conditions, rinsing the vehicle is recommended to preserve vehicle and its components and to keep lights clean.

NOTE: Never use a high pressure washer to clean the vehicle USE LOW PRESSURE ONLY (like a garden hose). The high pressure can cause electrical or mechanical damages.

## Turn Over

When vehicle is turned over or stays tilted on the side, replace the vehicle in its normal operating position (on all four wheels) and wait 3 to 5 minutes before starting the engine. Before starting engine, check engine oil level and refill if necessary. If the oil pressure light stays ON after starting engine, stop engine and see an authorized Bombardier ATV dealer as soon as possible.

## ATV Immersion

Should the ATV become immersed, it will be necessary to take it to an authorized Bombardier ATV dealer as soon as possible. **DO NOT START THE ENGINE!**

Immersion of the ATV can cause serious damage if the correct restart procedure is not followed.

## Storage and Preseason Preparation

### **WARNING**

Have an authorized Bombardier ATV dealer inspect fuel system integrity as specified in MAINTENANCE CHART.

When a vehicle is not in use for more than one month, proper storage is a necessity.

See an authorized Bombardier ATV dealer for proper procedures.

When using your ATV after storage, a preparation is required. See an authorized Bombardier ATV dealer for proper procedures.

# CARGO AND TRANSPORTATION

While reading this Operator's Guide, remember that:

## WARNING

Indicates a potential hazard that, if not avoided, could result in serious injury or death.

### Cargo:

## WARNING

The vehicle handling, stability and braking distance are affected when loading racks and using the vehicle. Correct loading and weight distribution are therefore important. Never overload, tow or carry cargo improperly. Always ensure the cargo is safely secured and properly distributed on the rack(s) before operating the vehicle. Safely reduce speed according to terrain conditions when carrying cargo or pulling a trailer. Allow greater distance for braking. Always secure cargo as low as possible on the rack(s) to reduce the effect of higher center of gravity. Failure to follow recommendations here could cause changes in vehicle handling which could lead to an accident resulting in severe injuries including the possibility of death.

When cargoing vehicle, respect these maximum loads.

**TOTAL LOAD ALLOWED:**  
**175 kg (386 lb)**  
(includes driver, all other loads and added accessories)

**16 kg (35 lb)**  
FRONT cargo rack

**30 kg (65 lb)**  
Includes REAR cargo rack and tongue load



V06A0TY

### Transportation

When transporting a vehicle, secure vehicle to trailer or in pickup box with suitable tie-downs. Using ordinary ropes is not recommended.

## WARNING



V00A174

Never tip this vehicle on end for transporting. We recommend that you carry the vehicle in its normal operating position (on all four wheels).

Place the fuel valve to OFF position.  
Select the NEUTRAL position and set the parking brake.  
Secure the vehicle by the front and rear bumpers.

**CAUTION:** Attaching vehicle at other locations may damage the vehicle.

Unload racks before transporting the vehicle.

### Front Location



TYPICAL

### Rear Location



TYPICAL

### WARNING

Do not tow this vehicle behind a car or other vehicle. Use a trailer.



# ***MAINTENANCE INFORMATION***

# MAINTENANCE CHART

The maintenance is very important, if you are not familiar with safe service practices and adjustment procedures, see your authorized Bombardier ATV dealer.

	Initial Inspection 10 H or 30 days or 200 KM (125 m.)	EVERY				To be performed by
		25 H or 500 KM (310 m.)	50 H or 100 km (620 m.)	100 H or 1 year or 2000 KM (1250 m.)	200 H or 2 years or 4000 KM (2485 m.)	
<b>ENGINE/TRANSMISSION</b>						
Engine oil and filter ②	R		R			CUSTOMER
Engine oil strainer					C	DEALER
Oil pressure regulator	I		C			CUSTOMER
Gearbox oil	I				R	CUSTOMER
Valve adjustment	I			I		DEALER
Engine mounting fasteners	I			I		DEALER
Exhaust system	I			I		DEALER
Spark arrester				C		CUSTOMER
Condition of seals	I			I		DEALER
Coolant ②	I			③	R	CUSTOMER
Radiator cap/cooling system pressure test	I				I	DEALER
Radiator condition/cleanliness (radiator fins) ④	I		I			CUSTOMER
Drive belt				I		DEALER
Drive and driven pulleys condition/cleanliness				C		DEALER
CVT air inlet/outlet duct condition/cleanliness	I		I			DEALER
<b>FUEL</b>						
Air filter ②		C④		R④		CUSTOMER
Fuel lines and connections	I			I		DEALER
Fuel tank strainers					R	DEALER
Carburetor	I			I		DEALER

I: Inspect, verify, clean, adjust, lubricate or replace if necessary C: Clean L: Lubricate R: Replace	Initial Inspection 10 H or 30 days or 200 KM (125 m.)	EVERY				To be performed by
		25 H or 500 KM (310 m.)	50 H or 100 km (620 m.)	100 H or 1 year or 2000 KM (1250 m.)	200 H or 2 years or 4000 KM (2485 m.)	
<b>ELECTRICAL</b>						
Spark plug ⑤				R		CUSTOMER
Battery electrolyte level and connections						CUSTOMER
Wiring harnesses, cables and lines						DEALER
Condition of ignition switch, start button and engine stop switch ②						CUSTOMER
Condition of lighting system (HI/LO intensity, brake lamp, headlamp aiming, etc.) ②						CUSTOMER
<b>DRIVE TRAIN</b>						
Drive chain lubrication		EVERY RIDE				CUSTOMER
Drive chain slider condition		EVERY RIDE				CUSTOMER
Drive chain adjustment		EVERY RIDE				CUSTOMER
Sprockets						CUSTOMER
Wheel bearing condition						CUSTOMER
<b>STEERING</b>						
Handlebar fasteners						DEALER
Throttle/housing/cable condition ②						CUSTOMER
Choke condition ②						CUSTOMER
Steering system (column, bearing, etc.)				④		DEALER
Tie rod ends						DEALER
Wheel nuts/studs ②						CUSTOMER
Tires pressure and wear ②		EVERY RIDE				CUSTOMER
Front wheels alignment						DEALER

I: Inspect, verify, clean, adjust, lubricate or replace if necessary C: Clean L: Lubricate R: Replace	Initial Inspection 10 H or 30 days or 200 KM (125 m.)	EVERY				To be performed by
		25 H or 500 KM (310 m.)	50 H or 100 km (620 m.)	100 H or 1 year or 2000 KM (1250 m.)	200 H or 2 years or 4000 KM (2485 m.)	
<b>SUSPENSION</b>						
Swing arm ②				I		CUSTOMER
Shock absorbers			I			CUSTOMER
A-arms			I			CUSTOMER
<b>BRAKE</b>						
Brake fluid (front and rear) ②	I	I			R ⑥	CUSTOMER
Brake cable ⑥	I	I	I			CUSTOMER
Brake pads ⑥		I ④				CUSTOMER
Brake system (discs, hoses etc.) ⑥				I		CUSTOMER
<b>BODY/FRAME</b>						
Engine compartment	C		C			CUSTOMER
Frame				I		DEALER
Hitch/trailer ball condition (if installed)	EVERY RIDE					CUSTOMER
Chassis fasteners			I			CUSTOMER
Seat fasteners	EVERY RIDE					CUSTOMER
Vehicle cleaning and protection			C ④			CUSTOMER

① To be performed by an authorized Bombardier ATV dealer. The initial maintenance is very important and must not be neglected.

② Pre-ride inspection item.

③ Every 100 hours, check coolant strength.

④ More often under severe use such as dusty area, sand, snow, wet or muddy conditions.

⑤ Make sure the spark plug is correctly gapped.

⑥ Brake fluid replacement or any brake system repairs must be performed by an authorized Bombardier ATV dealer.



# MAINTENANCE

While reading this Operator's Guide, remember that:

## WARNING

Indicates a potential hazard that, if not avoided, could result in serious injury or death.

## WARNING

Unless otherwise specified, engine should not be running for all maintenance procedures.

Before performing any service or inspection operation on the vehicle, wait until the engine and exhaust have cooled down to avoid potential burns.

## WARNING

Should removal of a locking device (e.g. lock tabs, self-locking fasteners, etc.) be required, when undergoing disassembly/assembly, always replace with a new one.

The following covers the maintenance items that can be performed by the customer if desired. Other items found in MAINTENANCE CHART must be performed by an authorized Bombardier ATV dealer.

NOTE: Among other things, this section gives the procedures to replace the liquids. Refer to LIQUIDS for procedures to check levels and refill.

## Engine

### Oil Change and Oil Filter Replacement

Oil and filter are to be replaced at the same time. Oil change should be done with a warm engine.

## WARNING

The engine oil can be very hot. Wait until engine oil is warm.

Ensure vehicle is on a level surface.

Remove dipstick.

Clean the drain plug area.

Place a drain pan under the engine drain plug area.

Unscrew drain plug.

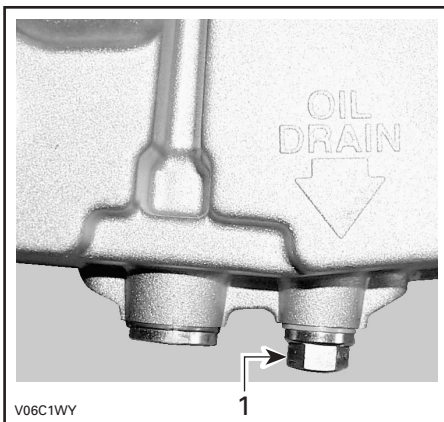

1. Oil drain plug

Allow enough time for oil to flow out of oil filter.  
Unscrew oil filter cover.

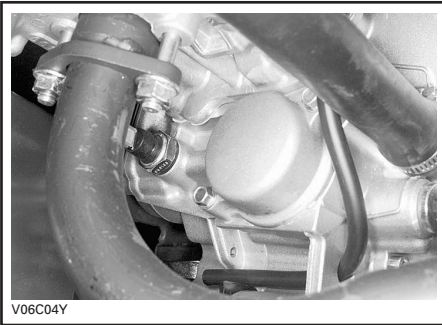

Remove the oil filter and replace by a new filter.

**NOTE:** Check the cover O-ring, and change it if necessary.

Wipe out any spillage on engine.

Remove oil strainer plug then clean oil strainer.

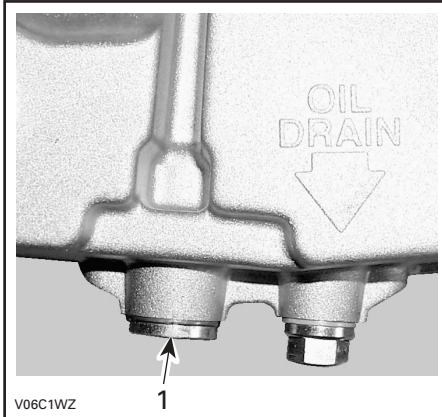

1. Oil strainer plug

To clean oil strainer, use a solvent then dry with compressed air.

## **WARNING**

Always wear eye protection and gloves.

Reinstall oil strainer plug with a new gasket.  
Change gasket on drain plug. Clean gasket area on engine and drain plug, then reinstall plug.

Refill engine at the proper level with the recommended oil. Refer to SPECIFICATIONS for capacity.

Start engine and let idle for a few minutes. Ensure oil filter area and drain plug areas are not leaking;

Stop engine. Wait a while to allow oil to flow down to crankcase then check oil level. Refill as necessary.

Dispose of oil as per your local environmental regulations.

## Oil Pressure Regulator

When changing engine oil at each 50 hours, the oil pressure regulator must be removed and cleaned.

The oil pressure regulator is located on the left side of the engine, near the cooling drain plug.

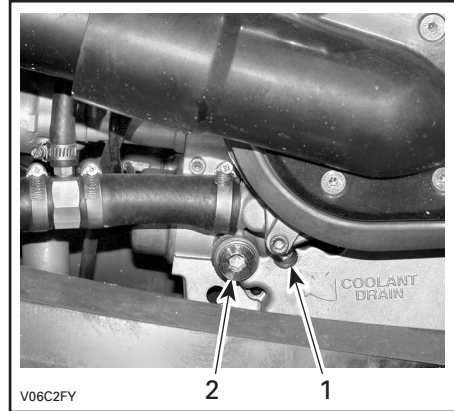

1. Cooling drain plug  
2. Oil pressure regulator plug

Clean plug area then remove it.

Remove valve housing, compression spring and ball.

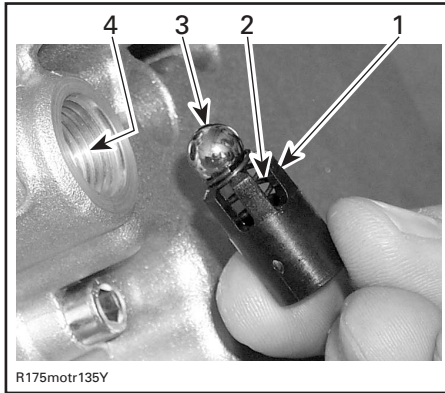

1. *Valve holding*
2. *Compression spring*
3. *Ball*
4. *Oil pressure valve port*

NOTE: Oil coming out will push out spring loaded ball; take care not to lose spring and ball.

Clean all parts and oil pressure regulator port. Check compression spring's free length. If the length of the spring is less than 13.2 mm (0.519 in), replace it by a new one.

Install all removed parts and torque the plug to 30 N·m (22 lbf·ft).

## Gearbox Oil Replacement

Place the vehicle on a level surface.

Remove the left footrest.

Clean drain plug area and oil level plug then remove the gearbox drain plug.

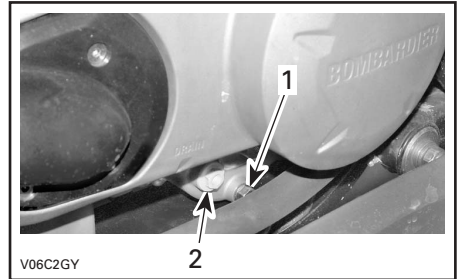

1. *Gearbox drain plug*
2. *Gearbox oil level plug*

NOTE: To completely drain the gearbox, place a jack under the right footrest and tilt the vehicle toward the left side. When the gearbox is empty, install the drainplug and replace the vehicle on the ground.

Refill gearbox, using BOMBARDIER chaincase oil (P/N 416 801 900) or an equivalent.

**CAUTION:** Do not use other unrecommended types of oil when servicing. Do not mix with other types of oil.

The oil should be level with the bottom of the oil level hole. Refill as required until gearbox oil level flows through oil level hole.

Reinstall oil level plug.

## Coolant Replacement

### **WARNING**

In order to avoid potential burns, do not remove the radiator cap or loosen the coolant if the engine is hot.

Remove front fascia.

Turn the radiator cap counterclockwise and remove it.

Unscrew the drain plug located on the left side of engine and drain the coolant into a suitable container.

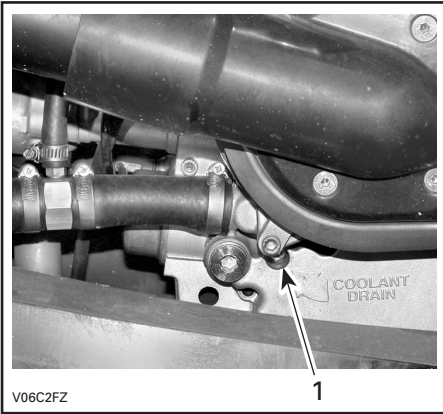

1. Cooling drain plug

Unscrew the bleeding screw on the top of thermostat housing.

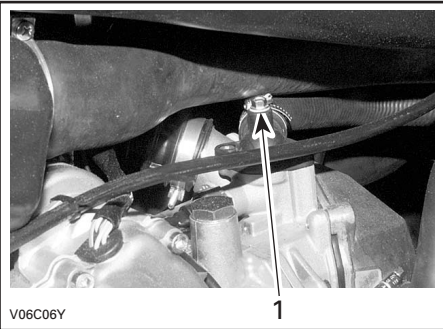

1. Bleeding screw

Drain the system completely and reinstall the drain plug.

Pinch hose between radiator and thermostat housing with a large hose pincher (P/N 529 032 500).

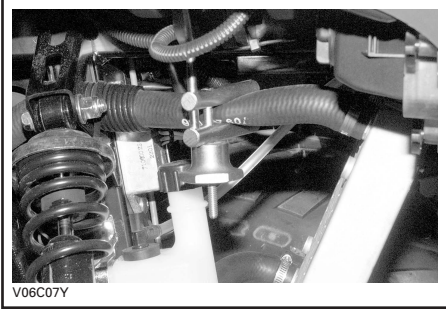

Lift the front of the vehicle high enough to have front wheels off the ground.

Fill radiator until the coolant comes out by the temperature sensor hole. Install the bleeding screw then remove the hose pincher.

NOTE: If no coolant comes out by the bleeding hole, squeeze the lower radiator hose several times until coolant comes out.

Complete the radiator filling.

Check the level in the coolant reservoir and refill if necessary.

Run engine at idle with the radiator cap off. Slowly add additional coolant if necessary.

At this point, wait until engine reaches normal operating temperature. Depress the throttle lever two or three times; then add coolant if required.

Install radiator cap. Inspect all connections for leaks and check coolant level in the reservoir.

Check if the carburetor heater is warm. If not, redo the bleeding procedure.

Reinstall front fascia.

## Drive Belt

See an authorized Bombardier ATV dealer to inspect and/or replace the drive belt.

## Valve Adjustment

See an authorized Bombardier ATV dealer for valves adjustment.

Insufficient clearance will cause loss of power and possibly damage the valves. Excessive clearance will cause noise.

## Spark Arrester

The muffler must be periodically purged of accumulated carbon.

### **WARNING**

Never perform this operation immediately after the engine has been run because exhaust system is very hot. Wear eye protection and gloves. Respect all applicable laws and regulations.

Place transmission on NEUTRAL position and apply parking brake.

Remove the spark arrester from the muffler

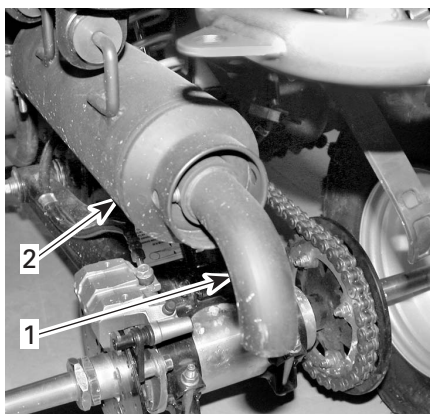

V06C2HY

1. Spark arrester
2. Muffler

Remove carbon deposits from the spark arrester using a brush.

NOTE: Use a soft brush and be careful to avoid damaging spark arrester.

Reinstall the spark arrester in muffler.

## Radiator

Periodically check the radiator area for cleanliness.

Inspect radiator fins. They must be clean, free of mud, dirt, leaves and any other deposit that would prevent the radiator to cool properly.

Remove as much deposits as you can with your hands. If water is available in proximity, try rinsing the radiator fins.

If available, use a garden hose to rinse the radiator fins.

### **WARNING**

Never clean radiator with your hands when it is hot. Let the radiator cool down before cleaning.

**CAUTION:** Be careful not to damage the radiator fins when cleaning. Do not use any object/tool that could damage the fins. The fins are purposely thin parts to allow efficient cooling. **WHEN HOSING, USE LOW PRESSURE ONLY. NEVER USE A HIGH PRESSURE WASHER.**

See an authorized Bombardier ATV dealer to check the performance of the cooling system.

## Carburetor

See an authorized Bombardier ATV dealer each year to verify and clean the fuel system.

# Air Intake System

## Air Filter Cleaning/Draining

**CAUTION:** Never remove or modify any component in the air box. The engine carburetion is calibrated to operate specifically with these components. Otherwise, engine performance degradation or damage can occur.

## Air Box Draining

Periodically inspect air box drain tube for liquid or deposits.

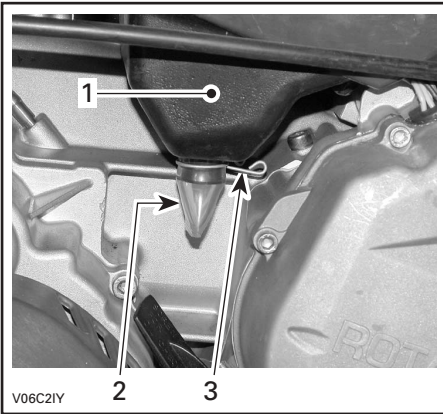

TYPICAL

1. Air box
2. Drain tube
3. Clamp

**NOTE:** If vehicle is used in dusty area, inspect more frequently than specified in MAINTENANCE CHART.

If liquid/deposits are found, squeeze and remove the clamp. Pull drain tube out then empty it.

**CAUTION:** Do not start engine when liquid/deposits are found in the drain tube.

When liquid/deposits are found, the air filter must be inspected/dried/replaced depending on its condition.

## Air Filter Cleaning

### Air Filter Removal

**CAUTION:** Never remove or modify any component in the air box. The engine carburetion is calibrated to operate specifically with these components. Otherwise, engine performance degradation or damage can occur.

Remove air box cover.

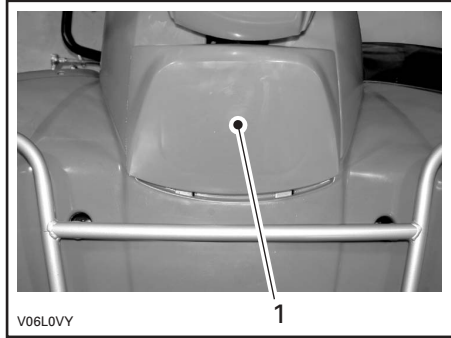

1. Air box cover

Remove air filter.



1. Latches
2. Air filter box cover

Pour cleaning solution (P/N 219 700 341) or an equivalent into a bucket. Put the filter in to soak.

While filter soaks, clean inside the air box.

Rinse the filter with warm water until all cleaning solution disappears.

NOTE: If the air filter foam is still dirty, replace it with a new one.

Then, let the filter dry completely.

When the filter is dried, re-oil with air filter oil (P/N 219 700 340) or an equivalent.

**CAUTION:** Engine performance degradation or severe damages can occur if the air filter is not properly maintained and/or if it is not well oiled.

#### Air Filter Installation

Properly reinstall removed parts in the reverse order of their removal.

Reinstall the air filter with the grey part on top.

NOTE: Check if the air filter broach is properly located before installing air filter.

## Electrical

### WARNING

Unless otherwise informed, always turn ignition switch to OFF before performing any maintenance or repair on electrical system.

## Battery

### WARNING

Never charge a battery while installed in vehicle.

Clean battery post with a wire brush. Apply dielectric grease (P/N 293 550 004) or an equivalent on post to protect against oxidation.

#### Removal

Disconnect BLACK (-) cable first then RED (+) cable.

### WARNING

Always respect this order for disassembly; disconnect BLACK (-) cable first. Electrolyte or fuel vapors can be present in engine compartment and a spark may ignite them and possibly cause personal injuries.

Remove the holding strap.

Remove battery from vehicle being careful not to tilt it so that electrolyte flows out of vent tube.

### WARNING

Electrolyte is poisonous and dangerous. Avoid contact with eyes, skin and clothing. Wear protective eyeglasses and a suitable pair of non-absorbent gloves when removing the battery by hand.



**CAUTION:** Should any electrolyte spillage occur, immediately wash off with a solution of baking soda and water.

#### Cleaning

Clean battery, battery casing, cables and battery posts using a solution of baking soda and water.

Remove corrosion from battery cable terminals and battery posts using a firm wire brush. Battery top should be cleaned by soft brush and any grease-cutting soap or baking soda solution.

#### Installation

Reinstall battery in vehicle.

### **WARNING**

Connect RED (+) cable first then BLACK (-) cable. Always connect RED (+) cable first.

## Fuse

If the fuse is damaged, replace it by one of the same rating.

**CAUTION:** Do not use a higher rated fuse as this can cause severe damage.

Fuse is located behind front right shock, near coolant reservoir. Remove the cluster cover to allow an access at the fuse holder.

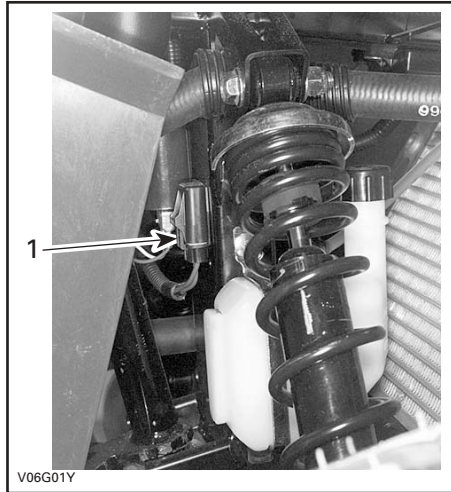

### 1. Fuse holder

To remove fuse from holder, unclip and remove holder cover then pull fuse out. Check if filament is melted.

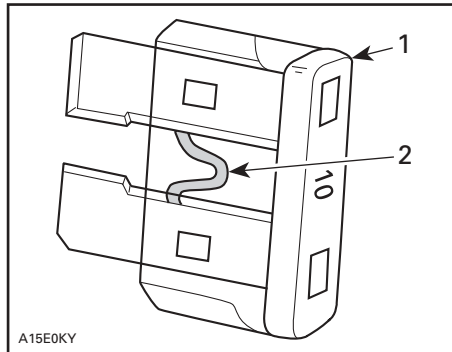

1. Fuse
2. Check if melted



## Bulb Replacement

Always check light operation after replacement.

### Headlamp

**CAUTION:** Never touch glass portion of an halogen bulb with bare fingers, it shortens its operating life. If glass is touched, clean it with isopropyl alcohol which will not leave a film on the bulb.

Unplug connector from headlamp.



V06G0PY

Remove rubber protector.

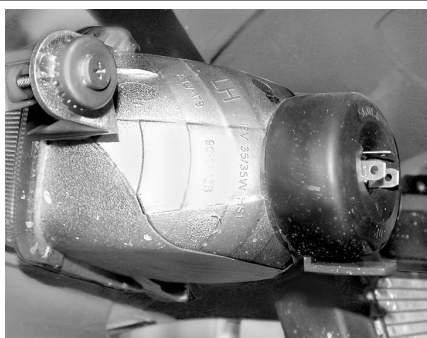

V06G0QY

**NOTE:** Concerning the following illustrations, the front fascia has been removed from the vehicle for a better comprehension.

Press the spindle then push it on the side to unlock headlamp bulb.



V06G0RY

Lift and hold the spindle then remove the bulb.



V06G0SY

Properly reinstall removed parts in the reverse order of their removal.

Adjust beam aiming as follows:

Turn knobs to adjust beam height and side orientation to your convenience.

Adjust both headlamps evenly.

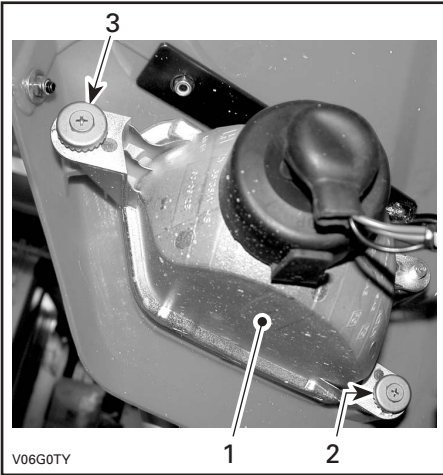

1. Headlamp housing
2. Beam height adjustment
3. Beam side adjustment

### Taillight

Unscrew lens screws to expose bulb.

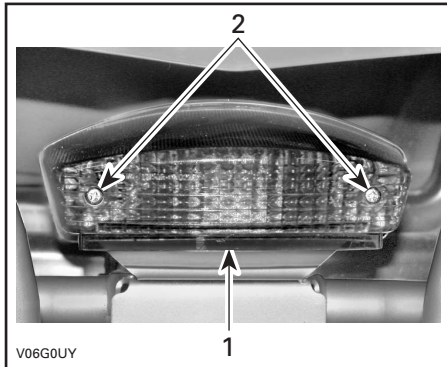

1. Lens
2. Screws

Push bulb in and hold while turning counter-clockwise to release.

Install the new bulb by first pushing in while turning clockwise. Reinstall lens.

### Indicator Lamp

Remove the cluster by unscrewing the screws.

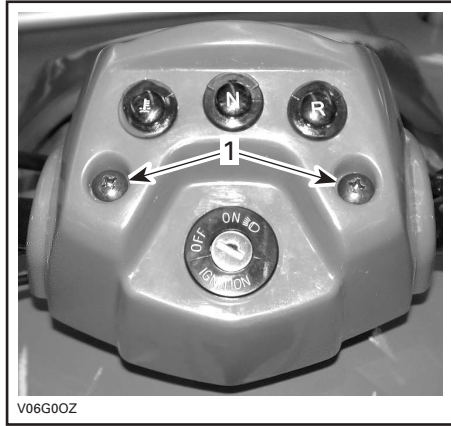

1. Cluster's screws

Pull the indicator lamp lens out of its location.



Turn the cluster and pull the rubber protector of the defective indicator lamp.

Turn round the rubber protector to expose the indicator lamp bulb.

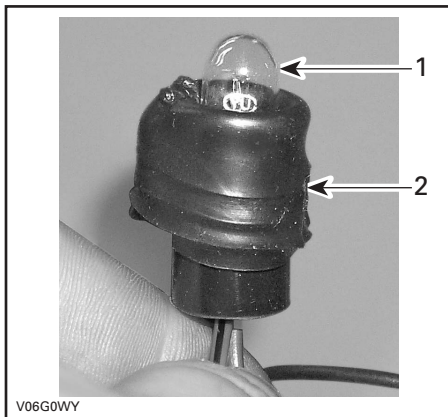

1. Indicator lamp bulb
2. Rubber protector

Pull the bulb to remove it.  
For installation, reverse the removal instructions.

## Drive Train

### Lubrication

Lubricate front knuckles. Use synthetic grease (P/N 293 550 033) or an equivalent. There is a grease fitting on each knuckle.

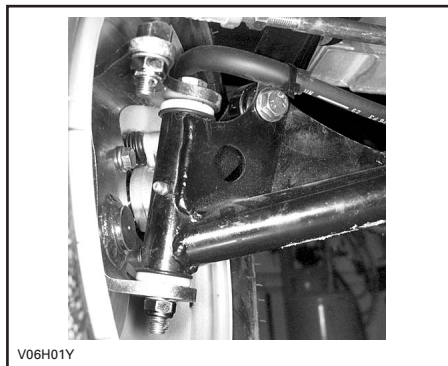

## Drive Chain

Adjust and lubricate the drive chain before each use.

### **WARNING**

Place ignition switch to OFF before you checking, adjusting or lubricating the drive chain.

**CAUTION:** Never operate this vehicle with the drive chain too loose or too tight as severe damage to the drive components can occur.

### Inspection

This ATV is equipped with O-ring sealed permanently greased pins and rollers. Before operating the vehicle, always inspect the drive chain.

Check the free play of drive chain and adjust if necessary.

Check for damage or missing O-ring or rollers.

#### Lubrication and Cleaning

**CAUTION:** Never wash the chain with a high pressure washer or gasoline. Damage to the O-ring will result, causing premature wear and drive chain failure.

Clean the side surfaces of the chain with a dry cloth.

**NOTE:** Do not brush chain.

Lubricate only with an approved O-ring chain lubricant. Other commercial chain lubricants may contain solvent which could damage the O-rings.

#### Adjustment

**NOTE:** Never adjust drive chain with the driver seated on the vehicle. Remove all load on vehicle.

Select a level surface and set transmission to **NEUTRAL**.

Loosen chain tensioner lock bolts.

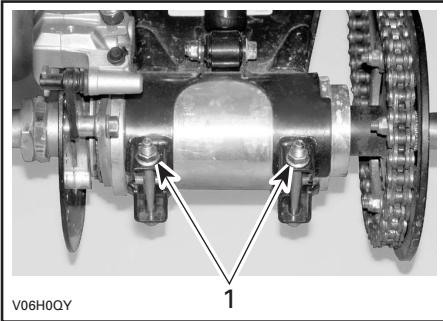

1. Chain tensioner lock bolts

Insert adjuster lock through sprocket hub and into chain tensioner.

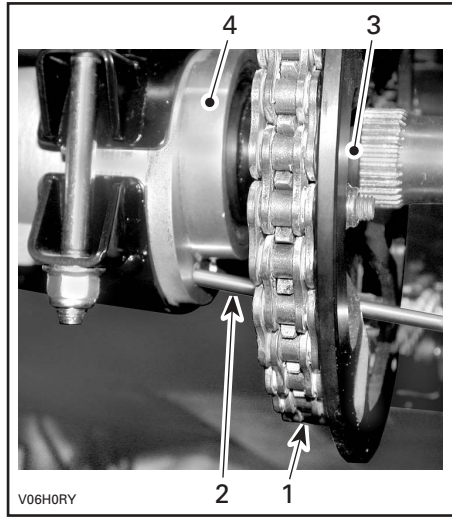

1. Drive chain
2. Adjuster lock
3. Sprocket hub
4. Chain tensioner

Adjust chain deflection by slowly moving the ATV forward so any slack that may have previously been on the under part of the chain is now on the top of the chain. The bottom part of the chain should be taught during adjustment.

The deflection should be between 20 and 30 mm (3/4 and 3-1/8 in).

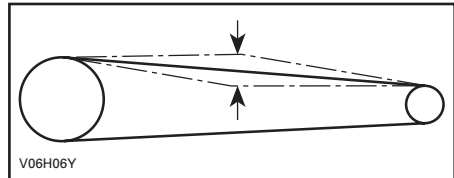

Turn the axle forward to increase or backwards to decrease chain free play.

Tighten the chain tensioner lock bolts to 48 N·m (35 lbf·ft).

**CAUTION:** Never operate this vehicle with the drive chain too loose or too tight as severe damage to the drive components can occur. When the adjustment is done, repeat the above procedure to check the deflection several times at different spots on the chain.

### Replacement

With the chain installed on vehicle, measure the distance between a span of 13 links from pin center to pin center. Change drive chain if the distance exceeds the service limit, see an authorized Bombardier ATV dealer.

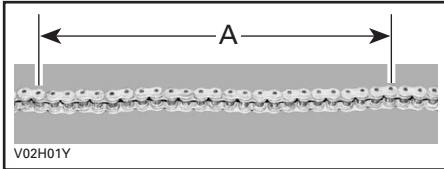

A. 404 mm (15-29/32 in)

### Drive Chain Slider

Check the drive chain slider at every ride. Replace the drive chain slider when it is worn. See an authorized Bombardier ATV dealer for replacement.

### Sprocket and Pinion

Check the sprocket axle and pinion for distortion, excessive wear or other damages.

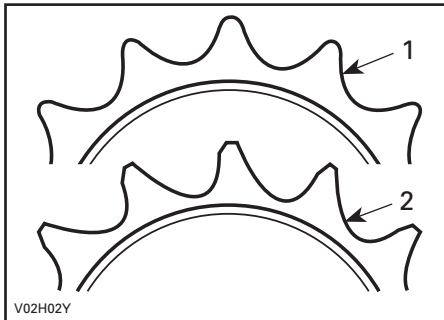

1. Good
2. Replace

**CAUTION:** Replace chain, sprocket axle and pinion together to prevent rapid chain and sprocket wear. Install a new retaining ring each time the pinion is removed.

**NOTE:** The drive pinion must be installed with the lip toward the outside of vehicle.

### Wheel

Occasionally, wheel nuts should be removed to apply anti-seize lubricant on studs to ease future removal. This is particularly important when vehicle is used in salt-water environment or in mud. Remove one nut at a time, lubricate then retorque to 70 N·m (52 lbf·ft).

### Wheel Bearing/Bushings Condition

Push and pull the wheels from the upper edge to feel the play. See an authorized Bombardier ATV dealer if there is any play.

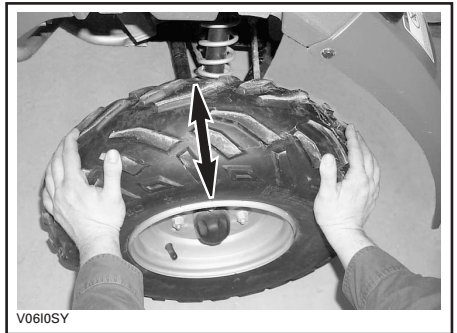

## Tires/Wheels

### Tire Pressure

#### **WARNING**

Tire pressure greatly affects vehicle handling and stability. Underpressure may cause tire to deflate and rotate on wheel. Overpressure may burst the tire. Always follow recommended pressure. Since tires are low-pressure types, a manual pump should be used.

Check pressure when tires are COLD before using the vehicle. Tire pressure changes with temperature and altitude. Recheck pressure if one of these conditions has changed.

For your convenience, a pressure gauge is supplied in tool box.

TIRE PRESSURE		
	FRONT	REAR
RECOMMENDED	35 kPa (5 PSI)	
MINIMUM	21 kPa (3 PSI)	

Although the tires are specifically designed for off-road use, a flat may still occur. Therefore, it is recommended to carry a tire pump and a repair kit.

### Tire/Wheel Condition

Check tire for damage and wear. Replace if necessary.

Do not rotate tires. The front and rear tires have a different size. The tires are directional and their rotation must be kept in a specific direction for proper operation.

### Wheel Removal

Loosen nuts then lift vehicle. Place a support under vehicle. Remove nuts then remove wheel.

At installation, it is recommended to apply an anti-seize lubricant on threads. Gently tighten nuts in a criss-cross sequence then apply a final torque of 70 N·m (52 lbf·ft).

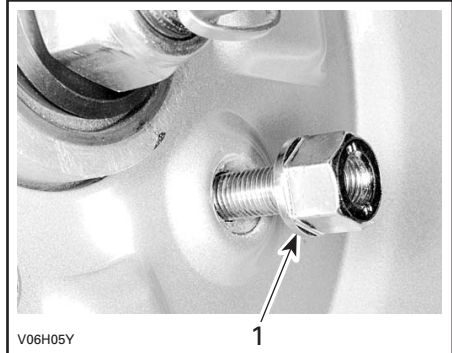

1. *Taper side of nut*

**CAUTION:** Always use the recommended wheel nuts (P/N 250 100 039). Using a different nut could cause damages to the rim.



# Steering System

## Throttle Cable Lubrication

The throttle cable must be lubricated with silicone cable lubricant (P/N 293 600 041) or equivalent.

**⚠ WARNING**

Always use a silicone-based lubricant. Using another lubricant (like water-based lubricant) could cause the throttle lever/cable sticking or stiffness.

Open the throttle lever housing.

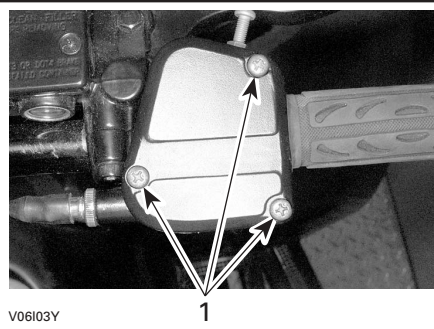

1. Remove screws

Slide the rubber protector to expose the cable adjuster.

Unscrew the lock nut of the cable adjuster then screw in the adjuster to release the cable tension.

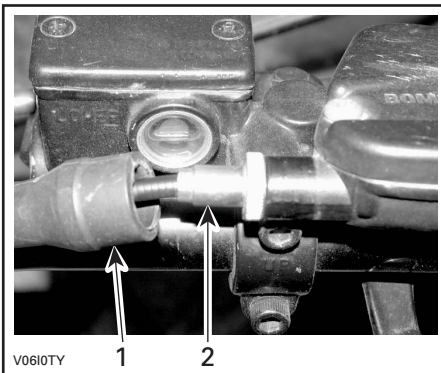

1. Rubber protector  
2. Cable adjuster

Remove the cable from the throttle lever.

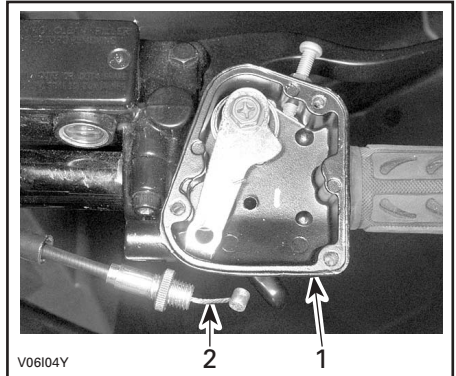

1. Throttle handle housing  
2. Throttle cable

NOTE: Slide cable in clip slot and remove the end of cable from clip.

Remove the carburetor cap on top of the carburetor. Place the carburetor cap far from carburetor body.

Install the cable luber (P/N 529 035 738) on the cable.

Insert the needle of spray can in the cable luber hole.

**⚠ WARNING**

Always wear eye protection and gloves when you lubricate a cable.

NOTE: Place a rag around the cable luber to prevent the lubricant splash.

Add lubricant until it runs out at carburetor end of the throttle cable.

Let the cable hang during approximately 15 minutes or until no lubricant flows out of cable.

Reinstall carburetor cap.

Reinstall and adjust the cable.

## Throttle Lever Adjustment

Slide rubber protector back to expose throttle cable adjuster.

Loosen lock nut then turn the adjuster to obtain correct throttle lever free play.

NOTE: Measure throttle free play at the tip of throttle lever.

Tighten lock nut and reinstall protector.

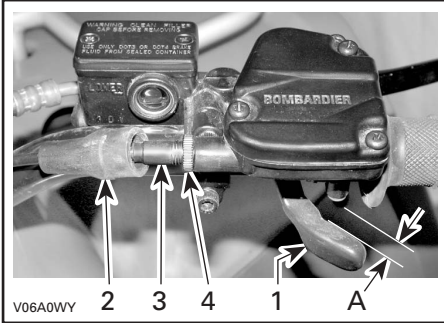

1. Throttle lever
  2. Protector
  3. Cable adjuster
  4. Lock nut
- A. 3 to 8 mm (1/8 to 5/16 in)

With the transmission lever on NEUTRAL position, start the engine. Check if the throttle cable is adjusted correctly by turning handlebar fully right then fully left. If the engine RPM increases, readjust the throttle lever free play.

## Suspension

### Adjustment

#### WARNING

Adjust both springs to the same load. Uneven adjustment can cause poor handling and loss of stability, and/or control, and increase the risk of an accident.

Spring preload may vary from rider to rider depending upon their weight. Preload can be changed by setting both lock nuts up or down to compress the spring to different lengths.

Shorten the spring for a firmer ride and rough road condition.

Lengthen the spring for a light load and a smooth road condition.

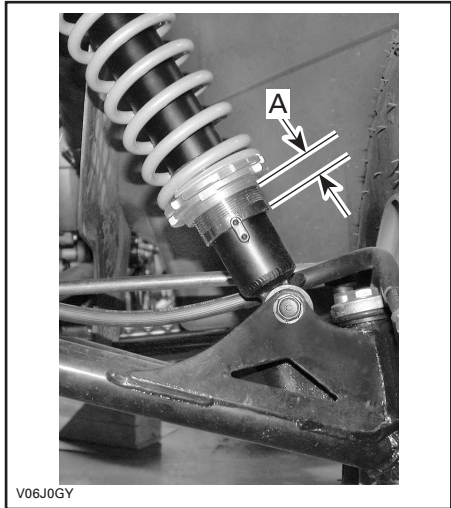

#### FRONT SUSPENSION

A. Same length on both sides



## Lubrication

### Front A-Arm

Lubricate front A-arms. Use synthetic grease (P/N 293 550 033) or an equivalent. There is two grease fittings on each A-arm.

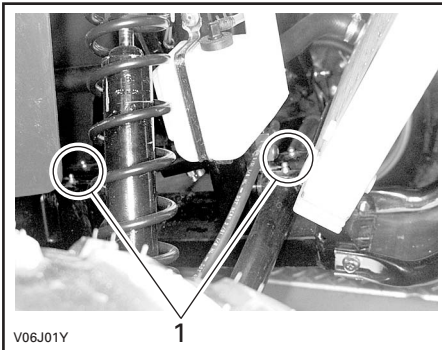

1. Grease fittings

### Swing Arm

Lubricate swing arm pivots. Use synthetic grease (P/N 293 550 033) or an equivalent.

## Inspection

### Front and Rear Suspension

Inspect shock absorbers for oil leaks and fasteners for tightness. See an authorized Bombardier ATV dealer as necessary.

### Swing Arm

Check swing arm for distortion, cracks or bending. See an authorized Bombardier ATV dealer if any problem is detected.

### A-Arms

Check arms for cracks, bending or other damages. See an authorized Bombardier ATV dealer as necessary.

## Brakes

### **WARNING**

Any brake system repair should be performed by an authorized Bombardier ATV dealer.

### Front Brake

The front brakes are hydraulic disc types. These brakes are self-adjusting and require no adjustment.

### Rear Brake

The rear brake employs two systems. The first system uses a cable; an adjustment is necessary. See an authorized Bombardier ATV dealer.

The second system is hydraulic and requires no adjustment.

### Brake Cable Lubrication

Remove brake lever and lock (screw, nut and spring).

Remove cable from hand lever. To ease this operation, apply a force on the brake pedal to loosen the cable.

Put the cable luber (P/N 529 035 738) on the cable.

Insert the needle of the spray can in the hole. Spray a small quantity of silicone cable lubricant (P/N 293 600 041) or an equivalent then press the brake pedal to remove the brake cable. Repeat this procedure until the silicone lubricant exits the other end of the cable.

### **WARNING**

Always use a silicone-based lubricant. Using another lubricant (like water-based lubricant) could cause brake cable sticking or stiffness.

## Inspection

### **WARNING**

See an authorized Bombardier ATV dealer to repair or replace any components of the brake system.

Check the following to keep the brakes in good operating condition:

- brake cable adjustment
- brake system for fluid leaks
- brake for spongy feel
- brake discs for excessive wear and surface condition
- brake pads for wear, damage or looseness.

#### SERVICE LIMITS

Brake pads thickness	1 mm (0.040 in)
Brake discs thickness	3.5 mm (0.138 in)
Maximum discs warpage	0.15 mm (0.010 in)

## Brake Fluid Replacement

### **WARNING**

The brake fluid replacement or any brake system repairs should be performed by an authorized Bombardier ATV dealer.

## Body/Frame

### Engine Area

Check engine area for any damage and leaks. Ensure all hose clamps are properly secured and no hose is cracked, kinked or otherwise damaged.

Inspect muffler, battery and reservoir fastening devices.

Check electrical connections for corrosion and tightness.

Replace or have damaged parts repaired.

### Hitch/Trailer Ball Condition (if so equipped)

Check tightness of fasteners and tightness/condition of trailer balls. Properly retighten as necessary and replace ball if worn.

### Fasteners

Check fastener condition and tightness on the vehicle. Retighten as required.

### Seat Fasteners

Check tightness of seat fasteners. Retorque or replace if damaged.

### Vehicle Cleaning and Protection

Never use a high pressure washer to clean the vehicle **USE LOW PRESSURE ONLY** (like a garden hose). The high pressure can cause electrical or mechanical damages.

Painted parts which are damaged should be properly repainted to prevent rust.

When required, wash the body with hot water and soap (only use mild detergent). Apply non-abrasive wax.

**CAUTION:** Never clean plastic parts with strong detergent, degreasing agent, paint thinner, acetone, etc.

---

# TROUBLESHOOTING

---

## Engine does not turn

---

1. Ignition switch is in the OFF position.
  - *Place switch to the ON position.*
2. Transmission is not set on NEUTRAL.
  - *Set transmission either in NEUTRAL or press the brake lever.*
3. Burnt fuse.
  - *Check main fuse condition.*
4. Weak battery or loose connections.
  - *Check charging system fuse.*
  - *Check connections and terminals condition.*
  - *Have the battery checked.*
  - *Contact an authorized Bombardier ATV dealer.*

---

## Engine turns over but fails to start

---

1. Burnt fuse.
  - *Check main fuse condition.*
2. Mixture not rich enough to start cold engine.
  - *Check fuel tank level and check starting procedure, particularly use of the choke.*
3. Flooded engine (spark plug wet when removed).
  - *Refer to SPECIAL PROCEDURES.*
4. No fuel to the engine (spark plug dry when removed).
  - *Check fuel tank level; turn fuel valve to ON (also try on RES). A failure of the fuel pump or carburetor may have occurred.*
  - *Contact an authorized Bombardier ATV dealer.*
5. Spark plug/ignition (no spark).
  - *Check main fuse condition.*
  - *Remove spark plug then reconnect to spark plug cap.*
  - *Check that ignition switch and/or engine stop switch is/are at the ON position.*
  - *Start engine with spark plug grounded to the engine away from spark plug hole. If no spark appears, replace spark plug.*
  - *If trouble persists, contact an authorized Bombardier ATV dealer.*
6. Engine compression.
  - *If no pulsating resistance is felt, it suggests a major loss of compression.*
  - *Contact an authorized Bombardier ATV dealer.*

---

## Engine lacks acceleration or power

---

1. Fouled or damaged spark plug.
  - *Check item ENGINE TURNS OVER BUT FAILS TO START.*
2. Lack of fuel to engine.
  - *Check item ENGINE TURNS OVER BUT FAILS TO START.*
3. Carburetor adjustments.
  - *Contact an authorized Bombardier ATV dealer.*

4. Engine is overheating.
  - Check *ENGINE OVERHEATING* in *SPECIAL PROCEDURES*.
  - If overheating persists, contact an authorized Bombardier ATV dealer.
5. Air filter/box plugged or dirty.
  - Check air filter and clean if necessary.
  - Check deposits in air box drain.
  - Check the position of the air intake tube.
6. CVT dirty or wear.
  - Contact an authorized Bombardier ATV dealer.

## **Engine backfire**

---

1. Exhaust system leakage.
  - Contact an authorized Bombardier ATV dealer.
2. Engine is running too hot.
  - See *ENGINE LACKS ACCELERATION OR POWER*.
3. Ignition timing is incorrect or there is an ignition system failure.
  - Contact an authorized Bombardier ATV dealer.
4. Improper carburetor setting.
  - Contact an authorized Bombardier ATV dealer.

## **Engine misfire**

---

1. Fouled/damaged/worn spark plug.
  - Clean/verify spark plug and heat range. Replace as required.
2. Water in fuel.
  - Drain fuel system and refill with fresh fuel.

## **Unusual engine noise**

---

1. Oil filter and/or oil pressure regulator plugged.
  - Change oil filter and engine oil.
  - Clean oil pressure regulator.
2. Valve adjustment.
  - Contact an authorized Bombardier ATV dealer.
3. Chain tensioner plugged.
  - Contact an authorized Bombardier ATV dealer.
4. Timing chain wear.
  - Contact an authorized Bombardier ATV dealer.

## **Vehicle cannot reach full speed**

---

1. Engine.
  - See *ENGINE LACKS ACCELERATION OR POWER*.
2. Parking brake.
  - *Ensure brake lever lock is completely removed.*
3. Air filter/box plugged or dirty.
  - *Check air filter and clean if necessary.*
  - *Check deposits in air box drain.*
  - *Check the position of the air intake tube.*
4. CVT dirty or wear.
  - *Contact an authorized Bombardier ATV dealer.*

## **Transmission lever is hard to move**

---

1. Transmission gears are in a position that prevents the transmission lever to work.
  - *Rock the vehicle back and forth to move the gears in the transmission and allow the transmission lever to be set.*
2. Engine idle speed is set too high.
  - *Adjust the idle speed. Refer to the SPECIFICATIONS.*
3. CVT dirty or wear.
  - *Contact an authorized Bombardier ATV dealer.*

## **The RPM increases but the vehicle does not move**

---

1. The transmission is in NEUTRAL position.
  - *Set transmission in REVERSE or HI.*
2. CVT dirty or wear.
  - *Contact an authorized Bombardier ATV dealer.*
3. Water in the CVT housing.
  - *Contact an authorized Bombardier ATV dealer.*

# SPECIFICATIONS

VEHICLE MODEL		RALLY™ 200
ENGINE		
Type	4 stroke. Single overhead camshaft engine, liquid cooled	
Number of cylinder	Single cylinder	
Number of valves	4 valves with mechanical lifters (adjustable)	
Displacement	176.3 cc (10.76 cu. in)	
Bore	Standard	62 mm (2.4 in)
Stroke	58.4 mm (2.3 in)	
Compression ratio	11.37:1	
Engine power	10.7 kW (14.3 HP)	
Lubrication	Wet sump with replaceable oil filter (lubrication of engine and transmission simultaneously)	
Decompressor	N.A.	
Exhaust system	Screen type. Spark arrestor approved by USDA Forest Service	
Air filter	2 stage foam filter	
TRANSMISSION		
Transmission	Continuously Variable Transmission (CVT)	
COOLING		
Type	Liquid cooled	
Radiator	Front mounted	
CARBURETION		
Carburetor	Make	Mikuni
	Type	VM24 with manual choke
Choke	Variable	
Idle speed	±50	1500 RPM

VEHICLE MODEL		RALLY™ 200
ELECTRICAL		
Magneto generator	Make	SEEC
	Type	260 W @ 6000 RPM
Ignition type		CDI
Ignition timing		Not adjustable
Engine RPM limiter		10 200 RPM (any gear in forward)
Vehicle speed limiter		15 km/h (9 MPH) in reverse
Spark plug	Make	NGK
	Type	CR8E
	Gap	0.7 mm (0.027 in)
Number of spark plug		1
Battery	Type	Electrolyte type battery
	Volt	12 Volts, 14Ah.
Starting system		Electric start
Headlamp bulb		2 x 35 W, HS1
Taillight bulb		5/21 W
	Solenoids	15 A
	Main	15 A
DRIVE TRAIN		
Rear axle		Chain driven/solid axle
Turning radius		1.950 m (77 in) at low speed
SUSPENSION		
Front	Type	Independent suspension — single A-arm, 2 shock absorbers (oil)
	Travel	115 mm (4.5 in)
Rear	Type	Rigid swing-arm, 1 shock absorber (oil)
	Travel	131 mm (5.2 in)
TIRES		
Pressure	Front	24 kPa (3.5 PSI) Maximum, 21 kPa (3 PSI) Maximum
	Rear	24 kPa (3.5 PSI) Maximum, 21 kPa (3 PSI) Maximum
Size	Front	22 x 7 – 10
	Rear	22 x 10 – 10

VEHICLE MODEL		RALLY™ 200
WHEELS		
Size	Front	10 x 5.5
	Rear	9 x 8.5
Wheel nut torque		70 N·m (52 lbf·ft)
BRAKES		
Front		hydraulic, 2 discs
Rear		hydraulic, 1 disc
Parking device		LH brake lever includes a lock
LOADING CAPACITY		
Front racks		16 kg (35 lb)
Rear racks		30 kg (65 lb)
Total vehicle load allowed		175 kg (386 lb) includes operator, all other loads and added accessories
GVWR (Gross Vehicle Weight Rating)		373 kg (822 lb)
Towing capacity		360 kg (794 lb)
Tongue capacity		14 kg (30 lb) included with rear racks
DIMENSIONS		
Dry mass		189 kg (417 lb)
Overall length		2.05 m (81 in)
Overall width		1.06 m (41.5 in)
Overall height		1.09 m (43 in)
Seat height		0.84 m (33 in)
Wheel base		1.18 m (46 in)
Wheel track	Front	880 mm (35 in)
	Rear	810 mm (32 in)
Ground clearance	Front and under engine	235 mm (9 in)
	Rear axle	167 mm (6.6 in)
Weight distribution (front/rear)		51/49%



VEHICLE MODEL		RALLY™ 200
LIQUIDS AND GREASES		
Engine oil type (engine and transmission)		SAE 4-stroke mineral-based. API classification SG, SH or SJ or Bombardier synthetic oil 5W40. Refer to OIL VISCOSITY CHART for proper grade
Gearbox oil		80W-90
Coolant		Ethylene-glycol/water mix (50% coolant, 50% water). Use Bombardier premixed coolant or a coolant specially designed for aluminum engines
Fuel	Type	Regular unleaded gasoline
	Octane	87 (R + M)/2 or higher
Brake		Brake fluid, DOT 4
CAPACITIES		
Fuel tank		18.3 L (4.8 U.S. gal) including an approximate reserve of 3.7 L (1 U.S. gal)
Engine/transmission oil		1.35 L (1.43 U.S. quarts)
Gearbox oil		400 mL (13.5 U.S. oz.)
Coolant		2.5 L (12.64 U.S. quarts)

A = ampere

Ah = ampere hour

hp = horsepower

kW = kilowatt

RPM = revolution per minute

USDA = United States Department of Agriculture

Volt = volt

W = Watt

Because of our ongoing commitment to product quality and innovation, BRP reserves the right, at any time, to make changes in design and specifications and/or to make additions to, or improvements in its products without imposing any obligation upon itself to install them on its products previously manufactured.

# INTERNATIONAL SYSTEM METRIC INFORMATION

BASE UNITS			
DESCRIPTION	UNIT	SYMBOL	
length.....	meter.....	m	
mass.....	kilogram.....	kg	
force.....	newton.....	N	
liquid.....	liter.....	L	
temperature.....	Celsius.....	°C	
pressure.....	kilo pascal.....	kPa	
torque.....	newton-meter.....	N·m	
land velocity.....	kilometer per hour.....	km/h	
navigation velocity.....	knot.....	kn	
PREFIXES			
PREFIX	SYMBOL	MEANING	VALUE
kilo.....	k.....	one thousand.....	1000
centi.....	c.....	one hundredth of.....	0.01
milli.....	m.....	one thousandth of.....	0.001
micro.....	μ.....	one millionth of.....	0.000001
CONVERSION FACTORS ①			
TO CONVERT	TO	MULTIPLY BY	
in.....	mm.....	25.4	
in.....	cm.....	2.54	
in <sup>2</sup> .....	cm <sup>2</sup> .....	6.45	
in <sup>3</sup> .....	cm <sup>3</sup> .....	16.39	
ft.....	m.....	0.3	
oz.....	g.....	28.35	
lb.....	kg.....	0.45	
lbf.....	N.....	4.4	
lbf·in.....	N·m.....	0.11	
lbf·ft.....	N·m.....	1.36	
lbf·ft.....	lbf·in.....	12	
PSI.....	kPa.....	6.89	
imp. oz.....	U.S. oz.....	0.96	
imp. oz.....	mL.....	28.41	
imp. gal.....	U.S. gal.....	1.2	
imp. gal.....	L.....	4.55	
U.S. oz.....	mL.....	29.57	
U.S. gal.....	L.....	3.79	
MPH.....	km/h.....	1.61	
Fahrenheit.....	Celsius.....	(°F - 32) ÷ 1.8	
Celsius.....	Fahrenheit.....	(°C x 1.8) + 32	
hp.....	kW.....	.75	

F00A2YL

① To obtain the reverse sequence, divide by the given factor. To convert millimeters to inches, divide by 25.4.

NOTE: Conversion factors are rounded off to 2 decimals for easier use.

# ***WARRANTY***

# **BRP INTERNATIONAL LIMITED WARRANTY: 2005 BOMBARDIER\* ATV PRODUCTS**

## **1. SCOPE OF THE LIMITED WARRANTY**

Bombardier Recreational Products INC. (hereinafter "BRP"), warrants its 2005 Bombardier ATV products from defects in material or workmanship for the period described below.

All genuine Bombardier parts and accessories, installed by an authorized Bombardier distributor/dealer (as hereinafter defined) at the time of delivery of the 2005 Bombardier ATV product, carry the same warranty as that of the ATV.

Use of the product for racing or any other competitive activity, at any point, even by a previous owner, will render this warranty null and void.

## **2. WARRANTY COVERAGE PERIOD**

This warranty will be in effect FROM THE DATE OF DELIVERY TO THE FIRST RETAIL CONSUMER or the date the product is first put into use, whichever occurs first and for a period of: SIX (6) CONSECUTIVE MONTHS, for private use or commercial use owners <sup>(1)</sup>.

The repair or replacement of parts or the performance of service under this warranty does not extend the life of this warranty beyond its original expiration date.

## **3. CONDITIONS TO HAVE WARRANTY COVERAGE**

This warranty coverage is available only on 2005 Bombardier ATV products purchased as new and unused by its first owner from a Bombardier distributor/dealer authorized to distribute Bombardier ATV products in the country in which the sale occurred (hereinafter "Bombardier ATV distributor/dealer"), and then only after the BRP specified pre-delivery inspection process is completed and documented. Warranty coverage only becomes available upon proper registration of the product by an authorized Bombardier ATV distributor/dealer. Such limitations are necessary in order to allow BRP to preserve both the safety of its products, and also that of its consumers and the public.

Routine maintenance outlined in the Operator's Guide must be timely performed in order to maintain warranty coverage. BRP reserves the right to make warranty coverage contingent upon proof of proper maintenance.

## **4. WHAT TO DO TO OBTAIN WARRANTY COVERAGE**

The customer must notify a servicing Bombardier ATV distributor/dealer within two (2) days of the appearance of a defect, and provide it with reasonable access to the product and reasonable opportunity to repair it. The customer must also present to the authorized Bombardier distributor/dealer, proof of purchase of the product and must sign the repair/work order prior to starting the repair in order to validate the warranty repair. All parts replaced under this limited warranty become the property of BRP.

1.The warranty is TWENTY FOUR (24) consecutive months if the product was sold in any of the member states of the European Union (EC directive 1999/44/EC).

The warranty period, however, is SIX (6) consecutive months if the product is used for commercial purposes.

## **5. WHAT BRP WILL DO**

BRP's obligations under this warranty are limited to, at its sole discretion, repairing parts found defective under normal use, maintenance and service, or replacing such parts with new genuine Bombardier parts without charge for parts and labor, at any authorized Bombardier distributor/dealer.

BRP reserves the right to improve or modify products from time to time without assuming any obligation to modify products previously manufactured.

## **6. EXCLUSIONS - ARE NOT WARRANTED**

- Normal wear and tear;
- Routine maintenance items, tune ups, adjustments;
- Damage caused by failure to provide proper maintenance and/or storage, as described in the Operator's Guide;
- Damage resulting from removal of parts, improper repairs, service, maintenance, modifications or use of parts not manufactured or approved by BRP or resulting from repairs done by a person that is not an authorized servicing Bombardier distributor/dealer;
- Damage caused by abuse, abnormal use, neglect or operation of the product in a manner inconsistent with the recommended operation described in the Operator's Guide;
- Damage resulting from accident, submersion, fire, theft, vandalism or any act of God;
- Operation with fuels, oils or lubricants which are not suitable for use with the product (see the Operator's Guide);
- Water or snow ingestion;
- Incidental or consequential damages, or damages of any kind including without limitation towing, storage, telephone, rental, taxi, inconvenience, insurance coverage, loan payments, loss of time, loss of income.

## **7. LIMITATIONS OF LIABILITY**

THIS WARRANTY IS EXPRESSLY GIVEN AND ACCEPTED IN LIEU OF ANY AND ALL OTHER WARRANTIES, EXPRESSED OR IMPLIED, INCLUDING WITHOUT LIMITATION ANY WARRANTY OF MERCHANTABILITY OR FITNESS FOR A PARTICULAR PURPOSE. TO THE EXTENT THAT THEY CANNOT BE DISCLAIMED, THE IMPLIED WARRANTIES ARE LIMITED IN DURATION TO THE LIFE OF THE EXPRESS WARRANTY. INCIDENTAL AND CONSEQUENTIAL DAMAGES ARE EXCLUDED FROM COVERAGE UNDER THIS WARRANTY. SOME STATES/PROVINCES DO NOT ALLOW FOR THE DISCLAIMERS, LIMITATIONS AND EXCLUSIONS IDENTIFIED ABOVE, AS A RESULT, THEY MAY NOT APPLY TO YOU. THIS WARRANTY GIVES YOU SPECIFIC RIGHTS, AND YOU MAY ALSO HAVE OTHER LEGAL RIGHTS WHICH MAY VARY FROM COUNTRY TO COUNTRY.

Neither the distributor, any Bombardier ATV dealer nor any other person has been authorized to make any affirmation, representation or warranty regarding the product, other than those contained in this limited warranty, and if made, shall not be enforceable against BRP.

BRP reserves the right to modify this warranty at any time, being understood that such modification will not alter the warranty conditions applicable to the products sold while this warranty is in effect.

## **8. TRANSFER**

If the ownership of a product is transferred during the warranty coverage period, this warranty shall also be transferred and be valid for the remaining coverage period provided that BRP is notified of such transfer of ownership in the following way:

BRP or an authorized Bombardier ATV distributor/dealer receives a proof that the former owner agreed to the transfer of ownership, in addition to the coordinates of the new owner. The distributor will then forward this information directly to BRP.

## **9. CONSUMER ASSISTANCE**

- a) In the event of a controversy or a dispute in connection with this BRP LIMITED WARRANTY, BRP suggests that you try to resolve the issue at the dealership level. We recommend discussing the issue with the authorized dealer's service manager or owner.
- b) If further assistance is required, the distributor's service department should be contacted in order to resolve the matter.
- c) If the matter still remains unresolved then contact BRP by writing to us at the address listed below.

BOMBARDIER RECREATIONAL PRODUCTS EUROPE N.V.  
CUSTOMER SERVICE CENTER  
BELGIUM  
Tel: +32 (0)9 272 63 30

© 2005 Bombardier Recreational Products Inc. All rights reserved

® Registered trademark of Bombardier Recreational Products Inc. or its subsidiaries.

\* Trademark of Bombardier Inc., used under license.

---

## **PRIVACY OBLIGATION/DISCLAIMER**

We wish to inform you that your coordinates will be used for safety and warranty purposes. Sometimes, we also use the coordinates of our clients to inform them about our products and to present them offers. Should you prefer not to receive information on our product, services and offers, please let us know by writing to the address below.

Also note that, from time to time, carefully selected and trustworthy organizations may be permitted to use the coordinates of our clients to promote quality products and services. If you prefer not to have your name and address released, please let us know by writing to the address below:

Bombardier Recreational Products Europe N.V.  
Customer Service  
Guldensporenpark 83, building I  
B-9820 Merelbeke, Belgium  
Fax Number +32 (0)9 272 63 49





---

# CHANGE OF ADDRESS/OWNERSHIP

If your address has changed or if you are the new owner of the ATV, be sure to notify BRP by either:

- mailing the card below;
- notifying an authorized Bombardier ATV dealer.

In case of change of ownership, please join a proof that the former owner agreed to the transfer. Notifying BRP, even after the expiration of the limited warranty, is very important as it enables BRP to reach the ATV owner if necessary, like when safety recalls are initiated. It is the owner's responsibility to notify BRP.

**STOLEN UNITS:** If your personal ATV is stolen, you should notify BRP or an authorized Bombardier ATV dealer. We will ask you to provide your name, address, phone number, the vehicle identification number and the date it was stolen.

CHANGE OF ADDRESS

CHANGE OF OWNERSHIP

---

VEHICLE IDENTIFICATION NUMBER

---

Model Number

Vehicle Identification Number (V.I.N.)

OLD ADDRESS  
OR PREVIOUS OWNER:

\_\_\_\_\_ NAME

NO. \_\_\_\_\_ STREET \_\_\_\_\_ APT

CITY \_\_\_\_\_ STATE/PROVINCE \_\_\_\_\_ ZIP/POSTAL CODE

\_\_\_\_\_ COUNTRY

NEW ADDRESS  
OR NEW OWNER:

\_\_\_\_\_ NAME

NO. \_\_\_\_\_ STREET \_\_\_\_\_ APT

CITY \_\_\_\_\_ STATE/PROVINCE \_\_\_\_\_ ZIP/POSTAL CODE

\_\_\_\_\_ COUNTRY



AFFIX  
PROPER  
POSTAGE

Bombardier Recreational Products Europe N.V.  
Customer Service  
Guldensporenpark 83, building I  
B-9820 Merelbeke, Belgium

---

# CHANGE OF ADDRESS/OWNERSHIP

If your address has changed or if you are the new owner of the ATV, be sure to notify BRP by either:

- mailing the card below;
- notifying an authorized Bombardier ATV dealer.

In case of change of ownership, please join a proof that the former owner agreed to the transfer. Notifying BRP, even after the expiration of the limited warranty, is very important as it enables BRP to reach the ATV owner if necessary, like when safety recalls are initiated. It is the owner's responsibility to notify BRP.

**STOLEN UNITS:** If your personal ATV is stolen, you should notify BRP or an authorized Bombardier ATV dealer. We will ask you to provide your name, address, phone number, the vehicle identification number and the date it was stolen.

CHANGE OF ADDRESS

CHANGE OF OWNERSHIP

---

VEHICLE IDENTIFICATION NUMBER

---

Model Number

Vehicle Identification Number (V.I.N.)

OLD ADDRESS  
OR PREVIOUS OWNER:

NAME

NO. STREET APT

CITY STATE/PROVINCE ZIP/POSTAL CODE

COUNTRY

NEW ADDRESS  
OR NEW OWNER:

NAME

NO. STREET APT

CITY STATE/PROVINCE ZIP/POSTAL CODE

COUNTRY



AFFIX  
PROPER  
POSTAGE

Bombardier Recreational Products Europe N.V.  
Customer Service  
Guldensporenpark 83, building I  
B-9820 Merelbeke, Belgium





## WARNING

**THIS VEHICLE CAN BE HAZARDOUS TO OPERATE.** A collision or rollover can occur quickly, even during routine manoeuvres such as turning and driving on hills or over obstacles, if you fail to take proper precautions.

**SEVERE INJURY OR DEATH** can result if you do not follow these instructions:

- **BEFORE YOU OPERATE THIS ATV, READ THIS OPERATOR'S GUIDE AND ALL ON-PRODUCT LABELS.**
- **NEVER OPERATE THIS ATV WITHOUT PROPER INSTRUCTIONS.** Beginners should complete a certified training course.
- **NEVER CARRY A PASSENGER.** You increase your risk of losing control if you carry a passenger.
- **NEVER OPERATE THIS ATV ON A PAVED SURFACE.** You increase your risk of losing control if you operate this ATV on pavement.
- **NEVER OPERATE THIS ATV ON PUBLIC ROADS.** You can collide with another vehicle if you operate this ATV on a public road.
- **ALWAYS WEAR AN APPROVED HELMET,** eye protection and protective clothing.
- **NEVER CONSUME ALCOHOL OR DRUGS** before or while operating this vehicle.
- **NEVER OPERATE THIS ATV AT EXCESSIVE SPEEDS.** You increase your risk of losing control if you operate this vehicle at speeds too fast for the terrain, visibility conditions, or your experience.
- **NEVER ATTEMPT WHEELIES, JUMPS, OR OTHER STUNTS.**

®™ TRADEMARKS OF BOMBARDIER RECREATIONAL PRODUCTS INC. OR ITS AFFILIATES.

\* TRADEMARK OF BOMBARDIER INC., USED UNDER LICENSE.

© 2005 BOMBARDIER RECREATIONAL PRODUCTS INC. ALL RIGHTS RESERVED. PRINTED IN THE E.U.

## OPERATOR'S GUIDE

**RALLY 200**

**2005**

**8191080**