

can-am®



2019

Operator's Guide

Includes
Safety, Vehicle
and Maintenance Information



RENEGADE® Series

WARNING

Read this guide thoroughly. It contains important safety information.

Minimum recommended age: Operator: 16 years old. Keep this Operator's Guide in the vehicle.

2 1 9 0 0 1 9 5 7

Original Instructions

WARNING

YOUR VEHICLE CAN BE HAZARDOUS TO OPERATE. A collision or rollover can occur quickly, if you fail to take proper precautions, even during routine maneuvers such as turning and driving on hills or over obstacles. For your safety, understand and follow all the warnings contained in this Operator's Guide and on the labels on your vehicle. **Failure to follow these warnings can result in SEVERE INJURY OR DEATH!** Keep this Operator's Guide with the vehicle at all times.

WARNING

Disregarding any of the safety precautions and instructions contained in this Operator's Guide, *SAFETY VIDEO* and on-product safety labels could result in an injury including the possibility of death!

WARNING

This vehicle may exceed the performance of other vehicles you may have ridden in the past. Take time to familiarize yourself with your new vehicle.

CALIFORNIA PROPOSITION 65 WARNING

 **WARNING:** Operating, servicing and maintaining an off-road vehicle can expose you to chemicals including engine exhaust, carbon monoxide, phthalates, and lead, which are known to the State of California to cause cancer and birth defects or other reproductive harm. To minimize exposure, avoid breathing exhaust, do not idle the engine except as necessary, service your vehicle in a well-ventilated area and wear gloves or wash your hands frequently when servicing your vehicle. For more information go to www.p65warnings.ca.gov/products/passenger-vehicle.

The following trademarks are the property of Bombardier Recreational Products Inc.:

In Canada, products are distributed by Bombardier Recreational Products Inc. (BRP). In USA, products are distributed by BRP US Inc.

Can-Am® D.E.S.S.™ DPST™ Renegade™ Rotax® TTI™ X™ XPST™

† Visco-Lok is a trademark of GKN Viscodrive GmbH.

FOREWORD

Deutsch	Dieses Handbuch ist möglicherweise in Ihrer Landessprache verfügbar. Bitte wenden Sie sich an Ihren Händler oder besuchen Sie: www.operatorsguides.brp.com
English	This guide may be available in your language. Check with your dealer or go to: www.operatorsguides.brp.com
Español	Es posible que este manual esté disponible en su idioma. Consulte a su distribuidor o visite: www.operatorsguides.brp.com
Français	Ce guide peut être disponible dans votre langue. Vérifier avec votre concessionnaire ou aller à: www.operatorsguides.brp.com
Italiano	Questa guida potrebbe essere disponibile nella propria lingua. Contattare il concessionario o consultare: www.operatorsguide.brp.com
中文	本手册可能有您的语种的翻译版本。请向经销商问询，或者登录 www.operatorsguides.brp.com 查询。
日本語	このガイドは、言語によって翻訳版が用意されています。ディーラーに問い合わせるか、次のアドレスでご確認ください： www.operatorsguides.brp.com
Nederlands	Deze handleiding kan beschikbaar zijn in uw taal. Vraag het aan uw dealer of ga naar: www.operatorsguides.brp.com
Norsk	Denne boken kan finnes tilgjengelig på ditt eget språk. Kontakt din forhandler eller gå til: www.operatorsguides.brp.com
Português	Este manual pode estar disponível em seu idioma. Fale com sua concessionária ou visite o site: www.operatorsguides.brp.com
Русский	Воспользуйтесь руководством на вашем языке. Узнайте о его наличии у дилера или на странице по адресу www.operatorsguide.brp.com
Suomi	Käyttöohjekirja voi olla saatavissa omalla kielelläsi. Tarkista jälleenmyyjältä tai käy osoitteessa: www.operatorsguides.brp.com
Svenska	Denna bok kan finnas tillgänglig på ditt språk. Kontakta din återförsäljare eller gå till: www.operatorsguides.brp.com

Congratulations on your purchase of a new Can-Am® ATV. It is backed by the BRP warranty and a network of authorized Can-Am dealers ready to provide the parts, service or accessories you may require.

Your dealer is committed to your satisfaction. He has taken training to perform the initial setup and inspection of your vehicle as well as completed the

final adjustment before you took possession. If you need more complete servicing information, please ask your dealer.

At delivery, you were also informed of the warranty coverage and signed the *PREDELIVERY CHECK LIST* to ensure your new vehicle was prepared to your entire satisfaction.

Know Before you Go

To learn how to reduce the risk for you or bystanders being injured or killed, read this Operator's Guide before you operate the vehicle.

Also, read all safety labels on your ATV and watch attentively the *SAFETY VIDEO* located at <https://can-am.brp.com/off-road/safety>.



This vehicle is for off road use only. It is mainly for general recreational use but it may also be used for utility purposes.

Failure to follow the warnings contained in this Operator's Guide can result in **SERIOUS INJURY** or **DEATH**.

Age Recommendation

This vehicle is a category S, always follow this age recommendation:

- A person under 16 years old should never operate this vehicle.
- This vehicle is for recreational use by experienced operator's only.

WARNING

This is a high performance ATV. Inexperienced riders may overlook risks and be surprised by the specific behavior of this ATV in any riding condition.

Training Course

Never operate this vehicle without proper instruction. **Take a training course.** All operators should receive training from a certified instructor.

For more information about ATV safety, contact an authorized Can-Am dealer to find out about available training courses nearest you.

In the United States, call the Specialty Vehicle Institute of America (SVIA) at 1 800 887-2887 or in Canada, the Canada Safety Council (CSC) at 1 613 739-1535.

Safety Messages

The types of safety messages, what they look like and how they are used in this guide are explained as follows:

The safety alert symbol  indicates a potential injury hazard.

WARNING

Indicates a potential hazard, if not avoided, could result in serious injury or death.

 **CAUTION** Indicates a hazard situation which, if not avoided, could result in minor or moderate injury.

NOTICE Indicates an instruction which, if not followed, could severely damage vehicle components or other property.

About this Operator's Guide

This Operator's Guide has been prepared to acquaint the owner/operator of a new vehicle with the various vehicle controls, maintenance and safe operating instructions. It is indispensable for the proper use of the product.

Note that this guide is available in several languages. In the event of any discrepancy, the English version shall prevail.

Keep this Operator's Guide in the vehicle as you can refer to it for things such as maintenance, troubleshooting and instructing others.

If you want to view and/or print an extra copy of your Operator's Guide, simply visit the following website www.operatorsguides.brp.com.

The information contained in this document are correct at the time of publication. However, BRP maintains a policy of continuous improvement of its products without imposing upon itself any obligation to install them on products previously manufactured. Due to late changes, some differences between the manufactured product and the descriptions and/or specifications in this guide may occur. BRP reserves the right at any time to discontinue or change specifications, designs, features, models or equipment without incurring any obligation upon itself.

This Operator's Guide should remain with the vehicle when it is sold.

While reading this Operator's Guide, remember that:

 **WARNING**

Indicates a potential hazard that, if not avoided, could result in serious injury or death.

TABLE OF CONTENTS

FOREWORD	1
Know Before you Go	2
Safety Messages	2
About this Operator's Guide	2

SAFETY INFORMATION

GENERAL PRECAUTIONS	10
Avoid Carbon Monoxide Poisoning	10
Avoid Gasoline Fires and Other Hazards	10
Avoid Burns from Hot Parts	10
Accessories and Modifications	10
SPECIAL SAFETY MESSAGES	11
OPERATION WARNINGS	13
IMPORTANT ON-PRODUCT LABELS(CANADA/UNITED STATES)	39
Hang Tag	39
Vehicle Safety Labels	41
Compliance Labels	43
Technical Information Labels	44
IMPORTANT ON-PRODUCT LABELS (ALL COUNTRIES EXCEPT CANADA/UNITED STATES)	45
Hang Tag	45
Vehicle Safety Labels	46
Compliance Labels	50
Technical Information Labels	50
PRE-RIDE INSPECTION	51
Pre-Ride Inspection Check List	52
RIDING THE VEHICLE	54
Riding Gear	55
Recreational Riding	55
Environment	56
Design Limitation	57
Off-Road Operation	57
Riding Techniques	57
MOVING LOADS AND DOING WORK	67
Working with your Vehicle	67
Carrying Loads	67

VEHICLE INFORMATION

CONTROLS	72
1) Throttle Lever	72
2) LH Brake Lever	73
3) RH Brake Lever	73
4) Parking Brake Lever	73

CONTROLS (cont'd)	
5) Brake Pedal	74
6) Shift Lever	74
7) RF D.E.S.S. Key	75
8) Multifunction Switch	76
9) 2WD/4WD and Driving Modes (if equipped) Selector Switch	78
MULTIFUNCTION GAUGE (LCD)	81
Multifunction Gauge Description	81
Multifunction Gauge Modes	82
Navigating in the LCD Gauge	83
Gauge Setup	85
EQUIPMENT	86
1) Seat	87
2) Footpegs	88
3) 12-Volt Power Outlet	88
4) Rear Cargo Area	88
5) Tool Kit	88
6) Recovery Hook	89
7) Gauge Support	89
8) Console	89
FUEL	90
Fuel Requirements	90
Vehicle Fueling Procedure	90
BREAK-IN PERIOD	92
Operation During Break-In	92
BASIC PROCEDURES	93
Starting the Engine	93
Waking Up the Electrical System	93
Changing Gear Selection	93
Stopping the Engine and Parking the Vehicle	93
SPECIAL PROCEDURES	95
What to Do if Water Entered the CVT	95
What to Do if Water Entered the Air Filter Housing	95
What to Do if Vehicle is Turned Over	96
What to Do if Vehicle is Immersed in Water	96
TUNE YOUR RIDE	97
Suspension Adjustments	97
Dynamic Power Steering (DPS) Assist Level Adjustment (X xc Models) ...	99
VEHICLE TRANSPORTATION	101
MAINTENANCE	
MAINTENANCE SCHEDULE	104
SEVERE DUSTY CONDITIONS	104
MAINTENANCE SCHEDULE LEGEND	104

MAINTENANCE SCHEDULE (cont'd)	
MAINTENANCE SCHEDULE	105
MAINTENANCE PROCEDURES	107
Air Filter	107
Engine Oil	110
Oil Filter	111
Radiator	112
Engine Coolant	113
Muffler Spark Arrester	115
CVT Air Filter	116
Gearbox Oil	117
Throttle Body	118
Throttle Cable	119
Spark Plugs	121
Battery	122
Fuses	122
Lights	124
Drive Shaft Boot and Protector	125
Wheel Bearing	126
Wheels and Tires	127
Steering	130
Suspension	130
Brakes	131
VEHICLE CARE	133
Post-Operation Care	133
Vehicle Cleaning	133
STORAGE AND PRESEASON PREPARATION	135

TECHNICAL INFORMATION

VEHICLE IDENTIFICATION	138
Vehicle Identification Number	138
Engine Identification Number (EIN)	138
Compliance Label	138
Radio Frequency Digitally Encoded Security System (RF D.E.S.S. key) ..	139
NOISE EMISSION CONTROL SYSTEM REGULATION (CANADA/UNITED STATES)	140
NOISE EMISSION AND VIBRATION VALUES (ALL COUNTRIES EXCEPT CANADA/UNITED STATES)	141
EC-DECLARATION OF CONFORMITY	142
SPECIFICATIONS	144

TROUBLESHOOTING

TROUBLESHOOTING GUIDELINES 152
MULTIFUNCTION GAUGE MESSAGES..... 157

WARRANTY

BRP LIMITED WARRANTY USA AND CANADA: 2019 CAN-AM® ATV.... 160
US EPA EMISSION-RELATED WARRANTY 163
BRP INTERNATIONAL LIMITED WARRANTY: 2019 CAN-AM® ATV..... 166
**BRP LIMITED WARRANTY FOR THE EUROPEAN ECONOMIC AREA,
 THE COMMONWEALTH OF THE INDEPENDENT STATES AND TURKEY
 ECONOMIC AREA: 2019 CAN-AM® ATV 170**

CUSTOMER INFORMATION

PRIVACY INFORMATION 176
CONTACT US..... 177
 North America 177
 Europe 177
 Oceania 177
 South America..... 177
 Asia..... 177
CHANGE OF ADDRESS/OWNERSHIP..... 178

SAFETY INFORMATION

GENERAL PRECAUTIONS

Avoid Carbon Monoxide Poisoning

All engine exhaust contains carbon monoxide, a deadly gas. Breathing carbon monoxide can cause headaches, dizziness, drowsiness, nausea, confusion and eventually death.

Carbon monoxide is a colorless, odorless, tasteless gas that may be present even if you do not see or smell any engine exhaust. Deadly levels of carbon monoxide can collect rapidly, and you can quickly be overcome and unable to save yourself. Also, deadly levels of carbon monoxide can linger for hours or days in enclosed or poorly ventilated areas. If you experience any symptoms of carbon monoxide poisoning, leave the area immediately, get fresh air and seek medical treatment.

To prevent serious injury or death from carbon monoxide:

- Never run the vehicle in poorly ventilated or partially enclosed areas such as garages, carports or barns. Even if you try to ventilate engine exhaust with fans or open windows and doors, carbon monoxide can rapidly reach dangerous levels.
- Never run the vehicle outdoors where engine exhaust can be drawn into a building through openings such as windows and doors.

Avoid Gasoline Fires and Other Hazards

Gasoline is extremely flammable and highly explosive. Fuel vapors can spread and be ignited by a spark or flame many feet away from the engine. To reduce the risk of fire or explosion, follow these instructions:

- Use only an approved red gasoline container to store fuel.
- Never fill a gasoline container on the vehicle. An electrical static discharge may ignite the fuel.

- For refueling, strictly adhere to instructions in *FUEL*.
- Never start or operate the engine if the fuel cap is not properly installed.

Gasoline is poisonous and can cause injury or death.

- Never siphon gasoline by mouth.
- If you swallow gasoline, get any in your eye(s), or inhale gasoline vapor, see your doctor immediately.

If gasoline spills on you, wash with soap and water and change your clothes.

Avoid Burns from Hot Parts

Certain components become hot during operation. Avoid contact with those parts during and shortly after operation to avoid burns.

Accessories and Modifications

Any modifications or addition of accessories may affect the handling of your vehicle. It is important to take the time to get familiar with the vehicle once modifications are made to understand how to adapt your driving behavior accordingly.

Do not temper with unauthorized modifications or install equipment not specifically certified by BRP for the vehicle. These modifications have not been tested by BRP and they may increase the risk of injury or loss of control, or render the vehicle illegal to ride. As an example, tempering with tire specifications may affect the behavior of the vehicle and increase the risk of a loss of control.

Ask your authorized BRP dealer for suitable available accessories for your vehicle.

SPECIAL SAFETY MESSAGES

THIS VEHICLE IS NOT A TOY AND CAN BE HAZARDOUS TO OPERATE.

- This vehicle handles differently from other vehicles including motorcycles and cars. A collision or rollover can occur quickly, if you fail to take proper precautions, even during routine maneuvers such as turning and driving on hills or over obstacles.

SEVERE INJURY OR DEATH can result if you do not follow these instructions:

- Read this Operator's Guide and all on-product safety labels carefully and follow the operating procedures described. Watch and pay attention to the *SAFETY VIDEO* before operating the vehicle.
- This is a high performance ATV for off-road use only. Inexperienced riders may overlook risks and be surprised by the specific behavior of this ATV in any terrain condition.
- Always follow this age recommendation: A person under 16 years old should never operate this vehicle.
- Never operate this vehicle without wearing an approved helmet of the proper size and other required riding gears. Refer to *RIDING GEAR* in the *RIDING THE VEHICLE* for detailed information.
- Never carry a passenger on this vehicle. This vehicle is designed for an operator only. Do not make any modifications to accommodate a passenger or use racks to carry a passenger. Passenger(s) affect balance and steering and increase risk of losing control.
- This vehicle is not designed to ride on paved surfaces; if you must shortly use the vehicle on such surfaces, avoid abrupt inputs to steering, accelerator and brakes. Reduce your speed.
- This vehicle is not designed for riding on roads or highways (in most places it is an illegal practice). Riding your vehicle on roads or highways could cause a collision with another vehicle.
- Never use this vehicle if you are tired, ill or with drugs or alcohol. Your reaction time and judgement is greatly affected under these conditions.
- Never attempt wheelies, jumps, or other stunts.
- Never operate at excessive speeds. Always go at a speed that is proper for the terrain, visibility, and operating conditions, and your experience.
- Always go slowly and be extra careful when operating on unfamiliar terrain. Always be alert to changing terrain conditions when operating this vehicle.
- Never operate on excessively rough, slippery or loose terrain until you have learned and practiced the skills necessary to control this vehicle on such terrain. Always be especially cautious on these kinds of terrain.
- Always follow proper procedures for turning as described in *RIDING TECHNIQUES* in this Operator's Guide. Practice turning at low speeds before attempting to turn at faster speeds. Do not turn at excessive speed.
- Never operate this vehicle on hills too steep for the vehicle or for your abilities.
- Always follow proper procedures for climbing hills as described in *RIDING TECHNIQUES*. Check the terrain carefully before you start up any hill. Never climb hills with excessively slippery or loose surfaces. Never go over the top of any hill at high speed.

- Always follow proper procedures for going down hills and for braking on hills as described in *RIDING TECHNIQUES*. Check the terrain carefully before you start down any hill. Never go down a hill at high speed. Avoid going down a hill at an angle that would cause the vehicle to lean sharply to one side. Go straight down the hill where possible.
- Always follow proper procedures for crossing the side of a hill as described in *RIDING TECHNIQUES*. Avoid hills with excessively slippery or loose surfaces. Never attempt to turn the vehicle around on any hill until you have mastered the turning technique on level ground. Avoid crossing the side of a steep hill if possible.
- Always use proper procedures if you stall or roll backwards when climbing a hill. To avoid stalling, use proper gear and maintain a steady speed when climbing a hill. If you stall or roll backwards, follow the driving technique procedures as described in *RIDING TECHNIQUES*.
- Always check for obstacles before operating in a new area. Never attempt to operate over large obstacles, such as large rocks or fallen trees. Always follow proper procedures when operating over obstacles as described in *RIDING TECHNIQUES*.
- Always be careful when skidding or sliding. Learn to safely control skidding or sliding by practicing at low speeds and on level smooth terrain. On extremely slippery surfaces, such as ice, go slowly and be very cautious in order to reduce the chance of skidding out of control.
- Never operate this vehicle through deep or fast flowing water. Water should never exceed footrests. Remember that wet brakes may have reduced stopping ability. Test your brakes after leaving water, mud or snow. If necessary, apply them several times to let friction dry out the pads. Allow greater distance for braking.
- Always keep in mind that braking distance is readily affected by but not limited to; weather and terrain conditions, braking system and tire conditions, vehicle speed and attitude, and vehicle load including towing. Remember to adjust your driving accordingly.
- Never exceed the stated load limits for this vehicle including operator, all other loads and added accessories. Cargo should be properly distributed and securely attached. Reduce speed and follow instructions in this guide for carrying cargo or pulling a trailer. Allow greater distance for braking.
- Always inspect and confirm the safe operating condition of your vehicle prior to ride. Refer to *PRE-RIDE INSPECTION*. Always follow the maintenance schedules as described in this Operator's Guide. Refer to *MAINTENANCE*.
- Always maintain proper tire pressure. When replacing tires, use only the recommended tire size and type. For tire information, refer to *SPECIFICATIONS*.
- Riding your vehicle too fast for the conditions may result in injury. Apply only enough throttle to proceed safely. Statistics show that mishaps and injury usually result from high speed turns. Always remember that this vehicle is heavy! Its pure weight alone may entrap you should it fall resulting in injury.
- This vehicle is not designed for jumping, nor can it fully absorb the high impact energy generated during manoeuvres such as jumping which, can be passed on to you, the operator. Performing wheelies can cause the vehicle to flip over onto you. Both practices have a high risk for you and should be avoided at all times.
- The tires of this vehicle are not suited for paved road use.

OPERATION WARNINGS

The following warning and their format have been requested by the United States Consumer Product Safety Commission and are required to be in the Operator's Guide for all ATVs.

NOTE: The following illustrations are general representations only. Your model may differ.

WARNING



POTENTIAL HAZARD

Operating this vehicle without proper instruction.

WHAT CAN HAPPEN

The risk of an accident is greatly increased if the operator does not know how to operate this vehicle properly in different situations and on different types of terrain.

HOW TO AVOID THE HAZARD

Beginners and inexperienced operators should complete a training course. They should then regularly practice the skills learned during the course as well as the operating techniques described in this Operator's Guide.

For more information about a training course, contact an authorized Can-Am dealer.

⚠ WARNING



V00A1AQ

POTENTIAL HAZARD

Failure to follow the age recommendations for this vehicle.

WHAT CAN HAPPEN

A lack of respect for this age recommendation can lead to severe injury or death of the child.

Even though a child may be within the age group for which this vehicle is recommended, he may not have the skills, abilities, or judgment needed to operate this vehicle safely and may be involved in a serious accident.

HOW TO AVOID THE HAZARD

No one under 16 should operate this vehicle.

⚠ WARNING

V00A02Q

POTENTIAL HAZARD

Carrying a passenger on this vehicle.

WHAT CAN HAPPEN

Greatly reduces your ability to balance and control this vehicle.

Could cause an accident, resulting in harm to you and/or your passenger.

HOW TO AVOID THE HAZARD

Never carry passenger. Even with a long seat that provides unrestricted operator movement, it is not designed nor intended to carry passenger(s).

⚠ WARNING



V00A2DQ

POTENTIAL HAZARD

Allowing passenger to sit in any location on this vehicle.

WHAT CAN HAPPEN

Allowing a passenger could:

- Impair vehicle stability which could lead to a loss of control.
- Result in injury to passenger from impact on hard surfaces.
- Cause an accident, resulting in harm to you and/or your passenger.

HOW TO AVOID THE HAZARD

This vehicle is designed for an operator only. Never allow any passenger on this vehicle.

⚠ WARNING**POTENTIAL HAZARD**

Operating this vehicle on public streets, roads or highways.

WHAT CAN HAPPEN

You can collide with another vehicle.

HOW TO AVOID THE HAZARD

Never operate this vehicle on any public street, road or highway, even a dirt or gravel one. In many states it is illegal to operate this vehicle on public streets, roads and highways.

⚠ WARNING



POTENTIAL HAZARD

Riding this vehicle without wearing an approved helmet, eye protection and protective gear.

WHAT CAN HAPPEN

- Riding without an approved helmet increases the chances of a severe head injury or death in the event of an accident.
- Riding without eye protection can result in an accident and increases the chances of a severe injury in the event of an accident.
- Riding without protective gear increases the chances of severe injury in the event of an accident.

HOW TO AVOID THE HAZARD

Always wear an approved helmet that fits properly. You should also wear:

- Eye protection (goggles or face shield)
- Rigid chin guard
- Gloves and boots
- Long sleeved shirt or jacket
- Long pants.

⚠ WARNING

V00A07Q

POTENTIAL HAZARD

Using this vehicle with drugs or alcohol.

WHAT CAN HAPPEN

- Could seriously affect your judgment.
- Could cause you to react more slowly.
- Could affect your balance and perception.
- Could result in an accident or death.

HOW TO AVOID THE HAZARD

Never use this vehicle with drugs or alcohol.

⚠ WARNING

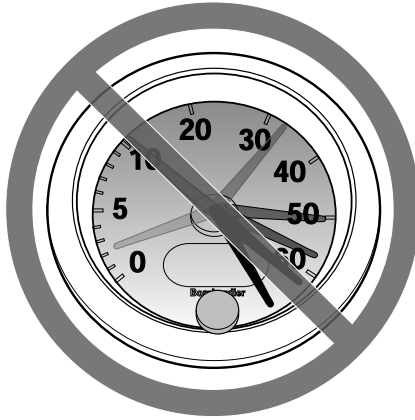

V00A08Q

POTENTIAL HAZARD

Operating this vehicle at excessive speeds.

WHAT CAN HAPPEN

Increases your chances of losing control of the vehicle, which can result in an accident.

HOW TO AVOID THE HAZARD

Always travel at a speed which is appropriate for the terrain, visibility and operating conditions, and your experience.

⚠ WARNING**POTENTIAL HAZARD**

Attempting wheelies, jumps and other stunts.

WHAT CAN HAPPEN

Increases the chance of an accident, including an overturn.

HOW TO AVOID THE HAZARD

Never attempt stunts, such as wheelies or jumps. Do not try to show off.

⚠ WARNING**POTENTIAL HAZARD**

Failure to inspect the vehicle before operating.

Failure to properly maintain the vehicle.

WHAT CAN HAPPEN

Increases the possibility of an accident or equipment damage.

HOW TO AVOID THE HAZARD

Always inspect your vehicle prior to ride to make sure the vehicle is in safe operating condition.

Always follow the maintenance schedule described in this Operator's Guide.

⚠ WARNING

POTENTIAL HAZARD

Riding on frozen waterways.

WHAT CAN HAPPEN

Breaking through the ice can lead to severe injury or death.

HOW TO AVOID THE HAZARD

Never ride this vehicle on a frozen surface before you are sure the ice is thick enough and sound enough to support the vehicle and its load, as well as the force that is created by a moving vehicle.

⚠ WARNING



POTENTIAL HAZARD

Removing hands from handlebars or feet from the footrests during operation.

WHAT CAN HAPPEN

Removing even one hand or foot can reduce your ability to control the vehicle or could cause you to lose your balance and fall off the vehicle. If you remove a foot from the footrests, your foot or leg may come into contact with the rear wheels, which could injure you or cause an accident.

HOW TO AVOID THE HAZARD

Operator must always keep both hands on the handlebars and both feet on the footrests during vehicle operation.

⚠ WARNING**POTENTIAL HAZARD**

Failure to use extra care when operating this vehicle on unfamiliar terrain.

WHAT CAN HAPPEN

You can come upon hidden rocks, bumps, or holes, without enough time to react.

Could result in the vehicle overturning or loss of control.

HOW TO AVOID THE HAZARD

Go slowly and be extra careful when operating on unfamiliar terrain.

Always be alert to changing terrain conditions when operating the vehicle.

⚠ WARNING



POTENTIAL HAZARD

Failure to use extra care when operating on excessively rough, slippery or loose terrain.

WHAT CAN HAPPEN

Could cause loss of traction or vehicle control, which could result in an accident, including an overturn.

HOW TO AVOID THE HAZARD

Do not operate on excessively rough, slippery or loose terrain until you have learned and practiced the skills necessary to control this vehicle on such terrain.

Always be especially cautious on these kinds of terrain.

⚠ WARNING**POTENTIAL HAZARD**

Turning improperly.

WHAT CAN HAPPEN

Vehicle could go out of control, causing a collision or an overturn.

HOW TO AVOID THE HAZARD

Always follow proper procedures for turning as described in this Operator's Guide. Practice turning at low speeds before attempting to turn at faster speeds.

Do not turn at excessive speed.

⚠ WARNING



POTENTIAL HAZARD

Operating on excessively steep hills.

WHAT CAN HAPPEN

The vehicle can overturn more easily on extremely steep hills than on level surfaces or small hills.

HOW TO AVOID THE HAZARD

Never operate this vehicle on hills too steep for the vehicle or for your abilities.

Practice on smaller hills before attempting larger hills.

⚠ WARNING**POTENTIAL HAZARD**

Climbing hills improperly.

WHAT CAN HAPPEN

Could cause loss of control or cause vehicle to overturn.

HOW TO AVOID THE HAZARD

Always follow proper procedures for climbing hills as described in this Operator's Guide.

Always check the terrain carefully before you start up any hill.

Never climb hills with excessively slippery or loose surfaces.

Shift your weight forward.

Never open the throttle suddenly or make sudden gear changes. The vehicle could flip over backwards.

Never go over the top of any hill at high speed. An obstacle, a sharp drop, or another vehicle or person could be on the other side of the hill.

⚠ WARNING



POTENTIAL HAZARD

Going down a hill improperly.

WHAT CAN HAPPEN

Could cause loss of control or cause vehicle to overturn.

HOW TO AVOID THE HAZARD

Always follow proper procedures for going down hills as described in this Operator's Guide.

NOTE: A special technique is required when braking as you go down a hill.

Always check the terrain carefully before you start down any hill.

Shift your weight backward.

Never go down a hill at high speed.

Avoid going down a hill at an angle which would cause the vehicle to lean sharply to one side. Go straight down the hill where possible.

⚠ WARNING**POTENTIAL HAZARD**

Improperly crossing hills or turning on hills.

WHAT CAN HAPPEN

Could cause loss of control or cause vehicle to overturn.

HOW TO AVOID THE HAZARD

Never attempt to turn the vehicle around on any hill until you have mastered the turning technique as described in this Operator's Guide on level ground. Be very careful when turning on any hill.

Avoid crossing the side of a steep hill if possible.

When crossing the side of a hill:

Always follow proper procedures as described further in this Operator's Guide.

Avoid hills with excessively slippery or loose surfaces.

Operator must shift weight to the uphill side of the vehicle.

⚠ WARNING

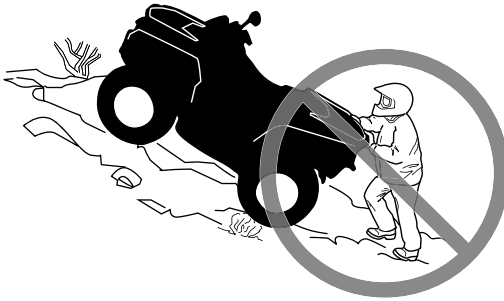

POTENTIAL HAZARD

Stalling, rolling backwards or improperly dismounting while climbing a hill.

WHAT CAN HAPPEN

Could result in vehicle overturning.

HOW TO AVOID THE HAZARD

Use proper gear and maintain steady speed when climbing a hill.

If you lose all forward speed:

Keep your weight uphill. Never open the throttle suddenly or make sudden gear changes. The vehicle could flip over backwards.

Apply brakes gradually.

Lock parking brake after you have stopped.

Dismount on uphill side, or to a side if pointed straight uphill.

If you begin rolling backwards:

Keep your weight uphill. Never open the throttle suddenly or make sudden gear changes. The vehicle could flip over backwards.

Apply brakes gradually.

When fully stopped, apply brakes and lock parking brake.

Dismount on uphill side, or to a side if pointed straight uphill.

Turn the vehicle around and remount, following the procedure described in this Operator's Guide.

⚠ WARNING**POTENTIAL HAZARD**

Improperly operating over obstacles.

WHAT CAN HAPPEN

Could cause loss of control, or a collision.

Could cause the vehicle to overturn.

HOW TO AVOID THE HAZARD

Before operating in a new area, check for obstacles.

Never attempt to ride over large obstacles, such as large rocks or fallen trees.

When you go over obstacles, always follow proper procedures as described in this Operator's Guide.

⚠ WARNING



POTENTIAL HAZARD

Skidding or sliding improperly.

WHAT CAN HAPPEN

You may lose control of this vehicle.

You may also regain traction unexpectedly, which may cause the vehicle to overturn.

HOW TO AVOID THE HAZARD

Learn to safely control skidding or sliding by practicing at low speeds and on level smooth terrain.

On extremely slippery surfaces, such as ice, go slowly and be very cautious in order to reduce the chance of skidding or sliding out of control.

⚠ WARNING**POTENTIAL HAZARD**

Operating this vehicle through deep or fast flowing water.

WHAT CAN HAPPEN

Tires may float, causing loss of traction and loss of control, which could lead to an accident.

HOW TO AVOID THE HAZARD

Never operate this vehicle in fast flowing water or in deep water.

Check water depth and current before you attempt to cross any water. Water should not go above footrests.

Remember that wet brakes may have reduced stopping ability. Test your brakes after leaving water. If necessary, apply them several times to let friction dry out the pads.

⚠ WARNING

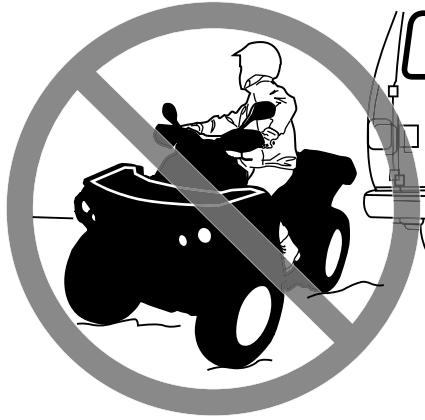

POTENTIAL HAZARD

Improperly operating in reverse.

WHAT CAN HAPPEN

You could hit an obstacle or person behind the vehicle, resulting in serious injury.

HOW TO AVOID THE HAZARD

When you select reverse gear, make sure there are no obstacles or people behind the vehicle. When it is safe to proceed, go slowly.

⚠ WARNING**POTENTIAL HAZARD**

Operating this vehicle with improper tires, or with improper or uneven tire pressure.

WHAT CAN HAPPEN

Use of improper tires on this vehicle, or operation of this vehicle with improper or uneven tire pressure, may cause loss of control, tire blow outs, tire to move around on its rim, and increases the risk of an accident.

HOW TO AVOID THE HAZARD

Always use the size and type of tires specified in this Operator's Guide for this vehicle.

Always maintain proper tire pressure as described in this Operator's Guide.

Always replace wheels or tires that are damaged.

⚠ WARNING



POTENTIAL HAZARD

Operating this vehicle with improper modifications.

WHAT CAN HAPPEN

Improper installation of accessories or modification of this vehicle may cause changes in handling which in some situations could lead to an accident.

HOW TO AVOID THE HAZARD

Never modify this vehicle through improper installation or use of accessories. All parts and accessories added to this vehicle should be approved by BRP and should be installed and used according to instructions. If you have questions, consult an authorized Can-Am dealer.

NEVER install a passenger seat or use the racks to carry a passenger.

Modification of the vehicle to increase speed and performance may violate the terms and conditions of your vehicle limited warranty. In addition, certain modifications including the removal of engine or exhaust components are illegal under most laws.

⚠ WARNING**POTENTIAL HAZARD**

Overloading this vehicle, carrying or towing cargo improperly.

WHAT CAN HAPPEN

Could cause changes in vehicle handling which could lead to an accident.

HOW TO AVOID THE HAZARD

Never exceed the stated load capacity for this vehicle including operator as well as other loads and added accessories.

Cargo should be properly distributed and securely attached.

Reduce speed when carrying cargo or pulling a trailer. Allow greater distance for braking.

Always follow the instructions in this Operator's Guide for carrying cargo or pulling a trailer.

⚠ WARNING



V03M01Q

POTENTIAL HAZARD

Transporting flammable or dangerous material can lead to explosions.

WHAT CAN HAPPEN

This can cause serious injury or death.

HOW TO AVOID THE HAZARD













Never transport flammable or dangerous material.

IMPORTANT ON-PRODUCT LABELS (CANADA/UNITED STATES)

Canada/United States

Hang Tag

This vehicle comes with a hang tag and labels containing important safety and emission informations.

<p>S SPORT MODEL</p> <p>THIS ATV IS FOR RECREATIONAL USE BY EXPERIENCED OPERATORS ONLY.</p> <p>OPERATOR ONLY-NO PASSENGERS</p> <p>NO OPERATOR UNDER AGE 16</p> <hr/> <p>THIS CATEGORY S (SPORT) ATV IS A HIGH PERFORMANCE ATV FOR OFF ROAD USE ONLY. IT IS FOR SPORT TYPE RECREATIONAL AND COMPETITIVE USE BY OPERATORS WITH ADVANCED SKILLS AND SUBSTANTIAL EXPERIENCE.</p> <hr/> <p>TRAINING COURSES TO TEACH ATV RIDING SKILLS ARE AVAILABLE. FOR INFORMATION CONTACT YOUR DEALER.</p> <hr/> <p>CHECK WITH YOUR DEALER TO FIND OUT ABOUT STATE OR LOCAL LAWS REGARDING ATV OPERATION.</p> <p>THIS HANGTAG IS NOT TO BE REMOVED BEFORE SALE.</p> <p>704903318</p>	<p>⚠ WARNING</p> <p>Improper ATV use can result in SEVERE INJURY or DEATH.</p> <table border="0"><tr><td></td><td></td><td></td><td></td></tr><tr><td>ALWAYS USE AN APPROVED HELMET AND PROTECTIVE GEAR.</td><td>NEVER USE ON PUBLIC ROADS.</td><td>NEVER CARRY PASSENGERS.</td><td>NEVER USE WITH DRUGS OR ALCOHOL.</td></tr></table> <p>NEVER operate:</p> <ul style="list-style-type: none">• without proper training or instructions.• at speeds too fast for your skills or the conditions.• on public roads - a collision can occur with another vehicle.• with a passenger - passengers affect balance and steering and increase risk of losing control. <p>ALWAYS:</p> <ul style="list-style-type: none">• use proper riding techniques to avoid vehicle overturns on hills and rough terrain and in turns.• avoid paved surfaces - pavement may seriously affect handling and control. <p>LOCATE AND READ OPERATOR'S GUIDE. FOLLOW ALL INSTRUCTIONS & WARNINGS.</p>					ALWAYS USE AN APPROVED HELMET AND PROTECTIVE GEAR.	NEVER USE ON PUBLIC ROADS.	NEVER CARRY PASSENGERS.	NEVER USE WITH DRUGS OR ALCOHOL.
									
ALWAYS USE AN APPROVED HELMET AND PROTECTIVE GEAR.	NEVER USE ON PUBLIC ROADS.	NEVER CARRY PASSENGERS.	NEVER USE WITH DRUGS OR ALCOHOL.						

704903318

TYPICAL

⚠ WARNING. Operating, servicing and maintaining an off-road vehicle can expose you to chemicals including engine exhaust, carbon monoxide, phthalates, and lead, which are known to the State of California to cause cancer and birth defects or other reproductive harm.

To minimize exposure, avoid breathing exhaust, do not idle the engine except as necessary, service your vehicle in a well-ventilated area and wear gloves or wash your hands frequently when servicing your vehicle.

For more information go to www.P65Warnings.ca.gov/products/passenger-vehicle



704906872

EN-704906872-DEC

VEHICLE ENGINE DESCRIPTION:
XXXXX

EPA CERTIFIED

NER (NORMALIZED EMISSION RATE) =
ON A 0 TO 10 SCALE, 0 BEING THE CLEANEST

***NOT TO BE REMOVED PRIOR TO SALE**



704901107

vmo2006-005-009_en

TYPICAL

Vehicle Safety Labels

Read and understand all the safety labels on your vehicle.

These labels are affixed to the vehicle for the safety of the operator or bystanders.



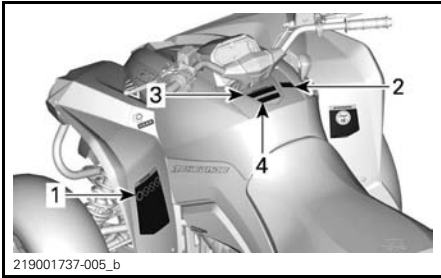
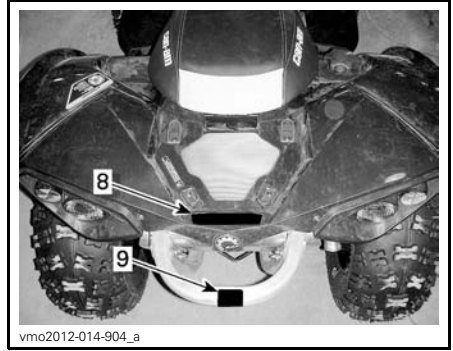

The safety labels on your vehicle should be considered permanent parts of the vehicle. If missing or damaged, they can be replaced free of charge. See an authorized Can-Am dealer.

NOTE: In the event of any discrepancy between this guide and the vehicle, the safety labels on the vehicle have precedence over the labels in this guide.



⚠ WARNING

Improper ATV use can result in SEVERE INJURY or DEATH.

			
ALWAYS USE AN APPROVED HELMET AND PROTECTIVE GEAR	NEVER USE ON PUBLIC ROADS	NEVER CARRY PASSENGERS	NEVER USE WITH DRUGS OR ALCOHOL

NEVER operate:



- without the proper ATV training or instructions.
- at speed too fast for your skills or conditions.
- on public roads - a collision can occur with another vehicle.
- with a passenger - passengers affect balance and steering and increase risk of losing control.

ALWAYS:

- use proper riding techniques to avoid vehicle overturns on hills and rough terrain and in turns.
- avoid paved surfaces - pavement may seriously affect handling and control.

Read and understand all safety labels, locate and read operator's guide and watch the safety video using the QR code link or visit Can-am web site before operation.

LOCATE AND READ OPERATOR'S GUIDE
FOLLOW ALL INSTRUCTIONS & WARNINGS.

70490723

EN-70490723-DEC

LABEL 1



LABEL 2

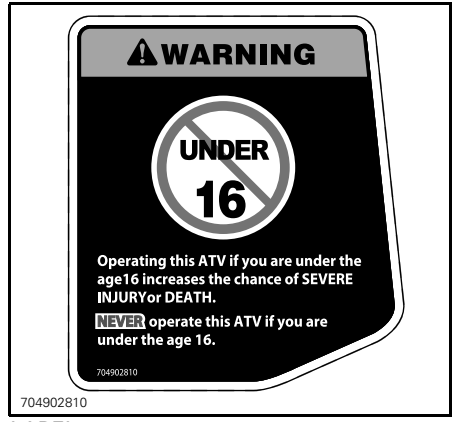

LABEL 5

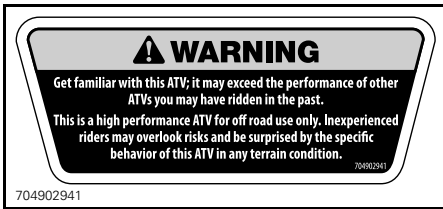

LABEL 3



LABEL 6

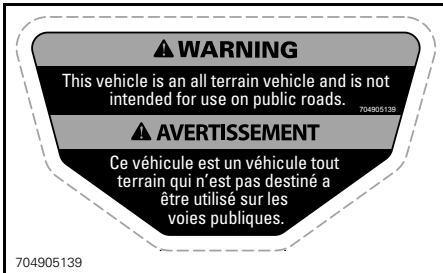

LABEL 4

WARNING

Improper tire pressure or overloading can cause loss of control, resulting in SEVERE INJURY or DEATH.

ALWAYS maintain proper tire pressure according to the load on the vehicle. Refer to table.

NEVER underinflate tire as it could cause the tire to dislodge from the rim.

NEVER exceed the vehicle load capacity of 141 kg (310 lb) including weight of operator, cargo and accessories.

NEVER exceed 110 km/h if total load is more than 114 kg (250 lb),

COLD TIRE PRESSURE	
FRONT	48.3 kPa (7 psi)
REAR	48.3 kPa (7 psi)

7620

EN-704907620-DEC

LABEL 7 (REFER TO SPECIFICATIONS FOR VALUES)

WARNING

- NEVER carry a passenger on this cargo area
- MAXIMUM REAR LOAD: 23 kg (50 lb) evenly distributed.

766011

704904741

LABEL 8

WARNING

NEVER attach here or on the luggage rack to pull a load.

This can cause the vehicle to tip over.

ALWAYS use the trailer hitch or the recovery hook to pull a load.

704902777

704902777A

LABEL 9



LABEL 10

Compliance Labels

These labels indicate vehicle's compliance.

Bombardier Recreational Products Inc. certifies that this ATV complies with ANSI / SVIA-1-2017 Standard.

Bombardier Produits Récréatifs inc. certifie que ce VTT est conforme à la norme ANSI / SVIA-1-2017 Standard.

7635

EN-704907635-DEC

UNDER SEAT

EMISSION CONTROL INFORMATION

THIS VEHICLE IS CERTIFIED TO OPERATE ON UNLEADED GASOLINE AND CONFORMS TO U.S. EPA EMISSION / ÉVAP REGULATIONS FOR ATVs. CERTIFIED FOR SALE IN ALL U.S. STATES EXCEPT CALIFORNIA.

121

ENGINE FAMILY	FAMILLE DE MOTEUR
PERMEATION FAMILY	FAMILLE DE PERMEATION
CERTIFICATION STANDARD (FEL)	LIMITE DES ÉMISSIONS DE LA FAMILLE
ENGINE DISPLACEMENT	CYLINDRÉE
EXHAUST EMISSION CONTROL SYSTEM	SYSTÈME DE CONTRÔLE DES ÉMISSIONS

RENSEIGNEMENTS SUR LE DISPOSITIF ANTIPOLLUTION



CE VÉHICULE EST CERTIFIÉ POUR FONCTIONNER À L'ESSENCE SANS PLOMB ET IL EST CONFORME AUX NORMES DE L'ÉPA AU NIVEAU DES RÉGLEMENTATIONS DE L'ÉCHAPPEMENT ET DE L'ÉVAPORATION POUR LES VTT

SEE OPERATOR'S GUIDE FOR MAINTENANCE SCHEDULE
VOIR LE PROGRAMME D'ENTRETIEN DANS LE GUIDE DU CONDUCTEUR

BOMBARDIER RECREATIONAL PRODUCTS INC. 704906388

704906388

TYPICAL - UNDER SEAT, EXCEPT CALIFORNIA MODELS

EMISSION CONTROL INFORMATION	
 THIS VEHICLE IS CERTIFIED TO OPERATE ON UNLEADED GASOLINE AND CONFORMS TO <input type="checkbox"/> U.S. EPA AND CALIFORNIA EMISSION / EVAP REGULATIONS. FOR ATV. 	
ENGINE FAMILY	FAMILLE DE MOTEUR
PERMEATION FAMILY	FAMILLE DE PERMEATION
CERTIFICATION STANDARD (FEL)	LIMITE DES EMISSIONS DE LA FAMILLE
ENGINE DISPLACEMENT	CYLINDRÉE
EXHAUST EMISSION CONTROL SYSTEM	SYSTÈME DE CONTRÔLE DES ÉMISSIONS
RENSEIGNEMENTS SUR LE DISPOSITIF ANTIPOLLUTION CE VEHICULE EST CERTIFIÉ POUR FONCTIONNER À L'ESSENCE SANS PLOMB ET IL EST CONFORME AUX NORMES <input type="checkbox"/> DE L'EPA ET DE LA CALIFORNIE AU NIVEAU DES RÉGLEMENTATIONS DE L'ÉCHAPPEMENT ET DE L'ÉVAPORATION POUR LES VTT. SEE OPERATOR'S GUIDE FOR MAINTENANCE SCHEDULE VOIR LE PROGRAMME D'ENTRETIEN DANS LE GUIDE DU CONDUCTEUR BOMBARDIER RECREATIONAL PRODUCTS INC. 704904648	
704904648	

TYPICAL - UNDER SEAT, CALIFORNIA MODELS

Technical Information Labels

AIR FILTER MAINTENANCE MAINTENANCE MUST BE PERFORMED AS SPECIFIED IN THE OPERATOR'S GUIDE. AIR FILTER MAINTENANCE SHOULD INCREASE IN FREQUENCY IN MORE SEVERE (DUSTY) CONDITIONS.
ENTRETIEN DU FILTRE À AIR L'ENTRETIEN DOIT ÊTRE EFFECTUÉ TEL QUE SPÉCIFIÉ DANS LE GUIDE DU CONDUCTEUR. ENTRETIENIR LE FILTRE À AIR PLUS SOUVENT DANS DES CONDITIONS PLUS EXTRÊMES (MILIEUX POUSSIÉREUX). 707800373
707800373

UNDER SEAT

IMPORTANT ON-PRODUCT LABELS (ALL COUNTRIES EXCEPT CANADA/UNITED STATES)

All Countries Except Canada/United States

Hang Tag

This vehicle comes with a hang tag and labels containing important safety and emission informations.

WARNING

- Locate and read operator's guide. Improper ATV use can result in SEVERE INJURY or DEATH. Follow all instructions and warnings.
- Always wear ear protection.
- Always use an approved helmet and protective gear.
- Never use on public roads.
- Never carry passengers.
- Never use with drugs or alcohol.

S
SPORT MODEL

THIS ATV IS FOR
RECREATIONAL USE
BY EXPERIENCED OPERATORS ONLY.

OPERATOR ONLY-NO PASSENGERS

NO OPERATOR UNDER AGE 16

THIS CATEGORY S (SPORT) ATV IS A HIGH PERFORMANCE ATV FOR OFF ROAD USE ONLY. IT IS FOR SPORT TYPE RECREATIONAL AND COMPETITIVE USE BY OPERATORS WITH ADVANCED SKILLS AND SUBSTANTIAL EXPERIENCE.

TRAINING COURSES TO TEACH ATV RIDING SKILLS ARE AVAILABLE. FOR INFORMATION CONTACT YOUR DEALER.



CHECK WITH YOUR DEALER TO FIND OUT ABOUT STATE OR LOCAL LAWS REGARDING ATV OPERATION.

THIS HANGTAG IS NOT TO BE REMOVED BEFORE SALE.

704903950







704903950

VEHICLE ENGINE DESCRIPTION:
XXXXX
EPA CERTIFIED

NER (NORMALIZED EMISSION RATE) = X
 ON A 0 TO 10 SCALE, 0 BEING THE CLEANEST
***NOT TO BE REMOVED PRIOR TO SALE**



704901107
 vmo2006-005-009_en

TYPICAL: APPLICABLE WHEN EQUIVALENT TO A MODEL CERTIFIED TO US EPA STANDARDS



Vehicle Safety Labels

Read and understand all the safety labels on your vehicle. These labels are affixed to your vehicle for the safety of the operator or bystanders.

These labels are affixed to the vehicle for the safety of the operator or bystanders.

The safety labels on your vehicle should be considered permanent parts of the vehicle. If missing or damaged, they can be replaced free of charge. See an authorized Can-Am dealer.

NOTE: In the event of any discrepancy between this guide and the vehicle, the safety labels on the vehicle have precedence over the labels in this guide.

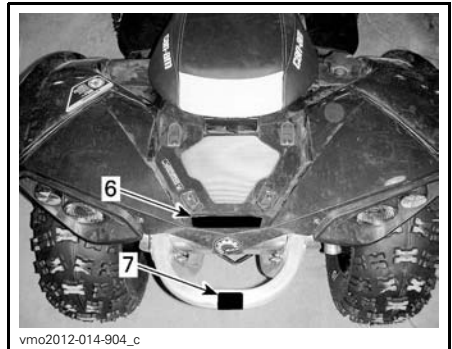
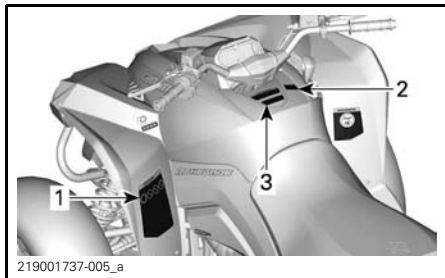
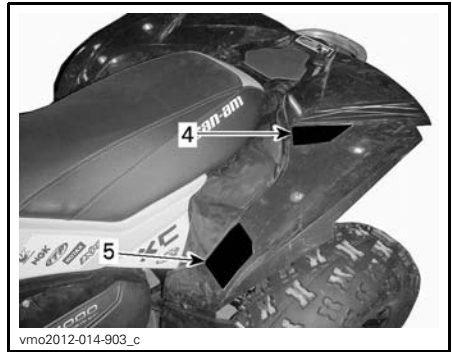

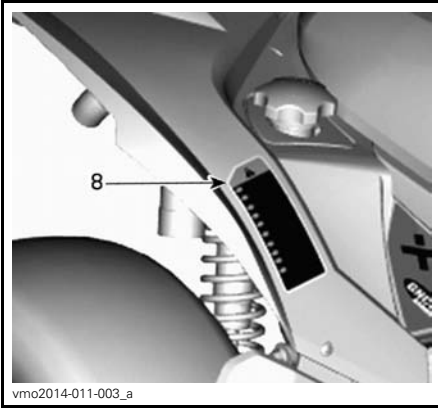

Label 1

⚠ WARNING

- Locate and read operator's guide. Improper ATV use can result in **SEVERE INJURY** or **DEATH**. Follow all instructions and warnings.
- Always wear ear protection.
- Always use an approved helmet and protective gear.
- Never use on public roads.
- Never carry a passenger.
- Never use with drugs or alcohol.

Safety Video

<https://can-am.brp.com/off-road/safety>

704907251

EN-704907251-DEC

LABEL 1

Label 2

NOTICE

- **ATV MUST** be stopped before shifting lever.
- **ALWAYS** apply foot brake to shift from Park (P) and Neutral (N).

704903969

LABEL 2

Label 3

⚠ WARNING

Operating this ATV if you are under the age of 16 increases the chance of SEVERE INJURY or DEATH to the operator. NEVER operate this ATV if you are under age 16.

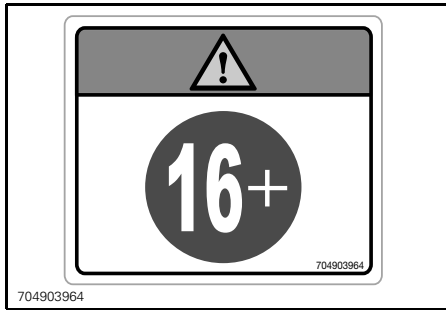

LABEL 3

Label 4

⚠ WARNING

- Locate and read operator's guide.
- NEVER carry a passenger.

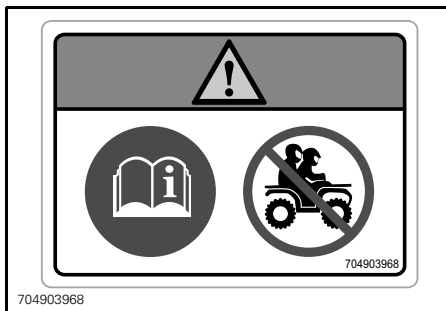

LABEL 4

Label 5

⚠ WARNING

- Locate and read operator's guide. Improper tire pressure and overloading can cause loss of control, resulting in SEVERE INJURY or DEATH.
- ALWAYS maintain proper tire pressure as shown.
- NEVER exceed the load capacity of 141 kg (310 lb) including weight of operator, cargo, and accessories (and including trailer tongue weight if applicable).

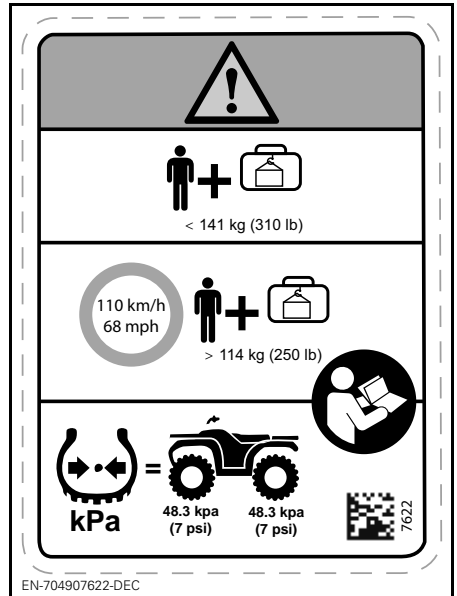

LABEL 5 (REFER TO SPECIFICATIONS FOR VALUES)

Label 6

⚠ WARNING

- NEVER carry a passenger on this carrier.
- MAXIMUM REAR LOAD: 23 kg (50 lb) evenly distributed (including trailer tongue weight if applicable).

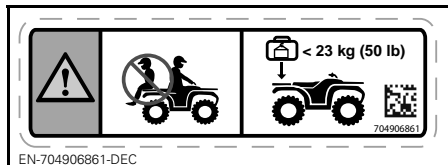

LABEL 6

Label 7

⚠ WARNING

NEVER attach here or on the luggage rack to pull a load. This can cause the vehicle to tip over. ALWAYS use the trailer hitch (if applicable) or the recovery hook to pull a load.

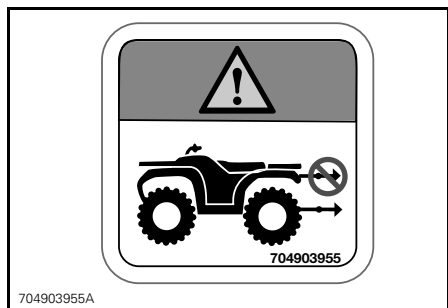

LABEL 7

Label 8

⚠

(EN) WARNING: GET FAMILIAR WITH THIS ATV. INEXPERIENCED RIDERS MAY OVERLOOK RISKS.

(DA) ADVARSEL: LÆR AT VÆN GRUNDIGT AT KENDE: UERFARNE FØRERE KAN LET OVERSE FARERNE.

(NL) WAARSCHUWING: MAAK UZELF VERTROUWD MET DEZE ATV. ONERVAREN BESTUURDERS KUNNEN DE RISICO'S OVER HET HOOFD ZIEN.

(FR) AVERTISSEMENT : FAMILIARISEZ-VOUS AVEC CE VTT. LES UTILISATEURS INEXPERIMENTÉS POURRAIENT SOUS ESTIMER LES RISQUES.

(FI) VAROITUS: TUTUSTU HUOLELLISESTI TAMÄN ATV:N KÄYTTÖÖN. KOKEAMATTOMAT KULJETTAJAT SAATTAVAT ALIARVOIDA VAARATILANTEET.

(ES) ADVERTENCIA: TÓMESE EL TIEMPO NECESARIO PARA FAMILIARIZARSE CON EL ATV. LA FALTA DE EXPERIENCIA PUEDE DAR LUGAR A LA OMISIÓN DE RIESGOS IMPORTANTES.

(DE) WARNUNG: MACHEN SIE SICH MIT DIESEM ATV VERTRAUT. UNERFAHRENE FAHRER KÖNNEN RISIKEN ÜBERSEHEN.

(EL) ΠΡΟΕΙΔΟΠΟΙΗΣΗ: ΕΞΟΙΚΕΙΩΣΕΙΤΕ ΜΕ ΑΥΤΟ ΤΟ ΟΧΗΜΑ ΠΑΝΤΟΣ ΕΛΑΦΟΥΣ (ATV), ΟΙ ΧΡΗΣΤΕΣ ΧΩΡΙΣ ΕΜΠΕΙΡΙΑ ΜΠΟΡΕΙ ΝΑ ΠΑΡΑΒΛΕΨΟΥΝ ΤΥΧΟΝ ΚΙΝΔΥΝΟΥΣ.

(IT) AVVERTENZA: ACQUISIRE FAMILIARITÀ CON QUESTO ATV. I PILOTI INESPERTI POTREBBERO SOTTOVALUTARE I RISCHI.

(PT) ADVERTÊNCIA: FAMILIARIZE-SE COM ESTE ATV. PILOTOS INEXPERIENTES PODEM SUBESTIMAR OS RISCOS.

(SV) VARNING: BEKANTA DIG VÄL MED DENNA ATV. OERFARNA FÖRARE KAN FÖRBISE RISKERNA.

704903967A

LABEL 8

Label 9



LABEL 9

Label 10



LABEL 10



NEAR GAS CAP

Technical Information Labels

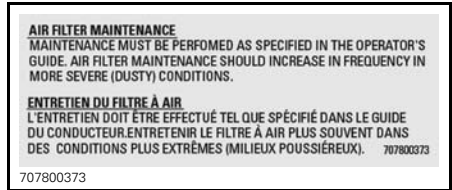

UNDER SEAT

Compliance Labels

These labels indicate vehicle's compliance.



UNDER SEAT

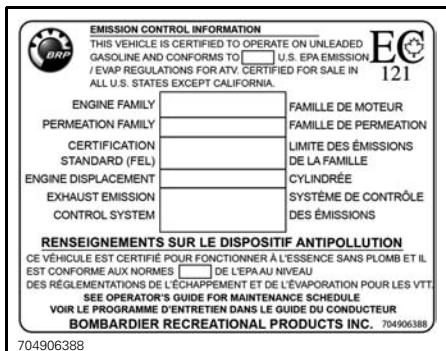

TYPICAL: APPLICABLE WHEN EQUIVALENT TO A MODEL CERTIFIED TO US EPA STANDARDS - LOCATION: UNDER SEAT, ON THE UPPER FRAME MEMBER

PRE-RIDE INSPECTION

WARNING

Perform a pre-ride inspection before each ride to detect any potential problem that could occur during operation. The pre-ride inspection can help you monitor component wear and deterioration before they become a problem. Correct any problem that you discover to reduce the risk of a breakdown or crash.

Before using this vehicle, the operator should always perform the following pre-ride inspection check list.

Pre-Ride Inspection Check List

What to Do Before Starting the Engine (Unpowered Electrical System)

ITEMS TO BE INSPECTED	INSPECTION TO PERFORM	✓
Engine oil	Check engine oil level.	
Coolant	Check coolant level.	
Brake fluid	Check brake fluid level.	
Leaks	Check for any leaks under vehicle	
Throttle lever	Activate throttle lever several times to ensure it operates freely. It must return to idle position when released	
Parking brake	Apply parking brake and check if it operates properly	
Tires	Check tire pressure and condition. Refer to <i>SPECIFICATIONS</i> for values and adjust according to load.	
Wheels	Check wheels for damage and for abnormal play. Check that lug nuts and beadlock screws are tightened. Refer to <i>WHEELS AND TIRES</i> in <i>MAINTENANCE PROCEDURES</i> for torque specification.	
Radiator	Check cleanliness of the radiator	
Drive shaft boots	Check drive shaft boots and protectors condition	
Seat	Check if operator seat is in place and properly latched	
Cargo	If you transport a cargo, respect the load capacity. Refer to <i>LOADING THE CARGO RACKS</i> . Ensure cargo is properly secured to the rack	
	If you are pulling a trailer or another equipment: <ul style="list-style-type: none"> – Check hitch (if applicable) and trailer ball condition – Respect the tongue capacity (if applicable) and towing capacity as indicated on the label affixed to the hitch or refer to <i>SPECIFICATIONS</i>. – Ensure trailer is properly secured to hitch (if applicable). 	
Chassis and suspension	Check underneath vehicle for any debris on chassis or suspension components and clean them properly	
Engine air filter	Inspect and clean engine air filter	
CVT air filter	Inspect and clean CVT air filter	

What to Do Before Starting the Engine (Electrical System Powered)

ITEMS TO BE INSPECTED	INSPECTION TO PERFORM	✓
Multifunction gauge	Check operation of indicator lamps in multifunction gauge (during first few seconds of key ON)	
	Check for messages on multifunction gauge	
Lights	Check operation and cleanliness of headlights and taillight	
	Check operation of low and high beams	
	Check operation of brake light	
Fuel level	Check the fuel level.	

What to Do After the Engine is Started

ITEMS TO BE INSPECTED	INSPECTION TO PERFORM	✓
Steering	Check if steering operates freely by completely turning it from side to side	
Shift lever	Check operation of shift lever (P, R, N, H and L)	
2WD/4WD selector	Check operation of 2WD/4WD selector	
Brakes	Drive forward slowly a few feet and apply brake lever and brake pedal individually. The brakes must fully apply. Lever and pedal must fully return when released	
Engine stop switch	Check that the engine stop switch is working properly	
RF D.E.S.S. Post	Check if D.E.S.S. post is working properly by pulling the D.E.S.S. key from the D.E.S.S. post and stopping the engine	

RIDING THE VEHICLE

To fully appreciate the pleasures and excitement of riding this vehicle, there are some basic rules and tips that you **MUST** follow. Some may be new to you while others may be common sense or obvious.

Please take the time to study this Operator's Guide and all on-product safety labels as well as the *SAFETY VIDEO* located at <https://can-am.brp.com/off-road/safety>. They more completely describe what you should know about this vehicle before riding it.

Whether you are a new user or an experienced rider, it is important for your personal safety that you know the controls and features of this vehicle. Equally important is knowing how to properly ride.

This is a high performance ATV for off-road use only. Inexperienced riders may overlook risks and be surprised by the specific behavior of this ATV in any terrain condition.

We recommend following the age recommendation indicated on the safety label affixed on the unit. Even though a person may be within the age group for which this vehicle is recommended, he may not have the skills, abilities, or judgment needed to operate this vehicle safely and may be involved in a serious accident.

Individuals with cognitive or physical impairments or who are high risk takers have an increased exposure to overturns or collisions which may result in injury including death.

Not all vehicles are the same. Each has its own unique performance characteristics, controls and features. Each will ride and handle differently.

Become completely familiar with the operational controls and the general operation of the vehicle before venturing into off road conditions. Practice driving in a suitable area free of hazards and feel the response of each control. Drive at low speeds. Higher speeds require greater experience, knowledge and suitable riding conditions.

Riding conditions vary from place to place. Each is subject to weather conditions which may radically change from time to time and from season to season.

Riding on sand is different than riding on snow or through forests or marshes. Each location may require a greater degree of awareness and skill. Show good judgement. Always proceed with caution. Please do not take any unnecessary risks that could leave you stranded or possibly injured.

Never assume that the vehicle will go everywhere safely. Sudden changes in terrain caused by holes, depressions, banks, softer or harder "ground" or other irregularities may cause the vehicle to topple or become unstable. To avoid this, slow down and always observe the terrain ahead. If the vehicle does begin to topple or tip over, the best advice is to immediately get off **AWAY** from the direction of the tip over!

We encourage you to have an Annual Safety Inspection of your vehicle. Please contact an authorized BRP dealer for further details. Though not required, it is recommended that an authorized BRP dealer performs the preseason preparation of your vehicle. Each visit to your authorized BRP dealer is a great opportunity for your dealer to verify if your vehicle is included in any safety campaign. We also urge you to visit your authorized BRP dealer in a timely manner if you become aware of any safety related campaigns.

See an authorized BRP dealer for available accessories you may require.

Riding Gear

Actual weather conditions should help you decide how to dress. Dress for the coldest weather expected. Thermal underwear next to the skin also provides a good insulation. It is important that the operator always wears the appropriate protective riding gear and apparel, including an approved helmet, eye protection, boots, gloves, a long sleeved shirt and pants. This type of clothing will provide you protection from some of the minor hazards you may encounter en route. The operator must never wear loose clothing such as a scarf that may get entangled in the vehicle or on tree branches and shrubs. Depending on conditions, anti-fogging goggles or sunglasses may be required. Different colored lenses available for goggles or sunglasses help you distinguish terrain variations. Sunglasses should only be worn during the daytime.

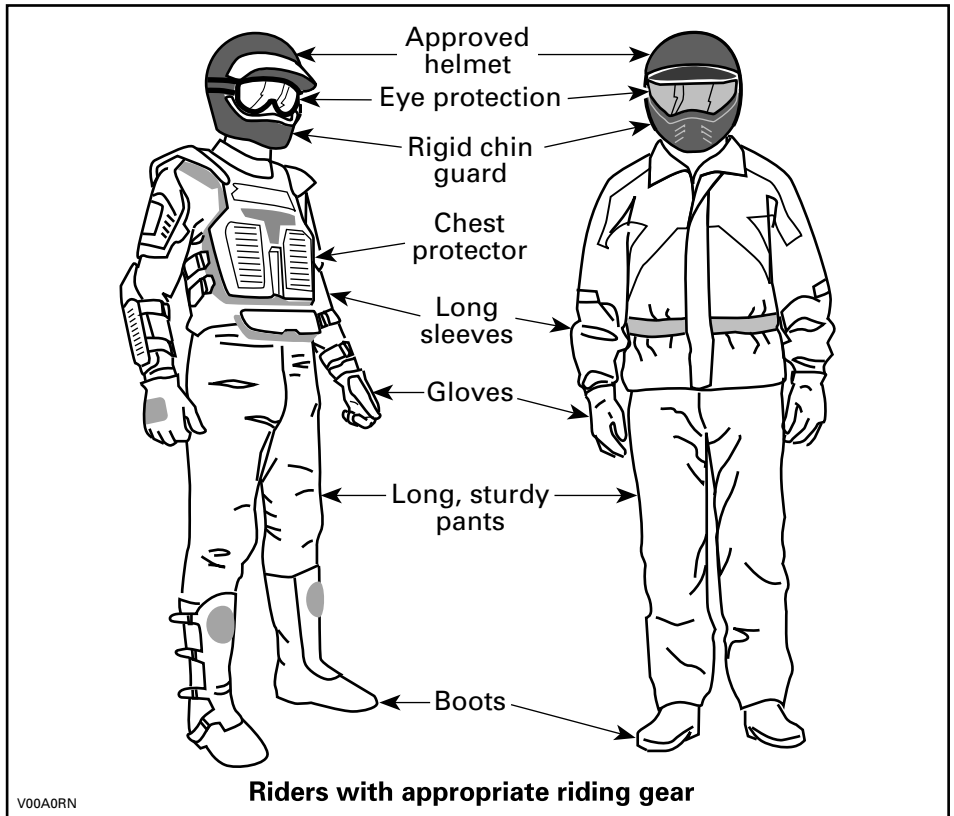

Recreational Riding

Respect the rights and limitations of others. Stay away from areas designated for other types of off road use. This includes snowmobile trails, equestrian trails, cross country ski trails, mountain bike trails, etc. Never assume there are no other

users on the trail. Always stay to the complete right of the trail and do not zigzag to one side of the trail then the other. Be prepared to stop or pull off to the side if another trail user appears in front of you.

Join a local ATV club. It will provide you with a map and advice or inform you where you can ride. If a club does not exist in your area, help to start one. Group riding and club activities provide a pleasurable, social experience.

Always keep a safe distance from other riders. Your judgment of speed, terrain conditions, weather, mechanical condition of your vehicle and the "trust in judgment" you have in others around you will help you make a better choice of appropriate safe distance. This vehicle, like any other motorized vehicle, cannot stop "on a dime". Allow greater distance for braking.

Before you ride, tell someone where you are planning to travel and your expected time of return.

Depending on the length of your ride, carry additional tools, drinking water, food and emergency equipment. Find out where you can get additional gasoline and oil. Be prepared for the possible conditions you may encounter.

First aid kit	Adjustable wrench
Mobile phone	Knife
Friction tape	Flashlight
A rope	Colored lens goggles
Spare light bulbs	Trail map
Provided tool kit	Snack

Environment

One of the benefits of this vehicle is that it can take you off the beaten path away from most communities. However, you should always respect nature and the rights of others to enjoy it. Do not ride in environmentally sensitive areas. Do not drive over forest crops or shrubs nor cut down trees or take down fencing nor spin your wheels and destroy the terrain. "Tread Lightly".

This vehicle can cause OHV wildfires if debris builds up near the exhaust or other engine hot spots and ignites then falls off into dry grass. Avoid riding in wet areas, through muskeg or tall grass, where debris can build up. Should you ride in those areas, inspect and remove all debris from your engine and hot spots.

Chasing wildlife is in many areas illegal. Wildlife can die of exhaustion after being chased by a motorized vehicle. If you encounter animals on the trail, stop and observe quietly and with caution. It will be one of the better memories of your life.

Observe the rule "what you take in, carry out". Do not litter. Do not start campfires unless you have permission to do so and then only away from dry areas. The hazards you may create on the trail may cause injury to others or yourself, even at a later date.

Respect farm lands. Always obtain the permission of the landowner before riding on private land. Respect crops, farm animals and property lines. If you come to a closed gate, close it again behind you.

Finally, do not pollute streams, lakes or rivers and do not modify the engine or exhaust system, or remove any of its components.

Design Limitation

Although the vehicle is exceptionally rugged for its class, it is still a light vehicle by definition and its operation must be restricted to its proper purpose.

The addition of weight to any part of the vehicle changes its gravitational stability and modifies its performance.

Off-Road Operation

The very nature of off-road operation is dangerous. Any terrain, which has not been specially prepared to carry vehicles, presents an inherent danger where angularity, terrain substance and exact steepness are unpredictable. The terrain itself presents a continual element of danger, which must be knowingly accepted by anyone venturing over it.

An operator who takes a vehicle off-road should always exercise the utmost care in selecting the safest path and keeping close watch on the terrain ahead of him. On no account should the vehicle be operated by anyone who is not completely familiar with the driving instructions applicable to the vehicle, nor should it be operated on steep or treacherous terrain.

Riding Techniques

Information in this guide is limited. Increase your knowledge and improve your skills by following a certified training course.

Care, caution, experience and driving skill are the best precautions against the hazards of vehicle operation.

Respect and follow all posted trail signs. They are there to help you and others.

When driving on hills or slopes two things are highly important be prepared for slippery surfaces or terrain variations and obstacles and use proper body positioning.

Whenever there is the slightest doubt that the vehicle can safely negotiate an obstacle or a particular piece of terrain, always choose an alternate route.

In off-road operation, power and traction, not speed, are important. Never drive faster than visibility and your own ability to select a safe route permits.

Constantly watch the terrain ahead for sudden changes in slopes or obstacles, such as rocks or stumps, that may cause loss of stability, resulting in tip over or rollover.

Never operate the vehicle if the controls do not function normally.

When stopped or parked, always set the shift lever to PARK position apply the parking brake. This is especially important when parking on a slope. On very steep inclines or if the vehicle is carrying cargo, the wheels should be blocked using rocks or bricks.

Always use proper riding techniques to avoid vehicle overturns on hills and rough terrain and in turns.

Body Position

To maintain proper control, it is strongly advised that you keep your hands on the handlebar and within easy reach of all controls. The same holds true for your feet on the foot pegs. To minimize the possibility of a leg or foot injury, keep your feet on the foot pegs at all times. Do not direct your toes outwards nor extend your feet out to assist in turning as they can be hit or be snagged on passing obstacles, or may come into contact with the wheels.

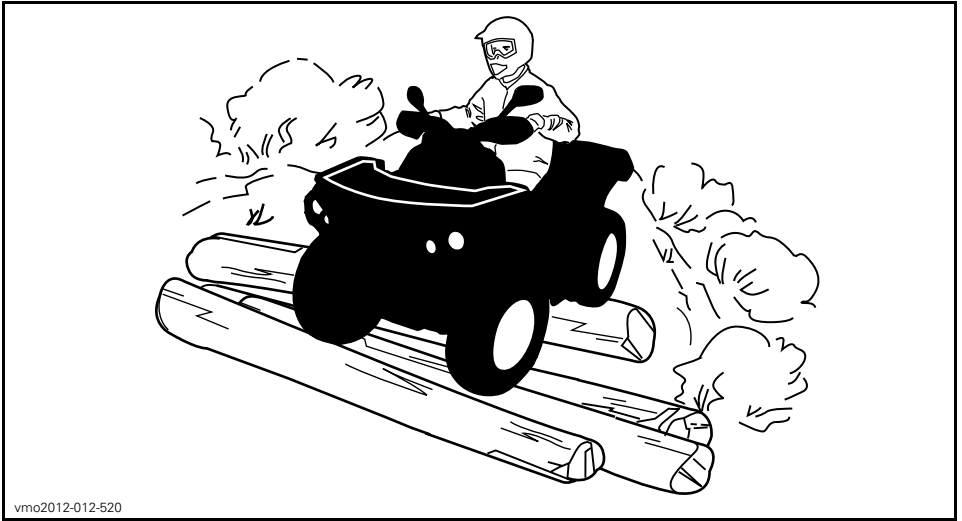

Even though there is a suspension on this vehicle, there are “washboard” or rough terrain conditions that will make you feel uncomfortable and can even cause a back injury. “Posting” or riding in a crouched position will often be required. Slow down and allow your flexed legs to absorb part of the impact energy.

Crossing Roads

If you have to cross a road, the lead driver should get off his vehicle, then observe and give directions to the other riders. The last person after crossing then assists the lead driver to cross. Do not travel on sidewalks. They are designated for pedestrian use.

Turning

Practice turning at low speeds before attempting to turn at faster speeds.

Keep both hands on handlebars and feet on foot pegs.

Maintain a constant speed or a slight acceleration during turn.

To reduce the risk of rollovers:

- Use care when turning.
 - Do not turn the handlebar too far or too fast for your speed and environment. Adjust steering inputs accordingly.
 - Slow down before entering a turn. Avoid hard braking during a turn.
 - Avoid sudden or hard acceleration when turning, even from a stop or low speed.
- Never attempt donuts, skids, slides, fishtails, jumps, or other stunts. If vehicle starts to skid or slide, steer in the direction of the skid or slide. Never slam the brakes and lock the wheels.
- Avoid paved surfaces. This vehicle is not designed to operate on paved surfaces and is more likely to roll over. If you must drive on pavement, turn gradually, go slowly, and avoid abrupt acceleration and braking.

Avoid sudden inputs to steering, throttle or brakes while turning.

⚠ WARNING

Do not attempt turns at excessive speed.

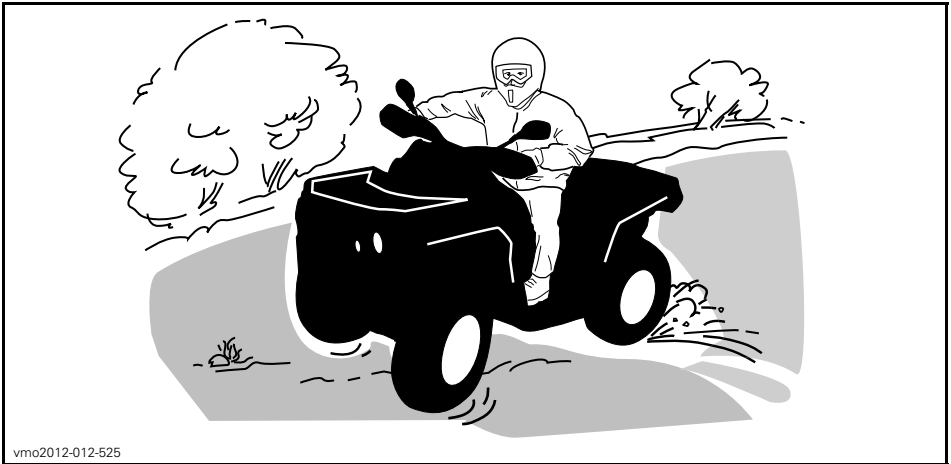

vmo2012-012-525

If you do get into a slide or skid, it may help to turn the handlebar in the direction of the skid until you regain control. Never jam the brakes and lock the wheels.

⚠ WARNING

The tires of this vehicle are not suited for paved road use. Also this vehicle is not equipped with a rear differential (rear wheels are always turning at the same speed). For these reasons, pavement may seriously affect the handling and control of the vehicle.

Braking

Always keep both hands on handlebars and feet on foot pegs when braking.

Practice braking to get familiar with the brake response.

- Do it at low speed first, then increase the speed.
- Practice braking in straight line at different speeds and different braking force.
- Practice emergency braking; optimal braking is obtained in straight line, with high force applied, without locking the wheels.

Remember, braking distance depends on vehicle speed, load and the type of surface. Also, the tires and brakes conditions play a major role.

NOTE: If going forward the vehicle weight is transferred to the front wheels when braking. To obtain greater stopping efficiency, the brake system distributes more braking force to the front wheels. This will affect vehicle handling and steering control when braking vigorously. Take it into account when braking.

Reverse Operation

When operating in reverse, check that the path behind the vehicle is free of people or obstacles. Proceed slowly and avoid sharp turns.

We recommend sitting on your ATV when operating in reverse. Avoid standing up. Your weight could shift forward against throttle lever, causing an unexpected acceleration.

Obstacles

Obstacles in the “trail” should be traversed with caution. This includes loose rocks, fallen trees, slippery surfaces, fences, posts, and embankments and depressions. You should avoid them whenever possible. Remember that some obstacles are too large or dangerous to cross and should be avoided. Small rocks or fallen trees may be safely crossed approach at a 90° angle. Stand on the footrests while keeping your knees flexed. Adjust speed without losing momentum and do not “gun” the throttle. Hold handlebar firmly. Place operator body weight rearwards and proceed. Do not try to lift the vehicle front wheels off the ground. Be aware that the object may be slippery or may move while crossing.

Uphill Driving

Before trying to climb a hill, keep these things in mind. Hill Climbing should only be attempted by experienced operators. Start on shallow slopes. Always drive straight uphill and keep your body weight forward towards the top of the hill. Keep your feet on the footrests, shift your ATV into a lower gear and accelerate before you start to climb. Try to keep a steady speed and go easy on the throttle to avoid acceleration. Abrupt slope or terrain variation or rolling one wheel over an obstacle could have a big impact on the stability as it will lift the front of the vehicle increasing the risk of tipping over. Some hills are too steep to safely stop or recover from after an unsuccessful climbing attempt. Try to avoid steep inclines. If you're not careful, you could tip over when going up hills. If the hill is too steep and you cannot proceed or the vehicle begins to roll backwards, apply the brake, being careful not to slide. Dismount then use the "K" turn (while walking back, next to the vehicle on the up hill side and with a hand on the brake lever, slowly back the rear of the vehicle toward the top of the hill then drive downhill). Always walk or dismount on the upside of the slope while keeping clear of the vehicle and its rotating wheels. Do not try to hold on to the vehicle if it begins to topple. Stay clear. Do not ride over the crest of the hill at high speed. Obstacles, including sharp drop-offs, may exist.



vmo2012-012-526

Downhill Driving

This vehicle can climb slopes that are steeper than it can safely descend. Therefore, it is essential to ensure that a safe route exists to descend a slope before you climb it.

Decelerating while negotiating a slippery downhill slope could “toboggan” the vehicle. Maintain steady speed and/or accelerate slightly to regain control.

Keep your body weight rearwards. Apply the brake gradually to prevent skidding. Do not “coast” down the slope using solely engine compression or in neutral gear. Try to avoid steep inclines. If you’re not careful, you could tip over when going down hills.

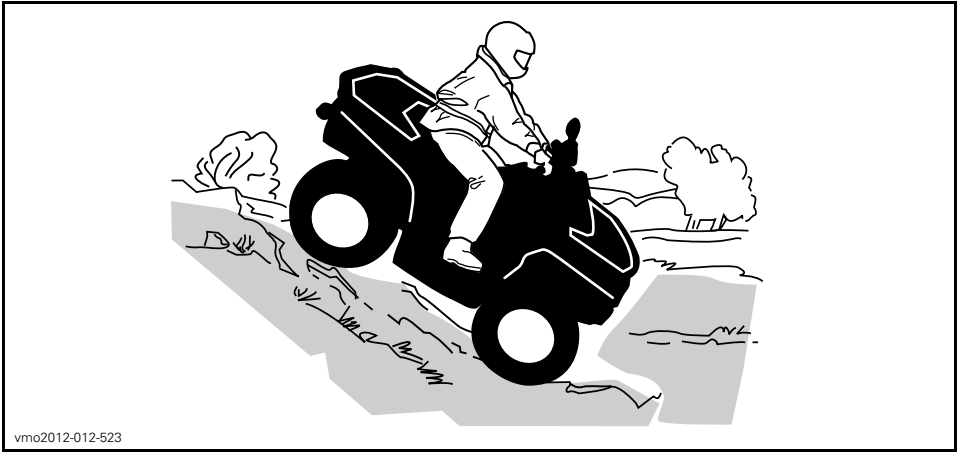

Side Hilling

This is one of the **most risky** types of riding since it may drastically change the balance of the vehicle. It should be avoided whenever possible. However, if it is necessary to do so, it is important that you **ALWAYS** keep your body weight on the up-side of the slope and be prepared to dismount on that side should the vehicle begin to topple. **Do not try to stop or save the vehicle from damage.**

Avoid all objects or depressions that will intensify the raising of one side of the vehicle higher than the other, thus causing rollover.

WARNING

Be careful when loading and transporting liquid reservoirs. They can affect vehicle stability when side hilling by pulling downhill and increasing the risk of a roll over.



Drop-Offs

This vehicle will “bottom-out” and usually stop if either the front or rear wheels are driven over a drop-off. If the drop is sharp or deep, the vehicle will nose dive and tip over.

WARNING

Avoid negotiating drop-offs. Reverse and select an alternate route.

Crossing Water

Water can be a unique hazard. If it is too deep the vehicle may “float” and topple. Check the water depth and current before you attempt to cross any water. Water should not go above the footrest. Be wary of slippery surfaces such as rocks, grass, logs, etc., both in the water and on its banks. A loss of traction may occur. Do not attempt to enter the water at high speed. The water will act as a brake and could throw you off the vehicle, on the ground.

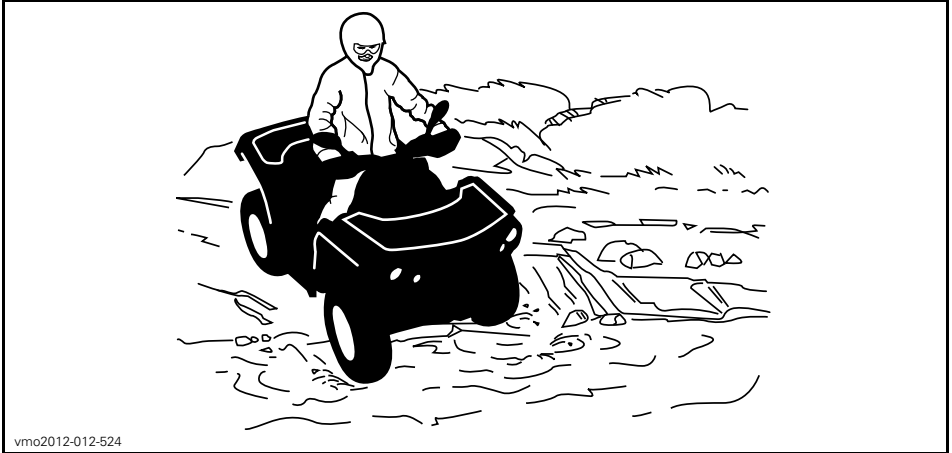

Wet brakes will affect the braking ability of your vehicle. Make sure you dry the brakes by applying them several times after the vehicle leaves the water, mud or snow. Allow greater distance for braking.

Mud or marsh lands may be encountered near water. Be prepared for sudden “holes” or changes in depth. Similarly so, be watchful of hazards such as rocks, logs, etc., partially covered by vegetation.

Riding on Ice

If your route crosses frozen waterways, make sure the ice is thick enough and sound enough to support the total weight of yourself, the vehicle and its load. Be ever watchful of open water it is a sure indication that the ice thickness will vary.

Ice will also affect the control of the vehicle. Slow down and do not “gun” the throttle. This will only result in spinning of the tires and possible tip over of the vehicle. Avoid rapid braking. This again will possibly result in an uncontrolled slide and tip over of the vehicle. Slush should be avoided at all times since it could block the operation or controls of the vehicle.

Riding on Snow Covered Surfaces

When performing the pre-ride inspection, pay special attention to locations on the vehicle where snow and/or ice accumulations may obstruct visibility of the taillight and reflectors, clog ventilation openings, block the radiator and fan, and interfere with the movement of control levers, switches and brake pedal. Before starting with your ATV check the steering, throttle and brake lever and pedal controls for interference free operation.

Whenever an ATV is ridden on a snow covered drive path the tire grip is generally reduced causing the vehicle to react differently to control inputs from the operator. On low grip surfaces, the steering responses are not as crisp and precise, stopping distances are lengthened and acceleration becomes sluggish. Slow down and do not "gun" the throttle. This will only result in spinning of the tires and possibly in an over steering slide of the vehicle. Avoid hard braking. This will possibly result in a straight line slide of the vehicle. Again, the best advice is to safely reduce speed in anticipation of a maneuver so to give yourself time and distance to regain total vehicle control before it spins out of your control.

As you drive your ATV over a loose snow covered surface, snow dust will be picked up in the wake turbulence of the moving vehicle and transported to contact and accumulate or melt on some exposed components including rotating parts like brake discs. Water, snow or ice may affect the response time of the brake system of your ATV. Even when not required to reduce vehicle speed apply brakes frequently to prevent ice or snow accumulation and to dry brake pads and discs. While doing so in low risk driving situations you will test for grip level and keep yourself alerted to how the vehicle reacts to your control inputs. Always keep brake pedal, footrests, floor boards, brake and throttle levers free of snow and ice. Frequently wipe snow off seat, hand grips, headlights, taillights and reflectors.

The depth of the snow cover may hide rocks, tree stumps or other objects and if it is wet may totally impede the driveability as the vehicle becomes bogged down or completely loses traction in slushy snow. Look far ahead and always be watchful of any visible clues that might indicate the presence of such obstacles. In doubt steer clear. Avoid driving on any frozen body of water before checking that the ice will safely support the ATV, its riders and its load of cargo. Remember that a given thickness of ice may be sufficient to support a snowmobile but not an ATV of an identical weight because of the smaller load bearing surface of the four tire contact patches as compared to that of a snowmobile track and skis.

To maximize comfort and avoid frostbite, always wear clothing and ATV protective equipment appropriate for the weather conditions you will be exposed to during your ride.

At the end of each ride it is a good practice to clean the vehicle body and all moving components (brakes, steering components, drivelines, controls, radiator fan etc.) from any snow or ice accumulations. Wet snow will turn to ice during the shut down period and become more difficult to remove at the next pre-ride inspection.

Riding in snow may reduce the brakes stopping capability. Safely reduce speed and allow greater distance for braking. Snow projection may cause ice build up or snow accumulation on brake components and controls. Apply brakes frequently to prevent ice or snow accumulation.

Riding on Sand

Riding on sand, sand dunes or on snow is another unique experience, but there are some basic precautions that should be observed. Wet, deep or fine sand/snow may create a loss of traction and cause the vehicle to slide, drop off or become "bogged" down. If this occurs look for a firmer base. Again, the best advice is to slow down and be watchful of the conditions.

When riding in sand dunes it is advisable to equip the vehicle with an antenna type safety flag. This will help make your location more visible to others over the next sand dune. Proceed carefully should you see another safety flag ahead. Since the antenna type safety flag can snag and rebound on your body if caught, do not use it in areas where there are low hanging branches or obstacles.

Riding on Loose Stones

Riding on loose stones or gravel is very similar to riding on ice. They will affect the steering of vehicle possibly causing it to slide or tip over especially at high speeds. In addition, braking distance may be affected. Remember that "gunning" the throttle or sliding may cause loose stones to be ejected rearwards into the path of another rider. Never do it deliberately.

MOVING LOADS AND DOING WORK

Working with your Vehicle

Your vehicle can help you perform a number of different LIGHT tasks ranging from snow removal to pulling wood or carrying cargo. A variety of accessories are available from your authorized Can-Am dealer. To prevent possible injury, follow the instructions and warnings that accompany the accessory. Always respect the load limits of the vehicle. Overloading the vehicle can overstress the components and cause failure. Avoid overexerting yourself if you lift or pull heavy loads or manually push the vehicle.

Carrying Loads

Any load carried on the vehicle will affect the handling, stability and braking distance of the vehicle. Do not exceed the total load allowed for this vehicle, including the weight of operator and passenger cargo, accessories and trailer tongue weight. Refer to *SPECIFICATIONS*. Always make sure the cargo is secured, properly distributed and cannot interfere with your controls or lights. Always be aware that the cargo may slide or fall off and cause an accident. Avoid loads that may protrude sideways and get snagged or caught in brush or other obstacles.

WARNING

Never overload, tow or carry cargo improperly. Safely reduce speed according to terrain conditions when carrying cargo or pulling a trailer, and avoid hills and rough terrain. Allow greater distance for braking, especially on inclined surfaces. Always secure cargo as low as possible to reduce the effect of a higher center of gravity. Failure to follow the recommendations here could cause changes in vehicle handling which could lead to an accident.

MAXIMUM LOAD TABLE

TOTAL LOAD ALLOWED	141 kg (311 lb)	Includes weight of operator, cargo, accessories and trailer tongue weight.
REAR LOAD	23 kg (51 lb)	Includes rear cargo area and tongue load (if applicable).

The following is an example of suitable load distribution:

EXAMPLE OF LOAD DISTRIBUTION

TOTAL VEHICLE LOAD	OPERATOR	CARGO LOAD	ACCESSORIES	TONGUE WEIGHT
141 kg (311 lb)	95 kg (209 lb)	23 kg (51 lb)	10 kg (22 lb)	13 kg (29 lb)

Loading the Rear Cargo Area

NOTICE When loading or unloading, do not exceed the weight limit of 16 kg (35 lb).

Load cargo as low as possible – a higher load can raise the vehicle’s center of gravity, which can reduce stability. Position cargo on the rack as evenly distributed as possible.

Secure the load on the rear cargo area. Do not secure cargo to other parts of the vehicle. If it is not properly secured, a load may slide or fall off, possibly striking occupants or bystanders; or it may shift during riding, affecting the handling of the vehicle.

Objects that are high may affect visibility for the driver and may act as projectiles in case of an accident. Loads that protrude sideways can get snagged or caught in bush, branches or other obstacles. Avoid covering and obstructing the brake lights with the cargo. Ensure no cargo protrudes outside the cargo rack and that cargo will not interfere with your visibility or control of the vehicle.

NOTICE Do not exceed the cargo racks capacity. Refer to *SPECIFICATIONS*.

Never carry gasoline container(s) or any dangerous liquids on the rear cargo area.

⚠ WARNING

Never overload, tow or carry cargo improperly. Safely reduce speed according to terrain conditions when carrying cargo or pulling a trailer, and avoid hills and rough terrain. Allow greater distance for braking. Always secure cargo as low as possible to reduce the effect of a higher center of gravity. Failure to follow the recommendations here could cause changes in vehicle handling which could lead to an accident.

**Hauling a Load
(if Equipped with Hitch)**

Never pull a load by attaching it to the bumper, rear cargo area or any other parts or accessories; this can cause the vehicle to tip over. Use only the trailer hitch (if installed) or winch to pull a load.

In an emergency situation, use the recovery hook to recover a stuck vehicle. Refer to *RECOVERY HOOK* in *EQUIPMENT*.

When pulling loads with a chain or cable, ensure that there is no slack before starting and maintain tension while pulling.

When pulling loads with a chain or cable, be sure to brake progressively. The inertia of the load could lead to an impact.

When hauling a load, respect the maximum . See *PULLING A TRAILER* in this section.

⚠ WARNING

A slack in the chain or cable can cause it to break and snap back.

When pulling another vehicle, be sure that someone is controlling the pulled vehicle. They must brake and steer to prevent the vehicle from going out of control.

Before pulling loads with a winch, refer to the winch manufacturer’s instructions.

Reduce your speed when hauling a load and turn gradually. Avoid hills and rough terrain. Never attempt steep hills. Allow more distance for braking, especially on inclined surfaces. Be careful not to skid or slide.

Pulling a Trailer (If Equipped with a Hitch)

NOTICE A BRP approved rear hitch must be properly installed on the vehicle for hauling trailers.

Riding this vehicle with a trailer substantially increases the risk of toppling, especially on inclined slopes. If a trailer is used behind the vehicle make sure that its hitch is compatible with the one installed on the vehicle as an accessory. Make sure the trailer is horizontal with the vehicle. (In some instances a special extension may have to be installed on the vehicle hitch). Use security chains or cables to secure the trailer with the vehicle.

Reduce your speed when pulling a trailer and turn gradually. Avoid hills and rough terrain. Never attempt steep hills. Allow more distance for braking, especially on inclined surfaces. Be careful not to skid or slide.

Improperly loading a trailer may cause a loss of control.

Do not exceed the towing capacity or tongue capacity. Refer to *SPECIFICATIONS*.

Make sure there is at least some weight on the tongue.

Always make sure load is evenly distributed and safely secured on the trailer; an evenly balanced trailer is easier to control.

Always put the shift lever to L (low range) for hauling a trailer – in addition to providing more torque, operating in low range helps account for the increased load on the rear tires.

When stopped or parked, block the vehicle and trailer wheels from possible movement.

Use caution when disconnecting a loaded trailer; it or its load may topple on you or others.

When hauling a trailer, respect the following maximum hauling capacity.

*This page is
intentionally blank*

VEHICLE INFORMATION

CONTROLS

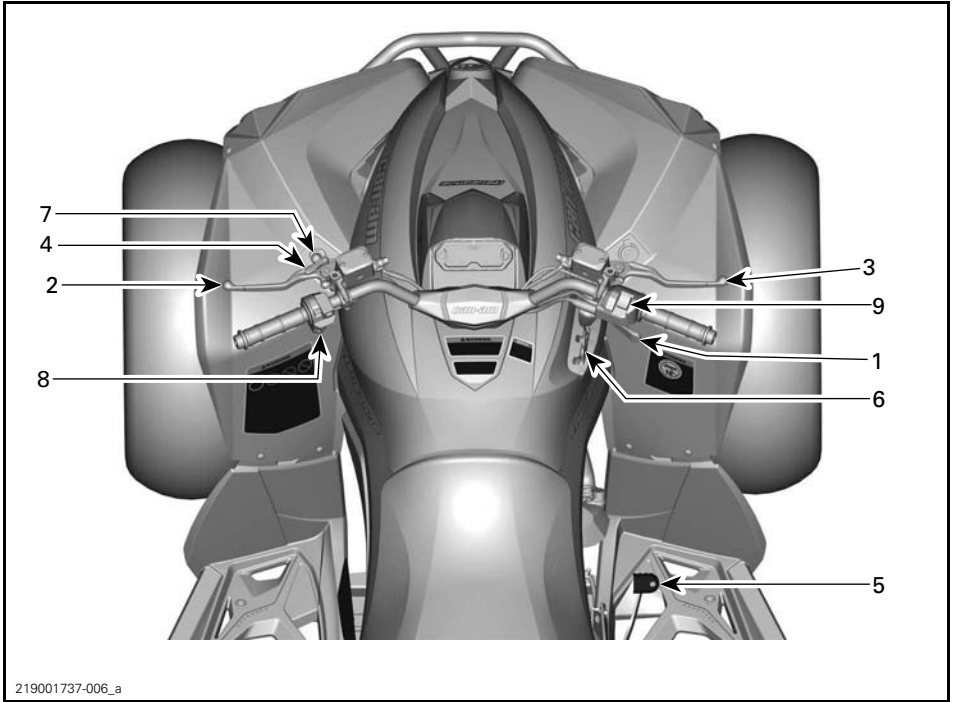

1) Throttle Lever

The throttle lever is located on the RH side of the handlebar.

The throttle lever controls the engine speed.

To increase or maintain vehicle speed, press the throttle lever with your right thumb.

To decrease vehicle speed, release the throttle lever.

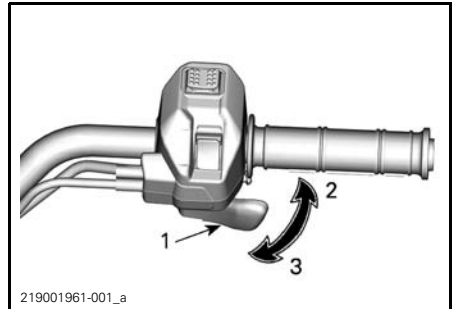

- TYPICAL**
1. Throttle lever
 2. To accelerate
 3. To decelerate

2) LH Brake Lever

The LH brake lever is located on the LH side of the handlebar.

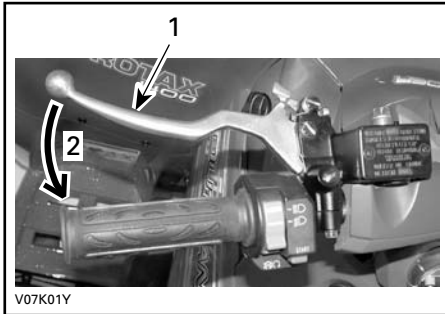

TYPICAL

1. Brake lever
2. To apply brakes

The LH brake lever function is to slow down or stop the vehicle.

When the brake lever is pressed, the rear brakes are applied.

Braking effect is proportional to the force applied on the lever.

3) RH Brake Lever

The RH brake lever is located on the RH side of the handlebar.

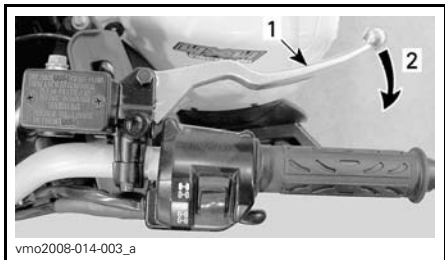

TYPICAL

1. Brake lever
2. To apply brakes

The RH brake lever function is to slow down or stop the vehicle.

When the brake lever is pressed, the front brakes are applied.

When released, the brake lever should automatically return to its original position.

Braking effect is proportional to the force applied on the lever.

4) Parking Brake Lever

The parking brake lever is located on the LH side of the handlebar.

The parking brake function is to maintain brake to rear wheels to prevent vehicle from moving when parked.

⚠ WARNING

Always use the parking brake **and** engage the **PARK** position on the shift lever when the vehicle is not in operation.

To engage the parking brake proceed as shown:

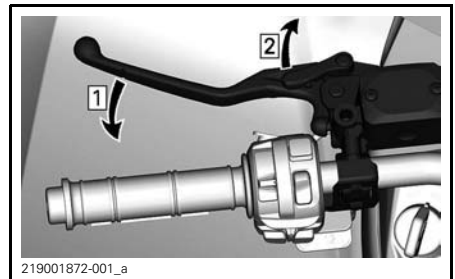

Step 1: Apply brakes

Step 2: Lock brakes

NOTE: The parking brake lever can be set in several positions.

⚠ WARNING

Ensure when the parking brake is applied that the vehicle stays **securely** in place.

To release the parking brake, simply squeeze the brake lever. It should return to the rest position.

⚠ WARNING

Make sure parking brake is released before operating the vehicle. If parking brake is left ON while riding, it may cause damage to the brake system and cause loss of braking capacity and/or fire.

5) Brake Pedal

The brake pedal is located on the RH side of the vehicle near engine.



vmo2012-012-015_a
1. Brake pedal

The brake pedal function is to slow down or stop the vehicle.

When the brake pedal is pressed down, **only** the rear brake is applied.

Braking effect is proportional to the force applied on the pedal.

NOTE: The brake will have also an effect on front wheels through the drive train when 4WD is engaged.

6) Shift Lever

The shift lever is located on the RH side of the vehicle near steering column.

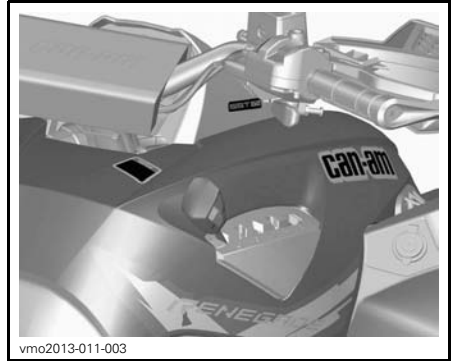

vmo2013-011-003
SHIFT LEVER LOCATION

The shift lever is used to change the gearbox position.

The shift lever has 5 positions:

SHIFT LEVER POSITIONS	
POSITION	GEAR
P	Park
R	Reverse
N	Neutral
H	High range (forward)
L	Low range (forward)



vmo2012-012-036
SHIFT PATTERN

The vehicle must be stopped and brakes applied prior to selecting any gear.

NOTICE This gearbox is not designed to shift while vehicle is moving.

P: Park

The park position locks the gearbox to help prevent vehicle movement.

 **WARNING**

Always use the PARK (P) position when the vehicle is not in operation. The vehicle can roll if the shift lever is not set to P (PARK).

R: Reverse

The reverse position allows the vehicle to go backwards.

NOTE: In reverse operation, the engine's RPM is limited, thus limiting the vehicle reverse speed.

 **WARNING**

When driving downhill in reverse, gravity can increase the vehicle speed above the set limited reverse speed.

Neutral

The neutral position disengages the gearbox.

 **WARNING**

Always use the PARK (P) position when the vehicle is not in operation. The vehicle can roll if the shift lever is set to N (NEUTRAL).

High Range (Forward)

This position selects the high speed range of the gearbox. It is the normal driving speed range. It allows the vehicle to reach its maximum speed.

Low Range (Forward)

This position selects the low speed range of the gearbox. It allows the vehicle to move slowly with maximum torque at the wheels.

NOTICE Use the low speed range to pull a trailer, carry heavy cargo, go over obstacles or drive uphill and downhill.

7) RFD.E.S.S. Key

The RF D.E.S.S. key must be securely attached to the D.E.S.S. post before starting the engine

The D.E.S.S. post is located on the LH side of central panel below handlebar.



D.E.S.S. POST

Digitally Encoded Security System (D.E.S.S.)

The D.E.S.S. keys contain an electronic circuit that gives it a unique electronic serial number.

The D.E.S.S. system reads the key code and allows engine starting for keys it recognizes.

D.E.S.S. Flexibility

The D.E.S.S. of your vehicle can be programmed by your authorized Can-Am dealer to accept up to 8 different keys.

If you have more than one D.E.S.S. equipped Can-Am vehicle, each can be programmed by your authorized Can-Am dealer to accept the other vehicle D.E.S.S. keys.

Types of Keys

This vehicle can be operated using 2 different types of D.E.S.S keys:

- Normal key (green)
- Performance key (grey).

The key type is differentiated by its color.

⚠ WARNING

Rollovers, tipovers, collisions and loss of control resulting in serious injury or death are possible with the performance or normal keys. Using the normal key is not a substitute for the operator being prepared, qualified, and operating with care.

Normal Key

The vehicle is delivered with a normal key (green).

570/650 Models

The normal key limits the vehicle speed to 70 km/h (43 MPH).

850/1000R Models

The normal key limits the vehicle rate of acceleration and the vehicle speed to 70 km/h (43 MPH).

All Models

⚠ WARNING

On steep downhills, the engine speed limiter may not prevent the vehicle from accelerating beyond this speed.

This key may be useful for riders who prefer more gradual acceleration, or for riding in environments where full speed and high acceleration are not desirable. For example, in narrow, winding trails, operators may prefer the normal key.

Performance Key

The vehicle is delivered with a performance key (grey), which allows the user to access the full torque of the engine as well as the top speed of the vehicle.

This may be useful for riders who prefer crisper throttle response, and for environments where higher speeds and greater acceleration are appropriate. For example, in wide-open, straight trails, operators may prefer the performance key.

8) Multifunction Switch

The multifunction switch is located on the LH side of the handlebar.

The controls located on this multifunction switch are:

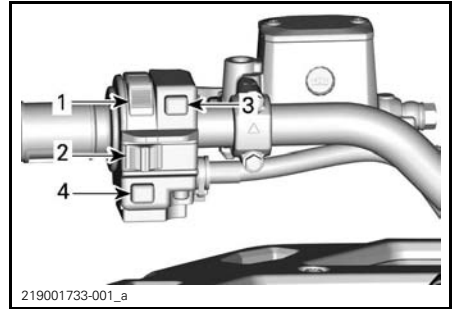

TYPICAL — MULTIFUNCTION SWITCH

1. Headlight switch
2. Engine stop switch
3. Engine start button
4. Override/DPS button (if applicable)

Low/High/OFF Headlight Switch

This switch is used to select either the headlights low or high beams or to turn lights OFF.



219001733-003_a

HEADLIGHT SWITCH FUNCTIONS

1. Lights OFF
2. Low beam
3. High beam

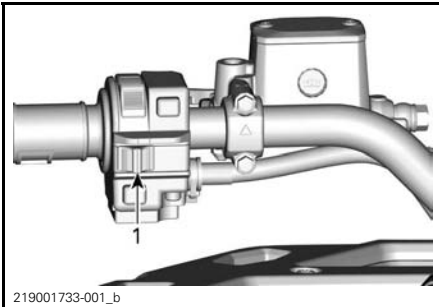
Engine Stop Switch

219001733-001_b

TYPICAL

1. Engine stop switch

This switch can be used to stop the engine and as an emergency control.

To stop engine, set the engine stop switch to the STOP position.

NOTE: Engine can be stopped by setting the engine stop switch to the STOP position.

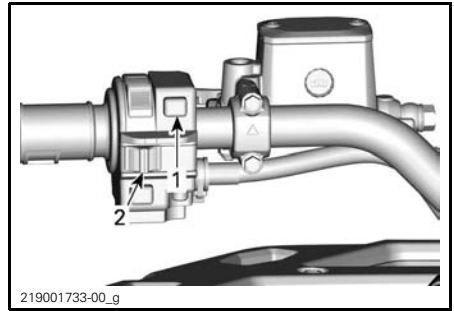
Engine Start Button

219001733-00_g

TYPICAL

1. Engine start button
2. Engine stop switch

When engine start button is pressed and held, it starts the engine.

NOTE: To allow engine starting, the D.E.S.S. key must be securely installed on the D.E.S.S. post and the engine stop button set to RUN.

To power up the vehicle without starting the engine, refer to *WAKING UP THE ELECTRICAL SYSTEM*.

Override/DPS Button

Depending on the vehicle model, this button has up to 2 functions.

While reading this Operator's Guide, remember that:

⚠️ WARNING

Indicates a potential hazard that, if not avoided, could result in serious injury or death.

Override Function

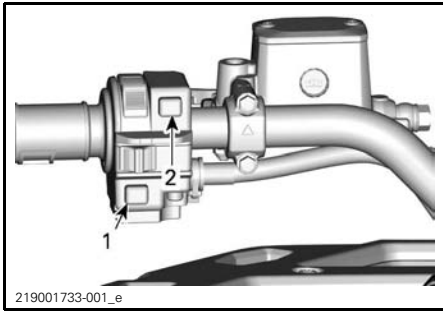

TYPICAL

1. Override button
2. Engine start button

The override switch main function is to bypass the engine speed limiter in reverse operation by allowing maximum engine torque.

⚠ WARNING

Use the "override" mode only if the vehicle is caught in mud or other soft terrain and the "low range" is not enough. Make sure the area is secure before using the "override" mode. Do not use the "override" mode when driving normally in reverse, this would result in excessive speed.

To engage the override function, proceed as follows:

While the shift lever is set to REVERSE position.

1. Ensure that the vehicle is stopped.
2. Press and hold the override/DPS button then press the throttle lever gradually.

NOTE: When using the override function, the gauge will scroll an **OVER-RIDE** message to confirm that the function is activated.

3. To disengage the override function, simply release the override/DPS button.

DPS Function (Renegade X xc Model)

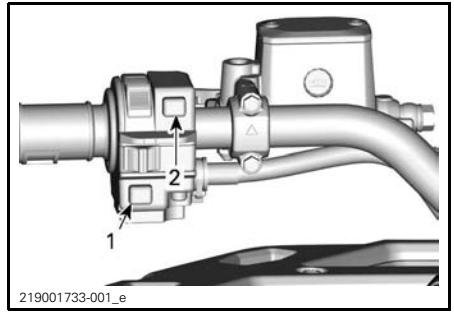

TYPICAL

1. DPS button
2. Engine start button

The DPS function is used to change the DPS (Dynamic Power Steering) mode.

For complete information on DPS modes, refer to *TUNE YOUR RIDE*.

9) 2WD/4WD and Driving Modes (if equipped) Selector Switch

The 2WD/4WD and Driving Modes selector switch is located on the RH side of the handlebar.

This switch is used to select the 2WD or 4WD modes.



TYPICAL

1. 2WD/4WD Selector
2. 2WD position
3. 4WD position
4. Driving modes selector

Bring the vehicle to a complete stop with the engine idling before changing between 2WD and 4WD modes or the opposite.

NOTICE Mechanical damage may occur if the 2WD/4WD selector switch is used while vehicle is moving. The vehicle must be stopped when changing between 2WD and 4WD

To engage the 4WD mode, press the switch down.



TYPICAL - 4WD MODE

To engage the 2WD mode, press the switch up.



TYPICAL - 2WD MODE

This switch is used to select the driving modes. (If equipped)



1. Driving modes selector

Choose between NORMAL and SPORT modes by pushing the selector on the left or right.



MODES				
ECO	Push right	NORMAL	Push right	SPORT
	Push left		Push left	

The SPORT mode provides a crisper throttle response.

NOTE: The SPORT mode can be activated with all key types and provides the maximum power with the used key.

NOTE: Use NORMAL mode on bumpy trails to provide smoother ride conditions.

While reading this Operator's Guide, remember that:

 **WARNING**

Indicates a potential hazard that, if not avoided, could result in serious injury or death.

MULTIFUNCTION GAUGE (LCD)

The multifunction gauge is located in the gauge support.

⚠ WARNING

Reading the multifunction gauge display can distract from the operation of the vehicle, particularly from constantly scanning the environment.

Multifunction Gauge Description

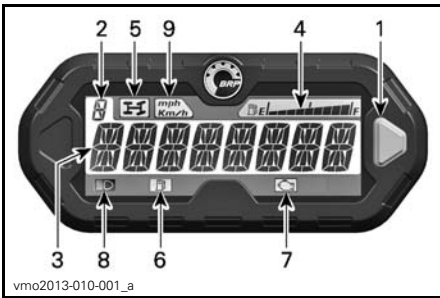

1. Selector button
2. Gearbox position display
3. Main screen
4. Fuel level display
5. 4WD indicator lamp
6. Low fuel level indicator lamp
7. Check engine indicator lamp
8. High beam indicator lamp
9. MPH, Km/h indicator lamp

1) Selector Button

The selector button is used to navigate or change settings in the multifunction gauge.

2) Gearbox Position Display

This display shows the selected gearbox position.

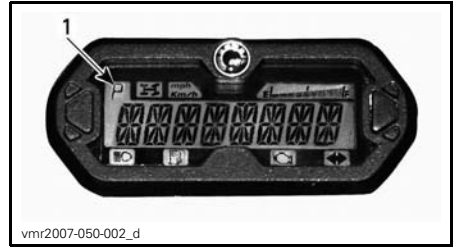

1. Transmission position

DISPLAY	FUNCTION
P	Park
R	Reverse
N	Neutral
H	High range
L	Low range

3) Main Screen

The main screen is used to display numerous functions of the multifunction gauge.

Refer to *MULTIFUNCTION GAUGE MODES* for the different available modes:

4) Fuel Level Display

Bar gauge that continuously indicates the level of fuel in the fuel tank while riding.

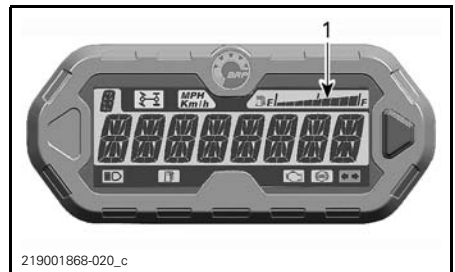

1. Fuel level display

5) 4WD Indicator Lamp



When this indicator is ON, it indicates the 4WD mode is selected.

6) Low Fuel Level Indicator Lamp



When this indicator is ON, it indicates that there is approximately 5 L (1.3 U.S. gal.) of fuel left in fuel tank.

7) Check Engine Indicator Lamp



When this indicator is ON, it indicates an engine fault code, look for a message at the LCD display.

When this indicator blinks, it indicates that the **LIMP HOME** mode is activated.

Refer to *TROUBLESHOOTING* for more details.

8) High Beam Indicator Lamp



When this indicator is ON, it indicates that **high beam** is selected on the headlights.

9) KM/H or MPH Indicator Lamp

mph
Km/h

The proper lamp turns on to indicate the unit the speedometer uses.

Multifunction Gauge Modes

Speedometer Mode

In this mode, the main screen displays the actual vehicle speed in km/h or in mph.



Tachometer Mode

In this mode, the main screen the actual engine speed in revolutions per minute (RPM).



Combined Mode

In this mode, the main screen displays both the vehicle speed and the engine speed (RPM).

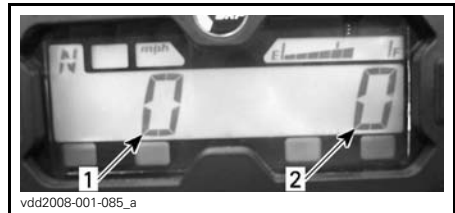

1. Vehicle speed
2. Engine speed (RPM)

Odometer (OD)

Odometer records the total distance travelled either in miles or kilometers.



vsi2009-018-030

Clock

Displays current time.



vmo2011-008-001

Refer to *GAUGE SETUP* to set current time.

Trip Meter (TP)

The trip meter records the travelled distance since it has been reset. Distance travelled is displayed either in kilometers or miles.



vsi2009-018-031

Press and HOLD the selector button for 2 seconds to reset the trip meter.

Trip Hour Meter (TH)

The trip hour meter records vehicle running time when the electrical system is activated. It can be used to establish traveling time between 2 places.



vsi2009-018-032

Press and HOLD the selector button for 2 seconds to reset the hour meter.

Engine Hour Meter (EH)

The engine hour meter records engine running time.



vsi2009-018-033

Message Display Mode

If an abnormal engine condition occurs, a message may scroll across the main screen in conjunction with a pilot lamp. Refer to *TROUBLESHOOTING* for details.

Fault Code Mode

Switch to HI beam and select engine hour meter display mode. Press and hold mode button while switching high and low beam (three cycles) to access diagnostic fault codes.

Navigating in the LCD Gauge**Default Display Mode**

After vehicle startup, the default display mode is either:

- Vehicle speed

- Engine revolutions per minute (RPM)
- Both parameters simultaneously (combined mode).

To change from one display to the other, proceed as follows.

1. Install D.E.S.S. key on D.E.S.S. post.
2. Wait until the "greeting message" has been displayed.
3. Press and release selector button once to display OD (odometer).
4. Press the selector button again, this time for 2 seconds.

This will change the Mode to either Speed, RPM or Combined.



5. To select another mode, repeat steps 3 and 4 until the desired mode is displayed.

Temporary Display Mode

In the temporary display mode, the following functions are available:

- Odometer
- Clock
- Trip meter (resettable)
- Trip Hour meter (resettable)
- Engine hour meter.

Press and release selector button to change the default display mode to the temporary mode.

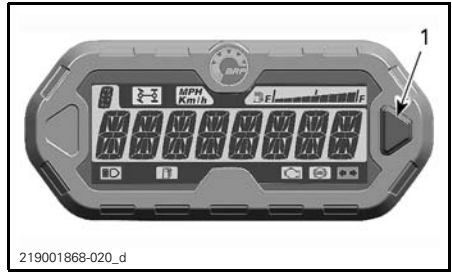

1. Selector button

The gauge will display the selected mode for 10 seconds then will return to the normal display mode.

While in a resettable mode, push and HOLD selector button for 2 seconds to reset it.

Driving Modes (If equipped)

Some models are equipped with a driving mode selector.



1. Driving mode selector

A message of the selected mode will be displayed at activation and deactivation as follow:

DRIVE MODE	MESSAGE AT ACTIVATION
Sport	SPORT MODE
Normal	NORMAL MODE
Eco (If equipped)	ECO MODE

Gauge Setup

Clock Setting Using Gauge Selector Button

To set current time, proceed as follows:

1. Select the clock display.



1. Selector button
2. Time

2. Press and HOLD selector button.

NOTE: The display will flash.

3. Choose the 12-hour (12H) or 24-hour (24H) format by pressing button.
4. If the 12-hour format was selected, choose Am (A) or Pm (P) by pressing button.
5. Choose hour first digit by pressing button.
6. Choose hour second digit by pressing button.
7. Choose minutes first digit by pressing button.
8. Choose minutes second digit by pressing button.

NOTE: The gauge will display the current time for 10 seconds then will return to the normal display mode.

While reading this Operator's Guide, remember that:

WARNING

Indicates a potential hazard that, if not avoided, could result in serious injury or death.

Unit Selection (km/h vs mph)

The speedometer, odometer and trip meter are factory preset in **miles** but it is possible to change them to **kilometer** reading. Contact an authorized Can-Am dealer.

Language Selection

The gauge display language can be changed. Refer to an authorized Can-Am dealer for language availability and setup the gauge to your preference.

EQUIPMENT

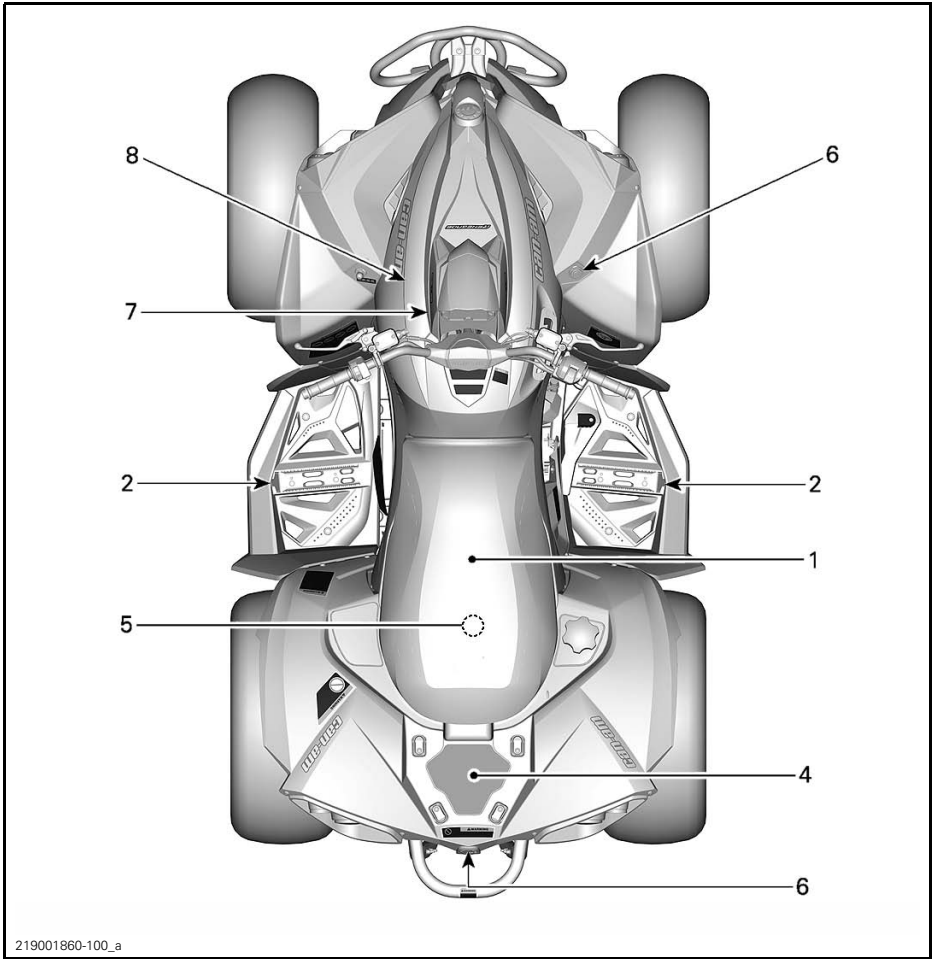

1) Seat

The seat is designed for an operator only.

⚠ WARNING

Never allow anyone to seat as a passenger on this vehicle.

Seat Removal

To remove the seat, push its latch forward. This latch is located underneath the rear of seat.



1. Seat latch

Pull seat rearward. Continue lifting movement until you can release the front retaining device under the seat from the retaining bar, then completely remove seat.

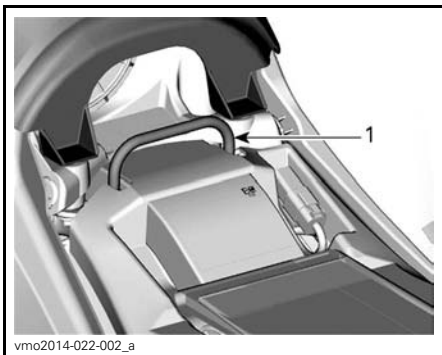

1. Retaining bar

Seat Installation

Position front end of seat so that the front retaining device under the seat engages with the retaining bar. When seat rests in its position, firmly push seat down to latch.

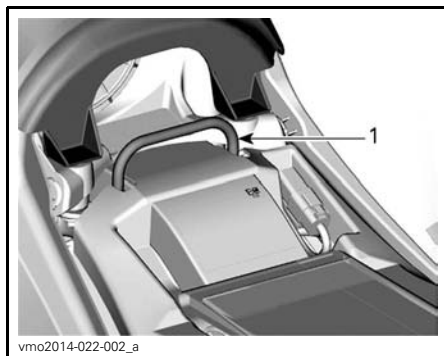

1. Retaining bar

NOTE: A distinctive snap will be felt. Double check that the seat is secure by giving it a tug to confirm proper latching.

⚠ WARNING

Confirm that the operator's seat is properly locked in position by pulling back and up several times.

2) Footpegs

The footpegs are located on the RH and LH footrests.



vmo2012-014-002_a

TYPICAL

1. RH footpeg

⚠ WARNING

Operator must have both feet on footpegs at all times during vehicle operation.

3) 12-Volt Power Outlet

Convenient for handheld spotlight or other portable equipment.

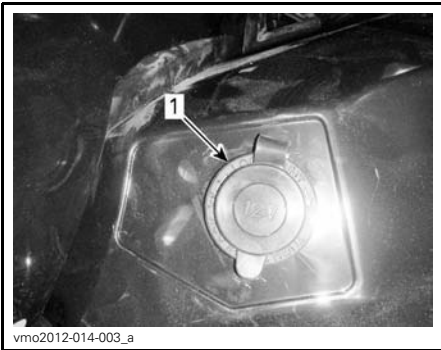

vmo2012-014-003_a

1. 12V power outlet

Remove protective cap to use. Always reinstall it after use to protect against weather.

4) Rear Cargo Area

Rear cargo area is convenient for carrying small articles.

Secure cargo using the eyelets.

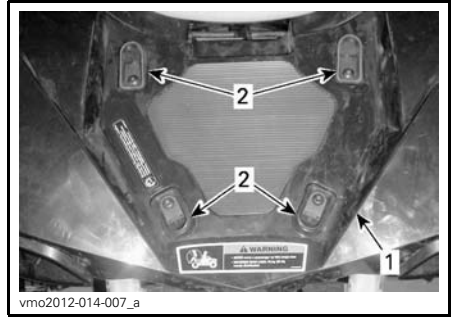

vmo2012-014-007_a

1. Cargo area
2. Plastic eyelets

⚠ WARNING

MAXIMUM load for cargo area is 16 kg (35 lb).

⚠ WARNING

- Never carry a passenger on the rear cargo area.
- Cargo must never interfere with the driver's line of sight or reduce his ability to steer the vehicle.
- Cargo must be secured and should not protrude the cargo area.

5) Tool Kit

The tool kit is located under seat. It contains tools for basic maintenance.

6) Recovery Hook

Convenient hook that can be used to recover a stuck ATV.

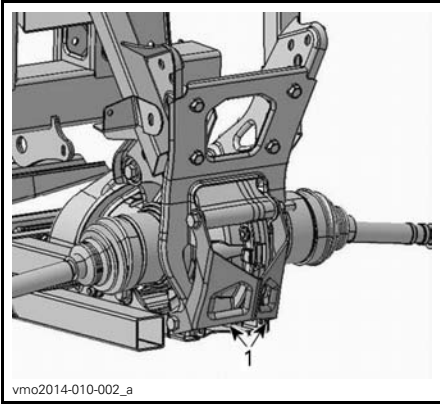

vmo2014-010-002_a

1. Recovery hook

7) Gauge Support

Gauge Support Removal

1. Pull the rear of gauge support up to release the lugs from the grommets.
2. Slide the gauge support backwards to release it from the console.

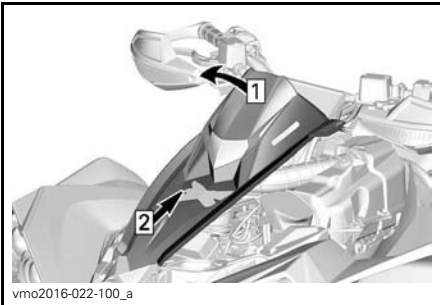

vmo2016-022-100_a

Step 1: Pull up

Step 2: Slide rearwards

3. Disconnect the gauge connector.

Gauge Support Installation

Reverse the removal procedure.

8) Console

Console Removal

1. See procedures in this section and remove:
 - Seat
 - Gauge support
2. At front of console, pull both lugs out of their grommets.
3. Pull both hooks out of their slots.

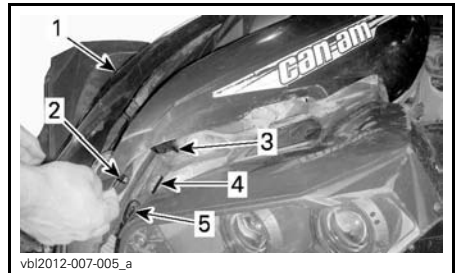

vbi2012-007-005_a

1. Console
2. Lug
3. Hook
4. Slot
5. Grommet

4. Pull the rear of console up to release the lugs from the grommets.
5. Remove console by pulling it rearwards.



vbi2012-007-006_a

Step 1: Pull up

Step 2: Pull rearwards

Console Installation

Reverse the removal procedure.

FUEL

Fuel Requirements

NOTICE Always use fresh gasoline. Gasoline will oxidize; the result is loss of octane, volatile compounds, and the production of gum and varnish deposits which can damage the fuel system.

Alcohol fuel blending varies by country and region. Your vehicle has been designed to operate using the recommended fuels, however, be aware of the following:

- Use of fuel containing alcohol above the percentage specified by government regulations is not recommended and can result in the following problems in the fuel system components:
 - Starting and operating difficulties.
 - Deterioration of rubber or plastic parts.
 - Corrosion of metal parts.
 - Damage to internal engine parts.
- Inspect frequently for the presence of fuel leaks or other fuel system abnormalities if you suspect the presence of alcohol in gasoline exceeds the current government regulations.
- Alcohol blended fuels attract and hold moisture which may lead to fuel phase separation and can result in engine performance problems or engine damage.

Recommended Fuel

For 570, 650 and 850 engines, use common unleaded gasoline with an AKI (R+M)/2 octane rating of 87, or a RON octane rating of 92.

For 1000R engines, use common unleaded gasoline with an AKI (R+M)/2 octane rating of 91, or a RON octane rating of 95.

Use unleaded gasoline containing MAXIMUM 10% ethanol.



NOTICE Never experiment with other fuels. Engine or fuel system damages may occur with the use of an inadequate fuel.

NOTICE Do NOT use fuel from fuel pumps labeled E85.

Use of fuel labeled E15 is prohibited by U.S. EPA Regulations.

Vehicle Fueling Procedure

WARNING

- Fuel is flammable and explosive under certain conditions.
- Never use an open flame to check fuel level.
- Never smoke or allow flame or spark in vicinity.
- Always work in a well-ventilated area.

1. Stop engine.

WARNING

Always stop engine before refueling.

2. Have operator get off vehicle.

WARNING

Do not allow anyone to remain on the vehicle while fueling. If there is a fire or explosion during fueling, a vehicle occupant could be unable to quickly leave the area.

3. Unscrew slowly the fuel reservoir cap counterclockwise to remove it.



1. Fuel reservoir cap

⚠ WARNING

If a differential pressure condition is noticed (whistling sound heard when loosening fuel reservoir cap) have vehicle inspected and/or repaired before further operation.

4. Insert the spout into the filler neck.
5. Pour fuel slowly so that air can escape from the tank and prevent fuel flow back. Be careful not to spill fuel.
6. Stop filling when the fuel reaches the bottom of filler neck. **Do not overfill.**

⚠ WARNING

Never top up the fuel tank before placing the vehicle in a warm area. As temperature increases, fuel expands and may overflow.

7. Fully tighten fuel reservoir cap clockwise.

⚠ WARNING

Always wipe off any fuel spillage from the vehicle.

BREAK-IN PERIOD

Operation During Break-In

A break-in period of 300 km (200 mi) or 10 operating hours is required for the vehicle.

Engine

During the break-in period:

- Avoid full throttle operation
- Maximum throttle should not exceed 3/4
- Avoid sustained accelerations
- Avoid prolonged cruising speeds
- Avoid engine overheating.

However, brief accelerations and speed variations contribute to a good break-in.

NOTE: It is normal that the engine will not operate at its maximum efficiency until the break-in period is completed.

Brakes

WARNING

New brakes will not operate at their maximum efficiency until their break-in is completed. Use extra caution.

Drive Belt

A new drive belt requires a break in period of 50 km (30 mi).

During the break-in period:

- Avoid strong acceleration and deceleration
- Avoid pulling a load
- Avoid high speed cruising.

BASIC PROCEDURES

Starting the Engine

The shift lever must be set to PARK or NEUTRAL.

NOTE: For your convenience, an over-ride mode allows the engine to be started with the shift lever in any position. Press and hold the brake lever or the brake pedal while pressing the engine start button.

Ensure D.E.S.S. key is installed on D.E.S.S. post.

Set the engine stop switch to RUN.

Press the engine start button and hold until the engine starts.

Release the engine start button immediately when the engine has started.

NOTICE If engine does not start after a few seconds, do not hold the engine start button more than 10 seconds. Refer to *TROUBLESHOOTING*.

Waking Up the Electrical System

Press and release the START button for less than half a second and the electrical system will turn ON:

- For 30 seconds, **without** powering any equipment, if the DESS key is **NOT** installed on the DESS post **OR** if the Engine Stop switch is set to the STOP position;
- For 10 minutes, powering equipment, if the DESS key is installed on the DESS post **AND** Engine Stop is set to the RUN position. The electrical system will be shutdown after 30 seconds if either the DESS key is removed **OR** the Engine Stop is set to the STOP position.

NOTICE Waking up the electrical system repeatedly or using electrical equipment will discharge the battery and you may not be able to start the engine.

Changing Gear Selection

Apply brakes and immobilize vehicle, then select the desired shift lever position.

Release brakes.

NOTICE When changing gear selection, always completely stop the vehicle and apply the brakes prior to moving the shift lever. Damage to the gearbox may occur.

Gradually press the throttle lever to increase engine speed and thus engaging the continuously variable transmission (CVT).

At the opposite, when the throttle lever is released, the engine speed decreases.

Stopping the Engine and Parking the Vehicle

WARNING

Avoid parking on steep slope as the vehicle may roll away.

WARNING

Always put the vehicle in PARK when stopped or parked to prevent rolling.

WARNING

Avoid parking in places where hot parts can start a fire.

When stopped or parked always bring shift lever to park position. This is especially important when parking on a slope.

Select the flattest terrain available for parking.

Release throttle and use brakes to completely stop the vehicle.

Set shift lever in PARK position.

Apply the parking brake.

Push the engine stop switch to OFF position.

Remove D.E.S.S. from D.E.S.S. post.

If you must park on a steep incline or if the vehicle is carrying cargo, block the wheels using rocks or bricks.

SPECIAL PROCEDURES

What to Do if Water Entered the CVT

Remove the CVT drain plug located on the rear portion of the CVT cover.. It is accessible from the rear LH fender.

Inspect the CVT drain plug to validate if water is present.

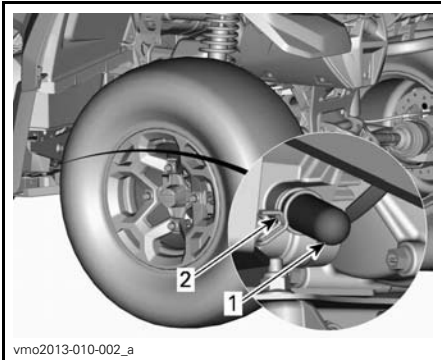

1. drain plug
2. Spring clamp

NOTICE If water is present in the CVT, it could result in belt slippage. The engine will accelerate but the vehicle will remain still.

If water is present, remove CVT drain plug to expel water.

NOTICE See an authorized Can-Am dealer to have the CVT inspected and cleaned.

Reinstall the drain plug and secure it using the spring clamp.

NOTE: Make sure hose is properly inserted on CVT cover nipple.

What to Do if Water Entered the Air Filter Housing

Remove the LH side panel.

Inspect the drain reservoir underneath the air filter housing to validate if water is present.

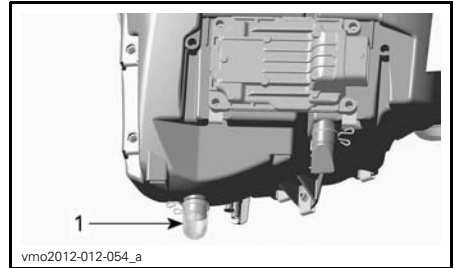

TYPICAL

1. Air filter housing drain reservoir

If water is present, press clamp and remove reservoir to drain water from air filter housing.

If one of the following conditions is met, bring the vehicle to your nearest authorized Can-Am dealer to have the vehicle serviced:

- If more than 50 ml (2 U.S. oz) of water (approximately 5 drain reservoirs) is found in the air filter housing.
- If any deposits are present in the drain reservoir.

In such a case, the vehicle must be serviced for:

- Vents
- CVT air filter cleaning
- CVT cleaning
- Fuel tank breather replacement
- Lubricant inspection and replacement as required (engine, gearbox and rear final drive).

NOTICE Failure to have vehicle serviced may lead to permanent damage to the following components but not limited to:

- Engine and gearbox
- Fuel pump
- CVT
- Front differential
- Rear final drive.

What to Do if Vehicle is Turned Over

When vehicle is turned over or stays tilted on the side, put the vehicle back on its wheel. Inspect vehicle for damages.

WARNING

Never operate the vehicle if damaged. Refer to an authorized Can-Am dealer.

If vehicle has no damage, refer to *MAINTENANCE PROCEDURES* and inspect the following.

- Inspect air filter housing for oil accumulation, if any oil is found, clean air filter and air filter housing.
- Check engine oil level and refill if necessary.
- Check engine coolant level and refill if necessary.
- Check gearbox oil level and refill if necessary.
- Check rear final drive oil level and refill if necessary.
- Start engine. If the oil pressure light stays on, stop engine immediately. See an authorized Can-Am dealer.

Whenever the vehicle is turned over, it should be inspected by an authorized Can-Am dealer.

What to Do if Vehicle is Immersed in Water

Should the vehicle become immersed, immediately stop the engine. Do not use any electrical equipment while vehicle is immersed. It will be necessary to take the vehicle to an authorized Can-Am dealer as soon as possible. **NEVER ATTEMPT TO START THE ENGINE!**

NOTICE Immersion of the vehicle can cause serious damage if the correct restart procedure is not followed.

As soon as vehicle is pulled out of water, carry out the following:

- Drain CVT. Refer to *WHAT TO DO IF WATER ENTERED THE AIR FILTER HOUSING* in this section.
- Drain CVT. Refer to *WHAT TO DO IF WATER ENTERED THE CVT* in this section.

NOTICE The vehicle should be serviced as soon as possible by an authorized Can-Am dealer.

TUNE YOUR RIDE

WARNING

Suspension adjustment could affect vehicle handling. Always take time to familiarize yourself with the vehicle's behavior after any suspension adjustment have been made.

Suspension Adjustments

Suspension adjustment and loading can have an effect on your vehicle handling and comfort.

Choice of suspension adjustments vary with driver's weight, personal preference, riding speed and field condition.

Perform adjustments one position (click) at a time. Test run the vehicle under the same conditions; trail, speed, driver riding position, etc. Proceed methodically until you are satisfied.

NOTE: Factory settings are suitable for almost all conditions. Take into consideration that an increase in ground clearance can affect the handling of the vehicle.

NOTE: Do not increase preload on FOX shock.

FRONT SUSPENSION FACTORY PRELOAD SETTINGS		
ADJUSTMENT	MODEL	FACTORY SETTING
Spring preload	570	Cam position 3
	850 / 1000R	46.6 mm
	All X xc	42.6 mm

REAR SUSPENSION FACTORY PRELOAD SETTINGS		
ADJUSTMENT	MODEL	FACTORY SETTING
Spring preload	570	Cam position 3
	850 / 1000R	59 mm
	All X xc	

Spring Preload Adjustment

WARNING

The left and right shock adjustment on front or rear suspension must always be set to the same position. Uneven adjustment can cause poor handling and loss of stability, which could lead to an accident.

Shorten the springs for a firmer ride and rough conditions.

Lengthen the springs for a softer ride and smooth conditions.

Adjust spring preload by turning the adjuster ring.

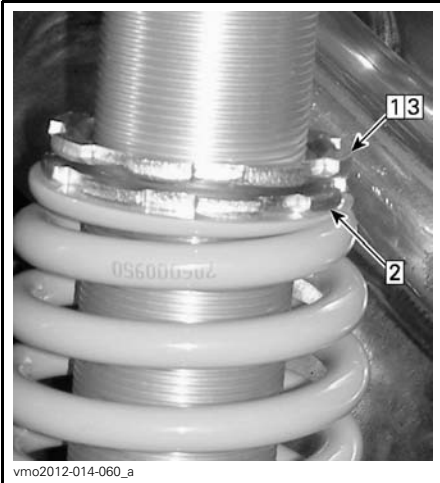

vmo2012-014-060_a

TYPICAL

- Step 1: Loosen top locking ring
- Step 2: Turn adjusting ring accordingly
- Step 3: Tighten top locking ring

Shock Absorber Damping X xc Model

FRONT SUSPENSION DAMPING FACTORY SETTINGS	
Rebound	12 clicks CCW from full stop
High Speed Compression	2.25 turn CCW from full stop
Slow Speed Compression	2.25 turn CCW from full stop

REAR SUSPENSION DAMPING FACTORY SETTINGS	
Rebound	12 clicks CCW from full stop
High Speed Compression	2.25 turn CCW from full stop
Slow Speed Compression	2.25 turn CCW from full stop

Shock Damping Compression Damping Adjustments (Xxc Models)

Compression damping controls how the shock absorber restrains the compression stroke.

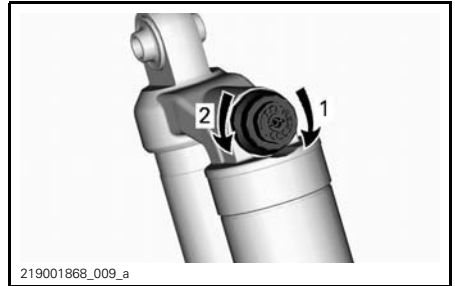

219001868_009_a

COMPRESSION DAMPING - TOP OF SHOCK ABSORBER

- 1. Increase (firmer)
- 2. Decreases (softer)

ACTION	RESULT
Increasing compression damping force	Firmer compression damping
Decreasing compression damping force	Softer compression damping

⚠ WARNING
Make sure compression damping setting is the same on both sides.

Shock Absorber Rebound Damping X xc Model

Rebound damping controls how the shock absorber restrains the extension stroke.

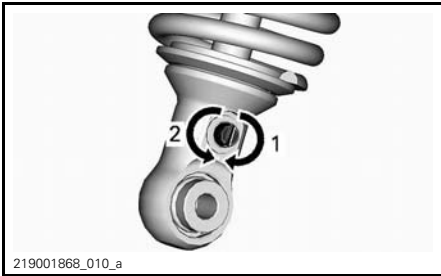

REBOUND DAMPING - BOTTOM OF SHOCK ABSORBER

1. Increase (*firmer*)
2. Decreases (*softer*)

Dynamic Power Steering (DPS) Assist Level Adjustment (X xc Models)

The Tri-Mode Dynamic Power Steering (DPS) offers easy steering assistance to the rider. The level of assistance will automatically adapt according to the vehicle's speed and rider's demand, in order to provide maximum steering power at lower speed where the demand is normally higher. As speed increases, the assistance is progressively reduced to keep maximum steering feel and precision to the rider.

It is possible to choose between three modes of assistance: Minimum, Medium and Maximum. Each mode will continue to automatically adapt to the vehicle's speed and rider's demand, so it does not require to be changed when riding. These modes are used to set the level of assistance to match each rider's preferences.

The following DPS modes are preset in the vehicle.

DPS MODE	
DPS MAX.	Maximum steering assist
DPS MED.	Medium steering assist
DPS MIN.	Minimum steering assist

To show the active DPS mode, proceed as follows:

1. Press and release **Override/DPS** button.

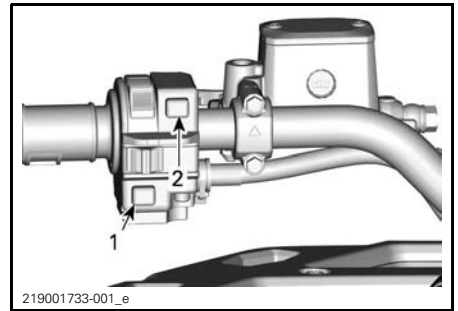

TYPICAL

1. *DPS button*
2. *Engine start button*

2. Check the multifunction gauge to confirm the current DPS mode.

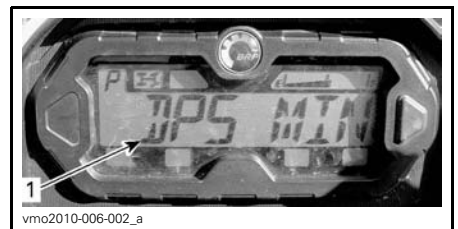

1. *DPS mode display*

While reading this Operator's Guide, remember that:

⚠ WARNING

Indicates a potential hazard that, if not avoided, could result in serious injury or death.

To change the DPS mode, proceed as follows:

1. Press and hold **Override/DPS** button for 2 seconds to go to the next setting.
2. Release **Override/DPS** button.
3. Repeat until desired setting is selected.

NOTE: The DPS assist adjustment is not available in reverse.

VEHICLE TRANSPORTATION

When transporting this vehicle, secure it to a trailer or in pickup box with suitable tie-downs. Use of ordinary ropes is not recommended.

⚠ WARNING

Do not tow this vehicle behind a car or other vehicle. Use a trailer. Never tip this vehicle on end for transporting. The vehicle must be in its normal operating position (on all four wheels).

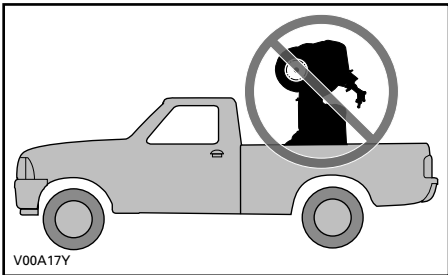

Remember to:

- Unload vehicle racks before transportation.
- Set shift lever to PARK position.
- Set the parking brake.
- Secure the vehicle by the front bumper and rear bumper.



TYPICAL - REAR TIE-DOWN POINT LOCATION

NOTICE Securing vehicle at other locations may damage the vehicle.



TYPICAL - FRONT TIE-DOWN POINT LOCATION

***This page is
intentionally blank***

MAINTENANCE

MAINTENANCE SCHEDULE

Maintenance is very important for keeping your vehicle in safe operating condition. The vehicle should be serviced as per the maintenance schedule.

The maintenance schedule does not exempt the pre-ride inspection.

A repair shop or person of the owner's choosing may maintain, replace, or repair emission control devices and systems. These instructions do not require components or service by BRP or authorized Can-Am dealers. Although an authorized Can-Am dealer has an in-depth technical knowledge and tools to service the Can-Am ATV, the emission-related warranty is not conditioned on the use of an authorized Can-Am dealer or any other establishment with which BRP has a commercial relationship. For emission-related warranty claims, BRP is limiting the diagnosis and repair of emission-related parts to the authorized Can-Am dealers. For more information, please refer to the *US EPA EMISSION-RELATED WARRANTY* contained herein. Proper maintenance is the owner's responsibility. A warranty claim may be denied if, among other things, the owner or operator caused the problem through improper maintenance or use.

You must follow the instructions for fuel requirements. Refer to *FUEL* in this manual. Even if gasoline containing greater than ten volume percent ethanol is readily available, the US EPA issued a prohibition against the use of gasoline containing greater than 10 vol% ethanol that applies to this vehicle. The use of gasoline containing greater than 10 vol% ethanol with this engine may harm the emission control system.

The following message appears in the gauge after every 50 hours of operation, to remind you of maintenance requirements: **MAINTENANCE REQUIRED**. To erase message, refer to the appropriate *MULTIFUNCTION GAUGE* section.

WARNING

Failure to properly maintain the vehicle according to the maintenance schedule and procedures can make it unsafe to operate.

SEVERE DUSTY CONDITIONS

Engine Air Filter Maintenance Guideline

Air filter maintenance should be adjusted according to riding conditions.

Air filter maintenance must be increased in frequency in the following dusty conditions:

- Riding on dry sand
- Riding on dry dirt covered surfaces
- Riding on dry gravel roads or similar conditions.

NOTE: Riding in a group in these conditions would increase even more the air filter maintenance.

MAINTENANCE SCHEDULE LEGEND

Operation in trail riding conditions

Operation in severe riding conditions (dusty or muddy) or carrying heavy loads condition

MAINTENANCE SCHEDULE

Make sure to perform proper maintenance at recommended intervals as indicated in the tables. Some items of the maintenance schedule must be performed in function of the calendar, regardless of the distance or time of operation.

EVERY 1 500 KM (1,000 MI) OR 50 HOURS (whichever comes first)
EVERY 750 KM (500 MI) OR 25 HOURS (whichever comes first)
Verify and clean engine air filter. Replace as needed
Verify battery connections
Lubricate rear propeller shaft joint
Inspect tie rod ends and ball joints for play and boots condition
Lubricate front suspension arm bushings
Lubricate front and rear stabilizer bar bushings
Inspect the drive shaft boots and protectors
Inspect brake pads. Replace as needed
Inspect wheel bearings for abnormal play
Inspect and clean CVT air filter. Replace as needed. (If equipped)
Tighten wheel beadlock bolts (If equipped)
Lubricate lower shock absorber spherical bearings (Renegade Xxc)
EVERY 3 000 KM (2,000 MI) OR 100 HOURS (whichever comes first)
EVERY 1 500 KM (1,000 MI) OR 50 HOURS (whichever comes first)
Adjust valve clearance
Clean muffler spark arrester
Verify and clean throttle body
Replace fuel vent breather filter
Verify CVT drive belt and clean CVT pulleys
Lubricate the one way bearing of the drive pulley
The following must be performed at least once a year:
Change engine oil and filter
Lubricate throttle cable
Inspect and clean brake system
Inspect battery condition

EVERY 3 000 KM (2,000 MI) OR 100 HOURS (whichever comes first)

EVERY 1 500 KM (1,000 MI) OR 50 HOURS (whichever comes first)

Verify steering system for abnormal play

Verify front differential and rear final drive oil level and look for contamination

Verify gearbox oil level and look for contamination

**PERFORM AT THE FIRST 3 000 KM (2,000 MI) AND AT 6 000 KM (4,000 MI)
THEN FOLLOW THE REGULAR SCHEDULE**

**PERFORM AT THE FIRST 1 500 KM (1,000 MI) AND AT 3 000 KM (2,000 MI)
THEN FOLLOW THE REGULAR SCHEDULE**

Replace gearbox oil

Clean the vehicle speed sensor (VSS)

EVERY 6 000 KM (4,000 MI) OR 200 HOURS (whichever comes first)

EVERY 3 000 KM (2,000 MI) OR 100 HOURS (whichever comes first)

Verify the cooling system

Test engine coolant strength

Verify fuel system for leaks

Verify fuel pump pressure

Replace spark plugs

Replace front differential oil

Replace rear final drive oil

Replace gearbox oil

Inspect input and output shaft seals (gearbox, differential and final drive)

Clean vehicle speed sensor

Clean and lubricate lower and upper steering column half bushings

The following must be performed every 2 years:

Replace the brake fluid

EVERY 12 000 KM (8,000 MI) OR 5 YEARS (whichever comes first)

EVERY 6 000 KM (4,000 MI) OR 5 YEARS (whichever comes first)

Replace engine coolant

MAINTENANCE PROCEDURES

This section includes instructions for basic maintenance procedures.

⚠ WARNING

Unless otherwise indicated, always remove D.E.S.S. key before performing any maintenance.

⚠ WARNING

Should removal of a locking device be required (e.g. lock tab, self-locking fastener, etc.), always replace it with a new one.

Air Filter

Air Filter Maintenance Guideline

As with any ATV, air filter maintenance is critical to ensure proper engine performance and life span.

Air filter maintenance should be adjusted according to riding conditions.

Air filter maintenance must be increased in frequency and oil must be added to the foam filter for the following dusty conditions:

- Riding on dry sand.
- Riding on dry dirt covered surfaces.
- Riding on dry gravel trails or similar conditions.

NOTE: Riding in a group in these conditions would increase even more the air filter maintenance. Refer to *AIR FILTER CLEANING AND OILING* in this section for maintenance procedure.

Engine Air Filter Removal

NOTICE Never remove or modify any component in the air filter housing. Otherwise, engine performance degradation or damage can occur. The engine is calibrated to operate specifically with these components.

1. Remove seat.

2. Lift the front part of the central panel.

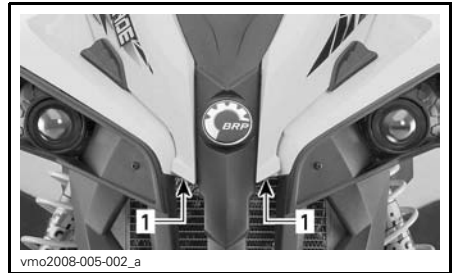

TYPICAL

1. Lift here

3. Remove console. Refer to *EQUIPMENT*.

4. Rotate air filter cover counterclockwise to remove it.

NOTE: A socket wrench may be used to remove the filter cover.



1. Air filter cover

5. Remove air filter.



AIR FILTER REMOVAL

Engine Air Filter Housing Inspection and Draining

1. Remove LH side panel.
2. Drain air filter housing inlet drain tube.

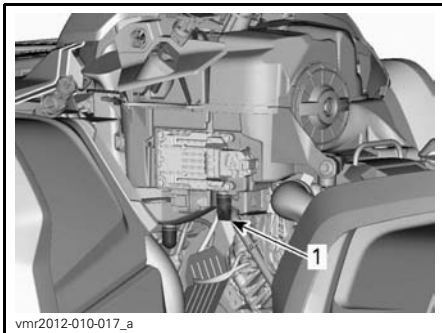

TYPICAL - SOME PARTS REMOVED FOR CLARITY

1. Air filter housing inlet drain tube
 3. Check air filter dirty chamber for cleanliness.
 - If any debris or water are found, clean air filter chamber using a vacuum cleaner.
- NOTICE** Do not blow compressed air into air filter chamber.
4. Check air filter drain tube (clean chamber).
 - If any debris or water are found, refer to *SPECIAL PROCEDURES*.
 - Investigate for contamination source.

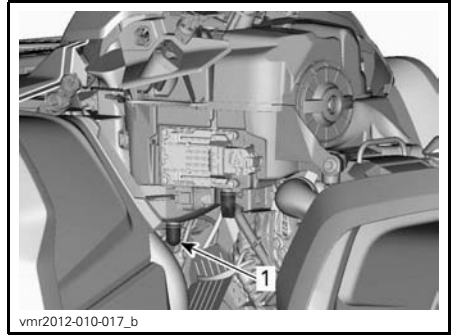

TYPICAL - SOME PARTS REMOVED FOR CLARITY

1. Air filter drain tube

Air Filter Cleaning and Oiling

Paper Filter Cleaning

1. Remove the foam filter from paper filter.
2. Tap out heavy dust from the paper filter.

This will allow dirt and dust to get out of the paper filter.

NOTE: Paper filter have a limited life span; replace filter if too dirty or clogged.

NOTICE It is not recommended to blow compressed air on the paper filter; this could damage the paper fibers and reduce its filtration ability when used in dusty environments.

NOTICE Do not wash the paper filter with any cleaning solution.

Foam Filter Cleaning

CAUTION Always wear appropriate skin and eye protection. Chemicals can cause a skin rash and eye injury.

1. Spray the foam filter inside and out with a good air filter cleaner and follow manufacturer's instructions.



TYPICAL - SPRAY THE FOAM FILTER

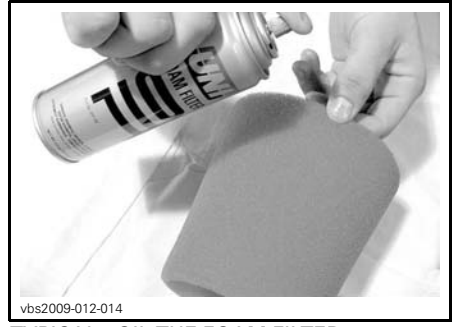

TYPICAL - OIL THE FOAM FILTER

2. Dry the foam filter completely.

2. Let stand for 3 to 5 minutes.

3. Remove any excess of oil that could transfer to the paper filter by wrapping the foam filter into an absorbent cloth and squeezing gently. This will also ensure a full oil coverage on foam filter.

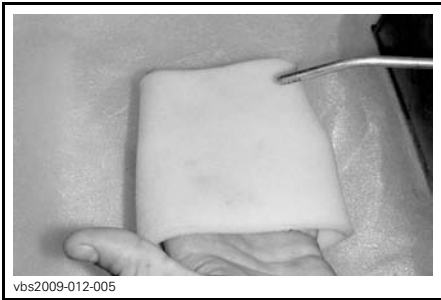

TYPICAL - DRY

NOTE: A second application may be necessary for heavily soiled elements.

Foam Filter Oiling

1. Spray AIR FILTER OIL (P/N 219 700 340) or equivalent on the foam filter.

Air Filter Installation

Reinstall oiled foam filter on paper air filter.

Slightly grease O-ring seal and plastic body of air filter.

Install air filter as the reverse of removal.

Ensure air filter cover is properly locked onto the air filter housing. See indications on filter cover and housing.



AIR FILTER OIL (P/N 219 700 340)

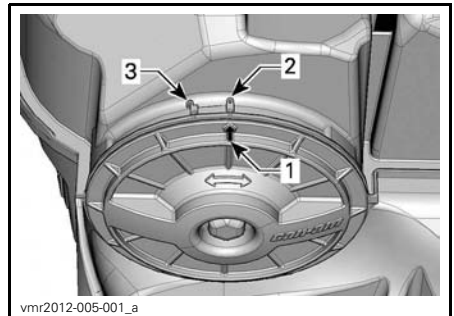

- 1. Cover position arrow
- 2. Locked
- 3. Unlocked

Reinstall:
 – Console

- Gauge support
- Seat.

Engine Oil

Engine Oil Level

NOTICE Check level frequently and refill if necessary. **Do not overfill.** Operating the engine/gearbox with an improper level may severely damage engine/gearbox. Wipe off any spillage.

NOTE: While checking the oil level, visually inspect engine area for leaks.

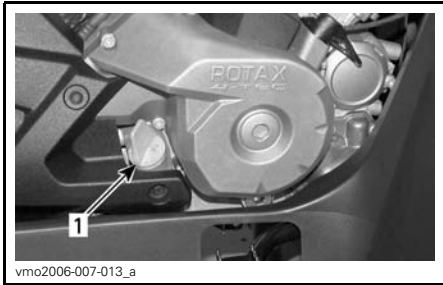

TYPICAL - RH SIDE OF ENGINE

1. Dipstick

With vehicle on a level surface and engine cold, not running, check the oil level as follows:

1. Unscrew dipstick then remove it and wipe clean.
2. Reinstall dipstick, screw in it completely.
3. Remove and check oil level. It should be near or equal to the upper mark.

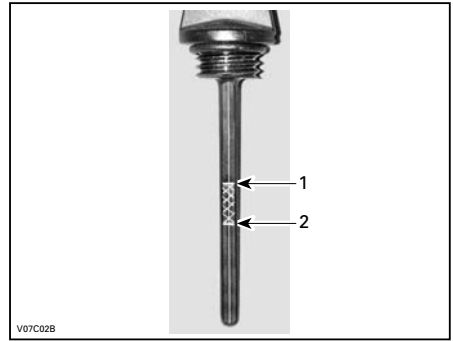

TYPICAL

1. Full
2. Add

To add oil, remove dipstick. Place a funnel into the dipstick tube to avoid spillage.

Add a small amount of recommended oil and recheck oil level.

Repeat the above procedures until oil level reaches the dipstick's upper mark. **Do not overfill.**

Properly tighten dipstick.

Recommended Engine Oil

RECOMMENDED ENGINE OIL (GENERAL PURPOSE)	
Scandinavia	4T 5W40 SYNTHETIC BLEND OIL (EUR) (P/N 779290)
All other countries	4T 5W40 SYNTHETIC BLEND OIL (P/N 779133)

RECOMMENDED ENGINE OIL (WARM TEMPERATURE)	
Scandinavia	4T 10W50 SYNTHETIC OIL (EUR) (P/N 779240)
All other countries	4T 10W50 SYNTHETIC OIL (P/N 779234)

RECOMMENDED ENGINE OIL (COLD TEMPERATURE)	
Scandinavia	4T 0W40 SYNTHETIC OIL (EUR) (P/N 779286)
All other countries	4T 0W40 SYNTHETIC OIL (P/N 779139)

NOTE: The XPS oil is specially formulated and tested for the severe requirements of this engine. BRP recommends the use of its XPS oil.

If XPS engine oil is not available, use a 4-stroke SAE 5W40 or 10W50 engine oil that meets or exceeds the requirements for API service classification SJ, SL, SM or SN. Always check the API service label certification on the oil container it must contain at least one of the above standards.

NOTICE Damages caused by the use of oil not suitable for this engine may not be covered by the BRP limited warranty.

Engine Oil Change

CAUTION The engine oil can be very hot. Wait until engine oil is warm.

NOTICE Engine oil and oil filter must be replaced at the same time.

Bring engine to its normal operating temperature.

Ensure vehicle is on a level surface.

Remove dipstick.

Clean the oil drain plug area.

Place a drain pan under the oil drain plug area.

Unscrew oil drain plug.



1. Drain plug

Allow enough time for oil to flow out of oil filter.

Replace the oil filter. Refer to *OIL FILTER* in this section.

Change gasket on oil drain plug.

Clean gasket area on engine and oil drain plug then reinstall plug.

Refill engine at the proper level with the recommended oil.

Refer to *SPECIFICATIONS* for oil capacity.

Start engine and let idle for a few minutes.

Ensure oil filter area and oil drain plug areas are not leaking.

Stop engine.

Wait a while to allow oil to flow down to crankcase then check oil level.

Refill as necessary.

Dispose of oil as per your local environmental regulations.

Oil Filter

Oil Filter Replacement

Remove the right engine cover.

Unscrew the oil filter cover.

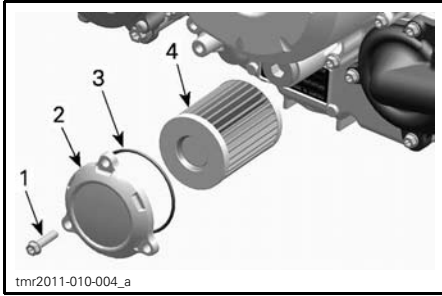

1. Oil filter screw
2. Oil filter cover
3. O-ring
4. Oil filter

NOTICE Pay attention to avoid pinching the O-ring during filter and cover installation.

Remove the oil filter and replace with a new filter.

Install a **NEW** O-ring on oil filter cover. Install the new filter into the cover.

Apply engine oil on O-ring and on end of filter.

Screw oil filter cover in place.

Tighten oil filter cover screws to recommended specification.

TIGHTENING TORQUE	
Oil filter cover screws	10 N•m ± 1 N•m (89 lbf•in ± 9 lbf•in)

Wipe out any oil spillage on engine.

Radiator

Radiator Inspection

Periodically check the radiator area for cleanliness.



TYPICAL

Inspect radiator and hoses for leaks or any damage.

Inspect radiating fins. They must be clean, free of mud, dirt, leaves and any other deposit that would prevent the radiator to cool properly.

Remove as much deposits as you can with your hands. If water is available in proximity, try rinsing the radiating fins.

If available, use a garden hose to rinse the radiating fins.

CAUTION Never clean radiator with your hands when it is hot. Let the radiator cool down before cleaning.

NOTICE Be careful not to damage the radiating fins when cleaning. Do not use any object/tool that could damage the fins. The fins are purposely thin parts to allow efficient cooling. **WHEN RINSING, USE LOW PRESSURE ONLY, NEVER USE A HIGH PRESSURE WASHER.**

See an authorized Can-Am dealer, repair shop or person of your own choosing to check the performance of the cooling system.

Engine Coolant

Engine Coolant Level Verification

⚠ WARNING

Check coolant level with engine cold. Never add coolant in cooling system when engine is hot.

1. Place vehicle on a level surface.
2. Remove seat.
3. Lift the front part of the central panel.



vmo2008-005-002_a

TYPICAL

1. Lift here

4. Remove console. Refer to *EQUIPMENT*.
5. Remove engine coolant reservoir cap.
6. With vehicle on a level surface, liquid should be between MIN. and MAX. level marks of coolant reservoir.



vmo2012-014-019_a

1. Engine coolant reservoir

NOTE: When checking level at temperature lower than 20°C (68°F), it may be slightly lower than MIN. mark.

7. Add coolant if required.

⚠ WARNING

Do not remove the coolant reservoir cap if engine is hot.

8. Use a funnel to avoid spillage. Do not overfill.
9. Properly reinstall and tighten reservoir cap.

⚠ WARNING

In order to avoid potential burns, do not remove the radiator cap if the engine is hot.

NOTE: A cooling system that frequently requires coolant is the indication of leaks or engine problems. See an authorized Can-Am dealer.

Reinstall:

- Console
- Gauge support
- Seat.

Recommended Engine Coolant

COUNTRY	RECOMMENDED COOLANT
Scandinavia	EXTENDED LIFE PRE-MIXED COOLANT (EUR) (P/N 779223)
All other countries	EXTENDED LIFE PRE-MIXED COOLANT (P/N 779150)
Alternative, or if not available	Distilled water and antifreeze solution (50% distilled water, 50% antifreeze)

NOTICE Always use ethylene-glycol antifreeze containing corrosion inhibitors specifically for internal combustion aluminum engines.

Engine Coolant Replacement

Cooling System Draining

Remove console. Refer to *EQUIPMENT*.

Remove the coolant reservoir cap.

⚠ WARNING

Warning: Do not remove the coolant reservoir cap if engine is hot.



1. Engine coolant reservoir cap

Unscrew the coolant drain plug and drain the coolant into a suitable container.

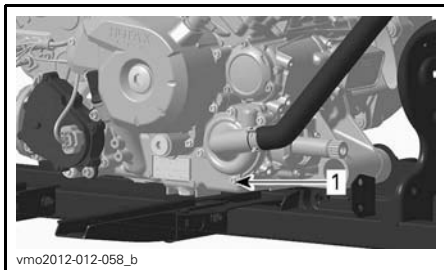

1. Coolant drain plug

NOTE: Do not unscrew the coolant drain plug completely.

570 and 650 Models

Disconnect the lower radiator hose and drain the remaining coolant into a suitable container.

NOTE: Take note of hose clamp position on the lower radiator hose.

Reinstall lower radiator hose.

Position the radiator hose clamp as noted during removal.

All Models

Install cooling system drain plug with a new sealing ring and tighten to specification.

TIGHTENING TORQUE	
Cooling system drain plug	9 N•m to 11 N•m (80 lbf•in to 97 lbf•in)

Bleed cooling system, refer to *COOLING SYSTEM BLEEDING*.

Cooling System Bleeding

1. Unscrew bleed screws on both front and rear cylinders.



TYPICAL

1. Front cylinder bleed screw

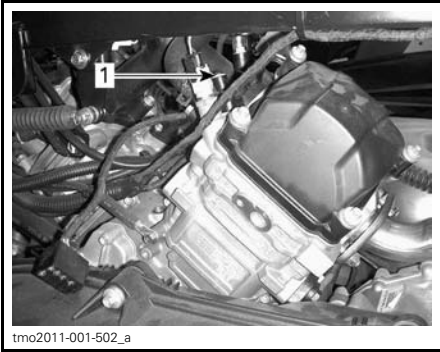

tmo2011-001-502_a

TYPICAL

1. Rear cylinder bleed screw

2. Remove the pressure cap.
3. Fill the cooling system until coolant comes out of the bleed screw(s).
4. Install the bleed screws using **NEW** gasket rings and tighten to specification.

TIGHTENING TORQUE	
Bleed screw	4.4 N•m to 5.6 N•m (39 lbf•in to 50 lbf•in)

5. Add coolant until system is full up to the pressure cap seat.
6. Start engine.

NOTE: Do not install pressure cap.

7. Run engine at idle until coolant fan turns ON.

NOTE: Monitor coolant level during engine warm-up and add coolant as required.

8. Depress the throttle lever two or three times; check coolant level.
9. Stop the engine and let it cool down.
10. Inspect cooling system for leaks.
11. Check coolant level in the reservoir. Add coolant as required.
12. Install pressure cap.

Reinstall:

- Console
- Gauge support
- Seat.

Muffler Spark Arrester

Muffler Spark Arrester Cleaning and Inspection

NOTE: Spark arrester screen replacement is required only when damaged.

⚠ CAUTION Let exhaust system cool down before proceeding with cleaning and inspection.

Remove and discard the tail pipe retaining screws.



vmo2012-012-709

TYPICAL - REMOVE TAIL PIPE

Remove exhaust tail pipe, gasket (discard) and spark arrester.

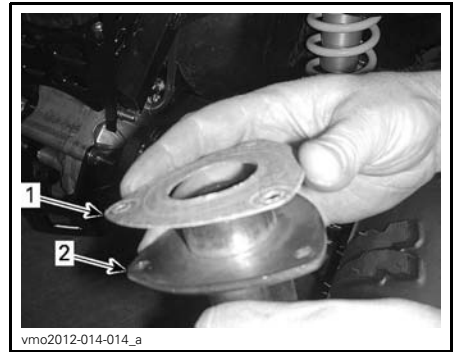

vmo2012-014-014_a

TYPICAL

1. Gasket
2. Exhaust tail pipe

Remove carbon deposits from the spark arrester using a brush.

NOTICE Use a soft brush and be careful to avoid damaging spark arrester mesh.

CAUTION Wear eye protection and gloves.



1. Clean spark arrester

Inspect mesh of spark arrester for any damage. Replace as required.

Inspect spark arrester chamber in muffler. Clean any debris as required.

Install new gasket, tail pipe and new retaining screws.

Reinstall muffler cover with new retaining screws. Tighten to specification.

TIGHTENING TORQUE	
Tail pipe retaining screws	11 N•m ± 1 N•m (97 lbf•in ± 9 lbf•in)
Cover retaining screws	11 N•m ± 1 N•m (97 lbf•in ± 9 lbf•in)

CVT Air Filter

CVT Air Filter Removal

1. Remove gauge support. Refer to *EQUIPMENT*.
2. Remove air filter from CVT air inlet by stretching its sides.



1. CVT air filter

CVT Air Filter Cleaning

1. Inspect filter and replace if damaged.
2. Gently clean filter using a solution of soft soap and tap water, then rinse thoroughly.
3. Dry filter completely.
4. Clean inside the CVT air inlet duct.

CVT Air Filter Installation

1. Install air filter on CVT inlet by stretching its sides.
2. Reinstall gauge support. Refer to *EQUIPMENT*.

While reading this Operator's Guide, remember that:

WARNING

Indicates a potential hazard that, if not avoided, could result in serious injury or death.

Gearbox Oil

Gearbox Oil Level Verification

NOTICE Check level and refill if necessary. **Do not overfill.** Operating the gearbox with an improper level may severely damage gearbox. Wipe off any spillage.

Place the vehicle on a level surface.

Select NEUTRAL position.

Apply parking brake.

NOTE: Check the gearbox oil level when engine is cold and not running.

Clean the oil level plug area.

Remove the oil level plug.

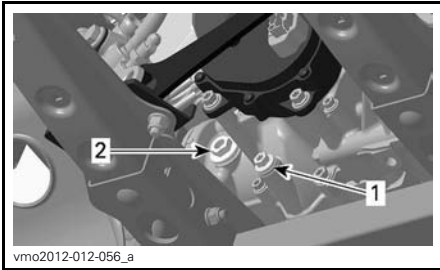

TYPICAL - 570/650/850 ENGINE

1. Drain plug
2. Oil level plug

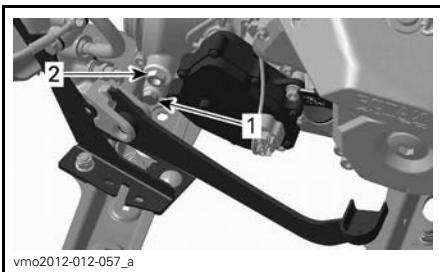

TYPICAL - 1000R ENGINE

1. Drain plug
2. Oil level plug

The oil should be level with the bottom of the oil level hole.

Refill as required until gearbox oil level flows through oil level hole.

Recommended Gearbox Oil

RECOMMENDED GEARBOX OIL	
Scandinavia	75W140 SYNTHETIC GEAR OIL (EUR) (P/N 779215)
All other countries	75W140 SYNTHETIC GEAR OIL (P/N 779160)

NOTE: The XPS oil is specially formulated to meet the lubrication requirements of this gearbox. BRP strongly recommends the use of its XPS oil. However, if the XPS synthetic gear oil is not available, use the following lubricant:

GEARBOX OIL REQUIREMENT
75W 140 API GL-5 synthetic gear oil

NOTICE Do not use another types of oil when servicing. Do not mix with other types of oil.

Gearbox Oil Change

NOTE: When replacing the gearbox oil, it is recommended to clean the vehicle speed sensor (VSS) at the same time.

Place the vehicle on a level surface.

Clean the drain plug area.

Clean the oil level plug area.

Place a drain pan underneath the oil drain plug.

Remove the oil level plug.

Remove the drain plug.

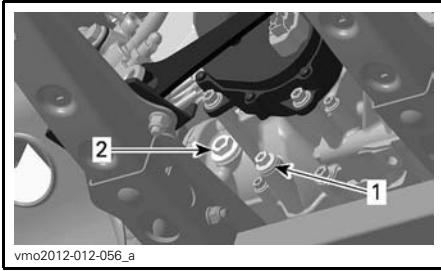

TYPICAL - 570/850 ENGINE

1. Drain plug
2. Oil level plug

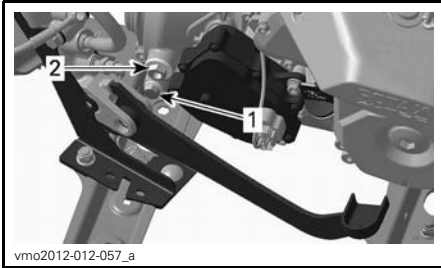

TYPICAL - 1000R ENGINE

1. Drain plug
2. Oil level plug

Let oil completely drain from gearbox.

Clean the drain plug from any metallic particles.

Install the drain plug and tighten to specification.

TIGHTENING TORQUE	
Drain plug	20 N•m ± 2 N•m (15 lbf•ft ± 1 lbf•ft)

Refill gearbox.

NOTICE Use **ONLY** the recommended type of oil.

The oil should be level with the bottom of the oil level orifice.

NOTICE Do not overfill.

Reinstall oil level plug and tighten to specification.

TIGHTENING TORQUE	
Oil level plug	5 N•m ± 0.6 N•m (44 lbf•in ± 5 lbf•in)

Wipe off any spillage.

Dispose gearbox oil as per your local environmental regulations.

Throttle Body

Throttle Body Inspection

1. Remove the following:
 - Air filter housing
 - Adapter hose between air filter housing and throttle body.
2. Visually inspect throttle plate and throttle body venturi for cleanliness.
3. Clean inside throttle body using a common throttle body cleaner if necessary.

Throttle Body Lubrication

No lubrication is required.

Throttle Body Cleaning

1. Remove air inlet hose from throttle body.
2. Check throttle body cleanliness using a flashlight. Fully open throttle plate and verify:
 - Throttle body bore
 - Throttle plate edge.

Look for:

- Dirt
 - Oily surfaces
 - Carbon and salt deposits on throttle plate and the surrounding bore.
3. Clean as necessary.

4. Use a throttle body cleaner such as GUNK INTAKE MEDIC or an equivalent.

NOTICE Only use an appropriate throttle body cleaner that will not damage O-rings and EFI sensors.

⚠ CAUTION Use the product in a well ventilated area. Refer to product manufacturer's warnings.

5. To avoid getting dirt into engine, spray cleaner on a clean rag then rub rag against throttle plate and bore. A toothbrush may also be used.

⚠ CAUTION Ensure key is removed so that nobody can activate the electrical system, otherwise the ECM would turn on. This could cause serious finger injury as the throttle plate moves quickly.

6. Gently open throttle plate and hold fully open to reach all surfaces.

7. To remove residual dirt, spray cleaner on throttle plate and on bore.

8. Reinstall removed parts.

Throttle Cable

Throttle Cable Lubrication

The throttle cable must be lubricated with a silicone based lubricant or an equivalent.

⚠ WARNING

Always use a silicone-based lubricant. Using another lubricant (like a water-based lubricant) could cause the throttle lever/cable to become sticky and stiff.

Open the throttle lever housing.

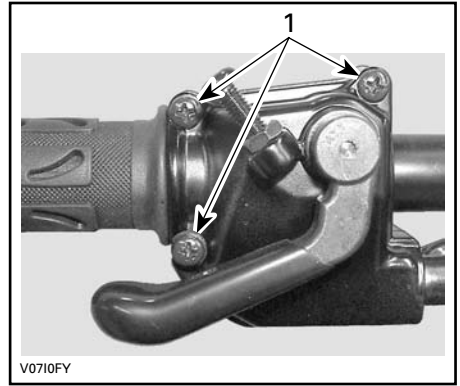

1. Remove these screws

Separate the housing.

Slide rubber protector back to expose throttle cable adjuster.

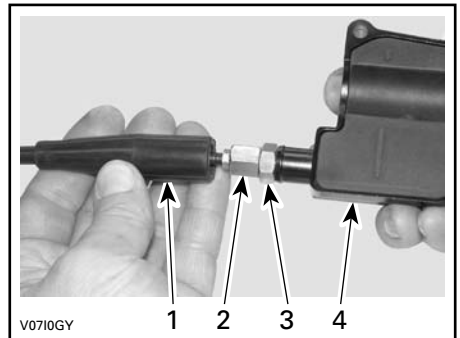

1. Cable protector
2. Throttle cable adjuster
3. Lock nut
4. Throttle lever housing

Screw in the throttle cable adjuster.
Remove inner housing protector.

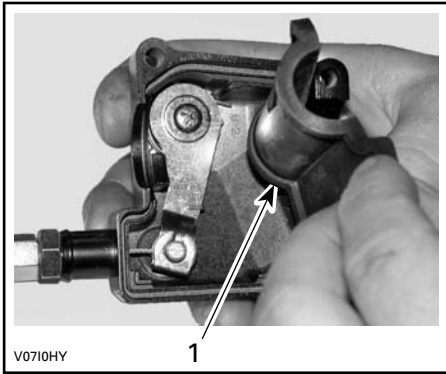

V0710HY

1

1. Inner housing protector

Remove the cable from the throttle lever housing.

NOTE: Slide cable in clip slot and remove the end of cable from clip.

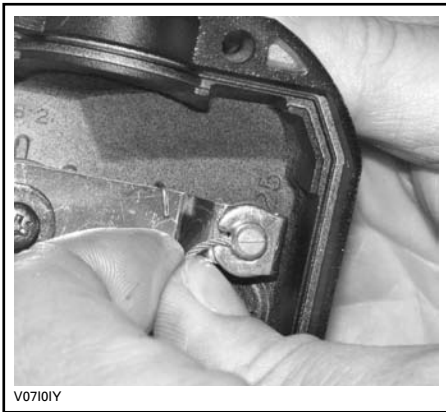

V0710IY

Remove the throttle body side cover.

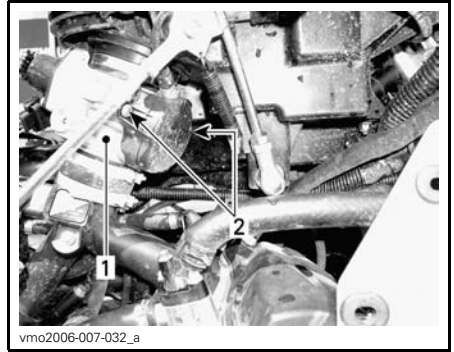

1. Throttle body

2. Side cover screws

Insert the needle of the lubricant can in the end of throttle cable adjuster.

⚠ CAUTION Always wear appropriate skin and eye protection. Chemicals can cause a skin rash and eye injury.



V0710JY

TYPICAL

NOTE: Place a rag around the throttle cable adjuster to prevent the lubricant from splashing.

Add lubricant until it runs out at throttle body end of the throttle cable.

Reinstall and adjust the cable.

Throttle Cable Adjustment

Slide rubber protector back to expose throttle cable adjuster.

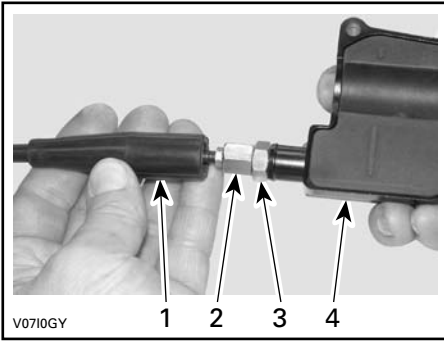

1. Cable protector
2. Throttle cable adjuster
3. Lock nut
4. Throttle lever housing

Loosen lock nut then turn the adjuster to obtain correct throttle lever free play.

NOTE: Measure throttle free play at the tip of throttle lever.

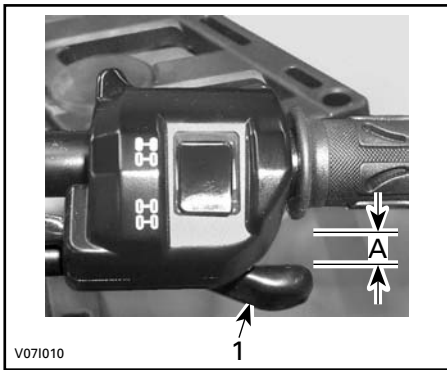

1. Throttle lever
- A. 2 mm (.079 in)

Tighten lock nut and reinstall protector. With the shift lever on PARK position, start the engine.

Check if the throttle cable is adjusted correctly by turning handlebar fully to the right then fully to the left. If the engine RPM increases, readjust the throttle lever free play.

Spark Plugs

Spark Plug Access

Remove side panels.
Unplug spark plug cables.

Spark Plug Removal

Unscrew spark plugs one turn.

⚠ CAUTION Always wear safety goggles when using pressurized air.

Clean spark plugs and cylinder heads with pressurized air if possible.

Unscrew spark plugs completely using a spark plug socket, then remove them.

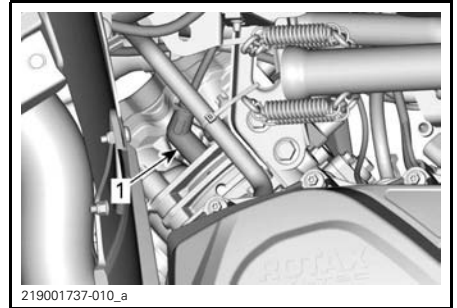

RH SIDE — REAR CYLINDER

1. Spark plug

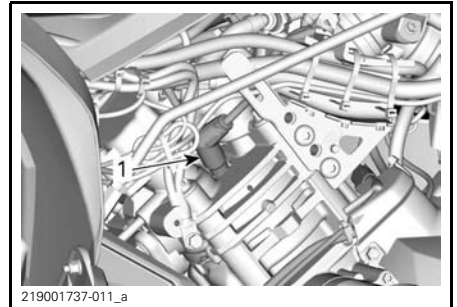

LH SIDE — FRONT CYLINDER

1. Spark plug

Spark Plug Installation

Prior to installation, make sure that contact surfaces of cylinder heads and spark plugs are free of grime.

Using a feeler gauge, set the spark plug gap.

SPARK PLUG GAP	
570 650	0.7 mm to 0.8 mm (.028 in to .031 in)
850 1000R	0.7 mm to 0.9 mm (.028 in to .035 in)

Apply a small amount of copper-based anti-seize lubricant over spark plug threads to prevent a possible seizure.

Screw spark plugs into cylinder heads by hand and tighten with a torque wrench and a proper socket.

CAUTION Do not overtighten spark plugs, engine damage can occur.

TIGHTENING TORQUE	
Spark plug	20 N•m ± 2.4 N•m (15 lbf•ft ± 2 lbf•ft)

Battery

CAUTION Never charge a battery while installed in vehicle.

These vehicles are equipped with a VRLA battery (Valve Regulated Lead Acid). It is a maintenance-free type battery, there is no need to add water to adjust electrolyte level.

NOTICE Never remove the battery sealing cap.

Battery Removal

Disconnect BLACK (-) cable first then RED (+) cable.

NOTICE Always disconnect BLACK (-) battery cable first.

Remove retaining screws, battery holding strap then pull the battery out of frame.

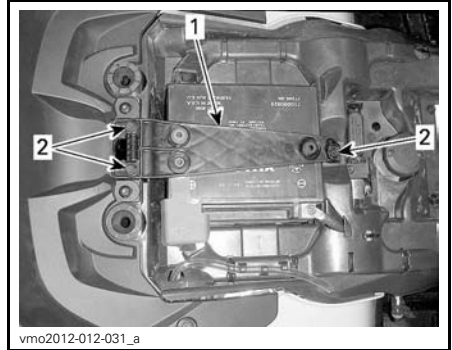

1. Battery holding strap
2. Retaining screws

Battery Cleaning

Clean battery, battery casing and battery posts using a solution of baking soda and water.

Remove corrosion from battery cable terminals and battery posts using a firm wire brush.

Battery Installation

Battery installation is the reverse of the removal procedure.

NOTICE Always connect RED (+) battery cable first.

Fuses

CAUTION Always remove key from D.E.S.S. post before replacing a defective fuse.

Fuse Inspection

Check if filament is melted.

If filament is melted, replace damaged fuse, refer to *FRONT FUSE BOX DESCRIPTION* for proper rating.

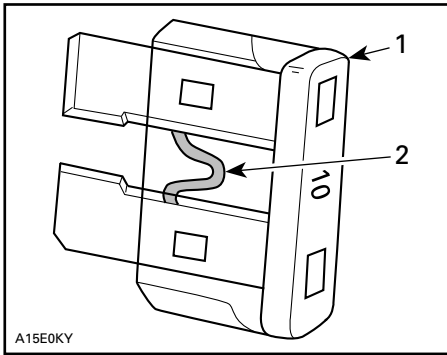

A15E0KY

TYPICAL

1. Fuse
2. Check if melted

NOTICE Do not use a higher rated fuse as this can cause severe damage.

Front Fuse Box Access

Remove the gauge support. Refer to *EQUIPMENT*.

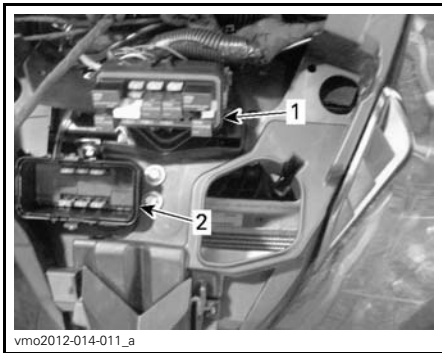

vmo2012-014-011_a

1. Front fuse box
2. Front fuse box cover

NOTE: Check inside fuse box cover to know fuses location.

NOTICE Do not store any objects in the front service compartment.

Front Fuse Box Description

All models except 1000R and NRMM models

FRONT FUSE BOX		
NO.	DESCRIPTION	RATING
R1	Fan Relay	-
R2	Main Relay	-
R3	Accessories Relay	-
R4	Fuel Pump Relay	-
R5	Lights Relay	-
R8	Brake Relay	-
F4	Relays DPS Gauge (Speedo)	5 A
F5	Injectors/Ignition	5 A
F6	ECM	5 A
F7	2WD/4WD	5 A
F8	Key Switch, Starter Solenoid	5 A
F9	Cooling Fan	25 A
F10	Euro Control (CE Models)	5 A
F11	Lights	30 A
F12	DC Outlet	15 A
F14	Taillight Accessories 2	15 A
F15	Fuel Pump	5 A

1000R and NRMM models

FRONT FUSE BOX		
NO.	DESCRIPTION	RATING
RY1	Fan Relay	-
RY2	Main Relay	-
RY3	Lights Relay	-

FRONT FUSE BOX		
NO.	DESCRIPTION	RATING
RY5	Accessories	-
RY6	Brake Relay	-
F1	Start Switch	10 A
F2	Lights	30 A
F3	Accessories 1	20 A
F4	Accessories 2	20 A
F5	Injectors Ignition coils Fuel Pump	10 A
F6	Relays DPS Gauge	10 A
F7	Brake lights	10 A
F8	DESS Key, ECM	5 A
F9	2WD/4WD	10 A
F12	DC Outlet	25 A

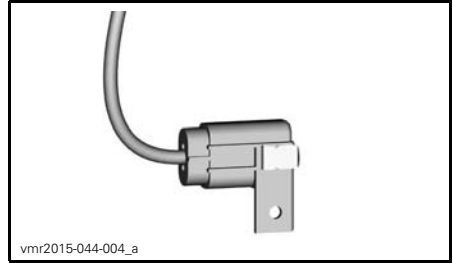

vmr2015-044-004_a
REAR FUSE HOLDER

FUSIBLE LINKS		
DESCRIPTION		Gauge
Fusible link 1	Main	16 awg
Fusible link 2	Cooling fan Accessories	16 awg

FUSE HOLDER	
DESCRIPTION	Rating
DPS (Dynamic Power Steering)	40 A

Fusible Links and Rear Fuse Holder

The fusible links and rear fuse holder are located behind the RH side panel.



vmr2016-132-004_a
1. Fusible links

Lights

Always check light operation after replacement.

Headlight Bulb Replacement

NOTICE Never touch glass portion of a halogen bulb with bare fingers, it shortens its operating life. If glass is touched, clean it with isopropyl alcohol which will not leave a film on the bulb.

Unplug connector from bulb.

Rotate light bulb counterclockwise to release it from light housing.



Disconnect the light bulb connector.
 Rotate light bulb counterclockwise to remove it from taillight.

Pull out bulb.

Properly reinstall removed parts in the reverse order of their removal.

Validate headlights operation.

Headlight Beam Aiming

Turn adjustment screws to adjust beam height to your convenience. Adjust headlights evenly.



Installation is the reverse of the removal procedure.

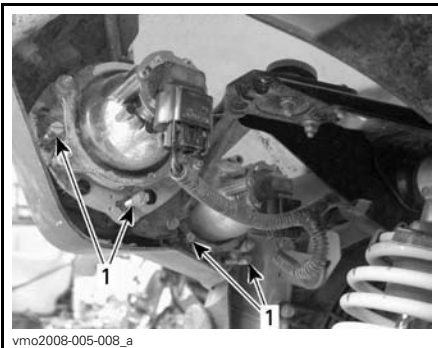

TYPICAL

1. Adjustment screws

Taillight Bulbs Replacement

Unplug taillight connector.

Rotate taillight counterclockwise to remove it from taillight housing.

Drive Shaft Boot and Protector

Drive Shaft Boot and Protector Inspection

Visually inspect drive shaft protectors and boots conditions.

Check protectors for damage or rubbing against shafts.

Check boots for cracks, tears, leaking grease etc.

Repair or replace damaged parts as necessary.

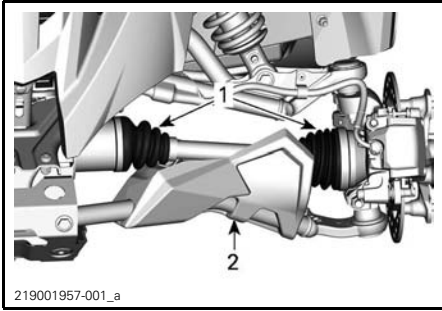

TYPICAL — FRONT OF VEHICLE

1. Drive shaft boots
2. Drive shaft protector

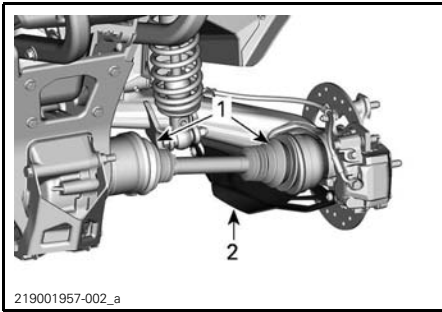

TYPICAL — REAR OF VEHICLE

1. Drive shaft boots
2. Drive shaft protector

Wheel Bearing

Wheel Bearing Inspection

- Place vehicle on a level surface.
- Apply parking brake.
- Lift and support vehicle.
- Secure vehicle on jack stands.
- Push and pull the wheels from the upper edge to feel the play.
- See an authorized Can-Am dealer if there is an abnormal play.



TYPICAL

Wheel Beadlock Inspection (If equipped)

Wheel Beadlock Retightening

NOTICE Do not use an impact wrench for tightening beadlock screws in order to avoid to damage them.

1. Tighten all screws to specification and according to the following tightening sequence.

TIGHTENING TORQUE	
Beadlock screws	11 N•m ± 1 N•m (97 lbf•in ± 9 lbf•in)

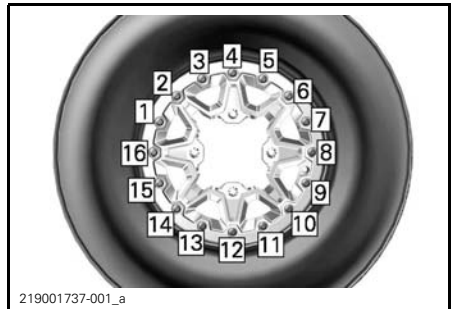

TYPICAL - FINAL TIGHTENING SEQUENCE

2. Tighten screws a few turns at a time to ensure even pressure on the beadlock clamp ring.

NOTE: It is normal that the beadlock clamp ring flexes slightly to match the tire bead.

Wheel Beadlock Gap Verification

1. Verify the gap between tire and beadlock clamp ring, it should be practically equal all around the ring.

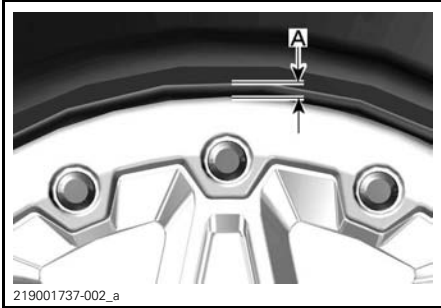

TYPICAL

A. Gap between tire and ring

If the gap is not acceptable, see **TIRE REPLACEMENT**.

Wheels and Tires

Tire Pressure

⚠ WARNING

Tire pressure greatly affects vehicle handling and stability. Insufficient pressure may cause tire to deflate and rotate on wheel. Overpressure may burst the tire. Always follow recommended pressure. NEVER set tire pressure below minimum. It could cause the tire to dislodge from the rim. Since tires are low-pressure types, a manual pump should be used.

Check pressure when tires are cold before using the vehicle. Tire pressure changes with temperature and altitude. Recheck pressure if one of these conditions has changed.

For your convenience, a pressure gauge is supplied in tool kit.

Refer to *SPECIFICATIONS* for values.

Although the tires are specifically designed for off-road use, a flat may still occur. Therefore, it is recommended to carry a tire pump and a repair kit.

Tire Inspection

Check tire for damage and wear. Replace if necessary.

Do not rotate tires. The front and rear tires have a different size. The tires are directional and their rotation must be kept in a specific direction for proper operation.

Tire Replacement

Tires replacement should be performed by an authorized Can-Am dealer.

⚠ WARNING

- Replace tires only with the same type and size as original tires.
- For unidirectional tread pattern, ensure that the tires are installed in the correct direction of rotation.
- Tires should be replaced, by an experienced person, in accordance with tire industry standards and tools.

While reading this Operator's Guide, remember that:

⚠ WARNING

Indicates a potential hazard that, if not avoided, could result in serious injury or death.

Tire Mounting on Beadlock Wheels (If equipped)

1. Mount the tire on wheel.
 - 1.1 On the opposite side of beadlock, apply tire mounting lube on inner bead of tire and wheel to ensure proper seat when inflating. Mount the inner bead over the wheel like normal.

NOTICE Mount tire from beadlock side only.
 - 1.2 Seat tire outer bead in the shoulder of the beadlock inner ring and center the tire.

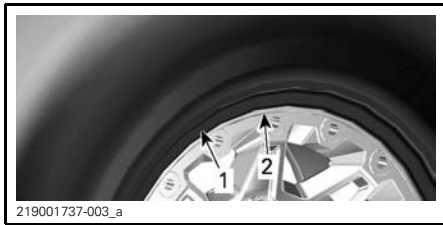

219001737-003_a

TYPICAL

1. Tire outer bead
2. Beadlock inner ring shoulder

2. Install all beadlock screws. To avoid cross threading, start all screws by hand.

NOTICE Do not use an impact wrench for installing beadlock screws. The risk of screw breaking or screw stripping is high when using an impact wrench.

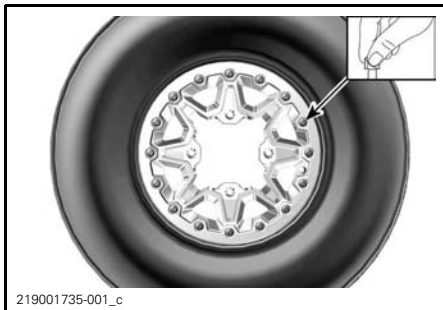

219001735-001_c

TYPICAL

3. Tighten beadlock screws as per following specification and sequence.

NOTE: To ensure even pressure on the beadlock clamp ring, tighten screws a few turns at a time.

TIGHTENING TORQUE	
Beadlock screws (FIRST SEQUENCE)	3 N•m ± 1 N•m (27 lbf•in ± 9 lbf•in)

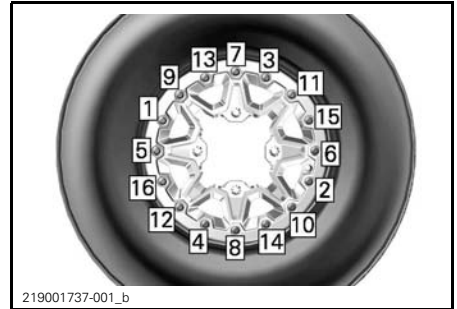

219001737-001_b

TYPICAL - TIGHTENING SEQUENCE

4. At this time check if the tire is still centered on wheel. Reposition it if necessary.
5. Tighten beadlock screws as per the **second** torque using the same sequence.

TIGHTENING TORQUE	
Beadlock screws (SECOND SEQUENCE)	8 N•m ± 1 N•m (71 lbf•in ± 9 lbf•in)

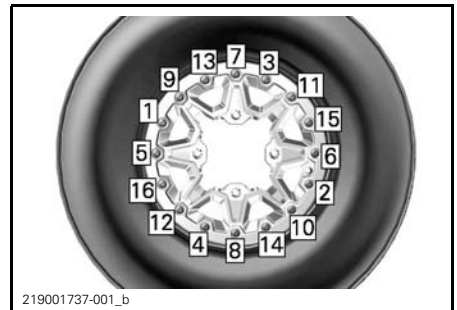

219001737-001_b

TYPICAL - TIGHTENING SEQUENCE

NOTE: The beadlock clamp ring can flex slightly to match the tire bead. IT IS NORMAL.

6. Verify the gap between tire and beadlock clamp ring, it should be practically equal all around the ring.

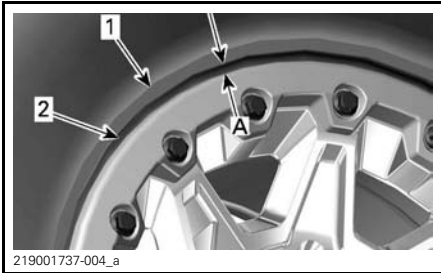

- 1. Tire
- 2. Beadlock clamp ring edge
- A. Gap equal all around beadlock clamp ring

If the gap is not acceptable,

- Loosen all screws.
- Check tire position on wheel and reposition it if necessary.
- Restart the torquing sequence as detailed.

7. Torque beadlock screws a **final** time following the indicated sequence.

TIGHTENING TORQUE	
Beadlock screws (FINAL SEQUENCE)	11 N•m ± 1 N•m (97 lbf•in ± 9 lbf•in)

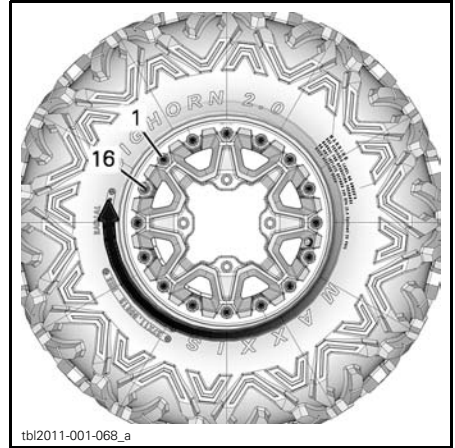

TYPICAL - FINAL TIGHTENING SEQUENCE

8. Inflate tire to seat the inner bead on wheel. Always use safe practices, such as a tire safety cage.

⚠ WARNING

Never exceed tire's recommended maximum pressure for seating beads.

Wheel Removal

- Place vehicle on a level surface.
- Engage 4WD mode.
- Apply the parking brake.
- Loosen lug nuts then lift vehicle.
- Secure vehicle on jack stands.
- Remove lug nuts then remove wheel.

Wheel Installation

- At installation, it is recommended to apply anti-seize lubricant on threads.
- If tires are unidirectional, make sure to install wheel according to tire rotation.
- Carefully tighten lug nuts in a criss-cross sequence then apply final torque.

TIGHTENING TORQUE	
Wheel lug nut	100 N•m ± 10 N•m (74 lbf•ft ± 7 lbf•ft)

NOTICE Always use the recommended wheel nuts according to the type of wheel. Using a different lug nut could cause damage to the rim or studs.

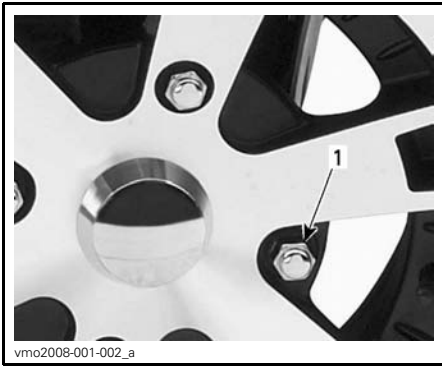

TYPICAL — ALUMINUM WHEEL
1. Wheel lug nut (closed end type)

Steering

Steering Inspection

Tie-rod Ends

Place vehicle on a level surface.

Apply parking brake.

Lift vehicle.

Secure vehicle on jack stands.

Inspect tie-rods boot for cracks.

Push and pull the wheels from the front or rear edge to feel the play.

See an authorized Can-Am dealer if there is an abnormal play or the boot is cracked.

⚠ WARNING

The tie-rod end must be replaced if the boot is cracked. The steering system must be inspected if abnormal play is detected. See an authorized Can-Am dealer.

Suspension

Front Suspension Lubrication

Lubricate front stabilizer bar bushings and suspension arms at grease fittings.

SUSPENSION GREASE	
Scandinavia	SYNTHETIC GREASE SUSPENSION (EUR) (P/N 779226)
All other countries	SYNTHETIC GREASE SUSPENSION (P/N 779163)

Rear Suspension Lubrication

Lubricate rear stabilizer bar links and pivot bushing at grease fittings.

SUSPENSION GREASE	
Scandinavia	SYNTHETIC GREASE SUSPENSION (EUR) (P/N 779226)
All other countries	SYNTHETIC GREASE SUSPENSION (P/N 779163)

Suspension Inspection

Shock Absorbers

Inspect shock absorber for oil leaks or other damage.

Check tightness of fasteners.

See an authorized Can-Am dealer as necessary.

Ball Joints

Place vehicle on a level surface.

Apply parking brake.

Lift vehicle.

Secure vehicle on jack stands.

Inspect ball joints boot for cracks.
 Push and pull the wheels from the upper and lower edge to feel the play.
 See an authorized Can-Am dealer if there is an abnormal play or the boot is cracked.



vmo2011-011-117_a

TYPICAL

⚠ WARNING

The ball joint must be replaced if the boot is cracked or it shows an abnormal play. See an authorized Can-Am dealer.

Front Suspension Arms

Check suspension arms for cracks, bending or other damage.
 See an authorized Can-Am dealer as necessary.

Rear Trailing Arms

Check trailing arms for distortion, cracks or bending.
 See an authorized Can-Am dealer if any problem is detected.

Brakes

Brake Fluid Reservoir Level Verification

With vehicle on a level surface, check brake fluid in reservoirs for proper level.

NOTE: A low level may indicate leaks or worn brake pads.

Front Brake Reservoir Level Verification

Turn steering in the straight-ahead position to ensure reservoir is level.

Check the brake fluid level, the reservoir is full when the fluid reaches of the top of window.

Visually inspect lever boot condition.

Check for cracks, tears, etc. Replace if damaged.



vmo2012-014-022_a

TYPICAL

Rear Brake Reservoir Level Verification

Remove the seat.

With vehicle on a level surface, liquid should be between MIN. and MAX. level marks of brake pedal fluid reservoir.



1. Rear brake fluid reservoir

Adding Brake FLuid

Clean filler cap.

⚠ WARNING

Clean filler cap before removing.

Remove screws retaining the reservoir cap.

Remove reservoir cap.

Add fluid as required using a clean funnel. Do not overfill.

NOTICE Brake fluid can damage plastic and painted surface. Wipe off and clean any spillage.

Reinstall reservoir cap and tighten screws.

NOTE: Ensure filler cap diaphragm is pushed inside the cap before closing the brake fluid reservoir.

Recommended Brake Fluid

Always use DOT 4 brake fluid from a sealed container.

⚠ WARNING

To avoid damage to the braking system, do not use other brake fluid types.

Brake Inspection

⚠ CAUTION The brakes can be very hot after prolonged use of the vehicle and can cause burns. Wait for the brakes to cool down.

The brake inspection, maintenance and repair should be performed by an authorized Can-Am dealer.

However, verify the following between visits to your dealer:

- Brake fluid level
- Brake system for fluid leaks
- Brake cleanliness.

⚠ WARNING

The brake fluid replacement or brake system maintenance and repairs should be performed by an authorized Can-Am dealer.

VEHICLE CARE

Post-Operation Care

When vehicle is used in salt-water environment (beach area, launching and loading boats etc.), rinsing the vehicle with fresh water is necessary to preserve vehicle and its components. Metallic parts lubrication is highly recommended. Use LUB. & ANTI-CORROSIVE (P/N 779168) or an equivalent. This must be performed at the end of each operating day.

When vehicle is operated in muddy conditions, rinsing the vehicle is recommended to preserve vehicle and its components and to keep lights clean.

Vehicle Cleaning

NOTICE Never use a high pressure washer to clean the vehicle. USE LOW PRESSURE ONLY (like a garden hose).

Pay attention to certain areas where mud or debris can accumulate and potentially cause wear, interferences or promote corrosion.

Wash the vehicle with a soapy water solution.

NOTICE Never clean polypropylene body parts with any petroleum base cleaning products, as it will alter the glossy finish.

Non Compatible Cleaning Products

MATERIAL TYPE	NON-COMPATIBLE CLEANING PRODUCTS
Polypropylene (body parts)	ANY PETROLEUM BASE CLEANING PRODUCTS
	XPS ATV FINISHING SPRAY (P/N 219 701 704)
	XPS ATV CLEANING KIT (P/N 219 701 713) (it contains the above XP-S ATV Finishing Spray)



DO NOT USE ON POLYPROPYLENE

Compatible Cleaning Products

MATERIAL TYPE	COMPATIBLE CLEANING PRODUCT
Polypropylene (body parts)	XPS ATV WASH (P/N 219 701 702)
	Soapy water



vbs2012-006-001

SAFE FOR POLYPROPYLENE

STORAGE AND PRESEASON PREPARATION

When a vehicle is not in use for more than four (4) months, proper storage is a necessity.

When using your vehicle after storage, a preparation is required.

See an authorized Can-Am dealer, repair shop or person of your own choosing to have your vehicle prepared for either storage or the preseason.

While reading this Operator's Guide, remember that:

WARNING

Indicates a potential hazard that, if not avoided, could result in serious injury or death.

***This page is
intentionally blank***

TECHNICAL INFORMATION

VEHICLE IDENTIFICATION

The main components of your vehicle (engine and frame) are identified using different serial numbers. It may sometimes become necessary to locate these numbers for warranty purposes or to trace your vehicle in the event of loss. These numbers are also required by the authorized Can-Am dealer to complete warranty claims properly. We strongly recommend that you take note of all the serial numbers on your vehicle and supply them to your insurance company.

Vehicle Identification Number

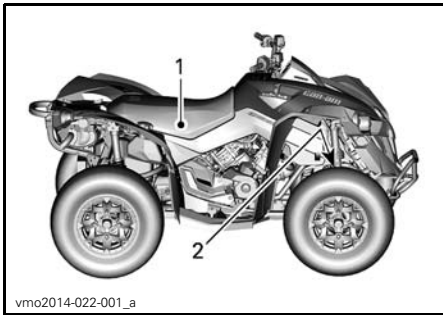

TYPICAL

1. Label 1 (on the frame under the seat in the middle)
2. Label 2 (stamped onto frame behind RH front wheel)



LABEL 1

1. VIN (Vehicle Identification Number)
2. Model



LABEL 2

1. VIN (Vehicle Identification Number)
2. Model number

Engine Identification Number (EIN)

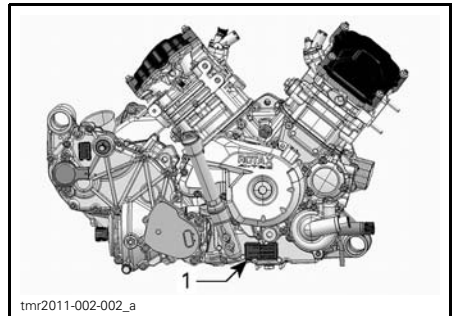

TYPICAL - RH SIDE OF ENGINE

1. Engine Identification Number (EIN)



Compliance Label

Regulation (EU) 2016/1628 applicable for Non-Road Mobile Machineries

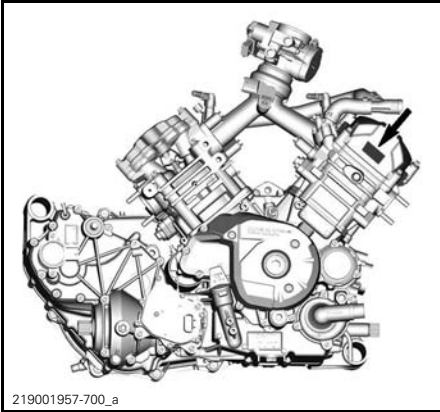
Vehicles who comply to Regulation (EU) 2016/1628 (NRMM) are identified on the engine valve cover.



TYPICAL

Rotax		#	M#####
	Production date:		MM-YYYY
	Family type:		#####
7469			AT1/P V-####
EN-704907469-DEC			

TYPICAL NRMM IDENTIFICATION

Radio Frequency Digitally Encoded Security System (RF D.E.S.S. key)

This device complies with FCC Part 15 and Industry Canada license exempt RSS standard(s). Operation is subject to the following two conditions: (1) this device may not cause interference, and (2) this device must accept any interference, including interference that may cause undesired operation of the device.

Changes or modifications not expressly approved by the party responsible for compliance could void the user's authority to operate the equipment.

IC Registration Number: 12006A-M01456

FCC ID: 2ACERM01456

We, the party responsible for compliance, declare under our sole responsibility that the device is in conformity with the provisions of the following Council Directive: 2014/53/EU. To which this declaration relates is in conformity with the essential requirements and other relevant requirements. The product is in conformity with the following directives, harmonized standards and regulations: Radio Equipment Directive (RED) 2014/53/EU and Harmonized Standards: EN 300 330-2, EN 60950-1.

NOISE EMISSION CONTROL SYSTEM REGULATION (CANADA/UNITED STATES)

Tampering with Noise Control System Is Prohibited!

U.S. Federal law and Canadian provincial laws may prohibit the following acts or the causing there of:

1. The removal or rendering inoperative by any person other than for purposes of maintenance, repair or replacement of any device or element of design incorporated into any new vehicle for the purpose of noise control prior to its sale or delivery to the ultimate purchaser or while it is in use or
2. The use of the vehicle after such device or element of design has been removed or rendered inoperative by any person.

Among those Acts Presumed to Constitute Tampering Are the Acts Listed Below:

1. Removal or alteration or the puncturing of the muffler or any engine component which conducts removal of engine exhaust gases.
2. Removal or alteration or the puncturing of any part of the intake system.
3. Replacing any moving parts of the vehicle or parts of the exhaust or intake system, with parts other than those specified by the manufacturer.
4. Lack of proper maintenance.

NOISE EMISSION AND VIBRATION VALUES (ALL COUNTRIES EXCEPT CANADA/UNITED STATES)

NOISE EMISSION AND VIBRATION VALUES ¹			
Noise	Sound pressure (L _{pA})	570	82 dB @ 4000 RPM (Uncertainty (K _{pA}) 3dB)
		650	78 dB @ 3600 RPM (Uncertainty (K _{pA}) 3 dB)
		850 1000R	84 dB @ 3500 RPM (Uncertainty (K _{pA}) 3dB)
	Sound power level (L _{WA})	570	93 dB @ 4000 RPM (Uncertainty (K _{WA}) 3dB)
		850 1000R	94 dB @ 3500 RPM (Uncertainty (K _{WA}) 3dB)
		Vibration	Hand-arm system
650	3.5 m/s ² @ 3600 RPM (Uncertainty 1.715 m/s ²)		
850 1000R	3.5 m/s ² @ 3500 RPM		
Whole body at seat	570		<0.5 m/s ² @ 4000 RPM
	650		<0.5 m/s ² @ 3600 RPM
	850 1000R		<0.5 m/s ² @ 3500 RPM
¹ : Noise emission and Vibration values are measured in accordance with Standard EN 15997:2011 on a paved surface, at Neutral.			

The EC-Declaration of Conformity does not appear in this version of the Operator's Guide.

Please refer to the printed version that was delivered with your vehicle.

The EC-Declaration of Conformity does not appear in this version of the Operator's Guide.

Please refer to the printed version that was delivered with your vehicle.

SPECIFICATIONS

ENGINE		
Engine type	570	ROTAX® 570, 4-stroke, 2 cylinders (V-twin), liquid cooled
	650	ROTAX® 650, 4-stroke, 2 cylinders (V-twin), liquid cooled
	850	ROTAX® 850, 4-stroke, 2 cylinders (V-twin), liquid cooled
	1000R	ROTAX®, 1000R, 4-stroke, 2 cylinders (V-twin), liquid cooled
Valve train		4 valves/cylinder (mechanical adjustment), single over head camshaft (SOHC) with timing chain
Valve clearance	Intake	0.06 mm to 0.14 mm (.0024 in to .0055 in)
	Exhaust	0.11 mm to 0.19 mm (.0043 in to .0075 in)
Bore	570	84 mm (3.31 in)
	650	82 mm (3.23 in)
	850	94 mm (3.7 in)
	1000R	91 mm (3.58 in)
Stroke	570	51.4 mm (2.02 in)
	650	61.5 mm (2.42 in)
	850	61.5 mm (2.42 in)
	1000R	75 mm (2.95 in)
Displacement	570	570 cm ³ (34.8 in ³)
	650	650 cm ³ (39.7 in ³)
	850	854 cm ³ (52.1 in ³)
	1000R	976 cm ³ (59.6 in ³)
Exhaust system		Spark arrestor approved by USDA Forest Service Catalyst on NRMM models
Air filter		Synthetic paper filter with foam
LUBRICATION SYSTEM		
Type		Wet sump. Replaceable cartridge oil filter
Oil filter		BRP Rotax paper type, replaceable

LUBRICATION SYSTEM		
Engine oil	Capacity (oil change with filter)	2.0 L (2.1 qt (U.S. liq.))
	Recommended oil Scandinavia	4T 10W50 SYNTHETIC OIL (EUR) (P/N 779240). or 4T 5W40 SYNTHETIC BLEND OIL (EUR) (P/N 779290) or 4T 0W40 SYNTHETIC OIL (EUR) (P/N 779286)
	Recommended oil All other countries	4T 10W50 SYNTHETIC OIL (P/N 779234) or 4T 5W40 SYNTHETIC BLEND OIL (P/N 779133) or 4T 0W40 SYNTHETIC OIL (P/N 779139)
	Alternate oil if XPS products are not available	10W50 motor oil that meets the requirements for API service classification SJ, SL, SM or SN

COOLING SYSTEM			
Coolant	Type	Scandinavia: EXTENDED LIFE PRE-MIXED COOLANT (EUR) (P/N 779223) All other countries: EXTENDED LIFE PRE-MIXED COOLANT (P/N 779150) or coolant specifically designed for aluminum engines	
	Capacity	570	3.4 L (.9 U.S. gal.)
		850 1000R	3.5 L (.92 U.S. gal.)

TRANSMISSION		
Type	CVT (Continuously Variable Transmission), sub-transmission with L/H/N/R/P, standard engine braking	
Engagement RPM	570	1800 RPM
	850/1000R	1800 RPM

SPECIFICATIONS

GEARBOX		
Type		Dual range (HI-LO) with park, neutral and reverse
Gearbox oil	Capacity	450 ml (15.22 U.S. oz)
	Recommended	Scandinavia: 75W140 SYNTHETIC GEAR OIL (EUR) (P/N 779215) All other countries: 75W140 SYNTHETIC GEAR OIL (P/N 779160) or a 75W140 API GL-5 synthetic gear oil

ELECTRICAL SYSTEM			
Magneto generator output		Without DPS	400 W @ 6000 RPM
		With DPS	625 W @ 6000 RPM
Ignition system type		IDI (Inductive Discharge Ignition)	
Ignition timing		Not adjustable	
Spark plug	570	Quantity	2
		Make and type	NGK DCPR8E or equivalent
		Gap	0.7 mm to 0.8 mm (.028 in to .031 in)
	650	Quantity	2
		Make and type	NGK DCPR8E or equivalent
		Gap	0.7 mm to 0.8 mm (.028 in to .031 in)
	850 1000R	Quantity	2
		Make and type	NGK LMAR8D-J or equivalent
		Gap	0.7 mm to 0.9 mm (.028 in to .035 in)
Engine RPM limiter setting	All models	Forward	8000 rpm
Battery		Type	Maintenance free
		Voltage	12 volts
		Nominal rating	18 A•h
		Power starter output	0.7 KW

ELECTRICAL SYSTEM		
Headlights	High	2 x 60 W (HB3)
	Low	2 x 60 W (HB3)
Taillights		2 x 5/21 W
Fuses		Refer to <i>FUSES</i> in <i>MAINTENANCE PROCEDURES</i>

FUEL SYSTEM			
Fuel delivery	Type	570/650	Electronic Fuel Injection (EFI), 46 mm throttle body, 1 injector per cylinder
		850/1000R	Electronic Fuel Injection (EFI), 54 mm throttle body, 1 injector per cylinder
Fuel pump	Type		Electrical (in fuel tank)
Idle speed			1400 rpm (not adjustable)
Fuel	Type	570/650/850	Regular unleaded gasoline Refer to <i>FUEL REQUIREMENTS</i>
	Minimum octane rating		87 Pump Posted AKI (92 RON or 95 E10 RON)
	Type	1000R	Premium unleaded gasoline Refer to <i>FUEL REQUIREMENTS</i>
	Recommended octane rating		91 Pump Posted AKI (95 E10 RON)
	Minimum octane rating		87 Pump Posted AKI (92 RON or 95 E10 RON)
Fuel tank capacity			20.5 L (5.4 U.S. gal.)
Fuel remaining when low fuel light turns ON			± 5 L (1.3 U.S. gal.)

DRIVE SYSTEM		
Drive system type		Selectable 2WD/4WD
Front drive	Renegade STD	Visco-lok [†] auto-locking front differential
	All other models	Visco-lok [†] OE auto-locking front differential
Front drive ratio		3.6:1
Rear drive		Straight bevel gear / Shaft driven final drive
Rear drive ratio		3.6:1

SPECIFICATIONS

DRIVE SYSTEM		
Front differential oil	Capacity	500 ml (17 U.S. oz)
	Type	Scandinavia: 75W90 SYNTHETIC GEAR OIL (EUR) (P/N 779212) All other countries: 75W90 SYNTHETIC GEAR OIL (P/N 779158) or synthetic gear oil 75W90 API GL-5
Rear final drive oil	Capacity	250 ml (8.45 U.S. oz)
	Type	Scandinavia: 75W140 SYNTHETIC GEAR OIL (EUR) (P/N 779215) All other countries: 75W140 SYNTHETIC GEAR OIL (P/N 779160) or synthetic gear oil 75W140 API GL-5
CV joint grease		CV JOINT GREASE (P/N 293 550 062) or an equivalent
Propeller shaft grease		PROPELLER SHAFT GREASE (P/N 293 550 063) or an equivalent

STEERING	
Turning radius	212.9 cm (83.8 in)

FRONT SUSPENSION			
Suspension type		Double suspension-arm with dive-control geometry and external stabilizer bar	
Suspension travel		23.3 cm (9.2 in)	
Shock absorber	Renegade X xc 650/850/ 1000R	Qty	2
		Type	Fox RC2 shock with piggyback reservoir, dual speed compression damping adjustment and rebound adjustment.
	Renegade STD 850/1000R	Qty	2
		Type	FOX IFP
	Renegade STD 570	Qty	2
		Type	Oil
Preload adjustment type	570	5 positions cam	
	All other models	Threaded	

REAR SUSPENSION			
Suspension type		Torsional Trailing arm Independent (TTI) with external stabilizer bar	
Suspension travel		25.1 cm (9.9 in)	
Shock absorber	Renegade X xc 650/850/1000R	Qty	2
		Type	Fox RC2 shock with piggyback reservoir, dual speed compression damping adjustment and rebound adjustment.
	Renegade STD 850/1000R	Qty	2
		Type	FOX IFP
	Renegade STD 570	Qty	2
		Type	Oil
Preload adjustment type	570		5 position cam
	All other models		Threaded

BRAKES		
Front brake	Qty	2
	Type	214 mm cross drilled disc brakes with hydraulic twin-piston calipers
Rear brake	Qty	2
	Type	214 mm cross drilled disc brake with hydraulic twin-piston caliper
Brake fluid	Capacity	340 ml (11.5 U.S. oz)
	Type	DOT 4
Caliper		Floating twin pistons (2 x 26 mm)
Brake pad material		Organic
Minimum brake pad thickness		1 mm (.04 in)
Minimum brake disc thickness		4.0 mm (.157 in)
Maximum brake disc warpage		0.2 mm (.01 in)

TIRES		
Front Tire Pressure		48.3 kPa (7 PSI)
Rear Tire Pressure		48.3 kPa (7 PSI)
Minimum tire thread depth		3 mm (.118 in)
Size	Front	635 x 203 x 305 mm (25 x 8 x 12 in)
	Rear	635 x 254 x 305 mm (25 x 10 x 12 in)

SPECIFICATIONS

WHEELS		
Type	Renegade STD	Cast aluminum
	Renegade X xc	Aluminum with beadlocks
Rim size	Front	305 x 152 mm (12 x 6 in)
	Rear	305 x 191 mm (12 x 7.5 in)
Wheel nut torque		100 N•m ± 10 N•m (74 lbf•ft ± 7 lbf•ft)

DIMENSIONS		
Overall length		218.4 cm (86 in)
Overall width		121.9 cm (48 in)
Overall height		124 cm (49 in)
Wheelbase		129.5 cm (51 in)
Wheel track	Front	102 cm (40.2 in)
	Rear	97.5 cm (38.4 in)
Ground clearance		26.7 cm (10.5 in)

WEIGHT AND LOADING CAPACITY		
Dry weight	570	286 kg (631 lb)
	650	312 kg (688 lb)
	850	310 kg (683 lb)
	1000R	323 kg (712 lb)
Rear cargo area capacity		16 kg (35 lb)
Rear storage compartment loading capacity		No rear storage compartment available
Total vehicle load allowed (including driver, all other loads and added accessories)		141 kg (310 lb)
Towing capacity		590 kg (1,300 lb)
Tongue capacity		13 kg (30 lb)

TROUBLESHOOTING

TROUBLESHOOTING GUIDELINES

ENGINE DOES NOT TURN

1. **Engine stop switch.**
 - *Make sure that engine stop switch is in ON position.*
2. **D.E.S.S. key is not installed on D.E.S.S. post.**
 - *Securely install key on D.E.S.S. post.*
3. **Transmission is not set on PARK or NEUTRAL.**
 - *Set transmission either in PARK or in NEUTRAL or press the brake lever.*
4. **Burnt fuse.**
 - *Check main fuse condition.*
5. **Weak battery or loose connections.**
 - *Check charging system.*
 - *Check connections and terminals condition.*
 - *Have the battery checked.*
 - *Contact an authorized Can-Am dealer.*
6. **Wrong D.E.S.S. key, multifunction gauge display shows BAD KEY.**
 - *Use the proper key for this vehicle.*
7. **Weak starter or loose connections.**
 - *Check starter connections.*
 - *Check starter relay.*
8. **Vehicle wakes up when START button is pressed.**
 - *Seek service from an authorized Can-Am dealer, repair shop, or person of your own choosing for maintenance, repair, or replacement. Please refer to the US EPA Emissions-related warranty contained herein for information about warranty claims.*

ENGINE TURNS OVER BUT FAILS TO START

1. **No fuel to the engine (spark plug dry when removed).**
 - *Check fuel tank level.*
 - *A failure of the fuel pump may have occurred.*
 - *Check fuel pump fuse and relay.*
 - *If engine does not start, seek service from an authorized Can-Am dealer, repair shop, or person of your own choosing for maintenance, repair, or replacement. Please refer to the US EPA Emissions-related warranty contained herein for information about warranty claims.*

ENGINE TURNS OVER BUT FAILS TO START (cont'd)**2. Flooded engine (spark plug wet when removed).**

- *(Drowned mode) If the engine does not start and it is fuel-flooded, this special mode can be activated to prevent fuel injection and to cut ignition while cranking. Proceed as follows:*

- *Install key on D.E.S.S. post.*
- *Press completely and HOLD throttle lever.*
- *Press the engine START button.*

The engine should be cranked for 20 seconds. Release engine START button.

Release throttle lever and start/crank engine again to allow starting.

If it does not work:

- *Clean the spark plug caps area then remove them.*
- *Remove the spark plugs.*
- *Unplug injector electrical connector.*
- *Crank engine several times.*
- *Install new spark plugs if possible or clean and dry spark plugs.*
- *Start engine as explained above.*

If engine continues to flood, see an authorized Can-Am dealer.

NOTE: *Make sure to verify that there is no fuel in engine oil, if so, replace engine oil.*

3. Spark plug/ignition (no spark).

- *Check injectors/ignition fuse condition.*
- *Remove spark plug then reconnect to ignition coil.*
- *Unplug injector electrical connector and start engine with spark plug grounded to the engine away from spark plug hole. If no spark appears, replace spark plug.*
- *If trouble persists, seek service from an authorized Can-Am dealer, repair shop or person of your own choosing for maintenance, repair or replacement. Please refer to the US EPA Emissions-related warranty contained herein for information about warranty claims.*

4. Multifunction gauge CHECK ENGINE indicator lamp is on and display shows CHECK ENGINE.

- *Seek service from an authorized Can-Am dealer, repair shop or person of your own choosing for maintenance, repair or replacement. Please refer to the US EPA Emissions-related warranty contained herein for information about warranty claims.*

5. Engine is under a protection (limp home) mode.

- *Multifunction gauge CHECK ENGINE indicator lamp is on and display shows CHECK ENGINE, seek service from an authorized Can-Am dealer, repair shop or person of your own choosing for maintenance, repair or replacement. Please refer to the US EPA Emissions-related warranty contained herein for information about warranty claims.*

ENGINE LACKS ACCELERATION OR POWER**1. Fouled or defective spark plug.**

- *Refer to ENGINE TURNS OVER BUT FAILS TO START.*

ENGINE LACKS ACCELERATION OR POWER (cont'd)

2. **Lack of fuel to engine.**
 - Refer to *ENGINE TURNS OVER BUT FAILS TO START*.
3. **Engine is overheating. (CHECK ENGINE indicator light will turn on and HI TEMP will appear in the multifunction display.)**
 - Refer to *ENGINE OVERHEATS*.
4. **Air filter/housing clogged or dirty.**
 - Check air filter and clean if necessary.
 - Check deposits in air filter housing drain.
 - Check the position of the air intake tube.
5. **CVT dirty or worn-out.**
 - Contact an authorized Can-Am dealer.
6. **Engine is under a protection (limp home) mode.**
 - Check multifunction gauge display for messages.
 - Multifunction gauge CHECK ENGINE indicator lamp is on and display shows CHECK ENGINE or LIMP HOME, seek service from an authorized Can-Am dealer, repair shop or person of your own choosing for maintenance, repair or replacement. Please refer to the US EPA Emissions-related warranty contained herein for information about warranty claims.

ENGINE OVERHEATS

1. **Low coolant in cooling system.**
 - Check engine coolant, refer to *ENGINE COOLANT* in *MAINTENANCE PROCEDURES*.
2. **Dirty radiator fins.**
 - Clean radiator fins, refer to *RADIATOR* in *MAINTENANCE PROCEDURES*.
3. **Cooling fan inoperative.**
 - Check cooling fan fuse or relay, refer to *FUSES* in *MAINTENANCE PROCEDURES*. If the fuse is good, seek service from an authorized Can-Am dealer, repair shop or person of your own choosing for maintenance, repair or replacement. Please refer to the US EPA Emissions-related warranty contained herein for information about warranty claims.

ENGINE BACKFIRE

1. **Exhaust system leakage.**
 - Seek service from an authorized Can-Am dealer, repair shop or person of your own choosing for maintenance, repair or replacement. Please refer to the US EPA Emissions-related warranty contained herein for information about warranty claims.
2. **Engine is running too hot.**
 - Refer to *ENGINE LACKS ACCELERATION OR POWER*.

ENGINE BACKFIRE (cont'd)

3. Ignition timing is incorrect or there is an ignition system failure.

- *Seek service from an authorized Can-Am dealer, repair shop or person of your own choosing for maintenance, repair or replacement. Please refer to the US EPA Emissions-related warranty contained herein for information about warranty claims.*

ENGINE MISFIRE

1. Fouled/defective/worn spark plug.

- *Clean/verify spark plug and heat range. Replace as required.*

2. Water in fuel.

- *Drain fuel system and refill with fresh fuel.*

VEHICLE CANNOT REACH FULL SPEED

1. Engine.

- *Refer to ENGINE LACKS ACCELERATION OR POWER.*

2. Parking brake.

- *Ensure parking brake is completely removed.*

3. Air filter/housing plugged or dirty.

- *Check air filter and clean if necessary.*
- *Check deposits in air filter housing drain.*
- *Check the position of the air intake tube.*

4. CVT dirty or worn-out.

- *Contact an authorized Can-Am dealer.*

5. Engine is under a protection (limp home) mode.

- *Check multifunction gauge display for messages.*
- *Multifunction gauge CHECK ENGINE indicator lamp is on and display shows CHECK ENGINE or LIMP HOME, seek service from an authorized Can-Am dealer, repair shop or person of your own choosing for maintenance, repair or replacement. Please refer to the US EPA Emissions-related warranty contained herein for information about warranty claims.*

SHIFT LEVER IS HARD TO MOVE

1. Transmission gears are in a position that prevents the shift lever to work.

- *Rock the vehicle back and forth to move the gears in the transmission and allow the shift lever to be set.*

2. CVT dirty or worn-out.

- *Contact an authorized Can-Am dealer.*

THE RPM INCREASES BUT THE VEHICLE DOES NOT MOVE

1. The transmission is on PARK or NEUTRAL position.

- *Select the R, HI or LO position.*

2. CVT dirty or worn-out.

- *Contact an authorized Can-Am dealer.*

THE RPM INCREASES BUT THE VEHICLE DOES NOT MOVE (cont'd)

3. Water in the CVT housing.

- *Contact an authorized Can-Am dealer.*

REDUCED POWER STEERING ASSIST

- 1. When DPS is subjected to sustained severe steering conditions, the assistance provided by the DPS motor may be reduced to protect the system.**
 - *Once the load is reduced, the normal steering assistance will return.*
- 2. CHECK ENGINE INDICATOR LAMP is ON and display shows CHECK DPS**
 - *Seek service from an authorized Can-Am dealer, repair shop or person of your own choosing for maintenance, repair or replacement.*

MULTIFUNCTION GAUGE MESSAGES

MESSAGE	PILOT LAMP(S) ON	DESCRIPTION
BAD KEY	Check engine	Indicates that you have used the wrong key, use the proper key for this vehicle. It is also possible that the key has a bad contact, remove and clean key.
DESS KEY NOT RECOGNIZED	Check engine	Indicates that there possibly is a bad contact, remove and clean key.
PARK BRAKE	None	Message displayed when brake is applied for more than 15 seconds (while riding).
LO BATT VOLT	Check engine	Low battery voltage, check battery voltage and charging system.
HIGH BATT VOLT	Check engine	High battery voltage, check battery voltage and charging system.
LOW OIL ⁽¹⁾	Check engine	Engine low oil pressure, stop engine immediately.
HI TEMP	Check engine	Engine is overheating, refer to <i>ENGINE OVERHEATS</i> in <i>TROUBLESHOOTING</i> .
LIMP HOME	Check engine	Serious fault on the engine that can change the normal operation of the engine, CHECK ENGINE indicator lamp will also blink, refer to <i>TROUBLESHOOTING</i> .
CHECK ENGINE	Check engine	Engine fault, CHECK ENGINE indicator lamp will also be ON, refer to <i>TROUBLESHOOTING</i> .
ECM NOT RECOGNIZED	Check engine	Communication error between speedometer and engine control module (ECM).
CHECK DPS	Check engine	Indicates that the DPS (Dynamic Power Steering) does not work properly. See an authorized Can-Am dealer.
MAINTENANCE REQUIRED ⁽²⁾	None	Displayed in gauge when vehicle is due for a maintenance
TPS FAULT PRESS OVERRIDE BUTTON TO LIMP HOME	Check engine	Throttle position sensor does not work properly. Seek service from an authorized Can-Am dealer, repair shop or person of your own choosing for maintenance, repair or replacement. Please refer to the US EPA Emissions-related warranty contained herein for information about warranty claims.

NOTICE ⁽¹⁾ If the message and the check engine light stay on after engine starting, stop engine. Check engine oil level. Refill if necessary. If the oil level is good, seek service from an authorized Can-Am dealer, repair shop or person of your own choosing for maintenance, repair or replacement. Please refer to the US EPA Emissions-related warranty contained herein for information about warranty claims. Do not use the vehicle until repaired.

⁽²⁾ To erase the MAINTENANCE REQUIRED message, proceed as follows:

1. From main display (vehicle speed), press SET and HOLD.
2. Alternate between LOW beam and HIGH beam 3 times.

NOTE: Step 2 must be completed within **2 seconds**.

3. Release SET button.

***This page is
intentionally blank***

WARRANTY

BRP LIMITED WARRANTY USA AND CANADA: 2019 CAN-AM® ATV

SCOPE OF THE LIMITED WARRANTY

Bombardier Recreational Products Inc. ("BRP")* warrants its 2019 Can-Am ATV sold by authorized Can-Am ATV dealers (as hereinafter defined) in the United States of America ("USA") and in Canada from defects in material or workmanship for the period and under the conditions described below. This limited warranty will become null and void if: (1) the ATV was used for racing or any other competitive activity, at any point, even by a previous owner; or (2) the ATV has been altered or modified in such a way so as to adversely affect its operation, performance or durability, or has been altered or modified to change its intended use.

Non-factory installed parts and accessories are not covered under this limited warranty. Please refer to the applicable parts and accessories limited warranty text.

LIMITATIONS OF LIABILITY

THIS WARRANTY IS EXPRESSLY GIVEN AND ACCEPTED IN LIEU OF ANY AND ALL OTHER WARRANTIES, EXPRESSED OR IMPLIED, INCLUDING WITHOUT LIMITATION ANY WARRANTY OF MERCHANTABILITY OR FITNESS FOR A PARTICULAR PURPOSE TO THE EXTENT THAT THEY CANNOT BE DISCLAIMED, THE IMPLIED WARRANTIES ARE LIMITED IN DURATION TO THE LIFE OF THE EXPRESS WARRANTY. INCIDENTAL AND CONSEQUENTIAL DAMAGES ARE EXCLUDED FROM COVERAGE UNDER THIS WARRANTY SOME STATES/PROVINCES DO NOT ALLOW FOR THE DISCLAIMERS, LIMITATIONS AND EXCLUSIONS IDENTIFIED ABOVE, AS A RESULT, THEY MAY NOT APPLY TO YOU. THIS WARRANTY GIVES YOU SPECIFIC RIGHTS, AND YOU MAY ALSO HAVE OTHER LEGAL RIGHTS WHICH MAY VARY FROM STATE TO STATE, OR PROVINCE TO PROVINCE.

Neither the distributor, any BRP dealer nor any other person has been authorized to make any affirmation, representation or warranty regarding the product, other than those contained in this limited warranty, and if made, shall not be enforceable against BRP. BRP reserves the right to modify this limited warranty at any time, being understood that such modification will not alter the warranty conditions applicable to the products sold while this warranty is in effect.

EXCLUSIONS – ARE NOT WARRANTED

The following are not warranted under any circumstances:

- Normal wear and tear;
- Routine maintenance items, tune ups, adjustments;
- Damage caused by failure to provide proper maintenance and/or storage, as described in the Operator's Guide;
- Damage resulting from removal of parts, improper repairs, service, maintenance, modifications or use of parts not manufactured or approved by BRP or resulting from repairs done by a person that is not an authorized servicing Can-Am ATV dealer;
- Damage caused by abuse, abnormal use, neglect or operation of the product in a manner inconsistent with the recommended operation described in the Can-Am ATV Operator's Guide;
- Damage resulting from accident, submersion, fire, theft, vandalism or any act of God;

- Operation with fuels, oils or lubricants which are not suitable for use with the product (see the Operator’s Guide);
- Damages from rust, corrosion or exposure to the elements;
- Damage resulting from water or snow ingestion;
- Incidental or consequential damages, or damages of any kind including without limitation towing, storage, telephone, rental, taxi, inconvenience, insurance coverage, loan payments, loss of time, loss of income.

WARRANTY COVERAGE PERIOD

This limited warranty will be in effect from (1) the date of delivery to the first retail consumer or (2) the date the product is first put into use, whichever occurs first and for the applicable period below:

SIX (6) CONSECUTIVE MONTHS, for private use or commercial use owners. For emission-related components; please also refer to the *US EPA EMISSION-RELATED WARRANTY* contained herein.

The repair or replacement of parts or the performance of service under this warranty does not extend the life of this warranty beyond its original expiration date.

CONDITIONS TO HAVE WARRANTY COVERAGE

This warranty coverage is available **only** if **each** of the following conditions has been fulfilled:

- The 2019 Can-Am ATV must be purchased as new and unused by its first owner from a Can-Am ATV dealer authorized to distribute Can-Am ATVs in the country in which the sale occurred (“Can-Am ATV dealer”);
- The BRP specified pre-delivery inspection process must be completed and documented and signed by the purchaser;
- The 2019 Can-Am ATV must have undergone proper registration by an authorized Can-Am ATV dealer;
- The 2019 Can-Am ATV must be purchased in the country in which the purchaser resides;
- Routine maintenance outlined in the Operator’s Guide must be timely performed in order to maintain warranty coverage. BRP reserves the right to make warranty coverage contingent upon proof of proper maintenance.

BRP will not honor this limited warranty to any private use owner or commercial use owner if one of the preceding conditions has not been met. Such limitations are necessary in order to allow BRP to preserve both the safety of its products, and also that of its consumers and the general public.

WHAT TO DO TO OBTAIN WARRANTY COVERAGE

The customer must cease using the Can-Am ATV upon the appearance of an anomaly. The customer must notify a servicing BRP dealer within three (3) days of the appearance of a defect, and provide it with reasonable access to the product and reasonable opportunity to repair it. The customer must also present to the authorized BRP dealer, proof of purchase of the product and must sign the repair/work order prior to starting the repair in order to validate the warranty repair. All parts replaced under this limited warranty become the property of BRP.

WHAT BRP WILL DO

BRP's obligations under this warranty are limited to, at its sole discretion, repairing parts found defective under normal use, maintenance and service, or replacing such parts with new genuine Can-Am ATV parts without charge for parts and labor, at any authorized BRP dealer during the warranty coverage period under the conditions described herein. No claim of breach of warranty shall be cause for cancellation or rescission of the sale of the Can-Am ATV to the owner.

In the event that service is required outside of the country of original sale, the owner will bear responsibility for any additional charges due to local practices and conditions, such as, but not limited to, freight, insurance, taxes, license fees, import duties, and any and all other financial charges, including those levied by governments, states, territories and their respective agencies.

BRP reserves the right to improve or modify products from time to time without assuming any obligation to modify products previously manufactured.

ADDITIONAL SUPPLIER WARRANTIES

A GPS receiver may be supplied by BRP as standard equipment on certain 2019 Can-Am ATV's. The GPS receiver is covered under BRP's limited warranty policy. Additional warranty coverage if offered by the GPS receiver "supplier" that is longer than BRP's limited warranty is to be dealt by the dealer or consumer directly with the GPS receiver "supplier".

TRANSFER

If the ownership of a product is transferred during the warranty coverage period, this limited warranty, subject to its terms and conditions, shall also be transferred and be valid for the remaining coverage period provided BRP or an authorized Can-Am ATV Distributor/Dealer receives a proof that the former owner agreed to the transfer of ownership, in addition to the co-ordinates of the new owner.

CONSUMER ASSISTANCE

In the event of a controversy or a dispute in connection with this limited warranty, BRP suggests that you try to resolve the issue at the dealership level. We recommend discussing the issue with the authorized dealer's service manager or owner.

If the matter still remains unresolved, contact BRP by filling out the customer contact form at www.brp.com or contact BRP by mail at one of the addresses listed under the *CONTACT US* section of this guide.

* In the USA, products are distributed and serviced by BRP US Inc.
© 2018 Bombardier Recreational Products Inc. All rights reserved.
® Registered trademark of Bombardier Recreational Products Inc.

US EPA EMISSION-RELATED WARRANTY

Bombardier Recreational Products Inc. (“BRP”)* warrants to the ultimate purchaser and each subsequent purchaser that this new vehicle, including all parts of its exhaust emission control system and its evaporative emission control system, meets two conditions:

1. It is designed, built, and equipped so it conforms at the time of sale to the ultimate purchaser with the requirements of 40 CFR 1051 and 40 CFR 1060.
2. It is free from defects in materials and workmanship that may keep it from meeting the requirements of 40 CFR 1051 and 40 CFR 1060.

Where a warrantable condition exists, BRP will repair or replace, as it elects, any part or component with a defect in materials or workmanship that would increase the engine’s emissions of any regulated pollutant within the stated warranty period at no cost to the owner, including expenses related to diagnosing and repairing or replacing emission-related parts. All defective parts replaced under this warranty become the property of BRP.

For all emission-related warranty claims, BRP is limiting the diagnosis and repair of emission-related parts to the authorized Can-Am dealers, unless for emergency repairs as required by item 2 of the following list.

As a certifying manufacturer, BRP will not deny emission-related warranty claims based on any of the following:

1. Maintenance or other service BRP or BRP’s authorized facilities performed.
2. Engine/equipment repair work that an operator performed to correct an unsafe, emergency condition attributable to BRP as long as the operator tries to restore the engine/equipment to its proper configuration as soon as possible.
3. Any action or inaction by the operator unrelated to the warranty claim.
4. Maintenance that was performed more frequently than BRP specify.
5. Anything that is BRP fault or responsibility.
6. The use of any fuel that is commonly available where the equipment operates unless BRP written maintenance instructions state that this fuel would harm the equipment’s emission control system and operators can readily find the proper fuel. See maintenance information section and fuel requirements of fueling section.

Emission-Related Warranty Period

The emission-related warranty is valid for the following period whichever comes first:

	HOURS	MONTHS	KILOMETERS
Exhaust emission-related components	500	30	5000
Evaporative emission-related components	N/A	24	N/A

Components Covered

The emission-related warranty covers all components whose failure would increase an engine's emissions of any regulated pollutant, including the following listed components:

1. For exhaust emissions, emission-related components include any engine parts related to the following systems:
 - Air-induction system
 - Fuel system
 - Ignition system
 - Exhaust gas recirculation systems
2. The following parts are also considered emission-related components for exhaust emissions:
 - Aftertreatment devices
 - Crankcase ventilation valves
 - Sensors
 - Electronic control units
3. The following parts are considered emission-related components for evaporative emissions:
 - Fuel tank
 - Fuel cap
 - Fuel line
 - Fuel line fittings
 - Clamps*
 - Pressure relief valves*
 - Control valves*
 - Control solenoids*
 - Electronic controls*
 - Vacuum control diaphragms*
 - Control cables*
 - Control linkages*
 - Purge valves
 - Vapor hoses
 - Liquid/vapor separator
 - Carbon canister
 - Canister mounting brackets
 - Carburetor purge port connector
4. Emission-related components also include any other part whose only purpose is to reduce emissions or whose failure will increase emissions without significantly degrading engine/equipment performance.

*As related to the evaporative emission control system

Limited Applicability

As a certifying manufacturer, BRP may deny emission-related warranty claims for failures that have been caused by the owner's or operator's improper maintenance or use, by accidents for which the manufacturer has no responsibility, or by acts of God. For example, an emission-related warranty claim need not be honored for failures that have been directly caused by the operator's abuse of the engine/equipment or the operator's use of the engine/equipment in a manner for which it was not designed and are not attributable to the manufacturer in any way.

If you have any question regarding your warranty rights and responsibility, you should contact Bombardier Recreational Products at 1-888-272-9222.

* In the USA, products are distributed and serviced by BRP US Inc.

BRP INTERNATIONAL LIMITED WARRANTY: 2019 CAN-AM® ATV

1) SCOPE OF THE LIMITED WARRANTY

Bombardier Recreational Products Inc. ("BRP")* warrants its 2019 Can-Am ATV sold by Can-Am ATV distributors or dealers authorized by BRP to distribute Can-Am ATVs ("Can-Am ATV Distributor/Dealer") outside of the United States of America ("USA"), Canada, member states of the European Economic Area (which is comprised of the states of the European Union plus Norway, Iceland and Liechtenstein) ("EEA"), Turkey, member states of the Commonwealth of the Independent States (including Ukraine and Turkmenistan) ("CIS") and Turkey, from defects in material or workmanship for the period and under the conditions described below.

Non-factory installed parts and accessories are not covered under this limited warranty. Please refer to the applicable parts and accessories limited warranty text.

This limited warranty will become null and void if: (1) The ATV was used for racing or any other competitive activity, at any point, even by a previous owner; or (2) the ATV has been altered or modified in such a way so as to adversely affect its operation, performance or durability, or has been altered or modified to change its intended use.

2) LIMITATIONS OF LIABILITY

TO THE EXTENT PERMITTED BY LAW, THIS WARRANTY IS EXPRESSLY GIVEN AND ACCEPTED IN LIEU OF ANY AND ALL OTHER WARRANTIES, EXPRESSED OR IMPLIED, INCLUDING WITHOUT LIMITATION ANY WARRANTY OF MERCHANTABILITY OR FITNESS FOR A PARTICULAR PURPOSE. TO THE EXTENT THAT THEY CANNOT BE DISCLAIMED, THE IMPLIED WARRANTIES ARE LIMITED IN DURATION TO THE LIFE OF THE EXPRESS WARRANTY. INCIDENTAL AND CONSEQUENTIAL DAMAGES ARE EXCLUDED FROM COVERAGE UNDER THIS WARRANTY. SOME JURISDICTIONS DO NOT ALLOW FOR THE DISCLAIMERS, LIMITATIONS AND EXCLUSIONS IDENTIFIED ABOVE, AS A RESULT, THEY MAY NOT APPLY TO YOU. THIS WARRANTY GIVES YOU SPECIFIC RIGHTS AND YOU MAY ALSO HAVE OTHER LEGAL RIGHTS WHICH MAY VARY FROM COUNTRY TO COUNTRY. (FOR PRODUCTS PURCHASED IN AUSTRALIA SEE CLAUSE 4 BELOW).

Neither the Can-Am ATV Distributor/Dealer nor any other person has been authorized to make any affirmation, representation or warranty regarding the product, other than those contained in this limited warranty, and if made, shall not be enforceable against BRP.

BRP reserves the right to modify this warranty at any time, being understood that such modification will not alter the warranty conditions applicable to the products sold while this warranty is in effect.

3) EXCLUSIONS – ARE NOT WARRANTED

The following are not warranted under this limited warranty under any circumstances:

- Normal wear and tear;
- Routine maintenance items, tune ups, adjustments;
- Damage caused by negligence or failure to provide proper maintenance and/or storage, as described in the Operator's Guide;

- Damage resulting from removal of parts, improper repairs, service, maintenance, modifications or use of parts or accessories not manufactured or approved by BRP which in its reasonable judgement are either incompatible with the product or adversely affect its operation, performance and durability, or resulting from repairs done by a person that is not an authorized servicing Can-Am ATV Distributor/Dealer;
- Damage caused by abuse, abnormal use, neglect, racing or operation of the product in a manner inconsistent with the recommended operation described in the Operator's Guide;
- Damage resulting from accident, submersion, fire, snow or water ingestion, theft, vandalism or any act of God;
- Operation with fuels, oils or lubricants which are not suitable for use with the product (see the Operator's Guide);
- Damage resulting from rust, corrosion or exposure to the elements;
- Incidental or consequential damages, or damages of any kind including without limitation towing, storage, transportation expenses, telephone, rental, taxi, inconvenience, insurance coverage, loan payments, loss of time, loss of income; or time missed for downtime experience due to service work.

4) WARRANTY COVERAGE PERIOD

This warranty will be in effect from (1) the date of delivery to the first retail consumer or (2) the date the product is first put into use, whichever occurs first and for a period of:

SIX (6) CONSECUTIVE MONTHS for private use or commercial use.

The repair or replacement of parts or the performance of service under this warranty does not extend the life of this warranty beyond its original expiration date.

Note that the duration and any other modalities of the warranty coverage are subject to the applicable national or local legislation in the customer's country.

FOR PRODUCTS SOLD IN AUSTRALIA ONLY

Nothing in these Warranty terms and conditions should be taken to exclude, restrict or modify the application of any condition, warranty, guarantee, right or remedy conferred or implied under the Competition and Consumer Act 2010 (Cth), including the Australian Consumer Law or any other law, where to do so would contravene that law, or cause any part of these terms and conditions to be void. The benefits given to you under this limited warranty are in addition to other rights and remedies that you have under Australian law.

Our goods come with guarantees that cannot be excluded under the Australian Consumer Law. You are entitled to a replacement or refund for a major failure and for compensation for any other reasonably foreseeable loss or damage. You are also entitled to have the goods repaired or replaced if the goods fail to be of acceptable quality and the failure does not amount to a major failure.

5) CONDITIONS TO HAVE WARRANTY COVERAGE

This warranty coverage is available **only** if each of the following conditions has been fulfilled:

- The 2019 Can-Am ATV must be purchased as new and unused by its first owner from a Can-Am ATV Distributor/Dealer authorized to distribute Can-Am ATVs in the country in which the sale occurred;
- The BRP specified pre-delivery inspection process must be completed and documented;
- The product must have undergone proper registration by an authorized Can-Am ATV Distributor/Dealer;
- The 2019 Can-Am ATV must be purchased in the country or union of countries in which the purchaser resides; and
- Routine maintenance outlined in the Operator's Guide must be timely performed in order to maintain warranty coverage. BRP reserves the right to make warranty coverage contingent upon proof of proper maintenance.

BRP will not honour this limited warranty to any private use owner or commercial use owner if one of the preceding conditions has not been met. Such limitations are necessary in order to allow BRP to preserve both the safety of its products, and also that of its consumers and the general public.

6) WHAT TO DO TO OBTAIN WARRANTY COVERAGE

The customer must cease using the ATV upon the appearance of an anomaly. The customer must notify a servicing Can-Am ATV Distributor/Dealer within two (2) days of the appearance of a defect, and provide it with reasonable access to the product and reasonable opportunity to repair it. The customer must also present to the authorized Can-Am ATV Distributor/Dealer proof of purchase of the product and must sign the repair/work order prior to starting the repair in order to validate the warranty repair. All parts replaced under this limited warranty become the property of BRP.

Note that the notification period is subject to the applicable national or local legislation in customer's country.

7) WHAT BRP WILL DO

To the extent permitted by law, BRP's obligations under this warranty are limited to, at its sole discretion, repairing parts found defective under normal use, maintenance and service, or replacing such parts with new genuine Can-Am ATV parts without charge for parts and labour, at any authorized Can-Am ATV Distributor/Dealer during the warranty coverage period under the conditions described herein. BRP's responsibility is limited to making the required repairs or replacements of parts. No claim of breach of warranty shall be cause for cancellation or rescission of the sale of the Can-Am ATV to the owner. You may have other legal rights which may vary from country to country.

In the event that service is required outside of the country of original sale, the owner will bear responsibility for any additional charges due to local practices and conditions, such as, but not limited to, freight, insurance, taxes, license fees, import duties, and any and all other financial charges, including those levied by governments, states, territories and their respective agencies.

BRP reserves the right to improve or modify products from time to time without assuming any obligation to modify products previously manufactured.

8) TRANSFER

If the ownership of a product is transferred during the warranty coverage period, this warranty shall also be transferred and be valid for the remaining coverage period provided BRP or an authorized Can-Am ATV Distributor/Dealer receives a proof that the former owner agreed to the transfer of ownership, in addition to the co-ordinates of the new owner.

9) CONSUMER ASSISTANCE

In the event of a controversy or a dispute in connection with this limited warranty, BRP suggests that you try to resolve the issue at the Can-Am ATV Distributor/Dealer level. We recommend discussing the issue with the authorized Can-Am ATV Distributor/Dealer's service manager or owner.

If the matter still remains unresolved, contact BRP by filling out the customer contact form at www.brp.com or contact BRP by mail at one of the addresses listed under the *CONTACT US* section of this guide.

* For the territory covered by this limited warranty, products are distributed and serviced by Bombardier Recreational Products Inc. or its affiliates.

© 2018 Bombardier Recreational Products Inc. All rights reserved.

™ Trademark of Bombardier Recreational Products Inc. or its affiliates.

® Registered trademark of Bombardier Recreational Products Inc.

BRP LIMITED WARRANTY FOR THE EUROPEAN ECONOMIC AREA, THE COMMONWEALTH OF THE INDEPENDENT STATES AND TURKEY ECONOMIC AREA: 2019 CAN-AM® ATV

1) SCOPE OF THE LIMITED WARRANTY

Bombardier Recreational Products Inc. ("BRP")* warrants its 2019 Can-Am ATVs sold by distributors or dealers authorized by BRP to distribute Can-Am ATVs ("Can-Am ATV Distributor/Dealer") in member states of the European Economic Area (which is comprised of the member states of the European Union plus Norway, Iceland and Liechtenstein) ("EEA"), in member states of the Commonwealth of the Independent States (including Ukraine and Turkmenistan) ("CIS") and Turkey from defects in material or workmanship for the period and under the conditions described below.

Non-factory installed parts and accessories are not covered under this limited warranty. Please refer to the applicable parts and accessories limited warranty text.

This limited warranty will become null and void if: (1) The ATV was used for racing or any other competitive activity, at any point, even by a previous owner; or (2) the ATV has been altered or modified in such a way so as to adversely affect its operation, performance or durability, or has been altered or modified to change its intended use.

2) LIMITATIONS OF LIABILITY

TO THE EXTENT PERMITTED BY LAW, THIS WARRANTY IS EXPRESSLY GIVEN AND ACCEPTED IN LIEU OF ANY AND ALL OTHER WARRANTIES, EXPRESSED OR IMPLIED, INCLUDING WITHOUT LIMITATION ANY WARRANTY OF MERCHANTABILITY OR FITNESS FOR A PARTICULAR PURPOSE. TO THE EXTENT THAT THEY CANNOT BE DISCLAIMED, THE IMPLIED WARRANTIES ARE LIMITED IN DURATION TO THE LIFE OF THE EXPRESS WARRANTY. INCIDENTAL AND CONSEQUENTIAL DAMAGES ARE EXCLUDED FROM COVERAGE UNDER THIS WARRANTY. SOME JURISDICTIONS DO NOT ALLOW FOR THE DISCLAIMERS, LIMITATIONS AND EXCLUSIONS IDENTIFIED ABOVE, AS A RESULT, THEY MAY NOT APPLY TO YOU. THIS WARRANTY GIVES YOU SPECIFIC RIGHTS AND YOU MAY ALSO HAVE OTHER LEGAL RIGHTS WHICH MAY VARY FROM COUNTRY TO COUNTRY.

Neither the Can-Am ATV Distributor/Dealer nor any other person has been authorized to make any affirmation, representation or warranty regarding the product, other than those contained in this limited warranty, and if made, shall not be enforceable against BRP.

BRP reserves the right to modify this warranty at any time, being understood that such modification will not alter the warranty conditions applicable to the products sold while this warranty is in effect.

3) EXCLUSIONS – ARE NOT WARRANTED

The following are not warranted under this limited warranty under any circumstances:

- Normal wear and tear;
- Routine maintenance items, tune ups, adjustments;

- Damage caused by negligence or failure to provide proper maintenance and/or storage, as described in the Operator's Guide;
- Damage resulting from removal of parts, improper repairs, service, maintenance, modifications or use of parts or accessories not manufactured or approved by BRP which in its reasonable judgement are either incompatible with the product or adversely affect its operation, performance and durability, or resulting from repairs done by a person that is not an authorized servicing Can-Am ATV Distributor/Dealer;
- Damage caused by abuse, abnormal use, neglect, racing or operation of the product in a manner inconsistent with the recommended operation described in the Operator's Guide;
- Damage resulting from accident, submersion, fire, snow or water ingestion, theft, vandalism or any act of God;
- Operation with fuels, oils or lubricants which are not suitable for use with the product (see the Operator's Guide);
- Damage resulting from rust, corrosion or exposure to the elements;
- Incidental or consequential damages, or damages of any kind including without limitation towing, transportation expenses, storage, telephone, rental, taxi, inconvenience, insurance coverage, loan payments, loss of time, loss of income or time missed for downtime experience due to service work.

4) WARRANTY COVERAGE PERIOD

This warranty will be in effect from (1) the date of delivery to the first retail consumer or (2) the date the product is first put into use, whichever occurs first and for a period of:

TWENTY-FOUR (24) CONSECUTIVE MONTHS for private use.

SIX (6) CONSECUTIVE MONTHS for commercial use or rental use.

The product is used commercially when it is used in connection with any work or employment that generates income during any part of the warranty period. The product is also used commercially when, at any point during the warranty period, it is licensed for commercial use.

The repair or replacement of parts or the performance of service under this warranty does not extend the life of this warranty beyond its original expiration date.

Note that the duration and any other modalities of the warranty coverage are subject to the applicable national or local legislation in the customer's country.

5) CONDITIONS TO HAVE WARRANTY COVERAGE

This warranty coverage is available **only** if **each** of the following conditions has been fulfilled:

- The 2019 Can-Am ATV must be purchased as new and unused by its first owner from a Can-Am ATV Distributor/Dealer authorized to distribute Can-Am ATVs in the country in which the sale occurred;
- The BRP specified pre-delivery inspection process must be completed and documented;
- The product must have undergone proper registration by an authorized Can-Am ATV Distributor/Dealer;

- The 2019 Can-Am ATV must be purchased within the EEA by an EEA resident, in the CIS for residents of the countries comprised in such area and in Turkey for residents of Turkey; and
- Routine maintenance outlined in the Operator's Guide must be timely performed in order to maintain warranty coverage. BRP reserves the right to make warranty coverage contingent upon proof of proper maintenance.

BRP will not honour this limited warranty to any private use owner or commercial use owner if one of the preceding conditions has not been met. Such limitations are necessary in order to allow BRP to preserve both the safety of its products, and also that of its consumers and the general public.

6) WHAT TO DO TO OBTAIN WARRANTY COVERAGE

The customer must cease using the ATV upon the appearance of an anomaly. The customer must notify a servicing Can-Am ATV Distributor/Dealer within two (2) months of the appearance of a defect and provide it with reasonable access to the product and reasonable opportunity to repair it. The customer must also present to the authorized Can-Am ATV Distributor/Dealer, proof of purchase of the product and must sign the repair/work order prior to starting the repair in order to validate the warranty repair. All parts replaced under this limited warranty become the property of BRP.

Note that the notification period is subject to the applicable national or local legislation in customer's country.

7) WHAT BRP WILL DO

To the extent permitted by law, BRP's obligations under this warranty are limited to, at its sole discretion, repairing parts found defective under normal use, maintenance and service, or replacing such parts with new genuine Can-Am ATV parts without charge for parts and labour, at any authorized Can-Am ATV Distributor/Dealer during the warranty coverage period under the conditions described herein. BRP's responsibility is limited to making the required repairs or replacements of parts. No claim of breach of warranty shall be cause for cancellation or rescission of the sale of the Can-Am ATV to the owner. You may have other legal rights which may vary from country to country.

In the event that service is required outside of the EEA, CIS or Turkey, the owner will bear responsibility for any additional charges due to local practices and conditions, such as, but not limited to, freight, insurance, taxes, license fees, import duties, and any and all other financial charges, including those levied by governments, states, territories and their respective agencies.

BRP reserves the right to improve or modify products from time to time without assuming any obligation to modify products previously manufactured.

8) TRANSFER

If the ownership of a product is transferred during the warranty coverage period, this warranty shall also be transferred and be valid for the remaining coverage period provided BRP or an authorized Can-Am ATV Distributor/Dealer receives a proof that the former owner agreed to the transfer of ownership, in addition to the co-ordinates of the new owner.

9) CONSUMER ASSISTANCE

In the event of a controversy or a dispute in connection with this limited warranty, BRP suggests that you try to resolve the issue at the Can-Am ATV Distributor/Dealer level. We recommend discussing the issue with the authorized Can-Am ATV Distributor/Dealer's service manager or owner.

If the matter still remains unresolved, contact BRP by filling out the customer contact form at www.brp.com or contact BRP by mail at one of the addresses listed under the *CONTACT US* section of this guide.

* In the EEA, products are distributed and serviced by BRP European Distribution S.A. and other affiliates or subsidiaries of BRP.

© 2018 Bombardier Recreational Products Inc. All rights reserved.

™ Trademark of Bombardier Recreational Products Inc. or its affiliates.

® Registered trademark of Bombardier Recreational Products Inc.

ADDITIONAL TERMS AND CONDITIONS FOR FRANCE ONLY

The following terms and conditions are applicable to products sold in France only:

The seller shall deliver goods that are complying with the contract and shall be responsible for defects existing upon delivery. The seller shall also be responsible for defects resulting from packaging, assembling instructions or the installation when it is its responsibility per the contract or if accomplished under its responsibility. To be compliant with the contract, the good shall:

1. Be fit for normal use for goods similar thereto and, if applicable:
 - Correspond to the description provided by the seller and have the qualities presented to the buyer through sample or model;
 - Have the qualities that a buyer may legitimately expect considering the public declarations of the seller, the manufacturer of its representative, including in advertising or labeling; or
2. Have the characteristics mutually agreed upon as between the parties or be fit for the specific use intended by the buyer and brought to the attention of the seller and which accepted by the seller.

The action for failure to comply is prescribed after two years after delivery of the goods. The seller is responsible for the warranty for hidden defects of the good sold if such hidden defects are rendering the good unfit for the intended use, or if they diminish its use in such a way that the buyer would not have acquired the good or would have given a lesser price, had he known. The action for such hidden defects shall be taken by the buyer within 2 years of the discovery of the defect.

CUSTOMER INFORMATION

PRIVACY INFORMATION

BRP wishes to inform you that your coordinates will be used for safety and warranty related purposes. Furthermore, BRP and its affiliates may use its customer list to distribute marketing and promotional information about BRP and related products.

To exercise your right to consult or correct your data, or to be removed from the addressee-list for direct marketing, please contact BRP.

By E-mail: privacyofficer@brp.com

By mail: BRP
 Senior Legal Counsel-Privacy Officer
 726 St-Joseph
 Valcourt QC
 Canada
 J0E 2L0

CONTACT US

www.brp.com

North America

565 de la Montagne Street
Valcourt (Québec) J0E 2L0
Canada

Sturtevant, Wisconsin, U.S.A.
10101 Science Drive
Sturtevant, Wisconsin
53177
U.S.A.

Sa De Cv, Av. Ferrocarril 202
Parque Ind. Querétaro, Lote2-B
76220
Santa Rosa Jáuregui, Qro., Mexico

Europe

Skaldenstraat 125
B-9042 Gent
Belgium

Itterpark 11
D-40724 Hilden
Germany

ARTEPARC Bâtiment B
Route de la côte d'Azur, Le Canet
13590 Meyreuil
France

Ingvald Ystgaardsvei 15
N-7484 Trondeim
Norway

Isoaavantie 7
PL 8040
96101 Rovaniemi

Formvägen 16
S-906 21 Umeå
Sweden

Avenue d'Ouchy 4-6
1006 Lausanne
Switzerland

Oceania

6 Lord Street
Lakes Business Park
Botany, NSW 2019
Australia

South America

Rua James Clerck Maxwell, 230
TechnoPark Campinas SP 13069-380
Brazil

Asia

15/F Parale Mitsui Building,8
Higashida-Cho, Kawasaki-ku
Kawasaki 210-0005
Japan

Room Dubai, level 12, Platinum Tower
233 Tai Cang Road
Xintiandi, Lu Wan District
Shanghai 200020
PR China

CHANGE OF ADDRESS/OWNERSHIP

If your address has changed or if you are the new owner of the ATV, be sure to notify BRP by either:

- Notifying an authorized Can-Am dealer.
- **North America Only:** calling at 1 888 272-9222.
- Mailing one of the change of address cards on the following pages at one of the BRP addresses indicated in the *CONTACT US* section of this guide.

In case of change of ownership, please join a proof that the former owner agreed to the transfer.

Notifying BRP, even after the expiration of the limited warranty, is very important as it enables BRP to reach the ATV owner if necessary, like when safety recalls are initiated. It is the owner's responsibility to notify BRP.

STOLEN UNITS: If your personal ATV is stolen, you should notify BRP or an authorized Can-Am dealer. We will ask you to provide your name, address, phone number, the vehicle identification number and the date it was stolen.

CHANGE OF ADDRESS

CHANGE OF OWNERSHIP



VEHICLE IDENTIFICATION NUMBER

Model Number

Vehicle Identification Number (V.I.N.)

Model Number

Vehicle Identification Number (V.I.N.)

OLD ADDRESS
OR PREVIOUS OWNER:

NAME

NO.

STREET

APT

CITY

STATE/PROVINCE

ZIP/POSTAL CODE

COUNTRY

TELEPHONE

NEW ADDRESS
OR NEW OWNER:

NAME

NO.

STREET

APT

CITY

STATE/PROVINCE

ZIP/POSTAL CODE

COUNTRY

TELEPHONE

E-MAIL ADDRESS

V00A2F

CHANGE OF ADDRESS

CHANGE OF OWNERSHIP



VEHICLE IDENTIFICATION NUMBER

Model Number

Vehicle Identification Number (V.I.N.)

Model Number

Vehicle Identification Number (V.I.N.)

OLD ADDRESS
OR PREVIOUS OWNER:

NAME

NO.

STREET

APT

CITY

STATE/PROVINCE

ZIP/POSTAL CODE

COUNTRY

TELEPHONE

NEW ADDRESS
OR NEW OWNER:

NAME

NO.

STREET

APT

CITY

STATE/PROVINCE

ZIP/POSTAL CODE

COUNTRY

TELEPHONE

E-MAIL ADDRESS

V00A2F

***This page is
intentionally blank***

CHANGE OF ADDRESS CHANGE OF OWNERSHIP 

VEHICLE IDENTIFICATION NUMBER

Model Number

Vehicle Identification Number (V.I.N.)

OLD ADDRESS
OR PREVIOUS OWNER:

NAME

NO.

STREET

APT

CITY

STATE/PROVINCE

ZIP/POSTAL CODE

COUNTRY

TELEPHONE

NEW ADDRESS
OR NEW OWNER:

NAME

NO.

STREET

APT

CITY

STATE/PROVINCE

ZIP/POSTAL CODE

COUNTRY

TELEPHONE

E-MAIL ADDRESS

V00A2F

CHANGE OF ADDRESS CHANGE OF OWNERSHIP 

VEHICLE IDENTIFICATION NUMBER

Model Number

Vehicle Identification Number (V.I.N.)

OLD ADDRESS
OR PREVIOUS OWNER:

NAME

NO.

STREET

APT

CITY

STATE/PROVINCE

ZIP/POSTAL CODE

COUNTRY

TELEPHONE

NEW ADDRESS
OR NEW OWNER:

NAME

NO.

STREET

APT

CITY

STATE/PROVINCE

ZIP/POSTAL CODE

COUNTRY

TELEPHONE

E-MAIL ADDRESS

V00A2F

***This page is
intentionally blank***

NOTES

NOTES

ATV MODEL No. _____

VEHICLE
IDENTIFICATION NUMBER (V.I.N.) _____

ENGINE
IDENTIFICATION NUMBER (E.I.N.) _____

Owner: _____
NAME

No. STREET APT

CITY STATE/PROVINCE ZIP/POSTAL CODE

Purchase Date _____
YEAR MONTH DAY

Warranty Expiry Date _____
YEAR MONTH DAY

To be completed by the dealer at the time of the sale.

DEALER IMPRINT AREA

V00A2IL

Please verify with your dealer to ensure your vehicle has been registered with BRP.

While reading this Operator's Guide, remember that:

 **WARNING**

Indicates a potential hazard that, if not avoided, could result in serious injury or death.

can-am®



2019 Operator's Guide

Includes
Safety, Vehicle
and Maintenance Information

RENEGADE SERIES



RENEGADE® Series

⚠ WARNING

THIS VEHICLE CAN BE HAZARDOUS TO OPERATE.

A collision or rollover can occur quickly, even during routine maneuvers such as turning and driving on hills or over obstacles, if you fail to take proper precautions.

SEVERE INJURY OR DEATH can result if you do not follow these instructions:

- **BEFORE YOU OPERATE THIS VEHICLE, READ THIS OPERATOR'S GUIDE, ALL ON PRODUCT SAFETY LABELS AND WATCH THE SAFETY VIDEO.**



- **NEVER OPERATE THIS VEHICLE WITHOUT PROPER INSTRUCTIONS.** Complete a certified training course.
- **DO NOT EXCEED VEHICLE SEATING CAPACITY**
- **FOR 1UP MODELS, NEVER CARRY A PASSENGER.** You increase your risk of losing control if you carry a passenger.
- **NEVER OPERATE THIS VEHICLE ON A PAVED SURFACE.** You increase your risk of losing control if you operate this vehicle on pavement.
- **NEVER OPERATE THIS VEHICLE ON PUBLIC ROADS.** You can collide with another vehicle if you operate this vehicle on a public road.
- **OPERATOR SHOULD ALWAYS WEAR AN APPROVED HELMET,** eye protection, and protective clothing.
- **NEVER USE WITH DRUGS OR ALCOHOL.** They slow reaction time and impair judgment.
- **NEVER OPERATE THIS VEHICLE AT EXCESSIVE SPEEDS.** You increase your risk of losing control if you operate this vehicle at speeds too fast for the terrain, visibility conditions, or your experience.
- **NEVER ATTEMPT WHEELIES, JUMPS, OR OTHER STUNTS.**

219 001 957
OPERATOR'S GUIDE RENEGADE Series / ENGLISH
GUIDE DU CONDUCTEUR Série RENEGADE / ANGLAIS

FAIT AU / MADE IN CANADA U/M:P.C.

©™ AND THE BRP LOGO ARE TRADEMARKS OF BOMBARDIER RECREATIONAL PRODUCTS INC. OR ITS AFFILIATES.
©2018 BOMBARDIER RECREATIONAL PRODUCTS INC. ALL RIGHTS RESERVED. PRINTED IN CANADA.

2019

⚠ WARNING

Read this guide thoroughly. It contains important safety information.
Minimum recommended age: Operator: 16 years old. Keep this Operator's Guide in the vehicle.

2 1 9 0 0 1 9 5 7

Original Instructions