

*can-am*®



**2017**

**Operator's  
Guide**

**Includes  
Safety, Vehicle  
and Maintenance Information**



**DS 70™**

**DS 90™**

**DS 90™ X™**

**⚠ WARNING**

Read this guide thoroughly. It contains important safety information.  
Category Y ATV, always follow this age recommendation under adult supervision:  
Age 6 or older for DS 70. Age 10 or older for DS 90 and DS 90 X.  
Keep this Operator's Guide in the vehicle.

**2 1 9 0 0 1 7 5 5**

**Original Instructions**

**! WARNING**

**YOUR VEHICLE CAN BE HAZARDOUS TO OPERATE.** A collision or rollover can occur quickly if you fail to take proper precautions, even during routine maneuvers such as turning and driving on hills or over obstacles. For your safety, understand and follow all the warnings contained in this Operator's Guide and on the labels on your vehicle. **Failure to follow these warnings can result in SEVERE INJURY OR DEATH!** Keep this Operator's Guide with the vehicle at all times.

**! WARNING**

Disregarding any of the safety precautions and instructions contained in this Operator's Guide, *SAFETY DVD* and on-product labels can result in severe injury including the possibility of death!

**CALIFORNIA PROPOSITION 65 WARNING**

**! WARNING**

This vehicle contains or emits chemicals known to the state of California to cause cancer and birth defects or other reproductive harm.

In Canada, products are distributed by Bombardier Recreational Products Inc. (BRP).

In USA, products are distributed by BRP US Inc.

The following trademarks are the property of Bombardier Recreational Products Inc.:

Can-Am®

X™

XPS™

DS 70™

DS 90™

# FOREWORD

Deutsch	Dieses Handbuch ist möglicherweise in Ihrer Landessprache verfügbar. Bitte wenden Sie sich an Ihren Händler oder besuchen Sie: <a href="http://www.operatorsguide.brp.com">www.operatorsguide.brp.com</a>
English	This guide may be available in your language. Check with your dealer or go to: <a href="http://www.operatorsguide.brp.com">www.operatorsguide.brp.com</a>
Español	Es posible que este manual esté disponible en su idioma. Consulte a su distribuidor o visite: <a href="http://www.operatorsguide.brp.com">www.operatorsguide.brp.com</a>
Français	Ce guide peut être disponible dans votre langue. Vérifier avec votre concessionnaire ou aller à: <a href="http://www.operatorsguide.brp.com">www.operatorsguide.brp.com</a>
日本語	このガイドは、言語によって翻訳版が用意されています。ディーラーに問い合わせるか、次のアドレスでご確認ください： <a href="http://www.operatorsguide.brp.com">www.operatorsguide.brp.com</a>
Nederlands	Deze handleiding kan beschikbaar zijn in uw taal. Vraag het aan uw dealer of ga naar: <a href="http://www.operatorsguide.brp.com">www.operatorsguide.brp.com</a>
Norsk	Denne boken kan finnes tilgjengelig på ditt eget språk. Kontakt din forhandler eller gå til: <a href="http://www.operatorsguide.brp.com">www.operatorsguide.brp.com</a>
Português	Este manual pode estar disponível em seu idioma. Fale com sua concessionária ou visite o site: <a href="http://www.operatorsguide.brp.com">www.operatorsguide.brp.com</a>
Suomi	Käyttöohjekirja voi olla saatavissa omalla kielelläsi. Tarkista jälleenmyyjältä tai käy osoitteessa: <a href="http://www.operatorsguide.brp.com">www.operatorsguide.brp.com</a>
Svenska	Denna bok kan finnas tillgänglig på ditt språk. Kontakta din återförsäljare eller gå till: <a href="http://www.operatorsguide.brp.com">www.operatorsguide.brp.com</a>

Multilan\_2016

Congratulations on your purchase of a new Can-Am® ATV. It is backed by the BRP warranty and a network of authorized Can-Am dealers ready to provide the parts, service or accessories you may require.

Your dealer is committed to your satisfaction. He has taken training to perform the initial setup and inspection of your vehicle, as well as completed the final adjustments before you took possession. If you need more complete servicing information, please ask your dealer.

At delivery, you were also informed of the warranty coverage and signed the *PREDELIVERY CHECK LIST* to ensure your new vehicle was prepared to your entire satisfaction.

## Know Before you Go

To learn how to reduce the risk for you or bystanders being injured or killed, read this Operator's Guide before you operate the vehicle:

Also, read all safety labels on your ATV and watch your *SAFETY DVD* video.

Failure to follow the warnings contained in this Operator's Guide can result in **SERIOUS INJURY** or **DEATH**.

## Age Recommendation

These vehicles are a category "Y" (Youth Model), always follow this age recommendation:

- DS 70 vehicle is a category **Y-6+** and should be used by children age 6 or older under adult supervision, or by an operator age 16 or older.
- DS 90 and DS 90 X vehicles are a category **Y-10+** and should be used by children age 10 or older under adult supervision, or by an operator age 16 or older.
- Also, never allow continued use of an ATV by a child if the child does not have the abilities to operate it safely, regardless of age.

## Training Course

Never operate this vehicle without proper instruction. **Take a training course.** All operators should receive training from a certified instructor.

**FOR MORE INFORMATION ABOUT ATV SAFETY**, contact an authorized Can-Am dealer to find out about available training courses nearest you.

In the United States, call the Specialty Vehicle Institute of America (SVIA) at 1 800 887-2887 or in Canada, the Canada Safety Council (CSC) at 1 613 739-1535.

## Safety Messages

The types of safety messages, what they look like, and how they are used in this guide are explained as follows:

The safety alert symbol  indicates a potential injury hazard.

### **WARNING**

Indicates a potential hazard that, if not avoided, could result in serious injury or death.

 **CAUTION** Indicates a hazardous situation which, if not avoided, could result in minor or moderate injury.

**NOTICE** Indicates an instruction which, if not followed, could result in severely damaged vehicle components or other property.

## About this Operator's Guide

This Operator's Guide has been prepared to acquaint the owner/operator of a new vehicle with the various vehicle controls, maintenance and safe operating instructions. It is indispensable for the proper use of the product.

Keep this Operator's Guide in the vehicle so that you can refer to it for things such as maintenance, troubleshooting and for instructing others.

Note that this guide is available in several languages. In the event of any discrepancy, the English version shall prevail.

If you want to view and/or print an extra copy of your Operator's Guide, simply visit the following website [www.operatorsguide.brp.com](http://www.operatorsguide.brp.com).

The information contained in this document are correct at the time of publication. However, BRP maintains a policy of continuous improvement of its products without imposing upon itself any obligation to install them on products previously manufactured. Due to late changes, some differences between the manufactured product and

the descriptions and/or specifications in this guide may occur. BRP reserves the right at any time to discontinue or change specifications, designs, features, models or equipment without incurring any obligation upon itself.

This Operator's Guide and the *SAFETY DVD* should remain with the vehicle when it's sold.

## Notice to Parents

Review this Operator's Guide with any user of the vehicle.

Please take time with the children to review the instructions on its safe and proper use, and pay particular attention to the on-product safety labels, before allowing them to ride the vehicle.

Understand the controls and operation of the vehicle and carefully read the Operator's Guide.

Always remember that your approach to safety influences the child.

## WARNING

### **This ATV is not a toy.**

- Children differ in skills, physical abilities, and judgement. Some children may not be able to operate an ATV safely.
- No one under age 16 should operate an ATV without adult supervision at all times.
- Never allow continued use of the vehicle by a child if he does not have the abilities, the strength or the judgement to operate it safely.

While reading this Operator's Guide, remember that:

## WARNING

Indicates a potential hazard that, if not avoided, could result in serious injury or death.

---

# TABLE OF CONTENTS

<b>FOREWORD</b> .....	<b>1</b>
Know Before you Go .....	1
Age Recommendation .....	2
Safety Messages .....	2
About this Operator's Guide .....	2
Notice to Parents .....	3

## ***SAFETY INFORMATION***

<b>GENERAL PRECAUTIONS</b> .....	<b>10</b>
Avoid Carbon Monoxide Poisoning .....	10
Avoid Gasoline Fires and Other Hazards .....	10
Avoid Burns from Hot Parts .....	10
Accessories and Modifications .....	10
<b>SPECIAL SAFETY MESSAGES</b> .....	<b>11</b>
<b>OPERATION WARNINGS</b> .....	<b>14</b>
<b>RIDING THE VEHICLE</b> .....	<b>40</b>
Pre-Ride Inspection .....	41
Pre-Ride Inspection Check List .....	41
Clothing .....	43
Carrying a Passenger .....	44
Carrying Loads .....	44
Recreational Riding .....	44
Environment .....	44
Design Limitation .....	45
Off-Road Operation .....	45
General Operating and Safety Precautions .....	45
Riding Techniques .....	48
<b>IMPORTANT ON PRODUCT LABELS (CANADA/UNITED STATES)</b> .....	<b>55</b>
Hang Tag .....	55
Vehicle Safety Labels .....	56
Compliance Labels .....	60
Technical Information Label .....	60
<b>IMPORTANT ON PRODUCT LABELS (ALL COUNTRIES EXCEPT CANADA/UNITED STATES)</b> .....	<b>61</b>
Hang Tag .....	61
Vehicle Safety Labels .....	63
Compliance Labels .....	66
Technical Information Label .....	66

**VEHICLE INFORMATION**

<b>CONTROLS/INSTRUMENTS/EQUIPMENT .....</b>	<b>68</b>
1) Throttle Lever .....	69
2) RH Brake Lever .....	70
3) LH Brake Lever .....	71
4) Parking Brake .....	71
5) Transmission Lever .....	72
6) Multifunction Switch .....	73
7) Indicator Lamps .....	74
8) Ignition Switch .....	75
9) Fuel Valve .....	75
10) Seat Latch .....	76
11) Tool Kit .....	76
12) Front Storage Compartment .....	77
<b>FUEL .....</b>	<b>78</b>
Fuel Requirements .....	78
Fueling Procedure .....	78
<b>BREAK-IN PERIOD .....</b>	<b>80</b>
Operating During Break-In .....	80
<b>OPERATING INSTRUCTIONS .....</b>	<b>81</b>
Starting the Engine (Basic Procedure) .....	81
Using the Choke to Start the Engine .....	82
Stopping the Engine .....	83
Shifting the Transmission .....	83
<b>TUNE YOUR RIDE .....</b>	<b>84</b>
Suspension Adjustment .....	84
<b>VEHICLE TRANSPORTATION .....</b>	<b>86</b>

**MAINTENANCE**

<b>FIRST INSPECTION .....</b>	<b>88</b>
<b>MAINTENANCE SCHEDULE .....</b>	<b>89</b>
SEVERE DUSTY CONDITIONS .....	89
MAINTENANCE SCHEDULE .....	89
<b>MAINTENANCE PROCEDURES .....</b>	<b>92</b>
Engine Oil .....	92
Oil Strainer .....	94
Air Filter .....	95
Air Filter Housing .....	96
Air Injection Valve .....	96

<b>MAINTENANCE PROCEDURES (cont'd)</b>	
Spark Arrester .....	97
CVT Cover .....	98
Gearbox Oil .....	98
Throttle Cable .....	99
Spark Plug .....	102
Battery .....	103
Fuse .....	103
Lights.....	104
Drive Chain and Sprockets .....	105
Tires and Wheels .....	107
Steering System .....	108
Mechanical Brakes (DS 70 and DS 90) .....	108
Hydraulic Brakes (DS 90 X) .....	110
Frame .....	111
<b>VEHICLE CARE .....</b>	<b>112</b>
Post-Operation Care .....	112
Vehicle Cleaning and Protection .....	112
<b>STORAGE AND PRESEASON PREPARATION .....</b>	<b>113</b>

### ***TECHNICAL INFORMATION***

<b>VEHICLE IDENTIFICATION .....</b>	<b>116</b>
Vehicle Identification Number Location .....	116
Engine Identification Number Location .....	116
<b>NOISE EMISSION CONTROL SYSTEM REGULATION (CANADA/UNITED STATES).....</b>	<b>117</b>
<b>NOISE EMISSION AND VIBRATION VALUES (OUTSIDE CANADA/UNITED STATES).....</b>	<b>118</b>
<b>EC DECLARATION OF CONFORMITY.....</b>	<b>119</b>
<b>SPECIFICATIONS .....</b>	<b>120</b>

### ***TROUBLESHOOTING***

<b>TROUBLESHOOTING GUIDELINES .....</b>	<b>124</b>
---	------------

### ***WARRANTY***

<b>BRP LIMITED WARRANTY USA AND CANADA: 2017 CAN-AM® ATV....</b>	<b>130</b>
<b>US EPA EMISSION-RELATED WARRANTY .....</b>	<b>134</b>



**BRP INTERNATIONAL LIMITED WARRANTY: 2017 CAN-AM® ATV..... 137**  
**BRP LIMITED WARRANTY FOR THE EUROPEAN ECONOMIC AREAS, THE COMMONWEALTH OF THE INDEPENDENT STATES AND TURKEY: 2017 CAN-AM® ATV ..... 141**

***CUSTOMER INFORMATION***

**PRIVACY INFORMATION..... 148**  
**CONTACT US..... 149**  
    North America ..... 149  
    Europe ..... 149  
    Oceania ..... 149  
    South America..... 149  
    Asia..... 149  
**CHANGE OF ADDRESS/OWNERSHIP..... 150**



# ***SAFETY INFORMATION***

---

# GENERAL PRECAUTIONS

## Avoid Carbon Monoxide Poisoning

All engine exhaust contains carbon monoxide, a deadly gas. Breathing carbon monoxide can cause headaches, dizziness, drowsiness, nausea, confusion and eventually death.

Carbon monoxide is a colorless, odorless, tasteless gas that may be present even if you do not see or smell any engine exhaust. Deadly levels of carbon monoxide can collect rapidly, and you can quickly be overcome and unable to save yourself. Also, deadly levels of carbon monoxide can linger for hours or days in enclosed or poorly ventilated areas. If you experience any symptoms of carbon monoxide poisoning, leave the area immediately, get fresh air and seek medical treatment.

To prevent serious injury or death from carbon monoxide:

- Never run the vehicle in poorly ventilated or partially enclosed areas such as garages, carports or barns. Even if you try to ventilate engine exhaust with fans or open windows and doors, carbon monoxide can rapidly reach dangerous levels.
- Never run the vehicle outdoors where engine exhaust can be drawn into a building through openings such as windows and doors.

## Avoid Gasoline Fires and Other Hazards

Gasoline is extremely flammable and highly explosive. Fuel vapors can spread and be ignited by a spark or flame many feet away from the engine. To reduce the risk of fire or explosion, follow these instructions:

- Use only an approved red gasoline container to store fuel.

- Strictly adhere to instructions in *FUEL* subsection.
- Never start or operate the engine if the fuel cap is not properly installed.

Gasoline is poisonous and can cause injury or death.

- Never siphon gasoline by mouth.
- If you swallow gasoline, get any in your eye(s), or inhale gasoline vapor, see your doctor immediately.

If gasoline spills on you, wash with soap and water and change your clothes.

## Avoid Burns from Hot Parts

Certain components become hot during operation. Avoid contact with those parts during and shortly after operation to avoid burns.

## Accessories and Modifications

Do not make unauthorized modifications, or use attachments or accessories that are not approved by BRP. Since these changes have not been tested by BRP, they may increase the risk of crashes or injury, and can render the vehicle illegal.

See your authorized Can-Am dealer for available accessories for your vehicle.

---

## SPECIAL SAFETY MESSAGES

### **THIS VEHICLE IS NOT A TOY AND CAN BE HAZARDOUS TO OPERATE.**

- This vehicle handles differently from other vehicles. A collision or rollover can occur quickly if you fail to take proper precautions, even during routine maneuvers such as turning and driving on hills or over obstacles.

**SEVERE INJURY OR DEATH** can result if you do not follow these instructions:

- Read this Operator's Guide and all on-product safety labels carefully and follow the operating procedures described. Watch and pay attention to the *SAFETY DVD* video before operating the vehicle.
- Always follow this age recommendation: DS 70 vehicle should be used by children age 6 or older under adult supervision, or by an operator age 16 or older.
- Always follow this age recommendation: DS 90 and DS 90 X vehicles should be used by children age 10 or older under adult supervision, or by an operator age 16 or older.
- Also, never allow continued use of an ATV by a child if he does not have the abilities to operate it safely, regardless of age.
- Never carry a passenger on this vehicle. Passenger(s) affect balance and steering and increase risk of losing control.
- Never operate this vehicle on any paved surfaces, including sidewalks, driveways, parking lots and streets.
- Never operate this vehicle on any public street, road or highway, even a dirt or gravel one.
- Never take place on this vehicle without wearing an approved helmet that fits properly. You should also wear eye protection (goggles or visor), gloves, boots, long sleeved shirt or jacket, and long pants.
- Never use this vehicle if you are tired, ill, or with drugs or alcohol. Your reaction time and judgement is greatly affected under these conditions.
- Never operate at excessive speeds. Always go at a speed that is proper for the terrain, visibility, and operating conditions, and your experience.
- Never attempt wheelies, jumps, or other stunts.
- Always inspect your vehicle prior to each time you use it to make sure it is in a safe operating condition. Always follow the inspection and maintenance procedures and schedules described in this Operator's Guide.
- Always keep both hands on the handlebars and both feet on the footpegs of the vehicle during operation.
- Always go slowly and be extra careful when operating on unfamiliar terrain. Always be alert to changing terrain conditions when operating this vehicle.
- Never operate on excessively rough, slippery, or loose terrain until you have learned and practiced the skills necessary to control this vehicle on such terrain. Always be especially cautious on these kinds of terrain.
- Always follow proper procedures for turning as described further in this Operator's Guide. Practice turning at low speeds before attempting to turn at faster speeds. Do not turn at excessive speed.

- Never operate this vehicle on hills too steep for the vehicle or for your abilities. Practice on smaller hills before attempting larger hills.
- Always follow proper procedures for climbing hills as described further in this Operator's Guide. Check the terrain carefully before you start up any hill. Never climb hills with excessively slippery or loose surfaces. Shift your weight forward. Never open the throttle suddenly or make sudden gear changes. Never go over the top of any hill at high speed.
- Always follow proper procedures for going down hills and for braking on hills as described further in this Operator's Guide. Check the terrain carefully before you start down any hill. Shift your weight backward. Never go down a hill at high speed. Avoid going down a hill at an angle that would cause the vehicle to lean sharply to one side. Go straight down the hill where possible.
- Always follow proper procedures for crossing the side of a hill as described further in this Operator's Guide. Avoid hills with excessively slippery or loose surfaces. Shift your weight to the uphill side of the vehicle. Never attempt to turn the vehicle around on any hill until you have mastered the turning technique described in this Operator's Guide on level ground. Avoid crossing the side of a steep hill if possible.
- Always use proper procedures if you stall or roll backwards when climbing a hill. To avoid stalling, use proper gear and maintain a steady speed when climbing a hill. If you stall or roll backwards, follow the special procedure for braking described in this Operator's Guide. Dismount on the uphill side or to a side if pointed straight uphill. Turn the vehicle around and remount, following the procedure described further in this Operator's Guide.
- Always check for obstacles before operating in a new area. Never attempt to operate over large obstacles, such as large rocks or fallen trees. Always follow proper procedures when operating over obstacles as described further in this Operator's Guide.
- Always be careful when skidding or sliding. Learn to safely control skidding or sliding by practicing at low speeds and on level smooth terrain. On extremely slippery surfaces, such as ice, go slowly and be very cautious in order to reduce the chance of skidding out of control.
- Never operate this vehicle in fast flowing water or in water deeper than that specified in this Operator's Guide. Remember that wet brakes may have reduced stopping ability. Test your brakes after leaving water, mud or snow. If necessary, apply them several times to let friction dry out the pads.
- Always keep in mind that braking distance is readily affected by but not limited to; weather and terrain conditions, braking system and tire conditions, vehicle speed and attitude. Remember to adjust your driving accordingly.

- BRP recommends sitting on your ATV when operating in reverse. Avoid standing up. Your weight could shift forward against the throttle lever causing an unexpected acceleration and loss of control.
- Always use the size and type tires specified further in this Operator's Guide. Always maintain proper tire pressure as described further in this Operator's Guide.
- Never load a youth model vehicle.
- Never operate this vehicle without proper instruction. **Take a training course.** All operators should receive training from a certified instructor.

## OPERATION WARNINGS

The following warning and their format have been requested by the United States Consumer Product Safety Commission and are required to be in the Operator's Guide for all ATVs.

**NOTE:** The following illustrations are general representations only. Your model may differ.

### **WARNING**



#### **POTENTIAL HAZARD**

Operating this vehicle without proper instruction.

#### **WHAT CAN HAPPEN**

The risk of an accident is greatly increased if the operator does not know how to operate this vehicle properly in different situations and on different types of terrain.

#### **HOW TO AVOID THE HAZARD**

Beginners and inexperienced operators should complete a training course. They should then regularly practice the skills learned during the course as well as the operating techniques described in this Operator's Guide.

For more information about the training course, contact an authorized Can-Am dealer.

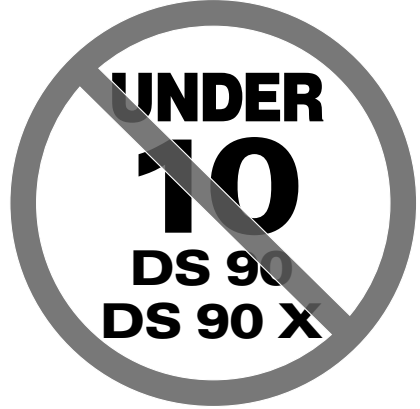

**⚠ WARNING****POTENTIAL HAZARD**

Failure to follow the age recommendations for this vehicle.

**WHAT CAN HAPPEN**

Use by children of ATVs that are not recommended for their age can lead to severe injury or death of the child.

Even though a child may be within the age group for which this vehicle is recommended, he may not have the skills, abilities, or judgment needed to operate this vehicle safely and may be involved in a serious accident.

**HOW TO AVOID THE HAZARD**

DS 70 vehicle should be used by children age 6 or older under adult supervision, or by an operator age 16 or older.

DS 90 and DS 90 X vehicles should be used by children age 10 or older under adult supervision, or by an operator age 16 or older.

Also, never allow continued use of an ATV by a child if he does not have the abilities to operate it safely, regardless of age.

**⚠ WARNING**



**POTENTIAL HAZARD**

Carrying a passenger on this vehicle.

**WHAT CAN HAPPEN**

Greatly reduces your ability to balance and control this vehicle.

Could cause an accident, resulting in harm to you and/or your passenger.

**HOW TO AVOID THE HAZARD**

Never carry passenger. Even with a long seat that provides unrestricted operator movement, it is not designed nor intended to carry passenger(s).

**⚠ WARNING****POTENTIAL HAZARD**

Operating this vehicle on paved surfaces.

**WHAT CAN HAPPEN**

The tires are designed for off-road use only, not for use on pavement. Paved surfaces may seriously affect handling and control of this vehicle, and may cause the vehicle to go out of control.

**HOW TO AVOID THE HAZARD**

Never operate this vehicle on any paved surfaces, including sidewalks, driveways, parking lots and streets.

**⚠ WARNING**



**POTENTIAL HAZARD**

Operating this vehicle on public streets, roads or highways.

**WHAT CAN HAPPEN**

You can collide with another vehicle.

**HOW TO AVOID THE HAZARD**

Never operate this vehicle on any public street, road or highway, even a dirt or gravel one. In many states or provinces it is illegal to operate this vehicle on public streets, roads or highways.

**⚠ WARNING****POTENTIAL HAZARD**

Riding this vehicle without wearing an approved helmet, eye protection and protective clothing.

**WHAT CAN HAPPEN**

The following items concern all ATV's operator:

- Riding without an approved helmet increases the chances of a severe head injury or death in the event of an accident.
- Riding without eye protection can result in an accident and increases the chances of a severe injury in the event of an accident.
- Riding without protective clothing increases the chances of severe injury in the event of an accident.

**HOW TO AVOID THE HAZARD**

Always wear an approved helmet that fits properly. You should also wear:

- Eye protection (goggles or visor)
- Gloves and boots
- Long sleeved shirt or jacket
- Long pants.

**⚠ WARNING**



V00A07Q

**POTENTIAL HAZARD**

Using this vehicle with drugs or alcohol.

**WHAT CAN HAPPEN**

- Could seriously affect your judgment.
- Could cause you to react more slowly.
- Could affect your balance and perception.
- Could result in an accident or death.

**HOW TO AVOID THE HAZARD**

Never use this vehicle with drugs or alcohol.

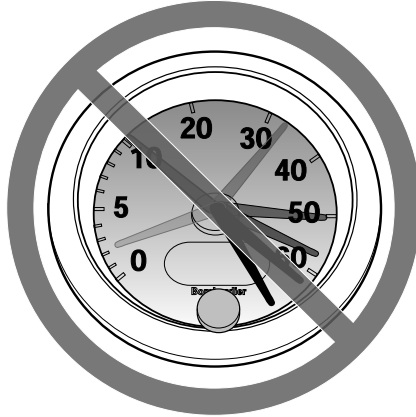
**⚠ WARNING**

V00A08Q

**POTENTIAL HAZARD**

Operating this vehicle at excessive speeds.

**WHAT CAN HAPPEN**

Increases your chances of losing control of the vehicle, which can result in an accident.

**HOW TO AVOID THE HAZARD**

Always travel at a speed which is appropriate for the terrain, visibility and operating conditions, and your experience.

**⚠ WARNING**



**POTENTIAL HAZARD**

Attempting wheelies, jumps and other stunts.

**WHAT CAN HAPPEN**

Increases the chance of an accident, including an overturn.

**HOW TO AVOID THE HAZARD**

Never attempt stunts, such as wheelies or jumps. Do not try to show off.

**⚠ WARNING**

**POTENTIAL HAZARD**

Failure to inspect the vehicle before operating.

Failure to properly maintain the vehicle.

**WHAT CAN HAPPEN**

Increases the possibility of an accident or equipment damage.

**HOW TO AVOID THE HAZARD**

Always inspect your vehicle prior to every time you use it to make sure the vehicle is in safe operating condition.

Always follow the inspection and maintenance procedures and schedules described further in this Operator's Guide.



## WARNING

### POTENTIAL HAZARD

Riding on frozen waterways.

### WHAT CAN HAPPEN

Breaking through the ice can lead to severe injury or death.

### HOW TO AVOID THE HAZARD

Never ride this vehicle on a frozen surface before you are sure the ice is thick enough and sound enough to support the vehicle and its load, as well as the force that is created by a moving vehicle.

## WARNING



### POTENTIAL HAZARD

Removing hands from handlebar or feet from the footrests during operation.

### WHAT CAN HAPPEN

Removing even one hand or foot can reduce your ability to control the vehicle or could cause you to lose your balance and fall off the vehicle. If you remove a foot from the footrests, your foot or leg may come into contact with the rear wheels, which could injure you or cause an accident.

### HOW TO AVOID THE HAZARD

Always keep both hands on the handlebar and both feet on the footrests during vehicle operation.

**⚠ WARNING**



**POTENTIAL HAZARD**

Failure to use extra care when operating this vehicle on unfamiliar terrain.

**WHAT CAN HAPPEN**

You can come upon hidden rocks, bumps, or holes without enough time to react.

Could result in the vehicle overturning or loss of control.

**HOW TO AVOID THE HAZARD**

Go slowly and be extra careful when operating on unfamiliar terrain.

Always be alert to changing terrain conditions when operating the vehicle.

**⚠ WARNING****POTENTIAL HAZARD**

Failure to use extra care when operating on excessively rough, slippery or loose terrain.

**WHAT CAN HAPPEN**

Could cause loss of traction or vehicle control, which could result in an accident, including an overturn.

**HOW TO AVOID THE HAZARD**

Do not operate on excessively rough, slippery or loose terrain until you have learned and practiced the skills necessary to control this vehicle on such terrain.

Always be especially cautious on these kinds of terrain.

**⚠ WARNING**



**POTENTIAL HAZARD**

Turning improperly.

**WHAT CAN HAPPEN**

Vehicle could go out of control, causing a collision or overturn.

**HOW TO AVOID THE HAZARD**

Always follow proper procedures for turning as described further in this Operator's Guide. Practice turning at low speeds before attempting to turn at faster speeds.

Do not turn at excessive speed.

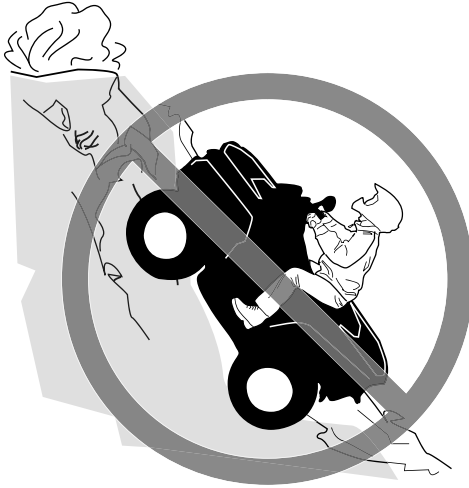
**⚠ WARNING****POTENTIAL HAZARD**

Operating on excessively steep hills.

**WHAT CAN HAPPEN**

The vehicle can overturn more easily on extremely steep hills than on level surfaces or small hills.

**HOW TO AVOID THE HAZARD**

Never operate this vehicle on hills too steep for the vehicle or for your abilities.

Practice on smaller hills before attempting larger hills.

**⚠ WARNING**



**POTENTIAL HAZARD**

Climbing hills improperly.

**WHAT CAN HAPPEN**

Could cause loss of control or cause vehicle to overturn.

**HOW TO AVOID THE HAZARD**

Always follow proper procedures for climbing hills as described further in this Operator's Guide.

Always check the terrain carefully before you start up any hill.

Never climb hills with excessively slippery or loose surfaces.

Shift your weight forward.

Never open the throttle suddenly or make sudden gear changes. The vehicle could flip over backwards.

Never go over the top of any hill at high speed. An obstacle, a sharp drop, or another vehicle or person could be on the other side of the hill.

**⚠ WARNING****POTENTIAL HAZARD**

Going down a hill improperly.

**WHAT CAN HAPPEN**

Could cause loss of control or cause vehicle to overturn.

**HOW TO AVOID THE HAZARD**

Always follow proper procedures for going down hills as described further in this Operator's Guide.

**NOTE:** A special technique is required when braking as you go down a hill.

Always check the terrain carefully before you start down any hill.

Shift your weight backward.

Never go down a hill at high speed.

Avoid going down a hill at an angle which would cause the vehicle to lean sharply to one side. Go straight down the hill where possible.

**⚠ WARNING**



**POTENTIAL HAZARD**

Improperly crossing hills or turning on hills.

**WHAT CAN HAPPEN**

Could cause loss of control or cause vehicle to overturn.

**HOW TO AVOID THE HAZARD**

Never attempt to turn the vehicle around on any hill until you have mastered the turning technique as described further in this Operator's Guide on level ground. Be very careful when turning on any hill.

Avoid crossing the side of a steep hill if possible.

***When crossing the side of a hill:***

Always follow proper procedures as described further in this Operator's Guide.

Avoid hills with excessively slippery or loose surfaces.

Shift your weight to the uphill side of the vehicle.



## ⚠ WARNING

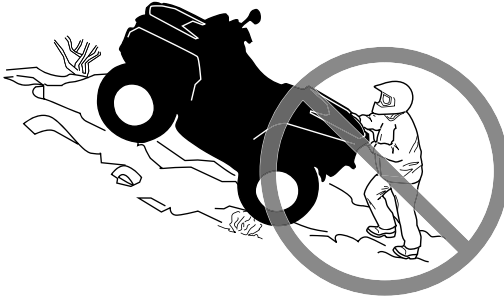

### **POTENTIAL HAZARD**

Stalling, rolling backwards or improperly dismounting while climbing a hill.

### **WHAT CAN HAPPEN**

Could result in vehicle overturning.

### **HOW TO AVOID THE HAZARD**

Use proper gear and maintain steady speed when climbing a hill.

#### ***If you lose all forward speed:***

Keep your weight uphill. Never open the throttle suddenly or make sudden gear changes. The vehicle could flip over backwards.

Apply the brakes.

Lock parking brake after you have stopped.

Dismount on uphill side, or to a side if pointed straight uphill.

#### ***If you begin rolling backwards:***

Keep your weight uphill. Never open the throttle suddenly or make sudden gear changes. The vehicle could flip over backwards.

Never apply the rear brake when rolling backwards.

Apply the front brake gradually.

When fully stopped, apply rear brake as well and lock parking brake.

Dismount on uphill side, or to a side if pointed straight uphill.

Turn the vehicle around and remount, following the procedure described further in this Operator's Guide.

**⚠ WARNING**



**POTENTIAL HAZARD**

Improperly operating over obstacles.

**WHAT CAN HAPPEN**

Could cause loss of control or a collision.

Could cause the vehicle to overturn.

**HOW TO AVOID THE HAZARD**

Before operating in a new area, check for obstacles.

Never attempt to ride over large obstacles, such as large rocks or fallen trees.

When you go over obstacles, always follow proper procedures as described further in this Operator's Guide.

**⚠ WARNING****POTENTIAL HAZARD**

Skidding or sliding improperly.

**WHAT CAN HAPPEN**

You may lose control of this vehicle.

You may also regain traction unexpectedly, which may cause the vehicle to overturn.

**HOW TO AVOID THE HAZARD**

Learn to safely control skidding or sliding by practicing at low speeds and on level smooth terrain.

On extremely slippery surfaces, such as ice, go slowly and be very cautious in order to reduce the chance of skidding or sliding out of control.

**⚠ WARNING**



**POTENTIAL HAZARD**

Operating this vehicle through deep or fast flowing water.

**WHAT CAN HAPPEN**

Tires may float, causing loss of traction and loss of control, which could lead to an accident.

**HOW TO AVOID THE HAZARD**

Never operate this vehicle in fast flowing water or in water deeper than that specified further in this Operator's Guide.

Check water depth and current before you attempt to cross any water. Water should not go above footrests.

Remember that wet brakes may have reduced stopping ability. Test your brakes after leaving water. If necessary, apply them several times to let friction dry out the pads.

**⚠ WARNING****POTENTIAL HAZARD**

Improperly operating in reverse.

**WHAT CAN HAPPEN**

You could hit an obstacle or person behind the vehicle, resulting in serious injury.

**HOW TO AVOID THE HAZARD**

When you select reverse gear, make sure there are no obstacles or people behind the vehicle. When it is safe to proceed, go slowly.

**⚠ WARNING**



**POTENTIAL HAZARD**

Operating this vehicle with improper tires, or with improper or uneven tire pressure.

**WHAT CAN HAPPEN**

Use of improper tires on this vehicle, or operation of this vehicle with improper or uneven tire pressure, may cause loss of control, tire blow outs, tire to move around on its rim, and increases the risk of an accident.

**HOW TO AVOID THE HAZARD**

Always use the size and type of tires specified further in this Operator's Guide for this vehicle.

Always maintain proper tire pressure as described further in this Operator's Guide.

Always replace wheels or tires that are damaged.

**⚠ WARNING****POTENTIAL HAZARD**

Operating this vehicle with improper modifications.

**WHAT CAN HAPPEN**

Improper installation of accessories or modification of this vehicle may cause changes in handling which in some situations could lead to an accident.

**HOW TO AVOID THE HAZARD**

Never modify this vehicle through improper installation or use of accessories. All parts and accessories added to this vehicle should be approved by BRP and should be installed and used according to instructions. If you have questions, consult an authorized Can-Am dealer.

**NEVER** install passenger seat or use the racks to carry a passenger.

Modification of the vehicle to increase speed and performance may violate the terms and conditions of your vehicle's limited warranty. In addition, certain modifications including the removal of engine or exhaust components are illegal under most laws.

**⚠ WARNING**



**POTENTIAL HAZARD**

Overloading this vehicle, carrying or towing cargo improperly.

**WHAT CAN HAPPEN**

Could cause changes in vehicle handling which could lead to an accident.

**HOW TO AVOID THE HAZARD**

Never load cargo on this vehicle.

Never tow cargo or another vehicle with this vehicle.



**⚠ WARNING**

V03M01Q

**POTENTIAL HAZARD**

Transporting flammable or dangerous material can lead to explosions.

**WHAT CAN HAPPEN**

This can cause serious injury or death.

**HOW TO AVOID THE HAZARD**

Never transport flammable or dangerous material.

---

## RIDING THE VEHICLE

To fully appreciate the pleasures and excitement of riding this vehicle, there are some basic rules and tips that you **MUST** follow. Some may be new to you while others may be common sense or obvious.

Please take the time to study this Operator's Guide and all on-product safety labels as well as the *SAFETY DVD* video that came with this vehicle. They more completely describe what you should know about this vehicle before riding it.

For the child's safety, we strongly recommend you also follow and enforce this recommendation. You are the sole judge of a rider's capability to understand the risks and operate a vehicle safely.

Individuals with cognitive or physical impairments or who are high risk takers have an increased exposure to overturns or collisions which may result in injury including death.

Not all vehicles are the same. Each has its own unique performance characteristics, controls and features. Each will ride and handle differently.

Become completely familiar with the operational controls and the general operation of the vehicle before venturing into off road conditions. Practice driving in a suitable area free of hazards and feel the response of each control. Drive at low speeds. Higher speeds require greater experience, knowledge and suitable riding conditions.

Riding conditions vary from place to place. Each is subject to weather conditions which may radically change from time to time and from season to season.

Riding on sand is different than riding on snow or through forests or marshes. Each location may require a greater degree of awareness and skills. Show good judgement. Always proceed with caution. Please do not take any unnecessary risks that could leave you stranded or possibly injured.

Never assume that the vehicle will go everywhere safely. Sudden changes in terrain caused by holes, depressions, banks, softer or harder "ground" or other irregularities may cause the vehicle to topple or become unstable. To avoid this, slow down and always observe the terrain ahead. If the vehicle does begin to topple or tip over, the best advice is to immediately get off... **AWAY** from the direction of the tip over!

We encourage you to have an Annual Safety Inspection of your vehicle. Please contact an authorized BRP dealer for further details. Though not required, it is recommended that an authorized BRP dealer performs the preseason preparation of your vehicle. Each visit to your authorized BRP dealer is a great opportunity for your dealer to verify if your vehicle is included in any safety campaign. We also urge you to visit your authorized BRP dealer in a timely manner if you become aware of any safety related campaigns.

See an authorized BRP dealer for available accessories you may require.

## Pre-Ride Inspection

### WARNING

Perform a pre-ride inspection before each ride to detect any potential problem that could occur during operation. The pre-ride inspection can help you monitor wear and deterioration before they become a problem. Correct any problem that you discover to reduce the risk of a breakdown or crash.

Before using this vehicle, the operator and/or an adult should always perform the following pre-ride inspection check list.

## Pre-Ride Inspection Check List

### What to Do Before Starting the Engine (Key OFF)

ITEMS TO BE INSPECTED	INSPECTION TO PERFORM	✓
Fluids	Check fuel and engine oil.	
	Check brake system for fluid leaks (DS 90 X).	
Leaks	Check for any leaks under vehicle.	
Steering	Check if steering operates freely by completely turning it from side to side.	
Throttle lever	Activate throttle lever several times to ensure it operates freely. It must return to idle position when released.	
	Ensure the speed limiter screw is properly adjusted according to rider capability.	
Parking brake	Apply parking brake and ensure it operates properly.	
Tires	Check tire pressure and condition.	
Wheels	Check wheels for damage and for abnormal play, and check lug nuts are tightened.	
Radiator	Check cleanliness of the radiator.	
Drive chain and sprockets	Inspect sprockets for wear or damages.	
	Check drive chain, slider and drive chain tensioner for proper adjustment and lubrication (as applicable).	

ITEMS TO BE INSPECTED	INSPECTION TO PERFORM	✓
Seat	Ensure operator seat is properly installed and latched.	
Service and storage compartments	Check if service and storage compartments are properly latched.	
Chassis and suspension	Check underneath vehicle for any debris on chassis or suspension, properly clean chassis and suspension.	

**What to Do Before Starting the Engine (Key ON)**

ITEMS TO BE INSPECTED	INSPECTION TO PERFORM	✓
Indicator lamps	Check operation of engine oil/temperature indicator lamp (during first few seconds of key ON).	
	Ensure the N (neutral) and R (reverse) indicator lamps come ON as applicable to transmission lever selection.	
Lights	Check operation and cleanliness of headlights and taillight.	
	Check operation of high and low beam.	
	Check operation of brake light.	
Engine	Ensure fuel valve is selected to the ON position.	

**What to Do After the Engine is Started**

ITEMS TO BE INSPECTED	INSPECTION TO PERFORM	✓
Indicator lamps	Ensure engine oil/temperature indicator lamp is off (shut engine off if light remains on).	
Transmission lever	Check operation of transmission lever (F, N, and R).	
Brakes	Drive forward slowly a few feet and apply both brake levers and the brake pedal individually. The brakes must fully apply. Lever and pedal must fully return when released.	
Emergency engine stop switch	Check that the emergency engine stop switch is working properly.	
Ignition switch	Check if ignition switch is working properly by restarting and stopping the engine.	

## Clothing

Actual weather conditions should help you decide how to dress. Always dress for the coldest weather expected. Thermal underwear next to the skin provides good insulation. It is important that the operator always wears the appropriate protective clothing and apparel, including an approved helmet, eye protection, boots, gloves, a long sleeved shirt and pants. This type of clothing will provide you protection from some of the minor hazards you may encounter en route. The operator must never wear loose clothing such as a scarf that may get entangled in the vehicle or on tree branches and shrubs. Depending on conditions, anti-fogging goggles or sun glasses may be required. Sun glasses should only be worn during the daytime. Different colored lenses available for goggles or glasses help you distinguish terrain variations.

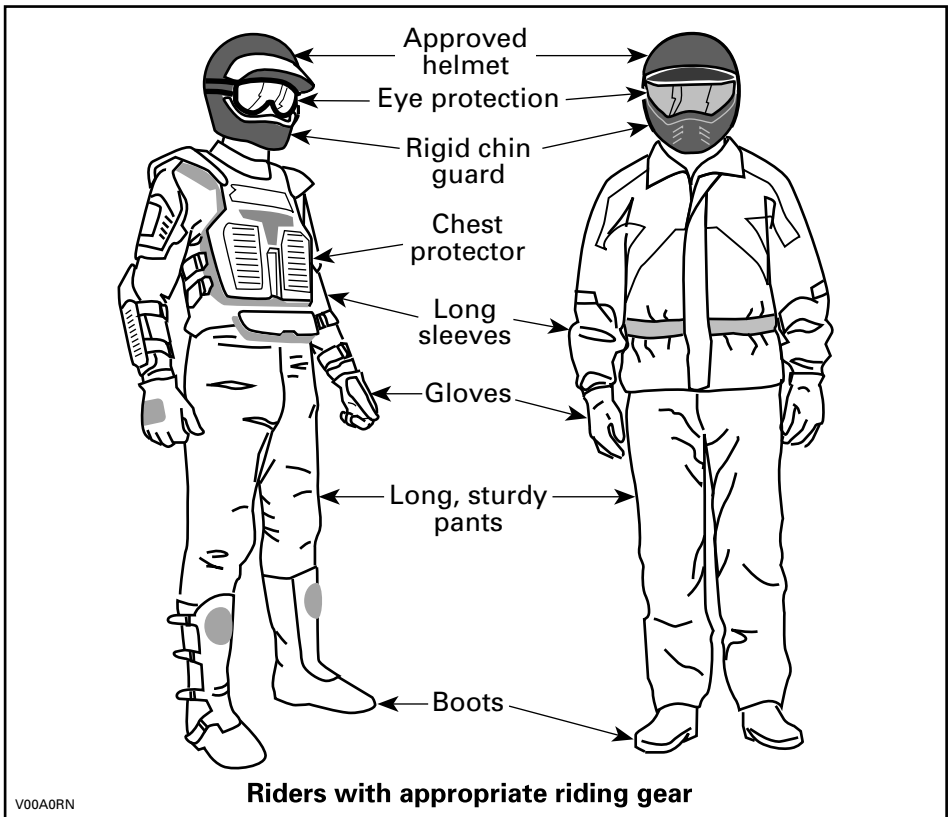

## Carrying a Passenger

This vehicle is designed specifically to carry an operator only. Even with a long seat, this vehicle is not designed nor intended to carry passenger(s). Carrying passenger(s) may affect the stability and your control of the vehicle.

## Carrying Loads

Never load cargo on this vehicle.

## Recreational Riding

Respect the rights and limitations of others. Stay away from areas designated for other types of off road use. This includes snowmobile trails, equestrian trails, cross country ski trails, mountain bike trails etc. Never assume there are no other users on the trail. Always stay to the complete right of the trail and do not zig zag to one side of the trail then the other. Be prepared to stop or pull off to the side if another trail user appears in front of you.

Always keep a safe distance from other riders. Your judgment of speed, terrain conditions, weather, mechanical condition of your vehicle and the "trust in judgment" you have in others around you will help you make a better choice of appropriate safe distance. This vehicle, like any other motorized vehicle, cannot stop "on a dime".

Before you ride, tell someone where you are planning to travel and your expected time of return.

Depending on the length of your ride, carry additional tools, drinking water, food and emergency equipment. Find out where you can get additional gasoline and oil. Be prepared for the possible conditions you may encounter.

Adjustable wrench	Mobile phone
Colored lens goggles	Provided tool kit
Flashlight	Snack
First aid kit	Spare light bulbs
Friction tape	Trail map
Knife	

## Environment

One of the benefits of this vehicle is that it can take you off the beaten path away from most communities. However, you should always respect nature and the rights of others to enjoy it. Do not ride in environmentally sensitive areas. Do not drive over forest crops or shrubs... nor cut down trees or take down fencing... nor spin your wheels and destroy the terrain. "Tread Lightly".

This vehicle can cause OHV wildfires if debris builds up near the exhaust or other engine hot spots and ignites then falls off into dry grass. Avoid riding in wet areas, through muskeg or tall grass, where debris can build up. Should you ride in those areas, inspect and remove all debris from your engine and hot spots.

Chasing wildlife is in many areas illegal. Wildlife can die of exhaustion after being chased by a motorized vehicle. If you encounter animals on the trail, stop and observe quietly and with caution. It will be one of the better memories of your life.

Observe the rule... "what you take in, carry out". Do not litter. Do not start campfires unless you have permission to do so... and then only... away from dry areas. The hazards you may create on the trail may cause injury to others or yourself, even at a later date.

Respect farm lands. Always obtain the permission of the landowner before riding on private land. Respect crops, farm animals and property lines. If you come to a closed gate, close it again behind you.

Finally, do not pollute streams, lakes or rivers and do not modify the engine or exhaust system, or remove any of its components.

## **Design Limitation**

Although the vehicle is exceptionally rugged for its class, it is still a light vehicle by definition and its operation must be restricted to its proper purpose.

The addition of weight to any part of the vehicle changes its gravitational stability and modifies its performance.

## **Off-Road Operation**

The very nature of off-road operation is dangerous. Any terrain, which has not been specially prepared to carry vehicles, presents an inherent danger where angularity, terrain substance and exact steepness are unpredictable. The terrain itself presents a continual element of danger, which must be knowingly accepted by anyone venturing over it.

An operator who takes a vehicle off-road should always exercise the utmost care in selecting the safest path and keeping close watch on the terrain ahead of him. On no account should the vehicle be operated by anyone who is not completely familiar with the driving instructions applicable to the vehicle, nor should it be operated on steep or treacherous terrain.

## **General Operating and Safety Precautions**

Care, caution, experience and driving skill are the best precautions against the hazards of vehicle operation.

Whenever there is the slightest doubt that the vehicle can safely negotiate an obstacle or a particular piece of terrain, always choose an alternate route.

In off-road operation, power and traction, not speed, are important. Never drive faster than visibility and your own ability to select a safe route permit.

Constantly watch the terrain ahead for sudden changes in slopes or obstacles, such as rocks or stumps, that may cause loss of stability, resulting in tip-over or rollover.

Never operate the vehicle if the controls do not function normally.

When operating in reverse, check that the path behind the vehicle is free of people or obstacles. Proceed slowly and avoid sharp turns.

BRP recommends that you remain seated on your ATV when operating in reverse. Avoid standing up. Your weight could shift forward against the throttle lever causing an unexpected acceleration and loss of control.

When stopped or parked, always apply the parking brake. This is especially important when parking on a slope. On very steep inclines or if the vehicle is carrying cargo, the wheels should be blocked using rocks or bricks. Remember to turn the fuel valve to the closed position.

### **Uphill Driving**

Due to configuration, this vehicle has excellent climbing ability, so much so that it is possible to tip over before traction is lost. For example, its common to encounter terrain situations where the top of the hill has eroded to a point that the hill peak rises very sharply. The vehicle can readily negotiate such a condition however, in doing so, when the front of the vehicle is driven to a point that the vehicle's balance moves rearward, a tip over can occur.

The same situation may apply if an embedded object causes the front of the vehicle to climb more than desired. If such a situation occurs take an alternate route. Be aware of side hilling dangers when doing so.

It is also wise to know the terrain condition on the other side of the hill or bank. All too often there exists a sharp drop-off that is impossible to negotiate or descend.

### **Downhill Driving**

This vehicle can climb slopes that are steeper than it can safely descend. Therefore, it is essential to ensure that a safe route exists to descend a slope before you climb it.

Decelerating while negotiating a slippery downhill slope could "toboggan" the vehicle. Maintain steady speed and/or accelerate slightly to regain control.

### **Side Hilling**

Whenever possible, such operation should be avoided. If necessary, do so with extreme caution. Side hilling on steep inclines could result in rollover. In addition, slippery or loose surfaces could result in uncontrollable side sliding. Do not attempt to turn the vehicle downhill with the slide. Avoid all objects or depressions that will intensify the raising of one side of the vehicle higher than the other, thus causing rollover.



## Drop-Offs

This vehicle will “bottom-out” and usually stop if either the front or rear wheels are driven over a drop-off. If the drop is sharp or deep, the vehicle will nose dive and tip over.

### **WARNING**

**Avoid negotiating drop-offs. Reverse and select an alternate route.**

## Riding on Snow Covered Surfaces

When performing the pre-ride inspection, pay special attention to locations on the vehicle where snow and/or ice accumulations may obstruct visibility of the lights and reflectors, clog ventilation openings, or interfere with the movement of the control levers and switches. Before starting with your ATV check the steering, throttle and brake lever and pedal controls for interference free operation.

Whenever an ATV is ridden on a snow covered drive path the tire grip is generally reduced causing the vehicle to react differently to control inputs from the operator. On low grip surfaces, the steering responses are not as crisp and precise, stopping distances are lengthened and acceleration becomes sluggish. Slow down and do not “gun” the throttle. This will only result in spinning of the tires and possibly in an over steering slide of the vehicle. Avoid hard braking. This will possibly result in a straight line slide of the vehicle. Again, the best advice is to safely reduce speed in anticipation of a maneuver so to give yourself time and distance to regain total vehicle control before it spins out of your control.

As you drive your ATV over a loose snow covered surface, snow dust will be picked up in the wake turbulence of the moving vehicle and transported to contact and accumulate or melt on some exposed components including rotating parts like brake discs. Water, snow or ice may affect the response time of the brake system of your ATV. Even when not required to reduce vehicle speed apply brakes frequently to prevent ice or snow accumulation and to dry brake pads and discs. While doing so in low risk driving situations you will test for grip level and keep yourself alerted to how the vehicle reacts to your control inputs. Always keep footboards, brake and throttle levers free of snow and ice. Frequently wipe snow off seat, hand grips, lights and reflectors.

The depth of the snow cover may hide rocks, tree stumps or other objects, and if it is wet, may totally impede the drivability as the vehicle becomes bogged down or completely loses traction in slushy snow. Look far ahead and always be watchful of any visible clues that might indicate the presence of such obstacles. In doubt steer clear. Avoid driving on any frozen body of water before checking that the ice will safely support the ATV, its riders and its load of cargo. Remember that a given thickness of ice may be sufficient to support a snowmobile, but not an ATV of an identical weight because of the smaller load bearing surface of the four tire contact patches as compared to that of a snowmobile track and skis.

To maximize comfort and avoid frostbite, always wear clothing and ATV protective equipment appropriate for the weather conditions you will be exposed to during your ride.

At the end of each ride it is a good practice to clean the vehicle body and all moving components (brakes, steering components, drive lines, controls, etc.) from any snow or ice accumulations. Wet snow will turn to ice during the shut down period and become more difficult to remove at the next pre-ride inspection.

## Riding Techniques

Riding your vehicle too fast for your skills or the conditions may result in injury. Apply only enough throttle to proceed safely. Statistics show that mishaps and injury usually result from high speed turns. Always remember that this vehicle is heavy! Its pure weight alone may entrap you should it fall and pin you down. Always use proper riding techniques to avoid vehicle overturns on hills and rough terrain and in turns.

This vehicle is not designed for jumping, nor can it fully absorb the high impact energy generated during manoeuvres such as jumping which, can be passed on to you, the operator. Performing "wheelies" can cause the vehicle to flip over onto you. Both practices have a high risk for you and should be avoided at all times.

To maintain proper control, it is strongly advised that you keep your hands on the handlebar and within easy reach of all controls. The same holds true for your feet. To minimize the possibility of a leg or foot injury, keep your feet on the footrests at all times. Do not direct your toes outwards nor extend your feet out to assist in turning as they can be hit or be snagged on passing obstacles, or may come into contact with wheels.

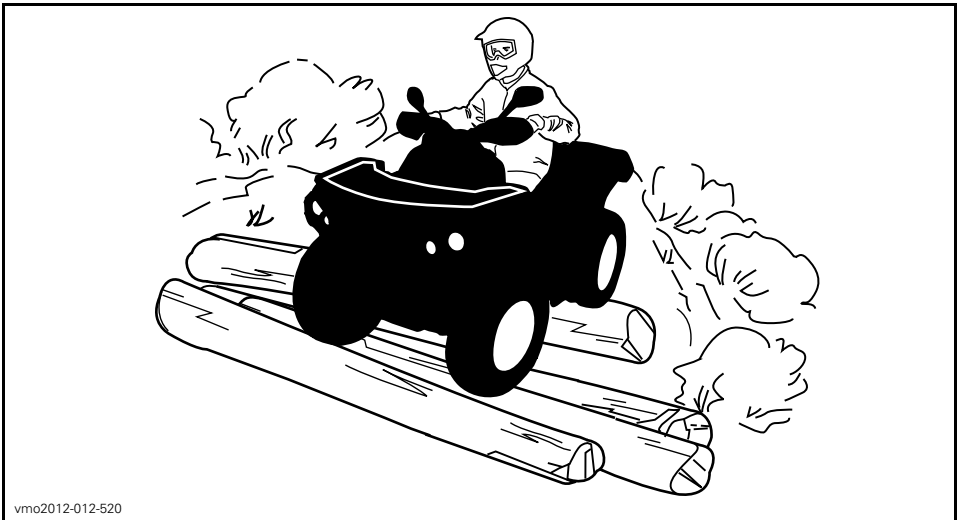

vmo2012-012-520

Even though there is an adequate suspension system on this vehicle, there are “washboard” or rough terrain conditions that will make you feel uncomfortable and can even cause a back injury. “Posting” or riding in a crouched position will often be required. Slow down and allow your flexed legs to absorb part of the impact energy.

This vehicle is not designed for riding on roads or highways. (In most places it is an illegal practice). Riding your vehicle on roads or highways could cause a collision to occur with another vehicle.

The tires of this vehicle are not suited for paved road use. Also, this vehicle is not equipped with a rear differential (rear wheels are always turning at the same speed). For these reasons, pavement may seriously affect the handling and control of the vehicle.

Riding on roads or soft shoulders may confuse other road users, especially if your daytime running lights are on.

If you have to cross a road, the lead driver should get off his vehicle, then observe and give directions to the other riders. The last person after crossing then assists the lead driver to cross. Do not travel on sidewalks. They are designated for pedestrian use.

This vehicle is not designed to cross waterways.

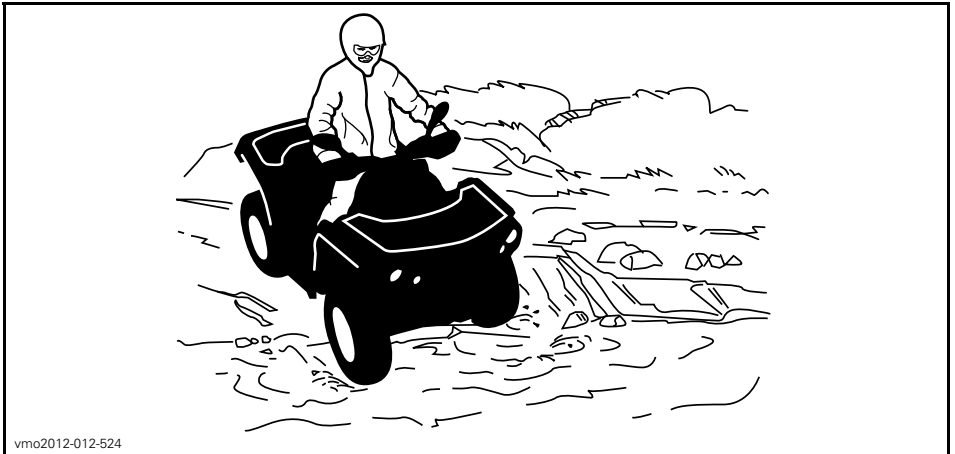

Wet brakes will affect the braking ability of your vehicle. Make sure you dry the brakes by applying them several times after the vehicle leaves the water, mud or snow.

Mud or marsh lands may be encountered near water. Be prepared for sudden “holes” or changes in depth. Similarly so, be watchful of hazards such as rocks, logs, etc., partially covered by vegetation.

If your route crosses frozen waterways, make sure the ice is thick enough and sound enough to support the total weight of yourself, the vehicle and its load. Be ever watchful of open water... it is a sure indication that the ice thickness will vary. If in doubt, do not attempt to cross.

Ice will also affect the control of the vehicle. Slow down and do not "gun" the throttle. This will only result in spinning of the tires and the vehicle may possibly tip over. Avoid rapid braking. This again can result in an uncontrolled slide and the vehicle may possibly tip over. Slush should be avoided at all times since it could block the operation or controls of the vehicle.

Riding in snow may reduce the brakes stopping capability. Safely reduce speed and allow greater distance for braking. Snow projection may cause ice build up or snow accumulation on brake components and controls. Apply brakes frequently to prevent ice or snow accumulation. Refer to General Operating and Safety Precautions in this subsection for more detailed information regarding riding on snow Covered surfaces.

Riding on sand, sand dunes, or on snow is another unique experience, but there are some basic precautions that should be observed. Wet, deep or fine sand/snow may create a loss of traction and cause the vehicle to slide, drop off, or become "bogged" down. If this occurs, look for a firmer base. Again, the best advice is to slow down and be watchful of the conditions.

When riding in sand dunes it is advisable to equip the vehicle with an antenna type safety flag. This will help make your location more visible to others over the next sand dune. Proceed carefully should you see another safety flag ahead. Since the antenna type safety flag can snag and rebound on your body if caught, do not use it in areas where there are low hanging branches or obstacles.

Riding on loose stones or gravel is very similar to riding on ice. They will affect the steering of vehicle... possibly causing it to slide and tip over especially at high speeds. In addition, braking distance may be affected. Remember that "gunning" the throttle or sliding may cause loose stones to be ejected rearwards into the path of another rider. Never do it deliberately.

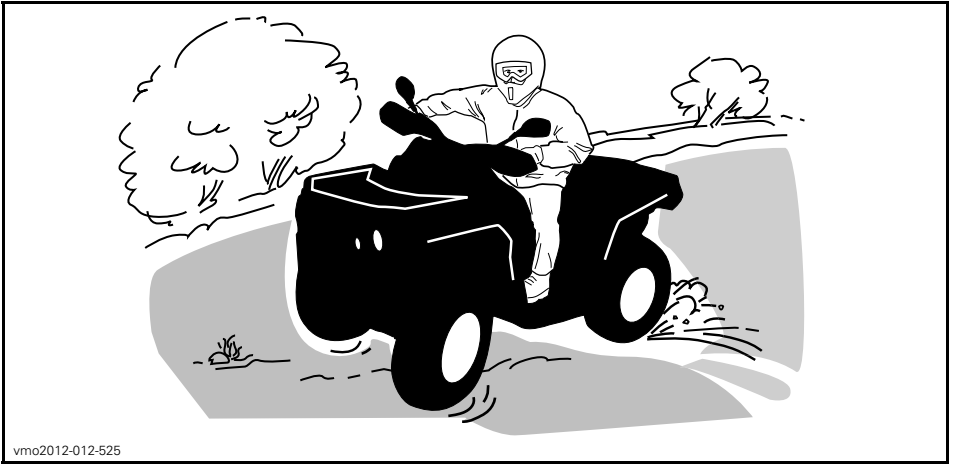

If you do get into a slide or skid, it may help to turn the handlebar in the direction of the skid until you regain control. Never jam the brakes and lock the wheels.

Respect and follow all posted trail signs. They are there to help you and others.

Obstacles in the "trail" should be traversed with caution. This includes loose rocks, fallen trees, slippery surfaces, fences, posts, and embankments and depressions. You should avoid them whenever possible. Remember that some obstacles are too large or dangerous to cross and should be avoided. Small rocks or fallen trees may be safely crossed... approach at a 90° angle. Stand on the footrests while keeping your knees flexed. Adjust speed without losing momentum and do not "gun" the throttle. Hold handlebar firmly. Place your body weight rearwards and proceed. Do not try to lift the vehicle front wheels off the ground. Be aware that the object may be slippery or may move while crossing.

When driving on hills or slopes two things are highly important: be prepared for slippery surfaces or terrain variations and obstacles and... use proper body positioning.

When stopped or parked always apply the parking device. This is especially important when parking on a slope. On very steep inclines or if the ATV is carrying cargo, the wheels should be blocked using rocks or bricks.

## Uphill

Before trying to climb a hill, keep these things in mind. Hill Climbing should only be attempted by experienced operators. Start on shallow slopes. Always drive straight uphill and keep your body weight forward towards the top of the hill. Keep your feet on the footrests and accelerate before you start to climb. Try to keep a steady speed and go easy on the throttle to avoid acceleration. Abrupt slope or terrain variation or rolling one wheel over an obstacle could have a big impact on the stability as it will lift the front of the vehicle increasing the risk of tipping over. Some hills are too steep to safely stop or recover from after an unsuccessful climbing attempt. Try to avoid steep inclines. If you're not careful, you could tip over when going up hills. If the hill is too steep and you cannot proceed or the vehicle begins to roll backwards, apply the brake, being careful not to slide. Dismount then use the "K" turn (while walking back, next to the vehicle on the up hill side and with a hand on the brake lever, slowly back the rear of the vehicle toward the top of the hill then drive downhill). Always walk or dismount on the upside of the slope while keeping clear of the vehicle and its rotating wheels. Do not try to hold on to the vehicle if it begins to topple. Stay clear. Do not ride over the crest of the hill at high speed. Obstacles, including sharp drop-offs, may exist.

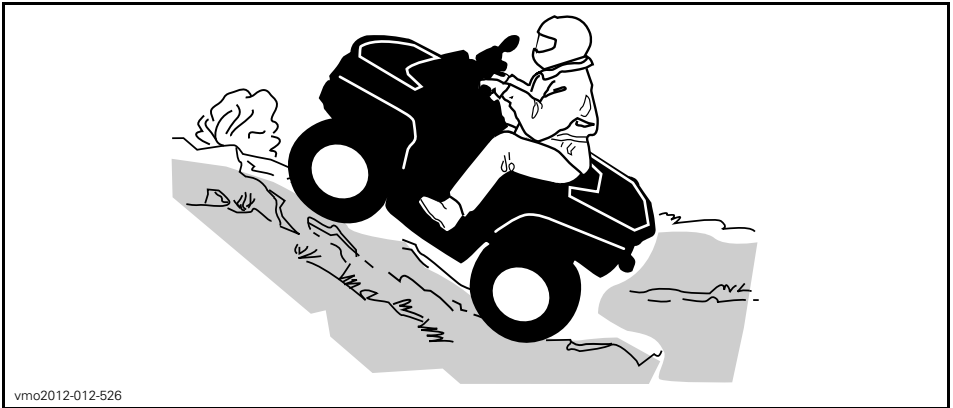

## Downhill

Keep your body weight rearwards. Apply the brake gradually to prevent skidding. Do not "coast" down the slope using solely engine compression or in neutral gear. Try to avoid steep inclines. If you're not careful, you could tip over when going down hills.

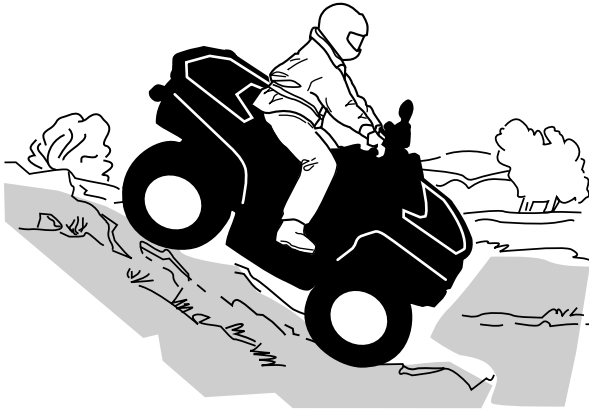

vmo2012-012-523

## Side Hilling

This is one of the **most risky** types of riding since it may drastically change the balance of the vehicle. It should be avoided wherever possible. However, if it is necessary to do so, it is important that you **ALWAYS** keep your body weight on the up-side of the slope... and be prepared to dismount on that side should the vehicle begin to topple. **Do not try to stop or save the vehicle from damage.**



vmo2012-012-527

While reading this Operator's Guide, remember that:

### **⚠ WARNING**

Indicates a potential hazard that, if not avoided, could result in serious injury or death.







# IMPORTANT ON PRODUCT LABELS (CANADA/UNITED STATES)

Canada/United States

## Hang Tag

This vehicle comes with a hang tag containing important information.

Any person who rides this vehicle should read and understand this information before riding.

<p style="text-align: center;"><b>Y</b> <b>YOUTH MODEL</b></p> <p style="text-align: center;">THIS ATV IS FOR RECREATIONAL USE BY YOUNG OPERATORS <b>UNDER ADULT SUPERVISION</b></p> <p style="text-align: center;">OPERATOR ONLY - NO PASSENGERS</p> <p style="text-align: center;">THIS CATEGORY ATV HAS BEEN DESIGNED TO BE USED UNDER LIMITED/RESTRICTED MAXIMUM SPEED</p> <hr/> <p style="text-align: center;"><b>DS70</b> <b>(NO OPERATOR UNDER AGE 6)</b> RESTRICTED MAXIMUM SPEED: 16 Km/h (10MPH) (FACTORY SET-UP) *UNRESTRICTED MAXIMUM SPEED: 24 Km/h (15MPH) (SET UNDER CLOSE PARENT SUPERVISION/JUDGMENT) A CATEGORY Y-6+ ATV IS A YOUTH MODEL</p> <hr/> <p style="text-align: center;"><b>DS90/DS90X</b> <b>(NO OPERATOR UNDER AGE 10)</b> RESTRICTED MAXIMUM SPEED: 24 Km/h (15MPH) (FACTORY SET-UP) *UNRESTRICTED MAXIMUM SPEED: 48 Km/h (30MPH) (SET UNDER CLOSE PARENT SUPERVISION/JUDGMENT) A CATEGORY Y-10+ IS A YOUTH MODEL</p> <hr/> <p style="text-align: center;">TRAINING COURSE TO TEACH ATV RIDING SKILLS ARE AVAILABLE. FOR INFORMATION CONTACT YOUR DEALER.</p> <p style="text-align: center;">CHECK WITH YOUR DEALER TO FIND OUT ABOUT STATE OR LOCAL LAWS REGARDING ATV OPERATION.</p> <p style="text-align: center;">*See operator's guide for the procedure <b>THIS HANGTAG IS NOT TO BE REMOVED BEFORE SALE.</b></p>	<p style="text-align: center;"><b>⚠ WARNING</b></p> <p style="text-align: center;">Improper ATV use can result in SEVERE INJURY or DEATH.</p> <div style="display: flex; justify-content: space-around; align-items: center;"><div style="text-align: center;"><p>ALWAYS USE AN APPROVED HELMET AND PROTECTIVE GEAR.</p></div><div style="text-align: center;"><p>NEVER USE ON PUBLIC ROADS</p></div><div style="text-align: center;"><p>NEVER CARRY PASSENGERS.</p></div><div style="text-align: center;"><p>NEVER USE UNDER THE INFLUENCE OF DRUGS OR ALCOHOL.</p></div></div> <p><b>NEVER</b> operate:</p> <ul style="list-style-type: none"><li>• without proper training or instructions.</li><li>• at speed too fast for your skills or the conditions.</li><li>• on public roads - a collision can occur with another vehicle</li><li>• with a passenger - passenger affect balance and steering and increase risk of losing control.</li></ul> <p><b>ALWAYS:</b></p> <ul style="list-style-type: none"><li>• use proper riding techniques to avoid vehicle overturns on hills and rough terrain and in turns.</li><li>• avoid paved surfaces - pavement may seriously affect handling and control.</li></ul> <p style="text-align: center;">LOCATE AND READ OPERATOR'S GUIDE. FOLLOW ALL INSTRUCTIONS &amp; WARNINGS</p> <p style="text-align: right; font-size: small;">704 902 024</p>
--	--

vmo2010-003-003\_en

TYPICAL

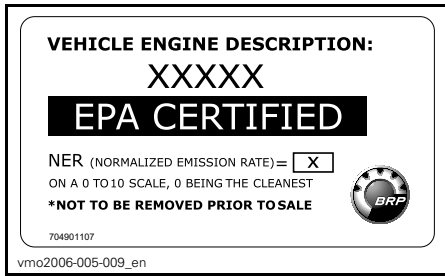

TYPICAL

## Vehicle Safety Labels

Read and understand all the safety labels on your vehicle. These labels are affixed to your vehicle for the safety of the operator or bystanders.

The safety labels on your vehicle should be considered permanent parts of the vehicle. If missing or damaged, they can be replaced free of charge. See an authorized Can-Am dealer.

**NOTE:** In the event of any discrepancy between this guide and the vehicle, the safety labels on the vehicle have precedence over the labels in this guide.

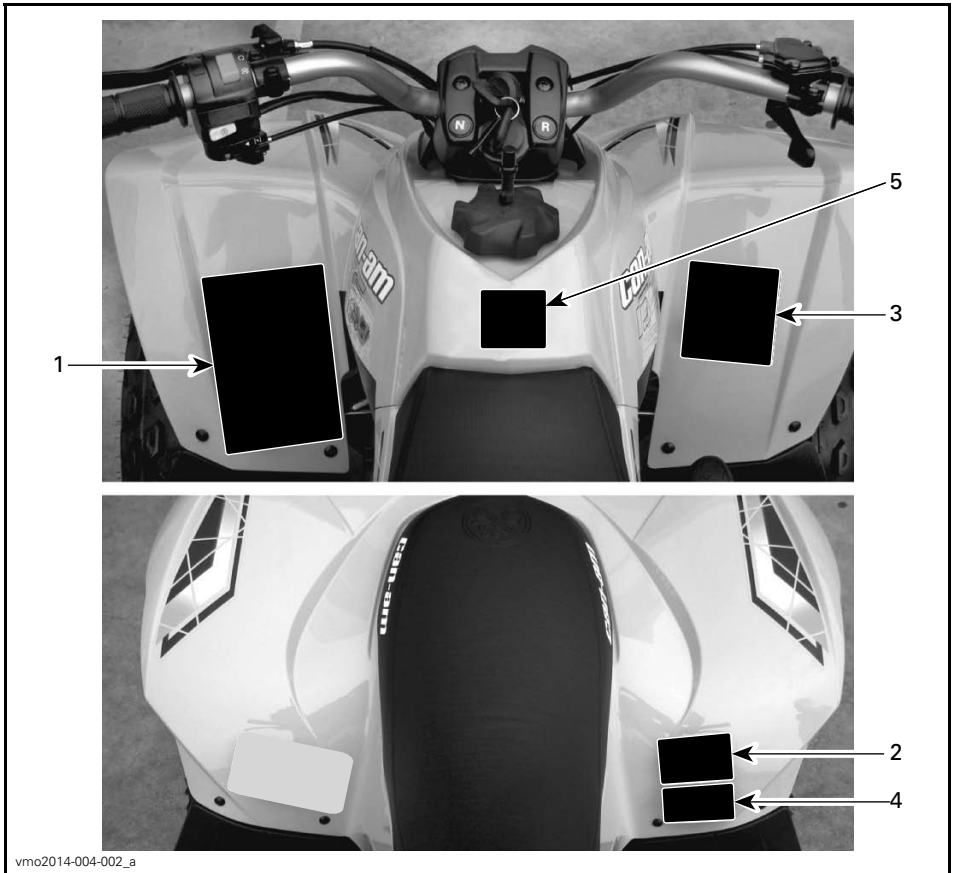

TYPICAL - LABEL LOCATIONS

**⚠ WARNING**

Improper ATV use can result in SEVERE INJURY or DEATH.

ALWAYS USE AN APPROVED HELMET AND PROTECTIVE GEAR.

NEVER USE ON PUBLIC ROADS.

NEVER CARRY PASSENGERS.

NEVER USE UNDER THE INFLUENCE OF DRUGS OR ALCOHOL.

**NEVER operate:**

- without proper training or instructions.
- at speeds too fast for your skills or the conditions.
- on public roads - a collision can occur with another vehicle.
- with a passenger - passengers affect balance and steering and increase risk of losing control.

**ALWAYS:**

- use proper riding techniques to avoid vehicle overturns on hills and rough terrain and in turns.
- avoid paved surfaces - pavement may seriously affect handling and control.

LOCATE AND READ OPERATOR'S GUIDE. FOLLOW ALL INSTRUCTIONS & WARNINGS.

vmo2009-003-004\_en

LABEL 1

**⚠ WARNING**

**NEVER ride as a passenger. Passengers can cause a loss of control, resulting in SEVERE INJURY or DEATH.**

704 900 005

V01M07Z

LABEL 2

**⚠ WARNING**

Operation of this ATV by children under the age of 6 increases the risk of SEVERE INJURY OR DEATH.

Adult supervision required for children under age 16.

NEVER permit children under age 6 to operate this ATV.

vmo2009-004-002\_en

LABEL 3 - DS 70

**⚠ WARNING**

Operation of this ATV by children under the age of 10 increases the risk of SEVERE INJURY OR DEATH.

Adult supervision required for children under age 16.

NEVER permit children under age 10 to operate this ATV.

704902025

vmo2010-003-004\_en

LABEL 3 - DS 90 AND DS 90 X

**⚠ WARNING**

Improper tire pressure or overloading can cause loss of control.

Loss of control can result in SEVERE INJURY OR DEATH.

**TIRE PRESSURE**

- Set with tires cold: DS 70 / DS90 / DS 90X
 

- Minimum	FRONT: 25 kpa	3.6 psi
	REAR: 25 kpa	3.6 psi
- Maximum	FRONT: 35 kpa	5 psi
	REAR: 35 kpa	5 psi
- Never set tire pressure below minimum. It could cause the tire to dislodge from the rim.
- Maximum Weight Capacity : 150 lbs. (70kg). Includes weight of operator and accessories.

704901845

LABEL 4 - TYPICAL



LABEL 9

## Compliance Labels

These labels indicate vehicle's compliance.

ENGINE FAMILY	FAMILLE DE MOTEUR	<b>RENSEIGNEMENTS SUR LE DISPOSITIF ANTIPOLLUTION</b> CE VEHICULE EST CERTIFIE POUR FONCTIONNER A L'ESSENCE SANS PLOMB ET IL REpond AUX NORMES <input type="checkbox"/> DE L'EPA POUR LES VTT A MOTEUR SI.	
PERMEATION FAMILY	FAMILLE DE PERMEATION		
CERTIFICATION STANDARD (FEL)	LIMITE DES ÉMISSIONS DE LA FAMILLE	<b>EMISSION CONTROL INFORMATION</b> THIS VEHICLE IS CERTIFIED TO OPERATE ON UNLEADED GASOLINE AND MEETS TO <input type="checkbox"/> U.S. EPA FOR ATV SI ENGINES. SEE OPERATOR'S GUIDE FOR MAINTENANCE SPECIFICATIONS VOIR GUIDE DU CONDUCTEUR POUR LES SPÉCIFICATIONS D'ENTRETIEN	
ENGINE DISPLACEMENT	CYLINDRÉE		
EXHAUST EMISSION CONTROL SYSTEM	SYSTÈME DE CONTRÔLE DES ÉMISSIONS	<b>BOMBARDIER RECREATIONAL PRODUCTS INC.</b>	

vmo2015-500

TYPICAL - LOCATION: UNDERNEATH REAR FENDER

	<b>Bombardier Recreational Products Inc. certifies that this ATV complies with the American National Standard for Four Wheel All-Terrain Vehicles, ANSI/SVIA-1-2010 Standard.</b>
	<b>Bombardier Produits Récréatifs inc. certifie que ce VTT est conforme à la norme "American National Standard for Four Wheel All-Terrain Vehicles" ANSI/SVIA-1-2010.</b>

704903327

LOCATION: FRONT FENDER

## Technical Information Label

CHAIN PLAY ADJUSTMENT	44 - 57 mm (1-3/4 to 2-3/4")
AJUSTEMENT DE LA CHAÎNE	

87604-DGF-00H

vmo2011-004-001\_a

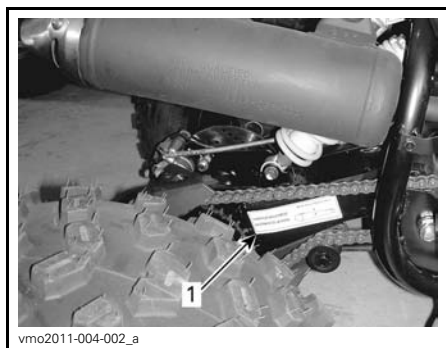

1. Chain adjustment label location

---

# IMPORTANT ON PRODUCT LABELS (ALL COUNTRIES EXCEPT CANADA/UNITED STATES)

*All countries except Canada/United States*

*DS 90 and DS 90 X models only*







## Hang Tag

This vehicle comes with a hang tag containing important information.

Any person who rides this vehicle should read and understand this information before riding.

### **WARNING**

- Locate and read operator's guide. Improper ATV use can result in SEVERE INJURY or DEATH. Follow all instructions and warnings.
- Always wear ear protection.
- Always use an approved helmet and protective gear.
- Never use on public roads.
- Never carry passengers.
- Never use with drugs or alcohol.

<p style="text-align: center;"><b>Y</b> <b>YOUTH MODEL</b></p> <p>THIS ATV IS FOR RECREATIONAL USE BY YOUNG OPERATORS <b>UNDER ADULT SUPERVISION</b></p> <p><b>OPERATOR ONLY - NO PASSENGERS</b></p> <p>THIS CATEGORY ATV HAS BEEN DESIGNED TO BE USED UNDER LIMITED/RESTRICTED MAXIMUM SPEED</p> <hr/> <p style="text-align: center;"><b>DS90/DS90X</b> <b>(NO OPERATOR UNDER AGE 10)</b> <b>RESTRICTED MAXIMUM SPEED:</b> 24 Km/h (15MPH) (FACTORY SET-UP) <b>*UNRESTRICTED MAXIMUM SPEED: 48 Km/h (30MPH)</b> (SET UNDER CLOSE PARENT SUPERVISION/JUDGMENT) A CATEGORY Y-10+ IS A YOUTH MODEL</p> <hr/> <p>TRAINING COURSE TO TEACH ATV RIDING SKILLS ARE AVAILABLE. FOR INFORMATION CONTACT YOUR DEALER.</p> <p>CHECK WITH YOUR DEALER TO FIND OUT ABOUT STATE OR LOCAL LAWS REGARDING ATV OPERATION.</p> <p>*See operator's guide for the procedure</p> <p style="text-align: center;"><b>THIS HANGTAG IS NOT TO BE REMOVED BEFORE SALE.</b></p>	      
---	---

704905262

TYPICAL

<p><b>VEHICLE ENGINE DESCRIPTION:</b></p> <p><b>XXXXX</b></p> <p><b>EPA CERTIFIED</b></p> <p>NER (NORMALIZED EMISSION RATE) = <input type="text" value="X"/></p> <p>ON A 0 TO 10 SCALE, 0 BEING THE CLEANEST</p> <p><b>*NOT TO BE REMOVED PRIOR TO SALE</b></p> 
---

704901107

vmo2006-005-009\_en

TYPICAL - APPLICABLE WHEN EQUIVALENT TO A MODEL CERTIFIED TO US EPA STANDARDS



## Vehicle Safety Labels

Read and understand all the safety labels on your vehicle. These labels are affixed to your vehicle for the safety of the operator or bystanders.

The safety labels on your vehicle should be considered permanent parts of the vehicle. If missing or damaged, they can be replaced free of charge. See an authorized Can-Am dealer.

**NOTE:** In the event of any discrepancy between this guide and the vehicle, the safety labels on the vehicle have precedence over the labels in this guide.

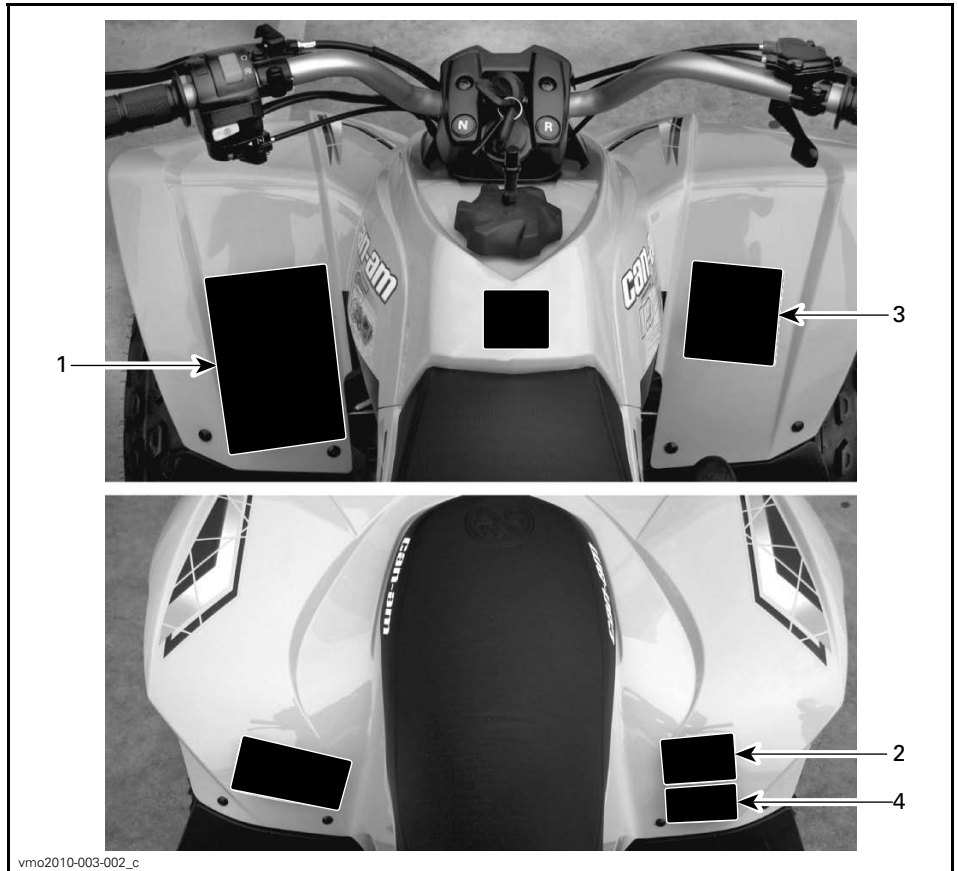

TYPICAL - LABEL LOCATIONS

Label 1

**⚠ WARNING**

- Locate and read operator's guide. Improper ATV use can result in SEVERE INJURY or DEATH. Follow all instructions and warnings.
- Always wear ear protection.
- Always use an approved helmet and protective gear.
- Never use on public roads.
- Never carry passengers.
- Never use with drugs or alcohol.

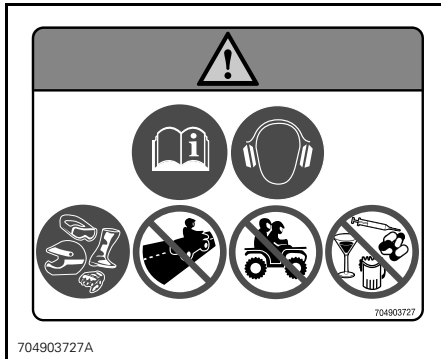

LABEL 1

Label 2

**⚠ WARNING**

- Locate and read operator's guide.
- NEVER carry a passenger.

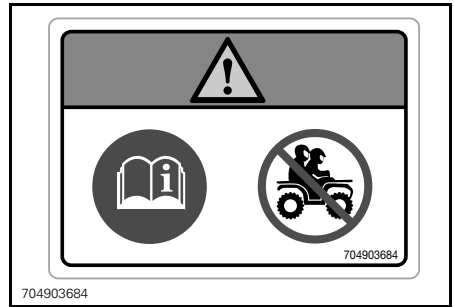

LABEL 2

Label 3

**⚠ WARNING**

Operating of this ATV if you are under the age of 10 increases your chance of SEVERE INJURY OR DEATH. NEVER operate this ATV if you are under age 10.

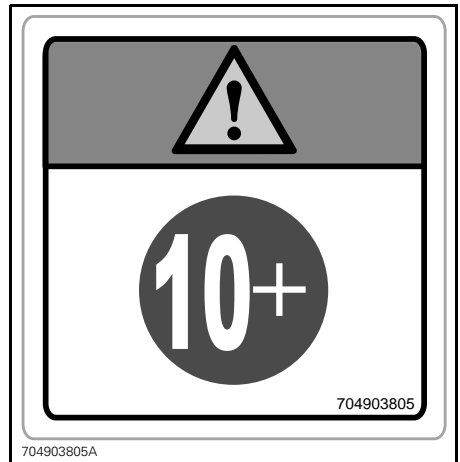

LABEL 3

Label 4

**⚠ WARNING**

- Locate and read operator's guide.
- Improper overloading or tire pressure can cause loss of control, resulting in SEVERE INJURY or DEATH.
- ALWAYS maintain proper tire pressure as shown.
- NEVER exceed the vehicle load capacity of 70 kg (150 lb), including weight of operator and accessories.

704903806A

LABEL 4

## Compliance Labels

These labels indicate vehicle's compliance.



LOCATION: LOWER RIGHT FRONT TUBE OF THE FRAME

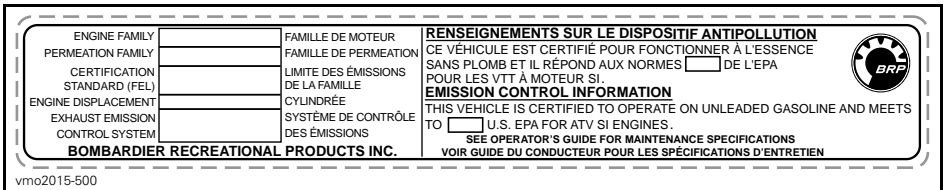

TYPICAL - APPLICABLE WHEN EQUIVALENT TO A MODEL CERTIFIED TO US EPA STANDARDS  
- LOCATION: UNDERNEATH REAR FENDER

## Technical Information Label

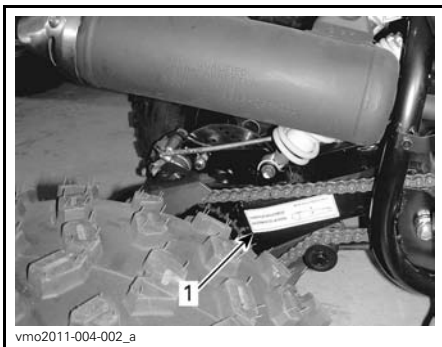
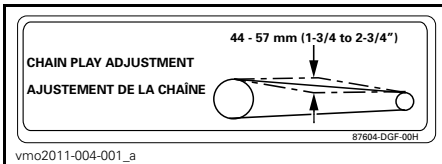

1. Chain adjustment label location

# ***VEHICLE INFORMATION***

# CONTROLS/INSTRUMENTS/EQUIPMENT



vmo2010-003-101\_b

TYPICAL

**NOTE:** This section provides basic information on the functions of the various controls of your vehicle. For more details on how to operate a control in conjunction with others, refer to *OPERATING INSTRUCTIONS* further in this section.

## 1) Throttle Lever

The throttle lever is located on the RH side of the handlebar.

When pushed forward, it increases the engine speed and allows engagement of the transmission.

When released, the engine speed should automatically return to idle and the vehicle will gradually slow down.

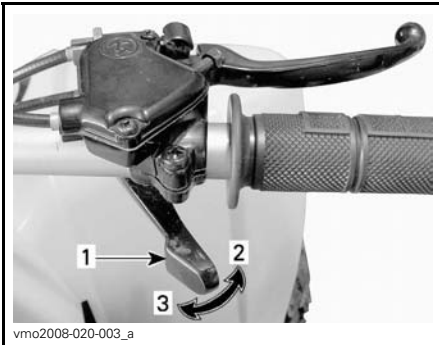

### TYPICAL

1. Throttle lever
2. To accelerate
3. To decelerate

## **⚠ WARNING**

Check throttle lever operation before you start the engine. If the throttle lever does not function smoothly, check for the cause. Correct the problem before riding the vehicle. Consult your authorized dealer if you can't find or solve the problem yourself.

## Speed Limiter

This vehicle is equipped with an adjustable speed limiter screw on the throttle lever housing. The speed limiter prevents the throttle from being fully opened, even when the throttle lever is pushed fully forward, thus limiting available engine power and therefore vehicle speed.

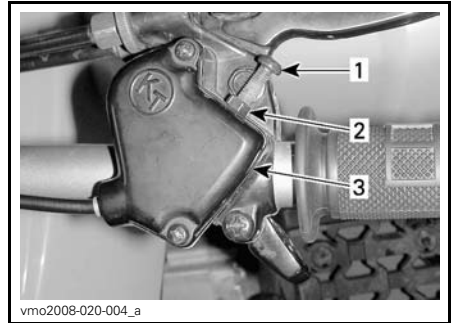

### TYPICAL

1. Speed limiter screw
2. Lock nut
3. Throttle lever cable housing

## **⚠ WARNING**

Adults should always limit the maximum restricted speed within the ability and capacity of the child to operate the vehicle safely. Never allow the child to adjust the speed limiter screw.

BRP recommends that all beginners start off with the speed limiter screw turned in while they learn.

Adults can adjust the speed limiter screw gradually to increase maximum speed as the beginner becomes more familiar with the operation of the vehicle. Refer to the following table.

SPEED SETTING	DS 70	DS 90 AND DS 90 X
Factory limited speed	16 km/h (10 MPH)	24 km/h (15 MPH)
Maximum unrestricted speed	24 km/h (15 MPH)	48 km/h (30 MPH)

**⚠ WARNING**

When traveling downhill, gravity can increase the vehicle speed above the desired maximum speed set using the speed limiter screw.

**⚠ WARNING**

Improper adjustment of the speed limiter screw could damage the throttle cable and impair throttle lever operation. Failure to follow adjustment recommendations could lead to an accident.

To adjust the speed limiter screw, loosen the lock nut, then turn the speed limiter screw accordingly. Turning the screw clockwise reduces throttle lever travel, turning the screw counter clockwise increases throttle lever travel.

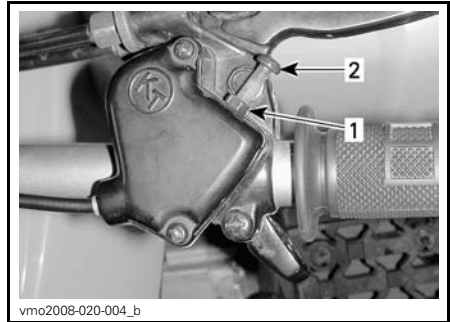

- 1. Lock nut
- 2. Speed limiter screw

To obtain maximum vehicle speed, adjust the throttle lever travel to 9 mm (11/32 in).

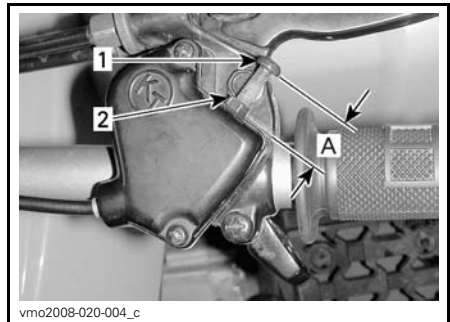

- 1. Speed limiter screw
- 2. Lock nut
- A. Maximum throttle lever travel adjustment 9 mm (11/32 in)

**2) RH Brake Lever**

The RH brake lever is located on the RH side of the handlebar.

When pulled in, the front brake is applied. When released, it should automatically return to its original position. Braking effect is proportional to the force applied on the lever.

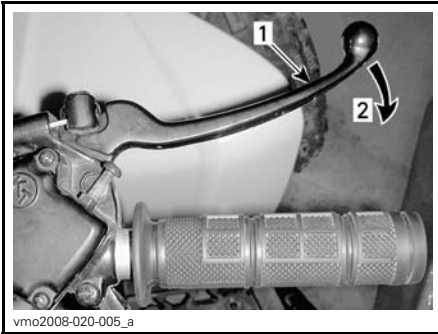

**TYPICAL**

1. Brake lever
2. To apply brake

**3) LH Brake Lever**

The LH brake lever is located on the LH side of the handlebar.

When pulled in, the rear brake is applied. When released, it should automatically return to its original position. Braking effect is proportional to the force applied on the lever.

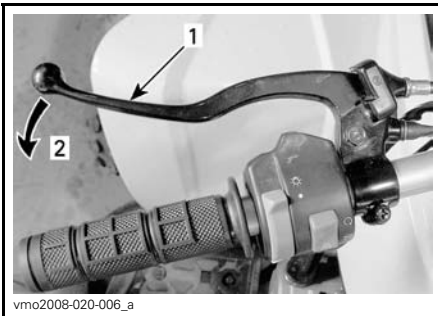
**TYPICAL**

1. Brake lever
2. To apply brake

**4) Parking Brake**

The parking brake is located on the LH side of the handlebar.

When applied, it prevents the vehicle from moving. Useful during transportation or when the vehicle is not in operation.

**⚠ WARNING**

Always use the parking brake when the vehicle is not in operation.

**⚠ WARNING**

Make sure the parking brake is fully disengaged before operating the vehicle. Riding the vehicle with a continuous pressure on the brakes may cause damage to the brake system and a loss of braking capacity and/or fire.

**To engage the parking brake mechanism:** Squeeze the LH brake lever and hold as you engage the lever lock, then release the lever against the lock. The brake lever is now held in applying the rear brake(s).

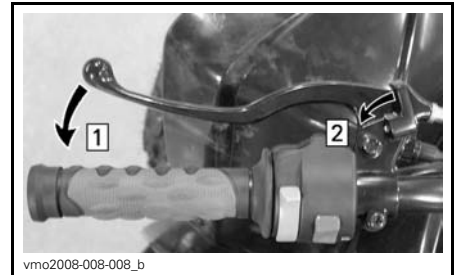
**DS 70 and DS 90****TYPICAL — LH BRAKE LEVER**

- Step 1: Squeeze brake lever and hold
- Step 2: Engage lever lock

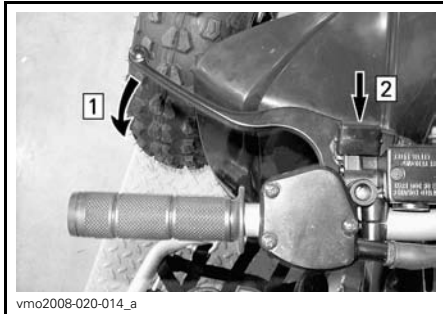
*DS 90 X Only***LH BRAKE LEVER**

Step 1: Squeeze brake lever and maintain  
Step 2: Push lever lock

**All Models**

To release the parking brake mechanism: Squeeze brake lever. Lever lock should automatically return to its original position. Brake lever should return to rest position. Always release parking brake before riding.

**5) Transmission Lever**

A 3 position transmission lever is located on the RH side of the vehicle near the engine.

**NOTICE** Always completely stop the vehicle and apply the brakes prior to moving the transmission lever.

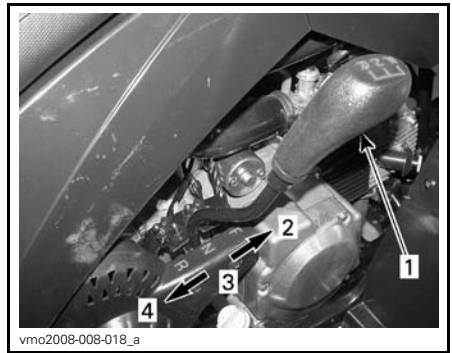
**TRANSMISSION LEVER PATTERN**

1. Transmission lever
2. Forward (F)
3. Neutral (N)
4. Reverse (R)

To change the transmission position, completely stop vehicle, apply brakes, then move lever to the desired position. Do not force lever.

**⚠ WARNING**

Before moving vehicle in reverse, ensure the path behind is clear of obstacles or bystanders. Remain seated.

**F: Forward**

It is the normal driving range. It allows the vehicle to reach its maximum speed.

**N: Neutral**

This position disengages the transmission to allow manual vehicle movement or towing.

**R: Reverse**

This allows the vehicle to go backwards.

**⚠ WARNING**

Before operating the vehicle in reverse, ensure the path behind is clear of obstacles or bystanders. BRP recommends that you remain seated. Avoid standing up. Your weight could shift forward against the throttle lever causing an unexpected acceleration and loss of control.

**6) Multifunction Switch**

The multifunction switch is located on the LH side of the handlebar.

The controls located on the multifunction switch are:

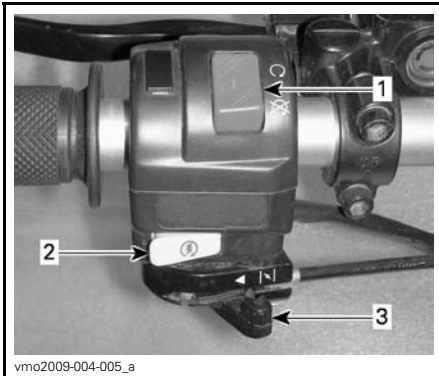

1. Emergency engine stop switch
2. Engine start button
3. Choke lever

**Emergency Engine Stop Switch**

This switch can be used to stop the engine, and as an emergency control.

While reading this Operator's Guide, remember that:

**⚠ WARNING**

Indicates a potential hazard that, if not avoided, could result in serious injury or death.

**NOTE:** While the engine can be stopped by turning the ignition key to the OFF position, we recommend the engine be stopped by setting the emergency engine stop switch to the STOP position.

To stop engine, fully release throttle lever, then set the emergency engine stop switch to the STOP position.

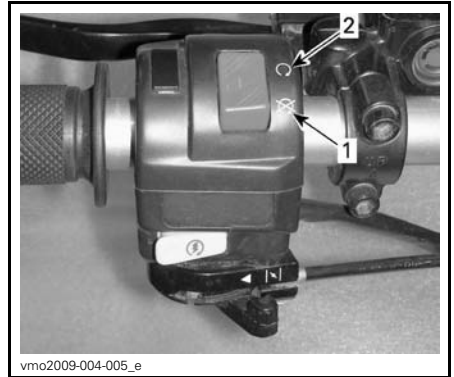
**TYPICAL - EMERGENCY ENGINE STOP SWITCH**

1. STOP position
2. RUN position

**Engine Start Button**

To start engine, place the emergency engine stop switch to the RUN position.

Press and hold LH brake lever.

Press and hold the engine start button. Release immediately after engine is started.

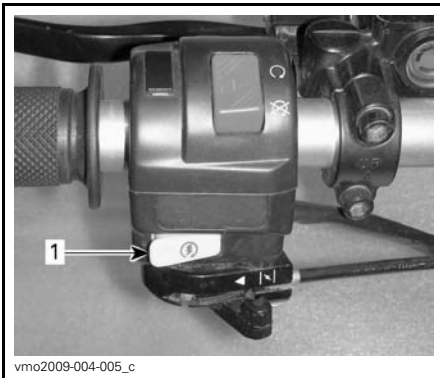

1. Engine start button

### Choke Lever

This device features a variable position lever used to ease starting a cold engine.

The OFF position is used when the engine is warm.



OFF POSITION

The full choke position is used when the engine is cold.



FULL CHOKE POSITION

The other positions between OFF and FULL will be used depending on the engine temperature.

### 7) Indicator Lamps

The indicator lamps are located near the middle of the handlebar.

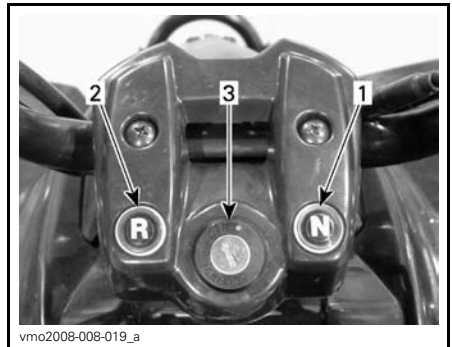

#### TYPICAL

1. Neutral (N)
2. Reverse (R)
3. Ignition switch

### Neutral Lamp (GREEN)

 When lit, it indicates the transmission is in neutral position.

## Reverse Lamp (RED)



When lit, it indicates the transmission is in reverse position.

## 8) Ignition Switch

The ignition switch is located in the middle of the handlebar.

It is a key-operated, 2 position switch: OFF and ON.

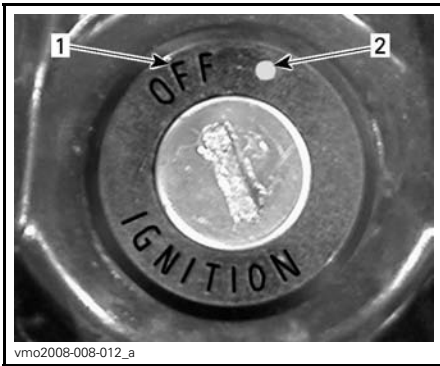

**IGNITION SWITCH**

1. OFF position
2. ON position

Insert key in switch and turn to ON position. To remove key, turn key to OFF position then pull it out.

**NOTE:** While the engine can be stopped by turning ignition key to OFF position, we recommend the engine be stopped using the emergency engine stop switch. Always turn ignition switch to OFF position after engine has been stopped.

While reading this Operator's Guide, remember that:

### **WARNING**

Indicates a potential hazard that, if not avoided, could result in serious injury or death.

## 9) Fuel Valve

The fuel valve is located on the LH side of the vehicle near the engine.

This is a 3 position rotary valve: OFF, ON, RES (reserve). Rotate the valve to align its arrow to the desired position.



**LH SIDE OF VEHICLE**

1. Align this arrow toward the desired position

**NOTICE** Improper opening of fuel valve will restrict the flow of fuel. Make sure valve is fully opened when engine is running.

### **OFF**

Stops fuel supply to carburetor.

**NOTICE** Turn fuel valve to OFF position as soon as the engine is stopped.

### **ON**

Allows fuel to flow to carburetor. This is the normal position for operation of the vehicle.

## RES (Reserve)

When the normal supply of fuel in the tank is used up (ON position), an emergency supply of fuel is available by turning the valve to RES. Use the RES position only when the ON supply is empty.

When in reserve, refuel as soon as possible. Be sure to turn the valve back to the ON position after refueling.

## 10) Seat Latch

Located under the rear fender, near rear bumper. It allows the removal of the seat to provide access to the engine compartment. Pull knob to release seat. Pull knob to release seat.



TYPICAL

1. Seat release knob

## Seat Removal

Pull latch while gently lifting rear of seat. Pull seat rearward then remove it.

## Seat Installation

Insert front tabs of seat into frame hooks. When seat rests in its position, firmly push seat down to latch.

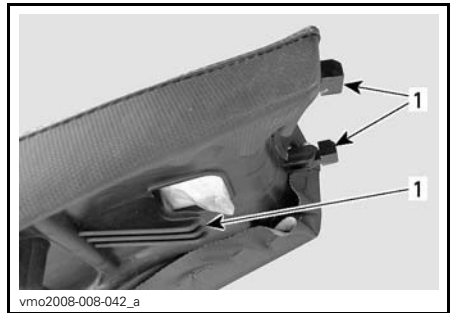

1. Seat tabs

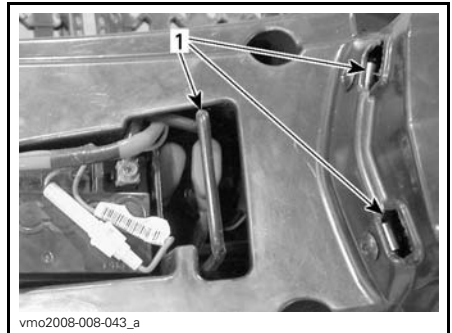

1. Hooks

## **⚠ WARNING**

Make sure seat is securely latched before riding.

## 11) Tool Kit

Located underneath the seat over the engine compartment, the tool kit contains tools for basic maintenance.

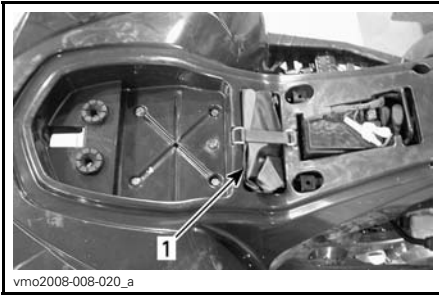

vmo2008-008-020\_a

1. Tool kit

## 12) Front Storage Compartment

A convenient area to carry personal articles.

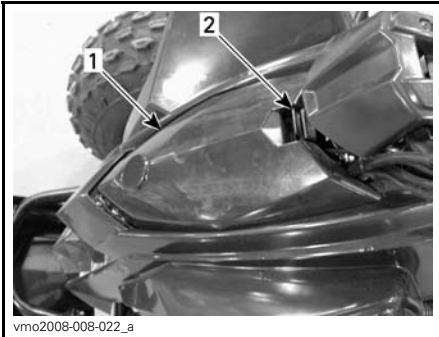

vmo2008-008-022\_a

TYPICAL

1. Front storage compartment
2. Cover latch

To open storage compartment cover, gently pull and hold latch while lifting cover.



vmo2008-008-023\_a

TYPICAL

### **⚠ WARNING**

When engine is running, always engage the NEUTRAL position on the transmission lever and apply parking brake before opening cover. Never leave any heavy or loose breakable object in the storage compartment. Always latch cover before riding.

While reading this Operator's Guide, remember that:

### **⚠ WARNING**

Indicates a potential hazard that, if not avoided, could result in serious injury or death.

# FUEL

## Fuel Requirements

**NOTICE** Always use fresh gasoline. Gasoline will oxidize; the result is loss of octane, volatile compounds, and the production of gum and varnish deposits which can damage the fuel system.

Alcohol fuel blending varies by country and region. Your vehicle has been designed to operate using the recommended fuels, however, be aware of the following:

- Use of fuel containing alcohol above the percentage specified by government regulations is not recommended and can result in the following problems in the fuel system components:
  - Starting and operating difficulties.
  - Deterioration of rubber or plastic parts.
  - Corrosion of metal parts.
  - Damage to internal engine parts.
- Inspect frequently for the presence of fuel leaks or other fuel system abnormalities if you suspect the presence of alcohol in gasoline exceeds the current government regulations.
- Alcohol blended fuels attract and hold moisture which may lead to fuel phase separation and can result in engine performance problems or engine damage.

## Recommended Fuel

Use common unleaded gasoline with an AKI (R+M)/2 octane rating of 87, or an RON octane rating of 92.

**NOTICE** Never experiment with other fuels. Engine or fuel system damages may occur with the use of an inadequate fuel.

**NOTICE** Do NOT use fuel from fuel pumps labeled E85.

Use of fuel labeled E15 is prohibited by U.S. EPA Regulations.

## Fueling Procedure

### WARNING

- Do not allow children to put fuel in the vehicle.
- Always stop engine before refueling. Open cap slowly.
- If a differential pressure condition is noticed (whistling sound heard when loosening fuel tank cap) have vehicle inspected and/or repaired before further operation.
- Fuel vapors are flammable and explosive under certain conditions.
- Never use an open flame to check fuel level.
- Never smoke or allow a flame or spark in the vicinity.
- Always work in a well-ventilated area.
- Never top off the fuel tank before placing the vehicle in a warm area. As temperature increases, fuel expands and may overflow.
- Always wipe off any fuel or oil spillage from the vehicle.

1. Stop engine.
2. Do not allow anyone to remain seated on the vehicle while fuelling.



3. Unscrew fuel tank cap counter-clockwise to remove.

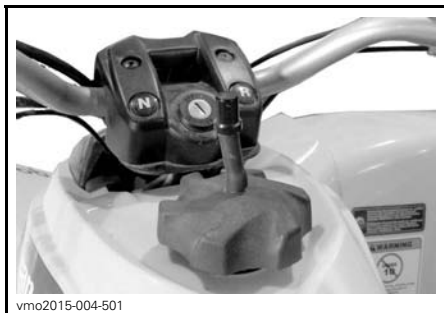

*TYPICAL — FUEL TANK CAP*

4. Insert the spout in the filler neck.
5. Pour fuel slowly to allow time for the air in the tank to escape and prevent fuel flow back. Be careful not to spill fuel.
6. Stop fuelling when the fuel reaches the bottom of filler neck. **Do not overfill.**
7. Fully tighten fuel tank cap clockwise.

---

# BREAK-IN PERIOD

## Operating During Break-In

A break-in period of 10 operating hours is required before running the vehicle at sustained full throttle.

After the break-in period, the vehicle should be inspected by an authorized Can-Am dealer, repair shop or person of your own choosing. Refer to *MAINTENANCE* section.

- Avoid pulling a load
- Avoid high speed cruising.

## Engine

During the break-in period:

- Avoid full throttle operation.
- Maximum throttle should not exceed 3/4.
- Avoid sustained accelerations.
- Avoid prolonged cruising speeds.
- Avoid engine overheating.

However, brief accelerations and speed variations contribute to a good break-in.

## Brakes

### **WARNING**

The new brakes will not perform to their maximum efficiency until their burnishing is completed. To achieve a good burnishing, bring the vehicle to a complete stop for a minimum of 50 times using brakes. Readjust brakes if needed, refer to *FRONT BRAKE CABLE ADJUSTMENT* and *REAR BRAKE LEVER ADJUSTMENT*.

## Belt

A new belt requires a break-in period of 50 km (30 mi).

During the break-in period:

- Avoid strong accelerations and decelerations

# OPERATING INSTRUCTIONS

## Starting the Engine (Basic Procedure)

### **⚠ WARNING**

Always proceed with the pre-ride inspection as described in the *SAFETY INFORMATION* section prior to operating the vehicle. Always check for proper operation of critical controls, safety features and mechanical components before starting.

Transmission lever must be set to NEUTRAL.

Insert key in ignition switch and turn to ON position.



vmo2008-008-024\_a

**TYPICAL — TURN TO ON POSITION**

1. Ignition key

Set the emergency engine stop switch to the RUN position.



vmo2009-004-005\_b

1. Emergency engine stop switch
2. STOP position
3. RUN position

Refer to ***USING THE CHOKE TO START THE ENGINE*** section.

Press and hold LH brake lever.

Press the engine start button and hold until engine starts.

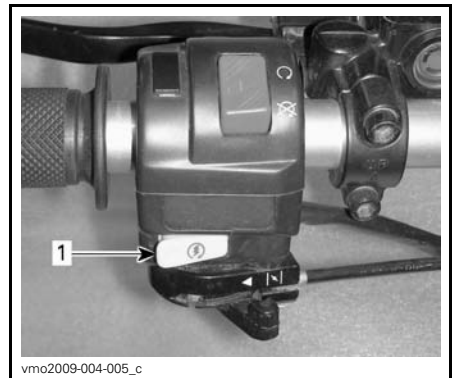

vmo2009-004-005\_c

1. Engine start button

**NOTICE** Do not hold start button more than 10 seconds. A rest period should be observed between cranking cycles to allow starter cool down. Pay attention not to discharge battery.

**NOTE:** Throttle assist may be used to help start the engine faster. Press the throttle lever slightly; if it is pressed too much, the choke system will not be activated.

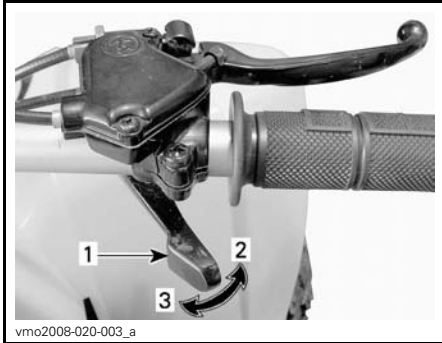

**TYPICAL**

1. Throttle lever
2. To accelerate
3. To decelerate

Release the engine start button immediately after the engine has started and then release brake.

**Emergency Manual Starting**

Manual start is provided in the event electric start does not work.

Follow the starting procedure previously described but instead of using the electric starter, use the kick start pedal.

To start engine, gently press pedal down until the kick starter mechanism engagement is felt, then kick down with a rapid follow through motion.

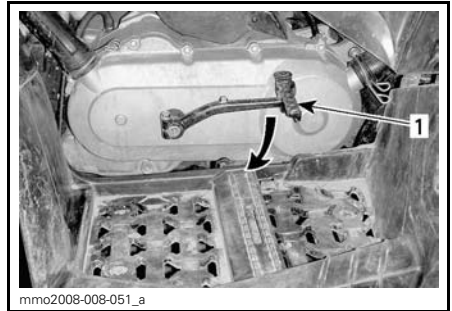

**TYPICAL**

1. Kick start pedal

Repeat this procedure completely if necessary.

**Using the Choke to Start the Engine**

**Cold Weather (Below 0°C (32°F))**

In temperatures below 0°C (32°F), place choke lever in full choke position (100%).



**FULL CHOKE POSITION**

After engine starts, adjust choke lever until optimal engine RPM is achieved.

**NOTE:** Overusing the choke may flood the engine and make it hard to start. Refer to *TROUBLESHOOTING* if this occurs.

## Cold Weather (Above 0°C (32°F))

In temperatures above 0°C (32°F), place choke lever at 75% of full choke position.

After engine starts, leave choke at 75% for 20 seconds and then set choke lever to off position.



vmo2009-004-005\_d

OFF POSITION

## Warm Engine Starting

No choke is needed.

## Stopping the Engine

### **⚠ WARNING**

Avoid parking on a slope.

Release throttle and completely stop the vehicle.

Apply the parking brake.

Set transmission lever to the FORWARD position.

Set the emergency engine stop switch to the STOP position.

Turn ignition key to OFF position.

Turn fuel valve to OFF position.

Remove key from ignition switch.

## Shifting the Transmission

Let engine idle to warm up.

Apply brakes and set the transmission selector lever to "F" (forward), or "R" (reverse).

Release brakes.

### **⚠ WARNING**

Make sure the parking brake is fully disengaged before operating the vehicle.

**NOTICE** When changing from forward to reverse, or vice-versa, always completely stop the vehicle and apply the brake prior to moving the transmission lever.

**NOTE:** The engine will stop if any shifting is done at high RPM.

# TUNE YOUR RIDE

## Suspension Adjustment

### **⚠ WARNING**

Suspension adjustment could affect vehicle handling. Always take time to familiarize yourself with the vehicle's behavior after any suspension adjustment has been made.

### **⚠ WARNING**

Left and right front shock adjustment must always be set to the same position. Never adjust one shock only. Uneven adjustment can cause poor handling and loss of stability, which could lead to an accident.

### Spring Preload Adjustment

Shorten the springs for a firmer ride and rough road condition.

Lengthen the springs for a softer ride and smooth road condition.

Adjust by turning adjustment cam or ring accordingly. Use tool from vehicle tool kit.



**DS 70 AND DS 90 — FRONT SUSPENSION**

1. Front spring
2. Turn adjusting cam

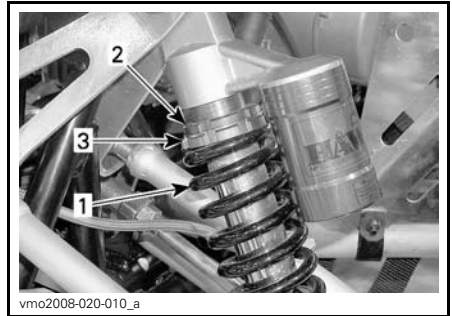

**DS 90 X — FRONT SUSPENSION**

1. Front spring
2. Loosen locking ring
3. Turn adjustment ring

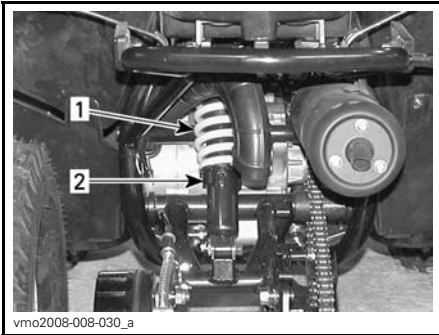
**DS 70 AND DS 90 — REAR SUSPENSION**

1. Rear spring
2. Turn adjusting cam

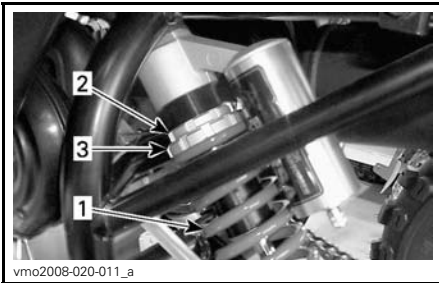
**DS 90 X — REAR SUSPENSION**

1. Rear spring
2. Loosen locking ring
3. Turn adjustment ring

While reading this Operator's Guide, remember that:

**⚠ WARNING**

Indicates a potential hazard that, if not avoided, could result in serious injury or death.

# VEHICLE TRANSPORTATION

When transporting this vehicle, secure it to a trailer using suitable tie-downs. Use of ordinary ropes is not recommended.

## **⚠ WARNING**

Do not tow this vehicle behind a car or other vehicle. Use a trailer. Never tip this vehicle on end for transporting. The vehicle must be in its normal operating position (on all four wheels) facing towards the front of the transporting vehicle.

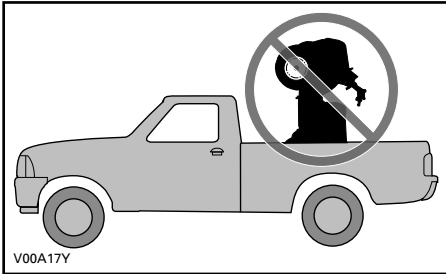

Remember to:

- Set the fuel valve to the OFF position.
- Apply the parking brake.
- Secure the front of the vehicle by the front bumper, and the rear of the vehicle by the rear bumper.

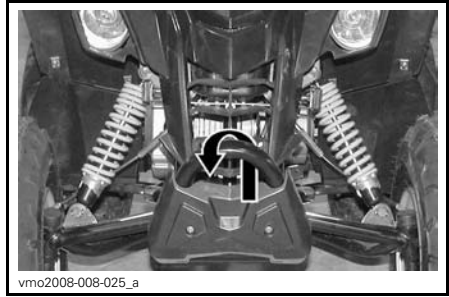

*DS 70 AND DS 90 — FRONT TIE-DOWN POINT LOCATION*

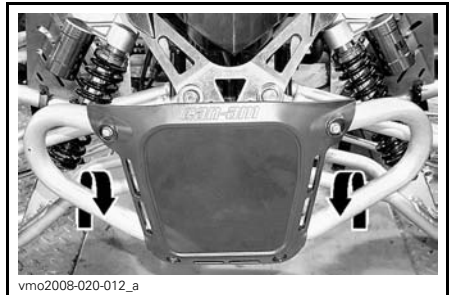

*DS 90 X — FRONT TIE-DOWN POINT LOCATION*

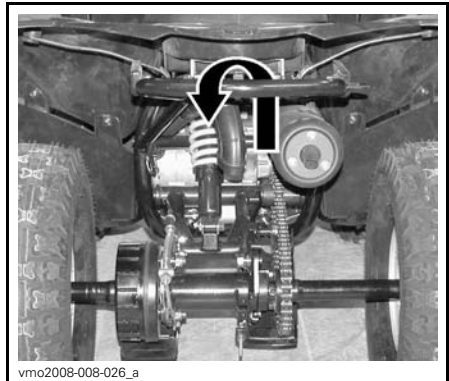

*ALL MODELS — REAR TIE-DOWN POINT LOCATION*

**NOTICE** Securing vehicle at other locations may damage the vehicle.



# ***MAINTENANCE***

---

# FIRST INSPECTION

This vehicle should be serviced after the first 5 hours or 100 km (62 mi) of operation, whichever comes first, by an authorized Can-Am dealer, repair shop or person of your own choosing. The first inspection is very important and must not be neglected.

**NOTE:** The first inspection is at the expense of the vehicle owner.

---

Date of inspection

---

Signature of the Authorized Can-Am dealer,  
repair shop, or person

---

Name of the Authorized Can-Am dealer,  
repair shop, or person

FIRST INSPECTION
Replace engine oil
Inspect valve clearance. Adjust if needed.
Inspect fuel lines and connections
Inspect throttle cable/housing. Adjust if needed.
Inspect carburetor
Inspect idle speed
Inspect spark plug. Adjust if needed.
Inspect battery and battery voltage
Inspect CVT air inlet/outlet ducts
Inspect gearbox oil
Inspect wheel nuts/studs
Inspect handlebar fasteners
Inspect brake system

---

## MAINTENANCE SCHEDULE

Maintenance is very important for keeping your vehicle in safe operating condition. The vehicle should be serviced as per maintenance schedule.

A repair shop or person of the owner's choosing may maintain, replace, or repair emission control devices and systems. These instructions do not require components or service by BRP or authorized Can-Am dealers. Although an authorized Can-Am dealer has an in-depth technical knowledge and tools to service the Can-Am ATV, the emission-related warranty is not conditioned on the use of an authorized Can-Am dealer or any other establishment with which BRP has a commercial relationship. For emission-related warranty claims, BRP is limiting the diagnosis and repair of emission-related parts to the authorized Can-Am dealers. For more information, please refer to the *US EPA EMISSION-RELATED WARRANTY* contained herein. Proper maintenance is the owner's responsibility. A warranty claim may be denied if, among other things, the owner or operator caused the problem through improper maintenance or use.

You must follow the instructions for fuel requirements in the fueling section of this manual. Even if gasoline containing greater than ten volume percent ethanol is readily available, the US EPA issued a prohibition against the use of gasoline containing greater than 10 vol% ethanol that applies to this vehicle. The use of gasoline containing greater than 10 vol% ethanol with this engine may harm the emission control system.

The maintenance schedule does not exempt the pre-ride inspection.

### **WARNING**

Failure to properly maintain the vehicle according to the maintenance schedule and procedures can make it unsafe to operate.

## SEVERE DUSTY CONDITIONS

### Engine Air Filter Maintenance Guideline

Air filter maintenance should be adjusted according to riding conditions.

Air filter maintenance must be increased in frequency in the following dusty conditions:

- Riding on dry sand
- Riding on dry dirt covered surfaces
- Riding on dry gravel roads or similar conditions.

**NOTE:** Riding in a group in these conditions would increase even more the air filter maintenance.

## MAINTENANCE SCHEDULE

Make sure to perform proper maintenance at recommended intervals as indicated in the tables. Some items of the maintenance schedule must be performed in function of the calendar, regardless of the distance or time of operation.

**WEEKLY**

Inspect and clean air filter (more often under dusty conditions)

Inspect and clean air injection valve filter (more often under dusty conditions)

**MONTHLY**

Inspect throttle cable/housing. Adjust if needed

Inspect battery

Inspect wheel bolts

Inspect and clean CVT air inlet/outlet ducts

Inspect and adjust brake system (hydraulic brakes are self-adjusting and require no adjustment)

Replace engine oil (every 3 months or 40 hours)

Inspect idle speed (every 6 months)

Inspect crankcase breather system (every 6 months)

Inspect, clean and adjust carburetor (models outside Canada/United States only) (every 6 months)

Lubricate steering knuckles (DS 70 and DS 90) (every 6 months)

**EVERY 100 HOURS OR ONCE A YEAR  
(whichever comes first)**

Clean engine oil strainer

Replace air filter (more often under dusty conditions)

Replace air injection valve filter (more often under dusty conditions)

Adjust valve clearance

Clean spark arrester

Inspect exhaust system

Inspect fuel lines and connections

Lubricate throttle cable/housing

Replace spark plug

Inspect drive chain and sprockets

Inspect wheel bearings

**EVERY 100 HOURS OR ONCE A YEAR  
(whichever comes first)**

Inspect drive belt

Inspect, clean and lubricate drive and driven pulleys

Inspect handlebar fasteners

Lubricate steering shaft

Inspect steering system

Inspect suspension system

Inspect brake pads/shoe

**EVERY 200 HOURS OR 2 YEARS  
(whichever comes first)**

Replace fuel filter

Replace gearbox oil

Replace brake fluid (DS 90 X)

# MAINTENANCE PROCEDURES

This section includes instructions for basic maintenance procedures.

## **⚠ WARNING**

Turn off the engine and follow these maintenance procedures when performing maintenance. If you do not follow proper maintenance procedures you can be injured by hot parts, moving parts, electricity, chemicals or other hazards.

## **⚠ WARNING**

Should removal of a locking device be required (e.g. lock tab, self-locking fastener, etc.), always replace it with a new one.

## Engine Oil

### Engine Oil Level

**NOTICE** Check level frequently and adjust as necessary. Do not overfill. Operating the engine with an improper level may severely damage engine. Wipe off any spillage.

**NOTE:** While checking the oil level, visually inspect engine area for leaks.



TYPICAL — RH SIDE OF ENGINE

1. Dipstick

With vehicle on a level surface, start engine and let it run for several minutes, then stop engine and check the oil level as follows:

1. Unscrew dipstick, remove it and wipe it clean.
2. Reinstall dipstick and **screw it in completely.**
3. Remove dipstick and check oil level. It should be near or equal to the upper mark.

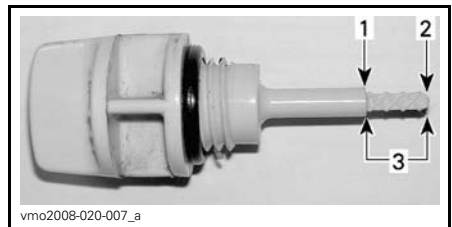

1. Full
2. Add
3. Operating range

To add oil, remove dipstick. Place a funnel in the dipstick hole to avoid spillage.

Add a small amount of oil and recheck oil level.

Repeat until oil level reaches the dipstick's upper mark. **Do not overfill.**

Completely tighten dipstick.

### Recommended Engine Oil

For the summer season, use XPS 4-STROKE SYNTH. BLEND OIL (P/N 293 600 121).

For the winter season, use XPS 4-STROKE SYNTHETIC OIL (P/N 293 600 112).

**NOTE:** The XPS oil is specially formulated and tested for the severe requirements of this engine.

If XPS engine oil is not available, use 4-stroke SAE 5W30 engine oil that meets or exceeds the requirements for API service classification SM, SL or SJ. Always check the API service label on the oil container, it must contain at least one of the above standards. Refer to the viscosity chart for details.

### Engine Oil Viscosity Chart

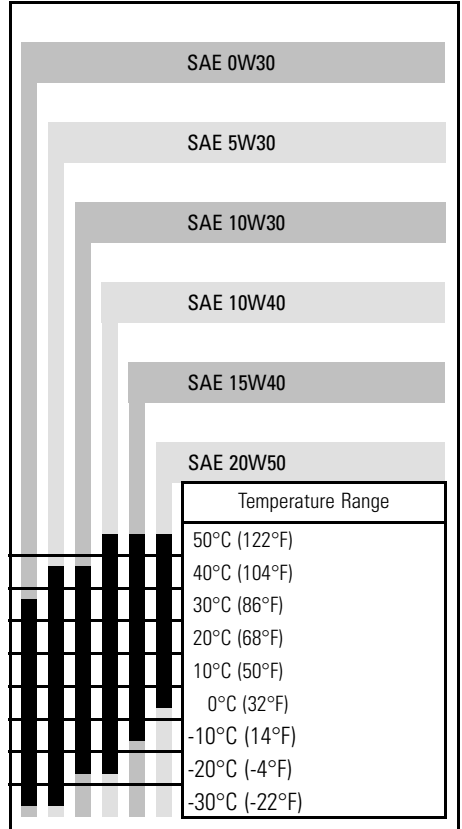

### Engine Oil Change

The oil change should be carried out on a warm engine.

**⚠ CAUTION** Engine oil can be very hot. In order to avoid potential burns, do not remove the engine drain plug if the engine is hot. Wait until the engine oil is warm. Always wear appropriate skin and eye protection. Chemicals can cause skin rash and eye injury.

Ensure vehicle is on a level surface.

Remove dipstick.

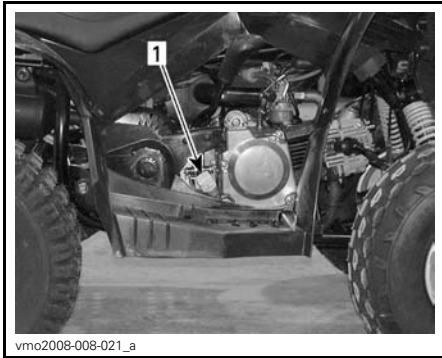

**TYPICAL — RH SIDE OF ENGINE**  
1. Dipstick

Clean the drain plug area.

Place a drain pan under the engine drain plug area.

Unscrew drain plug.



**LH SIDE OF ENGINE**  
1. Drain plug

Allow sufficient time for all the oil to flow out of the engine.

Clean oil strainer, refer to *OIL STRAINER* in this subsection.

Wipe off any oil spillage on engine.

Reinstall oil strainer, spring, and O-ring.

Install and torque strainer cover to  $42\text{ N}\cdot\text{m} \pm 4\text{ N}\cdot\text{m}$  ( $31\text{ lbf}\cdot\text{ft} \pm 3\text{ lbf}\cdot\text{ft}$ ).

Clean drain plug washer and check its condition, replace it if necessary.

Clean engine and drain plug contact surfaces, then reinstall drain plug and torque it to  $22.0\text{ N}\cdot\text{m} \pm 2.2\text{ N}\cdot\text{m}$  ( $16\text{ lbf}\cdot\text{ft} \pm 2\text{ lbf}\cdot\text{ft}$ ).

Refill engine with the specified quantity of recommended engine oil. Refer to *SPECIFICATIONS* for capacity.

Start engine and let idle for a few minutes. Ensure oil strainer and drain plug areas are not leaking.

Stop engine. Wait a few minutes to allow the oil to flow down into the crankcase, then recheck oil level. Adjust oil level if necessary.

Dispose of the used oil as per your local environmental regulations.

## Oil Strainer

### Oil Strainer Cleaning

Remove oil strainer and spring for cleaning (if necessary), refer to *MAINTENANCE SCHEDULE* for details.

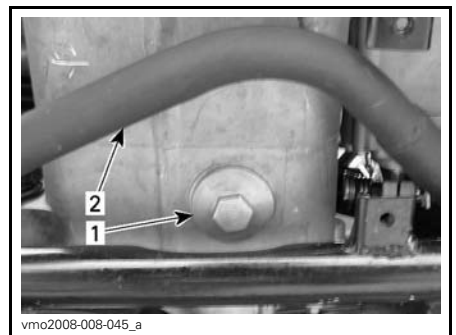

**UNDERNEATH ENGINE**  
1. Oil strainer cover  
2. Exhaust pipe



To clean oil strainer, use a solvent, then dry using compressed air.

**⚠ CAUTION** Always wear appropriate skin and eye protection. Chemicals can cause skin rash and eye injury.

**NOTE:** Check cover O-ring and replace it if necessary.

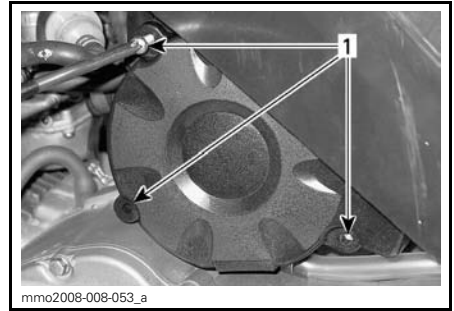

1. Screws

Remove air filter from housing.

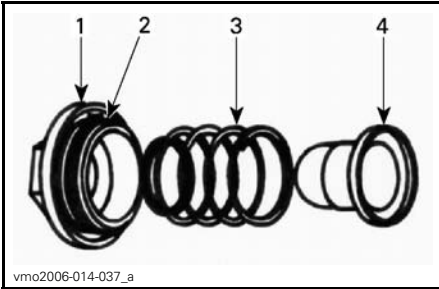

**TYPICAL**

- 1. Cover
- 2. O-ring
- 3. Spring
- 4. Strainer



1. Air filter

## Air Filter

### Air Filter Location

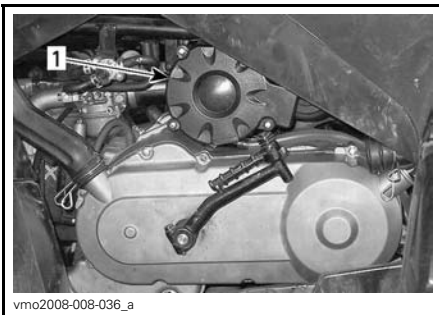

1. Air filter

### Air Filter Removal

Remove air filter box cover.

### Air Filter Maintenance and Replacement

For light maintenance on air filter, compressed air can be used to remove dust from air filter.

For any other condition, replace air filter.

**NOTICE** Engine performance degradation or severe damage can occur if the air filter is not properly maintained and/or replaced.

### Air Filter Installation

Installation is the reverse of removal procedure. Pay attention to ensure proper filter positioning in housing.



## Air Filter Housing

### Air Filter Housing Draining

Periodically inspect air filter housing drain tube for liquids or deposits.

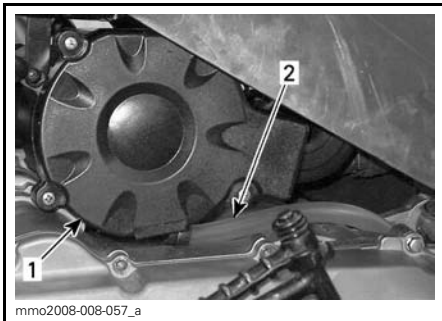

1. Air filter housing
2. Drain tube

**NOTE:** If vehicle is used in dusty areas, inspect more frequently than specified in *MAINTENANCE SCHEDULE*.

If liquids/deposits are found, squeeze and remove the clamp. Pull drain tube plug out and empty tube.

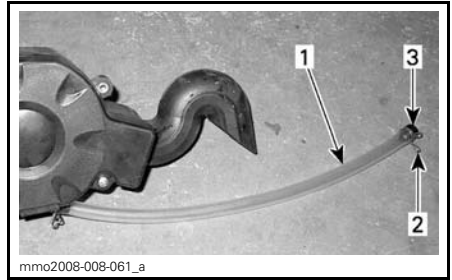

1. Drain tube
2. Clamp
3. Plug

**NOTICE** Do not start engine when liquids/deposits are found in the drain tube.

When liquids or deposits are found, air filter and housing must be inspected, dried or replaced depending on its condition.

## Air Injection Valve

### Air Injection Valve Location

Air injection valve is located on the LH side of the vehicle underneath front fender.



1. Air injection valve

### Air Injection Valve Cleaning

**NOTE:** Clean cover before removing. Remove cover retaining screws.

Remove air injection valve cover.

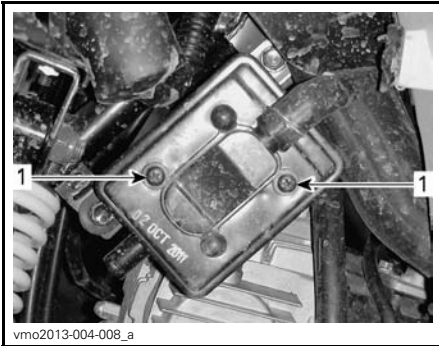

1. Remove screws

Remove filter from air injection valve.

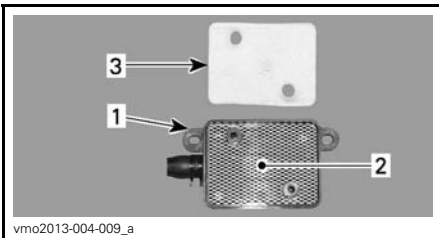

**TYPICAL**

1. Air injection valve
2. Screen
3. Air filter

Clean air filter and inside of air injection valve using pressurized air.

**NOTE:** If the air filter is still dirty, replace it with a new one.

When finished, properly reinstall removed parts in the reverse order of their removal.

## Spark Arrester

### Spark Arrester Cleaning

The muffler must be periodically purged of accumulated carbon.

## **⚠ WARNING**

Never perform this operation immediately after the engine has been run because exhaust system is very hot. Wear eye protection and gloves. Respect all applicable laws and regulations.

Remove muffler cover (if applicable).

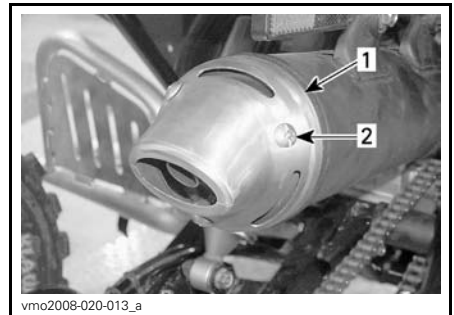

**DS 90 X**

1. Muffler cover
2. Remove screws

Remove the spark arrester from the muffler.

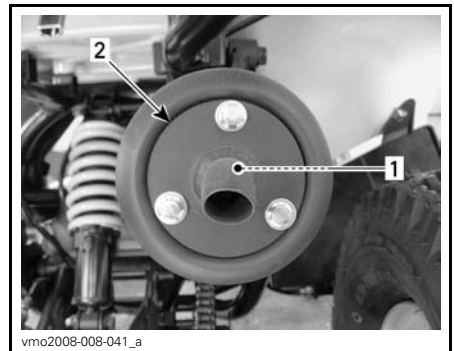

1. Spark arrester
2. Muffler tip

Remove carbon deposits from the spark arrester using a brush.

**NOTE:** Use a soft brush and be careful to avoid damaging spark arrester.

Reinstall the spark arrester in muffler.

Reinstall muffler cover (if applicable).

## CVT Cover

### CVT Cover Draining

Whenever you suspect that water has entered the CVT cover, drain the CVT housing by removing the drain tube plug.



LH SIDE OF VEHICLE

1. Drain tube
2. Clamp
3. Plug
4. Engine drain plug

## Gearbox Oil Level

There is no dipstick provided with this vehicle, the gear box oil level cannot be checked.

The only way to ensure the level is correct is to drain the gearbox and refill it with the specified quantity of the recommended gearbox oil. Refer to *GEARBOX OIL CHANGE* for procedure.

## Gearbox Oil Change

Place the vehicle on a level surface.

Remove the air filter housing from the vehicle.

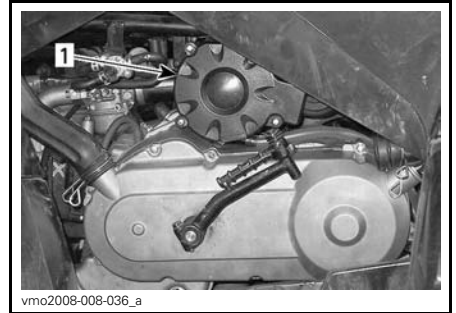

1. Air filter housing

## Gearbox Oil

### Recommended Gearbox Oil

Use 165 ml (6 U.S. oz) of XPS CHAIN-CASE OIL (P/N 415 129 500) or an equivalent SAE 75W90 chaincase oil).

**NOTICE** Do not use other types of oil when servicing the gearbox.

While reading this Operator's Guide, remember that:

### **⚠ WARNING**

Indicates a potential hazard that, if not avoided, could result in serious injury or death.

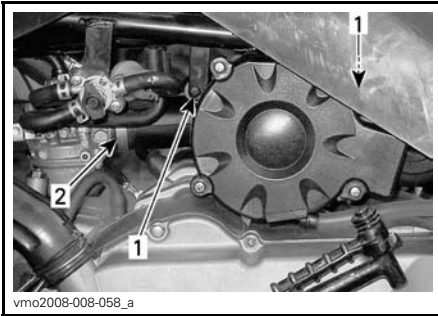

1. Remove screws
2. Loosen clamp



**REMOVE AIR FILTER HOUSING**

Clean gearbox drain plug and oil filler plug area, then remove the gearbox drain plug and washer.

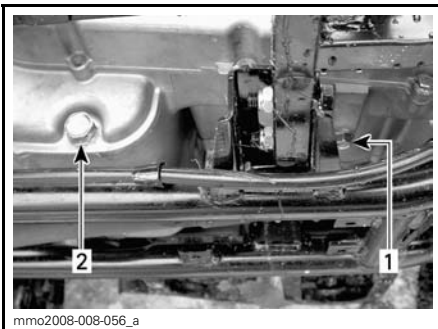

**DRAIN PLUG — LH SIDE OF ENGINE**

1. Gearbox drain plug
2. Engine oil drain plug

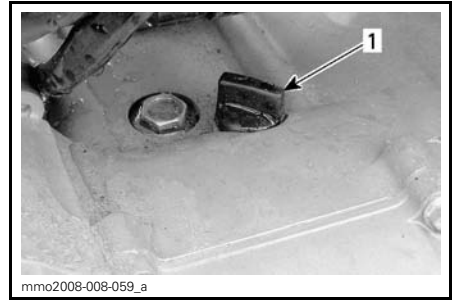

**FILL PLUG — LH SIDE OF ENGINE**

1. Gearbox oil filler plug

Allow enough time for oil to flow out of gearbox.

Reinstall drain plug and washer and torque to  $16.0 \text{ N}\cdot\text{m} \pm 1.6 \text{ N}\cdot\text{m}$  ( $142 \text{ lbf}\cdot\text{in} \pm 14 \text{ lbf}\cdot\text{in}$ ).

Remove gearbox oil filler plug and re-fill gearbox using 165 ml (6 U.S. oz) of XPS CHAINCASE OIL (P/N 415 129 500) or an equivalent SAE 75W90 chaincase oil.

**NOTICE** There is no dipstick provided with this vehicle to check gearbox oil level. Be sure gearbox is completely drained before replenishing it with the specified amount of recommended oil.

**NOTICE** Do not use other types of oil when servicing the gearbox.

Reinstall oil filler plug.

Reinstall all other removed parts.

**Throttle Cable**

**Throttle Cable Inspection**

Inspect throttle cable for excessive wear, kinking or fraying. Ensure cable moves freely.

**NOTICE** The throttle cable must be replaced if any signs of wear, fraying or other damages are found.

## Throttle Cable Lubrication

Lubricate cable using a silicone-based cable lubricant to reduce premature wear and to ensure proper movement of the cable.

### **⚠ WARNING**

Always use a silicone-based lubricant. Using another lubricant (such as a water-based lubricant) could cause the throttle lever/cable to stick or become stiff.

## Throttle Cable Adjustment

Check throttle lever free-play, adjust if necessary.

**NOTE:** If correct adjustment is unattainable, see an authorized Can-Am dealer.

The normal throttle free-play is 5 mm to 10 mm (.197 in to .394 in).

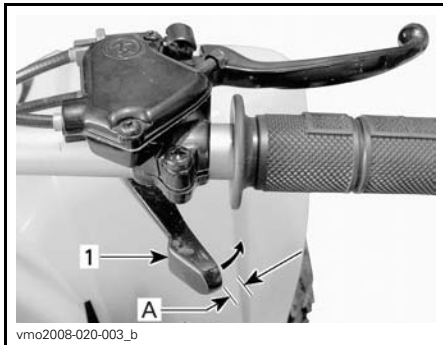

**TYPICAL — NORMAL FREE-PLAY**

1. Throttle lever

A. Free play

### THROTTLE FREE PLAY

5 mm to 10 mm (.197 in to .394 in)

## DS 70

There are 2 cables to adjust:

- Cable A: From throttle lever to throttle limiter box
- Cable B: From throttle limiter box to engine

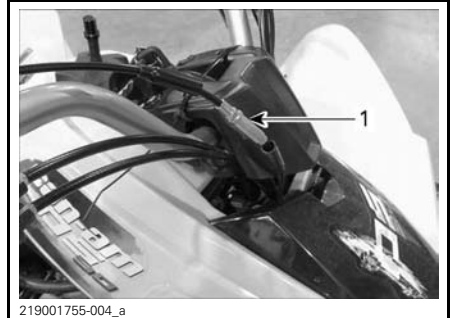

**ADJUSTMENT FROM THROTTLE LEVER TO THROTTLE LIMITER BOX**

1. Cable A

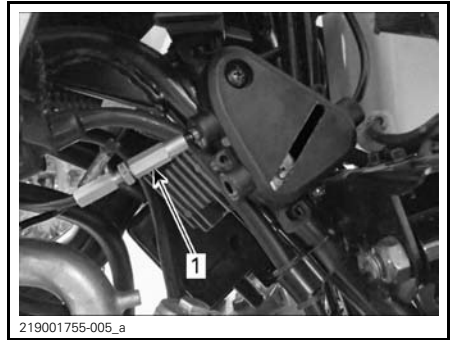

**ADJUSTMENT FROM THROTTLE LIMITER BOX TO ENGINE**

1. Cable B

Adjust both cables A and B to the fully closed position.

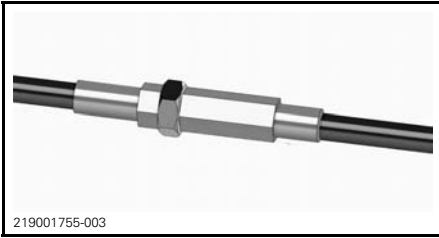

FULLY CLOSED POSITION

Start the engine.

Adjust cable B until engine RPM starts to increase.

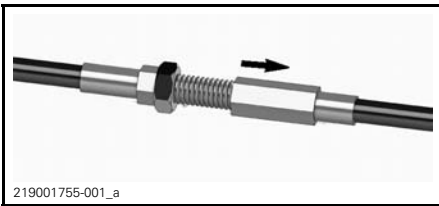

UNSCREW ADJUSTER NUT

Bring back adjuster nut from cable B by one turn.

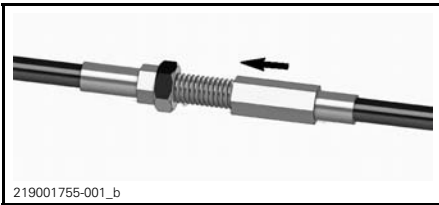

BRING BACK ADJUSTER NUT BY ONE TURN

Tighten lock nut in place.

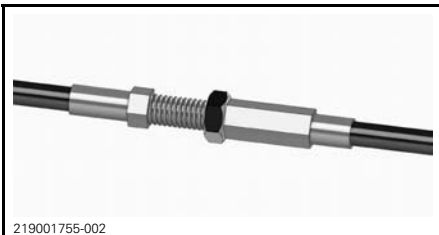

LOCKED POSITION

Once cable B is correctly adjusted, repeat procedure for cable A.

Stop the engine.

### DS 90 and DS 90 X

To adjust cable, slide rubber protector back to expose throttle cable adjuster.

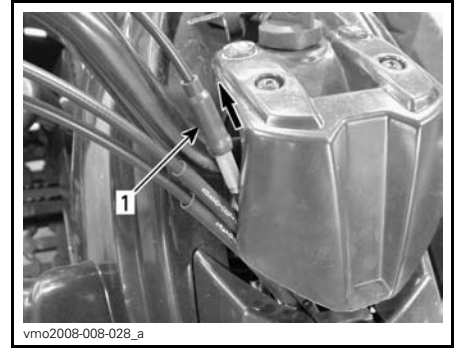

1. Rubber protector

Loosen lock nut and turn the adjuster to obtain proper adjustment.

**NOTE:** Measure throttle free play at the tip of throttle lever.

Tighten locking nut and reinstall protector.

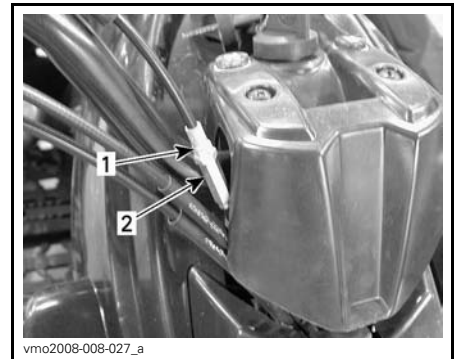

1. Lock nut  
2. Adjuster

With the transmission lever set to NEUTRAL position, start the engine.

### All models

Check if the throttle cable is adjusted correctly by turning handlebar fully to the right, then fully to the left. If the engine RPM increases, readjust the throttle lever free play. Ensure throttle cable is properly routed and not binding on anything when the handlebar is turned.

## Spark Plug

### Spark Plug Location



TYPICAL — RH SIDE OF VEHICLE

1. Spark plug

### Spark Plug Removal

Disconnect spark plug cable from spark plug.

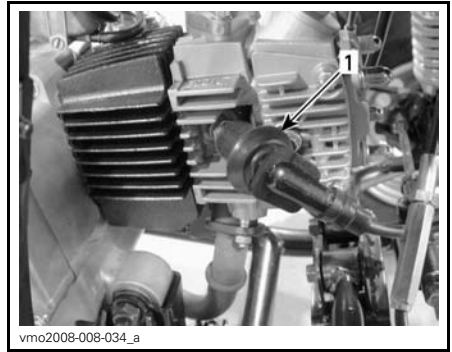

1. Spark plug cable

Unscrew spark plug one turn.



1. Spark plug

If possible, clean spark plug and cylinder head with pressurized air.

**⚠ CAUTION** Always wear safety goggles when using pressurized air.

Unscrew and remove spark plug completely.

### Spark Plug Installation

Prior to installation, make sure the contact surface of the cylinder head and spark plug is free of grime.

Using a feeler gauge, set the spark plug gap between 0.6 mm to 0.7 mm (.024 in. to .028 in.).



Apply anti-seize lubricant over spark plug threads to prevent a possible seizure.

Screw spark plug into cylinder head by hand and tighten with a torque wrench and proper socket.

Torque spark plug to  $11.0 \text{ N}\cdot\text{m} \pm 1.1 \text{ N}\cdot\text{m}$  ( $97 \text{ lbf}\cdot\text{in} \pm 10 \text{ lbf}\cdot\text{in}$ ).

## Battery

To access the battery, remove the seat.

### Battery Maintenance

**CAUTION** Never charge a battery while installed in vehicle.

**NOTICE** Never remove the battery sealing cap.

These vehicles are equipped with a VRLA battery (Valve Regulated Lead Acid). It is a maintenance-free type battery, there is no need to add water to adjust electrolyte level.

Clean battery post with a wire brush. Apply dielectric grease on post to protect against oxidation.

### Battery Inspection

Inspect battery connections for tightness and cleanliness.

Inspect battery support.

### Battery Removal

**CAUTION** Always respect this order for disassembly; disconnect BLACK (-) cable first.

Disconnect BLACK (-) cable first, then RED (+) cable.

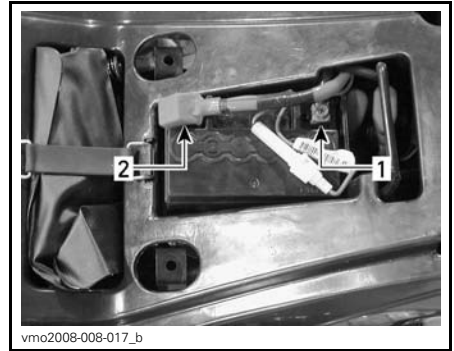

1. BLACK (-)
2. RED (+)

Remove battery from vehicle.

### Battery Cleaning

Clean battery, battery casing, cables and battery posts using a solution of baking soda and water.

Remove corrosion from battery cable terminals and battery posts using a firm wire brush. Battery top should be cleaned using a soft brush and any grease-cutting soap or baking soda solution.

Apply DIELECTRIC GREASE (P/N 293 550 004) or an equivalent on battery posts to protect against oxidation.

### Battery Installation

Reinstall battery in vehicle.

**NOTICE** Always reconnect RED (+) cable first, then the BLACK (-) cable.

## Fuse

### Fuse Replacement

**NOTICE** Do not use a higher rated fuse as this can cause severe electrical system component damage.

The electrical system is protected by a single 15 amp fuse.

If the fuse is open circuit (or burnt), replace it with a fuse of the same rating. An in-line fuse holder is located on the RED (+) battery cable.



vmo2008-008-017\_a

1. Fuse holder

To replace the fuse, slightly press the 2 halves of the fuse holder together as you twist them in a counterclockwise direction.

## Lights

### Daytime Running Light Bulb Replacement

*DS 70 and DS 90*

**⚠ CAUTION** Always turn the ignition switch to the OFF position before replacing a defective bulb.

Always check light operation after replacement.



vmo2008-008-038\_a

**REMOVE RUBBER PROTECTOR**

1. Rubber protector

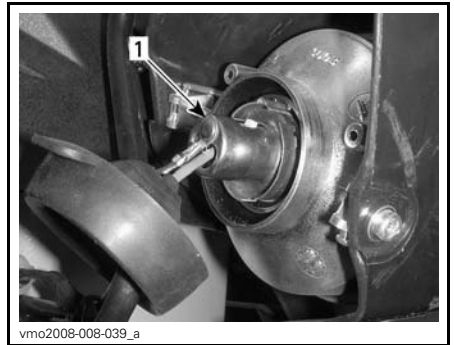

vmo2008-008-039\_a

**PUSH AND TURN BULB HOLDER  
COUNTERCLOCKWISE**

1. Bulb holder

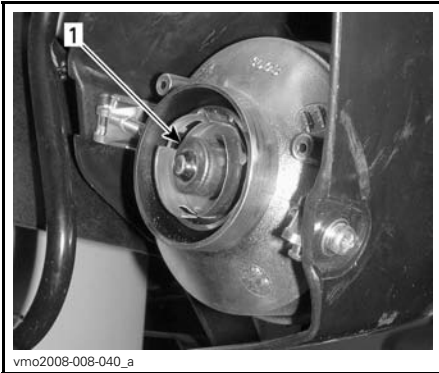

**PULL ON BULB TO REMOVE THEN REPLACE BULB**

1. Bulb

## Drive Chain and Sprockets

### Drive Chain and Sprocket Inspection

**NOTICE** Replace chain and sprockets together to prevent rapid wear of these components.

**NOTICE** Never operate this vehicle with the drive chain too loose or too tight as severe damage to the drive components can occur.

### Drive Chain

Inspect the chain for damaged links and rollers.

Replace chain if any damage is found.

Check the free-play of drive chain and adjust if necessary. Refer to *DRIVE CHAIN ADJUSTMENT*.

### Roller

Inspect the drive chain roller around swing arm pivot member for excessive wear and damage. Replace if necessary.

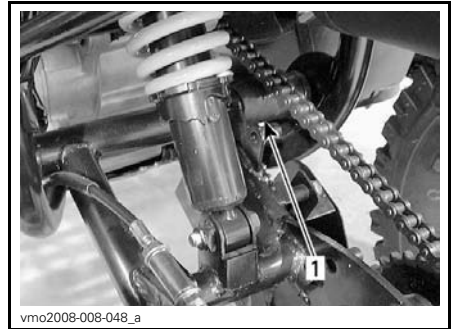

1. Drive chain roller

### Sprockets

Check the sprocket axle and pinion for distortion, excessive wear or other damages. Replace if necessary.

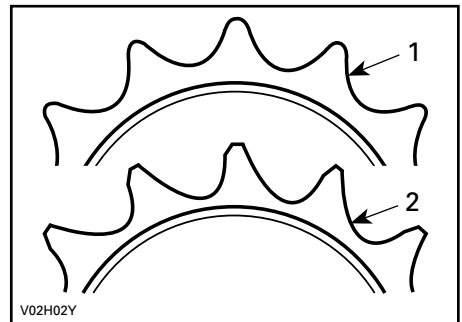

1. Good
2. Replace

### Drive Chain Lubrication

The drive chain should be checked for proper lubrication before each ride.

Lubricate using commercial chain lubricant.

### Drive Chain Adjustment

The drive chain should be checked for proper adjustment before every ride.

**NOTICE** Never adjust the drive chain with the driver seated on the vehicle. Remove any load on the vehicle.

1. Place vehicle on a level surface and set transmission to NEUTRAL.
2. Check drive chain condition.
3. Loosen drive axle locking bolts.

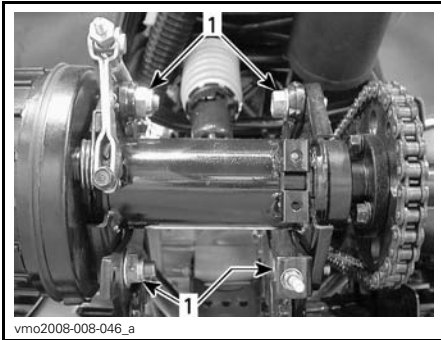

**TYPICAL — REAR AXLE**

1. Locking bolts

4. Loosen chain adjuster lock nut.
5. On models equipped with a chain tensioner, lift and hold the chain tensioner off the chain to release chain tension until the chain adjustment is completed.
6. Turn chain adjuster nut until proper adjustment is obtained.



**TYPICAL**

1. Chain adjuster
2. Chain adjuster lock nut
3. Chain adjuster nut

The drive chain deflection should be between 44 mm to 57 mm (1.7 in to 2.2 in) up and down.

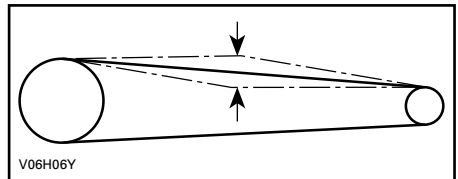

**FREE-PLAY: 44 MM TO 57 MM  
(1.7 IN TO 2.2 IN)**

7. When properly adjusted, tighten chain adjuster lock nut.
8. Then, tighten drive axle locking bolts to  $69 \text{ N}\cdot\text{m} \pm 7 \text{ N}\cdot\text{m}$  (51  $\text{lb}\cdot\text{ft} \pm 5 \text{ lb}\cdot\text{ft}$ ).
9. On models equipped with a chain tensioner, release the chain tensioner back onto the chain.

## Tires and Wheels

### Tire Pressure

#### **⚠ WARNING**

Tire pressure greatly affects vehicle handling and stability. Low pressure may cause tire to deflate and rotate on wheel. Overpressure may burst the tire. Always follow recommended pressure. NEVER set tire pressure below minimum. It could cause the tire to dislodge from the rim. Since tires are low-pressure types, a manual pump should be used.

Check pressure when tires are cold before using the vehicle. Tire pressure changes with temperature and altitude. Recheck pressure if one of these conditions has changed.

For your convenience, a pressure gauge is supplied in the tool kit.

TIRE PRESSURE	
FRONT AND REAR	
MINIMUM	25 kPa (3.6 PSI)
MAXIMUM	35 kPa (5 PSI)

Although the tires are specifically designed for off-road use, a flat may still occur. Therefore, it is recommended to carry a tire pump and a repair kit.

### Tire and Wheel Condition

Occasionally, wheel bolts should be removed to apply anti-seize lubricant to ease future removal. This is particularly important when vehicle is used in a salt-water environment or in mud.

Remove one nut at a time, lubricate it, then install and retorque it.

Check tires and rims for damage and wear.

Replace if necessary.

### Wheel Bearing Condition

Push and pull on the top of each wheel to check for free play. See an authorized Can-Am dealer if any free play is felt.

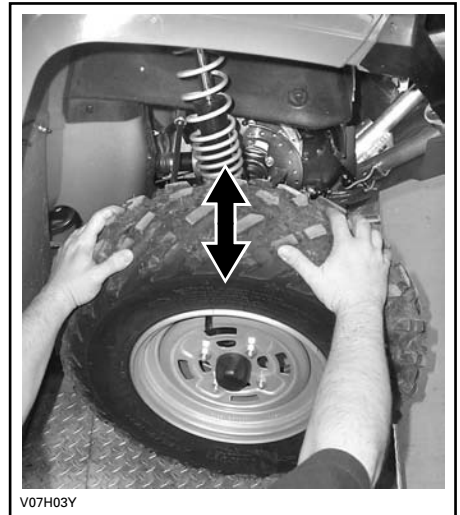

TYPICAL

### Wheel Removal and Installation

Loosen but do not remove wheel lug nuts. Lift vehicle and place a support under vehicle. Remove wheel lug nuts, then remove wheel.

At installation, it is recommended to apply LOCTITE 767 (ANTISEIZE LUBRICANT) (P/N 293 800 070) on the threads of the wheel mounting studs. Gently tighten nuts in a criss-cross sequence, then apply the specified torque.

RECOMMENDED PRODUCT	
LOCTITE 767 (ANTISEIZE LUBRICANT) (P/N 293 800 070)	
WHEEL LUG NUTS TORQUE	
Front and rear	40 N•m ± 4 N•m (30 lbf•ft ± 3 lbf•ft)

## Steering System

### Front Knuckle Lubrication

#### *DS 70 and DS 90*

Lubricate front knuckles. Use SUSPENSION GREASE (P/N 293 550 033) or an equivalent. The knuckle is fitted with a grease fitting.



#### TYPICAL

- Grease fitting

## Suspension Lubrication

### Rear Suspension

Lubricate swing arm pivots. Use synthetic SUSPENSION GREASE (P/N 293 550 033) or an equivalent.

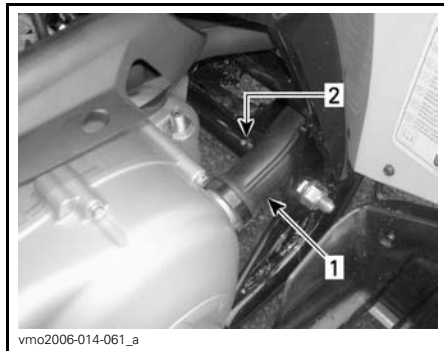

#### LH SIDE OF VEHICLE

- CVT duct
- Grease fitting

## Mechanical Brakes (DS 70 and DS 90)

### Mechanical Brake Inspection

#### **⚠ WARNING**

Any brake system repair should be performed by an authorized Can-Am Dealer.

**⚠ CAUTION** The brakes can be very hot after prolonged use of the vehicle and can cause burns. Wait for the brakes to cool down.

While reading this Operator's Guide, remember that:

#### **⚠ WARNING**

Indicates a potential hazard that, if not avoided, could result in serious injury or death.

Check brake lever free-play (both levers), adjust if necessary.

Check for lever operation, they should move freely and have a firm feel when brakes are applied.

If correct adjustment is unattainable, see an authorized Can-Am dealer for cable replacement.

Inspect brake cables for excessive wear, kinking or fraying.

Replace any cable that show signs of wear, fraying or other damages.

Lubricate cables using a silicone-based lubricant to reduce premature wear and to ensure proper movement of the cable.

**⚠ WARNING**

Always use a silicone-based lubricant. Using any other lubricant (such as a water-based lubricant) may cause the brake cables to stick or become stiff.

Have your authorized Can-Am dealer inspect brake shoes for wear or damage.

BRAKE SHOE MINIMUM THICKNESS	
FRONT AND REAR	1.5 mm (.06 in)

See your authorized Can-Am dealer if a problem is detected concerning the brake system.

**Front Brake Cable Adjustment**

Fully tighten all adjustment screws on brake cables.

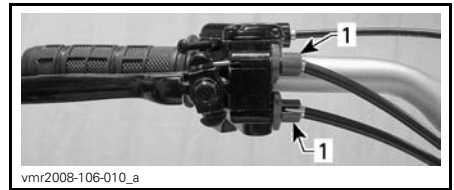

1. Adjustment screws on lever

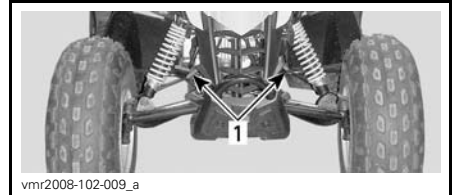

1. Adjustment screws on cables

Press brake lever.

Adjust cable link so it is parallel to cable support. Turn adjustment screws on cable (not at lever) as required.

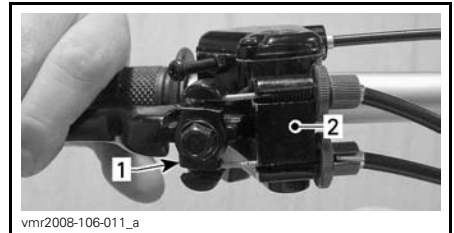

1. Cable link  
2. Cable support

Using adjustment screws on lever, adjust cable free-play.

BRAKE CABLE ADJUSTMENT	
FREE-PLAY	10mm to 12mm (.4 in to .5 in)

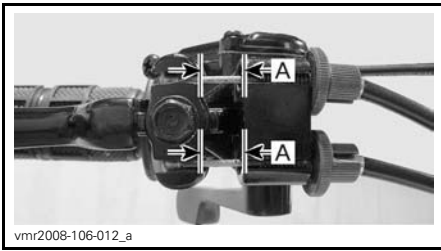

A. 10 mm to 12 mm (.4 in to .5 in)

Tighten all adjustment screw locks.

### Rear Brake Lever Adjustment

Position the vehicle on a level surface.

Block front wheels.

Shift the transmission to neutral position.

Raise the rear of vehicle until rear wheel are off the ground. Support the vehicle securely.

Manually rotate the rear wheels and tighten the nut of the brake cable adjuster until a drag, light but obvious, is felt.

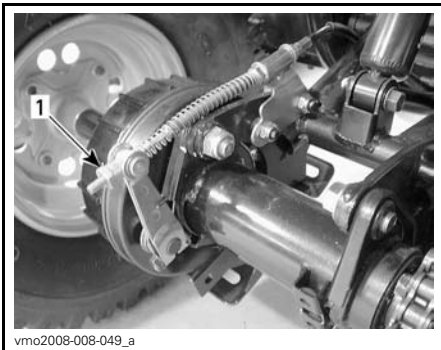

1. Brake cable adjuster

Squeeze completely the rear brake lever a few times and verify if the brake drag is still present and light. Readjust the brake cable until the brake drag remains stable.

Verify if the brake lever works properly and that it comes back to its original position.

Lower the vehicle on the ground.

## Hydraulic Brakes (DS 90 X)

### **! WARNING**

New brakes will not perform to their maximum efficiency until after their initial break-in is complete. Use extra caution.

### Hydraulic Brake Inspection

### **! WARNING**

Brake fluid replacement or brake system maintenance and repairs should be performed by an authorized Can-Am dealer.

**! CAUTION** The brakes can be very hot after prolonged use of the vehicle. Wait for the brakes to cool down.

The braking system is a hydraulic type and no adjustment is required.

Check the following to maintain the brake system in a good operating condition:

- Brake fluid level
- Brake system for fluid leaks
- Brake for spongy feel
- Brake cleanliness
- Brake discs for excessive wear and surface condition
- Brake pads for wear, damage or looseness.

Have your authorized Can-Am dealer inspect brake pads for wear or damage.



BRAKE PAD MINIMUM THICKNESS	1 mm (.039 in)
-----------------------------------	----------------

See your authorized Can-Am dealer if a problem is detected concerning the brake system.

**Recommended Brake Fluid**

Always use brake fluid meeting the specification DOT 4 only.

**NOTICE** To avoid serious damage to the braking system, do not use fluids other than the recommended one, nor mix different fluids for topping up.

**Brake Fluid Level**

Brake fluid reservoirs are located on the handlebar above brake levers.



vmr2008-101-003

LH REAR BRAKE FLUID RESERVOIR

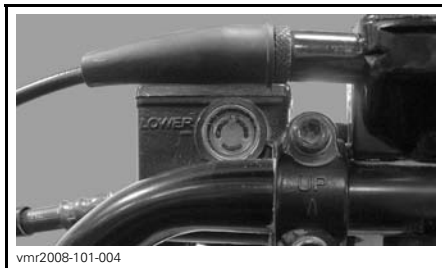

vmr2008-101-004

LH FRONT BRAKE FLUID RESERVOIR

Turn steering in the straight-ahead position to ensure reservoirs are levelled.

With vehicle on a level surface, check brake fluid in reservoirs for proper level. They should be above the MIN. mark.

**NOTE:** The reservoir is full when the fluid reaches the top of the window.

Add fluid as required. **Do not overfill.**

Clean filler cap before removing.

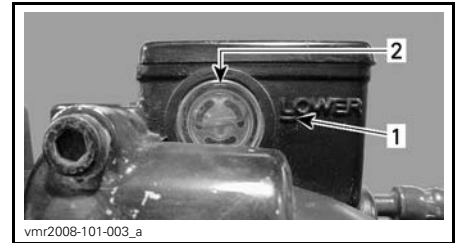

vmr2008-101-003\_a

**TYPICAL**

- 1. Minimum
- 2. Maximum

**NOTICE** Use only DOT 4 brake fluid from a sealed container. Do not use brake fluid taken from old or already opened containers.

**NOTE:** A low level may indicate leaks or worn brake pads. See an authorized Can-Am dealer.

Visually inspect lever boot condition. Check for cracks, tears, or other damages. Replace if damaged.

Repeat the same procedure for the other reservoir.

**Frame**

**Frame Fasteners**

Check fastener condition and tightness on the vehicle. Retighten as required.

---

# VEHICLE CARE

## Post-Operation Care

When the vehicle is used in a salt-water environment, rinsing the vehicle with fresh water is necessary to preserve the vehicle and its components. Lubrication of metal parts is highly recommended. Use XPS LUBE (P/N 293 600 016).

This must be performed at the end of each day of operation.

When the vehicle is operated in muddy conditions, rinsing the vehicle is recommended to preserve the vehicle and its components, and to keep the daytime running lights clean. See *VEHICLE CLEANING AND PROTECTION*.

## Vehicle Cleaning and Protection

**NOTICE** Wash vehicle with warm water and soap. Never use a high pressure washer to clean these vehicles. **USE LOW PRESSURE ONLY** (such as a garden hose). High pressure can cause electrical and mechanical damage.

Painted parts which are damaged should be properly repainted to prevent rust.

When required, wash the body parts using warm water and a mild detergent. Apply a non-abrasive wax.

**NOTICE** Never clean plastic parts with a strong detergent, de-greasing agent, paint thinner, acetone, etc.

While reading this Operator's Guide, remember that:

### **WARNING**

Indicates a potential hazard that, if not avoided, could result in serious injury or death.

---

## STORAGE AND PRESEASON PREPARATION

### **WARNING**

Have an authorized Can-Am dealer inspect the fuel system integrity as specified in *MAINTENANCE SCHEDULE*.

When a vehicle is not in use for more than four months, proper storage is a necessity.

When using your vehicle after storage, a post storage preparation is required.

See an authorized Can-Am dealer, repair shop, or person of your own choosing to have your vehicle prepared for either storage or the preseason.



# ***TECHNICAL INFORMATION***

# VEHICLE IDENTIFICATION

The main components of your vehicle (engine and frame) are identified using different serial numbers. It may sometimes become necessary to locate these numbers for warranty purposes or to trace your vehicle in the event of loss. These numbers are also required by the authorized Can-Am dealer to complete warranty claims properly. We strongly recommend that you take note of all the serial numbers on your vehicle and supply them to your insurance company.

## Vehicle Identification Number Location



TYPICAL — FRONT OF VEHICLE

1. VIN

## Engine Identification Number Location

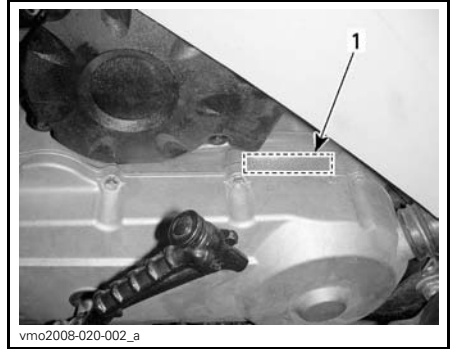

LH SIDE OF VEHICLE

1. EIN

---

# **NOISE EMISSION CONTROL SYSTEM REGULATION (CANADA/UNITED STATES)**

## **Tampering with a Noise Control System Is Prohibited!**

U.S. Federal law and Canadian provincial laws may prohibit the following acts or the causing there of:

1. The removal or rendering inoperative by any person other than for purposes of maintenance, repair or replacement of any device or element of design incorporated into any new vehicle for the purpose of noise control prior to its sale or delivery to the ultimate purchaser or while it is in use or,
2. The use of the vehicle after such device or element of design has been removed or rendered inoperative by any person.

## **Among those Acts Presumed to Constitute Tampering Are the Acts Listed Below:**

1. Removal or alteration or the puncturing of the muffler or any engine component which conducts removal of engine exhaust gases.
2. Removal or alteration or the puncturing of any part of the intake system.
3. Replacing any moving parts of the vehicle or parts of the exhaust or intake system, with parts other than those specified by the manufacturer.
4. Lack of proper maintenance.

# NOISE EMISSION AND VIBRATION VALUES (OUTSIDE CANADA/UNITED STATES)

MODEL		DS 70 DS 90 DS 90 X
NOISE EMISSION AND VIBRATION VALUES <sup>1</sup>		
Noise	Sound pressure (L <sub>pA</sub> )	80 dB @ 4000 RPM (Uncertainty (K <sub>pA</sub> ) 3 dB)
Vibration	Hand-arm system	3.41 m/s <sup>2</sup> @ 4000 RPM (Uncertainty 1.705 m/s <sup>2</sup> )
	Whole body at seat	<0.5 m/s <sup>2</sup> @ 4000 RPM
<sup>1</sup> : Noise emission and Vibration values are measured in accordance with Standard EN 15997:2011 on a paved surface, at Neutral.		



The EC-Declaration of Conformity does not appear in this version of the Operator's Guide.

Please refer to the printed version that was delivered with your vehicle.

# SPECIFICATIONS

MODEL		DS 70 DS 90 DS 90 X
<b>ENGINE</b>		
Type		4-stroke, forced air cooled
Number of cylinders		Single horizontal cylinder
Displacement		89.53 cm <sup>3</sup> (5.5 in <sup>3</sup> )
Number of valves		2
Valve clearance	Intake	0.02 mm (.0008 in)
	Exhaust	0.03 mm (.0012 in)
Starting		Electric/kick start
Engine oil	Type	For the summer season, use XPS 4-STROKE SYNTH. BLEND OIL (P/N 293 600 121). For the winter season, use XPS 4-STROKE SYNTHETIC OIL (P/N 293 600 112) If not available, use a 5W30 motor oil that meets the requirements for API service classification SG, SH, or SJ. Refer to <i>OIL VISCOSITY CHART</i>
	Capacity	Oil change with filter: 945 ml (1 qt (U.S. liq.))
<b>TRANSMISSION</b>		
Transmission		Continuously Variable Transmission (CVT)
<b>GEARBOX</b>		
Type		3 positions: Forward, Neutral and Reverse
Gearbox oil	Type	XPS CHAINCASE OIL (P/N 415 129 500) or an equivalent 75W90 chaincase oil
	Capacity	165 ml (6 U.S. oz)
<b>FUEL SYSTEM</b>		
Caburetor	Type	PTE
Idle speed		1700 ± 100 RPM
Fuel	Type	Unleaded gasoline
	Octane	87 Pump Posted AKI (92 RON) - Refer to <i>FUEL REQUIREMENTS</i>
Fuel tank	Capacity	6 L (1.6 U.S. gal.)

MODEL		DS 70 DS 90 DS 90 X
<b>ELECTRICAL</b>		
Ignition type		CDI (Capacitor Discharge Ignition)
Spark plug	Make and type	NGK CR7HSA or equivalent
	Gap	0.6 mm to 0.7 mm (.024 in to .028 in)
	Quantity	1
Battery	Type	Maintenance free
	Volt	12 volts, 4 A•h
Starting system		Electric start/kick start
Daytime running light bulb		2 x 5 W
Fuse	Main	15 A
<b>SUSPENSION</b>		
Type	Front	Independent suspension – A-arm. DS 90 X: Double A-arm
	Rear	Rigid swing arm
Travel	Front	86 mm (3.4 in) DS 90 X: 178 mm (7 in)
	Rear	160 mm (6.3 in) DS 90 X: 229 mm (9 in)
Shock absorber		Oil DS 90 X: HPG
<b>TIRES</b>		
Pressure	Front	Minimum: 25 kPa (3.6 PSI) Maximum: 35 kPa (5 PSI)
	Rear	
Size	Front	19 x 7-8 DS 90 X: 20 x 6-10
	Rear	18 x 9.5-8 DS 90 X: 18 x 10.5-8

**SPECIFICATIONS**

<b>MODEL</b>		<b>DS 70 DS 90 DS 90 X</b>
<b>WHEELS</b>		
Size	Front	8 x 5.5 DS 90 X: 10 x 5.5
	Rear	8 x 7 DS 90 X: 8 x 8.5
Wheel nut torque	Front and rear	40 N•m ± 4 N•m (30 lbf•ft ± 3 lbf•ft)
<b>BRAKES</b>		
Front		Mechanical, drum DS 90 X: hydraulic, disc
Rear		Mechanical, drum DS 90 X: hydraulic, disc
Parking device		LH brake lever with parking brake
<b>DIMENSION AND WEIGHT</b>		
Dry weight	DS 70 DS 90	111 kg (245 lb)
	DS 90 X	133 kg (293 lb)
Total vehicle load allowed		70 kg (150 lb)
Overall length		152 cm (59.8 in)
Overall width		91 cm (35.8 in) DS 90 X: 111 cm (43.7 in)
Overall height		93.5 cm (36.8 in) DS 90 X: 97 cm (38.2 in)
Wheelbase		100 cm (39.4 in) DS 90 X: 102.4 cm (40.3 in)
Ground clearance		11.5 cm (4.5 in)

# ***TROUBLESHOOTING***

---

# TROUBLESHOOTING GUIDELINES

---

## ENGINE DOES NOT CRANK

---

1. Ignition switch is in the OFF position.
  - Place switch to the ON position.
2. Burnt fuse.
  - Check main supply fuse.
3. Weak battery or loose connections.
  - Check connections and condition of terminals.
  - Have the battery checked.
  - Contact an authorized Can-Am dealer.

## ENGINE TURNS OVER BUT FAILS TO START

---

1. Emergency engine stop switch is in the OFF position.
  - Set switch to the ON position.
2. Mixture not rich enough to start cold engine.
  - Check fuel tank level and starting procedure for a cold engine, particularly use of the choke.
3. Flooded engine (spark plug wet when removed).
  - When the engine does not start after several attempts, the engine may be flooded with fuel. Proceed as follows:
    - Turn ignition switch to ON and ensure choke is not applied.
    - Fully depress throttle lever and hold while starting the engine.
    - As soon as the engine starts, release throttle lever. Do not race engine.
  - If the engine still does not start:**
    - Disconnect the spark plug cable.
    - Remove the spark plug.
    - Crank engine several times.
  - Install new spark plug if possible or clean and dry removed spark plug.
    - Start engine as explained above. If engine continues to flood, seek service from an authorized Can-Am dealer, repair shop, or person of your own choosing for maintenance, repair, or replacement. Please refer to the US EPA EMISSIONS-RELATED WARRANTY contained herein for information about warranty claims.
  - Ensure there is no fuel in the engine oil due to engine flooding, if so, replace engine oil.
4. No fuel to the engine (spark plug dry when removed).
  - Check fuel tank level; turn fuel valve to ON (also try on RES.). A failure of the fuel pump or carburetor may have occurred.
  - Seek service from an authorized Can-Am dealer, repair shop, or person of your own choosing for maintenance, repair, or replacement. Please refer to the US EPA EMISSIONS-RELATED WARRANTY contained herein for information about warranty claims.

---

**ENGINE TURNS OVER BUT FAILS TO START (cont'd)**

---

**5. Spark plug/ignition (no spark).**

- Remove spark plug from engine and reconnect it to spark plug cap.
- Ensure the ignition switch is set to ON, and the emergency engine stop switch is set to the RUN position.
- Start engine with spark plug grounded to the engine away from spark plug hole. If no spark appears, replace spark plug.
- If trouble persists, seek service from an authorized Can-Am dealer, repair shop, or person of your own choosing for maintenance, repair, or replacement. Please refer to the US EPA EMISSIONS-RELATED WARRANTY contained herein for information about warranty claims.

**6. Engine compression.**

- As the engine is rotated using the kick stater, “cycles” of resistance should be felt as the piston goes past top dead center (compression). If no pulsed resistance is felt, it suggests a major loss of compression. Contact an authorized Can-Am dealer.

---

**ENGINE LACKS ACCELERATION OR POWER**

---

**1. Fouled/damage/worn spark plug.**

- Clean/verify spark plug and heat range. Replace as required.

**2. Lack of fuel to engine.**

- Check items listed in ENGINE TURNS OVER BUT FAILS TO START.

**3. Carburetor adjustments.**

- Seek service from an authorized Can-Am dealer, repair shop, or person of your own choosing for maintenance, repair, or replacement. Please refer to the US EPA EMISSIONS-RELATED WARRANTY contained herein for information about warranty claims.

**4. Engine is overheating.**

- If the engine tends to overheat, try the following:
  - Reduce vehicle speed but maintain sufficient speed to supply cooling air to the engine. If engine is still overheating after approximately one minute, stop vehicle.
  - Apply parking brake and stop engine.
  - Let engine cool down.
  - See an authorized Can-Am dealer as soon as possible.
- If overheating persists, contact an authorized Can-Am dealer.

**5. Air filter/box clogged or dirty.**

- Check air filter and clean. If necessary replace air filter.
- Check the position of the air intake tube.

**6. CVT dirty or worn, including belt.**

- Contact an authorized Can-Am dealer.

---

**ENGINE BACKFIRE**

---

**1. Exhaust system leakage.**

- *Seek service from an authorized Can-Am dealer, repair shop, or person of your own choosing for maintenance, repair, or replacement. Please refer to the US EPA EMISSIONS-RELATED WARRANTY contained herein for information about warranty claims.*

**2. Engine is running too hot.**

- *See ENGINE LACKS ACCELERATION OR POWER.*

**3. Ignition timing is incorrect or there is an ignition system failure.**

- *Seek service from an authorized Can-Am dealer, repair shop, or person of your own choosing for maintenance, repair, or replacement. Please refer to the US EPA EMISSIONS-RELATED WARRANTY contained herein for information about warranty claims.*

**4. Improper carburetor setting.**

- *Seek service from an authorized Can-Am dealer, repair shop, or person of your own choosing for maintenance, repair, or replacement. Please refer to the US EPA EMISSIONS-RELATED WARRANTY contained herein for information about warranty claims.*

---

**ENGINE MISFIRE**

---

**1. Fouled/damaged/worn spark plug.**

- *Clean/verify spark plug and heat range. Replace as required.*

**2. Water in fuel.**

- *Drain fuel system and refill with fresh fuel.*

---

**VEHICLE CANNOT REACH FULL SPEED**

---

**1. Engine.**

- *See ENGINE LACKS ACCELERATION OR POWER.*

**2. Parking brake.**

- *Ensure brake lever lock is completely disengaged.*

**3. Air filter/box clogged or dirty.**

- *Check air filter and clean. If necessary replace air filter.*
- *Check the position of the air intake tube.*

**4. CVT dirty or worn, including belt.**

- *Contact an authorized Can-Am dealer.*

---

**THE RPM INCREASES BUT THE VEHICLE DOES NOT MOVE**

---

**1. The transmission is in NEUTRAL position.**

- *Set transmission in REVERSE or FORWARD.*



---

**THE RPM INCREASES BUT THE VEHICLE DOES NOT MOVE (cont'd)**

---

- 2. CVT is defective.**
  - *Contact an authorized Can-Am dealer.*
- 3. Water in the CVT housing.**
  - *Contact an authorized Can-Am dealer.*



# ***WARRANTY***

---

# **BRP LIMITED WARRANTY USA AND CANADA: 2017 CAN-AM® ATV**

## **1) SCOPE OF THE LIMITED WARRANTY**

Bombardier Recreational Products Inc. ("BRP")\* warrants its 2017 Can-Am ATV sold by authorized Can-Am ATV dealers (as hereinafter defined) in the United States of America ("USA") and in Canada from defects in material or workmanship for the period and under the conditions described below. This limited warranty will become null and void if: (1) the ATV was used for racing or any other competitive activity, at any point, even by a previous owner; or (2) the ATV has been altered or modified in such a way so as to adversely affect its operation, performance or durability, or has been altered or modified to change its intended use.

Non-factory installed parts and accessories are not covered under this limited warranty. Please refer to the applicable parts and accessories limited warranty text.

## **2) LIMITATIONS OF LIABILITY**

THIS WARRANTY IS EXPRESSLY GIVEN AND ACCEPTED IN LIEU OF ANY AND ALL OTHER WARRANTIES, EXPRESSED OR IMPLIED, INCLUDING WITHOUT LIMITATION ANY WARRANTY OF MERCHANTABILITY OR FITNESS FOR A PARTICULAR PURPOSE TO THE EXTENT THAT THEY CANNOT BE DISCLAIMED, THE IMPLIED WARRANTIES ARE LIMITED IN DURATION TO THE LIFE OF THE EXPRESS WARRANTY. INCIDENTAL AND CONSEQUENTIAL DAMAGES ARE EXCLUDED FROM COVERAGE UNDER THIS WARRANTY SOME STATES/PROVINCES DO NOT ALLOW FOR THE DISCLAIMERS, LIMITATIONS AND EXCLUSIONS IDENTIFIED ABOVE, AS A RESULT, THEY MAY NOT APPLY TO YOU. THIS WARRANTY GIVES YOU SPECIFIC RIGHTS, AND YOU MAY ALSO HAVE OTHER LEGAL RIGHTS WHICH MAY VARY FROM STATE TO STATE, OR PROVINCE TO PROVINCE.

Neither the distributor, any BRP dealer nor any other person has been authorized to make any affirmation, representation or warranty regarding the product, other than those contained in this limited warranty, and if made, shall not be enforceable against BRP. BRP reserves the right to modify this warranty at any time, being understood that such modification will not alter the warranty conditions applicable to the products sold while this warranty is in effect.

## **3) EXCLUSIONS – ARE NOT WARRANTED**

The following are not warranted under any circumstances:

- Normal wear and tear;
- Routine maintenance items, tune ups, adjustments;
- Damage caused by failure to provide proper maintenance and/or storage, as described in the Operator's Guide;
- Damage resulting from removal of parts, improper repairs, service, maintenance, modifications or use of parts not manufactured or approved by BRP or resulting from repairs done by a person that is not an authorized servicing Can-Am ATV dealer;

- Damage caused by abuse, abnormal use, neglect or operation of the product in a manner inconsistent with the recommended operation described in the Can-Am ATV Operator’s Guide;
- Damage resulting from accident, submersion, fire, theft, vandalism or any act of God;
- Operation with fuels, oils or lubricants which are not suitable for use with the product (see the Operator’s Guide);
- Damages from rust, corrosion or exposure to the elements;
- Damage resulting from water or snow ingestion;
- Incidental or consequential damages, or damages of any kind including without limitation towing, storage, telephone, rental, taxi, inconvenience, insurance coverage, loan payments, loss of time, loss of income.

#### **4) WARRANTY COVERAGE PERIOD**

This warranty will be in effect from (1) the date of delivery to the first retail consumer or (2) the date the product is first put into use, whichever occurs first and for the applicable period below:

SIX (6) CONSECUTIVE MONTHS, for private use or commercial use owners. For emission-related components; please also refer to the *US EPA EMISSION-RELATED WARRANTY* contained herein.

The repair or replacement of parts or the performance of service under this warranty does not extend the life of this warranty beyond its original expiration date.

#### **5) CONDITIONS TO HAVE WARRANTY COVERAGE**

This warranty coverage is available **only** if **each** of the following conditions has been fulfilled:

- The 2017 Can-Am ATV must be purchased as new and unused by its first owner from a Can-Am ATV dealer authorized to distribute Can-Am ATVs in the country in which the sale occurred (“**Can-Am ATV dealer**”);
- The BRP specified pre-delivery inspection process must be completed and documented and signed by the purchaser;
- The 2017 Can-Am ATV must have undergone proper registration by an authorized Can-Am ATV dealer;
- The 2017 Can-Am ATV must be purchased in the country in which the purchaser resides;
- Routine maintenance outlined in the Operator’s Guide must be timely performed in order to maintain warranty coverage. BRP reserves the right to make warranty coverage contingent upon proof of proper maintenance.

BRP will not honor this limited warranty to any private use owner or commercial use owner if one of the preceding conditions has not been met. Such limitations are necessary in order to allow BRP to preserve both the safety of its products, and also that of its consumers and the general public.

## **6) WHAT TO DO TO OBTAIN WARRANTY COVERAGE**

The customer must cease using the Can-Am ATV upon the appearance of an anomaly. The customer must notify a servicing BRP dealer within three (3) days of the appearance of a defect, and provide it with reasonable access to the product and reasonable opportunity to repair it. The customer must also present to the authorized BRP dealer, proof of purchase of the product and must sign the repair/work order prior to starting the repair in order to validate the warranty repair. All parts replaced under this limited warranty become the property of BRP.

## **7) WHAT BRP WILL DO**

BRP's obligations under this warranty are limited to, at its sole discretion, repairing parts found defective under normal use, maintenance and service, or replacing such parts with new genuine Can-Am ATV parts without charge for parts and labor, at any authorized BRP dealer during the warranty coverage period under the conditions described herein. No claim of breach of warranty shall be cause for cancellation or rescission of the sale of the Can-Am ATV to the owner.

In the event that service is required outside of the country of original sale, the owner will bear responsibility for any additional charges due to local practices and conditions, such as, but not limited to, freight, insurance, taxes, license fees, import duties, and any and all other financial charges, including those levied by governments, states, territories and their respective agencies.

BRP reserves the right to improve or modify products from time to time without assuming any obligation to modify products previously manufactured.

## **8) TRANSFER**

If the ownership of a product is transferred during the warranty coverage period, this limited warranty, subject to its terms and conditions, shall also be transferred and be valid for the remaining coverage period provided BRP or an authorized Can-Am ATV Distributor/Dealer receives a proof that the former owner agreed to the transfer of ownership, in addition to the co-ordinates of the new owner.

## 9) CONSUMER ASSISTANCE

In the event of a controversy or a dispute in connection with this limited warranty, BRP suggests that you try to resolve the issue at the dealership level. We recommend discussing the issue with the authorized dealer's service manager or owner.

If the matter still remains unresolved, contact BRP by filling out the customer contact form at [www.brp.com](http://www.brp.com) or contact BRP by mail at one of the addresses listed under the *CONTACT US* section of this guide.

\* In the USA, products are distributed and serviced by BRP US Inc.

© 2016 Bombardier Recreational Products Inc. All rights reserved.

®™ and the BRP logo are trademarks of Bombardier Recreational Products Inc. or its affiliates.

---

# US EPA EMISSION-RELATED WARRANTY

Bombardier Recreational Products Inc. ("BRP")\* warrants to the ultimate purchaser and each subsequent purchaser that this new vehicle, including all parts of its exhaust emission control system and its evaporative emission control system, meets two conditions:

1. It is designed, built, and equipped so it conforms at the time of sale to the ultimate purchaser with the requirements of 40 CFR 1051 and 40 CFR 1060.
2. It is free from defects in materials and workmanship that may keep it from meeting the requirements of 40 CFR 1051 and 40 CFR 1060.

Where a warrantable condition exists, BRP will repair or replace, as it elects, any part or component with a defect in materials or workmanship that would increase the engine's emissions of any regulated pollutant within the stated warranty period at no cost to the owner, including expenses related to diagnosing and repairing or replacing emission-related parts. All defective parts replaced under this warranty become the property of BRP.

For all emission-related warranty claims, BRP is limiting the diagnosis and repair of emission-related parts to the authorized Can-Am dealers, unless for emergency repairs as required by item 2 of the following list.

As a certifying manufacturer, BRP will not deny emission-related warranty claims based on any of the following:

1. Maintenance or other service BRP or BRP's authorized facilities performed.
2. Engine/equipment repair work that an operator performed to correct an unsafe, emergency condition attributable to BRP as long as the operator tries to restore the engine/equipment to its proper configuration as soon as possible.
3. Any action or inaction by the operator unrelated to the warranty claim.
4. Maintenance that was performed more frequently than BRP specify.
5. Anything that is BRP fault or responsibility.
6. The use of any fuel that is commonly available where the equipment operates unless BRP written maintenance instructions state that this fuel would harm the equipment's emission control system and operators can readily find the proper fuel. See maintenance information section and fuel requirements of fueling section.

## Emission-Related Warranty Period

The emission-related warranty is valid for the following period whichever comes first:

	HOURS	MONTHS	KILOMETERS
Exhaust emission-related components	250	30	2500
Evaporative emission-related components	N/A	24	N/A



## Components Covered

The emission-related warranty covers all components whose failure would increase an engine's emissions of any regulated pollutant, including the following listed components:

1. For exhaust emissions, emission-related components include any engine parts related to the following systems:
  - Air-induction system
  - Fuel system
  - Ignition system
  - Exhaust gas recirculation systems
2. The following parts are also considered emission-related components for exhaust emissions:
  - Aftertreatment devices
  - Crankcase ventilation valves
  - Sensors
  - Electronic control units
3. The following parts are considered emission-related components for evaporative emissions:
  - Fuel tank
  - Fuel cap
  - Fuel line
  - Fuel line fittings
  - Clamps\*
  - Pressure relief valves\*
  - Control valves\*
  - Control solenoids\*
  - Electronic controls\*
  - Vacuum control diaphragms\*
  - Control cables\*
  - Control linkages\*
  - Purge valves
  - Vapor hoses
  - Liquid/vapor separator
  - Carbon canister
  - Canister mounting brackets
  - Carburetor purge port connector

\*As related to the evaporative emission control system

4. Emission-related components also include any other part whose only purpose is to reduce emissions or whose failure will increase emissions without significantly degrading engine/equipment performance.

### **Limited Applicability**

As a certifying manufacturer, BRP may deny emission-related warranty claims for failures that have been caused by the owner's or operator's improper maintenance or use, by accidents for which the manufacturer has no responsibility, or by acts of God. For example, an emission-related warranty claim need not be honored for failures that have been directly caused by the operator's abuse of the engine/equipment or the operator's use of the engine/equipment in a manner for which it was not designed and are not attributable to the manufacturer in any way.

\* In the USA, products are distributed and serviced by BRP US Inc.

---

# **BRP INTERNATIONAL LIMITED WARRANTY: 2017 CAN-AM® ATV**

## **1) SCOPE OF THE LIMITED WARRANTY**

Bombardier Recreational Products Inc. ("BRP")\* warrants its 2017 Can-Am ATV sold by Can-Am ATV distributors or dealers authorized by BRP to distribute Can-Am ATVs ("Can-Am ATV Distributor/Dealer") outside of the United States of America (USA), Canada, members states of the European Economic Area (which is comprised of the states of the European Union plus Norway, Iceland and Liechtenstein) ("EEA"), member states of the Commonwealth of the Independent States (including Ukraine and Turkmenistan) ("CIS") and Turkey), from defects in material or workmanship for the period and under the conditions described below.

Non-factory installed parts and accessories are not covered under this limited warranty. Please refer to the applicable parts and accessories limited warranty text.

This limited warranty will become null and void if: (1) The ATV was used for racing or any other competitive activity, at any point, even by a previous owner; or (2) the ATV has been altered or modified in such a way so as to adversely affect its operation, performance or durability, or has been altered or modified to change its intended use.

## **2) LIMITATIONS OF LIABILITY**

TO THE EXTENT PERMITTED BY LAW, THIS WARRANTY IS EXPRESSLY GIVEN AND ACCEPTED IN LIEU OF ANY AND ALL OTHER WARRANTIES, EXPRESSED OR IMPLIED, INCLUDING WITHOUT LIMITATION ANY WARRANTY OF MERCHANTABILITY OR FITNESS FOR A PARTICULAR PURPOSE. TO THE EXTENT THAT THEY CANNOT BE DISCLAIMED, THE IMPLIED WARRANTIES ARE LIMITED IN DURATION TO THE LIFE OF THE EXPRESS WARRANTY. INCIDENTAL AND CONSEQUENTIAL DAMAGES ARE EXCLUDED FROM COVERAGE UNDER THIS WARRANTY. SOME JURISDICTIONS DO NOT ALLOW FOR THE DISCLAIMERS, LIMITATIONS AND EXCLUSIONS IDENTIFIED ABOVE, AS A RESULT, THEY MAY NOT APPLY TO YOU. THIS WARRANTY GIVES YOU SPECIFIC RIGHTS AND YOU MAY ALSO HAVE OTHER LEGAL RIGHTS WHICH MAY VARY FROM COUNTRY TO COUNTRY. (FOR PRODUCTS PURCHASED IN AUSTRALIA SEE CLAUSE 4 BELOW).

Neither the Can-Am ATV Distributor/Dealer nor any other person has been authorized to make any affirmation, representation or warranty regarding the product, other than those contained in this limited warranty, and if made, shall not be enforceable against BRP.

BRP reserves the right to modify this warranty at any time, being understood that such modification will not alter the warranty conditions applicable to the products sold while this warranty is in effect.

## **3) EXCLUSIONS – ARE NOT WARRANTED**

The following are not warranted under this limited warranty under any circumstances:

- Normal wear and tear;

- Routine maintenance items, tune ups, adjustments;
- Damage caused by negligence or failure to provide proper maintenance and/or storage, as described in the Operator's Guide;
- Damage resulting from removal of parts, improper repairs, service, maintenance, modifications or use of parts or accessories not manufactured or approved by BRP which in its reasonable judgement are either incompatible with the product or adversely affect its operation, performance and durability, or resulting from repairs done by a person that is not an authorized servicing Can-Am ATV Distributor/Dealer;
- Damage caused by abuse, abnormal use, neglect, racing or operation of the product in a manner inconsistent with the recommended operation described in the Operator's Guide;
- Damage resulting from accident, submersion, fire, snow or water ingestion, theft, vandalism or any act of God;
- Operation with fuels, oils or lubricants which are not suitable for use with the product (see the Operator's Guide);
- Damage resulting from rust, corrosion or exposure to the elements;
- Incidental or consequential damages, or damages of any kind including without limitation towing, storage, transportation expenses, telephone, rental, taxi, inconvenience, insurance coverage, loan payments, loss of time, loss of income; or time missed for downtime experience due to service work.

#### **4) WARRANTY COVERAGE PERIOD**

This warranty will be in effect from (1) the date of delivery to the first retail consumer or (2) the date the product is first put into use, whichever occurs first and for a period of:

SIX (6) CONSECUTIVE MONTHS for private use or commercial use.

The repair or replacement of parts or the performance of service under this warranty does not extend the life of this warranty beyond its original expiration date.

Note that the duration and any other modalities of the warranty coverage are subject to the applicable national or local legislation in the customer's country.

#### **FOR PRODUCTS SOLD IN AUSTRALIA ONLY**

Nothing in these Warranty terms and conditions should be taken to exclude, restrict or modify the application of any condition, warranty, guarantee, right or remedy conferred or implied under the Competition and Consumer Act 2010 (Cth), including the Australian Consumer Law or any other law, where to do so would contravene that law, or cause any part of these terms and conditions to be void. The benefits given to you under this limited warranty are in addition to other rights and remedies that you have under Australian law.

Our goods come with guarantees that cannot be excluded under the Australian Consumer Law. You are entitled to a replacement or refund for a major failure and for compensation for any other reasonably foreseeable loss or damage. You are also entitled to have the goods repaired or replaced if the goods fail to be of acceptable quality and the failure does not amount to a major failure.

## **5) CONDITIONS TO HAVE WARRANTY COVERAGE**

This warranty coverage is available only if each of the following conditions has been fulfilled:

- The 2017 Can-Am ATV must be purchased as new and unused by its first owner from a Can-Am ATV Distributor/Dealer authorized to distribute Can-Am ATVs in the country in which the sale occurred;
- The BRP specified pre-delivery inspection process must be completed and documented;
- The product must have undergone proper registration by an authorized Can-Am ATV Distributor/Dealer;
- The 2017 Can-Am ATV must be purchased in the country or union of countries in which the purchaser resides; and
- Routine maintenance outlined in the Operator's Guide must be timely performed in order to maintain warranty coverage. BRP reserves the right to make warranty coverage contingent upon proof of proper maintenance.

BRP will not honour this limited warranty to any private use owner or commercial use owner if one of the preceding conditions has not been met. Such limitations are necessary in order to allow BRP to preserve both the safety of its products, and also that of its consumers and the general public.

## **6) WHAT TO DO TO OBTAIN WARRANTY COVERAGE**

The customer must cease using the ATV upon the appearance of an anomaly. The customer must notify a servicing Can-Am ATV Distributor/Dealer within two (2) days of the appearance of a defect, and provide it with reasonable access to the product and reasonable opportunity to repair it. The customer must also present to the authorized Can-Am ATV Distributor/Dealer proof of purchase of the product and must sign the repair/work order prior to starting the repair in order to validate the warranty repair. All parts replaced under this limited warranty become the property of BRP.

Note that the notification period is subject to the applicable national or local legislation in customer's country.

## **7) WHAT BRP WILL DO**

To the extent permitted by law, BRP's obligations under this warranty are limited to, at its sole discretion, repairing parts found defective under normal use, maintenance and service, or replacing such parts with new genuine Can-Am ATV parts without charge for parts and labour, at any authorized Can-Am ATV Distributor/Dealer during the warranty coverage period under the conditions described

herein. BRP's responsibility is limited to making the required repairs or replacements of parts. No claim of breach of warranty shall be cause for cancellation or rescission of the sale of the Can-Am ATV to the owner. You may have other legal rights which may vary from country to country.

In the event that service is required outside of the country of original sale, the owner will bear responsibility for any additional charges due to local practices and conditions, such as, but not limited to, freight, insurance, taxes, license fees, import duties, and any and all other financial charges, including those levied by governments, states, territories and their respective agencies.

BRP reserves the right to improve or modify products from time to time without assuming any obligation to modify products previously manufactured.

## **8) TRANSFER**

If the ownership of a product is transferred during the warranty coverage period, this limited warranty, subject to its terms and conditions, shall also be transferred and be valid for the remaining coverage period provided BRP or an authorized Can-Am ATV Distributor/Dealer receives a proof that the former owner agreed to the transfer of ownership, in addition to the coordinates of the new owner.

## **9) CONSUMER ASSISTANCE**

If the matter still remains unresolved, contact BRP by filling out the customer contact form at [www.brp.com](http://www.brp.com) or contact BRP by mail at one of the addresses listed under the *CONTACT US* section of this guide.

\* For the territory covered by this limited warranty, products are distributed and serviced by Bombardier Recreational Products Inc. or its affiliates.

© 2016 Bombardier Recreational Products Inc. All rights reserved.

®™ and the BRP logo are trademarks of Bombardier Recreational Products Inc. or its affiliates.

---

# **BRP LIMITED WARRANTY FOR THE EUROPEAN ECONOMIC AREAS, THE COMMONWEALTH OF THE INDEPENDENT STATES AND TURKEY: 2017 CAN-AM® ATV**

## **1) SCOPE OF THE LIMITED WARRANTY**

Bombardier Recreational Products Inc. ("BRP")\* warrants its 2017 Can-Am ATVs sold by distributors or dealers authorized by BRP to distribute Can-Am ATVs ("Can-Am ATV Distributor/Dealer") in member states of the European Economic Area (which is comprised of the member states of the European Union plus Norway, Iceland and Liechtenstein) ("EEA"), in member states of the Commonwealth of the Independent States (including Ukraine and Turkmenistan) ("CIS") and Turkey from defects in material or workmanship for the period and under the conditions described below.

Non-factory installed parts and accessories are not covered under this limited warranty. Please refer to the applicable parts and accessories limited warranty text..

This limited warranty will become null and void if: (1) The ATV was used for racing or any other competitive activity, at any point, even by a previous owner; or (2) the ATV has been altered or modified in such a way so as to adversely affect its operation, performance or durability, or has been altered or modified to change its intended use.

## **2) LIMITATIONS OF LIABILITY**

TO THE EXTENT PERMITTED BY LAW, THIS WARRANTY IS EXPRESSLY GIVEN AND ACCEPTED IN LIEU OF ANY AND ALL OTHER WARRANTIES, EXPRESSED OR IMPLIED, INCLUDING WITHOUT LIMITATION ANY WARRANTY OF MERCHANTABILITY OR FITNESS FOR A PARTICULAR PURPOSE. TO THE EXTENT THAT THEY CANNOT BE DISCLAIMED, THE IMPLIED WARRANTIES ARE LIMITED IN DURATION TO THE LIFE OF THE EXPRESS WARRANTY. INCIDENTAL AND CONSEQUENTIAL DAMAGES ARE EXCLUDED FROM COVERAGE UNDER THIS WARRANTY. SOME JURISDICTIONS DO NOT ALLOW FOR THE DISCLAIMERS, LIMITATIONS AND EXCLUSIONS IDENTIFIED ABOVE, AS A RESULT, THEY MAY NOT APPLY TO YOU. THIS WARRANTY GIVES YOU SPECIFIC RIGHTS AND YOU MAY ALSO HAVE OTHER LEGAL RIGHTS WHICH MAY VARY FROM COUNTRY TO COUNTRY.

Neither the Can-Am ATV Distributor/Dealer nor any other person has been authorized to make any affirmation, representation or warranty regarding the product, other than those contained in this limited warranty, and if made, shall not be enforceable against BRP.

BRP reserves the right to modify this warranty at any time, being understood that such modification will not alter the warranty conditions applicable to the products sold while this warranty is in effect.

### **3) EXCLUSIONS – ARE NOT WARRANTED**

The following are not warranted under this limited warranty under any circumstances:

- Normal wear and tear;
- Routine maintenance items, tune ups, adjustments;
- Damage caused by negligence or failure to provide proper maintenance and/or storage, as described in the Operator's Guide;
- Damage resulting from removal of parts, improper repairs, service, maintenance, modifications or use of parts or accessories not manufactured or approved by BRP which in its reasonable judgement are either incompatible with the product or adversely affect its operation, performance and durability, or resulting from repairs done by a person that is not an authorized servicing Can-Am ATV Distributor/Dealer;
- Damage caused by abuse, abnormal use, neglect, racing or operation of the product in a manner inconsistent with the recommended operation described in the Operator's Guide;
- Damage resulting from accident, submersion, fire, snow or water ingestion, theft, vandalism or any act of God;
- Operation with fuels, oils or lubricants which are not suitable for use with the product (see the Operator's Guide);
- Damage resulting from rust, corrosion or exposure to the elements;
- Incidental or consequential damages, or damages of any kind including without limitation towing, transportation expenses, storage, telephone, rental, taxi, inconvenience, insurance coverage, loan payments, loss of time, loss of income or time missed for downtime experience due to service work.

### **4) WARRANTY COVERAGE PERIOD**

This warranty will be in effect from (1) the date of delivery to the first retail consumer or (2) the date the product is first put into use, whichever occurs first and for a period of:

TWENTY-FOUR (24) CONSECUTIVE MONTHS for private use.

SIX (6) CONSECUTIVE MONTHS for commercial use or rental use.

The product is used commercially when it is used in connection with any work or employment that generates income during any part of the warranty period. The product is also used commercially when, at any point during the warranty period, it is licensed for commercial use.

The repair or replacement of parts or the performance of service under this warranty does not extend the life of this warranty beyond its original expiration date.

Note that the duration and any other modalities of the warranty coverage are subject to the applicable national or local legislation in the customer's country.



## **5) CONDITIONS TO HAVE WARRANTY COVERAGE**

This warranty coverage is available **only** if **each** of the following conditions has been fulfilled:

- The 2017 Can-Am ATV must be purchased as new and unused by its first owner from a Can-Am ATV Distributor/Dealer authorized to distribute Can-Am ATVs in the country in which the sale occurred;
- The BRP specified pre-delivery inspection process must be completed and documented;
- The product must have undergone proper registration by an authorized Can-Am ATV Distributor/Dealer;
- The 2017 Can-Am ATV must be purchased within the EEA by an EEA resident, in the CIS for residents of the countries comprised in such area and in Turkey for residents of Turkey; and
- Routine maintenance outlined in the Operator's Guide must be timely performed in order to maintain warranty coverage. BRP reserves the right to make warranty coverage contingent upon proof of proper maintenance.

BRP will not honour this limited warranty to any private use owner or commercial use owner if one of the preceding conditions has not been met. Such limitations are necessary in order to allow BRP to preserve both the safety of its products, and also that of its consumers and the general public.

## **6) WHAT TO DO TO OBTAIN WARRANTY COVERAGE**

The customer must cease using the ATV upon the appearance of an anomaly. The customer must notify a servicing Can-Am ATV Distributor/Dealer within two (2) months of the appearance of a defect and provide it with reasonable access to the product and reasonable opportunity to repair it. The customer must also present to the authorized Can-Am ATV Distributor/Dealer, proof of purchase of the product and must sign the repair/work order prior to starting the repair in order to validate the warranty repair. All parts replaced under this limited warranty become the property of BRP.

Note that the notification period is subject to the applicable national or local legislation in customer's country.

## **7) WHAT BRP WILL DO**

To the extent permitted by law, BRP's obligations under this warranty are limited to, at its sole discretion, repairing parts found defective under normal use, maintenance and service, or replacing such parts with new genuine Can-Am ATV parts without charge for parts and labour, at any authorized Can-Am ATV Distributor/Dealer during the warranty coverage period under the conditions described herein. BRP's responsibility is limited to making the required repairs or replacements of parts. No claim of breach of warranty shall be cause for cancellation or rescission of the sale of the Can-Am ATV to the owner. You may have other legal rights which may vary from country to country.

In the event that service is required outside of the EEA, CIS or Turkey, the owner will bear responsibility for any additional charges due to local practices and conditions, such as, but not limited to, freight, insurance, taxes, license fees, import duties, and any and all other financial charges, including those levied by governments, states, territories and their respective agencies.

BRP reserves the right to improve or modify products from time to time without assuming any obligation to modify products previously manufactured.

## **8) TRANSFER**

If the ownership of a product is transferred during the warranty coverage period, this limited warranty, subject to its terms and conditions, shall also be transferred and be valid for the remaining coverage period provided BRP or an authorized Can-Am ATV Distributor/Dealer receives a proof that the former owner agreed to the transfer of ownership, in addition to the co-ordinates of the new owner.

## 9) CONSUMER ASSISTANCE

In the event of a controversy or a dispute in connection with this limited warranty, BRP suggests that you try to resolve the issue at the Can-Am ATV Distributor/Dealer level. We recommend discussing the issue with the authorized Can-Am ATV Distributor/Dealer's service manager or owner.

If the matter still remains unresolved, contact BRP by filling out the customer contact form at [www.brp.com](http://www.brp.com) or contact BRP by mail at one of the addresses listed under the *CONTACT US* section of this guide.

\* In the EEA, products are distributed and serviced by BRP European Distribution S.A. and other affiliates or subsidiaries of BRP.

© 2016 Bombardier Recreational Products Inc. All rights reserved.

®™ and the BRP logo are trademarks of Bombardier Recreational Products Inc. or its affiliates.

## **ADDITIONAL TERMS AND CONDITIONS FOR FRANCE ONLY**

The following terms and conditions are applicable to products sold in France only:

The seller shall deliver goods that are complying with the contract and shall be responsible for defects existing upon delivery. The seller shall also be responsible for defects resulting from packaging, assembling instructions or the installation when it is its responsibility per the contract or if accomplished under its responsibility. To be compliant with the contract, the good shall:

1. Be fit for normal use for goods similar thereto and, if applicable:
  - Correspond to the description provided by the seller and have the qualities presented to the buyer through sample or model;
  - Have the qualities that a buyer may legitimately expect considering the public declarations of the seller, the manufacturer of its representative, including in advertising or labeling; or
2. Have the characteristics mutually agreed upon as between the parties or be fit for the specific use intended by the buyer and brought to the attention of the seller and which accepted by the seller.

The action for failure to comply is prescribed after two years after delivery of the goods. The seller is responsible for the warranty for hidden defects of the good sold if such hidden defects are rendering the good unfit for the intended use, or if they diminish its use in such a way that the buyer would not have acquired the good or would have given a lesser price, had he known. The action for such hidden defects shall be taken by the buyer within 2 years of the discovery of the defect.

# ***CUSTOMER INFORMATION***

---

## PRIVACY INFORMATION

BRP wishes to inform you that your coordinates will be used for safety and warranty related purposes. Furthermore, BRP and its affiliates may use its customer list to distribute marketing and promotional information about BRP and related products.

To exercise your right to consult or correct your data, or to be removed from the addressee-list for direct marketing, please contact BRP.

**By E-mail:**    [privacyofficer@brp.com](mailto:privacyofficer@brp.com)

**By mail:**        BRP  
Senior Legal Counsel-Privacy Officer  
726 St-Joseph  
Valcourt QC  
Canada  
J0E 2L0

---

# CONTACT US

www.brp.com

## North America

565 de la Montagne Street  
Valcourt (Québec) J0E 2L0  
Canada

Circuito de la Productividad #111  
Parque Industrial Guadalajara  
Col. Las Pintas  
El Salto, Jalisco, 45690  
Mexico

Av. Ferrocarril # 202  
Parque Industrial Querétaro  
Santa Rosa Jáuregui, Querétaro  
Querétaro  
C.P. 76220 México

## Europe

Skaldenstraat 125  
B-9042 Gent  
Belgium

Itterpark 11  
D-40724 Hilden  
Germany

ARTEPARC Bâtiment B  
Route de la côte d'Azur, Le Canet  
13590 Meyreuil  
France

Ingvald Ystgaardsvei 15  
N-7484 Trondeim  
Norway

Isoaavantie 7  
PL 8040  
96101 Rovaniemi

Formvägen 16  
S-906 21 Umeå  
Sweden

Avenue d'Ouchy 4-6  
1006 Lausanne  
Switzerland

## Oceania

6 Lord Street  
Lakes Business Park  
Botany, NSW 2019  
Australia

## South America

Rodovia Anhanguera Km 104  
Loteamento Techno Park  
Condominio Empresarial AZTech  
Avenida James Clerck Maxwell, 280 -  
Modulo 04  
13069-380, Campinas SP  
Brazil

## Asia

15/F Parale Mitsui Building,8  
Higashida-Cho, Kawasaki-ku  
Kawasaki 210-0005  
Japan

Room Dubai, level 12, Platinum Tower  
233 Tai Cang Road  
Xintiandi, Lu Wan District  
Shanghai 200020  
PR China

---

## CHANGE OF ADDRESS/OWNERSHIP

If your address has changed or if you are the new owner of the ATV, be sure to notify BRP by either:

- Notifying an authorized Can-Am dealer/distributor.
- **North America Only:** calling at 1 888 272-9222.
- Mailing one of the change of address cards on the following pages at one of the BRP addresses indicated in the *CONTACT US* section of this guide.

In case of change of ownership, please join a proof that the former owner agreed to the transfer.

Notifying BRP, even after the expiration of the limited warranty, is very important as it enables BRP to reach the ATV owner if necessary, like when safety recalls are initiated. It is the owner's responsibility to notify BRP.

**STOLEN UNITS:** If your personal ATV is stolen, you should notify BRP or an authorized Can-Am dealer. We will ask you to provide your name, address, phone number, the vehicle identification number and the date it was stolen.







**ATV MODEL No.** \_\_\_\_\_

**VEHICLE IDENTIFICATION NUMBER (V.I.N.)** \_\_\_\_\_

**ENGINE IDENTIFICATION NUMBER (E.I.N.)** \_\_\_\_\_

**Owner:** \_\_\_\_\_  
NAME

\_\_\_\_\_  
No. STREET APT

\_\_\_\_\_  
CITY STATE/PROVINCE ZIP/POSTAL CODE

**Purchase Date** \_\_\_\_\_  
YEAR MONTH DAY

**Warranty Expiry Date** \_\_\_\_\_  
YEAR MONTH DAY

To be completed by the dealer at the time of the sale.

DEALER IMPRINT AREA

Please verify with your dealer to ensure your vehicle has been registered with BRP.

While reading this Operator's Guide, remember that:

 **WARNING**

Indicates a potential hazard that, if not avoided, could result in serious injury or death.

## WARNING

### **THIS VEHICLE CAN BE HAZARDOUS TO OPERATE.**

A collision or rollover can occur quickly, even during routine maneuvers such as turning and driving on hills or over obstacles, if you fail to take proper precautions.

**SEVERE INJURY OR DEATH** can result if you do not follow these instructions:

- **BEFORE YOU OPERATE THIS ATV, READ THIS OPERATOR'S GUIDE, ALL ON-PRODUCT SAFETY LABELS AND WATCH THE SAFETY VIDEO.**
- **NEVER OPERATE THIS VEHICLE WITHOUT PROPER INSTRUCTIONS.** Complete a certified training course.
- **NEVER CARRY A PASSENGER.** You increase your risk of losing control if you carry a passenger.
- **NEVER OPERATE THIS VEHICLE ON A PAVED SURFACE.** You increase your risk of losing control if you operate this vehicle on pavement.
- **NEVER OPERATE THIS VEHICLE ON PUBLIC ROADS.** You can collide with another vehicle if you operate this vehicle on a public road.
- **ALWAYS WEAR AN APPROVED HELMET,** eye protection, and protective clothing.
- **NEVER USE WITH DRUGS OR ALCOHOL.** They slow reaction time and impair judgment.
- **NEVER OPERATE THIS VEHICLE AT EXCESSIVE SPEEDS.** You increase your risk of losing control if you operate this vehicle at speeds too fast for the terrain, visibility conditions, or your experience.
- **NEVER ATTEMPT WHEELIES, JUMPS, OR OTHER STUNTS.**

219 001 755

OPERATOR'S GUIDE DS 70 / DS 90 / DS 90 X / ENGLISH  
GUIDE DU CONDUCTEUR DS 70 / DS 90 / DS 90 X / ANGLAIS

FAIT AU / MADE IN CANADA

U/M:P.C.