

**can-am**®



2016

Operator's  
Guide

Includes  
Safety, Vehicle  
and Maintenance Information

**OUTLANDER™ Series/  
OUTLANDER™ MAX™ Series**

**⚠ WARNING**

Read this guide thoroughly. It contains important safety information.  
Minimum recommended age: Operator: 16 years old. Keep this Operator's Guide in the vehicle.

2 1 9 0 0 1 5 8 2

Original Instructions



**⚠ WARNING**

**YOUR VEHICLE CAN BE HAZARDOUS TO OPERATE.** A collision or rollover can occur quickly, if you fail to take proper precautions, even during routine maneuvers such as turning and driving on hills or over obstacles. For your safety, understand and follow all the warnings contained in this Operator's Guide and on the labels on your vehicle. **Failure to follow these warnings can result in SEVERE INJURY OR DEATH!** Keep this Operator's Guide with the vehicle at all times.

**⚠ WARNING**

Disregarding any of the safety precautions and instructions contained in this Operator's Guide, *SAFETY DVD* video and on-product safety labels could result in an injury including the possibility of death!

**⚠ WARNING**

This vehicle may exceed the performance of other vehicles you may have ridden in the past. Take time to familiarize yourself with your new vehicle.

The following trademarks are the property of Bombardier Recreational Products Inc.:

Can-Am® D.E.S.S.™ DPST™ Outlander™ Rotax® TTI™ XPS™

This document contains the trademark of the following company:

- Garmin®, Garmin logo, City Navigator® and MapSource™ are trademarks of Garmin Ltd or its subsidiaries.
- MicroSD™ and SD™ are trademarks of SanDisk or its subsidiaries.
- Visco-lok is a trademark of GKN Viscodrive GmbH.

# FOREWORD

Deutsch	Dieses Handbuch ist möglicherweise in Ihrer Landessprache verfügbar. Bitte wenden Sie sich an Ihren Händler oder besuchen Sie: <a href="http://www.operatorsguide.brp.com">www.operatorsguide.brp.com</a> .
English	This guide may be available in your language. Check with your dealer or go to: <a href="http://www.operatorsguide.brp.com">www.operatorsguide.brp.com</a> .
Español	Es posible que este manual esté disponible en su idioma. Consulte a su distribuidor o visite: <a href="http://www.operatorsguide.brp.com">www.operatorsguide.brp.com</a> .
Français	Ce guide peut être disponible dans votre langue. Vérifier avec votre concessionnaire ou aller à: <a href="http://www.operatorsguide.brp.com">www.operatorsguide.brp.com</a> .
Nederlands	Deze handleiding kan beschikbaar zijn in uw taal. Vraag het aan uw dealer of ga naar: <a href="http://www.operatorsguide.brp.com">www.operatorsguide.brp.com</a> .
Norsk	Denne boken kan finnes tilgjengelig på ditt eget språk. Kontakt din forhandler eller gå til: <a href="http://www.operatorsguide.brp.com">www.operatorsguide.brp.com</a> .
Português	Este manual pode estar disponível em seu idioma. Fale com sua concessionária ou visite o site: <a href="http://www.operatorsguide.brp.com">www.operatorsguide.brp.com</a> .
Suomi	Käyttöohjekirja voi olla saatavissa omalla kielelläsi. Tarkista jälleenmyyjältä tai käy osoitteessa: <a href="http://www.operatorsguide.brp.com">www.operatorsguide.brp.com</a>
Svenska	Denna bok kan finnas tillgänglig på ditt språk. Kontakta din återförsäljare eller gå till: <a href="http://www.operatorsguide.brp.com">www.operatorsguide.brp.com</a> .

Congratulations on your purchase of a new Can-Am® ATV. It is backed by the BRP warranty and a network of authorized Can-Am dealers ready to provide the parts, service or accessories you may require.

Your dealer is committed to your satisfaction. He has taken training to perform the initial setup and inspection of your vehicle as well as completed the final adjustment before you took possession. If you need more complete servicing information, please ask your dealer.

At delivery, you were also informed of the warranty coverage and signed the *PREDELIVERY CHECK LIST* to ensure your new vehicle was prepared to your entire satisfaction.

## Know Before you Go

To learn how to reduce the risk for you or bystanders being injured or killed, read this Operator's Guide before you operate the vehicle.

Also, read all safety labels on your ATV and watch attentively your *SAFETY DVD* video.

This vehicle is mainly for general recreational use but it may also be used for utility purposes.

Failure to follow the warnings contained in this Operator's Guide can result in **SERIOUS INJURY** or **DEATH**.

## Age Recommendation

This vehicle is a category G, always follow this age recommendation:

- A person under 16 years old should never operate this vehicle.
- This vehicle is for recreational use by experienced operator's only.
- Passenger on 2-UP models must be capable of keeping his feet on the footrests and his hands on grab handles at all times when seated on this vehicle.

## Training Course

Never operate this vehicle without proper instruction. **Take a training course.** All operators should receive training from a certified instructor.

For more information about ATV safety, contact an authorized Can-Am dealer to find out about available training courses nearest you.

## Safety Messages

The types of safety messages, what they look like and how they are used in this guide are explained as follows:

The safety alert symbol  indicates a potential injury hazard.

### WARNING

Indicates a potential hazard, if not avoided, could result in serious injury or death.

 **CAUTION** Indicates a hazard situation which, if not avoided, could result in minor or moderate injury.

**NOTICE** Indicates an instruction which, if not followed, could severely damage vehicle components or other property.

## About this Operator's Guide

This Operator's Guide has been prepared to acquaint the owner/operator of a new vehicle with the various vehicle controls, maintenance and safe operating instructions. It is indispensable for the proper use of the product.

While reading this Operator's Guide, remember that:

### WARNING

Indicates a potential hazard that, if not avoided, could result in serious injury or death.

### WARNING

Throughout this Operator's Guide, the term "1-UP" refers to vehicles designed to carry the operator only while the term "2-UP" refers to vehicles designed to carry also a passenger. **Make sure to identify and follow the warnings and instructions that are applicable to your specific model.**

Note that this guide is available in several languages. In the event of any discrepancy, the English version shall prevail.

Keep this Operator's Guide in the vehicle as you can refer to it for things such as maintenance, troubleshooting and instructing others.

If you want to view and/or print an extra copy of your Operator's Guide, simply visit the following website [www.operatorsguide.brp.com](http://www.operatorsguide.brp.com).

The information contained in this document are correct at the time of publication. However, BRP maintains a policy of continuous improvement of its products without imposing upon itself any obligation to install them on products previously manufactured. Due to late changes, some differences between the manufactured product and the descriptions and/or specifications in this guide may occur. BRP reserves the right at any time to discontinue or change specifications, designs, features, models or equipment without incurring any obligation upon itself.

This and the *SAFETYDVD* video should remain with the vehicle when it is sold.

---

# TABLE OF CONTENTS

<b>FOREWORD</b> .....	<b>1</b>
Know Before you Go .....	1
Safety Messages.....	2
About this Operator's Guide .....	2

## ***SAFETY INFORMATION***

<b>GENERAL PRECAUTIONS</b> .....	<b>8</b>
Avoid Carbon Monoxide Poisoning .....	8
Avoid Gasoline Fires and Other Hazards .....	8
Avoid Burns from Hot Parts .....	8
Accessories and Modifications .....	8
<b>SPECIAL SAFETY MESSAGES</b> .....	<b>9</b>
European Community .....	12
<b>OPERATION WARNINGS</b> .....	<b>13</b>
<b>PRE-RIDE INSPECTION</b> .....	<b>41</b>
Pre-Ride Inspection Check List .....	42
<b>RIDING THE VEHICLE</b> .....	<b>44</b>
Riding Gear .....	45
Carrying a Passenger .....	46
Recreational Riding .....	47
Environment.....	47
Design Limitation .....	48
Off-Road Operation .....	48
Riding Techniques.....	48
<b>MOVING LOADS AND DOING WORK</b> .....	<b>60</b>
Working with your Vehicle .....	60
Carrying Loads .....	60
Loading the Cargo Racks .....	61
Hauling a Load (if Equipped with Hitch) .....	61
Pulling a Trailer (if Equipped with Hitch) .....	62
<b>IMPORTANT ON-PRODUCT LABELS</b> .....	<b>63</b>
Hang Tag .....	63
Vehicle Safety Labels .....	65
Compliance Labels .....	72
Technical Information Labels .....	72

## ***VEHICLE INFORMATION***

<b>CONTROLS</b> .....	<b>74</b>
1) Throttle Lever.....	74
2) LH Brake Lever .....	75
3) Brake Lock .....	75
4) Brake Pedal .....	76
5) Shift Lever .....	76

<b>CONTROLS</b> (cont'd)	
6) Ignition Switch.....	77
7) Multifunction Switch.....	78
8) 2WD/4WD Selector.....	81
9) Winch Control Switch (Models with Winch).....	82
10) Shift Lever Lock.....	82
<b>MULTIFUNCTION GAUGE (LCD) (DPS AND XT MODELS)</b> .....	<b>84</b>
Multifunction Gauge Description.....	84
Multifunction Gauge Features.....	85
Multifunction Gauge Set-Up.....	86
<b>MULTIFUNCTION GAUGE (ANALOG/DIGITAL) (XT-P AND LTD MODELS)</b> .....	<b>88</b>
Multifunction Gauge Description.....	88
Gauge Setup.....	90
<b>EQUIPMENT</b> .....	<b>92</b>
1) Operator's Seat.....	94
2) Passenger's Seat/Glove Box (2-UP Models).....	94
3) Footpegs.....	96
4) Grab Handles (2-UP Models).....	97
5) 12-Volt Power Outlet.....	97
6) Rear Storage Compartment.....	97
7) Cargo Racks.....	98
8) Trailer Hitch.....	99
9) Tool Kit.....	99
10) Winch (Models with Winch).....	99
11) Roller Fairlead (Models with Winch).....	100
12) GPS Receiver (Global Positioning System) (LTD Models).....	100
13) ACS Compressor (LTD Model Only).....	101
14) Recovery Hook.....	102
<b>FUEL</b> .....	<b>103</b>
Fuel Requirements.....	103
Vehicle Fueling Procedure.....	103
<b>BREAK-IN PERIOD</b> .....	<b>105</b>
Operation During Break-In.....	105
<b>BASIC PROCEDURES</b> .....	<b>106</b>
Starting the Engine.....	106
Shifting the Transmission.....	106
Stopping the Engine and Parking the Vehicle.....	106
<b>SPECIAL PROCEDURES</b> .....	<b>107</b>
What to Do if Water is in the CVT.....	107
What to Do if Water is in the Air Filter Housing.....	107
What to Do if Vehicle is Turned Over.....	108
What to Do if Vehicle is Immersed in Water.....	108
<b>TUNE YOUR RIDE</b> .....	<b>109</b>
Suspension Adjustment.....	109
Steering Assist Adjustment (DPS) (Models with DPS).....	112

<b>VEHICLE TRANSPORTATION</b> .....	<b>114</b>
-------------------------------------	------------

## ***MAINTENANCE***

<b>MAINTENANCE SCHEDULE</b> .....	<b>116</b>
SEVERE DUSTY CONDITIONS .....	116
MAINTENANCE SCHEDULE LEGEND .....	116
MAINTENANCE SCHEDULE .....	116

<b>MAINTENANCE PROCEDURES</b> .....	<b>119</b>
Air Filter .....	119
Engine Oil .....	123
Oil Filter .....	124
Radiator .....	125
Engine Coolant .....	126
Muffler Spark Arrester .....	128
CVT Air Filter (850/1000R) .....	129
Gearbox Oil .....	130
Throttle Cable .....	131
Spark Plugs .....	134
Battery .....	134
Fuses .....	135
Lights .....	137
Drive Shaft Boot and Protector .....	138
Wheel Bearing .....	139
Wheels and Tires .....	139
Steering .....	141
Suspension .....	141
Brakes .....	142

<b>VEHICLE CARE</b> .....	<b>144</b>
Post-Operation Care .....	144
Vehicle Cleaning and Protection .....	144

<b>STORAGE AND PRESEASON PREPARATION</b> .....	<b>146</b>
--	------------

## ***TECHNICAL INFORMATION***

<b>VEHICLE IDENTIFICATION</b> .....	<b>148</b>
Vehicle Identification Number .....	148
Engine Identification Number (EIN) .....	148
<b>DECLARATION OF CONFORMITY</b> .....	<b>149</b>
<b>SPECIFICATIONS</b> .....	<b>150</b>

## ***TROUBLESHOOTING***

<b>TROUBLESHOOTING GUIDELINES</b> .....	<b>158</b>
---	------------

MULTIFUNCTION GAUGE MESSAGES ..... 162

**WARRANTY**

BRP INTERNATIONAL LIMITED WARRANTY: 2016 CAN-AM® ATV ..... 164  
BRP LIMITED WARRANTY FOR THE EUROPEAN ECONOMIC AREA, THE  
COMMONWEALTH OF THE INDEPENDENT STATES AND TURKEY: 2016  
CAN-AM® ATV ..... 168

**CUSTOMER INFORMATION**

PRIVACY INFORMATION ..... 174  
CHANGE OF ADDRESS/OWNERSHIP ..... 175



# ***SAFETY INFORMATION***

---

## GENERAL PRECAUTIONS

### **Avoid Carbon Monoxide Poisoning**

All engine exhaust contains carbon monoxide, a deadly gas. Breathing carbon monoxide can cause headaches, dizziness, drowsiness, nausea, confusion and eventually death.

Carbon monoxide is a colorless, odorless, tasteless gas that may be present even if you do not see or smell any engine exhaust. Deadly levels of carbon monoxide can collect rapidly, and you can quickly be overcome and unable to save yourself. Also, deadly levels of carbon monoxide can linger for hours or days in enclosed or poorly ventilated areas. If you experience any symptoms of carbon monoxide poisoning, leave the area immediately, get fresh air and seek medical treatment.

To prevent serious injury or death from carbon monoxide:

- Never run the vehicle in poorly ventilated or partially enclosed areas such as garages, carports or barns. Even if you try to ventilate engine exhaust with fans or open windows and doors, carbon monoxide can rapidly reach dangerous levels.
- Never run the vehicle outdoors where engine exhaust can be drawn into a building through openings such as windows and doors.

### **Avoid Gasoline Fires and Other Hazards**

Gasoline is extremely flammable and highly explosive. Fuel vapors can spread and be ignited by a spark or flame many feet away from the engine. To reduce the risk of fire or explosion, follow these instructions:

- Use only an approved red gasoline container to store fuel.
- Never fill a gasoline container on the vehicle. An electrical static discharge may ignite the fuel.

- For refueling, strictly adhere to instructions in *FUEL* subsection.
- Never start or operate the engine if the fuel cap is not properly installed.

Gasoline is poisonous and can cause injury or death.

- Never siphon gasoline by mouth.
- If you swallow gasoline, get any in your eye(s), or inhale gasoline vapor, see your doctor immediately.

If gasoline spills on you, wash with soap and water and change your clothes.

### **Avoid Burns from Hot Parts**

Certain components become hot during operation. Avoid contact with those parts during and shortly after operation to avoid burns.

### **Accessories and Modifications**

Do not make unauthorized modifications, or use attachments or accessories that are not approved by BRP. Since these changes have not been tested by BRP, they may increase the risk of crashes or injury, and can render the vehicle illegal.

See your authorized Can-Am dealer for available accessories for your vehicle.

---

## SPECIAL SAFETY MESSAGES

### **THIS VEHICLE IS NOT A TOY AND CAN BE HAZARDOUS TO OPERATE.**

- This vehicle handles differently from other vehicles including motorcycles and cars. A collision or rollover can occur quickly, if you fail to take proper precautions, even during routine maneuvers such as turning and driving on hills or over obstacles.

**SEVERE INJURY OR DEATH** can result if you do not comply with the following instructions:

- Read this Operator's Guide and all on-product safety labels carefully and follow the operating procedures described. Watch and pay attention to the *SAFETY DVD* video before operating the vehicle.
- Always follow this age recommendation: A person under 16 years old should never operate this vehicle.
- Never take place on this vehicle without wearing an approved helmet of the proper size and other required riding gears. Refer to *RIDING GEAR* in the *RIDING THE VEHICLE* subsection for detailed information.
- Never carry a passenger on this vehicle unless you are operating a 2-UP model. Passenger(s) affect balance and steering and increase risk of losing control.
- On 1-UP models, do not make any modifications to accommodate a passenger or use racks to carry a passenger.
- Never use this vehicle if you are tired, ill or under with drugs or alcohol. Your reaction time and judgement is greatly affected under these conditions.
- Never attempt wheelies, jumps, or other stunts.
- Never operate at excessive speeds. Always go at a speed that is proper for the terrain, visibility, and operating conditions, and your experience.
- Always go slowly and be extra careful when operating on unfamiliar terrain. Always be alert to changing terrain conditions when operating this vehicle.
- Never operate on excessively rough, slippery or loose terrain until you have learned and practiced the skills necessary to control this vehicle on such terrain. Always be especially cautious on these kinds of terrain.
- Always follow proper procedures for turning as described in *RIDING TECHNIQUES* in this Operator's Guide.
- Never operate this vehicle on hills too steep for the vehicle or for your abilities.
- Always follow proper procedures for climbing hills as described in *RIDING TECHNIQUES* in this Operator's Guide. Check the terrain carefully before you start up any hill. Never climb hills with excessively slippery or loose surfaces.
- Always follow proper procedures for going down hills and for braking on hills as described in *RIDING TECHNIQUES* in this Operator's Guide. Check the terrain carefully before you start down any hill.
- Always follow proper procedures for crossing the side of a hill as described in *RIDING TECHNIQUES* in this Operator's Guide. Avoid hills with excessively slippery or loose surfaces.
- Always use proper procedures if you stall or roll backwards when climbing a hill. To avoid stalling, use low gear and maintain a steady speed when climbing a hill. If you stall or roll backwards, follow the driving technique procedures as described in *RIDING TECHNIQUES* in this Operator's Guide.

- Always check for obstacles before operating in a new area. Never attempt to operate over large obstacles, such as large rocks or fallen trees. Always follow proper procedures when operating over obstacles as described in *RIDING TECHNIQUES* in this Operator's Guide.
- Always be careful when skidding or sliding. Learn to safely control skidding or sliding by practicing at low speeds and on level smooth terrain. On extremely slippery surfaces, such as ice, go slowly and be very cautious in order to reduce the chance of skidding out of control. If you are operating a 2-UP model and have a passenger on-board, never attempt skidding or sliding; overturn or passenger ejection may occur.
- Never operate this vehicle through deep or fast flowing water. Water should never exceed footrests. Remember that wet brakes may have reduced stopping ability. Test your brakes after leaving water, mud or snow. If necessary, apply them several times to let friction dry out the pads.
- Always keep in mind that braking distance is readily affected by but not limited to; weather and terrain conditions, braking system and tire conditions, vehicle speed and attitude, and vehicle load including towing. Remember to adjust your driving accordingly.
- Always be sure there are no obstacles or people behind the vehicle when you operate in reverse. When it is safe to proceed in reverse, go slowly. Take into account that on a 2-UP model the passenger can obstruct your view.
- BRP recommends sitting on your ATV when operating in reverse. Avoid standing up. Your weight could shift forward against throttle lever, causing an unexpected acceleration and may lead to a loss of control.
- Never exceed the stated load limits for this vehicle including operator, passenger (2-UP models), all other loads and added accessories. Cargo should be properly distributed and securely attached. Reduce speed and follow instructions in this guide for carrying cargo or pulling a trailer. Allow greater distance for braking.
- Always inspect and confirm the safe operating condition of your vehicle prior to ride. Refer to *PRE-RIDE INSPECTION* subsection in this Operator's Guide. Always follow the maintenance schedules as described in this Operator's Guide. Refer to *MAINTENANCE* section.
- Never operate the vehicle if the controls do not function normally.
- Always maintain proper tire pressure. When replacing tires, use only the recommended tire size and type. For tire information, refer to *SPECIFICATIONS* in this guide.
- Riding your vehicle too fast for your skills or the conditions may result in injury. Apply only enough throttle to proceed safely. Statistics show that mishaps and injury usually result from high speed turns. Always remember that this vehicle is heavy! Its pure weight alone may entrap you should it fall resulting in injury.
- This vehicle is not designed for jumping, nor can it fully absorb the high impact energy generated during manoeuvres such as jumping which, can be passed on to you, the operator. Performing wheelies can cause the vehicle to flip over onto you. Both practices have a high risk for you and your passenger (2-UP models) and should be avoided at all times.

## 2-UP Models

### Driver must:

- Not forget is responsible for the safety of the passenger.
- Inform the passenger concerning the basic rules for a safe ride.
- Instruct the passenger to read the vehicle's safety labels and to watch the *SAFETY DVD* video.
- Always practice the maneuvers described in this Operator's Guide without and with a passenger. Greater skills are required with a passenger.
- Always remember that the vehicle handling and stability may be affected when riding with a passenger. Safely reduce speed. Use proper judgement. If in doubt, do not attempt and disembark the passenger before executing any maneuver.
- Always remember that the vehicle braking distance may be longer when riding with a passenger. Allow greater distance for braking.
- Never carry passenger on a 2-UP model if the passenger seat is not installed.
- Never carry more than one (1) passenger. Do not allow passenger to sit anywhere else than the designated passenger's seat.
- Never carry a passenger if you judge his ability or judgement insufficient to concentrate on the terrain conditions and adapt accordingly.
- Never carry a passenger who has used drugs or alcohol, or is tired or ill. These slow reaction time and impair judgment.

### Passenger must:

- Be capable of resting his feet on the footrests and his hands on grab handles when seated on this vehicle.
- Never take place on this vehicle without wearing an approved helmet (including a chin guard) that fits properly. The passenger should also wear eye protection (goggles or face shield), gloves, boots, long sleeved shirt or jacket, and long pants.
- Be seated on the designated passenger's seat.
- Always keep hands on grab handles and feet on the footrests during operation. Never hold on to the operator.
- Never get up during vehicle operation. An excessive movement could cause loss of control.
- Pay attention to vehicle and operator movements.
- Not wait and tell the driver to slow down or stop if you feel uncomfortable or insecure for any reason.

## European Community

### On Road Use

The following warnings apply only in the European Countries where on road usage is allowed. **SEVERE INJURY OR DEATH** can result if you do not comply with the following instructions.

#### **WARNING**

- This vehicle is built for OFF-ROAD purposes only. It may be used for short distances on paved surfaces at reduced speed, in order to move the vehicle from an off-road location to another.
- Always refrain from speeding and substantially reduce vehicle speed when turning.
- Always respect the road traffic laws, even on a dirt or gravel road.
- The front winch hook (if applicable) must be removed and stored.

# OPERATION WARNINGS

The following warning and their format have been requested by the United States Consumer Product Safety Commission and are required to be in the Operator's Guide for all ATVs.

**NOTE:** The following illustrations are general representations only. Your model may differ.

## **WARNING**



### **POTENTIAL HAZARD**

Operating this vehicle without proper instruction.

### **WHAT CAN HAPPEN**

The risk of an accident is greatly increased if the operator does not know how to operate this vehicle properly in different situations and on different types of terrain.

### **HOW TO AVOID THE HAZARD**

Beginners and inexperienced operators should complete a training course. They should then regularly practice the skills learned during the course as well as the operating techniques described in this Operator's Guide.

For more information about a training course, contact an authorized Can-Am dealer.

**⚠ WARNING**



V00A1AQ

**POTENTIAL HAZARD**

Failure to follow the age recommendations for this vehicle.

**WHAT CAN HAPPEN**

A lack of respect for this age recommendation can lead to severe injury or death of the child.

Even though a child may be within the age group for which this vehicle is recommended, he may not have the skills, abilities, or judgment needed to operate this vehicle safely and may be involved in a serious accident.

**HOW TO AVOID THE HAZARD**

No one under 16 should operate this vehicle.



*2-UP Models Only***⚠ WARNING**

vmo2014-005-100

**POTENTIAL HAZARD**

Failure to respect the physical limitations of the passenger on 2-UP models.

**WHAT CAN HAPPEN**

A passenger that cannot completely lean his feet on footrests can be ejected when riding on uneven terrain.

**HOW TO AVOID THE HAZARD**

The passenger must be capable of keeping his feet on the footrests and his hands on grab handles at all times when he is seated on the vehicle.

*1-UP Models Only*

**⚠ WARNING**



V00A02Q

**POTENTIAL HAZARD**

Carrying a passenger on this vehicle.

**WHAT CAN HAPPEN**

Greatly reduces your ability to balance and control this vehicle.

Could cause an accident, resulting in harm to you and/or your passenger.

**HOW TO AVOID THE HAZARD**

Never carry passenger. Even with a long seat that provides unrestricted operator movement, it is not designed nor intended to carry passenger(s).

*2-UP Models Only***⚠ WARNING**

V00A1CQ

**POTENTIAL HAZARD**

Carrying more than one (1) passenger on this vehicle.

**WHAT CAN HAPPEN**

Carrying more than one (1) passenger reduces your ability to balance and control this vehicle.

Could cause an accident, resulting in harm to you and/or your passengers.

**HOW TO AVOID THE HAZARD**

Never carry more than one (1) passenger. Even with a long seat that provides unrestricted operator movement, the vehicle is not designed nor intended to carry more than one (1) operator and one (1) passenger. The passenger must use the designated passenger's seat when he is seated on the vehicle with feet firmly planted on footrests and always hold on to the grab handles.

**⚠ WARNING**



V00A2DQ

**POTENTIAL HAZARD**

Allowing passenger(s) to sit on front or rear racks on this vehicle.

**WHAT CAN HAPPEN**

Allowing a passenger could:

- Impair vehicle stability which could lead to a loss of control.
- Result in injury to passenger(s) from impact on hard surfaces.
- Cause an accident, resulting in harm to you and/or your passenger.

**HOW TO AVOID THE HAZARD**

Never allow any passenger to sit on front or rear racks on this vehicle.

**⚠ WARNING****POTENTIAL HAZARD**

Operating this vehicle on paved surfaces.

**WHAT CAN HAPPEN**

Paved surfaces may seriously affect handling and control of the vehicle, and may cause the vehicle to go out of control.

**HOW TO AVOID THE HAZARD**

If a road usage is allowed in your area, operate your vehicle on paved surfaces only for short distance and for the only purpose of moving the vehicle from an off-road usage to another.

Always operate your vehicle at low speed (never exceed 65 km/h (40 MPH)) and reduce the speed before making a turn.

Always respect all road traffic laws when operating your vehicle on public roads or streets.

**⚠ WARNING**



**POTENTIAL HAZARD**

Riding this vehicle without wearing an approved helmet, eye protection and protective gear. On 2-UP models, passenger should also have an approved helmet with a rigid chin guard.

**WHAT CAN HAPPEN**

- Riding without an approved helmet increases the chances of a severe head injury or death in the event of an accident.
- Riding without eye protection can result in an accident and increases the chances of a severe injury in the event of an accident.
- Riding without protective gear increases the chances of severe injury in the event of an accident.

**HOW TO AVOID THE HAZARD**

Always wear an approved helmet that fits properly. You should also wear:

- Eye protection (goggles or face shield)
- Rigid chin guard
- Gloves and boots
- Long sleeved shirt or jacket
- Long pants.

**⚠ WARNING**

V00A07Q

**POTENTIAL HAZARD**

Using this vehicle with drugs or alcohol.

**WHAT CAN HAPPEN**

- Could cause the passenger to fall off (2-UP models).
- Could seriously affect your judgment.
- Could cause you to react more slowly.
- Could affect your balance and perception.
- Could result in an accident or death.

**HOW TO AVOID THE HAZARD**

The operator and the passenger (2-UP models) should never use this vehicle with drugs or alcohol.

**⚠ WARNING**

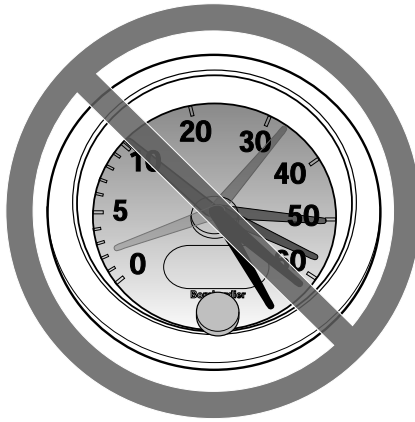

V00A08Q

**POTENTIAL HAZARD**

Operating this vehicle at excessive speeds.

**WHAT CAN HAPPEN**

Increases your chances of losing control of the vehicle, which can result in an accident.

**HOW TO AVOID THE HAZARD**

Always travel at a speed which is appropriate for the terrain, visibility and operating conditions, and your experience.

On 2-UP models, the vehicle handling, stability and braking distance may be affected when riding with a passenger. Safely reduce speed when riding with a passenger. Allow greater distance for braking.



**⚠ WARNING****POTENTIAL HAZARD**

Attempting wheelies, jumps and other stunts.

**WHAT CAN HAPPEN**

Increases the chance of an accident, for the operator and the passenger (2-UP models), including an overturn.

**HOW TO AVOID THE HAZARD**

Never attempt stunts, such as wheelies or jumps. Do not try to show off.

**⚠ WARNING****POTENTIAL HAZARD**

Failure to inspect the vehicle before operating.

Failure to properly maintain the vehicle.

**WHAT CAN HAPPEN**

Increases the possibility of an accident or equipment damage.

**HOW TO AVOID THE HAZARD**

Always inspect your vehicle prior to ride to make sure the vehicle is in safe operating condition.

Always follow the maintenance schedule described in this Operator's Guide.

**⚠ WARNING**

**POTENTIAL HAZARD**

Riding on frozen waterways.

**WHAT CAN HAPPEN**

Breaking through the ice can lead to severe injury or death.

**HOW TO AVOID THE HAZARD**

Never ride this vehicle on a frozen surface before you are sure the ice is thick enough and sound enough to support the vehicle and its load, as well as the force that is created by a moving vehicle.

**⚠ WARNING**



**POTENTIAL HAZARD**

Removing hands from handlebars for the operator and from grab handles for the passenger (2-UP models), or feet from the footrests during operation.

**WHAT CAN HAPPEN**

Removing even one hand or foot can reduce your ability to control the vehicle or could cause you to lose your balance and fall off the vehicle. If you remove a foot from the footrests, your foot or leg may come into contact with the rear wheels, which could injure you or cause an accident.

**HOW TO AVOID THE HAZARD**

Operator must always keep both hands on the handlebars and passenger (2-UP models) on grab handles. Both feet (operator and passenger on 2-UP models) must rest on the footrests during vehicle operation.

**⚠ WARNING****POTENTIAL HAZARD**

Failure to use extra care when operating this vehicle on unfamiliar terrain.

**WHAT CAN HAPPEN**

You can come upon hidden rocks, bumps, or holes, without enough time to react.

Could result in the vehicle overturning, passenger ejection (2-UP models) or loss of control.

**HOW TO AVOID THE HAZARD**

Go slowly and be extra careful when operating on unfamiliar terrain.

Always be alert to changing terrain conditions when operating the vehicle.

Do not forget, on 2-UP models, the operator is responsible for the safety of his passenger. Safely reduce speed when riding with a passenger.

**⚠ WARNING**



**POTENTIAL HAZARD**

Failure to use extra care when operating on excessively rough, slippery or loose terrain.

**WHAT CAN HAPPEN**

Could cause loss of traction or vehicle control, which could result in an accident, including an overturn or passenger ejection (2-UP models).

**HOW TO AVOID THE HAZARD**

Do not operate on excessively rough, slippery or loose terrain until you have learned and practiced the skills necessary to control this vehicle on such terrain.

Always be especially cautious on these kinds of terrain.

Do not forget, on 2-UP models, the operator is responsible for the safety of the passenger. In doubt, disembark him before operating on these terrains.

**⚠ WARNING****POTENTIAL HAZARD**

Turning improperly.

**WHAT CAN HAPPEN**

Vehicle could go out of control, causing a collision or an overturn or a passenger ejection (2-UP models).

**HOW TO AVOID THE HAZARD**

Always follow proper procedures for turning as described in this Operator's Guide. Practice turning at low speeds before attempting to turn at faster speeds.

Do not forget, on 2-UP models, the operator is responsible for the safety of the passenger. Never perform this maneuver with a passenger. Always remember that the vehicle handling, stability and braking distance may be affected when riding with a passenger.

Do not turn at excessive speed.

**⚠ WARNING**



**POTENTIAL HAZARD**

Operating on excessively steep hills.

**WHAT CAN HAPPEN**

The vehicle can overturn more easily on extremely steep hills than on level surfaces or small hills.

**HOW TO AVOID THE HAZARD**

Never operate this vehicle on hills too steep for the vehicle or for your abilities.

Practice, without and with passenger (2-UP models), on smaller hills before attempting larger hills.

Always remember that, on 2-UP models, even if this vehicle can climb some steep hills, it is not recommended to climb such hills with a passenger; always disembark him before attempting this maneuver. Show good judgment.

**⚠ WARNING****POTENTIAL HAZARD**

Climbing hills improperly.

**WHAT CAN HAPPEN**

Could cause loss of control, passenger ejection (2-UP models) or cause vehicle to overturn.

**HOW TO AVOID THE HAZARD**

Always follow proper procedures for climbing hills as described in this Operator's Guide.

Always check the terrain carefully before you start up any hill. Do not forget, on 2-UP models, the operator is responsible for the safety of the passenger. In doubt, disembark him before climbing hill. Always remember that the vehicle handling, stability and braking distance may be affected when riding with a passenger.

Never climb hills with excessively slippery or loose surfaces.

Shift your weight forward (operator and passenger on (2-UP models)).

Never open the throttle suddenly or make sudden gear changes. The vehicle could flip over backwards.

Never go over the top of any hill at high speed. An obstacle, a sharp drop, or another vehicle or person could be on the other side of the hill.

**⚠ WARNING**



**POTENTIAL HAZARD**

Going down a hill improperly.

**WHAT CAN HAPPEN**

Could cause loss of control, passenger ejection (2-UP models) or cause vehicle to overturn.

**HOW TO AVOID THE HAZARD**

Always follow proper procedures for going down hills as described in this Operator's Guide.

NOTE: A special technique is required when braking as you go down a hill.

Always check the terrain carefully before you start down any hill. Do not forget, on 2-UP models, the operator is responsible for the safety of the passenger. In doubt, disembark him before going down hill. Always remember that the vehicle handling, stability and braking distance may be affected when riding with a passenger.

Shift your weight backward (operator and passenger on 2-UP models).

Never go down a hill at high speed.

Avoid going down a hill at an angle which would cause the vehicle to lean sharply to one side. Go straight down the hill where possible.



**⚠ WARNING****POTENTIAL HAZARD**

Improperly crossing hills or turning on hills.

**WHAT CAN HAPPEN**

Could cause loss of control, passenger ejection (2-UP models) or cause vehicle to overturn.

**HOW TO AVOID THE HAZARD**

Never attempt this maneuver on 2-UP models when the passenger is on board. Always disembark him before executing.

Never attempt to turn the vehicle around on any hill until you have mastered the turning technique as described in this Operator's Guide on level ground. Be very careful when turning on any hill.

Avoid crossing the side of a steep hill if possible.

***When crossing the side of a hill:***

Always follow proper procedures as described further in this Operator's Guide.

Avoid hills with excessively slippery or loose surfaces.

Operator and passenger (2-UP models) must shift weight to the uphill side of the vehicle.

**⚠ WARNING**



V00A1PQ

**POTENTIAL HAZARD**

Stalling, rolling backwards or improperly dismounting while climbing a hill.

**WHAT CAN HAPPEN**

Could result in vehicle overturning.

**HOW TO AVOID THE HAZARD**

Use low gear and maintain steady speed when climbing a hill.

***If you lose all forward speed:***

Operator and passenger (2-UP models) must keep their weight uphill. Never open the throttle suddenly or make sudden gear changes. The vehicle could flip over backwards.

Apply the brakes.

Lock brake lock after you have stopped.

Disembark on uphill side, or to a side if pointed straight uphill (passenger first on 2-UP models).

***If you begin rolling backwards:***

Operator and passenger (2-UP models) must keep their weight uphill. Never open the throttle suddenly or make sudden gear changes. The vehicle could flip over backwards.

Never apply the rear brake while rolling backwards.

Apply the front brake gradually.

When fully stopped, apply rear brake as well and lock brake lock.

Disembark on uphill side, or to a side if pointed straight uphill (passenger first on 2-UP models).

Turn the vehicle around and remount, following the procedure described further in this Operator's Guide.

**⚠ WARNING****POTENTIAL HAZARD**

Improperly operating over obstacles.

**WHAT CAN HAPPEN**

Could cause loss of control (passenger ejection on 2-UP models), or a collision.

Could cause the vehicle to overturn.

**HOW TO AVOID THE HAZARD**

Before operating in a new area, check for obstacles.

Never attempt to ride over large obstacles, such as large rocks or fallen trees.

On 2-UP models, the operator is responsible for the safety of his passenger. In doubt, disembark him before riding over obstacles. Always remember that the vehicle handling and stability may be affected when riding with a passenger.

When you go over obstacles, always follow proper procedures as described in this Operator's Guide.

**⚠ WARNING**



**POTENTIAL HAZARD**

Skidding or sliding improperly.

**WHAT CAN HAPPEN**

You may lose control of this vehicle.

You may also regain traction unexpectedly, which may cause the vehicle to overturn or passenger ejection (2-UP models).

**HOW TO AVOID THE HAZARD**

Learn to safely control skidding or sliding by practicing at low speeds and on level smooth terrain.

On 2-UP models, never slide or skid with passenger. Always remember that the vehicle handling and stability may be affected when riding with a passenger.

On extremely slippery surfaces, such as ice, go slowly and be very cautious in order to reduce the chance of skidding or sliding out of control.

**⚠ WARNING****POTENTIAL HAZARD**

Operating this vehicle through deep or fast flowing water.

**WHAT CAN HAPPEN**

Tires may float, causing loss of traction and loss of control, which could lead to an accident.

**HOW TO AVOID THE HAZARD**

Never operate this vehicle in fast flowing water or in deep water.

Check water depth and current before you attempt to cross any water. Water should not go above footrests.

Remember that wet brakes may have reduced stopping ability. Test your brakes after leaving water. If necessary, apply them several times to let friction dry out the pads.

**⚠ WARNING**



**POTENTIAL HAZARD**

Improperly operating in reverse.

**WHAT CAN HAPPEN**

You could hit an obstacle or person behind the vehicle, resulting in serious injury.

**HOW TO AVOID THE HAZARD**

When you select reverse gear, make sure there are no obstacles or people behind the vehicle. When it is safe to proceed, go slowly. On 2-UP models, take account that the passenger can obstruct your view.

**⚠ WARNING****POTENTIAL HAZARD**

Operating this vehicle with improper tires, or with improper or uneven tire pressure.

**WHAT CAN HAPPEN**

Use of improper tires on this vehicle, or operation of this vehicle with improper or uneven tire pressure, may cause loss of control, tire blow outs, tire to move around on its rim, and increases the risk of an accident.

**HOW TO AVOID THE HAZARD**

Always use the size and type of tires specified in this Operator's Guide for this vehicle.

Always maintain proper tire pressure as described in this Operator's Guide.  
Always replace wheels or tires that are damaged.

**⚠ WARNING**



**POTENTIAL HAZARD**

Operating this vehicle with improper modifications.

**WHAT CAN HAPPEN**

Improper installation of accessories or modification of this vehicle may cause changes in handling which in some situations could lead to an accident.

**HOW TO AVOID THE HAZARD**

Never modify this vehicle through improper installation or use of accessories. All parts and accessories added to this vehicle should be approved by BRP and should be installed and used according to instructions. If you have questions, consult an authorized Can-Am dealer.

**NEVER** install a passenger seat (1-UP models) or use the racks to carry a passenger.

Modification of the vehicle to increase speed and performance may violate the terms and conditions of your vehicle limited warranty. In addition, certain modifications including the removal of engine or exhaust components are illegal under most laws.



**⚠ WARNING****POTENTIAL HAZARD**

Overloading this vehicle, carrying or towing cargo improperly.

**WHAT CAN HAPPEN**

Could cause changes in vehicle handling which could lead to an accident.

**HOW TO AVOID THE HAZARD**

Never exceed the stated load capacity for this vehicle including operator and passenger (2-UP models) as well as other loads and added accessories.

Cargo should be properly distributed and securely attached.

Reduce speed when carrying cargo or pulling a trailer. Allow greater distance for braking.

Always follow the instructions in this Operator's Guide for carrying cargo or pulling a trailer.

**⚠ WARNING**



V03M01Q

**POTENTIAL HAZARD**

Transporting flammable or dangerous material can lead to explosions.

**WHAT CAN HAPPEN**

This can cause serious injury or death.

**HOW TO AVOID THE HAZARD**

Never transport flammable or dangerous material.

---

## PRE-RIDE INSPECTION

### **WARNING**

Perform a pre-ride inspection before each ride to detect any potential problem that could occur during operation. The pre-ride inspection can help you monitor component wear and deterioration before they become a problem. Correct any problem that you discover to reduce the risk of a breakdown or crash. See an authorized Can-Am dealer as necessary.

Before using this vehicle, the operator should always perform the following pre-ride inspection check list.

Correct any problem found before riding the vehicle. See an authorized Can-Am dealer if necessary.

## Pre-Ride Inspection Check List

### What to Do Before Starting the Engine (Key OFF)

ITEMS TO BE INSPECTED	INSPECTION TO PERFORM	✓
Engine oil	Check engine oil level.	
Coolant	Check coolant level.	
Brake fluid	Check brake fluid level.	
Leaks	Check for any leaks under vehicle	
Throttle lever	Activate throttle lever several times to ensure it operates freely. It must return to idle position when released	
Brake lock	Apply brake lock and check if it operates properly	
Tires	Check tire pressure and condition. – Front: MIN 41.4 kPa (6 PSI), LOADED 48.3 kPa (7 PSI) – Rear: MIN 41.4 kPa (6 PSI), LOADED 68.9 kPa (10 PSI)	
Wheels	Check wheels for damage and for abnormal play, and check lug nuts are tightened. Tighten wheel beadlock bolts (if equipped).	
Radiator	Check cleanliness of the radiator	
Drive shaft boots	Check drive shaft boots and protectors condition	
Seat(s)	Check if operator seat is in place and properly latched	
	Check if passenger seat or the glove box are in place and properly latched (2-UP Models)	
	Check the passenger backrest and grab handles condition (2-UP Models)	
Cargo	If you transport a cargo, respect the load capacity. Ensure cargo is properly secured to the racks	
	If you are pulling a trailer or another equipment: – Check hitch and trailer ball condition – Respect the tongue capacity and towing capacity – Ensure trailer is properly secured to hitch.	
Storage compartment	Check if rear storage compartment is properly latched	
Chassis and suspension	Check underneath vehicle for any debris on chassis or suspension and clean them properly	
Engine air filter	Inspect and clean engine air filter	
CVT air filter	Inspect and clean CVT air filter	

**What to Do Before Starting the Engine (Key ON)**

ITEMS TO BE INSPECTED	INSPECTION TO PERFORM	✓
Multifunction gauge	Check operation of indicator lamps in multifunction gauge (during first few seconds of key ON)	
	Check for messages on multifunction gauge	
Lights	Check operation and cleanliness of headlights and taillight	
	Check operation of low and high beams	
	Check operation of brake light	
	Check operation and cleanliness of turn signal lights	
	Check operation of hazard warning lights	
Horn	Check operation of the horn	
Fuel level	Check the fuel level.	

**What to Do After the Engine is Started**

ITEMS TO BE INSPECTED	INSPECTION TO PERFORM	✓
Steering	Check if steering operates freely by completely turning it from side to side	
Shift lever	Check operation of shift lever (P, R, N, H and L)	
2WD/4WD selector	Check operation of 2WD/4WD selector	
Brakes	Drive forward slowly a few feet and apply brake lever and brake pedal individually. The brakes must fully apply. Lever and pedal must fully return when released	
Emergency engine stop switch	Check that the emergency engine stop switch is working properly	
Ignition switch	Check if ignition switch is working properly by restarting and stopping the engine	

---

## RIDING THE VEHICLE

To fully appreciate the pleasures and excitement of riding this vehicle, there are some basic rules and tips that you **MUST** follow. Some may be new to you while others may be common sense or obvious.

Please take the time to study this Operator's Guide and all on-product safety labels as well as the *SAFETY DVD* video that came with this vehicle. They more completely describe what you should know about this vehicle before riding it.

Whether you are a new user or an experienced rider, it is important for your personal safety that you know the controls and features of this vehicle. Equally important is knowing how to properly ride.

This is a high performance ATV for off-road use only. Inexperienced riders may overlook risks and be surprised by the specific behavior of this ATV in any terrain condition.

We recommend following the age recommendation indicated on the safety label affixed on the unit. Even though a person may be within the age group for which this vehicle is recommended, he may not have the skills, abilities, or judgment needed to operate this vehicle safely and may be involved in a serious accident.

Individuals with cognitive or physical impairments or who are high risk takers have an increased exposure to overturns or collisions which may result in injury including death.

Not all vehicles are the same. Each has its own unique performance characteristics, controls and features. Each will ride and handle differently.

Become completely familiar with the operational controls and the general operation of the vehicle before venturing into off road conditions. Practice driving in a suitable area free of hazards and feel the response of each control. Drive at low speeds. Higher speeds require greater experience, knowledge and suitable riding conditions.

Riding conditions vary from place to place. Each is subject to weather conditions which may radically change from time to time and from season to season.

Riding on sand is different than riding on snow or through forests or marshes. Each location may require a greater degree of awareness and skill. Show good judgement. Always proceed with caution. Please do not take any unnecessary risks that could leave you stranded or possibly injured.

Never assume that the vehicle will go everywhere safely. Sudden changes in terrain caused by holes, depressions, banks, softer or harder "ground" or other irregularities may cause the vehicle to topple or become unstable. To avoid this, slow down and always observe the terrain ahead. If the vehicle does begin to topple or tip over, the best advice is to immediately get off **AWAY** from the direction of the tip over!

If a road usage is allowed in your area, operate your vehicle on paved surface only for short distance and for the only purpose of moving the vehicle from an off-road usage to another. Always operate your vehicle at low speed (never exceed 65 km/h (40 MPH)) and reduce the speed before making a turn. This vehicle is not equipped with a rear differential (rear wheels are always turning at the same speed). For this reasons, pavement may seriously affect the handling and control of the vehicle.

Always respect all road traffic laws when operating your vehicle on public roads or streets. If you have to cross a road, the lead driver should get off his vehicle the observe and give direction to the other riders. The last person after crossing then assists the lead driver to cross. Do not travel on sidewalks. They are designated for pedestrian use.

For the users in the European Community, it is mandatory to remove the winch hook (if so equipped) to operate the vehicle on the roadway. Failure to follow this requirement could cause additional injuries including the possibility of death if an accident occurs.

We encourage you to have an Annual Safety Inspection of your vehicle. Please contact an authorized BRP dealer for further details. Though not required, it is recommended that an authorized BRP dealer performs the preseason preparation of your vehicle. Each visit to your authorized BRP dealer is a great opportunity for your dealer to verify if your vehicle is included in any safety campaign. We also urge you to visit your authorized BRP dealer in a timely manner if you become aware of any safety related campaigns.

See an authorized BRP dealer for available accessories you may require.

## **Riding Gear**

Actual weather conditions should help you decide how to dress. Dress for the coldest weather expected. Thermal underwear next to the skin also provides a good insulation. It is important that the operator always wears the appropriate protective riding gear and apparel, including an approved helmet, eye protection, boots, gloves, a long sleeved shirt and pants. This type of clothing will provide you protection from some of the minor hazards you may encounter en route. The operator must never wear loose clothing such as a scarf that may get entangled in the vehicle or on tree branches and shrubs. Depending on conditions, anti-fogging goggles or sunglasses may be required. Different colored lenses available for goggles or sunglasses help you distinguish terrain variations. Sunglasses should only be worn during the daytime.

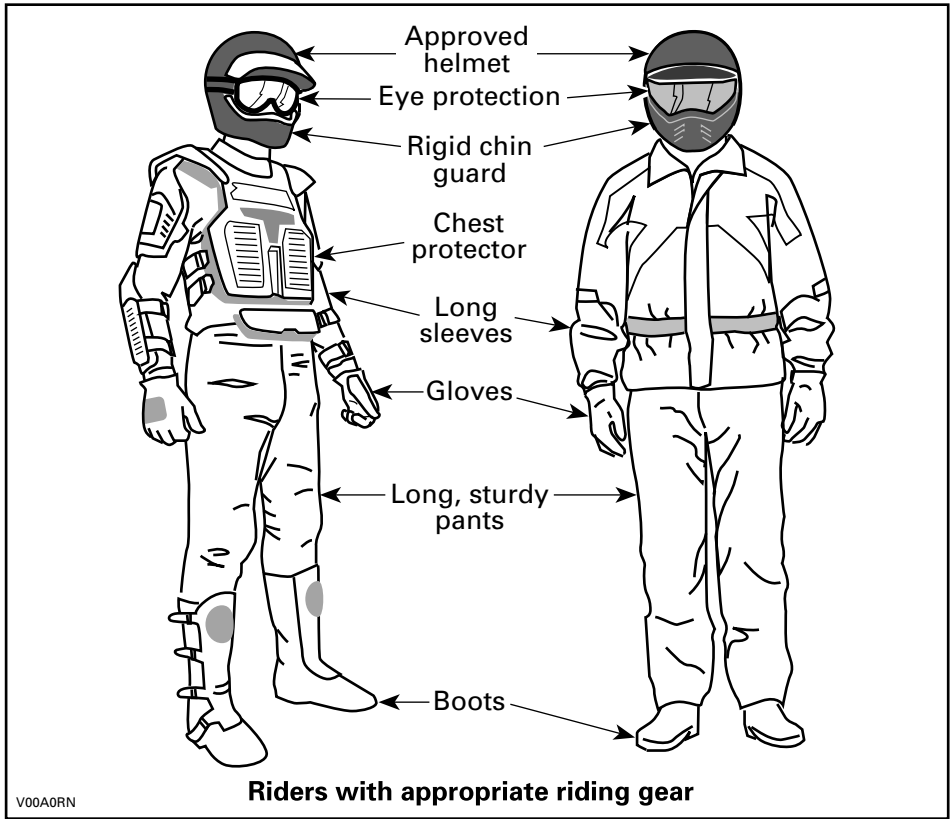

## Carrying a Passenger

### 1-UP Models

This vehicle is designed to carry ONE (1) operator only. Do not install passenger seat or use the racks to carry a passenger.

### 2-UP Models

This vehicle is designed specifically to carry an operator and ONE (1) passenger only. The passenger must be seated on the designated passenger's seat and hold on to the grab handles at all times. NEVER install other passenger's seat other than the one recommended by BRP. Do not use the racks or their location to carry passenger(s). Carrying more than one (1) passenger may affect the stability and your control of the vehicle. When the glove box is installed (in place of rear seat), the vehicle becomes a ONE-RIDER vehicle (1-UP model) and NO PASSENGER must be allowed on it.



## Recreational Riding

Respect the rights and limitations of others. Stay away from areas designated for other types of off road use. This includes snowmobile trails, equestrian trails, cross country ski trails, mountain bike trails, etc. Never assume there are no other users on the trail. Always stay to the complete right of the trail and do not zigzag to one side of the trail then the other. Be prepared to stop or pull off to the side if another trail user appears in front of you.

Join a local ATV club. It will provide you with a map and advice or inform you where you can ride. If a club does not exist in your area, help to start one. Group riding and club activities provide a pleasurable, social experience.

Always keep a safe distance from other riders. Your judgment of speed, terrain conditions, weather, mechanical condition of your vehicle and the "trust in judgment" you have in others around you will help you make a better choice of appropriate safe distance. This vehicle, like any other motorized vehicle, cannot stop "on a dime". Allow greater distance for braking. On 2-UP models, the vehicle handling, stability and braking distance may be affected when riding with a passenger. Safely reduce speed when riding with a passenger.

Before you ride, tell someone where you are planning to travel and your expected time of return.

Depending on the length of your ride, carry additional tools, drinking water, food and emergency equipment. Find out where you can get additional gasoline and oil. Be prepared for the possible conditions you may encounter.

First aid kit	Adjustable wrench
Mobile phone	Knife
Friction tape	Flashlight
A rope	Colored lens goggles
Spare light bulbs	Trail map
Provided tool kit	Snack

## Environment

One of the benefits of this vehicle is that it can take you off the beaten path away from most communities. However, you should always respect nature and the rights of others to enjoy it. Do not ride in environmentally sensitive areas. Do not drive over forest crops or shrubs nor cut down trees or take down fencing nor spin your wheels and destroy the terrain. "Tread Lightly".

This vehicle can cause OHV wildfires if debris builds up near the exhaust or other engine hot spots and ignites then falls off into dry grass. Avoid riding in wet areas, through muskeg or tall grass, where debris can build up. Should you ride in those areas, inspect and remove all debris from your engine and hot spots.

Chasing wildlife is in many areas illegal. Wildlife can die of exhaustion after being chased by a motorized vehicle. If you encounter animals on the trail, stop and observe quietly and with caution. It will be one of the better memories of your life.

Observe the rule “what you take in, carry out”. Do not litter. Do not start campfires unless you have permission to do so and then only away from dry areas. The hazards you may create on the trail may cause injury to others or yourself, even at a later date.

Respect farm lands. Always obtain the permission of the landowner before riding on private land. Respect crops, farm animals and property lines. If you come to a closed gate, close it again behind you.

Finally, do not pollute streams, lakes or rivers and do not modify the engine or exhaust system, or remove any of its components.

## **Design Limitation**

Although the vehicle is exceptionally rugged for its class, it is still a light vehicle by definition and its operation must be restricted to its proper purpose.

The addition of weight to any part of the vehicle changes its gravitational stability and modifies its performance.

## **Off-Road Operation**

The very nature of off-road operation is dangerous. Any terrain, which has not been specially prepared to carry vehicles, presents an inherent danger where angularity, terrain substance and exact steepness are unpredictable. The terrain itself presents a continual element of danger, which must be knowingly accepted by anyone venturing over it.

An operator who takes a vehicle off-road should always exercise the utmost care in selecting the safest path and keeping close watch on the terrain ahead of him. On no account should the vehicle be operated by anyone who is not completely familiar with the driving instructions applicable to the vehicle, nor should it be operated on steep or treacherous terrain.

## **Riding Techniques**

Information in this guide is limited. Increase your knowledge and improve your skills by following a certified training course.

Care, caution, experience and driving skill are the best precautions against the hazards of vehicle operation.

Respect and follow all posted trail signs. They are there to help you and others.

In off-road operation, power and traction, not speed, are important. Never drive faster than visibility and your own ability to select a safe route permits.

Constantly watch the terrain ahead for sudden changes in slopes or obstacles, such as rocks or stumps, that may cause loss of stability, resulting in tip over or rollover.

It is also wise to know the terrain condition on the other side of a hill or bank. All too often there exists a sharp drop-off that is impossible to negotiate or descend.

Whenever there is the slightest doubt that the vehicle can safely negotiate an obstacle or a particular piece of terrain, always choose an alternate route.

Always use proper riding techniques to avoid vehicle overturns on hills and rough terrain and in turns.

## Body Position

To maintain proper control, it is strongly advised that you keep your hands on the handlebar and within easy reach of all controls. The same holds true for your feet on the foot pegs. To minimize the possibility of a leg or foot injury, keep your feet on the foot pegs at all times. Do not direct your toes outwards nor extend your feet out to assist in turning as they can be hit or be snagged on passing obstacles, or may come into contact with the wheels.

Even though there is a suspension on this vehicle, there are “washboard” or rough terrain conditions that will make you feel uncomfortable and can even cause a back injury. “Posting” or riding in a crouched position will often be required. Slow down and allow your flexed legs to absorb part of the impact energy.

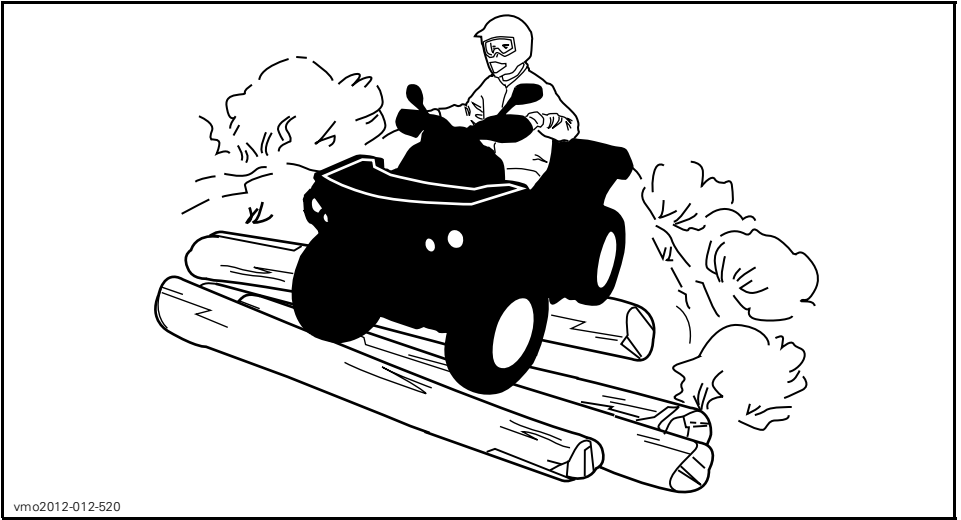

vmo2012-012-520

## 2-UP Models

The passenger must keep his hands on the grab handles and his feet on footrests at all times.

The passenger must synchronize his movements with the operator.

## Crossing Roads

If you have to cross a road, the lead driver should get off his vehicle, then observe and give directions to the other riders. The last person after crossing then assists the lead driver to cross. Do not use sidewalks. They are designated for pedestrian use.

If road usage is allowed in your area, operate your vehicle on paved surface only for short distance and for the only purpose of moving the vehicle from an off-road usage to another. Always operate your vehicle at low speed (never exceed 65 km/h) and reduce the speed before making a turn. This vehicle is not equipped with a rear differential (rear wheels are always turning at the same speed). For this reasons, pavement may seriously affect the handling and control of the vehicle.

## Riding on Roads

Always respect all road traffic laws when operating your vehicle on public roads or streets. If you have to cross a road, the lead driver should get off his vehicle the observe and give direction to the other riders. The last person after crossing then assists the lead driver to cross. Do not travel on sidewalks. They are designated for pedestrian use.

## Turning

Practice turning at low speeds before attempting to turn at faster speeds.

Keep both hands on handlebars and feet on foot pegs.

Maintain a constant speed or a slight acceleration during turn.

To reduce the risk of rollovers:

- Use care when turning.
  - Do not turn the handlebar too far or too fast for your speed and environment. Adjust steering inputs accordingly.
  - Slow down before entering a turn. Avoid hard braking during a turn.
  - Avoid sudden or hard acceleration when turning, even from a stop or low speed.
- Never attempt donuts, skids, slides, fishtails, jumps, or other stunts. If vehicle starts to skid or slide, steer in the direction of the skid or slide. Never slam the brakes and lock the wheels.
- Avoid paved surfaces. This vehicle is not designed to operate on paved surfaces and is more likely to roll over. If you must drive on pavement, turn gradually, go slowly, and avoid abrupt acceleration and braking.

Avoid sudden inputs to steering, throttle or brakes while turning.

### **WARNING**

Do not attempt turns at excessive speed.

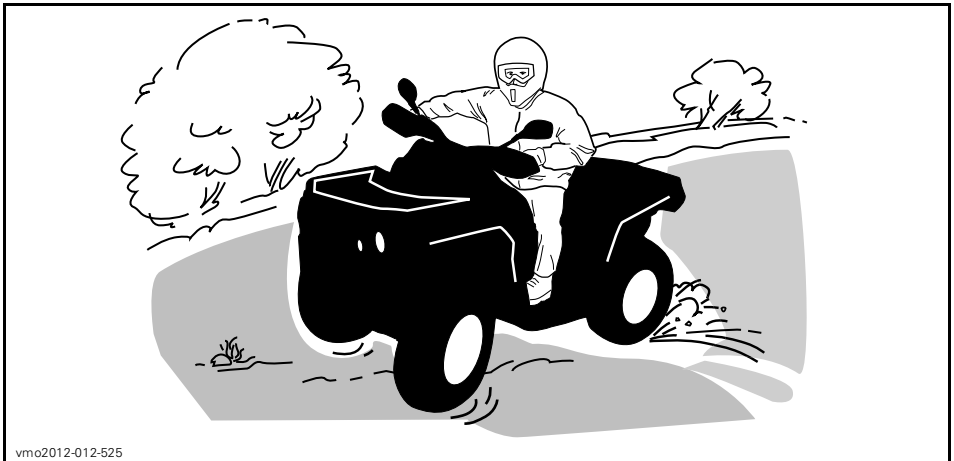

vmo2012-012-525

If you do get into a slide or skid, it may help to turn the handlebar in the direction of the skid until you regain control. Never jam the brakes and lock the wheels.

## Braking

Always keep both hands on handlebars and feet on foot pegs when braking.

Practice braking to get familiar with the brake response.

- Do it at low speed first, then increase the speed.
- Practice braking in straight line at different speeds and different braking force.
- Practice emergency braking; optimal braking is obtained in straight line, with high force applied, without locking the wheels.

Remember, braking distance depends on vehicle speed, load and the type of surface. Also, the tires and brakes conditions play a major role.

**NOTE:** If going forward the vehicle weight is transferred to the front wheels when braking. To obtain greater stopping efficiency, the brake system distributes more braking force to the front wheels. This will affect vehicle handling and steering control when braking vigorously. Take it into account when braking.

## Reverse Operation

When operating in reverse, check that the path behind the vehicle is free of people or obstacles. Proceed slowly and avoid sharp turns.

When riding on a 2-UP model, take into account that the passenger can obstruct your view. Disembark the passenger if necessary.

We recommend sitting on your ATV when operating in reverse. Avoid standing up. Your weight could shift forward against throttle lever, causing an unexpected acceleration.

## Obstacles

Obstacles in the “trail” should be traversed with caution. This includes loose rocks, fallen trees, slippery surfaces, fences, posts, and embankments and depressions. You should avoid them whenever possible. Remember that some obstacles are too large or dangerous to cross and should be avoided. Small rocks or fallen trees may be safely crossed approach at a 90° angle. Stand on the footrests while keeping your knees flexed. Adjust speed without losing momentum and do not “gun” the throttle. Hold handlebar (operator) or grab handles (passenger on 2-UP models) firmly. Place body weight rearwards (operator and passenger 2-UP models) and proceed. Do not try to lift the vehicle front wheels off the ground. Be aware that the object may be slippery or may move while crossing.

When riding on 2-UP models, the operator is responsible for the safety of the passenger; in doubt, disembark the passenger before proceeding.

## Uphill Driving

### *1-UP Models*

Before trying to climb a hill, keep these things in mind. Hill Climbing should only be attempted by experienced operators. Start on shallow slopes. Always drive straight uphill and keep your body weight forward towards the top of the hill. Keep your feet on the footrests, shift your ATV into a lower gear and accelerate

before you start to climb. Try to keep a steady speed and go easy on the throttle to avoid acceleration. Abrupt slope or terrain variation or rolling one wheel over an obstacle could have a big impact on the stability as it will lift the front of the vehicle increasing the risk of tipping over. Some hills are too steep to safely stop or recover from after an unsuccessful climbing attempt. Try to avoid steep inclines. If you're not careful, you could tip over when going up hills. If the hill is too steep and you cannot proceed or the vehicle begins to roll backwards, apply the brake, being careful not to slide. Dismount then use the "K" turn (while walking back, next to the vehicle on the up hill side and with a hand on the brake lever, slowly back the rear of the vehicle toward the top of the hill then drive downhill). Always walk or dismount on the upside of the slope while keeping clear of the vehicle and its rotating wheels. Do not try to hold on to the vehicle if it begins to topple. Stay clear. Do not ride over the crest of the hill at high speed. Obstacles, including sharp drop-offs, may exist.

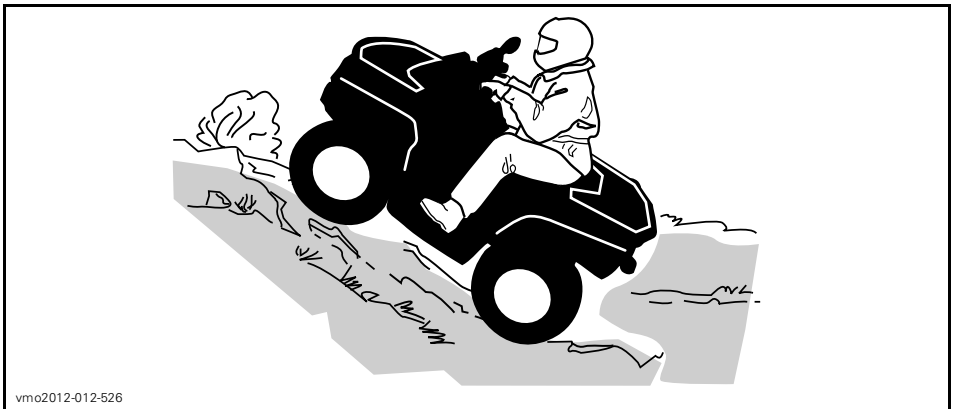

vmo2012-012-526

### **2-UP Models**

The passenger must synchronize his movements with the operator. The passenger must remain seated at all times.

Do not forget, the operator is responsible for the safety of the passenger. In doubt, disembark the passenger before climbing a hill.

Before trying to climb a hill, keep these things in mind. Hill Climbing should only be attempted by experienced operators. Start on shallow slopes. Always drive straight uphill. Operator and passenger must keep their body weight forward, towards the top of the hill. Keep feet on the footrests, shift the ATV into a lower gear and accelerate before you start to climb. Try to keep a steady speed and go easy on the throttle to avoid acceleration. Abrupt slope or terrain variation or rolling one wheel over an obstacle could have a big impact on the stability as it will lift the front of the vehicle increasing the risk of tipping over. Some hills are too steep to safely stop or recover from after an unsuccessful climbing attempt. Try to avoid steep inclines. If you're not careful, you could tip over when going up hills. If the hill is too steep and you cannot proceed or the vehicle begins to roll backwards, apply the brake, being careful not to slide. Dismount, passenger first, then use the "K" turn (while walking back, next to the vehicle on the up hill side and with a hand on the brake lever, slowly back the rear of the vehicle toward the top of the hill then drive downhill). Always walk or dismount on the upside of the

slope while keeping clear of the vehicle and its rotating wheels. Do not try to hold on to the vehicle if it begins to topple. Stay clear. Do not ride over the crest of the hill at high speed. Obstacles, including sharp drop-offs, may exist. The passenger should get on the vehicle only when the vehicle has returned to a safe location.

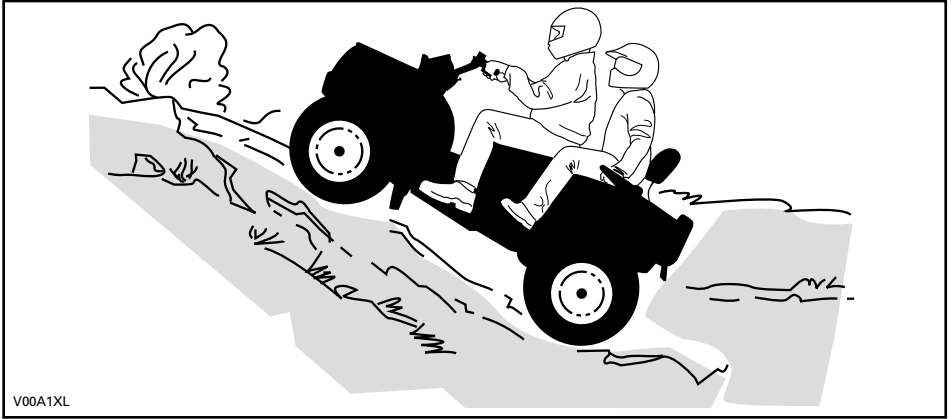

V00A1XL

### Vehicle Behaviors

Due to configuration, this vehicle has excellent climbing ability, so much so that it is possible to tip over before traction is lost. For example, it is common to encounter terrain situations where the top of the hill has eroded to a point that the hill peak rises very sharply. The vehicle can readily negotiate such a condition, however, in doing so, when the front of the vehicle is driven to a point that the vehicle's balance moves rearward, a tip over can occur.

The same situation may apply if an embedded object causes the front of the vehicle to climb more than desired. If such a situation occurs take an alternate route. Be aware of side hilling dangers when doing so. Refer to *SIDE HILLING*.

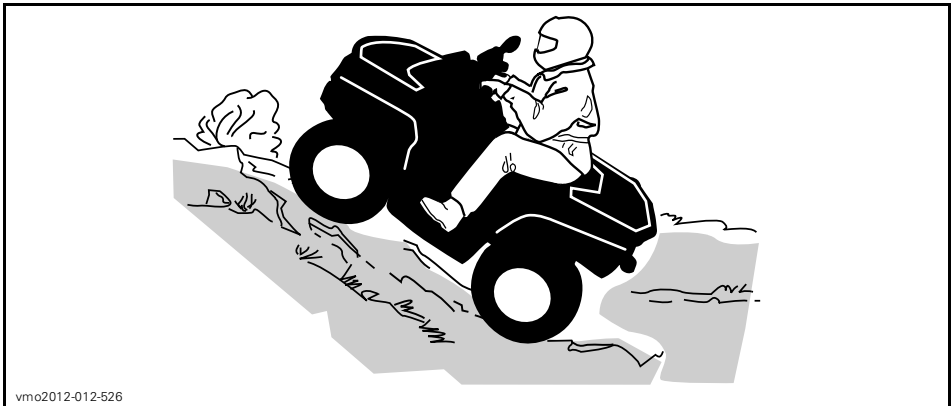

vmo2012-012-526

## Downhill Driving

### 1-UP Models

Keep your body weight rearwards. Stay seated. Apply the brake gradually to prevent skidding. Do not "coast" down the slope using solely engine compression or in neutral gear.

Decelerating while negotiating a slippery downhill slope could "toboggan" the vehicle. Maintain steady speed and/or accelerate slightly to regain control. Try to avoid steep inclines. If you're not careful, you could tip over when going down hills.

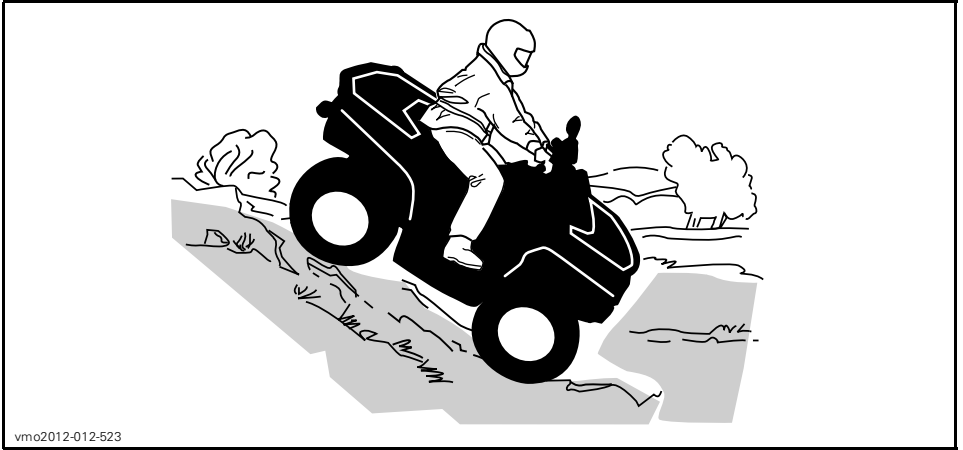

### 2-UP Models

The operator is responsible for the safety of the passenger; in doubt, disembark the passenger before proceeding.

Always remember that the vehicle handling, stability and braking distance may be affected when riding with a passenger.

The passenger must synchronize his movements with the operator. The passenger must remain seated at all times.

Operator and passenger must keep their body weight rearwards. Apply the brake gradually to prevent skidding. Do not "coast" down the slope using solely engine compression or in neutral gear. Try to avoid steep inclines. If you're not careful, you could tip over when going down hills.



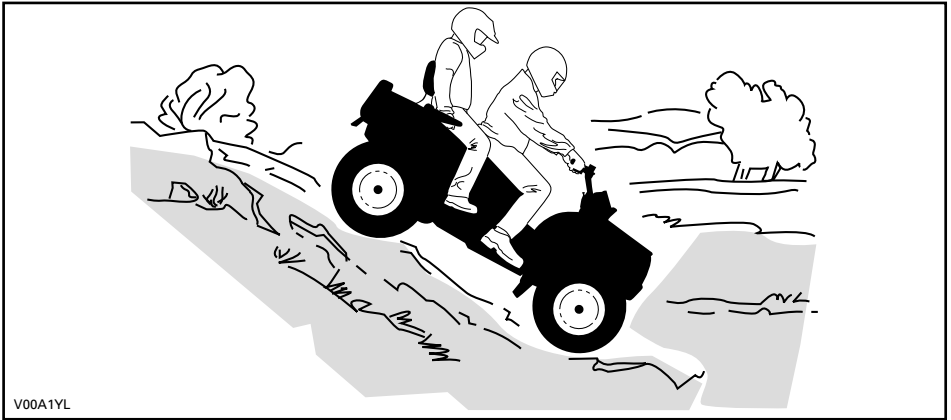

### Vehicle Behaviors

This vehicle can climb slopes that are steeper than it can safely descend. Therefore, it is essential to ensure that a safe route exists to descend a slope before you climb it.

### Side Hilling

This is one of the **most risky** types of riding since it may drastically change the balance of the vehicle. It should be avoided whenever possible. However, if it is necessary to do so, it is important that you **ALWAYS** keep your body weight on the up-side of the slope and be prepared to dismount on that side should the vehicle begin to topple.

Avoid all objects or depressions that will intensify the raising of one side of the vehicle higher than the other, thus causing rollover.

#### **⚠ WARNING**

Do not try to stop or save the vehicle from damage.

#### **⚠ WARNING**

Be careful when loading and transporting liquid reservoirs. They can affect vehicle stability when side hilling by pulling downhill and increasing the risk of a roll over.

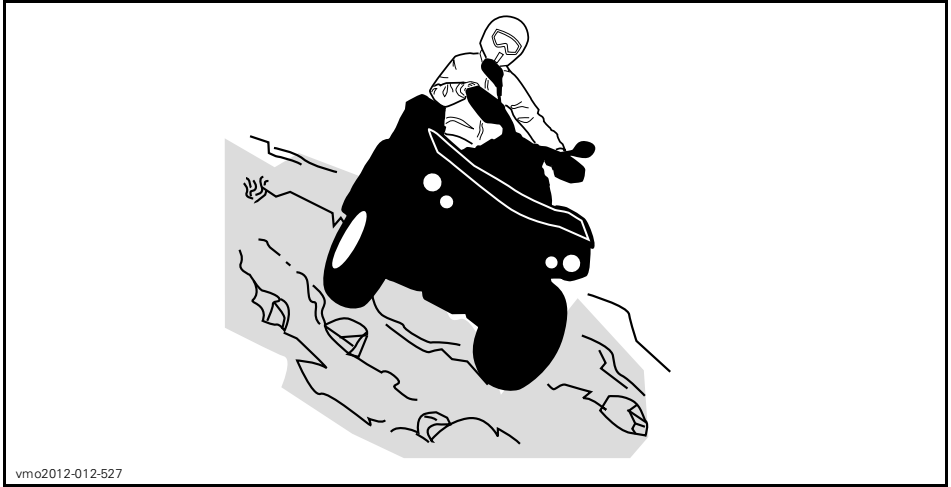

### **2-UP Models**

The passenger must synchronize his movements with the operator. The passenger must remain seated at all times.

The operator is responsible for the safety of the passenger; in doubt, disembark the passenger before proceeding.

### **Drop-Offs**

This vehicle will “bottom-out” and usually stop if either the front or rear wheels are driven over a drop-off. If the drop is sharp or deep, the vehicle will nose dive and tip over.

When riding on a 2-UP model, the operator is responsible for the safety of the passenger; in doubt, disembark the passenger before proceeding.

## **⚠ WARNING**

**Avoid negotiating drop-offs. Reverse and select an alternate route.**

### **Crossing Water**

Water can be a unique hazard. If it is too deep the vehicle may “float” and topple. Check the water depth and current before you attempt to cross any water. Water should not go above the footrest. Be wary of slippery surfaces such as rocks, grass, logs, etc., both in the water and on its banks. A loss of traction may occur. Do not attempt to enter the water at high speed. The water will act as a brake and could throw you off the vehicle, on the ground.

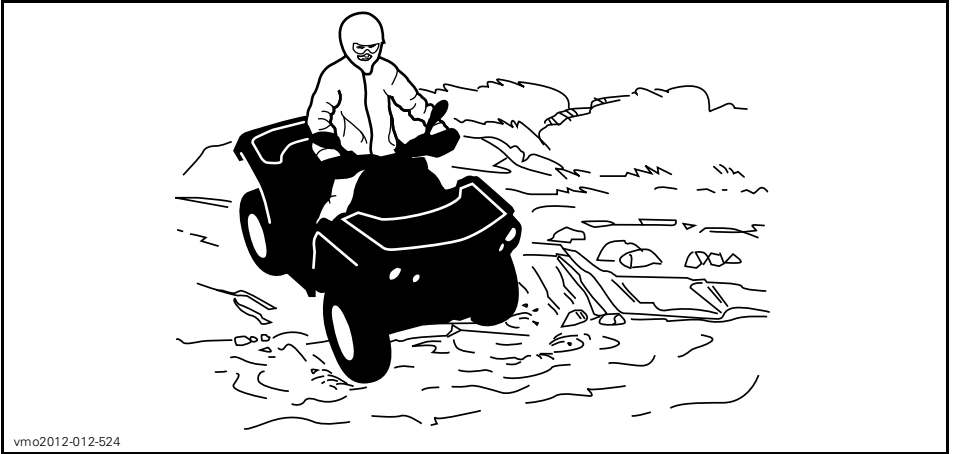

Wet brakes will affect the braking ability of your vehicle. Make sure you dry the brakes by applying them several times after the vehicle leaves the water, mud or snow. Allow greater distance for braking.

Mud or marsh lands may be encountered near water. Be prepared for sudden "holes" or changes in depth. Similarly so, be watchful of hazards such as rocks, logs, etc., partially covered by vegetation.

### **Riding on Ice**

If your route crosses frozen waterways, make sure the ice is thick enough and sound enough to support the total weight of yourself, your passenger (2-UP models), the vehicle and its load. Be ever watchful of open water it is a sure indication that the ice thickness will vary.

On 2-UP models, the operator is responsible for the safety of the passenger; in doubt, do not attempt to cross.

Ice will also affect the control of the vehicle. Slow down and do not "gun" the throttle. This will only result in spinning of the tires and possible tip over of the vehicle or passenger ejection (2-UP models). Avoid rapid braking. This again will possibly result in an uncontrolled slide and tip over of the vehicle. Slush should be avoided at all times since it could block the operation or controls of the vehicle.

### **Riding on Snow Covered Surfaces**

When performing the pre-ride inspection, pay special attention to locations on the vehicle where snow and/or ice accumulations may obstruct visibility of the taillight and reflectors, clog ventilation openings, block the radiator and fan, and interfere with the movement of control levers, switches and brake pedal. Before starting with your ATV check the steering, throttle and brake lever and pedal controls for interference free operation.

Whenever an ATV is ridden on a snow covered drive path the tire grip is generally reduced causing the vehicle to react differently to control inputs from the operator. On low grip surfaces, the steering responses are not as crisp and precise, stopping distances are lengthened and acceleration becomes sluggish. Slow down and do not "gun" the throttle. This will only result in spinning of the tires and possibly in an over steering slide of the vehicle. Avoid hard braking. This will possibly result in a

straight line slide of the vehicle. Again, the best advice is to safely reduce speed in anticipation of a maneuver so to give yourself time and distance to regain total vehicle control before it spins out of your control.

As you drive your ATV over a loose snow covered surface, snow dust will be picked up in the wake turbulence of the moving vehicle and transported to contact and accumulate or melt on some exposed components including rotating parts like brake discs. Water, snow or ice may affect the response time of the brake system of your ATV. Even when not required to reduce vehicle speed apply brakes frequently to prevent ice or snow accumulation and to dry brake pads and discs. While doing so in low risk driving situations you will test for grip level and keep yourself alerted to how the vehicle reacts to your control inputs. Always keep brake pedal, footrests, floor boards, brake and throttle levers free of snow and ice. Frequently wipe snow off seat, hand grips, headlights, taillights and reflectors.

The depth of the snow cover may hide rocks, tree stumps or other objects and if it is wet may totally impede the driveability as the vehicle becomes bogged down or completely loses traction in slushy snow. Look far ahead and always be watchful of any visible clues that might indicate the presence of such obstacles. In doubt steer clear. Avoid driving on any frozen body of water before checking that the ice will safely support the ATV, its riders and its load of cargo. Remember that a given thickness of ice may be sufficient to support a snowmobile but not an ATV of an identical weight because of the smaller load bearing surface of the four tire contact patches as compared to that of a snowmobile track and skis.

To maximize comfort and avoid frostbite, always wear clothing and ATV protective equipment appropriate for the weather conditions you will be exposed to during your ride.

At the end of each ride it is a good practice to clean the vehicle body and all moving components (brakes, steering components, drivelines, controls, radiator fan etc.) from any snow or ice accumulations. Wet snow will turn to ice during the shut down period and become more difficult to remove at the next pre-ride inspection.

Riding in snow may reduce the brakes stopping capability. Safely reduce speed and allow greater distance for braking. Snow projection may cause ice build up or snow accumulation on brake components and controls. Apply brakes frequently to prevent ice or snow accumulation.

## **Riding on Sand**

Riding on sand, sand dunes or on snow is another unique experience, but there are some basic precautions that should be observed. Wet, deep or fine sand/snow may create a loss of traction and cause the vehicle to slide, drop off or become "bogged" down. If this occurs look for a firmer base. Again, the best advice is to slow down and be watchful of the conditions. When you ride with a passenger (2-UP models), slow down even more.

When riding in sand dunes it is advisable to equip the vehicle with an antenna type safety flag. This will help make your location more visible to others over the next sand dune. Proceed carefully should you see another safety flag ahead. Since the antenna type safety flag can snag and rebound on your body if caught, do not use it in areas where there are low hanging branches or obstacles. Always remember when riding on a 2-UP model that the vehicle handling and stability may be affected when riding with a passenger.

## **Riding on Loose Stones**

Riding on loose stones or gravel is very similar to riding on ice. They will affect the steering of vehicle possibly causing it to slide or tip over especially at high speeds (resulting in operator and passenger ejection (2-UP models)).

Again, the best advice is to slow down and be watchful of the conditions. When you ride with a passenger (2-UP models), slow down even more.

In addition, braking distance may be affected. Remember that “gunning” the throttle or sliding may cause loose stones to be ejected rearwards into the path of another rider. Never do it deliberately.

# MOVING LOADS AND DOING WORK

## Working with your Vehicle

Your vehicle can help you perform a number of different LIGHT tasks ranging from snow removal to pulling wood or carrying cargo. A variety of accessories are available from your authorized Can-Am dealer. To prevent possible injury, follow the instructions and warnings that accompany the accessory. Always respect the load limits of the vehicle. Overloading the vehicle can overstress the components and cause failure. Avoid overexerting yourself if you lift or pull heavy loads or manually push the vehicle.

## Carrying Loads

Any load carried on the vehicle including a passenger (2-UP models) and/or the carrying rack(s) will affect the handling, stability and braking distance of the vehicle. Do not exceed the load limits of the vehicle, including the weight of operator and passenger cargo, accessories and trailer tongue weight. Always make sure the load is secured, properly distributed (1/3 of cargo weight in front and 2/3 of cargo weight in back) and cannot interfere with your proper control. Always be aware that the "load" may slide or fall off and create an accident. Avoid loads that may protrude sideways and get snagged or caught in brush or other obstacles. Avoid covering and obstructing the headlights or taillight with the cargo.

## WARNING

The vehicle handling, stability and braking distance are affected when loading racks and using the vehicle. Correct loading and weight distribution are therefore important. Never overload, tow or carry cargo improperly. Always ensure the cargo is safely secured and properly distributed on the rack(s) before operating the vehicle. Safely reduce speed according to terrain conditions when carrying cargo or pulling a trailer, and avoid hills and rough terrain. Allow greater distance for braking, especially on inclined surfaces and when a passenger (2-UP models) is on board. Be careful not to skid or slide. Always secure cargo as low as possible on the rack(s) to reduce the effect of a higher center of gravity. Failure to follow the recommendations here could cause changes in vehicle handling which could lead to an accident.

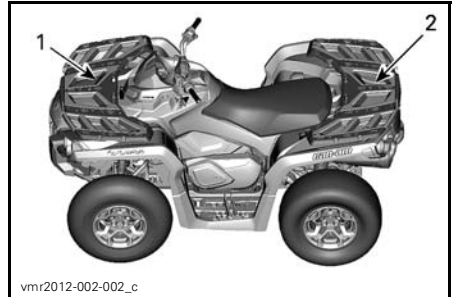

1. 1/3 of cargo weight
2. 2/3 of cargo weight

MAXIMUM LOAD TABLE			INCLUDES WEIGHT OF OPERATOR, CARGO, ACCESSORIES AND TRAILER TONGUE WEIGHT
TOTAL LOAD ALLOWED	1-UP MODELS	235 kg (517 lb)	Includes weight of operator, cargo, accessories and trailer tongue weight.
	2-UP MODELS	272 kg (600 lb)	Includes weight of operator, passenger, cargo, accessories and trailer tongue weight.
FRONT LOAD		45 kg (100 lb)	Evenly distributed.
REAR LOAD		90 kg (200 lb)	Evenly distributed. Includes rear rack, rear glove box and tongue load.

## Loading the Cargo Racks

**NOTICE** When loading or unloading, do not exceed the weight limit of 90 kg (200 lb) for rear load and 45 kg (100 lb) for front load.

Load cargo as low as possible – a higher load can raise the vehicle's center of gravity, which can reduce stability. Position cargo on the rack as evenly as possible.

Secure the load on the cargo rack. Do not secure cargo to other parts of the vehicle. If it is not properly secured, a load may slide or fall off, possibly striking occupants or bystanders; or it may shift during riding, affecting the handling of the vehicle.

Objects that are high may affect visibility for the driver and may act as projectiles in case of an accident. Loads that protrude sideways can get snagged or caught in bush, branches or other obstacles. Avoid covering and obstructing the brake lights with the cargo. Ensure no cargo protrudes outside the cargo rack and that cargo will not interfere with your visibility or control of the vehicle.

Do not overload cargo rack.

Never carry gasoline container(s) or any dangerous liquids on the cargo rack.

## Hauling a Load (if Equipped with Hitch)

Never pull a load by attaching it to the bumper or luggage racks; this can cause the vehicle to tip over. Use only the trailer hitch (if installed) to pull a load.

In an emergency situation, use the recovery hook to recover a stuck vehicle.

When pulling loads with a chain or cable, ensure that there is no slack before starting and maintain tension while pulling.

When pulling loads with a chain or cable, be sure to brake progressively. The inertia of the load could lead to an impact.

When hauling a load, respect the maximum hauling capacity. See *PULLING A TRAILER* subsection.

### WARNING

**Slack can cause the chain or cable to break and snap back.**

When pulling another vehicle, be sure that someone is controlling the pulled vehicle. They must brake and steer to prevent the vehicle from going out of control.

Reduce your speed when hauling a load and turn gradually. Avoid hills and rough terrain. Never attempt steep hills. Allow more distance for braking, especially on inclined surfaces and when a passenger (2-up models) is on board. Be careful not to skid or slide.

## Pulling a Trailer (if Equipped with Hitch)

**NOTICE** A BRP approved rear hitch must be properly installed on the vehicle for hauling trailers.

Riding this vehicle with a trailer substantially increases the risk of toppling, especially on inclined slopes. If a trailer is used behind the vehicle make sure that its hitch is compatible with the one on the vehicle. Make sure the trailer is horizontal with the vehicle. (In some instances a special extension may have to be installed on the vehicle hitch). Use security chains or cables to secure the trailer with the vehicle.

Reduce your speed when pulling a trailer and turn gradually. Avoid hills and rough terrain. Never attempt steep hills. Allow more distance for braking, especially on inclined surfaces and when a passenger (2-up models) is on board. Be careful not to skid or slide.

Improperly loading a trailer may cause loss of control. Respect the recommended maximum hauling capacity and maximum tongue load (Refer to *MAXIMUM HAULING CAPACITY* table). Make sure there is at least some weight on the tongue.

Always make sure load is evenly distributed and safely secured on the trailer; an evenly balanced trailer is easier to control.

Always put the shift lever to L (low range) for hauling a trailer – in addition to providing more torque, operating in low range helps account for the increased load on the rear tires.

When stopped or parked, block the vehicle and trailer wheels from possible movement.

Use caution when disconnecting a loaded trailer; it or its load may topple on you or others.

When hauling a trailer, respect the maximum hauling capacity indicated on the label on the hitch.

MAXIMUM HAULING CAPACITY	
TRAILER LOAD ALLOWED	TONGUE WEIGHT ALLOWED
135 kg (300 lb)	13 kg (30 lb)
NOTE: Includes trailer and trailer load. Ensure to properly load the trailer so that tongue is always pushing on hitch support and not pulling on hitch ball.	



# IMPORTANT ON-PRODUCT LABELS







## Hang Tag

This vehicle comes with a hang tag and labels containing important safety information.

Any person who rides this vehicle should read and understand this information before riding.







### **WARNING**

- Locate and read operator's guide. Improper ATV use can result in SEVERE INJURY or DEATH. Follow all instructions and warnings.
- Always wear ear protection.
- Always use an approved helmet and protective gear.
- Never carry passengers on 1-up models and NEVER carry more than one passenger on 2-up models.
- Never use with drugs or alcohol.

<p><b>G</b> GENERAL USE MODEL</p> <p>THIS ATV IS FOR RECREATIONAL USE OR UTILITY USE</p> <p><b>OPERATOR ONLY-NO PASSENGERS</b></p> <p><b>NO OPERATOR UNDER AGE 16</b></p> <hr/> <p>TRAINING COURSES TO TEACH ATV RIDING SKILLS ARE AVAILABLE. FOR INFORMATION CONTACT YOUR DEALER.</p> <hr/> <p>CHECK WITH YOUR DEALER TO FIND OUT ABOUT STATE OR LOCAL LAWS REGARDING ATV OPERATION.</p> <p><b>THIS HANGTAG IS NOT TO BE REMOVED BEFORE SALE.</b></p> <p>704903931</p>	<p></p> <p> </p> <p>  </p>
---	--

704903931A

1-UP MODELS

<p><b>G</b> <b>GENERAL USE MODEL</b></p> <p><b>THIS ATV IS FOR RECREATIONAL USE OR UTILITY USE.</b></p> <p><b>NO OPERATOR UNDER AGE 16</b></p> <hr/> <p><b>TRAINING COURSES TO TEACH ATV RIDING SKILLS ARE AVAILABLE. FOR INFORMATION CONTACT YOUR DEALER. MAKE SURE TO WATCH SAFETY VIDEO.</b></p> <hr/> <p><b>CHECK WITH YOUR DEALER TO FIND OUT ABOUT STATE OR LOCAL LAWS REGARDING ATV OPERATION.</b></p> <p><b>THIS HANGTAG IS NOT TO BE REMOVED BEFORE SALE.</b></p> <p>704903947</p>	<p></p> <p></p> <p></p>
---	---

704903947  
2-UP MODELS

**VEHICLE ENGINE DESCRIPTION:**  
**XXXXX**

**EPA CERTIFIED**

NER (NORMALIZED EMISSION RATE) =   
ON A 0 TO 10 SCALE, 0 BEING THE CLEANEST

**\*NOT TO BE REMOVED PRIOR TO SALE**



704901107  
vmo2006-005-009\_en

TYPICAL

## Vehicle Safety Labels

Read and understand all the safety labels on your vehicle.

These labels are affixed to the vehicle for the safety of the operator, passenger (2-UP) or bystanders.

The safety labels on your vehicle should be considered permanent parts of the vehicle. If missing or damaged, they can be replaced free of charge. See an authorized Can-Am dealer.

**NOTE:** In the event of any discrepancy between this guide and the vehicle, the safety labels on the vehicle have precedence over the labels in this guide.

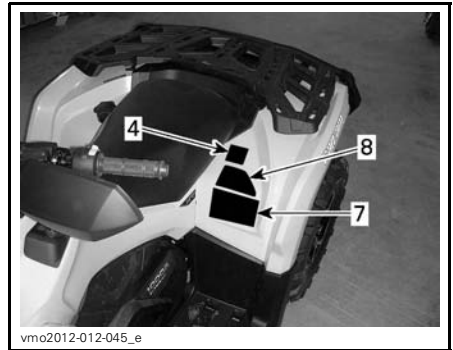
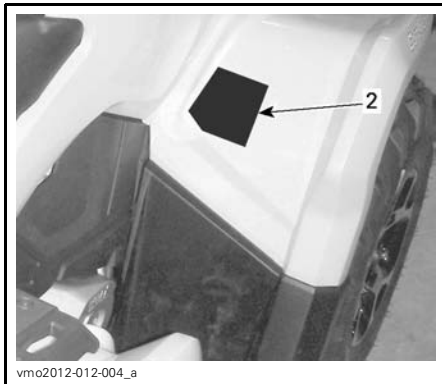
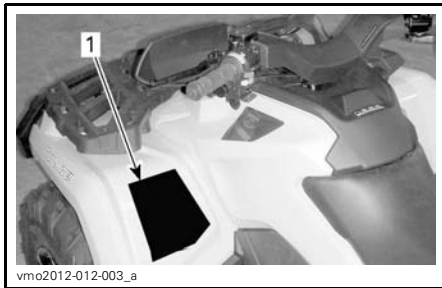

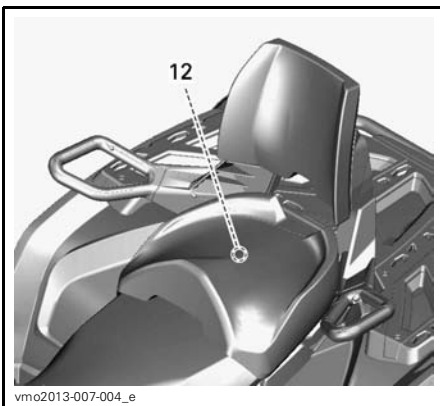
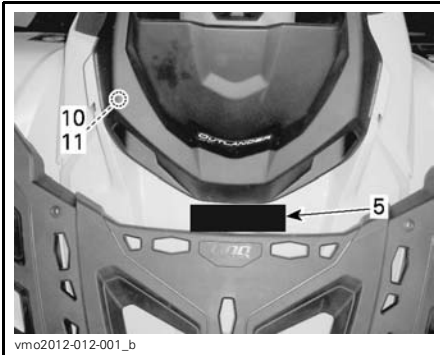
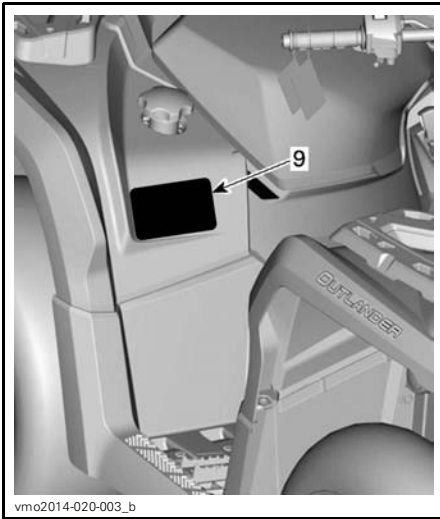

TYPICAL

Label 1

**⚠ WARNING**

- Locate and read operator's guide. Improper ATV use can result in SEVERE INJURY or DEATH. Follow all instructions and warnings.
- Always wear ear protection.
- Always use an approved helmet and protective gear.
- Never carry a passenger on 1-up models and NEVER carry more than one passenger on 2-up models.
- Never use with drugs or alcohol.



LABEL 1 - 1-UP MODELS



LABEL 1 - 2-UP MODELS

Label 2

**⚠ WARNING**

Operating this ATV if you are under the age of 16 increases the chance of SEVERE INJURY or DEATH to the operator, and to both the operator and passenger on 2-up models. NEVER operate this ATV if you are under age 16.

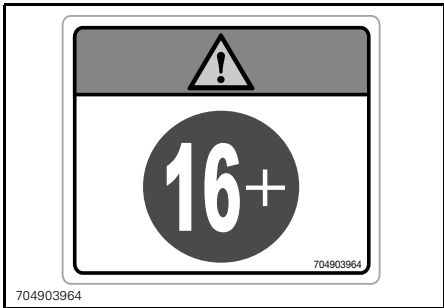

LABEL 2

Label 3

**NOTICE**

- ATV MUST be stopped before shifting lever.
- ALWAYS apply foot brake to shift from Park (P) and Neutral (N).

704903970

LABEL 3

Label 4

**⚠ WARNING**

- Locate and read operator's guide.
- NEVER carry a passenger on 1-up models and NEVER carry more than 1 passenger on 2-up models.
- Passenger on 2-up models must always use an approved helmet and protective gear.
- Passenger on 2-up models must NEVER ride after using drugs or alcohol.

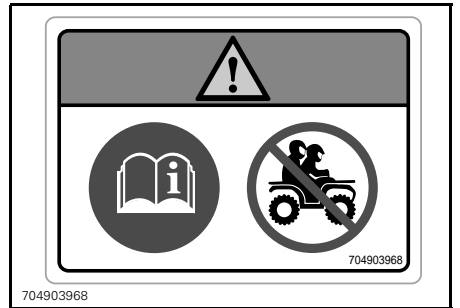

LABEL 4 - 1-UP MODELS

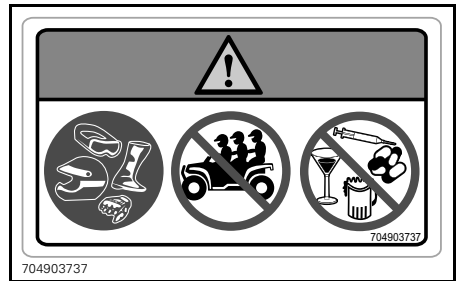

LABEL 4 - 2-UP MODELS

Label 5

**⚠ WARNING**

- NEVER carry a passenger on this carrier.
- MAXIMUM FRONT LOAD: 45 kg (100 lb) evenly distributed.
- MAXIMUM REAR LOAD: 90 kg (200 lb) evenly distributed (including trailer tongue weight if applicable).

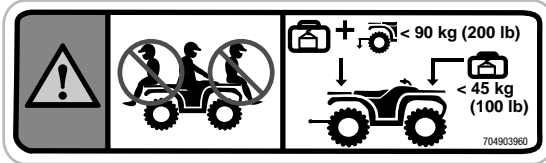

704903960

LABEL 5

Label 6

**⚠ WARNING**

NEVER attach here or on the luggage rack to pull a load. This can cause the vehicle to tip over. ALWAYS use the trailer hitch or the recovery hook to pull a load.



704903955A

LABEL 6

Label 7

**⚠ WARNING**

- Locate and read operator's guide. Improper tire pressure or overloading can cause loss of control, resulting in SEVERE INJURY or DEATH.
- ALWAYS maintain proper tire pressure as shown.
- On 1-up models, NEVER exceed the load capacity of 235 kg (517 lb) including weight of operator, cargo, accessories, and trailer tongue weight.
- On 2-up models, NEVER exceed the load capacity of 272 kg (600 lb) including weight of operator, cargo, accessories, and trailer tongue weight.
- ALWAYS pull a load using the trailer hitch or recovery hook.
- NEVER exceed the maximum towing weight of 135 kg (300 lb).
- NEVER exceed the maximum tongue weight of 13 kg (30 lb).

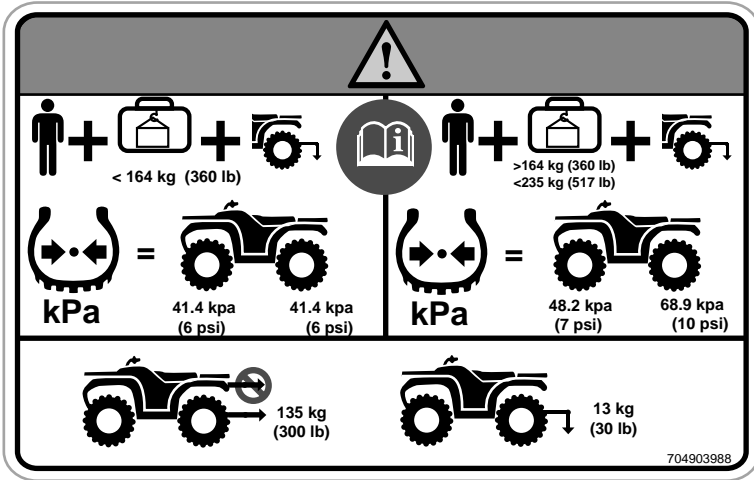

704903988

LABEL 7 1-UP MODELS

704903995

LABEL 7 - 2-UP MODELS

*Label 8*

704903987

LABEL 8



Label 9

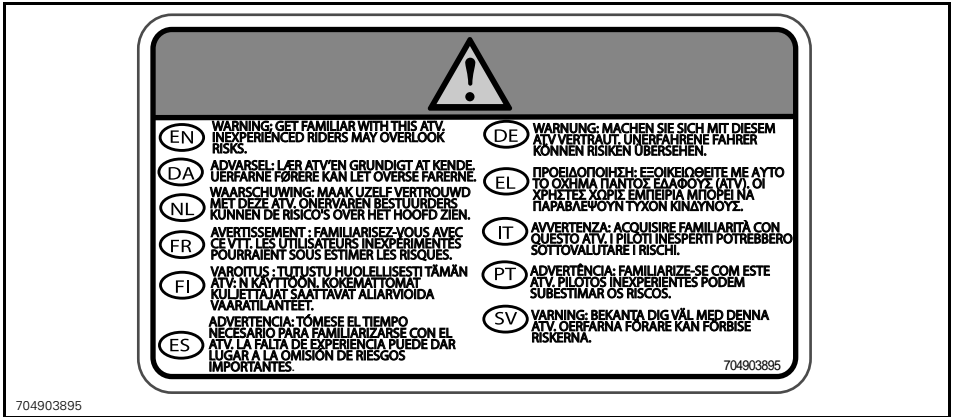

LABEL 9

Label 10



LABEL 10

Label 11



LABEL 11

**Label 12**

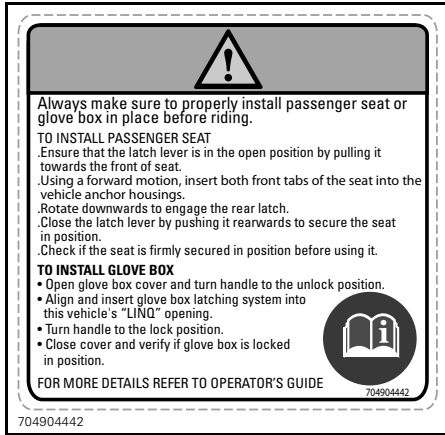

**LABEL 12 - LOCATED UNDER GLOVE BOX**

**Compliance Labels**

These labels indicate vehicle's compliance.

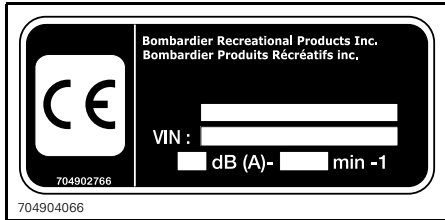

**LOCATION: UNDER SEAT, ON THE UPPER FRAME MEMBER**

**Technical Information Labels**

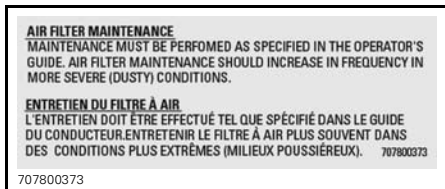

**LOCATION: UNDER SEAT, ON THE UPPER FRAME MEMBER**

# ***VEHICLE INFORMATION***

# CONTROLS

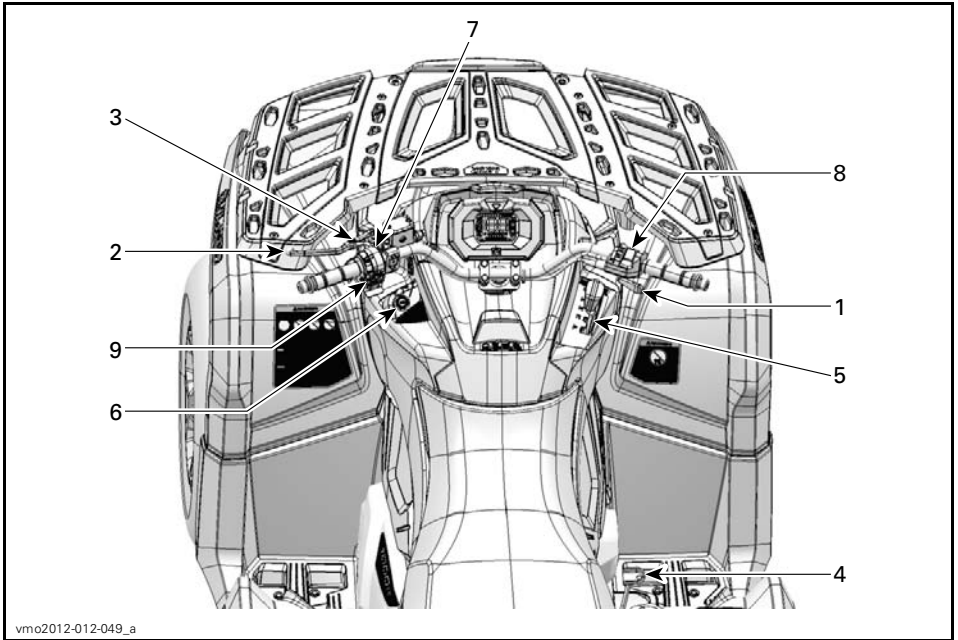

## 1) Throttle Lever

The throttle lever is located on the RH side of the handlebar.

The throttle lever controls the engine speed.

To increase or maintain vehicle speed, press the throttle lever with your right thumb.

To decrease vehicle speed, release the throttle lever.



### TYPICAL

1. Throttle lever
2. To accelerate
3. To decelerate

## 2) LH Brake Lever

The LH brake lever is located on the LH side of the handlebar.

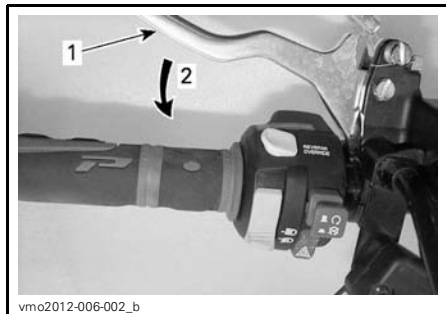

### TYPICAL

1. Brake lever
2. To apply brakes

The brake lever function is to slow down or stop the vehicle.

When the brake lever is compressed, the front and rear brakes are applied.

Braking effect is proportional to the force applied on the lever.

## 3) Brake Lock

The brake lock is located on the LH side of the handlebar.

The brake lock function is to apply brake to all wheels to prevent vehicle from moving when parked.

### **⚠ WARNING**

Always use the brake lock and engage the PARK position on the shift lever when the vehicle is not in operation.

**To engage brake lock:** Squeeze brake lever and maintain while moving lever lock. Brake lever is now compressed and applying all brakes.



### TYPICAL

1. Brake lever lock
2. Press to apply brake locks

**NOTE:** Locking lever can be adjusted in several positions.

**NOTICE** Ensure when the brake lock is applied that the vehicle stays securely in place.

**To release brake lock:** Squeeze brake lever. Lever lock should automatically return to its original position. Brake lever should return to rest position.

### **⚠ WARNING**

Make sure brake lock is released before operating the vehicle. If brake lock is left ON while riding, it may cause damage to the brake system and cause loss of braking capacity and/or fire.

#### 4) Brake Pedal

The brake pedal is located on the RH side of the vehicle near engine.

When pressed down, the front and rear brakes are applied.



1. Brake pedal

When released, the brake pedal should return to its original position.

Braking effect is proportional to the force applied on the pedal.

**NOTE:** As on other wheeled vehicles, the vehicle weight is transferred to the front wheels when braking. To obtain greater stopping efficiency, the brake system distributes more braking force to the front wheels. This will affect vehicle handling and steering control when braking vigorously. Take it into account when braking.

#### 5) Shift Lever

The shift lever is located on the RH side of the vehicle near steering column.



SHIFT LEVER LOCATION

The shift lever is used to change the gearbox position.

The shift lever has 5 positions:

SHIFT LEVER POSITIONS	
POSITION	GEAR
P	Park
R	Reverse
N	Neutral
H	High range (forward)
L	Low range (forward)



SHIFT PATTERN

The vehicle must be stopped and brakes applied prior to selecting any gear.

**NOTICE** This gearbox is not designed to shift while vehicle is moving.

**P: Park**

The park position locks the gearbox to help prevent vehicle movement.

**⚠ WARNING**

Always use the PARK (P) position when the vehicle is not in operation. The vehicle can roll if the shift lever is not set to P (PARK).

**R: Reverse**

The reverse position allows the vehicle to go backwards.

**NOTE:** In reverse operation, the engine's RPM is limited, thus limiting the vehicle reverse speed.

**⚠ WARNING**

When driving downhill in reverse, gravity can increase the vehicle speed above the set limited reverse speed.

**Neutral**

The neutral position disengages the gearbox.

**⚠ WARNING**

Always use the PARK (P) position when the vehicle is not in operation. The vehicle can roll if the shift lever is set to N (NEUTRAL).

**High Range (Forward)**

This position selects the high speed range of the gearbox. It is the normal driving speed range. It allows the vehicle to reach its maximum speed.

**Low Range (Forward)**

This position selects the low speed range of the gearbox. It allows the vehicle to move slowly with maximum torque at the wheels.

**NOTICE** Use the low speed range to pull a trailer, carry heavy cargo, go over obstacles or drive uphill and downhill.

**6) Ignition Switch**

The ignition switch is located on the LH side of the central panel below the handbar.



IGNITION SWITCH POSITIONS

1. OFF
2. ON "with light"
3. ON position no longer available

**OFF**

The key can be inserted or removed in this position only.

In OFF position, the electrical system of the vehicle is disabled.

The engine is shut down by turning the ignition switch to OFF position.

**NOTE:** While the engine can be stopped by turning the ignition key to OFF position, we recommend the engine be stopped by setting the emergency engine stop switch to the STOP position.

**NOTE:** When turning the key to OFF position, the vehicle electrical system will take a few seconds to shut down.

**ON with Lights**

When the key is turned in this position, the electrical system of the vehicle is activated.

The gauge should wake-up.  
 The vehicle lights are turned on.  
 The engine can be started.

**ON**

**NOTICE** Position no longer available. To avoid damaging ignition switch, do not force key to the ON position.

**Digitally Encoded Security System (D.E.S.S.)**

The ignition keys contain an electronic circuit that gives it a unique electronic serial number.

The D.E.S.S. system reads the key code and allows engine starting for keys it recognizes.

**7) Multifunction Switch**

The multifunction switch is located on the LH side of the handlebar.

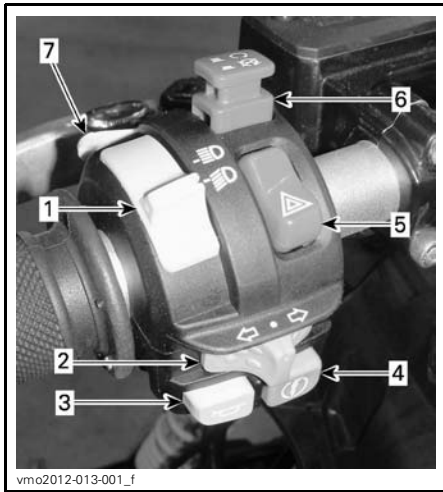

TYPICAL - MULTIFUNCTION SWITCH

1. Low/high beam headlight switch
2. Turn signal switch
3. Horn button
4. Engine start button
5. Hazard warning button
6. Emergency engine stop switch
7. Override/DPS/ACS button (if applicable)

**Low/High Headlight Switch**

This switch is used to select either the headlights low or high beams.

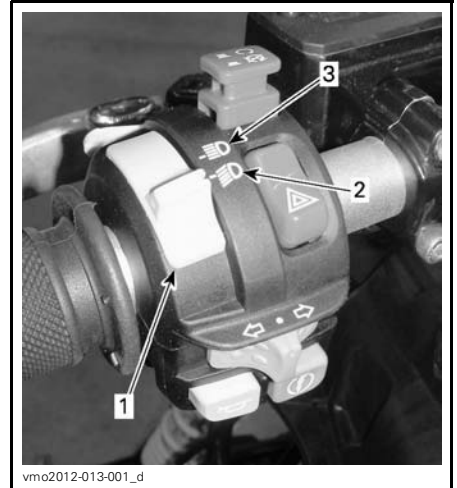

1. Low/high beam headlight switch
2. Low beam
3. High beam

**Turn Signal Switch**

The turn signal switch is located on the LH side of handlebar.

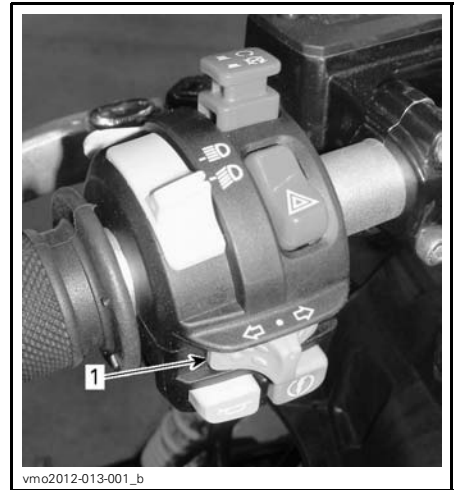

1. Turn signal switch



To activate the turn signals, move the switch button on the right or the left side, depending on which direction you picked. Reposition the switch in the middle when the maneuver is completed.

### Horn Button

The horn button is located on the LH side of handlebar.



TYPICAL

1. Horn button

### Engine Start Button



TYPICAL

1. Engine start button

When engine start button is pressed and held, it starts the engine.

**NOTE:** To allow engine starting, the ignition switch must be in the ON or ON with lights position and the emergency engine stop button set to RUN.

### Hazard Warning Button

The hazard warning button is located on the LH side of handlebar.

While reading this Operator's Guide, remember that:

## **WARNING**

Indicates a potential hazard that, if not avoided, could result in serious injury or death.



1. Hazard warning button

Device fitted to the vehicle that operates a simultaneous flashing of all the turn signals, used when the vehicle is stationary to indicate that the vehicle is temporarily obstructing traffic.

Press the hazard warning button once to activate the device.

**NOTE:** Hazard warning lights can be activated even when the vehicle electrical system is shut down.

## Emergency Engine Stop Switch



1. Emergency engine stop switch

This switch can be used to stop the engine and as an emergency control.

To stop engine, set the emergency engine stop switch to the STOP position.

**NOTE:** While the engine can be stopped by turning the ignition key to OFF position, we recommend the engine be stopped by setting the emergency engine stop switch to the STOP position.

## Override/DPS/ACS Button

Depending on the vehicle model, this button has up to 3 functions.

While reading this Operator's Guide, remember that:

### **WARNING**

Indicates a potential hazard that, if not avoided, could result in serious injury or death.



1. Override/DPS/ACS button

### Override Function

The override switch main function is to bypass the engine speed limiter in reverse operation by allowing maximum engine torque.

#### **⚠ WARNING**

Only use the override to help get the vehicle unstuck from mud or other soft terrain. Do not use the override for normal operation in reverse. This would allow driving in reverse at excessive speeds and can increase the risk of losing control.

To engage the override function, proceed as follows:

While the shift lever is set to REVERSE position.

1. Ensure that the vehicle is stopped.
2. Press and hold the override switch then press the throttle lever gradually.

**NOTE:** When using the override function, the gauge will scroll an **OVER-RIDE** message to confirm that the function is activated.

3. To disengage the override function, simply release the override switch.

### DPS Function (Models with DPS)

This button is also used to change the DPS mode.

To change DPS mode, refer to *TUNE YOUR RIDE* subsection.

### ACS Function (LTD Models)

This button is also used to change the ACS suspension setting.

To change the ACS suspension setting, refer to *TUNE YOUR RIDE* subsection.

## 8) 2WD/4WD Selector

The 2WD/4WD selector is located on the RH side of the handlebar.

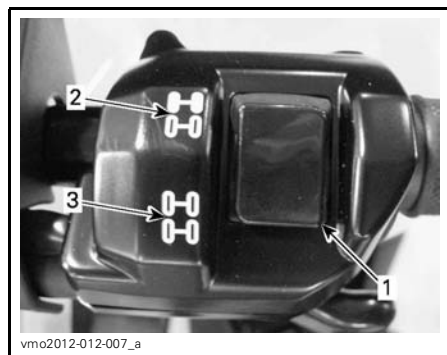

#### TYPICAL

1. Selector
2. 2WD position
3. 4WD position

This switch selects 2 wheel drive or 4 wheel drive mode when the vehicle is stopped and the engine is running.

**NOTICE** The vehicle must be stopped to engage or disengage 2WD/4WD switch. Mechanical damage may occur if switch is engaged or disengaged while driving.

The 4WD mode is engaged when the switch is pushed downwards.



V0710DY

4WD MODE - TYPICAL

The 2WD mode is engaged when the switch is pushed upwards. The vehicle is then rear wheel drive only.



V0710EY

2WD MODE - TYPICAL

## 9) Winch Control Switch (Models with Winch)

This switch controls the winch operation.

To let out the cable, press the left side of switch.

To reel in the cable, press the right side of switch.

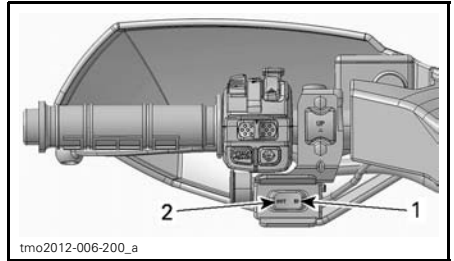

tmo2012-006-200\_a

TYPICAL

1. In
2. Out

**NOTE:** Using the winch intensively over a long period of time may discharge the battery.

Refer to *BASIC GUIDE TO WINCHING TECHNIQUES* for proper operating instructions.

## 10) Shift Lever Lock

The shift lever can be locked when the vehicle is parked and left unattended.

To unlock shift lever, open protective cover, insert key and turn it clockwise.

To lock shift lever, turn key counter-clockwise.

While reading this Operator's Guide, remember that:

### **WARNING**

Indicates a potential hazard that, if not avoided, could result in serious injury or death.

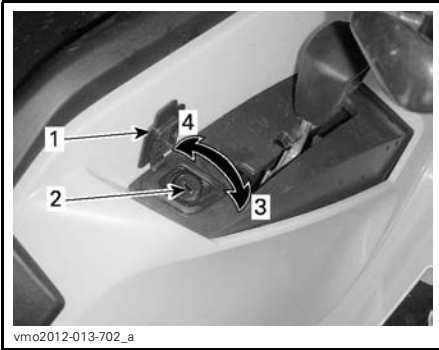
**SHIFT LEVER LOCKING MECHANISM**

1. Protective cover
2. Keylock
3. Turn key clockwise to unlock
4. Turn key counterclockwise to lock

**NOTE:** The vehicle will not be locked if the shift lever is not placed in park position when the mechanism is engaged.

# MULTIFUNCTION GAUGE (LCD) (DPS AND XT MODELS)

## ⚠ WARNING

Reading the multifunction gauge display can distract from the operation of the vehicle, particularly from constantly scanning the environment.

## Multifunction Gauge Description

The multifunction gauge is located in the middle of the handlebar.

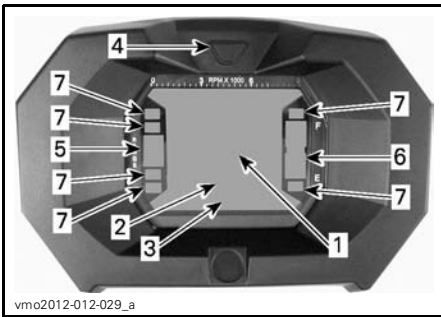

vmo2012-012-029\_a

1. Display 1
2. Display 2
3. Display 3
4. Display selector button
5. Transmission position display
6. Fuel level display
7. Indicator lamps

## Tachometer

Measures engine revolutions per minute (RPM). Multiply by 1000 to obtain the actual revolutions.

**NOTE:** RPM can also be displayed via Display 2 (mode) display. Refer to *DISPLAY 2 (MODE)* in this subsection.

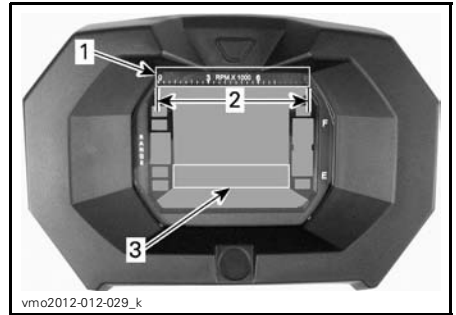

vmo2012-012-029\_k

1. Tachometer
2. Operating range
3. Tachometer via display 2 (mode)

## Transmission Position Display

This display will show transmission position.

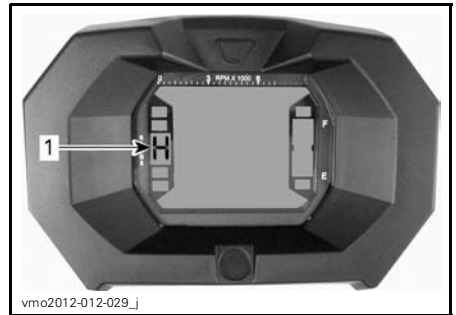

vmo2012-012-029\_j

1. Transmission position

## Speedometer

This display will show vehicle speed.



vmo2012-012-029\_i

1. Vehicle speed (Display 1)

DISPLAY	FUNCTION
P	Park
R	Reverse

DISPLAY	FUNCTION
N	Neutral
H	High gear
L	Low gear

**NOTE:** If the letter “E” is displayed in the transmission position display, it means that there is an electrical communication error. Contact an authorized Can-Am dealer.

### Fuel Level Display

Bar gauge continuously indicates the fuel level in the fuel tank.

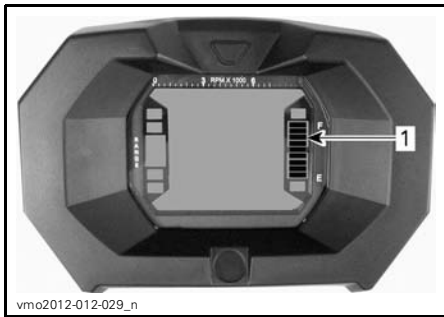

vmo2012-012-029\_n

1. Fuel level display

### Low Fuel Level Indicator Lamp



When this indicator turns ON, it indicates that there is approximately 5 L (1.32 U.S. gal.) of fuel left in fuel tank.

### 4WD Indicator Lamp



When this indicator is ON, it indicates the 4WD system is activated.

### Brake Lock Indicator Lamp



When this indicator is ON, it indicates the brake is activated for more than 15 seconds (while riding).

### High Beam Indicator Lamp



When this indicator is ON, it indicates that **high beam** is selected.

### Check Engine Indicator Lamp



When this indicator is ON, it indicates an engine fault code, look for a message at the LCD display.

Refer to *TROUBLESHOOTING* section for more details.

### Turn Signal Light Indicator Lamp



When this indicator is ON, it indicates the turn signal lights are in operation.

## Multifunction Gauge Features

**⚠ WARNING**

Never adjust or set functions on the multifunction gauge while riding the vehicle.

The modes can be displayed by pressing the selector button.

**NOTE:** An abbreviation of the mode selected will also be displayed in display 3 (see abbreviations in parenthesis).

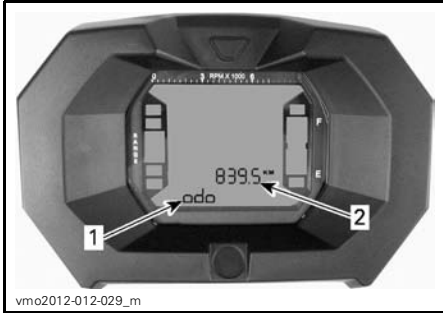

1. Display 2 (mode)
2. Display 3 (mode/message)

### Odometer

Records the total distance travelled.

### Clock

Shows current time.

### Trip Meter

Records the distance travelled since it has been reset.

Press and HOLD display selection button to reset.

### Hour Meter (Trip Time)

Records the vehicle running time when the electrical system is activated since it has been reset.

Press and HOLD display selection button to reset.

### Engine Hour Meter

Records engine running time.

### Engine RPM

Measures engine revolutions per minute (RPM).

## Multifunction Gauge Set-Up

### ⚠ WARNING

Never adjust or set functions on the multifunction gauge while riding the vehicle.

### Unit Selection (MPH vs KM/H)

This multifunction gauge is factory pre-set in Imperial units but it is possible to change it to Metric units, contact an authorized Can-Am dealer for unit settings.

**NOTE:** All features will have their units changed all together.

### Language Selection

The gauge display language can be changed. Refer to authorized Can-Am dealer for language availability and setup the gauge to your preference.

### Clock Setting

To set current time, proceed as follows:

1. Select the clock display.

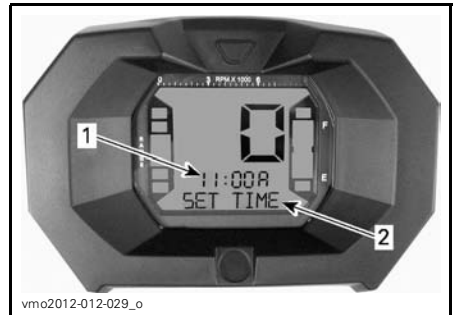

1. Time (Display 2)
2. Message (Display 3)

2. Press and HOLD button (SET TIME will appear on display 3).
3. Choose the 12-hour (12H) or 24-hour (24H) format by pressing button.



4. If the 12-hour format was selected, choose Am ("A") or Pm ("P") by pressing button.
5. Choose hour first digit by pressing button.
6. Choose hour second digit by pressing button.
7. Choose minutes first digit by pressing button.
8. Choose minutes second digit by pressing button.
9. Press button to enter settings (CLOCK will appear on display 3).

# MULTIFUNCTION GAUGE (ANALOG/DIGITAL) (XT-P AND LTD MODELS)

## Multifunction Gauge Description

The Multifunction Gauge (Analog/digital) is located on the steering column.

The Multifunction Gauge (Analog/digital) is comprised of a digital gauge and two analog gauges (speedometer and tachometer).

The engine temperature and fuel level bar graphs are comprised in the digital gauge.

The indicators lamps are comprised in both analog gauges.

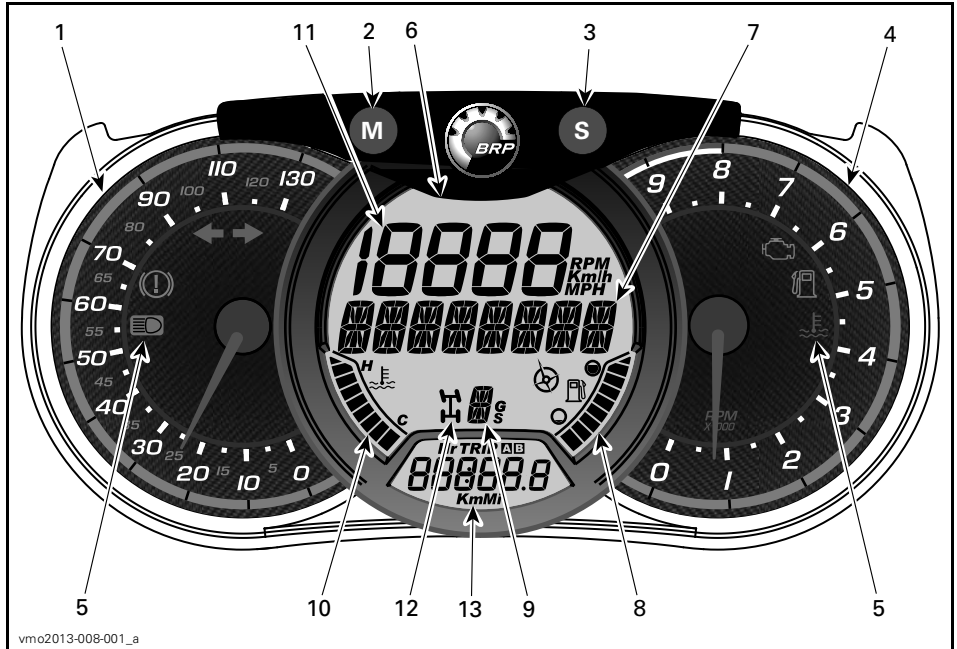

vmo2013-008-001\_a

### **⚠ WARNING**

Do not adjust the display while riding. You could lose control.

### 1) Analog Speedometer

Measures vehicle speed in km/h or mph.

### 2) MODE (M) Button

Pressing the MODE (M) button will scroll through the functions of the main digital display.

FUNCTION SEQUENCE	OPTIONS
Air Suspension (LTD model only)	Press ACS button to change setting (1 to 6)
Numerical Display is flashing	Press SET (S) to scroll and select desired function and press MODE (M) to confirm
Multifunction display is flashing	Press SET (S) to scroll and select desired function and press MODE (M) to confirm

### 3) SET (S) Button

Pressing the SET (S) button will scroll through the functions of the secondary digital display.

FUNCTION SEQUENCE	INFORMATION DISPLAYED
Clock	XX:XX (24:00 time base) XX:XX A or P (12:00 AM/PM time base)
Cumulative distance odometer	XXXXX.X km or mi
Trip distance — odometer A (TRIP A)	XXXXX.X km or mi
Trip distance — odometer B (TRIP B)	XXXXX.X km or mi
Engine time chronometer (Hr)	XXXXX.X
Trip time chronometer (HrTRIP)	XXXXX.X

To reset any trip functions, push and hold the MODE (M) button for three seconds.







### 4) Analog Tachometer (RPM)

Measures engine revolutions per minute (RPM). Multiply by 1000 to obtain actual revolutions.

### 5) Indicator Lamps

Indicator lamps will inform you of various conditions or problems.

An indicator lamp can flash alone or in combination with another lamp.

INDICATOR LAMP(S)		DESCRIPTION
All indicator lamps	On	All indicator lamps are activated when ignition switch is ON and the engine is not started
	On	Low Fuel
	On	Check Engine
	On	High Engine Temperature
	On	Headlights in the HIGH beam position
	On	Turn signal lights are in operation
	On	Brake is pressed for more than 15 seconds while riding

### 6) Main Digital Display

Displays useful real-time information to the rider.

### 7) Multifunction Display

The vehicle speed or the engine revolutions (RPM) can be displayed. See *MODE (M) BUTTON* in this section.

Important messages can also be displayed. Refer to table below.

MESSAGE	DESCRIPTION
BRAKE	Message displayed when the brakes are applied continuously for 15 seconds.
OVERRIDE	Override is displayed when the override switch is pressed and the shift lever is set to reverse gear.

If an abnormal engine condition occurs, a message can be combined with a pilot lamp. Refer to *TROUBLESHOOTING* section for details.

### 8) Fuel Level Indicator

Bar graph that continuously indicates the level of fuel left in the fuel tank.

### 9) Gearbox Position Indicator

Displays the selected gearbox position.

#### *LTD Model Only*

As a second function, will indicate the current ACS position setting.

### 10) Engine Temperature Indicator

Bar graph that continuously indicates the engine coolant temperature.

### 11) Numerical Display

The vehicle speed or the engine revolutions (RPM) can be displayed. See *MODE (M) BUTTON* in this section.

### 12) 2WD/4WD Indicator

When this indicator is ON, the 4WD system is activated.

### 13) Secondary Digital Display

Displays useful real time information to the rider. For display function information, refer to *SET (S) BUTTON*.

## Gauge Setup

### Setting Metric/Imperial Units

See a Can-Am dealer for adjustments.

### Setting Clock

1. Press SET (S) button to select clock display.
2. Push and hold SET (S) button for three seconds.
3. Press SET (S) button to select 12:00 AM PM or 24:00 time base.

4. If 12:00 AM PM time base is selected, A or P flashes. Press SET (S) button to select A (AM) or P (PM).
5. Choose hour first digit by pressing SET (S) button.
6. Choose hour second digit by pressing SET (S) button.
7. Choose minutes first digit by pressing SET (S) button.
8. Choose minutes second digit by pressing SET (S) button.
9. Press SET (S) button.

### **Setting Language**

The gauge display language can be changed. Refer to an authorized Can-Am dealer for language availability and setup the gauge to your preference.

# EQUIPMENT

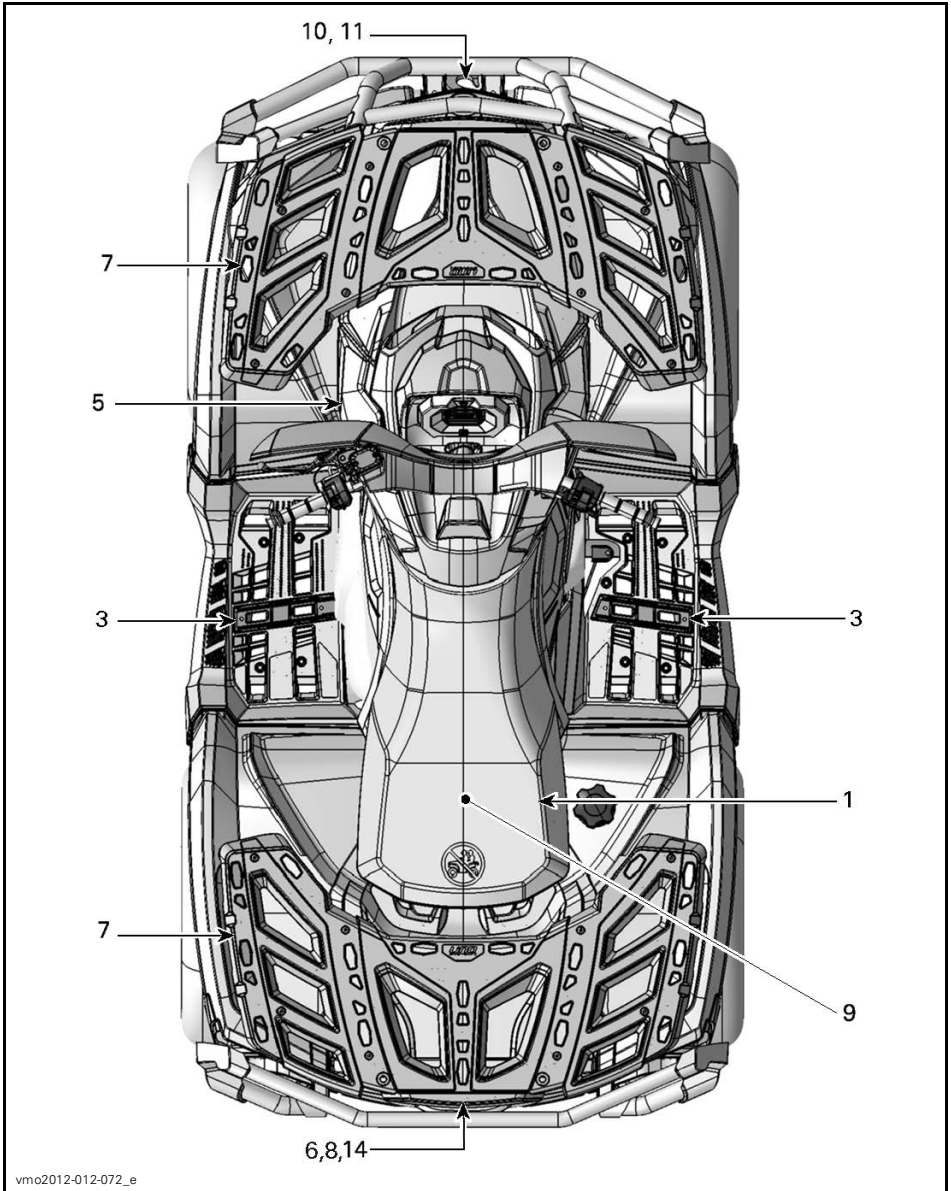

vmo2012-012-072\_e

TYPICAL - 1-UP MODEL

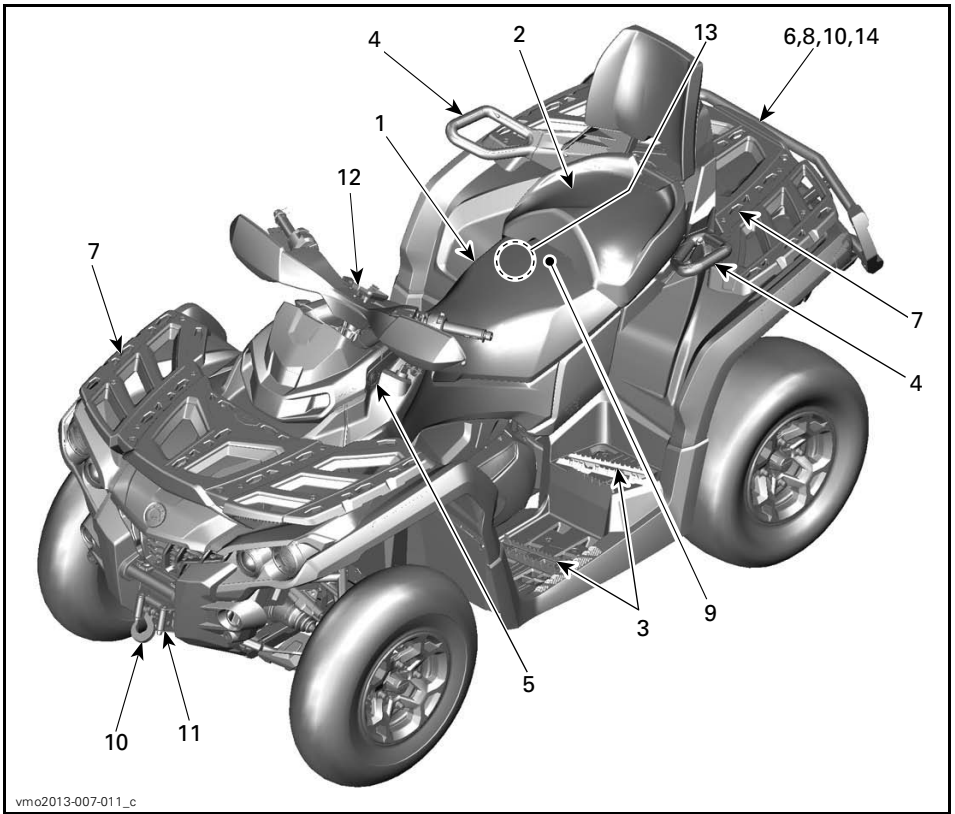

TYPICAL - 2-UP MODEL

## 1) Operator's Seat

The seat is designed for an operator only.

### **⚠ WARNING**

Never allow anyone to seat as a passenger on this vehicle.

### Seat Removal

To remove the operator's seat, push its latch upward. This latch is located underneath the rear of seat.



1. Seat latch

Pull seat upward then rearward. Continue lifting movement until you can release the front retaining device then completely remove seat.

### Seat Installation

Insert front tabs of seat into steel hooks of frame. When seat rests in its position, firmly push seat down to latch.

**NOTE:** A distinctive snap will be felt. Double check that the seat is secure by giving it a tug to confirm proper latching.

While reading this Operator's Guide, remember that:

### **⚠ WARNING**

Indicates a potential hazard that, if not avoided, could result in serious injury or death.

### **⚠ WARNING**

Confirm that the operator's seat is properly locked in position by pulling back and up several times.

## 2) Passenger's Seat/ Glove Box (2-UP Models)

### **⚠ WARNING**

Never operate the vehicle without passenger's seat or glove box installed.

The passenger's seat is designed for a passenger only. The integrated backrest supports his back during the ride.

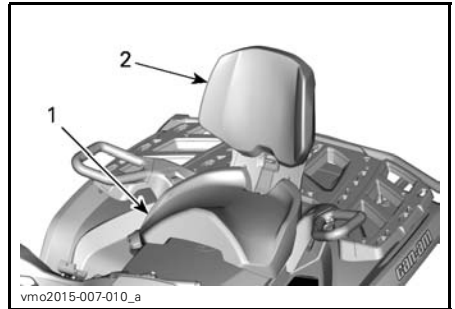

1. Passenger's seat  
2. Integrated backrest

When riding without a passenger, the passenger seat can be removed to allow the use of a glove box.



**TYPICAL**

1. *Glove box*

The conversion of the vehicle is easy, remove the passenger's seat then install the glove box or vice versa. Use the procedure describes below to remove and install the features correctly.

## ⚠ WARNING

Without its passenger's seat, the vehicle becomes a ONE RIDER vehicle (1-UP model) and NO PASSENGER must be allowed on vehicle. NEVER carry passenger on glove box.

### Passenger's Seat Removal

1. To unlock latch, pull the passenger's seat latch lever toward the front of the seat..

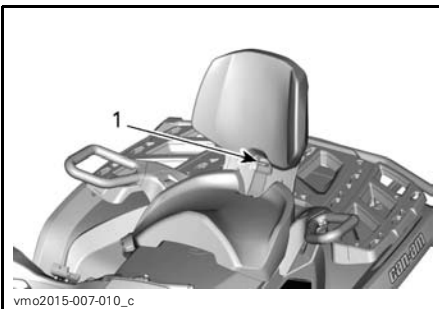

1. *Seat handle*

2. Apply downwards pressure on the back of latch lever to clear rear latch from pin and turn seat towards front using backrest.
3. While maintaining latch lever pulled towards the front, apply downward pressure on the back of latch lever to clear rear latch from pin and toggle seat towards front using backrest.
4. Pull seat rearward and up out of location to clear the front tabs.

### Passenger's Seat Installation

1. Ensure the latch lever is in the open position by pulling it towards the front of seat.
2. Using a forward motion, insert both front tabs of the seat into the vehicle anchor housings.
3. Rotate downwards to engage the rear latch.
4. Close the latch lever by pushing it rearwards to secure seat in position.
5. Check if the seat is firmly secured in position before using it.

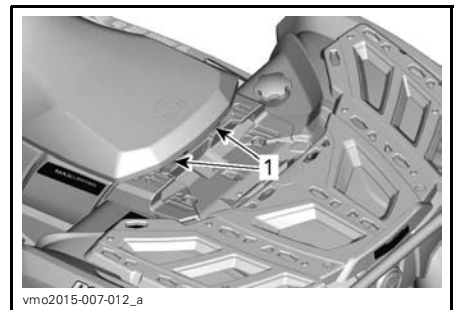

1. *Front pins*

## ⚠ WARNING

It is of the utmost importance for the passenger's safety that you confirm that the passenger's seat is properly locked in position by pulling back and up several times.

### Glove Box Installation

1. Remove passenger's seat. Refer to *PASSENGER'S SEAT REMOVAL* in this subsection.
2. Open glove box cover and turn handle to the unlock position.
3. Align and insert glove box latching system into this vehicle's "LINO" opening.

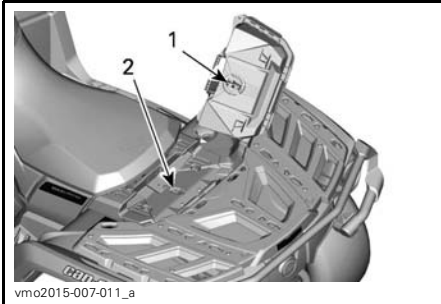

1. Glove box latch
2. "LINO" opening

4. Turn handle to the lock position.

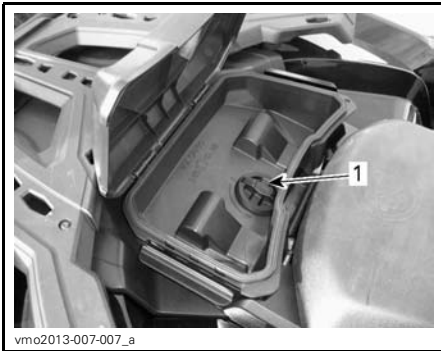

- TYPICAL
1. Latch

5. Close cover and verify if glove box is locked in position.

### Glove Box Removal

1. Unlock latch on each side of glove box and open lid.
2. Turn latch counter clock wise to unlock.

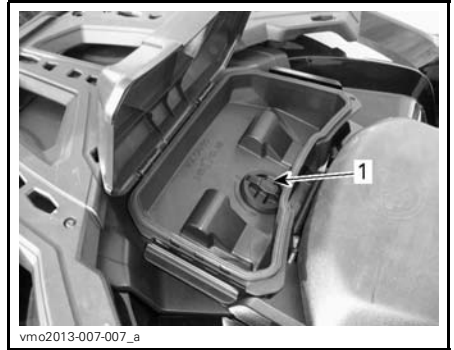

TYPICAL

1. Latch

3. Remove glove box.
4. Reinstall passenger's seat. Refer to *PASSENGER'S SEAT INSTALLATION* in this subsection.

### 3) Footpegs

The operator footpegs are located on the RH and LH side of the vehicle.



TYPICAL

1. Operator's LH footpeg

## ⚠ WARNING

Operator must have both feet on footpegs at all time during vehicle operation.

### 2-UP Models

The passenger footpegs are located on the RH and LH side of the vehicle behind the operator footpegs.

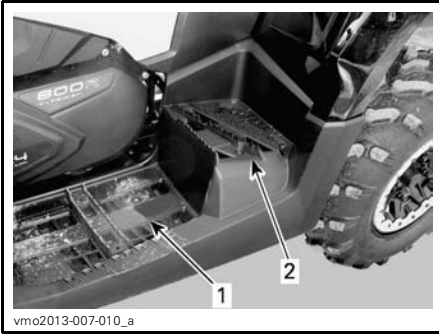
**TYPICAL**

1. Operator's LH footpeg
2. Passenger's LH footpeg

**⚠ WARNING**

Passenger must have both feet on footpegs at all time during vehicle operation.

#### 4) Grab Handles (2-UP Models)

The grab handles are located on the RH and LH side of the passenger's seat.

The grab handles must be used by the passenger to hold on firmly during vehicle operation.

**⚠ WARNING**

The passenger must always hold on to the passenger grab handles, not the operator. He must also have both feet resting firmly against the footrests.

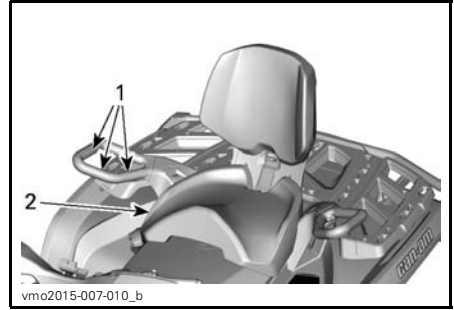
**TYPICAL**

1. Grab handles
2. Passenger's seat

#### 5) 12-Volt Power Outlet

Convenient for handheld spotlight or other portable equipment.



1. 12 V power outlet

Remove protective cap to use. Always reinstall it after use to protect against weather.

Do not exceed the rating capacity. Refer to *SPECIFICATIONS* subsection.

#### 6) Rear Storage Compartment

Convenient location to carry personal articles.



1. Rear storage compartment cover



1. Rear storage compartment latch

**⚠ WARNING**

Always engage the PARK position on the shift lever before opening cover. Never leave any heavy or loose breakable objects in the storage area. Always latch cover before riding.

**To Open Rear Storage Compartment**

Unlock the cover with the supplied key.

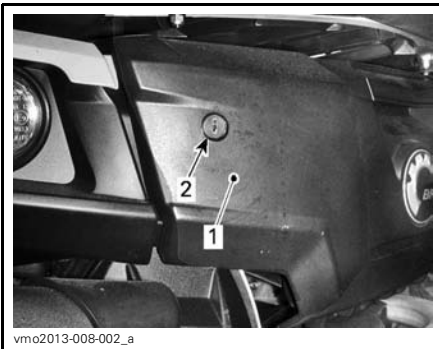

1. Rear storage compartment  
2. Keyhole

Unlatch cover and gently lower cover.

**To Close Rear Storage Compartment**

Gently lift and push cover until the latch clicks two times to ensure the seal is compressed.

Lock the compartment with the supplied key.

**7) Cargo Racks**

Cargo racks are convenient for carrying equipment and various other cargo. They must never be used to carry a passenger.



FRONT CARGO RACK



REAR CARGO RACK

### **⚠ WARNING**

- Never carry a passenger on a cargo rack.
- Cargo must never interfere with the driver's line of sight or affect his ability to properly steer the vehicle.
- Do not overload the vehicle.
- Always ensure all cargo is properly secured and does not extend out past the racks.

Refer to *SPECIFICATIONS* subsection for cargo weight recommendations.

## **8) Trailer Hitch**

Convenient hitch to install a ball to tow a trailer or other equipment. Install the proper ball size as per trailer manufacturer recommendations. Refer to *SPECIFICATIONS* subsection for carrying loads and towing recommendations.



TYPICAL

1. Trailer hitch

### **⚠ WARNING**

Ensure to install the proper ball size that matches the equipment you will tow.

**NOTE:** Follow manufacturer's instructions for proper attachment.

## **9) Tool Kit**

The tool kit is located under seat. It contains tools for basic maintenance.

## **10) Winch (Models with Winch)**

The winch can be actuated using the winch control switch or with the remote control.

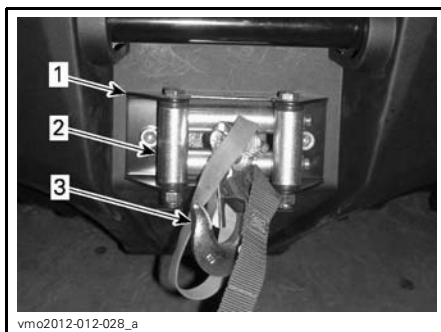

1. Winch
2. Roller fairlead
3. Winch hook

**NOTE:** Using the winch intensively over a long period of time may discharge the battery.

Refer to *BASIC GUIDE TO WINCHING TECHNIQUES* for more information about the winch.

## 11) Roller Fairlead (Models with Winch)

The roller fairlead is used to prevent damages to the vehicle and guide the wire rope into the winch.

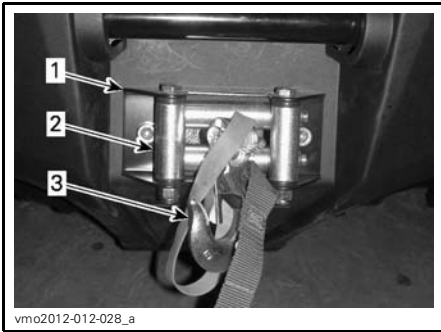

1. Winch
2. Roller fairlead
3. Winch hook

## 12) GPS Receiver (Global Positioning System) (LTD Models)

The GPS receiver is located on the handlebar and provides the vehicle position on earth.

### **⚠ WARNING**

**NEVER** hold the GPS while operating the vehicle. Not having **BOTH** hands on the handlebar during operation can lead to a collision.

**⚠ CAUTION** Always install the GPS on its support whenever using the vehicle.



**TYPICAL**  
1. GPS receiver

It is powered via the vehicle electrical system when installed on its support (with ignition switch to ON position), or via batteries when removed from its support.

GPS receiver can be activated using the ON/OFF button on the receiver or with the vehicle ignition switch when turned to ON or OFF position (when installed on the vehicle).

The GPS comes from factory with all the necessary accessories to be specifically used on this vehicle. It includes:

- Rechargeable battery
- Standard map: WW Autoroute DEM Basemap NR 3.00 with general basic road information
- Quick Start Manual and Warranty information.

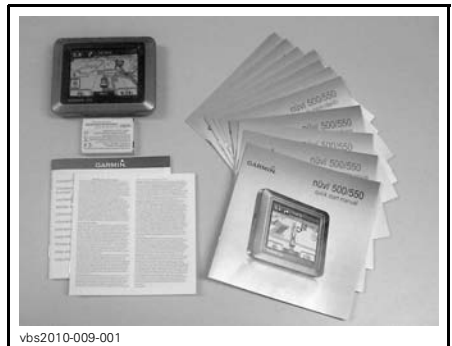

**TYPICAL KIT**

**NOTE:** Always refer to manufacturer's documentation supplied with the GPS receiver for proper use.

**NOTE:** For more details about the GPS receiver, available maps or accessories, contact an authorized Can-Am dealer or visit **Garmin** website at [www.garmin.com](http://www.garmin.com).

### **⚠ WARNING**

- Reading the GPS receiver can distract from the operation of the vehicle, particularly from constantly scanning the environment. This could lead to a collision.
- Before reading the GPS receiver, ensure your environment is clear and free from obstacle, and bring the vehicle to a low speed.
- Additionally, make sure to often double-check for obstacles.

### **⚠ WARNING**

Remember, the data provided by the GPS receiver is for reference only. For your safety, **NEVER** rely solely on this information.

### **GPS Receiver Installation**

Remove tamper resistant screw on front of GPS receiver.

Insert GPS receiver onto the lower tab of support.

Lock GPS receiver onto its support by pushing it towards upper tab.

Push on locking tab.

Install tamper resistant screw on front of GPS receiver.

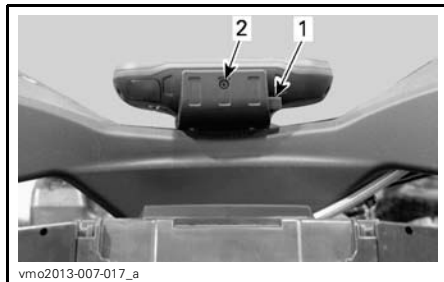

1. Locking tab
2. Tamper resistant screw

**NOTICE** To prevent weather damage or theft to your GPS receiver, always remove it from its support when leaving the vehicle.

### **GPS Receiver Removal**

The removal is the reverse of installation procedure.

## **13) ACS Compressor (LTD Model Only)**

The ACS compressor can be used to inflate tires.

**NOTE:** The air compressor output pressure will vary according to the ACS suspension setting. The **ACS 1** adjustment will provide less pressure than the **ACS 6** adjustment.

To inflate tires, proceed as follows:

1. Ensure that the shift lever is set in **PARK** position.
2. Apply brake lock.
3. Start engine and let it run at idle.
4. Remove seat(s).
5. Connect supplied hose into the compressor fitting.



1. Compressor fitting

6. Inflate tire at the recommended air pressure.

**NOTE:** Usually, to properly inflate an ATV tire, the proper ACS suspension setting should be **ACS 1**.



**NOTE:** For your convenience, a pressure gauge is supplied in tool kit.

**NOTICE** Always inflate tires at the recommended air pressure. Refer to **MAINTENANCE PROCEDURES** subsection.

## 14) Recovery Hook

Convenient hook that can be use to recover a stuck ATV.

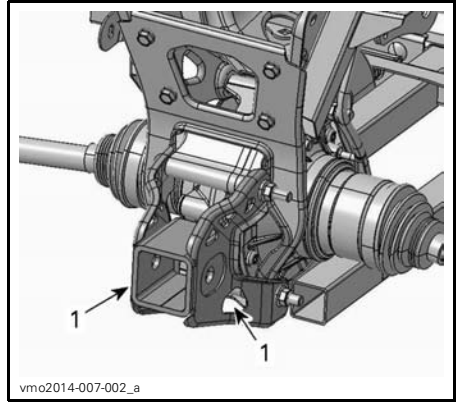

1. Recovery hook



# FUEL

## Fuel Requirements

**NOTICE** Always use fresh gasoline. Gasoline will oxidize; the result is loss of octane, volatile compounds, and the production of gum and varnish deposits which can damage the fuel system.

Alcohol fuel blending varies by country and region. Your vehicle has been designed to operate using the recommended fuels, however, be aware of the following:

- Use of fuel containing alcohol above the percentage specified by government regulations is not recommended and can result in the following problems in the fuel system components:
  - Starting and operating difficulties.
  - Deterioration of rubber or plastic parts.
  - Corrosion of metal parts.
  - Damage to internal engine parts.
- Inspect frequently for the presence of fuel leaks or other fuel system abnormalities if you suspect the presence of alcohol in gasoline exceeds the current government regulations.
- Alcohol blended fuels attract and hold moisture which may lead to fuel phase separation and can result in engine performance problems or engine damage.

## Recommended Fuel

Use common unleaded gasoline with an AKI (R+M)/2 octane rating of 87, or an RON octane rating of 92.

**NOTICE** Never experiment with other fuels. Engine or fuel system damages may occur with the use of an inadequate fuel.

## Vehicle Fueling Procedure

### WARNING

- Fuel is flammable and explosive under certain conditions.
- Never use an open flame to check fuel level.
- Never smoke or allow flame or spark in vicinity.
- Always work in a well-ventilated area.

1. Stop engine.

### WARNING

Always stop engine before refueling.

2. Have operator get off vehicle.

### WARNING

Do not allow anyone to remain on the vehicle while fueling. If there is a fire or explosion during fueling, a vehicle occupant could be unable to quickly leave the area.

3. Slide protective cover away from fuel tank cap lock.
4. Insert key in fuel tank cap lock.
5. Turn key counterclockwise to unlock fuel tank cap.
6. Unscrew slowly the fuel reservoir cap counterclockwise to remove it.

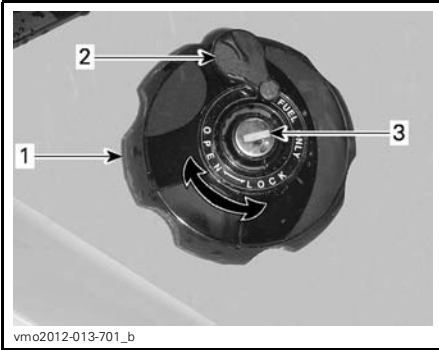

**RH REAR FENDER**

1. Fuel tank cap
2. Protective cover
3. Fuel tank cap lock

**⚠ WARNING**

If a differential pressure condition is noticed (whistling sound heard when loosening fuel reservoir cap) have vehicle inspected and/or repaired before further operation.

7. Insert the spout into the filler neck.
8. Pour fuel slowly so that air can escape from the tank and prevent fuel flow back. Be careful not to spill fuel.
9. Stop filling when the fuel reaches the bottom of filler neck. **Do not overfill.**

**⚠ WARNING**

Never top up the fuel tank before placing the vehicle in a warm area. As temperature increases, fuel expands and may overflow.

10. Fully tighten fuel reservoir cap clockwise.
11. Lock fuel tank cap by turning key clockwise.

**⚠ WARNING**

Always wipe off any fuel spillage from the vehicle.

---

# BREAK-IN PERIOD

## Operation During Break-In

A break-in period of 300 km (200 mi) or 10 operating hours is required for the vehicle.

### Engine

During the break-in period:

- Avoid full throttle operation.
- Maximum throttle should not exceed 3/4.
- Avoid sustained accelerations.
- Avoid prolonged cruising speeds.
- Avoid engine overheating.

However, brief accelerations and speed variations contribute to a good break-in.

**NOTE:** It is normal that the engine will not operate at its maximum efficiency until the break-in period is completed.

### Brakes

 <b>WARNING</b>
New brakes will not operate at their maximum efficiency until their break-in is completed. Use extra caution.

### Belt

A new belt requires a break in period of 50 km (30 mi).

During the break-in period:

- Avoid strong acceleration and deceleration.
- Avoid pulling a load.
- Avoid high speed cruising.

# BASIC PROCEDURES

## Starting the Engine

The shift lever must be set to PARK or NEUTRAL.

**NOTE:** For your convenience, an over-ride mode allows the engine to be started with the shift lever in any position. Press and hold the brake lever or the brake pedal while pressing the engine start button.

Insert key in ignition switch and turn to ON position.

Set the emergency engine stop switch to RUN.

Press the engine start button and hold until the engine starts.

Release the engine start button immediately when the engine has started.

**NOTICE** If engine does not start after a few seconds, do not hold the engine start button more than 10 seconds. Refer to TROUBLESHOOTING section.

## Shifting the Transmission

Apply brakes and immobilize vehicle, then select the desired shift lever position.

Release brakes.

**NOTICE** When changing gear selection, always completely stop the vehicle and apply the brakes prior to moving the shift lever. Otherwise, damage to the transmission may occur.

Gradually press the throttle lever to increase engine speed and thus engaging the continuously variable transmission (CVT).

At the opposite, when the throttle lever is released, the engine speed decreases.

## Stopping the Engine and Parking the Vehicle

### WARNING

Avoid parking on steep slope as the vehicle may roll away.

### WARNING

Always put the vehicle in PARK when stopped or parked to prevent rolling.

### WARNING

Avoid parking in places where hot parts can start a fire.

When stopped or parked always bring shift lever to park position. This is especially important when parking on a slope. On very steep inclines or if the vehicle is carrying a cargo, the wheels should be blocked using rocks or bricks.

Select the flattest terrain available for parking.

Release accelerator pedal and use brakes to completely stop the vehicle.

Set shift lever in PARK position.

Turn key in ignition switch to OFF position.

Remove key from ignition switch.

If you must park on a steep incline or if the vehicle is carrying cargo, block the wheels using rocks or bricks.

# SPECIAL PROCEDURES

## What to Do if Water is in the CVT

The CVT drain plug is located on the rear portion of the CVT cover. It is accessible from the rear LH fender.

Inspect the CVT drain plug to validate if water is present.

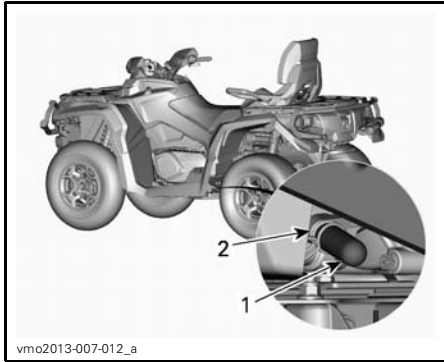

vmo2013-007-012\_a

1. Drain plug
2. Spring clamp

**NOTICE** If water is present in the CVT, it could result in belt slippage. The engine will accelerate but the vehicle will remain still.

If water is present, remove CVT drain plug to expel water.

**NOTICE** See an authorized Can-Am dealer to have the CVT inspected and cleaned.

Reinstall the drain plug and secure it using the spring clamp.

**NOTE:** Make sure hose is properly inserted on CVT cover nipple.

## What to Do if Water is in the Air Filter Housing

Remove the LH side panel.

Inspect the underneath the air filter housing to validate if water is present.

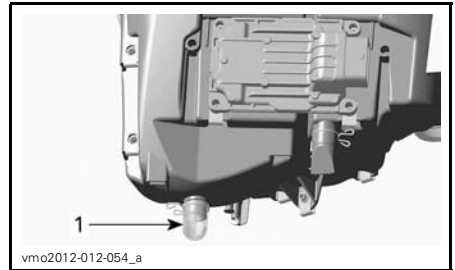

vmo2012-012-054\_a

### TYPICAL

1. Air filter housing

If water is present, press clamp and remove reservoir to drain water from air filter housing.

If one of the following conditions is met, bring the vehicle to your nearest authorized Can-Am dealer to have the vehicle serviced:

- If more than 50 ml (2 U.S. oz) of water (approximately 5 drain reservoirs) is found in the air filter housing.
- If any deposits are present in the drain reservoir.

In such a case, the vehicle must be serviced for:

- Vents
- CVT air filter cleaning
- CVT cleaning
- Fuel tank breather replacement
- Lubricant inspection and replacement as required (engine, gearbox and rear final drive).

**NOTICE** Failure to have vehicle serviced may lead to permanent damage to the following components but not limited to:

- Engine and gearbox
- Fuel pump
- ACS compressor (LTD model only)
- CVT
- Front differential
- Rear final drive.

## What to Do if Vehicle is Turned Over

When vehicle is turned over or stays tilted on the side, put the vehicle back on its wheel. Inspect vehicle for damages.

### WARNING

Never operate the vehicle if damaged. Refer to an authorized Can-Am dealer.

If vehicle has no damage, refer to *MAINTENANCE* section and inspect the following.

- Inspect air filter housing for oil accumulation, if any oil is found, clean air filter and air filter housing.
- Check engine oil level and refill if necessary.
- Check engine coolant level and refill if necessary.
- Check gearbox oil level and refill if necessary.
- Check rear final drive oil level and refill if necessary.
- Start engine. If the oil pressure light stays on, stop engine immediately. See an authorized Can-Am dealer.

Whenever the vehicle is turned over, it should be inspected by an authorized Can-Am dealer.

## What to Do if Vehicle is Immersed in Water

Should the vehicle become immersed, immediately stop the engine. Do not use:

- Any electrical equipments
- Winch (if equipped)
- ACS (LTD model).

It will be necessary to take the vehicle to an authorized Can-Am dealer as soon as possible. **NEVER ATTEMPT TO START THE ENGINE!**

**NOTICE** Immersion of the vehicle can cause serious damage if the correct restart procedure is not followed.

As soon as vehicle is pulled out of water, carry out the following:

- Drain CVT. See procedure in this subsection.

**NOTICE** The vehicle should be serviced as soon as possible by an authorized Can-Am dealer.

# TUNE YOUR RIDE

## **⚠ WARNING**

Suspension adjustment could affect vehicle handling. Always take time to familiarize yourself with the vehicle's behavior after any suspension adjustment have been made.

## **Suspension Adjustment**

Suspension adjustment and loading can have an effect on your vehicle handling and comfort.

Choice of suspension adjustments vary with driver's weight, personal preference, riding speed and field condition.

## **Spring Preload Adjustment**

## **⚠ WARNING**

The left and right shock adjustment on front or rear suspension must always be set to the same position. Never adjust one only. Uneven adjustment can cause poor handling and loss of stability, which could lead to an accident.

Shorten the springs for a firmer ride and rough conditions.

Lengthen the springs for a softer ride and smooth conditions.

### ***All Models Except XT-P***

Adjust spring preload by turning adjustment cam. Use tool from vehicle tool kit.

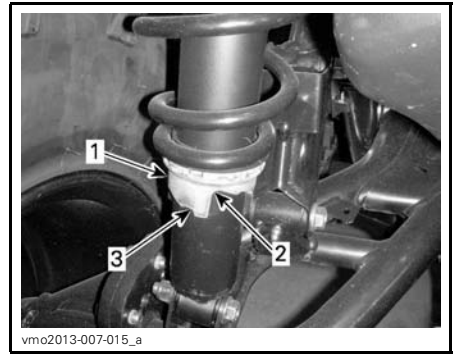

1. Adjustment cam
2. Softer adjustment
3. Firmer adjustment

### ***XT-P Model***

Adjust by turning adjustment cam accordingly. Use tool from vehicle tool kit.

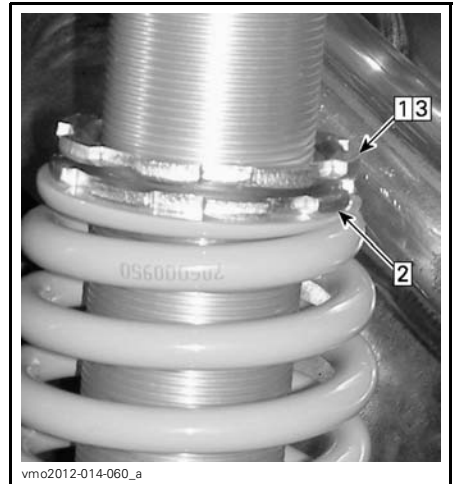

### ***TYPICAL***

- Step 1: Loosen top locking ring*
- Step 2: Turn adjusting ring accordingly*
- Step 3: Tighten top locking ring*

## Shock Damping Adjustments (XT-P Model)

### Low Speed Compression Damping

Low speed compression damping controls how the shock absorber reacts to a low suspension velocity (slow compression strokes, in most cases when riding at lower speeds).

ACTION	RESULT ON BIG BUMPS
Increasing low speed compression damping force	Firmer compression damping (slow compression)
Decreasing low speed compression damping force	Softer compression damping (slow compression)

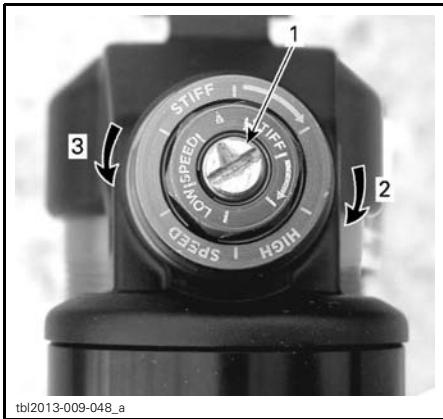

### LOW SPEED COMPRESSION DAMPING (USE A SCREWDRIVER)

1. Adjustment screw
2. Increases damping (stiffer)
3. Decreases damping (softer)

Turn adjuster clockwise (H) to **increase** shock damping action (stiffer).

Turn adjuster counterclockwise (S) to **decrease** shock damping action (softer).

### High Speed Compression Damping

High speed compression damping controls how the shock absorber reacts to a high suspension velocity (quick compression strokes, in most cases when riding at higher speeds).

ACTION	RESULT ON SMALL BUMPS
Increasing high speed compression damping force	Firmer compression damping (fast compression)
Decreasing high speed compression damping force	Softer compression damping (fast compression)

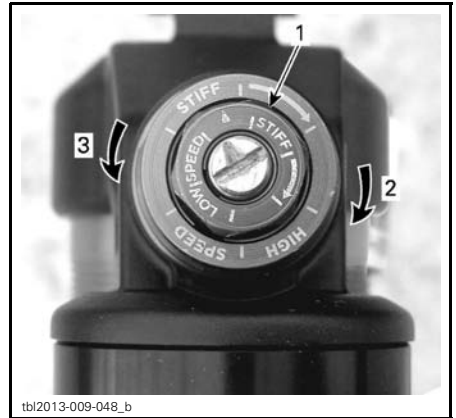

### HIGH SPEED COMPRESSION DAMPING (USE A 17 MM WRENCH)

1. Adjustment screw
2. Increases damping (stiffer)
3. Decreases damping (softer)

Turn adjuster clockwise (H) to **increase** shock damping action (stiffer).

Turn adjuster counterclockwise (S) to **decrease** shock damping action (softer).



## Rebound Damping

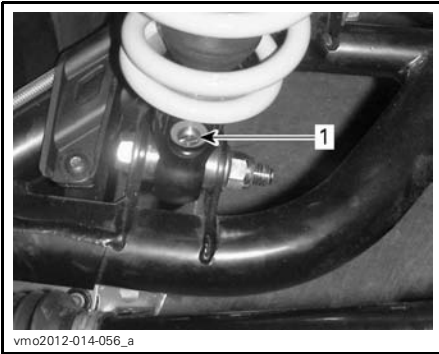

1. Rebound adjuster (screwdriver required)

Turn adjuster clockwise (H) to **increase** shock damping action (stiffer).

Turn adjuster counterclockwise (S) to **decrease** shock damping action (softer).

## Air Controlled Suspension (ACS) Adjustment (LTD Model Only)

This system allows the operator to adjust the rear suspension by simply pressing a button. By changing the ACS setting, air pressure in the rear shocks absorber will change to provide a different suspension adjustment.

The following suspension settings are preset in the vehicle.

ACS SUSPENSION SETTINGS		
SETTING	RIDING COMFORT	RECOMMENDED LOAD
ACS 1	Softest	Operator only
ACS 2	Soft	

ACS SUSPENSION SETTINGS		
SETTING	RIDING COMFORT	RECOMMENDED LOAD
ACS 3	Semi-soft	Transporting a passenger OR a cargo
ACS 4	Semi-firm	
ACS 5	Firm	Transporting a passenger AND a cargo
ACS 6	Firmest	

## ⚠ WARNING

Always adjust the ACS suspension setting according to load. Adhere to the above recommendations regarding the transportation of a load (passenger and cargo) on your vehicle.

To show the actual setting, proceed as follows:

1. Press MODE (M) button to display AIR\_SUSP.
2. Check the multifunction gauge to confirm the actual setting.

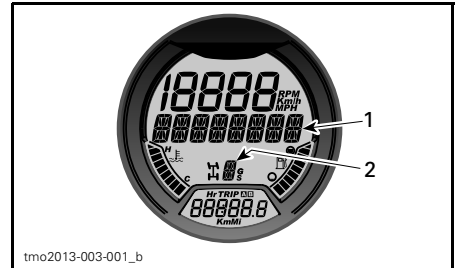

1. AIR\_SUSP displayed
2. Actual setting

While reading this Operator's Guide, remember that:

## ⚠ WARNING

Indicates a potential hazard that, if not avoided, could result in serious injury or death.

To change the actual setting, proceed as follows:

1. Press MODE (M) button to display AIR\_SUSP.

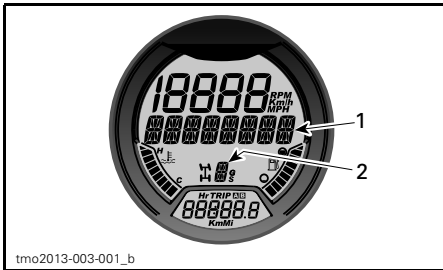

1. AIR\_SUSP displayed
2. Actual setting

2. Press and release ACS button until the requested setting is displayed.



- TYPICAL
1. ACS button

### ACS Suspension Setting Acknowledgement

If ACS suspension was set to **ACS 5** or **ACS 6** before shutting down the vehicle for a short period of time, the multifunction gauge will scroll an acknowledgement message at startup. Make sure that the suspension is adjusted according to the load carried.

To acknowledge the ACS suspension setting, press and release **ACS** button while message appears.

**NOTE:** If the message is not acknowledged, the suspension will automatically return to setting **ACS 3**.

**NOTE:** If the MODE (M) button is pressed while the acknowledgement message appears, the suspension will directly return to setting **ACS 3**.

**NOTE:** If the vehicle transmission is set to **REVERSE** position at startup, the override message will be displayed instead of acknowledgement message.

### Steering Assist Adjustment (DPS) (Models with DPS)

The applicable models are equipped with a Dynamic Power Steering (DPS) system. The DPS reduces the effort to turn the handlebars.

When the Dynamic Power Steering (DPS) is subjected to certain conditions, the power steering assistance provided by the DPS motor may be reduced to protect the system. This is known as DPS derating.

DPS derating could occur during specific situations requiring frequent and significant steering effort or when terrain offers a high resistance to steering inputs. Some situations may include:

- Constant low speed maneuvering,
- Rock climbing,
- Usage of tracks.

**NOTE:** The amount of DPS derating or the gradual reduction of steering assistance, depends on how long the DPS motor is subjected to a heavy load. Once the load is reduced to a certain level, derating will stop and normal steering assistance will return.

The following DPS modes are preset in the vehicle.

DPS MODE	
DPS MAX.	Maximum steering assist
DPS MED.	Medium steering assist
DPS MIN.	Minimum steering assist

To show the active DPS mode, proceed as follows:

1. Press and release **DPS** button.

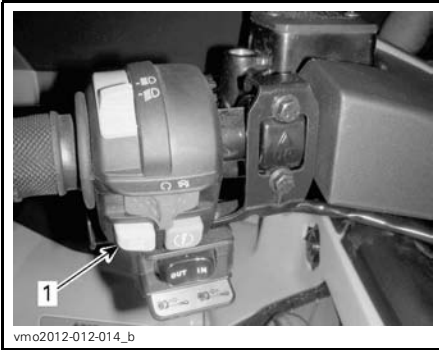

#### TYPICAL

1. *DPS* button

2. Check the multifunction gauge to confirm the active DPS mode.

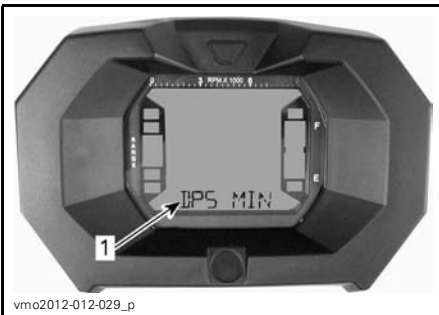

#### LCD GAUGE

1. *DPS* mode (Display 3)

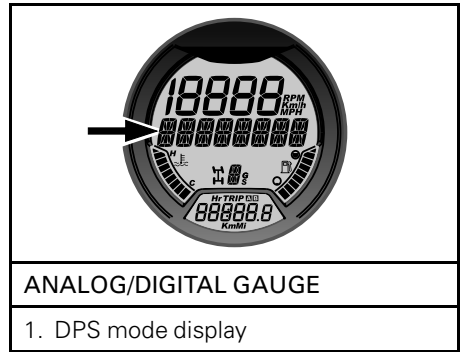

To change the DPS mode, proceed as follows:

1. Press and hold **DPS** button for 2 seconds to go to the next setting.
2. Release **DPS** button.
3. Repeat until desired setting is selected.

**NOTE:** The DPS adjustment will not be possible if the vehicle transmission is set to **REVERSE** or if the ACS mode (LTD model) is displayed in the multifunction gauge.

# VEHICLE TRANSPORTATION

When transporting this vehicle, secure it to a trailer or in pickup box with suitable tie-downs. Use of ordinary ropes is not recommended.

## **⚠ WARNING**

Do not tow this vehicle behind a car or other vehicle. Use a trailer. Never tip this vehicle on end for transporting. The vehicle must be in its normal operating position (on all four wheels).

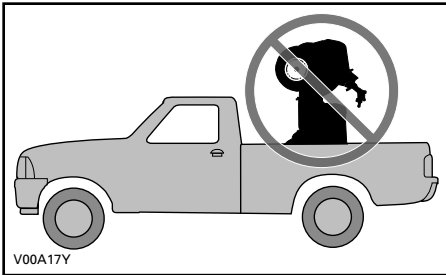

Remember to:

- Unload vehicle racks before transportation.
- Set shift lever to PARK position.
- Set the brake lock.
- Secure the vehicle by the front and rear tie-down points.



1. Front tie-down point location

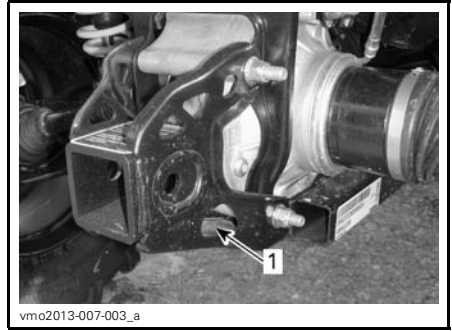

TYPICAL - REAR TIE-DOWN POINT LOCATION

1. Rear tie-down point location

**NOTICE** Securing vehicle at other locations may damage the vehicle.

# ***MAINTENANCE***

# MAINTENANCE SCHEDULE

Maintenance is very important for keeping your vehicle in safe operating condition. Proper maintenance is the owner's responsibility. The vehicle should be serviced as per the maintenance schedule.

The maintenance schedule does not exempt the pre-ride inspection.

## WARNING

Failure to properly maintain the vehicle according to the maintenance schedule and procedures can make it unsafe to operate.

## SEVERE DUSTY CONDITIONS

### Engine Air Filter Maintenance Guideline

Air filter maintenance should be adjusted according to riding conditions.

Air filter maintenance must be increased in frequency in the following dusty conditions:

- Riding on dry sand
- Riding on dry dirt covered surfaces
- Riding on dry gravel roads or similar conditions.

**NOTE:** Riding in a group in these conditions would increase even more the air filter maintenance.

## MAINTENANCE SCHEDULE LEGEND

Operation in trail riding conditions

Operation in severe riding conditions (dusty or muddy) or carrying heavy loads condition

## MAINTENANCE SCHEDULE

Make sure to perform proper maintenance at recommended intervals as indicated in the tables. Some items of the maintenance schedule must be performed in function of the calendar, regardless of the distance or time of operation.

**EVERY 1 500 KM (1,000 MI) OR 50 HOURS (whichever comes first)**

**EVERY 750 KM (500 MI) OR 25 HOURS (whichever comes first)**

Verify and clean engine air filter. Replace as needed

Verify battery connections

Lubricate front and rear propeller shaft joints

Inspect tie rod ends and ball joints for play and boots condition

Lubricate front suspension arm bushings

Lubricate rear stabilizer bar bushings

Inspect the drive shaft boots and protectors

Inspect brake pads. Replace as needed

**EVERY 1 500 KM (1,000 MI) OR 50 HOURS (whichever comes first)**

**EVERY 750 KM (500 MI) OR 25 HOURS (whichever comes first)**

Inspect wheel bearings for abnormal play

Inspect and clean CVT air filter. Replace as needed. (If equipped)

Tighten wheel beadlock bolts (If equipped)

Lubricate lower shock absorber spherical bearings (Outlander LTD and XT-P)

Lubricate upper shock absorber spherical bearings (Outlander LTD)

**EVERY 3 000 KM (2,000 MI) OR 100 HOURS (whichever comes first)**

**EVERY 1 500 KM (1,000 MI) OR 50 HOURS (whichever comes first)**

Adjust valve clearance

Clean muffler spark arrester

Verify and clean throttle body

Replace fuel vent breather filter

Verify CVT drive belt and clean CVT pulleys

Lubricate the one way bearing of the drive pulley

Inspect ACS suspension hoses condition (LTD)

**The following must be performed at least once a year:**

Change engine oil and filter

Lubricate throttle cable

Inspect and clean brake system

Inspect battery condition

Verify steering system for abnormal play

Verify front differential and rear final drive oil level and look for contamination

Verify gearbox oil level and look for contamination

**PERFORM AT THE FIRST 3 000 KM (2,000 MI) AND AT 6 000 KM (4,000 MI)  
THEN FOLLOW THE REGULAR SCHEDULE**

**PERFORM AT THE FIRST 1 500 KM (1,000 MI) AND AT 3 000 KM (2,000 MI)  
THEN FOLLOW THE REGULAR SCHEDULE**

Replace gearbox oil

Clean the vehicle speed sensor (VSS)

**EVERY 6 000 KM (4,000 MI) OR 200 HOURS (whichever comes first)**

**EVERY 3 000 KM (2,000 MI) OR 100 HOURS (whichever comes first)**

Verify the cooling system

Test engine coolant strength

Verify fuel system for leaks

Verify fuel pump pressure

Replace spark plugs

Replace front differential oil

Replace rear final drive oil

Replace gearbox oil

Inspect input and output shaft seals (gearbox, differential and final drive)

Clean vehicle speed sensor

Clean and lubricate lower and upper steering column half bushings

**The following must be performed every 2 years:**

Replace the brake fluid

**EVERY 12 000 KM (8,000 MI) OR 5 YEARS (whichever comes first)**

**EVERY 6 000 KM (4,000 MI) OR 5 YEARS (whichever comes first)**

Replace engine coolant



# MAINTENANCE PROCEDURES

This section includes instructions for basic maintenance procedures. If you have the necessary mechanical skills and the required tools, you can perform these procedures. If not, see your authorized Can-Am dealer.

Other important items in the maintenance schedule that are more difficult and require in-depth technical knowledge or special tools are best performed by your authorized Can-Am dealer.

## **⚠ WARNING**

Unless otherwise indicated, always turn ignition switch to OFF position and remove key before performing any maintenance.

## **⚠ WARNING**

Should removal of a locking device be required (e.g. lock tab, self-locking fastener, etc.), always replace it with a new one.

## Air Filter

### Air Filter Maintenance Guideline

As with any ATV, air filter maintenance is critical to ensure proper engine performance and life span.

Air filter maintenance should be adjusted according to riding conditions.

Air filter maintenance must be increased in frequency and oil must be added to the foam filter for the following dusty conditions:

- Riding on dry sand.
- Riding on dry dirt covered surfaces.
- Riding on dry gravel trails or similar conditions.

**NOTE:** Riding in a group in these conditions would increase even more the air filter maintenance. Refer to *AIR FILTER CLEANING AND OILING* in this subsection for maintenance procedure.

**NOTE:** An accessory pre-filter for "dusty conditions" may be used. Contact an authorized Can-Am dealer for details.

### Air Filter Removal

**NOTICE** Never remove or modify any component in the air filter housing. Otherwise, engine performance degradation or damage can occur. The engine is calibrated to operate specifically with these components.

Remove seat.

Remove console.

Lift rear portion of console upwards until the studs are released from the grommets.

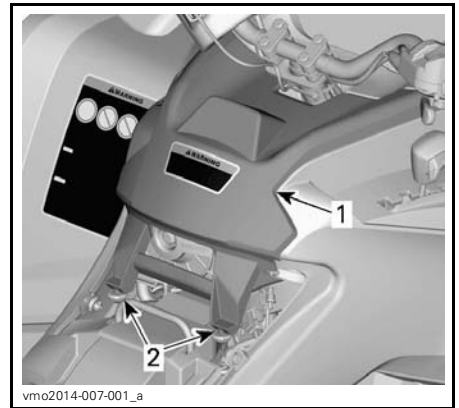

#### TYPICAL

1. Console
2. Studs and grommets

Pull console rearwards.

Rotate air filter cover counterclockwise to remove.

**NOTE:** A socket wrench may be used to ease removal.



1. Air filter cover

Remove air filter.



**AIR FILTER REMOVAL**

**Engine Air Filter Housing Inspection and Draining**

1. Remove LH side panel.
2. Drain air filter housing inlet drain tube.

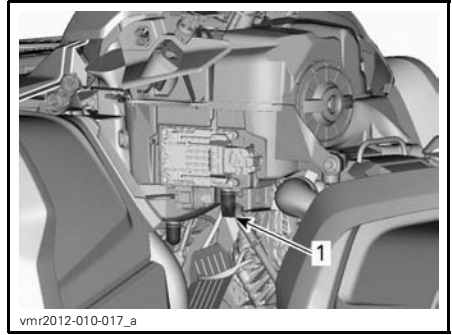

**TYPICAL - SOME PARTS REMOVED FOR CLARITY**

1. Air filter housing inlet drain tube

3. Check air filter dirty chamber for cleanliness.

- If any debris or water are found, clean air filter chamber using a vacuum cleaner.

**NOTICE** Do not blow compressed air into air filter chamber.

4. Check air filter drain tube (clean chamber).

- If any debris or water are found, refer to *SPECIAL PROCEDURES* subsection.
- Investigate for contamination source.

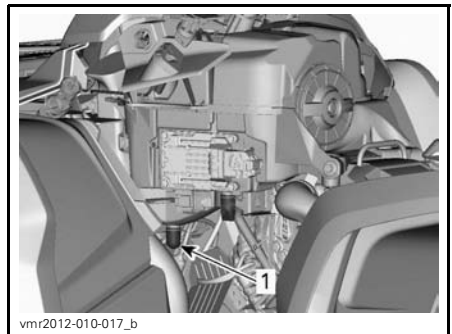

**TYPICAL - SOME PARTS REMOVED FOR CLARITY**

1. Air filter drain tube

## Air Filter Cleaning and Oiling

**⚠ CAUTION** Always wear appropriate skin and eye protection. Chemicals can cause a skin rash and eye injury.

### Paper Filter Cleaning

1. Ensure that the foam filter is removed from paper filter.
2. Tap out heavy dust from the paper filter.

This will allow dirt and dust to get out of the paper filter.

**NOTE:** Paper filter have a limited life span; replace filter if too dirty or clogged.

**NOTICE** It is not recommended to blow compressed air on the paper filter; this could damage the paper fibers and reduce its filtration ability when used in dusty environments.

**NOTICE** Do not wash the paper filter with any cleaning solution.

### Foam Filter Cleaning

1. Spray the foam filter inside and out with AIR FILTER CLEANER (P/N 219 700 341).



219700341

AIR FILTER CLEANER (P/N 219 700 341)



vbs2009-012-015\_a

TYPICAL - SPRAY THE FOAM FILTER

2. Let stand for 3 minutes.
3. As stated on air filter cleaner (UNI) container, rinse with plain water.
4. Dry the foam filter completely.

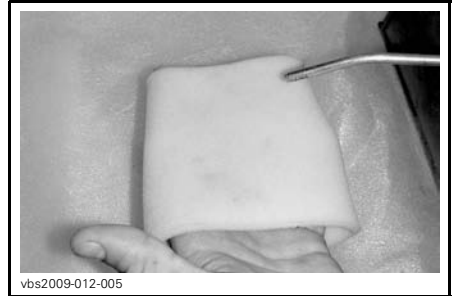

vbs2009-012-005

TYPICAL - DRY

**NOTE:** A second application may be necessary for heavily soiled elements.

### Foam Filter Oiling

1. Make sure filter is clean. Refer to *FOAM FILTER CLEANING*.
2. Spray AIR FILTER OIL (P/N 219 700 340) on the foam filter previously dried.



219700340

AIR FILTER OIL (P/N 219 700 340)



vbs2009-012-014

TYPICAL - OIL THE FOAM FILTER

3. Let stand for 3 to 5 minutes.
4. Remove any excess of oil that could transfer to the paper filter by wrapping the foam filter into an absorbent cloth and squeezing gently. This will also ensure a full oil coverage on foam filter.
5. Reinstall the foam filter over the paper filter.

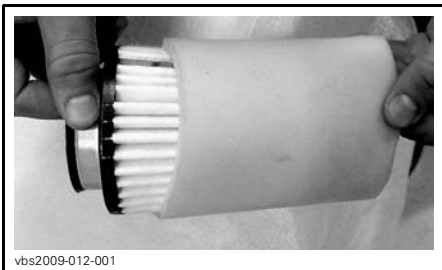

vbs2009-012-001

TYPICAL

6. Slightly grease plastic body of filter for ease of installation and future removal.

### Air Filter Installation

Slightly grease O-ring seal and plastic body of air filter.

Install air filter as the reverse of removal.

Ensure air filter cover is properly locked onto the air filter housing. See indications on filter cover and housing.

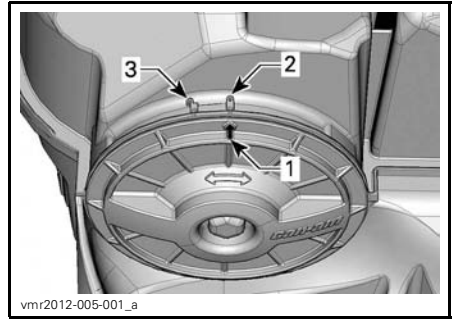

vmr2012-005-001\_a

1. Cover position arrow
2. Locked
3. Unlocked

Install console as the reverse of removal. However, pay attention to the following.

Align console front tabs with slots, then push console forward.

Then align and insert studs with grommets on rear portion of console until studs engage with grommets.

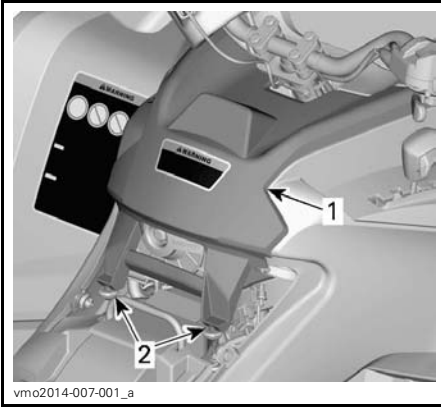

**TYPICAL**

1. Console
2. Studs and grommets

## Engine Oil

### Engine Oil Level

**NOTICE** Check level frequently and refill if necessary. **Do not overfill.** Operating the engine/gearbox with an improper level may severely damage engine/gearbox. Wipe off any spillage.

**NOTE:** While checking the oil level, visually inspect engine area for leaks.

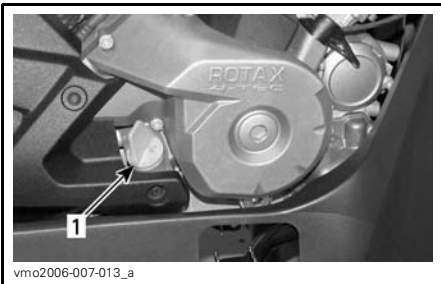

**TYPICAL - RH SIDE OF ENGINE**

1. Dipstick

With vehicle on a level surface and engine cold, not running, check the oil level as follows:

1. Unscrew dipstick then remove it and wipe clean.

2. Reinstall dipstick, screw in it completely.
3. Remove and check oil level. It should be near or equal to the upper mark.

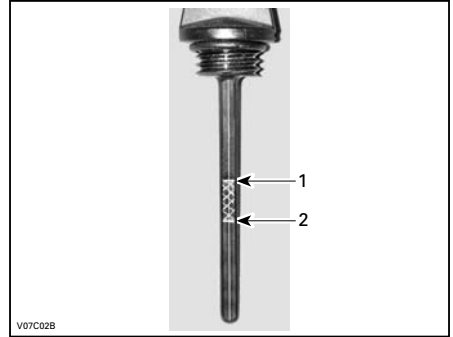

**TYPICAL**

1. Full
2. Add

To add oil, remove dipstick. Place a funnel into the dipstick tube to avoid spillage.

Add a small amount of recommended oil and recheck oil level.

Repeat the above procedures until oil level reaches the dipstick's upper mark. **Do not overfill.**

Properly tighten dipstick.

### Recommended Engine Oil

For the summer season, use XPS 4-STROKE SYNTH. BLEND OIL (SUMMER) (P/N 293 600 121).

For all season, use XPS 4-STROKE SYNTHETIC OIL (ALL CLIMATE) (P/N 293 600 112).

**NOTE:** The XPS oil is specially formulated and tested for the severe requirements of this engine.

If not available, use 4-stroke SAE 5W40 engine oil that meets or exceeds the requirements for API service classification SG, SH or SJ. Always check the API service label certification on the oil container it must contain at least one of the above standards.

## Engine Oil Change

Start and warm-up engine. Stop engine.

Ensure vehicle is on a level surface.

Remove dipstick.

Clean the oil drain plug area.

Place a drain pan under the oil drain plug area.

Unscrew oil drain plug.

**⚠ CAUTION** The engine oil can be very hot. In order to avoid potential burns, do not remove the engine drain plug if the engine is hot. Wait until engine oil is warm.

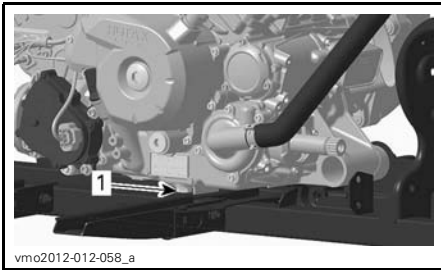

1. Drain plug

Allow enough time for oil to flow out of oil filter.

Replace the oil filter. Refer to *OIL FILTER* in this subsection.

Change gasket on oil drain plug.

Clean gasket area on engine and oil drain plug then reinstall plug.

Refill engine at the proper level with the recommended oil.

Refer to *SPECIFICATIONS* subsection for oil capacity.

Start engine and let idle for a few minutes.

Ensure oil filter area and oil drain plug areas are not leaking.

Stop engine.

Wait a while to allow oil to flow down to crankcase then check oil level.

Refill as necessary.

Dispose of oil as per your local environmental regulations.

## Oil Filter

### Oil Filter Removal

To reach oil filter, remove the following parts:

- Seat
- Console
- RH side panel
- RH footrest panel.

1. Clean oil filter area.
2. Remove oil filter cover screws.
3. Remove oil filter cover.
4. Remove oil filter.

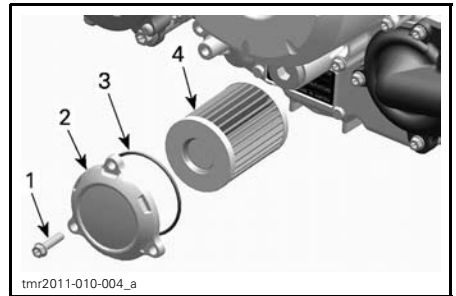

1. Oil filter screw
2. Oil filter cover
3. O-ring
4. Oil filter

### Oil Filter Installation

1. Check and clean the oil filter inlet and outlet area of dirt and other contaminations.

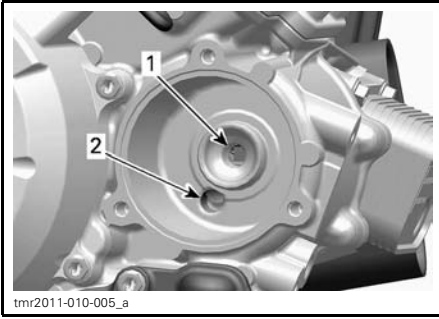

1. Outlet bore to the engine oil providing system
  2. Inlet bore from the oil pump to the oil filter
2. Install a NEW O-ring on oil filter cover.
  3. Install the filter into the cover.
  4. Apply engine oil on O-ring and on end of filter.

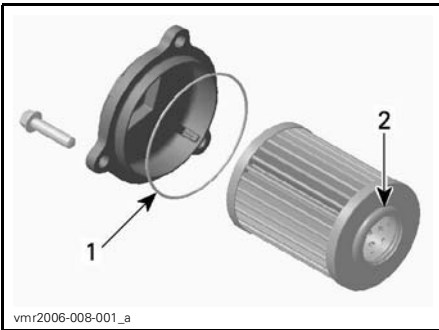

1. Slightly oil
  2. Slightly oil
5. Install the cover on the engine.
  6. Tighten oil filter cover screws to recommended torque.

TIGHTENING TORQUE	
Oil filter cover screws	10 N•m ± 1 N•m (89 lbf•in ± 9 lbf•in)

7. Reinstall remaining parts if applicable.

## Radiator

### Radiator Inspection

Periodically check the radiator area for cleanliness.



TYPICAL - PARTS REMOVED FOR CLARITY

Inspect radiator and hoses for leaks or any damage.

Inspect radiating fins. They must be clean, free of mud, dirt, leaves and any other deposit that would prevent the radiator to cool properly.

Remove as much deposits as you can with your hands. If water is available in proximity, try rinsing the radiating fins.

**NOTE:** Inner fenders can be removed to ease cleaning.

If available, use a garden hose to rinse the radiating fins.

**⚠ CAUTION** Never clean radiator with your hands when it is hot. Let the radiator cool down before cleaning.

**NOTICE** Be careful not to damage the radiating fins when cleaning. Do not use any object/tool that could damage the fins. The fins are purposely thin parts to allow efficient cooling. **WHEN RINSING, USE LOW PRESSURE ONLY, NEVER USE A HIGH PRESSURE WASHER.**

See an authorized Can-Am dealer to check the performance of the cooling system.

## Engine Coolant

### Engine Coolant Level Verification

#### **⚠ WARNING**

Check coolant level with engine cold. Never add coolant in cooling system when engine is hot.

Place vehicle on a level surface.

Remove the gauge support.

With vehicle on a level surface, liquid should be between MIN. and MAX. level marks of coolant reservoir.



1. Engine coolant reservoir

**NOTE:** When checking level at temperature lower than 20°C (68°F), it may be slightly lower than MIN. mark.

Add coolant up to MAX. mark if required.

#### **⚠ WARNING**

Warning: Do not remove the coolant reservoir cap if engine is hot.

Use a funnel to avoid spillage. Do not overfill.

Properly reinstall and tighten reservoir cap.

Reinstall gauge support.

#### **⚠ WARNING**

In order to avoid potential burns, do not remove the radiator cap if the engine is hot.

**NOTE:** A cooling system that frequently requires coolant is the indication of leaks or engine problems. See an authorized Can-Am dealer.

**NOTICE** Do not store any objects under the gauge support.

### Recommended Engine Coolant

Always use ethylene-glycol antifreeze containing corrosion inhibitors specifically for internal combustion aluminum engines.

Cooling system must be filled with LONG LIFE ANTIFREEZE (P/N 219 702 685) or with distilled water and antifreeze solution (50% distilled water, 50% antifreeze).

### Engine Coolant Replacement

#### Cooling System Draining

Remove the gauge support.

Remove the coolant reservoir cap.

#### **⚠ WARNING**

To avoid potential burns, do not remove the pressure cap if the engine is hot.





vmo2012-012-042\_a

1. Engine coolant reservoir cap

Unscrew the coolant drain plug and drain the coolant into a suitable container.

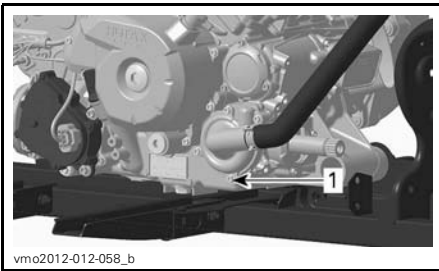

vmo2012-012-058\_b

1. Coolant drain plug

**NOTE:** Do not unscrew the coolant drain plug completely.

**650 Models**

Disconnect the lower radiator hose and drain the remaining coolant into a suitable container.

**NOTE:** Take note of hose clamp position on the lower radiator hose.

Reinstall lower radiator hose.

Position the radiator hose clamp as noted during removal.

Tighten radiator hose clamp to specification.

**All Models**

Reinstall cooling system drain plug with a new sealing ring.

Tighten the coolant drain plug to specification.

**TIGHTENING TORQUE**

Cooling drain plug	9 N•m to 11 N•m (80 lbf•in to 97 lbf•in)
--------------------	---

Bleed cooling system, refer to *COOLING SYSTEM FILLING AND BLEEDING*.

**Cooling System Filling and Bleeding**

1. Unscrew bleed screws on both front and rear cylinders.



tmo2011-001-501\_a

**TYPICAL**

1. Front cylinder bleed screw

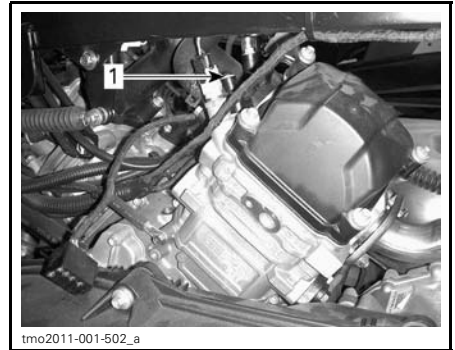

tmo2011-001-502\_a

**TYPICAL**

1. Rear cylinder bleed screw

2. Fill the cooling system until coolant comes out of the bleed screw(s).

650

- Squeeze the top of the coolant hose between the radiator and coolant pump several times until all air is bled from the highest point of the hose.

All Models

- Install the bleed screws using NEW gasket rings and torque as per following chart.

TIGHTENING TORQUE	
Bleed screws	5.0 N•m ± 0.6 N•m (44 lbf•in ± 5 lbf•in)

- Add coolant until system is full up to the pressure cap seat.
- Refill coolant tank up to MAX level mark.
- Start engine.

**NOTE:** Do not install pressure cap.

- Run engine at idle until coolant fan turns ON.

**NOTE:** Monitor coolant level during engine warm-up and add coolant as required.

- Depress the throttle lever two or three times; check coolant level.
- Stop the engine and let it cool down.
- Inspect cooling system for leaks.
- Check coolant level in the reservoir. Add coolant as required.
- Install pressure cap.

## Muffler Spark Arrester

### Muffler Spark Arrester Cleaning and Inspection

**NOTE:** Spark arrester screen replacement is required only when damaged.

**CAUTION** Let exhaust system cool down before proceeding with cleaning and inspection.

Remove the muffler cover. Discard retaining screws.

**NOTICE** Do not use an impact tool for any screw removal.

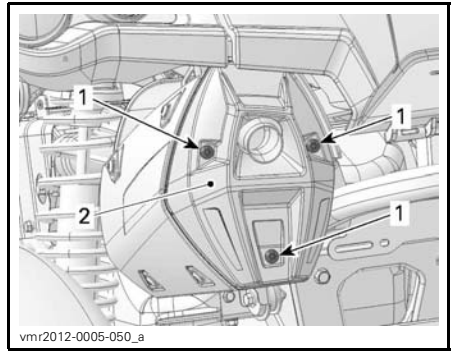

**TYPICAL**  
1. Screws  
2. Cover

Remove and discard the tail pipe retaining screws.

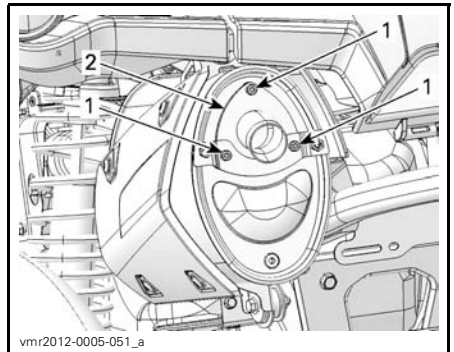

**TYPICAL**  
1. Screws  
2. Tail pipe

Remove exhaust tail pipe, gasket (discard) and spark arrester.

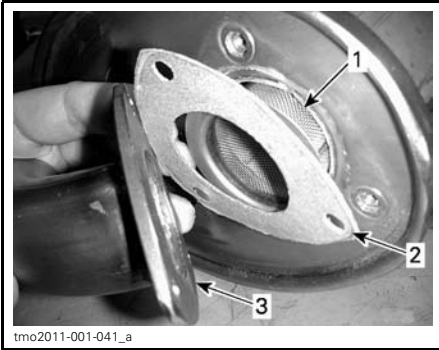

**TYPICAL**

1. Spark arrester
2. Gasket
3. Exhaust tail pipe

Remove carbon deposits from the spark arrester using a brush.

**NOTICE** Use a soft brush and be careful to avoid damaging spark arrester mesh.

**CAUTION** Wear eye protection and gloves.



1. Clean spark arrester

Inspect mesh of spark arrester for any damage. Replace as required.

While reading this Operator's Guide, remember that:

**WARNING**

Indicates a potential hazard that, if not avoided, could result in serious injury or death.

**NOTE:** Spark arrester screen replacement is required only when damaged.

Inspect spark arrester chamber in muffler.

Clean any debris as required.

Install new gasket, tail pipe and new retaining screws.

Reinstall muffler cover with new retaining screws. Tighten to specification.

TIGHTENING TORQUE	
Tail pipe retaining screws and cover retaining screws	11 N•m ± 1 N•m (97 lbf•in ± 9 lbf•in)

**CVT Air Filter (850/1000R)**

**CVT Air Filter Removal**

1. Push on three tabs and remove air filter.

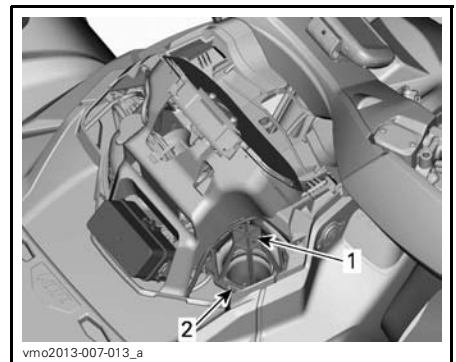

1. CVT air filter
2. Tab

## CVT Air Filter Cleaning

1. Spray filter inside and out with AIR FILTER CLEANER (P/N 219 700 341).



AIR FILTER CLEANER (P/N 219 700 341)

2. Let stand for 3 minutes.
3. As stated on air filter cleaner (UNI) container, rinse filter with plain water.
4. Dry filter completely.

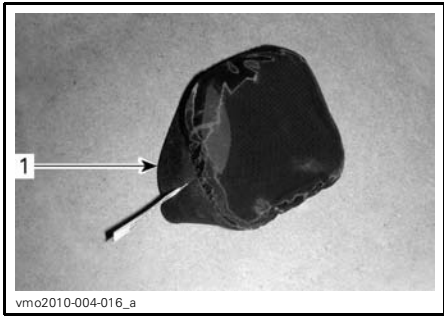

1. CVT air filter (slip-on type)



1. CVT air filter (clip-on type)

5. Clean inside the CVT air inlet end.

## CVT Air Filter Installation

### *Models with Slip-On Air Filter*

1. Install air filter on CVT inlet by stretching its sides.
2. Reinstall gauge support.

### *Models with Clip-On Air Filter*

1. Install air filter on CVT by inserting tabs in their slots and push on air filter until it clicks.

## Gearbox Oil

### Gearbox Oil Level Verification

**NOTICE** Check level and refill if necessary. **Do not overfill.** Operating the gearbox with an improper level may severely damage gearbox. Wipe off any spillage.

Place the vehicle on a level surface.

Select NEUTRAL position.

Apply brake lock.

Check the gearbox oil level when engine cold, not running, by removing the gearbox oil level plug.

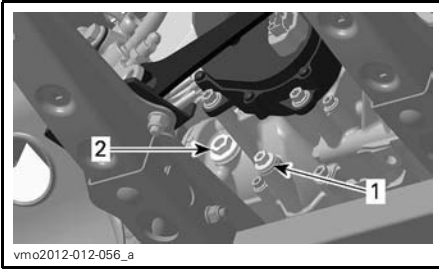

TYPICAL

The oil should be level with the bottom of the oil level hole.

Refill as required until gearbox oil level flows through oil level hole.

### Recommended Gearbox Oil

ENGINE	RECOMMENDED PRODUCT	QUANTITY
650 850 1000R	XPS SYNTHETIC GEAR OIL (75W 140) (P/N 293 600 140)	Approximately 450 ml (15.22 U.S. oz)

If the recommended oil is not available, use a 75W140 gearbox oil that meets the API GL-5 specification.

**NOTICE** Do not use another types of oil when servicing. Do not mix with other types of oil.

### Gearbox Oil Change

**NOTE:** When replacing the gearbox oil, it is recommended to clean the vehicle speed sensor (VSS) at the same time.

Place the vehicle on a level surface.

Clean drain plug area.

Clean the oil level plug area.

Under the vehicle, place a drain pan underneath the oil drain plug area.

Remove the oil level plug.

Remove the gearbox drain plug.

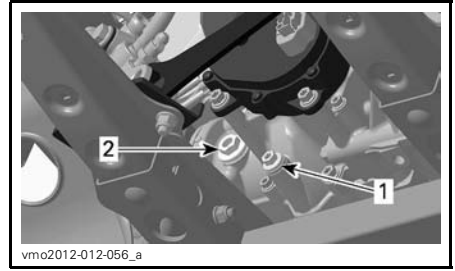

TYPICAL

1. Drain plug
2. Oil level plug

Let oil completely drain from gearbox.

Install the drain plug.

**NOTE:** Clean drain plug from any metallic particles prior to installation.

Refill gearbox.

**NOTICE** Use ONLY the recommended type of oil.

The oil should be level with the bottom of the oil level orifice.

**NOTICE** Do not overfill.

Reinstall oil level plug.

Wipe off any spillage.

### Throttle Cable

#### Throttle Cable Lubrication

The throttle cable must be lubricated with a silicone based lubricant or an equivalent.

**⚠ WARNING**

Always use a silicone-based lubricant. Using another lubricant (like a water-based lubricant) could cause the throttle lever/cable to become sticky and stiff.

Open the throttle lever housing.

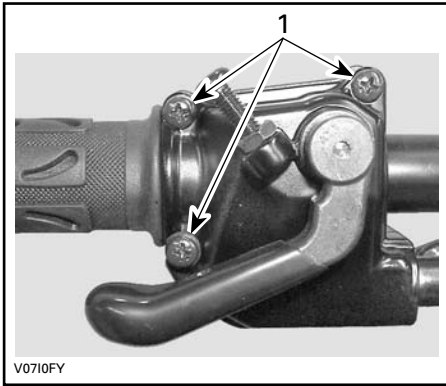

1. Remove these screws

Separate the housing.  
Slide rubber protector back to expose throttle cable adjuster.

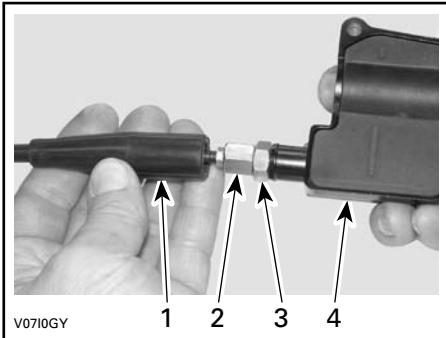

1. Cable protector
2. Throttle cable adjuster
3. Lock nut
4. Throttle lever housing

Screw in the throttle cable adjuster.  
Remove inner housing protector.

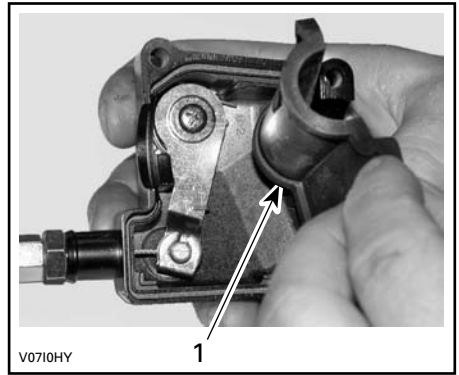

1. Inner housing protector

Remove the cable from the throttle lever housing.

**NOTE:** Slide cable in clip slot and remove the end of cable from clip.

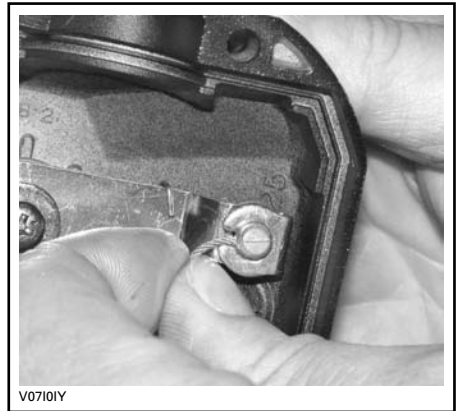

Remove the throttle body side cover.

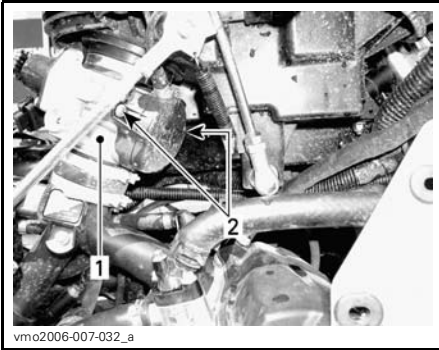

1. Throttle body
2. Side cover screws

Insert the needle of the lubricant can in the end of throttle cable adjuster.

**⚠ CAUTION** Always wear appropriate skin and eye protection. Chemicals can cause a skin rash and eye injury.



TYPICAL

**NOTE:** Place a rag around the throttle cable adjuster to prevent the lubricant from splashing.

Add lubricant until it runs out at throttle body end of the throttle cable.

Reinstall and adjust the cable.

### Throttle Cable Adjustment

Slide rubber protector back to expose throttle cable adjuster.

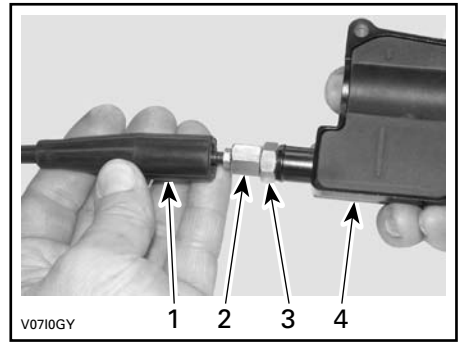

1. Cable protector
2. Throttle cable adjuster
3. Lock nut
4. Throttle lever housing

Loosen lock nut then turn the adjuster to obtain correct throttle lever free play. Measure throttle free play at the tip of throttle lever.

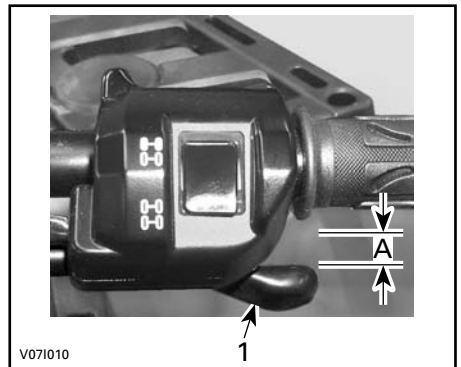

1. Throttle lever
- A. 2 mm (.079 in)

Tighten lock nut and reinstall protector. With the shift lever on PARK position, start the engine.

Check if the throttle cable is adjusted correctly by turning handlebar fully to the right then fully to the left. If the engine RPM increases, readjust the throttle lever free play.

## Spark Plugs

### Spark Plug Access

Remove side panels.

Unplug spark plug cables.

### Spark Plug Removal

Unscrew spark plugs one turn.

**⚠ CAUTION** Always wear safety goggles when using pressurized air.

Clean spark plugs and cylinder heads with pressurized air if possible.

Unscrew spark plugs completely then remove them.

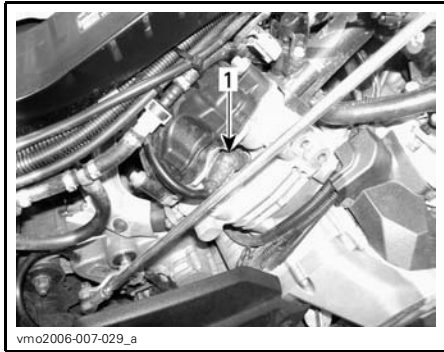

RH SIDE — REAR CYLINDER

1. Spark plug

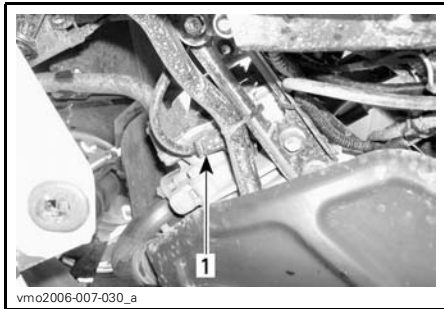

LH SIDE — FRONT CYLINDER

1. Spark plug

### Spark Plug Installation

Prior to installation, make sure that contact surfaces of cylinder heads and spark plugs are free of grime.

Using a feeler gauge, set the spark plug gap.

SPARK PLUG GAP	
650	0.7 mm to 0.8 mm (.028 in to .031 in)
850 1000R	0.7 mm to 0.9 mm (.028 in to .035 in)

Apply a small amount of copper-based anti-seize lubricant over spark plug threads to prevent a possible seizure.

Screw spark plugs into cylinder heads by hand and tighten with a torque wrench and a proper socket.

SPARK PLUG TORQUE
20 N•m ± 2.4 N•m (15 lbf•ft ± 2 lbf•ft)

## Battery

**⚠ CAUTION** Never charge a battery while installed in vehicle.

These vehicles are equipped with a VRLA battery (Valve Regulated Lead Acid). It is a maintenance-free type battery, there is no need to add water to adjust electrolyte level.

**NOTICE** Never remove the battery sealing cap.

### Battery Removal

Disconnect BLACK (-) cable first then RED (+) cable.

**NOTICE** Always disconnect BLACK (-) battery cable first.

Remove retaining screws, battery holder then pull the battery out of frame.



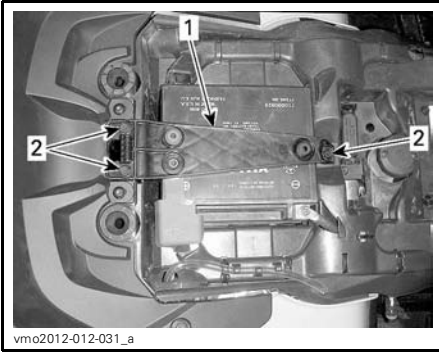

1. Battery holder
2. Retaining screws

### Battery Cleaning

Clean battery, battery casing and battery posts using a solution of baking soda and water.

Remove corrosion from battery cable terminals and battery posts using a firm wire brush.

### Battery Installation

Battery installation is the reverse of the removal procedure.

**NOTICE** Always connect RED (+) battery cable first.

### Fuses

**CAUTION** Always turn the ignition switch to OFF position before replacing a defective fuse.

### Fuse Inspection

Check if filament is melted.

If filament is melted, replace damaged fuse, refer to *FUSE LOCATION* tables for proper rating.

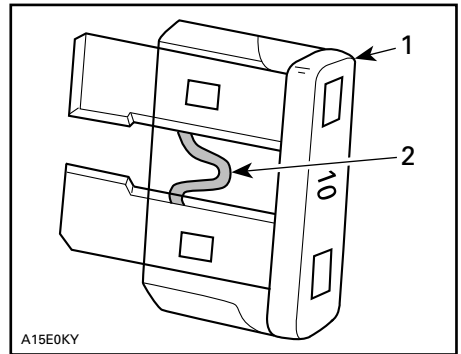

A15E0KY

### TYPICAL

1. Fuse
2. Check if melted

**NOTICE** Do not use a higher rated fuse as this can cause severe damage.

### Front Fuse Box Location

Pull upwards and front to remove the gauge support from its location.



1. Gauge support

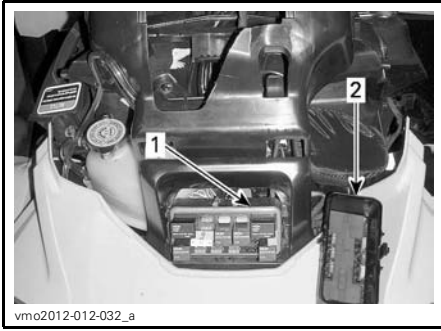

1. Front fuse box
2. Front fuse box cover

**NOTE:** Check inside fuse box cover to know fuses location.

**NOTICE** Do not store any objects in the front service compartment.

### Front Fuse Box Description

FRONT FUSE BOX		
NO.	DESCRIPTION	RATING
R1	Fan Relay	-
R2	Main Relay	-
R3	Accessories Relay	-
R4	Fuel Pump Relay	-
R5	Lights Relay	-
R8	Brake Relay	-
F4	Gauge (Speedo)	5 A
F5	Injectors/Ignition	5 A
F6	ECM	5 A
F7	2WD/4WD, Winch (if equipped)	5 A
F8	Key Switch, Starter Solenoid	5 A
F9	Cooling Fan	25 A
F10	Euro Control (CE Models)	5 A
F11	Lights	30 A

FRONT FUSE BOX		
NO.	DESCRIPTION	RATING
F12	DC Outlet	15 A
F14	Accessories 2	15 A
F15	Fuel Pump	5 A

### Fuse Links and Fuse Box 2



1. Fuse links

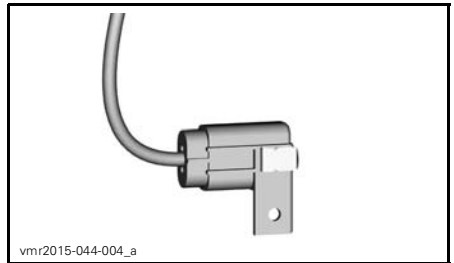

### FUSE BOX 2

### Rear Fuse Holder Identification

FUSE LINK IDENTIFICATION			
Fuse links	1	Main	16 awg
	2	Fan/accessories	16 awg
FUSE IN FUSE BOX 2 IDENTIFICATION			
Fuse	3	DPS/ACS (dynamic power steering)	40 A

### Lights

Always check light operation after replacement.

### Headlight Bulb Replacement

**NOTICE** Never touch glass portion of a halogen bulb with bare fingers, it shortens its operating life. If glass is touched, clean it with isopropyl alcohol which will not leave a film on the bulb.

Unplug connector from bulb.

Rotate light bulb counterclockwise to release it from light housing.



vmo2012-012-059\_a

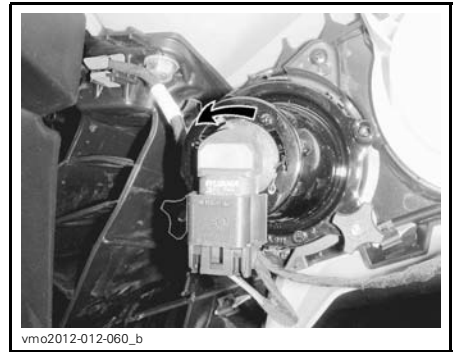

vmo2012-012-060\_b

Pull out bulb.

Properly reinstall removed parts in the reverse order of their removal.

Validate headlights operation.

### Headlight Beam Aiming

Turn adjustment knobs to adjust beam height to your convenience.

**NOTE:** Adjust headlights evenly.

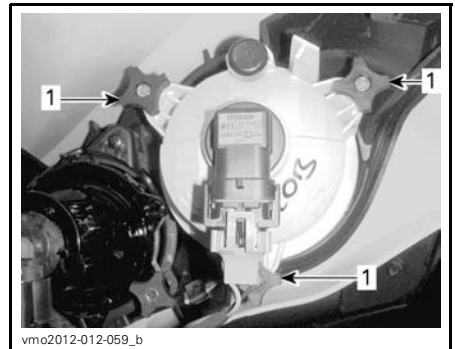

vmo2012-012-059\_b

### LOW BEAM ADJUSTMENT

1. Adjustment knobs

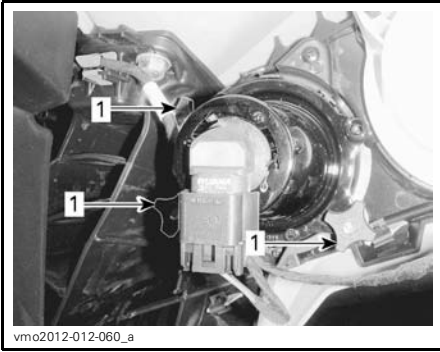

**HIGH BEAM ADJUSTMENT**

1. Adjustment knobs

**Taillight Bulbs Replacement**

Rotate taillight counterclockwise to remove it from taillight housing.



**ROTATE TAILLIGHT CCW TO REMOVE**

Pull tail light out of its location.  
Unplug connector from bulb.  
Rotate light bulb counterclockwise to remove it from taillight.



**ROTATE BULB COUNTERCLOCKWISE**

Remove bulb socket from taillight.  
Installation is the reverse of the removal procedure.

**Drive Shaft Boot and Protector**

**Drive Shaft Boot and Protector Inspection**

Visually inspect drive shaft protectors and boots conditions.  
Check protectors for damage or rubbing against shafts.  
Check boots for cracks, tears, leaking grease etc.  
Repair or replace damaged parts as necessary.



**TYPICAL — FRONT OF VEHICLE**

1. Drive shaft boots  
2. Drive shaft protector

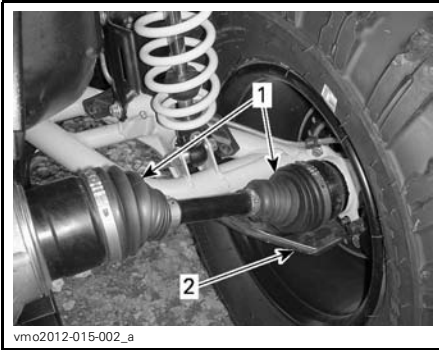

TYPICAL — REAR OF VEHICLE

1. Drive shaft boots
2. Drive shaft protector

## Wheel Bearing

### Wheel Bearing Inspection

Place vehicle on a level surface.

Apply brake lock.

Lift and support vehicle.

Secure vehicle on jack stands.

Push and pull the wheels from the upper edge to feel the play.

See an authorized Can-Am dealer if there is any play.



TYPICAL

## Wheels and Tires

### Tire Pressure

#### **⚠ WARNING**

Tire pressure greatly affects vehicle handling and stability. Insufficient pressure may cause tire to deflate and rotate on wheel. Overpressure may burst the tire. Always follow recommended pressure. NEVER set tire pressure below minimum. It could cause the tire to dislodge from the rim. Since tires are low-pressure types, a manual pump should be used.

Check pressure when tires are cold before using the vehicle. Tire pressure changes with temperature and altitude. Recheck pressure if one of these conditions has changed.

For your convenience, a pressure gauge is supplied in tool kit.

Although the tires are specifically designed for off-road use, a flat may still occur. Therefore, it is recommended to carry a tire pump and a repair kit.

TIRE PRESSURE			
	TOTAL LOAD	FRONT	REAR
1-UP	UP TO 164 KG (360 LB)	41.4 kPa (6 PSI)	41.4 kPa (6 PSI)
	FROM 164 KG (360 LB) UP TO 235 KG (517 LB)	48.2 kPa (7 PSI)	68.9 kPa (10 PSI)
2-UP	UP TO 132 kg (290 lb)	41.4 kPa (6 PSI)	41.4 kPa (6 PSI)
	FROM 132 KG (290 LB) UP TO 272 KG (600 LB)	48.2 kPa (7 PSI)	68.9 kPa (10 PSI)

### Tire Inspection

Check tire for damage and wear. Replace if necessary.

Do not rotate tires. The front and rear tires have a different size. The tires are directional and their rotation must be kept in a specific direction for proper operation.

### Tire Replacement

Tires replacement should be performed by an authorized Can-Am dealer.

** WARNING**

- Replace tires only with the same type and size as original tires.
- For unidirectional tread pattern, ensure that the tires are installed in the correct direction of rotation.
- Tires should be replaced, by an experienced person, in accordance with tire industry standards and tools.

### Wheel Removal

Place vehicle on a level surface.

Apply brake lock.

Loosen lug nuts then lift vehicle.

Secure vehicle on jack stands.

Remove nuts then remove wheel.

### Wheel Installation

At installation, it is recommended to apply anti-seize lubricant on threads.

If tires are unidirectional, make sure to install wheel according to tire rotation.

Carefully tighten nuts in a criss-cross sequence then apply final torque.

TIGHTENING TORQUE	
Wheel nut	100 N•m ± 10 N•m (74 lbf•ft ± 7 lbf•ft)

**NOTICE** Always use the recommended wheel nuts according to the type of wheel. Using a different nut could cause damage to the rim or studs.

While reading this Operator’s Guide, remember that:

** WARNING**

Indicates a potential hazard that, if not avoided, could result in serious injury or death.

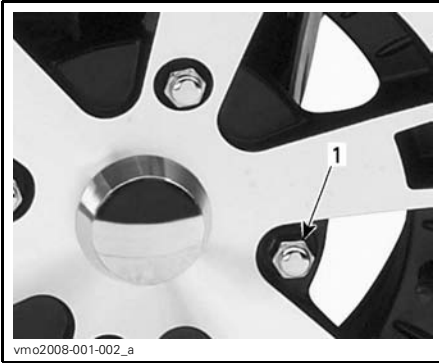

TYPICAL — ALUMINUM WHEEL  
1. Wheel nut (closed end type)

### Wheel Beadlock Inspection (XT-P Models)

#### Wheel Beadlock Retorque

**NOTICE** Do not use an impact wrench for tightening beadlock screws in order to avoid to damage them.

1. Retorque all screws to specification and according to the following tightening sequence.

TIGHTENING TORQUE	
Beadlock screws	11 N•m ± 1 N•m (97 lbf•in ± 9 lbf•in)

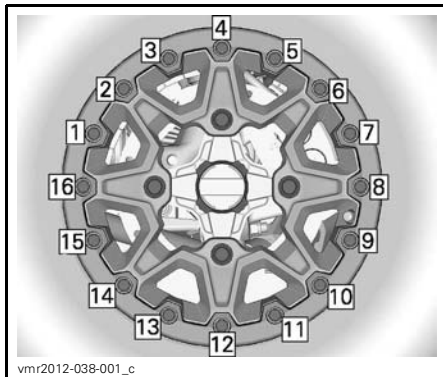

FINAL TIGHTENING SEQUENCE

2. Tighten screws a few turns at a time to ensure even pressure on the beadlock clamp ring.

**NOTE:** It is normal that the beadlock clamp ring flexes slightly to match the tire bead.

#### Wheel Beadlock Gap Verification

1. Verify the gap between tire and beadlock clamp ring, it should be practically equal all around the ring.

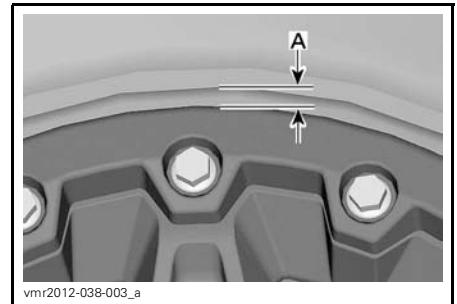

A. Gap between tire and ring

If the gap is not acceptable, see an authorized Can-Am dealer.

## Steering

### Steering Inspection

#### Tie-Rods

Inspect tie-rod boots for cracks.

**⚠ WARNING**

The tie-rod must be replaced if the boot is cracked.

## Suspension

### Front Suspension Lubrication

Lubricate front A-arms at grease fittings.

SUSPENSION GREASE	
BRP recommended product	SUSPENSION GREASE (P/N 293 550 033)

### Rear Suspension Lubrication

Lubricate rear sway bar links and pivot bushing at grease fittings.

SUSPENSION GREASE	
BRP recommended product	SUSPENSION GREASE (P/N 293 550 033)

### Suspension Inspection

#### Shock Absorbers

Inspect shock absorber for oil leaks or other damage.

Check tightness of fasteners.

See an authorized Can-Am dealer as necessary.

#### Ball Joints

Inspect ball joint boots for cracks.

<b>⚠ WARNING</b>
The ball joint must be replaced if the boot is cracked.

#### Front A-Arms

Check A-arms for cracks, bending or other damage.

See an authorized Can-Am dealer as necessary.

#### Rear Trailing Arms

Check trailing arms for distortion, cracks or bending.

See an authorized Can-Am dealer if any problem is detected.

## Brakes

### Brake Fluid Reservoir Level Verification

With vehicle on a level surface, check brake fluid in reservoirs for proper level.

**NOTE:** A low level may indicate leaks or worn brake pads.

### Front Brake Reservoir Level Verification

Turn steering in the straight-ahead position to ensure reservoir is level.

Check the brake fluid level, the reservoir is full when the fluid reaches of the top of window.

Visually inspect lever boot condition.

Check for cracks, tears, etc. Replace if damaged.



TYPICAL

### Rear Brake Reservoir Level Verification

Remove the seat.

With vehicle on a level surface, liquid should be between MIN. and MAX. level marks of brake pedal fluid reservoir.





1. Rear brake fluid reservoir

### Adding Brake Fluid

Clean filler cap.

#### **⚠ WARNING**

Clean filler cap before removing.

Remove screws retaining the reservoir cap.

Remove reservoir cap.

Add fluid as required using a clean funnel. Do not overfill.

**NOTICE** Brake fluid can damage plastic and painted surface. Wipe off and clean any spillage.

Reinstall reservoir cap and tighten screws.

**NOTE:** Ensure filler cap diaphragm is pushed inside the cap before closing the brake fluid reservoir.

### Recommended Brake Fluid

Always use brake fluid meeting the specification DOT 4 only.

#### **⚠ WARNING**

To avoid damage to the braking system, do not use other brake fluid types.

### Brake Inspection

**⚠ CAUTION** The brakes can be very hot after prolonged use of the vehicle and can cause burns. Wait for the brakes to cool down.

The brake inspection, maintenance and repair should be performed by an authorized Can-Am dealer.

However, verify the following between visits to your dealer:

- Brake fluid level
- Brake system for fluid leaks
- Brake cleanliness.

#### **⚠ WARNING**

The brake fluid replacement or brake system maintenance and repairs should be performed by an authorized Can-Am dealer.

# VEHICLE CARE

## Post-Operation Care

When vehicle is used in salt-water environment (beach area, launching and loading boats etc.), rinsing the vehicle with fresh water is necessary to preserve vehicle and its components. Metallic parts lubrication is highly recommended. Use XPS LUBE (P/N 293 600 016) or an equivalent. This must be performed at the end of each operating day.

When vehicle is operated in muddy conditions, rinsing the vehicle is recommended to preserve vehicle and its components and to keep lights clean.

## Vehicle Cleaning and Protection

**NOTICE** Never use a high pressure washer to clean the vehicle. USE LOW PRESSURE ONLY (like a garden hose).

Pay attention to certain areas where mud or debris can accumulate and potentially cause wear, interferences or promote corrosion.

Wash the vehicle with a soapy water solution.

**NOTICE** Never clean polypropylene body parts with any petroleum base cleaning products, as it will alter the glossy finish.

## Non Compatible Cleaning Products

MATERIAL TYPE	NON-COMPATIBLE CLEANING PRODUCTS
Polypropylene	ANY PETROLEUM BASE CLEANING PRODUCTS
	XP-S ATV Finishing Spray (P/N 219 701 704)
	XP-S ATV Cleaning Kit (P/N 219 701 713) (it contains the above XP-S ATV Finishing Spray)



DO NOT USE ON POLYPROPYLENE

## Compatible Cleaning Products

MATERIAL TYPE	COMPATIBLE CLEANING PRODUCT
Polypropylene	XPS ATV Wash (P/N 219 701 702)
	Soapy water



vbs2012-006-001

**SAFE FOR POLYPROPYLENE**

---

## **STORAGE AND PRESEASON PREPARATION**

When a vehicle is not in use for more than 4 months, proper storage is a necessity.

When using your vehicle after storage, a preparation is required.

See an authorized Can-Am dealer to have your vehicle prepared for either storage or the preseason.

# ***TECHNICAL INFORMATION***

# VEHICLE IDENTIFICATION

The main components of your vehicle (engine and frame) are identified using different serial numbers. It may sometimes become necessary to locate these numbers for warranty purposes or to trace your vehicle in the event of loss. These numbers are also required by the authorized Can-Am dealer to complete warranty claims properly. No warranty will be allowed by BRP if the engine identification number (EIN) or vehicle identification number (VIN) is removed, mutilated or altered in any way. We strongly recommend that you take note of all the serial numbers on your vehicle and supply them to your insurance company.

## Vehicle Identification Number

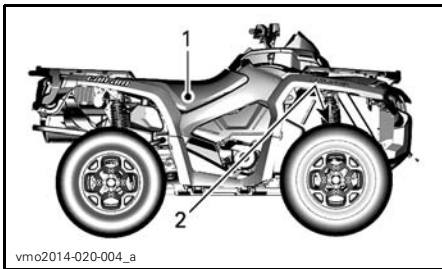

### TYPICAL

1. Label 1 (on the frame under the seat in the middle)
2. Label 2 (stamped onto frame behind RH front wheel)



### LABEL 1

1. VIN (Vehicle Identification Number)
2. Model



### LABEL 2

1. VIN (Vehicle Identification Number)
2. Model number

## Engine Identification Number (EIN)

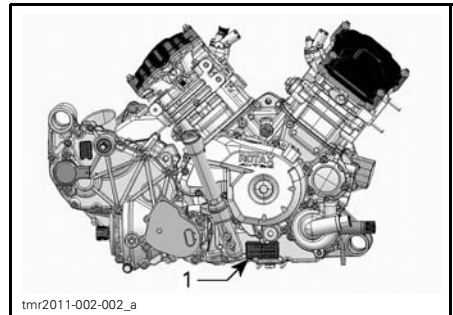

### TYPICAL - RH SIDE OF ENGINE

1. Engine Identification Number (EIN)

The EC-Declaration of Conformity does not appear in this version of the Operator's Guide.

Please refer to the printed version that was delivered with your vehicle.

# SPECIFICATIONS

ENGINE		
Engine type	650	ROTAX 650, 4-stroke, 2 cylinders (V-twin), liquid cooled
	850	ROTAX® 850, 4-stroke, 2 cylinders (V-twin), liquid cooled
	1000R	ROTAX®, 1000R, 4-stroke, 2 cylinders (V-twin), liquid cooled
Valve train		4 valves/cylinder (mechanical adjustment), single over head camshaft (SOHC) with timing chain
Bore	650	82 mm (3.23 in)
	850	94 mm (3.7 in)
	1000R	91 mm (3.58 in)
Stroke	650	61.5 mm (2.42 in)
	850	61.5 mm (2.42 in)
	1000R	75 mm (2.95 in)
Displacement	650	650 cm <sup>3</sup> (39.7 in <sup>3</sup> )
	850	854 cm <sup>3</sup> (52.1 in <sup>3</sup> )
	1000R	976 cm <sup>3</sup> (59.6 in <sup>3</sup> )
Exhaust system		Spark arrestor approved by USDA Forest Service
Air filter		Synthetic paper filter with foam

LUBRICATION SYSTEM		
Type		Wet sump. Replaceable cartridge oil filter
Oil filter		BRP Rotax paper type, replaceable
Engine oil	Capacity (oil change with filter)	2.0 L (2.1 qt (U.S. liq.))
	Recommended	For the summer season, use the XPS 4-stroke synth. blend oil (summer) (P/N 293 600 121). For all season, use the XPS 4-stroke synthetic oil (All climate) (P/N 293 600 112). If not available, use a 5W40 motor oil that meets the requirements for API service classification SG, SH or SJ



COOLING SYSTEM			
Coolant	Type	Ethyl glycol/water mix (50% coolant, 50% water). Use the Long life antifreeze (P/N 219 702 685) or (P/N 619 590 204) (Finland, Norway and Sweden) or coolant specifically designed for aluminum engines	
	Capacity	650	3.4 L (.9 U.S. gal.)
		850 1000R	3.5 L (.92 U.S. gal.)

TRANSMISSION	
Type	CVT (Continuously Variable Transmission), sub-transmission with L/H/N/R/P, standard engine braking
Engagement RPM	1800 RPM

GEARBOX		
Type	Dual range (HI-LO) with park, neutral and reverse	
Gearbox oil	Capacity	450 ml (15.22 U.S. oz)
	Recommended	XPS synthetic gear oil (75W 140) (P/N 293 600 140) or a 75W140 API GL-5 synthetic gear oil

ELECTRICAL SYSTEM			
Magneto generator output		625 W @ 6000 RPM	
Ignition system type		IDI (Inductive Discharge Ignition)	
Ignition timing		Not adjustable	
Spark plug	650	Quantity	2
		Make and type	NGK DCPR8E or equivalent
		Gap	0.7 mm to 0.8 mm (.028 in to .031 in)
	850 1000R	Quantity	2
		Make and type	NGK LMAR8D-J or equivalent
		Gap	0.7 mm to 0.9 mm (.028 in to .035 in)
Engine RPM limiter setting	All models	Forward	8000 rpm
		Reverse	15 km/h (9 MPH) (without override)

**SPECIFICATIONS**

<b>ELECTRICAL SYSTEM</b>		
Battery	Type	Maintenance free
	Voltage	12 volts
	Nominal rating	18 A•h
	Power starter output	0.7 KW
Headlights	High	2 x 60 W (HB3)
	Low	2 x 55 W (H1)
Taillights		2 x 5/21 W
Turn signal lights		4 x 10 W
Position lights		2 x 5 W
Licence plate light		1 x 10 W
Fuses		Refer to <i>FUSES</i> in the <i>MAINTENANCE</i> section

<b>FUEL SYSTEM</b>		
Fuel delivery	Type	Electronic Fuel Injection (EFI), 46 mm throttle body, 1 injector per cylinder
Fuel pump	Type	Electrical (in fuel tank)
Idle speed	650	1250 RPM
	850/1000R	1400 RPM
Fuel	Type	Regular unleaded gasoline
	Minimum octane rating	87 Pump Posted AKI (92 RON or 95 E10 RON)
Fuel tank capacity		20.5 L (5.4 U.S. gal.)
Fuel remaining when low fuel light turns ON		± 5 L (1.3 U.S. gal.)

<b>DRIVE SYSTEM</b>		
Drive system type		Selectable 2WD/4WD
Front drive	Outlander STD Outlander MAX STD	Visco-lok <sup>†</sup> front differential
	All other models	Visco-lok <sup>†</sup> QE front differential
Front drive ratio		3.6:1
Rear drive		Straight bevel gear / Shaft driven final drive
Rear drive ratio		3.6:1

DRIVE SYSTEM		
Front differential oil	Capacity	500 ml (17 U.S. oz)
	Type	XPS synthetic gear oil (75W 90) (P/N 293 600 043) or synthetic gear oil 75W90 API GL-5
Rear final drive oil	Capacity	250 ml (8.45 U.S. oz)
	Type	XPS synthetic gear oil (75W 140) (P/N 293 600 140) or synthetic gear oil 75W140 API GL-5
CV joint grease		Castrol CV joint grease (P/N 293 550 062) or an equivalent
Propeller shaft grease		Propeller shaft grease (P/N 293 550 063) or an equivalent

STEERING		
Turning radius	1-UP	205.7 cm (81 in)
	2-UP	233.68 cm (92 in)
Total toe (front wheels off ground)		0.1° to 0.5° <b>toe-in</b>
Camber angle (vehicle on ground)		0°

FRONT SUSPENSION			
Suspension type		Double suspension-arm with dive-control geometry	
Suspension travel		229 mm (9 in)	
Shock absorber	XT-P	Qty	2
		Type	HPG shock with piggy back reservoir and dual speed compression and rebound damping adjustments
	All other models	Qty	2
		Type	Oil
Preload adjustment type	XT-P	Threaded	
	All other models	5 positions cam	

REAR SUSPENSION	
Suspension type	Torsional Trailing arm Independent (TTI) with external stabilizer bar
Suspension travel	236 mm (9.3 in)

**SPECIFICATIONS**

REAR SUSPENSION			
Shock absorber	LTD	Qty	2
		Type	High pressure gas shock
	XT-P	Qty	2
		Type	HPG shock with piggy back reservoir and dual speed compression and rebound damping adjustments
	All other models	Qty	2
		Type	Oil
ACS pneumatic pressure range	LTD	0.35 bar to 6.9 bar (5 PSI to 100 PSI)	
Preload adjustment type	LTD	6 Presets	
	XT-P	Threaded	
	All other models	5 position cam	

BRAKES			
Front brake	Qty		2
	Type		214 mm cross drilled disc brakes with hydraulic twin-piston calipers
Rear brake	Qty		1
	Type		214 mm cross drilled disc brake with hydraulic twin-piston caliper
Brake fluid	Capacity		260 ml (8.8 U.S. oz)
	Type		DOT 4
Caliper			Floating twin pistons (2 x 26 mm)
Brake pad material			Organic
Minimum brake pad thickness			1 mm (.04 in)
Minimum brake disc thickness			4.0 mm (.157 in)
Maximum brake disc warpage			0.2 mm (.01 in)

TIRES			
Front tire pressure	1-UP	UP TO 164 kg (360 lb)	41.4 kPa (6 PSI)
		FROM 164 kg (360 lb) TO 235 kg (517 lb)	48.2 kPa (7 PSI)
	2-UP	UP TO 132 kg (290 lb)	41.4 kPa (6 PSI)
		FROM 132 kg (290 lb) TO 272 kg (600 lb)	48.2 kPa (7 PSI)

TIRES			
Rear tire pressure	1-UP	UP TO 164 kg (360 lb)	41.4 kPa (6 PSI)
		FROM 164 kg (360 lb) TO 235 kg (517 lb)	68.9 kPa (10 PSI)
	2-UP	UP TO 132 kg (290 lb)	41.4 kPa (6 PSI)
		FROM 132 kg (290 lb) TO 272 kg (600 lb)	68.9 kPa (10 PSI)
Minimum tire thread depth			3 mm (.118 in)
Size	Front	660 x 203 x 305 mm (26 x 8 x 12 in)	
	Rear	660 x 254 x 305 mm (26 x 10 x 12 in)	

WHEELS			
Type		Standard models	Steel
		XT-P	Aluminium with beadlocks
		All other models	Cast aluminum
Rim size	Front	305 x 152 mm (12 x 6 in)	
	Rear	305 x 191 mm (12 x 7.5 in)	
Wheel nut torque			100 N•m ± 10 N•m (74 lbf•ft ± 7 lbf•ft)

DIMENSIONS			
Overall length	1-UP	218.4 cm (86 in)	
	2-UP	238.8 cm (94 in)	
Overall width			116.8 cm (46 in)
Overall height		Outlander MAX	135 cm (53 in)
		All other models	126 cm (49.5 in)
Wheelbase	1-UP	129.5 cm (51 in)	
	2-UP	149.9 cm (59 in)	
Wheel track	Front	96.5 cm (38 in)	
	Rear	91.4 cm (36 in)	
Ground clearance			27.9 cm (11 in)

**SPECIFICATIONS**

<b>WEIGHT AND LOADING CAPACITY</b>			
Dry weight	1-UP	650 engine	329 kg (726 lb)
		850 engine	331 kg (730 lb)
		1000R engine	348 kg (767 lb)
	2-UP	650 engine	361 kg (795 lb)
		850 engine	361 kg (797 lb)
		1000R engine	374 kg (824 lb)
Front rack capacity			45 kg (100 lb)
Rear rack capacity			90 kg (200 lb)
Rear storage compartment loading capacity			21.4 L (5.7 U.S. gal.) or 10 kg (22 lb)
Total vehicle load allowed (including driver, passenger, all other loads and added accessories)		1-UP	235 kg (518 lb)
		2-UP	272 kg (600 lb)
Towing capacity			135 kg (300 lb)
Tongue capacity			13 kg (30 lb)

# ***TROUBLESHOOTING***

---

# TROUBLESHOOTING GUIDELINES

---

## ENGINE DOES NOT TURN

---

1. Ignition switch is in the OFF position.
  - Place switch to the ON position.
2. Emergency engine stop switch.
  - Make sure that emergency engine stop switch is in ON position.
3. Transmission is not set on PARK or NEUTRAL.
  - Set transmission either in PARK or in NEUTRAL or press the brake lever.
4. Burnt fuse.
  - Check main fuse condition.
5. Weak battery or loose connections.
  - Check connections and terminals condition.
  - Have the battery checked.
  - Contact an authorized Can-Am dealer.
6. Wrong ignition key, multifunction gauge display shows INVALID KEY.
  - Use the proper key for this vehicle.
7. Weak starter or loose connections.
  - Check starter connections.
  - Check starter relay.

---

## ENGINE TURNS OVER BUT FAILS TO START

---

1. Flooded engine (spark plug wet when removed).
    - (Drowned mode) If the engine does not start and it is fuel-flooded, this special mode can be activated to prevent fuel injection and to cut ignition while cranking. Proceed as follows:
      - Insert key in ignition switch and turn to ON position.
      - Move shift lever in park position.
      - Press completely and HOLD throttle lever.
      - Press the engine START button.The engine should be cranked for 20 seconds. Release engine START button.  
Release throttle lever and start/crank engine again to allow starting.
    - If it does not work:**
      - Clean the spark plug caps area then remove them.
      - Remove the spark plugs (tools are supplied in tool kit).
      - Unplug injector electrical connector.
      - Crank engine several times.
      - Install new spark plugs if possible or clean and dry spark plugs.
      - Start engine as explained above.If engine continues to flood, see an authorized Can-Am dealer.
- NOTE:** Make sure to verify that there is no fuel in engine oil, if so, replace engine oil.



---

**ENGINE TURNS OVER BUT FAILS TO START (cont'd)**

---

**2. No fuel to the engine (spark plug dry when removed).**

- *Check fuel tank level.*
- *A failure of the fuel pump may have occurred.*
- *Check fuel pump fuse and relay.*
- *Contact an authorized Can-Am dealer.*

**3. Spark plug/ignition (no spark).**

- *Check injectors/ignition fuse condition.*
- *Remove spark plug then reconnect to ignition coil.*
- *Check that ignition switch and/or emergency engine stop switch is/are at the ON position.*
- *Start engine with spark plug grounded to the engine away from spark plug hole. If no spark appears, replace spark plug.*
- *If trouble persists, contact an authorized Can-Am dealer.*

**4. Multifunction gauge CHECK ENGINE indicator lamp is on and display shows CHECK ENGINE.**

- *Contact an authorized Can-Am dealer.*

**5. Engine is under a protection (limp home) mode.**

- *Multifunction gauge CHECK ENGINE indicator lamp is on and display shows CHECK ENGINE, contact an authorized Can-Am dealer.*

---

**ENGINE LACKS ACCELERATION OR POWER**

---

**1. Fouled or defective spark plug.**

- *Refer to ENGINE TURNS OVER BUT FAILS TO START.*

**2. Lack of fuel to engine.**

- *Refer to ENGINE TURNS OVER BUT FAILS TO START.*

**3. Engine is overheating. (CHECK ENGINE indicator light will turn on and HI TEMP will appear in the multifunction display.)**

- *Refer to ENGINE OVERHEATS.*

**4. Air filter/housing clogged or dirty.**

- *Check air filter and clean if necessary.*
- *Check deposits in air filter housing drain.*
- *Check the position of the air intake tube.*

**5. CVT dirty or worn-out.**

- *Contact an authorized Can-Am dealer.*

**6. Engine is under a protection (limp home) mode.**

- *Check multifunction gauge display for messages.*
- *Multifunction gauge CHECK ENGINE indicator lamp is on and display shows CHECK ENGINE or LIMP HOME, contact an authorized Can-Am dealer.*

---

**ENGINE OVERHEATS**

---

**1. Low coolant in cooling system.**

- *Check engine coolant, refer to ENGINE COOLANT in MAINTENANCE section.*

**ENGINE OVERHEATS (cont'd)**

---

**2. Dirty radiator fins.**

- *Clean radiator fins, refer to RADIATOR in MAINTENANCE section.*

**3. Cooling fan inoperative.**

- *Check cooling fan fuse or relay, refer to MAINTENANCE section. If the fuse is good, contact an authorized Can-Am dealer.*

**ENGINE BACKFIRE**

---

**1. Exhaust system leakage.**

- *Contact an authorized Can-Am dealer.*

**2. Engine is running too hot.**

- *Refer to ENGINE LACKS ACCELERATION OR POWER.*

**3. Ignition timing is incorrect or there is an ignition system failure.**

- *Contact an authorized Can-Am dealer.*

**ENGINE MISFIRE**

---

**1. Fouled/defective/worn spark plug.**

- *Clean/verify spark plug and heat range. Replace as required.*

**2. Water in fuel.**

- *Drain fuel system and refill with fresh fuel.*

**VEHICLE CANNOT REACH FULL SPEED**

---

**1. Engine.**

- *Refer to ENGINE LACKS ACCELERATION OR POWER.*

**2. Brake lock.**

- *Ensure brake lock is completely removed.*

**3. Air filter/housing plugged or dirty.**

- *Check air filter and clean if necessary.*
- *Check deposits in air filter housing drain.*
- *Check the position of the air intake tube.*

**4. CVT dirty or worn-out.**

- *Contact an authorized Can-Am dealer.*

**5. Engine is under a protection (limp home) mode.**

- *Check multifunction gauge display for messages.*
- *Multifunction gauge CHECK ENGINE indicator lamp is on and display shows CHECK ENGINE or LIMP HOME, contact an authorized Can-Am dealer.*

**SHIFT LEVER IS HARD TO MOVE**

---

**1. Transmission gears are in a position that prevents the shift lever to work.**

- *Rock the vehicle back and forth to move the gears in the transmission and allow the shift lever to be set.*

**2. CVT dirty or worn-out.**

- *Contact an authorized Can-Am dealer.*

---

**THE RPM INCREASES BUT THE VEHICLE DOES NOT MOVE**

---

- 1. The transmission is on PARK or NEUTRAL position.**
  - *Select the R, HI or LO position.*
- 2. CVT dirty or worn-out.**
  - *Contact an authorized Can-Am dealer.*
- 3. Water in the CVT housing.**
  - *Contact an authorized Can-Am dealer.*

# MULTIFUNCTION GAUGE MESSAGES

MESSAGE	PILOT LAMP(S) ON	DESCRIPTION
DESS KEY NOT RECOGNIZED	Check engine	Indicates that you have used the wrong ignition key, use the proper key for this vehicle. It is also possible that the ignition key has a bad contact, remove and clean key.
PARK BRAKE	Brake lock	Displayed when brake is applied for more than 15 seconds (while riding).
LO BATT VOLT	Check engine	Low battery voltage, check battery voltage and charging system.
HIGH BATT VOLT	Check engine	High battery voltage, check battery voltage and charging system.
LOW OIL <sup>(1)</sup>	Check engine	Engine low oil pressure, stop engine immediately.
HI TEMP	Check engine	Engine is overheating, refer to <i>ENGINE OVERHEATS</i> in <i>TROUBLESHOOTING</i> section.
LIMP HOME	Check engine	Serious fault on the engine that can change the normal operation of the engine, CHECK ENGINE indicator lamp will also blink, refer to <i>TROUBLESHOOTING</i> section.
CHECK ENGINE	Check engine	Engine fault, CHECK ENGINE indicator lamp will also be ON, refer to <i>TROUBLESHOOTING</i> section.
ECM NOT RECOGNIZED	Check engine	Communication error between speedometer and engine control module (ECM), contact an authorized Can-Am dealer.
CHECK DPS (models with DPS)	Check engine	Indicates that the DPS (Dynamic Power Steering) does not work properly. See an authorized Can-Am dealer.
ACS FAULT (LTD model)	Check engine	Indicates that the ACS suspension does not work properly. See an authorized Can-Am dealer.
TPS FAULT PRESS OVERRIDE BUTTON TO LIMP HOME	Check engine	Throttle position sensor does not work properly. See an authorized Can-Am dealer.

**NOTICE** <sup>(1)</sup> If the message and the check engine light stay on after engine starting, stop engine. Check engine oil level. Refill if necessary. If the oil level is good, see an authorized Can-Am dealer. Do not use the vehicle until repaired.

# ***WARRANTY***

---

# **BRP INTERNATIONAL LIMITED WARRANTY: 2016 CAN-AM® ATV**

## **1) SCOPE OF THE LIMITED WARRANTY**

Bombardier Recreational Products Inc. ("BRP")\* warrants its 2016 Can-Am ATV sold by Can-Am ATV distributors or dealers authorized by BRP to distribute Can-Am ATVs ("Can-Am ATV Distributor/Dealer") outside of the United States of America ("USA"), Canada, member states of the European Economic Area (which is comprised of the states of the European Union plus Norway, Iceland and Liechtenstein) ("EEA"), Turkey, member states of the Commonwealth of the Independent States (including Ukraine and Turkmenistan) ("CIS") and Turkey, from defects in material or workmanship for the period and under the conditions described below.

All genuine Can-Am ATV parts and accessories, installed by an authorized Can-Am ATV Distributor/Dealer at the time of delivery of the 2016 Can-Am ATV, carry the same warranty as that of the Can-Am ATV.

This limited warranty will become null and void if: (1) The ATV was used for racing or any other competitive activity, at any point, even by a previous owner; or (2) the ATV has been altered or modified in such a way so as to adversely affect its operation, performance or durability, or has been altered or modified to change its intended use.

## **2) LIMITATIONS OF LIABILITY**

TO THE EXTENT PERMITTED BY LAW, THIS WARRANTY IS EXPRESSLY GIVEN AND ACCEPTED IN LIEU OF ANY AND ALL OTHER WARRANTIES, EXPRESSED OR IMPLIED, INCLUDING WITHOUT LIMITATION ANY WARRANTY OF MERCHANTABILITY OR FITNESS FOR A PARTICULAR PURPOSE. TO THE EXTENT THAT THEY CANNOT BE DISCLAIMED, THE IMPLIED WARRANTIES ARE LIMITED IN DURATION TO THE LIFE OF THE EXPRESS WARRANTY. INCIDENTAL AND CONSEQUENTIAL DAMAGES ARE EXCLUDED FROM COVERAGE UNDER THIS WARRANTY. SOME JURISDICTIONS DO NOT ALLOW FOR THE DISCLAIMERS, LIMITATIONS AND EXCLUSIONS IDENTIFIED ABOVE, AS A RESULT, THEY MAY NOT APPLY TO YOU. THIS WARRANTY GIVES YOU SPECIFIC RIGHTS AND YOU MAY ALSO HAVE OTHER LEGAL RIGHTS WHICH MAY VARY FROM COUNTRY TO COUNTRY. (FOR PRODUCTS PURCHASED IN AUSTRALIA SEE CLAUSE 4 BELOW).

Neither the Can-Am ATV Distributor/Dealer nor any other person has been authorized to make any affirmation, representation or warranty regarding the product, other than those contained in this limited warranty, and if made, shall not be enforceable against BRP.

BRP reserves the right to modify this warranty at any time, being understood that such modification will not alter the warranty conditions applicable to the products sold while this warranty is in effect.

## **3) EXCLUSIONS – ARE NOT WARRANTED**

The following are not warranted under this limited warranty under any circumstances:

- Normal wear and tear;
- Routine maintenance items, tune ups, adjustments;

- Damage caused by negligence or failure to provide proper maintenance and/or storage, as described in the Operator's Guide;
- Damage resulting from removal of parts, improper repairs, service, maintenance, modifications or use of parts or accessories not manufactured or approved by BRP which in its reasonable judgement are either incompatible with the product or adversely affect its operation, performance and durability, or resulting from repairs done by a person that is not an authorized servicing Can-Am ATV Distributor/Dealer;
- Damage caused by abuse, abnormal use, neglect, racing or operation of the product in a manner inconsistent with the recommended operation described in the Operator's Guide;
- Damage resulting from accident, submersion, fire, snow or water ingestion, theft, vandalism or any act of God;
- Operation with fuels, oils or lubricants which are not suitable for use with the product (see the Operator's Guide);
- Damage resulting from rust, corrosion or exposure to the elements;
- Incidental or consequential damages, or damages of any kind including without limitation towing, storage, transportation expenses, telephone, rental, taxi, inconvenience, insurance coverage, loan payments, loss of time, loss of income; or time missed for downtime experience due to service work.

#### **4) WARRANTY COVERAGE PERIOD**

This warranty will be in effect from (1) the date of delivery to the first retail consumer or (2) the date the product is first put into use, whichever occurs first and for a period of:

SIX (6) CONSECUTIVE MONTHS for private use or commercial use.

The repair or replacement of parts or the performance of service under this warranty does not extend the life of this warranty beyond its original expiration date.

Note that the duration and any other modalities of the warranty coverage are subject to the applicable national or local legislation in the customer's country.

#### **FOR PRODUCTS SOLD IN AUSTRALIA ONLY**

Nothing in these Warranty terms and conditions should be taken to exclude, restrict or modify the application of any condition, warranty, guarantee, right or remedy conferred or implied under the Competition and Consumer Act 2010 (Cth), including the Australian Consumer Law or any other law, where to do so would contravene that law, or cause any part of these terms and conditions to be void. The benefits given to you under this limited warranty are in addition to other rights and remedies that you have under Australian law.

Our goods come with guarantees that cannot be excluded under the Australian Consumer Law. You are entitled to a replacement or refund for a major failure and for compensation for any other reasonably foreseeable loss or damage. You are also entitled to have the goods repaired or replaced if the goods fail to be of acceptable quality and the failure does not amount to a major failure.

## **5) CONDITIONS TO HAVE WARRANTY COVERAGE**

This warranty coverage is available **only** if **each** of the following conditions has been fulfilled:

- The 2016 Can-Am ATV must be purchased as new and unused by its first owner from a Can-Am ATV Distributor/Dealer authorized to distribute Can-Am ATVs in the country in which the sale occurred;
- The BRP specified pre-delivery inspection process must be completed and documented;
- The product must have undergone proper registration by an authorized Can-Am ATV Distributor/Dealer;
- The 2016 Can-Am ATV must be purchased in the country or union of countries in which the purchaser resides; and
- Routine maintenance outlined in the Operator's Guide must be timely performed in order to maintain warranty coverage. BRP reserves the right to make warranty coverage contingent upon proof of proper maintenance.

BRP will not honour this limited warranty to any private use owner or commercial use owner if one of the preceding conditions has not been met. Such limitations are necessary in order to allow BRP to preserve both the safety of its products, and also that of its consumers and the general public.

## **6) WHAT TO DO TO OBTAIN WARRANTY COVERAGE UNDER THIS WARRANTY**

The customer must cease using the ATV upon the appearance of an anomaly. The customer must notify a servicing Can-Am ATV Distributor/Dealer within two (2) days of the appearance of a defect, and provide it with reasonable access to the product and reasonable opportunity to repair it. The customer must also present to the authorized Can-Am ATV Distributor/Dealer proof of purchase of the product and must sign the repair/work order prior to starting the repair in order to validate the warranty repair. All parts replaced under this limited warranty become the property of BRP.

Note that the notification period is subject to the applicable national or local legislation in customer's country.

## **7) WHAT BRP WILL DO**

To the extent permitted by law, BRP's obligations under this warranty are limited to, at its sole discretion, repairing parts found defective under normal use, maintenance and service, or replacing such parts with new genuine Can-Am ATV parts without charge for parts and labour, at any authorized Can-Am ATV Distributor/Dealer during the warranty coverage period under the conditions described herein. BRP's responsibility is limited to making the required repairs or replacements of parts. No claim of breach of warranty shall be cause for cancellation or rescission of the sale of the Can-Am ATV to the owner. You may have other legal rights which may vary from country to country.

In the event that service is required outside of the country of original sale, the owner will bear responsibility for any additional charges due to local practices and conditions, such as, but not limited to, freight, insurance, taxes, license fees, import duties, and any and all other financial charges, including those levied by governments, states, territories and their respective agencies.



BRP reserves the right to improve or modify products from time to time without assuming any obligation to modify products previously manufactured.

## **8) TRANSFER**

If the ownership of a product is transferred during the warranty coverage period, this warranty shall also be transferred and be valid for the remaining coverage period provided BRP or an authorized Can-Am ATV Distributor/Dealer receives a proof that the former owner agreed to the transfer of ownership, in addition to the coordinates of the new owner.

## **9) CONSUMER ASSISTANCE**

1. In the event of a controversy or a dispute in connection with this limited warranty, BRP suggests that you try to resolve the issue at the Can-Am ATV Distributor/Dealer level. We recommend discussing the issue with the authorized Can-Am ATV Distributor/Dealer's service manager or owner.
2. If further assistance is required, the Can-Am ATV Distributor/Dealer service department should be contacted in order to resolve the matter.
3. If the matter still remains unresolved then contact BRP by writing at the address listed below.

**For countries within Middle East and Africa please contact our European office:**

**BRP EUROPE N.V.**

Customer Assistance Center

Skaldenstraat 125

9042 Gent

Belgium

Tel.: + 32 9 218 26 00

**For all other countries, please contact your local Can-Am ATV Distributor/Dealer (visit our website at [www.brp.com](http://www.brp.com) for contact information), or contact our North American office at:**

**BOMBARDIER RECREATIONAL PRODUCTS INC.**

Customer Assistance Center

75, J.-A. Bombardier Street

Sherbrooke QC J1L 1W3

Canada

Tel.: + 1 819 566-3366

\* For the territory covered by this limited warranty, products are distributed and serviced by Bombardier Recreational Products Inc. or its affiliates.

© 2015 Bombardier Recreational Products Inc. All rights reserved.

™ Trademark of Bombardier Recreational Products Inc. or its affiliates.

® Registered trademark of Bombardier Recreational Products Inc.

---

# **BRP LIMITED WARRANTY FOR THE EUROPEAN ECONOMIC AREA, THE COMMONWEALTH OF THE INDEPENDENT STATES AND TURKEY: 2016 CAN-AM® ATV**

## **1) SCOPE OF THE LIMITED WARRANTY**

Bombardier Recreational Products Inc. ("BRP")\* warrants its 2016 Can-Am ATVs sold by distributors or dealers authorized by BRP to distribute Can-Am ATVs ("Can-Am ATV Distributor/Dealer") in member states of the European Economic Area (which is comprised of the member states of the European Union plus Norway, Iceland and Liechtenstein) ("EEA"), in member states of the Commonwealth of the Independent States (including Ukraine and Turkmenistan) ("CIS") and Turkey from defects in material or workmanship for the period and under the conditions described below.

All genuine Can-Am ATV parts and accessories, installed by an authorized Can-Am ATV Distributor/Dealer at the time of delivery of the 2016 Can-Am ATV, carry the same warranty as that of the ATV.

This limited warranty will become null and void if: (1) The ATV was used for racing or any other competitive activity, at any point, even by a previous owner; or (2) the ATV has been altered or modified in such a way so as to adversely affect its operation, performance or durability, or has been altered or modified to change its intended use.

## **2) LIMITATIONS OF LIABILITY**

TO THE EXTENT PERMITTED BY LAW, THIS WARRANTY IS EXPRESSLY GIVEN AND ACCEPTED IN LIEU OF ANY AND ALL OTHER WARRANTIES, EXPRESSED OR IMPLIED, INCLUDING WITHOUT LIMITATION ANY WARRANTY OF MERCHANTABILITY OR FITNESS FOR A PARTICULAR PURPOSE. TO THE EXTENT THAT THEY CANNOT BE DISCLAIMED, THE IMPLIED WARRANTIES ARE LIMITED IN DURATION TO THE LIFE OF THE EXPRESS WARRANTY. INCIDENTAL AND CONSEQUENTIAL DAMAGES ARE EXCLUDED FROM COVERAGE UNDER THIS WARRANTY. SOME JURISDICTIONS DO NOT ALLOW FOR THE DISCLAIMERS, LIMITATIONS AND EXCLUSIONS IDENTIFIED ABOVE, AS A RESULT, THEY MAY NOT APPLY TO YOU. THIS WARRANTY GIVES YOU SPECIFIC RIGHTS AND YOU MAY ALSO HAVE OTHER LEGAL RIGHTS WHICH MAY VARY FROM COUNTRY TO COUNTRY.

Neither the Can-Am ATV Distributor/Dealer nor any other person has been authorized to make any affirmation, representation or warranty regarding the product, other than those contained in this limited warranty, and if made, shall not be enforceable against BRP.

BRP reserves the right to modify this warranty at any time, being understood that such modification will not alter the warranty conditions applicable to the products sold while this warranty is in effect.

## **3) EXCLUSIONS – ARE NOT WARRANTED**

The following are not warranted under this limited warranty under any circumstances:

- Normal wear and tear;
- Routine maintenance items, tune ups, adjustments;

- Damage caused by negligence or failure to provide proper maintenance and/or storage, as described in the Operator's Guide;
- Damage resulting from removal of parts, improper repairs, service, maintenance, modifications or use of parts or accessories not manufactured or approved by BRP which in its reasonable judgement are either incompatible with the product or adversely affect its operation, performance and durability, or resulting from repairs done by a person that is not an authorized servicing Can-Am ATV Distributor/Dealer;
- Damage caused by abuse, abnormal use, neglect, racing or operation of the product in a manner inconsistent with the recommended operation described in the Operator's Guide;
- Damage resulting from accident, submersion, fire, snow or water ingestion, theft, vandalism or any act of God;
- Operation with fuels, oils or lubricants which are not suitable for use with the product (see the Operator's Guide);
- Damage resulting from rust, corrosion or exposure to the elements;
- Incidental or consequential damages, or damages of any kind including without limitation towing, transportation expenses, storage, telephone, rental, taxi, inconvenience, insurance coverage, loan payments, loss of time, loss of income or time missed for downtime experience due to service work.

#### **4) WARRANTY COVERAGE PERIOD**

This warranty will be in effect from (1) the date of delivery to the first retail consumer or (2) the date the product is first put into use, whichever occurs first and for a period of:

TWENTY-FOUR (24) CONSECUTIVE MONTHS for private use.

SIX (6) CONSECUTIVE MONTHS for commercial use or rental use.

The product is used commercially when it is used in connection with any work or employment that generates income during any part of the warranty period. The product is also used commercially when, at any point during the warranty period, it is licensed for commercial use.

The repair or replacement of parts or the performance of service under this warranty does not extend the life of this warranty beyond its original expiration date.

Note that the duration and any other modalities of the warranty coverage are subject to the applicable national or local legislation in the customer's country.

#### **5) CONDITIONS TO HAVE WARRANTY COVERAGE**

This warranty coverage is available **only** if **each** of the following conditions has been fulfilled:

- The 2016 Can-Am ATV must be purchased as new and unused by its first owner from a Can-Am ATV Distributor/Dealer authorized to distribute Can-Am ATVs in the country in which the sale occurred;
- The BRP specified pre-delivery inspection process must be completed and documented;
- The product must have undergone proper registration by an authorized Can-Am ATV Distributor/Dealer;

- The 2016 Can-Am ATV must be purchased within the EEA by an EEA resident, in the CIS for residents of the countries comprised in such area and in Turkey for residents of Turkey; and
- Routine maintenance outlined in the Operator's Guide must be timely performed in order to maintain warranty coverage. BRP reserves the right to make warranty coverage contingent upon proof of proper maintenance.

BRP will not honour this limited warranty to any private use owner or commercial use owner if one of the preceding conditions has not been met. Such limitations are necessary in order to allow BRP to preserve both the safety of its products, and also that of its consumers and the general public.

## **6) WHAT TO DO TO OBTAIN WARRANTY COVERAGE UNDER THIS WARRANTY**

The customer must cease using the ATV upon the appearance of an anomaly. The customer must notify a servicing Can-Am ATV Distributor/Dealer within two (2) months of the appearance of a defect and provide it with reasonable access to the product and reasonable opportunity to repair it. The customer must also present to the authorized Can-Am ATV Distributor/Dealer, proof of purchase of the product and must sign the repair/work order prior to starting the repair in order to validate the warranty repair. All parts replaced under this limited warranty become the property of BRP.

Note that the notification period is subject to the applicable national or local legislation in customer's country.

## **7) WHAT BRP WILL DO**

To the extent permitted by law, BRP's obligations under this warranty are limited to, at its sole discretion, repairing parts found defective under normal use, maintenance and service, or replacing such parts with new genuine Can-Am ATV parts without charge for parts and labour, at any authorized Can-Am ATV Distributor/Dealer during the warranty coverage period under the conditions described herein. BRP's responsibility is limited to making the required repairs or replacements of parts. No claim of breach of warranty shall be cause for cancellation or rescission of the sale of the Can-Am ATV to the owner. You may have other legal rights which may vary from country to country.

In the event that service is required outside of the EEA, CIS or Turkey, the owner will bear responsibility for any additional charges due to local practices and conditions, such as, but not limited to, freight, insurance, taxes, license fees, import duties, and any and all other financial charges, including those levied by governments, states, territories and their respective agencies.

BRP reserves the right to improve or modify products from time to time without assuming any obligation to modify products previously manufactured.

## **8) TRANSFER**

If the ownership of a product is transferred during the warranty coverage period, this warranty shall also be transferred and be valid for the remaining coverage period provided BRP or an authorized Can-Am ATV Distributor/Dealer receives a proof that the former owner agreed to the transfer of ownership, in addition to the co-ordinates of the new owner.

## 9) CONSUMER ASSISTANCE

1. In the event of a controversy or a dispute in connection with this limited warranty, BRP suggests that you try to resolve the issue at the Can-Am ATV Distributor/Dealer level. We recommend discussing the issue with the authorized Can-Am ATV Distributor/Dealer's service manager or owner.
2. If further assistance is required, the Can-Am ATV Distributor/Dealer service department should be contacted in order to resolve the matter.
3. If the matter still remains unresolved then contact BRP at the address listed below:

**For countries within EEA, CIS or Turkey, except Scandinavian countries, please contact our European office:**

**BRP EUROPE N.V.**

Customer Assistance Center  
Skaldenstraat 125  
9042 Gent  
Belgium  
Tel.: + 32 9 218 26 00

**For Scandinavian countries, please contact our Finland office:**

**BRP FINLAND OY**

Service Department  
Isoaavantie 7  
FIN-96320 Rovaniemi  
Finland  
Tel.: + 358 16 3208 111

You can find your Can-Am Distributor/Dealer's coordinates on [www.brp.com](http://www.brp.com).

\* In the EEA, products are distributed and serviced by BRP European Distribution S.A. and other affiliates or subsidiaries of BRP.

© 2015 Bombardier Recreational Products Inc. All rights reserved.

™ Trademark of Bombardier Recreational Products Inc. or its affiliates.

® Registered trademark of Bombardier Recreational Products Inc.

## **ADDITIONAL TERMS AND CONDITIONS FOR FRANCE ONLY**

The following terms and conditions are applicable to products sold in France only:

The seller shall deliver goods that are complying with the contract and shall be responsible for defects existing upon delivery. The seller shall also be responsible for defects resulting from packaging, assembling instructions or the installation when it is its responsibility per the contract or if accomplished under its responsibility. To be compliant with the contract, the good shall:

1. Be fit for normal use for goods similar thereto and, if applicable:
  - Correspond to the description provided by the seller and have the qualities presented to the buyer through sample or model;
  - Have the qualities that a buyer may legitimately expect considering the public declarations of the seller, the manufacturer of its representative, including in advertising or labeling; or
2. Have the characteristics mutually agreed upon as between the parties or be fit for the specific use intended by the buyer and brought to the attention of the seller and which accepted by the seller.

The action for failure to comply is prescribed after two years after delivery of the goods. The seller is responsible for the warranty for hidden defects of the good sold if such hidden defects are rendering the good unfit for the intended use, or if they diminish its use in such a way that the buyer would not have acquired the good or would have given a lesser price, had he known. The action for such hidden defects shall be taken by the buyer within 2 years of the discovery of the defect.

# ***CUSTOMER INFORMATION***

---

## PRIVACY INFORMATION

BRP wishes to inform you that your coordinates will be used for safety and warranty related purposes. Furthermore, BRP and its affiliates may use its customer list to distribute marketing and promotional information about BRP and related products.

To exercise your right to consult or correct your data, or to be removed from the addressee-list for direct marketing, please contact BRP.

By E-mail: [privacyofficer@brp.com](mailto:privacyofficer@brp.com)

By mail:

BRP  
Senior Legal Counsel-Privacy Officer  
726 St-Joseph  
Valcourt QC  
Canada  
J0E 2L0



---

## CHANGE OF ADDRESS/OWNERSHIP

If your address has changed or if you are the new owner of the ATV, be sure to notify BRP by either:

- Mailing one of the change of address cards on the following pages
- Notifying an authorized Can-Am dealer.

In case of change of ownership, please join a proof that the former owner agreed to the transfer.

Notifying BRP, even after the expiration of the limited warranty, is very important as it enables BRP to reach the ATV owner if necessary, like when safety recalls are initiated. It is the owner's responsibility to notify BRP.

**STOLEN UNITS:** If your personal ATV is stolen, you should notify BRP or an authorized Can-Am dealer. We will ask you to provide your name, address, phone number, the vehicle identification number and the date it was stolen.

### **Scandinavian countries**

#### **BRP FINLAND OY**

Service Department  
Isoaavantie 7  
FIN-96320 Rovaniemi

### **Other countries in the world**

#### **BRP EUROPEAN DISTRIBUTION**

Warranty Department  
Chemin de Messidor 5-7  
1006 Lausanne  
Switzerland

***This page is  
intentionally blank***

CHANGE OF ADDRESS

CHANGE OF OWNERSHIP



VEHICLE IDENTIFICATION NUMBER

Model Number

Vehicle Identification Number (V.I.N.)

OLD ADDRESS  
OR PREVIOUS OWNER:

NAME

NO. STREET APT

CITY STATE/PROVINCE ZIP/POSTAL CODE

COUNTRY TELEPHONE

NEW ADDRESS  
OR NEW OWNER:

NAME

NO. STREET APT

CITY STATE/PROVINCE ZIP/POSTAL CODE

COUNTRY TELEPHONE

E-MAIL ADDRESS

V00A2F

CHANGE OF ADDRESS

CHANGE OF OWNERSHIP



VEHICLE IDENTIFICATION NUMBER

Model Number

Vehicle Identification Number (V.I.N.)

OLD ADDRESS  
OR PREVIOUS OWNER:

NAME

NO. STREET APT

CITY STATE/PROVINCE ZIP/POSTAL CODE

COUNTRY TELEPHONE

NEW ADDRESS  
OR NEW OWNER:

NAME

NO. STREET APT

CITY STATE/PROVINCE ZIP/POSTAL CODE

COUNTRY TELEPHONE

E-MAIL ADDRESS

V00A2F

***This page is  
intentionally blank***

CHANGE OF ADDRESS

CHANGE OF OWNERSHIP



VEHICLE IDENTIFICATION NUMBER

--	--	--	--

Model Number

--	--	--	--	--	--	--	--	--	--	--	--	--	--	--	--	--	--	--	--

Vehicle Identification Number (V.I.N.)

OLD ADDRESS  
OR PREVIOUS OWNER:

NAME

NO.

STREET

APT

CITY

STATE/PROVINCE

ZIP/POSTAL CODE

COUNTRY

TELEPHONE

NEW ADDRESS  
OR NEW OWNER:

NAME

NO.

STREET

APT

CITY

STATE/PROVINCE

ZIP/POSTAL CODE

COUNTRY

TELEPHONE

E-MAIL ADDRESS

V00A2F

CHANGE OF ADDRESS

CHANGE OF OWNERSHIP



VEHICLE IDENTIFICATION NUMBER

--	--	--	--

Model Number

--	--	--	--	--	--	--	--	--	--	--	--	--	--	--	--	--	--	--	--

Vehicle Identification Number (V.I.N.)

OLD ADDRESS  
OR PREVIOUS OWNER:

NAME

NO.

STREET

APT

CITY

STATE/PROVINCE

ZIP/POSTAL CODE

COUNTRY

TELEPHONE

NEW ADDRESS  
OR NEW OWNER:

NAME

NO.

STREET

APT

CITY

STATE/PROVINCE

ZIP/POSTAL CODE

COUNTRY

TELEPHONE

E-MAIL ADDRESS

V00A2F

***This page is  
intentionally blank***



# NOTES







**ATV MODEL No.** \_\_\_\_\_

**VEHICLE IDENTIFICATION NUMBER (V.I.N.)** \_\_\_\_\_

**ENGINE IDENTIFICATION NUMBER (E.I.N.)** \_\_\_\_\_

**Owner:** \_\_\_\_\_  
NAME

\_\_\_\_\_  
No. STREET APT

\_\_\_\_\_  
CITY STATE/PROVINCE ZIP/POSTAL CODE

**Purchase Date** \_\_\_\_\_  
YEAR MONTH DAY

**Warranty Expiry Date** \_\_\_\_\_  
YEAR MONTH DAY

To be completed by the dealer at the time of the sale.

DEALER IMPRINT AREA

V00A21L

Please verify with your dealer to ensure your vehicle has been registered with BRP.

While reading this Operator's Guide, remember that:

 **WARNING**

Indicates a potential hazard that, if not avoided, could result in serious injury or death.



## WARNING

### **THIS VEHICLE CAN BE HAZARDOUS TO OPERATE.**

A collision or rollover can occur quickly, even during routine maneuvers such as turning and driving on hills or over obstacles, if you fail to take proper precautions.

**SEVERE INJURY OR DEATH** can result if you do not follow these instructions:

- **BEFORE YOU OPERATE THIS VEHICLE, READ THIS OPERATOR'S GUIDE, ALL ON PRODUCT SAFETY LABELS AND WATCH THE SAFETY VIDEO.**
- **NEVER OPERATE THIS VEHICLE WITHOUT PROPER INSTRUCTIONS.** Complete a certified training course.
- **FOR MAX MODELS, NEVER CARRY MORE THAN ONE PASSENGER.** You increase your risk of losing control if you carry more than one passenger.
- **FOR 1UP MODELS, NEVER CARRY A PASSENGER.** You increase your risk of losing control if you carry a passenger.
- **NEVER OPERATE THIS VEHICLE ON ANY PAVED SURFACE** unless it is for short distances, at reduced speed and in order to move the vehicle from an off-road location to another.
- **ALWAYS RESPECT THE ROAD TRAFFIC LAWS** when you operate this vehicle on the roadway, even a dirt or gravel road.
- **OPERATOR AND PASSENGER (MAX Models) SHOULD ALWAYS WEAR AN APPROVED HELMET,** eye protection, and protective clothing.
- **NEVER USE WITH DRUGS OR ALCOHOL.** They slow reaction time and impair judgment.
- **NEVER OPERATE THIS VEHICLE AT EXCESSIVE SPEEDS.** You increase your risk of losing control if you operate this vehicle at speeds too fast for the terrain, visibility conditions, or your experience.
- **NEVER ATTEMPT WHEELIES, JUMPS, OR OTHER STUNTS.**

219 001 582

OPERATOR'S GUIDE OUTLANDER / MAX Series (CE) / ENGLISH  
GUIDE DU COND. Série OUTLANDER / MAX (CE) / ANGLAIS

FAIT AU / MADE IN CANADA

U/M:P.C.