

BOMBARDIER® ATV

OPERATOR'S GUIDE

2004

INCLUDES
SAFETY, VEHICLE
AND MAINTENANCE
INFORMATION

QUEST™
500/500 XT
650/650 XT

TRAXTER®
AUTO
XL
XT

 **WARNING**

Read this guide thoroughly.
It contains important safety information.

Minimum recommended operator age:
16 years.

Do not remove this *Operator's Guide* from
the vehicle.

2 1 9 0 0 0 2 6 7



This *Operator's Guide* utilizes the following symbols to emphasize particular information:



The Safety Alert Symbol indicates a potential personal injury hazard.



WARNING

Indicates a potentially hazardous situation which, if not avoided, could result in serious injury or death.

CAUTION: Denotes an instruction which, if not followed, may damage the ATV and/or components.

WARNING

YOUR ATV CAN BE HAZARDOUS TO OPERATE. A collision or rollover can occur quickly, even during routine maneuvers such as turning and driving on hills or over obstacles, if you fail to take proper precautions.

For your safety, understand and follow all the warnings contained in this *Operator's Guide* and the labels on your vehicle. **Failure to follow these warnings can result in SEVERE INJURY OR DEATH.**

Keep this *Operator's Guide* with the vehicle at all times.

WARNING

Disregarding any of the safety precautions and instructions contained in this *Operator's Guide*, *Safety Videocassette* and on-product labels could cause injury including the possibility of death!

All safety documentation should remain with the vehicle at the time of sale.

All content of the *Safety Information section* should be interpreted by the reader as a warning which, if not followed, may result in injury including the possibility of death.

In USA, products are distributed by Bombardier Motor Corporation of America. In Canada, products are distributed by Bombardier Inc.

The following are trademarks of Bombardier Inc. or its subsidiaries:

BOMBARDIER®

TRAXTER®

QUEST™

ROTAX®

BOMBARDIER
RECREATIONAL PRODUCTS



FOREWORD

Congratulations on your purchase of a new Bombardier® all-terrain vehicle (ATV). It is backed by the Bombardier warranty and a network of authorized Bombardier ATV dealers ready to provide the parts, service or accessories you may require.

Your dealer is committed to your satisfaction. He has taken training to perform the initial set-up and inspection of your vehicle as well as completed the final adjustment before you took possession. At delivery, your dealer would have explained the operation, maintenance and safety features of the vehicle. We trust you have taken full advantage of this! If you need more complete servicing information, please ask your dealer.

At delivery, you were also informed of the warranty coverage and completed the Warranty Registration Form which is to be sent to us for processing. In the near future you should be receiving a warranty card which will confirm our receipt of the registration as well as be used for warranty or recall purposes.

You are invited to contact our customer assistance center should you experience problems which cannot be resolved by an authorized Bombardier ATV dealer.

It is understood that this guide may be translated into another language. In the event of any discrepancy, the English version shall prevail. Throughout this document, the masculine is used to denote the masculine and feminine.

The information and components/system descriptions contained in this document are correct at the time of publication. Bombardier Inc. however, maintains a policy of continuous improvement of its products without imposing upon itself any obligation to install them on products previously manufactured. Due to late changes, some differences between the manufactured product and the descriptions and/or specifications in this *Operator's Guide* may occur. Bombardier Inc. reserves the right at any time to discontinue or change specifications, designs, features, models or equipment without incurring any obligation upon itself.

The illustrations in this document show the typical construction of the different assemblies and may not reproduce the full detail or exact shape of the parts. However, they represent parts that have the same or similar function.

The use of RIGHT and LEFT indications in the text always refers to driving position (when sitting on vehicle).

Specifications are given in the SI metric system with the SAE U.S. equivalent in parenthesis. Where precise accuracy is not required, some conversions are rounded off for easier use.

We recommend genuine Bombardier products for replacement parts and accessories. They've been especially designed for your vehicle and manufactured to meet Bombardier's demanding standards.

A *Shop Manual* can be obtained for complete service and maintenance information and more repair information.

TABLE OF CONTENTS

While reading this *Operator's Guide*, remember that:

WARNING

Indicates a potential hazard that, if not avoided, could result in serious injury or death.

NOTICE	5
INTRODUCTION	6

SAFETY INFORMATION

SPECIAL SAFETY MESSAGES	8
OPERATION WARNINGS	10
SAFETY WARNING	37
RIDING TIPS	38
Clothing	39
Carrying Loads.....	40
Hauling a Trailer.....	40
Working with your ATV	40
Recreational Riding.....	40
Environment	41
Design Limitation	41
Off-Highway Operation	42
General Operating and Safety Precautions	42
Uphill Driving	42
Downhill Driving	43
Side Hilling.....	43
Drop-Offs.....	43
Riding Techniques	44
Routine Maintenance	51
LOCATION OF THE IMPORTANT LABELS	52

VEHICLE INFORMATION

HOW TO IDENTIFY YOUR ATV	62
Engine and Vehicle Identification Number Location.....	62
EMISSION REQUIREMENTS	64

CONTROLS/INSTRUMENTS/EQUIPMENT	65
1) Throttle Lever	69
2) Front Brake Lever	69
3) Rear Brake Lever	69
4) Brake Lever Lock	70
5) Transmission Lever	71
6) Multi-Function Switch	72
7) Indicator Lights Cluster	75
8) Speedometer	77
9) Ignition Switch	79
10) Choke Knob Lever	80
11) Fuel Tank Cap	80
12) Fuel Gauge	81
13) Fuel Valve	81
14) Rear Brake Pedal	82
15) Rewind Starter Handle	82
16) Footpeg	82
17) Storage Compartment	83
18) Tool Box	83
19) Seat Latch	84
20) Front/Rear Cargo Racks	85
21) Air Duct	85
22) Trailer Hitch	85
23) Radiator Cap	86
24) 12-Volt Power Outlet	86
25) Fuses	87
26) Winch	87
27) Winch Control Switch	87
28) Fairlead	87
29) Rear Cargo Box	87
30) Release Lever	88
31) Rear Cargo Box Gate	88
32) Lateral Compartment	89
LIQUIDS	90
Fuel	90
Engine/Transmission Oil	91
Engine Coolant	93
Brake Fluid	95
Battery	96
BREAK-IN PERIOD	98
Engine	98
Belt	98
10-Hour Inspection	98
PRE-OPERATION CHECK	99

OPERATING INSTRUCTIONS	100
General	100
Initial Cold Starting	100
Warm Engine Starting	101
Emergency Manual Starting	101
Stopping the Engine	102
Shifting the Transmission	102
Winch Operation	103
Dumping the Rear Cargo Box.....	103
SPECIAL PROCEDURES.....	104
Flooded Engine.....	104
Engine Overheat.....	104
Turn Over	104
ATV Immersion.....	105
Post-Operation Care	105
Emergency Shifter.....	105
Storage and Preseason Preparation	106
CARGO AND TRANSPORTATION	107
Cargo	107
Transportation	109

MAINTENANCE INFORMATION

MAINTENANCE CHART	112
MAINTENANCE	114
Engine/Transmission	114
Carburetor	119
Air Intake System	119
Electrical	121
Drive Train	124
Steering System	126
Suspension.....	128
Brake	129
Body/Frame	129
TROUBLESHOOTING	131
SPECIFICATIONS.....	134
SI METRIC INFORMATION GUIDE.....	146

WARRANTY

BOMBARDIER LIMITED WARRANTY NORTH AMERICA	148
BOMBARDIER INTERNATIONAL LIMITED WARRANTY.....	151
FREQUENTLY ASKED QUESTIONS.....	154
PRIVACY OBLIGATIONS/DISCLAIMER	156
CHANGE OF ADDRESS/OWNERSHIP.....	157

NOTICE

This *Operator's Guide* has been prepared to acquaint the owner/operator of a new vehicle with the various vehicle controls, maintenance and safe operating instructions. It is indispensable for the proper use of the product.

This *Operator's Guide* uses the following symbols.

WARNING

Indicates a potentially hazardous situation which, if not avoided, could result in serious injury or death.

CAUTION: Denotes an instruction which, if not followed, could severely damage vehicle components.

NOTE: Indicates supplementary information needed to fully complete an instruction.

Although the mere reading of such information does not eliminate the hazard, the understanding and application of the information will promote the correct use of the all-terrain vehicle (ATV).

To fully appreciate the pleasures, enjoyment and excitement of using an ATV, there are some basic rules that **MUST** be observed and followed by any user.

INTRODUCTION

Your dealer should have provided you with some basic information on the particular controls and features of your new ATV. Please take the time to study this *Operator's Guide* and all on-product warning labels as well as the *Safety Videocassette* that came with the ATV. It more completely describes what you should know about the ATV before riding it.

Whether you are a new user or an experienced rider, it is important for your personal safety that you know the controls and features of the ATV. Equally important is knowing how to properly ride.

Regardless of your age, experience or state regulations, it is safer for you or any other person who may ride your ATV, to take an approved ATV safe riding course. Please check with your dealer or local authorities for availability in your area. If you are a completely new ATV rider, this should be done before your first ride. Your ATV instructor should be able to provide advice on local conditions and safe riding practices particular to the area.

Riding conditions vary from place to place. Each is subject to weather conditions which may radically change from time to time and from season to season. Riding on sand is different than riding on snow or through forests or marshes. Each location may require a greater degree of awareness and skill. Always proceed with caution. Please do not take any unnecessary risks that could leave you stranded or possibly injured.

The contents of this *Operator's Guide* provide riding information which has been proven reliable by other ATV users. They are not intended as a definitive means of avoiding accidents. How you apply this information, coupled with your mental and physical condition, the particular terrain hazard and your risk acceptance level will have an effect on your riding experience. Have fun... and ride responsibly.

This *Operator's Guide* has been prepared to acquaint the owner/operator of a new vehicle with the various vehicle controls, maintenance and safe operating instructions. It is indispensable for the proper use of the product.

We would be pleased to receive any comments on the content and format of the *Operator's Guide*, the *Safety Videocassette* or on-product warnings.

SAFETY INFORMATION

SPECIAL SAFETY MESSAGES

AN ATV IS NOT A TOY AND CAN BE HAZARDOUS TO OPERATE.

An ATV handles differently from other vehicles including motorcycles and cars. A collision or rollover can occur quickly, even during routine maneuvers such as turning and driving on hills or over obstacles, if you fail to take proper precautions.

SEVERE INJURY OR DEATH can result if you do not follow these instructions:

- ⚠ Read this *Operator's Guide* and all on-product warning labels carefully and follow the operating procedures described. Watch and pay attention to the *Safety Videocassette* before operation.
- ⚠ Never operate an ATV without proper instruction. **Take a training course.** Beginners should receive training from a certified instructor. Contact an authorized Bombardier ATV dealer to find out about available training courses nearest you or call the Specialty Vehicle Institute of America (SVIA) at 1 800 887-2887 or in Canada, the Canada Safety Council (CSC) at 1 (613) 739-1535 ext. 227.
- ⚠ Always follow this age recommendation: A child under 16 years old should never operate this ATV.
- ⚠ Never carry a passenger on an ATV.
- ⚠ Never operate an ATV on any paved surfaces, including sidewalks, driveways, parking lots and streets.
- ⚠ Never operate an ATV on any public street, road or highway, even a dirt or gravel one.
- ⚠ Never operate an ATV without wearing an approved helmet that fits properly. You should also wear eye protection (goggles or face shield), gloves, boots, long sleeved shirt or jacket, and long pants.
- ⚠ Never consume alcohol or drugs before or while operating this ATV.
- ⚠ Never operate at excessive speeds. Always go at a speed that is proper for the terrain, visibility, and operating conditions, and your experience.
- ⚠ Never attempt wheelies, jumps, or other stunts.
- ⚠ Always inspect your ATV each time you use it to make sure it is in safe operating condition. Always follow the inspection and maintenance procedures and schedules described further in this *Operator's Guide*.
- ⚠ Always keep both hands on the handlebars and both feet on the footrests of the ATV during operation.
- ⚠ Always go slowly and be extra careful when operating on unfamiliar terrain. Always be alert to changing terrain conditions when operating the ATV.
- ⚠ Never operate on excessively rough, slippery or loose terrain until you have learned and practiced the skills necessary to control the ATV on such terrain. Always be especially cautious on these kinds of terrain.
- ⚠ Always follow proper procedures for turning as described further in this *Operator's Guide*. Practice turning at low speeds before attempting to turn at faster speeds. Do not turn at excessive speed.
- ⚠ Never operate the ATV on hills too steep for the ATV or for your abilities. Practice on smaller hills before attempting larger hills.

- ⚠ Always follow proper procedures for climbing hills as described further in this *Operator's Guide*. Check the terrain carefully before you start up any hill. Never climb hills with excessively slippery or loose surfaces. Shift your weight forward. Never open the throttle suddenly or make sudden gear changes. Never go over the top of any hill at high speed.
- ⚠ Always follow proper procedures for going down hills and for braking on hills as described further in this *Operator's Guide*. Check the terrain carefully before you start down any hill. Shift your weight backward. Never go down a hill at high speed. Avoid going down a hill at an angle that would cause the vehicle to lean sharply to one side. Go straight down the hill where possible.
- ⚠ Always follow proper procedures for crossing the side of a hill as described further in this *Operator's Guide*. Avoid hills with excessively slippery or loose surfaces. Shift your weight to the uphill side of the ATV. Never attempt to turn the ATV around on any hill until you have mastered the turning technique described further in this *Operator's Guide* on level ground. Avoid crossing the side of a steep hill if possible.
- ⚠ Always use proper procedures if you stall or roll backwards when climbing a hill. To avoid stalling, use proper gear and maintain a steady speed when climbing a hill. If you stall or roll backwards, follow the special procedure for braking described further in this *Operator's Guide*. Dismount on the uphill side or to a side if pointed straight uphill. Turn the ATV around and remount, following the procedure described further in this *Operator's Guide*.
- ⚠ Always check for obstacles before operating in a new area. Never attempt to operate over large obstacles, such as large rocks or fallen trees. Always follow proper procedures when operating over obstacles as described further in this *Operator's Guide*.
- ⚠ Always be careful when skidding or sliding. Learn to safely control skidding or sliding by practicing at low speeds and on level, smooth terrain. On extremely slippery surfaces, such as ice, go slowly and be very cautious in order to reduce the chance of skidding out of control.
- ⚠ Never operate an ATV in fast flowing water or in water deeper than that specified further in this *Operator's Guide*. Remember that wet brakes may have reduced stopping ability. Test your brakes after leaving water. If necessary, apply them several times for friction to dry out the pads.
- ⚠ Always be sure there are no obstacles or people behind you when you operate in reverse. When it is safe to proceed in reverse, go slowly.
- ⚠ Always use the size and type tires specified further in this *Operator's Guide*. Always maintain proper tire pressure as described further in this guide.
- ⚠ Never modify an ATV through improper installation or use of accessories.
- ⚠ Never exceed the stated load limits for an ATV. Cargo should be properly distributed and securely attached. Reduce speed and follow instructions in this *Operator's Guide* for carrying cargo or pulling a trailer. Allow greater distance for braking.
- ⚠ **FOR MORE INFORMATION ABOUT ATV SAFETY**, call the Specialty Vehicle Institute of America (SVIA) at 1 800 887-2887 or in Canada, the Canada Safety Council (CSC) at 1 (613) 739-1535 ext. 227 or contact an authorized Bombardier ATV dealer to find out about the training courses nearest you.

OPERATION WARNINGS

While reading this *Operator's Guide*, remember that:

WARNING

Indicates a potential hazard that, if not avoided, could result in serious injury or death.

The following warnings and their format have been requested by the United States Consumer Product Safety Commission and are required to be in this *Operator's Guide* for all ATVs.

NOTE: The following illustrations are general representations only. Your model may differ.

WARNING



V00A0AQ

POTENTIAL HAZARD

Operating this ATV without proper instruction.

WHAT CAN HAPPEN

The risk of an accident is greatly increased if the operator does not know how to operate the ATV properly in different situations and on different types of terrain.

HOW TO AVOID THE HAZARD

Beginning and inexperienced operators should complete the certified training course offered by Bombardier Inc. They should then regularly practice the skills learned in the course and the operating techniques described further in this *Operator's Guide*.

For more information about the training course, contact an authorized Bombardier ATV dealer or call Bombardier Inc. at 1 (819) 566-3366.



V00A01Q

POTENTIAL HAZARD

Failure to follow the age recommendations for this ATV.

WHAT CAN HAPPEN

Use by children of ATVs that are not recommended for their age can lead to severe injury or death of the child.

Even though a child may be within the age group for which an ATV is recommended, he or she may not have the skills, abilities, or judgment needed to operate the ATV safely and may be involved in a serious accident.

HOW TO AVOID THE HAZARD

No one under 16 should operate a Bombardier ATV.

⚠ WARNING



V00A02Q

POTENTIAL HAZARD

Carrying a passenger on this ATV or in the rear cargo box.

WHAT CAN HAPPEN

Greatly reduces your ability to balance and control this ATV.

Could cause an accident, resulting in harm to you and/or your passenger.

HOW TO AVOID THE HAZARD

Never carry a passenger. The long seat is to allow the operator to shift position as needed during operation. The rear cargo box is used to transport material only. They are not for carrying passengers.

⚠ WARNING

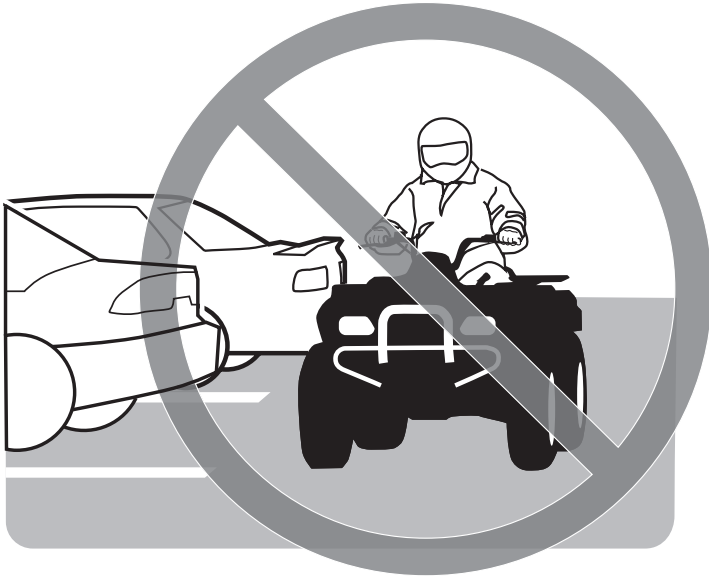

V00A03Q

POTENTIAL HAZARD

Operating this ATV on paved surfaces.

WHAT CAN HAPPEN

The ATV's tires are designed for off-road use only, not for use on pavement. Paved surfaces may seriously affect handling and control of the ATV, and may cause the vehicle to go out of control.

HOW TO AVOID THE HAZARD

Never operate the ATV on any paved surfaces, including sidewalks, drive-ways, parking lots and streets.

⚠ WARNING



V00A04Q

POTENTIAL HAZARD

Operating this ATV on public streets, roads or highways.

WHAT CAN HAPPEN

You can collide with another vehicle.

HOW TO AVOID THE HAZARD

Never operate this ATV on any public street, road or highway, even a dirt or gravel one. In many states it is illegal to operate ATVs on public streets, roads and highways.

⚠ WARNING



V00A06Q

POTENTIAL HAZARD

Operating this ATV without wearing an approved helmet, eye protection and protective clothing.

WHAT CAN HAPPEN

Operating without an approved helmet increases your chances of a severe head injury or death in the event of an accident.

Operating without eye protection can result in an accident and increases your chances of a severe injury in the event of an accident.

Operating without protective clothing increases your chances of severe injury in the event of an accident.

HOW TO AVOID THE HAZARD

Always wear an approved helmet that fits properly. You should also wear:

- eye protection (goggles or face shield)
- gloves
- boots
- long sleeved shirt or jacket
- long pants.

WARNING



V00A07Q

POTENTIAL HAZARD

Operating this ATV after consuming alcohol or drugs.

WHAT CAN HAPPEN

- Could seriously affect your judgment.
- Could cause you to react more slowly.
- Could affect your balance and perception.
- Could result in an accident.

HOW TO AVOID THE HAZARD

Never consume alcohol or drugs before or while driving this ATV.

⚠ WARNING

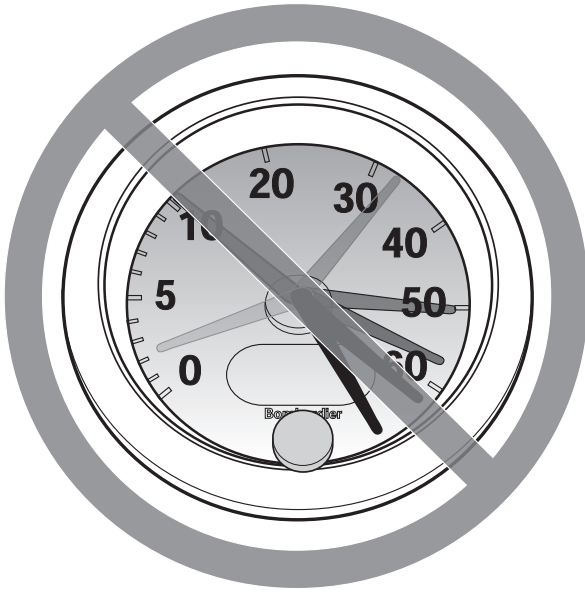

V00A08Q

POTENTIAL HAZARD

Operating this ATV at excessive speeds.

WHAT CAN HAPPEN

Increases your chances of losing control of the ATV, which can result in an accident.

HOW TO AVOID THE HAZARD

Always travel at a speed which is proper for the terrain, visibility and operating conditions, and your experience.

⚠ WARNING

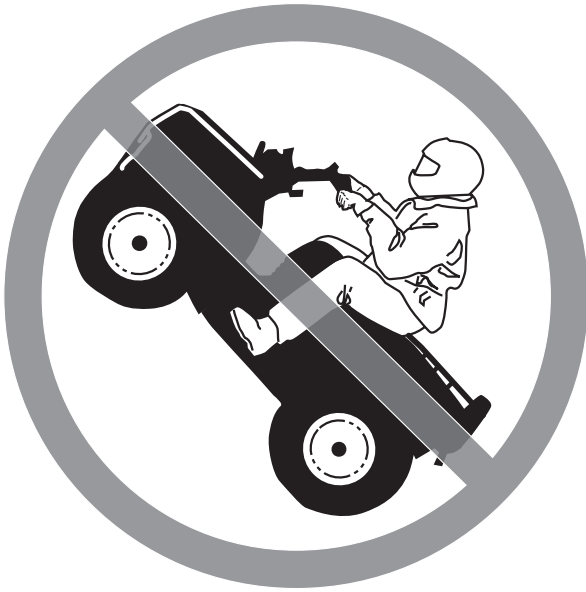

V00A09Q

POTENTIAL HAZARD

Attempting wheelies, jumps and other stunts.

WHAT CAN HAPPEN

Increases the chance of an accident, including an overturn.

HOW TO AVOID THE HAZARD

Never attempt stunts, such as wheelies or jumps. Do not try to show off.

 **WARNING**

POTENTIAL HAZARD

Failure to inspect the ATV before operating.
Failure to properly maintain the ATV.

WHAT CAN HAPPEN

Increases the possibility of an accident or equipment damage.

HOW TO AVOID THE HAZARD

Always inspect your ATV each time you use it to make sure the ATV is in safe operating condition.

Be sure that the rear cargo box is properly latched before operating the vehicle.

Always follow the inspection, maintenance procedures and schedules described further in this *Operator's Guide*.

 **WARNING**

POTENTIAL HAZARD

Riding on frozen waterways.

WHAT CAN HAPPEN

Severe injury or death can result if the vehicle and/or operator break through the ice.

HOW TO AVOID THE HAZARD

Never ride this vehicle on a frozen surface before you are sure the ice is thick enough and sound enough to support the vehicle and its load, as well as the force that is created by a moving vehicle.

⚠ WARNING



V00A0BQ

POTENTIAL HAZARD

Removing hands from handlebars or feet from footrests during operation.

WHAT CAN HAPPEN

Removing even one hand or foot can reduce your ability to control the ATV or could cause you to lose your balance and fall off the ATV. If you remove a foot from the footrests, your foot or leg may come into contact with the rear wheels, which could injure you or cause an accident.

HOW TO AVOID THE HAZARD

Always keep both hands on the handlebars and both feet on the footrests of your ATV during operation.

⚠ WARNING

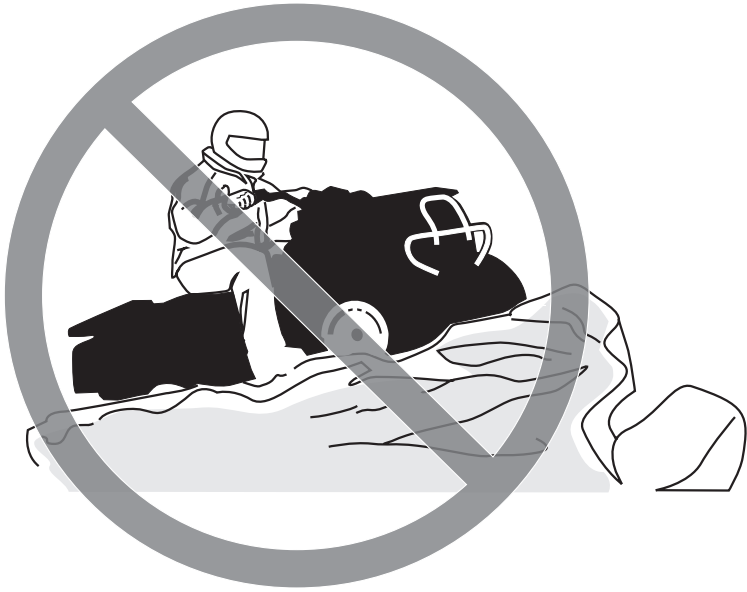

V00A0CQ

POTENTIAL HAZARD

Failure to use extra care when operating this ATV on unfamiliar terrain.

WHAT CAN HAPPEN

You can come upon hidden rocks, bumps, or holes, without enough time to react.

Could result in the ATV overturning or loss of control.

HOW TO AVOID THE HAZARD

Go slowly and be extra careful when operating on unfamiliar terrain.

Always be alert to changing terrain conditions when operating the ATV.

WARNING



V00A0D0

POTENTIAL HAZARD

Failure to use extra care when operating on excessively rough, slippery or loose terrain.

WHAT CAN HAPPEN

Could cause loss of traction or vehicle control, which could result in an accident, including an overturn.

HOW TO AVOID THE HAZARD

Do not operate on excessively rough, slippery or loose terrain until you have learned and practiced the skills necessary to control the ATV on such terrain.

Always be especially cautious on these kinds of terrain.

⚠ WARNING



V00A0EQ

POTENTIAL HAZARD

Turning improperly.

WHAT CAN HAPPEN

ATV could go out of control, causing a collision or overturn.

HOW TO AVOID THE HAZARD

Always follow proper procedures for turning as described further in this *Operator's Guide*. Practice turning at low speeds before attempting to turn at faster speeds.

Do not turn at excessive speed.

⚠ WARNING



V00A00Q

POTENTIAL HAZARD

Operating on excessively steep hills.

WHAT CAN HAPPEN

The vehicle can overturn more easily on extremely steep hills than on level surfaces or small hills.

HOW TO AVOID THE HAZARD

Never operate the ATV on hills too steep for the ATV or for your abilities. Practice on smaller hills before attempting larger hills.

⚠ WARNING



V00A0FQ

POTENTIAL HAZARD

Climbing hills improperly.

WHAT CAN HAPPEN

Could cause loss of control or cause ATV to overturn.

HOW TO AVOID THE HAZARD

Always follow proper procedures for climbing hills as described further in this *Operator's Guide*.

Always check the terrain carefully before you start up any hill.

Never climb hills with excessively slippery or loose surfaces.

Shift your weight forward.

Never open the throttle suddenly or make sudden gear changes. The ATV could flip over backwards.

Never go over the top of any hill at high speed. An obstacle, a sharp drop, or another vehicle or person could be on the other side of the hill.

⚠ WARNING



V00A0GQ

POTENTIAL HAZARD

Going down a hill improperly.

WHAT CAN HAPPEN

Could cause loss of control or cause ATV to overturn.

HOW TO AVOID THE HAZARD

Always follow proper procedures for going down hills as described further in this *Operator's Guide*. **NOTE:** A special technique is required when braking as you go down a hill.

Always check the terrain carefully before you start down any hill.

Shift your weight backward.

Never go down a hill at high speed.

Avoid going down a hill at an angle which would cause the vehicle to lean sharply to one side. Go straight down the hill where possible.

⚠ WARNING



V00A0HQ

POTENTIAL HAZARD

Improperly crossing hills or turning on hills.

WHAT CAN HAPPEN

Could cause loss of control or cause ATV to overturn.

HOW TO AVOID THE HAZARD

Never attempt to turn the ATV around on any hill until you have mastered the turning technique as described further in this *Operator's Guide* on level ground. Be very careful when turning on any hill.

Avoid crossing the side of a steep hill if possible.

When crossing the side of a hill:

Always follow proper procedures as described further in this *Operator's Guide*.

Avoid hills with excessively slippery or loose surfaces.

Shift your weight to the uphill side of the ATV.

WARNING



V00A01Q

POTENTIAL HAZARD

Stalling, rolling backwards or improperly dismounting while climbing a hill.

WHAT CAN HAPPEN

Could result in ATV overturning.

HOW TO AVOID THE HAZARD

Use proper gear and maintain steady speed when climbing a hill.

If you lose all forward speed:

Keep weight uphill.

Apply the brakes.

Lock parking brake after you are stopped.

If you begin rolling backwards:

Keep weight uphill.

Apply the brakes gradually.

When fully stopped, lock parking brake.

Dismount on uphill side, or to a side if pointed straight uphill.

Turn the ATV around and remount, following the procedure described further in this *Operator's Guide*.

⚠ WARNING



V00A0JQ

POTENTIAL HAZARD

Improperly operating over obstacles.

WHAT CAN HAPPEN

Could cause loss of control or a collision. Could cause the ATV to overturn.

HOW TO AVOID THE HAZARD

Before operating in a new area, check for obstacles.

Never attempt to ride over large obstacles, such as large rocks or fallen trees.

When you go over obstacles, always follow proper procedures as described further in this *Operator's Guide*.

WARNING



V00A0KQ

POTENTIAL HAZARD

Skidding or sliding improperly.

WHAT CAN HAPPEN

You may lose control of this ATV.

You may also regain traction unexpectedly, which may cause the ATV to overturn.

HOW TO AVOID THE HAZARD

Learn to safely control skidding or sliding by practicing at low speeds and on level, smooth terrain.

On extremely slippery surfaces, such as ice, go slowly and be very cautious in order to reduce the chance of skidding or sliding out of control.

⚠ WARNING



V00A0LQ

POTENTIAL HAZARD

Operating this ATV through deep or fast flowing water.

WHAT CAN HAPPEN

Tires may float, causing loss of traction and loss of control, which could lead to an accident.

HOW TO AVOID THE HAZARD

Never operate this ATV in fast flowing water or in water deeper than that specified further in this *Operator's Guide*.

Check water depth and current before you attempt to cross any water. Water should not go above footrests.

Remember that wet brakes may have reduced stopping ability. Test your brakes after leaving water. If necessary, apply them several times to let friction dry out the pads.

⚠ WARNING



V00A0MQ

POTENTIAL HAZARD

Improperly operating in reverse.

WHAT CAN HAPPEN

You could hit an obstacle or person behind you, resulting in serious injury.

HOW TO AVOID THE HAZARD

When you select reverse gear, make sure there are no obstacles or people behind you. When it is safe to proceed, go slowly.



V00A00Q

POTENTIAL HAZARD

Operating this ATV with improper tires, or with improper or uneven tire pressure.

WHAT CAN HAPPEN

Use of improper tires on this ATV, or operation of this ATV with improper or uneven tire pressure, may cause loss of control, and increases the risk of an accident.

HOW TO AVOID THE HAZARD

Always use the size and type of tires specified further in this *Operator's Guide* for this vehicle.

Always maintain proper tire pressure as described further in this *Operator's Guide*.

⚠ WARNING



V00A0NQ

POTENTIAL HAZARD

Operating this ATV with improper modifications.

WHAT CAN HAPPEN

Improper installation of accessories or modification of this vehicle may cause changes in handling which in some situations could lead to an accident.

HOW TO AVOID THE HAZARD

Never modify this ATV through improper installation or use of accessories. All parts and accessories added to this vehicle should be genuine Bombardier or equivalent components designed for use on this ATV and should be installed and used according to instructions. If you have questions, consult an authorized Bombardier ATV dealer.

⚠ WARNING



V00A0PQ

POTENTIAL HAZARD

Overloading this ATV or carrying or towing cargo improperly.

WHAT CAN HAPPEN

Could cause changes in vehicle handling which could lead to an accident.

HOW TO AVOID THE HAZARD

Never exceed the stated load capacity for this ATV.

Cargo should be properly distributed and securely attached.

Reduce speed when carrying cargo or pulling a trailer. Allow greater distance for braking.

Always follow the instructions in this *Operator's Guide* for carrying cargo or pulling a trailer.

⚠ WARNING



V03M01Q

POTENTIAL HAZARD

Transporting inflammable or dangerous material can lead to explosions.

WHAT CAN HAPPEN

This can cause serious injury or death.

HOW TO AVOID THE HAZARD

Never transport inflammable or dangerous material.

While reading this *Operator's Guide*, remember that:

⚠ WARNING

Indicates a potential hazard that, if not avoided, could result in serious injury or death.

SAFETY WARNING

To fully appreciate the pleasures and excitement of riding an ATV, there are some basic rules and tips that you should follow. Some may be new to you while others may be common sense or obvious. However, we ask that you take a few minutes to read this *Operator's Guide* completely before you operate the ATV.

Information in this *Operator's Guide* is limited. It is strongly recommended that you obtain further information and training from your local authorities, ATV clubs or a recognized ATV training organization such as the Specialty Vehicle Institute of America or the Canada Safety Council.

The U.S. Consumer Product Safety Commission and all ATV manufacturers do not recommend that anyone under the age of 16 to ride an ATV having an engine higher than 90 cc. For the child's safety, we strongly recommend you also follow and enforce this recommendation. You are the sole judge of a rider's capability to understand the risks and operate an ATV safely.

Persons with cognitive or physical impairments or who are high risk takers have an increased exposure to overturns or collisions which may result in injury including death.

Become completely familiar with the operational controls and the general operation of the ATV before venturing into off road conditions. Practice driving in a suitable area free of hazards and feel the response of each control. Drive at low speeds. Higher speeds require greater experience, knowledge and suitable riding conditions.

Not all ATVs are the same. Each has its own unique performance characteristics, controls and features. Each will ride and handle differently.

Never assume that the ATV will go everywhere safely. Sudden changes in terrain caused by holes, depressions, banks, softer or harder "ground" or other irregularities may cause the ATV to topple or become unstable. To avoid this, slow down and always observe the terrain ahead. If the ATV does begin to topple or tipover, it is usually the best advice to immediately get off... AWAY from the direction of the tipover!

RIDING TIPS

WARNING

The pre-operation check is very important prior to operating the vehicle. Always check the proper operation of critical controls, safety features and mechanical components before starting. If not done, severe injury or death might occur.

Before using an ATV you should always:

- a) Disengage the parking brake.
- b) Check the steering operation.
- c) Test throttle operation.
- d) Check brake functions.
- e) Check engine stop switch function.
- f) Verify operation and cleanliness of headlamp and taillight.
- g) Verify fuel and oil levels.
- h) Inspect tires and wheel rims for excessive wear or damage.
- i) Check tire air pressure.
- j) Secure all cargo and storage compartments.

Proceed only if all items are satisfactory.

Clothing

Actual weather conditions should help you decide how to dress. However, it is important that you always wear the appropriate protective clothing and apparel, including an approved helmet, eye protection, boots, gloves, long sleeved shirt and pants. Never wear loose clothing such as a scarf that may get entangled in the ATV or on tree branches and shrubs. Depending on conditions, antifogging or protective goggles may be required. This type of clothing will provide you protection from some of the minor hazards you may encounter en route. Sun glasses should only be worn during the daytime. Different colored lenses available for goggles or glasses help you distinguish terrain variations.

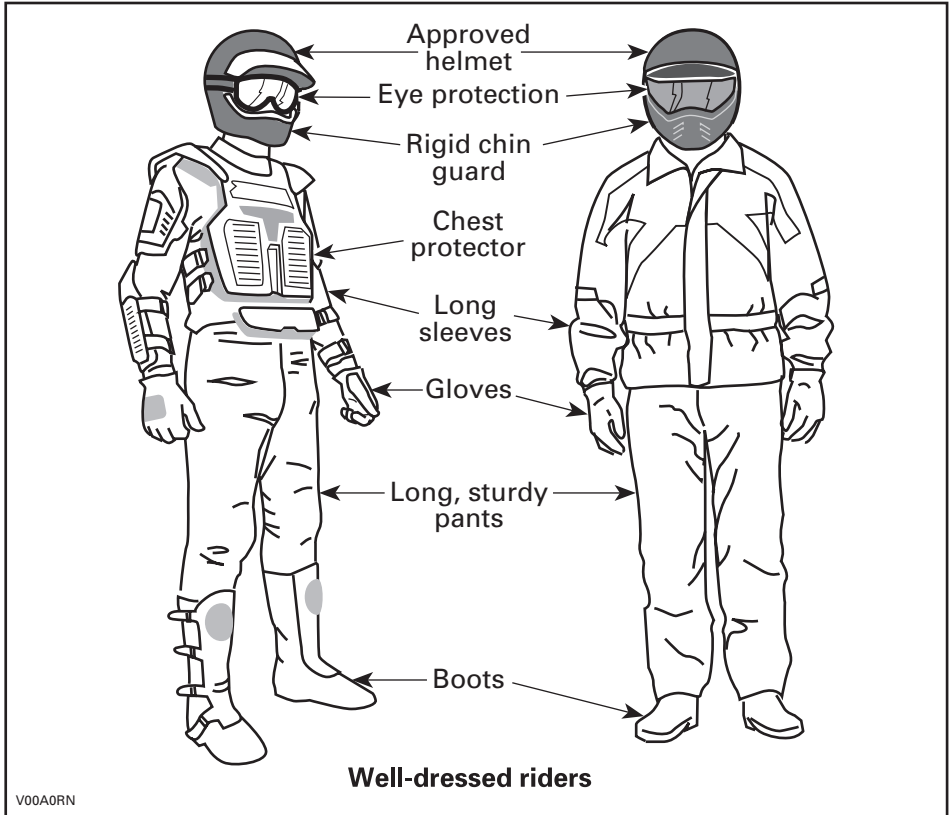

Carrying Loads

Any load carried on the ATV's carrying rack(s) will affect the stability and control of the ATV. For this reason, do not exceed the load limits of the ATV manufacturer. Always make sure the load is secured and cannot interfere with your proper control. Always be aware that the "load" may slide or fall off and create an accident. Avoid loads that may protrude sideways and get snagged or caught in brush or other obstacles. Avoid covering and obstructing the headlamp or taillights with the cargo. Always make sure any storage compartment latches are closed. If a removable compartment cover is removed to carry a load, make sure that the load is secure and that smaller objects cannot "fly out". Secure compartment cover to the rear rack.

All ATVs are intended for an operator only. Even with a long seat that provides unrestricted operator movement, they are not designed nor intended to carry passenger(s). Do not install passenger seats or use the racks or their location to carry passenger(s). Carrying a passenger (s) will affect the stability and your control of the ATV.

Hauling a Trailer

Riding an ATV with a trailer substantially increases the risk of toppling, especially on inclined slopes. If a trailer is used behind the ATV make sure that its hitch is compatible with the one on the ATV. Make sure the trailer is horizontal with the ATV. (In some instances a special extension may have to be installed on the ATV hitch). Use security chains to secure the trailer with the ATV. The ATV may require additional stopping distance if hauling heavy loads, especially on inclined surfaces. Be careful not to skid or slide. When stopped or parked, block the ATV and trailer wheels from possible movement. Always make sure load is evenly distributed on the trailer. Use caution when disconnecting a loaded trailer; it or its load may topple on you or others. Do not turn at high speeds.

Working with your ATV

Your ATV can help you perform a number of different LIGHT tasks ranging from snow removal to pulling wood or carrying cargo. A variety of accessories are available from your ATV dealer. However, always respect the load and capacities of the ATV. Overloading of the ATV can overstress the components and cause failure. To prevent possible injury, it is equally important to follow the instructions and warnings that accompany the accessory. Avoid any physical exertion through lifting or pulling of heavy loads or manpowering the ATV. (Continue to read RECREATIONAL RIDING below).

Recreational Riding

Respect the rights and limitations of others. Stay away from areas designated for other types of off road use. This includes snowmobile trails, equestrian trails, cross country ski trails, mountain bike trails etc. Never assume there are no other users on the trail. Always stay to the complete right of the trail and do not zig zag to one side of the trail then the other. Be prepared to stop or pull off to the side if another trail user appears in front of you.

Join a local ATV club. They will provide you with a map and advice or inform you where you can ride. If a club does not exist in your area, help start one. Group riding and club activities provide a pleasurable, social experience.

Always keep a safe distance from other riders. Your judgment of speed, terrain conditions, weather, mechanical condition of your ATV and the “trust in judgment” you have in others around you will help you make a better choice of appropriate safe distance. ATVs, like any other vehicle, cannot stop “on a dime”.

Before you ride, tell someone where you are planning to travel and your expected time of return. Never consume alcohol or drugs before or while riding!

Depending on the length of your ride, carry additional tools or emergency equipment. Find out where you can get additional gasoline and oil. Be prepared for the possible conditions you may encounter. An emergency first aid kit should always be a consideration.

Environment

One of the benefits of an ATV is that it can take you off the beaten path away from most communities. However, you should always respect nature and the rights of others to enjoy it. Do not ride in environmentally sensitive areas. Do not drive over crops or tree shrubs... nor cut down trees or take down fencing... nor spin your wheels and destroy the terrain. “Tread Lightly”.

Chasing wildlife is in many areas illegal. Wildlife can die of exhaustion after being chased by an ATV. If you encounter animals on the trail, stop and observe quietly and with caution. It will be one of the better memories of your life.

Observe the rule... “what you take in, carry out”. Do not litter. Do not start campfires unless you have permission to do so... and then only... away from dry areas. The hazards you may create on the trail may cause injury to others or yourself, even at a later date.

Respect farm lands. Always obtain the permission of the landowner before riding on private land. Respect crops, farm animals and property lines. If you come to a closed gate, close it again behind yourself.

Finally, do not pollute streams, lakes or rivers and do not modify the engine or muffling system, or remove any of its components.

Design Limitation

The fundamental design concept is a compromise between ruggedness which call for strength and weight, and light-footedness. Although the vehicle is exceptionally rugged for its class, it is still a light vehicle by definition and its operation must be restricted to its proper purpose.

The addition of weight to any part of the vehicle changes its gravitational stability and modifies its performance.

Off-Highway Operation

The very nature of off-highway operation is dangerous. Any terrain, which has not been specially prepared to carry vehicles, presents an inherent danger where angularity, terrain substance and exact steepness are unpredictable. The terrain itself presents a continual element of danger, which must be knowingly accepted by anyone venturing over it.

An operator who takes a vehicle off-road should always exercise the utmost care in selecting the safest path and keeping close watch on the terrain ahead of him. On no account should the vehicle be operated by anyone who is not completely familiar with the driving instructions applicable to the vehicle, nor should it be operated on steep or treacherous terrain.

General Operating and Safety Precautions

Care, caution, experience and driving skill are the best precautions against the hazards of ATV operation.

Whenever there is the slightest doubt that the vehicle can safely negotiate an obstacle or a particular piece of terrain, always choose an alternate route.

In off-road operation, power and traction, not speed, are important. Never drive faster than visibility and your own ability to select a safe route permit.

Constantly watch the terrain ahead for sudden changes in slopes or obstacles, such as rocks or stumps, that may cause loss of stability, resulting in tip-over or roll-over.

Never operate the vehicle if the controls do not function normally.

When operating in reverse, check that the path behind you is free of people or obstacles. Proceed slowly and avoid any sharp turns.

When stopped or parked always apply the parking brake. This is especially important when parking on a slope. On very steep inclines or if the ATV is carrying cargo, the wheels should be blocked using rocks or bricks. Remember to turn the fuel valve to the closed position.

Uphill Driving

Due to configuration, ATVs have excellent climbing ability, so much so that tip-over is possible before traction is lost. For example, it is common to encounter terrain situations where the top of the hill has eroded to a point that the hill peak rises very sharply. The ATV can readily negotiate such a condition, however, in doing so, when the front of the vehicle is driven to a point that the vehicle's balance changes rearward tip over can occur.

The same situation may apply if an embedded object causes the front of the vehicle to climb more than desired. If such a situation occurs take an alternate route. Be aware of sidehilling dangers when doing so.

It is also wise to know the terrain condition on the other side of the hill or bank. All too often there exists a sharp drop-off that is impossible to negotiate or descend.

Downhill Driving

As a rule, ATVs can climb slopes that are steeper than they can safely descend. Therefore, it is essential to assure that a safe route exists to descend a slope before you climb it.

Decelerating while negotiating a slippery downhill slope could “toboggan” the vehicle. Maintain steady speed and/or accelerate slightly to regain control.

Side Hilling

Whenever possible, such operation should be avoided. If necessary, do so with extreme caution. Sidehilling on steep inclines could result in roll-over. In addition, slippery or unfirm surfaces could result in uncontrollable side sliding. Do not attempt to turn the vehicle downhill with the slide. Avoid all objects or depressions that will intensify the raising of one side of the vehicle higher than the other, thus causing roll-over.

Drop-Offs

An ATV will “bottom-out” and usually stop if either the front or rear wheels are driven over a drop-off. If the drop is sharp or deep, the vehicle will nose dive and tip-over.

WARNING

Avoid negotiating drop-offs. Reverse and select an alternate route.

Riding Techniques

Riding your ATV too fast for the conditions may result in injury. Apply only enough throttle to proceed safely. Statistics show that high speed turns usually result in mishaps and injury. Always remember that an ATV is heavy! Its pure weight alone may entrap you should it fall and pin you down.

ATVs are not designed for jumping nor can they, or you, absorb the energy of high impacts such as jumping. Performing "wheelies" can cause the ATV to flip over onto you. Both practices have a high risk and should be avoided at all times.

To maintain proper control it is strongly advised that you keep your hands on the handlebar and within easy reach of all controls. The same holds true for your feet. To minimize the possibility of any leg or foot injury, keep your feet on the footrests at all times. Do not direct your toes outwards nor place your foot out to assist turning as they can be hit or snagged by passing obstacles or may contact the wheels.

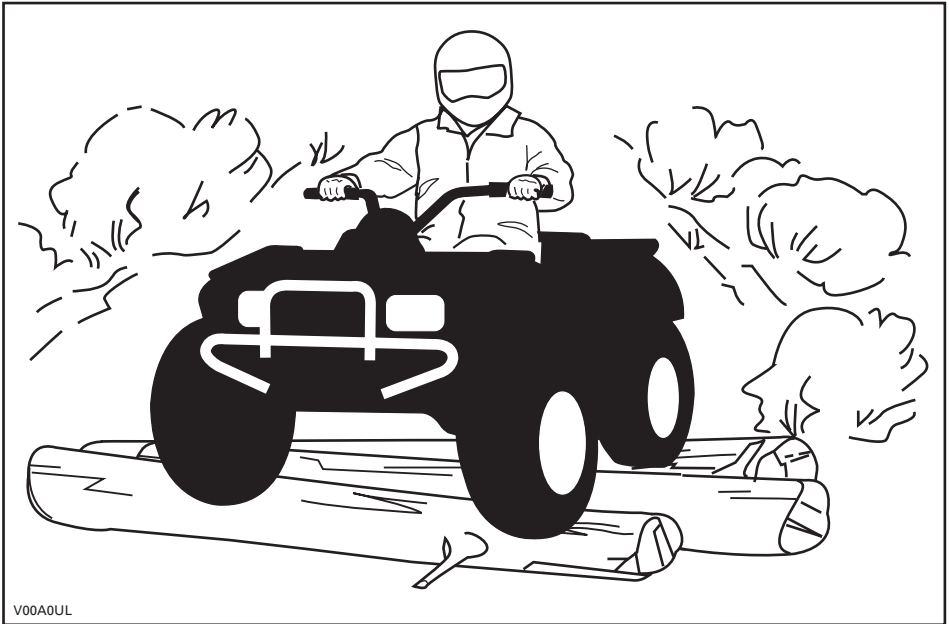

Even though there is an adequate suspension system on an ATV there are "wash-board" or rough terrain conditions that will make you feel uncomfortable and even cause back injury. "Posting" or riding in a crouched position will often be required. Slow down and allow your flexed legs to absorb impact.

An ATV is not designed for riding on roads or highways. (In most places it is an illegal practice). Riding your ATV on roads or highways could cause a collision to occur with another vehicle. ATV tires are not suited for paved road use. Pavement may seriously affect the handling and control of the ATV. Riding on roads or soft shoulders may confuse other road users, especially if your lights are on. If you have to cross a road, the lead driver should get off his ATV then observe and give directions to the other ATV riders. The last person after crossing then assists the lead driver to cross. Do not travel on sidewalks. They are designated for pedestrian use.

Water can be a unique hazard. If it is too deep the ATV may “float” and topple. Check the water depth and current before you attempt to cross any water. Water should not go above the footrest. Be wary of slippery surfaces such as rocks, grass, logs, etc., both in the water and on its banks. A loss of traction may occur. Do not attempt to enter the water at high speed. The water will act as a brake and could wash you away.

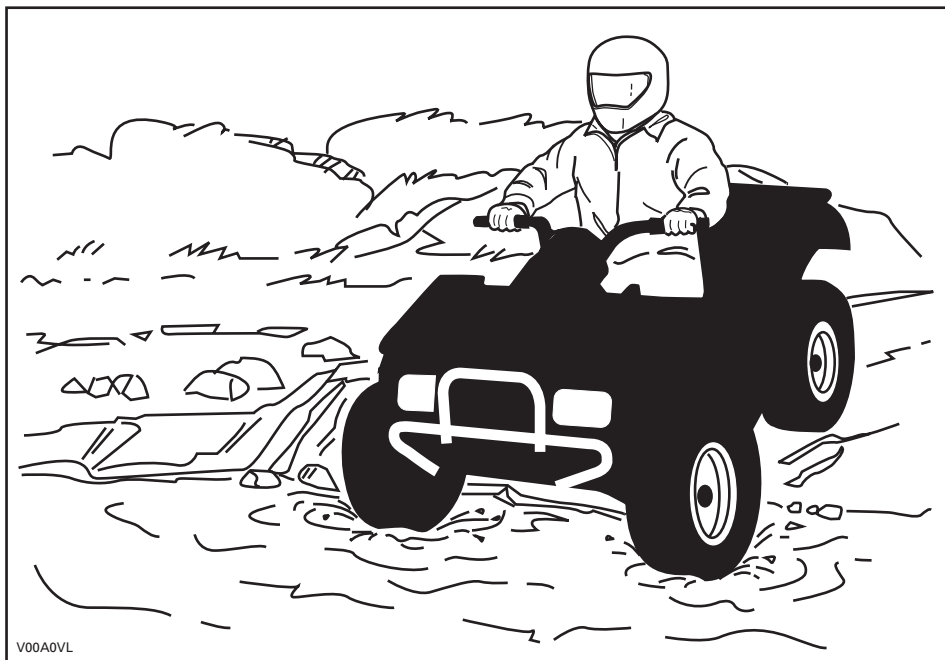

Water will affect the braking ability of your ATV. Make sure you dry the brakes by applying them several times after the ATV leaves the water.

Mud or marsh lands may be encountered near water. Be prepared for sudden “holes” or changes in depth. Similarly so, be watchful of hazards such as rocks, logs, etc., partially covered by vegetation.

If your trip crosses frozen waterways, make sure the ice is thick enough to support the total weight of yourself, the ATV and its load. Be ever watchful of open ice... it is a sure indication that the thickness of the ice varies. If in doubt, do not attempt to cross.

Ice will also affect the control of an ATV. Slow down and do not “gun” the throttle. This will only result in spinning of the tires and possible tipover of the ATV. Avoid rapid braking. This again will possibly result in an uncontrolled slide and tipover of the ATV. Slush should be avoided at all times since it could block the operation or controls of the ATV.

Sand and riding on sand dunes or on snow is another unique experience but there are some basic precautions that should be observed. Wet, deep or fine sand/snow may create a loss of traction and cause the ATV to slide, drop off or become “bogged” down. If this occurs look for a firmer base. Again, the best advice is to slow down and be watchful of the conditions.

When riding in sand dunes it is advisable to equip the ATV with an antenna type safety flag. This will help make your location more visible to others over the next sand bank. Proceed carefully should you see another safety flag ahead. Since the antenna type safety flag can snag and rebound on your body if caught, do not use it in areas where there are low hanging branches or obstacles.

Riding on loose stones or gravel is very similar to riding on ice. They will affect the steering of an ATV... possibly causing it to slide and tipover, especially at high speeds. In addition, braking distance may be affected. Remember that “gunning” the throttle or sliding may cause loose stones to be ejected rearwards, into another ATV rider’s way.

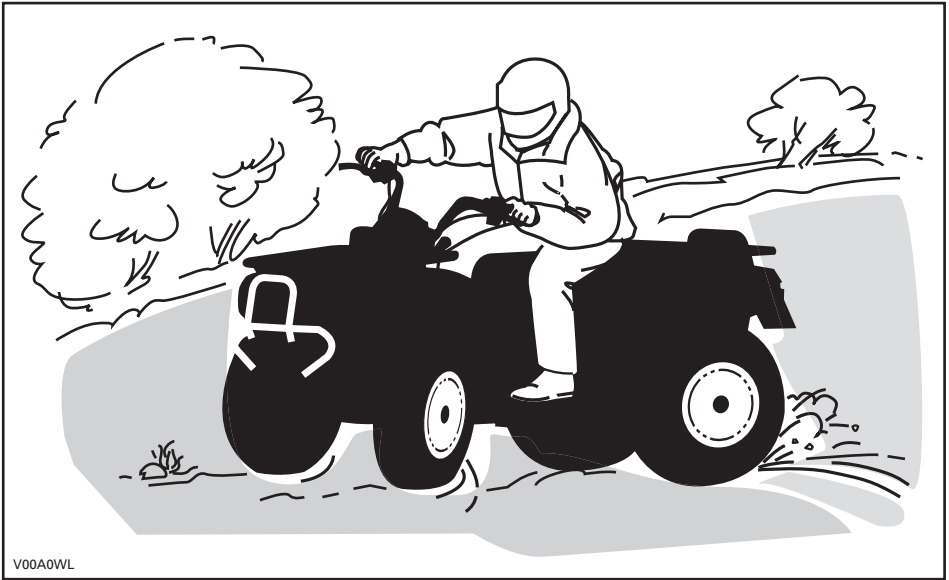

If you do get into a slide or skid, it may help to turn the handlebar into the direction of the skid until you regain control. Never jam the brakes and lock the wheels.

Respect and follow all posted trail signs. They are there to help you and others.

Obstacles on the "trail" should be crossed with caution. This includes loose rocks, fallen trees, slippery surfaces, fences, posts, embankments and depressions. You should avoid them whenever possible. Remember that some obstacles are too large or dangerous to cross and should be avoided. Small rocks or fallen trees may be safely crossed if approached at a 90° angle. Stand on the footrests while keeping your knees flexed. Adjust speed without losing momentum and do not "gun" the throttle. Hold handlebar firmly. Place your body weight rearwards and proceed. Do not try to lift the ATV's front wheels off the ground. Be aware that the object may be slippery or may move while crossing.

When driving on hills or slopes two things are highly important: be prepared for slippery surfaces or terrain variations and obstacles and use proper body positioning.

While reading this *Operator's Guide*, remember that:

 **WARNING**

Indicates a potential hazard that, if not avoided, could result in serious injury or death.

Uphill

Keep your body weight forward towards the top of the hill. Keep your feet on the footrests and shift into low gear then accelerate and when necessary, change gear quickly as you climb. Do not over-speed since this may cause the front of the ATV to lift from the ground and fall back on you. If the hill is too steep and you cannot proceed or the ATV begins to roll backwards, apply the brake, being careful not to slide. Dismount then use the "U" turn or "K" turn (while walking back, next to the ATV on the up hill side and with a hand on the brake lever, slowly back the rear of the ATV toward the top of the hill then drive downhill). Always walk or dismount on the upside of the slope while keeping clear of the ATV and its rotating wheels. Do not try to hold on to an ATV if it begins to topple. Stay clear. Do not ride over the crest of the hill at high speed. Obstacles, including sharp drop-offs, may exist.

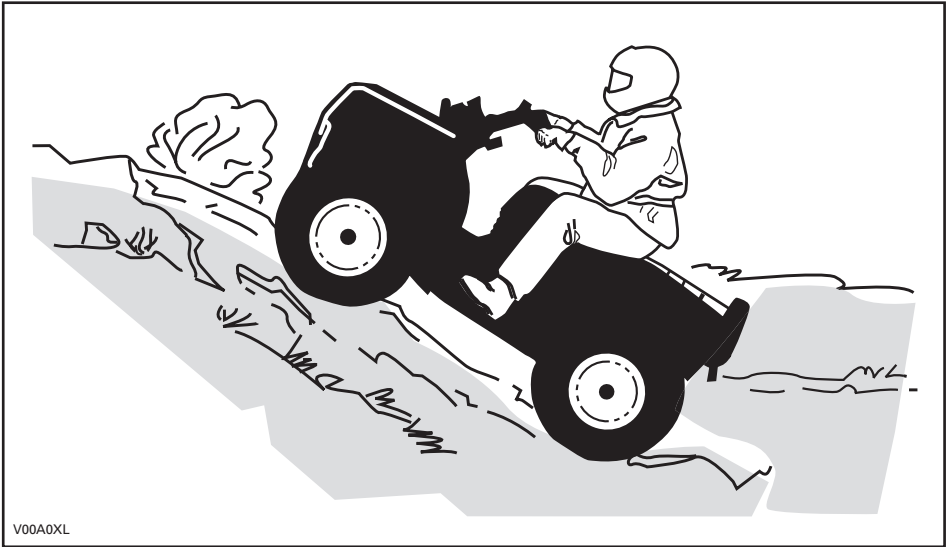

V00A0XL

Downhill

Keep your body weight rearwards. Apply the brake gradually to prevent skidding. Do not "coast" down the slope using solely engine compression or in neutral gear.

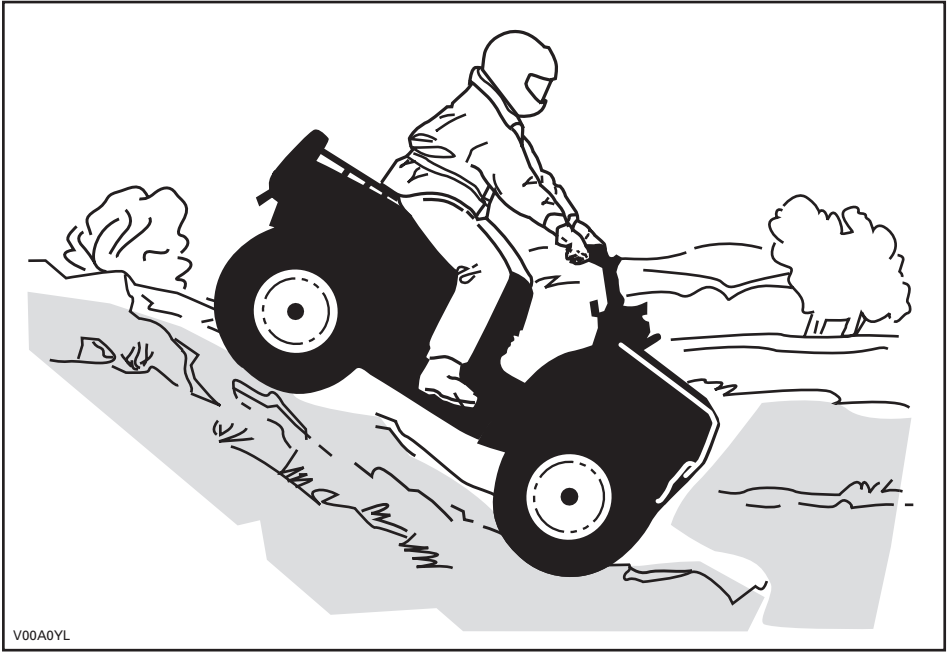

Side-Hilling

This is one of the **most risky** types of riding since it may drastically change the balance of the ATV. It should be avoided wherever possible. If it is necessary to do so however, it is important that you **ALWAYS** keep your body weight on the upside of the slope... and be prepared to dismount on that side should the ATV begin to topple. **Do not try to stop or save the ATV from damage.**



Routine Maintenance

Once your ride completed it is wise to remove any build up of snow, ice, mud and grime. Not only will this help you keep the ATV longer and in good condition for resale but will eliminate potential hazards the next time you use the ATV. Wash the ATV with warm soapy water then allow it to dry. (A towel may help). Do not wash the ATV outside during freezing weather. Apply appropriate lubrication as described in the MAINTENANCE section.

Part of your responsibility towards safety is to respect the contents of this *Operator's Guide*. It provides valuable advice on how to properly take care of your ATV. If further assistance is required your authorized Bombardier ATV dealer is always willing to help.

Modification of the ATV to increase speed and performance may violate the terms and conditions of your ATV limited warranty. In addition, certain modifications including the removal of engine or exhaust components are illegal under most laws.

Changing the wheel and/or tire size may affect the stability of the ATV. Incorrect tire pressure may lead to blow outs or cause a tire to move around on its rim and become lost or damaged. Wheels or tires which are damaged should always be replaced.

LOCATION OF THE IMPORTANT LABELS

The following labels are on your ATV. If missing or damaged, they can be replaced free of charge. See an authorized Bombardier ATV dealer.

NOTE: The following illustrations used in this *Operator's Guide* are a general representation only. Your model may differ.

Quest Series

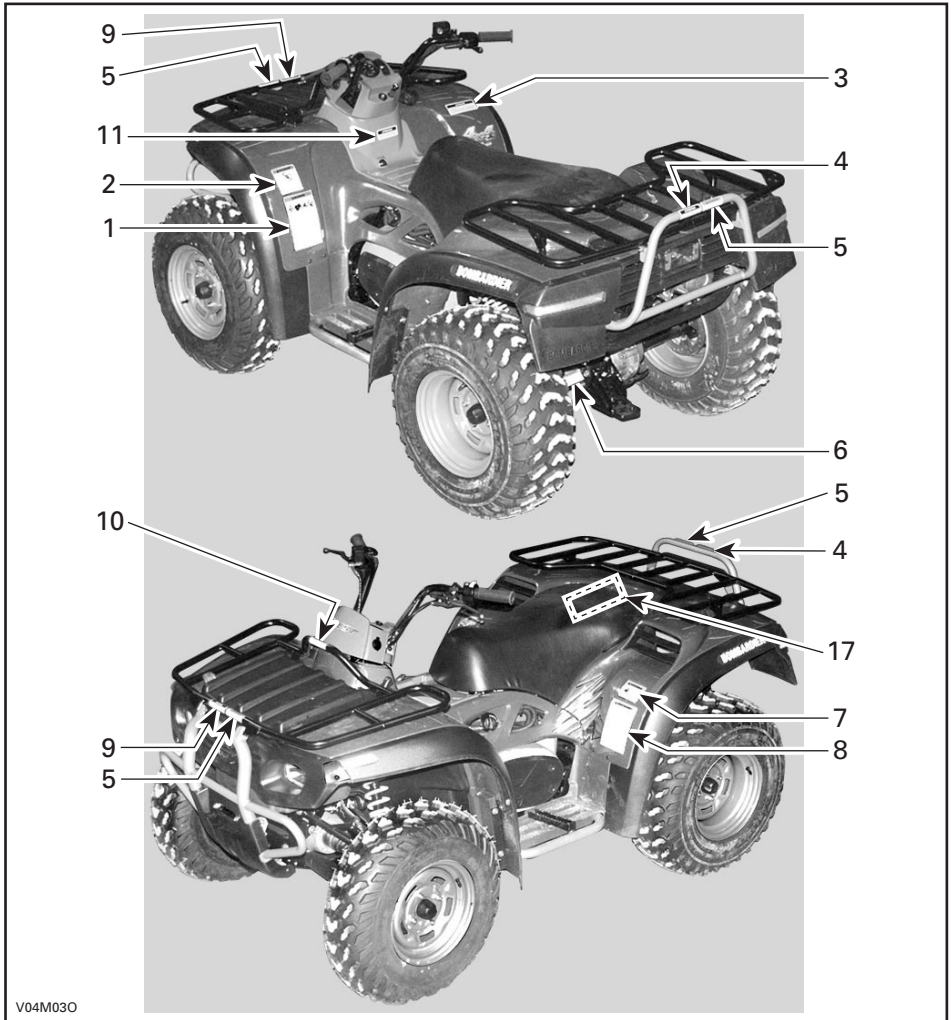

Traxter Series except Traxter XL

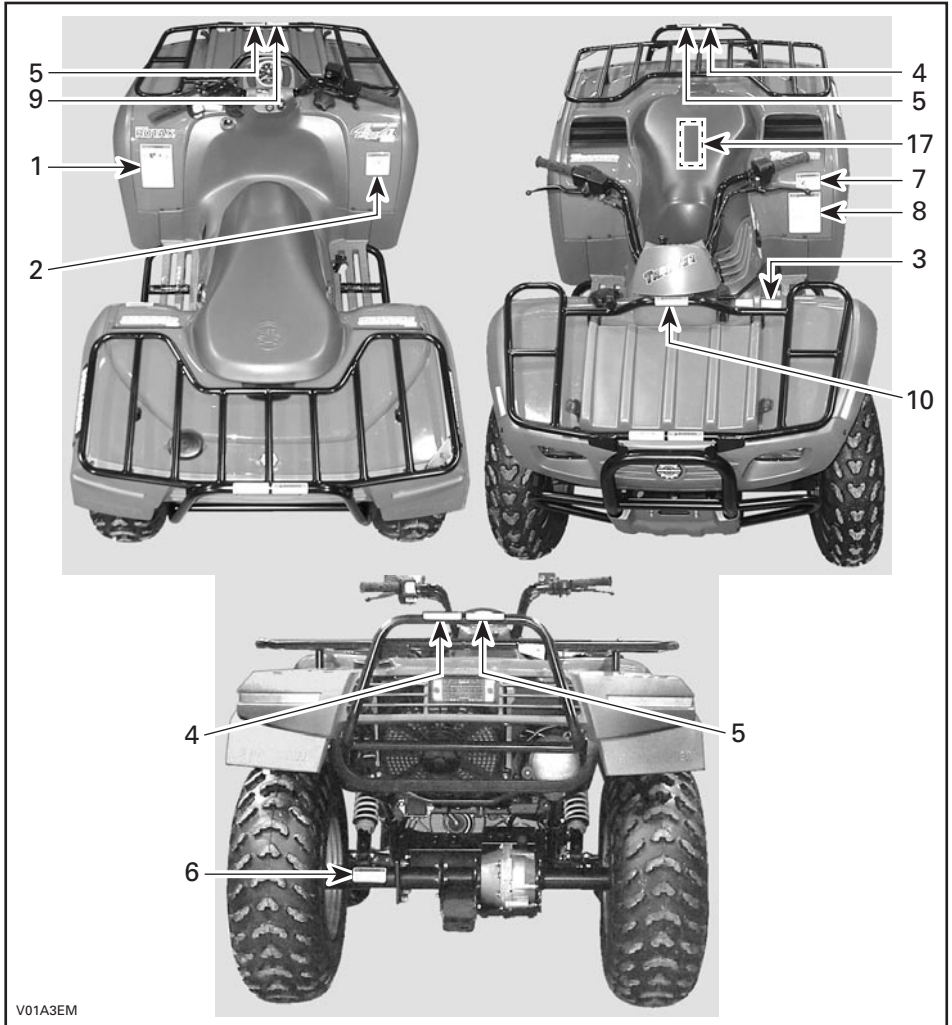

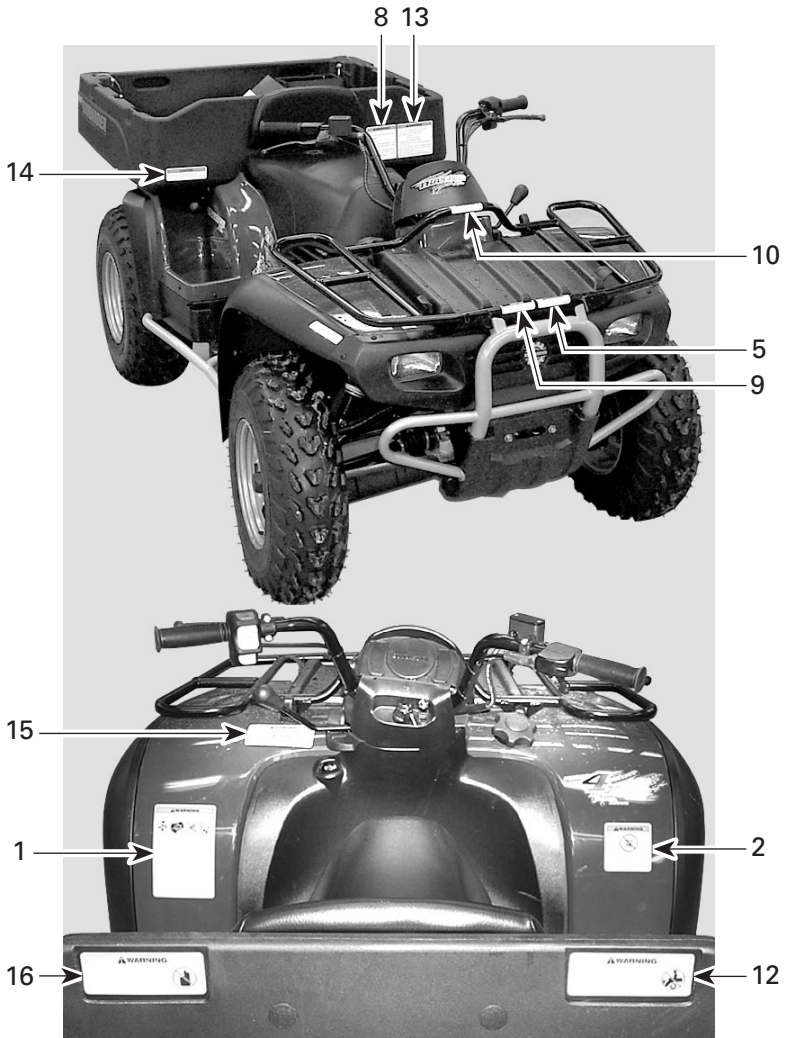

V03M0CM

Label 1

⚠ WARNING

Improper ATV use can result in SEVERE INJURY or DEATH.



ALWAYS USE AN APPROVED HELMET AND PROTECTIVE GEAR.



NEVER USE ON PUBLIC ROADS.



NEVER CARRY PASSENGERS.



NEVER USE WITH DRUGS OR ALCOHOL.

NEVER operate:

- without proper training or instructions.
- at speeds too fast for your skills or the conditions.
- on public roads - a collision can occur with another vehicle.
- with a passenger - passengers affect balance and steering and increase risk of losing control.

ALWAYS:

- use proper riding techniques to avoid vehicle overturns on hills and rough terrain and in turns.
- avoid paved surfaces - pavement may seriously affect handling and control.

LOCATE AND READ OPERATOR'S GUIDE.
FOLLOW ALL INSTRUCTIONS & WARNINGS.

XXX XXX XXX

V01M01Z

QUEST AND TRAXTER SERIES

Label 4

CAUTION

MAXIMUM REAR LOAD : 175 lb (80 kg)
(Includes trailer tongue weight if applicable)

704 900 013

V01M04Z

QUEST AND TRAXTER SERIES EXCEPT TRAXTER XL

Label 5

⚠ WARNING

NEVER sit here.

704 900 017

V01M050

QUEST AND TRAXTER SERIES

Label 2

⚠ WARNING



UNDER
16

Operating this ATV if you are under the age of 16 increases your chance of SEVERE INJURY or DEATH.

NEVER operate this ATV if you are under age 16.

704 900 011

V01M02Z

QUEST AND TRAXTER SERIES

Label 6

⚠ WARNING

Improper loading of a trailer may cause loss of vehicle control.

- Maximum towing weight: **1100 lb (500 kg).**
- Maximum tongue weight: **30 lb (14 kg).**

704 900 009

V01M06Z

QUEST AND TRAXTER SERIES

Label 3

CAUTION

- ATV **MUST** be stopped before shifting transmission lever.
- Always apply foot brake to shift from PARK (P).

704 900 007

V01M03Z

QUEST AND TRAXTER SERIES EXCEPT TRAXTER XL

Label 7

⚠ WARNING



NEVER ride as a passenger.
Passengers can cause a loss of control, resulting in **SEVERE INJURY** or **DEATH**.

704 900 005

V01M07Z

QUEST AND TRAXTER SERIES EXCEPT TRAXTER XL

Label 8

⚠ WARNING

Improper tire pressure or overloading can cause loss of control.
Loss of control can result in **SEVERE INJURY** or **DEATH**.

TIRE PRESSURE

- Set with tires cold:
 - Recommended: FRONT: 37,9 kPa, (0,39 kgf/cm²), 5,5 psi.
REAR: 31,0 kPa, (0,32 kgf/cm²), 4,5 psi.
 - Minimum: FRONT: 34,5 kPa, (0,35 kgf/cm²), 5,0 psi.
REAR: 27,6 kPa, (0,28 kgf/cm²), 4,0 psi.
- Never set tire pressure below minimum. It could cause the tire to dislodge from the rim.

LOADING / TRAILER TOWING

- Cargo or trailer can affect stability and handling.
- When loading with cargo or towing a trailer:
 - Reduce speed.
 - Allow more room to stop.
 - Avoid hills and rough terrain.
- Maximum Vehicle Load: 485 lb (220 kg).
Includes weight of operator, cargo and accessories (and if applicable, trailer tongue weight).

704 900 246

V04M07Y

QUEST SERIES

⚠ WARNING

Improper tire pressure or overloading can cause loss of control.
Loss of control can result in **SEVERE INJURY** or **DEATH**.

TIRE PRESSURE

- Set with tires cold:
 - Recommended: FRONT: 37,9 kPa, (0,39 kgf/cm²), 5,5 psi.
REAR: 34,5 kPa, (0,35 kgf/cm²), 5,0 psi.
 - Minimum: FRONT: 34,5 kPa, (0,35 kgf/cm²), 5,0 psi.
REAR: 31,0 kPa, (0,32 kgf/cm²), 4,5 psi.
- Never set tire pressure below minimum. It could cause the tire to dislodge from the rim.

LOADING / TRAILER TOWING

- Cargo or trailer can affect stability and handling.
- When loading with cargo or towing a trailer:
 - Reduce speed.
 - Allow more room to stop.
 - Avoid hills and rough terrain.
- Maximum Vehicle Load: 485 lb. (220 kg).
Includes weight of operator, cargo and accessories (and if applicable, trailer tongue weight).

704 900 133

V01M0CY

TRAXTER SERIES EXCEPT TRAXTER XL

⚠ WARNING

Improper tire pressure can cause loss of control.
Loss of control can result in **SEVERE INJURY** or **DEATH**.

TIRE PRESSURE

- Set with tires cold:
 - Recommended: FRONT: 48,3 kPa, 0,49 kgf / cm², 7,0 psi.
REAR: 48,3 kPa, 0,49 kgf / cm², 7,0 psi.
 - Minimum FRONT: 41,4 kPa, 0,42 kgf / cm², 6,5 psi.
REAR: 41,4 kPa, 0,42 kgf / cm², 6,5 psi.
- Never set tire pressure below minimum. It could cause the tire to dislodge from the rim.

704 900 133

V03M04Y

TRAXTER XL

Label 9

CAUTION

MAXIMUM FRONT LOAD : 90 lb (40 kg)
(Includes front storage tray load : 22 lb (10 kg))

704 900 015

V01M09Z

QUEST AND TRAXTER SERIES

Label 10

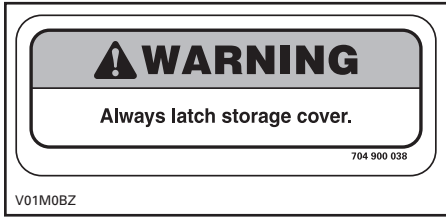

QUEST AND TRAXTER SERIES

Label 11

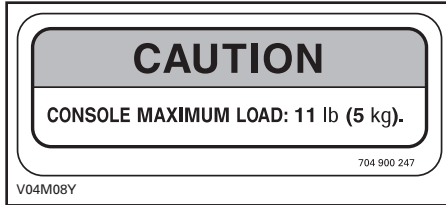

QUEST SERIES

Label 12

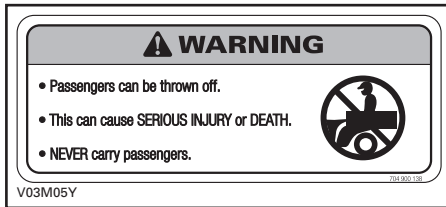

TRAXTER XL

Label 13

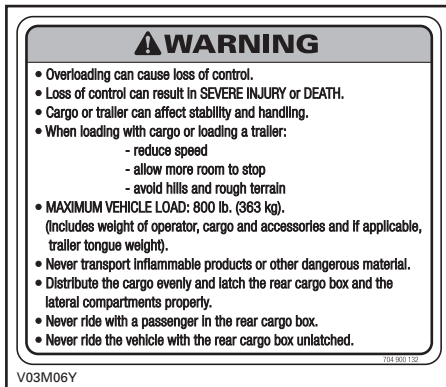

TRAXTER XL

Label 14

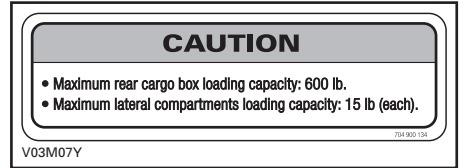

TRAXTER XL

Label 15

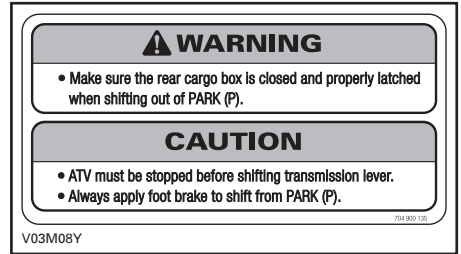

TRAXTER XL

Label 16

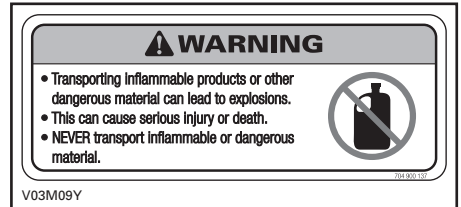

TRAXTER XL

Label 17

VEHICLE EMISSION CONTROL INFORMATION	ENGINE FAMILY: 4BCXX.4983GC EXHAUST EMISSION CONTROL SYSTEM: EM DISPLACEMENT: 498.0cc TUNE-UP SPECIFICATIONS:		BOMBARDIER <i>RECREATIONAL PRODUCTS</i>	
	IDLE SPEED: IDLE AIR/FUEL MIXTURE SETTING:	1300 RPM ± 100 RPM FROM POSITION OF PILOT SCREW FOR MAXIMUM SPEED AT IDLE, UNSCREW 3/4 OF TURN		
	SPARK PLUG: FUEL: (RON + MON) /2 ENGINE OIL:	NGK DCPR8E ELECTRODE GAP → 0.6 mm - 0.7 mm UNLEADED 87 OCTANE SAE 10W40		
	THIS VEHICLE CONFORMS TO CALIFORNIA REGULATIONS APPLICABLE TO 2004 MODEL YEAR NEW OFF-ROAD MOTORCYCLES AND ALL TERRAIN VEHICLES AND IS CERTIFIED TO 10 g/bhp-hr HC+NOx ENGINE FAMILY EXHAUST EMISSION STANDARD.			
V04M0BL				704 900 326

QUEST 500 AND QUEST 500 XT

VEHICLE EMISSION CONTROL INFORMATION	ENGINE FAMILY: 4BCXX.6442GC EXHAUST EMISSION CONTROL SYSTEM: EM DISPLACEMENT: 644.0cc TUNE-UP SPECIFICATIONS:		BOMBARDIER <i>RECREATIONAL PRODUCTS</i>	
	IDLE SPEED: IDLE AIR/FUEL MIXTURE SETTING:	1100 RPM ± 100 RPM FROM POSITION OF PILOT SCREW FOR MAXIMUM SPEED AT IDLE, UNSCREW 3/4 OF TURN		
	SPARK PLUG: FUEL: (RON + MON) /2 ENGINE OIL:	NGK DCPR8E ELECTRODE GAP → 0.6 mm - 0.7 mm UNLEADED 87 OCTANE SAE 10W40		
	THIS VEHICLE CONFORMS TO CALIFORNIA REGULATIONS APPLICABLE TO 2004 MODEL YEAR NEW OFF-ROAD MOTORCYCLES AND ALL TERRAIN VEHICLES AND IS CERTIFIED TO 10 g/bhp-hr HC+NOx ENGINE FAMILY EXHAUST EMISSION STANDARD.			
V01M0NL				704 900 327

QUEST 650 AND QUEST 650 XT

Label 17 (cont'd)

VEHICLE EMISSION CONTROL INFORMATION	ENGINE FAMILY: 4BCXX.4982GC EXHAUST EMISSION CONTROL SYSTEM: EM DISPLACEMENT: 497.70cc TUNE-UP SPECIFICATIONS:	<div style="display: flex; justify-content: space-between; align-items: center;"> <div style="text-align: left;"> <p>BOMBARDIER</p> <p><i>RECREATIONAL PRODUCTS</i></p> </div>  </div>
	IDLE SPEED: IDLE AIR/FUEL MIXTURE SETTING:	1100 RPM ± 100 RPM FROM POSITION OF PILOT SCREW FOR MAXIMUM SPEED AT IDLE, UNSCREW 3/8 OF TURN
	SPARK PLUG: FUEL: (RON + MON) /2 ENGINE OIL:	NGK DR8EA ELECTRODE GAP → 0.6 mm - 0.7 mm UNLEADED 87 OCTANE SAE 10W40
	THIS VEHICLE CONFORMS TO CALIFORNIA REGULATIONS APPLICABLE TO 2004 MODEL YEAR NEW OFF-ROAD MOTORCYCLES AND ALL TERRAIN VEHICLES AND IS CERTIFIED TO 10 g/bhp-hr HC+NOx ENGINE FAMILY EXHAUST EMISSION STANDARD.	
V01M0YL		704 900 625

TRAXTER SERIES EXCEPT TRAXTER XL

VEHICLE INFORMATION

HOW TO IDENTIFY YOUR ATV

The main components of your vehicle (engine and frame) are identified by different serial numbers. It may sometimes become necessary to locate these numbers for warranty purposes or to trace your vehicle in the event of loss. These numbers are required by the authorized Bombardier ATV dealer to complete warranty claims properly. No warranty will be allowed by Bombardier Inc. if the engine identification number (EIN) or vehicle identification number (VIN) is removed or mutilated in any way. We strongly recommend that you take note of all the serial numbers on your vehicle and supply them to your insurance company.

Engine and Vehicle Identification Number Location

Quest Series

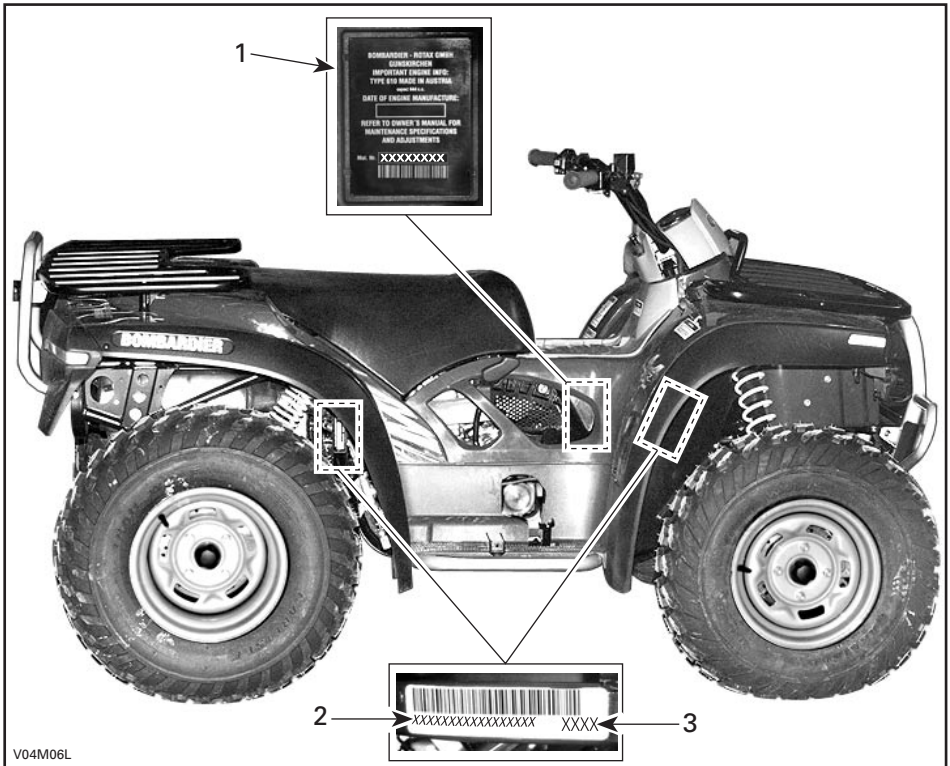

TYPICAL

1. EIN (Engine Identification Number)
2. VIN (Vehicle Identification Number)
3. Model

Traxter Series

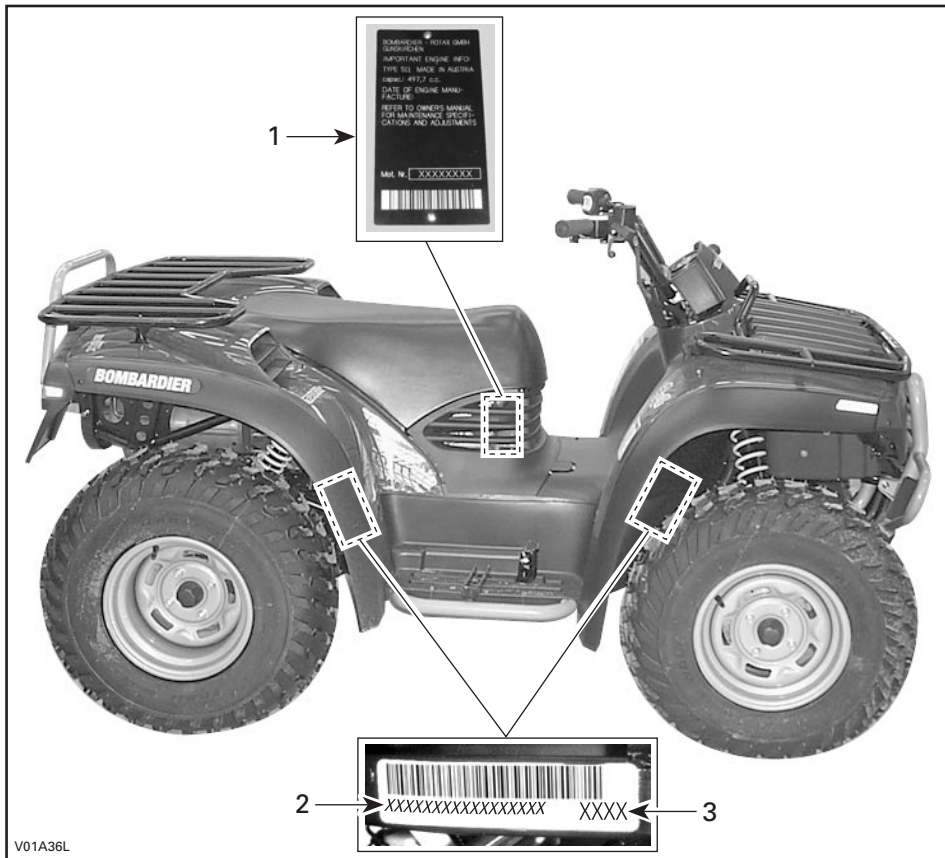

TYPICAL

1. EIN (Engine Identification Number)
2. VIN (Vehicle Identification Number)
3. Model

EMISSION REQUIREMENTS

The California Air Resources Board (CARB) requires that your ATV comply with applicable exhaust emissions standards during its useful life, when operated and maintained according to the instructions supplied.

A non-compliance Red Label (as well as a Green Label) is obtained annually during California Vehicle registration. The appropriate label is denoted by the vehicle identification number (in the 8th character detailed herein).

VEHICLE CATEGORY	VIN 8th CHARACTER
Non-complying Red Label	Must denote a C or 3
Complying Green Label	Any alphanumeric designation other than a C or 3

CONTROLS/INSTRUMENTS/EQUIPMENT

NOTE: Some controls/instruments/equipment do not apply to some models. In these cases their reference numbers are deliberately missing in the illustrations. Some controls/instruments/equipment are optional on some models.

Quest Series

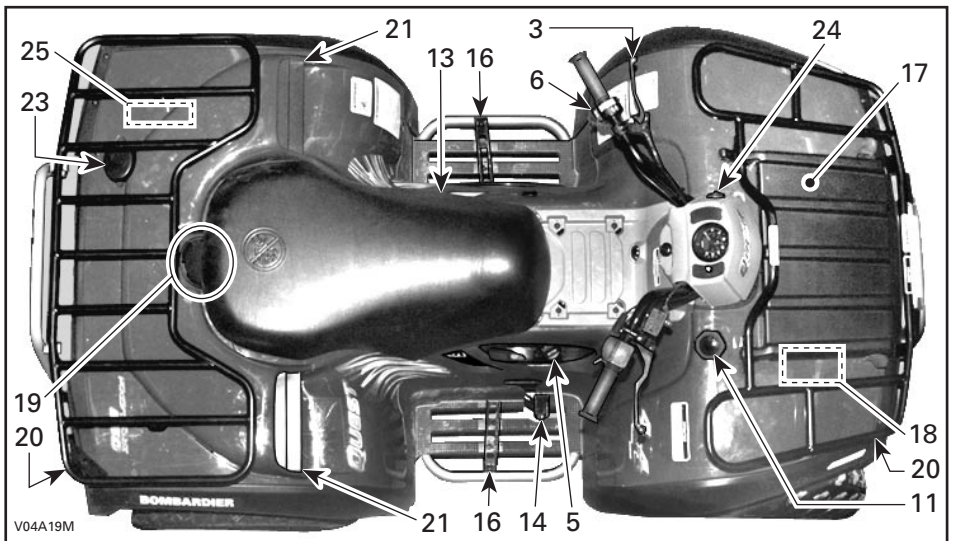
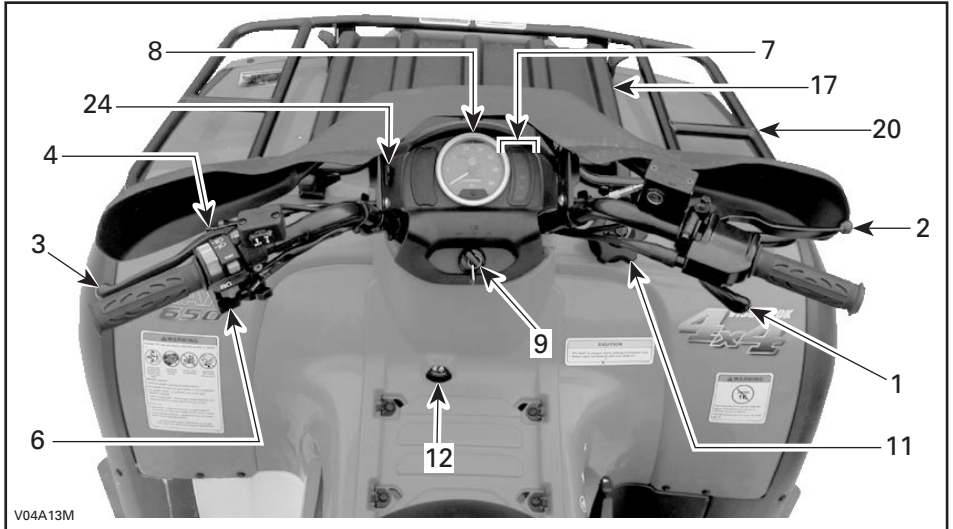

Quest Series (cont'd)

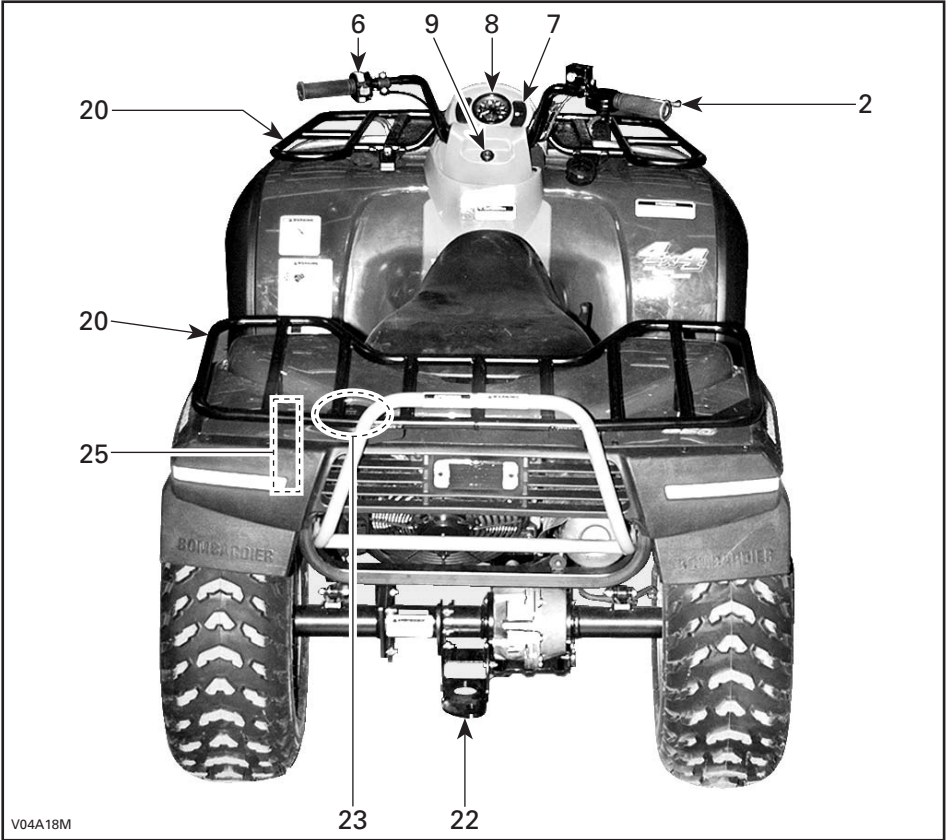

V04A18M

Traxter Series

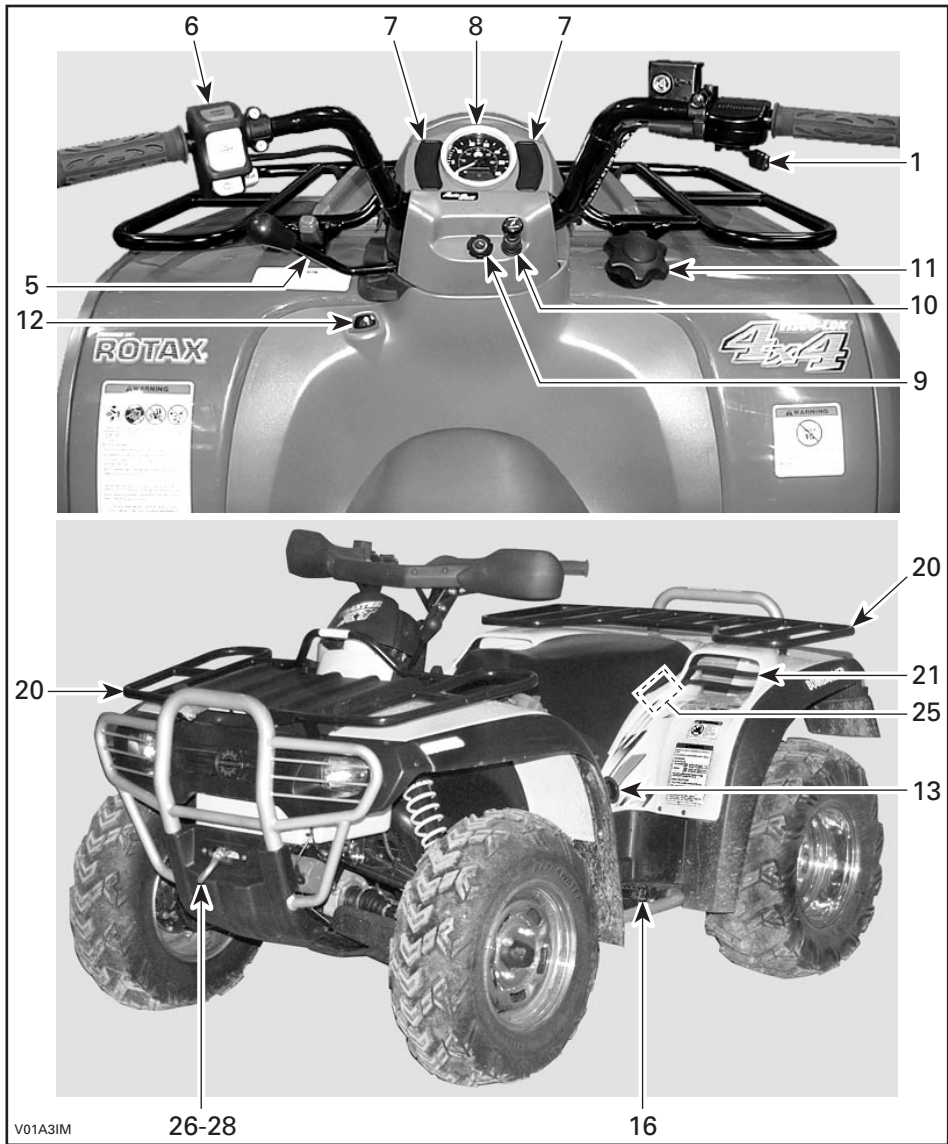

V01A31M

26-28

16

Traxter Series (cont'd)

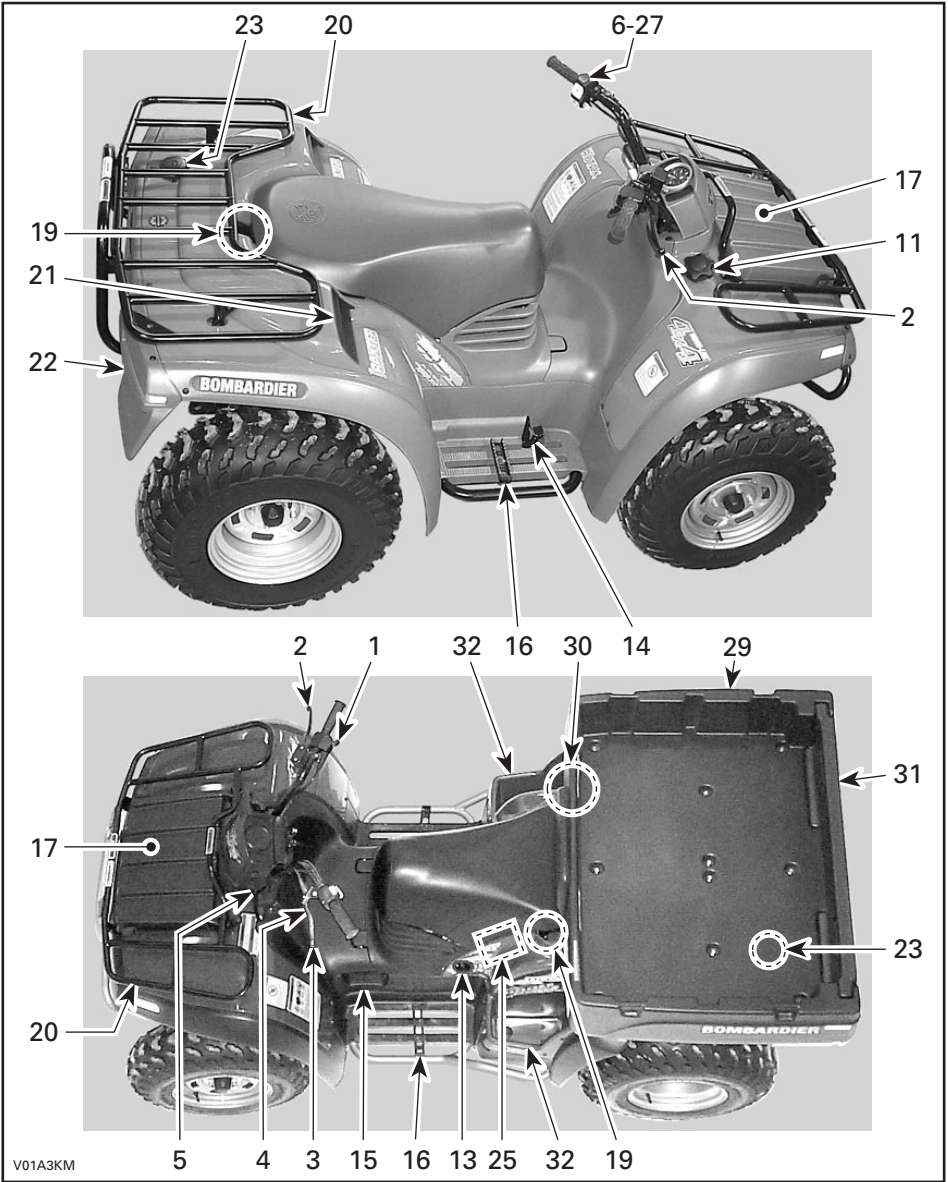

V01A3KM

While reading this *Operator's Guide*, remember that:

WARNING

Indicates a potential hazard that, if not avoided, could result in serious injury or death.

NOTE: This section gives basic functions of the various controls of your ATV. For more details of how to operate one control in conjunction with some others, refer to OPERATING INSTRUCTIONS further in this section.

1) Throttle Lever

Quest and Traxter Series

Located on the right side of handlebar. When pushed, it increases the engine speed that allows the engagement of the transmission on the selected gear.

When released, the engine speed should return automatically to idle and the vehicle will gradually slow down.

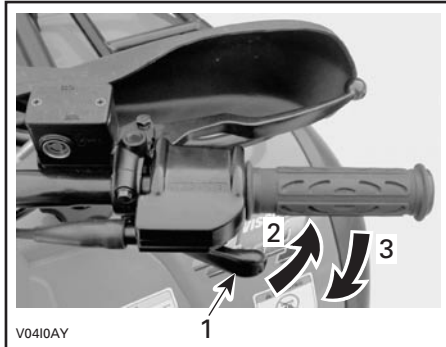

1. Throttle lever
2. To accelerate
3. To decelerate

2) Front Brake Lever

Quest and Traxter Series

Located on the right side of handlebar. When compressed, the brake is applied. When released, it should automatically return to its original position. Braking effect is proportional to the force applied on the lever and to the type and condition of the terrain. The front brake will have also an effect on rear wheels through the drive train.

See the note at **Rear Brake Lever** below for additional information.

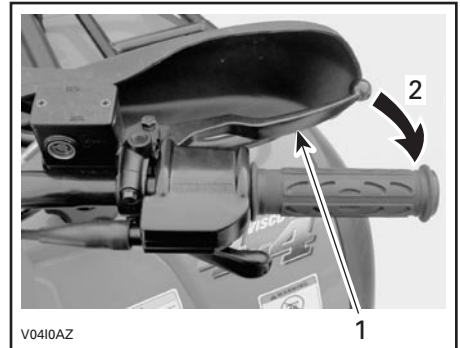

1. Brake lever
2. To apply brake

3) Rear Brake Lever

Quest and Traxter Series

Located on the left side of handlebar. When compressed, the brake is applied. When released, it should automatically return to its original position. Braking effect is proportional to the force applied on the lever and to the type and condition of the terrain.

NOTE: Using the rear brake will have also an effect on front wheels because they are interconnected through the drive train. As on other wheeled vehicles, the vehicle weight is transferred to the front wheels when braking. To obtain greater stopping efficiency, the brake system distributes more braking force to the front wheels. This will affect vehicle handling and steering control when braking vigorously. Take it into account when braking.

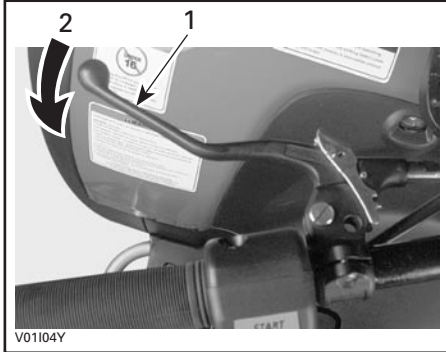

TYPICAL

1. Brake lever
2. To apply brake

4) Brake Lever Lock

Quest and Traxter Series

Located on left side of handlebar on the rear brake lever. When applied, it prevents the vehicle from moving. Useful when the brake needs to be locked for example such as doing a K-turn, during transportation or when the vehicle is not in operation.

⚠ WARNING

Always use the brake lever lock **and** engage the PARK position on the transmission lever when the vehicle is not in operation.

⚠ WARNING

Make sure brake lever lock is fully disengaged before operating the ATV.

When you ride the vehicle, brakes that are caused to drag by a continuous pressure on the lever may cause damage to the brake system and cause loss of braking capacity and/or fire.

To engage mechanism: Squeeze brake lever and maintain while moving lever lock. Brake lever is now compressed and applying rear brakes.

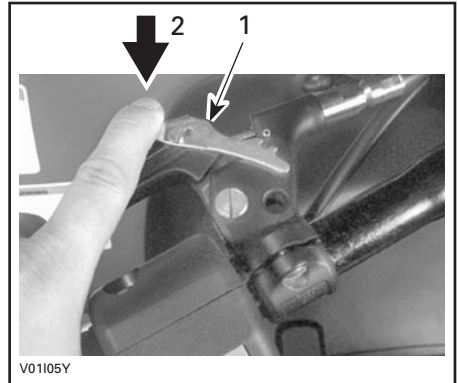

TYPICAL

1. Brake lever lock
2. Press to apply parking brake

To release mechanism: Squeeze brake lever. Lever lock should automatically return to its original position. Brake lever should return to rest position. Always release brake lever lock before riding.

5) Transmission Lever

Quest Series

Located on the right side of vehicle. A 5-position lever: P, R, N, H and L.

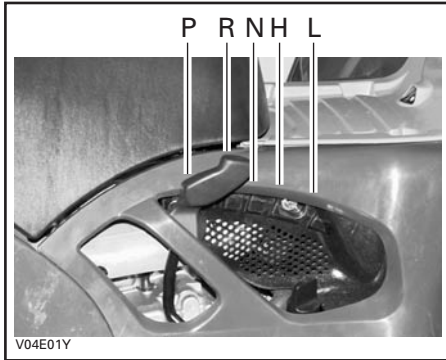

To change the transmission position, completely stop vehicle then move lever to the right then to the desired position while moving lever forward. Do not force lever. If unable to shift, gently apply throttle to move ATV and try again.

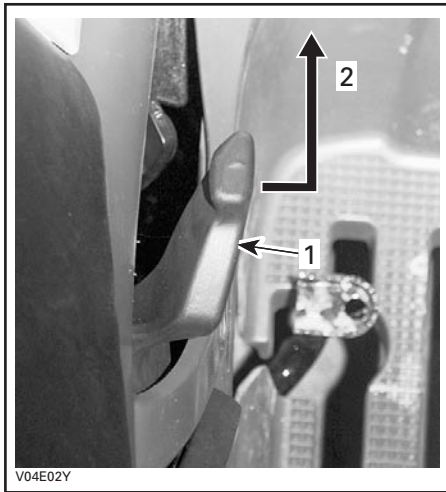

1. Transmission lever
2. To change position

CAUTION: Always completely stop the vehicle and apply the brake prior to moving the transmission lever.

Traxter Series

Located on the left side of steering column. A 5-position lever: P, R, N, H and L. To change the transmission position, completely stop vehicle then move lever to the desired position while pulling lever upward. Do not force lever. If unable to shift, gently apply throttle to move the vehicle and try again.

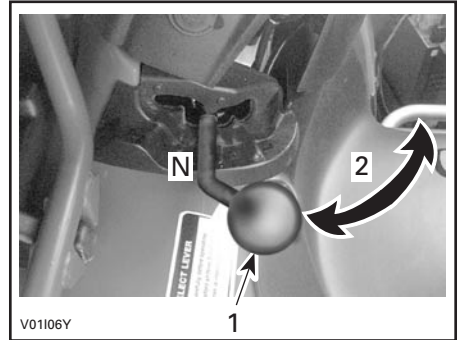

1. Transmission lever
2. To change position

CAUTION: Always completely stop the vehicle and apply the brake prior to moving the transmission lever.

Quest and Traxter Series

P: Park

This position locks the transmission to help prevent vehicle movement. Always use when the vehicle is not in operation. In some circumstances, it may be necessary to rock the vehicle back and forth to move the gears in the transmission to allow the park to be engaged.

R: Reverse

This allows the vehicle to go backward. The vehicle speed is limited.

WARNING

Before moving vehicle in reverse, ensure the path behind is clear of obstacles or bystanders. Remain seated.

N: Neutral

This position disengages the transmission to allow manual vehicle movement or towing.

H: High gear

This selects the high speed range of the transmission in the gear box. It is the normal riding position. It allows the vehicle to reach its maximum speed.

L: Low gear

This selects the low speed range of transmission in the gear box. It is the working position. It allows the vehicle to move slowly with the maximum traction and power.

NOTE: Use the low speed range to pull any load or to climb a steep slope.

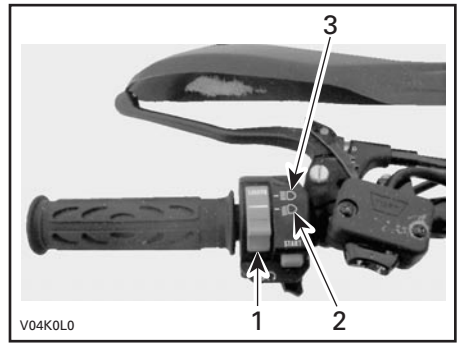

1. Headlamp switch
2. Low beam position
3. High beam position

NOTE: Place ignition switch to ON "without light" position to close the headlamp.

6) Multi-Function Switch

Quest Series

The multi-function switch is located on the left side of handlebar.

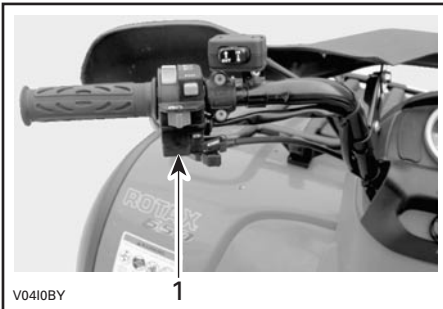

QUEST SERIES

1. Multi-function switch

The controls located on this multi-function switch are:

Headlamp Switch

Located on the top of multi-function switch. Place headlamp switch to LO for the low beam and taillight. Place headlamp switch to HI for the high beam and taillight.



ON POSITION "WITHOUT LIGHT"

Engine Stop Switch

Located at the middle of multi-function switch. The engine will turn over but will not start if the engine stop switch is turned to OFF position.

This switch can be used to stop engine and as an emergency control.

NOTE: While engine can be stopped by turning ignition key OFF, we recommend the engine be stopped by the engine stop switch.

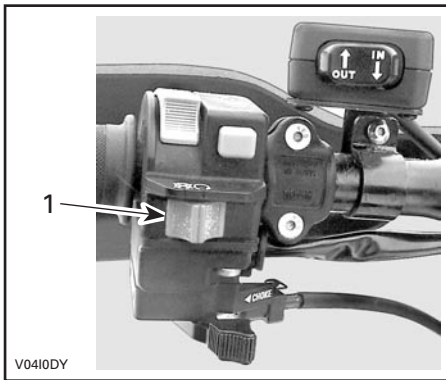

V0410DY

1. Engine stop switch

To stop engine, fully release throttle lever then use the engine stop switch.

Start Button

Located above the engine stop switch.

To start engine, place the engine stop switch to RUN.

Press and hold the start button. Release immediately after engine is started.

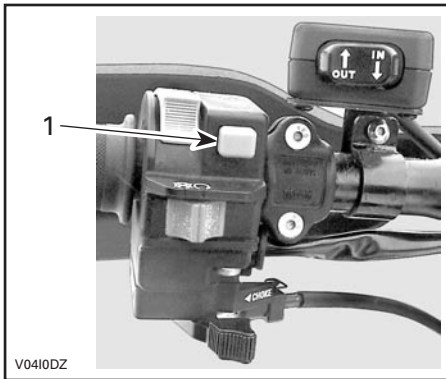

V0410DZ

1. Start button

Choke Lever

Located at bottom of multi-function switch. This device features a variable lever to ease cold start.

Position OFF is for normal use with a warm engine.



V0410EY

CHOKE LEVER IN THE OFF POSITION

The full choke position is used for lower engine temperature.



V0410FY

CHOKE LEVER IN THE FULL CHOKE POSITION

The other positions between OFF and FULL position, will be use depending on the engine temperature.

Traxter Series

The multi-function switch is located on the left side of handlebar.

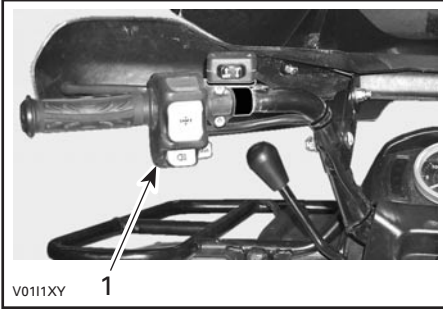

TRAXTER SERIES

1. Multi-function switch

The controls located on this multi-function switch are:

Electric Gear Shift Button

Located at the middle of multi-function switch. When pressing on the upper face, it shifts the transmission to the next higher gear. When pressing on the lower face, it shifts the transmission to the next lower gear.

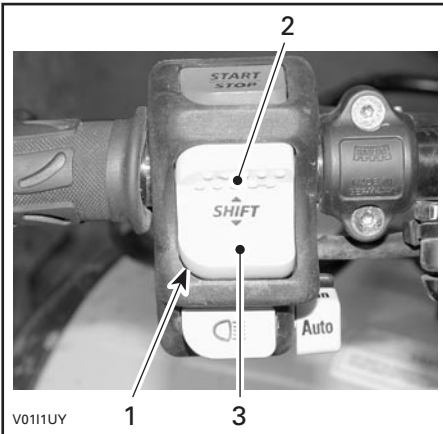

1. Gear shift button
2. Press here to upshift
3. Press here to downshift

The lower the gear, the slower the vehicle speed and the higher the gear, the higher the vehicle speed.

Vehicle must be running to allow gear change.

The button must be released then pressed again to perform another gear shift.

There are 5 gears in high and low gear positions.

Manual/Autoshift Selector

Located beside headlamp dimmer switch, at the bottom of the multi-function switch. It is possible to change the mode at any time, even when vehicle is running.

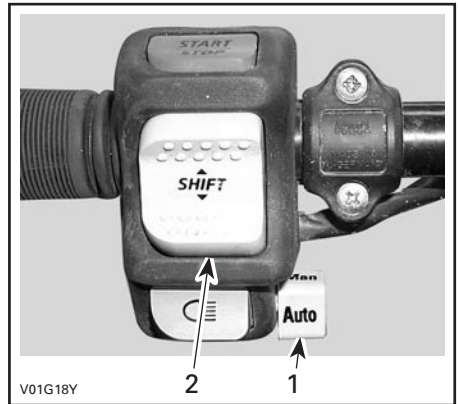

1. Manual/autoshift selector
2. Gear shift button

The autoshift mode activates a change of gear in accordance with the engine RPM and throttle opening. When autoshift mode is selected, just press or release throttle lever.

On some occasions, it may be useful or necessary to manually change the gear selection. The electronic module will allow the rider to override the autoshift mode by pressing the shift button to a lower gear or a higher gear. The autoshift mode will be kept and the shifting sequence will resume after shift is performed.

However, if the vehicle is used in severe conditions, it is highly recommended to use the manual mode (use the gear shift button).

Start/Stop Switch

Located on top of the multi-function switch. Dual function switch.

To start engine, press and hold the switch. Release immediately after engine is started.

To stop engine, fully release throttle lever then press the switch. It is not necessary to hold the switch.

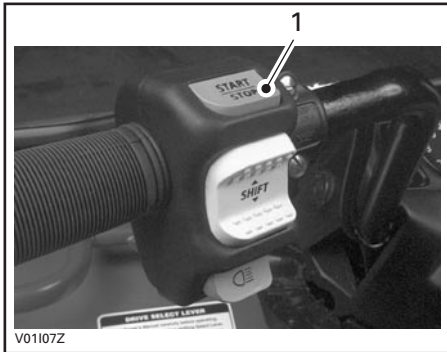

1. Start/stop switch

NOTE: While engine can be stopped by turning ignition key OFF, we recommend the engine be stopped by pressing the start/stop switch.

Headlamp Dimmer Switch

Located under the electric gear shift button. Toggle type switch. It allows selection of headlamp intensity.

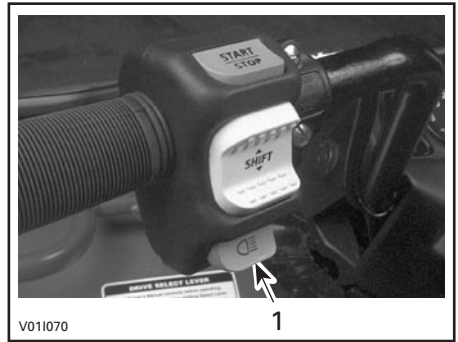

1. Headlamp dimmer switch

7) Indicator Lights Cluster

Quest and Traxter Series

NOTE: When first turning switch to ON (either position), all indicator lights will turn on for a brief moment. This validates their operation. Thereafter, only the lights that are activated will remain on: P, R or N for the **Quest series** and R, N, AUTO, high intensity lights and gear position for the **Traxter series**.

NOTE: Oil pressure (**Quest series**) and temperature (**Traxter series**) lights stay on until the engine runs.

On **Traxter series**, if all lights flash, it indicates a particular malfunction of the transmission or the electrical system. See an authorized **Bombardier** ATV dealer as soon as possible.

Traxter Series

Gear Position Display

Located on left side of cluster. It lights up to indicate the gear position whenever the ignition switch is turned on when the transmission lever is NOT in PARK or in NEUTRAL position (whether or not engine is running).

If all lights flash **while shifting gear**, it indicates the shifting is not completed yet. Simply wait until the shifting completes or retry the shift with the gear shift button.

If all lights flash **continuously**, it indicates a damaged sensor (gearbox). Although the vehicle can still be operated in this condition, downshifting may increase engine "braking". Drive slowly. See an authorized Bombardier ATV dealer as soon as possible.

Traxter Series

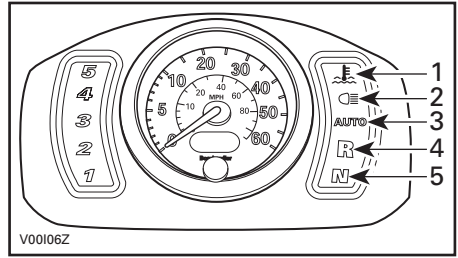

1. Engine
2. High intensity
3. Auto (autoshift mode)
4. Reverse
5. Neutral

If REVERSE and NEUTRAL lights flash **continuously**, it indicates a damaged sensor (sub-transmission). Although the vehicle can still be operated in this condition, downshifting may increase engine "braking". Drive slowly. See an authorized Bombardier ATV dealer as soon as possible.

IF AUTO light flashes, it indicates a possible problem with the TPS sensor. The manual mode is immediately selected. See an authorized Bombardier ATV dealer as soon as possible.

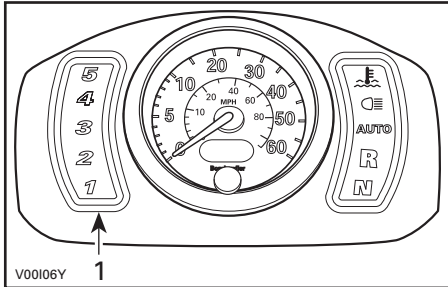

1. Gear position display

Other Indicator Lights

Located on right side of cluster. They light up to monitor different functions.

Quest Series

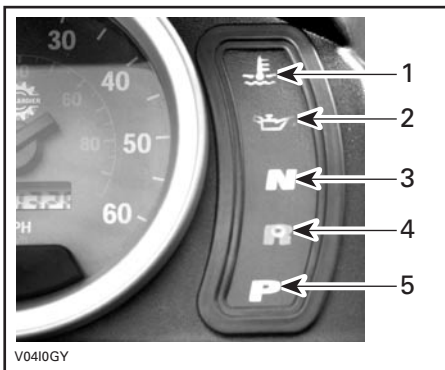

1. Engine temperature
2. Oil pressure
3. Neutral
4. Reverse
5. Park

Indicator Lights Description

Engine (RED)



Quest Series

When this indicator light is ON, it indicates the engine is overheating.

Traxter Series

Dual function light. When indicator light is ON, it indicates a low oil pressure condition of the engine. When flashing, it indicates the engine is overheating.

This light turns on when the ignition switch is turned on and remains on until engine is running.

If engine overheats, refer to ENGINE OVERHEAT in SPECIAL PROCEDURES.

CAUTION: If the light does not turn off right after engine starting, stop engine. See an authorized Bombardier ATV dealer. Do not use the vehicle until repaired.

Oil Pressure (RED)



Quest Series

When this indicator light is ON, it indicates a low oil pressure condition of the engine.

CAUTION: If the light does not turn off right after engine starting, stop engine. Check engine oil level. Refill if necessary. If the oil level is good, see an authorized Bombardier ATV dealer. Do not use the vehicle until repaired

High Intensity (BLUE)



Traxter Series

When the indicator light is ON, it indicates high intensity is selected on the headlights.

Auto (AMBER)



Traxter Series except Traxter XL

When lit, it indicates the vehicle is operating in autoshift mode.

Reverse (RED)



Quest and Traxter Series

When lit, it indicates the transmission is engaged in reverse.

Neutral (GREEN)



Quest and Traxter Series

When lit, it indicates the transmission is in neutral position.

Park (AMBER)



Quest Series

When lit, it indicates the transmission is in park position.

8) Speedometer

Quest and Traxter Series

These vehicles are equipped with an electronic speedometer. It indicates the speed of the vehicle either in MPH and km/h.

The speedometer is located at the middle of cluster and it is backlit when the ignition switch is turned ON (either position).

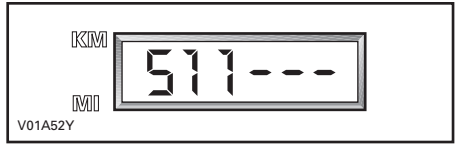

TRAXTER SERIES

After these 7 seconds, the units should be changed from miles to kilometers or vice-versa.

NOTE: A dash appears on the left side of the LCD display to indicate which unit is used.

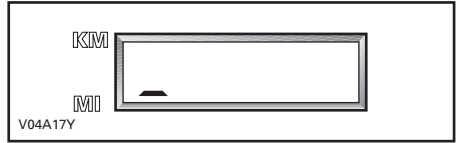

This speedometer being used on many models, it is factory pre-set. However, if the speedometer shows a number applying to another model, release and repress the display button. The number should be change for the proper number. Hold the button to change the unit until the normal display comes back.

Odometer/Trip Meter/Hourmeter

Combined LCD (Liquid Crystal Display) display. Odometer records the total distance traveled in miles or in km/h (00000). The trip meter records the distance traveled in miles or in km/h (000.0) until it is reset. The last right digit indicates the tenth of a mile or in km/h (on trip meter mode only). It can be used to approximately monitor the fuel tank range or distance between two locations for instance. The hourmeter records total hours when the ignition switch is turned ON (H0000.0).

Display Selection Button

To change the display momentarily press the button on the speedometer. The display will indicate odometer/trip meter/hourmeter, one after the other.

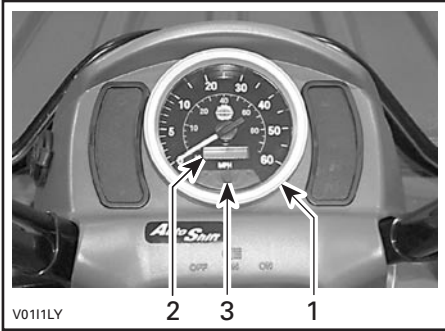

1. Speedometer
2. Odometer/trip meter/hourmeter
3. Display selection button

Change from One Unit to the Other

The speedometer is factory pre-set in miles but it is possible to change is reading to kilometer.

NOTE: The unit modification is applied to the speedometer, odometer and trip meter.

With the ignition switch OFF.

Press and hold the display selection button then turn the ignition switch ON.

The number **514610** for a **Quest**; or **511---** for a **Traxter** will appear in the display. Hold button until the normal display comes back (approximately 7 seconds).

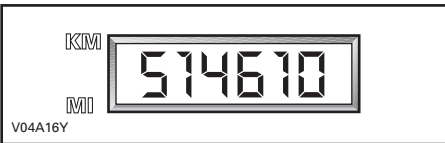

QUEST SERIES

To reset the trip meter, push and HOLD button until all numbers read zero. The trip meter can be reset at any time, even if the odometer or the hourmeter is selected.



TYPICAL

The odometer can indicate in miles or in kilometers depending which unit is selected.

9) Ignition Switch

Quest and Traxter Series

Located at bottom of cluster.

Key-operated, 3-position switch: OFF, ON with lights and ON without lights.

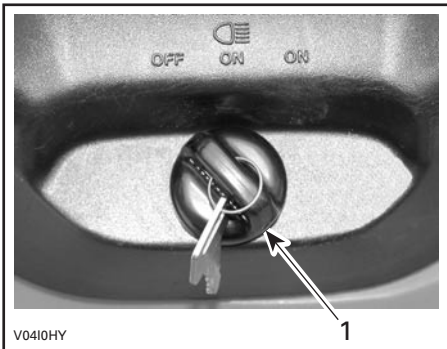

QUEST SERIES

1. Ignition switch

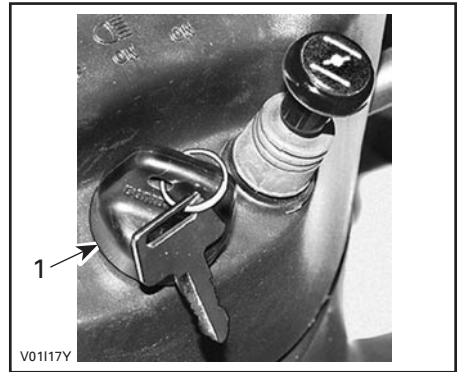

TRAXTER SERIES

1. Ignition switch

Insert key in switch and turn to the desired position. To remove key, turn key to OFF then pull it out.

The ON with lights position, turns on all lights with either the engine running or not. The headlights automatically dim to low intensity. Remember that having the lights on without the engine running discharges the battery. Always turn ignition to OFF after engine has been stopped.

NOTE: While engine can be stopped by turning ignition key OFF, we recommend the engine be stopped by pressing the start/stop switch.

Traxter Series

Auto Shut-Down

If for some reason, the engine is not started within approximately 6 minutes, the MPEM (Multi-Purpose Electronic Module) will shut down to cut all electrical system functions. Simply turn the key to OFF then to ON to regain normal use.

10) Choke Knob Lever

Traxter Series

Located at bottom of cluster. This device features a variable lever to ease cold start.

Position OFF is for normal use with a warm engine (pushed in).



CHOKE KNOB LEVER IN THE OFF POSITION

The full choke position is used for lower temperature (fully extended).

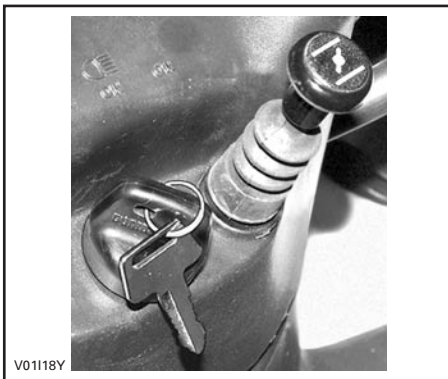

CHOKE LEVER IN THE FULL CHOKE POSITION

The other positions between OFF and FULL position, will be use depending on the temperature.

To adjust the choke lever resistance, lift the rubber bellows then screw the choke lever nut. Do not torque excessively because the choke lever won't move easily. Put back the rubber bellows in its original position.

11) Fuel Tank Cap

Quest and Traxter Series

Unscrew counterclockwise and remove cap to allow fuel tank filling then fully tighten clockwise.

⚠ WARNING

Always stop engine before refueling. Open cap slowly. If a differential pressure condition is noticed (whistling sound heard when loosening fuel tank cap) have vehicle inspected and/or repaired before further operation. Fuel is flammable and explosive. Never use an open flame to check fuel level. Never smoke or allow flame or spark in vicinity. Always work in a well-ventilated area. Never top off the fuel tank before placing the vehicle in a warm area. As temperature increases, fuel expands and may overflow. Always wipe off any fuel spillage from the vehicle.

12) Fuel Gauge

Quest and Traxter Series

Located under cluster, the gauge shows an approximate amount of the fuel in tank.

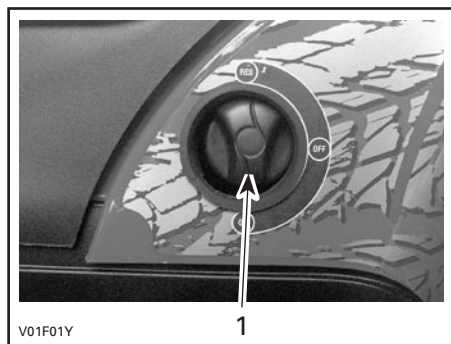

TRAXTER SERIES

1. Align this pointer toward the desired position

OFF

Stops fuel supply to carburetor.

CAUTION: Turn valve to OFF position when the vehicle is not being operated or when transporting.

ON

Allows fuel to flow to carburetor. This is the normal position for operation of the vehicle.

RES (reserve)

When fuel is exhausted in the fuel tank when in the ON position, an emergency supply of fuel is available by turning the knob to RES. The reserve contains approximately 20% of the fuel tank capacity for a Quest and 30% for a Traxter. Use this position only when the ON supply is empty.

When down to the reserve, refuel as soon as possible. Be sure to turn the valve back to the ON position after refuelling.

CAUTION: Improper opening of fuel valve will restrict the flow of fuel. Make sure valve is fully opened while running.

13) Fuel Valve

Located on left side panel under front part of seat. This is a 3-position rotary valve: OFF, ON, RES. Rotate the knob to align its pointer with ON, OFF or RES.

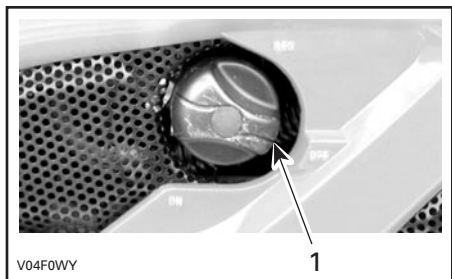

QUEST SERIES

1. Align this pointer toward the desired position

14) Rear Brake Pedal

Quest and Traxter Series

Located on the right footrest. When pressed down, the rear brake is applied. When released, it should return to its original position. Braking effect is proportional to the force applied on the pedal and to the type and condition of the terrain.

NOTE: The brake will have also an effect on front wheels through the drive train.

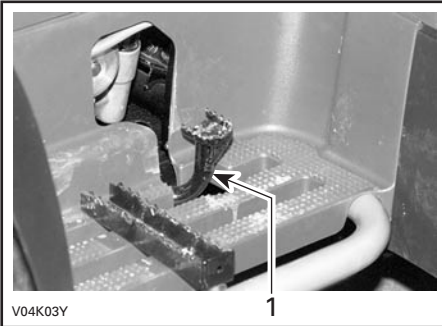

QUEST SERIES

1. Rear brake pedal

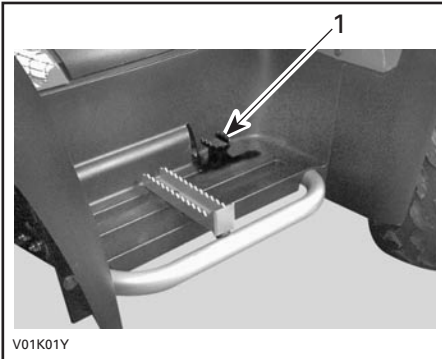

TRAXTER SERIES

1. Rear brake pedal

15) Rewind Starter Handle

Traxter Series

The rewind starter handle is provided as an emergency starting device.

Follow the usual starting procedure; but use the rewind starter instead of the electric starter.

Located on left side panel under front part of seat. Auto-rewind type. To engage mechanism, pull handle slowly until a resistance is felt then continue to slowly pull the handle until the compression stroke **peak** (strong rotating resistance) is passed, then pull vigorously. Slowly release handle.

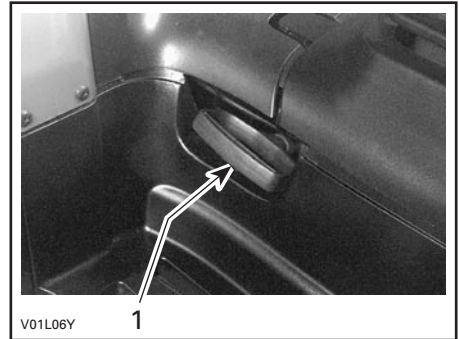

1. Rewind starter handle

16) Footpeg

Quest and Traxter Series

Located on footrest. Use this area to keep your feet stable.

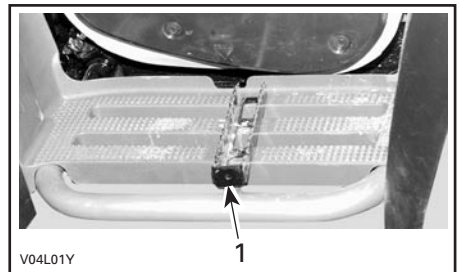

QUEST SERIES

1. Footpeg

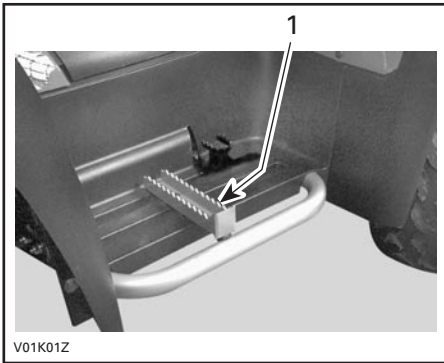

TRAXTER SERIES

1. Footpeg

17) Storage Compartment

Quest and Traxter Series

Located in front of vehicle. Convenient location to carry personal articles such as an a helmet, spare spark plugs, first aid kit, etc. Unlatch cover, gently lift then remove cover.

The compartment is equipped with a drain plug under the tool box. Remove plug to allow draining when necessary. Reinstall plug when finished.

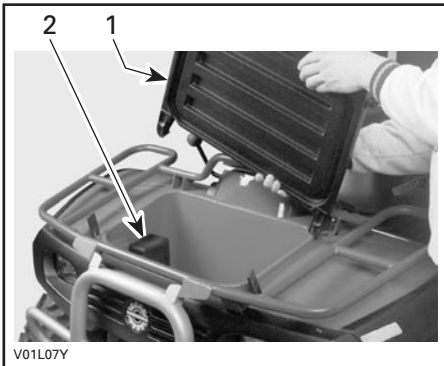

TYPICAL

1. Removing cover
2. Tool box

It also contains this *Operator's Guide* which should be kept in a waterproof bag and remain with the vehicle at all times.

⚠ WARNING

When engine is running, always engage the **PARK** position on the transmission lever before opening cover. Never leave any heavy or loose breakable objects in the storage basket. Always latch cover before riding. If storage cover is removed to provide greater carrying area, ensure that cargo is secured and will not "fly out" when riding at speed on rough terrain. Slow down.

18) Tool Box

Quest and Traxter Series

The tool box is located in the storage compartment. It contains tools for basic maintenance, this *Operator's Guide* and, with the **XT models**, an *ATV Winch Operator's Manual*.

The tools included in the tool box are:

- pliers (1)
- screwdriver (1)
- open wrench 10/13 mm (1)
- open wrench 15/17 mm (1)
- socket wrench 10/13 mm (1)
- socket wrench 16/18 mm (1)
- tire pressure gauge (1)
- Allen key 3 mm (1)
- fuse 30 A (1)
- fuse 20 A (1)
- fuse 15 A (1).

19) Seat Latch

Located underneath rear end of seat. It allows the removal of seat to give access to engine compartment.

Quest and Traxter Series except Traxter XL

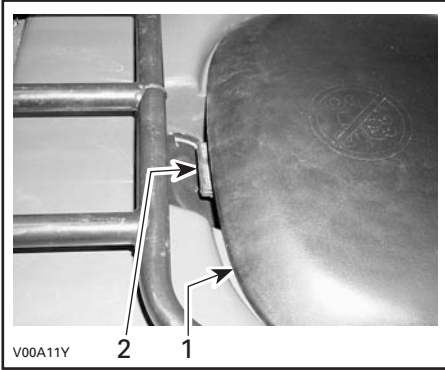

1. Seat
2. Seat latch

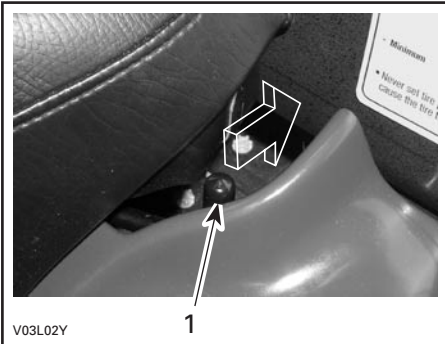

1. Seat latch

Seat Removal

Quest and Traxter Series except Traxter XL

Pull latch upward while gently lifting rear of seat. Continue lifting movement until you can release the front retaining devices then completely remove seat.

Traxter XL

Push latch backwards while gently lifting rear of seat. Continue lifting movement until you can release the front retaining devices then completely remove seat.

Seat Installation

⚠ WARNING

Periodically verify the seat lock pin and tighten if needed. Make sure seat is securely latched before riding.

Quest Series

Insert front tab of seat into frame hook. When seat rests in its position, firmly push seat down to latch.

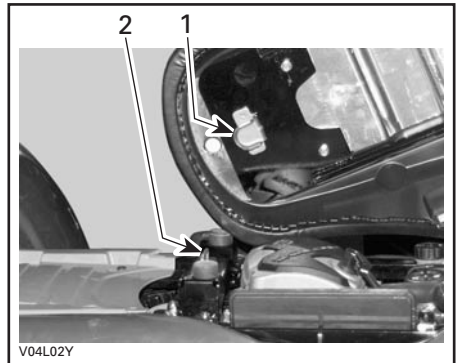

1. Insert this tab in hook
2. Hook

Traxter Series

Place seat to allow the insertion of the U-shaped bracket over the rollers. Gently slide the brackets over rollers then lower seat. When seat rests in its position, firmly push seat down to latch.

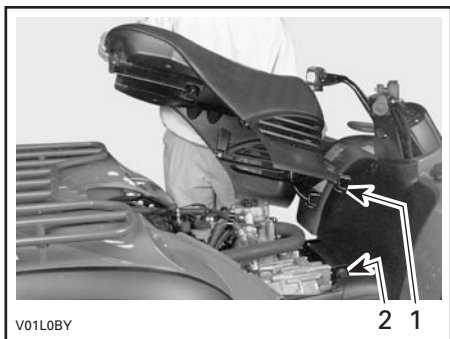

1. U-shaped bracket
2. Rollers

20) Front/Rear Cargo Racks

Quest and Traxter Series

Located on top of chassis at front and rear. Convenient racks to carry gear.

WARNING

Ensure to properly secure material to rack. Do not overload. Ensure load does not interfere with visibility and/or steering. Do not carry passenger(s).

Refer to SPECIFICATIONS for carrying loads and cargo weight distribution recommendations.

21) Air Duct

Quest and Traxter Series except Traxter XL

Located on rear fenders. They force the flow of air to cool radiator and supply air inside air box.

CAUTION: Do not place anything over air intake ducts.

22) Trailer Hitch

Quest and Traxter Series

Located on rear axle. Convenient hitch to install a ball to tow a trailer or other equipment. Install the proper ball size as per trailer manufacturer recommendations. Refer to SPECIFICATIONS for carrying loads and towing recommendations.

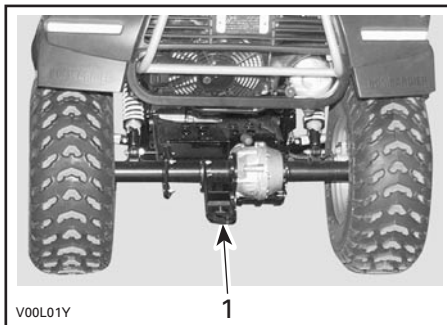

TYPICAL

1. Trailer hitch

WARNING

Be sure to install the proper ball size that matches the equipment you will tow.

Follow manufacturer instructions for proper attachment.

23) Radiator Cap

Quest and Traxter Series except Traxter XL

Located at rear of rear panel. It provides access to the radiator filling neck.

Pull the protector cap to give access to the radiator cap. When finished, properly reinstall radiator cap then protector cap.

⚠ WARNING

To prevent burning yourself do not remove the radiator cap if the engine is hot.



1. Radiator cap

24) 12-Volt Power Outlet

Quest and Traxter Series

It is located on left side of cluster.

Convenient for handheld spotlight or other portable equipment.

Remove cap to use. Always reinstall protective cap after use to protect against weather.

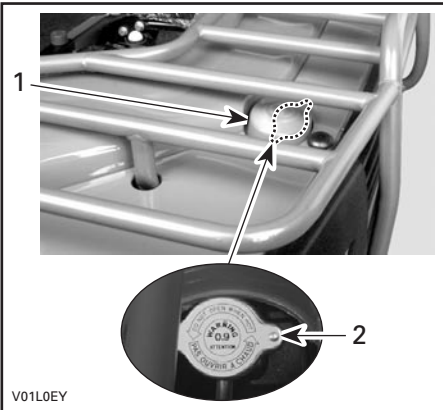

1. Protector cap
2. Radiator cap

Traxter XL

Located under rear cargo box.

Lift rear cargo box to gain access to the radiator cap. Then, properly reinstall radiator cap and close the rear cargo box properly.

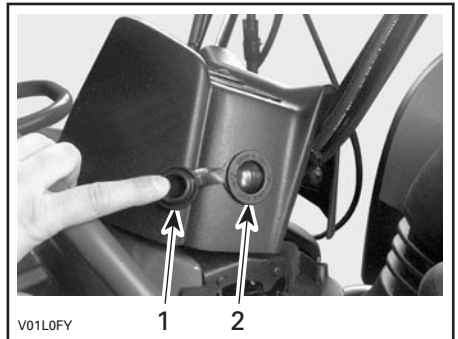

TYPICAL

1. Protective cap
2. Power outlet

Do not exceed the rating capacity. See SPECIFICATIONS.

An auxiliary supply is available to connect additional accessories. Two wires are hidden in the wiring harness at the rear of vehicle. See an authorized Bombardier ATV dealer for more details.

25) Fuses

Quest and Traxter Series

The electrical system is protected with fuses. Refer to MAINTENANCE for details.

26) Winch

Quest XT and Traxter XT

Located behind front skid plate.

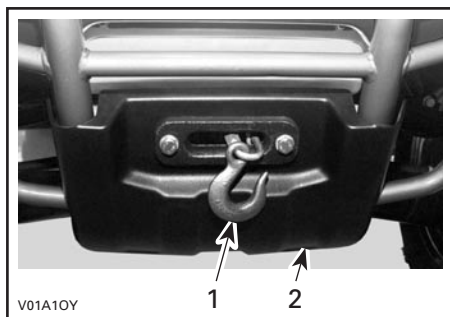

1. Winch
2. Front skid plate

27) Winch Control Switch

Quest XT and Traxter XT

Located on the LH side of the front fender.

To take out wire rope from winch, press the left side of switch.

To get wire rope into the winch, press the right side of switch.

Refer to *ATV Winch Operator's Manual* for more informations concerning the instructions for use the winch safely.

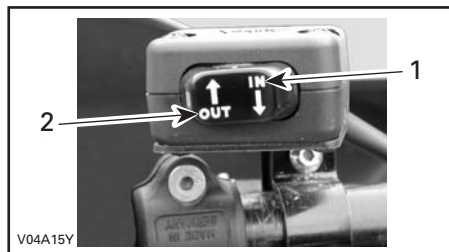

1. In
2. Out

28) Fairlead

Quest XT and Traxter XT

Located on the front skid plate.

The fairlead is used to prevent the damages to the vehicle and guide the wire rope into the winch.

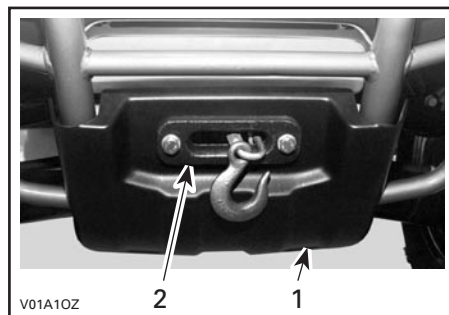

1. Front skid plate
2. Fairlead

29) Rear Cargo Box

Traxter XL

Located at the rear of vehicle. The rear cargo box is designed to receive varied materials.

WARNING

Never transport inflammable or dangerous material.

30) Release Lever

Traxter XL

Located under rear cargo box on the right side of seat.

It allows the dumping of rear cargo box. To dump rear cargo box, move release lever toward the right side.

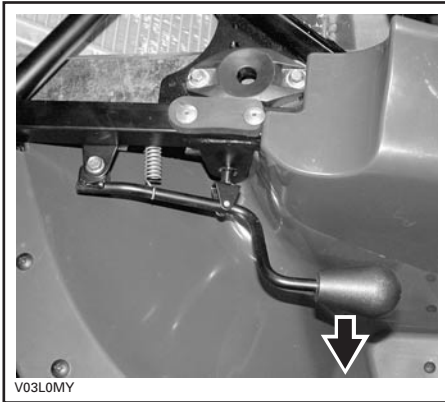

31) Rear Cargo Box Gate

Traxter XL

Located at the rear end of the rear cargo box.

To open gate, unlatch and lift up gate about 50 mm (2 in) then slowly pivot gate downwards, toward rear. Two cables located on each side of rear cargo box will hold gate in place.

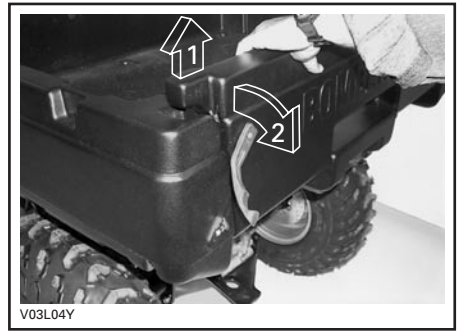

OPENING PROCEDURE

Step 1: Lift up gate

Step 2: Lower gate

To close gate, raise and lift up gate. Then insert gate locks into lock grooves. Install latches.

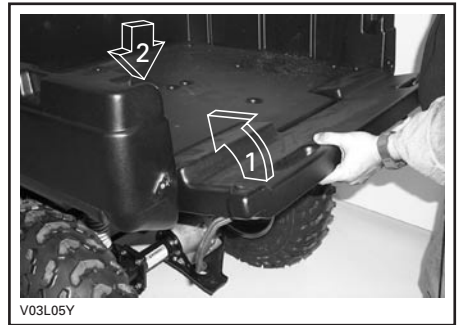

CLOSING PROCEDURE

Step 1: Raise gate

Step 2: Lower gate

32) Lateral Compartment

Traxter XL

Located on both side of vehicle. The compartments are equipped with a drain plug. Remove plug to allow draining when necessary. Reinstall plug when finished.

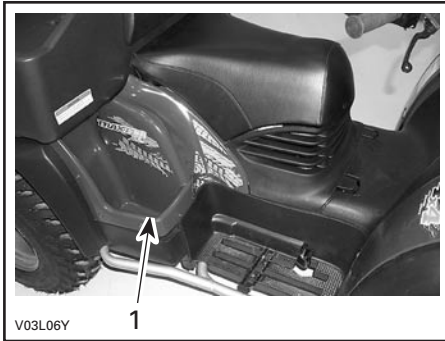

1. Lateral compartment

LIQUIDS

While reading this *Operator's Guide*, remember that:

WARNING

Indicates a potential hazard that, if not avoided, could result in serious injury or death.

NOTE: This section specifies the recommended liquids and procedures to check their levels. Refer to MAINTENANCE for procedures to replace the liquids.

Fuel

Quest and Traxter Series

Recommended Fuel

Use regular unleaded gasoline or gasohol containing less than 10% of ethanol or methanol, available from most service stations. The gasoline used must have an octane number of 87 ((R + M)/2) or higher.

NOTE: In most service stations, pump octane number corresponds to (R + M)/2 octane number. Usually a sticker can be found on the pump.

CAUTION: Never experiment with other fuels. The use of unrecommended fuel can result in vehicle performance deterioration and damage to critical parts in the fuel system and engine components.

CAUTION: Never mix oil with fuel. This ATV has a 4-stroke engine. Oil must be added to engine base only.

Fuel Level

WARNING

Always stop engine before refueling. Open cap slowly. If a differential pressure condition is noticed (whistling sound heard when loosening fuel tank cap) have vehicle inspected and/or repaired before further operation. Fuel is flammable and explosive under certain conditions. Never use an open flame to check fuel level. Never smoke or allow flame or spark in vicinity. Always work in a well-ventilated area. Never top off the fuel tank before placing the vehicle in a warm area. As temperature increases, fuel expands and may overflow. Always wipe off any fuel or oil spillage from the vehicle.

Engine/Transmission Oil

Quest and Traxter Series

Recommended Oil

Use 4-stroke mineral-based engine oil that meets or exceeds the requirements for API service classification SG, SH or SJ. Always check the API service label on the oil container to be sure it includes the letters SG, SH or SJ. Only use high-quality high-detergent oil.

NOTE: The same oil lubricates both engine and transmission. For improve overall performance and wear protection use **Bombardier synthetic oil (P/N 293 600 039)**. This is a special synthetic oil formulated for clutch type gear box.

Traxter Series

CAUTION: Use of synthetic or synthetic blend oil, other than Bombardier synthetic oil 5W40 (P/N 293 600 039), may cause clutch slippage.

Oil Viscosity

Quest and Traxter Series

SAE 10W40 is recommended for summer time while SAE 5W30 is recommended for winter time.

Other viscosity should be used if the average temperature is outside the range of the recommended oil. See chart below.

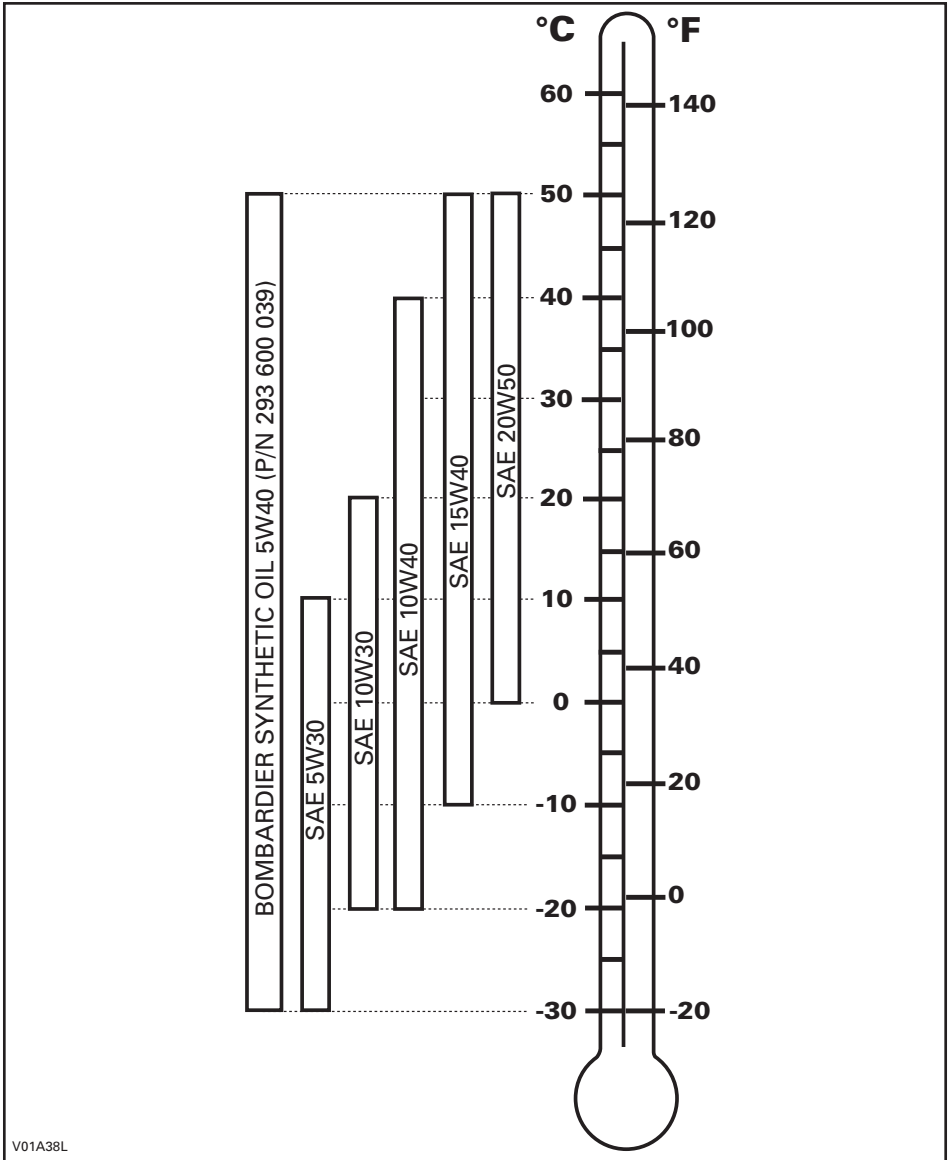

V01A38L

Oil Level

Quest and Traxter Series

CAUTION: Check level frequently and refill if necessary. Do not overfill. Operating the engine/transmission with an improper level may severely damage engine/transmission. Wipe off any spillage.

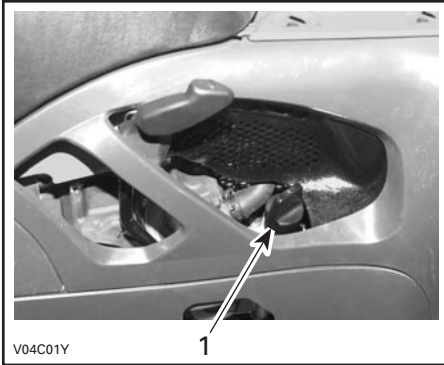

QUEST SERIES — RH SIDE OF ENGINE

1. Dipstick

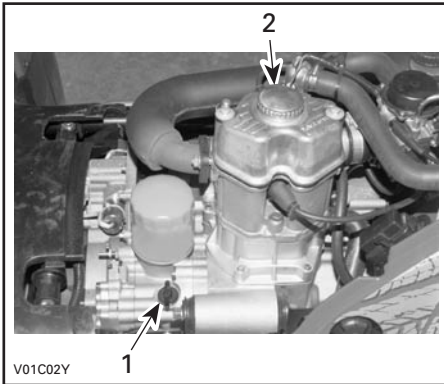

TRAXTER SERIES — LH SIDE OF ENGINE

1. Dipstick
2. Filler cap

With vehicle on a level surface and engine cold, not running, check the oil level as follows:

1. Remove the dipstick and wipe clean.
2. Reinstall dipstick. The dipstick must be inserted properly and completely.

3. Remove the dipstick again and check oil level. It should be near or equal with the upper mark.

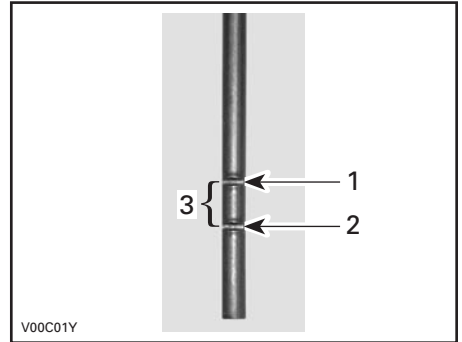

TYPICAL

1. Full
2. Add
3. Operating range

To add oil, remove the dipstick (**Quest series**) or unscrew filler cap (**Traxter series**). Add a small amount of oil and recheck oil level. Repeat until oil level reaches the dipstick's upper mark. **Do not overfill.**

NOTE: Use a funnel to avoid spillage.

Properly reinstall the dipstick and/or tighten filler cap then reinstall seat.

Engine Coolant

Quest and Traxter Series

Recommended Coolant

Always use ethylene-glycol antifreeze containing corrosion inhibitors specifically for internal combustion aluminum engines.

Cooling system must be filled with Bombardier premixed coolant (P/N 293 600 038) or with distilled water and antifreeze solution (50% water, 50% antifreeze).

Coolant Level

WARNING

Check coolant level with engine cold. Never add coolant in cooling system when engine is hot.

Remove seat.

Quest Series

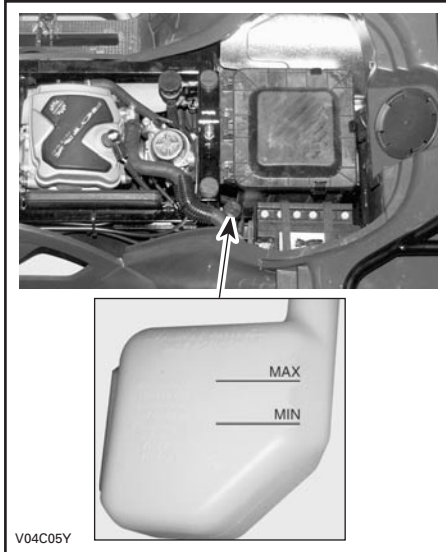

Traxter Series

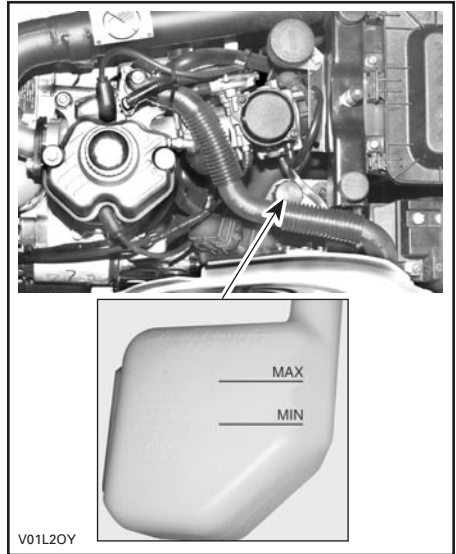

With vehicle on a level surface, liquid should be between MIN. and MAX. level marks of coolant reservoir.

NOTE: When checking level at temperature lower than 20°C (68°F), it may be slightly lower than MIN. mark.

Add coolant up to MAX. mark if required. Use a funnel to avoid spillage. **Do not overflow.**

Properly reinstall and tighten filler cap and reinstall seat.

If the coolant is added in the coolant reservoir, check the level in the radiator too. Add coolant if necessary.

WARNING

To prevent burning yourself do not remove the radiator cap if the engine is hot.

NOTE: A cooling system that frequently requires coolant is the indication of leaks or engine problems. See an authorized Bombardier ATV dealer.

Coolant Replacement

Refer to MAINTENANCE section.

Brake Fluid

Quest and Traxter Series

Recommended Fluid

Always use brake fluid meeting the specification DOT 4 only.

CAUTION: To avoid serious damage to the braking system, do not use fluids other than the recommended one, nor mix different fluids for topping up.

Fluid Level

With vehicle on a level surface, check brake fluid in reservoir for proper level. It should be above MIN. mark.

Add fluid as required. **Do not overfill.**

Clean filler cap before removing.

CAUTION: Use only DOT 4 brake fluid from a sealed container. Do not use brake fluid taken from old or already opened containers.

NOTE: A low level may indicate leaks or worn brake pads. See an authorized Bombardier ATV dealer.

Front Brake Fluid Reservoir

Turn steering in the straight-ahead position to ensure reservoir is level.

Check the brake fluid level; the reservoir is full when the fluid reaches the top of window.

Quest and Traxter Series

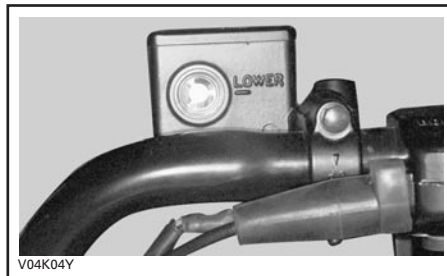

Visually inspect lever boot condition. Check for cracks, tears etc. Replace if damaged.

Rear Brake Fluid Reservoir

Quest Series

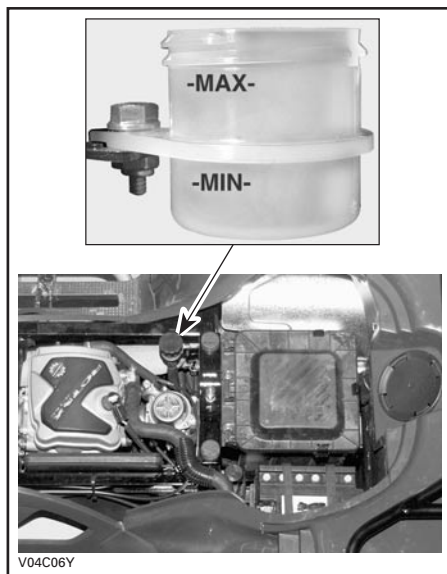

Traxter Series

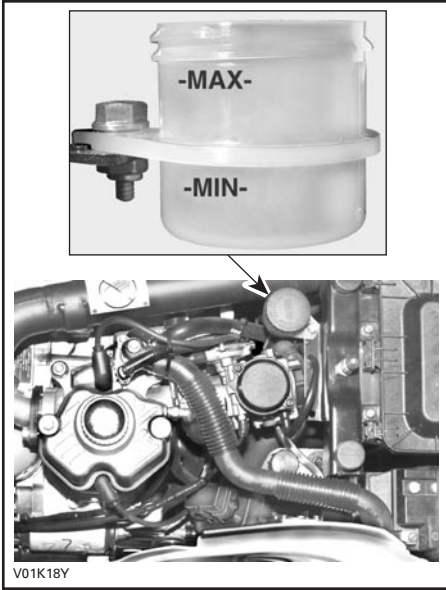

Battery

Quest and Traxter Series

This vehicle is equipped with an electrolyte type battery that requires a minimum of maintenance.

Electrolyte Level

Place the vehicle on a level surface.

Check electrolyte level by the rear left inner fender. Use a flashlight if necessary. Do not use an open flame.

The electrolyte should be between lower and upper marks. If level is low, remove battery from vehicle to add distilled water.

Battery

Removal

Disconnect BLACK (-) cable first then RED (+) cable.

WARNING

Always respect this order for disassembly; disconnect BLACK (-) cable first. Electrolyte or fuel vapors can be present in engine compartment and a spark may ignite them and possibly cause personal injuries.

Remove the holding straps.

Pull out vent tube from frame.

Remove battery from vehicle being careful not to tilt it so that electrolyte flows out of vent tube.

WARNING

Battery electrolyte is a caustic substance that burns or destroys organic tissues by chemical action. Avoid contact with eyes, skin and clothing. Wear protective eyeglasses and a suitable pair of non-absorbent gloves when removing the battery by hand. Should any electrolyte spillage occur, immediately wash off with a solution of baking soda and water.

Cleaning

Clean battery, battery casing, cables and battery posts using a solution of baking soda and water.

Remove corrosion from battery cable terminals and battery posts using a firm wire brush. Battery top should be cleaned by soft brush and any grease-cutting soap or baking soda solution.

Refilling

Place battery on a level surface.

Unscrew caps and add distilled water up to upper mark as required. Do not overfill.



1. Upper mark

Properly retighten caps.

Installation

Reinstall battery in vehicle. Fasten battery and make sure to reinstall the vent tube.

WARNING

Connect RED (+) cable first then BLACK (-) cable. Always connect RED (+) cable first.

NOTE: Place the RED (+) cable between holding straps and battery.

BREAK-IN PERIOD

Engine

Quest and Traxter Series

A break-in period of 10 operating hours is required before running the vehicle at sustained full throttle.

CAUTION: Never mix oil with fuel. This vehicle has a 4-stroke engine. Oil must be added to engine base only.

During this period, maximum throttle should not exceed $\frac{3}{4}$. **However, brief full acceleration and speed variations contribute to a good break-in.** Continued wide open throttle accelerations, prolonged cruising speeds and engine overheating are detrimental during the break-in period.

Belt

Quest Series

A new belt requires a break-in period of 50 km (30 miles). Avoid strong acceleration/deceleration, pulling a load or high speed cruising.

10-Hour Inspection

Quest and Traxter Series

As with any precision piece of mechanical equipment, we suggest that after the first 10 hours or 30 days after the purchase, whichever comes first, your vehicle be inspected by an authorized Bombardier ATV dealer. This inspection will give you the opportunity to discuss the unanswered questions you may have encountered during the first hours of operation.

The 10-hour inspection is at the expense of the vehicle owner.

While reading this *Operator's Guide*, remember that:

WARNING

Indicates a potential hazard that, if not avoided, could result in serious injury or death.

PRE-OPERATION CHECK

Quest and Traxter Series

WARNING

The pre-operation check is very important prior to operating the vehicle. Always check the proper operation of critical controls, safety features and mechanical components before starting. If not done as specified here, severe injury or death might occur.

- Apply parking brake and check if it operates properly.
- Check tire pressure and condition.
- Check wheels and bearings for wear and damage.
- Check location of controls and ensure they work properly.
- Verify steering operates freely.
- Activate throttle control lever several times to ensure it operates freely. It must return to idle position when released.
- Activate the brake levers and foot pedal to make sure the brakes fully apply. Levers and pedal must fully return when released.
- Ensure transmission lever is working then reset in PARK position.
- Check fuel, oil and coolant levels.
- Check for oil leaks on the engine/transmission and drive train components.
- Ensure fuel valve is in fully open position (ON).
- Clean headlamps and taillight.
- Ensure front storage cover compartment is properly latched.
- Ensure seat is properly latched.
- If you transport cargo, respect load capacity. Ensure cargo is properly secured to the racks.
- If you are pulling a trailer or other equipment, ensure it respects the tongue capacity and towing capacity. Ensure trailer is properly secured to hitch.
- Look and feel for loose parts **while engine is off**. Check fasteners.
- Ensure the path of travel is free of persons and obstacles.
- Check operation of ignition switch, start button, engine stop switch, headlamps, dimmer switch, taillight and indicator lights.
- Start engine and drive forward slowly a few feet and apply all brakes individually to test them.

Correct any problem you may have found. See an authorized Bombardier ATV dealer as necessary.

OPERATING INSTRUCTIONS

General

Quest and Traxter Series

Transmission lever must be on PARK or NEUTRAL to allow engine starting.

For your convenience, an override mode allows to start the engine with the transmission lever in any position. Press and hold the front or rear brake lever or the brake pedal while pressing the start button.

Quest Series

To start engine, place the engine stop switch to RUN position, insert key in ignition switch and turn to ON then press start button.

Traxter Series

The engine can be started in any gear (from 1 to 5).

To start engine, insert key in ignition switch and turn to ON then press the start/stop switch.

Initial Cold Starting

Quest and Traxter Series

Insert key in ignition switch and turn to ON.

In cold weather, colder than 0°C (32°F), place the choke lever in full position.

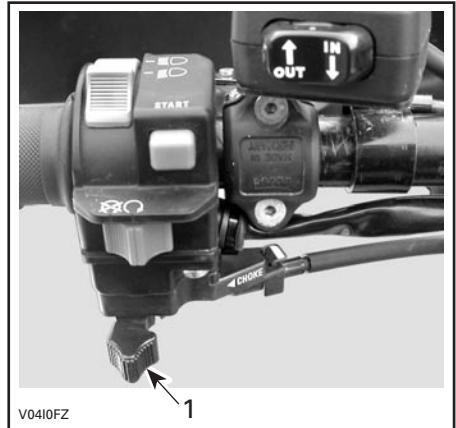

QUEST SERIES

1. Full choke position

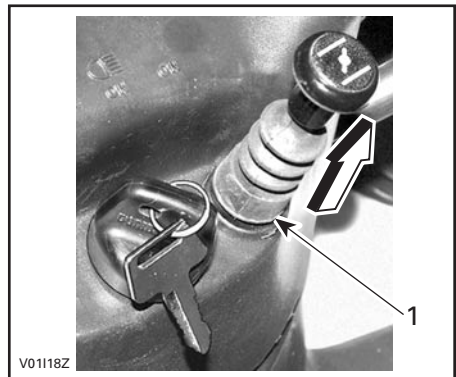

TRAXTER SERIES

1. Full choke position

NOTE: On Traxter series, when the temperature is below - 15°C (5°F), the primer kit (P/N 703 500 045) installation is recommended. See an authorized Bombardier ATV dealer.

Press the start/stop switch or the start button and hold until engine starts.

CAUTION: Do not hold start/stop switch or start button more than 30 seconds. A rest period should be observed between the cranking cycles to let starter cool down. Pay attention to battery; do not discharge it.

NOTE: The throttle can be use to help starting the engine faster. Press the throttle lever slightly. If it is pressed too much, the choke system will not be activated.

Release start/stop switch or start button immediately when engine has started.

After a few seconds, move the choke lever from full choke position to an intermediate position until a best engine RPM is achieved.

NOTE: Over using choke may flood engine and make it hard to start. Refer to SPECIAL PROCEDURES if this occurs.

When the engine is warm, push the choke lever to OFF and release brakes.

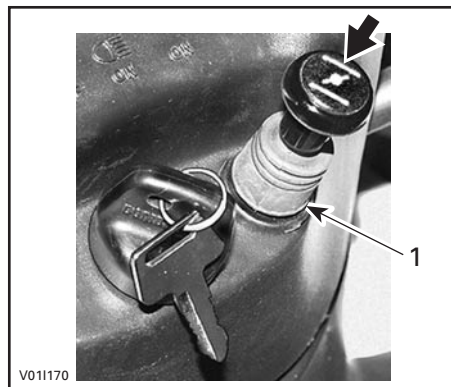

TRAXTER SERIES

1. OFF position

Warm Engine Starting

Quest and Traxter Series

Start the engine as explained above but without the choke. If the engine will not start after two 5-second attempts with the electric starter, place the choke lever between the FULL and the OFF position. Start the engine without activating the throttle lever. After a few times, push the choke lever to OFF.

Emergency Manual Starting

Traxter Series

⚠ WARNING

Always place transmission lever on PARK or NEUTRAL before starting engine manually.

Manual start is provided in the event electric start does not work.

If the engine indicator light is turned off, it indicates the electrical system is in the auto shut-down mode. Turn the ignition key OFF then ON to reactivate it.

Follow the same procedure as starting procedures above except use the re-wind starter to start instead.

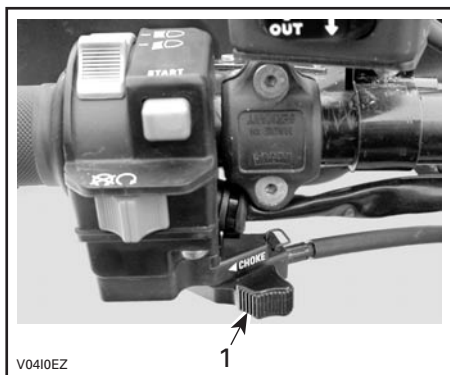

QUEST SERIES

1. OFF position

Grasp manual starter handle firmly and, slowly, crank engine until a resistance appears.

Pass this resistance and release the handle.

Take again the handle firmly and crank engine.

Repeat this procedure completely if necessary.

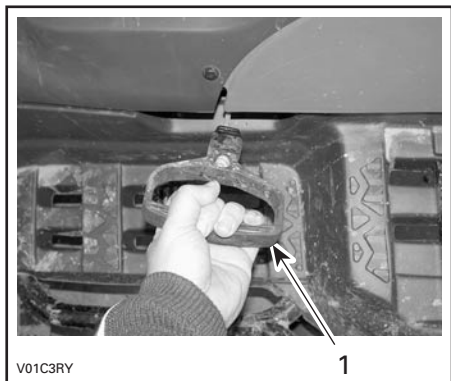

1. Grasp manual starter handle firmly and crank engine

Stopping the Engine

Quest and Traxter Series

WARNING

Avoid parking on an inclined surface.

Release throttle and completely stop the vehicle.

Apply the parking brake by using brake lever lock on rear brake lever.

On **Traxter series**, shift to 1st gear.

Set transmission lever in PARK position.

Press the start/stop switch or push the engine stop switch in OFF position.

Turn key in ignition switch to OFF.

Remove key from ignition switch.

Shifting the Transmission

Quest and Traxter Series

Let engine idle to warm up.

Apply brakes and select the desired gear range H/L.

NOTE: The brake must be applied when the transmission lever is engaged in the park position. Shift to 1st gear for the **Traxter series**.

Release brakes.

CAUTION: Make sure parking brake is fully disengaged before operating the ATV.

Quest Series

Gradually press the throttle lever to increase engine speed and thus engaging the continuously variable transmission (CVT).

At the opposite, when the throttle lever is released, the engine speed decreases.

Traxter Series

Gradually press the throttle lever to increase engine speed and thus engaging the centrifugal clutch.

When vehicle speed increases, slightly release throttle lever while pressing the electric gear shift button to upshift one gear then release button and press throttle lever again to continue the acceleration. Repeat until the last gear if desired or until vehicle speed you want is attained.

NOTE: While any throttle position can be used during shifting, it is recommended to slightly release the throttle position during upshifting.

Reverse the sequence to downshift.

Manual/Autoshift Selector Traxter Series except Traxter XL

When selector is in autoshift mode, the transmission upshifts automatically when the vehicle speed increases. Inversely, when vehicle speed decreases, the transmission downshifts automatically.

Using Reverse

Quest and Traxter Series

CAUTION: When changing from forward to reverse, or vice-versa, always completely stop the vehicle and apply the brake prior to moving the transmission lever.

The same procedures as SHIFTING THE TRANSMISSION above apply except for the following.

Set the transmission lever in REVERSE position.

Winch Operation

Quest XT and Traxter XT

See the *ATV Winch Operator's Manual*. This manual should be kept in the tool box and remain in the vehicle at all time.

Dumping the Rear Cargo Box

Traxter XL

Select a level ground to dump the load of rear cargo box.

WARNING

Do not attempt to dump or unload the vehicle on an inclined surface.

Set the parking brake.

Dismount from the vehicle.

Open rear cargo box gate.

Move the release lever toward right side and lift the front end of the rear cargo box to dump.

WARNING

Never operate the release lever without checking the position of the load. If weight distribution on the rear cargo box is located towards the back of the box and the release lever is activated, the box will want to dump on its own.

Adequately distributed cargo will prevent unexpected dumping of rear cargo box.

SPECIAL PROCEDURES

Flooded Engine

Quest and Traxter Series

When the engine does not start after several attempts, the engine may be fuel flooded. Proceed as follows.

Turn ignition switch to ON and ensure choke is not applied.

Ensure the transmission lever is on PARK.

Fully press throttle lever and hold while starting the engine.

As soon as the engine starts, release throttle lever. Do not race engine.

If it does not work:

Disconnect the ignition coil or unplug the spark plug cables.

Clean the ignition coil or the spark plugs area then remove spark plug(s) (tools are supplied in tool box).

WARNING

Always wear eye protector and gloves when the spark plug hole is cleaned.

Crank engine several times. Add a small quantity of engine oil in cylinder (equivalent to a cap of oil quart). Install new spark plug(s) if possible or clean and dry spark plug(s).

Start engine as explained above. If engine continues to flood, see an authorized Bombardier ATV dealer.

Engine Overheat

Quest and Traxter Series

If engine overheats and indicator light turns on, try the following:

Ensure air ducts are not obstructed.

Check and clean radiator fins. See MAINTENANCE section.

WARNING

The radiator can be very hot; wear gloves before touching radiator.

Reduce vehicle speed but try to keep vehicle moving to supply air to radiator. If engine is still overheating after approximately one minute, stop vehicle and set transmission to PARK. Stop engine.

Place the ignition switch to ON position (**DO NOT RESTART ENGINE YET**). The radiator fan will cool the radiator.

Let engine cool down. Check coolant level and refill if possible.

WARNING

Never refill cooling system when engine is hot.

See an authorized Bombardier ATV dealer as soon as possible.

Turn Over

Quest and Traxter Series

When vehicle is turned over or stays tilted on the side, replace the vehicle in its normal operating position (on all four wheels) and wait 3 to 5 minutes before starting engine. Before starting engine, check engine oil level and refill if necessary. If the oil pressure light stays ON after starting engine, stop engine and see an authorized Bombardier ATV dealer as soon as possible.

ATV Immersion

Quest and Traxter Series

Should the ATV become immersed, it will be necessary to take it to an authorized Bombardier ATV dealer as soon as possible. **DO NOT START THE ENGINE!** Immersion of the ATV can cause serious damage if the correct restart procedure is not followed.

Post-Operation Care

Quest and Traxter Series

When vehicle is used in salt-water environment (beach area, launching/loading boats etc.), rinsing the vehicle with fresh water is necessary to preserve vehicle and its components. Metallic parts lubrication is highly recommended. Use BOMBARDIER LUBE (P/N 293 600 016). This must be performed at the end of each operating day.

When vehicle is operated in muddy conditions, rinsing the vehicle is recommended to preserve vehicle and its components and to keep lights clean.

Emergency Shifter

Traxter Series

If the shifting system is not operational, you may use the emergency shifter. It allows transmission gear change when the vehicle is not in motion. You set the desired gear once then go back home while the transmission remains in this gear. No gear change can take place since the shifting system is not operational. The shifter shaft end is located on rear side of engine.

Place transmission on PARK position.
Remove seat.

Use the special key in the tool box to rotate the emergency shifter. Open the tab of the tool approximately at a right angle (90°). Insert the screwdriver included in the tool box at the end of the special tool so that it can be used as a handgrip.

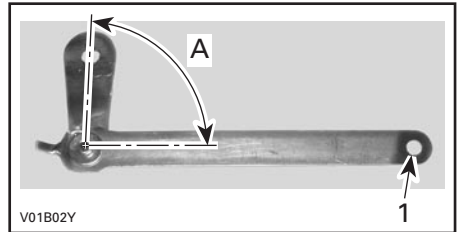

1. Insert the screwdriver here as a handgrip
A. Open tab at a right angle (90°)

⚠ WARNING

The exhaust pipe can be very hot.
Wear gloves and/or allow exhaust pipe to cool.

Insert the tool to the end of the shifter shaft.

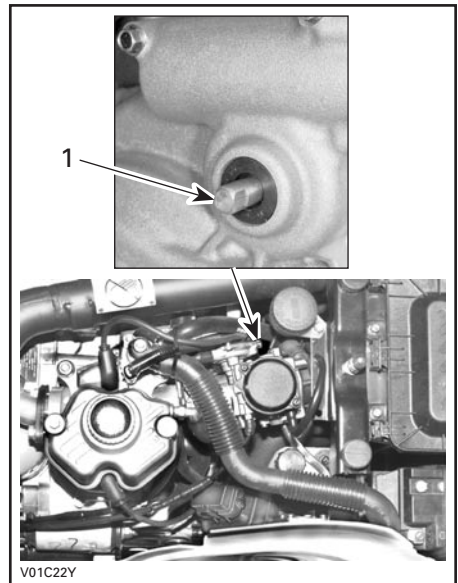

1. Emergency shifter shaft. Insert special tool here

Pull special tool upward to downshift and push downward to upshift. Place the gear in the desired position.

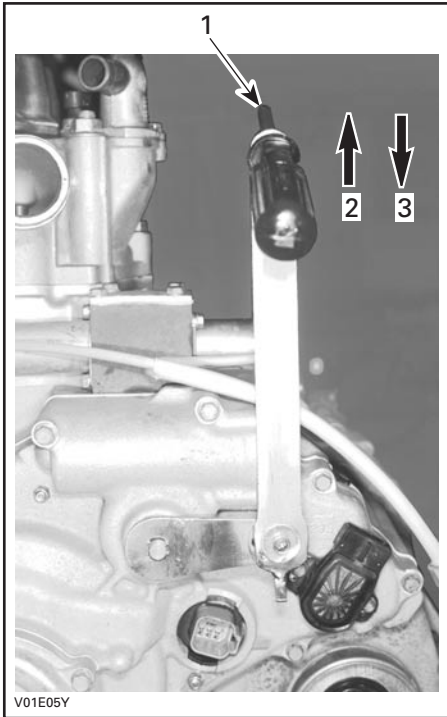

1. Use screwdriver as a handgrip
2. Pull to downshift
3. Push to upshift

NOTE: The 2nd or 3rd gear is recommended.

Remove the special tool. Close the tab of the tool. Replace tool and screwdriver in tool box.

Replace seat.

Storage and Preseason Preparation

Quest and Traxter Series

⚠ WARNING

Have an authorized Bombardier ATV dealer inspect fuel system integrity as specified in MAINTENANCE CHART.

When a vehicle is not in use for more than one month, proper storage is a necessity.

See an authorized Bombardier ATV dealer for proper procedures.

When using your ATV after storage, a preparation is required. See an authorized Bombardier ATV dealer for proper procedures.

CARGO AND TRANSPORTATION

While reading this *Operator's Guide*, remember that:

WARNING

Indicates a potential hazard that, if not avoided, could result in serious injury or death.

Cargo

WARNING

The vehicle handling, stability and braking distance are affected when loading racks and using the vehicle. Correct loading and weight distribution are therefore important. Never overload, tow or carry cargo improperly. Always ensure the cargo is safely secured and properly distributed on the rack(s) or in the rear cargo box before operating the vehicle. Safely reduce speed when carrying cargo or pulling a trailer. Allow greater distance for breaking. Always secure cargo as low as possible on the rack(s) or in the rear cargo box to reduce the effect of a higher center of gravity. Failure to follow the recommendations here could cause changes in vehicle handling which could lead to an accident resulting in severe injuries including the possibility of death. For more information, see the *Safety Handbook*.

When cargoing vehicle, respect these maximum loads.

Quest Series

TOTAL LOAD ALLOWED:

220 kg (485 lb)

(includes driver, all other loads and added accessories)

80 kg (175 lb)

Includes rear rack and tongue load

5 kg (11 lb)

Console maximal load

40 kg (90 lb)

Includes front rack and storage compartment

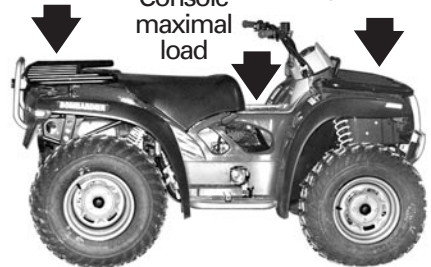

V04A01Y

Traxter Series except Traxter XL

**TOTAL LOAD ALLOWED:
220 kg (485 lb)**

(includes driver, all other loads
and added accessories)

80 kg (175 lb)

Includes rear
rack and
tongue load

40 kg (90 lb)

Includes front
rack and storage
compartment



V01L0VZ

Secure Material in Rear Cargo Box

Traxter XL

When carrying material in rear cargo box, it is highly recommended to secure the material properly. See the following illustration for the safety locations.

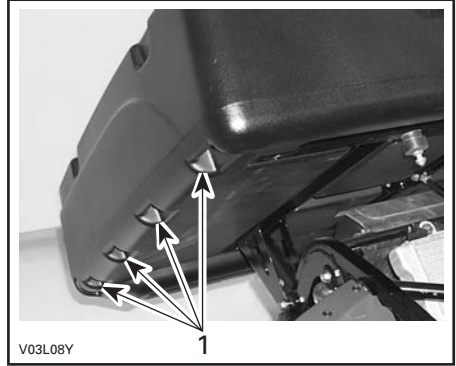

UNDER REAR CARGO BOX

1. Secure here

Traxter XL

**TOTAL LOAD ALLOWED:
364 kg (800 lb)**

(includes driver, all other loads
and added accessories)

40 kg (90 lb)

Includes front
rack and storage
compartment

273 kg (600 lb)

Includes rear
cargo box and
tongue load

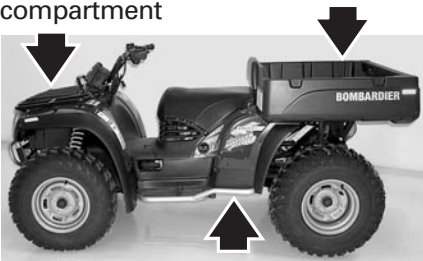

14 kg (30 lb)

Includes both lateral compartments

V03L07Y

Transportation

Quest and Traxter Series

When transporting a vehicle, secure vehicle to trailer or in pickup box with suitable tie-downs. Using ordinary ropes is not recommended.

WARNING



Never tip this vehicle on end for transporting. We recommend that you carry the vehicle in its normal operating position (on all four wheels).

Place the fuel valve to OFF position.
Select the PARK position and set the parking brake.

Secure the vehicle to front by the front bumper and rear by the frame.

CAUTION: Attaching vehicle at other locations may damage the vehicle.

Front Location

Quest and Traxter Series



TYPICAL

Rear Location

Quest and Traxter Series except Traxter XL



Traxter XL

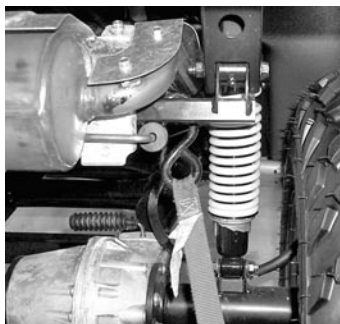

V03L0GY

⚠ WARNING

Do not tow this vehicle behind a car or other vehicle. Use a trailer.

MAINTENANCE INFORMATION

MAINTENANCE CHART

The maintenance is very important; if you are not familiar with safe service practices and adjustment procedures, see your authorized Bombardier ATV dealer.

MAINTENANCE CHART I: Inspect, verify, clean, adjust, lubricate, replace if necessary C: Clean L: Lubricate R: Replace	INITIAL 10 h INSPECTION OR 250 km (150 m.) ①	EVERY				TO BE PERFORMED BY
		25 h OR 625 km (388 m.)	50 h OR 1250 km (777 m.)	100 h OR 1 YEAR OR 2500 km (1553 m.)	200 h OR 2 YEARS OR 5000 km (3107 m.)	
ENGINE/TRANSMISSION						
Engine/transmission oil and filter ④	R		R			Customer
Engine/transmission oil strainer cleaning					C	Customer
Engine mount fasteners	I			I		Dealer
Exhaust system	I			I		Dealer
Spark arrester				C		Customer
Condition of seals	I			I		Dealer
Coolant ④	I			②	R	Customer
Radiator cap/cooling system pressure test	I				I	Dealer
Radiator condition/cleanliness (air ducts and radiator fins) ③	I		I			Customer
Rewind starter rope condition				I		Dealer
Clutch and transmission operation				I		Dealer
Drive belt				I		Dealer
Cleaning/condition of drive and driven pulleys				C		Dealer
CVT air inlet/outlet duct condition/cleanliness and sealing	I		I			Dealer
FUEL SYSTEM						
Air filter ④		C ③		R ③		Customer
Fuel lines and connections	I			I		Dealer
Fuel tank strainer					R	Dealer
Carburetor adjustment	I			I		Dealer
ELECTRICAL SYSTEM						
Spark plug(s)	I			R		Dealer
Battery electrolyte level/connections/vent condition	I		I			Customer
Wiring harnesses, cables and lines	I			I		Dealer
Condition of ignition switch and start/stop switch ④	I			I		Customer
Condition of lighting system (HI/LO intensity, brake light, headlamp aiming, etc.) ④	I			I		Customer
Winch connections	Refer to <i>ATV Winch Operator's Manual</i>					Customer
Wheel bearings condition				I		Customer
Front differential and rear axle oil, seals and vent	I		I		R	Dealer
DRIVE TRAIN						
Drive shaft boot and protector ④	I	I				Customer
Drive shaft joint			I			Dealer
Front/rear propeller shaft joint	I		L			Dealer

MAINTENANCE CHART I: Inspect, verify, clean, adjust, lubricate, replace if necessary C: Clean L: Lubricate R: Replace	INITIAL 10 h INSPECTION OR 250 km (150 m.) ①	EVERY				TO BE PERFORMED BY
		25 h OR 625 km (388 m.)	50 h OR 1250 km (777 m.)	100 h OR 1 YEAR OR 2500 km (1553 m.)	200 h OR 2 YEARS OR 5000 km (3107 m.)	
STEERING/CONTROL SYSTEMS						
Handlebar fasteners				I		Dealer
Throttle/housing/cable ④	I		I			Customer
Choke condition ④	I		I			Customer
Steering system	I			I		Dealer
Tie rod ends			I			Dealer
Wheel nuts/studs	I		I			Customer
Wear/pressure of tires ④	EVERY RIDE					Customer
Front wheel alignment	I			I		Dealer
SUSPENSION						
Swing arm ④				I		Dealer
Shock absorber ④			I			Dealer
A-arm lubrication			I			Customer
BRAKE						
Brake fluid front/rear ④	I	I			R ⑤	Customer
Brake cable	I		I			Dealer
Brake pad		I				Customer
Brake system (discs, hoses etc.)				I		Customer
BODY/FRAME						
Engine compartment	C		C			Customer
Skid plate	EVERY RIDE					Customer
Frame				I		Dealer
Hitch/trailer ball condition (if installed)	I		I			Customer
Chassis fasteners			I			Customer
Seat fasteners	EVERY RIDE					Customer
Front storage compartment cover/seat latches ④			I			Customer
Rear cargo box release lever		I				Customer
Rear cargo box gate latches ④		I				Customer
Vehicle cleaning and protection			C			Customer

① To be performed by an authorized Bombardier ATV dealer. The initial maintenance is very important and must not be neglected.

② Every 100 hours, check coolant strength.

③ More often under severe use such dusty area, sand, snow, wet or muddy conditions.

④ Pre-ride inspection item.

⑤ Must be performed by an authorized Bombardier ATV dealer.

MAINTENANCE

While reading this *Operator's Guide*, remember that:

WARNING

Indicates a potential hazard that, if not avoided, could result in serious injury or death.

WARNING

Unless otherwise specified, engine should not be running for all maintenance procedures.

Before performing any service or inspection operation on the vehicle, wait until the engine and exhaust have cooled down to avoid potential burns.

WARNING

Should removal of a locking device (e.g. lock tabs, self-locking fasteners, etc.) be required when undergoing disassembly/assembly, always replace with a new one.

The following covers the maintenance items that can be performed by the customer if desired. Other items found in maintenance chart must be performed by an authorized Bombardier ATV dealer.

NOTE: Among other things, this section gives the procedures to replace the liquids. Refer to LIQUIDS for procedures to check levels and refill.

Engine/Transmission

Quest and Traxter Series

Oil Change and Oil Filter Replacement

Oil and filter are to be replaced at the same time. Oil change should be done with a warm engine.

WARNING

The engine oil can be very hot. Wait until engine oil is warm.

Ensure vehicle is on a level surface.

Clean the drain plug area.

Remove dipstick.

Place a drain pan under the engine drain plug area.

Unscrew drain plug.

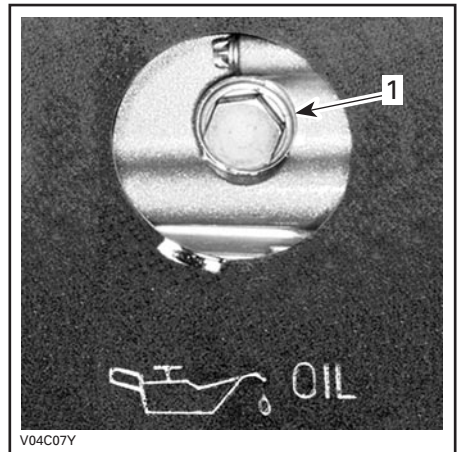

QUEST SERIES

1. Oil drain plug

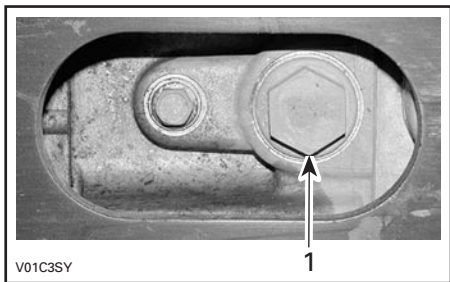

TRAXTER SERIES

1. Oil drain plug

Allow enough time for oil to flow out of oil filter.

Quest Series

Unscrew the oil filter cover.

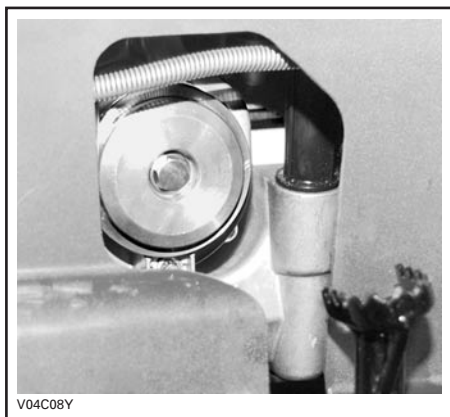

Remove the oil filter and replace with a new filter.

NOTE: Check the cover O-ring and change it if necessary.

Wipe out any oil spillage on engine.

Remove skid plate.

Remove oil strainer cover and oil collector, located near drain plug, then clean oil strainer.

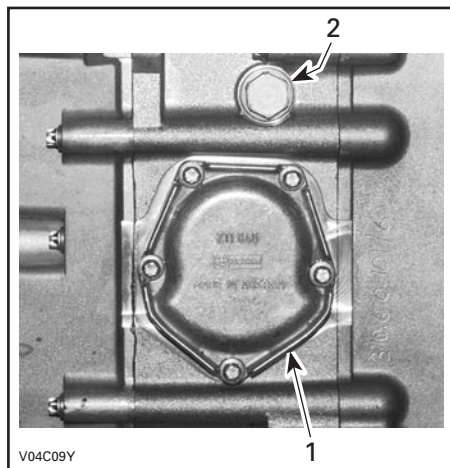

1. Oil strainer cover
2. Oil plug

Traxter Series

Carefully unscrew oil filter and as soon as it can be removed from the engine, turn it upright. Discard filter.

NOTE: Be sure that the old filter O-ring is removed.

CAUTION: Only use Bombardier high pressure filter or suitable equivalent. The Bombardier filter is specifically designed for this engine. This filter does not operate at the same pressure as other brands. Using a non-recommended filter may cause serious engine/transmission damage. See an authorized Bombardier ATV dealer.

Lubricate the O-ring on the filter with engine oil. Install the new filter then screw one full turn after O-ring contact.

Wipe out any oil spillage on engine.

Remove skid plate.

Remove oil strainer cover and oil collector, located near drain plug, then clean oil strainer.

Coolant Replacement

Quest and Traxter Series

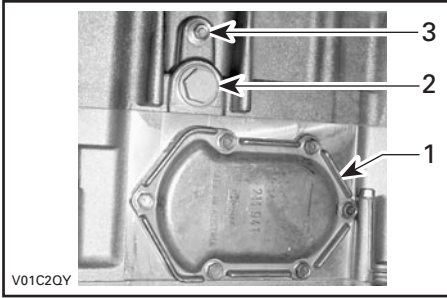

1. Oil strainer cover
2. Oil plug
3. Coolant plug

Quest and Traxter Series

To clean oil strainer, use a solvent then dry with compressed air.

⚠ WARNING

Always wear eye protection and gloves.

Reinstall oil strainer, oil collector and oil strainer cover.

Change gasket on drain plug. Clean gasket area on engine and drain plug then reinstall plug. Refill engine at the proper level with the recommended oil. Refer to SPECIFICATIONS for capacity.

Start engine and let idle for a few minutes. Ensure oil filter area and drain plug areas are not leaking.

Stop engine. Wait a while to allow oil to flow down to crankcase then check oil level. Refill as necessary.

Dispose of oil as per your local environmental regulations.

⚠ WARNING

To avoid burning yourself, do not remove the radiator cap or loosen the engine drain plug if the engine is hot.

Turn the radiator cap counterclockwise and remove it.

On **Quest series**, remove the skid plate under vehicle.

Remove the drain plug and drain the coolant into a suitable container.



QUEST SERIES — UNDER OIL FILTER COVER

1. Cooling drain plug

NOTE: Do not unscrew the drain plug completely.

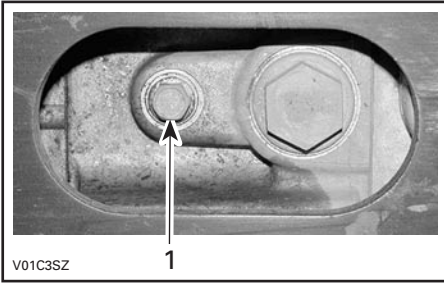

TRAXTER SERIES — UNDER ENGINE

1. Cooling drain plug

Unscrew the bleeding screw on the top of thermostat housing.

Drain the system completely and reinstall the drain plug.

NOTE: On **Traxter series**, lift the rear of vehicle, about 75 mm (3 in).

Pinch hose between radiator and thermostat housing with a large hose pincher (P/N 529 032 500).



QUEST SERIES



TRAXTER SERIES

Fill the radiator until the coolant comes out by the thermostat housing hole. Install the bleeding screw then remove the hose pincher.

Complete the radiator filling.

Check the level in the coolant reservoir and refill if necessary.

Run engine at idle with the radiator cap off. Slowly add additional coolant if necessary.

At this point, wait until engine reaches normal operating temperature. Depress the throttle lever two or three times; then add coolant if required.

Install radiator cap. Inspect all connections for leaks and check coolant level in the reservoir.

Valve Adjustment

Quest and Traxter Series

Valve adjustment is not required on this engine.

Spark Arrester

Quest and Traxter Series

The muffler must be periodically purged of accumulated carbon.

WARNING

Never run engine in an enclosed area. Never perform this operation immediately after the engine has been run because exhaust system is very hot. Make sure that there are no combustible materials in the area. Wear eye protection and gloves. Never stand behind the vehicle while purging exhaust system. Respect all applicable laws and regulations.

Select a well-ventilated area and make sure the muffler is cool.

Place transmission on PARK position.

Remove the clean-out plug from muffler.

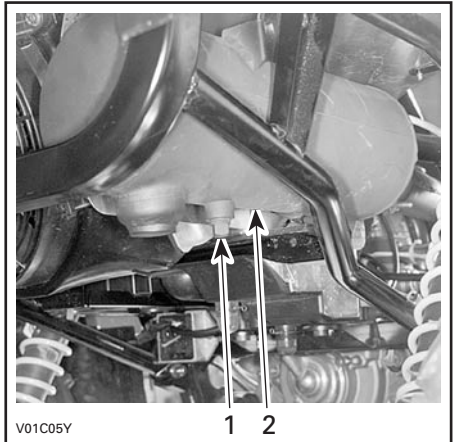

TYPICAL — TRAXTER SERIES

1. Clean-out plug
2. Muffler

Block the end of muffler with a shop rag and start engine.

Momentarily increase engine RPM several times to purge accumulated carbon out of the muffler.

Stop engine and allow muffler to cool.

Reinstall the clean-out plug.

Radiator

Quest and Traxter Series

Periodically check the radiator area and the air ducts for cleanliness. Ensure air ducts are unobstructed to allow air flow going to the radiator.

NOTE: On Traxter XL, there are not air ducts.

Quest and Traxter Series except Traxter XL

An access hole is available to inspect the radiator condition and to give access for cleaning.

Remove seat.

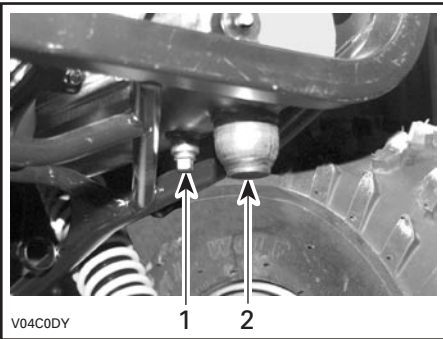

TYPICAL — QUEST SERIES

1. Clean-out plug
2. Muffler

Pull on the circumference of the access plug and remove plug.

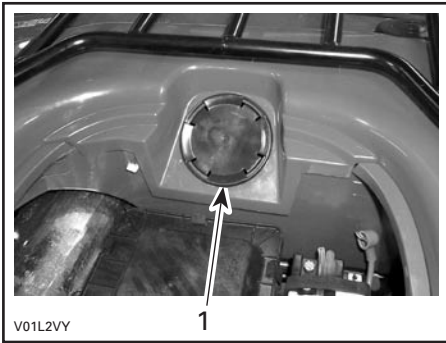

1. Access plug

Traxter XL

To reach the radiator, lift the rear cargo box.

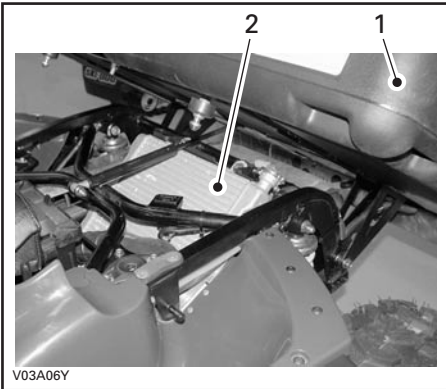

1. Rear cargo box
2. Radiator

Quest and Traxter Series

Inspect radiator fins. They must be clean, free of mud, dirt, leaves and any other deposit that would prevent the radiator from cooling properly.

Remove as much deposits as you can with your hands. If water is available in proximity, try rinsing the radiator fins.

If available, use a garden hose to rinse the radiator fins.

⚠ WARNING
Never clean radiator with your hands when it is hot. Let the radiator cool down before cleaning.

CAUTION: Be careful not to damage the radiator fins when cleaning. Do not use any object/tool that could damage the fins. The fins are purposefully thin parts to allow efficient cooling. **WHEN HOSING, USE LOW PRESSURE ONLY, NEVER USE A HIGH PRESSURE WASHER.**

Properly reinstall access plug and seat.

Carburetor

Quest and Traxter Series

See an authorized Bombardier ATV dealer each year to verify and clean the fuel system.

Air Intake System

Quest and Traxter Series

Air Filter Cleaning/Draining

Periodically inspect air filter box drain tube for liquid or deposits.

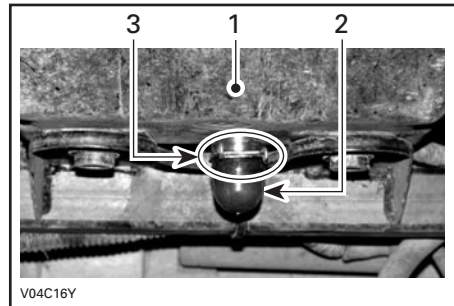

TYPICAL

- 1. Air filter box
- 2. Drain tube
- 3. Clamp

NOTE: If vehicle is used in dusty area, inspect more frequently than specified in MAINTENANCE CHART.

If liquid/deposits are found, squeeze and remove the clamp. Pull drain tube out and empty it.

CAUTION: Do not start engine when liquid/deposits are found in the drain tube.

When liquid/deposits are found, the air filter must be inspected/dried/replaced depending on its condition.

Remove air filter as explained below.

Air Filter Removal

CAUTION: Never remove or modify any component in the air box. Otherwise, engine performance degradation or damage can occur. The engine carburation is calibrated to operate specifically with these components.

Remove seat.

NOTE: On XL, lift the rear cargo box to have access to the air filter box.

Release clamps and remove air filter box cover.

Loosen clamp and remove air filter.

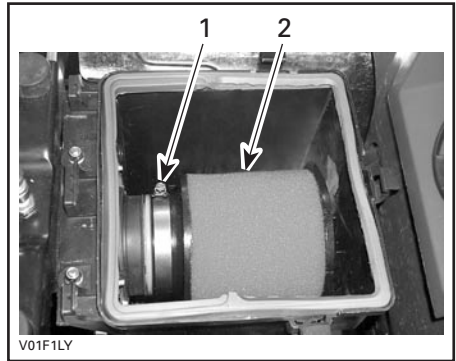

1. Clamp
2. Air filter

Pour air filter cleaning solution (P/N 293 600 059 or an equivalent) into a bucket. Put the filter in to soak.

While filter soaks, clean inside the air box.

Rinse the filter with warm water until all cleaning solution disappears.

NOTE: If the air filter foam is still dirty, replace it with a new one.

Then, let the filter dry completely.

When the filter is dried, re-oil with air filter oil (P/N 293 600 058 or an equivalent).

Air Filter Installation

Properly reinstall removed parts in the reverse order of their removal.

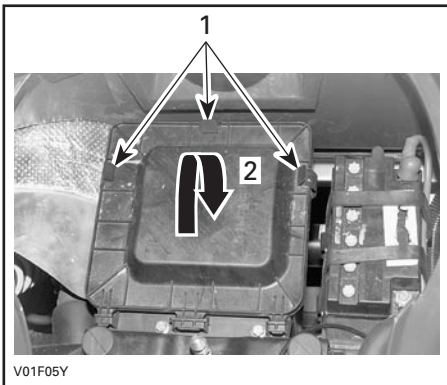

TYPICAL

1. Release clamps
2. Lift to remove

Electrical

Battery

Quest and Traxter Series

WARNING

Never charge a battery while installed in vehicle.

To remove the battery, refer to LIQUID in VEHICLE INFORMATION section.

Clean battery post with a wire brush. Apply dielectric grease on post to protect against oxidation.

Fuses

Quest and Traxter Series

If a fuse is damaged, replace it by one of the same rating.

CAUTION: Do not use a higher rated fuse as this can cause severe damage.

On Quest series, the fuse holder is located at the rear of the vehicle, on left side, under rear fender.

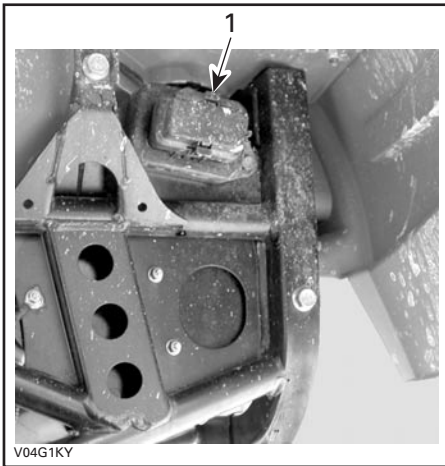

QUEST SERIES

1. Fuse holder

On Traxter series, the fuse holder is located in engine compartment on LH side of battery.

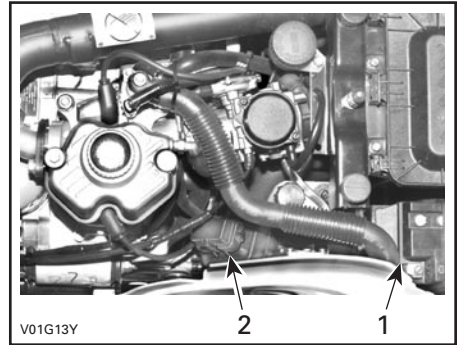

TRAXTER SERIES

1. Battery
2. Fuse holder

Fuses are identified by a number located beside the fuse.

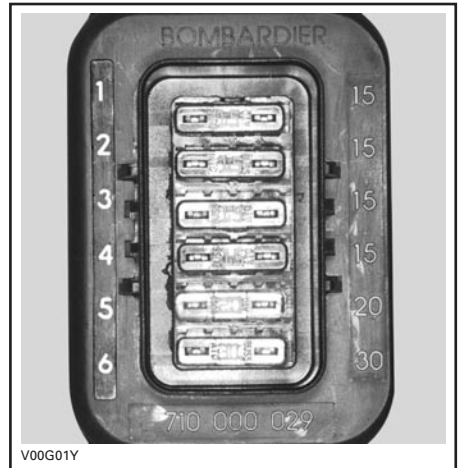

QUEST SERIES

1. Spare
2. Spare
3. Accessories (power outlet and auxiliary supply)
4. Fan
5. Main
6. Charging system

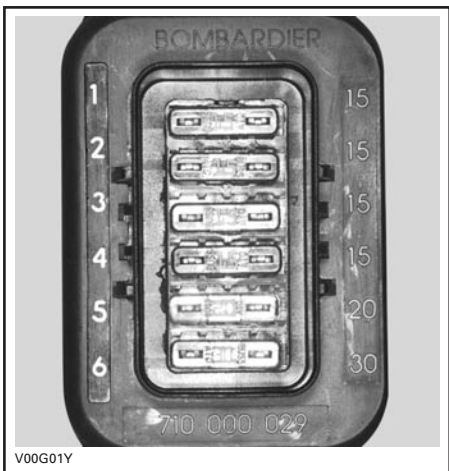

TRAXTER SERIES

1. Ignition system
2. Accessories (power outlet and auxiliary supply)
3. Solenoids
4. Fan
5. MPEM (Multi-Purpose Electronic Module)
6. Charging system

To remove fuse from holder, remove the fuse holder cover then pull fuse out. Check if filament is melted.

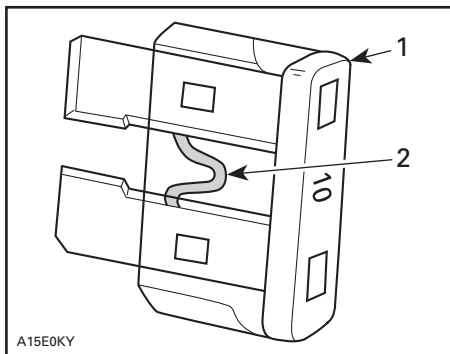

TYPICAL

1. Fuse
2. Check if melted

Bulb Replacement

Always check light operation after replacement.

Headlamps

Quest Series

CAUTION: Never touch glass portion of an halogen bulb with bare fingers, it shortens its operating life. If glass is touched, clean it with isopropyl alcohol which will not leave a film on the bulb.

Unplug connector from headlamp.

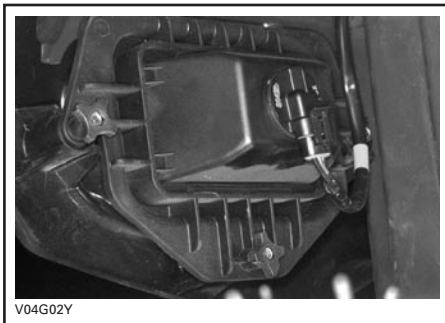

Rotate the bulb socket counterclockwise then remove headlamp.

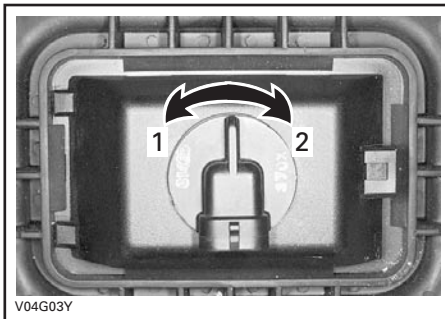

1. Unlock
2. Lock

Properly reinstall removed parts in the reverse order of their removal.

Adjust beam aiming as follows:

Turn knobs to adjust beam height and side orientation to your convenience. Adjust both headlamps evenly.

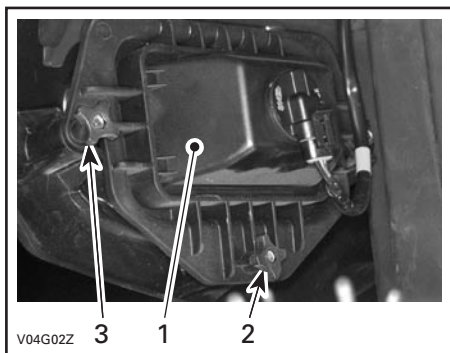

1. Headlamp cover
2. Beam height adjustment
3. Beam side adjustment

Traxter Series

Lift sealed beam cover then remove sealed beam.

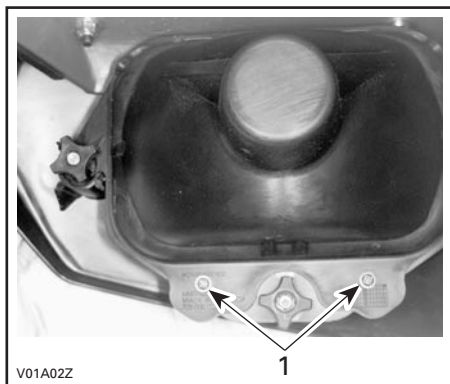

1. Remove screws and lift up the sealed beam cover

Properly reinstall removed parts in the reverse order of their removal.

Adjust beam aiming as follows:

Turn knobs to adjust beam height and side orientation to your convenience. Adjust both headlamps evenly.

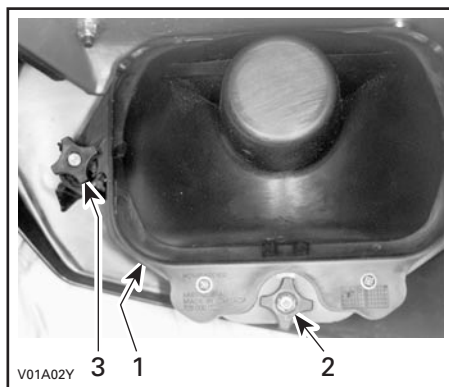

1. Headlamp
2. Beam height adjustment
3. Beam side adjustment

Taillight

Unscrew lens screws to expose bulb.

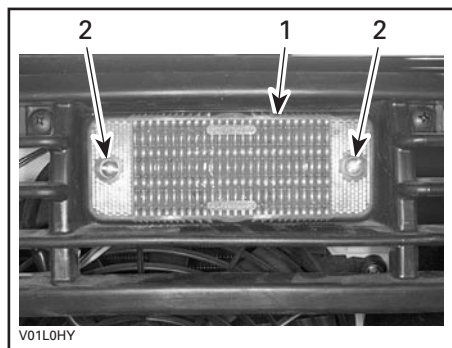

1. Lens
2. Screws

Push bulb in and hold while turning counterclockwise to release.

Install the new bulb by first pushing in while turning clockwise.

Indicator Light (if so equipped)

If one LED is burnt in the indicator light cluster, see an authorized Bombardier ATV dealer for replacement of the light cluster.

Speedometer

The speedometer is lighted with LEDs. If one LED burns, replace the speedometer. The LEDs are not available separately.

Drive Train

Quest Series

Front Propeller Shaft

Check the front propeller shaft boots for cracks, tears or other damages. See an authorized Bombardier ATV dealer if any damage is detected.

Check if the propeller shaft is straight and not damaged.

Rear Propeller Shaft

Lubricate the rear propeller shaft steadily. Use the synthetic grease (P/N 293 550 033).

Traxter Series

Propeller Shafts

Lubricate front and rear propeller shafts steadily. Use the synthetic grease (P/N 293 550 033).

Drive Shaft Boot/Protector

Quest and Traxter Series

Visually inspect drive shaft protectors and boot conditions. Check protectors for damage or rubbing against shafts. Check boots for cracks, tears, leaking grease etc. Repair or replace damaged parts as necessary.

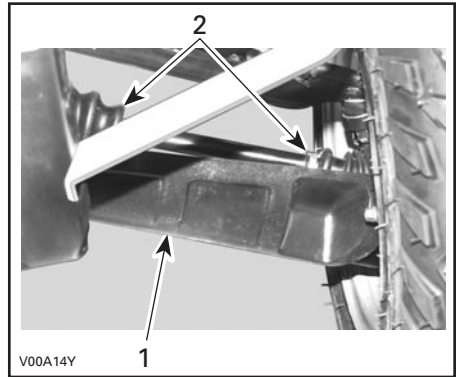

1. Drive shaft protector
2. Drive shaft boots

Wheel

Quest and Traxter Series

Occasionally, wheel nuts should be removed to apply anti-seize lubricant on studs to ease further removal. This is particularly important when vehicle is used in salt-water environment or in mud. Remove one nut at a time, lubricate then retorque.

Wheel Bearing Condition

Quest and Traxter Series

Push and pull the wheels from the upper edge to feel the play. See an authorized Bombardier ATV dealer if there is any play.



Tires/Wheels

Quest and Traxter Series

Tire Pressure

WARNING

Tire pressure greatly affects vehicle handling and stability. Underpressure may cause tire to deflate and rotate on wheel. Overpressure may burst the tire. Always follow recommended pressure. Since tires are low-pressure types, a manual pump should be used.

Check pressure when tires are “cold” before using the vehicle. Tire pressure changes with temperature and altitude. Recheck pressure if one of these conditions has changed.

For your convenience, a pressure gauge is supplied in tool box.

TIRE PRESSURE		
QUEST SERIES		
RECOMMENDED	FRONT	REAR
	38 kPa (5.5 PSI)	31 kPa (4.5 PSI)
MINIMUM	35 kPa (5 PSI)	28 kPa (4 PSI)
TRAXTER SERIES EXCEPT TRAXTER XL		
RECOMMENDED	FRONT	REAR
	38 kPa (5.5 PSI)	35 kPa (5 PSI)
MINIMUM	35 kPa (5 PSI)	31 kPa (4.5 PSI)
TRAXTER XL		
RECOMMENDED	FRONT	REAR
	48 kPa (7 PSI)	48 kPa (7 PSI)
MINIMUM	45 kPa (6.5 PSI)	45 kPa (6.5 PSI)

Although the tires are specifically designed for off-road use, a flat may still occur. Therefore, it is recommended to carry a tire pump and a repair kit.

Tire/Wheel Condition

Check tire for damage and wear. Replace if necessary.

Do not make a tire rotation. The front and rear tires have a different size. The tires are directional and their rotation must be kept in a specific direction for proper operation.

Wheel Removal

Loosen nuts then lift vehicle. Place a support under vehicle. Remove nuts then remove wheel.

At installation, it is recommended to apply anti-seize lubricant on threads. Gently tighten nuts in a criss-cross sequence then apply a final torque of 75 N•m (55 lbf•ft).

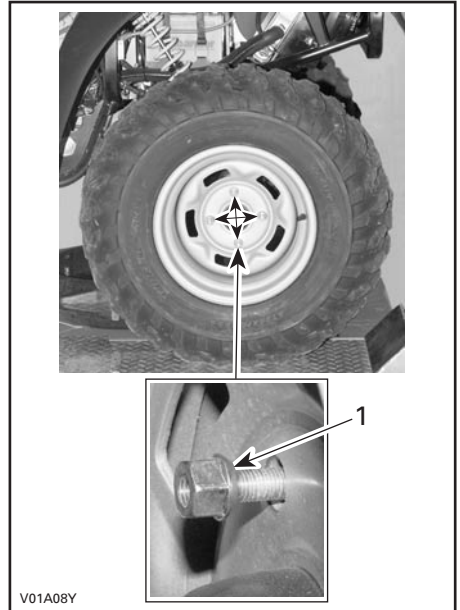

1. Taper side of nut

CAUTION: Always use the recommended wheel nuts (P/N 705 400 013). Using a different nut could cause damages to the rim.

Steering System

Quest and Traxter Series

Throttle Cable Lubrication

The throttle cable must be lubricated with Bombardier cable lubricant (P/N 293 600 041) or an equivalent.

WARNING

Using another lubricant could cause the throttle lever/cable sticking or stiffness.

Open the throttle lever housing.

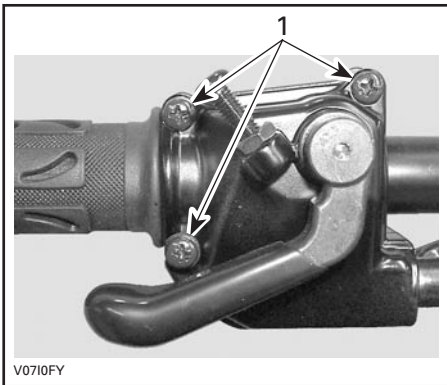

1. Remove these screws

Separate the housing. Slide rubber protector back to expose throttle cable adjuster.

Unscrew the locking nut of the cable adjuster then screw in the adjuster to release the cable tension.

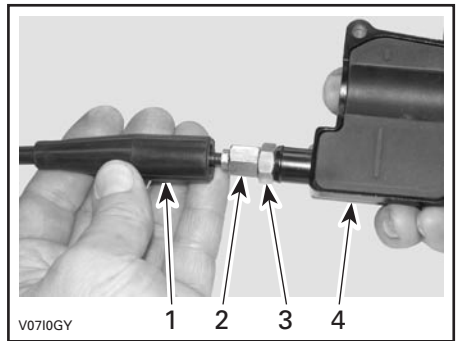

1. Cable protector
2. Throttle cable adjuster
3. Lock nut
4. Throttle lever housing

Remove:

- inner housing protector

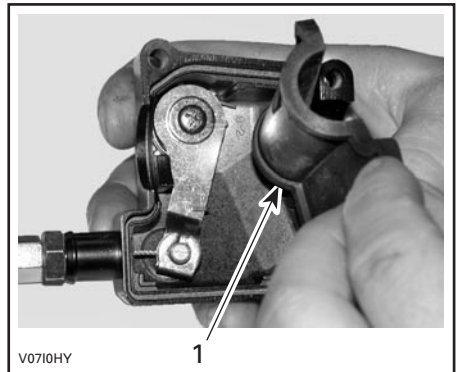

1. Inner housing protector

- the cable from the throttle lever housing.

NOTE: Slide cable in clip slot and remove the end of cable from clip.



Remove the carburetor side cover. Insert the needle of spray can in the end of throttle cable adjuster.

⚠ WARNING

Always wear eye protection and gloves when you lubricate a cable.

NOTE: Place a rag around the throttle cable adjuster to prevent the lubricant splash.

Add lubricant until it runs out at carburetor end of the throttle cable.

Reinstall and adjust the cable.

Throttle Lever Adjustment

Slide rubber protector back to expose throttle cable adjuster.

Loosen lock nut then turn the adjuster to obtain correct throttle lever free play.

NOTE: Measure throttle free play at the tip of throttle lever.

Tighten lock nut and reinstall protector.

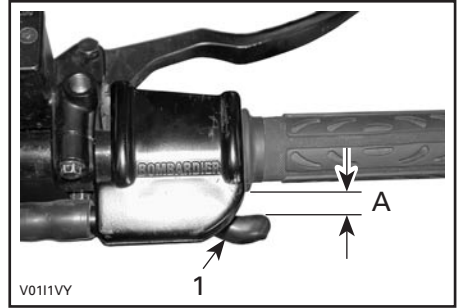

- 1. Throttle lever
- A. 3 to 6 mm (1/8 to 7/32 in)

With the transmission lever on PARK position, start the engine. Check if the throttle cable is adjusted correctly by turning handlebar fully right then fully left. If the engine RPM increases, re-adjust the throttle lever free play.

Suspension

Quest and Traxter Series Lubrication

A-Arms

Lubricate front A-arms. Use suspension synthetic grease (P/N 293 550 033). There are two grease fittings on the upper A-arm and two on the lower A-arm (underneath).

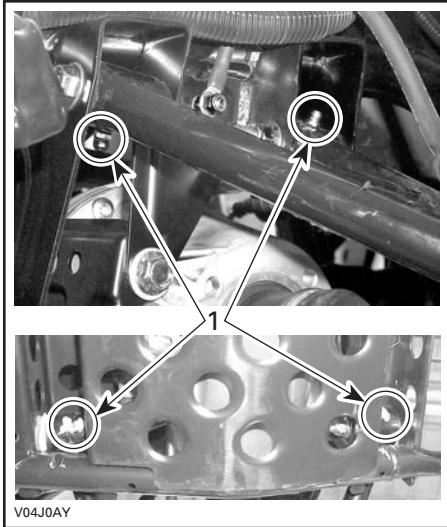

1. Grease fittings

Inspection

A-Arms

Check A-arms for cracks, bending or other damages. See an authorized Bombardier ATV dealer as necessary.

Swing Arm

Check swing arm for distortion, cracks or bending. See an authorized Bombardier ATV dealer if any problem is detected.

Shock Absorbers

Inspect shock absorber for oil leaks and fasteners for tightness. See an authorized Bombardier ATV dealer as necessary.

Adjustment

Rear Shocks

WARNING

Left and right adjusting cams must always be set at the same position. Never adjust one adjusting cam only. Uneven adjustment can cause poor handling and loss of stability, which could lead to an accident.

Preload Adjustment

Adjust spring preload by turning adjusting cam accordingly with the adjusting wrench in vehicle tool box.

Turn the adjusting cams clockwise for a firmer ride and rough road condition or when carrying cargo or pulling a trailer.

Turn the adjusting cams counterclockwise for a light load and a smooth road condition.

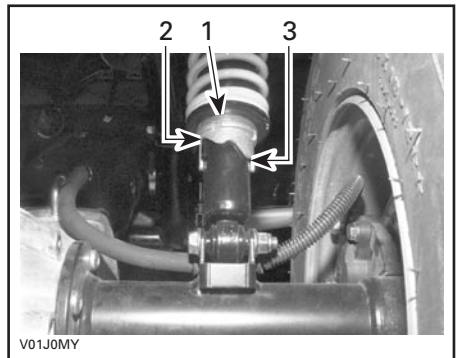

TYPICAL

1. Adjusting cams
2. Smooth adjustment
3. Hard adjustment

Brake

Quest and Traxter Series

WARNING

Any brake system repair should be performed by an authorized Bombardier ATV dealer.

The front brakes are hydraulic disc types. These brakes are self-adjusting and require no adjustment.

The rear brake employs two systems. The first system uses a cable; an adjustment is necessary. See an authorized Bombardier ATV dealer. The second system is hydraulic and requires no adjustment. The systems are linked together for a higher efficiency.

Inspection

Check the following to keep the brakes in a good operating condition:

- brake system for fluid leaks
- brake for spongy feel
- brake discs for excessive wear and surface condition
- brake pads for wear, damage or looseness.

SERVICE LIMITS	
Brake pads thickness	1 mm (.040 in)
Discs thickness	4.5 mm (.18 in)
Maximum discs warpage	0.2 mm (.01 in)

Brake Fluid Replacement

WARNING

The brake fluid replacement should be performed by an authorized Bombardier ATV dealer.

Brake Cable Lubrication

Remove brake lever and lock (screw, nut and spring).

Remove cable from hand lever. To ease this operation, apply a force on the brake pedal to loosen the cable.

Put the cable luber (P/N 529 035 738) on the cable.

Insert the needle of the spray can in the cable luber hole.

Spray a small quantity of silicone lubricant (P/N 293 600 041) then press the brake pedal to move the brake cable. Repeat this procedure until the silicone lubricant exits the other end of the cable.

Body/Frame

Quest and Traxter Series

Engine Compartment

Check engine compartment for any damage and leaks. Ensure all hose clamps are properly secured and no hose is cracked, kinked or otherwise damaged.

Inspect muffler, battery and reservoir fastening devices. Check electrical connections for corrosion and tightness.

Replace or have damaged parts repaired.

Skid Plate Condition

Check tightness of fasteners and condition of plate for cracks or other damage. Properly retighten fasteners as necessary and have skid plate replaced if damaged.

Hitch/Trailer Ball Condition

Check tightness of fasteners and tightness/condition of trailer ball. Properly retighten as necessary and replace ball if worn.

Fasteners

Check fastener condition and tightness on the vehicle. Retighten as required.

Seat Latch

Remove seat and check the locking mechanism and its pin for wear. See an authorized Bombardier ATV dealer for parts replacement if damaged.

Front Storage Compartment Latch

Check latch condition. See an authorized Bombardier ATV dealer for parts replacement if damaged.

Vehicle Cleaning and Protection

Never use a high pressure washer to clean the vehicle **USE LOW PRESSURE ONLY (like a garden hose)**. High pressure can cause electrical or mechanical damages.

Painted parts which are damaged should be properly repainted to prevent rust.

When required, wash the body with hot water and soap (only use mild detergent). Apply non-abrasive wax.

CAUTION: Never clean plastic parts with strong detergent, degreasing agent, paint thinner, acetone, etc.

Winch

Quest XT and Traxter XT

No lubrication is required for the life of the winch.

Check battery cables at 90 day intervals to be certain that they are clean and tight at all connections.

Inspect the wire rope before and after each winching operation. Replace winch rope when damage.

For more details, see *ATV Winch Operator's Manual*.

NOTE: This manual should be kept in the tool box and remain with the vehicle at all time.

Rear Cargo Box

Traxter XL

Check release lever and its mechanism for bend, cracks or other damages.

Lift up rear cargo box and check latches mechanism and pins for wear.

Check gate latches condition. See an authorized Bombardier ATV dealer for parts replacement if damaged.

TROUBLESHOOTING

SYMPTOM: Engine does not turn	
POSSIBLE CAUSES	WHAT TO DO
1. Ignition switch is in the OFF position.	Place switch to ON position.
2. Transmission is not set on PARK or NEUTRAL.	Set transmission either in PARK or in NEUTRAL or press any brake lever.
3. Burnt fuse.	On Quest series , check main fuse condition. On Traxter series , check MPEM and solenoids fuses condition.
4. Weak battery or loose connections.	Check charging system fuse. Check connections and terminals condition. Have the battery checked. Contact an authorized Bombardier ATV dealer.

SYMPTOM: Engine turns over but fails to start	
POSSIBLE CAUSES	WHAT TO DO
1. Burnt fuse.	Check ignition fuse condition.
2. Mixture not rich enough to start cold engine.	Check fuel tank level and check starting procedure, particularly use of the choke. NOTE: On Traxter series , below - 15°C (5°F) the use of fuel primer (optional) is required. Also, it is recommended to add gas line antifreeze.
3. Flooded engine (spark plug(s) wet when removed).	Refer to SPECIAL PROCEDURES.
4. No fuel to the engine (spark plug(s) dry when removed).	Check fuel tank level; turn fuel valve to ON (also try on RES). A failure of the fuel pump or carburetor may have occurred. Contact an authorized Bombardier ATV dealer.
5. Spark plug/ignition (no spark).	Check ignition fuse condition. Remove spark plug(s) then reconnect to ignition coil or spark plug caps. Check that ignition switch and/or engine stop switch(es) is/are at the ON position. Start engine with spark plug(s) grounded to engine away from spark plug holes. If no spark appears, replace spark plug(s). If trouble persists, contact an authorized Bombardier ATV dealer.
6. Engine compression.	As the engine is pulled over with the starter or with the rewind starter, "cycles" of resistance should be felt as piston goes past top dead center. If no pulsating resistance is felt, it suggests a major loss of compression. Contact an authorized Bombardier ATV dealer.

SYMPTOM: <i>Engine lacks acceleration or power</i>	
POSSIBLE CAUSES	WHAT TO DO
1. Fouled or damaged spark plug(s).	Check item ENGINE TURNS OVER BUT FAILS TO START.
2. Lack of fuel to engine.	Check item ENGINE TURNS OVER BUT FAILS TO START.
3. Carburetor adjustments.	Contact an authorized Bombardier ATV dealer.
4. Engine is overheating.	Check ENGINE OVERHEAT in SPECIAL PROCEDURES. If overheating persists, contact an authorized Bombardier ATV dealer.
5. Air filter box plugged or dirty.	Check air filter and clean if necessary. Check deposits in air box drain. Check the position of the air intake tube, reinstall properly if necessary.
6. CVT dirty or wear.	Contact an authorized Bombardier ATV dealer.

SYMPTOM: <i>Engine backfire</i>	
POSSIBLE CAUSES	WHAT TO DO
1. Exhaust system leakage.	Contact an authorized Bombardier ATV dealer.
2. Engine is running too hot.	See ENGINE LACKS ACCELERATION OR POWER.
3. Ignition timing is incorrect or there is an ignition system failure.	Contact an authorized Bombardier ATV dealer.
4. Improper carburetor setting.	Contact an authorized Bombardier ATV dealer.

SYMPTOM: <i>Engine misfire</i>	
POSSIBLE CAUSES	WHAT TO DO
1. Fouled/damaged/worn spark plug(s).	Clean/verify spark plug(s) and heat range. Replace as required.
2. Water in fuel.	Drain fuel system and refill with fresh fuel.

SYMPTOM: <i>Vehicle cannot reach full speed</i>	
POSSIBLE CAUSES	WHAT TO DO
1. Engine.	See ENGINE LACKS ACCELERATION OR POWER.
2. Parking brake.	Ensure brake lever lock is completely removed.
3. Air filter box plugged or dirty.	Check air filter and clean if necessary. Check deposits in air box drain. Check the position of the air intake tube, reinstall properly if necessary.
4. CVT dirty or wear.	Contact an authorized Bombardier ATV dealer.

SYMPTOM: Engine indicator light irregularly flashes at idle speed**POSSIBLE CAUSES****WHAT TO DO**

1. Engine idle is set too low.

Contact an authorized Bombardier ATV dealer.

SYMPTOM: Transmission does not shift smoothly**POSSIBLE CAUSES****WHAT TO DO**

1. Engine/transmission oil level is low.

Refill engine with recommended oil at the proper level.

2. Transmission shifting system.

Try depressing the throttle lever more while shifting.

3. Improper oil type.

Drain oil in engine and use recommended oil only.

4. Transmission.

See an authorized Bombardier ATV dealer.

SYMPTOM: Transmission lever is hard to move**POSSIBLE CAUSES****WHAT TO DO**

1. Transmission gears are in a position that prevents the transmission lever from working.

Rock the vehicle back and forth to move the gears in the transmission and allow the transmission lever to be set.

2. Engine idle speed is set too high.

Adjust the idle speed. Refer to the specification.

3. CVT dirty or wear.

Contact an authorized Bombardier ATV dealer.

SYMPTOM: AUTOSHIFT mode does not work**POSSIBLE CAUSES****WHAT TO DO**

1. Multi-function switch problem.

Contact an authorized Bombardier ATV dealer.

2. TPS sensor is defect.

Check TPS connector on carburetor. If the connection is good, contact an authorized Bombardier ATV dealer.

3. Engine.

Contact an authorized Bombardier ATV dealer.

SYMPTOM: Rear cargo box does not latch properly**POSSIBLE CAUSES****WHAT TO DO**

1. Debris in locking mechanism.

Remove debris, clean locking mechanism and close rear cargo box.

2. Debris or object underneath rear cargo box.

Remove any object or debris underneath rear cargo box and close it properly.

SYMPTOM: The RPM increases but the vehicle doesn't move**POSSIBLE CAUSES****WHAT TO DO**

1. Transmission is set on PARK or NEUTRAL.

Move the transmission lever to R, H or L position.

2. CVT is defective.

Contact an authorized Bombardier ATV dealer.

3. Water in the CVT housing.

Contact an authorized Bombardier ATV dealer.

SPECIFICATIONS

QUEST SERIES			
VEHICLE MODEL		500	500 XT
ENGINE			
Type		BOMBARDIER-ROTAX 4-TEC, 4 stroke. Over Head Camshaft (OHC), liquid cooled	
Number of cylinder		Single cylinder	
Number of valves		4 valves with hydraulic lifters (no adjustment)	
Displacement		498 cc (30.4 cu. in)	
Bore	Standard	100 mm (3.9 in)	
Stroke		63.4 mm (2-1/2 in)	
Compression ratio		10.5:1	
Lubrication		Wet sump with replaceable oil filter (lubrication of engine and transmission simultaneously)	
Decompressor		Automatic	
Exhaust system		Nelson, stainless steel, USDA Forest Service approved	
Air filter		2 stage foam filter	
TRANSMISSION			
Transmission		Continuously Variable Transmission (CVT)	
COOLING			
Type		Liquid cooled	
Radiator		Rear mounted with thermostatic fan	
CARBURATION			
Carburetor make and type		Mikuni BSR42. Constant velocity with manual choke and ECS (Enrichner Coasting System)	
Choke plunger position		Variable	
Idle speed	± 100	1300 RPM	
Fuel pump make and type		Mikuni, external (vacuum-operated)	

QUEST SERIES		
VEHICLE MODEL	500	500 XT
ELECTRICAL		
Magneto generator make and type	Denso, 400 W @ 6000 RPM	
Ignition type	CDI (Capacitor Discharge Ignition)	
Ignition timing	Not adjustable	
Engine RPM limiter	7400 RPM (any gear in forward)	
Vehicle speed limiter	15 km/h (9 MPH) in reverse	
Spark plug make and type	NGK DCPR8E	
Number of spark plug	1	
Spark plug gap	0.6 to 0.7 mm (.024 to .027 in)	
Battery	12 V, 19 Ah. Electrolyte type battery	
Starting system	Electric start. Start on P, R, N, H or L position (with brake applied)	
Headlamp	2 x 30 W	
Taillight	8/27 W	
Pilot lamp cluster	LEDS, 0.7 V approx. (each)	
FUSES		
Location no. 1 (spare 15 A)	N.A.	
Location no. 2 (spare 15 A)	N.A.	
Location no. 3 (accessories)	15 A (power outlet and auxiliary supply)	
Location no. 4 (fan)	15 A	
Location no. 5 (main)	20 A	
Location no. 6 (charging system)	30 A	
DRIVE TRAIN		
Front differential	Shaft driven/single auto-lock differential (shear pump)	
Rear axle	Shaft driven/solid axle	
SUSPENSION		
Front	Type	Independent suspension — double A-arm
	Travel	178 mm (7 in)
Rear	Type	Rigid swing-arm
	Travel	191 mm (7.5 in)
Size	Front	25 x 8 - 12
	Rear	25 x 11 - 12
TIRES		
Pressure	Front	38 kPa (5.5 PSI) recommended, 35 kPa (5 PSI) minimum
	Rear	31 kPa (4.5 PSI) recommended, 28 kPa (4 PSI) minimum

QUEST SERIES		
VEHICLE MODEL	500	500 XT
WHEELS		
Size	Front	12 x 6.5
	Rear	12 x 8
Wheel nut torque		75 N•m (55 lbf•ft)
BRAKES		
Front		Hydraulic, 2 discs
Rear		Mechanical cable/hydraulic, 1 disc
Parking		Park through transmission. LH brake lever includes a lock
LOADING CAPACITY		
Front rack		40 kg (90 lb) includes front storage tray
Rear rack		80 kg (175 lb) includes tongue load
Console		5 kg (11 lb)
Total vehicle load allowed		220 kg (485 lb) includes driver, all other loads and added accessories
GVWR (Gross Vehicle Weight Rating)		545 kg (1200 lb)
Towing capacity		500 kg (1100 lb)
Tongue capacity		14 kg (30 lb) included with rear rack
Front storage tray		10 kg (22 lb) included with front rack
DIMENSIONS		
Dry mass		338 kg (745 lb)
Overall length		2071 mm (81.5 in) 2116 mm (83 in)
Overall width		1194 mm (47 in)
Overall height		1143 mm (45 in)
Seat height		945 mm (37 in)
Wheel base		1296 mm (51 in)
Wheel track	Front	992 mm (39 in)
	Rear	940 mm (37 in)
Turning radius		2130 mm (84 in)
Toe-out adjustment (each side)	Front	8 mm ± 4 mm (5/16 in ± 5/32 in)
	Rear	N.A.
Ground clearance	Front and under engine	244 mm (9.6 in)
	Rear axle	188 mm (7.4 in)
Weight distribution (front/rear)		49/51%

QUEST SERIES		
VEHICLE MODEL	500	500 XT
LIQUIDS		
Oil type (engine and transmission)	SAE, 4-stroke mineral-based engine oil. API classification SG, SH or SJ or Bombardier synthetic oil. Refer to OIL VISCOSITY CHART for proper grade	
Coolant	Ethylene-glycol/water mix (50% coolant, 50% water). Use coolant specifically designed for aluminum engines	
Fuel	Type	Regular unleaded gasoline
	Octane	87 (R + M)/2 or higher
Differential	Front	Synthetic polyolester oil 75W90 (API GL-5)
	Rear	Synthetic polyolester oil 75W90 (API GL-5)
Hydraulic brake	Brake fluid, DOT 4	
Propeller shaft joint grease	Shell, Alvania EP-2 only	
CAPACITIES		
Fuel tank	22 L (5.8 U.S. gal) including approximately 4 L (1.1 U.S. gal) reserve	
Engine/transmission oil	Oil change with filter: 2.5 L (2.65 quarts). Total: 3 L (3.17 quarts)	
Coolant	2.5 L (2.65 quarts)	
Differential	Front	610 mL (21 U.S. oz)
	Rear	250 mL (8.5 U.S. oz)

W = Watt

N.A. = Not Applicable

Because of our ongoing commitment to product quality and innovation, Bombardier reserves the right, at any time, to make changes in design and specifications and/or to make additions to, or improvements in its products without imposing any obligation upon itself to install them on its products previously manufactured.

QUEST SERIES			
VEHICLE MODEL		650	650 XT
ENGINE			
Type		BOMBARDIER-ROTAX 4-TEC, 4 stroke. Over Head Camshaft (OHC), liquid cooled	
Number of cylinder		Single cylinder	
Number of valve		4 valves with hydraulic lifters (no adjustment)	
Displacement		644 cc (39.3 cu. in)	
Bore	Standard	100 mm (3.9 in)	
Stroke		82 mm (3.2 in)	
Compression ratio		9.5:1	
Lubrication		Wet sump with replaceable oil filter (lubrication of engine and transmission simultaneously)	
Decompressor		Automatic	
Exhaust system		Nelson, stainless steel, USDA Forest Service approved	
Air filter		2 stage foam filter	
TRANSMISSION			
Transmission		Continuously Variable Transmission (CVT)	
COOLING			
Type		Liquid cooled	
Radiator		Rear mounted with thermostatic fan	
CARBURATION			
Carburetor make and type		Mikuni BSR42. Constant velocity with manual choke and ECS (Enrichner Coasting System)	
Choke plunger position		Variable	
Idle speed	± 100	1100 RPM	
Fuel pump make and type		Mikuni, external (vacuum-operated)	

QUEST SERIES		
VEHICLE MODEL	650	650 XT
ELECTRICAL		
Magneto generator make and type	Denso, 400 W @ 6000 RPM	
Ignition type	CDI (Capacitor Discharge Ignition)	
Ignition timing	Not adjustable	
Engine RPM limiter	7400 RPM (any gear in forward)	
Vehicle speed limiter	15 km/h (9 MPH) in reverse	
Spark plug make and type	NGK DCPR8E	
Number of spark plug	1	
Spark plug gap	0.6 to 0.7 mm (.024 to .027 in)	
Battery	12 V, 19 Ah. Electrolyte type battery	
Starting system	Electric start. Start on P, R, N, H or L position (with brake applied)	
Headlamp	2 x 30 W	
Taillight	8/27 W	
Pilot lamp cluster	LEDS, 0.7 V approx. (each)	
FUSES		
Location no. 1 (spare 15 A)	N.A.	
Location no. 2 (spare 15 A)	N.A.	
Location no. 3 (accessories)	15 A (power outlet and auxiliary supply)	
Location no. 4 (fan)	15 A	
Location no. 5 (main)	20 A	
Location no. 6 (charging system)	30 A	
DRIVE TRAIN		
Front differential	Shaft driven/single auto-lock differential (shear pump)	
Rear axle	Shaft driven/solid axle	
SUSPENSION		
Front	Type	Independent suspension — double A-arm
	Travel	178 mm (7 in)
Rear	Type	Rigid swing-arm
	Travel	191 mm (7.5 in)
Size	Front	25 x 8 - 12
	Rear	25 x 11 - 12

QUEST SERIES		
VEHICLE MODEL	650	650 XT
TIRES		
Pressure	Front	38 kPa (5.5 PSI) recommended, 35 kPa (5 PSI) minimum
	Rear	31 kPa (4.5 PSI) recommended, 28 kPa (4 PSI) minimum
Size	Front	25 x 8 - 12
	Rear	25 x 11 - 12
WHEELS		
Size	Front	12 x 6.5
	Rear	12 x 8
Wheel nut torque		75 N•m (55 lbf•ft)
BRAKES		
Front		Hydraulic, 2 discs
Rear		Mechanical cable/hydraulic, 1 disc
Parking		Park through transmission. LH brake lever includes a lock
LOADING CAPACITY		
Front rack		40 kg (90 lb) includes front storage tray
Rear rack		80 kg (175 lb) includes tongue load
Total vehicle load allowed		220 kg (485 lb) includes driver, all other loads and added accessories
GVWR (Gross Vehicle Weight Rating)		545 kg (1200 lb)
Towing capacity		500 kg (1100 lb)
Tongue capacity		14 kg (30 lb) included with rear rack
Front storage tray		10 kg (22 lb) included with front rack
DIMENSIONS		
Dry mass		338 kg (745 lb)
Overall length		2071 mm (81.5 in) 2116 mm (83 in)
Overall width		1194 mm (47 in)
Overall height		1143 mm (45 in)
Seat height		945 mm (37 in)
Wheel base		1296 mm (51 in)
Wheel track	Front	992 mm (39 in)
	Rear	940 mm (37 in)
Turning radius		2130 mm (84 in)
Toe-out adjustment		8 mm ± 4 mm (5/16 in ± 5/32 in)
Ground clearance	Front and under engine	244 mm (9.6 in)
	Rear axle	188 mm (7.4 in)
Weight distribution (front/rear)		49/51%

QUEST SERIES			
VEHICLE MODEL	650		650 XT
LIQUIDS			
Oil type (engine and transmission)	SAE, 4-stroke mineral-based engine oil. API classification SG, SH or SJ or Bombardier synthetic oil. Refer to OIL VISCOSITY CHART for proper grade		
Coolant	Ethylene-glycol/water mix (50% coolant, 50% water). Use coolant specifically designed for aluminum engines		
Fuel	Type	Regular unleaded gasoline	
	Octane	87 (R + M)/2 or higher	
Differential	Front	Synthetic polyolester oil 75W90 (API GL-5)	
	Rear	Synthetic polyolester oil 75W90 (API GL-5)	
Hydraulic brake	Brake fluid, DOT 4		
Propeller shaft joint grease	Shell, Alvania EP-2 only		
CAPACITIES			
Fuel tank	22 L (5.8 U.S. gal) including approximately 4 L (1.1 U.S. gal) reserve		
Engine/transmission oil	Oil change with filter: 2.5 L (2.65 quarts). Total: 3 L (3.17 quarts)		
Coolant	2.5 L (2.65 quarts)		
Differential	Front	610 mL (21 U.S. oz)	
	Rear	250 mL (8.5 U.S. oz)	

W = Watt

N.A. = Not Applicable

Because of our ongoing commitment to product quality and innovation, Bombardier reserves the right, at any time, to make changes in design and specifications and/or to make additions to, or improvements in its products without imposing any obligation upon itself to install them on its products previously manufactured.

TRAXTER SERIES

VEHICLE MODEL		AUTOSHIFT	XT	XL
ENGINE				
Type		BOMBARDIER-ROTAX, 4-stroke. Longitudinal mount, liquid cooled, OHV		
Number of cylinder		Single cylinder		
Number of valve		2 valves with hydraulic lifters (no adjustment)		
Displacement		498 cc (30.4 cu. in)		
Bore	Standard	89 mm (3.5 in)		
Stroke		80 mm (3.15 in)		
Compression ratio		9:1		
Lubrication		Wet sump with replaceable oil filter (lubrication of engine and transmission simultaneously)		
Oil filter		BOMBARDIER-ROTAX		
Decompressor		Automatic		
Exhaust system		Nelson, stainless steel, USDA Forest Service approved		
Air filter		2 stage foam filter		
TRANSMISSION				
Clutch		1 centrifugal and 1 multi-disc hydraulically controlled		
Transmission		Dual range (HI-LO) with park, neutral and reverse. 5 speeds. Electronically controlled hydraulic shift. Limited vehicle reverse speed		
COOLING				
Type		Liquid cooled		
Radiator		Rear mounted with thermostatic fan		
CARBURATION				
Carburetor make and type		Mikuni BSR33. Constant depression type with manual choke and ECS (Enrichner Coasting System)		
Choke plunger position		Variable		
Idle speed	± 100	1100 RPM		
Fuel pump make and type		Mikuni, external (vacuum-operated)		

TRAXTER SERIES			
VEHICLE MODEL	AUTOSHIFT	XT	XL
ELECTRICAL			
Magneto generator make and type	Denso, 400 W @ 6000 RPM		
Ignition type	IDI (Inductive Discharge Ignition)		
Ignition timing	Not adjustable		
Engine RPM limiter	7700 RPM (any gear in forward)		
Vehicle speed limiter	15 km/h (9 MPH) in reverse		
Spark plug make and type	NGK DR8EA		
Number of spark plug	2		
Spark plug gap	0.6 to 0.7 mm (.024 to .027 in)		
Battery	12 V, 19 Ah. Electrolyte type battery		
Starting system	Electric start and manual rewind starter. Start in any gear (with brake applied)		
Headlamp	2 x 55 W, H4703		
Taillight	8/27 W, 1157		
Pilot lamp cluster	LEDS, 0.7 V approx.		
FUSES			
Ignition (no. 1)	15 A		
Accessories (no. 2)	15 A (power outlet and auxiliary supply)		
Solenoids (no. 3)	15 A		
Fan (no. 4)	15 A		
MPEM (Multi-Purpose Electronic Module) (no. 5)	20 A		
Charging system (no. 6)	30 A		
DRIVE TRAIN			
Front differential	Shaft driven/single auto-lock differential (shear pump)		
Rear axle	Shaft driven/solid axle		
Turning radius	2130 mm (84 in)	2130 mm (84 in)	2515 mm (99 in)
Toe-out adjustment (each side)	8 mm ± 4 mm (5/16 in ± 5/32 in)		
SUSPENSION			
Front	Type	Independent suspension — double A-arm	
	Travel	178 mm (7 in)	
Rear	Type	Rigid swing-arm	
	Travel	190.5 mm (7.5 in)	

TRAXTER SERIES

VEHICLE MODEL		AUTOSHIFT	XT	XL
TIRES				
Pressure	Front	RECOMMENDED		
		38 kPa (5.5 PSI)	48 kPa (7 PSI)	
		MINIMUM		
	Rear	35 kPa (5 PSI)	41 kPa (6 PSI)	
		RECOMMENDED		
		35 kPa (5 PSI)	48 kPa (7 PSI)	
MINIMUM				
31 kPa (4.5 PSI)	41 kPa (6 PSI)			
Size	Front	25 x 8 — 12 TRAILWOLF		
	Rear	26 x 10 — 12 TRAILWOLF		
WHEELS				
Size	Front	12 x 6.5		
	Rear	12 x 8		
Wheel nut torque		75 N•m (55 lbf•ft)		
BRAKES				
Front		Hydraulic, 2 discs		
Rear		Hydraulic, 1 disc		
Parking		Park through transmission. LH brake lever includes a lock		
LOADING CAPACITY				
Front rack (includes front storage tray)		40 kg (90 lb)		
Rear rack (includes tongue load)		80 kg (175 lb)	N.A.	
Rear cargo box (includes tongue load)		N.A.	273 kg (601 lb)	
Lateral compartment (each compartment)		N.A.	6.8 kg (15 lb)	
Total vehicle load allowed (includes driver, all other loads and added accessories)		220 kg (485 lb)	364 kg (802 lb)	
GVWR (Gross Vehicle Weight Rating)		545 kg (1200 lb)	750 kg (1650 lb)	
Towing capacity		500 kg (1100 lb)		
Tongue capacity		14 kg (30 lb) included with rear rack or rear cargo box		
Front storage tray		10 kg (22 lb) included with front rack		

TRAXTER SERIES				
VEHICLE MODEL		AUTOSHIFT	XT	XL
DIMENSIONS				
Dry mass		340 kg (755 lb)		386 kg (850 lb)
Overall length		2.1 m (82 in)	2.2 m (83 in)	2.5 m (82 in)
Overall width		1.2 m (47 in)		
Overall height		1.1 m (45 in)		
Seat height		945 mm (37 in)		
Wheel base		1.3 m (51 in)		1.6 m (61 in)
Wheel track	Front	992 mm (39 in)		
	Rear	940 mm (37 in)		
Ground clearance	Front and under engine	244 mm (9.6 in)		
	Rear axle	188 mm (7.4 in)		
Weight distribution (front/rear)		49/51%		
LIQUIDS				
Oil type (engine and transmission)		SAE, 4-stroke mineral-based engine oil. API classification SG,SH or SJ or Bombardier synthetic oil. Do not use other synthetic oil, synthetic blend oil or special additive. Refer to OIL VISCOSITY CHART for proper grade.		
Coolant		Ethylene-glycol/water mix (50% coolant, 50% water). Use coolant specifically designed for aluminum engines		
Fuel	Type	Regular unleaded gasoline		
	Octane	87 (R + M)/2 or higher		
Differential	Front/rear	Synthetic polyolester oil 75W90 (API GL-5)		
Hydraulic brake		Brake fluid, DOT 4		
Propeller shaft joint grease		Shell, Alvania EP-2 only		
CAPACITIES				
Vehicle range		Approximately 10 hours depending on many factors such as temperature, operating conditions and load		
Fuel tank		20 L (5.3 U.S. gal) including approximately 6 L (1.6 U.S. gal) reserve		
Engine/transmission oil		Oil change with filter: 2.5 L (2.65 quarts). Total: 3 L (3.17 quarts)		
Coolant		2.5 L (2.65 quarts)		
Differential	Front	610 mL (21 U.S. oz)		
	Rear	250 mL (8.5 U.S. oz)		

W = Watt

N.A. = Not Applicable

Because of our ongoing commitment to product quality and innovation, Bombardier reserves the right, at any time, to make changes in design and specifications and/or to make additions to, or improvements in its products without imposing any obligation upon itself to install them on its products previously manufactured.

SI* METRIC INFORMATION GUIDE

BASE UNITS

DESCRIPTION	UNIT	SYMBOL
length	meter	m
mass	kilogram	kg
force	newton	N
liquid	liter	L
temperature	Celsius	°C
pressure	kilo pascal	kPa
torque	newton-meter	N•m
land velocity	kilometer per hour	km/h

PREFIXES

PREFIX	SYMBOL	MEANING	VALUE
kilo	k	one thousand	1000
centi	c	one hundredth of	0.01
milli	m	one thousandth of	0.001
micro	μ	one millionth of	0.000001

CONVERSION FACTORS

TO CONVERT	TO ①	MULTIPLY BY
in	mm	25.4
in	cm	2.54
in ²	cm ²	6.45
in ³	cm ³	16.39
ft	m	0.3
oz	g	28.35
lb	kg	0.45
lbf	N	4.4
lbf•in	N•m	0.11
lbf•ft	N•m	1.36
lbf•ft	lbf•in	12
PSI	kPa	6.89
imp. oz	U.S. oz	0.96
imp. oz	mL	28.41
imp. gal	U.S. gal	1.2
imp. gal	L	4.55
U.S. oz	mL	29.57
U.S. gal	L	3.79
MPH	km/h	1.61
Fahrenheit	Celsius	(°F - 32) ÷ 1.8
Celsius	Fahrenheit	(°C × 1.8) + 32
hp	kW75

* The international system of units abbreviates SI in all languages.

① To obtain the reverse sequence, divide by the given factor. To convert **millimeters** to **inches**, divide by 25.4.

NOTE: Conversion factors are rounded off to 2 decimals for easier use.

WARRANTY

BOMBARDIER LIMITED WARRANTY NORTH AMERICA: 2004 BOMBARDIER® ATV

1. SCOPE OF THE LIMITED WARRANTY

In Canada, BOMBARDIER INC. (hereinafter "BOMBARDIER"), and in the USA, BOMBARDIER ON BEHALF OF BOMBARDIER MOTOR CORPORATION OF AMERICA (BMCA) warrants its 2004 BOMBARDIER ATV from defects in material or workmanship for the period described below.

All genuine BOMBARDIER parts and accessories, installed by an authorized BOMBARDIER ATV dealer (as hereinafter defined) at the time of delivery of the 2004 BOMBARDIER ATV, carry the same warranty as that of the ATV.

Following tires and winches supplied as original equipment on your ATV are warranted separately by the individual tire or winch manufacturer as identified below. If an original tire or winch on your BOMBARDIER ATV has a defect in material or workmanship, please contact these manufacturers or ask your authorized BOMBARDIER dealer for assistance.

Carlisle Tire & Wheel Company
(TRAXTER AND QUEST TIRES)
23 Windham Boulevard
Aiken, SC 29805

Warn Industries Inc. (Winch)
12900 SE Capps Road
Clackamas, Oregon 97015-8903

Warranty Information:

In USA 1 800 260-7959

In Canada 1 800 265-6155

In Quebec 1 877 997-4999

Customer service :

In USA 1 800 543-9276

In Canada 1 800 668-6012

In Quebec 1 800 361-9291

Please note that for any other 2004 ATV models, unless differently specified, tires are warranted directly by BOMBARDIER and not by the manufacturer company which produce these tires.

Use of the product for racing or any other competitive activity, at any point, even by a previous owner, will render this warranty null and void.

2. WARRANTY COVERAGE PERIOD

This warranty will be in effect FROM THE DATE OF DELIVERY TO THE FIRST RETAIL CONSUMER or the date the product is first put into use, whichever occurs first and for a period of:

SIX (6) CONSECUTIVE MONTHS, for private use or commercial use owners.

The repair or replacement of parts or the performance of service under this warranty does not extend the life of this warranty beyond its original expiration date.

3. CONDITIONS TO HAVE WARRANTY COVERAGE

This warranty coverage is available only on 2004 BOMBARDIER ATV purchased as new and unused by its first owner from a BOMBARDIER dealer authorized to distribute Bombardier ATV products in the country in which the sale occurred (hereinafter "BOMBARDIER ATV dealer"), and then only after the BOMBARDIER specified pre-delivery inspection process is completed and documented. Moreover, this warranty coverage is only available if the Bombardier ATV is purchased in the country in which the purchaser resides. Bombardier will not honor this limited warranty to any personal use owner or commercial use owner where the preceding conditions have not been met. Warranty coverage only becomes available upon proper registration of the product by an authorized BOMBARDIER ATV dealer. Such limitations are necessary in order to allow BOMBARDIER to preserve both the safety of its products, and also that of its consumers and the public.

Routine maintenance outlined in the *Operator's Guide* must be timely performed in order to maintain warranty coverage. BOMBARDIER reserves the right to make warranty coverage contingent upon proof of proper maintenance.

4. WHAT TO DO TO OBTAIN WARRANTY COVERAGE

The customer must notify a servicing BOMBARDIER ATV dealer within two (2) days of the appearance of a defect, and provide it with reasonable access to the product and reasonable opportunity to repair it. The customer must also present to the authorized BOMBARDIER dealer, proof of purchase of the product and must sign the repair/work order prior to starting the repair in order to validate the warranty repair. All parts replaced under this limited warranty become the property of BOMBARDIER.

5. WHAT BOMBARDIER WILL DO

BOMBARDIER's obligations under this warranty are limited to, at its sole discretion, repairing parts found defective under normal use, maintenance and service, or replacing such parts with new genuine BOMBARDIER parts without charge for parts and labor, at any authorized BOMBARDIER ATV dealer during the warranty coverage period.

BOMBARDIER reserves the right to improve or modify products from time to time without assuming any obligation to modify products previously manufactured.

6. EXCLUSIONS - ARE NOT WARRANTED

- Normal wear and tear;
- Routine maintenance items, tune ups, adjustments;
- Damage caused by failure to provide proper maintenance and/or storage, as described in the *Operator's Guide*;
- Damage resulting from removal of parts, improper repairs, service, maintenance, modifications or use of parts not manufactured or approved by BOMBARDIER or resulting from repairs done by a person that is not an authorized servicing BOMBARDIER ATV dealer;
- Damage caused by abuse, abnormal use, neglect or operation of the product in a manner inconsistent with the recommended operation described in the *Bombardier ATV Operator's Guide*;
- Damage resulting from accident, submersion, fire, theft, vandalism or any act of God;
- Operation with fuels, oils or lubricants which are not suitable for use with the product (see the *Operator's Guide*);
- Water or snow ingestion;
- Incidental or consequential damages, or damages of any kind including without limitation towing, storage, telephone, rental, taxi, inconvenience, insurance coverage, loan payments, loss of time, loss of income.

7. LIMITATIONS OF LIABILITY

THIS WARRANTY IS EXPRESSLY GIVEN AND ACCEPTED IN LIEU OF ANY AND ALL OTHER WARRANTIES, EXPRESSED OR IMPLIED, INCLUDING WITHOUT LIMITATION ANY WARRANTY OF MERCHANTABILITY OR FITNESS FOR A PARTICULAR PURPOSE. TO THE EXTENT THAT THEY CANNOT BE DISCLAIMED, THE IMPLIED WARRANTIES ARE LIMITED IN DURATION TO THE LIFE OF THE EXPRESS WARRANTY. INCIDENTAL AND CONSEQUENTIAL DAMAGES ARE EXCLUDED FROM COVERAGE UNDER THIS WARRANTY. SOME STATES/PROVINCES DO NOT ALLOW FOR THE DISCLAIMERS, LIMITATIONS AND EXCLUSIONS IDENTIFIED ABOVE, AS A RESULT, THEY MAY NOT APPLY TO YOU. THIS WARRANTY GIVES YOU SPECIFIC RIGHTS, AND YOU MAY ALSO HAVE OTHER LEGAL RIGHTS WHICH MAY VARY FROM STATE TO STATE, OR PROVINCE TO PROVINCE.

Neither the distributor, any BOMBARDIER ATV dealer nor any other person has been authorized to make any affirmation, representation or warranty regarding the product, other than those contained in this limited warranty, and if made, shall not be enforceable against BOMBARDIER.

BOMBARDIER reserves the right to modify this warranty at any time, being understood that such modification will not alter the warranty conditions applicable to the products sold while this warranty is in effect.

8. TRANSFER

If the ownership of a product is transferred during the warranty coverage period, this warranty shall also be transferred and be valid for the remaining coverage period provided that BOMBARDIER is notified of such transfer of ownership in the following way:

- a) The former owner contacts BOMBARDIER (at the phone number provided below) or an authorized BOMBARDIER ATV dealer and gives the coordinates of the new owner; or
- b) BOMBARDIER or an authorized BOMBARDIER ATV dealer receives a proof that the former owner agreed to the transfer of ownership, in addition to the coordinates of the new owner.

9. CONSUMER ASSISTANCE

- a) In the event of a controversy or a dispute in connection with this BOMBARDIER LIMITED WARRANTY, BOMBARDIER suggests that you try to resolve the issue at the dealership level. We recommend discussing the issue with the authorized dealer's service manager or owner.
- b) If the issue has not yet been resolved, please submit your complaint in writing or call the appropriate number below:

In Canada:

**BOMBARDIER INC.
RECREATIONAL PRODUCTS
BOMBARDIER ATV
CUSTOMER ASSISTANCE CENTER
VALCOURT QC J0E 2L0
Tel.: (819) 566-3366**

In USA:

**BOMBARDIER MOTOR
CORPORATION OF AMERICA
RECREATIONAL PRODUCTS
BOMBARDIER ATV
CUSTOMER ASSISTANCE CENTER
7575 BOMBARDIER COURT
WAUSAU WI 54401
Tel.: (715) 848-4957**

BOMBARDIER INTERNATIONAL LIMITED WARRANTY: 2004 BOMBARDIER® ATV

1. SCOPE OF THE LIMITED WARRANTY

BOMBARDIER INC. (hereinafter "BOMBARDIER"), warrants its 2004 BOMBARDIER ATV from defects in material or workmanship for the period described below.

All genuine BOMBARDIER parts and accessories, installed by an authorized BOMBARDIER distributor/dealer (as hereinafter defined) at the time of delivery of the 2004 BOMBARDIER ATV, carry the same warranty as that of the ATV.

Use of the product for racing or any other competitive activity, at any point, even by a previous owner; will render this warranty null and void.

2. WARRANTY COVERAGE PERIOD

This warranty will be in effect FROM THE DATE OF DELIVERY TO THE FIRST RETAIL CONSUMER or the date the product is first put into use, whichever occurs first and for a period of:

SIX (6) CONSECUTIVE MONTHS, for private use or commercial use owners.

The repair or replacement of parts or the performance of service under this warranty does not extend the life of this warranty beyond its original expiration date.

3. CONDITIONS TO HAVE WARRANTY COVERAGE

This warranty coverage is available only on 2004 BOMBARDIER ATV purchased as new and unused by its first owner from a BOMBARDIER distributor/dealer authorized to distribute BOMBARDIER ATV products in the country in which the sale occurred (hereinafter "BOMBARDIER ATV distributor/dealer", and then only after the BOMBARDIER specified pre-delivery inspection process is completed and documented. Moreover, this warranty coverage is only available if the BOMBARDIER ATV is purchased in the country in which the purchaser resides. BOMBARDIER will not honor this limited warranty to any personal use owner or commercial use owner where the preceding conditions have not been met. Warranty coverage only becomes available upon proper registration of the product by an authorized BOMBARDIER ATV distributor/dealer. Such limitations are necessary in order to allow BOMBARDIER to preserve both the safety of its products, and also that of its consumers and the public.

Routine maintenance outlined in the *Operator's Guide* must be timely performed in order to maintain warranty coverage. BOMBARDIER reserves the right to make warranty coverage contingent upon proof of proper maintenance.

4. WHAT TO DO TO OBTAIN WARRANTY COVERAGE

The customer must notify a servicing BOMBARDIER ATV distributor/dealer within two (2) days of the appearance of a defect, and provide it with reasonable access to the product and reasonable opportunity to repair it. The customer must also present to the authorized BOMBARDIER distributor/dealer, proof of purchase of the product and must sign the repair/work order prior to starting the repair in order to validate the warranty repair. All parts replaced under this limited warranty become the property of BOMBARDIER.

5. WHAT BOMBARDIER WILL DO

BOMBARDIER's obligations under this warranty are limited to, at its sole discretion, repairing parts found defective under normal use, maintenance and service; or replacing such parts with new genuine BOMBARDIER parts without charge for parts and labour, at any authorized BOMBARDIER distributor/dealer.

BOMBARDIER reserves the right to improve or modify products from time to time without assuming any obligation to modify products previously manufactured.

6. EXCLUSIONS - ARE NOT WARRANTED

- Normal wear and tear;
- Routine maintenance items, tune ups, adjustments;
- Damage caused by failure to provide proper maintenance and/or storage, as described in the *Operator's Guide*;
- Damage resulting from removal of parts, improper repairs, service, maintenance, modifications or use of parts not manufactured or approved by BOMBARDIER or resulting from repairs done by a person that is not an authorized servicing BOMBARDIER distributor/dealer;
- Damage caused by abuse, abnormal use, neglect or operation of the product in a manner inconsistent with the recommended operation described in the *Operator's Guide*;
- Damage resulting from accident, submersion, fire, theft, vandalism or any act of God;
- Operation with fuels, oils or lubricants which are not suitable for use with the product (see the *Operator's Guide*);
- Water or snow ingestion;
- Incidental or consequential damages, or damages of any kind including without limitation towing, storage, telephone, rental, taxi, inconvenience, insurance coverage, loan payments, loss of time, loss of income.

7. LIMITATIONS OF LIABILITY

THIS WARRANTY IS EXPRESSLY GIVEN AND ACCEPTED IN LIEU OF ANY AND ALL OTHER WARRANTIES, EXPRESSED OR IMPLIED, INCLUDING WITHOUT LIMITATION ANY WARRANTY OF MERCHANTABILITY OR FITNESS FOR A PARTICULAR PURPOSE. TO THE EXTENT THAT THEY CANNOT BE DISCLAIMED, THE IMPLIED WARRANTIES ARE LIMITED IN DURATION TO THE LIFE OF THE EXPRESS WARRANTY. INCIDENTAL AND CONSEQUENTIAL DAMAGES ARE EXCLUDED FROM COVERAGE UNDER THIS WARRANTY. SOME JURISDICTIONS DO NOT ALLOW FOR THE DISCLAIMERS, LIMITATIONS AND EXCLUSIONS IDENTIFIED ABOVE, AS A RESULT, THEY MAY NOT APPLY TO YOU. THIS WARRANTY GIVES YOU SPECIFIC RIGHTS, AND YOU MAY ALSO HAVE OTHER LEGAL RIGHTS WHICH MAY VARY FROM COUNTRY TO COUNTRY.

Neither the distributor, any BOMBARDIER dealer nor any other person has been authorized to make any affirmation, representation or warranty regarding the product, other than those contained in this limited warranty, and if made, shall not be enforceable against BOMBARDIER.

BOMBARDIER reserves the right to modify this warranty at any time, being understood that such modification will not alter the warranty conditions applicable to the products sold while this warranty is in effect.

8. TRANSFER

If the ownership of a product is transferred during the warranty coverage period, this warranty shall also be transferred and be valid for the remaining coverage period provided that BOMBARDIER is notified of such transfer of ownership in the following way:

BOMBARDIER or an authorized BOMBARDIER ATV distributor/dealer receives a proof that the former owner agreed to the transfer of ownership, in addition to the co-ordinates of the new owner. The distributor will then forward this information directly to BOMBARDIER.

9. CONSUMER ASSISTANCE

- a) In the event of a controversy or a dispute in connection with this BOMBARDIER LIMITED WARRANTY, BOMBARDIER suggests that you try to resolve the issue at the dealership level. We recommend discussing the issue with the authorized dealer's service manager or owner.
- b) If further assistance is required, the distributor's service department should be contacted in order to resolve the matter.
- c) If the matter still remains unresolved then contact BOMBARDIER by writing to us at the address listed below.

BOMBARDIER INC.
RECREATIONAL PRODUCTS
BOMBARDIER ATV
CUSTOMER ASSISTANCE CENTER
VALCOURT QC J0E 2L0
Tel: (819) 566-3366

FREQUENTLY ASKED QUESTIONS

- Q: Why must my vehicle be registered with the factory? After all, I do have my original invoice as proof of when I purchased my vehicle.
- A: *Registration is very important and an authorized Bombardier ATV dealer must register your vehicle with Bombardier Inc. Make sure the registration card has been sent. All of this will allow you to:*
- Have warranty work performed at any authorized Bombardier ATV dealer in North America. Your registration card will provide the dealer with all the necessary data to complete warranty claim forms.*
 - Be advised by Bombardier Inc. should there be a safety recall or a particular warranty campaign.*
 - Be contacted much faster by the police, in the event that they find your vehicle subsequent to a theft.*
- Q: Why must my vehicle be registered with the governing body having jurisdiction over vehicle use?
- A: *Vehicle registration has two purposes: In many provinces or States, it is mandatory to register a vehicle in the same way as for a car. It allows the State or province to maintain records of existing vehicles. In some jurisdictions, governmental agencies use part of the registration fees for establishing and maintaining trails.*
- Q: Where can I find information on the lubrication and maintenance of my vehicle?
- A: *In the Operator's Guide provided with the vehicle at the time of delivery.*
- Q: Will the entire warranty be voided or cancelled, if I do not operate or maintain my new vehicle exactly as specified in the *Operator's Guide*?
- A: *The warranty of the new vehicle cannot be "Voided" or "Cancelled" if predelivered by an authorized Bombardier ATV dealer. However, if a particular failure is caused by operation or maintenance other than what is shown in the Operator's Guide, THAT failure may not be covered under warranty. This includes service work performed by the customer, oil and filter change and especially the critical adjustments such as the carburetor.*
- Q: Would you give some examples of abnormal use or strain, neglect or abuse which may affect the limited warranty coverage?
- A: *These terms are general and overlap each other in some cases. Some specific examples may include: running the engine out of oil, operating the vehicle with a broken or damaged part which causes another part to fail, and so on. If you have any specific questions on operation or maintenance, please contact an authorized Bombardier ATV dealer for advice.*
- Q: What costs are my responsibility during the warranty period?
- A: *The customer's responsibility includes all costs of normal maintenance services, non-warranty repairs, accidents and collision damage, as well as oils, and spark plugs, and incidental or consequential damages costs as explained in the warranty.*

Q: Are "Genuine" Bombardier replacement parts used in warranty repairs also covered by the limited warranty coverage?

A: *Yes. When installed by an authorized Bombardier ATV dealer, any "Genuine" Bombardier part used in warranty repairs assumes the remaining warranty that exists on the vehicle.*

Q: If I sell my vehicle within the warranty period, will the new owner qualify for the balance of the limited warranty coverage?

A: *Yes, provided the re-sale has been registered with the manufacturer.*

Q: How can I receive the best owner assistance?

A: *The satisfaction, safety and goodwill of the owners of Bombardier products are of primary concern to your ATV dealer and Bombardier Inc. Normally, any problems that arise in connection with the sales transaction or the operation of your vehicle will be handled by your Dealer's Sales or Service Departments. It is recognized, however, that despite the best intentions of everyone concerned, misunderstandings will sometimes occur. Frequently, complaints are the result of a breakdown in communications and can quickly be resolved by a member of the dealership management. If the problem already has been reviewed with the Sales Manager or Service Manager, contact the Dealer Principal himself or the General Manager.*

We are always pleased to receive your comments on this Bombardier ATV.

PRIVACY OBLIGATIONS/DISCLAIMER

We wish to inform you that your coordinates will be used for safety and warranty purposes. Sometimes, we also use the coordinates of our clients to inform them about our products and to present them offers. Should you prefer not to receive information on our products, services and offers, please let us know by writing to the address below.

Also note that, from time to time, carefully selected and trustworthy organizations may be permitted to use the coordinates of our clients to promote quality products and services. If you prefer not to have your name and address released, please let us know by writing to the address below:

Bombardier Inc.
Recreational Products
Warranty Department
75 J.A. Bombardier Street
Sherbrooke, Québec J1L 1W3
Canada
Fax Number (819) 566-3590



AFFIX
PROPER
POSTAGE

BOMBARDIER
RECREATIONAL PRODUCTS

WARRANTY DEPARTMENT
75, J.A. BOMBARDIER ST.
SHERBROOKE (QUÉBEC)
CANADA J1L 1W3



AFFIX
PROPER
POSTAGE

BOMBARDIER
RECREATIONAL PRODUCTS

WARRANTY DEPARTMENT
75, J.A. BOMBARDIER ST.
SHERBROOKE (QUÉBEC)
CANADA J1L 1W3

ATV MODEL No. _____

VEHICLE IDENTIFICATION NUMBER (V.I.N.) _____

ENGINE IDENTIFICATION NUMBER (E.I.N.) _____

Owner: _____
NAME

No. STREET APT

CITY STATE/PROVINCE ZIP/POSTAL CODE

Purchase Date _____
YEAR MONTH DAY

Warranty Expiry Date _____
YEAR MONTH DAY

To be completed by the dealer at the time of the sale.

DEALER IMPRINT AREA

Please verify with your selling dealer to ensure your ATV has been registered with Bombardier.

 **WARNING**

Indicates a potential hazard that, if not avoided, could result in serious injury or death.



WARNING

THIS VEHICLE CAN BE HAZARDOUS TO OPERATE.

A collision or rollover can occur quickly, even during routine maneuvers such as turning and driving on hills or over obstacles, if you fail to take proper precautions.

SEVERE INJURY OR DEATH can result if you do not follow these instructions:

- **BEFORE YOU OPERATE THIS ATV, READ THIS OPERATOR'S GUIDE AND ALL ON-PRODUCT LABELS.**
- **NEVER OPERATE THIS ATV WITHOUT PROPER INSTRUCTIONS.** Beginners should complete a certified training course.
- **NEVER CARRY A PASSENGER.** You increase your risk of losing control if you carry a passenger.
- **NEVER OPERATE THIS ATV ON A PAVED SURFACE.** You increase your risk of losing control if you operate this ATV on pavement.
- **NEVER OPERATE THIS ATV ON PUBLIC ROADS.** You can collide with another vehicle if you operate this ATV on a public road.
- **ALWAYS WEAR AN APPROVED HELMET,** eye protection, and protective clothing.
- **NEVER CONSUME ALCOHOL OR DRUGS** before or while operating this vehicle.
- **NEVER OPERATE THIS ATV AT EXCESSIVE SPEEDS.** You increase your risk of losing control if you operate this ATV at speeds too fast for the terrain, visibility conditions, or your experience.
- **NEVER ATTEMPT WHEELIES, JUMPS, OR OTHER STUNTS.**

®™ TRADEMARKS OF BOMBARDIER INC. OR ITS SUBSIDIARIES.

©2003 BOMBARDIER INC. ALL RIGHTS RESERVED

PRINTED IN CANADA

