

***can-am***™



**2014**

**Operator's  
Guide**

**Includes  
Safety, Vehicle  
and Maintenance Information**

**RENEGADE™**

**500/800R/1000**

**⚠ WARNING**

Read this guide thoroughly. It contains important safety information.  
Minimum recommended age: Operator: 16 years old. Keep this Operator's Guide in the vehicle.

2 1 9 0 0 1 1 7 6



**⚠ WARNING**

**YOUR VEHICLE CAN BE HAZARDOUS TO OPERATE.** A collision or rollover can occur quickly, if you fail to take proper precautions, even during routine maneuvers such as turning and driving on hills or over obstacles. For your safety, understand and follow all the warnings contained in this Operator's Guide and on the labels on your vehicle. **Failure to follow these warnings can result in SEVERE INJURY OR DEATH!** Keep this Operator's Guide with the vehicle at all times.

**⚠ WARNING**

Disregarding any of the safety precautions and instructions contained in this Operator's Guide, *SAFETY DVD* video and on-product safety labels could result in an injury including the possibility of death!

**⚠ WARNING**

This vehicle may exceed the performance of other vehicles you may have ridden in the past. Take time to familiarize yourself with your new vehicle.

The following trademarks are the property of Bombardier Recreational Products Inc.:

Can-Am™

D.E.S.S.™

RENEGADE™

ROTAX®

TTI™

XPS™

DPS™

† Visco-Lok is a trademark of GKN Viscodrive GmbH.

# FOREWORD

Deutsch	Dieses Handbuch ist möglicherweise in Ihrer Landessprache verfügbar. Bitte wenden Sie sich an Ihren Händler oder besuchen Sie: <a href="http://www.operatorsguide.brp.com">www.operatorsguide.brp.com</a> .
English	This guide may be available in your language. Check with your dealer or go to: <a href="http://www.operatorsguide.brp.com">www.operatorsguide.brp.com</a> .
Español	Es posible que este manual esté disponible en su idioma. Consulte a su distribuidor o visite: <a href="http://www.operatorsguide.brp.com">www.operatorsguide.brp.com</a> .
Français	Ce guide peut être disponible dans votre langue. Vérifier avec votre concessionnaire ou aller à: <a href="http://www.operatorsguide.brp.com">www.operatorsguide.brp.com</a> .
Nederlands	Deze handleiding kan beschikbaar zijn in uw taal. Vraag het aan uw dealer of ga naar: <a href="http://www.operatorsguide.brp.com">www.operatorsguide.brp.com</a> .
Norsk	Denne boken kan finnes tilgjengelig på ditt eget språk. Kontakt din forhandler eller gå til: <a href="http://www.operatorsguide.brp.com">www.operatorsguide.brp.com</a> .
Português	Este manual pode estar disponível em seu idioma. Fale com sua concessionária ou visite o site: <a href="http://www.operatorsguide.brp.com">www.operatorsguide.brp.com</a> .
Suomi	Käyttöohjekirja voi olla saatavissa omalla kielelläsi. Tarkista jälleenmyyjältä tai käy osoitteessa: <a href="http://www.operatorsguide.brp.com">www.operatorsguide.brp.com</a> .
Svenska	Denna bok kan finnas tillgänglig på ditt språk. Kontakta din återförsäljare eller gå till: <a href="http://www.operatorsguide.brp.com">www.operatorsguide.brp.com</a> .

Congratulations on your purchase of a new Can-Am™ ATV. It is backed by the BRP warranty and a network of authorized Can-Am dealers ready to provide the parts, service or accessories you may require.

Your dealer is committed to your satisfaction. He has taken training to perform the initial setup and inspection of your vehicle as well as completed the final adjustment before you took possession. If you need more complete servicing information, please ask your dealer.

At delivery, you were also informed of the warranty coverage and signed the *PREDELIVERY CHECK LIST* to ensure your new vehicle was prepared to your entire satisfaction.

## Know Before you Go

To learn how to reduce the risk for you or bystanders being injured or killed, read this Operator's Guide before you operate the vehicle.

Also, read all safety labels on your ATV and watch attentively your *SAFETY DVD* video.

It is mainly for general recreational use but it may also be used for utility purposes.

Failure to follow the warnings contained in this Operator's Guide can result in **SERIOUS INJURY** or **DEATH**.

## Age Recommendation

This vehicle is a category S, always follow this age recommendation:

- A person under 16 years old should never operate this vehicle.
- This vehicle is for recreational use by experienced operator's only.

## WARNING

This is a high performance ATV. Inexperienced riders may overlook risks and be surprised by the specific behavior of this ATV in any riding condition.

## Training Course

Never operate this vehicle without proper instruction. **Take a training course.** All operators should receive training from a certified instructor.

For more information about ATV safety, contact an authorized Can-Am dealer to find out about available training courses nearest you.

## Safety Messages

The types of safety messages, what they look like and how they are used in this guide are explained as follows:

The safety alert symbol  indicates a potential injury hazard.

### WARNING

Indicates a potential hazard, if not avoided, could result in serious injury or death.

 **CAUTION** Indicates a hazard situation which, if not avoided, could result in minor or moderate injury.

**NOTICE** Indicates an instruction which, if not followed, could severely damage vehicle components or other property.

## About this Operator's Guide

This Operator's Guide has been prepared to acquaint the owner/operator of a new vehicle with the various vehicle controls, maintenance and safe operating instructions. It is indispensable for the proper use of the product.

While reading this Operator's Guide, remember that:

### WARNING

Indicates a potential hazard that, if not avoided, could result in serious injury or death.

Note that this guide is available in several languages. In the event of any discrepancy, the English version shall prevail.

Keep this Operator's Guide in the vehicle as you can refer to it for things such as maintenance, troubleshooting and instructing others.

If you want to view and/or print an extra copy of your Operator's Guide, simply visit the following website [www.operatorsguide.brp.com](http://www.operatorsguide.brp.com).

The information contained in this document are correct at the time of publication. However, BRP maintains a policy of continuous improvement of its products without imposing upon itself any obligation to install them on products previously manufactured. Due to late changes, some differences between the manufactured product and the descriptions and/or specifications in this guide may occur. BRP reserves the right at any time to discontinue or change specifications, designs, features, models or equipment without incurring any obligation upon itself.

This Operator's Guide and the *SAFETY DVD* video should remain with the vehicle when it is sold.



---

# TABLE OF CONTENTS

<b>FOREWORD</b> .....	<b>1</b>
Know Before you Go .....	1
Safety Messages .....	2
About this Operator's Guide .....	2

## ***SAFETY INFORMATION***

<b>GENERAL PRECAUTIONS</b> .....	<b>8</b>
Avoid Carbon Monoxide Poisoning .....	8
Avoid Gasoline Fires and Other Hazards .....	8
Avoid Burns from Hot Parts .....	8
Accessories and Modifications .....	8
<b>SPECIAL SAFETY MESSAGES</b> .....	<b>9</b>
European Community .....	11
<b>OPERATION WARNINGS</b> .....	<b>12</b>
<b>IMPORTANT ON-PRODUCT LABELS</b> .....	<b>37</b>
Hang Tag .....	37
Vehicle Safety Labels .....	38
Compliance Labels .....	42
Technical Information Labels .....	42
<b>PRE-RIDE INSPECTION</b> .....	<b>43</b>
Pre-Ride Inspection Check List .....	44
<b>RIDING THE VEHICLE</b> .....	<b>46</b>
Riding Gear .....	47
Recreational Riding .....	48
Environment .....	48
Design Limitation .....	49
Off-Road Operation .....	49
Riding Techniques .....	49
<b>MOVING LOADS AND DOING WORK</b> .....	<b>59</b>
Working with your Vehicle .....	59
Carrying Loads .....	59

## ***VEHICLE INFORMATION***

<b>CONTROLS</b> .....	<b>62</b>
1) Throttle Lever .....	62
2) LH Brake Lever .....	63
3) RH Brake Lever .....	63
4) Brake Lock .....	63
5) Brake Pedal .....	64
6) Shift Lever .....	64
7) Ignition Switch .....	65
8) Multifunction Switch .....	66
9) 2WD/4WD Selector .....	69

<b>MULTIFUNCTION GAUGE (LCD)</b> .....	<b>71</b>
Multifunction Gauge Description .....	71
Multifunction Gauge Modes .....	72
Navigating in the LCD Gauge .....	74
Gauge Setup .....	74
<b>EQUIPMENT</b> .....	<b>76</b>
1) Operator's Seat .....	77
2) Footpeg .....	78
3) 12-Volt Power Outlet .....	78
4) Rear Cargo Area .....	78
5) Tool Kit .....	78
6) Shift Lever Lock .....	79
7) Recovery Hook .....	79
<b>FUEL</b> .....	<b>80</b>
Fuel Requirements .....	80
Vehicle Fueling Procedure .....	80
<b>BREAK-IN PERIOD</b> .....	<b>82</b>
Operation During Break-In .....	82
<b>BASIC PROCEDURES</b> .....	<b>83</b>
Starting the Engine .....	83
Shifting the Transmission .....	83
Stopping the Engine and Parking the Vehicle .....	83
<b>SPECIAL PROCEDURES</b> .....	<b>84</b>
What to Do if Water is in the CVT .....	84
What to Do if Water is in the Air Filter Housing .....	84
What to Do if Vehicle is Turned Over .....	85
What to Do if Vehicle is Immersed in Water .....	85
<b>TUNE YOUR RIDE</b> .....	<b>86</b>
Suspension Adjustment .....	86
Steering Assist Adjustment (DPS) (X xc Models) .....	88
<b>VEHICLE TRANSPORTATION</b> .....	<b>89</b>

## **MAINTENANCE**

<b>BREAK-IN INSPECTION</b> .....	<b>92</b>
<b>MAINTENANCE SCHEDULE</b> .....	<b>94</b>
<b>MAINTENANCE PROCEDURES</b> .....	<b>97</b>
Air Filter .....	97
Engine Oil .....	100
Oil Filter .....	102
Radiator .....	102
Engine Coolant .....	103
Muffler Spark Arrester .....	106
CVT Air Filter (800R/1000) .....	107
Gearbox Oil .....	107

**MAINTENANCE PROCEDURES (cont'd)**

Throttle Cable ..... 109

Spark Plugs ..... 111

Battery ..... 112

Fuses..... 112

Lights..... 114

Drive Shaft Boot and Protector..... 115

Wheel Bearing..... 115

Wheels and Tires ..... 116

Steering ..... 117

Suspension ..... 117

Brakes..... 118

**VEHICLE CARE ..... 120**

Post-Operation Care ..... 120

Vehicle Cleaning and Protection ..... 120

Non Compatible Cleaning Products ..... 120

**STORAGE AND PRESEASON PREPARATION ..... 122**

***TECHNICAL INFORMATION***

**VEHICLE IDENTIFICATION ..... 124**

Vehicle Identification Number ..... 124

Engine Identification Number (EIN)..... 124

**SPECIFICATIONS ..... 125**

***TROUBLESHOOTING***

**TROUBLESHOOTING GUIDELINES ..... 132**

**MULTIFUNCTION GAUGE MESSAGES..... 136**

***WARRANTY***

**BRP INTERNATIONAL LIMITED WARRANTY: 2014 CAN-AM™ ATV ..... 140**

**BRP LIMITED WARRANTY FOR THE EUROPEAN ECONOMIC AREA, THE COMMONWEALTH OF THE INDEPENDENT STATES AND TURKEY: 2014 CAN-AM™ ATV ..... 144**

***CUSTOMER INFORMATION***

**PRIVACY INFORMATION ..... 150**

**CHANGE OF ADDRESS/OWNERSHIP..... 151**



# ***SAFETY INFORMATION***

---

## GENERAL PRECAUTIONS

### **Avoid Carbon Monoxide Poisoning**

All engine exhaust contains carbon monoxide, a deadly gas. Breathing carbon monoxide can cause headaches, dizziness, drowsiness, nausea, confusion and eventually death.

Carbon monoxide is a colorless, odorless, tasteless gas that may be present even if you do not see or smell any engine exhaust. Deadly levels of carbon monoxide can collect rapidly, and you can quickly be overcome and unable to save yourself. Also, deadly levels of carbon monoxide can linger for hours or days in enclosed or poorly ventilated areas. If you experience any symptoms of carbon monoxide poisoning, leave the area immediately, get fresh air and seek medical treatment.

To prevent serious injury or death from carbon monoxide:

- Never run the vehicle in poorly ventilated or partially enclosed areas such as garages, carports or barns. Even if you try to ventilate engine exhaust with fans or open windows and doors, carbon monoxide can rapidly reach dangerous levels.
- Never run the vehicle outdoors where engine exhaust can be drawn into a building through openings such as windows and doors.

### **Avoid Gasoline Fires and Other Hazards**

Gasoline is extremely flammable and highly explosive. Fuel vapors can spread and be ignited by a spark or flame many feet away from the engine. To reduce the risk of fire or explosion, follow these instructions:

- Use only an approved red gasoline container to store fuel.
- Never fill a gasoline container on the vehicle. An electrical static discharge may ignite the fuel.

- For refueling, strictly adhere to instructions in *FUEL* subsection.
- Never start or operate the engine if the fuel cap is not properly installed.

Gasoline is poisonous and can cause injury or death.

- Never siphon gasoline by mouth.
- If you swallow gasoline, get any in your eye(s), or inhale gasoline vapor, see your doctor immediately.

If gasoline spills on you, wash with soap and water and change your clothes.

### **Avoid Burns from Hot Parts**

Certain components become hot during operation. Avoid contact with those parts during and shortly after operation to avoid burns.

### **Accessories and Modifications**

Do not make unauthorized modifications, or use attachments or accessories that are not approved by BRP. Since these changes have not been tested by BRP, they may increase the risk of crashes or injury, and can render the vehicle illegal.

See your authorized Can-Am dealer for available accessories for your vehicle.

---

## SPECIAL SAFETY MESSAGES

### **THIS VEHICLE IS NOT A TOY AND CAN BE HAZARDOUS TO OPERATE.**

- This vehicle handles differently from other vehicles including motorcycles and cars. A collision or rollover can occur quickly, if you fail to take proper precautions, even during routine maneuvers such as turning and driving on hills or over obstacles.

### **SEVERE INJURY OR DEATH** can result if you do not follow these instructions:

- Read this Operator's Guide and all on-product safety labels carefully and follow the operating procedures described. Watch and pay attention to the *SAFETY DVD* video before operating the vehicle.
- Always follow this age recommendation: A person under 16 years old should never operate this vehicle.
- Never operate this vehicle without wearing an approved helmet of the proper size and other required riding gears. Refer to *RIDING GEAR* in the *RIDING THE VEHICLE* subsection for detailed information.
- Never carry a passenger on this vehicle. This vehicle is designed for an operator only. Do not make any modifications to accommodate a passenger or use racks to carry a passenger. Passenger(s) affect balance and steering and increase risk of losing control.
- This vehicle is not designed to ride on paved surfaces; if you must shortly use the vehicle on such surfaces, avoid abrupt inputs to steering, accelerator and brakes. Reduce your speed.
- Never use this vehicle if you are tired, ill or with drugs or alcohol. Your reaction time and judgement is greatly affected under these conditions.
- Never attempt wheelies, jumps, or other stunts.
- Never operate at excessive speeds. Always go at a speed that is proper for the terrain, visibility, and operating conditions, and your experience.
- Always go slowly and be extra careful when operating on unfamiliar terrain. Always be alert to changing terrain conditions when operating this vehicle.
- Never operate on excessively rough, slippery or loose terrain until you have learned and practiced the skills necessary to control this vehicle on such terrain. Always be especially cautious on these kinds of terrain.
- Always follow proper procedures for turning as described in *RIDING TECHNIQUES* in this Operator's Guide. Practice turning at low speeds before attempting to turn at faster speeds. Do not turn at excessive speed.
- Never operate this vehicle on hills too steep for the vehicle or for your abilities.
- Always follow proper procedures for climbing hills as described in *RIDING TECHNIQUES* in this Operator's Guide. Check the terrain carefully before you start up any hill. Never climb hills with excessively slippery or loose surfaces. Never go over the top of any hill at high speed.
- Always follow proper procedures for going down hills and for braking on hills as described in *RIDING TECHNIQUES* in this Operator's Guide. Check the terrain carefully before you start down any hill. Never go down a hill at high speed. Avoid going down a hill at an angle that would cause the vehicle to lean sharply to one side. Go straight down the hill where possible.



- Always follow proper procedures for crossing the side of a hill as described in *RIDING TECHNIQUES* in this Operator's Guide. Avoid hills with excessively slippery or loose surfaces. Never attempt to turn the vehicle around on any hill until you have mastered the turning technique on level ground. Avoid crossing the side of a steep hill if possible.
- Always use proper procedures if you stall or roll backwards when climbing a hill. To avoid stalling, use proper gear and maintain a steady speed when climbing a hill. If you stall or roll backwards, follow the driving technique procedures as described in *RIDING TECHNIQUES* in this Operator's Guide.
- Always check for obstacles before operating in a new area. Never attempt to operate over large obstacles, such as large rocks or fallen trees. Always follow proper procedures when operating over obstacles as described in *RIDING TECHNIQUES* in this Operator's Guide.
- Always be careful when skidding or sliding. Learn to safely control skidding or sliding by practicing at low speeds and on level smooth terrain. On extremely slippery surfaces, such as ice, go slowly and be very cautious in order to reduce the chance of skidding out of control.
- Never operate this vehicle through deep or fast flowing water. Water should never exceed footrests. Remember that wet brakes may have reduced stopping ability. Test your brakes after leaving water, mud or snow. If necessary, apply them several times to let friction dry out the pads. Allow greater distance for braking.
- Always keep in mind that braking distance is readily affected by but not limited to; weather and terrain conditions, braking system and tire conditions, vehicle speed and attitude, and vehicle load including towing. Remember to adjust your driving accordingly.
- Never exceed the stated load limits for this vehicle including operator, all other loads and added accessories. Cargo should be properly distributed and securely attached. Reduce speed and follow instructions in this guide for carrying cargo or pulling a trailer. Allow greater distance for braking.
- Always inspect and confirm the safe operating condition of your vehicle prior to ride. Refer to *PRE-RIDE INSPECTION* subsection in this Operator's Guide. Always follow the maintenance schedules as described in this Operator's Guide. Refer to *MAINTENANCE* section.
- Always maintain proper tire pressure. When replacing tires, use only the recommended tire size and type. For tire information, refer to *SPECIFICATIONS* in this guide.
- Riding your vehicle too fast for the conditions may result in injury. Apply only enough throttle to proceed safely. Statistics show that high speed turns usually result in mishaps and injury. Always remember that this vehicle is heavy! Its pure weight alone may entrap you should it fall resulting in injury.
- This vehicle is not designed for jumping, nor can it fully absorb the high impact energy generated during manoeuvres such as jumping which, can be passed on to you, the operator. Performing wheelies can cause the vehicle to flip over onto you. Both practices have a high risk for you and should be avoided at all times.

## European Community

### On Road Use

The following warnings apply only in the European Countries where on road use is allowed. **SEVERE INJURY OR DEATH** can result if you do not comply with the following instructions.

#### **WARNING**

- This vehicle is built for OFF-ROAD purposes only. It may be used for short distances on paved surfaces at reduced speed, in order to move the vehicle from an off-road location to another.
- Always refrain from speeding and substantially reduce vehicle speed when turning.
- Always respect the road traffic laws, even on a dirt or gravel road.
- The front winch hook (if applicable) must be removed and stored.

## OPERATION WARNINGS

The following warning and their format have been requested by the United States Consumer Product Safety Commission and are required to be in the Operator's Guide for all ATVs.

**NOTE:** The following illustrations are general representations only. Your model may differ.

### **WARNING**



#### **POTENTIAL HAZARD**

Operating this vehicle without proper instruction.

#### **WHAT CAN HAPPEN**

The risk of an accident is greatly increased if the operator does not know how to operate this vehicle properly in different situations and on different types of terrain.

#### **HOW TO AVOID THE HAZARD**

Beginners and inexperienced operators should complete a training course. They should then regularly practice the skills learned during the course as well as the operating techniques described in this Operator's Guide.

For more information about a training course, contact an authorized Can-Am dealer.

**⚠ WARNING**

V00A1AQ

**POTENTIAL HAZARD**

Failure to follow the age recommendations for this vehicle.

**WHAT CAN HAPPEN**

A lack of respect for this age recommendation can lead to severe injury or death of the child.

Even though a child may be within the age group for which this vehicle is recommended, he may not have the skills, abilities, or judgment needed to operate this vehicle safely and may be involved in a serious accident.

**HOW TO AVOID THE HAZARD**

No one under 16 should operate this vehicle.

**⚠ WARNING**



V00A02Q

**POTENTIAL HAZARD**

Carrying a passenger on this vehicle.

**WHAT CAN HAPPEN**

Greatly reduces your ability to balance and control this vehicle.

Could cause an accident, resulting in harm to you and/or your passenger.

**HOW TO AVOID THE HAZARD**

Never carry passenger. Even with a long seat that provides unrestricted operator movement, it is not designed nor intended to carry passenger(s).

**⚠ WARNING**

V00A2DQ

**POTENTIAL HAZARD**

Allowing passenger to sit in any location on this vehicle.

**WHAT CAN HAPPEN**

Allowing a passenger could:

- Impair vehicle stability which could lead to a loss of control.
- Result in injury to passenger from impact on hard surfaces.
- Cause an accident, resulting in harm to you and/or your passenger.

**HOW TO AVOID THE HAZARD**

This vehicle is designed for an operator only. Never allow any passenger on this vehicle.

**⚠ WARNING**



**POTENTIAL HAZARD**

Riding this vehicle without wearing an approved helmet, eye protection and protective gear.

**WHAT CAN HAPPEN**

- Riding without an approved helmet increases the chances of a severe head injury or death in the event of an accident.
- Riding without eye protection can result in an accident and increases the chances of a severe injury in the event of an accident.
- Riding without protective gear increases the chances of severe injury in the event of an accident.

**HOW TO AVOID THE HAZARD**

Always wear an approved helmet that fits properly. You should also wear:

- Eye protection (goggles or face shield)
- Rigid chin guard
- Gloves and boots
- Long sleeved shirt or jacket
- Long pants.



**⚠ WARNING**

V00A07Q

**POTENTIAL HAZARD**

Using this vehicle with drugs or alcohol.

**WHAT CAN HAPPEN**

- Could seriously affect your judgment.
- Could cause you to react more slowly.
- Could affect your balance and perception.
- Could result in an accident or death.

**HOW TO AVOID THE HAZARD**

Never use this vehicle with drugs or alcohol.

**⚠ WARNING**

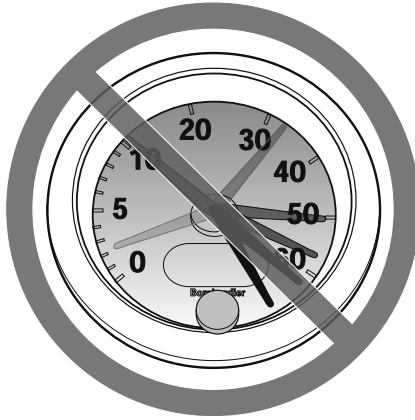

V00A08Q

**POTENTIAL HAZARD**

Operating this vehicle at excessive speeds.

**WHAT CAN HAPPEN**

Increases your chances of losing control of the vehicle, which can result in an accident.

**HOW TO AVOID THE HAZARD**

Always travel at a speed which is appropriate for the terrain, visibility and operating conditions, and your experience.

**⚠ WARNING****POTENTIAL HAZARD**

Attempting wheelies, jumps and other stunts.

**WHAT CAN HAPPEN**

Increases the chance of an accident, including an overturn.

**HOW TO AVOID THE HAZARD**

Never attempt stunts, such as wheelies or jumps. Do not try to show off.

**⚠ WARNING****POTENTIAL HAZARD**

Failure to inspect the vehicle before operating.

Failure to properly maintain the vehicle.

**WHAT CAN HAPPEN**

Increases the possibility of an accident or equipment damage.

**HOW TO AVOID THE HAZARD**

Always inspect your vehicle prior to ride to make sure the vehicle is in safe operating condition.

Always follow the maintenance schedule described in this Operator's Guide.

**⚠ WARNING**

**POTENTIAL HAZARD**

Riding on frozen waterways.

**WHAT CAN HAPPEN**

Breaking through the ice can lead to severe injury or death.

**HOW TO AVOID THE HAZARD**

Never ride this vehicle on a frozen surface before you are sure the ice is thick enough and sound enough to support the vehicle and its load, as well as the force that is created by a moving vehicle.

**⚠ WARNING**



**POTENTIAL HAZARD**

Removing hands from handlebars or feet from the footrests during operation.

**WHAT CAN HAPPEN**

Removing even one hand or foot can reduce your ability to control the vehicle or could cause you to lose your balance and fall off the vehicle. If you remove a foot from the footrests, your foot or leg may come into contact with the rear wheels, which could injure you or cause an accident.

**HOW TO AVOID THE HAZARD**

Operator must always keep both hands on the handlebars and both feet on the footrests during vehicle operation.

**⚠ WARNING****POTENTIAL HAZARD**

Failure to use extra care when operating this vehicle on unfamiliar terrain.

**WHAT CAN HAPPEN**

You can come upon hidden rocks, bumps, or holes, without enough time to react.

Could result in the vehicle overturning or loss of control.

**HOW TO AVOID THE HAZARD**

Go slowly and be extra careful when operating on unfamiliar terrain.

Always be alert to changing terrain conditions when operating the vehicle.

**⚠ WARNING**



**POTENTIAL HAZARD**

Failure to use extra care when operating on excessively rough, slippery or loose terrain.

**WHAT CAN HAPPEN**

Could cause loss of traction or vehicle control, which could result in an accident, including an overturn.

**HOW TO AVOID THE HAZARD**

Do not operate on excessively rough, slippery or loose terrain until you have learned and practiced the skills necessary to control this vehicle on such terrain.

Always be especially cautious on these kinds of terrain.

**⚠ WARNING****POTENTIAL HAZARD**

Turning improperly.

**WHAT CAN HAPPEN**

Vehicle could go out of control, causing a collision or an overturn.

**HOW TO AVOID THE HAZARD**

Always follow proper procedures for turning as described in this Operator's Guide. Practice turning at low speeds before attempting to turn at faster speeds.

Do not turn at excessive speed.



**⚠ WARNING**



**POTENTIAL HAZARD**

Operating on excessively steep hills.

**WHAT CAN HAPPEN**

The vehicle can overturn more easily on extremely steep hills than on level surfaces or small hills.

**HOW TO AVOID THE HAZARD**

Never operate this vehicle on hills too steep for the vehicle or for your abilities.

Practice on smaller hills before attempting larger hills.

**⚠ WARNING****POTENTIAL HAZARD**

Climbing hills improperly.

**WHAT CAN HAPPEN**

Could cause loss of control or cause vehicle to overturn.

**HOW TO AVOID THE HAZARD**

Always follow proper procedures for climbing hills as described in this Operator's Guide.

Always check the terrain carefully before you start up any hill.

Never climb hills with excessively slippery or loose surfaces.

Shift your weight forward.

Never open the throttle suddenly or make sudden gear changes. The vehicle could flip over backwards.

Never go over the top of any hill at high speed. An obstacle, a sharp drop, or another vehicle or person could be on the other side of the hill.

**⚠ WARNING**



**POTENTIAL HAZARD**

Going down a hill improperly.

**WHAT CAN HAPPEN**

Could cause loss of control or cause vehicle to overturn.

**HOW TO AVOID THE HAZARD**

Always follow proper procedures for going down hills as described in this Operator's Guide.

NOTE: A special technique is required when braking as you go down a hill.

Always check the terrain carefully before you start down any hill.

Shift your weight backward.

Never go down a hill at high speed.

Avoid going down a hill at an angle which would cause the vehicle to lean sharply to one side. Go straight down the hill where possible.

**⚠ WARNING****POTENTIAL HAZARD**

Improperly crossing hills or turning on hills.

**WHAT CAN HAPPEN**

Could cause loss of control or cause vehicle to overturn.

**HOW TO AVOID THE HAZARD**

Never attempt to turn the vehicle around on any hill until you have mastered the turning technique as described in this Operator's Guide on level ground. Be very careful when turning on any hill.

Avoid crossing the side of a steep hill if possible.

***When crossing the side of a hill:***

Always follow proper procedures as described further in this Operator's Guide.

Avoid hills with excessively slippery or loose surfaces.

Operator must shift weight to the uphill side of the vehicle.

**! WARNING**

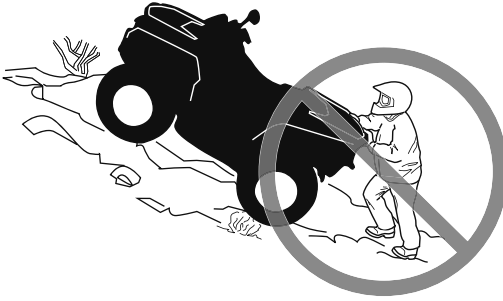

**POTENTIAL HAZARD**

Stalling, rolling backwards or improperly dismounting while climbing a hill.

**WHAT CAN HAPPEN**

Could result in vehicle overturning.

**HOW TO AVOID THE HAZARD**

Use proper gear and maintain steady speed when climbing a hill.

***If you lose all forward speed:***

Keep your weight uphill. Never open the throttle suddenly or make sudden gear changes. The vehicle could flip over backwards.

Apply brakes gradually.

Lock brake lock after you have stopped.

Dismount on uphill side, or to a side if pointed straight uphill.

***If you begin rolling backwards:***

Keep your weight uphill. Never open the throttle suddenly or make sudden gear changes. The vehicle could flip over backwards.

Apply brakes gradually.

When fully stopped, apply brakes and lock brake lock.

Dismount on uphill side, or to a side if pointed straight uphill.

Turn the vehicle around and remount, following the procedure described in this Operator's Guide.

**⚠ WARNING****POTENTIAL HAZARD**

Improperly operating over obstacles.

**WHAT CAN HAPPEN**

Could cause loss of control, or a collision.

Could cause the vehicle to overturn.

**HOW TO AVOID THE HAZARD**

Before operating in a new area, check for obstacles.

Never attempt to ride over large obstacles, such as large rocks or fallen trees.

When you go over obstacles, always follow proper procedures as described in this Operator's Guide.

**⚠ WARNING**



**POTENTIAL HAZARD**

Skidding or sliding improperly.

**WHAT CAN HAPPEN**

You may lose control of this vehicle.

You may also regain traction unexpectedly, which may cause the vehicle to overturn.

**HOW TO AVOID THE HAZARD**

Learn to safely control skidding or sliding by practicing at low speeds and on level smooth terrain.

On extremely slippery surfaces, such as ice, go slowly and be very cautious in order to reduce the chance of skidding or sliding out of control.



**⚠ WARNING****POTENTIAL HAZARD**

Operating this vehicle through deep or fast flowing water.

**WHAT CAN HAPPEN**

Tires may float, causing loss of traction and loss of control, which could lead to an accident.

**HOW TO AVOID THE HAZARD**

Never operate this vehicle in fast flowing water or in deep water.

Check water depth and current before you attempt to cross any water. Water should not go above footrests.

Remember that wet brakes may have reduced stopping ability. Test your brakes after leaving water. If necessary, apply them several times to let friction dry out the pads.

**⚠ WARNING**

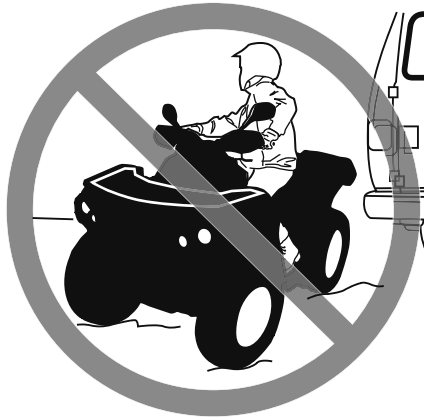

**POTENTIAL HAZARD**

Improperly operating in reverse.

**WHAT CAN HAPPEN**

You could hit an obstacle or person behind the vehicle, resulting in serious injury.

**HOW TO AVOID THE HAZARD**

When you select reverse gear, make sure there are no obstacles or people behind the vehicle. When it is safe to proceed, go slowly.

**⚠ WARNING****POTENTIAL HAZARD**

Operating this vehicle with improper tires, or with improper or uneven tire pressure.

**WHAT CAN HAPPEN**

Use of improper tires on this vehicle, or operation of this vehicle with improper or uneven tire pressure, may cause loss of control, tire blow outs, tire to move around on its rim, and increases the risk of an accident.

**HOW TO AVOID THE HAZARD**

Always use the size and type of tires specified in this Operator's Guide for this vehicle.

Always maintain proper tire pressure as described in this Operator's Guide.  
Always replace wheels or tires that are damaged.

**⚠ WARNING**



**POTENTIAL HAZARD**

Operating this vehicle with improper modifications.

**WHAT CAN HAPPEN**

Improper installation of accessories or modification of this vehicle may cause changes in handling which in some situations could lead to an accident.

**HOW TO AVOID THE HAZARD**

Never modify this vehicle through improper installation or use of accessories. All parts and accessories added to this vehicle should be approved by BRP and should be installed and used according to instructions. If you have questions, consult an authorized Can-Am dealer.

**NEVER** install a passenger seat or use the racks to carry a passenger.

Modification of the vehicle to increase speed and performance may violate the terms and conditions of your vehicle limited warranty. In addition, certain modifications including the removal of engine or exhaust components are illegal under most laws.

**⚠ WARNING****POTENTIAL HAZARD**

Overloading this vehicle, carrying or towing cargo improperly.

**WHAT CAN HAPPEN**

Could cause changes in vehicle handling which could lead to an accident.

**HOW TO AVOID THE HAZARD**

Never exceed the stated load capacity for this vehicle including operator as well as other loads and added accessories.

Cargo should be properly distributed and securely attached.

Reduce speed when carrying cargo or pulling a trailer. Allow greater distance for braking.

Always follow the instructions in this Operator's Guide for carrying cargo or pulling a trailer.

**⚠ WARNING**



V03M01Q

**POTENTIAL HAZARD**

Transporting flammable or dangerous material can lead to explosions.

**WHAT CAN HAPPEN**

This can cause serious injury or death.

**HOW TO AVOID THE HAZARD**

Never transport flammable or dangerous material.

# IMPORTANT ON-PRODUCT LABELS

## Hang Tag

This vehicle comes with a hang tag and labels containing important safety and emission informations.

### **WARNING**

- Locate and read operator's guide. Improper ATV use can result in SEVERE INJURY or DEATH. Follow all instructions and warnings.
- Always wear ear protection.
- Always use an approved helmet and protective gear.
- Never carry a passenger.
- Never use with drugs or alcohol.

### **S** **SPORT MODEL**

THIS ATV IS FOR  
RECREATIONAL USE  
BY EXPERIENCED OPERATORS ONLY.

**OPERATOR ONLY-NO PASSENGERS**

**NO OPERATOR UNDER AGE 16**

THIS CATEGORY S (SPORT) ATV IS A HIGH PERFORMANCE ATV IS FOR SPORT TYPE RECREATIONAL AND COMPETITIVE USE BY OPERATORS WITH ADVANCED SKILLS AND SUBSTANTIAL EXPERIENCE.

TRAINING COURSES TO TEACH ATV RIDING SKILLS ARE AVAILABLE. FOR INFORMATION CONTACT YOUR DEALER.

CHECK WITH YOUR DEALER TO FIND OUT ABOUT STATE OR LOCAL LAWS REGARDING ATV OPERATION.

**THIS HANGTAG IS NOT TO BE REMOVED BEFORE SALE.**

704903951



704903951

#### VEHICLE ENGINE DESCRIPTION:

**1000 4 STROKE**

**EPA CERTIFIED**

NER (NORMALIZED EMISSION RATE) = **6.3**

ON A 0 TO 10 SCALE, 0 BEING THE CLEANEST

**\*NOT TO BE REMOVED PRIOR TO SALE**



704902349

704902349\_en

TYPICAL - 1000 ENGINE SHOWN

## Vehicle Safety Labels

Read and understand all the safety labels on your vehicle. These labels are affixed to your vehicle for the safety of the operator or bystanders.

The safety labels on your vehicle should be considered permanent parts of the vehicle. If missing or damaged, they can be replaced free of charge. See an authorized Can-Am dealer.

**NOTE:** In the event of any discrepancy between this guide and the vehicle, the safety labels on the vehicle have precedence over the labels in this guide.

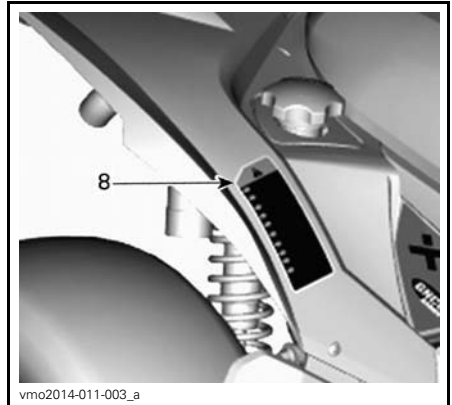
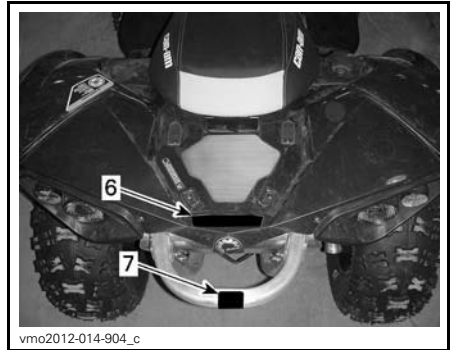
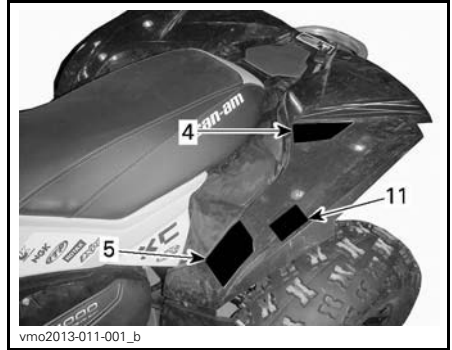
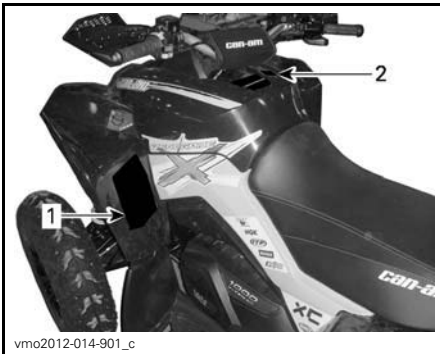





Label 2



LABEL 2

Label 3

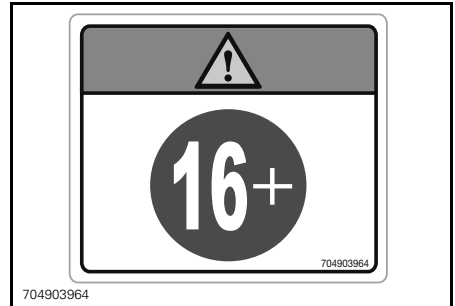
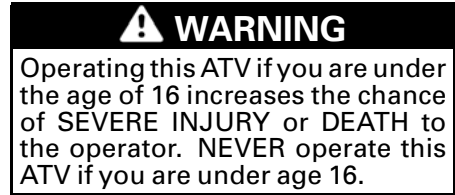

LABEL 3

Label 1



Label 4

**! WARNING**

- Locate and read operator's guide.
- NEVER carry a passenger.

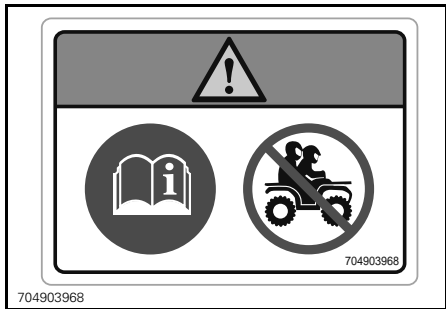

LABEL 4

Label 5

**! WARNING**

- Locate and read operator's guide. Improper overloading or tire pressure can cause loss of control, resulting in SEVERE INJURY or DEATH.
- ALWAYS maintain proper tire pressure as shown.
- NEVER exceed the load capacity of 141 kg (310 lb) including weight of operator, cargo, and accessories (and including trailer tongue weight if applicable).

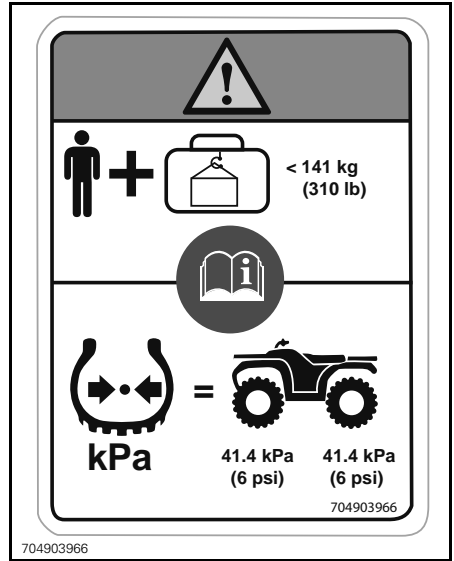

LABEL 5 (REFER TO SPECIFICATIONS FOR VALUES)

Label 6

**! WARNING**

- NEVER carry a passenger on this carrier.
- MAXIMUM REAR LOAD: 16 kg (35 lb) evenly distributed (including trailer tongue weight if applicable).

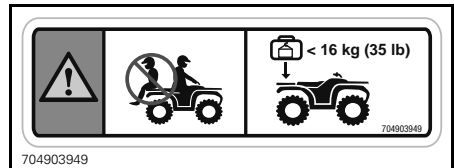

LABEL 6

Label 7

**⚠ WARNING**

NEVER attach here or on the luggage rack to pull a load. This can cause the vehicle to tip over. ALWAYS use the trailer hitch (if applicable) or the recovery hook to pull a load.

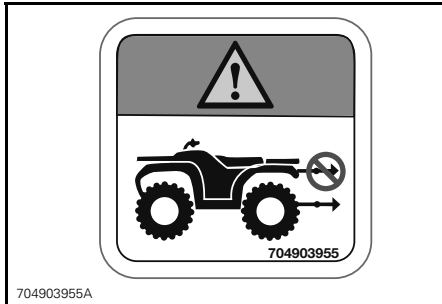

704903955A

LABEL 7

Label 8

**⚠**

**(EN)** WARNING: GET FAMILIAR WITH THIS ATV. INEXPERIENCED RIDERS MAY OVERLOOK RISKS.

**(DA)** ADVARSEL: LÆR AT VÆN GRUNDIGT AT KENDE. UERFARNE FØRERE KAN LET OVERSE FARERNE.

**(NL)** WAARSCHUWING: MAAK UZELF VERTROUWD MET DEZE ATV. ONERVAREN BESTUURDERS KUNNEN DE RISICO'S OVER HET HOOFD ZIEN.

**(FR)** AVERTISSEMENT : FAMILIARISEZ-VOUS AVEC CE VTT. LES UTILISATEURS INEXPERIMENTES POURRAIENT SOUS ESTIMER LES RISQUES.

**(FI)** VAROITUS: TUTUSTU HUOLELLISESTI TAMAN ATV:N KÄYTTÖÖN. KOKEAMATTOMAT KULJETTAJAT SAATTAVAT ALIARVOIDA VAARATILANTEET.

**(ES)** ADVERTENCIA: TÓMESE EL TIEMPO NECESARIO PARA FAMILIARIZARSE CON EL ATV. LA FALTA DE EXPERIENCIA PUEDE DAR LUGAR A LA OMISIÓN DE RIESGOS IMPORTANTES.

**(DE)** WARNUNG: MACHEN SIE SICH MIT DIESEM ATV VERTRAUT. UNERFAHRENE FAHRER KÖNNEN RISIKEN ÜBERSEHEN.

**(EL)** ΠΡΟΕΙΔΟΠΟΙΗΣΗ: ΕΞΟΙΚΕΙΩΘΕΙΤΕ ΜΕ ΑΥΤΟ ΤΟ ΟΧΗΜΑ ΠΑΝΤΟΣ ΕΛΑΦΟΥΣ (ATV). ΟΙ ΧΡΗΣΤΕΣ ΧΩΡΙΣ ΕΜΠΕΙΡΙΑ ΜΠΟΡΕΙ ΝΑ ΠΑΡΑΒΛΕΨΟΥΝ ΤΥΧΟΝ ΚΙΝΔΥΝΟΥΣ.

**(IT)** AVVERTENZA: ACQUISIRE FAMILIARITÀ CON QUESTO ATV. I PILOTI INESPERTI POTREBBERO SOTTOVALUTARE I RISCHI.

**(PT)** ADVERTÊNCIA: FAMILIARIZE-SE COM ESTE ATV. PILOTOS INEXPERIENTES PODEM SUBESTIMAR OS RISCOS.

**(SV)** VARNING: BEKANTA DIG VÄL MED DENNA ATV. OERFARNA FÖRARE KAN FÖRBISE RISKERNA.

704903967

704903967A

LABEL 8

Label 9



vmo2010-010-100\_a

LABEL 9

Label 10



LABEL 10

Label 11



LABEL 11

**Compliance Labels**

These labels indicate vehicle's compliance.

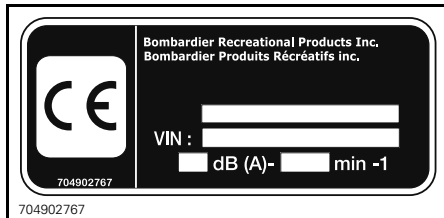

LOCATION: UNDER SEAT, ON THE UPPER BAR OF FRAME

**Technical Information Labels**

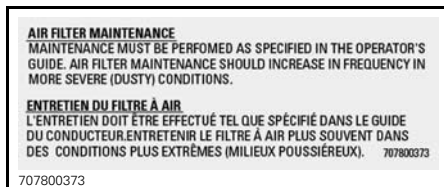

LOCATION: UNDER SEAT, ON THE UPPER BAR OF FRAME

---

## PRE-RIDE INSPECTION

### **WARNING**

Perform a pre-ride inspection before each ride to detect any potential problem that could occur during operation. The pre-ride inspection can help you monitor component wear and deterioration before they become a problem. Correct any problem that you discover to reduce the risk of a breakdown or crash. See an authorized Can-Am dealer as necessary.

Before using this vehicle, the operator should always perform the following pre-ride inspection check list.

Correct any problem found before riding the vehicle. See an authorized Can-Am dealer if necessary.

## Pre-Ride Inspection Check List

### What to Do Before Starting the Engine (Key OFF)

ITEMS TO BE INSPECTED	INSPECTION TO PERFORM	✓
Fluids	Check fuel, engine oil and coolant levels	
Leaks	Check for any leaks under vehicle	
Throttle lever	Activate throttle lever several times to ensure it operates freely. It must return to idle position when released	
Brake lock	Apply brake lock and check if it operates properly	
Tires	Check tire pressure and condition	
Wheels	Check wheels for damage and check lug nuts are tightened	
Radiator	Check cleanliness of the radiator	
Drive shaft boots	Check drive shaft boots and protectors condition	
Seat	Check if operator seat is in place and properly latched	
Cargo	If you transport a cargo, respect the load capacity. Ensure cargo is properly secured to the rack	
	If you are pulling a trailer or another equipment: <ul style="list-style-type: none"> <li>– Check hitch (if applicable) and trailer ball condition</li> <li>– Respect the tongue capacity (if applicable) and towing capacity</li> <li>– Ensure trailer is properly secured to hitch (if applicable).</li> </ul>	
Chassis and suspension	Check underneath vehicle for any debris on chassis or suspension and clean them properly	

**What to Do Before Starting the Engine (Key ON)**

ITEMS TO BE INSPECTED	INSPECTION TO PERFORM	✓
Multifunction gauge	Check operation of indicator lamps in multifunction gauge (during first few seconds of key ON)	
	Check for messages on multifunction gauge	
Lights	Check operation and cleanliness of headlights and taillight	
	Check operation of low and high beams	
	Check operation of brake light	
	Check operation and cleanliness of turn signal lights	
	Check operation of hazard warning lights	
Horn	Check operation of the horn	

**What to Do After the Engine is Started**

ITEMS TO BE INSPECTED	INSPECTION TO PERFORM	✓
Steering	Check if steering operates freely by completely turning it from side to side	
Shift lever	Check operation of shift lever (P, R, N, H and L)	
2WD/4WD selector	Check operation of 2WD/4WD selector	
Brakes	Drive forward slowly a few feet and apply brake lever and brake pedal individually. The brakes must fully apply. Lever and pedal must fully return when released	
Emergency engine stop switch	Check that the emergency engine stop switch is working properly	
Ignition switch	Check if ignition switch is working properly by restarting and stopping the engine	

---

## RIDING THE VEHICLE

To fully appreciate the pleasures and excitement of riding this vehicle, there are some basic rules and tips that you **MUST** follow. Some may be new to you while others may be common sense or obvious.

Please take the time to study this Operator's Guide and all on-product safety labels as well as the *SAFETY DVD* video that came with this vehicle. They more completely describe what you should know about this vehicle before riding it.

Whether you are a new user or an experienced rider, it is important for your personal safety that you know the controls and features of this vehicle. Equally important is knowing how to properly ride.

We recommend following the age recommendation indicated on the safety label affixed on the unit. Even though a person may be within the age group for which this vehicle is recommended, he may not have the skills, abilities, or judgment needed to operate this vehicle safely and may be involved in a serious accident.

Individuals with cognitive or physical impairments or who are high risk takers have an increased exposure to overturns or collisions which may result in injury including death.

Not all vehicles are the same. Each has its own unique performance characteristics, controls and features. Each will ride and handle differently.

Become completely familiar with the operational controls and the general operation of the vehicle before venturing into off road conditions. Practice driving in a suitable area free of hazards and feel the response of each control. Drive at low speeds. Higher speeds require greater experience, knowledge and suitable riding conditions.

Riding conditions vary from place to place. Each is subject to weather conditions which may radically change from time to time and from season to season.

Riding on sand is different than riding on snow or through forests or marshes. Each location may require a greater degree of awareness and skill. Show good judgement. Always proceed with caution. Please do not take any unnecessary risks that could leave you stranded or possibly injured.

Never assume that the vehicle will go everywhere safely. Sudden changes in terrain caused by holes, depressions, banks, softer or harder "ground" or other irregularities may cause the vehicle to topple or become unstable. To avoid this, slow down and always observe the terrain ahead. If the vehicle does begin to topple or tip over, the best advice is to immediately get off **AWAY** from the direction of the tip over!

If a road usage is allowed in your area, operate your vehicle on paved surface only for short distance and for the only purpose of moving the vehicle from an off-road usage to another. Always operate your vehicle at low speed (never exceed 65 km/h (40 MPH)) and reduce the speed before making a turn. This vehicle is not equipped with a rear differential (rear wheels are always turning at the same speed). For this reasons, pavement may seriously affect the handling and control of the vehicle.

Always respect all road traffic laws when operating your vehicle on public roads or streets. If you have to cross a road, the lead driver should get off his vehicle the observe and give direction to the other riders. The last person after crossing then assists the lead driver to cross. Do not travel on sidewalks. They are designated for pedestrian use.



For the users in the European Community, it is mandatory to remove the winch hook (if so equipped) to operate the vehicle on the roadway. Failure to follow this requirement could cause additional injuries including the possibility of death if an accident occurs.

## Riding Gear

Actual weather conditions should help you decide how to dress. Dress for the coldest weather expected. Thermal underwear next to the skin also provides a good insulation. It is important that the operator always wears the appropriate protective riding gear and apparel, including an approved helmet, eye protection, boots, gloves, a long sleeved shirt and pants. This type of clothing will provide you protection from some of the minor hazards you may encounter en route. The operator must never wear loose clothing such as a scarf that may get entangled in the vehicle or on tree branches and shrubs. Depending on conditions, anti-fogging goggles or sunglasses may be required. Different colored lenses available for goggles or sunglasses help you distinguish terrain variations. Sunglasses should only be worn during the daytime.



## Recreational Riding

Respect the rights and limitations of others. Stay away from areas designated for other types of off road use. This includes snowmobile trails, equestrian trails, cross country ski trails, mountain bike trails, etc. Never assume there are no other users on the trail. Always stay to the complete right of the trail and do not zigzag to one side of the trail then the other. Be prepared to stop or pull off to the side if another trail user appears in front of you.

Join a local ATV club. It will provide you with a map and advice or inform you where you can ride. If a club does not exist in your area, help to start one. Group riding and club activities provide a pleasurable, social experience.

Always keep a safe distance from other riders. Your judgment of speed, terrain conditions, weather, mechanical condition of your vehicle and the "trust in judgment" you have in others around you will help you make a better choice of appropriate safe distance. This vehicle, like any other motorized vehicle, cannot stop "on a dime". Allow greater distance for braking.

Before you ride, tell someone where you are planning to travel and your expected time of return.

Depending on the length of your ride, carry additional tools , drinking water, food and emergency equipment. Find out where you can get additional gasoline and oil. Be prepared for the possible conditions you may encounter.

First aid kit	Adjustable wrench
Mobile phone	Knife
Friction tape	Flashlight
A rope	Colored lens goggles
Spare light bulbs	Trail map
Provided tool kit	Snack

## Environment

One of the benefits of this vehicle is that it can take you off the beaten path away from most communities. However, you should always respect nature and the rights of others to enjoy it. Do not ride in environmentally sensitive areas. Do not drive over forest crops or shrubs nor cut down trees or take down fencing nor spin your wheels and destroy the terrain. "Tread Lightly".

This vehicle can cause OHV wildfires if debris builds up near the exhaust or other engine hot spots and ignites then falls off into dry grass. Avoid riding in wet areas, through muskeg or tall grass, where debris can build up. Should you ride in those areas, inspect and remove all debris from your engine and hot spots.

Chasing wildlife is in many areas illegal. Wildlife can die of exhaustion after being chased by a motorized vehicle. If you encounter animals on the trail, stop and observe quietly and with caution. It will be one of the better memories of your life.

Observe the rule "what you take in, carry out". Do not litter. Do not start campfires unless you have permission to do so and then only away from dry areas. The hazards you may create on the trail may cause injury to others or yourself, even at a later date.

Respect farm lands. Always obtain the permission of the landowner before riding on private land. Respect crops, farm animals and property lines. If you come to a closed gate, close it again behind you.

Finally, do not pollute streams, lakes or rivers and do not modify the engine or exhaust system, or remove any of its components.

## **Design Limitation**

Although the vehicle is exceptionally rugged for its class, it is still a light vehicle by definition and its operation must be restricted to its proper purpose.

The addition of weight to any part of the vehicle changes its gravitational stability and modifies its performance.

## **Off-Road Operation**

The very nature of off-road operation is dangerous. Any terrain, which has not been specially prepared to carry vehicles, presents an inherent danger where angularity, terrain substance and exact steepness are unpredictable. The terrain itself presents a continual element of danger, which must be knowingly accepted by anyone venturing over it.

An operator who takes a vehicle off-road should always exercise the utmost care in selecting the safest path and keeping close watch on the terrain ahead of him. On no account should the vehicle be operated by anyone who is not completely familiar with the driving instructions applicable to the vehicle, nor should it be operated on steep or treacherous terrain.

## **Riding Techniques**

Information in this guide is limited. Increase your knowledge and improve your skills by following a certified training course.

Care, caution, experience and driving skill are the best precautions against the hazards of vehicle operation.

Respect and follow all posted trail signs. They are there to help you and others.

When driving on hills or slopes two things are highly important be prepared for slippery surfaces or terrain variations and obstacles and use proper body positioning.

Whenever there is the slightest doubt that the vehicle can safely negotiate an obstacle or a particular piece of terrain, always choose an alternate route.

In off-road operation, power and traction, not speed, are important. Never drive faster than visibility and your own ability to select a safe route permits.

Constantly watch the terrain ahead for sudden changes in slopes or obstacles, such as rocks or stumps, that may cause loss of stability, resulting in tip over or rollover.

Never operate the vehicle if the controls do not function normally.

When stopped or parked, always set the shift lever to PARK position apply the brake lock. This is especially important when parking on a slope. On very steep inclines or if the vehicle is carrying cargo, the wheels should be blocked using rocks or bricks.

Always use proper riding techniques to avoid vehicle overturns on hills and rough terrain and in turns.

## Body Position

To maintain proper control, it is strongly advised that you keep your hands on the handlebar and within easy reach of all controls. The same holds true for your feet on the foot pegs. To minimize the possibility of a leg or foot injury, keep your feet on the foot pegs at all times. Do not direct your toes outwards nor extend your feet out to assist in turning as they can be hit or be snagged on passing obstacles, or may come into contact with the wheels.

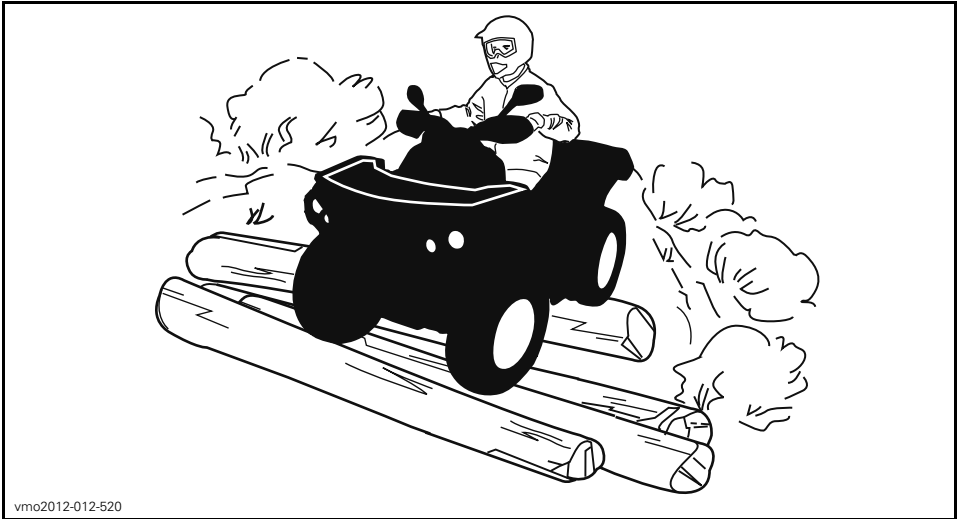

Even though there is a suspension on this vehicle, there are “washboard” or rough terrain conditions that will make you feel uncomfortable and can even cause a back injury. “Posting” or riding in a crouched position will often be required. Slow down and allow your flexed legs to absorb part of the impact energy.

## Riding on Roads

If road usage is allowed in your area, operate your vehicle on paved surface only for short distance and for the only purpose of moving the vehicle from an off-road usage to another. Always operate your vehicle at low speed (never exceed 65 km/h) and reduce the speed before making a turn. This vehicle is not equipped with a rear differential (rear wheels are always turning at the same speed). For this reason, pavement may seriously affect the handling and control of the vehicle.

Always respect all road traffic laws when operating your vehicle on public roads or streets. If you have to cross a road, the lead driver should get off his vehicle to observe and give direction to the other riders. The last person after crossing then assists the lead driver to cross. Do not travel on sidewalks. They are designated for pedestrian use.

## Turning

Practice turning at low speeds before attempting to turn at faster speeds.

Keep both hands on handlebars and feet on foot pegs.

Maintain a constant speed or a slight acceleration during turn.

To reduce the risk of rollovers:

- Use care when turning.
  - Do not turn the handlebar too far or too fast for your speed and environment. Adjust steering inputs accordingly.
  - Slow down before entering a turn. Avoid hard braking during a turn.
  - Avoid sudden or hard acceleration when turning, even from a stop or low speed.
- Never attempt donuts, skids, slides, fishtails, jumps, or other stunts. If vehicle starts to skid or slide, steer in the direction of the skid or slide. Never slam the brakes and lock the wheels.
- Avoid paved surfaces. This vehicle is not designed to operate on paved surfaces and is more likely to roll over. If you must drive on pavement, turn gradually, go slowly, and avoid abrupt acceleration and braking.

Avoid sudden inputs to steering, throttle or brakes while turning.

## ⚠ WARNING

Do not attempt turns at excessive speed.

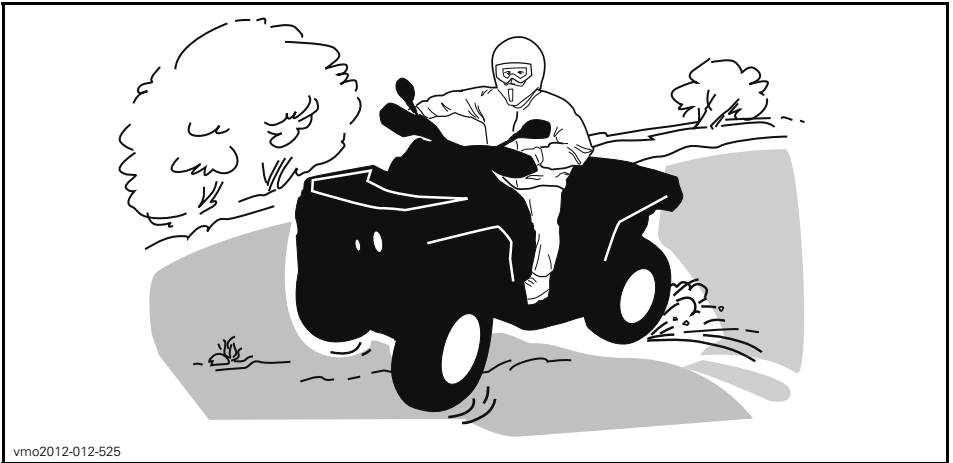

vmo2012-012-525

If you do get into a slide or skid, it may help to turn the handlebar in the direction of the skid until you regain control. Never jam the brakes and lock the wheels.

### Braking

Always keep both hands on handlebars and feet on foot pegs when braking.

Practice braking to get familiar with the brake response.

- Do it at low speed first, then increase the speed.
- Practice braking in straight line at different speeds and different braking force.
- Practice emergency braking; optimal braking is obtained in straight line, with high force applied, without locking the wheels.

Remember, braking distance depends on vehicle speed, load and the type of surface. Also, the tires and brakes conditions play a major role.

**NOTE:** If going forward the vehicle weight is transferred to the front wheels when braking. To obtain greater stopping efficiency, the brake system distributes more braking force to the front wheels. This will affect vehicle handling and steering control when braking vigorously. Take it into account when braking.

### **Reverse Operation**

When operating in reverse, check that the path behind the vehicle is free of people or obstacles. Proceed slowly and avoid sharp turns.

We recommend sitting on your ATV when operating in reverse. Avoid standing up. Your weight could shift forward against throttle lever, causing an unexpected acceleration.

### **Obstacles**

Obstacles in the "trail" should be traversed with caution. This includes loose rocks, fallen trees, slippery surfaces, fences, posts, and embankments and depressions. You should avoid them whenever possible. Remember that some obstacles are too large or dangerous to cross and should be avoided. Small rocks or fallen trees may be safely crossed approach at a 90° angle. Stand on the footrests while keeping your knees flexed. Adjust speed without losing momentum and do not "gun" the throttle. Hold handlebar firmly. Place operator body weight rearwards and proceed. Do not try to lift the vehicle front wheels off the ground. Be aware that the object may be slippery or may move while crossing.

## Uphill Driving

Before trying to climb a hill, keep these things in mind. Hill Climbing should only be attempted by experienced operators. Start on shallow slopes. Always drive straight uphill and keep your body weight forward towards the top of the hill. Keep your feet on the footrests, shift your ATV into a lower gear and accelerate before you start to climb. Try to keep a steady speed and go easy on the throttle to avoid acceleration. Abrupt slope or terrain variation or rolling one wheel over an obstacle could have a big impact on the stability as it will lift the front of the vehicle increasing the risk of tipping over. Some hills are too steep to safely stop or recover from after an unsuccessful climbing attempt. Try to avoid steep inclines. If you're not careful, you could tip over when going up hills. If the hill is too steep and you cannot proceed or the vehicle begins to roll backwards, apply the brake, being careful not to slide. Dismount then use the "K" turn (while walking back, next to the vehicle on the up hill side and with a hand on the brake lever, slowly back the rear of the vehicle toward the top of the hill then drive downhill). Always walk or dismount on the upside of the slope while keeping clear of the vehicle and its rotating wheels. Do not try to hold on to the vehicle if it begins to topple. Stay clear. Do not ride over the crest of the hill at high speed. Obstacles, including sharp drop-offs, may exist.



vmo2012-012-526

## Downhill Driving

This vehicle can climb slopes that are steeper than it can safely descend. Therefore, it is essential to ensure that a safe route exists to descend a slope before you climb it.

Decelerating while negotiating a slippery downhill slope could “toboggan” the vehicle. Maintain steady speed and/or accelerate slightly to regain control.

Keep your body weight rearwards. Apply the brake gradually to prevent skidding. Do not “coast” down the slope using solely engine compression or in neutral gear. Try to avoid steep inclines. If you’re not careful, you could tip over when going down hills.

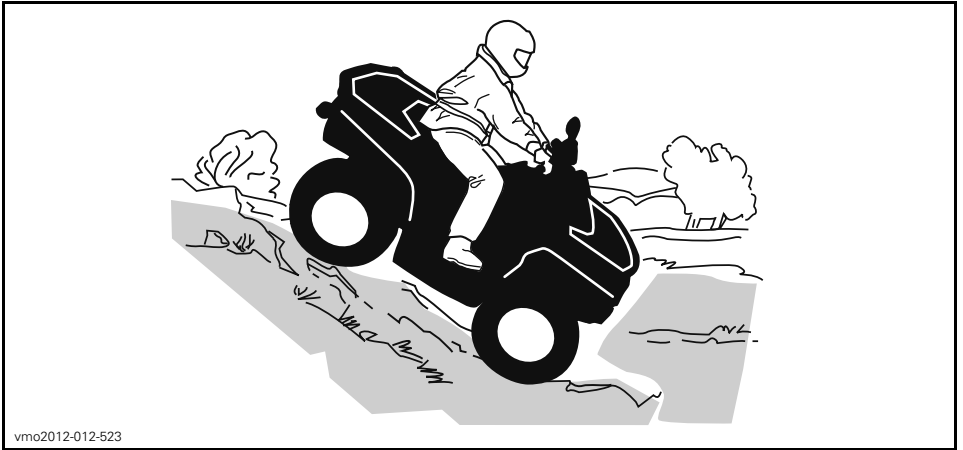



## Side Hilling

This is one of the **most risky** types of riding since it may drastically change the balance of the vehicle. It should be avoided whenever possible. However, if it is necessary to do so, it is important that you **ALWAYS** keep your body weight on the up-side of the slope and be prepared to dismount on that side should the vehicle begin to topple. **Do not try to stop or save the vehicle from damage.**

Avoid all objects or depressions that will intensify the raising of one side of the vehicle higher than the other, thus causing rollover.

### **WARNING**

Be careful when loading and transporting liquid reservoirs. They can affect vehicle stability when side hilling by pulling downhill and increasing the risk of a roll over.

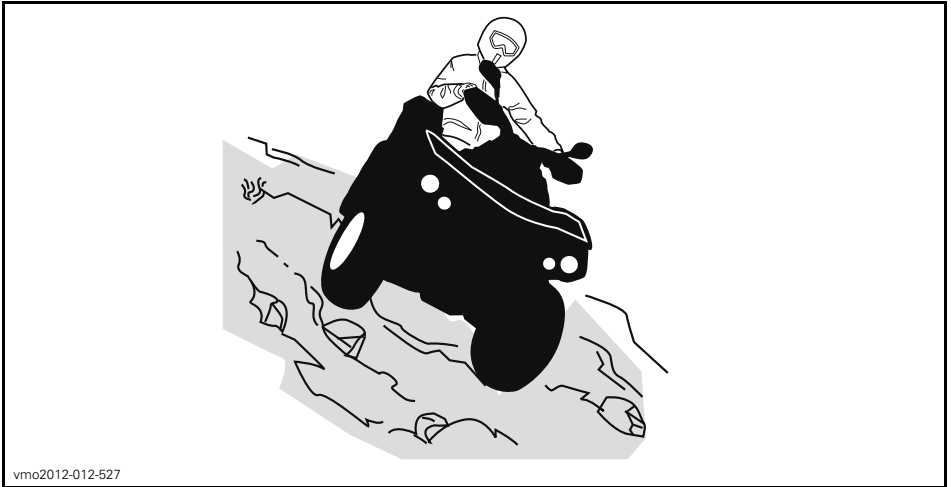

## Drop-Offs

This vehicle will “bottom-out” and usually stop if either the front or rear wheels are driven over a drop-off. If the drop is sharp or deep, the vehicle will nose dive and tip over.

### **WARNING**

Avoid negotiating drop-offs. Reverse and select an alternate route.

## Crossing Water

Water can be a unique hazard. If it is too deep the vehicle may “float” and topple. Check the water depth and current before you attempt to cross any water. Water should not go above the footrest. Be wary of slippery surfaces such as rocks, grass, logs, etc., both in the water and on its banks. A loss of traction may occur. Do not attempt to enter the water at high speed. The water will act as a brake and could throw you off the vehicle, on the ground.

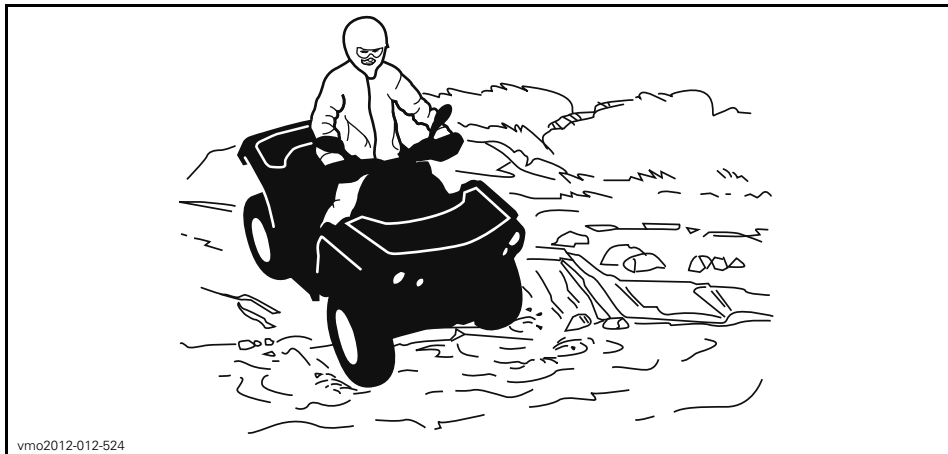

Wet brakes will affect the braking ability of your vehicle. Make sure you dry the brakes by applying them several times after the vehicle leaves the water, mud or snow. Allow greater distance for braking.

Mud or marsh lands may be encountered near water. Be prepared for sudden “holes” or changes in depth. Similarly so, be watchful of hazards such as rocks, logs, etc., partially covered by vegetation.

## Riding on Ice

If your route crosses frozen waterways, make sure the ice is thick enough and sound enough to support the total weight of yourself, the vehicle and its load. Be ever watchful of open water it is a sure indication that the ice thickness will vary.

Ice will also affect the control of the vehicle. Slow down and do not “gun” the throttle. This will only result in spinning of the tires and possible tip over of the vehicle. Avoid rapid braking. This again will possibly result in an uncontrolled slide and tip over of the vehicle. Slush should be avoided at all times since it could block the operation or controls of the vehicle.

## Riding on Snow Covered Surfaces

When performing the pre-ride inspection, pay special attention to locations on the vehicle where snow and/or ice accumulations may obstruct visibility of the taillight and reflectors, clog ventilation openings, block the radiator and fan, and interfere with the movement of control levers, switches and brake pedal. Before starting with your ATV check the steering, throttle and brake lever and pedal controls for interference free operation.

Whenever an ATV is ridden on a snow covered drive path the tire grip is generally reduced causing the vehicle to react differently to control inputs from the operator. On low grip surfaces, the steering responses are not as crisp and precise, stopping distances are lengthened and acceleration becomes sluggish. Slow down and do not "gun" the throttle. This will only result in spinning of the tires and possibly in an over steering slide of the vehicle. Avoid hard braking. This will possibly result in a straight line slide of the vehicle. Again, the best advice is to safely reduce speed in anticipation of a maneuver so to give yourself time and distance to regain total vehicle control before it spins out of your control.

As you drive your ATV over a loose snow covered surface, snow dust will be picked up in the wake turbulence of the moving vehicle and transported to contact and accumulate or melt on some exposed components including rotating parts like brake discs. Water, snow or ice may affect the response time of the brake system of your ATV. Even when not required to reduce vehicle speed apply brakes frequently to prevent ice or snow accumulation and to dry brake pads and discs. While doing so in low risk driving situations you will test for grip level and keep yourself alerted to how the vehicle reacts to your control inputs. Always keep brake pedal, footrests, floor boards, brake and throttle levers free of snow and ice. Frequently wipe snow off seat, hand grips, headlights, taillights and reflectors.

The depth of the snow cover may hide rocks, tree stumps or other objects and if it is wet may totally impede the driveability as the vehicle becomes bogged down or completely loses traction in slushy snow. Look far ahead and always be watchful of any visible clues that might indicate the presence of such obstacles. In doubt steer clear. Avoid driving on any frozen body of water before checking that the ice will safely support the ATV, its riders and its load of cargo. Remember that a given thickness of ice may be sufficient to support a snowmobile but not an ATV of an identical weight because of the smaller load bearing surface of the four tire contact patches as compared to that of a snowmobile track and skis.

To maximize comfort and avoid frostbite, always wear clothing and ATV protective equipment appropriate for the weather conditions you will be exposed to during your ride.

At the end of each ride it is a good practice to clean the vehicle body and all moving components (brakes, steering components, drivelines, controls, radiator fan etc.) from any snow or ice accumulations. Wet snow will turn to ice during the shut down period and become more difficult to remove at the next pre-ride inspection.

Riding in snow may reduce the brakes stopping capability. Safely reduce speed and allow greater distance for braking. Snow projection may cause ice build up or snow accumulation on brake components and controls. Apply brakes frequently to prevent ice or snow accumulation.

## **Riding on Sand**

Riding on sand, sand dunes or on snow is another unique experience, but there are some basic precautions that should be observed. Wet, deep or fine sand/snow may create a loss of traction and cause the vehicle to slide, drop off or become “bogged” down. If this occurs look for a firmer base. Again, the best advice is to slow down and be watchful of the conditions.

When riding in sand dunes it is advisable to equip the vehicle with an antenna type safety flag. This will help make your location more visible to others over the next sand dune. Proceed carefully should you see another safety flag ahead. Since the antenna type safety flag can snag and rebound on your body if caught, do not use it in areas where there are low hanging branches or obstacles.

## **Riding on Loose Stones**

Riding on loose stones or gravel is very similar to riding on ice. They will affect the steering of vehicle possibly causing it to slide or tip over especially at high speeds. In addition, braking distance may be affected. Remember that “gunning” the throttle or sliding may cause loose stones to be ejected rearwards into the path of another rider. Never do it deliberately.

# MOVING LOADS AND DOING WORK

## Working with your Vehicle

Your vehicle can help you perform a number of different LIGHT tasks ranging from snow removal to pulling wood or carrying cargo. A variety of accessories are available from your authorized Can-Am dealer. To prevent possible injury, follow the instructions and warnings that accompany the accessory. Always respect the load limits of the vehicle. Overloading the vehicle can overstress the components and cause failure. Avoid overexerting yourself if you lift or pull heavy loads or manually push the vehicle.

## Carrying Loads

Any load carried on the vehicle will affect the handling, stability and braking distance of the vehicle. Do not exceed the load limits of the vehicle, including the weight of operator, cargo, accessories and trailer tongue weight. Always make sure the load is secured, properly distributed and cannot interfere with your proper control. Always be aware that the "load" may slide or fall off and create an accident. Avoid loads that may protrude sideways and get snagged or caught in brush or other obstacles.

### WARNING

Never overload, tow or carry cargo improperly. Safely reduce speed according to terrain conditions when carrying cargo or pulling a trailer, and avoid hills and rough terrain. Allow greater distance for braking. Always secure cargo as low as possible to reduce the effect of a higher center of gravity. Failure to follow the recommendations here could cause changes in vehicle handling which could lead to an accident.

### MAXIMUM LOAD TABLE

TOTAL LOAD ALLOWED	141 kg (310 lb)	Includes weight of operator, cargo, accessories and trailer tongue weight.
REAR LOAD	16 kg (35 lb)	Includes rear cargo area load (if applicable).

## Pulling a Trailer (If Equipped with a Hitch)

**NOTICE** A BRP approved rear hitch plate must be properly installed on the vehicle for hauling trailers.

If a trailer is used behind the vehicle make sure that its hitch is compatible with the one installed on the vehicle as an accessory. Make sure the trailer is horizontal with the vehicle. (In some instances a special extension may have to be installed on the vehicle hitch). Use security chains or cables to secure the trailer with the vehicle.

Improperly loading a trailer may cause loss of control. Respect the recommended maximum hauling capacity and maximum tongue load (Refer to *MAXIMUM HAULING CAPACITY* table). Make sure there is at least some weight on the tongue.

Always make sure load is evenly distributed and safely secured on the trailer; an evenly balanced trailer is easier to control.

Always put the shift lever to L (low range) for hauling a trailer – in addition to providing more torque, operating in low range helps account for the increased load on the rear tires.

When stopped or parked, block the vehicle and trailer wheels from possible movement.

Use caution when disconnecting a loaded trailer; it or its load may topple on you or others.

When hauling a trailer, respect the following maximum hauling capacity.

<b>MAXIMUM HAULING CAPACITY</b>		
<b>TRAILER LOAD ALLOWED</b>	<b>TONGUE WEIGHT ALLOWED</b>	<b>NOTE</b>
135 kg (298 lb)	14 kg (31 lb)	Includes trailer and trailer load. Ensure to properly load the trailer so that tongue is always pushing on hitch support and not pulling on hitch ball.

# ***VEHICLE INFORMATION***

# CONTROLS

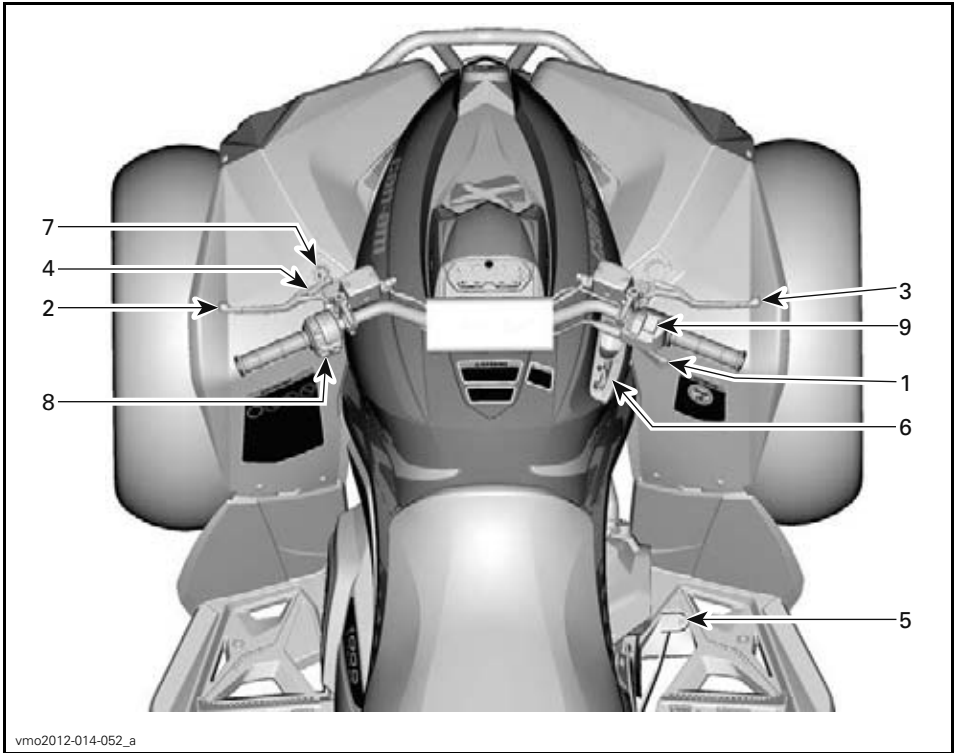

vmo2012-014-052\_a

## 1) Throttle Lever

The throttle lever is located on the RH side of the handlebar.

The throttle lever controls the engine speed.

To increase or maintain vehicle speed, press the throttle lever with your right thumb.

To decrease vehicle speed, release the throttle lever.



vmo2012-012-006\_a

### TYPICAL

1. Throttle lever
2. To accelerate
3. To decelerate



## 2) LH Brake Lever

The LH brake lever is located on the LH side of the handlebar.

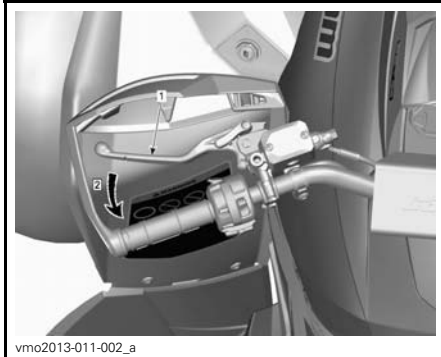

### TYPICAL

1. Brake lever
2. To apply brakes

The brake lever function is to slow down or stop the vehicle.

When the brake lever is pressed, the rear brakes are applied.

Braking effect is proportional to the force applied on the lever.

## 3) RH Brake Lever

The RH brake lever is located on the RH side of the handlebar.

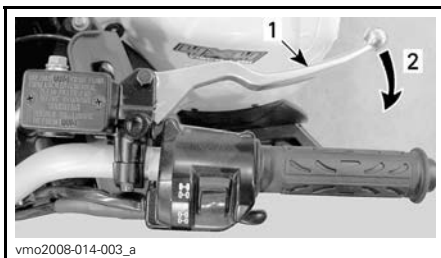

### TYPICAL

1. Brake lever
2. To apply brakes

The RH brake lever function is to slow down or stop the vehicle

When the brake lever is pressed, the front brakes are applied.

When released, the brake lever should automatically return to its original position.

Braking effect is proportional to the force applied on the lever.

## 4) Brake Lock

The brake lock is located on the LH side of the handlebar.

The brake lock function is to apply brake to all wheels to prevent vehicle from moving when parked.

### **⚠ WARNING**

Always use the brake lock **and** engage the PARK position on the shift lever when the vehicle is not in operation.

**To engage brake lock:** Squeeze brake lever and maintain while moving lever lock. Brake lever is now compressed and applying all brakes.

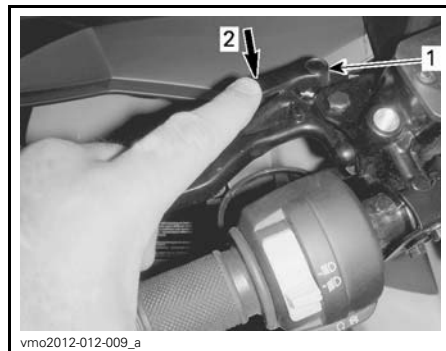

### TYPICAL

1. Brake lever lock
2. Press to apply brake lock

**NOTE:** Locking lever can be adjusted in several positions.

**NOTICE** Ensure when the brake lock is applied that the vehicle stays securely in place.

To release brake lock: Squeeze brake lever. Lever lock should automatically return to its original position. Brake lever should return to rest position.

**⚠ WARNING**

Make sure brake lock is released before operating the vehicle. If brake lock is left ON while riding, it may cause damage to the brake system and cause loss of braking capacity and/or fire.

### 5) Brake Pedal

The brake pedal is located on the RH side of the vehicle near engine.

When pressed down, the front and rear brakes are applied.



1. Brake pedal

When released, the brake pedal should return to its original position.

Braking effect is proportional to the force applied on the pedal.

**NOTE:** As on other wheeled vehicles, the vehicle weight is transferred to the front wheels when braking. To obtain greater stopping efficiency, the brake system distributes more braking force to the front wheels. This will affect vehicle handling and steering control when braking vigorously. Take it into account when braking.

### 6) Shift Lever

The shift lever is located on the RH side of the vehicle near steering column.

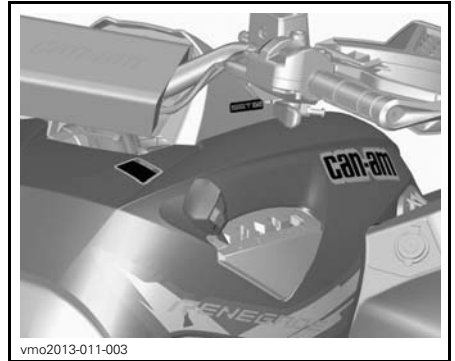

SHIFT LEVER LOCATION

The shift lever is used to change the gearbox position.

The shift lever has 5 positions:

SHIFT LEVER POSITIONS	
POSITION	GEAR
P	Park
R	Reverse
N	Neutral
H	High range (forward)
L	Low range (forward)

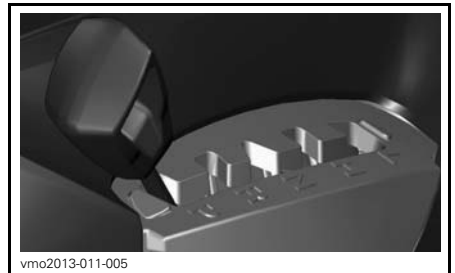

SHIFT PATTERN

The vehicle must be stopped and brakes applied prior to selecting any gear.

**NOTICE** This gearbox is not designed to shift while vehicle is moving.

#### P: Park

The park position locks the gearbox to help prevent vehicle movement.

### **⚠ WARNING**

Always use the PARK (P) position when the vehicle is not in operation. The vehicle can roll if the shift lever is not set to P (PARK).

#### R: Reverse

The reverse position allows the vehicle to go backwards.

**NOTE:** In reverse operation, the engine's RPM is limited, thus limiting the vehicle reverse speed.

### **⚠ WARNING**

When driving downhill in reverse, gravity can increase the vehicle speed above the set limited reverse speed.

#### Neutral

The neutral position disengages the gearbox.

### **⚠ WARNING**

Always use the PARK (P) position when the vehicle is not in operation. The vehicle can roll if the shift lever is set to N (NEUTRAL).

#### High Range (Forward)

This position selects the high speed range of the gearbox. It is the normal driving speed range. It allows the vehicle to reach its maximum speed.

#### Low Range (Forward)

This position selects the low speed range of the gearbox. It allows the vehicle to move slowly with maximum torque at the wheels.

**NOTICE** Use the low speed range to pull a trailer, carry heavy cargo, go over obstacles or drive uphill and downhill.

### 7) Ignition Switch

The ignition switch is located on the LH side of the central panel below the handlebar.

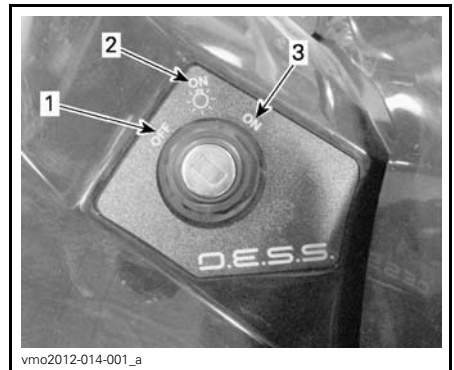

IGNITION SWITCH POSITIONS

1. OFF
2. ON "with light"
3. ON "without light"

#### OFF

The key can be inserted or removed in this position only.

In OFF position, the electrical system of the vehicle is disabled.

The engine is shut down by turning the ignition switch to OFF position.

**NOTE:** While the engine can be stopped by turning the ignition key to OFF position, we recommend the engine be stopped by setting the emergency engine stop switch to the STOP position.

**NOTE:** When turning the key to OFF position, the vehicle electrical system will take a few seconds to shut down.

### ON with Lights

When the key is turned in this position, the electrical system of the vehicle is activated.

The gauge should wake-up.

The vehicle lights are turned on.

The engine can be started.

### ON

This position offers the same functions as ON with lights position, except the vehicle lights are turned off.

### Digitally Encoded Security System (D.E.S.S.)

The ignition keys contain an electronic circuit that gives it a unique electronic serial number.

The D.E.S.S. system reads the key code and allows engine starting for keys it recognizes.

## 8) Multifunction Switch

The multifunction switch is located on the LH side of the handlebar.

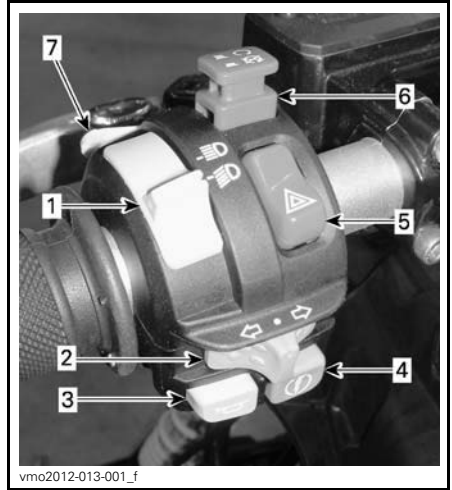

**TYPICAL - MULTIFUNCTION SWITCH**

1. Low/High Beam Headlight switch
2. Turn signal switch
3. Horn button
4. Engine start button
5. Hazard warning button
6. Emergency engine stop switch
7. Override

### Low/High Headlight Switch

This switch is used to select either the headlights low or high beams.

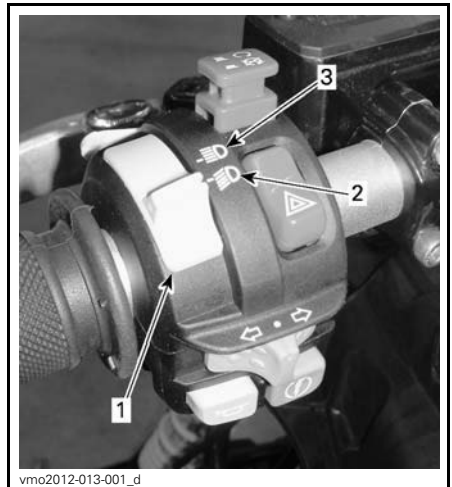

1. Low/High Beam Headlight switch
2. Low beam
3. High beam

## Turn Signal Switch

The turn signal switch is located on the LH side of handlebar.



1. Turn signal switch

To activate the turn signals, move the switch button on the right or the left side, depending on which direction you picked. Reposition the switch in the middle when the maneuver is completed.

## Horn Button

The horn button is located on the LH side of handlebar.



**TYPICAL**

1. Horn button

## Engine Start Button



**TYPICAL**

1. Engine start button

When engine start button is pressed and held, it starts the engine.

**NOTE:** To allow engine starting, the ignition switch must be in the ON or ON with lights position and the emergency engine stop button set to RUN.

While reading this Operator's Guide, remember that:

## **WARNING**

Indicates a potential hazard that, if not avoided, could result in serious injury or death.

## Hazard Warning Button

The hazard warning button is located on the LH side of handlebar.

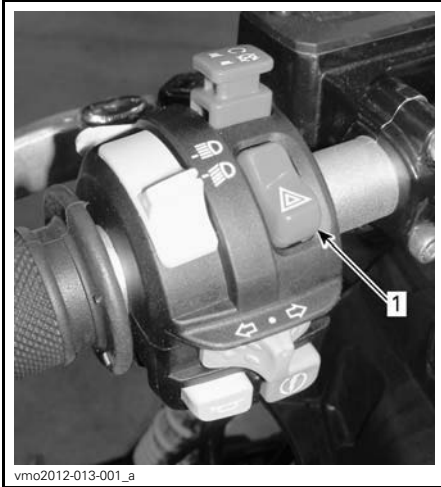

1. Hazard warning button

Device fitted to the vehicle that operates a simultaneous flashing of all the turn signals, used when the vehicle is stationary to indicate that the vehicle is temporarily obstructing traffic.

Press the hazard warning button once to activate the device.

**NOTE:** Hazard warning lights can be activated even when the vehicle electrical system is shut down.

## Emergency Engine Stop Switch

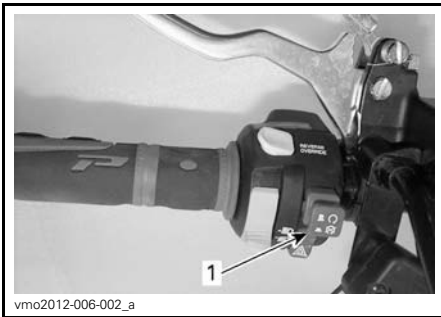

1. Emergency engine stop switch

This switch can be used to stop the engine and as an emergency control.

To stop engine, set the EMERGENCY engine stop switch to the STOP position.

**NOTE:** While the engine can be stopped by turning the ignition key to OFF position, we recommend the engine be stopped by setting the emergency engine stop switch to the STOP position.

## Override

Depending on the vehicle model, this button has up to 2 functions.

### Override Function

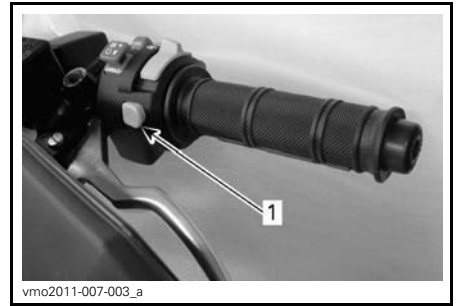

1. Override/DPS button

The override switch main function is to bypass the engine speed limiter in reverse operation by allowing maximum engine torque.

## **⚠ WARNING**

Only use the override to help get the vehicle unstuck from mud or other soft terrain. Do not use the override for normal operation in reverse. This would allow driving in reverse at excessive speeds and can increase the risk of losing control.

To engage the override function, proceed as follows:

While the shift lever is set to REVERSE position.

1. Ensure that the vehicle is stopped.
2. Press and hold the override switch then press the throttle lever gradually.

**NOTE:** When using the override function, the gauge will scroll an **OVER-RIDE** message to confirm that the function is activated.

3. To disengage the override function, simply release the override switch.

### DPS Function (Renegade X xc Model)

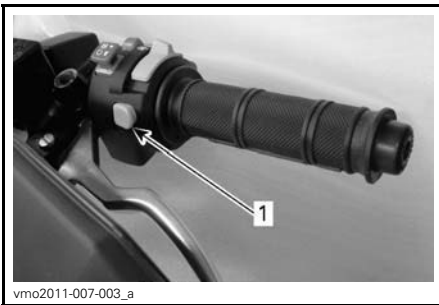

1. *Override/DPS button*

The DPS function is used to change the DPS (Dynamic Power Steering) mode.

To change the DPS mode, proceed as follows:

1. Move shift lever in park position.
2. Press and hold **DPS** button for 2 seconds.

**NOTE:** The DPS adjustment will not be possible if the vehicle transmission is set to **REVERSE**.

### 9) 2WD/4WD Selector

The 2WD/4WD selector is located on the RH side of the handlebar.

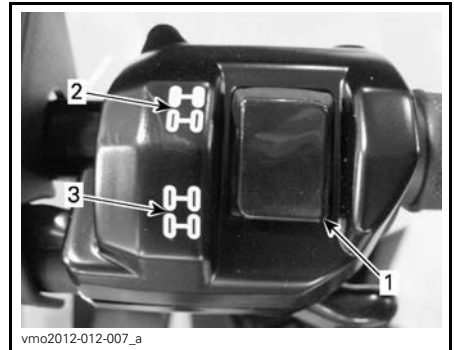

#### TYPICAL

1. *Selector*
2. *2WD position*
3. *4WD position*

This switch selects 2 Wheel Drive or 4 Wheel Drive mode when the vehicle is stopped and the engine is running.

**NOTICE** The vehicle must be stopped to engage or disengage 2WD/4WD switch. Mechanical damage may occur if switch is engaged or disengaged while driving.

The 4WD mode is engaged when the switch is pushed downwards.



TYPICAL - 4WD MODE

The 2WD mode is engaged when the switch is pushed upwards. The vehicle is then rear wheel drive only.



TYPICAL - 2WD MODE

While reading this Operator's Guide, remember that:

**⚠ WARNING**

Indicates a potential hazard that, if not avoided, could result in serious injury or death.



# MULTIFUNCTION GAUGE (LCD)

The multifunction gauge is located on the gauge support

## **⚠ WARNING**

Reading the multifunction gauge display can distract from the operation of the vehicle, particularly from constantly scanning the environment.

## Multifunction Gauge Description

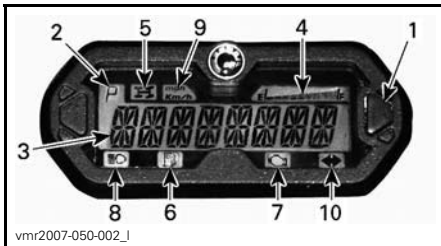

1. Selector button
2. Transmission position display
3. Main screen
4. Fuel level display
5. 4WD indicator lamp
6. Low fuel level indicator lamp
7. Check engine indicator lamp
8. High beam indicator lamp
9. MPH, km/h indicator lamp
10. Flasher/hazard signal indicator lamp

### 1) Selector Button

The selector button is used to navigate or change settings in the multifunction gauge.

### 2) Transmission Position Display

This display will show transmission position.

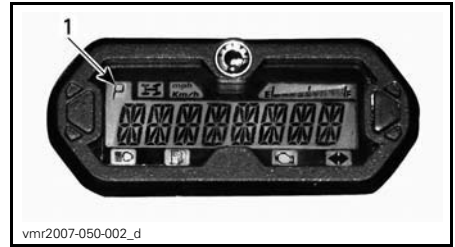

1. Transmission position

DISPLAY	FUNCTION
P	Park
R	Reverse
N	Neutral
H	High range
L	Low range

### 3) Main Screen

The main screen is used to display numerous functions of the multifunction gauge.

Refer to *MULTIFUNCTION GAUGE MODES* for the different available modes:

### 4) Fuel Level Display

Bar gauge continuously indicates the level of fuel in the fuel tank while riding.



1. Fuel level display

### 5) 4WD Indicator Lamp



When this indicator is ON, it indicates the 4WD system is activated.

### 6) Low Fuel Level Indicator Lamp



When this indicator is ON, it indicates that there is approximately 5 L (1.3 U.S. gal.) of fuel left in fuel tank.

### 7) Check Engine Indicator Lamp



When this indicator is ON, it indicates an engine fault code, look for a message at the LCD display.

When this indicator blinks, it indicates that the **LIMP HOME** mode is activated.

Refer to *TROUBLESHOOTING* section for more details.

### 8) High Beam Indicator Lamp



When this indicator is ON, it indicates that **high beam** is selected on the headlights and that ignition key is in ON with lights position.

### 9) KM/H or MPH Indicator Lamp

*mph*  
*Km/h*

The proper lamp turns on to indicate the unit the speedometer uses.

### 10) Flasher/hazard signal indicator lamp



When this indicator is blinking, it indicates the flasher/hazard is activated

## Multifunction Gauge Modes

### Speed Mode

In this mode, the main screen shows the speed of the vehicle either in km/h or in mph.



### RPM Mode

In this mode, the main screen shows the engine RPM.

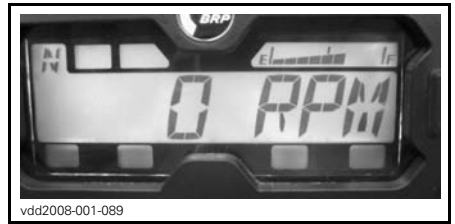

### Combined Mode

In this mode, the main screen shows the speed of the vehicle and the engine RPM.

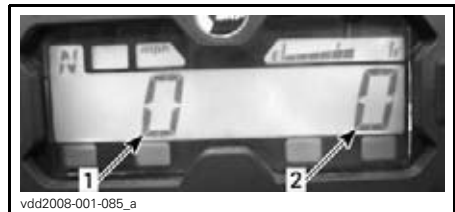

1. Vehicle speed
2. Engine RPM

**Odometer (OD)**

Odometer records the total distance travelled either in miles or kilometers.



vsi2009-018-030

**Clock**

Shows current time.



vmo2011-008-001

Refer to *GAUGE SETUP* to set current time.

**Trip Meter (TP)**

The trip meter records the travelled distance since it has been reset. Distance travelled is displayed either in kilometers or miles.



vsi2009-018-031

It can be used to establish a fuel tank range or distance between 2 way points for instance.

Press and HOLD the selector button for 2 seconds to reset the trip meter.

**Trip Hour Meter (TH)**

The trip hour meter records vehicle running time when the electrical system is activated. It can be used to establish traveling time between 2 way points for instance.



vsi2009-018-032

Press and HOLD the selector button for 2 seconds to reset the hour meter.

**Engine Hour Meter (EH)**

The engine hour meter records engine running time.

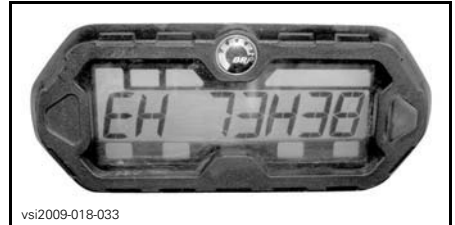

vsi2009-018-033

**Message Mode**

If an abnormal engine condition occurs, a message can be combined with a pilot lamp. Refer to *TROUBLESHOOTING* section for details.

**Fault Code Mode**

Press and hold mode button while switching high and low beam ( three cycles) to access diagnostic fault codes.

## Navigating in the LCD Gauge

### Default Display Mode

After vehicle startup, the default display mode is either:

- Vehicle speed
- Engine revolutions per minute (RPM)
- Both parameters simultaneously (combined mode).

To change from one display to the other, proceed as follows.

1. Turn ignition key to ON to power the system up.
2. Wait until the “greeting message” has been displayed.
3. Press and release selector button once to display OD (odometer).
4. Press the selector button again, this time for 2 seconds.

This will change the Mode to either Speed, RPM or Combined.



5. To select another mode, repeat steps 3 and 4 until the desired mode is displayed.

### Temporary Display Mode

In the temporary display mode, the following functions are available:

- Odometer
- Clock
- Trip meter (resettable)
- Trip Hour meter (resettable)
- Engine hour meter.

Press and release selector button to change the default display mode to the temporary mode.



1. Selector button

The gauge will display the selected mode for 10 seconds then will return to the normal display mode.

While in a resettable mode, push and HOLD selector button for 2 seconds to reset it.

## Gauge Setup

### Clock Setting

Once clock display as been selected, use the display selector button to set clock as follows:

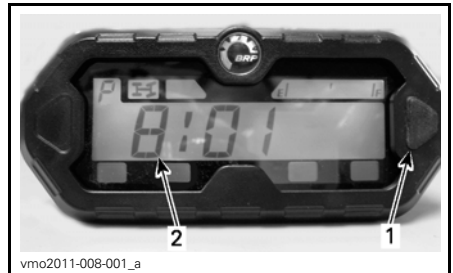

1. Selector button  
2. Time

1. Press and HOLD button (Display will flash).
2. Choose the 12-hour (12H) or 24-hour (24H) format by pressing button.
3. If the 12-hour format was selected, choose Am (A) or Pm (P) by pressing button.

4. Press and HOLD button.
5. Choose hour first digit by pressing button.
6. Press and HOLD button.
7. Choose hour second digit by pressing button.
8. Press and HOLD button.
9. Choose minutes first digit by pressing button.
10. Press and HOLD button.
11. Choose minutes second digit by pressing button.
12. Press button to enter settings (CLOCK will appear on display).

**NOTE:** The gauge will display the current time for 10 seconds then will return to the normal display mode.

### **Unit Selection (km/h vs MPH)**

The speedometer, odometer and trip meter are factory preset in **miles** but it is possible to change them to **kilometer** reading. Contact an authorized Can-Am dealer.

### **Language Selection**

The gauge display language can be changed. Refer to an authorized Can-Am dealer for language availability and setup the gauge to your preference.

# EQUIPMENT

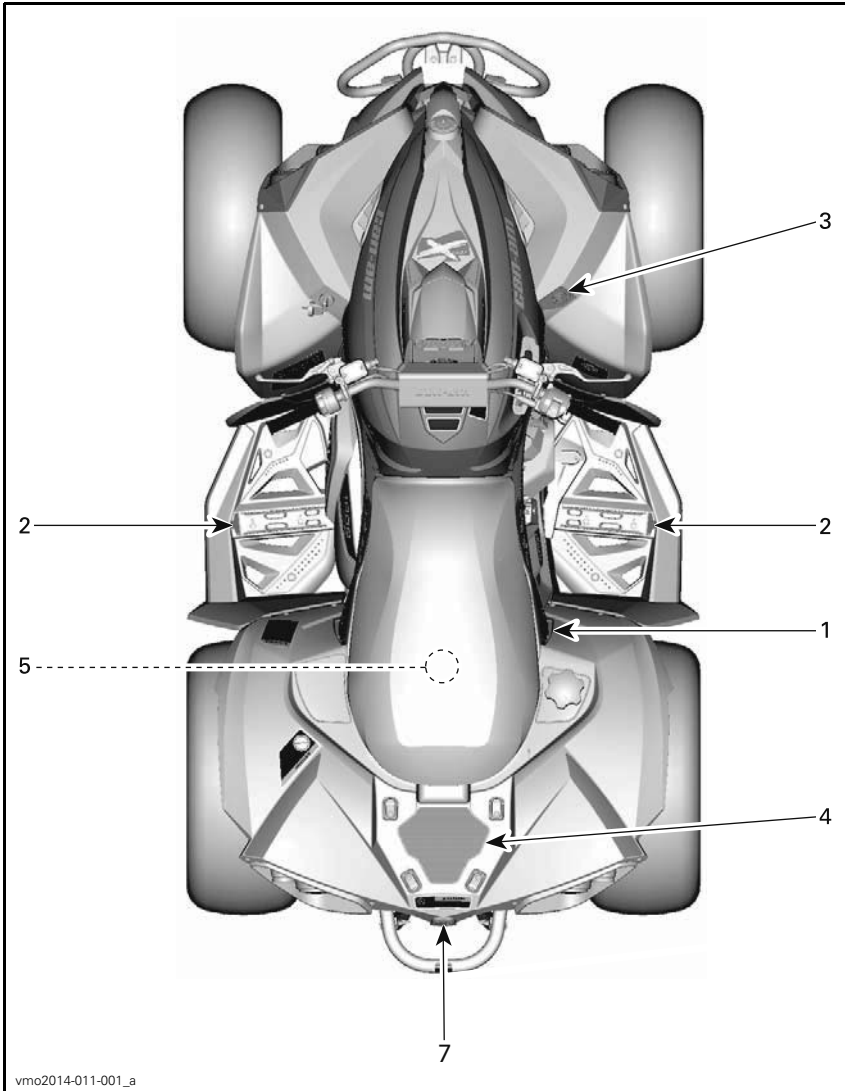

## 1) Operator's Seat

The seat is designed for an operator only.

### **⚠ WARNING**

Never allow anyone to seat as a passenger on this vehicle.

### Seat Removal

To remove the operator's seat, push its latch forward. This latch is located underneath the rear of seat.



1. Seat latch

Pull seat rearward. Continue lifting movement until you can release the front retaining device under the seat from the retaining bar, then completely remove seat.

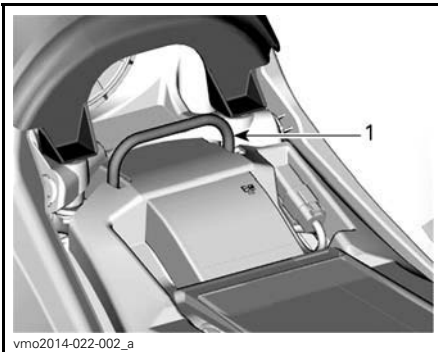

1. Retaining bar

### Seat Installation

Position front end of seat so that the front retaining device under the seat engages with the retaining bar. When seat rests in its position, firmly push seat down to latch.

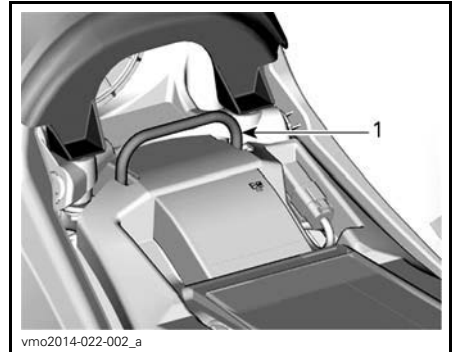

1. Retaining bar

**NOTE:** A distinctive snap will be felt. Double check that the seat is secure by giving it a tug to confirm proper latching.

### **⚠ WARNING**

Confirm that the operator's seat is properly locked in position by pulling back and up several times.

## 2) Footpeg

The footpegs are located on the RH and LH side of the vehicle near engine.



TYPICAL

1. Operator's RH footpeg

## 3) 12-Volt Power Outlet

Convenient for handheld spotlight or other portable equipment.



1. 12V power outlet

Remove protective cap to use. Always reinstall it after use to protect against weather.

Do not exceed the rating capacity. Refer to *SPECIFICATIONS* subsection.

## 4) Rear Cargo Area

Rear cargo area is convenient for carrying small articles.

Secure articles to rear cargo area by using the plastic eyelets provided.

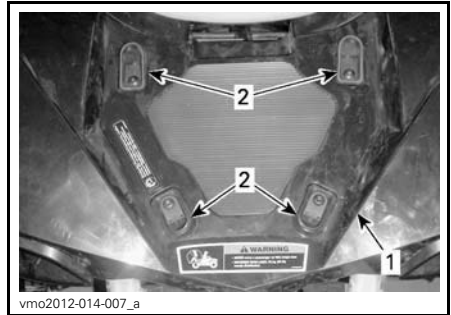

1. Cargo area
2. Plastic eyelets

### **⚠ WARNING**

MAXIMUM load for cargo area is 16 kg (35 lb).

### **⚠ WARNING**

- Never carry a passenger on the rear cargo area.
- Cargo must never interfere with the driver's line of sight or affect his ability to properly steer the vehicle.
- Do not overload the vehicle.
- Always ensure all cargo is properly secured and does not extend out past the rear cargo area.

Refer to *SPECIFICATIONS* subsection for carrying loads and cargo weight distribution recommendations.

## 5) Tool Kit

The tool kit is located under seat. It contains tools for basic maintenance.



## 6) Shift Lever Lock

The shift lever can be locked when the vehicle is parked and left unattended.

To unlock shift lever, turn key clockwise.

To lock shift lever, turn key counter-clockwise.

The vehicle lock is located on the RH side of the vehicle near engine.

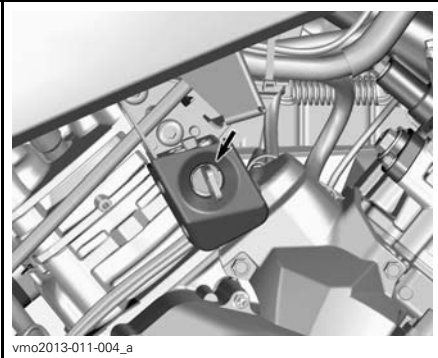

**NOTE:** The vehicle will not be locked if the shift lever is not placed in park position when the mechanism is engaged.

## 7) Recovery Hook

Convenient hook that can be used to recover a stuck ATV.

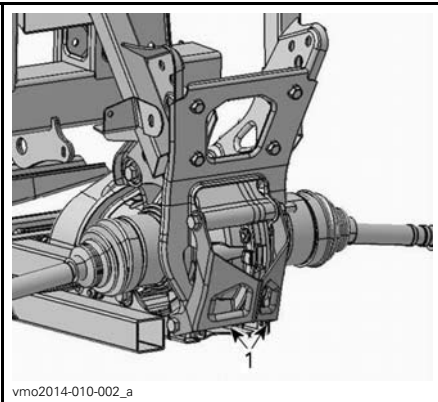

1. Recovery hook

# FUEL

## Fuel Requirements

**NOTICE** Always use fresh gasoline. Gasoline will oxidize; the result is loss of octane, volatile compounds, and the production of gum and varnish deposits which can damage the fuel system.

Alcohol fuel blending varies by country and region. Your vehicle has been designed to operate using the recommended fuels, however, be aware of the following:

- Use of fuel containing alcohol above the percentage specified by government regulations is not recommended and can result in the following problems in the fuel system components:
  - Starting and operating difficulties.
  - Deterioration of rubber or plastic parts.
  - Corrosion of metal parts.
  - Damage to internal engine parts.
- Inspect frequently for the presence of fuel leaks or other fuel system abnormalities if you suspect the presence of alcohol in gasoline exceeds the current government regulations.
- Alcohol blended fuels attract and hold moisture which may lead to fuel phase separation and can result in engine performance problems or engine damage.

## Recommended Fuel

Use common unleaded gasoline with an AKI (R+M)/2 octane rating of 87, or an RON octane rating of 92.

**NOTICE** Never experiment with other fuels. Engine or fuel system damages may occur with the use of an inadequate fuel.

## Vehicle Fueling Procedure

### WARNING

- Fuel is flammable and explosive under certain conditions.
- Never use an open flame to check fuel level.
- Never smoke or allow flame or spark in vicinity.
- Always work in a well-ventilated area.

1. Stop engine.

### WARNING

Always stop engine before refueling.

2. Have operator get off vehicle.

### WARNING

Do not allow anyone to remain on the vehicle while fueling. If there is a fire or explosion during fueling, a vehicle occupant could be unable to quickly leave the area.

3. Slide protective cover away from fuel tank cap lock.
4. Insert key in fuel tank cap lock.
5. Turn key counterclockwise to unlock fuel tank cap.
6. Unscrew slowly the fuel reservoir cap counterclockwise to remove it.

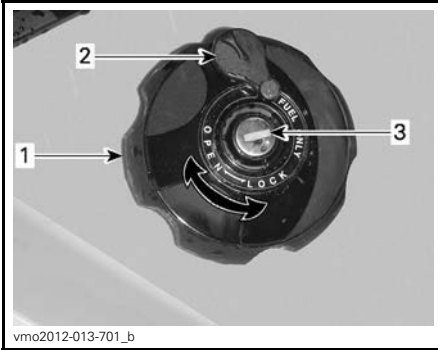
**RH REAR FENDER**

1. Fuel tank cap
2. Protective cover
3. Fuel tank cap lock

### **⚠ WARNING**

If a differential pressure condition is noticed (whistling sound heard when loosening fuel reservoir cap) have vehicle inspected and/or repaired before further operation.

7. Insert the spout into the filler neck.
8. Pour fuel slowly so that air can escape from the tank and prevent fuel flow back. Be careful not to spill fuel.
9. Stop filling when the fuel reaches the bottom of filler neck. **Do not overfill.**

### **⚠ WARNING**

Never top up the fuel tank before placing the vehicle in a warm area. As temperature increases, fuel expands and may overflow.

10. Fully tighten fuel reservoir cap clockwise.
11. Lock fuel tank cap by turning key clockwise.

### **⚠ WARNING**

Always wipe off any fuel spillage from the vehicle.

**NOTICE** Never place anything over fuel tank cap because the vent hole on the top of fuel tank cap can be blocked and the engine could misfire.

---

# BREAK-IN PERIOD

## Operation During Break-In

A break-in period of 300 km (200 mi) or 10 operating hours is required for the vehicle.

After the break-in period, the vehicle should be inspected by an authorized Can-Am dealer.

## Engine

During the break-in period:

- Avoid full throttle operation
- Maximum throttle should not exceed 3/4
- Avoid sustained accelerations
- Avoid prolonged cruising speeds
- Avoid engine overheating.

However, brief accelerations and speed variations contribute to a good break-in.

**NOTE:** It is normal that the engine will not operate at its maximum efficiency until the break-in period is completed.

## Brakes

### **WARNING**

New brakes will not operate at their maximum efficiency until their break-in is completed. Use extra caution.

## Belt

A new belt requires a break in period of 50 km (30 mi).

During the break-in period:

- Avoid strong acceleration and deceleration
- Avoid pulling a load
- Avoid high speed cruising.

---

# BASIC PROCEDURES

## Starting the Engine

The shift lever must be set to PARK or NEUTRAL.

**NOTE:** For your convenience, an over-ride mode allows the engine to be started with the shift lever in any position. Press and hold the brake lever or the brake pedal while pressing the engine start button.

Insert key in ignition switch and turn to ON position.

Set the emergency engine stop switch to RUN.

Press the engine start button and hold until the engine starts.

Release the engine start button immediately when the engine has started.

**NOTICE** If engine does not start after a few seconds, do not hold the engine start button more than 10 seconds. Refer to TROUBLESHOOTING section.

## Shifting the Transmission

Apply brakes and immobilize vehicle, then select the desired shift lever position.

Release brakes.

**NOTICE** When changing gear selection, always completely stop the vehicle and apply the brakes prior to moving the shift lever. Damage to the transmission may occur.

Gradually press the throttle lever to increase engine speed and thus engaging the continuously variable transmission (CVT).

At the opposite, when the throttle lever is released, the engine speed decreases.

## Stopping the Engine and Parking the Vehicle

### WARNING

Avoid parking on steep slope as the vehicle may roll away.

### WARNING

Always put the vehicle in PARK when stopped or parked to prevent rolling.

### WARNING

Avoid parking in places where hot parts can start a fire.

When stopped or parked always bring shift lever to park position. This is especially important when parking on a slope. On very steep inclines or if the vehicle is carrying a cargo, the wheels should be blocked using rocks or bricks.

Select the flattest terrain available for parking.

Release accelerator pedal and use brakes to completely stop the vehicle.

Set shift lever in PARK position.

Turn key in ignition switch to OFF position.

Remove key from ignition switch.

If you must park on a steep incline or if the vehicle is carrying cargo, block the wheels using rocks or bricks.

## SPECIAL PROCEDURES

### What to Do if Water is in the CVT

Remove the CVT drain plug located on the rear portion of the CVT cover. It is accessible from the rear LH fender.

Inspect the CVT drain plug to validate if water is present.

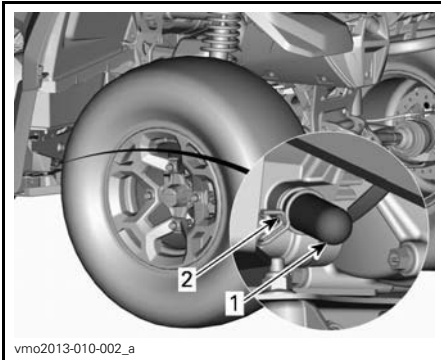

1. Drain plug
2. Spring clamp

**NOTICE** If water is present in the CVT, it could result in belt slippage. The engine will accelerate but the vehicle will remain still.

If water is present, remove CVT drain plug to expel water.

**NOTICE** See an authorized Can-Am dealer to have the CVT inspected and cleaned.

Reinstall the drain plug and secure it using the spring clamp.

**NOTE:** Make sure hose is properly inserted on CVT cover nipple.

### What to Do if Water is in the Air Filter Housing

Remove the LH side panel.

Inspect the drain reservoir underneath the air filter housing to validate if water is present.

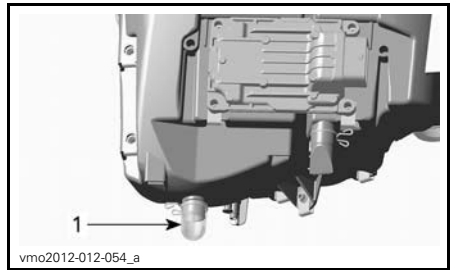

#### TYPICAL

1. Air filter housing drain reservoir

If water is present, press clamp and remove reservoir to drain water from air filter housing.

If one of the following conditions is met, bring the vehicle to your nearest authorized Can-Am dealer to have the vehicle serviced:

- If more than 50 ml (2 U.S. oz) of water (approximately 5 drain reservoirs) is found in the air filter housing.
- If any deposits are present in the drain reservoir.

In such a case, the vehicle must be serviced for:

- Vents
- CVT air filter cleaning
- CVT cleaning
- Fuel tank breather replacement
- Lubricant inspection and replacement as required (engine, gearbox and rear final drive).

**NOTICE** Failure to have vehicle serviced may lead to permanent damage to the following components but not limited to:

- Engine and gearbox
- Fuel pump
- CVT
- Front differential
- Rear final drive.

## What to Do if Vehicle is Turned Over

When vehicle is turned over or stays tilted on the side, put the vehicle back on its wheels. Inspect vehicle for damages.

### WARNING

Never operate the vehicle if damaged. Refer to an authorized Can-Am dealer.

If vehicle has no damage, refer to *MAINTENANCE* section and inspect the following.

- Inspect air filter housing for oil accumulation, if any oil is found, clean air filter and air filter housing.
- Check engine oil level and refill if necessary.
- Check engine coolant level and refill if necessary.
- Check gearbox oil level and refill if necessary.
- Check rear final drive oil level and refill if necessary.
- Start engine. If the oil pressure light stays on, stop engine immediately. See an authorized Can-Am dealer.

Whenever the vehicle is turned over, it should be inspected by an authorized Can-Am dealer.

## What to Do if Vehicle is Immersed in Water

Should the vehicle become immersed, immediately stop the engine. Do not use any electrical equipment while vehicle is immersed.

It will be necessary to take the vehicle to an authorized Can-Am dealer as soon as possible. **NEVER ATTEMPT TO START THE ENGINE!**

**NOTICE** Immersion of the vehicle can cause serious damage if the correct restart procedure is not followed.

As soon as vehicle is pulled out of water, carry out the following:

- Drain CVT. See procedure in this subsection.

**NOTICE** The vehicle should be serviced as soon as possible by an authorized Can-Am dealer.

# TUNE YOUR RIDE

## **⚠ WARNING**

Suspension adjustment could affect vehicle handling. Always take time to familiarize yourself with the vehicle's behavior after any suspension adjustment have been made.

## **Suspension Adjustment**

Suspension adjustment and loading can have an effect on your vehicle handling and comfort.

Choice of suspension adjustments vary with driver's weight, personal preference, riding speed and field condition.

Perform adjustments one position (click) at a time. Test run the vehicle under the same conditions; trail, speed, driver riding position, etc. Proceed methodically until you are satisfied.

## **Spring Preload Adjustment**

## **⚠ WARNING**

The left and right shock adjustment on front or rear suspension must always be set to the same position. Never adjust one only. Uneven adjustment can cause poor handling and loss of stability, which could lead to an accident.

Shorten the springs for a firmer ride and rough conditions.

Lengthen the springs for a softer ride and smooth conditions.

### **All Models Except Xxc**

Adjust spring preload by turning adjustment cam. Use tool from vehicle tool kit.

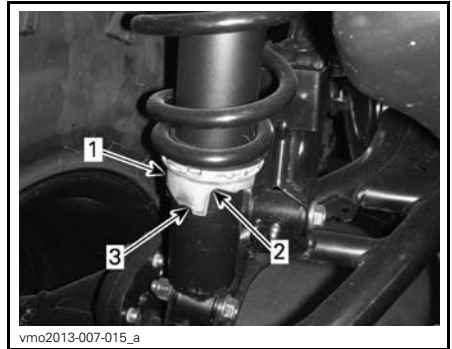

1. Adjustment cam
2. Softer adjustment
3. Firmer adjustment

## **Xxc Models**

Use tool provided in tool kit to adjust spring preload.

Adjust spring preload by turning the adjuster ring.

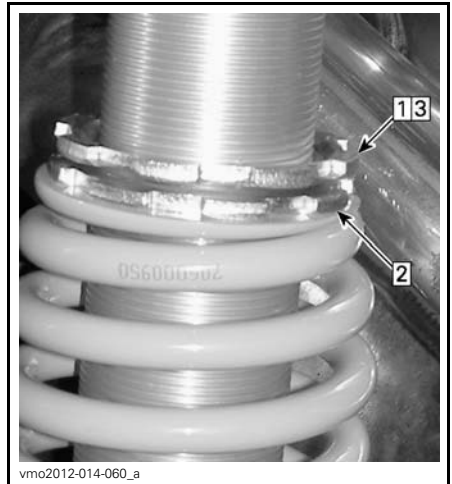

### **TYPICAL**

- Step 1: Loosen top locking ring
- Step 2: Turn adjusting ring accordingly
- Step 3: Tighten top locking ring



## Shock Damping Adjustments (X xc Models)

### Low Speed Compression Damping

Low speed compression damping controls how the shock absorber reacts to a low suspension velocity (slow compression strokes, in most cases when riding at lower speeds).

ACTION	RESULT ON BIG BUMPS
Increasing low speed compression damping force	Firmer compression damping (slow compression)
Decreasing low speed compression damping force	Softer compression damping (slow compression)



### LOW SPEED COMPRESSION DAMPING (USE A SCREWDRIVER)

1. Adjustment screw
2. Increases damping (stiffer)
3. Decreases damping (softer)

Turn adjuster clockwise (H) to **increase** shock damping action (stiffer).

Turn adjuster counterclockwise (S) to **decrease** shock damping action (softer).

### High Speed Compression Damping

High speed compression damping controls how the shock absorber reacts to a high suspension velocity (quick compression strokes, in most cases when riding at higher speeds).

ACTION	RESULT ON SMALL BUMPS
Increasing high speed compression damping force	Firmer compression damping (fast compression)
Decreasing high speed compression damping force	Softer compression damping (fast compression)



### HIGH SPEED COMPRESSION DAMPING (USE A 17 MM WRENCH)

1. Adjustment screw
2. Increases damping (stiffer)
3. Decreases damping (softer)

Turn adjuster clockwise (H) to **increase** shock damping action (stiffer).

Turn adjuster counterclockwise (S) to **decrease** shock damping action (softer).

### Rebound Damping

Rebound damping controls the rate at which the shock absorber returns after it has been compressed.

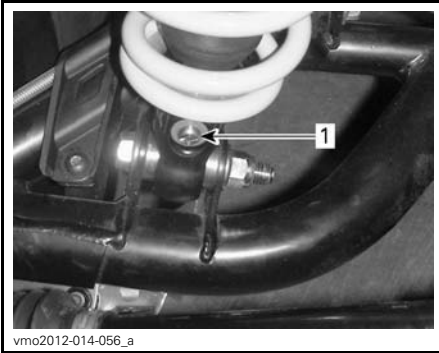

1. Rebound adjuster (screwdriver required)

Turn adjuster clockwise (H) to **increase** shock damping action (stiffer).

Turn adjuster counterclockwise (S) to **decrease** shock damping action (softer).

### Steering Assist Adjustment (DPS) (X xc Models)

The following DPS modes are preset in the vehicle.

DPS MODE	
DPS MAX.	Maximum steering assist
DPS MED.	Medium steering assist
DPS MIN.	Minimum steering assist

To show the active DPS mode, proceed as follows:

1. Press and release **DPS** button.

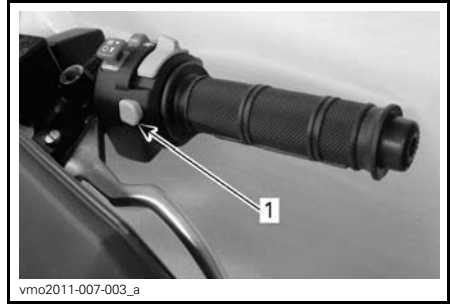

vmo2011-007-003\_a

**TYPICAL**

1. Override/DPS button

2. Check the multifunction gauge to confirm the current DPS mode.

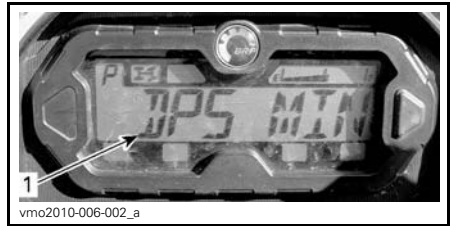

vmo2010-006-002\_a

1. DPS mode display

To change the DPS mode, proceed as follows:

1. Press and hold **DPS** button for 2 seconds to go to the next setting.
2. Release **DPS** button.
3. Repeat until desired setting is selected.

**NOTE:** The DPS assist adjustment is not available in reverse.

While reading this Operator's Guide, remember that:

## ⚠ WARNING

Indicates a potential hazard that, if not avoided, could result in serious injury or death.

# VEHICLE TRANSPORTATION

When transporting this vehicle, secure it to a trailer or in pickup box with suitable tie-downs. Use of ordinary ropes is not recommended.

**⚠ WARNING**

Do not tow this vehicle behind a car or other vehicle. Use a trailer. Never tip this vehicle on end for transporting. The vehicle must be in its normal operating position (on all four wheels).

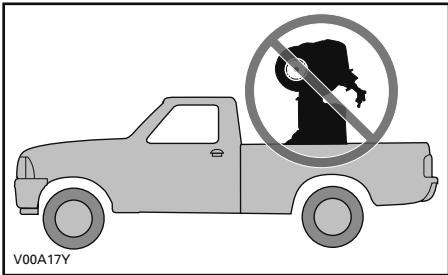

Remember to:

- Unload vehicle racks before transportation.
- Set shift lever to PARK position.
- Set the brake lock.
- Secure the vehicle by the front bumper and rear bumper.



TYPICAL - REAR TIE-DOWN POINT LOCATION

**NOTICE** Securing vehicle at other locations may damage the vehicle.



TYPICAL - FRONT TIE-DOWN POINT LOCATION

***This page is  
intentionally blank***

# ***MAINTENANCE***

---

## **BREAK-IN INSPECTION**

BRP suggests that after 300 km (200 mi) or the first 10 hours of operation, whichever comes first, your vehicle be inspected by an authorized Can-Am dealer. The break-in inspection is very important and must not be neglected.

**NOTE:** The break-in inspection is at the expense of the vehicle owner.

We recommend that this inspection be signed by an authorized Can-Am dealer.

---

Date of inspection

---

Authorized dealer signature

---

Dealer name

BREAK-IN INSPECTION
Change engine oil and filter
Check engine mounting fasteners
Check valve clearance and adjust as required
Check coolant level
Clean radiator and carry out a cooling system leak test
Inspect engine seals and gaskets for leaks
Inspect fuel lines, fuel rails, connections, check valves and carry out a fuel system leak test
Inspect throttle cable and adjust as required
Inspect exhaust system and check for leaks
Inspect engine air filter
Inspect/clean CVT inlet/outlet
Inspect CVT air filter
Inspect battery connections
Replace gearbox oil
Clean vehicle speed sensor
Check operation of 4 x 4 coupling unit
Inspect front differential and rear final drive (oil level, seals and vents)
Inspect rear propeller shaft joints
Check brake fluid level
Inspect steering system for abnormal play or damage
Check front wheel alignment
Inspect wheel nuts/studs

# MAINTENANCE SCHEDULE

Maintenance is very important for keeping your vehicle in safe operating condition. Proper maintenance is the owner's responsibility. The vehicle should be serviced as per the maintenance schedule.

The maintenance schedule does not exempt the pre-ride inspection.

## WARNING

Failure to properly maintain the vehicle according to the maintenance schedule and procedures can make it unsafe to operate.

### EVERY 750 KM (500 MI) OR 25 HOURS OF OPERATION (WHICHEVER COMES FIRST)

For dusty conditions: inspect and clean (or replace if necessary) engine air filter and oil foam filter. Service more often if required in severe dusty conditions

For dusty conditions: inspect and clean CVT air filter. Service more often if required in severe dusty conditions

Check brake fluid level

Inspect brake pads

Tighten wheel lug nuts

Inspect the drive shaft boots and protectors

Inspect hitch condition (if applicable)

Inspect seat latch operation

Inspect rear cargo compartment latch operation

### EVERY 1 500 KM (1,000 MI) OR 50 HOURS OF OPERATION (WHICHEVER COMES FIRST)

Inspect, adjust and lubricate throttle cable

Replace engine air filter (normal riding condition)

Inspect and clean CVT air filter (normal riding conditions)

Check battery condition

Inspect front differential/rear final drive oil level

Inspect drive shaft joint condition

Inspect front/rear propeller shaft joint condition

Grease rear propeller shaft joints

Inspect tie rod ends and ball joints

Inspect shock absorbers



**EVERY 1 500 KM (1,000 MI) OR 50 HOURS OF OPERATION  
(WHICHEVER COMES FIRST)**

Lubricate shock absorber spherical bearings

Inspect and lubricate front suspension arms

Inspect and lubricate rear anti sway bar bushings

**EVERY 3 000 KM (2,000 MI) OR 100 HOURS OF OPERATION  
OR 1 YEAR (WHICHEVER COMES FIRST)**

Replace engine oil and filter

Inspect and adjust valve clearance

Inspect and clean muffler spark arrester

Check engine coolant strength

Inspect and clean throttle body

Clean the fuel pump pre-filter

Carry out a fuel pump pressure test

Replace fuel vent breather filter

Inspect drive belt

Inspect, clean and lubricate drive and driven pulleys (including one-way bearing)

Check gearbox oil level and condition

Inspect wheel bearings

Inspect steering system (check for abnormal play)

Clean and lubricate lower and upper steering column half bushings (severe muddy conditions)

Inspect and clean brake system

Inspect frame for any damage

Replace rear final drive oil

**EVERY 6 000 KM (4,000 MI) OR 200 HOURS OF OPERATION  
OR 2 YEARS (WHICHEVER COMES FIRST)**

Replace the engine coolant

Check cooling system and perform a pressure test on pressure cap and cooling system

Check fuel system condition and perform a fuel system leak test

Replace spark plugs

Replace front differential oil

Clean and lubricate lower and upper steering column half bushings (normal riding conditions)

Replace gearbox oil

Clean vehicle speed sensor

Replace the brake fluid

# MAINTENANCE PROCEDURES

This section includes instructions for basic maintenance procedures. If you have the necessary mechanical skills and the required tools, you can perform these procedures. If not, see your authorized Can-Am dealer.

Other important items in the maintenance schedule that are more difficult and require in-depth technical knowledge or special tools are best performed by your authorized Can-Am dealer.

## **⚠ WARNING**

Unless otherwise indicated, always turn ignition switch to OFF position and remove key before performing any maintenance.

## **⚠ WARNING**

Should removal of a locking device be required (e.g. lock tab, self-locking fastener, etc.), always replace it with a new one.

## Air Filter

### Air Filter Maintenance Guideline

As with any ATV, air filter maintenance is critical to ensure proper engine performance and life span.

Air filter maintenance should be adjusted according to riding conditions.

Air filter maintenance must be increased in frequency and oil must be added to the foam filter for the following dusty conditions:

- Riding on dry sand
- Riding on dry dirt covered surfaces
- Riding on dry gravel trails or similar conditions.

**NOTE:** Riding in a group in these conditions would increase even more the air filter maintenance. Refer to *AIR FILTER CLEANING AND OILING* in this subsection for maintenance procedure.

## Engine Air Filter Removal

**NOTICE** Never remove or modify any component in the air filter housing. Otherwise, engine performance degradation or damage can occur. The engine is calibrated to operate specifically with these components.

1. Remove seat.
2. Lift the front part of the central panel.

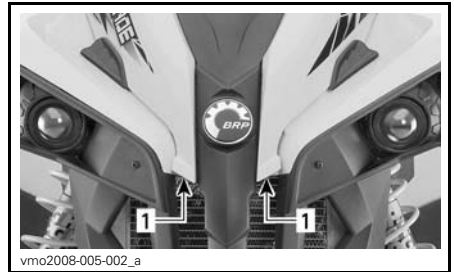

**TYPICAL**

1. Lift here

3. Remove console.

- 3.1 Lift rear portion of console upwards until the studs are released from the grommets.

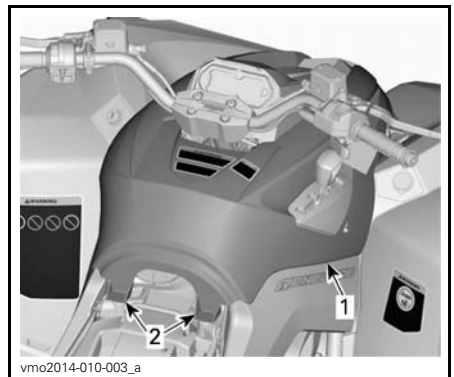

**TYPICAL**

1. Console
2. Studs and grommets

- 3.2 Pull console rearwards.

4. Rotate air filter cover counterclockwise to remove it.

**NOTE:** A socket wrench may be used to remove the filter cover.



1. Air filter cover

5. Remove air filter.



### AIR FILTER REMOVAL

### Engine Air Filter Housing Inspection and Draining

1. Remove LH side panel.
2. Drain air filter housing inlet drain tube.

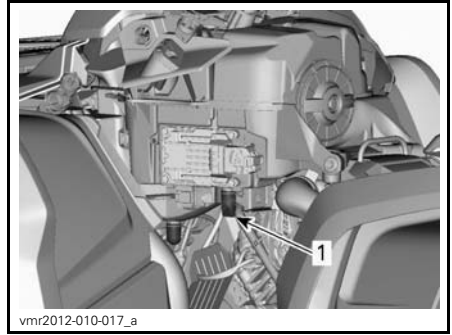

**TYPICAL - SOME PARTS REMOVED FOR CLARITY**

1. Air filter housing inlet drain tube

3. Check air filter dirty chamber for cleanliness.

- If any debris or water are found, clean air filter chamber using a vacuum cleaner.

**NOTICE** Do not blow compressed air into air filter chamber.

4. Check air filter drain tube (clean chamber).

- If any debris or water are found, refer to *SPECIAL PROCEDURES* subsection.
- Investigate for contamination source.

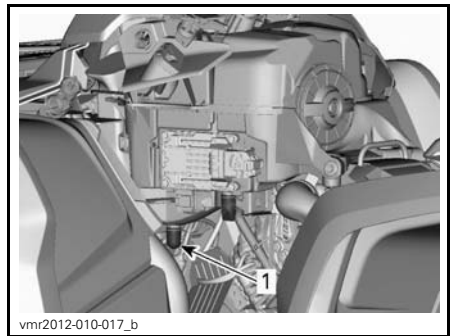

**TYPICAL - SOME PARTS REMOVED FOR CLARITY**

1. Air filter drain tube

## Air Filter Cleaning and Oiling

### Paper Filter Cleaning

1. Remove the foam filter from paper filter.
2. Tap out heavy dust from the paper filter.

This will allow dirt and dust to get out of the paper filter.

**NOTE:** Paper filter have a limited life span; replace filter if too dirty or clogged.

**NOTICE** It is not recommended to blow compressed air on the paper filter; this could damage the paper fibers and reduce its filtration ability when used in dusty environments.

**NOTICE** Do not wash the paper filter with any cleaning solution.

### Foam Filter Cleaning

**⚠ CAUTION** Always wear appropriate skin and eye protection. Chemicals can cause a skin rash and eye injury.

1. Spray the foam filter inside and out with AIR FILTER CLEANER (P/N 219 700 341).



219700341

AIR FILTER CLEANER (P/N 219 700 341)



vbs2009-012-015\_a

TYPICAL - SPRAY THE FOAM FILTER

2. Let stand for 3 minutes.
3. As stated on air filter cleaner (UNI) container, rinse with plain water.
4. Dry the foam filter completely.

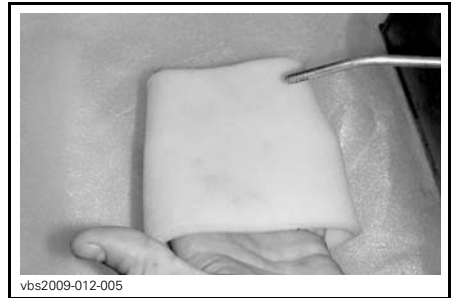

vbs2009-012-005

TYPICAL - DRY

**NOTE:** A second application may be necessary for heavily soiled elements.

### Foam Filter Oiling

1. Spray AIR FILTER OIL (P/N 219 700 340) on the foam filter.



219700340

AIR FILTER OIL (P/N 219 700 340)



vbs2009-012-014

TYPICAL - OIL THE FOAM FILTER

2. Let stand for 3 to 5 minutes.
3. Remove any excess of oil that could transfer to the paper filter by wrapping the foam filter into an absorbent cloth and squeezing gently. This will also ensure a full oil coverage on foam filter.

### Air Filter Installation

Reinstall oiled foam filter on paper air filter.

Slightly grease O-ring seal and plastic body of air filter.

Install air filter as the reverse of removal.

Ensure air filter cover is properly locked onto the air filter housing. See indications on filter cover and housing.

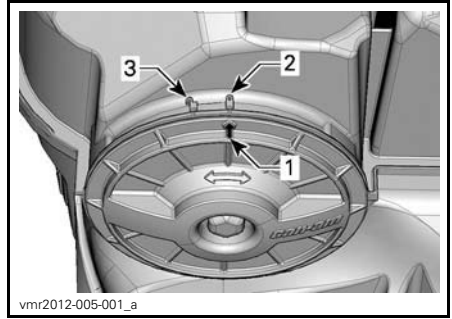

vmr2012-005-001\_a

1. Cover position arrow
2. Locked
3. Unlocked

Install console as the reverse of removal. However, pay attention to the following.

Align and insert studs with grommets on rear portion of console until studs engage with grommets.

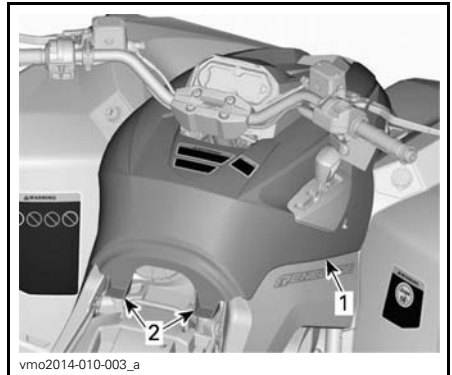

vmo2014-010-003\_a

- TYPICAL
1. Console
  2. Studs and grommets

## Engine Oil

### Engine Oil Level

**NOTICE** Check level frequently and refill if necessary. **Do not overfill.** Operating the engine/gearbox with an improper level may severely damage engine/gearbox. Wipe off any spillage.

**NOTE:** While checking the oil level, visually inspect engine area for leaks.

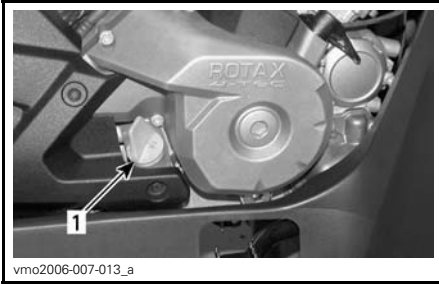

TYPICAL - RH SIDE OF ENGINE

1. Dipstick

With vehicle on a level surface and engine cold, not running, check the oil level as follows:

1. Unscrew dipstick then remove it and wipe clean.
2. Reinstall dipstick, screw in it completely.
3. Remove and check oil level. It should be near or equal to the upper mark.

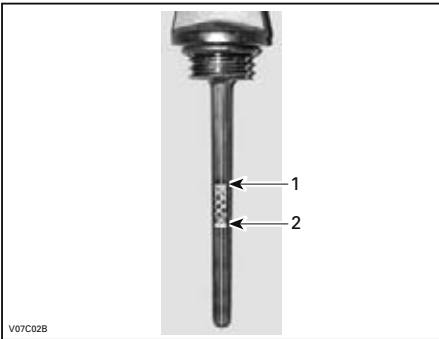

TYPICAL

1. Full
2. Add

To add oil, remove dipstick. Place a funnel into the dipstick tube to avoid spillage.

Add a small amount of recommended oil and recheck oil level.

Repeat the above procedures until oil level reaches the dipstick's upper mark. **Do not overfill.**

Properly tighten dipstick.

## Recommended Engine Oil

For the summer season, use XPS 4-STROKE SYNTH. BLEND OIL (SUMMER) (P/N 293 600 121).

For all season, use XPS 4-STROKE SYNTHETIC OIL (ALL CLIMATE) (P/N 293 600 112).

**NOTE:** The XPS oil is specially formulated and tested for the severe requirements of this engine.

If not available, use 4-stroke SAE 5W40 engine oil that meets or exceeds the requirements for API service classification SG, SH or SJ. Always check the API service label certification on the oil container it must contain at least one of the above standards. Refer to the viscosity chart for details.

## Engine Oil Change

Start and warm-up engine. Stop engine.

Ensure vehicle is on a level surface.

Remove dipstick.

Clean the oil drain plug area.

Place a drain pan under the oil drain plug area.

Unscrew oil drain plug.

**! CAUTION** The engine oil can be very hot. In order to avoid potential burns, do not remove the engine drain plug if the engine is hot. Wait until engine oil is warm.

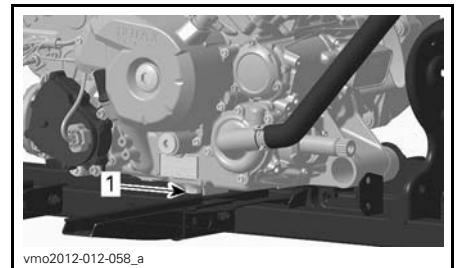

1. Drain plug

Allow enough time for oil to flow out of oil filter.

Replace the oil filter. Refer to *OIL FILTER* in this subsection.

Change gasket on oil drain plug.

Clean gasket area on engine and oil drain plug then reinstall plug.

Refill engine at the proper level with the recommended oil.

Refer to *SPECIFICATIONS* subsection for oil capacity.

Start engine and let idle for a few minutes.

Ensure oil filter area and oil drain plug areas are not leaking.

Stop engine.

Wait a while to allow oil to flow down to crankcase then check oil level.

Refill as necessary.

Dispose of oil as per your local environmental regulations.

## Oil Filter

### Oil Filter Replacement

Remove the right engine cover.

Unscrew the oil filter cover.

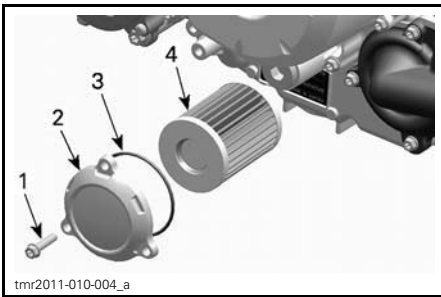

1. Oil filter screw
2. Oil filter cover
3. O-ring
4. Oil filter

Remove the oil filter and replace with a new filter.

Check the cover O-ring and change it if necessary.

Screw oil filter cover in place.

Wipe out any oil spillage on engine.

## Radiator

### Radiator Inspection

Periodically check the radiator area for cleanliness.



TYPICAL

Inspect radiator and hoses for leaks or any damage.

Inspect radiating fins. They must be clean, free of mud, dirt, leaves and any other deposit that would prevent the radiator to cool properly.

Remove as much deposits as you can with your hands. If water is available in proximity, try rinsing the radiating fins.

If available, use a garden hose to rinse the radiating fins.

**⚠ CAUTION** Never clean radiator with your hands when it is hot. Let the radiator cool down before cleaning.



**NOTICE** Be careful not to damage the radiating fins when cleaning. Do not use any object/tool that could damage the fins. The fins are purposely thin parts to allow efficient cooling. **WHEN RINSING, USE LOW PRESSURE ONLY, NEVER USE A HIGH PRESSURE WASHER.**

See an authorized Can-Am dealer to check the performance of the cooling system.

## Engine Coolant

### Engine Coolant Level Verification

#### **⚠ WARNING**

Check coolant level with engine cold. Never add coolant in cooling system when engine is hot.

1. Place vehicle on a level surface.
2. Remove seat.
3. Lift the front part of the central panel.

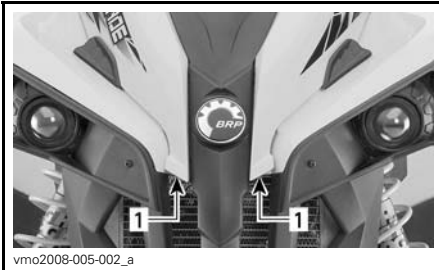

**TYPICAL**

1. Lift here

4. Remove console.
  - 4.1 Lift rear portion of console upwards until the studs are released from the grommets.

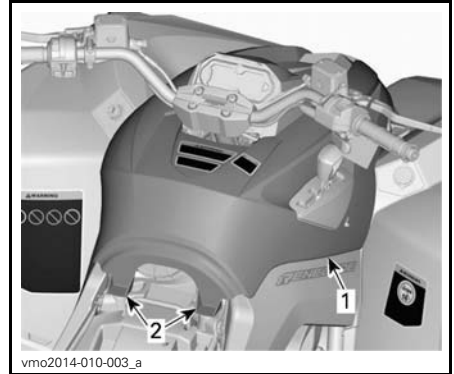

**TYPICAL**

1. Console
2. Studs and grommets

- 4.2 Pull console rearwards.

5. With vehicle on a level surface, liquid should be between MIN. and MAX. level marks of coolant reservoir.



1. Engine coolant reservoir

**NOTE:** When checking level at temperature lower than 20°C (68°F), it may be slightly lower than MIN. mark.

6. Add coolant up to MAX. mark if required.

#### **⚠ WARNING**

Do not remove the coolant reservoir cap if engine is hot.

7. Use a funnel to avoid spillage. Do not overfill.

- Properly reinstall and tighten reservoir cap.

**⚠ WARNING**

In order to avoid potential burns, do not remove the radiator cap if the engine is hot.

**NOTE:** A cooling system that frequently requires coolant is the indication of leaks or engine problems. See an authorized Can-Am dealer.

- Install console as the reverse of removal. However, pay attention to the following.
- Align and insert studs with grommets on rear portion of console until studs engage with grommets.

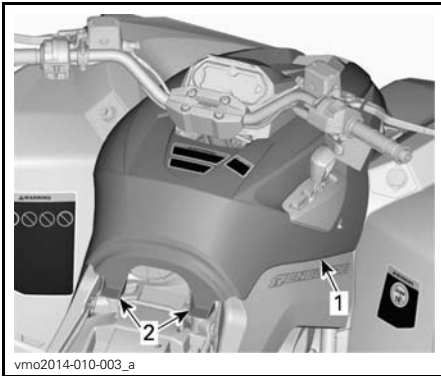

**TYPICAL**

- Console
- Studs and grommets

- Reinstall the seat.

**Recommended Engine Coolant**

Always use ethylene-glycol antifreeze containing corrosion inhibitors specifically for internal combustion aluminum engines.

Cooling system must be filled with BRP PREMIXED COOLANT (P/N 219 700 362) or with distilled water and antifreeze solution (50% distilled water, 50% antifreeze).

**Engine Coolant Replacement**

**Cooling System Draining**

Remove the console. Refer to *ENGINE COOLANT LEVEL VERIFICATION*.

Remove the coolant reservoir cap.

**⚠ WARNING**

To avoid potential burns, do not remove the pressure cap if the engine is hot.



1. Engine coolant reservoir cap

Unscrew the coolant drain plug and drain the coolant into a suitable container.

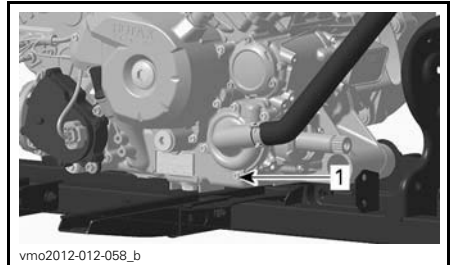

1. Coolant drain plug

**NOTE:** Do not unscrew the coolant drain plug completely.

**500/800R Models**

Disconnect the lower radiator hose and drain the remaining coolant into a suitable container.

**NOTE:** Take note of hose clamp position on the lower radiator hose.

Reinstall radiator hose as noted prior to removal.

**All Models**

Reinstall cooling system drain plug with a new sealing ring.

Tighten the coolant drain plug.

<b>COOLING SYSTEM DRAIN PLUG TORQUE</b>
9 N•m to 11 N•m (80 lbf•in to 97 lbf•in)

Bleed cooling system, refer to *COOLING SYSTEM BLEEDING*.

**Cooling System Bleeding**

1. Unscrew bleed screws on both front and rear cylinders.

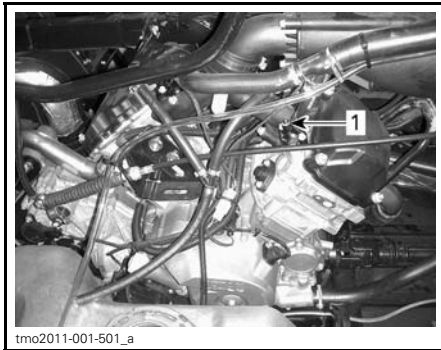

**TYPICAL**

1. Front cylinder bleed screw

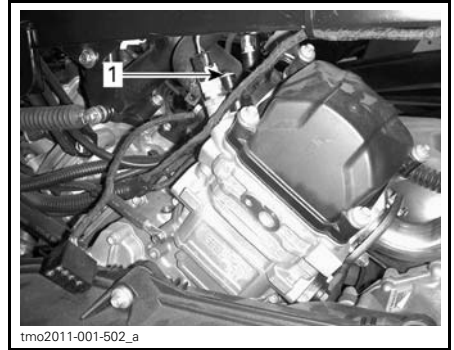

**TYPICAL**

1. Rear cylinder bleed screw

2. Remove the pressure cap.
3. Fill the cooling system until coolant comes out of the bleed screw(s).
4. Install the bleed screws using **NEW** gasket rings and torque as per following chart.

<b>TIGHTENING TORQUE</b>	
Gasket ring	4.4 N•m to 5.6 N•m (39 lbf•in to 50 lbf•in)

5. Add coolant until system is full up to the pressure cap seat.
6. Start engine.

**NOTE:** Do not install pressure cap.

7. Run engine at idle until coolant fan turns ON.

**NOTE:** Monitor coolant level during engine warm-up and add coolant as required.

8. Depress the throttle lever two or three times; check coolant level.
9. Stop the engine and let it cool down.
10. Inspect cooling system for leaks
11. Check coolant level in the reservoir. Add coolant as required .
12. Install pressure cap.
13. Reinstall the console. Refer to *ENGINE COOLANT LEVEL VERIFICATION*.

## Muffler Spark Arrester

### Muffler Spark Arrester Cleaning and Inspection

NOTE: Spark arrester screen replacement is required only when damaged.

**CAUTION** Let exhaust system cool down before proceeding with cleaning and inspection.

Remove and discard the tail pipe retaining screws.

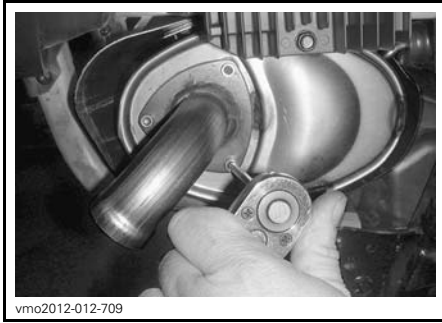

*TYPICAL - REMOVE TAIL PIPE*

Remove exhaust tail pipe, gasket (discard) and spark arrester.

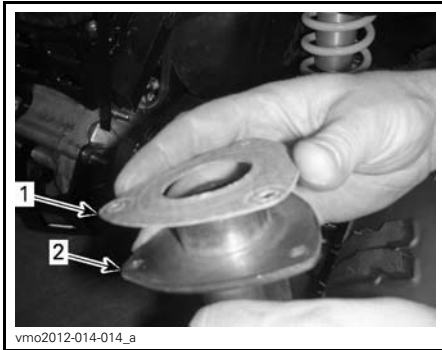

*TYPICAL*

1. Gasket
2. Exhaust tail pipe

Remove carbon deposits from the spark arrester using a brush.

**NOTICE** Use a soft brush and be careful to avoid damaging spark arrester mesh.

**CAUTION** Wear eye protection and gloves.

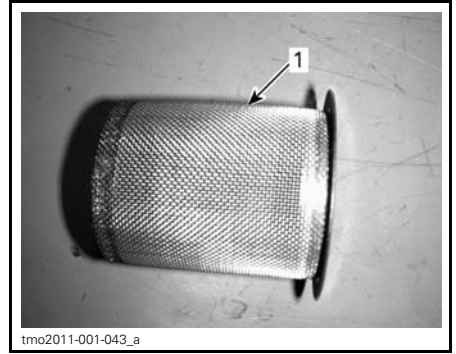

1. Clean spark arrester

Inspect mesh of spark arrester for any damage. Replace as required.

Inspect spark arrester chamber in muffler. Clean any debris as required.

Install new gasket, tail pipe and new retaining screws.

Reinstall muffler cover with new retaining screws. Tighten to specification.

TIGHTENING TORQUE	
Tail pipe retaining screws	11 N•m ± 1 N•m (97 lbf•in ± 9 lbf•in)
Cover retaining screws	11 N•m ± 1 N•m (97 lbf•in ± 9 lbf•in)

## CVT Air Filter (800R/1000)

### CVT Air Filter Removal

1. Remove gauge support.
2. Remove air filter from CVT air inlet by stretching its sides.



1. CVT air filter

### CVT Air Filter Cleaning

1. Spray filter inside and out with AIR FILTER CLEANER (P/N 219 700 341).



AIR FILTER CLEANER (P/N 219 700 341)

2. Let stand for 3 minutes.

While reading this Operator's Guide, remember that:

### **WARNING**

Indicates a potential hazard that, if not avoided, could result in serious injury or death.

3. As stated on air filter cleaner (UNI) container, rinse filter with plain water.
4. Dry filter completely.

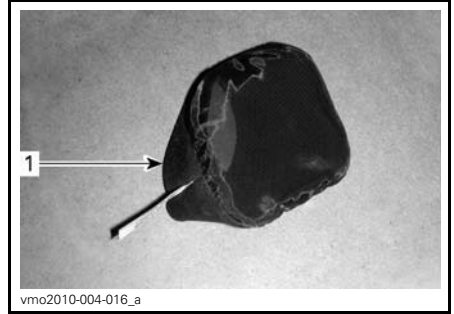

1. CVT air filter

5. Clean inside the CVT air inlet end

### CVT Air Filter Installation

1. Install air filter on CVT inlet by stretching its sides.
2. Reinstall gauge support.

## Gearbox Oil

### Gearbox Oil Level Verification

**NOTICE** Check level and refill if necessary. **Do not overfill.** Operating the gearbox with an improper level may severely damage gearbox. Wipe off any spillage.

Place the vehicle on a level surface.

Select NEUTRAL position.

Apply brake lock.

Check the gearbox oil level by removing the gearbox oil level plug.

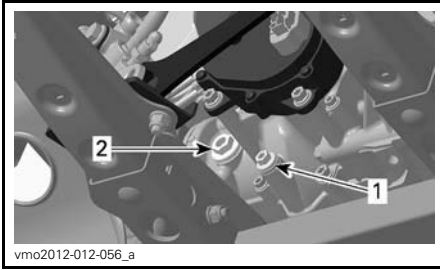

TYPICAL - 800R ENGINE

1. Drain plug
2. Oil level plug

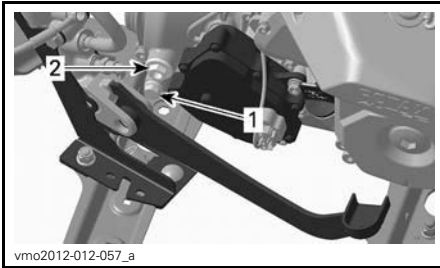

TYPICAL - 1000 ENGINE

1. Drain plug
2. Oil level plug

## Gearbox Oil Change

**NOTE:** When replacing the gearbox oil, it is recommended to clean the vehicle speed sensor (VSS) at the same time.

Place the vehicle on a level surface.

Clean drain plug area.

Clean the oil level plug area.

Under the vehicle, place a drain pan underneath the oil drain plug area.

Remove the oil level plug.

Remove the gearbox drain plug.

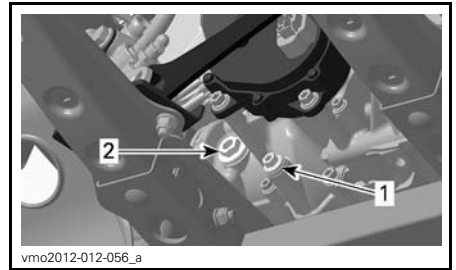

TYPICAL - 800R ENGINE

1. Drain plug
2. Oil level plug

The oil should be level with the bottom of the oil level hole.

Refill as required until gearbox oil level flows through oil level hole.

## Recommended Gearbox Oil

ENGINE	RECOMMENDED PRODUCT	QUANTITY
500 800R	XPS SYNTHETIC GEAR OIL (75W 140) (P/N 293 600 140)	Approximately 400 ml (13.53 U.S. oz)
1000		Approximately 450 ml (15.22 U.S. oz)

If the recommended oil is not available, use a 75W 140 gearbox oil that meets the API GL-5 specification.

**NOTICE** Do not use another types of oil when servicing. Do not mix with other types of oil.

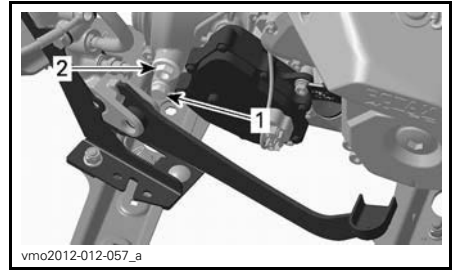

TYPICAL - 1000 ENGINE

1. Drain plug
2. Oil level plug

Let oil completely drain from gearbox.

Install the drain plug.

**NOTE:** Clean drain plug from any metallic particles prior to installation.

Refill gearbox.

**NOTICE** Use ONLY the recommended type of oil.

The oil should be level with the bottom of the oil level orifice.

**NOTICE** Do not overfill.

Reinstall oil level plug.

Wipe off any spillage.

## Throttle Cable

### Throttle Cable Lubrication

The throttle cable must be lubricated with CABLE LUBRICANT (P/N 293 600 041) or an equivalent.

### **⚠ WARNING**

Always use a silicone-based lubricant. Using another lubricant (like a water-based lubricant) could cause the throttle lever/cable to become sticky and stiff.

Open the throttle lever housing.

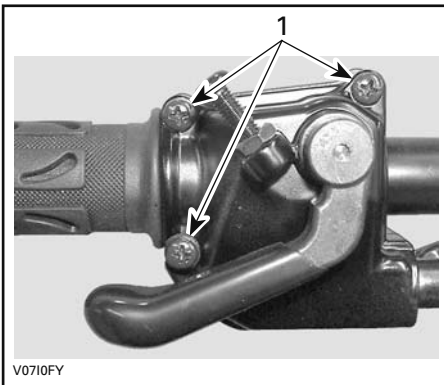

1. Remove these screws

Separate the housing.

Slide rubber protector back to expose throttle cable adjuster.

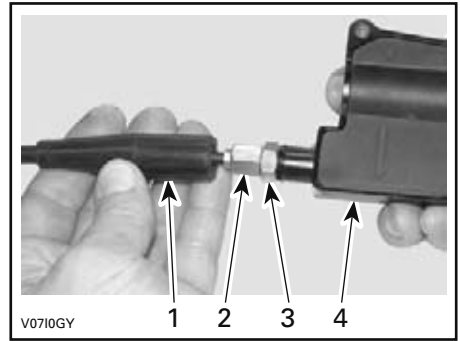

1. Cable protector
2. Throttle cable adjuster
3. Lock nut
4. Throttle lever housing

Screw in the throttle cable adjuster.

Remove inner housing protector.

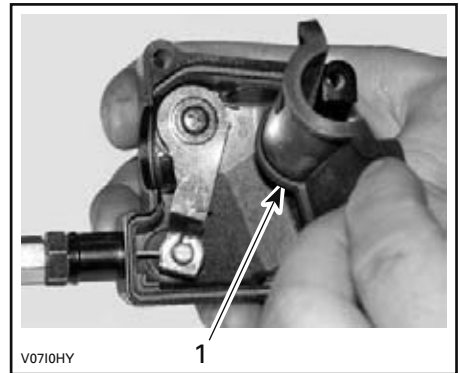

1. Inner housing protector

Remove the cable from the throttle lever housing.

**NOTE:** Slide cable in clip slot and remove the end of cable from clip.

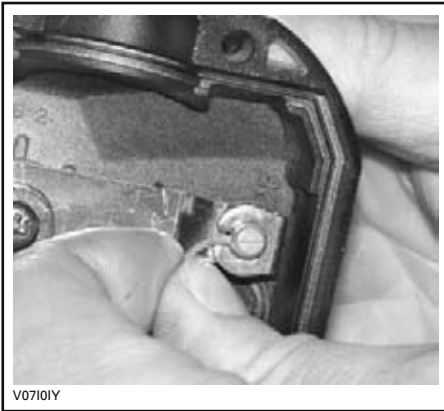

V07101Y

Remove the throttle body side cover.

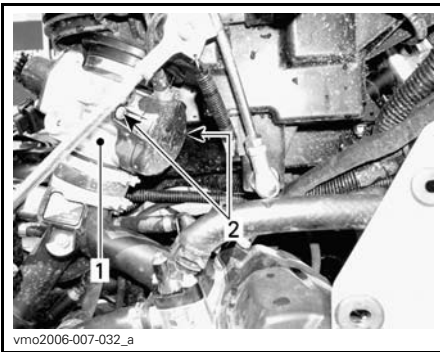

vmo2006-007-032\_a

1. Throttle body
2. Side cover screws

Insert the needle of the lubricant can in the end of throttle cable adjuster.

**CAUTION** Always wear appropriate skin and eye protection. Chemicals can cause a skin rash and eye injury.



V0710JY

TYPICAL

**NOTE:** Place a rag around the throttle cable adjuster to prevent the lubricant from splashing.

Add lubricant until it runs out at throttle body end of the throttle cable.

Reinstall and adjust the cable.

### Throttle Cable Adjustment

Slide rubber protector back to expose throttle cable adjuster.

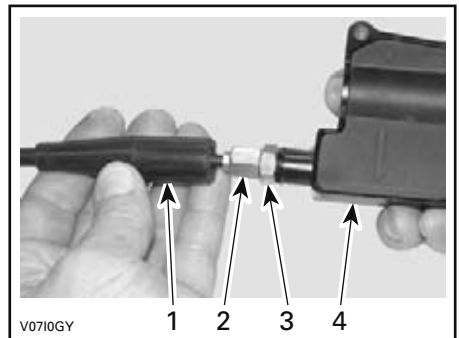

V0710GY

1. Cable protector
2. Throttle cable adjuster
3. Lock nut
4. Throttle lever housing

Loosen lock nut then turn the adjuster to obtain correct throttle lever free play.

**NOTE:** Measure throttle free play at the tip of throttle lever.



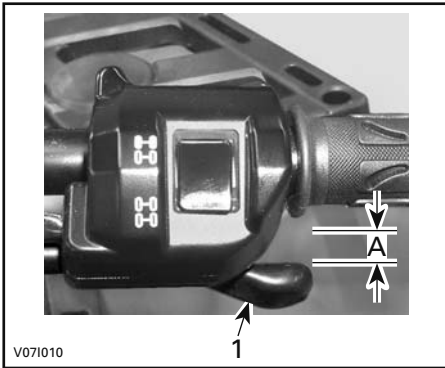

V071010

- 1. Throttle lever
- A. 2 mm (.079 in)

Tighten lock nut and reinstall protector. With the shift lever on PARK position, start the engine.

Check if the throttle cable is adjusted correctly by turning handlebar fully to the right then fully to the left. If the engine RPM increases, readjust the throttle lever free play.

## Spark Plugs

### Spark Plug Access

- Remove side panels.
- Unplug spark plug cables.

### Spark Plug Removal

Unscrew spark plugs one turn.

**⚠ CAUTION** Always wear safety goggles when using pressurized air.

Clean spark plugs and cylinder heads with pressurized air if possible.

Unscrew spark plugs completely then remove them.

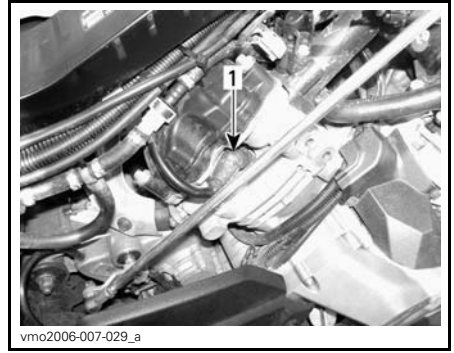

vmo2006-007-029\_a

**RH SIDE — REAR CYLINDER**  
1. Spark plug

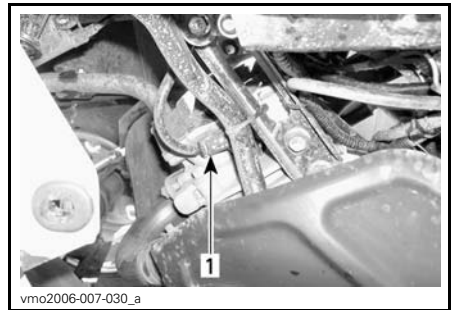

vmo2006-007-030\_a

**LH SIDE — FRONT CYLINDER**  
1. Spark plug

### Spark Plug Installation

Prior to installation, make sure that contact surfaces of cylinder heads and spark plugs are free of grime.

Using a feeler gauge, set the spark plug gap.

SPARK PLUG GAP
0.6 mm - 0.7 mm (.024 in - .028 in)

Apply a small amount of copper-based anti-seize lubricant over spark plug threads to prevent a possible seizure.

Screw spark plugs into cylinder heads by hand and tighten with a torque wrench and a proper socket.

TIGHTENING TORQUE	
Spark plug	20 N•m ± 2.4 N•m (15 lbf•ft ± 2 lbf•ft)

## Battery

**CAUTION** Never charge a battery while installed in vehicle.

These vehicles are equipped with a VRLA battery (Valve Regulated Lead Acid). It is a maintenance-free type battery, there is no need to add water to adjust electrolyte level.

**NOTICE** Never remove the battery sealing cap.

### Battery Removal

Disconnect BLACK (-) cable first then RED (+) cable.

**NOTICE** Always disconnect BLACK (-) battery cable first.

Remove retaining screws, battery holding strap then pull the battery out of frame.

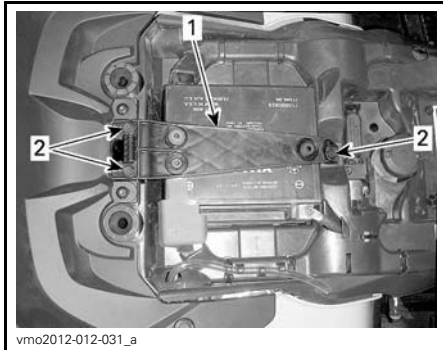

1. Battery holding strap
2. Retaining screws

### Battery Cleaning

Clean battery, battery casing and battery posts using a solution of baking soda and water.

Remove corrosion from battery cable terminals and battery posts using a firm wire brush.

## Battery Installation

Battery installation is the reverse of the removal procedure.

**NOTICE** Always connect RED (+) battery cable first.

## Fuses

**CAUTION** Always turn the ignition switch to OFF position before replacing a defective fuse.

### Fuse Inspection

Check if filament is melted.

If filament is melted, replace damaged fuse, refer to *FUSE LOCATION* tables for proper rating.

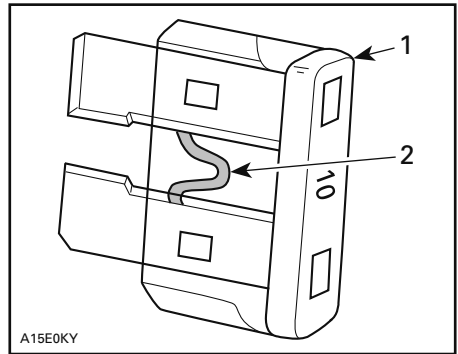

- TYPICAL**
1. Fuse
  2. Check if melted

**NOTICE** Do not use a higher rated fuse as this can cause severe damage.

### Front Fuse Box Location

Pull upwards and front to remove the gauge support from its location.



1. Gauge support

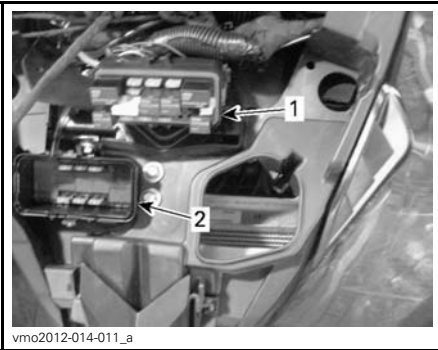

1. Front fuse box  
2. Front fuse box cover

**NOTE:** Check inside fuse box cover to know fuses location.

**NOTICE** Do not store any objects in the front service compartment.

**Front Fuse Box Description**

FRONT FUSE BOX		
NO.	DESCRIPTION	RATING
R1	Fan Relay	-
R2	Main Relay	-
R3	Accessories Relay	-
R4	Lights Relay	-
R5	Fuel Pump Relay	-
R8	Brake Relay	-
F4	Gauge (Speedo)	10 A

FRONT FUSE BOX		
NO.	DESCRIPTION	RATING
F5	Injectors/Ignition	5 A
F6	ECM	5 A
F7	2WD/4WD	5 A
F8	Key Switch, Starter Solenoid	5 A
F9	Cooling Fan	25 A
F10	Euro Control (CE Models)	5 A
F11	Lights	30 A
F12	DC Outlet	15 A
F14	Accessories 2	15 A
F15	Fuel Pump	5 A

**Rear Fuse Holder Location**

The rear fuse holder is located under seat near battery.



1. Rear fuse holder cap

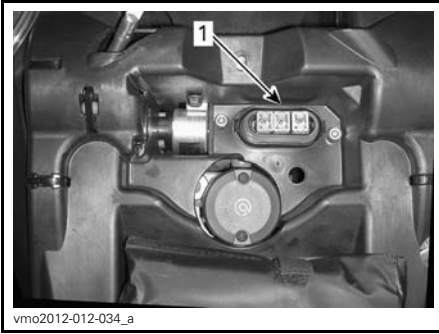

1. Rear fuse holder

### Rear Fuse Holder Identification

REAR FUSE HOLDER		
NO.	DESCRIPTION	RATING
F1	Main	30 A
F2	Fan/Accessories	40 A
F3	Dynamic power steering (DPS) (If applicable)	40 A

## Lights

Always check light operation after replacement.

### Headlight Bulb Replacement

**NOTICE** Never touch glass portion of a halogen bulb with bare fingers, it shortens its operating life. If glass is touched, clean it with isopropyl alcohol which will not leave a film on the bulb.

Unplug connector from bulb.

Rotate light bulb counterclockwise to release it from light housing.



Pull out bulb.

Properly reinstall removed parts in the reverse order of their removal.

Validate headlights operation.

### Headlight Beam Aiming

Turn adjustment screws to adjust beam height to your convenience. Adjust headlights evenly.

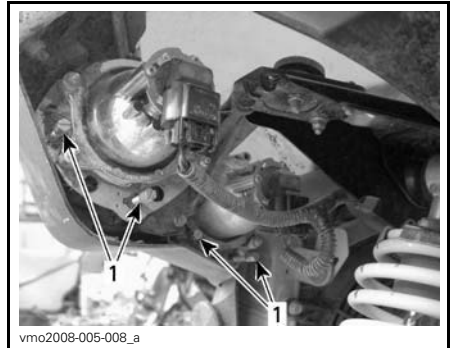

**TYPICAL**

1. Adjustment screws

### Taillight Bulbs Replacement

Unplug taillight connector.

Rotate light bulb counterclockwise to remove it from taillight.



vmo2012-012-062\_a

**ROTATE BULB COUNTERCLOCKWISE**

Remove bulb socket from taillight.

Installation is the reverse of the removal procedure.

**Drive Shaft Boot and Protector**

**Drive Shaft Boot and Protector Inspection**

Visually inspect drive shaft protectors and boots conditions.

Check protectors for damage or rubbing against shafts.

Check boots for cracks, tears, leaking grease etc.

Repair or replace damaged parts as necessary.



vmo2012-015-003\_a

**TYPICAL — FRONT OF VEHICLE**

1. Drive shaft boots
2. Drive shaft protector

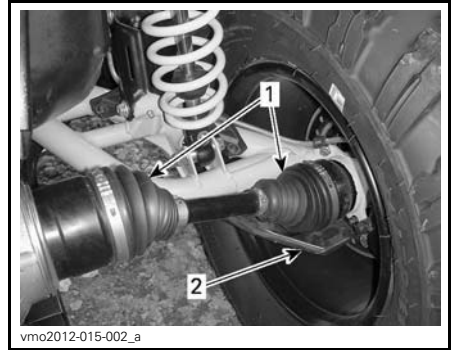

vmo2012-015-002\_a

**TYPICAL — REAR OF VEHICLE**

1. Drive shaft boots
2. Drive shaft protector

**Wheel Bearing**

**Wheel Bearing Inspection**

Place vehicle on a level surface.

Apply brake lock.

Lift and support vehicle.

Secure vehicle on jack stands.

Push and pull the wheels from the upper edge to feel the play.

See an authorized Can-Am dealer if there is any play.



tmo2011-001-131\_a

**TYPICAL**

## Wheel Beadlock Inspection (X xc Models)

### Wheel Beadlock Retorque

**NOTICE** Do not use an impact wrench for tightening beadlock screws in order to avoid to damage them.

1. Retorque all screws to to specification and according to the following tightening sequence.

TIGHTENING TORQUE	
Beadlock screws	8 N•m (71 lbf•in)

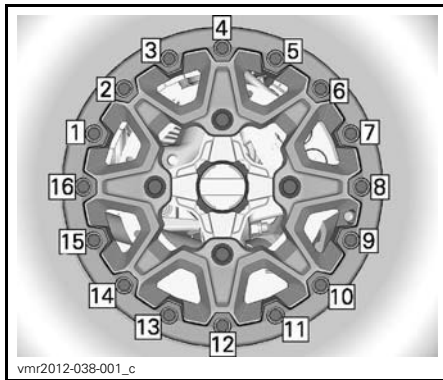

FINAL TIGHTENING SEQUENCE

2. Tighten screws a few turns at a time to ensure even pressure on the beadlock clamp ring.

**NOTE:** It is normal that the beadlock clamp ring flexes slightly to match the tire bead.

### Wheel Beadlock Gap Verification

1. Verify the gap between tire and beadlock clamp ring, it should be practically equal all around the ring.

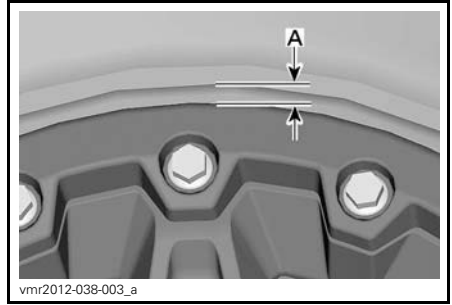

A. Gap between tire and ring

If the gap is not acceptable, see an authorized Can-Am dealer.

## Wheels and Tires

### Tire Pressure

⚠ **WARNING**

Tire pressure greatly affects vehicle handling and stability. Under-pressure may cause tire to deflate and rotate on wheel. Overpressure may burst the tire. Always follow recommended pressure. NEVER set tire pressure below minimum. It could cause the tire to dislodge from the rim. Since tires are low-pressure types, a manual pump should be used.

Check pressure when tires are cold before using the vehicle. Tire pressure changes with temperature and altitude. Recheck pressure if one of these conditions has changed.

For your convenience, a pressure gauge is supplied in tool kit.

TIRE PRESSURE		
	FRONT	REAR
<b>All Models</b>	41.4 kPa (6 PSI)	41.4 kPa (6 PSI)

Although the tires are specifically designed for off-road use, a flat may still occur. Therefore, it is recommended to carry a tire pump and a repair kit.

### Tire Inspection

Check tire for damage and wear. Replace if necessary.

Do not rotate tires. The front and rear tires have a different size. The tires are directional and their rotation must be kept in a specific direction for proper operation.

### Tire Replacement

Tires replacement should be performed by an authorized Can-Am dealer.

#### **⚠ WARNING**

- Replace tires only with the same type and size as original tires.
- For unidirectional tread pattern, ensure that the tires are installed in the correct direction of rotation.
- Tires should be replaced, by an experienced person, in accordance with tire industry standards and tools.

### Wheel Removal

- Place vehicle on a level surface.
- Apply brake lock.
- Loosen lug nuts then lift vehicle.
- Secure vehicle on jack stands.
- Remove nuts then remove wheel.

### Wheel Installation

- At installation, it is recommended to apply anti-seize lubricant on threads.
- If tires are unidirectional, make sure to install wheel according to tire rotation.
- Carefully tighten nuts in a criss-cross sequence then apply final torque.

TIGHTENING TORQUE	
Wheel nut	100 N•m ± 10 N•m (74 lbf•ft ± 7 lbf•ft)

**NOTICE** Always use the recommended wheel nuts according to the type of wheel. Using a different nut could cause damage to the rim or studs.

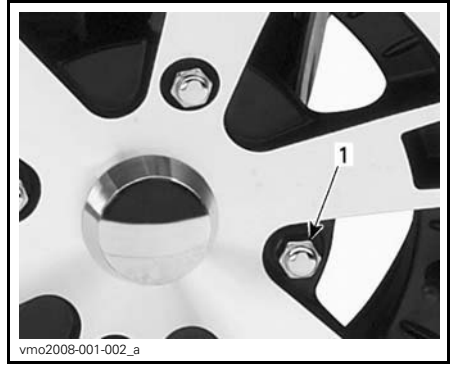

TYPICAL — ALUMINUM WHEEL  
1. Wheel nut (closed end type)

### Steering

#### Steering Inspection

##### Tie-Rods

Inspect tie-rod boots for cracks.

#### **⚠ WARNING**

The tie-rod must be replaced if the boot is cracked. The steering system must be inspected if abnormal play is detected. See an authorized Can-Am dealer.

### Suspension

#### Front Suspension Lubrication

Lubricate front A-arms at grease fittings.

SUSPENSION GREASE	
BRP Recommended Product	SUSPENSION GREASE (P/N 293 550 033)

## Rear Suspension Lubrication

Lubricate rear sway bar links and pivot bushing at grease fittings.

SUSPENSION GREASE	
BRP Recommended Product	SUSPENSION GREASE (P/N 293 550 033)

## Suspension Inspection

### Shock Absorbers

Inspect shock absorber for oil leaks or other damage.

Check tightness of fasteners.

See an authorized Can-Am dealer as necessary.

### Ball Joints

Inspect ball joint boots for cracks.

## **⚠ WARNING**

The ball joint must be replaced if the boot is cracked. See an authorized Can-Am dealer.

## Front A-Arms

Check A-arms for cracks, bending or other damage.

See an authorized Can-Am dealer as necessary.

## Rear Trailing Arms

Check trailing arms for distortion, cracks or bending.

See an authorized Can-Am dealer if any problem is detected.

## Brakes

### Brake Fluid Reservoir Level Verification

With vehicle on a level surface, check brake fluid in reservoirs for proper level.

**NOTE:** A low level may indicate leaks or worn brake pads.

### Front Brake Reservoir Level Verification

Turn steering in the straight-ahead position to ensure reservoir is level.

Check the brake fluid level, the reservoir is full when the fluid reaches the top of window.

Visually inspect lever boot condition.

Check for cracks, tears, etc. Replace if damaged.



TYPICAL

### Rear Brake Reservoir Level Verification

Remove the seat.

With vehicle on a level surface, liquid should be between MIN. and MAX. level marks of brake pedal fluid reservoir.





1. Rear brake fluid reservoir

However, verify the following between visits to your dealer:

- Brake fluid level
- Brake system for fluid leaks
- Brake cleanliness.

### **⚠ WARNING**

The brake fluid replacement or brake system maintenance and repairs should be performed by an authorized Can-Am dealer.

## **Adding Brake FLuid**

### **⚠ WARNING**

Clean filler cap before removing.

Remove screws from reservoir cap.

Add fluid as required. **Do not overfill.**

**NOTE:** Ensure filler cap diaphragm is pushed inside before to close the cap on brake fluid reservoir.

Reinstall cap and tighten screws.

## **Recommended Brake Fluid**

Always use brake fluid meeting the specification DOT 4 only.

### **⚠ WARNING**

To avoid serious damage to the braking system, do not use fluids other than the recommended one, nor mix different fluids for topping up.

## **Brake Inspection**

**⚠ CAUTION** The brakes can be very hot after prolonged use of the vehicle and can cause burns. Wait for the brakes to cool down.

The brake inspection, maintenance and repair should be performed by an authorized Can-Am dealer.

# VEHICLE CARE

## Post-Operation Care

When vehicle is used in salt-water environment (beach area, launching and loading boats etc.), rinsing the vehicle with fresh water is necessary to preserve vehicle and its components. Metallic parts lubrication is highly recommended. Use XPS LUBE (P/N 293 600 016) or an equivalent. This must be performed at the end of each operating day.

When vehicle is operated in muddy conditions, rinsing the vehicle is recommended to preserve vehicle and its components and to keep lights clean.

## Vehicle Cleaning and Protection

**NOTICE** Never use a high pressure washer to clean the vehicle. USE LOW PRESSURE ONLY (like a garden hose).

Pay attention to certain areas where mud or debris can accumulate and potentially cause wear, interferences or promote corrosion.

Wash the vehicle with a soapy water solution.

**NOTICE** Never clean polypropylene body parts with any petroleum base cleaning products, as it will alter the glossy finish.

## Non Compatible Cleaning Products

MATERIAL TYPE	NON-COMPATIBLE CLEANING PRODUCTS
Polypropylene	ANY PETROLEUM BASE CLEANING PRODUCTS
	XP-S ATV Finishing Spray (P/N 219 701 704)
	XP-S ATV Cleaning Kit (P/N 219 701 713) (it contains the above XP-S ATV Finishing Spray)



*DO NOT USE ON POLYPROPYLENE*

## Compatible Cleaning Products

MATERIAL TYPE	COMPATIBLE CLEANING PRODUCT
Polypropylene	XPS ATV Wash (P/N 219 701 702)
	Soapy water



vbs2012-006-001

**SAFE FOR POLYPROPYLENE**

---

## STORAGE AND PRESEASON PREPARATION

When a vehicle is not in use for more than 4 months, proper storage is a necessity.

When using your vehicle after storage, a preparation is required.

See an authorized Can-Am dealer to have your vehicle prepared for either storage or the preseason.

While reading this Operator's Guide, remember that:

### **WARNING**

Indicates a potential hazard that, if not avoided, could result in serious injury or death.

# ***TECHNICAL INFORMATION***

# VEHICLE IDENTIFICATION

The main components of your vehicle (engine and frame) are identified using different serial numbers. It may sometimes become necessary to locate these numbers for warranty purposes or to trace your vehicle in the event of loss. These numbers are also required by the authorized Can-Am dealer to complete warranty claims properly. No warranty will be allowed by BRP if the engine identification number (EIN) or vehicle identification number (VIN) is removed, mutilated or altered in any way. We strongly recommend that you take note of all the serial numbers on your vehicle and supply them to your insurance company.

## Vehicle Identification Number

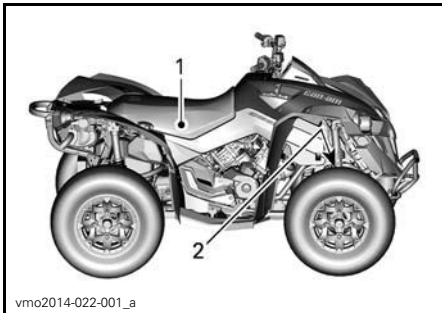

### TYPICAL

1. Label 1
2. Label 2



### LABEL 1

1. VIN (Vehicle Identification Number)
2. Model



### LABEL 2

1. VIN (Vehicle Identification Number)
2. Model number

## Engine Identification Number (EIN)

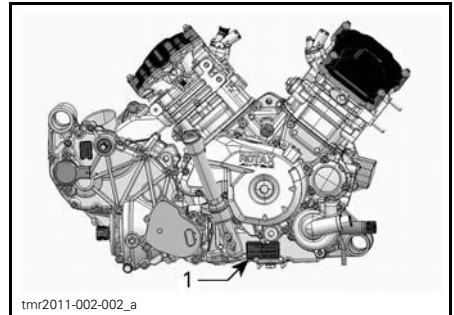

### TYPICAL - RH SIDE OF ENGINE

1. Engine Identification Number (EIN)

# SPECIFICATIONS

MODEL		RENEGADE
<b>ENGINE</b>		
Engine type	500	ROTAX® 490, 4-stroke, 2 cylinders (V-twin), liquid cooled
	800R	ROTAX® 810, 4-stroke, 2 cylinders (V-twin), liquid cooled
	1000	ROTAX® 1010, 4-stroke, 2 cylinders (V-twin), liquid cooled
	4-stroke, Single Over Head Camshaft (SOHC), liquid cooled	
Valve train		4 valves/cylinder (mechanical adjustment), single over head camshaft (SOHC) with timing chain
Number of valves		4 valves/cylinder (mechanical adjustment)
Bore	500	82 mm (3.228 in)
	800R	91 mm (3.58 in)
	1000	
Stroke	500	47 mm (1.85 in)
	800R	61.5 mm (2.42 in)
	1000	75 mm (2.95 in)
Displacement	500	499.6 cm <sup>3</sup> (30.49 in <sup>3</sup> )
	800R	800 cm <sup>3</sup> (48.82 in <sup>3</sup> )
	1000	976 cm <sup>3</sup> (59.56 in <sup>3</sup> )
Exhaust system		Spark arrester approved by USDA Forest Service
Engine air filter		Synthetic paper filter with foam
<b>LUBRICATION SYSTEM</b>		
Type		Wet sump. Replaceable oil filter
Oil filter		Replaceable cartridge
Engine oil	Capacity	2.0 L (2.1 qt (U.S. liq.))
	Recommended	For the summer season, use XPS 4-STROKE SYNTH. BLEND OIL (SUMMER) (P/N 293 600 121). For all seasons, use XPS 4-STROKE SYNTHETIC OIL (ALL CLIMATE) (P/N 293 600 112). If not available, use a 5W40 motor oil that meets the requirements for API service classification SG, SH, or SJ
<b>COOLING SYSTEM</b>		
Coolant	Type	Ethyl glycol/water mix (50% coolant, 50% water). Use premixed coolant sold by BRP (P/N 219 700 362) or coolant specifically designed for aluminum engines
	Capacity	500
		800R
	1000	3.5 L (.9 U.S. gal.)

**SPECIFICATIONS**

<b>MODEL</b>		<b>RENEGADE</b>	
<b>CVT TRANSMISSION</b>			
Type		CVT (Continuously Variable Transmission)	
Engagement RPM	500	1600± 100RPM	
	800R 1000	1650 ± 100 RPM	
<b>GEARBOX</b>			
Type		Dual range (HI-LO) with PARK, neutral and reverse	
Overall gear ratio	500	High: 3.078/Low: 5.293/Reverse: 5.45	
	800R	High: 2.888/Low: 5.293/Reverse: 5.45	
	1000	High: 2.829/Low: 5.842/Reverse: 7.148	
Gearbox oil	Capacity	500	400 ml (14 U.S. oz)
		800R	
	1000	450 ml (15 U.S. oz)	
	Type	XPS SYNTHETIC GEAR OIL (75W 140) (P/N 293 600 140) or a 75W140 API GL-5	
<b>ELECTRICAL SYSTEM</b>			
Magneto generator output	Renegade	400 W @ 6000 RPM	
	Renegade X xc (with DPS)	625 W @ 6000 RPM	
Ignition system type		IDI (Inductive Discharge Ignition)	
Ignition timing		Variable	
Spark plug	Quantity	2	
	Make and type	NGK DCPR8E	
	Gap	0.6 mm to 0.7 mm (.024 in to .028 in)	
Engine RPM limiter setting	500	8000 RPM	
	800R	8200 RPM	
	1000		
Battery	Type	Dry battery type	
	Voltage	12 volts	
	Nominal rating	18 A•h	
	Power starter output	0.7 KW	
Headlights	High	2 x 60 W	
	Low	2 x 60 W	
Taillight		2 x 5/21 W	
Turn signal lights		4 x 10 W	
Position light		5 W	



MODEL		RENEGADE	
<b>ELECTRICAL SYSTEM (cont'd)</b>			
Licence plate light		1 x 10 W	
Fuses		Refer to <i>FUSES</i> in the <i>MAINTENANCE</i> section	
<b>FUEL SYSTEM</b>			
Fuel delivery	Type	Electronic fuel injection (EFI)	
Throttle body		46 mm	
Fuel pump	Type	Electric (in fuel tank)	
Idle speed		1250 ± 50 RPM (not adjustable)	
Fuel	Type	Regular unleaded gasoline	
	Minimum octane	87 Pump Posted AKI (92 RON) - Refer to <i>FUEL REQUIREMENTS</i>	
Fuel tank capacity		20.5 L (5.4 U.S. gal.)	
Fuel remaining when low fuel light turns ON		± 5 L (1.3 U.S. gal.)	
<b>DRIVE SYSTEM</b>			
Drive system type		Selectable 2WD/4WD	
Front differential oil/ rear final drive oil	Capacity	Front	500 ml (17 U.S. oz)
		Rear	300 ml (10.1 U.S. oz)
	Type	Front	XPS SYNTHETIC GEAR OIL (75W 90) (P/N 293 600 043) or synthetic oil 75W90 API GL5
		Rear	XPS SYNTHETIC GEAR OIL (75W 140) (P/N 293 600 140) or a 75W140 API GL-5 synthetic gear oil
Front drive	Renegade	Visco-lok <sup>†</sup> front differential	
	Renegade X xc	Visco-lok QE <sup>†</sup> front differential	
Front drive ratio		3.6:1	
Rear drive		Shaft driven/ final drive	
Rear drive ratio		3.6:1	
CV joint grease		CV GREASE (P/N 293 550 019)	
Propeller shaft grease		PROPELLER SHAFT GREASE (P/N 293 550 063)	
<b>STEERING</b>			
Turning radius		2 057 mm (81 in)	
Total toe (front wheels off ground)		.1° to .5° toe-out	
Camber angle (vehicle on ground)		0°	

**SPECIFICATIONS**

<b>MODEL</b>		<b>RENEGADE</b>	
<b>FRONT SUSPENSION</b>			
Suspension type		Double suspension-arm with dive-control geometry	
Suspension travel		226 mm (8.9 in)	
Shock absorber	Qty	2	
	Type	Base	Gas
		X Xc	High Pressure Gas (HPG) with remote reservoir and dual speed compression damping
<b>REAR SUSPENSION</b>			
Suspension type		Torsional Trailing arm Independent (TTI) with external sway bar	
Suspension travel		236 mm (9.3 in)	
Shock absorber	Qty	2	
	Type	Base	Gas
		X Xc	High Pressure Gas (HPG) with remote reservoir and dual speed compression damping
<b>BRAKES</b>			
Front brake	Type	Dual 214 mm cross-drilled disc brakes with hydraulic twin-piston calipers	
Rear brake	Type	Single 214 mm cross-drilled disc brake with hydraulic twin-piston caliper (1 rear caliper)	
Brake fluid	Capacity	340 ml (11.5 U.S. oz)	
	Type	DOT 4	
Caliper	Floating twin pistons (2 x 26 mm)		
Brake pad material	Organic		
Minimum brake pad thickness	3.5 mm (.138 in) including back plate thickness		
Minimum brake disc thickness	4.0 mm (.157 in)		
Maximum brake disc warp	0.2 mm (.008 in)		
<b>TIRES</b>			
Pressure	Front	41.4 kPa (6 PSI)	
	Rear	41.4 kPa (6 PSI)	
Minimum tire thread depth	3 mm (.118 in)		
Tire size	Front	635 X 203 X 305 mm (25 x 8 x 12 (in))	
	Rear	635 X 254 X 305 mm (25 x 10 x 12 (in))	

MODEL		RENEGADE	
<b>WHEELS</b>			
Type	Renegade	Cast aluminum	
	Renegade X xc	Aluminum beadlock wheels	
Rim size	Front	305 x 152 mm (12 X 6 (in))	
	Rear	305 x 191 (12 X 7.5 (in))	
Wheel nuts torque		100 N•m ± 10 N•m (74 lbf•ft ± 7 lbf•ft)	
<b>DIMENSIONS</b>			
Overall length		218.4 cm (86 in)	
Overall width		116.8 cm (46 in)	
Overall height		114.3 cm (45 in)	
Wheelbase		129.5 cm (51 in)	
Wheel track	Front	96.5 cm (38 in)	
	Rear	91.4 cm (36 in)	
Ground clearance		30.5 cm (12 in)	
<b>LOADING CAPACITY AND WEIGHT</b>			
Dry weight	Renegade	500	303 kg (668 lb)
		800R	303 kg (668 lb)
		1000	312 kg (687 lb)
	Renegade X Xc	800R	323 kg (712 lb)
		1000	331 kg (730 lb)
Weight distribution (front/rear)		49 / 51	
Rear cargo area		16 kg (35 lb)	
Total vehicle load allowed (including driver, all other loads and added accessories)		141 kg (310 lb)	
Towing capacity		135 kg (298 lb)	
Tongue capacity		14 kg (31 lb)	

***This page is  
intentionally blank***

# ***TROUBLESHOOTING***

---

# TROUBLESHOOTING GUIDELINES

## ENGINE DOES NOT TURN

---

1. Ignition switch is in the OFF position.
  - Place switch to the ON position.
2. Emergency engine stop switch.
  - Make sure that emergency engine stop switch is in ON position.
3. Transmission is not set on PARK or NEUTRAL.
  - Set transmission either in PARK or in NEUTRAL or press the brake lever.
4. Burnt fuse.
  - Check main fuse condition.
5. Weak battery or loose connections.
  - Check charging system fuse.
  - Check connections and terminals condition.
  - Have the battery checked.
  - Contact an authorized Can-Am dealer.
6. Wrong ignition key, multifunction gauge display shows INVALID KEY.
  - Use the proper key for this vehicle.

## ENGINE TURNS OVER BUT FAILS TO START

---

1. Flooded engine (spark plug wet when removed).
  - (Drowned mode) If the engine does not start and it is fuel-flooded, this special mode can be activated to prevent fuel injection and to cut ignition while cranking. Proceed as follows:
    - Insert key in ignition switch and turn to ON position.
    - Press completely and HOLD throttle lever.
    - Press the engine START button.The engine should be cranked for 20 seconds. Release engine START button.  
Release throttle lever and start/crank engine again to allow starting.
  - If it does not work:**
    - Clean the spark plug caps area then remove them.
    - Remove the spark plugs (tools are supplied in tool kit).
    - Crank engine several times.
    - Install new spark plugs if possible or clean and dry spark plugs.
    - Start engine as explained above.If engine continues to flood, see an authorized Can-Am dealer.
  - NOTE:** Make sure to verify that there is no fuel in engine oil, if so, replace engine oil.
2. No fuel to the engine (spark plug dry when removed).
  - Check fuel tank level.
  - A failure of the fuel pump may have occurred.
  - Contact an authorized Can-Am dealer.

---

**ENGINE TURNS OVER BUT FAILS TO START (cont'd)**

---

**3. Spark plug/ignition (no spark).**

- Check main fuse condition.
- Remove spark plug then reconnect to ignition coil.
- Check that ignition switch and/or emergency engine stop switch is/are at the ON position.
- Start engine with spark plug grounded to the engine away from spark plug hole. If no spark appears, replace spark plug.
- If trouble persists, contact an authorized Can-Am dealer.

**4. Multifunction gauge CHECK ENGINE indicator lamp is on and display shows CHECK ENGINE.**

- Contact an authorized Can-Am dealer.

**5. Engine is under a protection (limp home) mode.**

- Multifunction gauge CHECK ENGINE indicator lamp is on and display shows CHECK ENGINE, contact an authorized Can-Am dealer.

---

**ENGINE LACKS ACCELERATION OR POWER**

---

**1. Fouled or defective spark plug.**

- Refer to ENGINE TURNS OVER BUT FAILS TO START.

**2. Lack of fuel to engine.**

- Refer to ENGINE TURNS OVER BUT FAILS TO START.

**3. Engine is overheating. (CHECK ENGINE indicator light will turn on and HI TEMP will appear in the multifunction display.)**

- Refer to ENGINE OVERHEATS.

**4. Air filter/housing clogged or dirty.**

- Check air filter and clean if necessary.
- Check deposits in air filter housing drain.
- Check the position of the air intake tube.

**5. CVT dirty or worn-out.**

- Contact an authorized Can-Am dealer.

**6. Engine is under a protection (limp home) mode.**

- Check multifunction gauge display for messages.
- Multifunction gauge CHECK ENGINE indicator lamp is on and display shows CHECK ENGINE or LIMP HOME, contact an authorized Can-Am dealer.

---

**ENGINE OVERHEATS**

---

**1. Low coolant in cooling system.**

- Check engine coolant, refer to ENGINE COOLANT in MAINTENANCE section.

**2. Dirty radiator fins.**

- Clean radiator fins, refer to RADIATOR in MAINTENANCE section.

**ENGINE OVERHEATS (cont'd)**

---

**3. Cooling fan inoperative.**

- *Check cooling fan fuse, refer to MAINTENANCE section. If the fuse is good, contact an authorized Can-Am dealer.*

**ENGINE BACKFIRE**

---

**1. Exhaust system leakage.**

- *Contact an authorized Can-Am dealer.*

**2. Engine is running too hot.**

- *Refer to ENGINE LACKS ACCELERATION OR POWER.*

**3. Ignition timing is incorrect or there is an ignition system failure.**

- *Contact an authorized Can-Am dealer.*

**ENGINE MISFIRE**

---

**1. Fouled/defective/worn spark plug.**

- *Clean/verify spark plug and heat range. Replace as required.*

**2. Water in fuel.**

- *Drain fuel system and refill with fresh fuel.*

**VEHICLE CANNOT REACH FULL SPEED**

---

**1. Engine.**

- *Refer to ENGINE LACKS ACCELERATION OR POWER.*

**2. Brake lock.**

- *Ensure brake lock is completely removed.*

**3. Air filter/housing plugged or dirty.**

- *Check air filter and clean if necessary.*
- *Check deposits in air filter housing drain.*
- *Check the position of the air intake tube.*

**4. CVT dirty or worn-out.**

- *Contact an authorized Can-Am dealer.*

**5. Engine is under a protection (limp home) mode.**

- *Check multifunction gauge display for messages.*
- *Multifunction gauge CHECK ENGINE indicator lamp is on and display shows CHECK ENGINE or LIMP HOME, contact an authorized Can-Am dealer.*

**SHIFT LEVER IS HARD TO MOVE**

---

**1. Transmission gears are in a position that prevents the shift lever to work.**

- *Rock the vehicle back and forth to move the gears in the transmission and allow the shift lever to be set.*

**2. CVT dirty or worn-out.**

- *Contact an authorized Can-Am dealer.*



---

**THE RPM INCREASES BUT THE VEHICLE DOES NOT MOVE**

---

- 1. The transmission is on PARK or NEUTRAL position.**
  - *Select the R, HI or LO position.*
- 2. CVT dirty or worn-out.**
  - *Contact an authorized Can-Am dealer.*
- 3. Water in the CVT housing.**
  - *Contact an authorized Can-Am dealer.*

# MULTIFUNCTION GAUGE MESSAGES

MESSAGE	PILOT LAMP(S) ON	DESCRIPTION
DESS KEY NOT RECOGNIZED	Check engine	indicates that you have used the wrong ignition key, use the proper key for this vehicle. It is also possible that the ignition key has a bad contact, remove and clean key.
BRAKE	Brake lock	Is displayed when brake is applied for more than 15 seconds (while riding).
LO BATT VOLT	Check engine	Low battery voltage, check battery voltage and charging system.
HIGH BATT VOLT	Check engine	High battery voltage, check battery voltage and charging system.
LOW OIL <sup>(1)</sup>	Check engine	Engine low oil pressure, stop engine immediately.
HI TEMP	Check engine	Engine is overheating, refer to <i>ENGINE OVERHEATS</i> in <i>TROUBLESHOOTING</i> section.
LIMP HOME	Check engine	Serious fault on the engine that can change the normal operation of the engine, CHECK ENGINE indicator lamp will also blink, refer to <i>TROUBLESHOOTING</i> section.
CHECK ENGINE	Check engine	Engine fault, CHECK ENGINE indicator lamp will also be ON, refer to <i>TROUBLESHOOTING</i> section.
MAINTENANCE REQUIRED <sup>(2)</sup>	Check engine	Periodic maintenance required. See an authorized Can-Am dealer.
ECM NOT RECOGNIZED	Check engine	Communication error between speedometer and engine control module (ECM), contact an authorized Can-Am dealer.
CHECK DPS	Check engine	Indicates that the DPS (Dynamic Power Steering) does not work properly. See an authorized Can-Am dealer.
DPS OVERTORQUE	None	Indicates that DPS module is lowering its assist level to protect itself against extreme torque level.
DPS OVERHEAT	None	Indicates that DPS module is lowering its assist level to protect itself against extreme temperature.

MESSAGE	PILOT LAMP(S) ON	DESCRIPTION
TPS FAULT PRESS OVERRIDE BUTTON TO LIMP HOME	Check engine	Throttle position sensor does not work properly. See an authorized Can-Am dealer.
PPS FAULT PRESS OVERRIDE BUTTON TO LIMP HOME	Check engine	PPS sensor does not work properly. See an authorized Can-Am dealer.

**NOTICE** <sup>(1)</sup> If the message and the check engine light stay on after engine starting, stop engine. Check engine oil level. Refill if necessary. If the oil level is good, see an authorized Can-Am dealer. Do not use the vehicle until repaired.

<sup>(2)</sup> Message must be erased by an authorized Can-Am dealer.

***This page is  
intentionally blank***

# ***WARRANTY***

---

# **BRP INTERNATIONAL LIMITED WARRANTY: 2014 CAN-AM™ ATV**

## **1) SCOPE OF THE LIMITED WARRANTY**

Bombardier Recreational Products Inc. ("BRP")\* warrants its 2014 Can-Am ATV sold by Can-Am ATV distributors or dealers authorized by BRP to distribute Can-Am ATVs ("Can-Am ATV Distributor/Dealer") outside of the United States of America ("USA"), Canada, member states of the European Economic Area (which is comprised of the states of the European Union plus Norway, Iceland and Liechtenstein) ("EEA"), Turkey, member states of the Commonwealth of the Independent States (including Ukraine and Turkmenistan) ("CIS") and Turkey, from defects in material or workmanship for the period and under the conditions described below.

All genuine Can-Am ATV parts and accessories, installed by an authorized Can-Am ATV Distributor/Dealer at the time of delivery of the 2014 Can-Am ATV, carry the same warranty as that of the Can-Am ATV.

This limited warranty will become null and void if: (1) The ATV was used for racing or any other competitive activity, at any point, even by a previous owner; or (2) the ATV has been altered or modified in such a way so as to adversely affect its operation, performance or durability, or has been altered or modified to change its intended use.

## **2) LIMITATIONS OF LIABILITY**

TO THE EXTENT PERMITTED BY LAW, THIS WARRANTY IS EXPRESSLY GIVEN AND ACCEPTED IN LIEU OF ANY AND ALL OTHER WARRANTIES, EXPRESSED OR IMPLIED, INCLUDING WITHOUT LIMITATION ANY WARRANTY OF MERCHANTABILITY OR FITNESS FOR A PARTICULAR PURPOSE. TO THE EXTENT THAT THEY CANNOT BE DISCLAIMED, THE IMPLIED WARRANTIES ARE LIMITED IN DURATION TO THE LIFE OF THE EXPRESS WARRANTY. INCIDENTAL AND CONSEQUENTIAL DAMAGES ARE EXCLUDED FROM COVERAGE UNDER THIS WARRANTY. SOME JURISDICTIONS DO NOT ALLOW FOR THE DISCLAIMERS, LIMITATIONS AND EXCLUSIONS IDENTIFIED ABOVE, AS A RESULT, THEY MAY NOT APPLY TO YOU. THIS WARRANTY GIVES YOU SPECIFIC RIGHTS AND YOU MAY ALSO HAVE OTHER LEGAL RIGHTS WHICH MAY VARY FROM COUNTRY TO COUNTRY. (FOR PRODUCTS PURCHASED IN AUSTRALIA SEE CLAUSE 4 BELOW).

Neither the Can-Am ATV Distributor/Dealer nor any other person has been authorized to make any affirmation, representation or warranty regarding the product, other than those contained in this limited warranty, and if made, shall not be enforceable against BRP.

BRP reserves the right to modify this warranty at any time, being understood that such modification will not alter the warranty conditions applicable to the products sold while this warranty is in effect.

## **3) EXCLUSIONS – ARE NOT WARRANTED**

The following are not warranted under this limited warranty under any circumstances:

- Normal wear and tear;
- Routine maintenance items, tune ups, adjustments;

- Damage caused by negligence or failure to provide proper maintenance and/or storage, as described in the Operator's Guide;
- Damage resulting from removal of parts, improper repairs, service, maintenance, modifications or use of parts or accessories not manufactured or approved by BRP which in its reasonable judgement are either incompatible with the product or adversely affect its operation, performance and durability, or resulting from repairs done by a person that is not an authorized servicing Can-Am ATV Distributor/Dealer;
- Damage caused by abuse, abnormal use, neglect, racing or operation of the product in a manner inconsistent with the recommended operation described in the Operator's Guide;
- Damage resulting from accident, submersion, fire, snow or water ingestion, theft, vandalism or any act of God;
- Operation with fuels, oils or lubricants which are not suitable for use with the product (see the Operator's Guide);
- Damage resulting from rust, corrosion or exposure to the elements;
- Incidental or consequential damages, or damages of any kind including without limitation towing, storage, transportation expenses, telephone, rental, taxi, inconvenience, insurance coverage, loan payments, loss of time, loss of income; or time missed for downtime experience due to service work.

#### **4) WARRANTY COVERAGE PERIOD**

This warranty will be in effect from (1) the date of delivery to the first retail consumer or (2) the date the product is first put into use, whichever occurs first and for a period of:

SIX (6) CONSECUTIVE MONTHS for private use or commercial use.

The repair or replacement of parts or the performance of service under this warranty does not extend the life of this warranty beyond its original expiration date.

Note that the duration and any other modalities of the warranty coverage are subject to the applicable national or local legislation in the customer's country.

#### **FOR PRODUCTS SOLD IN AUSTRALIA ONLY**

Nothing in these Warranty terms and conditions should be taken to exclude, restrict or modify the application of any condition, warranty, guarantee, right or remedy conferred or implied under the Competition and Consumer Act 2010 (Cth), including the Australian Consumer Law or any other law, where to do so would contravene that law, or cause any part of these terms and conditions to be void. The benefits given to you under this limited warranty are in addition to other rights and remedies that you have under Australian law.

Our goods come with guarantees that cannot be excluded under the Australian Consumer Law. You are entitled to a replacement or refund for a major failure and for compensation for any other reasonably foreseeable loss or damage. You are also entitled to have the goods repaired or replaced if the goods fail to be of acceptable quality and the failure does not amount to a major failure.

## **5) CONDITIONS TO HAVE WARRANTY COVERAGE**

This warranty coverage is available **only** if each of the following conditions has been fulfilled:

- The 2014 Can-Am ATV must be purchased as new and unused by its first owner from a Can-Am ATV Distributor/Dealer authorized to distribute Can-Am ATVs in the country in which the sale occurred;
- The BRP specified pre-delivery inspection process must be completed and documented;
- The product must have undergone proper registration by an authorized Can-Am ATV Distributor/Dealer;
- The 2014 Can-Am ATV must be purchased in the country or union of countries in which the purchaser resides; and
- Routine maintenance outlined in the Operator's Guide must be timely performed in order to maintain warranty coverage. BRP reserves the right to make warranty coverage contingent upon proof of proper maintenance.

BRP will not honour this limited warranty to any private use owner or commercial use owner if one of the preceding conditions has not been met. Such limitations are necessary in order to allow BRP to preserve both the safety of its products, and also that of its consumers and the general public.

## **6) WHAT TO DO TO OBTAIN WARRANTY COVERAGE UNDER THIS WARRANTY**

The customer must cease using the ATV upon the appearance of an anomaly. The customer must notify a servicing Can-Am ATV Distributor/Dealer within two (2) days of the appearance of a defect, and provide it with reasonable access to the product and reasonable opportunity to repair it. The customer must also present to the authorized Can-Am ATV Distributor/Dealer proof of purchase of the product and must sign the repair/work order prior to starting the repair in order to validate the warranty repair. All parts replaced under this limited warranty become the property of BRP.

Note that the notification period is subject to the applicable national or local legislation in customer's country.

## **7) WHAT BRP WILL DO**

To the extent permitted by law, BRP's obligations under this warranty are limited to, at its sole discretion, repairing parts found defective under normal use, maintenance and service, or replacing such parts with new genuine Can-Am ATV parts without charge for parts and labour, at any authorized Can-Am ATV Distributor/Dealer during the warranty coverage period under the conditions described herein. BRP's responsibility is limited to making the required repairs or replacements of parts. No claim of breach of warranty shall be cause for cancellation or rescission of the sale of the Can-Am ATV to the owner. You may have other legal rights which may vary from country to country.

In the event that service is required outside of the country of original sale, the owner will bear responsibility for any additional charges due to local practices and conditions, such as, but not limited to, freight, insurance, taxes, license fees, import duties, and any and all other financial charges, including those levied by governments, states, territories and their respective agencies.



BRP reserves the right to improve or modify products from time to time without assuming any obligation to modify products previously manufactured.

## **8) TRANSFER**

If the ownership of a product is transferred during the warranty coverage period, this warranty shall also be transferred and be valid for the remaining coverage period provided BRP or an authorized Can-Am ATV Distributor/Dealer receives a proof that the former owner agreed to the transfer of ownership, in addition to the co-ordinates of the new owner.

## **9) CONSUMER ASSISTANCE**

1. In the event of a controversy or a dispute in connection with this limited warranty, BRP suggests that you try to resolve the issue at the Can-Am ATV Distributor/Dealer level. We recommend discussing the issue with the authorized Can-Am ATV Distributor/Dealer's service manager or owner.
2. If further assistance is required, the Can-Am ATV Distributor/Dealer service department should be contacted in order to resolve the matter.
3. If the matter still remains unresolved then contact BRP by writing at the address listed below.

**For countries within Middle East and Africa please contact our European office:**

**BRP EUROPE N.V.**

Customer Assistance Center  
Skaldenstraat 125  
9042 Gent  
Belgium  
Tel.: + 32 9 218 26 00

**For all other countries, please contact your local Can-Am ATV Distributor/Dealer (visit our website at [www.brp.com](http://www.brp.com) for contact information), or contact our North American office at:**

**BOMBARDIER RECREATIONAL PRODUCTS INC.**

Customer Assistance Center  
75, J.-A. Bombardier Street  
Sherbrooke QC J1L 1W3  
Canada  
Tel.: + 1 819 566-3366

\* For the territory covered by this limited warranty, products are distributed and serviced by Bombardier Recreational Products Inc. or its affiliates.

© 2013 Bombardier Recreational Products Inc. All rights reserved.

™ Trademark of Bombardier Recreational Products Inc. or its affiliates.

---

# **BRP LIMITED WARRANTY FOR THE EUROPEAN ECONOMIC AREA, THE COMMONWEALTH OF THE INDEPENDENT STATES AND TURKEY: 2014 CAN-AM™ ATV**

## **1) SCOPE OF THE LIMITED WARRANTY**

Bombardier Recreational Products Inc. ("BRP")\* warrants its 2014 Can-Am ATVs sold by distributors or dealers authorized by BRP to distribute Can-Am ATVs ("Can-Am ATV Distributor/Dealer") in member states of the European Economic Area (which is comprised of the member states of the European Union plus Norway, Iceland and Liechtenstein) ("EEA"), in member states of the Commonwealth of the Independent States (including Ukraine and Turkmenistan) ("CIS") and Turkey from defects in material or workmanship for the period and under the conditions described below.

All genuine Can-Am ATV parts and accessories, installed by an authorized Can-Am ATV Distributor/Dealer at the time of delivery of the 2014 Can-Am ATV, carry the same warranty as that of the ATV.

This limited warranty will become null and void if: (1) The ATV was used for racing or any other competitive activity, at any point, even by a previous owner; or (2) the ATV has been altered or modified in such a way so as to adversely affect its operation, performance or durability, or has been altered or modified to change its intended use.

## **2) LIMITATIONS OF LIABILITY**

TO THE EXTENT PERMITTED BY LAW, THIS WARRANTY IS EXPRESSLY GIVEN AND ACCEPTED IN LIEU OF ANY AND ALL OTHER WARRANTIES, EXPRESSED OR IMPLIED, INCLUDING WITHOUT LIMITATION ANY WARRANTY OF MERCHANTABILITY OR FITNESS FOR A PARTICULAR PURPOSE. TO THE EXTENT THAT THEY CANNOT BE DISCLAIMED, THE IMPLIED WARRANTIES ARE LIMITED IN DURATION TO THE LIFE OF THE EXPRESS WARRANTY. INCIDENTAL AND CONSEQUENTIAL DAMAGES ARE EXCLUDED FROM COVERAGE UNDER THIS WARRANTY. SOME JURISDICTIONS DO NOT ALLOW FOR THE DISCLAIMERS, LIMITATIONS AND EXCLUSIONS IDENTIFIED ABOVE, AS A RESULT, THEY MAY NOT APPLY TO YOU. THIS WARRANTY GIVES YOU SPECIFIC RIGHTS AND YOU MAY ALSO HAVE OTHER LEGAL RIGHTS WHICH MAY VARY FROM COUNTRY TO COUNTRY.

Neither the Can-Am ATV Distributor/Dealer nor any other person has been authorized to make any affirmation, representation or warranty regarding the product, other than those contained in this limited warranty, and if made, shall not be enforceable against BRP.

BRP reserves the right to modify this warranty at any time, being understood that such modification will not alter the warranty conditions applicable to the products sold while this warranty is in effect.

## **3) EXCLUSIONS – ARE NOT WARRANTED**

The following are not warranted under this limited warranty under any circumstances:

- Normal wear and tear;
- Routine maintenance items, tune ups, adjustments;

- Damage caused by negligence or failure to provide proper maintenance and/or storage, as described in the Operator's Guide;
- Damage resulting from removal of parts, improper repairs, service, maintenance, modifications or use of parts or accessories not manufactured or approved by BRP which in its reasonable judgement are either incompatible with the product or adversely affect its operation, performance and durability, or resulting from repairs done by a person that is not an authorized servicing Can-Am ATV Distributor/Dealer;
- Damage caused by abuse, abnormal use, neglect, racing or operation of the product in a manner inconsistent with the recommended operation described in the Operator's Guide;
- Damage resulting from accident, submersion, fire, snow or water ingestion, theft, vandalism or any act of God;
- Operation with fuels, oils or lubricants which are not suitable for use with the product (see the Operator's Guide);
- Damage resulting from rust, corrosion or exposure to the elements;
- Incidental or consequential damages, or damages of any kind including without limitation towing, transportation expenses, storage, telephone, rental, taxi, inconvenience, insurance coverage, loan payments, loss of time, loss of income or time missed for downtime experience due to service work.

#### **4) WARRANTY COVERAGE PERIOD**

This warranty will be in effect from (1) the date of delivery to the first retail consumer or (2) the date the product is first put into use, whichever occurs first and for a period of:

TWENTY-FOUR (24) CONSECUTIVE MONTHS for private use.

SIX (6) CONSECUTIVE MONTHS for commercial use or rental use.

The product is used commercially when it is used in connection with any work or employment that generates income during any part of the warranty period. The product is also used commercially when, at any point during the warranty period, it is licensed for commercial use.

The repair or replacement of parts or the performance of service under this warranty does not extend the life of this warranty beyond its original expiration date.

Note that the duration and any other modalities of the warranty coverage are subject to the applicable national or local legislation in the customer's country.

#### **5) CONDITIONS TO HAVE WARRANTY COVERAGE**

This warranty coverage is available **only** if **each** of the following conditions has been fulfilled:

- The 2014 Can-Am ATV must be purchased as new and unused by its first owner from a Can-Am ATV Distributor/Dealer authorized to distribute Can-Am ATVs in the country in which the sale occurred;
- The BRP specified pre-delivery inspection process must be completed and documented;
- The product must have undergone proper registration by an authorized Can-Am ATV Distributor/Dealer;

- The 2014 Can-Am ATV must be purchased within the EEA by an EEA resident, in the CIS for residents of the countries comprised in such area and in Turkey for residents of Turkey; and
- Routine maintenance outlined in the Operator's Guide must be timely performed in order to maintain warranty coverage. BRP reserves the right to make warranty coverage contingent upon proof of proper maintenance.

BRP will not honour this limited warranty to any private use owner or commercial use owner if one of the preceding conditions has not been met. Such limitations are necessary in order to allow BRP to preserve both the safety of its products, and also that of its consumers and the general public.

## **6) WHAT TO DO TO OBTAIN WARRANTY COVERAGE UNDER THIS WARRANTY**

The customer must cease using the ATV upon the appearance of an anomaly. The customer must notify a servicing Can-Am ATV Distributor/Dealer within two (2) months of the appearance of a defect and provide it with reasonable access to the product and reasonable opportunity to repair it. The customer must also present to the authorized Can-Am ATV Distributor/Dealer, proof of purchase of the product and must sign the repair/work order prior to starting the repair in order to validate the warranty repair. All parts replaced under this limited warranty become the property of BRP.

Note that the notification period is subject to the applicable national or local legislation in customer's country.

## **7) WHAT BRP WILL DO**

To the extent permitted by law, BRP's obligations under this warranty are limited to, at its sole discretion, repairing parts found defective under normal use, maintenance and service, or replacing such parts with new genuine Can-Am ATV parts without charge for parts and labour, at any authorized Can-Am ATV Distributor/Dealer during the warranty coverage period under the conditions described herein. BRP's responsibility is limited to making the required repairs or replacements of parts. No claim of breach of warranty shall be cause for cancellation or rescission of the sale of the Can-Am ATV to the owner. You may have other legal rights which may vary from country to country.

In the event that service is required outside of the EEA, CIS or Turkey, the owner will bear responsibility for any additional charges due to local practices and conditions, such as, but not limited to, freight, insurance, taxes, license fees, import duties, and any and all other financial charges, including those levied by governments, states, territories and their respective agencies.

BRP reserves the right to improve or modify products from time to time without assuming any obligation to modify products previously manufactured.

## **8) TRANSFER**

If the ownership of a product is transferred during the warranty coverage period, this warranty shall also be transferred and be valid for the remaining coverage period provided BRP or an authorized Can-Am ATV Distributor/Dealer receives a proof that the former owner agreed to the transfer of ownership, in addition to the co-ordinates of the new owner.

## 9) CONSUMER ASSISTANCE

1. In the event of a controversy or a dispute in connection with this limited warranty, BRP suggests that you try to resolve the issue at the Can-Am ATV Distributor/Dealer level. We recommend discussing the issue with the authorized Can-Am ATV Distributor/Dealer's service manager or owner.
2. If further assistance is required, the Can-Am ATV Distributor/Dealer service department should be contacted in order to resolve the matter.
3. If the matter still remains unresolved then contact BRP at the address listed below:

**For countries within EEA, CIS or Turkey, except Scandinavian countries, please contact our European office:**

**BRP EUROPE N.V.**

Customer Assistance Center  
Skaldenstraat 125  
9042 Gent  
Belgium  
Tel.: + 32 9 218 26 00

**For Scandinavian countries, please contact our Finland office:**

**BRP FINLAND OY**

Service Department  
Isoaavantie 7  
FIN-96320 Rovaniemi  
Finland  
Tel.: + 358 16 3208 111

You can find your Can-Am Distributor/Dealer's coordinates on [www.brp.com](http://www.brp.com).

\* In the EEA, products are distributed and serviced by BRP European Distribution S.A. and other affiliates or subsidiaries of BRP.

© 2013 Bombardier Recreational Products Inc. All rights reserved.

™ Trademark of Bombardier Recreational Products Inc. or its affiliates.

## **ADDITIONAL TERMS AND CONDITIONS FOR FRANCE ONLY**

The following terms and conditions are applicable to products sold in France only:

The seller shall deliver goods that are complying with the contract and shall be responsible for defects existing upon delivery. The seller shall also be responsible for defects resulting from packaging, assembling instructions or the installation when it is its responsibility per the contract or if accomplished under its responsibility. To be compliant with the contract, the good shall:

1. Be fit for normal use for goods similar thereto and, if applicable:
  - Correspond to the description provided by the seller and have the qualities presented to the buyer through sample or model;
  - Have the qualities that a buyer may legitimately expect considering the public declarations of the seller, the manufacturer of its representative, including in advertising or labeling; or
2. Have the characteristics mutually agreed upon as between the parties or be fit for the specific use intended by the buyer and brought to the attention of the seller and which accepted.

The action for failure to comply is prescribed after two years after delivery of the goods. The seller is responsible for the warranty for hidden defects of the good sold if such hidden defects are rendering the good unfit for the intended use, or if they diminish its use in such a way that the buyer would not have acquired the good or would have given a lesser price, had he known. The action for such hidden defects shall be taken by the buyer within 2 years of the discovery of the defect.

# ***CUSTOMER INFORMATION***

---

## **PRIVACY INFORMATION**

BRP wishes to inform you that your coordinates will be used for safety and warranty related purposes. Furthermore, BRP and its affiliates may use its customer list to distribute marketing and promotional information about BRP and related products.

To exercise your right to consult or correct your data, or to be removed from the addressee-list for direct marketing, please contact BRP.

**By E-mail:**    [privacyofficer@brp.com](mailto:privacyofficer@brp.com)

**By mail:**        BRP  
                      Senior Legal Counsel-Privacy Officer  
                      726 St-Joseph  
                      Valcourt QC  
                      Canada  
                      J0E 2L0



---

## CHANGE OF ADDRESS/OWNERSHIP

If your address has changed or if you are the new owner of the ATV, be sure to notify BRP by either:

- Mailing one of the change of address cards on the following pages
- Notifying an authorized Can-Am dealer.

In case of change of ownership, please join a proof that the former owner agreed to the transfer.

Notifying BRP, even after the expiration of the limited warranty, is very important as it enables BRP to reach the ATV owner if necessary, like when safety recalls are initiated. It is the owner's responsibility to notify BRP.

**STOLEN UNITS:** If your personal ATV is stolen, you should notify BRP or an authorized Can-Am dealer. We will ask you to provide your name, address, phone number, the vehicle identification number and the date it was stolen.

### **Scandinavian countries**

#### **BRP FINLAND OY**

Service Department  
Isoaavantie 7  
FIN-96320 Rovaniemi

### **Other countries in the world**

#### **BRP EUROPEAN DISTRIBUTION**

Warranty Department  
Chemin de Messidor 5-7  
1006 Lausanne  
Switzerland

***This page is  
intentionally blank***





CHANGE OF ADDRESS CHANGE OF OWNERSHIP 

VEHICLE IDENTIFICATION NUMBER

Model Number

Vehicle Identification Number (V.I.N.)

OLD ADDRESS  
OR PREVIOUS OWNER:

NAME

NO.

STREET

APT

CITY

STATE/PROVINCE

ZIP/POSTAL CODE

COUNTRY

TELEPHONE

NEW ADDRESS  
OR NEW OWNER:

NAME

NO.

STREET

APT

CITY

STATE/PROVINCE

ZIP/POSTAL CODE

COUNTRY

TELEPHONE

E-MAIL ADDRESS

V00A2F

CHANGE OF ADDRESS CHANGE OF OWNERSHIP 

VEHICLE IDENTIFICATION NUMBER

Model Number

Vehicle Identification Number (V.I.N.)

OLD ADDRESS  
OR PREVIOUS OWNER:

NAME

NO.

STREET

APT

CITY

STATE/PROVINCE

ZIP/POSTAL CODE

COUNTRY

TELEPHONE

NEW ADDRESS  
OR NEW OWNER:

NAME

NO.

STREET

APT

CITY

STATE/PROVINCE

ZIP/POSTAL CODE

COUNTRY

TELEPHONE

E-MAIL ADDRESS

V00A2F













ATV MODEL No. \_\_\_\_\_

**VEHICLE**  
IDENTIFICATION NUMBER (V.I.N.) \_\_\_\_\_

**ENGINE**  
IDENTIFICATION NUMBER (E.I.N.) \_\_\_\_\_

**Owner:** \_\_\_\_\_  
NAME

\_\_\_\_\_  
No. STREET APT

\_\_\_\_\_  
CITY STATE/PROVINCE ZIP/POSTAL CODE

**Purchase Date** \_\_\_\_\_  
YEAR MONTH DAY

**Warranty Expiry Date** \_\_\_\_\_  
YEAR MONTH DAY

To be completed by the dealer at the time of the sale.

DEALER IMPRINT AREA

V00A2IL

Please verify with your dealer to ensure your vehicle has been registered with BRP.

While reading this Operator's Guide, remember that:

 **WARNING**

Indicates a potential hazard that, if not avoided, could result in serious injury or death.

## WARNING

### **THIS VEHICLE CAN BE HAZARDOUS TO OPERATE.**

A collision or rollover can occur quickly, even during routine manoeuvres such as turning and driving on hills or over obstacles, if you fail to take proper precautions.

**SEVERE INJURY OR DEATH** can result if you do not follow these instructions:

- **BEFORE YOU OPERATE THIS VEHICLE, READ THIS OPERATOR'S GUIDE AND ALL ON-PRODUCT SAFETY LABELS.**
- **NEVER OPERATE THIS VEHICLE WITHOUT PROPER INSTRUCTIONS.** Complete a certified training course.
- **NEVER OPERATE THIS VEHICLE ON ANY PAVED SURFACE** unless it is for short distances, at reduced speed and in order to move the vehicle from an off-road location to another.
- **ALWAYS RESPECT THE ROAD TRAFFIC LAWS** when you operate this vehicle on the roadway, even a dirt or gravel road.
- **ALWAYS WEAR AN APPROVED HELMET,** eye protection, and protective clothing.
- **NEVER USE WITH DRUGS OR ALCHOL.** They slow reaction time and impair judgment.
- **NEVER OPERATE THIS VEHICLE AT EXCESSIVE SPEEDS.** You increase your risk of losing control if you operate this vehicle at speeds too fast for the terrain, visibility conditions, or your experience. The maximum speed authorized with this vehicle is 65 km/h.
- **NEVER ATTEMPT WHEELIES, JUMPS, OR OTHER STUNTS.**

219 001 176

CA

OPERATOR'S GUIDE RENEGADE 500/800R/1000 / ENGLISH  
GUIDE DU COND. RENEGADE 500/800R/1000 / ANGLAIS

FAIT AU / MADE IN CANADA

U/M:P.C.