

ROTAX®



2025 Operator's Guide

Includes Safety, Use, and Maintenance
Information

ROTAX ACE 130, 170, 230, 300 APA and Newer Models

465201

Version - Original Instructions



⚠ WARNING

Read this Guide thoroughly. It contains important safety information.
Minimum recommended operators age: 16 years old.
Keep this Operators Guide in the boat.

CALIFORNIA PROPOSITION 65 WARNING

⚠ WARNING

Operating, servicing and maintaining a recreational marine vessel can expose you to chemicals including engine exhaust, carbon monoxide, phthalates, and lead, which are known to the State of California to cause cancer and birth defects or other reproductive harm. To minimize exposure, avoid breathing exhaust, do not idle the engine except as necessary, service your vehicle in a well-ventilated area and wear gloves or wash your hands frequently when servicing your vehicle. For more information go to www.p65warnings.ca.gov/marine

™ Trademarks of BRP or its affiliates.

This is a non-exhaustive list of trademarks that are the property of Bombardier Recreational Products Inc. or its affiliates (BRP):

Trademarks may not be registered in every jurisdiction.

BOSSWeb™

ROTAX®

XPS®

iNRT™

iDFT™

All rights reserved. No parts of this Guide may be reproduced in any form without the prior written permission of BRP US Inc.

©BRP US Inc. 2024

TABLE OF CONTENTS

SAFETY INFORMATION

SPECIAL SAFETY MESSAGES	10
Safe Boating Practices.....	14
Fueling.....	16
Use In European Union.....	17
Important On Product Labels.....	17
Engine Identification Number.....	18

BREAK-IN AND SPECIAL PROCEDURES

BREAK-IN	20
OPERATION.....	20
ENGINE SPEED LIMITATION — 130, 170, 230, 300 and 325 ENGINE MODELS.....	20
JET PUMP WATER INTAKE AND IMPELLER CLEANING.....	20
In Water Towing— Hose Pincher Installation Locations.....	22
SPECIAL PROCEDURES	23
iNR System Overview.....	23
Intelligent Debris Free Pump System (iDF).....	23

INSPECTIONS AND MAINTENANCE

PRE-RIDE INSPECTION	26
PRE-RIDE CHECKLIST	29
POST OPERATION CARE	31
Exhaust System Flushing.....	31
Anti-Corrosion Treatment.....	31
Additional Care For Foul Water or Salt Water Use.....	31
EXHAUST SYSTEM	32
Exhaust System Flushing.....	32
Optional Flushing Kit.....	33
MAINTENANCE SCHEDULE	35
ROTAX JET PROPULSION PERIODIC MAINTENANCE SCHEDULE	36
GENERAL	38
Recommended Engine Oil For ROTAX ACE 130, 170, 230, 300 Engines.....	38
Engine Oil Level.....	38
Engine Coolant.....	40
Recommended Engine Coolant.....	40
Anodes.....	40
Hull Finish.....	42
Storage.....	42
Maintenance Records.....	45

TECHNICAL SPECIFICATIONS

SPECIFICATIONS	50
-----------------------------	-----------

TROUBLESHOOTING GUIDELINES

TROUBLESHOOTING CHARTS	56
MONITORING SYSTEM	62
General	62
Pilot Lamps and Message Display Information (Typical)	62

WARRANTY INFORMATION

BRP US INC. LIMITED WARRANTY - USA AND CANADA	66
US EPA EMISSION-RELATED WARRANTY	71
Emission-Related Warranty Period	71
Components Covered	72
Limited Applicability	73
CALIFORNIA EMISSION CONTROL WARRANTY STATEMENT FOR ROTAX®	
INBOARD JET PROPULSION SYSTEMS	74
Your Emission Control Warranty Rights And Obligations	74
Manufacturers Limited Warranty Coverage	74
OWNER'S WARRANTY RESPONSIBILITIES	75
Star Rating System	75
CORROSION WARRANTY STATEMENT	79
BRP US INC. INTERNATIONAL LIMITED WARRANTY	83
BRP US INC. LIMITED WARRANTY FOR THE EUROPEAN ECONOMIC AND	
THE INDEPENDENT STATES (CIS) AREAS AND TURKEY	89

CUSTOMER INFORMATION

DATA PRIVACY INFORMATION	96
CONTACT US	98
Asia Pacific	98
Europe, Middle East and Africa	98
Latin America	99
North America	99
CHANGE OF ADDRESS/OWNERSHIP	100

Congratulations on your purchase of a new Power Pack by BRP. It is backed by the BRP limited warranty and a network of authorized *Rotax*® Jet Propulsion systems dealers ready to provide the parts, service or accessories you may require.

Your dealer is committed to your satisfaction. If you need more complete servicing information, please ask your dealer.

Know Before You Go

To learn how to reduce the risk of accident, read the following sections of this Guide before you operate the boat:

SAFETY INFORMATION

Also, read all safety labels on your boat.

We highly recommend that you take a safe boating course. Please check your dealer or local authorities for availability in your area.

In certain areas, an operator competency card is mandatory to operate a pleasure craft.

Failure to follow the warnings contained in this Operator's Guide can result in **SERIOUS INJURY** or **DEATH**.

Safety Messages

The types of safety messages, what they

look like and how they are used in this Guide are explained as follows:

DANGER

Indicates a hazardous situation which, if not avoided, will result in death or serious injury.

WARNING

Identifies an instruction which, if not followed, may cause serious injury including the possibility of death.

CAUTION

Identifies an instruction which, if not followed, may cause minor or moderate injury.

NOTICE

Denotes an instruction which, if not followed, may severely damage the engine or other components.

IMPORTANT: Indicates supplementary information which may be needed to fully complete or understand an instruction.

ENVIRONMENTAL NOTE

Environment note gives you tips and behaviors to environmental protection.

About This Operator's Guide

This Operators Guide has been prepared to acquaint the owner and the operator of a new boat with the various controls, maintenance and safe operating instructions. It is indispensable for the proper use of the product. Keep this Operators Guide in the boat as you can refer to it for things such as maintenance, troubleshooting and instructing others.

Note that this Guide is available in several languages. In the event of any

discrepancy, the English version shall prevail. If you want to view and/or print an extra copy of your Operator's Guide simply visit the following web-site at:

<https://www.operatorsguides.brp.com/>

The information contained in this document are correct at the time of publication. BRP, however, maintains a policy of continuous improvement of its products without imposing upon itself any obligation to install them on products previously manufactured. Due to late changes, some differences between the manufactured product and the descriptions and/or specifications in this Guide may occur. BRP reserves the right at any time to discontinue or change specifications, designs, features, models or equipment without incurring any obligation upon itself.

This Operators Guide should remain with the boat when it's sold.

Reminders Regarding Operation

WARNING

Avoid personal injury! Do not allow anyone near the jet pump or intake grate, even when the engine is off. Items such as long hair, loose clothing or personal flotation device straps can become entangled in moving parts resulting in serious injury or drowning. In shallow water, shells, sand, pebbles or other objects could be drawn up by the jet pump and be thrown rearward.

Engine exhaust contains carbon monoxide (CO), which can cause injury or death if inhaled in sufficient quantities. Educate all occupants about the risks and symptoms of CO accumulation and CO poisoning. For more information, refer to CARBON MONOXIDE AND BOATING section.

Gasoline vapors can explode, resulting in injury or death. Always use blower as per the boat manufacturer's recommendation before starting engine, then turn it OFF above idle speed. Use of the bilge blower should never replace "smelling" for gasoline vapor odors.

If at any time, gasoline leaks/odors are found, do not start the engine. Have the boat serviced by an authorized *Rotax*® Inboard Jet Propulsion systems dealer.

Always keep in mind that as the throttle lever is returned to the idle position, less directional control is available. To turn the boat, both steering and throttle are necessary.

This boat has no brake. Stopping distance will vary depending on initial speed, load, wind, and water conditions. Practice stopping and docking in a safe, traffic-free area to have an idea of how long it will take to stop the boat under varying conditions. Do not release the throttle when trying to steer away from objects. You need throttle to steer. Do not use the boat's reverse to stop.

Do not start or operate the boat if any person is not properly seated in a seat intended for use when underway (refer to boat labels) or if a person is nearby in the water.

The boat's jet thrust can cause injury. Always accelerate slowly, and decelerate in a controlled fashion.

Observe the instructions on all safety labels. They are there to help assure that you have a safe and enjoyable outing.

Riding with passenger(s) or pulling other boats, tubes, a skier or a wake boarder makes the boat handle differently and requires greater skills.

In shallow water, proceed with caution and at very low speeds. Grounding or abrupt stops may result in injury to you, your passengers or others. The jet pump

may pick up debris and throw it rearward causing a risk of injuring people or damaging the jet pump or other property.

Combustion engines need air to operate; consequently this boat can not be totally water-tight. Any maneuvers such as figure eights that cause the upper deck to be under water may cause severe engine problems due to water ingestion. Refer to the **SPECIAL PROCEDURES** and **WARRANTY** sections contained in this Operators Guide.

Respect no wake zones, the rights of other water users and the environment. As the "skipper" and owner of a boat, you are responsible for damage to other boats caused by the wake of your boat. Do not let anyone throw refuse overboard.

Between sunset and sunrise, use the boat's navigation lights and reduce speed. Do not operate the boat in reduced visibility.

Do not add accessories or equipment that may adversely affect visibility or alter control of the boat.

The skipper should personally take the helm during storms.

This page is intentionally blank

SAFETY INFORMATION

SPECIAL SAFETY MESSAGES

CARBON MONOXIDE AND BOATING

Burning a material containing carbon produces carbon monoxide (CO), an odorless and colorless gas. Because CO has a similar density as air, it can spread throughout an enclosed space unnoticed because you cannot see it or smell it. Any device used to burn carbon-based materials on a boat can be a source of CO. Common sources of CO include internal combustion engines.

CO reacts with the blood to reduce the ability of the blood to carry oxygen. The reduced oxygen supply to body tissues results in death of the tissue. Prolonged exposure can cause brain damage or death. In high concentrations, CO can be fatal within minutes. The effects of CO in lower concentrations are cumulative and can be just as lethal over long periods of time.

Symptoms of CO poisoning include: Itchy and watering eyes, flushed appearance, throbbing temples, inability to think coherently, ringing in the ears, tightness across the chest, head-aches, drowsiness, nausea, dizziness, fatigue, vomiting, collapse, and convulsions. If any of these symptoms are evident, begin treatment immediately. Prompt action can make the difference between life and death.

Evacuate the area and move the victim to fresh air.

Administer oxygen if available and get medical help.

Open all canvas enclosures to ventilate the area.

Investigate the source of CO and take immediate corrective action.

Be especially aware of other CO sources which may be near boat.

CARBON MONOXIDE ACCUMULATION

Following are examples of possible situations where CO may accumulate within your boat while docked, anchored, or underway. Become familiar with these examples and their precautions to prevent personal injury or death.

⚠ WARNING

Exhaust fumes! Generator or hull exhaust from other vessels while either docked or anchored can emit poisonous CO gas and cause excessive accumulation within cabin and cockpit areas. Be alert for generator exhaust from your vessel or other vessels alongside. Exhaust outlets near a pier, dock, seawall or outlets blocked by any other means can cause excessive accumulation of poisonous CO gas within cockpit area.

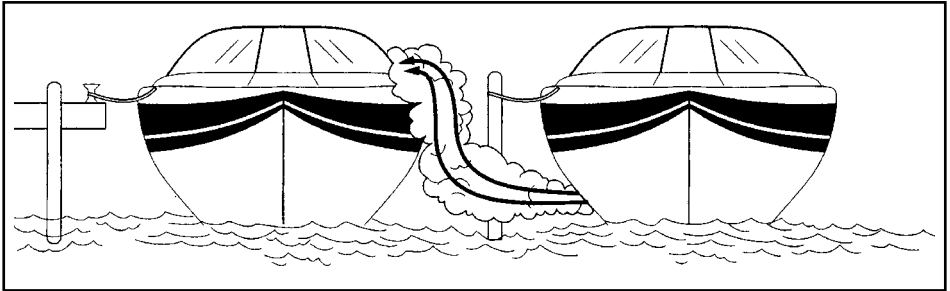

⚠ WARNING

Engine exhaust fumes contain carbon monoxide (CO) which can accumulate in and around the boat (under bimini top, in cockpit, etc.). CO can be harmful or fatal if inhaled. Assure there is adequate ventilation whenever running engine(s).

Boat houses, seawalls, and other boats in close proximity or confined areas can contribute to increased CO levels. Operators must be aware that operation, mooring, and anchoring in an area with other boats puts them in jeopardy of CO accumulation from other sources. Likewise, a boat operator must be aware of how exhaust from his boat will affect others. Operation of the engines while moored may cause CO accumulation in your boat and those around you.

CARBON MONOXIDE ACCUMULATION

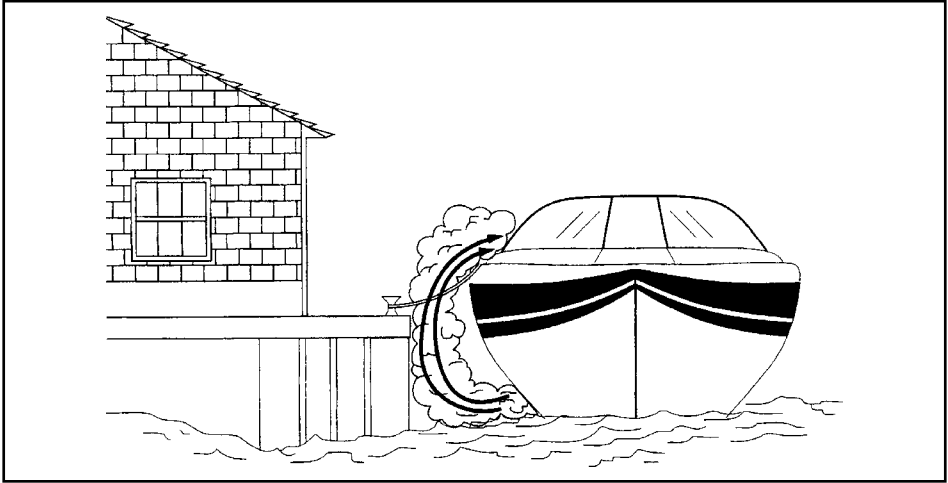

Be sure to provide adequate ventilation. If the windshield has vents, open them before getting underway to increase positive air flow and decrease the chances of CO accumulation.

⚠ WARNING

Backdrafting! Under certain conditions, moving air currents can direct poisonous CO fumes into boat. These fumes can accumulate to dangerous levels without proper air-flow. Provide adequate ventilation, redistribute the load or bring boat out of high bow angle.

While underway, CO concentrations can increase by backdrafting or “the station wagon effect”. Backdrafting is caused by factors such as relative wind direction, speed, or the bow being too high. To prevent this, open canvas whenever possible to provide positive airflow through the hull.

CARBON MONOXIDE ACCUMULATION

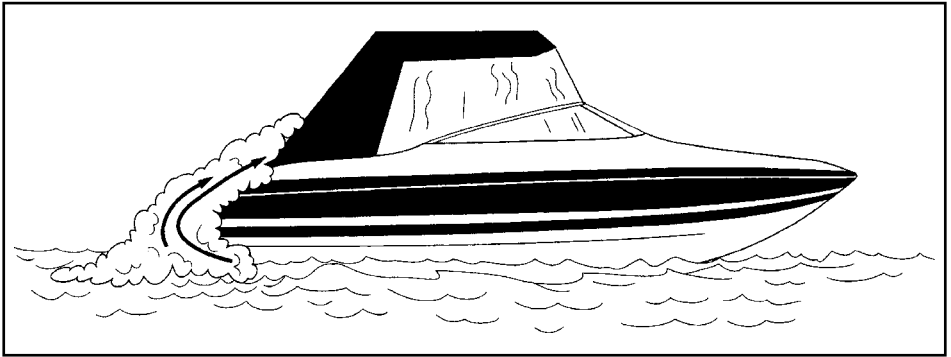

Even with the best boat design and construction, CO may still accumulate in enclosed or confined areas under certain conditions. Continually observe passengers for symptoms of CO poisoning.

CO DETECTOR

It is strongly recommended that you have CO detectors installed in boats with canvas enclosures. Monitors are available from your dealer. Monitors should be professionally installed and calibrated.

A CO detector is not a gas fuel vapor detector. Gas fuel vapor detectors do not monitor the buildup of CO in an enclosed area.

DO NOT Operate your Boat Without Performing the Following Checklist:

OPERATION	SIGN
Make sure you and your passengers know where exhaust outlets are located on the vessel.	
Educate all passengers about the symptoms of CO poisoning and where CO may accumulate.	
When docked or rafting with another boat, be aware of exhaust emissions from the other boat.	

OPERATION	SIGN
Listen for any change in exhaust sound, which could indicate an exhaust component failure.	
Test the operation of each CO alarm by pressing the test button (if applicable).	

Safe Boating Practices

YOU are responsible for your own safety, the safety of your passengers, and the safety of fellow boaters.

DRUGS AND ALCOHOL

Do not use drugs or drink alcohol while operating a boat. Like driving a car, driving a boat requires sober, attentive care. Operating a boat while intoxicated or under the influence of drugs is not only dangerous, but it is also a Federal offense carrying a significant penalty. These laws are vigorously enforced. The use of drugs and alcohol, singly or in combination, decreases reaction time, impedes judgment, impairs vision, and inhibits your ability to safely operate a boat.

 WARNING
<p>Alcohol consumption and boating are a deadly combination! Operating under the influence endangers the lives of your passengers and other boaters. Federal laws prohibit operating a boat under the influence of alcohol or drugs.</p>

SAFE OPERATION

For safety reasons and proper care, always perform daily PRE-RIDE INSPECTION as specified in your Operators Guide before operating your boat. Safe operation means that you do not misuse your boat nor do you allow your passengers to do so. Safe operation means using good judgment at all times. It

includes, without limitation, the following actions:

Load the boat within the limits listed on the capacity plate. Balance loads bow to stern and port to starboard.

Maintain boat speed at or below the local legal limit. Avoid excessive speed or speeds not appropriate for operating conditions.

Do not use the boat in weather or waterway conditions beyond the skill or experience of the operator or the capability of the boat and comfort of passengers.

Be sure at least one other passenger is familiar with the operation and safety aspects of the boat in case of an emergency.

Make sure that passengers and gear do not obstruct the operator's view or ability to move.

Do not exceed the maximum engine power rating stated on the certification plate attached to the boat.

Observe all safety signs and warnings both inside the boat and in the immediate boating area.

While your boat has the capacity of operating at high speeds, it is strongly recommended that high speed operation only be applied when ideal conditions exist and are permitted. Higher speed operation requires a higher degree of skill and increases the risk of severe injuries.

In shallow water, proceed with caution and at very low speed. Grounding or

abrupt stops may result in injury. Debris may also be picked up and be thrown rearward by the jet pump onto people or property.

Do not use the boat's reverse, to stop. You or your passenger(s) could be violently ejected forward or even off the boat onto the hazard.

MANEUVERABILITY OF THE BOAT AND TOWING

Always keep in mind that as the throttle lever is returned to idle position, less directional control is available, and when the engine is OFF, directional control is lost. You need throttle to steer.

Do not overload the boat or take on more passengers than designated for the particular boat. Overloading can affect maneuverability, stability and performance.

Avoid adding on accessories or equipment which may alter your control of the boat.

Riding with a passenger(s) or pulling a tube, skier or wakeboarder makes the boat handle differently and requires greater skill.

Always respect the safety and comfort of your passenger(s) and person being towed on skis, wakeboard or other towables.

Always carry an observer when pulling a tube, skier or wakeboarder, proceed with only as much speed as required and follow the observer's instructions. Unless absolutely necessary, do not make tight, sharp turns. Keep a safe distance from the docks, other swimmers, craft or objects.

Use a tow rope of sufficient length and size and make sure it is adequately secured to your boat. Some boats are equipped or can be fitted with a specially designed towing mechanism. It can become a hazard should someone fall on it.

PASSENGER SAFETY

Before getting underway, show all passengers where emergency and safety equipment is stowed, and explain how to use it. Everyone aboard should wear rubber-soled shoes which resist slipping on wet surfaces. While underway, passengers should remain seated inside the deck rails. Don't allow passengers to drag their feet or hands in the water. Always use hand holds and other safety hardware to prevent falls. All non-swimmers, poor swimmers, and children should wear a PFD at all times. Federal regulations require that children under 13 years of age wear a PFD when the boat is underway unless they are in an enclosed cabin or below deck.

Do not start or operate the boat if anyone is seated on the sun deck or swim platform, or is nearby in the water. Water and/or debris exiting jet thrust nozzle can cause severe injury.

The operator and passenger(s) should be properly seated before starting or moving the boat. All passenger(s) should be instructed to use the hand holds or seat straps provided.

When accelerating a boat with a passenger(s), whether from a complete stop or while underway, always do so progressively. Fast acceleration may cause your passenger(s) to lose their balance or grip and strike something in the boat or fall out of the boat. Make sure that your passenger(s) know of, or anticipate, any rapid acceleration.

FIRST AID

As a boat operator, you should be familiar with basic first aid procedures that may be needed while you are far from help. Fish hook accidents or minor cuts and abrasions may be the most serious mishaps on board a boat, but you should also learn the proper procedures and be ready to deal with the truly serious problems like excessive bleeding,

hypothermia, and burns. First aid literature and courses are available through most Red Cross chapters.

OPERATION BY MINORS

Minors should always be supervised by an adult whenever operating a boat. Many countries have laws regarding the minimum age and licensing requirements of minors. Be sure to contact the state boating authorities for information. BRP recommends a minimum operator age of 16 years.

Fueling

Recommended Fuel

NOTICE

Always use fresh gasoline. Gasoline will oxidize; the result is loss of octane, volatile compounds, and the production of gum and varnish deposits which can damage the fuel system.

Alcohol fuel blending varies by country and region. Your engine has been designed to operate using the recommended fuels, however, be aware of the following:

- Use of fuel containing alcohol above 10% is not recommended and can result in the following problems in the fuel system components:
 - Starting and operating difficulties
 - Deterioration of rubber or plastic parts
 - Damage to internal engine parts
- Inspect frequently for the presence of fuel leaks or other fuel system abnormalities if you suspect the presence of alcohol in gasoline exceeds the current government regulations.
- Alcohol blended fuels attract and hold moisture which may lead to fuel phase separation and can result in engine performance problems or engine damage.

Use premium unleaded gasoline with an AKI (RON + MON)/2 rating of 91 or an RON octane rating of 95.

NOTICE

Never experiment with other fuels. The use of inadequate fuel can result in boat performance deterioration and damage to critical parts in the fuel system and engine components.

NOTICE

Do NOT use fuel from fuel pumps labeled E85.

Use of fuel labeled E15 is prohibited by U.S. EPA.

NOTICE

Do NOT use fuel from fuel pumps labeled E15

MINIMUM OCTANE RATING

AKI (RON+MON/2)	87	91
130 (ECT)	X	
170 (ECT)	X	
230 (ECT)	X	
300	X	X ¹

MINIMUM OCTANE RATING

RON	92	95
130 (ECT)	X	
170 (ECT)	X	
230 (ECT)	X	

MINIMUM OCTANE RATING		
300	X	X ¹
¹ For optimum engine performance		

Fueling Procedure

⚠ WARNING

Fuel is flammable and explosive under certain conditions. Do not smoke or allow open flames or sparks in the vicinity.

Be very careful when fueling and adhere to the fueling procedures described below in this Operators Guide and those given to you by the marina.

Know the capacity of the fuel tank. Avoid fueling at night except under well-lighted conditions. Gas spills are not noticeable in the dark. Do not carry spare fuel or flammable liquids in any of the storage or engine compartments.

⚠ WARNING

Follow these safe boating fueling instructions explicitly.

Use In European Union

(2014/94/EU — on the deployment of alternative fuels infrastructure)

A European Standard provides harmonized labeling across Europe and this effectively assists consumers in identifying the compatibility of the fuel supplied at a refueling point with an engine.

In the European Union, this Rotax engine is compatible with the following petrol-type fuel;

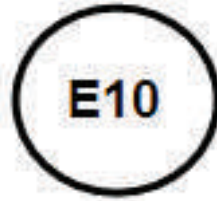

Important On Product Labels

The following labels are on your engine. If missing or damaged, they can be replaced free of charge. See an authorized dealer. Please read the following labels carefully before operating your boat.

LABELS



LABEL-ISO 13592

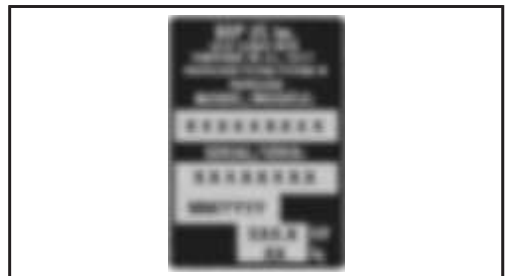

TYPICAL-MODEL/SERIAL



TYPICAL (WHEN APPLICABLE)-EMISSIONS CONTROL INFORMATION



TYPICAL ECM BRACKET 130, 170, 230, 300 MODELS

1. Engine identification number

Engine Identification Number

130, 170, 230, 300 HP Versions

The Engine Identification Number is located on the front of the engine as well as on the ECM bracket.

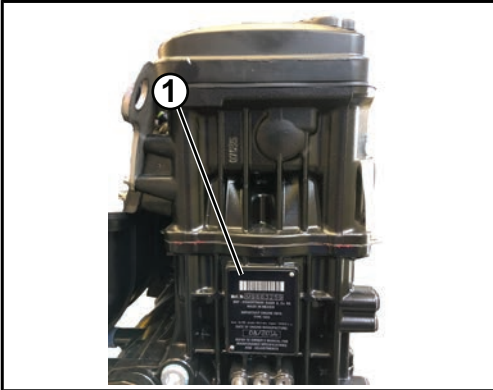

TYPICAL FRONT OF ENGINE TYPICAL FRONT OF ENGINE 1630, ALL MODELS.

1. Engine identification number

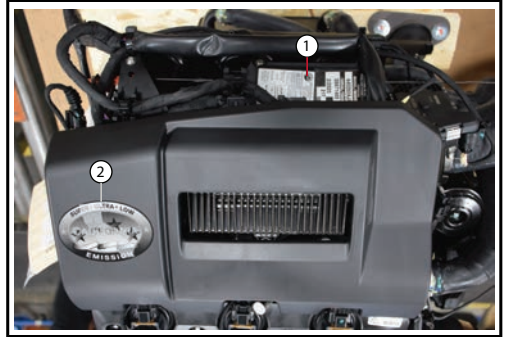

TYPICAL TOP OF ENGINE (BEAUTY COVER INSTALLED)

1. Emissions control information
2. Ultra low emission decal

BREAK-IN AND SPECIAL PROCEDURES

BREAK-IN AND SPECIAL PROCEDURES

BREAK-IN

OPERATION

NOTICE

Carefully follow the instructions in this section. Failure to do so may reduce the life and/or performance of the engines.

A break-in period of 3 hours is required before continuous operation at full throttle.

To achieve a good break-in, a maximum of 3/4 throttle should be observed, however, brief acceleration and speed variations contribute to a good break-in.

NOTICE

Continued wide open throttle runs and prolonged cruising without speed variations should be avoided. This can cause engine damage during the break-in period.

ENGINE SPEED LIMITATION — 130, 170, 230, 300 and 325 ENGINE MODELS

IMPORTANT: During the first three (3) hours of operation engine speed is limited by a break-in strategy programmed into the ECM.

Depending on the engine model and boat combination, maximum engine speed could be reduced to 7000 RPM or less.

Over the initial three hours of operation, the engine speed limitation is progressively reduced.

At the conclusion of the three hour run time, maximum engine speed is available.

JET PUMP WATER INTAKE AND IMPELLER CLEANING

Water is drawn up by the impeller through these openings. The grate minimizes entry of foreign objects into the propulsion system.

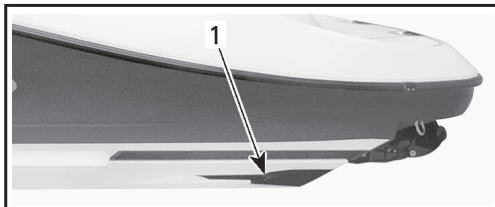

1. Intake grate

⚠ WARNING

Keep away from intake grates while engines are running. Items such as long hair, loose clothing or personal flotation device straps can become entangled in moving parts resulting in severe injury or drowning.

Weeds, shells or debris can get caught on the intake grates, drive shafts and/or impellers. A clogged water intake may cause troubles such as:

1. **Cavitation:** Engine speed is high but boat moves slowly due to reduced jet thrust. Jet pump components may be damaged.
2. **Overheating:** Since the jet pump operation controls the flow of water to cool the exhaust system, a clogged intake will cause the engine to overheat and damage internal engine components.

NOTICE

Avoid operation in weeded areas. If unavoidable, vary speed. Weeds tend to entangle more at steady and slow speeds. Inspect water intake grates for damage. Refer to an authorized Rotax® Jet Propulsion systems dealer for repair as necessary.

IN-WATER CLEANING

Pull the tether cord from engine cut-off switch to stop engine (s). Let the boat stop by itself. Wait a while to allow weeds or other debris to escape from grate(s). It may be necessary to repeat the procedure. In severe conditions if the above method does not work, the following can be performed:

1. With engine (s) running, put shifter lever in reverse position and vary throttle setting quickly several times.
2. Try accelerating again. Most of the time, debris will escape from the propulsion system. If not, refer to OUT OF WATER CLEANING.

OUT OF WATER CLEANING** WARNING**

Keep away from intake grates while engines are running. Items such as long hair, loose clothing or personal flotation device straps can become entangled in moving parts resulting in severe injury or drowning.

From underneath boat, manually clean water intakes area. If the system is still clogged, refer to an authorized boat dealer for servicing.

In Water Towing— Hose Pincher Installation Locations

NOTICE

Special precautions **MUST** be taken when towing a BRP Rotax powered boat in the water to prevent the exhaust system and engine from filling with water.

Maximum recommended towing speed is 24 km/h (15 MPH).

IMPORTANT: On models with twin engines, this procedure must be followed for both engines.

The cooling water supply hose to the inter-cooler (if applicable) and to the exhaust system **MUST** be pinched closed.

A Hose Pincher Tool, P/N 460717, is available for this purpose.

NOTE: The clamp(s) shown in the images below are not representative of 460717, but indicate where the hoses must be pinched.

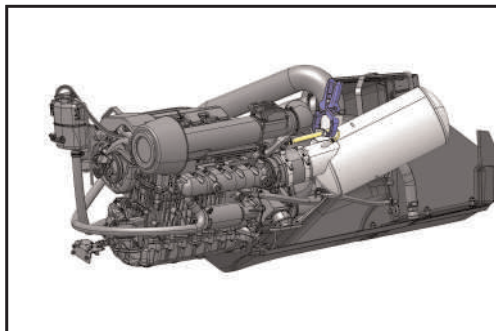

300 NON CAT ENGINES

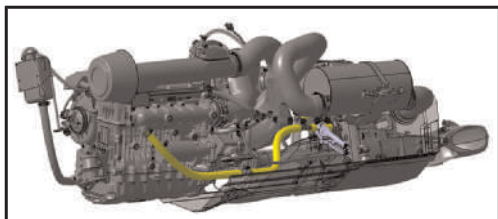

130, 170, 230 CAT ENGINES

SPECIAL PROCEDURES

iNR System Overview

The iNR (intelligent Neutral & Reverse) is an electronically controlled shifting system. The iNR system replaces the traditional mechanical cable/gate activation (Reverse-Neutral-Forward) with a fly-by-wire style system that uses an electronic actuator to eliminate the mechanical forces on the controller. The iNR actuator controls the position of the reverse gate via a push/pull cable, providing effortless forward and reverse shifting with a true neutral position.

The neutral position of the boat can be adjusted on-the-fly to obtain optimal forward/aft movement using the Neutral Adjustment function in the helm gauge cluster.

This function provides an adjustable window of +15 (forward) to -15 (reverse).

iNR Neutral Adjustment

IMPORTANT: The boat must be in the water with the engine running and the throttle control lever in the neutral position.

Boats equipped with a touch screen: Simply press the neutral adjustment arrows located on the home screen.

Boats equipped with the standard gauge cluster: Access the neutral adjustment using the gauge cluster “settings” menu.

Use the UP and DOWN switch to locate NEUTRAL ADJUSTMENT and press set to enter the NEUTRAL ADJUSTMENT screen.

Press the SET button again to access the NEUTRAL ADJUSTMENT. Use the UP and DOWN switch to make the changes.

NOTE: Adjustment will be stored by pressing the SET button or moving the throttle control arm.

NOTE: When the neutral adjustment is completed, the value is stored in the system memory.

iNR Override

WARNING

Keep hands and objects clear of the pump area when using override mode. Unexpected movement of the reverse gate can cause severe injury.

With the engine OFF, the iNR shift function will not operate. The iNR can only be used to command a change in the gate position if the engine is running. For iNR override procedures, see the appropriate service manual or your Rotax® servicing dealer.

Intelligent Debris Free Pump System (iDF)

The iDF system is designed to allow removing small debris or a cord caught in the jet pump by turning the propeller in reverse for a few seconds.

To activate the system, refer to your OEM's instrument cluster / information center instructions.

This page is intentionally blank

INSPECTIONS AND MAINTENANCE

INSPECTIONS AND MAINTENANCE

PRE-RIDE INSPECTION

WARNING

The pre-ride inspection is very important before operating the boat. Bring all safety equipment required by local laws. Perform a pre-ride inspection before each ride to detect potential problems during operation. The pre-ride inspection can help you monitor wear and deterioration before they become a problem. Correct any problems that you discover to reduce the risk of a breakdown or accident.

For more detailed information on these items, refer to the applicable sections.

WARNING

Engines must be off and the tether cord removed from engine cut-off switch except where specified otherwise.

PRE-RIDE CHECKLIST WHEN BOAT IS TRAIERED TO WATERWAY (RECOMMENDED CHECKS)

SUMMARY

	ITEM	OPERATION	CHECK
BOAT ON TRAILER	Fuel tank	Refill	
	Hull and deck	Inspect hull, ride plate and water inlet grate for damages. Properly clean the hull before launching the watercraft when moving to a different body of water to prevent spreading of aquatic invasive species.	
	Jet pump water intake	Inspect/clean	
	Bilge	Check for abnormal water presence in bilge and ensure drain	

**PRE-RIDE CHECKLIST WHEN BOAT IS TRAILERED TO WATERWAY
(RECOMMENDED CHECKS)**

		plug is properly secured	
	Engine compartment	Verify for leaks or gasoline vapor odor. Verify fuel system components integrity.	
	Throttle lever	Check operation	
	Shift lever	Check operation	
	Steering	Check operation	
	Bilge blower	Turn ON bilge blower to ventilate bilge. Refer to the Boat Manufacturer Operator's guide.	
	Instrumentation	Check operation	
	Mandatory safety boating equipment	Ensure all required safety equipment is on board	
	Storage compartment covers	Ensure they are closed and latched	
	Navigation lights	Check operation	
	Engine(s) start/stop switch	Check operation for starting and stopping engine(s)	
	Engine cut-off-switch	Check if engine can be stopped by pulling off the tether cord from the engine cut-off-switch.	
	Removable cushions	Removable cushions securely fastened or stowed.	

PRE-RIDE CHECKLIST WHEN BOAT IS TRAILERED TO WATERWAY (RECOMMENDED CHECKS)			
BOAT IN WATER (ENGINE STARTED)	Throttle lever	Check operation	
	Shift lever	Check operation	
	Steering	Check operation	

PRE-RIDE CHECKLIST

PRE-RIDE CHECKLIST WHEN BOAT IS MOORED TO A DOCK			
SUMMARY			
	ITEM	OPERATION	CHECK
BOAT AT THE DOCK	Fuel tank	Refill	
	Bilge	Check for abnormal water presence in bilge and ensure drain plug is properly secured	
	Engine compartment	Verify for leaks or gasoline vapor odor. Verify fuel system components integrity.	
	Throttle lever	Check operation	
	Shift lever	Check operation	
	Steering	Check operation	
	Bilge blower	Turn ON bilge blower to ventilate bilge. Refer to the Boat Manufacturer Operator's guide.	
	Instrumentation	Check operation	
	Mandatory safety boating equipment	Ensure all required safety equipment is on board	
	Storage compartment covers	Ensure they are closed and latched	
	Navigation lights	Check operation	
	Engine(s) start/stop switch	Check operation for starting and stopping engine(s)	

PRE-RIDE CHECKLIST WHEN BOAT IS MOORED TO A DOCK

	Engine cut-off-switch	Check if engine can be stopped by pulling off the tether cord from the engine cut-off-switch.	
	Removable cushions	Removable cushions securely fastened or stowed.	
BOAT IN WATER (ENGINE STARTED)	Throttle lever	Check operation	
	Shift lever	Check operation	
	Steering	Check operation	

POST OPERATION CARE

1. Remove the boat from the water every day to prevent growth of marine organisms.
2. With the boat removed from the water, start the engine, and let idle.
3. Run the engine at 5000 RPM for 5 seconds.
4. Stop the engine.

NOTE: Running the engine removes excess water from the exhaust system.

NOTICE

Failure to perform proper care such as boat rinsing, exhaust system flushing and anti-corrosion treatment when used in salt water will result in damage to the boat and its components.

WARNING

Allow engine to cool before performing any maintenance.

Exhaust System Flushing

The exhaust system should be flushed daily when boat is used in salt or foul water.

On supercharged models, the intercooler is flushed at the same time.

Anti-Corrosion Treatment

To prevent corrosion, spray a corrosion inhibitor (salt water resistant) such as XPS® Lube, P/N 9779701, or equivalent over metallic components in engine compartment.

Engine fogging should be done with XPS® Lube, P/N 9779701, or equivalent whenever the boat is to be stored for an extended period of time.

Apply Dielectric Grease, P/N 460781,

(salt water resistant) on battery posts and cable connectors.

NOTICE

Never leave rags or tools in the engine compartment or in the bilge.

Additional Care For Foul Water or Salt Water Use

When the boat is operated in foul water and particularly in salt water, additional care must be taken to protect the boat and its components.

Rinse trailer and boat's hull/bilge area with fresh water.

Never use a high pressure washer to clean the bilge. USE LOW PRESSURE ONLY (such as a garden hose). High pressure can cause damage to electrical or mechanical systems.

In coastal areas, special care should also be taken on stainless steel or chrome parts like grab handles, mooring cleats, fuel cap and navigation lights.

INSPECTIONS AND MAINTENANCE

EXHAUST SYSTEM

DANGER

DO NOT run the engine indoors or without adequate ventilation or permit exhaust fumes to accumulate in confined areas. Engine exhaust contains carbon monoxide (CO) which, if inhaled, can cause serious brain damage or death.

Exhaust System Flushing

Flushing the exhaust system with fresh water is essential to neutralize corroding effects of salt or other chemical products present in water. It will help to remove sand, salt, shells or other particles in water jackets, exhaust system, intercooler (supercharged engines) and hoses.

Exhaust system flushing should be performed when the boat is not expected to

be used further the same day or when the boat is stored for any extended time.

NOTICE

Failure to flush the system, when necessary, will severely damage the engine intercooler or exhaust system. Make sure the engine operates during the entire flushing procedure.

WARNING

Perform these operations in a well ventilated area. Certain components in the engine compartment may be very hot. Direct contact may result in skin burn. Do not touch any electrical part or jet pump area when engine is running.

WARNING

When performing these operations while the boat is out of the water, the heat exchanger in the ride plate may become very hot. Avoid any contact with ride plate as burns may occur.

1. Connect a water hose to connector located at the rear of boat on jet pump support. Do not open water tap yet.

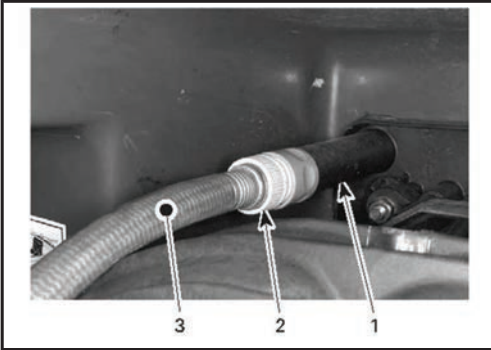
**TYPICAL**

1. Flushing connector
2. Quick connect adapter and flushing connector adapter (optional)
3. Water hose

NOTE:

The following tool is recommended when a quick connect adapter is used to ease water hose installation.

Required Tool**Flushing Connector Adapter**

P/N 460711

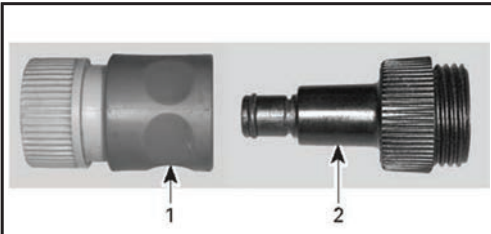

1. Quick connect adapter
2. Flushing connector adapter

2. To flush the exhaust system, start the engine then immediately open the water tap.

NOTICE

Always start the engine before opening the water tap. Open water tap immediately after engine is started to prevent overheating. Never run engine without supplying water to the exhaust system when boat is out of water.

3. Run the engine about 20 seconds at a fast idle.

NOTICE

Never run engine longer than 2 minutes. Drive line seal has no cooling when boat is out of water.

4. Ensure the water flows out of the jet pump while flushing.

NOTE: If water does not flow freely out of the jet pump during flushing, refer to an authorized *Rotax*® marine engine dealer for service.

5. Close the water tap.

NOTICE

Always close water tap before stopping the engine.

6. Run the engine at 5000 RPM for 5 seconds and stop the engine.

NOTE: Running the engine removes excess water from the exhaust system.

7. Disconnect the water hose.

NOTICE

Remove flushing connector adapter after operation (if used).

Optional Flushing Kit

Remote Flush Kit, P/N 461478, is designed to work with the Rotax 130, 170, 230, 300, and 325 ACE engines. Use the

onboard flush kit to flush the exhaust system.

For the installation procedure refer to the instruction sheet provided with the kit.

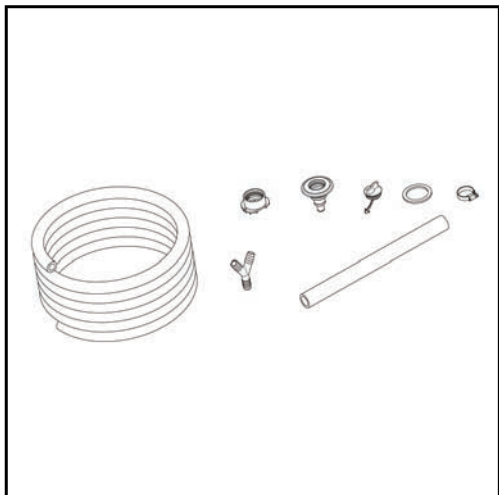

1. Remote flush kit P/N 461478

MAINTENANCE SCHEDULE

The boat should be serviced as per the maintenance schedule.

A repair shop or person the owner's choosing may maintain, replace, or repair emission control devices and systems. These instructions do not require components or service by BRP or authorized Rotax® Jet Propulsion dealers. Although an authorized Rotax® Jet Propulsion dealer has an in-depth technical knowledge and tools to service the Rotax® Jet Propulsion System, the emission-related warranty is not conditioned on the use of an authorized Rotax® Jet Propulsion dealer or any other establishment with which BRP has a commercial relationship. For emission-related warranty claims, BRP is limiting the diagnosis and repair of emission-related parts to the authorized Rotax® Jet Propulsion dealers. For more information, please refer to the US EPA EMISSION RELATED WARRANTY contained herein. Proper maintenance is the owner's responsibility. A warranty claim may be denied if, among other things, the owner or operator caused the problem through improper maintenance or use.

You must follow the instructions for fuel requirements in the fueling section of this Guide. Even if gasoline containing greater than ten volume percent ethanol is readily available, the US EPA issued a prohibition against the use of gasoline containing greater than 10 vol% ethanol that applies to this vehicle. The use of gasoline containing greater than 10% ethanol with this engine may harm the emission control system.

The schedule should be adjusted according to operating conditions and use. Intensive use of engine will require greater frequency of inspection and maintenance.

The maintenance schedule does not exempt the pre-ride inspection.

WARNING

Failure to properly maintain the boat according to the maintenance schedule can make it unsafe to operate.

INSPECTIONS AND MAINTENANCE

ROTAX JET PROPULSION PERIODIC MAINTENANCE SCHEDULE

TO BE PERFORMED BY				
EVERY 200 HOURS OR 2 YEARS				
EVERY 100 HOURS OR PRE-SEASON				
FIRST 50 HOURS				
PART/TASK				
ENGINE				
Engine oil and filter	R	R ⁽¹⁾		RS
Rubber mounts	I	I		O, RS
Corrosion protection ⁽³⁾		L ⁽⁴⁾		O
EXHAUST SYSTEM				
Exhaust system (including hoses, fasteners, components and leaks)	I	I, C		O, RS
Exhaust system flushing		I, C ⁽⁵⁾		O
COOLING SYSTEM				
Hose and fasteners	I	I		O, RS
Coolant	I		R	O, RS
FUEL SYSTEM				
Throttle body	I	I		O, RS
Fuel lines, connections, pressure relief valve and fuel system leak test	I	I		RS
ENGINE MANAGEMENT SYSTEM				
Fault Codes	I	I		O, RS
AIR INTAKE SYSTEM				
Air filter		I, ⁽⁶⁾		RS

ELECTRICAL SYSTEM				
Test the engine cut-off switch and the monitoring beeper at first 50 hours and every 100 hours or once a year	I	I		O
Spark plugs	I	I	R	RS
Ignition coils	I	I		RS
Electrical connections and fastening (visual inspection)	I	I		RS
STEERING SYSTEM				
Steering cable and connections	I ⁽⁵⁾	I		O
Steering nozzle bushings	I ⁽⁵⁾	I		O, RS
PROPULSION SYSTEM				
Carbon ring and rubber boot (drive shaft)	I	I		RS
Shifter system, cable and connections	I ⁽⁵⁾	I		O, RS
Reverse gate	L ⁽⁵⁾	L		RS
Drive shaft / impeller splines		I, L		RS
Drive shaft		L ⁽⁷⁾		RS
Impeller boot	I	I		RS
Impeller shaft seal		I	R ⁽²⁾	RS
Impeller wear ring clearance	I	I		RS
Sacrificial anode		I ⁽⁸⁾		O
HULL AND BODY				
Ride plate and water intake grate		I		O
<p>A: ADJUST C: CLEAN I: INSPECT L: LUBRICATE R: REPLACE RS: REPAIR SHOP O: OPERATOR</p> <p>1) At storage period or after 100 hours of use whichever comes first 2) Replace at 200 hours of use, irrespective of the number of years 3) Spray an anti-corrosion lubricant on metallic components in engine compartment 4) Every 10 hours in salt water 5) Flush every 6 weeks when used in salt water or foul water. 6) Replace if required 7) Lubricate for corrosion protection 8) Inspect each month and change when necessary</p>				

INSPECTIONS AND MAINTENANCE

GENERAL

This section includes instructions for basic maintenance procedures.

WARNING

Turn off the engine and follow these maintenance procedures when performing maintenance. If you do not follow proper maintenance procedures you can be injured by hot parts, moving parts, electricity, chemicals or other hazards.

WARNING

Should removal of a locking device be required (e.g. lock tabs, self-locking fasteners, etc.), always replace it with a new one.

CAUTION

Some components in the engine compartment may be very hot.

Recommended Engine Oil For ROTAX ACE 130, 170, 230, 300 Engines

Use XPS® 4- STROKE 5W40 or 10W40 SYNTH. BLEND OIL.

If the recommended XPS® engine oil is not available, use a 5W40 or 10W40 engine oil meeting the requirements for API service classification SN or JASO MA2. Always check the API service label certification on the oil container, it must contain at least one of the above standards.

Engine Oil Level

NOTICE

These engines have been developed and validated using the BRP XPS® Synthetic blend oil. BRP recommends the use of its XPS® Synthetic blend oil at all times. If the recommended XPS® engine oil is not available, use a 5W40 or 10W40 mineral engine oil compatible with wet clutches. Damages caused by oil which is not suitable for the engine may not be covered by the BRP limited warranty.

NOTICE

NEVER use fully synthetic oil. This would impair the proper operation of the supercharger clutch. Do not add any additives to the recommended oil. Mineral oils for API service classification SM contain additives (friction modifiers) that may cause inappropriate slippage of the supercharger and eventually lead to premature wear.

NOTICE

Check level frequently and refill if necessary. Operating the engines with improper oil levels may severely damage engines.

IF THE BOAT IS IN OR OUT OF THE WATER

It is of the utmost importance to follow this procedure in order to obtain an accurate reading of the engine oil level.

⚠ CAUTION

Engine oil may be hot. Certain components in the engine compartment may be very hot. Direct contact may result in skin burn.

1. Ensure engine is at normal operating temperature.
2. Let engine run at idle speed for 30 seconds. **DO NOT INCREASE ENGINE RPM BEYOND IDLE.**

NOTE: If the engine is operated past idle speed during the 30 second time, results will be inaccurate. Return to step 1.

3. Stop engine
4. Wait at least 30 seconds
5. Pull dipstick out and wipe clean

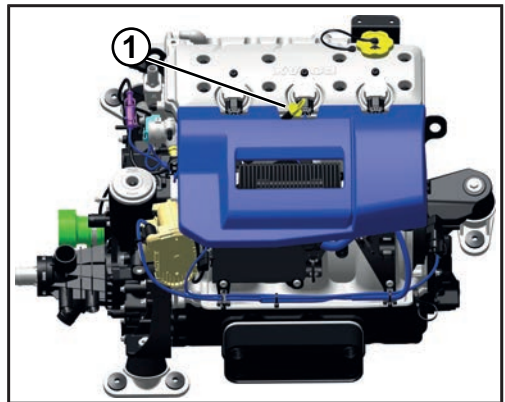

TYPICAL

1. Oil dipstick

6. Reinstall dipstick, push in completely
7. Remove dipstick and read oil level. It should be between marks.

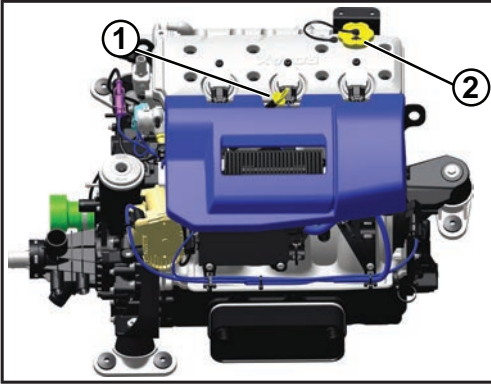

TYPICAL

1. Oil dipstick
2. Oil cap

IMPORTANT: Boat must be leveled. Oil level can be checked either with boat in water or out of water.

If The Boat Is Out Of The Water

If the boat is out of the water and on a trailer, block the wheels and raise the bow slightly with the trailer jack (if so equipped) until the bumper rail is level.

Install a water hose to the flushing connector. Refer to **EXHAUST SYSTEM FLUSHING**.

NOTICE

Never run engine without supplying water to the exhaust systems when boat is out of water. Failure to supply water to the exhaust systems may severely damage exhaust systems.

NOTICE

Never run engine longer than 2 minutes. Drive line seals have no cooling when boat is out of water.

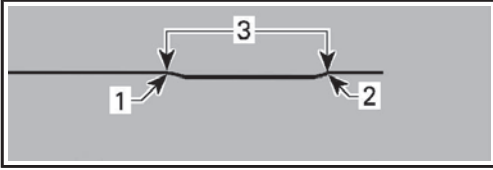

8. If needed, add oil up to have the level between marks as required.
9. To add oil, unscrew oil cap. Place a funnel into the opening and add the recommended oil to the proper level. Do not overfill.
10. Properly reinstall oil cap and dipstick.
11. If you have 2 inboards: Repeat the procedure on the other engine.
12. Wipe off any oil spillage that may have occurred during this procedure.

Engine Coolant

Recommended Engine Coolant

Always use ethylene-glycol antifreeze containing corrosion inhibitors specifically for internal combustion aluminum engines.

ENVIRONMENTAL NOTE

When available, it is recommended to use biodegradable antifreeze compatible with internal combustion aluminum engines. This will contribute to protecting the environment.

Cooling system must be filled with BRP Pre-mixed Coolant, P/N 9779150, or with a water and antifreeze solution (50% distilled water, 50% antifreeze).

Refer to an authorized Rotax® Jet Propulsion dealer

ENGINE COOLANT LEVEL

With boat on a level surface, coolant should be between MIN. and MAX. level marks for each coolant reservoir when each engine is cold.

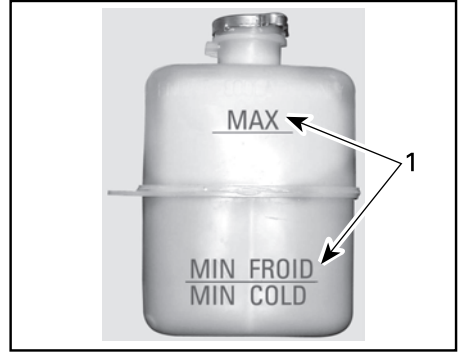

1. Level between marks when engine is cold

⚠ WARNING

Check coolant level with cold engine. Never add coolant in cooling system when engine is hot.

IMPORTANT: The boat is considered level when it is in water. When boat is on a trailer, block the wheels and raise the bow slightly with the trailer jack (if so equipped) until the bumper rail is level.

Add coolant to have the level between marks as required. Use a funnel to avoid spillage. Do not overfill.

Properly reinstall and tighten filler cap.

IMPORTANT: A cooling system that frequently requires coolant indicates leaks or engine problems. See an authorized Rotax® Jet Propulsion dealer.

Anodes

Your boat is equipped with one or more sacrificial anodes that protect it from galvanic corrosion. Disintegration of the anode is normal and indicates it is working. Check each anode periodically. Replace anodes smaller than 2/3 their original size. See your dealer for replacements.

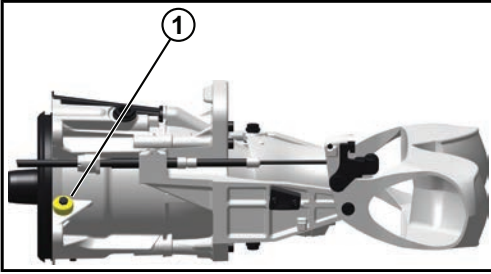

PORT SIDE

1. Anode

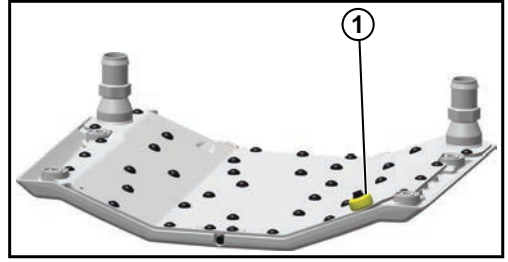

SINGLE ENGINE RIDE PLATE

1. Anode

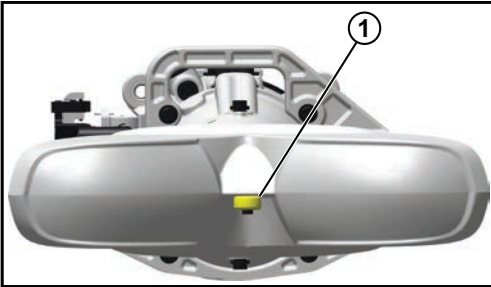

REVERSE GATE

1. Anode

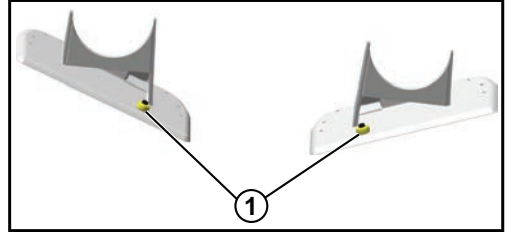

TWIN ENGINE RIDE PLATES

1. Anodes

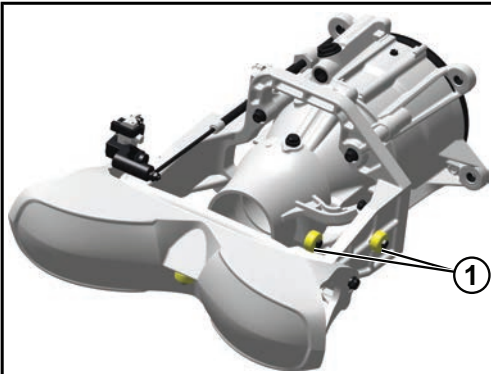

STARBOARD SIDE

1. Anodes

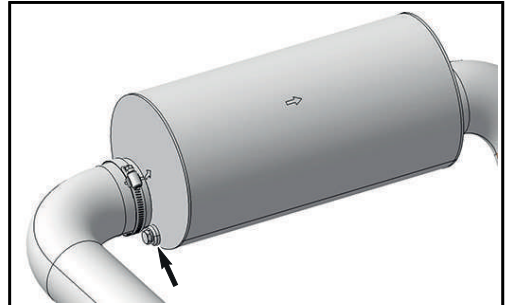

RESONATOR, ANODE LOCATION (IF APPLICABLE)

Galvanic corrosion destroys underwater metal parts and can occur in fresh or salt water; however, salt, brackish, and polluted waters will accelerate corrosion.

Metal-based anti-fouling paint on the boat and the use of improperly installed

shore power in the area of your moored boat will also accelerate corrosion.

NOTICE

NEVER paint the anode, its fasteners, or its mounting surface. Painting will reduce its corrosion protection.

Hull Finish

The condition of your boat's bottom affects performance. Marine growth or bottom painting may reduce speed and fuel efficiency.

For maximum performance, keep the boats' surface clean by rinsing it with fresh water and wiping it dry. Apply anti-corrosion spray to any surface subject to corrosion, but avoid the anti-corrosion anode(s).

Storage

It is recommended that the boat be taken to an authorized Rotax Jet Propulsion dealer, repair shop, or person of your choosing for proper storage but the following operations can be performed by you with a minimum of tools.

IMPORTANT: Leave the drain plug out during the storage period.

Jet Pump Cleaning

Clean the jet pump by spraying water into the jet pump inlet and outlet. Apply a coating of XPS® Lube, P/N 9779701, or equivalent.

⚠ WARNING

Always remove the tether cord cap from the engine cut-off switch to prevent unexpected engine starting before cleaning the jet pump area. The engine must not be running for this operation.

Fuel System Protection

XPS® Fuel Stabilizer, P/N 460795, (or equivalent), can be added in fuel tank to prevent fuel deterioration and fuel system gumming. Follow stabilizer manufacturers instructions for proper use.

NOTICE

It is highly recommended to add fuel stabilizer at storage in order to maintain fuel system in good condition.

Engine Oil and Filter Replacement

The oil change and filter replacement may be performed by an authorized Rotax Jet Propulsion dealer, repair shop, or person of your choosing.

INTERCOOLER DRAINING

It is important to expel any trapped water that may have accumulated from condensation in the intercooler of each engine.

1. Open the engine cover.
2. Locate the intercooler outlet hose. Verify that there is an alignment mark on the hose where it meets the engine and on the intercooler.
3. Loosen the clamp retaining the intercooler outlet hose.
4. Remove the intercooler outlet hose from the intercooler.

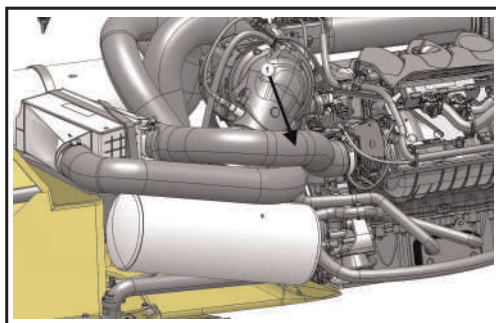

1. Intercooler outlet hose

5. Start and rev the engine up to 4000 rpm several times.

IMPORTANT: Prevent air intake system from aspirating foreign objects which may cause severe engine damage.

6. Stop engine.
7. Reinstall the intercooler air outlet hose.

IMPORTANT: Properly align the intercooler air outlet hose upon installation to ensure proper operation.

EXHAUST SYSTEM AND INTERCOOLER PROTECTION

Flushing-Air

Expel water from the exhaust system and intercooler as follows:

Using the flushing connectors on the jet pump supports, inject pressurized air (around 689 kPa (100 psi)) into the system until there is no more water flowing from the jet pumps.

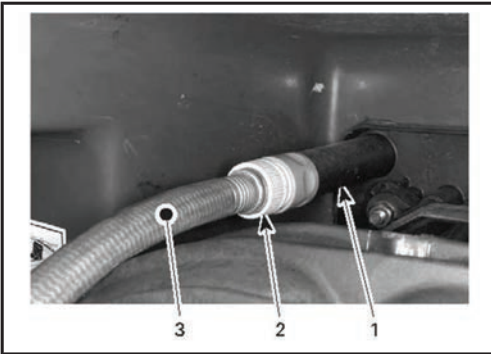

TYPICAL

1. Flushing connector
2. Quick connect adapter and flushing connector adapter (optional)
3. Water hose

To ease the procedure, a custom hose can be assembled. See the following illustration.

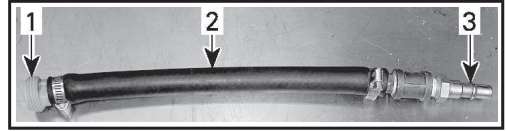

TYPICAL

1. Flushing connector adapter
2. Hose 13 mm (1/2 in.)
3. Air hose male adapter

NOTICE

Failure to drain the exhaust system may cause severe damage to intercooler and exhaust manifold.

ENGINE INTERNAL LUBRICATION

IMPORTANT: All engines, single or twin engine configurations, must be internally lubricated for the storage period.

1. Open the engine compartment lid.
2. Remove storage tray.
3. Remove dipstick.
4. Remove engine cover.
5. Reinstall dipstick.
6. Remove ignition coils. Refer to *MAINTENANCE PROCEDURES* section.
7. Remove spark plugs. Refer to *MAINTENANCE PROCEDURES* section.

NOTICE

Ensure there is no dirt in coil holes before removing the spark plugs. Otherwise, dirt would fall into cylinder and will damage the internal components.

IMPORTANT: After loosening the spark plugs, a coil may be used to remove the spark plugs. Simply bring the coil down to spark plug and "hook" it, then extract spark plug.

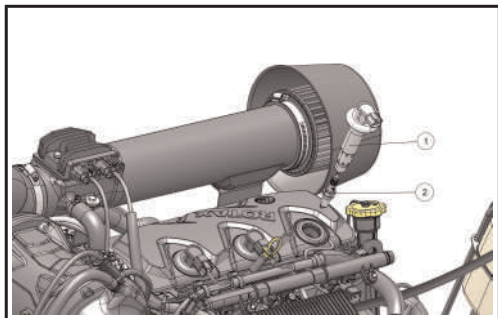

1. Ignition coil
2. Spark plug

8. Spray XPS® Lube, P/N 9779701, or equivalent, into spark plug holes.

IMPORTANT: To allow engine lubrication for storage, the DROWNED MODE can be activated to prevent fuel injection and ignition while cranking in order to lubricate the cylinder walls.

IMPORTANT: Ask a person to assist you for this operation.

9. To activate drowned mode, ensure both engines are OFF.

⚠ WARNING

Both engines must be stopped when using drowned mode to lubricate the engines.

10. Install the tether cord on the engine cut-off switch.
11. Ensure the throttle/shifter lever is in the NEUTRAL position
12. Move the throttle accelerator sensor (TAS) to the wide open throttle (WOT) position.
13. Turn the ignition key to the ON position.

IMPORTANT: The ECM will allow engine cranking while inhibiting fuel injection and ignition. Do not crank the engine(s)

14. Ensure both engines are OFF.
15. Crank each engine a few turns to distribute the oil on the cylinder walls.
16. Release the TAS.
17. Turn the ignition key to the OFF position.
18. Apply anti-seize lubricant over the spark plug threads to prevent possible seizure.
19. Lubricate and install the ignition coils.
20. Reinstall the engine cover until it snaps properly into place.
21. Install the oil dipstick.

IMPORTANT: It is recommended to fog the engine valves with XPS® Lube, P/N 9779701 or equivalent. Contact your authorized Rotax Jet Propulsion dealer.

Engine Coolant Test

If the antifreeze is not replace, test the density.

The antifreeze replacement and a density test should be performed by an authorized Rotax Jet Propulsion dealer.

NOTICE

Improper antifreeze density may allow freezing of the liquid in the cooling system if the boat is stored in an area where the freezing point is attained. This would seriously damage the engine.

Battery Removal and Storage

For battery removal, cleaning and storage, contact your Rotax Jet Propulsion dealer.

Preseason Preparation

Maintenance preparation must be performed in conjunction with the maintenance schedule.

Ensure to perform all tasks included in the 100 hours or Pre-Season column.

Preseason maintenance preparation may be performed by an authorized

Rotax Jet Propulsion dealer, repair shop, or person of your own choosing.

performed by the authorized Rotax Jet Propulsion dealer.

Though not required, it is recommended that an authorized Rotax Jet Propulsion dealer perform preseason maintenance preparation at the same time that any safety-related factory campaigns are

WARNING

Only perform procedures as detailed in the maintenance schedule. It is recommended that the assistance of an authorized Rotax® Jet Propulsion dealer be periodically obtained on other components and systems not covered in this Guide.

NOTICE

When component conditions seem less than satisfactory, replace using genuine BRP parts, or equivalents.

Maintenance Records

Send photocopy of maintenance record to BRP if needed.

Predelivery	
Serial number: _____ Mileage / km: _____ Hours: _____ Date: _____ Dealer no.: _____ Notes: _____ _____ _____	Signature/Print:
Refer to vehicle Pre-Delivery Bulletin for detailed installation procedures	

First Inspection	
Mileage / km: _____ Hours: _____ Date: _____ Dealer no.: _____ Notes: _____ _____ _____	Signature/Print:
For maintenance schedule, refer to Maintenance Information section of this operator's guide	

Service

Mileage / km: _____
Hours: _____
Date: _____
Dealer no.: _____
Notes: _____

Signature/Print:

For maintenance schedule, refer to Maintenance Information section of this operator's guide

Service

Mileage / km: _____
Hours: _____
Date: _____
Dealer no.: _____
Notes: _____

Signature/Print:

For maintenance schedule, refer to Maintenance Information section of this operator's guide

Service

Mileage / km: _____
Hours: _____
Date: _____
Dealer no.: _____
Notes: _____

Signature/Print:

For maintenance schedule, refer to Maintenance Information section of this operator's guide

Service

Mileage / km: _____
 Hours: _____
 Date: _____
 Dealer no.: _____
 Notes: _____

Signature/Print:

For maintenance schedule, refer to Maintenance Information section of this operator's guide

Service

Mileage / km: _____
 Hours: _____
 Date: _____
 Dealer no.: _____
 Notes: _____

Signature/Print:

For maintenance schedule, refer to Maintenance Information section of this operator's guide

Service

Mileage / km: _____
 Hours: _____
 Date: _____
 Dealer no.: _____
 Notes: _____

Signature/Print:

For maintenance schedule, refer to Maintenance Information section of this operator's guide

This page is intentionally blank

TECHNICAL SPECIFICATIONS

TECHNICAL SPECIFICATIONS

SPECIFICATIONS

Engine		
Engine Type		4-stroke, Single Over Head Camshaft (SOHC)
Number of Engines		1, (2)
Model		Rotax® 1630 ACE - 130 ECT Rotax® 1630 ACE - 170 ECT Rotax® 1630 ACE - 230 ECT Rotax® 1630 ACE -300
Declared Power ⁽¹⁾	Rotax® 1630 ACE - 130 ECT	100 kW @ 7200 RPM
	Rotax® 1630 ACE - 170 ECT	125.03 kW @ 7950 RPM
	Rotax® 1630 ACE - 230 ECT	169.16 kW @ 8000 RPM
	Rotax® 1630 ACE - 300	217 kW @ 8000 RPM
Induction	Rotax® 1630 ACE - 130 ECT Rotax® 1630 ACE - 170 ECT	Naturally-Aspirated
	Rotax® 1630 ACE - 230 ECT Rotax® 1630 ACE - 300	Supercharged and intercooled
Exhaust System		D-Sea-Bel sound reduction system. Water cooled/water injected (open loop). Direct flow from jet pump
Number of Cylinders / Engine		3
Number of valves / Engine		12 valves with hydraulic lifters (no adjustment)
Bore		100 mm (3.9 in)
Stroke		69.7 mm (2.7 in)
Displacement		1630.5 cm ³ (99.5 in ³)

Engine		
Compression Ratio	Rotax® 1630 ACE - 130 ECT Rotax® 1630 ACE - 170 ECT	11.0:1
	Rotax® 1630 ACE - 230 ECT	8.3:1
	Rotax® 1630 ACE - 300	8.4:1

(1) Declared power as per ISO 8665 at propeller-shaft.

Lubrication System		
Type		Dry sump (2 oil pumps). Replaceable oil filter. Water-cooled oil cooler
Engine oil	Recommended	See <i>Recommended Engine Oil</i> in <i>Maintenance Procedures</i> section of this guide
	Capacity	3 l (3.2 qt(liq.,US)) oil change w/filter 5 l (5.3 qt(liq.,US)) total

Cooling System		
Type		Closed-loop cooling system (CLCS)
Coolant	Recommended coolant	See <i>Recommended Engine Coolant</i> in <i>Maintenance Procedures</i> section of this guide
	Capacity	5.4 l (5.7 qt(liq.,US)) total

Fuel System	
Fuel injection type	Multipoint fuel injection with iTC (intelligent Throttle Control). Single throttle body (60 mm) with an actuator
Fuel Tank	See documentation of hull manufacturer

Fuel System			
Fuel	Type	Rotax® 1630 ACE - 130 ECT Rotax® 1630 ACE - 170 ECT Rotax® 1630 ACE -230 ECT	Regular unleaded Refer to <i>Fuel Requirements</i>
		Rotax® 1630 ACE - 300	Premium unleaded Refer to <i>Fuel Requirements</i>
	Recommended octane	Rotax® 1630 ACE - 130 ECT Rotax® 1630 ACE - 170 ECT Rotax® 1630 ACE -230 ECT	Inside North America 87 Pump Posted AKI (RON+MON)/2
			Outside North America 91 (RON) E10
		Rotax® 1630 ACE - 300	Inside North America 91 Pump Posted AKI (RON+MON)/2
			Outside North America 95 (RON) E10 ⁽¹⁾

⁽¹⁾For optimum engine performance.

Electrical System			
Magneto Generator Output		650 W @ 6000 RPM	
Ignition system type		IDI (inductive discharge ignition)	
Spark plug	Make and type	Rotax® 1630 ACE - 130 ECT Rotax® 1630 ACE - 170 ECT Rotax® 1630 ACE - 230 ECT	NGK, DCPR8E with solid post or equivalent
		Rotax® 1630 ACE - 300	NGK, KR9C-G with solid post or equivalent
	Gap	Rotax® 1630 ACE - 130 ECT Rotax® 1630 ACE - 170 ECT Rotax® 1630 ACE - 230 ECT	0.80 to 0.90 mm (.031 to .035 in)

Electrical System			
		Rotax® 1630 ACE - 300	0.70 to 0.80 mm (.028 to .031 in)
Starting System			Electric starter
Maximum Engine Speed Under Load		Rotax® 1630 ACE - 130 ECT	7300 +/- 100 RPM
		Rotax® 1630 ACE - 170 ECT Rotax® 1630 ACE - 230 ECT Rotax® 1630 ACE - 300	7800 +/- 200 RPM
		Rotax® 1630 ACE - 130 ECT	7400 RPM
Engine RPM Limiter Setting		Rotax® 1630 ACE - 170 ECT Rotax® 1630 ACE - 230 ECT Rotax® 1630 ACE - 300	8050 RPM

Propulsion			
Propulsion system		BRP® jet pump	
Jet pump	Type	Axial flow, single stage, large hub with double row ball bearings	
	Material	Aluminum	
Jet pump grease		XPS® Jet pump bearing grease	
Impeller		Stainless steel	
Transmission	Coupling type	Crowned splines, direct drive	
Pivoting Angle and Direction (Nozzle)		20°	
Minimum Required Water Level for Jet Pumps		90 cm (3 ft) underneath the lowest rear portion of hull	

Dimensions, Weight and Loading Capacity
--

See documentation of hull manufacturer
--

NOTE:

BRP reserves the right to make changes in design and specifications and/or to make additions to, or improvements in its products without imposing any obligation upon itself to in-stall them on its products previously manufactured.

TROUBLESHOOTING GUIDELINES

TROUBLESHOOTING GUIDELINES

TROUBLESHOOTING CHARTS

The following information is provided to help in diagnosing the probable source of simple troubles. You may be able to solve many of these problems rather quickly, but others may require the skills of a trained technician.

In such case, consult an authorized Rotax Jet Propulsion dealer, repair shop, or person of your own choosing for maintenance, repair, or replacement.

BATTERY IS REGULARLY DISCHARGED

1. Check battery condition
 - Have the battery charged or replace by an authorized Rotax Jet Propulsion dealer
2. Loose battery connections
 - Check/clean/tighten
3. Check the charging system fuse
 - Replace fuse if necessary and have charging system checked by an authorized Rotax Jet Propulsion dealer

WARNING

See your authorized Rotax Jet Propulsion marine engine dealer to have the battery charged or replaced. Do not charge or boost the battery while installed in the engine compartment. Electrolyte is poisonous and capable of causing severe burns.

ENGINE DOES NOT TURN OVER

1. Refer to MONITORING SYSTEM.
 - Have the Battery charged or replaced by an authorized Rotax Jet Propulsion dealer, repair shop, or person of your own choosing for maintenance, repair, or replacement

ENGINE WILL NOT START

1. Tether cord removed
 - Install safety lanyard over engine cut-off switch
2. Burnt fuse
 - Check fuse(s). See an authorized Rotax Jet Propulsion dealer, repair shop, or person of your own choosing for maintenance, repair, or replacement if problem is repetitive
3. Discharged battery

ENGINE WILL NOT START

- Have the battery charged or replaced by an authorized Rotax Jet Propulsion dealer, repair shop, or person of your own choosing for maintenance, repair, or replacement

4. Battery connections, corroded or loose

- Contact an authorized Rotax Jet Propulsion dealer, repair shop, or person of your own choosing for maintenance, repair, or replacement

5. Water flooded engine

- Contact an authorized Rotax Jet Propulsion dealer, repair shop, or person of your own choosing for maintenance, repair, or replacement

6. Obstructed jet pump

- Try to clean. Otherwise, refer to an authorized Rotax Jet Propulsion dealer, repair shop, or person of your own choosing for maintenance, repair, or replacement

7. Faulty engine management system

- Seek service from an authorized Rotax Jet Propulsion dealer, repair shop, or person of your own choosing for maintenance, repair, or replacement.

ENGINE TURNS SLOWLY

1. Loose battery cable connections.

- Check/clean/tighten

2. Discharged or weak battery

- Have the battery charged or replaced by an authorized Rotax Jet Propulsion dealer, repair shop, or person of your own choosing for maintenance, repair, or replacement

3. Bad grounds

- Refer to an authorized Rotax Jet Propulsion dealer, repair shop, or person of your own choosing for maintenance, repair, or replacement

4. Worn starter or related parts

- Refer to an authorized Rotax Jet Propulsion dealer, repair shop, or person of your own choosing for maintenance, repair, or replacement

ENGINE TURNS NORMALLY BUT WILL NOT START

1. Fuel tank empty or water contaminated
- Refill or siphon and fill with fresh fuel.

2. Fouled/defective spark plugs
- Replace

3. Burnt fuse
- Check fuse(s). See an authorized Rotax Jet Propulsion dealer, repair shop, or person of your own choosing for maintenance, repair, or replacement if problem is repetitive.

4. Engine management System Fault Detected (Check If Engine Pilot Lamp Is On)
- Seek service from an authorized Rotax Jet Propulsion dealer, repair shop, or person of your own choosing for maintenance, repair, or replacement.

5. Faulty fuel pump
- Seek service from an authorized Rotax Jet Propulsion dealer, repair shop, or person of your own choosing for maintenance, repair, or replacement.

6. Cluster was replaced
- If the cluster was replaced the security coding could have been executed improperly. Seek service from an authorized Rotax Jet Propulsion dealer, repair shop, or person of your own choosing for maintenance, repair, or replacement.

ENGINE MISFIRES, RUNS IRREGULARLY

1. Fouled/defective/worn spark plugs
- Check/clean/tighten

2. Faulty ignition coil(s)
- Seek service from an authorized Rotax Jet Propulsion dealer, repair shop, or person of your own choosing for maintenance, repair, or replacement.

3. Fuel: Level too low, stale or water contaminated
- Siphon and/or refill

4. Clogged injectors
- Seek service from an authorized Rotax Jet Propulsion dealer, repair shop, or person of your own choosing for maintenance, repair, or replacement.

5. Engine management system fault detected (check if engine pilot lamp is ON)
- Seek service from an authorized Rotax Jet Propulsion dealer, repair shop, or person of your own choosing for maintenance, repair, or replacement.

6. Operating the engine with bad gasoline or gasoline containing the improper octane level.
- Seek service from an authorized Rotax Jet Propulsion dealer, repair shop, or person of your own choosing for maintenance, repair, or replacement.

7. Leaking air intercooler and/or water in the intake.
- Seek service from an authorized Rotax Jet Propulsion dealer, repair shop, or person of your own choosing for maintenance, repair, or replacement.

ENGINE SMOKES

1. Oil level too high
- Seek service from an authorized Rotax Jet Propulsion dealer, repair shop, or person of your own choosing for maintenance, repair, or replacement.

2. Water ingestion, coolant leak or damaged cylinder head gasket
- Seek service from an authorized Rotax Jet Propulsion dealer, repair shop, or person of your own choosing for maintenance, repair, or replacement.

3. Internal engine damage
- Seek service from an authorized Rotax Jet Propulsion dealer, repair shop, or person of your own choosing for maintenance, repair, or replacement.

NOTICE

If beeper emits a continuous beep, stop engine as soon as possible!

ENGINE OVERHEATING OR IMPROPER OIL PRESSURE (MONITORING BEEPER EMITS A CONTINUOUS BEEP)

1. Check oil and coolant level
- Refer to Maintenance Procedures. Refill if necessary.
2. Clogged jet pump water intake
- Perform the Jet Pump and Water Intake and Impeller Cleaning.
3. Clogged exhaust system
- Flush exhaust system

NOTICE

If these actions do not correct the problem, discontinue use and seek service from an authorized Rotax Jet Propulsion dealer, repair shop, or person of your own choosing for maintenance, repair, or replacement.

ENGINE LACKS ACCELERATION OR POWER

1. Jet pump water intake clogged
- Clean. Refer to Jet Pump Water Intake And Impeller Cleaning Procedure.
2. Damaged impeller or worn out wear ring
- Seek service from an authorized Rotax Jet Propulsion dealer, repair shop, or person of your own choosing for maintenance, repair, or replacement.
3. Faulty supercharger or intercooler
- Seek service from an authorized Rotax Jet Propulsion dealer, repair shop, or person of your own choosing for maintenance, repair, or replacement.
4. Supercharger clutch slipping
- Seek service from an authorized Rotax Jet Propulsion dealer, repair shop, or person of your own choosing for maintenance, repair, or replacement.
5. Weak spark
- Refer to Troubleshooting Charts.
6. Engine management system fault detected (check if engine pilot lamp is ON)
- Seek service from an authorized Rotax Jet Propulsion dealer, repair shop, or person of your own choosing for maintenance, repair, or replacement.
7. Clogged injectors
- Seek service from an authorized Rotax Jet Propulsion dealer, repair shop, or person of your own choosing for maintenance, repair, or replacement.

ENGINE LACKS ACCELERATION OR POWER**8. Low fuel pressure**

- Seek service from an authorized Rotax Jet Propulsion dealer, repair shop, or person of your own choosing for maintenance, repair, or replacement.

9. Water in fuel

- Siphon and replace

BOAT CANNOT REACH TOP SPEED**1. Jet pump water intake clogged**

- Clean. Refer to Jet Pump Water Intake And Impeller Cleaning Procedure.

2. Damaged impeller or worn-out wear ring

- Replace. Refer to an authorized Rotax Jet Propulsion dealer, repair shop, or person of your own choosing for maintenance, repair, or replacement

3. Faulty supercharger or intercooler

- Seek service from an authorized Rotax Jet Propulsion dealer, repair shop, or person of your own choosing for maintenance, repair, or replacement.

4. Check for a warning light and/or scrolling message, go to fault display page and look for an active Fault Code.

- Seek service from an authorized Rotax Jet Propulsion dealer, repair shop, or person of your own choosing for maintenance, repair, or replacement.

ABNORMAL NOISE FROM PROPULSION SYSTEM**1. Weeds or debris jammed around impeller**

- Clean. Refer to Jet Pump Water Intake And Impeller Cleaning Procedure.

2. Damaged impeller or drive shaft

- Seek service from an authorized Rotax Jet Propulsion dealer, repair shop, or person of your own choosing for maintenance, repair, or replacement

TROUBLESHOOTING GUIDELINES

MONITORING SYSTEM

General

A system monitors the electronic components of the EMS (engine management system) and other components of the electrical system. When a fault occurs, it sends visual messages through the information center and/or audible signals through a beeper to inform you of a particular condition.

A fault code may also be recorded.

When a minor or transient fault occurs, the fault message and beeper will cease automatically if the condition that caused the fault does not exist anymore.

Releasing the throttle and letting the engine return to idle speed may allow normal operation to come back.

The electronic system will react differently depending on the fault type. In severe failure, the engine may not be allowed to be started. In other cases, the engine will operate in limp home mode (reduced speed).





When a fault occurs, Seek service from an authorized Rotax Jet Propulsion dealer, repair shop, or person of your own choosing for maintenance, repair, or replacement.

Pilot Lamps and Message Display Information (Typical)

Indicator lights (pilot lamps), located in the multifunction display, inform you of a system anomaly.

An indicator light may be accompanied by a scrolling message in the multifunction display. See table below for typical malfunction pilot lamps.

Other important items in the maintenance schedule are more difficult and require special tools.

PILOT LAMPS	BEEP	MESSAGE DISPLAY	DESCRIPTION
	Continue	HIGH TEMPERATURE	Engine or exhaust system overheating
	-	LOW or HIGH BATTERY VOLTAGE	Low/high battery voltage
	Continue	LOW OIL PRESSURE	Low oil pressure
	1 beep every 15 minutes	CHECK ENGINE or LIMP HOME MODE	Engine management system fault detected

NOTICE

If the monitoring beeper continuously sounds, stop engine as soon as possible.

This page is intentionally blank

WARRANTY INFORMATION

WARRANTY INFORMATION

BRP US INC. LIMITED WARRANTY - USA AND CANADA

For ROTAX® Jet Propulsion Systems

1. SCOPE

BRP US Inc. ("BRP") warrants its *Rotax*® Jet Propulsion Systems ("Product") which are incorporated into boats made by authorized manufacturers and sold through authorized dealers/ distributors ("Dealer") in the fifty United States and Canada from defects in material or workmanship for the period and under the conditions described below.

This limited warranty will become null and void if:

- The Product was used for racing or any other competitive activity, at any point, even by a previous owner; or
- The Product has been altered or modified in such a way so as to adversely affect its operation, performance or durability; or
- The Product has been altered or modified to change its intended use, horsepower or emission levels.

2. LIMITATIONS OF LIABILITY

THIS WARRANTY IS EXPRESSLY GIVEN AND ACCEPTED IN LIEU OF ANY AND ALL OTHER WARRANTIES, EXPRESSED OR IMPLIED, INCLUDING WITHOUT LIMITATION ANY WARRANTY OF MERCHANTABILITY OR FITNESS FOR A PARTICULAR PURPOSE. TO THE EXTENT THAT THEY CANNOT BE DISCLAIMED, THE IMPLIED WARRANTIES ARE LIMITED IN DURATION TO THE LIFE OF THE EXPRESS WARRANTY. INCIDENTAL AND CONSEQUENTIAL DAMAGES ARE EXCLUDED FROM COVERAGE UNDER THIS WARRANTY. SOME STATES/PROVINCES DO NOT ALLOW FOR THE DISCLAIMERS, LIMITATIONS AND EXCLUSIONS IDENTIFIED ABOVE, AS A RESULT, THEY MAY NOT APPLY TO YOU. THIS WARRANTY GIVES YOU SPECIFIC RIGHTS, AND YOU MAY ALSO HAVE OTHER LEGAL RIGHTS WHICH MAY VARY FROM STATE TO STATE, OR PROVINCE TO PROVINCE.

Neither the boat manufacturer, distributor, dealer or any other person has been authorized to make any affirmation, representation or warranty regarding the product, other than those contained in this limited warranty, and if made, shall not be enforceable against BRP. BRP reserves the right to modify this warranty at any time, being understood that such modification will not alter the warranty conditions applicable to the products sold while this warranty is in effect.

3. EXCLUSIONS - ARE NOT WARRANTED

The following are not warranted under any circumstances:

- Normal wear and tear;
- Routine maintenance parts and services including but not limited to: maintenance requirements, oil changes, lubrication, valve and linkage adjustments and replacement of fuses, zinc anodes, thermostats, timing belts (or chains), filters, impellers;
- Damage caused by improper or lack of installation, maintenance, winterization and/or storage, failure to follow the procedures and recommendations in the Operators Guide;
- Damage resulting from removal of parts, improper repairs, service, maintenance, or modification, or use of parts or accessories not manufactured or approved by BRP, which in its reasonable judgment, are either incompatible with Product or adversely affect its operation, performance, or durability, or resulting from repairs done by a person that is not an Authorized Dealer (as described below);
- Damage caused by abuse, abnormal use, neglect, or operation of the product in a manner inconsistent with the recommended operation described in the Operator's Guide;
- Damage resulting from external damage, accident, submersion, water ingestion, fire, theft, vandalism or any act of God;
- Operation without proper fuel, oil or lubrication, or with fuels, oils or lubricants which are not suitable for use with the Product (see the Operators Guide);
- Damage from rust or corrosion (see Corrosion Warranty Statement);
- Cosmetic or paint changes due to exposure to the elements.
- Damage from cooling system or jet pump blockage by foreign material;
- Incidental or consequential damages, or damages of any kind including without limitation towing, storage, telephone, rental, taxi, inconvenience, insurance coverage, loan payments, loss of time, loss of income.

4. WARRANTY COVERAGE PERIOD

This limited warranty will be in effect from the date of delivery to the first retail consumer or the date the Product is first put to use, whichever occurs first and for the applicable period below:

1. THIRTY-SIX (36) CONSECUTIVE MONTHS for private, recreational use; or
2. TWELVE (12) CONSECUTIVE MONTHS for commercial use. The Product is used commercially when it is used in connection with generating income or any work or employment during any part of the warranty period. The Product is also used commercially when, at any point during the warranty period, it is installed on a boat that has commercial tags or is licensed for commercial use.
3. For emission related components; please also refer to the U.S. EPA EMISSION-RELATED WARRANTY contained herein.
4. For Rotax® Inboard Jet Propulsion Systems produced by BRP for sale in the state of California that are originally sold to a resident or subsequently warranty registered to a resident of the State of California, please also refer to the applicable California Emissions Control Warranty Statement contained herein.

In cases where the delivery date is not established to BRP's satisfaction, the date of sale will be used to determine the warranty start date. The repair or replacement of parts or the performance of service to Product under this warranty does not extend the life of this limited warranty beyond its original expiration date.

For all genuine parts and accessories installed on the Product by an authorized Dealer at the time of sale, reference the BRP parts and accessories limited Warranty Statement.

5. CONDITIONS REQUIRED FOR WARRANTY COVERAGE

This warranty coverage is available **only if each** of the following conditions has been fulfilled:

- The Product must be purchased as new and unused by its first owner from a dealer authorized to distribute the Product in the country in which the sale occurred ;
- The BRP specified pre delivery inspection process must be completed and documented by the purchaser and authorized Dealer;
- The Product must have undergone proper registration by an authorized Dealer;
- Only the original purchaser and any subsequent owners who reside in the United States and Canada and have purchased Product from an authorized Dealer located in Canada or in the United States are eligible for warranty registration and warranty coverage hereunder; and
- Routine maintenance outlined in the Operator's Guide must be timely performed in order to maintain warranty coverage. BRP reserves the right to make warranty coverage contingent upon proof of proper maintenance.

BRP will not honor this limited warranty to any private use owner or commercial use owner if one of the preceding conditions has not been met. Such limitations are necessary in order to allow BRP to protect the safety of its products, its consumers and the general public.

6. WHAT TO DO TO OBTAIN WARRANTY COVERAGE

The user must cease using the Product upon the appearance of an anomaly. The registered owner must notify an authorized Dealer within two (2) days of the appearance of a defect. BRP is not responsible for damages caused by the use of a Product after the appearance of a defect. Owner must bring Product, including any defective part therein, within the warranty period, and must provide Dealer with reasonable opportunity to repair the defect. The expenses of transporting Product to and from Dealer for warranty service are to be borne by the owner. Owner is required to sign the repair work order prior to the start of the repair in order to validate the warranty repair. All parts replaced under this warranty become the property of BRP.

7. WHAT BRP WILL DO

BRP's obligations under this warranty are limited to, at its sole discretion, repairing or replacing parts of Product found to be defective in material or workmanship, in the reasonable judgment of BRP. Such repair or replacement of parts will be done without charge for parts and labor, at any authorized Dealer. BRP's responsibility is limited to making the required repairs or replacements of parts. No claim of breach of warranty shall be cause for cancellation or rescission of the sale of Product to owner.

In the event that warranty service is required outside of the fifty United States or Canada, owner will bear responsibility for any additional charges due to local practices and conditions, such as, but not limited to, freight, insurance, taxes, license fees, import duties, and any and all other financial charges, including those levied by governments, states, territories and their respective agencies.

BRP reserves the right to improve, modify or change Products from time to time without assuming any obligation to modify Products previously manufactured.

8. TRANSFER

If the ownership of Product is transferred during the warranty coverage period, this warranty, subject to its terms and conditions, shall also be transferred and be valid for the remaining coverage period provided that BRP or an authorized Dealer receives a proof that the former owner agreed to the transfer of ownership, in addition to the coordinates of the new owner.

9. CONSUMER ASSISTANCE

In the event of a controversy or a dispute in connection with this BRP limited warranty, BRP suggests that you try to resolve the issue at the dealership level. We recommend discussing the issue with the Authorized Dealer's service manager or owner.

If the matter still remains unresolved, contact BRP by filling out the customer contact form at www.brp.com or contact BRP by mail at one of the addresses listed under the *CONTACT US* section of this guide.

US EPA EMISSION-RELATED WARRANTY

BRP US Inc. ("BRP") warrants to the ultimate purchaser and each subsequent purchaser that this new engine, including all parts of its exhaust emission control system and its evaporative emission control system, meets two conditions:

1. It is designed, built, and equipped so it conforms at the time of sale to the ultimate purchaser with the requirements of 40 CFR 1045 and 40 CFR 1060.
2. It is free from defects in materials and workmanship that may keep it from meeting the requirements of 40 CFR 1045 and 40 CFR 1060.

Where a warrantable condition exists, BRP will repair or replace, as it elects, any part or component with a defect in materials or workmanship that would increase the engine's emissions of any regulated pollutant within the stated warranty period at no cost to the owner, including expenses related to diagnosing and repairing or replacing emission-related parts. All defective parts replaced under this warranty become the property of BRP.

For all emission-related warranty claims, BRP is limiting the diagnosis and repair of emission-related parts to the authorized *Rotax*® Jet Propulsion dealers, unless for emergency repairs as required by item 2 of the following list.

As a certifying manufacturer, BRP will not deny emission-related warranty claims based on any of the following:

1. Maintenance or other service BRP or BRP's authorized facilities performed.
2. Engine/equipment repair work that an operator performed to correct an unsafe, emergency condition attributable to BRP as long as the operator tries to restore the engine/equipment to its proper configuration as soon as possible.
3. Any action or inaction by the operator unrelated to the warranty claim.
4. Maintenance that was performed more frequently than BRP specify.
5. Anything that is BRP fault or responsibility.
6. The use of any fuel that is commonly available where the equipment operates unless BRP written maintenance instructions state that this fuel would harm the equipment's emission control system and operators can readily find the proper fuel. See maintenance information section and fuel requirements of fueling section.

Emission-Related Warranty Period

The emission-related warranty is valid for the following period whichever comes first: For model: Rotax® ACE 130 ECT, Rotax® ACE 170 ECT, and Rotax® ACE 230 ECT.

	HOURS	MONTHS
Exhaust emission-related components	480	36
Evaporative emission related components	N/A	24

For model:Rotax® ACE 300 (model is not allowed in the state of California)

	HOURS	MONTHS
Exhaust emission-related components	175	30
Evaporative emission related components	N/A	24

Components Covered

The emission-related warranty covers all components whose failure would increase an engine's emissions of any regulated pollutant, including the following listed components:

1. For exhaust emissions, emission-related components include any engine parts related to the following systems:
 - Air-induction system
 - Fuel system
 - Ignition system
 - Exhaust gas recirculation systems
2. The following parts are also considered emission-related components for exhaust emissions:
 - Aftertreatment devices
 - Crankcase ventilation valves
 - Sensors
 - Electronic control units
3. The following parts are considered emission-related components for evaporative emissions:
 - Fuel tank
 - Fuel cap
 - Fuel line
 - Fuel line fittings
 - Clamps*
 - Pressure relief valves*
 - Control valves*
 - Control solenoids*
 - Electronic controls*
 - Vacuum control diaphragms*
 - Control cables*
 - Control linkages*
 - Purge valves
 - Vapor hoses
 - Liquid/ vapor separator
 - Carbon canister
 - Canister mounting brackets
 - Carburetor purge port connector

4. Emission-related components also include any other part whose only purpose is to reduce emissions or whose failure will increase emissions without significantly degrading engine/ equipment performance.

* As related to the evaporative emission control system.

Limited Applicability

As a certifying manufacturer, BRP may deny emission-related warranty claims for failures that have been caused by the owner's or operator's improper maintenance or use, by accidents for which the manufacturer has no responsibility, or by acts of God. For example, an emission-related warranty claim need not be honored for failures that have been directly caused by the operator's abuse of the engine/ equipment or the operator's use of the engine/equipment in a manner for which it was not designed and are not attributable to the manufacturer in any way.

If you have any questions regarding your warranty rights and responsibilities or for the name and location of the nearest authorized BRP Dealer, you should contact the Customer Assistance Center at 1-844-345-4BRP (4277).

WARRANTY INFORMATION

CALIFORNIA EMISSION CONTROL WARRANTY STATEMENT FOR ROTAX® INBOARD JET PROPULSION SYSTEMS

Your Emission Control Warranty Rights And Obligations

The California Air Resources Board and BRP US Inc. (“BRP”) are pleased to explain the emission control system warranty for your 2025 sterndrive/inboard Rotax® Inboard Jet Propulsion System. In California, new boat engines must be designed, built and equipped to meet the State’s stringent anti-smog standards. BRP must warrant the emission control system on your boat engine for the period of time listed below provided there has been no abuse, neglect or improper maintenance of your engine.

Your emission control system may include parts such as the fuel injection system, the ignition system and catalytic converter. Also included may be hoses, belts, connectors and other emission related assemblies.

Where a warrantable condition exists, BRP will repair your boat engine at no cost to you including diagnosis, parts and labor provided that such work is performed by an authorized BRP dealer.

Manufacturers Limited Warranty Coverage

This emission limited warranty covers Rotax® Inboard Jet Propulsion Systems certified and produced by BRP for sale in California, that are originally sold in California to a California resident or subsequently warranty registered to a California resident. The BRP limited warranty conditions for Rotax® Inboard Jet Propulsion Systems are still applicable to these models with the necessary modifications. Select emission control parts of your Rotax® Inboard Jet Propulsion System are warranted from the date of delivery to the first retail consumer for a period of 36 months, or for 480 hours of use, whichever occurs first. However, warranty coverage based on the hourly period is only permitted for boats equipped with the appropriate hour meters or their equivalent. If any emission-related part on your engine is defective under warranty, the part will be repaired or replaced by BRP

Parts Covered For Boats Equipped With Rotax® Inboard Jet Propulsion Systems:

Throttle Position Sensor	Air Intake Adapter
Intake Manifold Air Pressure Sensor	Spark Plugs
Intake Manifold Air Temperature Sensor	Ignition Coils
Engine Temperature Sensor	Air Box
Knock Sensor	Intake and Exhaust Valve & Seals
Engine Control Module	Crankcase Ventilation Valve
Throttle Body	Throttle Body Seal

Fuel Rail	Wire Harness and Connectors
Fuel Injectors	Intake Manifold
Fuel Pressure Regulator	Intake Manifold Seal
Fuel Pump	Fuel Filter
Oxygen Sensor	Supercharger
	Catalytic Converter

The emission warranty covers damage to other engine components that is caused by the failure of a warranted part.

The BRP *Operators Manual* provided contains written instructions for the proper maintenance and use of your Inboard Jet Propulsion System. All emission warranty parts are warranted by BRP for the entire warranty period of the engine, unless the part is scheduled for replacement as required maintenance in the *Operators Manual*.

Emission warranty parts that are scheduled for replacement, as required maintenance, are warranted by BRP for the period of time before the first scheduled replacement date for that part. Emission warranty parts that are scheduled for regular inspection, but not regular replacement, are warranted by BRP for the entire warranty period of the engine. Any emission warranty part repaired or replaced under the terms of this warranty statement is warranted by BRP for the remainder of the warranty period of the original part. All parts replaced under this limited warranty become the property of BRP. Maintenance receipts and records should be transferred to each subsequent owner of the boat.

OWNER'S WARRANTY RESPONSIBILITIES

As the owner of a boat with a Rotax® Inboard Jet Propulsion System, you are responsible for the performance of the required maintenance listed in your *Operators Manual*. BRP recommends that you retain all receipts covering maintenance your boat engine, but BRP cannot deny warranty solely for the lack of receipts or your failure to ensure the performance of all scheduled maintenance. As the owner of a Rotax® Inboard Jet Propulsion System, you should however be aware that BRP may deny you warranty coverage if your engine(s) or a part has failed due to abuse, neglect, improper maintenance or unapproved modifications. You are responsible for presenting your engine to an authorized BRP Dealer as soon as a problem exists. The warranty repairs will be completed in a reasonable amount of time, not to exceed 30 days. If you have any questions regarding your warranty rights and responsibilities, or for the name and location of the nearest authorized BRP Dealer, you should contact the Customer Assistance Center at 1-844-345-4BRP (4277).

Star Rating System

For California, your boat has a special environmental label required by the California Air Resources Board located to the port side of the hull, either to the right or left and in close proximity to the required location of the California Assigned Vessel Number. The label has 4 stars. A hang tag, provided with your boat, describes the meaning of the

star rating system. Dealer located in California has the responsibility of displaying the hang-tag on a visible location to each boat equipped with Rotax® Jet Propulsion System and to identify the corresponding Star Label.

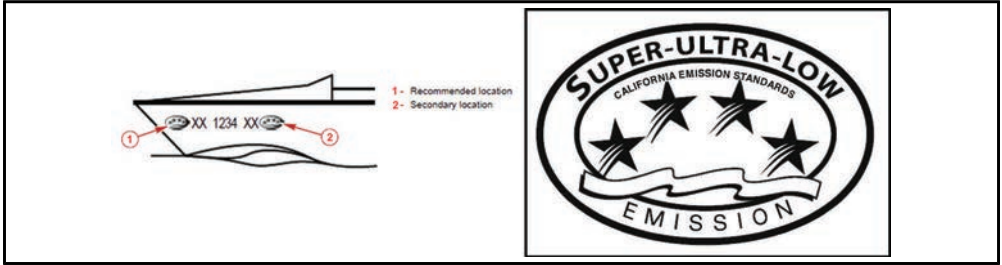

TYPICAL

1. Recommended location
2. Secondary location

The Star Label means Cleaner Marine Engines

This engine has been certified as:



The Symbol for Cleaner Marine Engines:

Cleaner Air and Water

For a healthier lifestyle and environment.

Better Fuel Economy

Burns up to 30-40 percent less gas and oil than conventional carbureted two-stroke engines, saving money and resources.

Longer Emission Warranty

Protects consumer for worry-free operation.

219902678



One Star-Low emission

The one-star label identifies personal watercraft, outboard, sterndrive and inboard engines that meet the Air Resources Board's Personal Watercraft and Outboard marine engine 2001 exhaust emission standards. Engines meeting these standards have 75% lower emissions than conventional carbureted two-stroke engines. These engines are equivalent to the U.S. EPA's 2006 standards for marine engines.



Two Stars-Very Low emission

The two-star label identifies personal watercraft, outboard, sterndrive and inboard engines that meet the Air Resources Board's Personal Watercraft and Outboard marine engine 2004 exhaust emission standards. Engines meeting these standards have 20% lower emissions than One Star – Low-Emission engines.



Three Stars-Ultra Low emission

The three-star label identifies engines that meet the Air Resources Board's Personal Watercraft and Outboard marine engine 2008 exhaust emission standards or the Sterndrive and Inboard marine engine 2003 exhaust emission standards. Engines meeting these standards have 65% lower emissions than One Star – Low Emission engines.



Four Stars-Super Ultra Low emission

The four-star label identifies engines that meet the Air Resources Board's Sterndrive and Inboard marine engine 2009 exhaust emission standards. Personal Watercraft and Outboard marine engines may also comply with these standards. Engines meeting these standards have 90% lower emissions than One Star – Low Emission engines.

219902678

HANG TAG

The Star Label Means Cleaner Marine Engines

The Symbol for Cleaner Marine Engines:



F18L3CQ

Cleaner Air and Water

For a healthier lifestyle and environment.

Better Fuel Economy

Burns up to 30 - 40 percent less gas and oil than conventional carbureted two-stroke engines saving money and resources.

Longer Emission Warranty

Protects consumer for worry free operation.

One Star – Low Emission

The one-star label identifies personal watercraft, outboard, stern drive and inboard engines that meet the Air Resources Board's Personal Watercraft and Outboard marine engine 2001 exhaust emission standards. Engines meeting these standards have 75% lower emissions than conventional carbureted two-stroke engines. These engines are equivalent to the U.S. EPA's 2006 standards for marine engines.

Two Stars – Very Low Emission

The two-star label identifies personal watercraft, outboard, stern drive and inboard engines that meet the Air Resources Board's Personal Watercraft and Outboard marine engine 2004 exhaust emission standards. Engines meeting these standards have 20% lower emissions than One Star - Low-Emission engines.

Three Stars – Ultra Low Emission

The three-star label identifies engines that meet the Air Resources Board's Personal Watercraft and Outboard marine engine 2008 exhaust emission standards or the Stern drive and Inboard marine engine 2003 exhaust emission standards. Engines meeting these standards have 65% lower emissions than One Star – Low Emission engines.

Four Stars – Super Ultra Low Emission

The four-star label identifies engines that meet the Air Resources Board's Stern-drive and Inboard marine engine 2012 exhaust emission standards. Personal Watercraft and Outboard marine engines may also comply with these standards. Engines meeting these standards have 90% lower emissions than One Star – Low Emission engines.

For more information: Cleaner Watercraft – Get the Facts 1 800 END-SMOG www.arb.ca.gov
--

CORROSION WARRANTY STATEMENT

BRP US INC. LIMITED CORROSION WARRANTY FOR ROTAX® JET PROPULSION SYSTEMS

1. SCOPE

BRP US Inc. ("BRP") warrants that each new Rotax® Jet Propulsion System ("Product") that are incorporated into boats made by authorized manufacturers and sold by authorized distributors or dealers will not be rendered inoperative as a direct result of corrosion for the period of time described below.

2. LIMITATIONS OF LIABILITY

THIS WARRANTY IS EXPRESSLY GIVEN AND ACCEPTED IN LIEU OF ANY AND ALL OTHER WARRANTIES, EXPRESSED OR IMPLIED, INCLUDING WITHOUT LIMITATION ANY WARRANTY OF MERCHANTABILITY OR FITNESS FOR A PARTICULAR PURPOSE. TO THE EXTENT THAT THEY CANNOT BE DISCLAIMED, THE IMPLIED WARRANTIES ARE LIMITED IN DURATION TO THE LIFE OF THE EXPRESS WARRANTY. INCIDENTAL AND CONSEQUENTIAL DAMAGES ARE EXCLUDED FROM COVERAGE UNDER THIS WARRANTY. SOME STATES/PROVINCES DO NOT ALLOW FOR THE DISCLAIMERS, LIMITATIONS AND EXCLUSIONS IDENTIFIED ABOVE, AS A RESULT, THEY MAY NOT APPLY TO YOU. THIS WARRANTY GIVES YOU SPECIFIC RIGHTS, AND YOU MAY ALSO HAVE OTHER LEGAL RIGHTS WHICH MAY VARY FROM STATE TO STATE, PROVINCE TO PROVINCE, OR COUNTRY TO COUNTRY.

Neither the boat manufacturer, distributor or dealer or any other person has been authorized to make any affirmation, representation or warranty regarding the product, other than those contained in this limited warranty, and if made, shall not be enforceable against BRP. BRP reserves the right to modify this warranty at any time, being understood that such modification will not alter the warranty conditions applicable to the products sold while this warranty is in effect.

3. EXCLUSIONS - ARE NOT WARRANTED

The following are not warranted under any circumstances:

- Corrosion damage caused by stray electrical currents (e.g. on-shore power connections, nearby boats);
- Damage caused by improper application of copper based anti-fouling paints;
- Electrical system corrosion;
- Corrosion resulting from damage;
- Corrosion which causes purely cosmetic damage;
- Abuse or improper service;
- Corrosion to accessories, instruments, steering systems;
- Damage due to marine growth;
- Replacement parts (parts purchased by Owner); and
- Products used in commercial application or use. Commercial application or use is defined as any work or employment related to use of the Product, or any use of the Products which generates income, for any part of the warranty period, even if the Product is only occasionally used for such purposes.

If anti-fouling protection is required, Bis (tributyltin) adipate (“TBTA”) base anti-fouling paints are recommended on Rotax® engine boating applications. In areas where TBTA base paints are prohibited by law, copper base paints can be used on the hull and transom. Do not apply paint to the Product. In addition, care must be taken to avoid an electrical interconnection between the Product and the paint.

4. WARRANTY COVERAGE PERIOD

This limited corrosion warranty will be in effect from the date of delivery to the first retail customer or the date the Product is first put to use, whichever comes first, for a period of on (1) year. The repair or replacement of parts, or the performance of service under this limited corrosion warranty, does not extend the life of this limited corrosion warranty beyond its original expiration date. Unexpired warranty coverage can be transferred to a subsequent (non-commercial use) purchaser upon proper registration of the Product.

5. CONDITIONS REQUIRED FOR WARRANTY COVERAGE:

This limited corrosion warranty is available **only** if **each** of the following conditions has been fulfilled:

- The Product must be purchased as new and unused by its first owner from a authorized Product dealer or distributor ("Dealer") authorized to distribute Products in the country which the sale occurred ;
- The BRP specified pre-delivery inspection process must be completed and documented and signed by the Dealer and the purchaser ("Owner");
- The Product must have undergone proper registration by a Dealer;
- The Product must be purchased in the country in which the Owner resides;
- Corrosion prevention devices specified in the Operator's Guide must be in use on the boat; and
- Routine maintenance outlined in the Operator's Guide must be timely performed (including, without limitation, the replacement of sacrificial anodes, use of specified lubricants, and paint touch-up of nicks and scratches) in order to maintain warranty coverage. BRP reserves the right to make warranty coverage contingent upon proof of proper maintenance.

6. WHAT TO DO TO OBTAIN WARRANTY COVERAGE

The registered Owner must notify an authorized dealer / distributor within two (2) days of the appearance of a defect. BRP is not responsible for damages caused by the use of a Product after the appearance of a defect. Owner must bring Product, including any defective part therein, to Dealer promptly after the appearance of the defect, and in any event, within the warranty period, and must provide Dealer with reasonable opportunity to repair the defect. The expenses of transporting Product to and from Dealer for warranty service are to be borne by the Owner.

Owner is required to sign the repair work order prior to the start of the repair in order to validate the warranty repair.

All parts replaced under this warranty become the property of BRP.

7. WHAT BRP WILL DO

BRP's sole and exclusive obligation under this limited corrosion warranty is limited to, at BRP's option, repairing a corroded part, replacing such part or parts, or refunding the purchase price of the Product. BRP reserves the right to improve or modify Products from time to time without assuming an obligation to modify Products previously manufactured.

8. TRANSFER

If the ownership of the Product is transferred during the limited warranty coverage period, this limited warranty, subject to its terms and conditions, shall also be transferred and be valid for the remaining coverage period provided that BRP is notified of such transfer of ownership in one of the following ways:

- The former Owner contacts BRP (at the phone number provided below);
- A Dealer transfers ownership using the BRP BOSSWeb™ system; or
- BRP or a Dealer receives such other proof, acceptable to BRP, that the former Owner agreed to the transfer of ownership, in addition to the coordinates of the new Owner.

9. CONSUMER ASSISTANCE

In the event of a controversy or a dispute in connection with this BRP limited warranty, BRP suggests that you try to resolve the issue at the dealership level. We recommend discussing the issue with the authorized BRP dealer's service manager or owner.

If the matter still remains unresolved, contact BRP by filling out the customer contact form at www.brp.com or contact BRP by mail at one of the addresses listed under the *CONTACT US* section of this guide.

BRP US INC. INTERNATIONAL LIMITED WARRANTY

For ROTAX® Jet Propulsion Systems

1. SCOPE

BRP US Inc. ("BRP") warrants its *Rotax*® Jet Propulsion Systems ("Product") which are incorporated into boats made by authorized manufacturers and sold through authorized dealers/distributors ("Dealer") outside of the fifty United States, Canada, member states of the European Economic Area (which is comprised of the member states of the European Union plus the United Kingdom, Norway, Iceland and Liechtenstein) ("EEA"), member states of the Commonwealth of the Independent States (including Ukraine and Turkmenistan) ("CIS") and Turkey, from defects in material or workmanship for the period and under the conditions described below.

Non-factory installed parts and accessories are not covered under this limited warranty. Please refer to the applicable parts and accessories limited warranty text.

This limited warranty will become null and void if:

1. The Product was used for racing or any other competitive activity, at any point, even by a previous owner; or
2. The Product has been altered or modified in such a way so as to adversely affect its operation, performance or durability; or
3. The Product has been altered or modified to change its intended use, horsepower or emission levels.

2. LIMITATIONS OF LIABILITY

THIS WARRANTY IS EXPRESSLY GIVEN AND ACCEPTED IN LIEU OF ANY AND ALL WARRANTIES, EXPRESSED OR IMPLIED, INCLUDING WITHOUT LIMITATION ANY WARRANTY OF MERCHANTABILITY OR FITNESS FOR A PARTICULAR PURPOSE ARE LIMITED IN DURATION TO THE LIFE OF THE EXPRESS LIMITED WARRANTY. INCIDENTAL AND CONSEQUENTIAL DAMAGES ARE EXCLUDED FROM COVERAGE UNDER THIS WARRANTY. SOME COUNTRIES, PROVINCES, OR JURISDICTIONS DO NOT ALLOW FOR THE DISCLAIMERS, LIMITATIONS OF INCIDENTAL OR CONSEQUENTIAL DAMAGES, OR OTHER EXCLUSIONS IDENTIFIED ABOVE. AS A RESULT, THEY MAY NOT APPLY TO YOU. THIS WARRANTY GIVES YOU SPECIFIC RIGHTS, AND YOU MAY ALSO HAVE OTHER LEGAL RIGHTS WHICH MAY VARY FROM COUNTRY TO COUNTRY. BRP SHALL NOT BE HELD LIABLE IF PRODUCTS OR WARRANTY PARTS ARE NOT AVAILABLE IN CERTAIN COUNTRIES FOR REASONS OUTSIDE OF BRP'S CONTROL.

NOTE:

For Products purchased in Australia, refer to the Australia-specific section below.

Neither the boat manufacturer, distributor, dealer or any other person has been authorized to make any affirmation, representation or warranty regarding Product other than those contained in this limited warranty and, if made, shall not be enforceable against BRP.

BRP reserves the right to modify this warranty at any time, being understood that such modification will not alter the warranty conditions applicable to the Products sold while this warranty is in effect.

3. EXCLUSIONS - ARE NOT WARRANTED

- Replacement of parts due to normal wear and tear;
- Routine maintenance parts and items, services, tune-ups, adjustments;
- Damage caused by improper or lack of installation, maintenance, winterization and/or storage, failure to follow the procedures and recommendations in the Operator's Guide;
- Damage resulting from removal of parts, improper repairs, service, maintenance, or modification, or use of parts or accessories not manufactured or approved by BRP, which in its reasonable judgment, are either incompatible with Product or adversely affect its operation, performance, or durability, or resulting from repairs done by a person that is not an Authorized Dealer (as described below);
- Damage caused by abuse, misuse, abnormal use, neglect, improper operation or operation of the Product in a manner inconsistent with the recommended operation described in the Operator's Guide;
- Damage resulting from external damage, accident, submersion, water ingestion, fire, theft, vandalism or any act of God;
- Operation with fuels, oils or lubricants which are not suitable for use with the product (see the Operator's Guide);
- Damage from rust or corrosion (see Corrosion Warranty Statement);
- Damages from cooling system or jet pump blockage by foreign material;
- Damage caused by overheat in the exhaust system resulting from sand or debris;
- Cosmetic or paint changes due to exposure to the elements.
- Incidental or consequential damages, or damages of any kind including without limitation expense for gasoline, expense for transporting Product to and from Dealer, removal of Product from a boat and reinstallation, mechanic's travel time, in-and-out of water charges, slip or dock fees, trailering or towing, storage, telephone, cell phone, fax or telegram charges, rental of a like or replacement Product or boat during warranty services or down time, taxi, travel, lodging, loss of or damage to personal property, inconvenience, cost of insurance coverage, loan payments, loss of time, loss of income, revenue or profits, or loss of enjoyment or use of Product.

4. WARRANTY COVERAGE PERIOD

This limited warranty will be in effect from the date of delivery to the first retail consumer or the date the Product is first put to use, whichever occurs first, for a period of:

1. TWELVE (12) CONSECUTIVE MONTHS for private, recreational use. For AUSTRALIA and NEW ZEALAND only, TWENTY-FOUR (24) CONSECUTIVE MONTHS for private, recreational use.
2. FOUR (4) CONSECUTIVE MONTHS for commercial use.

This is a minimal warranty period which can be extended by any applicable warranty promotional program, as the case may be. The Product is used commercially when it is used in connection with generating income or any work or employment during any part of the warranty period. The Product is also used commercially when, at any point during the warranty period, it is installed on a boat that has commercial tags or is licensed for commercial use.

The repair or replacement of parts or the performance of service to under this warranty does not extend the life of this limited warranty beyond its original expiration date.

Note that the duration and any other modalities of the warranty coverage are subject to the applicable national or local legislation in the customer's country.

In cases where the delivery date is not established to BRP's satisfaction, the date of sale will be used to determine the warranty start date.

FOR PRODUCTS SOLD IN AUSTRALIA ONLY

Nothing in these Warranty terms and conditions should be taken to exclude, restrict or modify the application of any condition, warranty, guarantee, right or remedy conferred or implied under the Competition and Consumer Act 2010 (Cth), including the Australian Consumer Law or any other law, where to do so would contravene that law, or cause any part of these terms and conditions to be void. The benefits given to you under this limited warranty are in addition to other rights and remedies that you have under Australian law.

Our goods come with guarantees that cannot be excluded under the Australian Consumer Law. You are entitled to a replacement or refund for a major failure and for compensation for any other reasonably foreseeable loss or damage. You are also entitled to have the goods repaired or replaced if the goods fail to be of acceptable quality and the failure does not amount to a major failure.

5. CONDITIONS TO HAVE WARRANTY COVERAGE

This warranty coverage is available **only** if **each** of the following conditions has been fulfilled:

- The Product must be purchased as new and unused by its first owner from a Dealer authorized to distribute the Product in the country in which the sale occurred ;
- The BRP specified pre delivery inspection process must be completed and documented by the purchaser and authorized Dealer;
- The Product must have undergone proper registration of Product by an authorized Dealer;
- The Product must be purchased in the country in which the purchaser resides.
- Routine maintenance outlined in the operator's guide must be timely performed in order to maintain warranty coverage. BRP reserves the right to make warranty coverage contingent upon proof of proper maintenance.

BRP will not honor this limited warranty to any private use owner or commercial use owner if one of the preceding conditions has not been met. Such limitations are necessary in order to allow BRP to protect the safety of its products, its consumers and the general public.

6. WHAT TO DO TO OBTAIN WARRANTY COVERAGE

The customer must cease using the Product upon the appearance of an anomaly. The customer must notify an authorized Dealer within two (2) days of the appearance of a defect, provide it with reasonable access to the product and reasonable opportunity to repair it. The customer must also present to the authorized Dealer proof of purchase of the product and must sign the repair/work order prior to starting the repair in order to validate the warranty repair. All parts replaced under this warranty become the property of BRP.

Note that the notification period is subject to the applicable national or local legislation in customer's country.

7. WHAT BRP WILL DO

To the extent permitted by law, BRP's obligations under this warranty are limited to, at its sole discretion, repairing parts found defective under normal use, maintenance and service, or replacing such parts without charge for parts and labor, at any authorized distributor/dealer during the warranty coverage period under the conditions described herein. BRP's responsibility is limited to making the required repairs or replacements of parts. No claim of breach of warranty shall be cause for cancellation or rescission of the sale of the Product to the owner. You may have other legal rights which may vary from country to country.

In the event that service is required outside of the country of original sale, the owner will bear responsibility for any additional charges due to local practices and conditions, such as, but not limited to, freight, insurance, taxes, license fees, import duties, and any and all other financial charges, including those levied by governments, states, territories and their respective agencies.

BRP reserves the right to improve or modify products from time to time without assuming any obligation to modify products previously manufactured.

8. TRANSFER

If the ownership of a product is transferred during the warranty coverage period, this limited warranty, subject to its terms and conditions, shall also be transferred and be valid for the remaining coverage period provided BRP or an authorized Dealer receives a proof that the former owner agreed to the transfer of ownership, in addition to the coordinates of the new owner.

9. CONSUMER ASSISTANCE

In the event of a controversy or a dispute in connection with this BRP limited warranty, BRP suggests that you try to resolve the issue at the distributorship / dealership level. We recommend discussing the issue with the authorized BRP dealer's service manager or owner.

If the matter still remains unresolved, contact BRP by filling out the customer contact form at www.brp.com or contact BRP by mail at one of the addresses listed under the *CONTACT US* section of this guide.

BRP US INC. LIMITED WARRANTY FOR THE EUROPEAN ECONOMIC AND THE INDEPENDENT STATES (CIS) AREAS AND TURKEY

For ROTAX® Jet Propulsion Systems

1. SCOPE

BRP US Inc. ("BRP") warrants its *Rotax*® Jet Propulsion Systems ("Product") which are incorporated into boats made by authorized manufacturers and sold through authorized dealers/distributors ("Dealer") in member states of the European Economic Area (which is comprised of the member states of the European Union plus the United Kingdom, Norway, Iceland and Liechtenstein) ("EEA"), in member states of the Commonwealth of the Independent States (including Ukraine and Turkmenistan) ("CIS") and Turkey from defects in material or workmanship for the period and under the conditions described below.

Non-factory installed parts and accessories are not covered under this limited warranty. Please refer to the applicable parts and accessories limited warranty text.

This limited warranty will become null and void if:

1. The Product was used for racing or any other competitive activity, at any point, even by a previous owner; or
2. The Product has been altered or modified in such a way so as to adversely affect its operation, performance or durability; or
3. The Product has been altered or modified to change its intended use, horsepower or emission levels.

2. LIMITATIONS OF LIABILITY

THIS WARRANTY IS EXPRESSLY GIVEN AND ACCEPTED IN LIEU OF ANY AND ALL WARRANTIES, EXPRESSED OR IMPLIED, INCLUDING WITHOUT LIMITATION ANY WARRANTY OF MERCHANTABILITY OR FITNESS FOR A PARTICULAR PURPOSE ARE LIMITED IN DURATION TO THE LIFE OF THE EXPRESS LIMITED WARRANTY. INCIDENTAL AND CONSEQUENTIAL DAMAGES ARE EXCLUDED FROM COVERAGE UNDER THIS WARRANTY. SOME COUNTRIES, PROVINCES, OR JURISDICTIONS DO NOT ALLOW FOR THE DISCLAIMERS, LIMITATIONS OF INCIDENTAL OR CONSEQUENTIAL DAMAGES, OR OTHER EXCLUSIONS IDENTIFIED ABOVE. AS A RESULT, THEY MAY NOT APPLY TO YOU. THIS WARRANTY GIVES YOU SPECIFIC RIGHTS, AND YOU MAY ALSO HAVE OTHER LEGAL RIGHTS WHICH MAY VARY FROM COUNTRY TO COUNTRY. BRP SHALL NOT BE HELD LIABLE IF PRODUCTS OR WARRANTY PARTS ARE NOT AVAILABLE IN CERTAIN COUNTRIES FOR REASONS OUTSIDE OF BRP'S CONTROL.

Neither the boat manufacturer, distributor, dealer or any other person has been authorized to make any affirmation, representation or warranty regarding Product other than those contained in this limited warranty and, if made, shall not be enforceable against BRP.

BRP reserves the right to modify this warranty at any time, being understood that such modification will not alter the warranty conditions applicable to the Products sold while this warranty is in effect.

3. EXCLUSIONS - ARE NOT WARRANTED

- Replacement of parts due to normal wear and tear;
- Routine maintenance parts and items, services, tune-ups, adjustments;
- Damage caused by improper or lack of installation, maintenance, winterization and/or storage, failure to follow the procedures and recommendations in the Operator's Guide;
- Damage resulting from removal of parts, improper repairs, service, maintenance, or modification, or use of parts or accessories not manufactured or approved by BRP, which in its reasonable judgment, are either incompatible with Product or adversely affect its operation, performance, or durability, or resulting from repairs done by a person that is not an Authorized Dealer (as described below);
- Damage caused by abuse, misuse, abnormal use, neglect, improper operation or operation of the Product in a manner inconsistent with the recommended operation described in the Operator's Guide;
- Damage resulting from external damage, accident, submersion, water ingestion, fire, theft, vandalism or any act of God;
- Operation with fuels, oils or lubricants which are not suitable for use with the product (see the Operator's Guide);
- Damage from rust or corrosion (see Corrosion Warranty Statement);
- Damages from cooling system or jet pump blockage by foreign material;
- Damage caused by overheat in the exhaust system resulting from sand or debris;
- Cosmetic or paint changes due to exposure to the elements.
- Incidental or consequential damages, or damages of any kind including without limitation expense for gasoline, expense for transporting Product to and from Dealer, removal of Product from a boat and reinstallation, mechanic's travel time, in-and-out of water charges, slip or dock fees, trailering or towing, storage, telephone, cell phone, fax or telegram charges, rental of a like or replacement Product or boat during warranty services or down time, taxi, travel, lodging, loss of or damage to personal property, inconvenience, cost of insurance coverage, loan payments, loss of time, loss of income, revenue or profits, or loss of enjoyment or use of Product.

4. WARRANTY COVERAGE PERIOD

This limited warranty will be in effect from the date of delivery to the first retail consumer or the date the Product is first put to use, whichever occurs first, for a period of:

1. TWENTY-FOUR (24) CONSECUTIVE MONTHS for private, recreational use.
2. FOUR (4) CONSECUTIVE MONTHS for commercial use.
The Product is used commercially when it is used in connection with generating income or any work or employment during any part of the warranty period. The Product is also used commercially when, at any point during the warranty period, it is installed on a boat that has commercial tags or is licensed for commercial use.

The repair or replacement of parts or the performance of service to under this warranty does not extend the life of this limited warranty beyond its original expiration date.

Note that the duration and any other modalities of the warranty coverage are subject to the applicable national or local legislation in the customer's country.

5. CONDITIONS TO HAVE WARRANTY COVERAGE

This warranty coverage is available **only** if **each** of the following conditions has been fulfilled:

- The Product must be purchased as new and unused by its first owner from a Dealer authorized to distribute the Product in the country in which the sale occurred;
- The BRP specified pre delivery inspection process must be completed and documented by the purchaser and authorized Dealer;
- The Product must have undergone proper registration of Product by an authorized Dealer;
- The Product must be purchased in the country (or in the case of the EEA, union of countries) in which the purchaser resides; and
- Routine maintenance outlined in the operator's guide must be timely performed in order to maintain warranty coverage. BRP reserves the right to make warranty coverage contingent upon proof of proper maintenance.

BRP will not honor this limited warranty to any private use owner or commercial use owner if one of the preceding conditions has not been met. Such limitations are necessary in order to allow BRP to protect the safety of its products, its consumers and the general public.

6. WHAT TO DO TO OBTAIN WARRANTY COVERAGE

The customer must cease using the Product upon the appearance of an anomaly. The customer must notify an authorized Dealer within two (2) months of the appearance of a defect, and provide it with reasonable access to the product and reasonable opportunity to repair it. The customer must also present to the authorized Dealer proof of purchase of the product and must sign the repair/work order prior to starting the repair in order to validate the warranty repair. All parts replaced under this warranty become the property of BRP.

Note that the notification period is subject to the applicable national or local legislation in customer's country.

7. WHAT BRP WILL DO

To the extent permitted by law, BRP's obligations under this warranty are limited to, at its sole discretion, repairing parts found defective under normal use, maintenance and service, or replacing such parts without charge for parts and labor, at any authorized distributor/dealer during the warranty coverage period under the conditions described herein. BRP's responsibility is limited to making the required repairs or replacements of parts. No claim of breach of warranty shall be cause for cancellation or rescission of the sale of the Product to the owner. You may have other legal rights which may vary from country to country.

In the event that service is required outside of the country of original sale, or for EEA residents, if service is required outside of the EEA, the owner will bear responsibility for any additional charges due to local practices and conditions, such as, but not limited to, freight, insurance, taxes, license fees, import duties, and any and all other financial charges, including those levied by governments, states, territories and their respective agencies.

BRP reserves the right to improve or modify products from time to time without assuming any obligation to modify products previously manufactured.

8. TRANSFER

If the ownership of a product is transferred during the warranty coverage period, this limited warranty, subject to its terms and conditions, shall also be transferred and be valid for the remaining coverage period provided BRP or an authorized Dealer receives a proof that the former owner agreed to the transfer of ownership, in addition to the coordinates of the new owner.

9. CONSUMER ASSISTANCE

In the event of a controversy or a dispute in connection with this BRP limited warranty, BRP suggests that you try to resolve the issue at the distributorship / dealership level. We recommend discussing the issue with the authorized BRP dealer's service manager or owner.

If the matter still remains unresolved, contact BRP by filling out the customer contact form at www.brp.com or contact BRP by mail at one of the addresses listed under the *CONTACT US* section of this guide.

ADDITIONAL TERMS AND CONDITIONS FOR FRANCE ONLY

The following terms and conditions are applicable to products sold in France only:

The seller shall deliver goods that are complying with the contract and shall be responsible for defects existing upon delivery. The seller shall also be responsible for defects resulting from packaging, assembling instructions or the installation when it is its responsibility per the contract or if accomplished under its responsibility. To be compliant with the contract, the good shall:

1. Be fit for normal use for goods similar thereto and, if applicable:
 - Correspond to the description provided by the seller and have the qualities presented to the buyer through sample or model;
 - Have the qualities that a buyer may legitimately expect considering the public declarations of the seller, the manufacturer of its representative, including in advertising or labeling; or
2. Have the characteristics mutually agreed upon as between the parties or be fit for the specific use intended by the buyer and brought to the attention of the seller and which accepted.

The action for failure to comply is prescribed after two years after delivery of the goods. The seller is responsible for the warranty for hidden defects of the goods sold if such hidden defects are rendering the good unfit for the intended use, or if they diminish its use in such a way that the buyer would not have acquired the good or would have given a lesser price, had he known. The action for such hidden defects shall be taken by the buyer within 2 years of the discovery of the defect.

CUSTOMER INFORMATION

CUSTOMER INFORMATION

DATA PRIVACY INFORMATION

Bombardier Recreational Products Inc., its affiliates and subsidiaries (“BRP”) is committed to protecting your privacy and support a general policy of openness about how we collect, use and disclose your personal information in the course of managing our relationship with you. **More details can be found by visiting BRP’s Privacy Policy at:**

<https://brp.com/en/privacy-policy.html> or by scanning the QR Code below.

Please be assured that we have appropriate security measures in place to ensure that your personal information is protected against loss and unauthorized access.

Your personal information that may be collected by BRP, directly from you or from authorized dealers or authorized third parties, includes:

- **Contact, Demographic & Registration Information** (e.g., name, full address, phone number, email, gender, ownership history, language of communication)
- **Vehicle Information** (e.g., serial number, purchase and delivery date, unit usage, vehicle location and movements)
- **Third Party Information** (e.g., information received from BRP partners, joint marketing activities information, social media)
- **Technological Information** (e.g., IP address, type of device, operating system, browser type, webpages you view, cookies and similar technologies when you use BRP or dealers’ websites or mobile application)
- **Interaction with BRP Information** (e.g., information collected when you call BRP’s in-house sales representatives, buy items on a BRP website, sign up for BRP emails, participate in BRP-sponsored contests and sweepstakes or attend BRP-sponsored events)
- **Transactional Information** (e.g., information necessary to handle returns, payment information when you purchase our products or services through our websites or mobile applications and other issues related to your purchase of BRP products)

This information may be used and processed for the following purposes:

- Safety & Security
- Customer Support for Sales and After Sales (e.g., complete or follow up with you about your purchase or maintenance)
- Registration & Warranty
- Communication (e.g., sending you a BRP satisfaction survey)
- Online Behavioural Advertising, Profiling and Location-Based Services (e.g., offer customized experience)
- Compliance & Dispute Resolution
- Marketing & Advertising
- Assistance (e.g., help with any delivery issues, handle returns, and other issues related to your purchase of BRP products).

We also may use personal information to generate aggregated or statistical data that no longer identifies you personally.

Your personal information may be disclosed to the following: BRP, BRP’s authorized dealerships, distributors, service providers, advertising and market research partners and other authorized third parties.

We may receive information about you from diverse sources, including third parties, such as BRP's authorized dealerships and partners, with whom we offer services or engage in joint-marketing activities. We may also receive information about you from social media platforms when you interact with us on those platforms.

Depending on the circumstances, your personal information may be communicated outside the region where you reside. Your personal information is retained only for as long as necessary for the purpose for which we obtained it and according to our retention policies.

To exercise your data privacy rights (e.g. right of access, right of rectification), to withdraw your consent in order to be removed from the address list for marketing purposes or for the satisfaction survey or for general data privacy questions, please contact BRP's Data Protection Officer at or by mail at **privacyofficer@brp.com** or by mail at: BRP Legal Service, 726 St-Joseph, Valcourt, Quebec, Canada, J0E 2L0.

When BRP processes your personal information, they do so in compliance with its Privacy Policy available at: <https://www.brp.com/en/privacy-policy.html> or by using the following QR Code.



CUSTOMER INFORMATION

CONTACT US

www.brp.com

Asia Pacific

BRP Asia

107D and 107E, 17/F, Tower 1,
Grand Century Place, Mongkok,
Kowloon, Hong Kong

Australia

Level 26
477 Pitt Street
Sydney, NSW 2020

China

上海市徐汇区衡山路10号6号楼301
Rm 301, Building 6,
No.10 Heng Shan Rd,
Shanghai, China

Japan

21F Shinagawa East One Tower
2-16-1 Konan, Minato-ku-ku,
Tokyo 108-0075

New Zealand

Suite 1.6, 2-8 Osborne Street,
Newmarket, Auckland 2013

Europe, Middle East and Africa

Belgium

Oktrooiplein 1
9000 Gent

Czech Republic

Stefanikova 43a
Prague 5
150 00

Germany

Itterpark 11
40724 Hilden

Finland

Isoaavantie 7
PL 8040
96101 Rovaniemi

France

Arteparc Bâtiment B
Route de la côte d'Azur,
13 590 Meyreuil

Norway

Ingvald Ystgaardsvei 15
N-7484 Trondheim
Salg, marketing, ettermarked

Sweden

Spinnvägen 15
903 61 Umeå
Sweden 90821

Switzerland

Avenue d'Ouchy 4-6
1006 Lausanne

Latin America

Brazil

Av. James Clerck Maxwell, 230
Campinas, Sao Paulo
CEP 13069-380

Mexico

Av. Ferrocarril 202
Parque Industrial Querétaro
Santo Rosa Jauregui, Querétaro
C.P. 76220

North America

Canada

3200A, rue King Ouest,
Suite 300
Sherbrooke (Québec) J1L 1C9

United States of America

10101 Science Drive
Sturtevant, Wisconsin
53177

CUSTOMER INFORMATION

CHANGE OF ADDRESS/OWNERSHIP

If your address has changed or if you are the new owner of the boat, be sure to notify BRP by either:

- Notifying an authorized dealer.
- **North America Only:** calling at 1-844-345-4BRP (4277).
- Mailing one of the change of address cards on the following pages at one of the BRP addresses indicated in the *Contact Us* section of this guide.

In case of change of ownership, please join a proof that the former owner agreed to the transfer.

Notifying BRP, even after the expiration of the limited warranty, is very important as it enables BRP to reach the boat owner if necessary, like when safety recalls are initiated. It is the owner's responsibility to notify BRP.

STOLEN UNITS: In the event that your boat is stolen, you should notify your area's distributor warranty department of such. We will ask you to provide your name, address, phone number, Hull Identification Number and date it was stolen.

CHANGE OF ADDRESS CHANGE OF OWNERSHIP 

VEHICLE IDENTIFICATION NUMBER

--	--	--	--	--	--	--	--	--	--	--	--	--	--	--	--	--	--	--	--	--

Model Number Vehicle Identification Number (V.I.N.)

OLD ADDRESS OR PREVIOUS OWNER: _____ NAME _____

NO. _____ STREET _____ APT _____

CITY _____ STATE/PROVINCE _____ ZIP/POSTAL CODE _____

COUNTRY _____ TELEPHONE _____

NEW ADDRESS OR NEW OWNER: _____ NAME _____

NO. _____ STREET _____ APT _____

CITY _____ STATE/PROVINCE _____ ZIP/POSTAL CODE _____

COUNTRY _____ TELEPHONE _____

E-MAIL ADDRESS _____

CHANGE OF ADDRESS CHANGE OF OWNERSHIP 

VEHICLE IDENTIFICATION NUMBER

--	--	--	--	--	--	--	--	--	--	--	--	--	--	--	--	--	--	--	--	--

Model Number Vehicle Identification Number (V.I.N.)

OLD ADDRESS OR PREVIOUS OWNER: _____ NAME _____

NO. _____ STREET _____ APT _____

CITY _____ STATE/PROVINCE _____ ZIP/POSTAL CODE _____

COUNTRY _____ TELEPHONE _____

NEW ADDRESS OR NEW OWNER: _____ NAME _____

NO. _____ STREET _____ APT _____

CITY _____ STATE/PROVINCE _____ ZIP/POSTAL CODE _____

COUNTRY _____ TELEPHONE _____

E-MAIL ADDRESS _____

This page is
intentionally blank

CHANGE OF ADDRESS

CHANGE OF OWNERSHIP



VEHICLE IDENTIFICATION NUMBER

--	--	--	--	--	--	--	--	--	--	--	--	--	--	--	--	--	--	--	--	--	--	--	--	--	--	--	--	--	--	--	--	--	--	--	--	--	--	--	--	--	--	--	--

Model Number

Vehicle Identification Number (V.I.N.)

OLD ADDRESS
OR PREVIOUS OWNER:

NAME

NO.

STREET

APT

CITY

STATE/PROVINCE

ZIP/POSTAL CODE

COUNTRY

TELEPHONE

NEW ADDRESS
OR NEW OWNER:

NAME

NO.

STREET

APT

CITY

STATE/PROVINCE

ZIP/POSTAL CODE

COUNTRY

TELEPHONE

E-MAIL ADDRESS

CHANGE OF ADDRESS

CHANGE OF OWNERSHIP



VEHICLE IDENTIFICATION NUMBER

--	--	--	--	--	--	--	--	--	--	--	--	--	--	--	--	--	--	--	--	--	--	--	--	--	--	--	--	--	--	--	--	--	--	--	--	--	--	--	--	--	--	--	--	--	--	--	--

Model Number

Vehicle Identification Number (V.I.N.)

OLD ADDRESS
OR PREVIOUS OWNER:

NAME

NO.

STREET

APT

CITY

STATE/PROVINCE

ZIP/POSTAL CODE

COUNTRY

TELEPHONE

NEW ADDRESS
OR NEW OWNER:

NAME

NO.

STREET

APT

CITY

STATE/PROVINCE

ZIP/POSTAL CODE

COUNTRY

TELEPHONE

E-MAIL ADDRESS

This page is
intentionally blank

NOTE: _____

NOTE: _____

NOTE: _____

WATERCRAFT

Model No. _____

HULL

Identification Number (H.I.N.) _____

ENGINE

Identification Number (E.I.N.) _____

OWNER: _____

NAME

No.

STREET

APT

CITY

STATE/PROVINCE

ZIP/POSTAL CODE

Purchase Date

YEAR	MONTH	DAY

Warranty Expiry Date

YEAR	MONTH	DAY

To be completed by the authorized dealer at the time of the sale.

DEALER IMPRINT AREA

This page is intentionally blank

www.brp.com



SKI-DOO®
LYNX®

SEA-DOO®
ROTAX®
ALUMACRAFT®

CAN-AM®
MANITOU®